



MET Laboratories, Inc. *Safety Certification - EMI - Telecom Environmental Simulation*

914 WEST PATAPSCO AVENUE • BALTIMORE, MARYLAND 21230-3432 • PHONE (410) 354-3300 • FAX (410) 354-3313
33439 WESTERN AVENUE • UNION CITY, CALIFORNIA 94587 • PHONE (510) 489-6300 • FAX (510) 489-6372
3162 BELICK STREET • SANTA CLARA, CALIFORNIA 95054 • PHONE (408) 748-3585 • FAX (510) 489-6372
13501 MCCALLEN PASS • AUSTIN, TX 78753 • PHONE (512) 287-2500 • FAX (512) 287-2513

September 15, 2016

ARRIS Group, Inc.
101 Tournament Drive
Horsham, Pennsylvania, 19044

Dear Chris Rubis,

Enclosed is the EMC Wireless test report for compliance testing of the ARRIS Group, Inc., VAP3400 & VAP3402 as tested to the requirements of Title 47 of the CFR, Ch. 1 (10-1-06 ed.), Title 47 of the CFR, Part 15.407, Subpart E (UNII 2) DFS Requirements.

Thank you for using the services of MET Laboratories, Inc. If you have any questions regarding these results or if MET can be of further service to you, please feel free to contact me.

Sincerely yours,
MET LABORATORIES, INC.

Jennifer Warnell
Documentation Department

Reference: (\ARRIS Group, Inc.\EMCS89412B-DFS Rev. 2)

Certificates and reports shall not be reproduced except in full, without the written permission of MET Laboratories, Inc.



MET Laboratories, Inc. *Safety Certification - EMI - Telecom Environmental Simulation*

914 WEST PATAPSCO AVENUE • BALTIMORE, MARYLAND 21230-3432 • PHONE (410) 354-3300 • FAX (410) 354-3313

33439 WESTERN AVENUE • UNION CITY, CALIFORNIA 94587 • PHONE (510) 489-6300 • FAX (510) 489-6372

3162 BELICK STREET • SANTA CLARA, CALIFORNIA 95054 • PHONE (408) 748-3585 • FAX (510) 489-6372

13501 MCCALLEN PASS • AUSTIN, TX 78753 • PHONE (512) 287-2500 • FAX (512) 287-2513

**Electromagnetic Compatibility Criteria
Test Report**

for the

**ARRIS Group, Inc.
Model VAP3400 & VAP3402**

Tested under
the FCC Certification Rules
contained in
Title 47 of the CFR
15.407 Subpart E

MET Report: EMCS89412B-DFS Rev. 2

September 15, 2016

Prepared For:

**ARRIS Group, Inc.
101 Tournament Drive
Horsham, Pennsylvania, 19044**

Prepared By:
MET Laboratories, Inc.
914 W. Patapsco Ave.
Baltimore, MD 21230

Electromagnetic Compatibility Criteria Test Report

for the

ARRIS Group, Inc.
Model VAP3400 & VAP3402

Tested under
The FCC Certification Rules
contained in
Title 47 of the CFR
15.407 Subpart E



Ajaz Khan, Project Engineer
Electromagnetic Compatibility Lab

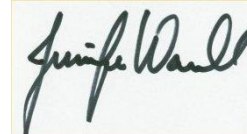

Jennifer Warnell
Documentation Department

Engineering Statement: The measurements shown in this report were made in accordance with the procedures indicated, and the emissions from this equipment were found to be within the limits applicable. I assume full responsibility for the accuracy and completeness of these measurements, and for the qualifications of all persons taking them. It is further stated that upon the basis of the measurements made, the equipment tested is capable of operation in accordance with the requirements of 15.407 of the FCC Rules under normal use and maintenance.



Asad Bajwa,
Director, Electromagnetic Compatibility Lab

Report Status Sheet

Revision	Report Date	Reason for Revision
∅	June 8, 2016	Initial Issue.
1	July 6, 2016	Customer corrections.
2	September 15, 2016	Updated channel closing time plots.

Table of Contents

I.	Executive Summary	1
	A. Purpose of Test	2
	B. Executive Summary	2
II.	Equipment Configuration	3
	A. Overview.....	4
	B. References.....	5
	C. Test Site	5
	D. Description of Test Sample.....	5
	E. Equipment Configuration.....	6
	F. Support Equipment	7
	G. Ports and Cabling Information.....	7
	H. Mode of Operation.....	7
	I. Method of Monitoring EUT Operation	8
	J. Modifications	8
	a) Modifications to EUT.....	8
	b) Modifications to Test Standard.....	8
	K. Disposition of EUT	8
III.	DFS Requirements and Radar Waveform Description & Calibration	9
	A. DFS Requirements	10
	B. Radar Test Waveforms	12
	C. Radar Waveform Calibration	17
IV.	DFS Test Procedure and Test Results	27
	A. DFS Test Setup	28
	B. UNII Detection Bandwidth	29
	C. Channel Availability Check Time.....	30
	D. In-Service Monitoring for Channel Move Time, Channel Closing Time, and Non-Occupancy.....	31
	E. Statistical Performance Check	34
V.	Test Equipment	35
VI.	Certification & User’s Manual Information	37
	A. Certification Information	38
	B. Label and User’s Manual Information	42

List of Tables

Table 1. Executive Summary of EMC Part 15.407 Compliance Testing	2
Table 2. EUT Summary.....	4
Table 3. References	5
Table 4. Equipment Configuration	6
Table 5. Support Equipment.....	7
Table 6. Ports and Cabling Information	7
Table 7. Applicability of DFS Requirements Prior to Use of a Channel.....	10
Table 8. Applicability of DFS Requirements During Normal Operation	10
Table 9. DFS Detection Thresholds for Master or Client Devices Incorporating DFS	11
Table 10. DFS Response Requirement Values.....	11
Table 11. Pulse Repetition Intervals Values for Test A	13
Table 12. Test Equipment List	36

List of Figures

Figure 1. Block Diagram of Test Configuration.....	6
Figure 2. Long Pulse Radar Test Signal Waveform.....	15
Figure 3. Radiated DFS Calibration Block Diagram.....	17
Figure 4. Test Setup Diagram.....	28

List of Photographs

Photograph 1. DFS Radar Test Signal Generator.....	17
Photograph 2. DFS Test Setup	28

List of Plots

Plot 1. DFS Calibration, Radar Type 0, 5500 MHz.....	18
Plot 2. DFS Calibration, Radar Type 1, 5500 MHz.....	18
Plot 3. DFS Calibration, Radar Type 2, 5500 MHz.....	18
Plot 4. DFS Calibration, Radar Type 3, 5500 MHz.....	19
Plot 5. DFS Calibration, Radar Type 4, 5500 MHz.....	19
Plot 6. DFS Calibration, Radar Type 5, 5500 MHz.....	19
Plot 7. DFS Calibration, Radar Type 6, 5500 MHz.....	20
Plot 8. DFS Calibration, Radar Type 0, 5510 MHz.....	21
Plot 9. DFS Calibration, Radar Type 1, 5510 MHz.....	21
Plot 10. DFS Calibration, Radar Type 2, 5510 MHz.....	21
Plot 11. DFS Calibration, Radar Type 3, 5510 MHz.....	22
Plot 12. DFS Calibration, Radar Type 4, 5510 MHz.....	22
Plot 13. DFS Calibration, Radar Type 5, 5510 MHz.....	22
Plot 14. DFS Calibration, Radar Type 6, 5510 MHz.....	23
Plot 15. DFS Calibration, Radar Type 0, 5530 MHz.....	24
Plot 16. DFS Calibration, Radar Type 1, 5530 MHz.....	24
Plot 17. DFS Calibration, Radar Type 2, 5530 MHz.....	24
Plot 18. DFS Calibration, Radar Type 3, 5530 MHz.....	25
Plot 19. DFS Calibration, Radar Type 4, 5530 MHz.....	25
Plot 20. DFS Calibration, Radar Type 5, 5530 MHz.....	25
Plot 21. DFS Calibration, Radar Type 6, 5530 MHz.....	26
Plot 22. DFS Channel Closing Transmission, Time Aggregate, 80 MHz, Channel 106	32
Plot 24. DFS Channel Move Time, 500ms, 80 MHz, Channel 106	32
Plot 25. DFS Channel Move Time, 15s, 80 MHz, Channel 106	32
Plot 25. DFS Channel Move Time, 5s, 80 MHz, Channel 106	33
Plot 26. Non-Occupancy, 80 MHz, Channel 100	33

List of Terms and Abbreviations

AC	Alternating Current
ACF	Antenna Correction Factor
Cal	Calibration
<i>d</i>	Measurement Distance
dB	Decibels
dB μ A	Decibels above one microamp
dB μ V	Decibels above one microvolt
dB μ A/m	Decibels above one microamp per meter
dB μ V/m	Decibels above one microvolt per meter
DC	Direct Current
E	Electric Field
DSL	Digital Subscriber Line
ESD	Electrostatic Discharge
EUT	Equipment Under Test
<i>f</i>	Frequency
FCC	Federal Communications Commission
GRP	Ground Reference Plane
H	Magnetic Field
HCP	Horizontal Coupling Plane
Hz	Hertz
IEC	International Electrotechnical Commission
kHz	kilohertz
kPa	kilopascal
kV	kilovolt
LISN	Line Impedance Stabilization Network
MHz	Megahertz
μ H	microhenry
μ	microfarad
μ s	microseconds
PRF	Pulse Repetition Frequency
RF	Radio Frequency
RMS	Root-Mean-Square
TWT	Traveling Wave Tube
V/m	Volts per meter
VCP	Vertical Coupling Plane

I. Executive Summary

A. Purpose of Test

An EMC evaluation was performed to determine compliance of the ARRIS Group, Inc. VAP3400 & VAP3402, with the requirements of Part 15, §15.407. All references are to the most current version of Title 47 of the Code of Federal Regulations in effect. In accordance with §2.1033, the following data is presented in support of the Certification of the VAP3400 & VAP3402. ARRIS Group, Inc. should retain a copy of this document which should be kept on file for at least two years after the manufacturing of the VAP3400 & VAP3402, has been **permanently** discontinued.

B. Executive Summary

The following tests were conducted on a sample of the equipment for the purpose of demonstrating compliance with Part 15, §15.407, in accordance with ARRIS Group, Inc., purchase order number AR1080668. All tests were conducted using measurement procedure ANSI C63.4-2014.

FCC Reference	IC Reference	Description	Results
15.407 (h)(2)	RSS-247 (6.3)	DFS Calibration Plots	Compliant
15.407 (h)(2)	RSS-247 (6.3)	U-NII Detection Bandwidth	Not Applicable
15.407(h)(2)(ii)	RSS-247 (6.3)	Channel Availability Check Time	Not Applicable
15.407(h)(2)(ii)	RSS-247 (6.3)	Radar Burst at the Beginning of CACT	Not Applicable
15.407(h)(2)(ii)	RSS-247 (6.3)	Radar Burst at the End of CACT	Not Applicable
15.407(h)(2)(iii)	RSS-247 (6.3)	Channel Move Time and Channel Closing Time	Compliant
15.407(h)(2)(iv)	RSS-247 (6.3)	Non-Occupancy Period	Not Applicable
15.407(h)(2)	RSS-247 (6.3)	Statistical Performance Check	Not Applicable

Table 1. Executive Summary of EMC Part 15.407 Compliance Testing

Note: Device is a Client device without radar detection capability.

II. Equipment Configuration

A. Overview

MET Laboratories, Inc. was contracted by ARRIS Group, Inc. to perform testing on the VAP3400 & VAP3402, under ARRIS Group, Inc.'s purchase order number AR1080668.

This document describes the test setups, test methods, required test equipment, and the test limit criteria used to perform compliance testing of the ARRIS Group, Inc. VAP3400 & VAP3402.

The results obtained relate only to the item(s) tested.

Model(s) Tested:	VAP3400 & VAP3402	
Model(s) Covered:	VAP3400 & VAP3402	
EUT Specifications:	Primary Power: 12 VDC	
	FCC ID: ACQ-VAP3402 IC: 109AS-VAP3402	
	Type of Modulations:	OFDM
	Equipment Code:	NII
Analysis:	The results obtained relate only to the item(s) tested.	
Environmental Test Conditions:	Temperature: 15-35° C	
	Relative Humidity: 30-60%	
	Barometric Pressure: 860-1060 mbar	
Evaluated by:	Ajaz Khan	
Report Date(s):	September 15, 2016	

Table 2. EUT Summary

B. References

CFR 47, Part 15, Subpart E	Unlicensed National Information Infrastructure Devices (UNII)
ANSI C63.4:2014	Methods and Measurements of Radio-Noise Emissions from Low-Voltage Electrical And Electronic Equipment in the Range of 9 kHz to 40 GHz
ISO/IEC 17025:2005	General Requirements for the Competence of Testing and Calibration Laboratories
ANSI C63.10-2013	American National Standard for Testing Unlicensed Wireless Devices
789033 D02 General UNII Test Procedures New Rules v01	Guidelines for Compliance Testing of Unlicensed National Information Infrastructure (U-NII) Devices Part 15, Subpart E
905462 DO2 UNII DFS Compliance Procedures New Rules v01r02	Compliance Measurement Procedures for Unlicensed-National Information Infrastructure Devices Operating in the 5250-5350 MHz and 5470-5725 MHz Bands Incorporating Dynamic Frequency Selection

Table 3. References

C. Test Site

All testing was performed at MET Laboratories, Inc., 3162 Belick St., Santa Clara, CA 95054. All equipment used in making physical determinations is accurate and bears recent traceability to the National Institute of Standards and Technology.

Radiated Emissions measurements were performed in a 10 meter semi-anechoic chamber (equivalent to an Open Area Test Site). In accordance with §2.948(a)(3), a complete site description is contained at MET Laboratories.

D. Description of Test Sample

The ARRIS Group, Inc. VAP3400 & VAP3402, Equipment Under Test (EUT), is an 802.11ac based video bridge product designed to operate inside residences and businesses. It includes a 10/100/1000BaseT Ethernet port and a 4x4 5 GHz RF Wi-Fi port. It includes a web GUI for configuration and status and a remote management application based on the TR-069 standard.

- VAP3400 802.11ac 1 Gigabit Ethernet Port Video Access Point (Dongle)
- VAP3400 802.11ac 1 Gigabit Ethernet Port AP (dongle) and CLIENT (dongle) as a pair
- VAP3402 802.11ac 2 Gigabit Ethernet Ports Video Access Point (Dongle)

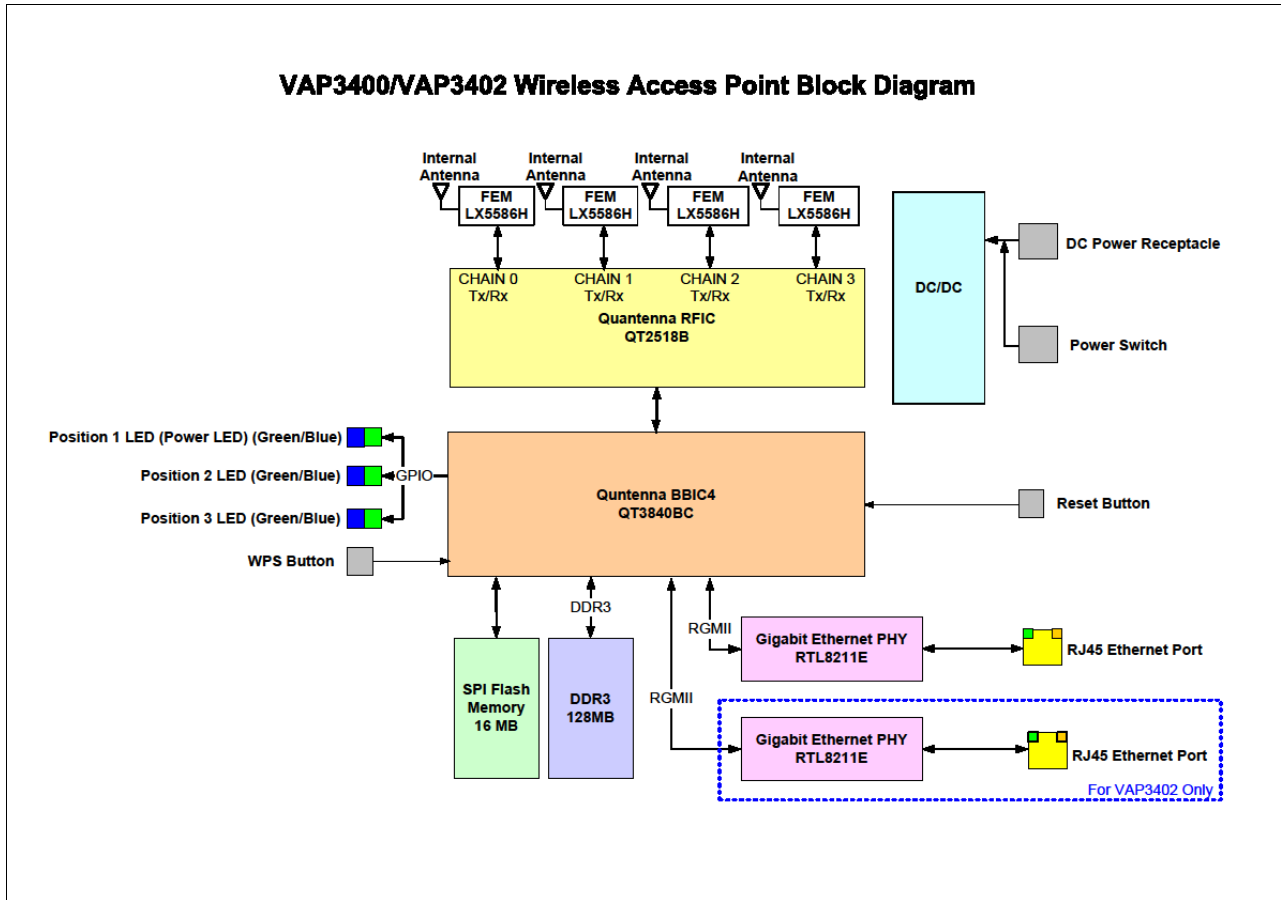

Figure 1. Block Diagram of Test Configuration

E. Equipment Configuration

The EUT was set up as outlined in Figure 1, Block Diagram of Test Setup. All cards, racks, etc., incorporated as part of the EUT is included in the following list.

Name / Description	Model Number	Part Number	Serial Number	Revision
VAP	3400	595594-001	M91547S0554	--
VAP	3400	595594-001	M91547S054T	--
VAP	3402	595595-001	M91602SA03YX	--
VAP	3402	595595-001	M91602SA0568	--

Table 4. Equipment Configuration

F. Support Equipment

Support equipment necessary for the operation and testing of the EUT is included in the following list.

Ref. ID	Name / Description	Manufacturer	Model Number
--	Lap Top	HP	--
--	Lap Top	Lenovo	--
--	AC Adapter	APD	WA-12M12FU
--	AC Adapter	NetBit	NBS12E120100VU

Table 5. Support Equipment

G. Ports and Cabling Information

Ref. ID	Port Name on EUT	Cable Description	Qty.	Length (m)	Shielded (Y/N)	Termination Point
1	Ethernet	CAT5e	1	5	No	--
2	Ethernet	CAT5e	1	5	No	--

Table 6. Ports and Cabling Information

H. Mode of Operation

The VAP340n will automatically configure itself as either an AP or a STA as part of its power-on and initialization process.

AP mode:

The VAP340n will bridge IP packets from a source through the Ethernet port and then out the RF WiFi interface. In order to operate as an AP it must be connected via Ethernet to a router/gateway or other device that supports DHCP.

STA mode:

The VAP340n will bridge IP packets from a source through the RF Wi-Fi interface and then out the Ethernet port. In order to operate as a STA it must be associated to the AP and the AP must be connected to a DHCP server (router/gateway or other equipment).

The main application for the VAP340N is for the IPTV network operators to be able to use 802.11n wireless connectivity to distribute video within the home. Key benefits of doing so are reduced installation time, easier installation and reduced clutter (no wiring).

The typical home setup will consist of one or more wireless STBs (VIP2200W) that communicates wirelessly with the access point (VAP340N). The AP, in turn, connects to the IPTV network through a residential gateway. There may be other wired STB's present (e.g. VIP2200/ VIP2250) in the LAN. Further, the same VAP340N device can operate as either an AP, when connected to the residential gateway or as a client, when connected to a non-wireless STB.

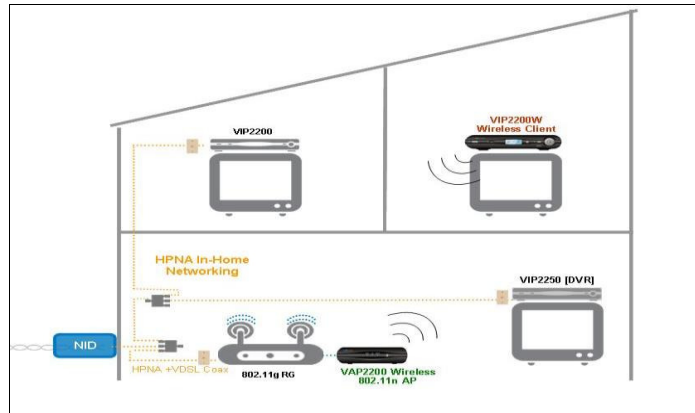

I. Method of Monitoring EUT Operation

Power (Front)
Wireless Signal Quality (Front)
WPS (AP/STA) (Front)
Ethernet Link (rear panel)

The VAP340n's Ethernet port has standard link and traffic LEDs that can be monitored. The Wi-Fi status LED on the front panel indicates the relative signal strength being received by the STA on the other end of the RF link. Green is good, cyan is minimally acceptable, blue is bad.

J. Modifications

a) Modifications to EUT

No modifications were made to the EUT.

b) Modifications to Test Standard

No modifications were made to the test standard.

K. Disposition of EUT

The test sample including all support equipment submitted to the Electro-Magnetic Compatibility Lab for testing was returned to ARRIS Group, Inc. upon completion of testing.

III. DFS Requirements and Radar Waveform Description & Calibration

A. DFS Requirements

Requirement	Operational Mode		
	Master	Client Without Radar Detection	Client With Radar Detection
<i>Non-Occupancy Period</i>	Yes	Not required	Yes
<i>DFS Detection Threshold</i>	Yes	Not required	Yes
<i>Channel Availability Check Time</i>	Yes	Not required	Not required
<i>U-NII Detection Bandwidth</i>	Yes	Not required	Yes

Table 7. Applicability of DFS Requirements Prior to Use of a Channel

Requirement	Operational Mode	
	Master Device or Client with Radar Detection	Client Without Radar Detection
<i>DFS Detection Threshold</i>	Yes	Not required
<i>Channel Closing Transmission Time</i>	Yes	Yes
<i>Channel Move Time</i>	Yes	Yes
<i>U-NII Detection Bandwidth</i>	Yes	Not required
Additional requirements for devices with multiple bandwidth modes	Master Device or Client with Radar Detection	Client Without Radar Detection
<i>U-NII Detection Bandwidth and Statistical Performance Check</i>	All BW modes must be tested	Not required
<i>Channel Move Time and Channel Closing Transmission Time</i>	Test using widest BW mode available	Test using the widest BW mode available for the link
<i>All other tests</i>	Any single BW mode	Not required
Note: Frequencies selected for statistical performance check (Section 7.8.4) should include several frequencies within the radar detection bandwidth and frequencies near the edge of the radar detection bandwidth. For 802.11 devices it is suggested to select frequencies in each of the bonded 20 MHz channels and the channel center frequency.		

Table 8. Applicability of DFS Requirements During Normal Operation

Maximum Transmit Power	Value (See Notes 1, 2, and 3)
EIRP \geq 200 milliwatt	-64 dBm
EIRP < 200 milliwatt and power spectral density < 10 dBm/MHz	-62 dBm
EIRP < 200 milliwatt that do not meet the power spectral density requirement	-64 dBm
<p>Note 1: This is the level at the input of the receiver assuming a 0 dBi receive antenna. Note 2: Throughout these test procedures an additional 1 dB has been added to the amplitude of the test transmission waveforms to account for variations in measurement equipment. This will ensure that the test signal is at or above the detection threshold level to trigger a DFS response. Note 3: EIRP is based on the highest antenna gain. For MIMO devices refer to KDB Publication 662911 D01.</p>	

Table 9. DFS Detection Thresholds for Master or Client Devices Incorporating DFS

Parameter	Value
<i>Non-occupancy period</i>	Minimum 30 minutes
<i>Channel Availability Check Time</i>	60 seconds
<i>Channel Move Time</i>	10 seconds See Note 1.
<i>Channel Closing Transmission Time</i>	200 milliseconds + an aggregate of 60 milliseconds over remaining 10 second period. See Notes 1 and 2.
<i>U-NII Detection Bandwidth</i>	Minimum 100% of the U- NII 99% transmission power bandwidth. See Note 3.
<p>Note 1: <i>Channel Move Time</i> and the <i>Channel Closing Transmission Time</i> should be performed with Radar Type 0. The measurement timing begins at the end of the Radar Type 0 burst. Note 2: The <i>Channel Closing Transmission Time</i> is comprised of 200 milliseconds starting at the beginning of the <i>Channel Move Time</i> plus any additional intermittent control signals required to facilitate a <i>Channel</i> move (an aggregate of 60 milliseconds) during the remainder of the 10 second period. The aggregate duration of control signals will not count quiet periods in between transmissions. Note 3: During the <i>U-NII Detection Bandwidth</i> detection test, radar type 0 should be used. For each frequency step the minimum percentage of detection is 90 percent. Measurements are performed with no data traffic.</p>	

Table 10. DFS Response Requirement Values

B. Radar Test Waveforms

This section provides the parameters for required test waveforms, minimum percentage of successful detections, and the minimum number of trials that must be used for determining DFS conformance. Step intervals of 0.1 microsecond for Pulse Width, 1 microsecond for PRI, 1 MHz for chirp width and 1 for the number of pulses will be utilized for the random determination of specific test waveforms.

Short Pulse Radar Test Waveforms

Radar Type	Pulse Width (μsec)	PRI (μsec)	Number of Pulses	Minimum Percentage of Successful Detection	Minimum Number of Trials
0	1	1428	18	See Note 1	See Note 1
1	1	Test A: 15 unique PRI values randomly selected from the list of 23 PRI values in Table 5a	Roundup $\left\{ \begin{array}{l} \left(\frac{1}{360} \right) \\ \left(\frac{19 \cdot 10^6}{\text{PRI}_{\mu\text{sec}}} \right) \end{array} \right\}$	60%	30
		Test B: 15 unique PRI values randomly selected within the range of 518-3066 μsec, with a minimum increment of 1 μsec, excluding PRI values selected in Test A			
2	1-5	150-230	23-29	60%	30
3	6-10	200-500	16-18	60%	30
4	11-20	200-500	12-16	60%	30
Aggregate (Radar Types 1-4)				80%	120
Note 1: Short Pulse Radar Type 0 should be used for the detection bandwidth test, channel move time, and channel closing time tests.					

A minimum of 30 unique waveforms are required for each of the short pulse radar types 2 through 4. If more than 30 waveforms are used for short pulse radar types 2 through 4, then each additional waveform must also be unique and not repeated from the previous waveforms. If more than 30 waveforms are used for Short Pulse Radar Type 1, then each additional waveform is generated with Test B and must also be unique and not repeated from the previous waveforms in Tests A or B.

Pulse Repetition Frequency Number	Pulse Repetition Frequency (Pulses Per Second)	Pulse Repetition Interval (Microseconds)
1	1930.5	518
2	1858.7	538
3	1792.1	558
4	1730.1	578
5	1672.2	598
6	1618.1	618
7	1567.4	638
8	1519.8	658
9	1474.9	678
10	1432.7	698
11	1392.8	718
12	1355	738
13	1319.3	758
14	1285.3	778
15	1253.1	798
16	1222.5	818
17	1193.3	838
18	1165.6	858
19	1139	878
20	1113.6	898
21	1089.3	918
22	1066.1	938
23	326.2	3066

Table 11. Pulse Repetition Intervals Values for Test A

Long Pulse Radar Test Waveform

Radar Type	Pulse Width (μsec)	Chirp Width (MHz)	PRI (μsec)	Number of Pulses per Bursts	Number of Bursts	Minimum Percentage of Successful Detection	Minimum Trials
5	50-100	5-20	1000-2000	1-3	8-20	80%	30

The parameters for this waveform are randomly chosen. Thirty unique waveforms are required for the Long Pulse radar test signal. If more than 30 waveforms are used for the Long Pulse radar test signal, then each additional waveform must also be unique and not repeated from the previous waveforms.

Each waveform is defined as follows:

- 1) The transmission period for the Long Pulse Radar test signal is 12 seconds.
- 2) There are a total of 8 to 20 Bursts in the 12 second period, with the number of Bursts being randomly chosen. This number is Burst_Count.
- 3) Each Burst consists of 1 to 3 pulses, with the number of pulses being randomly chosen. Each Burst within the 12 second sequence may have a different number of pulses.
- 4) The pulse width is between 50 and 100 microseconds, with the pulse width being randomly chosen. Each pulse within a Burst will have the same pulse width. Pulses in different Bursts may have different pulse widths.
- 5) Each pulse has a linear FM chirp between 5 and 20 MHz, with the chirp width being randomly chosen. Each pulse within a Burst will have the same chirp width. Pulses in different Bursts may have different chirp widths. The chirp is centered on the pulse. For example, with radar frequency of 5300 MHz and a 20 MHz chirped signal, the chirp starts at 5290 MHz and ends at 5310 MHz.
- 6) If more than one pulse is present in a Burst, the time between the pulses will be between 1000 and 2000 microseconds, with the time being randomly chosen. If three pulses are present in a Burst, the time between the first and second pulses is chosen independently of the time between the second and third pulses.
- 7) The 12 second transmission period is divided into even intervals. The number of intervals is equal to Burst_Count. Each interval is of length $(12,000,000 / \text{Burst_Count})$ microseconds. Each interval contains one Burst. The start time for the Burst, relative to the beginning of the interval, is between 1 and $[(12,000,000 / \text{Burst_Count}) - (\text{Total Burst Length}) + (\text{One Random PRI Interval})]$ microseconds, with the start time being randomly chosen. The step interval for the start time is 1 microsecond. The start time for each Burst is chosen independently.

A representative example of a Long Pulse radar test waveform:

- 1) The total test signal length is 12 seconds.
- 2) 8 Bursts are randomly generated for the Burst_Count.
- 3) Burst 1 has 2 randomly generated pulses.
- 4) The pulse width (for both pulses) is randomly selected to be 75 microseconds.
- 5) The PRI is randomly selected to be at 1213 microseconds.
- 6) Bursts 2 through 8 are generated using steps 3 – 5.
- 7) Each Burst is contained in even intervals of 1,500,000 microseconds. The starting location for Pulse 1, Burst 1 is randomly generated (1 to 1,500,000 minus the total Burst 1 length + 1 random PRI interval) at the 325,001 microsecond step. Bursts 2 through 8 randomly fall in successive 1,500,000 microsecond intervals (i.e. Burst 2 falls in the 1,500,001 – 3,000,000 microsecond range).

Long Pulse Radar Test Signal Waveform
12 Second Transmission

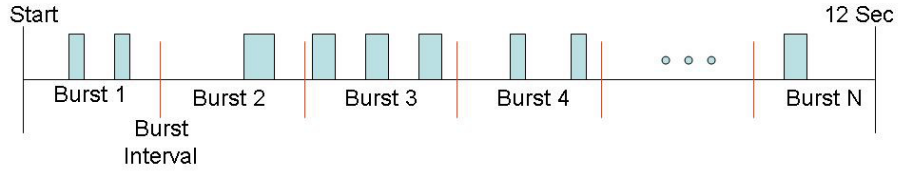

Figure 2. Long Pulse Radar Test Signal Waveform

Frequency Hopping Radar Test Waveform

Radar Type	Pulse Width (μsec)	PRI (μsec)	Pulses per Hop	Hopping Rate (kHz)	Hopping Sequence Length (msec)	Minimum Percentage of Successful Detection	Minimum Trials
6	1	333	9	.333	300	70%	30

For the Frequency Hopping Radar Type, the same *Burst* parameters are used for each waveform. The hopping sequence is different for each waveform and a 100-length segment is selected¹ from the hopping sequence defined by the following algorithm:

The first frequency in a hopping sequence is selected randomly from the group of 475 integer frequencies from 5250 – 5724 MHz. Next, the frequency that was just chosen is removed from the group and a frequency is randomly selected from the remaining 474 frequencies in the group. This process continues until all 475 frequencies are chosen for the set. For selection of a random frequency, the frequencies remaining within the group are always treated as equally likely.

C. Radar Waveform Calibration

The following equipment setup was used to calibrate the radiated Radar Waveform. A signal generator capable of producing all radar pulse types (0-6) was used to generate the required signals. A spectrum analyzer was used to establish the test signal level for each radar type. During this process there were no transmissions by either the Master or Client Device. The spectrum analyzer was switched to the zero span (Time Domain) mode at the frequency of the Radar Waveform generator. Peak detection was utilized. The spectrum analyzer's resolution bandwidth (RBW) was set to 3 MHz and the video bandwidth (VBW) was set to 3 Mhz. The calibration setup is diagrammed in Figure 3, and the radar test signal generator is shown in Photograph 1. Because the device has 6dBi antennas, the radar signal power is increased from -64dbm to -58dbm.

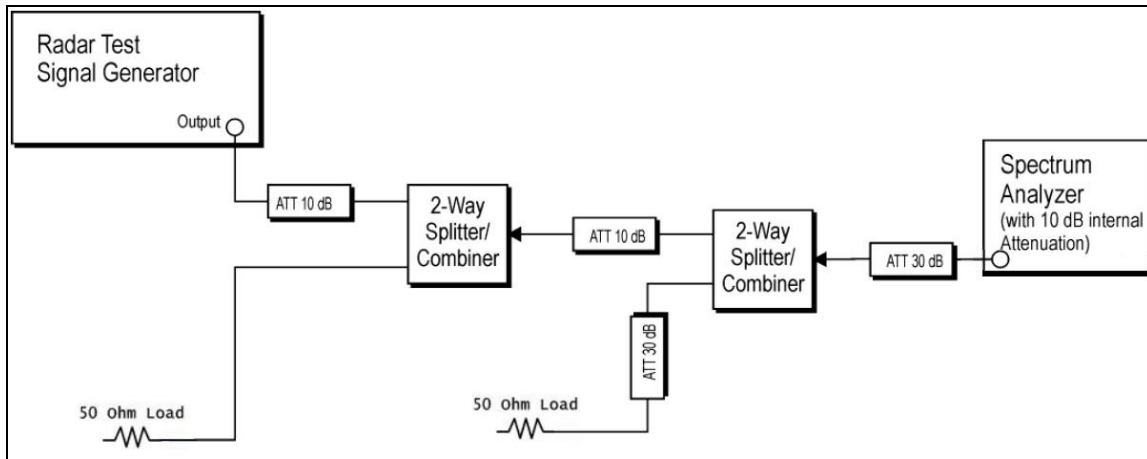
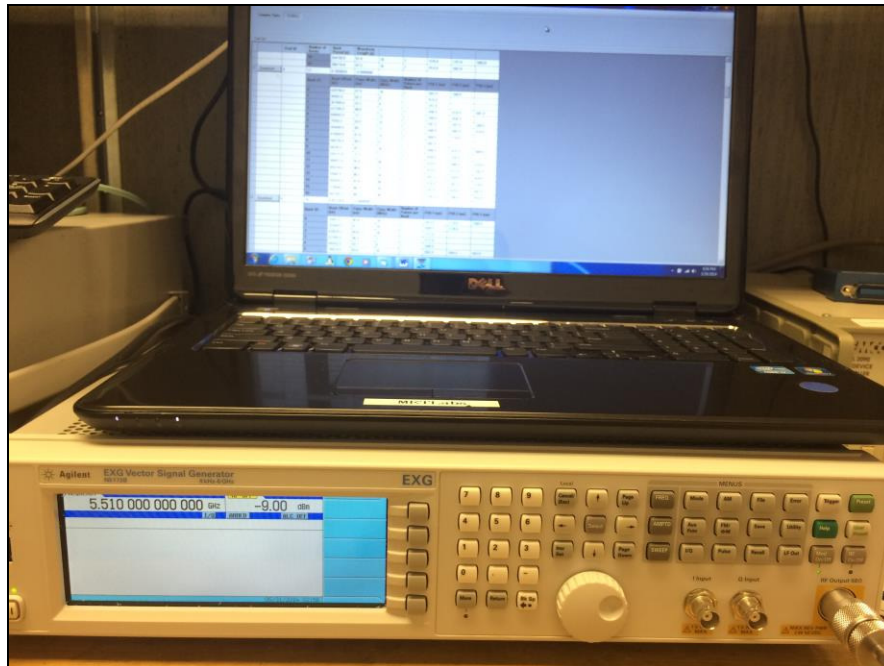
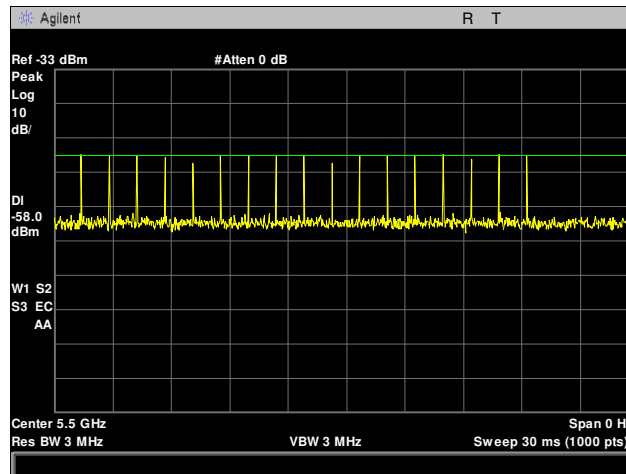

Figure 3. Radiated DFS Calibration Block Diagram



Photograph 1. DFS Radar Test Signal Generator

Radar Waveform Calibration, 5500 MHz



Plot 1. DFS Calibration, Radar Type 0, 5500 MHz

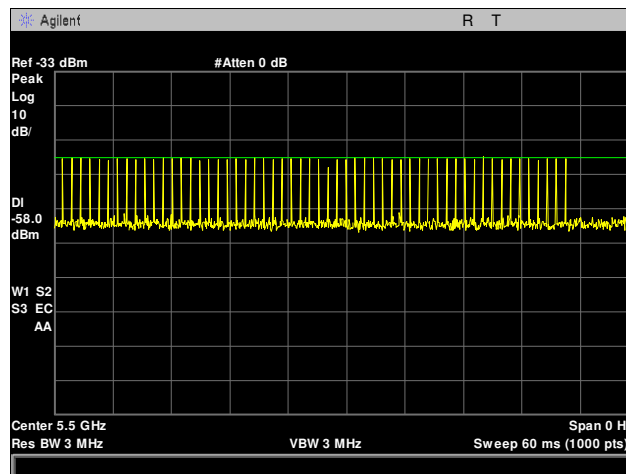

Plot 2. DFS Calibration, Radar Type 1, 5500 MHz

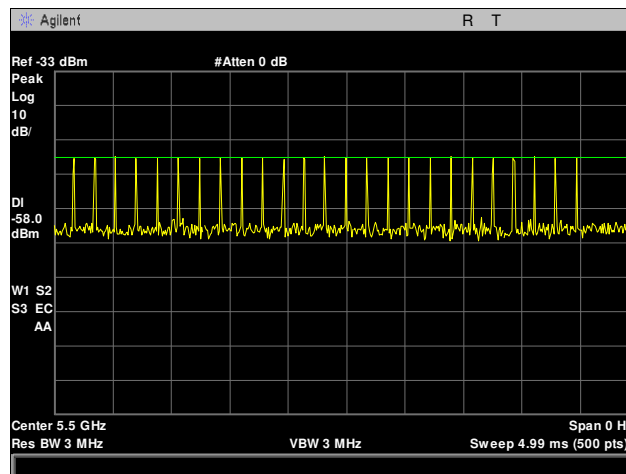

Plot 3. DFS Calibration, Radar Type 2, 5500 MHz

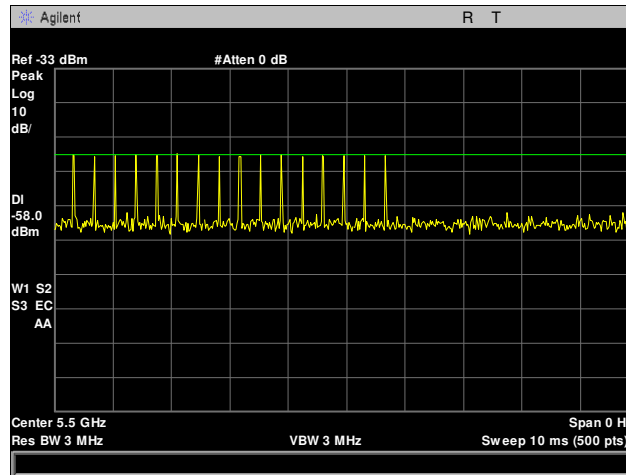

Plot 4. DFS Calibration, Radar Type 3, 5500 MHz

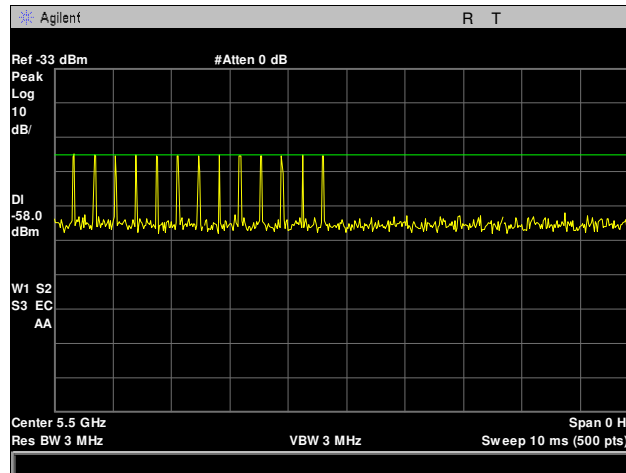

Plot 5. DFS Calibration, Radar Type 4, 5500 MHz

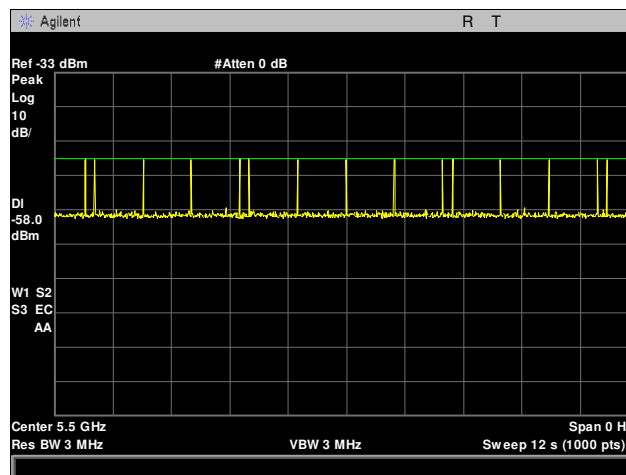

Plot 6. DFS Calibration, Radar Type 5, 5500 MHz

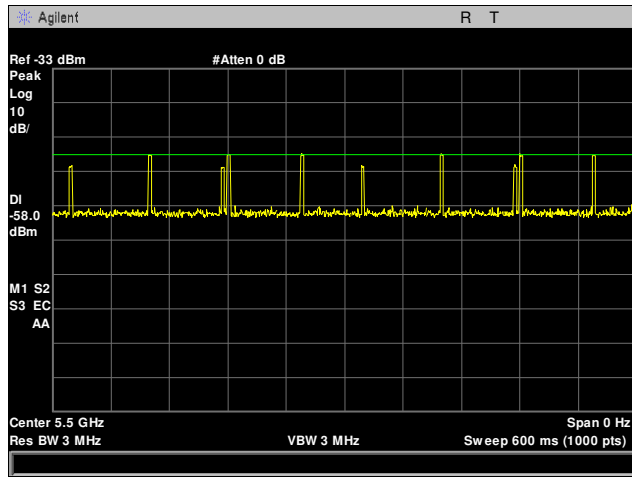

Plot 7. DFS Calibration, Radar Type 6, 5500 MHz

Radar Waveform Calibration, 5510 MHz

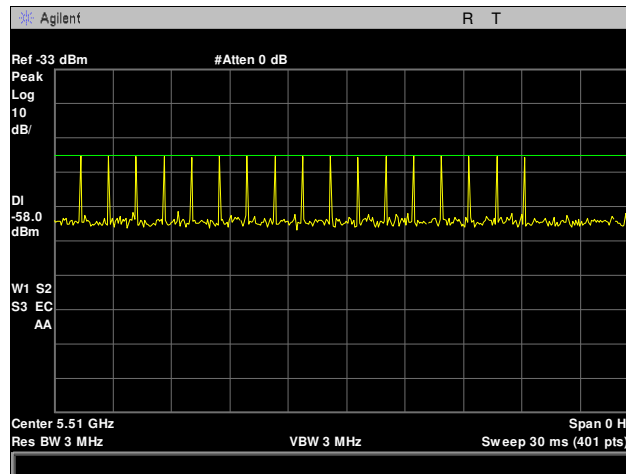

Plot 8. DFS Calibration, Radar Type 0, 5510 MHz

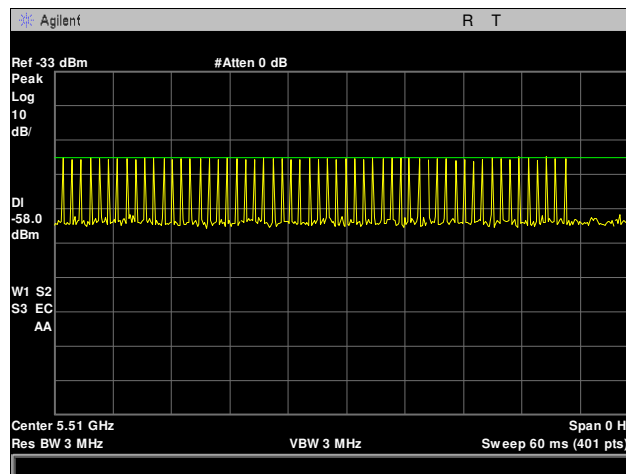

Plot 9. DFS Calibration, Radar Type 1, 5510 MHz

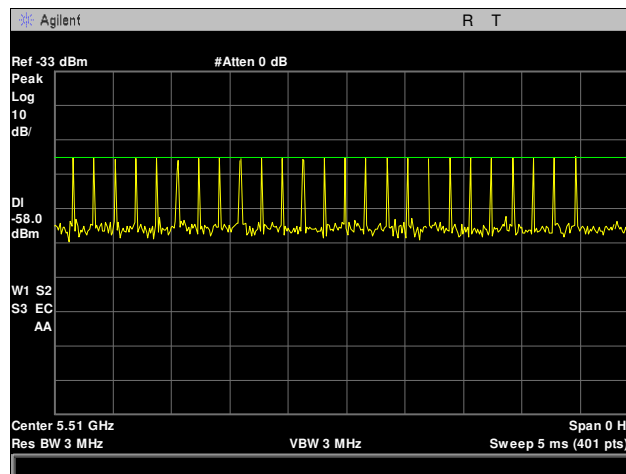

Plot 10. DFS Calibration, Radar Type 2, 5510 MHz

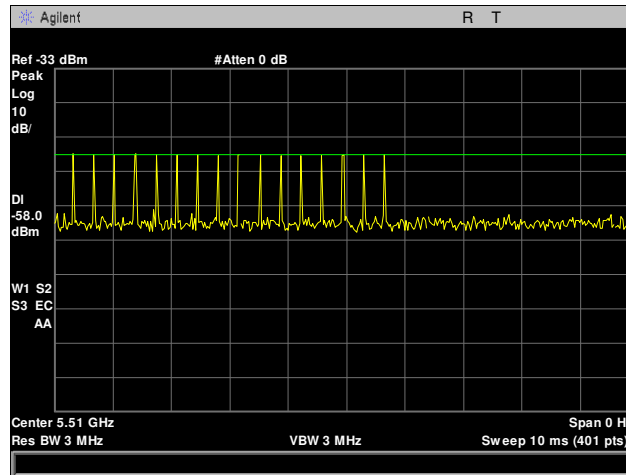

Plot 11. DFS Calibration, Radar Type 3, 5510 MHz

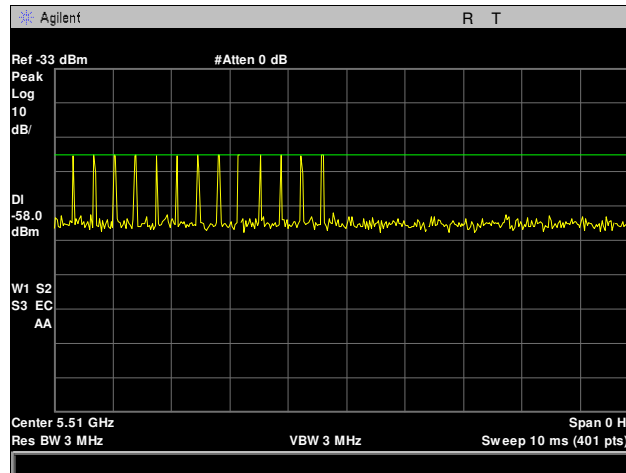

Plot 12. DFS Calibration, Radar Type 4, 5510 MHz

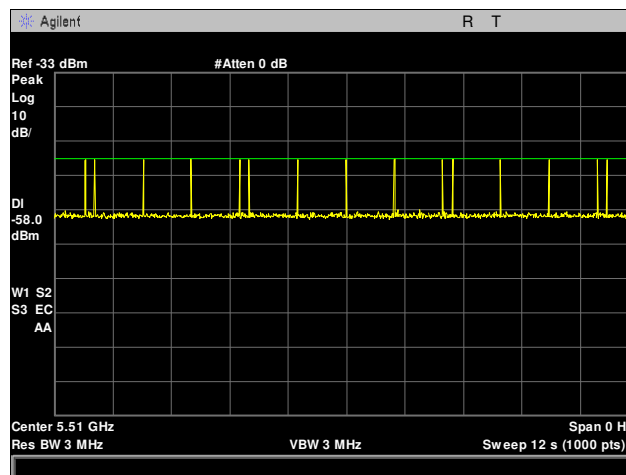

Plot 13. DFS Calibration, Radar Type 5, 5510 MHz

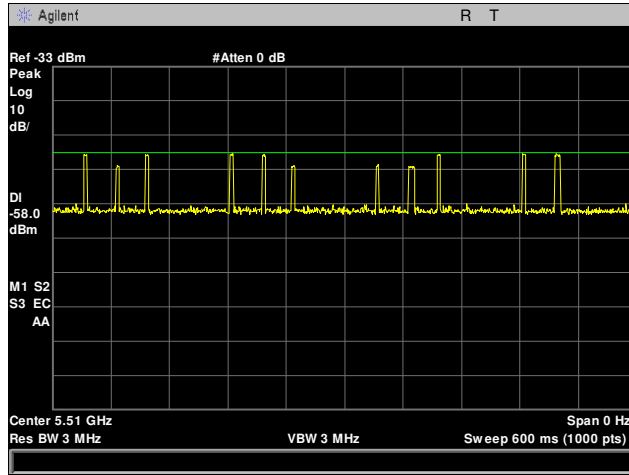

Plot 14. DFS Calibration, Radar Type 6, 5510 MHz

Radar Waveform Calibration, 5530 MHz

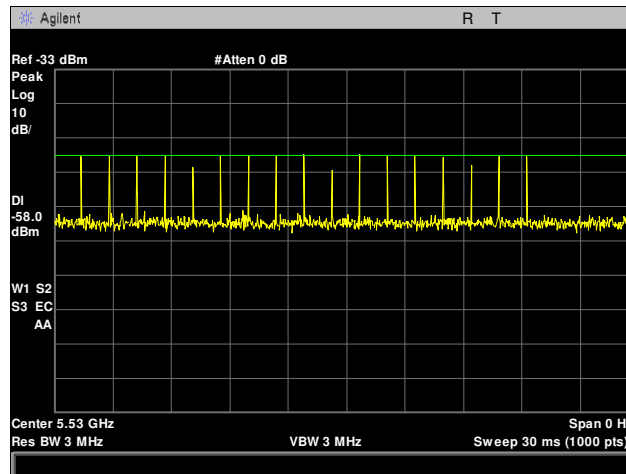

Plot 15. DFS Calibration, Radar Type 0, 5530 MHz

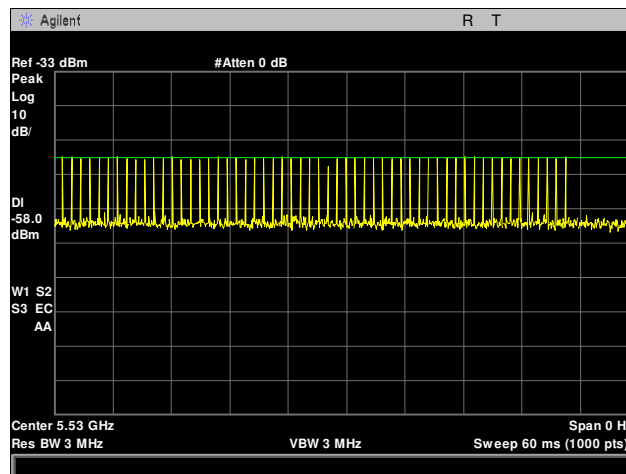

Plot 16. DFS Calibration, Radar Type 1, 5530 MHz

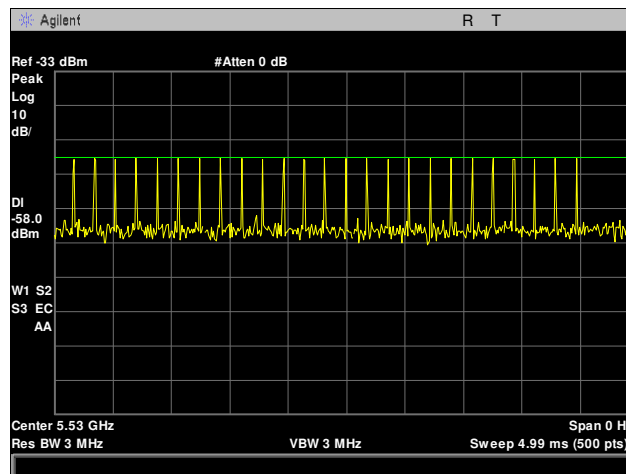

Plot 17. DFS Calibration, Radar Type 2, 5530 MHz

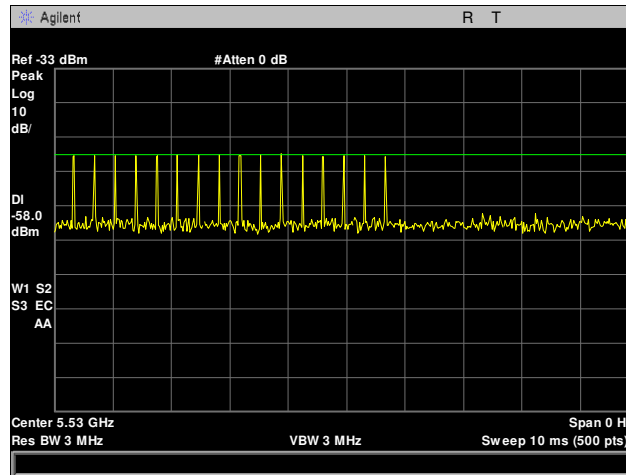

Plot 18. DFS Calibration, Radar Type 3, 5530 MHz

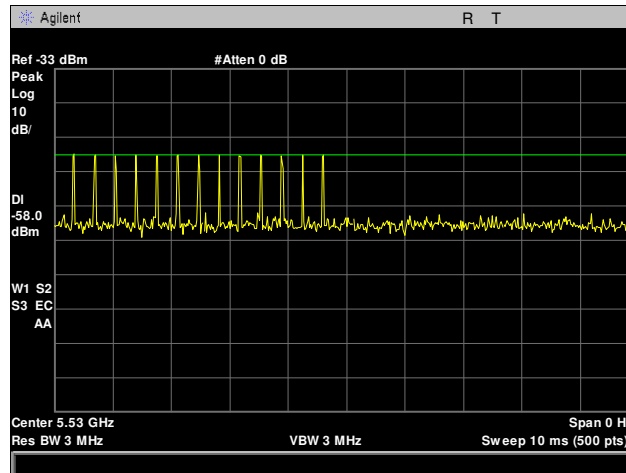

Plot 19. DFS Calibration, Radar Type 4, 5530 MHz

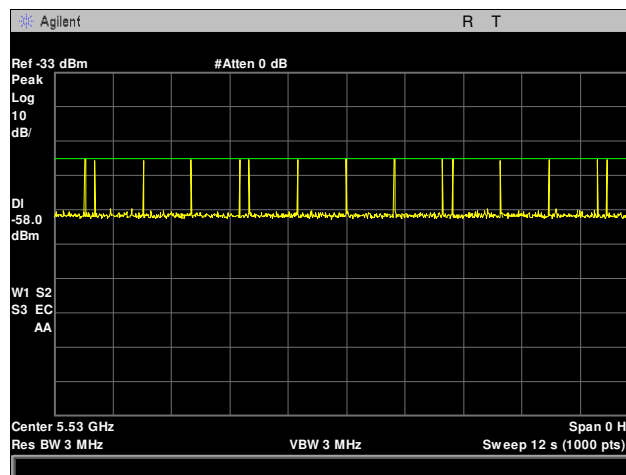

Plot 20. DFS Calibration, Radar Type 5, 5530 MHz

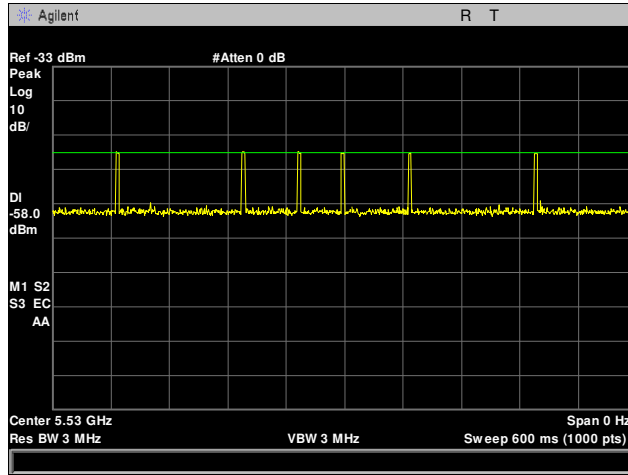

Plot 21. DFS Calibration, Radar Type 6, 5530 MHz

IV. DFS Test Procedure and Test Results

A. DFS Test Setup

1. A spectrum analyzer is used as a monitor to verify that the Unit Under Test (EUT) has vacated the Channel within the Channel Closing Transmission Time and Channel Move Time, and does not transmit on a Channel during the Non-Occupancy Period after the detection and subsequent Channel move. It is also used to monitor EUT transmissions during the Channel Availability Check Time.
2. The test setup, which consists of test equipment and equipment under test (EUT), is diagrammed in Figure 4 and the pictured is Photograph 2.

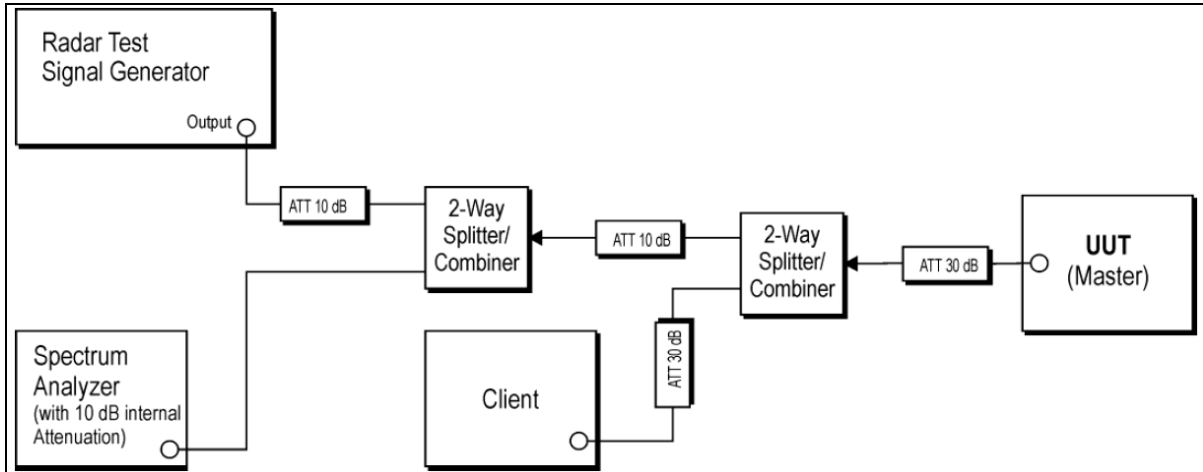
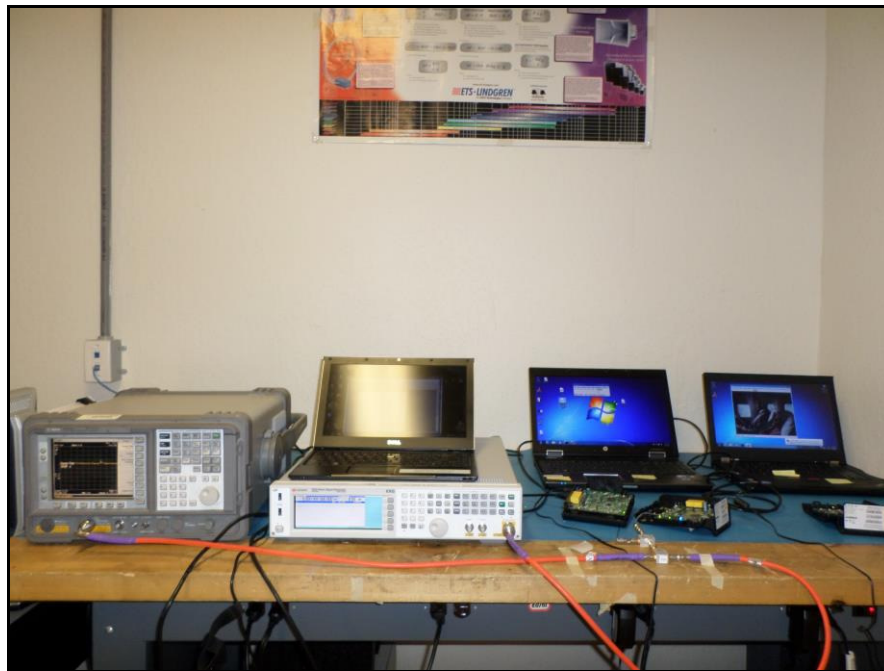

Figure 4. Test Setup Diagram



Photograph 2. DFS Test Setup

B. UNII Detection Bandwidth

Test Requirement(s): KDB 905462 §5.1 All BW modes must be tested.

§15407 A minimum 100% detection rate is required across a EUT's 99% bandwidth.

Test Procedure: The EUT was set up as a standalone device (no associated Client or Master, as appropriate) and no traffic.

A single radar burst of type 0 at the center frequency was generated and the response of the EUT was noted. This was repeated for a minimum of 10 trials. The minimum percentage of detection was 90%, as per the KDB 905462.

Starting at the center frequency of the EUT operating Channel, the radar frequency was increased in 1 MHz steps, repeating the minimum of 10 trials, until the detection rate fell below the U-NII Detection Bandwidth criterion (90%). The highest frequency (denoted as F_H) at which detection was greater or equal than the U-NII Detection Bandwidth criterion (90%) was recorded.

Starting at the center frequency of the EUT operating Channel, the radar frequency was decreased in 1 MHz steps, repeating the minimum of 10 trials, until the detection rate fell below the U-NII Detection Bandwidth criterion (90%). The lowest frequency (denoted as F_L) at which detection was greater or equal than the U-NII Detection Bandwidth criterion (90%) was recorded.

The U-NII Detection Bandwidth was calculated as follow:

$$\text{U-NII Detection Bandwidth} = F_H - F_L$$

Test Results: The EUT was not applicable with the requirements of this section.

C. Channel Availability Check Time

Test Requirements: §15.407(h)(2)(ii) A U-NII device shall check if there is a radar system already operating on the channel before it can initiate a transmission on a channel and when it has to move to a new channel. The U-NII device may start using the channel if no radar signal with a power level greater than the interference threshold values listed in paragraph (h)(2) of this section, is detected within 60 seconds.

Test Procedure: The spectrum analyzer was set to a zero span mode with a 3 MHz RBW and 3 MHz VBW on the test channel with a 2.5 minute sweep time. The spectrum analyzer's sweep was started at the same time power was applied to the U-NII device.

For the initial Channel Availability Check Time no radar burst was generated and the EUT was monitored for how long after startup transmission started.

Test Results: The EUT was not applicable with the requirements of this section.

D. In-Service Monitoring for Channel Move Time, Channel Closing Transmission Time, and Non-Occupancy Period

Test Requirements: §15.407(h)(2)(iii) Channel Move Time. After a radar's presence is detected, all transmissions shall cease on the operating channel within 10 seconds. Transmissions during this period shall consist of normal traffic for a maximum of 200 ms after detection of the radar signal. In addition, intermittent management and control signals can be sent during the remaining time to facilitate vacating the operating channel.

§15.407(h)(2)(iv) Non-occupancy Period. A channel that has been flagged as containing a radar system, either by a channel availability check or in-service monitoring, is subject to a non-occupancy period of at least 30 minutes. The non-occupancy period starts at the time when the radar system is detected.

KDB 905462 §5.1 Test using widest BW mode available.

Test Procedure: The EUT was setup as a Master device and associated with a Client device. A test file was streamed from the Master device to the Client device for the entire period of the test. A Radar Burst of type 0 with a level equal to the DFS Detection Threshold + 1 dB was used.

A radar pulse was generated while the EUT was transmitting. A spectrum analyzer set to a zero span was used to observe the transmission of the EUT at the end of the burst.

For radar burst at the beginning of the Channel Availability Check Time a short pulse radar type (0-4) with a level equal to the DFS Detection Threshold + 1 dB was generated within the first 6 seconds of the EUT's channel availability check. The EUT was monitored to ensure that it did not start transmitting on the channel.

For radar burst at the end of the Channel Availability Check Time a short pulse radar type (0-4) with a level equal to the DFS Detection Threshold + 1 dB was generated within the last 6 seconds of the EUT's channel availability check. The EUT was monitored to ensure that it did not start transmitting on the channel.

Test Results: The EUT was compliant with the requirements of this section.

Test Engineer(s): Jun Qi

Test Date(s): 9/14/16

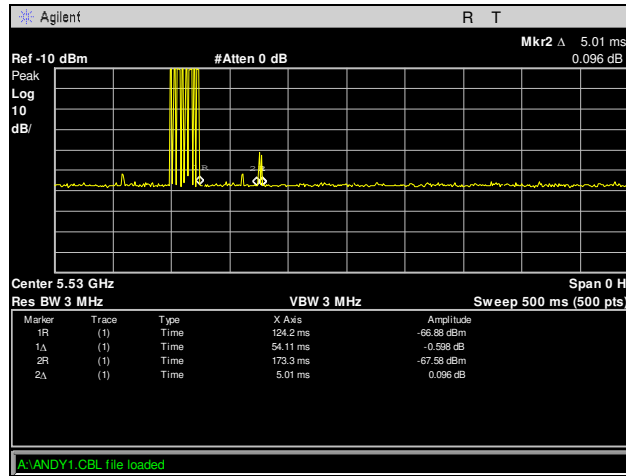

Plot 22. DFS Channel Closing Transmission, Time Aggregate, 80 MHz, Channel 106

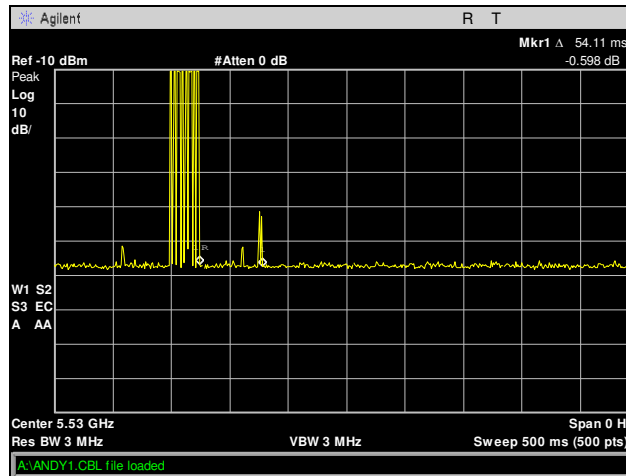

Plot 23. DFS Channel Move Time, 500ms, 80 MHz, Channel 106

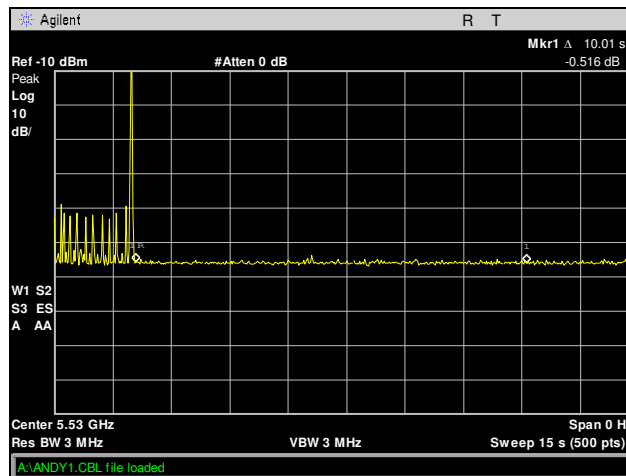

Plot 24. DFS Channel Move Time, 15s, 80 MHz, Channel 106

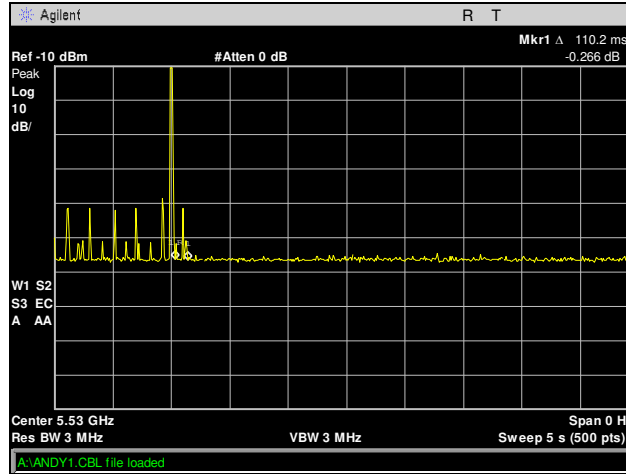

Plot 25. DFS Channel Move Time, 5s, 80 MHz, Channel 106

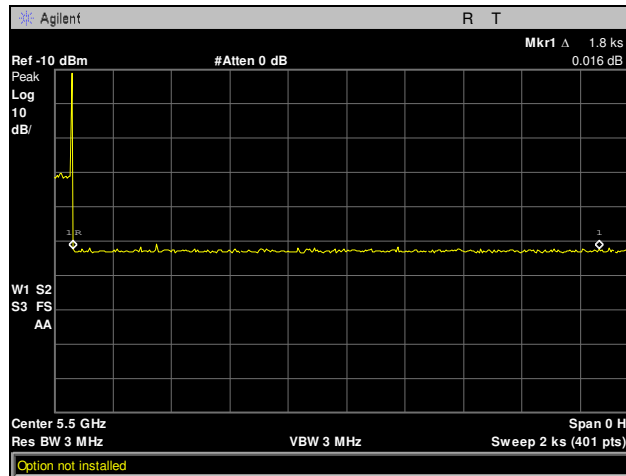

Plot 26. Non-Occupancy, 80 MHz, Channel 100

E. Statistical Performance Check

Test Requirements: **KDB 905462 §5.1** All BW modes must be tested.

KDB 905462: Each of the Radar Pulse types requires a minimum percentage of detections while the EUT is transmitting and listening for potential radar systems operating within the DFS Detection Bandwidth.

For Short Pulse Radar types the aggregate minimum percentage of detections is 80 percent.

For the Long Pulse Radar types the minimum percentage of detections is 80 percent.

For the Frequency Hopping Radar type the minimum percentage of detections is 70 percent.

Test Procedure:

The EUT was setup as a Master device and associated with a Client device. A test file was streamed from the Master device to the Client device for the entire period of the test. The EUT was also set to a test mode as to demonstrate when the detection occurred without resetting the device between trials.

A Radar Burst of each type (1-6) with a level equal to the DFS Detection Threshold + 1 dB was used. The frequencies selected for the radar burst included several frequencies within the DFS Detection Bandwidth and frequencies near the edge of the bandwidth.

For Short Pulse Radar types, an observation of the EUT's transmission was made for duration greater than 10 seconds after the burst to ensure detection occurred.

For Long Pulse Radar types, an observation of the EUT's transmission was made for duration greater than 10 seconds after the burst to ensure detection occurred. Also, center frequencies for the 30 trials were randomly selected within 80% of the Occupied Bandwidth.

Once the performance check was completed, statistical data was gathered as to determine the ability of the EUT to detect radar waveforms. An aggregate total for the Short Pulse Radar detections was calculated.

Test Results: The EUT was not applicable with the requirements of this section.

V. Test Equipment

Test Equipment

Calibrated test equipment utilized during testing was maintained in a current state of calibration per the requirements of ISO/IEC 17025:2005.

Asset	Equipment	Manufacturer	Model	Calibration Date	Calibration Due Date
1S3905	VECTOR SIGNAL GENERATOR	KEYSIGHT TECHNOLOGIES	N5172B	3/30/2015	3/30/2017
1U0258	SPECTRUM ANALYZER	AGILENT TECHNOLOGIES	E4407B	2/2/2016	2/2/2017

Table 12. Test Equipment List

VI. Certification & User's Manual Information

Certification & User's Manual Information

L. Certification Information

The following is extracted from Title 47 of the Code of Federal Regulations, Part 2, Subpart I — Marketing of Radio frequency devices:

§ 2.801 Radio-frequency device defined.

As used in this part, a radio-frequency device is any device which in its operation is capable of Emitting radio-frequency energy by radiation, conduction, or other means. Radio- frequency devices include, but are not limited to:

- (a) The various types of radio communication transmitting devices described throughout this chapter.
- (b) *The incidental, unintentional and intentional radiators defined in Part 15 of this chapter.*
- (c) The industrial, scientific, and medical equipment described in Part 18 of this chapter.
- (d) Any part or component thereof which in use emits radio-frequency energy by radiation, conduction, or other means.

§ 2.803 Marketing of radio frequency devices prior to equipment authorization.

- (a) Except as provided elsewhere in this chapter, no person shall sell or lease, or offer for sale or lease (including advertising for sale or lease), or import, ship or distribute for the purpose of selling or leasing or offering for sale or lease, any radio frequency device unless:
 - (1) In the case of a device subject to certification, such device has been authorized by the Commission in accordance with the rules in this chapter and is properly identified and labeled as required by §2.925 and other relevant sections in this chapter; or
 - (2) In the case of a device that is not required to have a grant of equipment authorization issued by the Commission, but which must comply with the specified technical standards prior to use, such device also complies with all applicable administrative (including verification of the equipment or authorization under a Declaration of Conformity, where required), technical, labeling and identification requirements specified in this chapter.
- (d) Notwithstanding the provisions of paragraph (a) of this section, the offer for sale solely to business, commercial, industrial, scientific or medical users (but not an offer for sale to other parties or to end users located in a residential environment) of a radio frequency device that is in the conceptual, developmental, design or pre-production stage is permitted prior to equipment authorization or, for devices not subject to the equipment authorization requirements, prior to a determination of compliance with the applicable technical requirements *provided* that the prospective buyer is advised in writing at the time of the offer for sale that the equipment is subject to the FCC rules and that the equipment will comply with the appropriate rules before delivery to the buyer or to centers of distribution.

- (e)(1) Notwithstanding the provisions of paragraph (a) of this section, prior to equipment authorization or determination of compliance with the applicable technical requirements any radio frequency device may be operated, but not marketed, for the following purposes and under the following conditions:
- (i) *Compliance testing;*
 - (ii) Demonstrations at a trade show provided the notice contained in paragraph (c) of this section is displayed in a conspicuous location on, or immediately adjacent to, the device;
 - (iii) Demonstrations at an exhibition conducted at a business, commercial, industrial, scientific or medical location, but excluding locations in a residential environment, provided the notice contained in paragraphs (c) or (d) of this section, as appropriate, is displayed in a conspicuous location on, or immediately adjacent to, the device;
 - (iv) Evaluation of product performance and determination of customer acceptability, provided such operation takes place at the manufacturer's facilities during developmental, design or pre-production states; or
 - (v) Evaluation of product performance and determination of customer acceptability where customer acceptability of a radio frequency device cannot be determined at the manufacturer's facilities because of size or unique capability of the device, provided the device is operated at a business, commercial, industrial, scientific or medical user's site, but not at a residential site, during the development, design or pre-production stages.
- (e)(2) For the purpose of paragraphs (e)(1)(iv) and (e)(1)(v) of this section, the term *manufacturer's facilities* includes the facilities of the party responsible for compliance with the regulations and the manufacturer's premises, as well as the facilities of other entities working under the authorization of the responsible party in connection with the development and manufacture, but not the marketing, of the equipment.
- (f) For radio frequency devices subject to verification and sold solely to business, commercial, industrial, scientific and medical users (excluding products sold to other parties or for operation in a residential environment), parties responsible for verification of the devices shall have the option of ensuring compliance with the applicable technical specifications of this chapter at each end user's location after installation, provided that the purchase or lease agreement includes a proviso that such a determination of compliance be made and is the responsibility of the party responsible for verification of the equipment.

Certification & User's Manual Information

The following is extracted from Title 47 of the Code of Federal Regulations, Part 2, Subpart J — Equipment Authorization Procedures:

§ 2.901 Basis and Purpose

- (a) In order to carry out its responsibilities under the Communications Act and the various treaties and international regulations, and in order to promote efficient use of the radio spectrum, the Commission has developed technical standards for radio frequency equipment and parts or components thereof. The technical standards applicable to individual types of equipment are found in that part of the rules governing the service wherein the equipment is to be operated.¹ *In addition to the technical standards provided, the rules governing the service may require that such equipment be verified by the manufacturer or importer, be authorized under a Declaration of Conformity, or receive an equipment authorization from the Commission by one of the following procedures: certification or registration.*
- (b) The following sections describe the verification procedure, the procedure for a Declaration of Conformity, and the procedures to be followed in obtaining certification from the Commission and the conditions attendant to such a grant.

§ 2.907 Certification.

- (a) Certification is an equipment authorization issued by the Commission, based on representation and test data submitted by the applicant.
- (b) Certification attaches to all units subsequently marketed by the grantee which are identical (see Section 2.908) to the sample tested except for permissive changes or other variations authorized by the Commission pursuant to Section 2.1043.

¹ In this case, the equipment is subject to the rules of Part 15. More specifically, the equipment falls under Subpart B (of Part 15), which deals with unintentional radiators.

Certification & User's Manual Information

§ 2.948 Description of measurement facilities.

- (a) Each party making measurements of equipment that is subject to an equipment authorization under Part 15 or Part 18 of this chapter, regardless of whether the measurements are filed with the Commission or kept on file by the party responsible for compliance of equipment marketed within the U.S. or its possessions, shall compile a description of the measurement facilities employed.
 - (1) If the measured equipment is subject to the verification procedure, the description of the measurement facilities shall be retained by the party responsible for verification of the equipment.
 - (i) *If the equipment is verified through measurements performed by an independent laboratory, it is acceptable for the party responsible for verification of the equipment to rely upon the description of the measurement facilities retained by or placed on file with the Commission by that laboratory. In this situation, the party responsible for the verification of the equipment is not required to retain a duplicate copy of the description of the measurement facilities.*
 - (ii) If the equipment is verified based on measurements performed at the installation site of the equipment, no specific site calibration data is required. It is acceptable to retain the description of the measurement facilities at the site at which the measurements were performed.
 - (2) If the equipment is to be authorized by the Commission under the certification procedure, the description of the measurement facilities shall be filed with the Commission's Laboratory in Columbia, Maryland. The data describing the measurement facilities need only be filed once but must be updated as changes are made to the measurement facilities or as otherwise described in this section. At least every three years, the organization responsible for filing the data with the Commission shall certify that the data on file is current.

Certification & User's Manual Information

Label and User's Manual Information

The following is extracted from Title 47 of the Code of Federal Regulations, Part 15, Subpart A — General:

§ 15.19 Labeling requirements.

(a) *In addition to the requirements in Part 2 of this chapter, a device subject to certification or verification shall be labeled as follows:*

- (1) Receivers associated with the operation of a licensed radio service, e.g., FM broadcast under Part 73 of this chapter, land mobile operation under Part 90, etc., shall bear the following statement in a conspicuous location on the device:

This device complies with Part 15 of the FCC Rules. Operation is subject to the condition that this device does not cause harmful interference.

- (2) A stand-alone cable input selector switch, shall bear the following statement in a conspicuous location on the device:

This device is verified to comply with Part 15 of the FCC Rules for use with cable television service.

- (3) All other devices shall bear the following statement in a conspicuous location on the device:

This device complies with Part 15 of the FCC Rules. Operation is subject to the following two conditions: (1) This device may not cause harmful interference, and (2) this device must accept any interference received, including interference that may cause undesired operation.

- (4) Where a device is constructed in two or more sections connected by wires and marketed together, the statement specified under paragraph (a) of this section is required to be affixed only to the main control unit.

- (5) When the device is so small or for such use that it is not practicable to place the statement specified under paragraph (a) of this section on it, the information required by this paragraph shall be placed in a prominent location in the instruction manual or pamphlet supplied to the user or, alternatively, shall be placed on the container in which the device is marketed. However, the FCC identifier or the unique identifier, as appropriate, must be displayed on the device.

§ 15.21 Information to user.

The users manual or instruction manual for an intentional or unintentional radiator shall caution the user that changes or modifications not expressly approved by the party responsible for compliance could void the user's authority to operate the equipment.

Verification & User's Manual Information

The following is extracted from Title 47 of the Code of Federal Regulations, Part 15, Subpart B — Unintentional Radiators:

§ 15.105 Information to the user.

- (a) For a Class A digital device or peripheral, the instructions furnished the user shall include the following or similar statement, placed in a prominent location in the text of the manual:

Note: This equipment has been tested and found to comply with the limits for a Class A digital device, pursuant to Part 15 of the FCC Rules. These limits are designed to provide reasonable protection against harmful interference when the equipment is operated in a commercial environment. This equipment generates, uses, and can radiate radio frequency energy and, if not installed and used in accordance with the instruction manual, may cause harmful interference to radio communications. Operation of this equipment in a residential area is likely to cause harmful interference in which case the user will be required to correct the interference at own expense.

- (b) For a Class B digital device or peripheral, the instructions furnished the user shall include the following or similar statement, placed in a prominent location in the text of the manual:

Note: This equipment has been tested and found to comply with the limits for a Class B digital device, pursuant to Part 15 of the FCC Rules. These limits are designed to provide reasonable protection against harmful interference when the equipment is operated in a residential environment. This equipment generates, uses, and can radiate radio frequency energy and, if not installed and used in accordance with the instruction manual, may cause harmful interference to radio communications. However, there is no guarantee that interference will not occur in a particular installation. If this equipment does cause harmful interference to radio or television reception, which can be determined by turning the equipment off and on, the user is encouraged to try to correct the interference by one or more of the following measures:

- Reorient or relocate the receiving antenna.
- Increase the separation between the equipment and receiver.
- Connect the equipment into an outlet on a circuit different from that to which the receiver is connected.
- Consult the dealer or an experienced radio/TV technician for help.

End of Report