

FCC C2PC Test Report

FCC ID : ACQ-VAP3400
Equipment : 802.11ac 5GHz 4T4R Access Point
Model No. : VAP3400
Brand Name : ARRIS
Applicant : ARRIS Group, Inc.
Address : 101 Tournament Drive, Horsham,
Pennsylvania, United States, 19044
Standard : 47 CFR FCC Part 15.407
Received Date : Aug. 17, 2015
Tested Date : Mar. 03 ~ Apr. 25, 2016

We, International Certification Corp., would like to declare that the tested sample has been evaluated and in compliance with the requirement of the above standards. The test results contained in this report refer exclusively to the product. It may be duplicated completely for legal use with the approval of the applicant. It shall not be reproduced except in full without the written approval of our laboratory.

Approved & Reviewed by:



Gary Chang / Manager



Table of Contents

1	GENERAL DESCRIPTION	5
1.1	Information.....	5
1.2	Local Support Equipment List	11
1.3	Test Setup Chart	11
1.4	The Equipment List	12
1.5	Testing Applied Standards	13
1.6	Measurement Uncertainty	13
2	TEST CONFIGURATION	14
2.1	Testing Condition	14
2.2	The Worst Test Modes and Channel Details	14
3	TRANSMITTER TEST RESULTS.....	17
3.1	Conducted Emissions.....	17
3.2	Emission Bandwidth	28
3.3	RF Output Power	35
3.4	Peak Power Spectral Density	41
3.5	Transmitter Radiated and Band Edge Emissions	48
3.6	Frequency Stability.....	171
4	TEST LABORATORY INFORMATION	173

Release Record

Report No.	Version	Description	Issued Date
FR452702-02AN	Rev. 01	Initial issue	Jun. 16, 2016

Summary of Test Results

FCC Rules	Test Items	Measured	Result
15.207	Conducted Emissions	[dBuV]: 0.387MHz 44.91 (Margin -3.21dB) - AV	Pass
15.407(b) 15.209	Radiated Emissions	[dBuV/m at 3m]: 17355.00MHz 53.00 (Margin -1.00dB) - AV [dBuV/m at 3m]: 5725.00MHz 53.00 (Margin -1.00dB) - AV	Pass
15.407(a)	Emission Bandwidth	Meet the requirement of limit	Pass
15.407(e)	6dB bandwidth	Meet the requirement of limit	Pass
15.407(a)	RF Output Power	Max Power [dBm]: Non-beamforming mode 5470~5725MHz: 23.52 5725~5850MHz: 24.04 Beamforming mode 5150~5250MHz: 15.81 5250~5350MHz: 22.40 5470~5725MHz: 23.17 5725~5850MHz: 23.96	Pass
15.407(a)	Peak Power Spectral Density	Meet the requirement of limit	Pass
15.407(g)	Frequency Stability	Meet the requirement of limit	Pass
15.203	Antenna Requirement	Meet the requirement of limit	Pass

1 General Description

1.1 Information

This report is prepared for FCC class II Permissive change.

This report is issued as a supplementary report to the original ICC project no. 452702. The modifications are concerned as follows:

- ✧ Complying with New U-NII rule requirement for U-NII band -1 / -2A / -2C / -3.
- ✧ Frequency 5600~5650MHz band activated by software.
- ✧ Support beamforming function by software setting.
- ✧ Additional two adapters
- ✧ Additional one RJ45 cable
- ✧ Adding Resistance / Capacitor to reduce spurious emission below 1GHz

Therefore, related test items had been performed and presented in the following sections.

1.1.1 Specification of the Equipment under Test (EUT)

RF General Information					
Frequency Range (MHz)	IEEE Std. 802.11	Ch. Freq. (MHz)	Channel Number	Transmit Chains (N _{TX})	Data Rate / MCS
5150-5250 5250-5350 5470-5725 5725-5850	a	5180-5240 5260-5320 5500-5720 5745-5825	36-48 [4] 52-64 [4] 100-144 [12] 149-165 [5]	4	6-54 Mbps
5150-5250 5250-5350 5470-5725 5725-5850	n (HT20)	5180-5240 5260-5320 5500-5720 5745-5825	36-48 [4] 52-64 [4] 100-144 [12] 149-165 [5]	4	MCS 0-31
5150-5250 5250-5350 5470-5725 5725-5850	n (HT40)	5190-5230 5270-5310 5510-5710 5755-5795	38-46 [2] 54-62 [2] 102-142[6] 151-159 [2]	4	MCS 0-31
5150-5250 5250-5350 5470-5725 5725-5850	ac (VHT20)	5180-5240 5260-5320 5500-5720 5745-5825	36-48 [4] 52-64 [4] 100-144 [12] 149-165 [5]	4	MCS 0-9
5150-5250 5250-5350 5470-5725 5725-5850	ac (VHT40)	5190-5230 5270-5310 5510-5710 5755-5795	38-46 [2] 54-62 [2] 102-142[6] 151-159 [2]	4	MCS 0-9
5150-5250 5250-5350 5470-5725 5725-5850	ac (VHT80)	5210 5290 5530-5690 5775	42 [1] 58 [1] 106-138 [3] 155 [1]	4	MCS 0-9

Note 1: RF output power specifies that Maximum Conducted Output Power.
Note 2: 802.11 a/n/ac uses a combination of OFDM-BPSK, QPSK, 16QAM, 64QAM, 256QAM modulation.

1.1.2 Antenna Details

Ant. Group	Ant. No.	Model	Type	Connector	Operating Frequencies (MHz) / Antenna Gain (dBi)		
					5150~5350	5470~5725	5725~5850
1	1	Mag.Layers - PCA-2108-5G0C1-A1	PCB	MHF PLUG	0	0	0.1
	2	Mag.Layers - PCA-2108-5G0C1-A1	PCB	MHF PLUG	0	0	0.1
	3	Mag.Layers - PCA-2108-5G0C1-A2	PCB	MHF PLUG	0	0	0.1
	4	Mag.Layers - PCA-2108-5G0C1-A2	PCB	MHF PLUG	0	0	0.1
2	1	Airgain - N5X20SC-PK1-G65U	PCB	MHF PLUG	0	-0.1	0
	2	Airgain - N5X20SC-PK1-G65U	PCB	MHF PLUG	0	-0.1	0
	3	Airgain - N5X20SC-PK1-G100U	PCB	MHF PLUG	0	-0.1	0
	4	Airgain - N5X20SC-PK1-G100U	PCB	MHF PLUG	0	-0.1	0

Note:

For Antenna group 1

Above antenna gain value is for single TX antenna. Correlated antenna gain is 6.02dBi for 5150~5350 and 5470~5725 MHz and 6.12dBi for 5725~5850 MHz.

For Antenna group 2

Above antenna gain value is for single TX antenna. Correlated antenna gain is 6.02dBi for 5150~5350 and 5725~5850 MHz and 5.92dBi for 5470~5725 MHz.

1.1.3 Power Supply Type of Equipment under Test (EUT)

Power Supply Type	12Vdc from AC adapter
--------------------------	-----------------------

1.1.4 Accessories

Accessories		
No.	Equipment	Description
1	AC Adapter	Brand Name: NetBit Model Name: NBS12E120100VU Power Rating: I/P: 100-120Vac, 50-60Hz, 0.3A O/P: 12Vdc, 1.0A Power Line: 1.8m non-shielded cable w/o core Efficiency Level: VI
2	AC Adapter	Brand Name: APD Model Name: WA-12M12FU Power Rating: I/P: 100-120Vac, 50-60Hz, 0.3A O/P: 12Vdc, 1.0A Power Line: 1.8m non-shielded cable with one core Efficiency Level: VI
3	RJ45 Cable	1.75m non-shielded cable w/o core.

1.1.5 Channel List

802.11 a / HT20 / VHT20		HT40 / VHT40	
Channel	Frequency(MHz)	Channel	Frequency(MHz)
36	5180	38	5190
40	5200	46	5230
44	5220	54	5270
48	5240	62	5310
52	5260	102	5510
56	5280	110	5550
60	5300	118	5590
64	5320	126	5630
100	5500	134	5670
104	5520	142	5710
108	5540	151	5755
112	5560	159	5795
116	5580	VHT80	
120	5600	42	5210
124	5620	58	5290
128	5640	106	5530
132	5660	122	5610
136	5680	138	5690
140	5700	155	5775
144	5720	---	---
149	5745	---	---
153	5765	---	---
157	5785	---	---
161	5805	---	---
165	5825	---	---

1.1.6 Test Tool and Duty Cycle

Test Tool	lperf				
Duty Cycle and Duty Factor	Mode	Non-beamforming		Beamforming	
		Duty cycle (%)	Duty factor (dB)	Duty cycle (%)	Duty factor (dB)
	VHT20	---	---	95.62%	0.19
	VHT40	98.83%	0.05	95.53%	0.20
VHT80	95.21%	0.21	97.02%	0.13	

1.1.7 Power Setting

For Frequency band 5150-5250 MHz			
Modulation Mode	Test Frequency (MHz)	Power Set	
		Non-Beamforming	Beamforming
VHT20	5180	---	9
VHT20	5200	---	9
VHT20	5240	---	9
VHT40	5190	---	10
VHT40	5230	---	10
VHT80	5210	---	10

For Frequency band 5250~5350 MHz			
Modulation Mode	Test Frequency (MHz)	Power Set	
		Non-Beamforming	Beamforming
VHT20	5260	---	16
VHT20	5300	---	16
VHT20	5320	---	16
VHT40	5270	---	16
VHT40	5310	---	14
VHT80	5290	---	11

For Frequency band 5470~5725 MHz			
Modulation Mode	Test Frequency (MHz)	Power Set	
		Non-Beamforming	Beamforming
HT40	5590	17	---
VHT20	5500	---	15
VHT20	5580	---	15
VHT20	5700	---	14
VHT40	5510	---	12
VHT40	5590	17	17
VHT40	5670	---	16
VHT80	5530	---	11
VHT80	5610	17	17

Channel that extends across the 5.725 GHz boundary (Beamforming mode only.)

For Frequency band 5470~5725 MHz		
Modulation Mode	Test Frequency (MHz)	Power Set
VHT20	5720	16
VHT40	5710	17
VHT80	5690	17

For Frequency band 5725~5850 MHz			
Modulation Mode	Test Frequency (MHz)	Power Set	
		Non-Beamforming	Beamforming
11a	5745	15	---
11a	5785	16	---
11a	5825	15	---
HT20	5745	15	---
HT20	5785	18	---
HT20	5825	17	---
HT40	5755	14	---
HT40	5795	18	---
VHT20	5745	15	14
VHT20	5785	18	18
VHT20	5825	17	15
VHT40	5755	14	13
VHT40	5795	18	17
VHT80	5775	13	13

1.2 Local Support Equipment List

Support Equipment List					
No.	Equipment	Brand	Model	FCC ID	Signal cable / Length (m)
1	Notebook	DELL	Latitude E6430	DoC	RJ45, 10m non-shielded.

1.3 Test Setup Chart

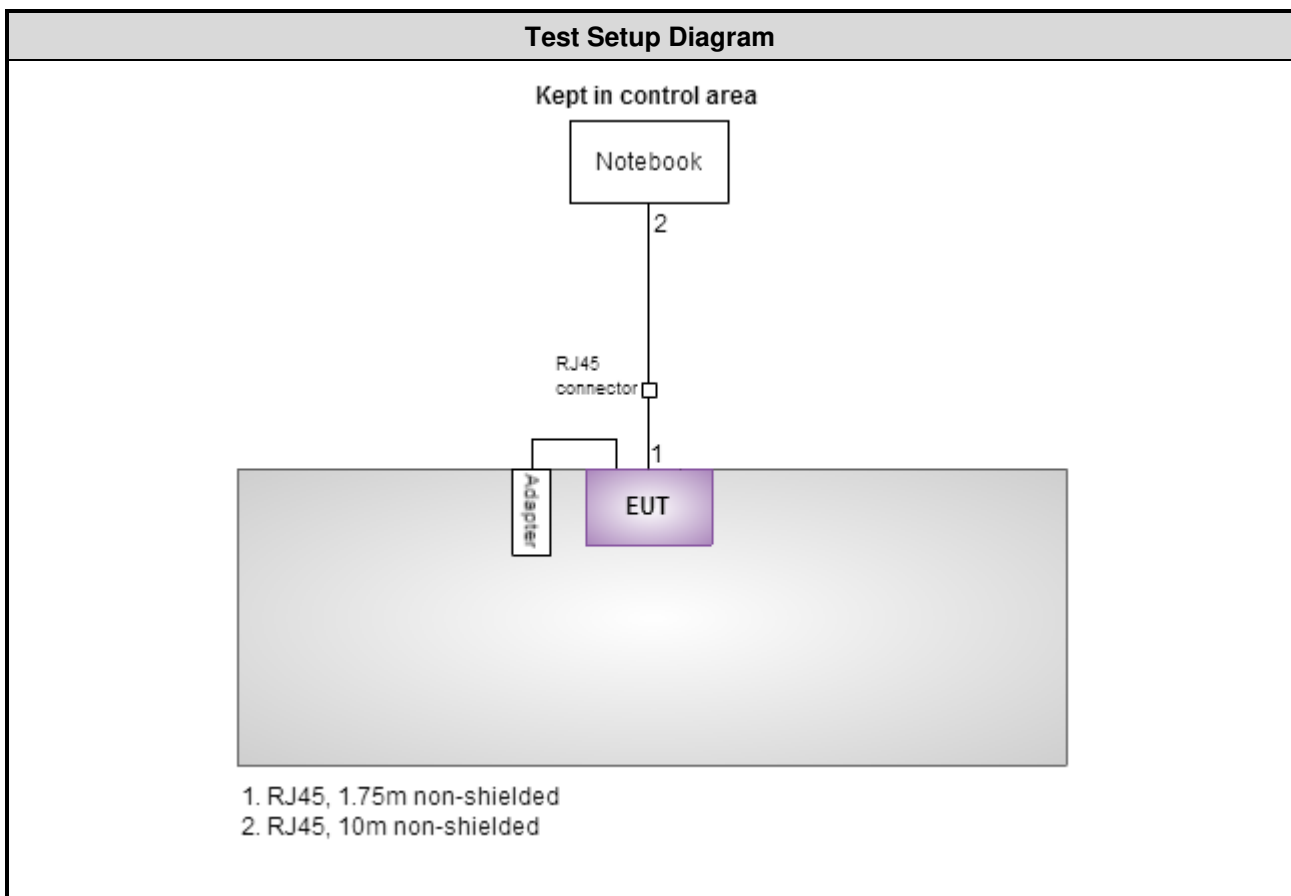

1.4 The Equipment List

Test Item	Conducted Emission				
Test Site	Conduction room 1 / (CO01-WS)				
Instrument	Manufacturer	Model No.	Serial No.	Calibration Date	Calibration Until
EMC Receiver	R&S	ESCS 30	100169	Oct. 21, 2015	Oct. 20, 2016
LISN	SCHWARZBECK	Schwarzbeck 8127	8127-667	Nov. 13, 2015	Nov. 12, 2016
RF Cable-CON	EMC	EMCCFD300-BM-BM-6000	50821	Dec. 21, 2015	Dec. 20, 2016
Measurement Software	AUDIX	e3	6.120210k	NA	NA

Note: Calibration Interval of instruments listed above is one year.

Test Item	Radiated Emission				
Test Site	966 chamber1 / (03CH01-WS)				
Instrument	Manufacturer	Model No.	Serial No.	Calibration Date	Calibration Until
Spectrum Analyzer	R&S	FSV40	101498	Dec. 13, 2015	Dec. 12, 2016
Receiver	R&S	ESR3	101658	Nov. 04, 2015	Nov. 03, 2016
Bilog Antenna	SCHWARZBECK	VULB9168	VULB9168-522	Aug. 20, 2015	Aug. 19, 2016
Horn Antenna 1G-18G	SCHWARZBECK	BBHA 9120 D	BBHA 9120 D 1096	Dec. 16, 2015	Dec. 15, 2016
Horn Antenna 18G-40G	SCHWARZBECK	BBHA 9170	BBHA 9170517	Nov. 04, 2015	Nov. 03, 2016
Loop Antenna	R&S	HFH2-Z2	11900	Nov. 16, 2015	Nov. 15, 2016
Loop Antenna Cable	KOAX KABEL	101354-BW	101354-BW	Dec. 10, 2015	Dec. 09, 2016
Preamplifier	Burgeon	BPA-530	SN:100219	Sep. 10, 2015	Sep. 09, 2016
Preamplifier	Agilent	83017A	MY39501308	Oct. 02, 2015	Oct. 01, 2016
Preamplifier	EMC	EMC184045B	980192	Sep. 01, 2015	Aug. 31, 2016
RF Cable	HUBER+SUHNER	SUCOFLEX104	MY16014/4	Dec. 10, 2015	Dec. 09, 2016
RF Cable	HUBER+SUHNER	SUCOFLEX104	MY16019/4	Dec. 10, 2015	Dec. 09, 2016
RF Cable	HUBER+SUHNER	SUCOFLEX104	MY16139/4	Dec. 10, 2015	Dec. 09, 2016
LF cable 3M	Woken	CFD400NL-LW	CFD400NL-001	Dec. 10, 2015	Dec. 09, 2016
LF cable 10M	Woken	CFD400NL-LW	CFD400NL-002	Dec. 10, 2015	Dec. 09, 2016
Measurement Software	AUDIX	e3	6.120210g	NA	NA

Note: Calibration Interval of instruments listed above is one year.

Test Item	RF Conducted				
Test Site	(TH01-WS)				
Instrument	Manufacturer	Model No.	Serial No.	Calibration Date	Calibration Until
Spectrum Analyzer	R&S	FSV40	101063	Feb. 17, 2016	Feb. 16, 2017
TEMP&HUMIDITY CHAMBER	GIANT FORCE	GCT-225-40-SP-SD	MAF1212-002	Nov. 27, 2015	Nov. 26, 2016
Power Meter	Anritsu	ML2495A	1241002	Sep. 21, 2015	Sep. 20, 2016
Power Sensor	Anritsu	MA2411B	1207366	Sep. 21, 2015	Sep. 20, 2016
Measurement Software	Sporton	Sporton_1	1.3.30	NA	NA

Note: Calibration Interval of instruments listed above is one year.

1.5 Testing Applied Standards

According to the specification of EUT, the EUT must comply with following standards and KDB documents.

47 CFR FCC Part 15.407

ANSI C63.10-2013

FCC KDB 789033 D02 General UNII Test Procedures New Rules v01r01

FCC KDB 644545 D03 Guidance for IEEE 802.11ac New Rules v01

FCC KDB 662911 D01 Multiple Transmitter Output v02r01

FCC KDB 412172 D01 Determining ERP and EIRP v01r01

1.6 Measurement Uncertainty

ISO/IEC 17025 requires that an estimate of the measurement uncertainties associated with the emissions test results be included in the report. The measurement uncertainties given below are based on a 95% confidence level (based on a coverage factor $k=2$)

Measurement Uncertainty	
Parameters	Uncertainty
Bandwidth	± 34.134 Hz
Conducted power	± 0.808 dB
Frequency error	± 34.134 Hz
Power density	± 0.463 dB
Conducted emission	± 2.670 dB
AC conducted emission	± 2.90 dB
Radiated emission ≤ 1 GHz	± 3.66 dB
Radiated emission > 1 GHz	± 5.63 dB
Time	$\pm 0.1\%$
Temperature	± 0.6 °C

2 Test Configuration

2.1 Testing Condition

Test Item	Test Site	Ambient Condition	Tested By
AC Conduction	CO01-WS	19°C / 60%	Sky Huang
Radiated Emissions	03CH01-WS	20-22°C / 61-63%	Aska Huang Vincent Yeh
RF Conducted	TH01-WS	22°C / 64%	Anderson Hung

➤ FCC site registration No.: 181692

➤ IC site registration No.: 10807A-1

2.2 The Worst Test Modes and Channel Details

Non-beamforming mode

Frequency band 5470~5725 MHz				
Test item	Modulation Mode	Test Frequency (MHz)	Data Rate (Mbps) / MCS	Test Configuration
Conducted Emissions	VHT40	5590	MCS 0	---
	VHT80	5610	MCS 0	---
Radiated Emissions ≤1GHz	VHT40	5590	MCS 0	---
	VHT80	5610	MCS 0	---
Radiated Emissions >1GHz	VHT40	5590	MCS 0	---
	VHT80	5610	MCS 0	---
RF Output Power	HT40	5590	MCS 0	---
	VHT40	5590	MCS 0	
	VHT80	5610	MCS 0	
Emission Bandwidth	VHT40	5590	MCS 0	---
Peak Power Spectral Density	VHT80	5610	MCS 0	

NOTE:

1. Adapter 1 and Adapter 2 had been pretested and found that **Adapter 1** was the worst case and was selected for final testing (**Adapter 1: NetBit adapter**; Adapter 2: APD adapter).
2. Only channels within in 5600~5650MHz band are tested. Other channels are tested and recorded in original report.

Frequency band 5725-5850 MHz				
Test item	Modulation Mode	Test Frequency (MHz)	Data Rate (Mbps) / MCS	Test Configuration
Conducted Emissions	VHT40	5795	MCS 0	---
Radiated Emissions \leq 1GHz	VHT40	5795	MCS 0	---
RF Output Power	11a	5745 / 5785 / 5825	6 Mbps	---
	HT20	5745 / 5785 / 5825	MCS 0	
	HT40	5755 / 5795	MCS 0	
	VHT20	5745 / 5785 / 5825	MCS 0	
	VHT40	5755 / 5795	MCS 0	
	VHT80	5775	MCS 0	
Radiated Emissions >1GHz Emission Bandwidth 6dB bandwidth Peak Power Spectral Density	11a	5745 / 5785 / 5825	6 Mbps	---
	VHT20	5745 / 5785 / 5825	MCS 0	
	VHT40	5755 / 5795	MCS 0	
	VHT80	5775	MCS 0	
Frequency Stability	Un-modulation	5785	---	---

NOTE:

- Adapter 1 and Adapter 2 had been pretested and found that **Adapter 1** was the worst case and was selected for final testing (**Adapter 1: NetBit adapter**; Adapter 2: APD adapter).

Beamforming mode

Frequency band 5150~5350 MHz / 5470~5725 MHz				
Test item	Modulation Mode	Test Frequency (MHz)	Data Rate	Test Configuration
Conducted Emissions	VHT40	5590	MCS 0	---
Radiated Emissions ≤1GHz	VHT40	5590	MCS 0	---
RF Output Power	VHT20	5180 / 5200 / 5240 / 5260 / 5300 5320 / 5500 / 5580 / 5700 / 5720	MCS 0	---
	VHT40	5190 / 5230/ 5270 / 5310 / 5510 5590 / 5670 / 5710	MCS 0	
	VHT80	5210 / 5290 / 5530 / 5610 / 5690	MCS 0	
Radiated Emissions >1GHz Emission Bandwidth Peak Power Spectral Density	VHT20	5180 / 5200 / 5240 / 5260 / 5300 5320 / 5500 / 5580 / 5700 / 5720	MCS 0	---
	VHT40	5190 / 5230/ 5270 / 5310 / 5510 5590 / 5670 / 5710	MCS 0	
	VHT80	5210 / 5290 / 5530 / 5610 / 5690	MCS 0	
NOTE:				
1. Adapter 1 and Adapter 2 had been pretested and found that Adapter 1 was the worst case and was selected for final testing (Adapter 1: NetBit adapter ; Adapter 2: APD adapter).				

Frequency band 5725-5850 MHz				
Test item	Modulation Mode	Test Frequency (MHz)	Data Rate	Test Configuration
Conducted Emissions	VHT20	5785	MCS 0	---
Radiated Emissions ≤1GHz	VHT20	5785	MCS 0	---
RF Output Power	VHT20	5745 / 5785 / 5825 5755 / 5795 5775	MCS 0	---
	VHT40		MCS 0	
	VHT80		MCS 0	
Radiated Emissions >1GHz Emission Bandwidth 6dB bandwidth Peak Power Spectral Density	VHT20	5745 / 5785 / 5825 5755 / 5795 5775	MCS 0	---
	VHT40		MCS 0	
	VHT80		MCS 0	
Frequency Stability	Un-modulation	5785	---	---
NOTE:				
1. Adapter 1 and Adapter 2 had been pretested and found that Adapter 1 was the worst case and was selected for final testing (Adapter 1: NetBit adapter ; Adapter 2: APD adapter).				

3 Transmitter Test Results

3.1 Conducted Emissions

3.1.1 Limit of Conducted Emissions

Conducted Emissions Limit		
Frequency Emission (MHz)	Quasi-Peak	Average
0.15-0.5	66 - 56 *	56 - 46 *
0.5-5	56	46
5-30	60	50

Note 1: * Decreases with the logarithm of the frequency.

3.1.2 Test Procedures

1. The device is placed on a test table, raised 80 cm above the reference ground plane. The vertical conducting plane is located 40 cm to the rear of the device.
2. The device is connected to line impedance stabilization network (LISN) and other accessories are connected to other LISN. Measured levels of AC power line conducted emission are across the 50 Ω LISN port.
3. AC conducted emission measurements is made over frequency range from 150 kHz to 30 MHz.
4. This measurement was performed with AC 120V/60Hz

3.1.3 Test Setup

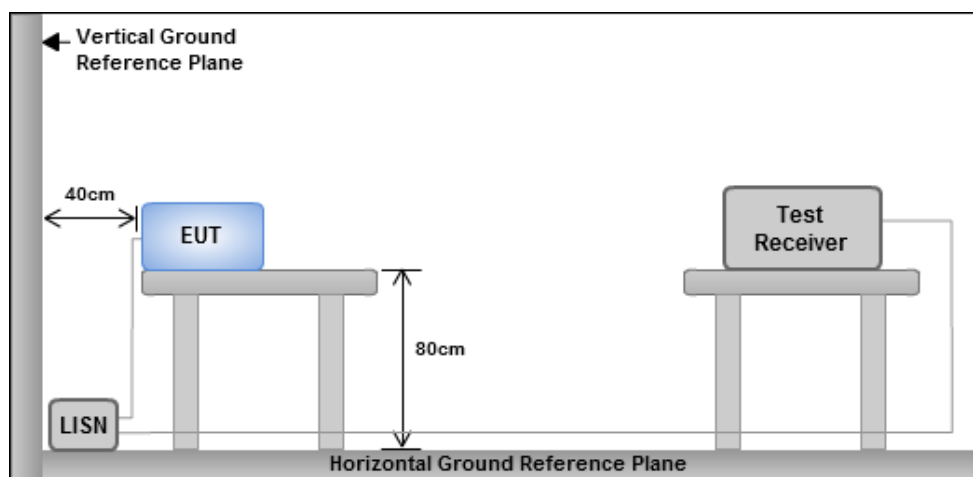

- Note: 1. Support units were connected to second LISN.
 2. Both of LISNs (AMN) are 80 cm from EUT and at least 80 cm from other units and other metal planes

3.1.4 Test Result of Conducted Emissions

Non-beamforming mode

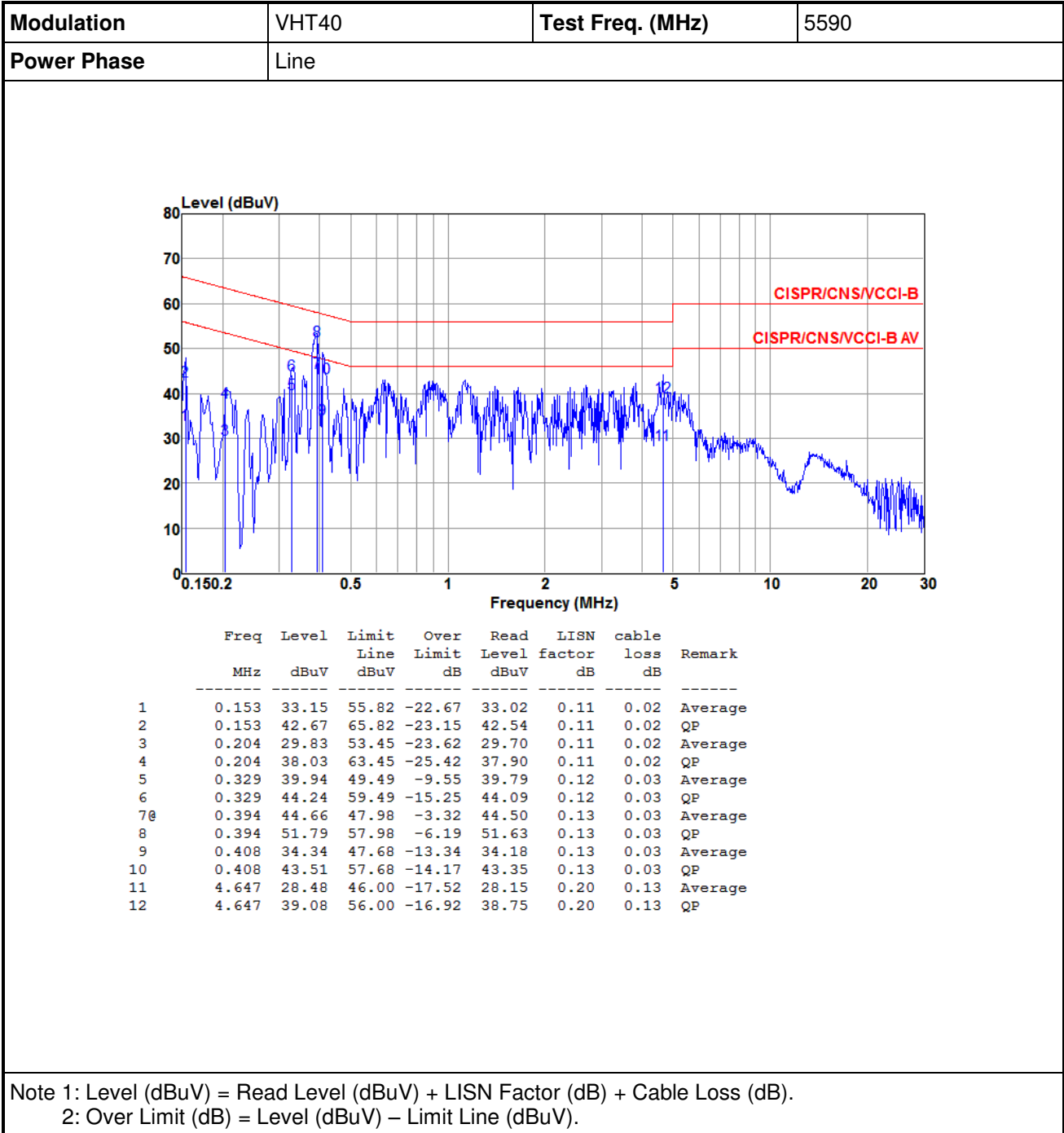

Modulation	VHT40	Test Freq. (MHz)	5590
Power Phase	Neutral		

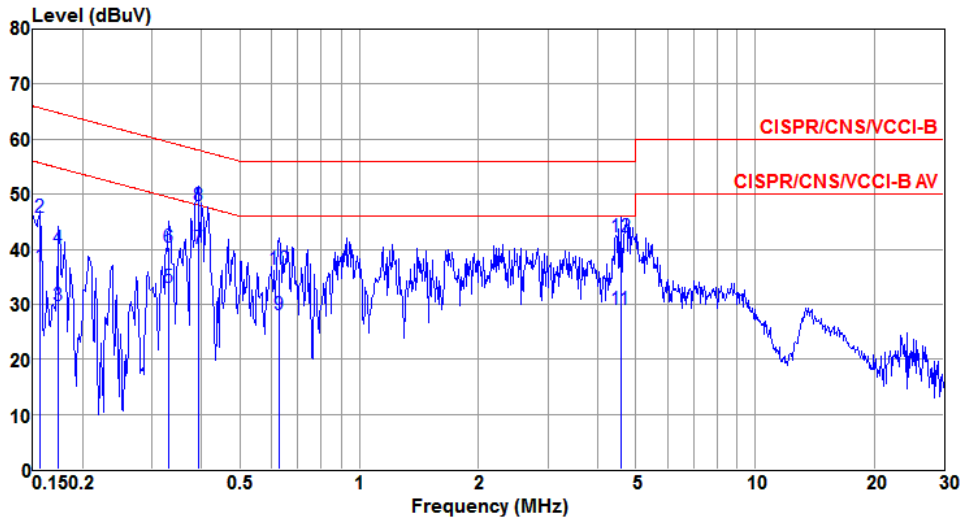

	Freq MHz	Level dBuV	Limit Line dBuV	Over Limit dB	Read Level dBuV	LISN factor dB	cable loss dB	Remark
1	0.156	36.93	55.65	-18.72	36.78	0.13	0.02	Average
2	0.156	45.77	65.65	-19.88	45.62	0.13	0.02	QP
3	0.174	29.83	54.77	-24.94	29.70	0.11	0.02	Average
4	0.174	40.03	64.77	-24.74	39.90	0.11	0.02	QP
5	0.330	33.02	49.44	-16.42	32.86	0.13	0.03	Average
6	0.330	40.38	59.44	-19.06	40.22	0.13	0.03	QP
7@	0.391	40.14	48.03	-7.89	39.97	0.14	0.03	Average
8	0.391	47.82	58.03	-10.21	47.65	0.14	0.03	QP
9	0.627	28.09	46.00	-17.91	27.91	0.14	0.04	Average
10	0.627	36.39	56.00	-19.61	36.21	0.14	0.04	QP
11	4.574	28.92	46.00	-17.08	28.61	0.18	0.13	Average
12	4.574	42.19	56.00	-13.81	41.88	0.18	0.13	QP

Note 1: Level (dBuV) = Read Level (dBuV) + LISN Factor (dB) + Cable Loss (dB).
 2: Over Limit (dB) = Level (dBuV) – Limit Line (dBuV).

Modulation	VHT80	Test Freq. (MHz)	5610
Power Phase	Line		

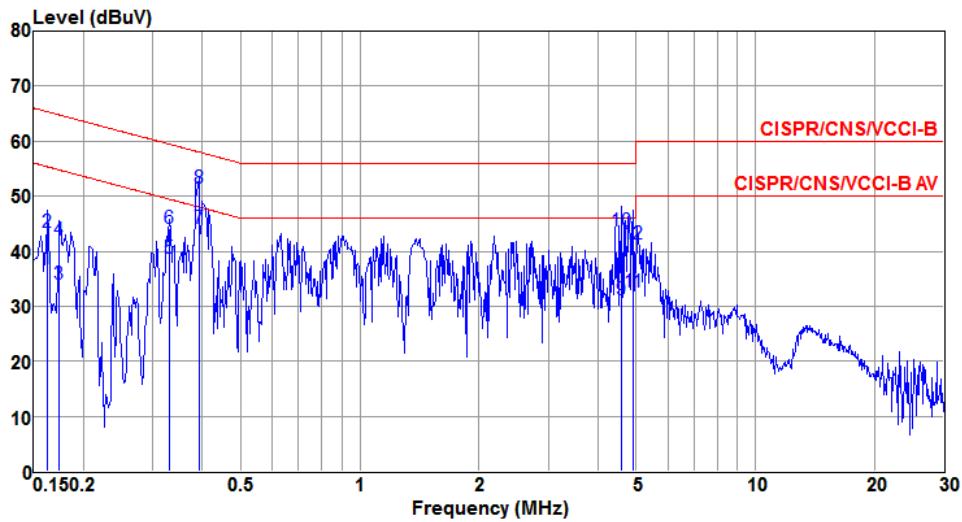

	Freq MHz	Level dBuV	Limit Line dBuV	Over Limit dB	Read Level dBuV	LISN factor dB	cable loss dB	Remark
1	0.162	36.71	55.34	-18.63	36.58	0.11	0.02	Average
2	0.162	43.43	65.34	-21.91	43.30	0.11	0.02	QP
3	0.174	33.95	54.77	-20.82	33.82	0.11	0.02	Average
4	0.174	42.03	64.77	-22.74	41.90	0.11	0.02	QP
5	0.330	38.80	49.44	-10.64	38.65	0.12	0.03	Average
6	0.330	44.11	59.44	-15.33	43.96	0.12	0.03	QP
7@	0.392	44.06	48.02	-3.96	43.90	0.13	0.03	Average
8	0.392	51.47	58.02	-6.55	51.31	0.13	0.03	QP
9	4.598	31.04	46.00	-14.96	30.71	0.20	0.13	Average
10	4.598	43.73	56.00	-12.27	43.40	0.20	0.13	QP
11	4.926	32.52	46.00	-13.48	32.19	0.20	0.13	Average
12	4.926	41.37	56.00	-14.63	41.04	0.20	0.13	QP

Note 1: Level (dBuV) = Read Level (dBuV) + LISN Factor (dB) + Cable Loss (dB).
 2: Over Limit (dB) = Level (dBuV) – Limit Line (dBuV).

Modulation	VHT80	Test Freq. (MHz)	5610
Power Phase	Neutral		

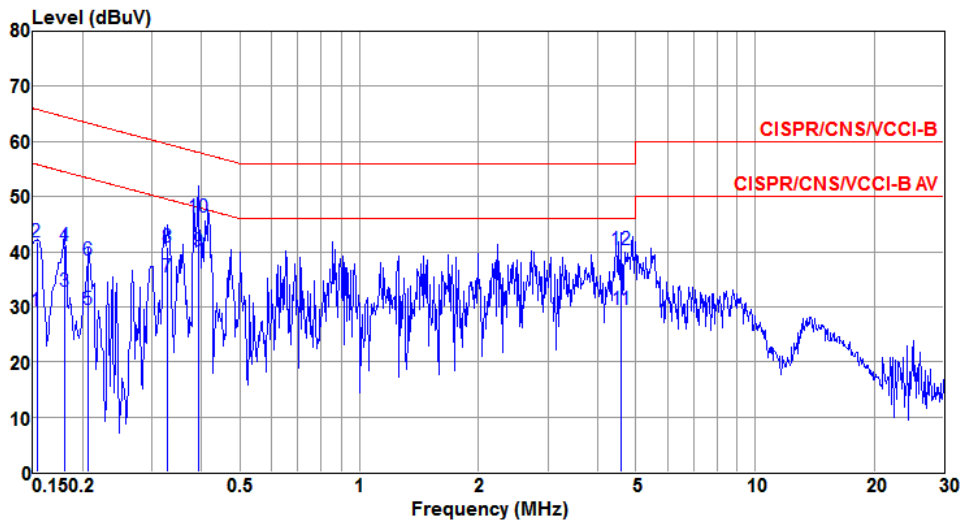

	Freq MHz	Level dBuV	Limit Line dBuV	Over Limit dB	Read Level dBuV	LISN factor dB	cable loss dB	Remark
1	0.153	29.34	55.82	-26.48	29.19	0.13	0.02	Average
2	0.153	41.67	65.82	-24.15	41.52	0.13	0.02	QP
3	0.181	32.91	54.46	-21.55	32.78	0.11	0.02	Average
4	0.181	41.07	64.46	-23.39	40.94	0.11	0.02	QP
5	0.207	29.57	53.32	-23.75	29.45	0.10	0.02	Average
6	0.207	38.36	63.32	-24.96	38.24	0.10	0.02	QP
7	0.327	35.44	49.53	-14.09	35.28	0.13	0.03	Average
8	0.327	40.90	59.53	-18.63	40.74	0.13	0.03	QP
9@	0.391	40.08	48.03	-7.95	39.91	0.14	0.03	Average
10	0.391	46.33	58.03	-11.70	46.16	0.14	0.03	QP
11	4.598	29.47	46.00	-16.53	29.15	0.19	0.13	Average
12	4.598	40.31	56.00	-15.69	39.99	0.19	0.13	QP

Note 1: Level (dBuV) = Read Level (dBuV) + LISN Factor (dB) + Cable Loss (dB).
 2: Over Limit (dB) = Level (dBuV) – Limit Line (dBuV).

Modulation	VHT40	Test Freq. (MHz)	5795
Power Phase	Line		

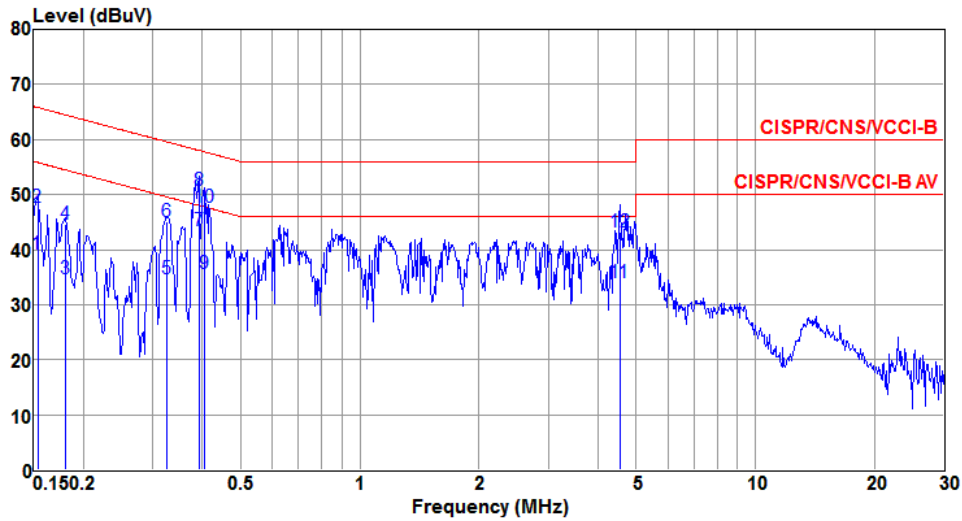

	Freq MHz	Level dBuV	Limit Line dBuV	Over Limit dB	Read Level dBuV	LISN factor dB	cable loss dB	Remark
1	0.153	39.13	55.82	-16.69	39.00	0.11	0.02	Average
2	0.153	47.75	65.82	-18.07	47.62	0.11	0.02	QP
3	0.181	34.72	54.46	-19.74	34.59	0.11	0.02	Average
4	0.181	44.52	64.46	-19.94	44.39	0.11	0.02	QP
5	0.325	34.76	49.57	-14.81	34.61	0.12	0.03	Average
6	0.325	45.10	59.57	-14.47	44.95	0.12	0.03	QP
7	0.393	43.35	48.00	-4.65	43.19	0.13	0.03	Average
8	0.393	50.64	58.00	-7.36	50.48	0.13	0.03	QP
9	0.404	35.60	47.77	-12.17	35.44	0.13	0.03	Average
10	0.404	47.74	57.77	-10.03	47.58	0.13	0.03	QP
11	4.549	34.05	46.00	-11.95	33.72	0.20	0.13	Average
12	4.549	43.28	56.00	-12.72	42.95	0.20	0.13	QP

Note 1: Level (dBuV) = Read Level (dBuV) + LISN Factor (dB) + Cable Loss (dB).
 Note 2: Over Limit (dB) = Level (dBuV) – Limit Line (dBuV).

Modulation	VHT40	Test Freq. (MHz)	5795
Power Phase	Neutral		

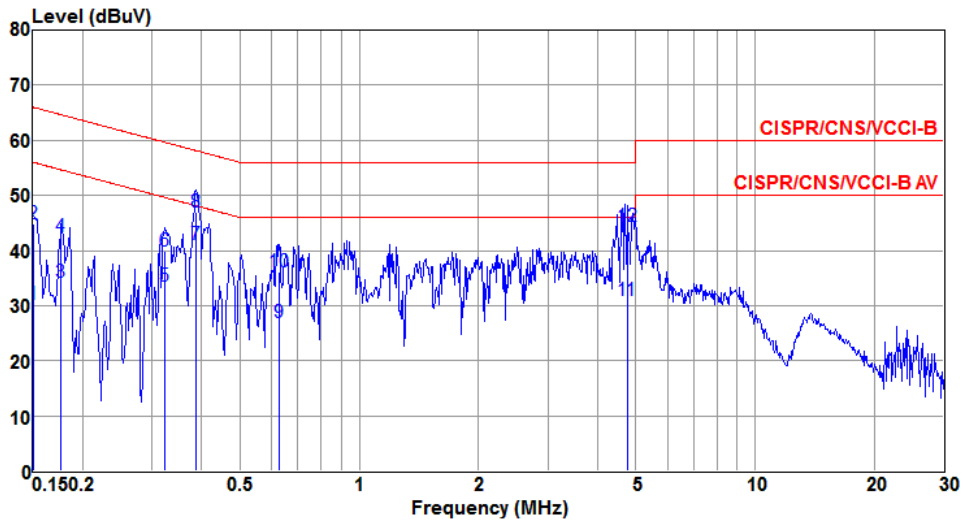

	Freq	Level	Limit	Over	Read	LISN	cable	
	MHz	dBuV	Line	Limit	Level	factor	loss	Remark
			dBuV	dB	dBuV	dB	dB	
1	0.150	30.33	56.00	-25.67	30.18	0.13	0.02	Average
2	0.150	44.76	66.00	-21.24	44.61	0.13	0.02	QP
3	0.177	34.21	54.64	-20.43	34.08	0.11	0.02	Average
4	0.177	42.56	64.64	-22.08	42.43	0.11	0.02	QP
5	0.322	33.42	49.66	-16.24	33.26	0.13	0.03	Average
6	0.322	39.92	59.66	-19.74	39.76	0.13	0.03	QP
7@	0.387	40.96	48.12	-7.16	40.79	0.14	0.03	Average
8	0.387	46.95	58.12	-11.17	46.78	0.14	0.03	QP
9	0.627	27.02	46.00	-18.98	26.84	0.14	0.04	Average
10	0.627	36.05	56.00	-19.95	35.87	0.14	0.04	QP
11	4.746	30.96	46.00	-15.04	30.64	0.19	0.13	Average
12	4.746	44.32	56.00	-11.68	44.00	0.19	0.13	QP

Note 1: Level (dBuV) = Read Level (dBuV) + LISN Factor (dB) + Cable Loss (dB).
 Note 2: Over Limit (dB) = Level (dBuV) – Limit Line (dBuV).

Beamforming mode

Modulation	VHT40	Test Freq. (MHz)	5590
Power Phase	Line		

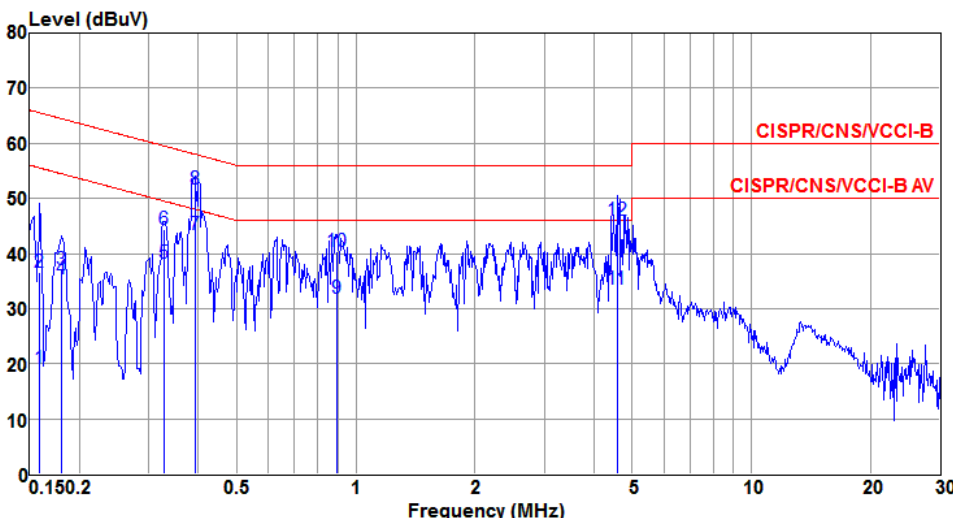

The plot displays the measured signal level in dBuV against frequency in MHz. Two red limit lines are shown: CISPR/CNS/VCCI-B (upper) and CISPR/CNS/VCCI-B AV (lower). The measured signal (blue line) fluctuates around 40 dBuV, with several peaks exceeding the lower limit line. The x-axis is logarithmic from 0.150.2 to 30 MHz, and the y-axis is linear from 0 to 80 dBuV.

	Freq MHz	Level dBuV	Limit Line dBuV	Over Limit dB	Read Level dBuV	LISN factor dB	cable loss dB	Remark
1	0.159	19.04	55.52	-36.48	18.91	0.11	0.02	Average
2	0.159	36.69	65.52	-28.83	36.56	0.11	0.02	QP
3	0.181	37.06	54.46	-17.40	36.93	0.11	0.02	Average
4	0.181	35.32	64.46	-29.14	35.19	0.11	0.02	QP
5	0.327	38.14	49.53	-11.39	37.99	0.12	0.03	Average
6	0.327	44.28	59.53	-15.25	44.13	0.12	0.03	QP
7@	0.392	43.41	48.02	-4.61	43.25	0.13	0.03	Average
8	0.392	51.71	58.02	-6.31	51.55	0.13	0.03	QP
9	0.894	31.94	46.00	-14.06	31.75	0.13	0.06	Average
10	0.894	40.37	56.00	-15.63	40.18	0.13	0.06	QP
11	4.574	33.57	46.00	-12.43	33.24	0.20	0.13	Average
12	4.574	46.02	56.00	-9.98	45.69	0.20	0.13	QP

Note 1: Level (dBuV) = Read Level (dBuV) + LISN Factor (dB) + Cable Loss (dB).
 Note 2: Over Limit (dB) = Level (dBuV) – Limit Line (dBuV).

Modulation	VHT40	Test Freq. (MHz)	5590
Power Phase	Neutral		

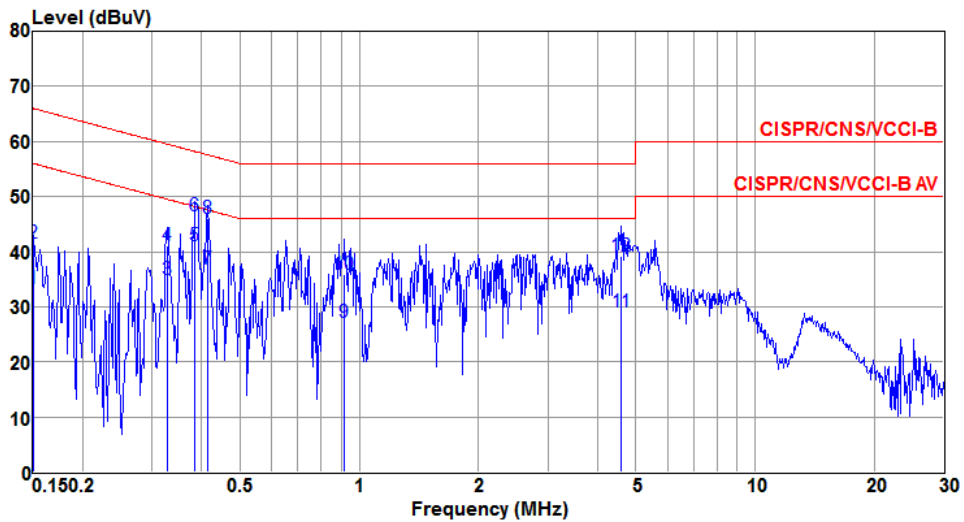

	Freq	Level	Limit	Over	Read	LISN	cable	Remark
	MHz	dBuV	Line	Limit	Level	factor	loss	
			dBuV	dB	dBuV	dB	dB	
1	0.150	33.34	56.00	-22.66	33.19	0.13	0.02	Average
2	0.150	41.52	66.00	-24.48	41.37	0.13	0.02	QP
3	0.327	34.98	49.53	-14.55	34.82	0.13	0.03	Average
4	0.327	40.96	59.53	-18.57	40.80	0.13	0.03	QP
5	0.385	41.09	48.17	-7.08	40.92	0.14	0.03	Average
6	0.385	46.49	58.17	-11.68	46.32	0.14	0.03	QP
7	0.413	36.76	47.59	-10.83	36.59	0.14	0.03	Average
8	0.413	45.99	57.59	-11.60	45.82	0.14	0.03	QP
9	0.918	27.21	46.00	-18.79	27.02	0.13	0.06	Average
10	0.918	35.97	56.00	-20.03	35.78	0.13	0.06	QP
11	4.598	29.13	46.00	-16.87	28.81	0.19	0.13	Average
12	4.598	39.27	56.00	-16.73	38.95	0.19	0.13	QP

Note 1: Level (dBuV) = Read Level (dBuV) + LISN Factor (dB) + Cable Loss (dB).
 2: Over Limit (dB) = Level (dBuV) – Limit Line (dBuV).

Modulation	VHT20	Test Freq. (MHz)	5785
Power Phase	Line		

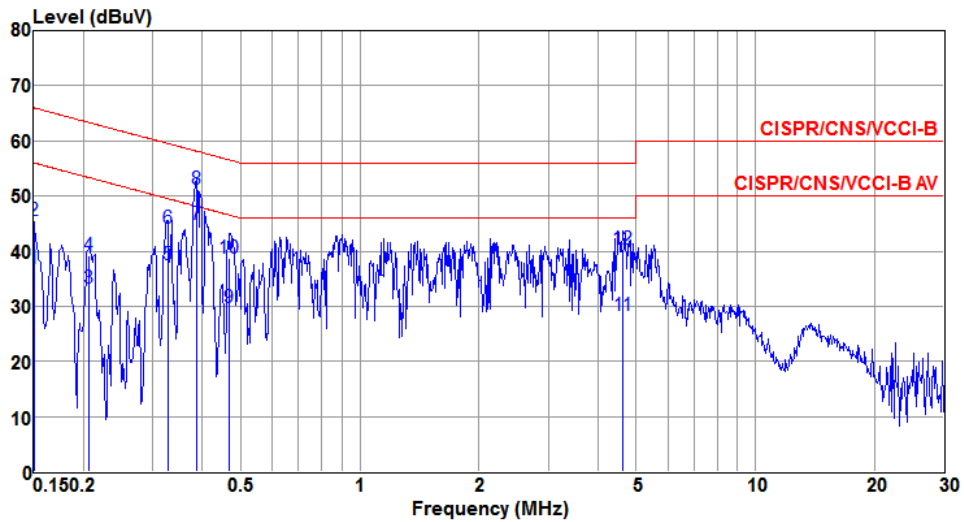

	Freq MHz	Level dBuV	Limit Line dBuV	Over Limit dB	Read Level dBuV	LISN factor dB	cable loss dB	Remark
1	0.150	36.83	56.00	-19.17	36.70	0.11	0.02	Average
2	0.150	45.45	66.00	-20.55	45.32	0.11	0.02	QP
3	0.207	33.30	53.32	-20.02	33.17	0.11	0.02	Average
4	0.207	39.19	63.32	-24.13	39.06	0.11	0.02	QP
5	0.327	37.64	49.53	-11.89	37.49	0.12	0.03	Average
6	0.327	44.24	59.53	-15.29	44.09	0.12	0.03	QP
7@	0.387	44.91	48.12	-3.21	44.75	0.13	0.03	Average
8	0.387	51.30	58.12	-6.82	51.14	0.13	0.03	QP
9	0.469	29.76	46.54	-16.78	29.59	0.13	0.04	Average
10	0.469	38.67	56.54	-17.87	38.50	0.13	0.04	QP
11	4.622	28.24	46.00	-17.76	27.91	0.20	0.13	Average
12	4.622	40.27	56.00	-15.73	39.94	0.20	0.13	QP

Note 1: Level (dBuV) = Read Level (dBuV) + LISN Factor (dB) + Cable Loss (dB).
 2: Over Limit (dB) = Level (dBuV) – Limit Line (dBuV).

Modulation	VHT20	Test Freq. (MHz)	5785
Power Phase	Neutral		

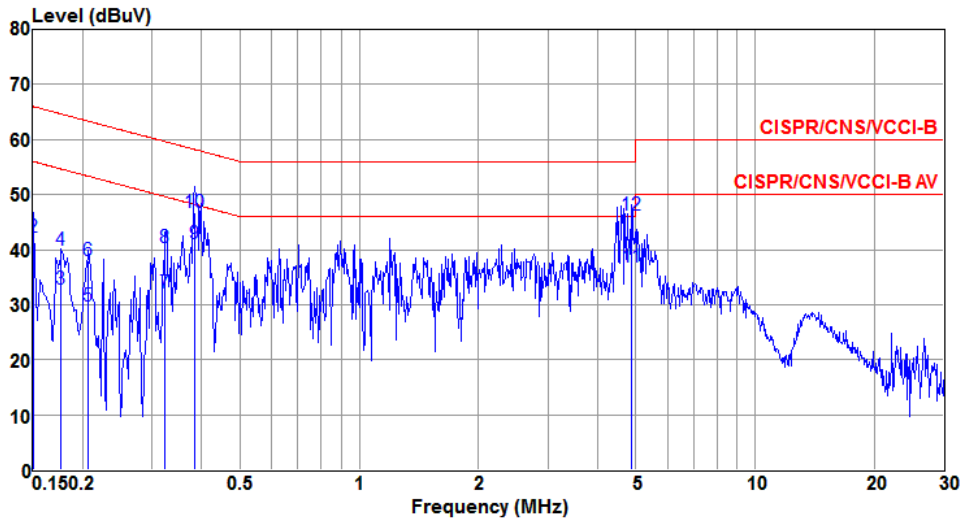

	Freq MHz	Level dBuV	Limit Line dBuV	Over Limit dB	Read Level dBuV	LISN factor dB	cable loss dB	Remark
1	0.150	34.62	56.00	-21.38	34.47	0.13	0.02	Average
2	0.150	42.20	66.00	-23.80	42.05	0.13	0.02	QP
3	0.177	32.81	54.64	-21.83	32.68	0.11	0.02	Average
4	0.177	39.84	64.64	-24.80	39.71	0.11	0.02	QP
5	0.207	29.70	53.32	-23.62	29.58	0.10	0.02	Average
6	0.207	37.96	63.32	-25.36	37.84	0.10	0.02	QP
7	0.323	32.20	49.62	-17.42	32.04	0.13	0.03	Average
8	0.323	40.36	59.62	-19.26	40.20	0.13	0.03	QP
9@	0.385	41.18	48.17	-6.99	41.01	0.14	0.03	Average
10	0.385	46.66	58.17	-11.51	46.49	0.14	0.03	QP
11	4.874	36.88	46.00	-9.12	36.56	0.19	0.13	Average
12	4.874	46.36	56.00	-9.64	46.04	0.19	0.13	QP

Note 1: Level (dBuV) = Read Level (dBuV) + LISN Factor (dB) + Cable Loss (dB).
 2: Over Limit (dB) = Level (dBuV) – Limit Line (dBuV).

3.2 Emission Bandwidth

3.2.1 Limit of Emission Bandwidth

Within the 5.725-5.85 GHz band, the minimum 6 dB bandwidth of U-NII devices shall be at least 500 kHz.

3.2.2 Test Procedures

26dB Bandwidth

1. Set RBW = approximately 1% of the emission bandwidth.
2. Set the VBW > RBW, Detector = Peak.
3. Trace mode = max hold.
4. Measure the maximum width of the emission that is 26 dB down from the peak of the emission.

Occupied Bandwidth

1. Set RBW = 1 % to 5 % of the OBW
2. Set VBW \geq 3 RBW
3. Sample detection and single sweep mode shall be used
4. Use the 99 % power bandwidth function of the instrument

6dB Bandwidth

1. Set RBW = 100kHz, VBW = 300kHz
2. Detector = Peak, Trace mode = max hold.
3. Allow the trace to stabilize.
4. Measure the maximum width of the emission that is constrained by the frequencies associated with the two outermost amplitude points (upper and lower frequencies) that are attenuated by 6 dB relative to the maximum level measured in the fundamental emission

3.2.3 Test Setup

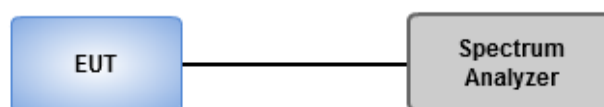

3.2.4 Test Result of Emission Bandwidth

Non-beamforming mode

For Frequency band 5470~5725 MHz											
Mode	N _{TX}	Freq. (MHz)	26dB Bandwidth (MHz)				99% Bandwidth (MHz)				Power Limit (dBm)
			Chain 0	Chain 1	Chain 2	Chain 3	Chain 0	Chain 1	Chain 2	Chain 3	
VHT40	4	5590	44.17	44.87	44.64	44.06	37.14	36.84	36.98	36.86	24.00
VHT80	4	5610	96.23	96.00	96.00	85.56	75.76	75.44	75.72	75.88	24.00

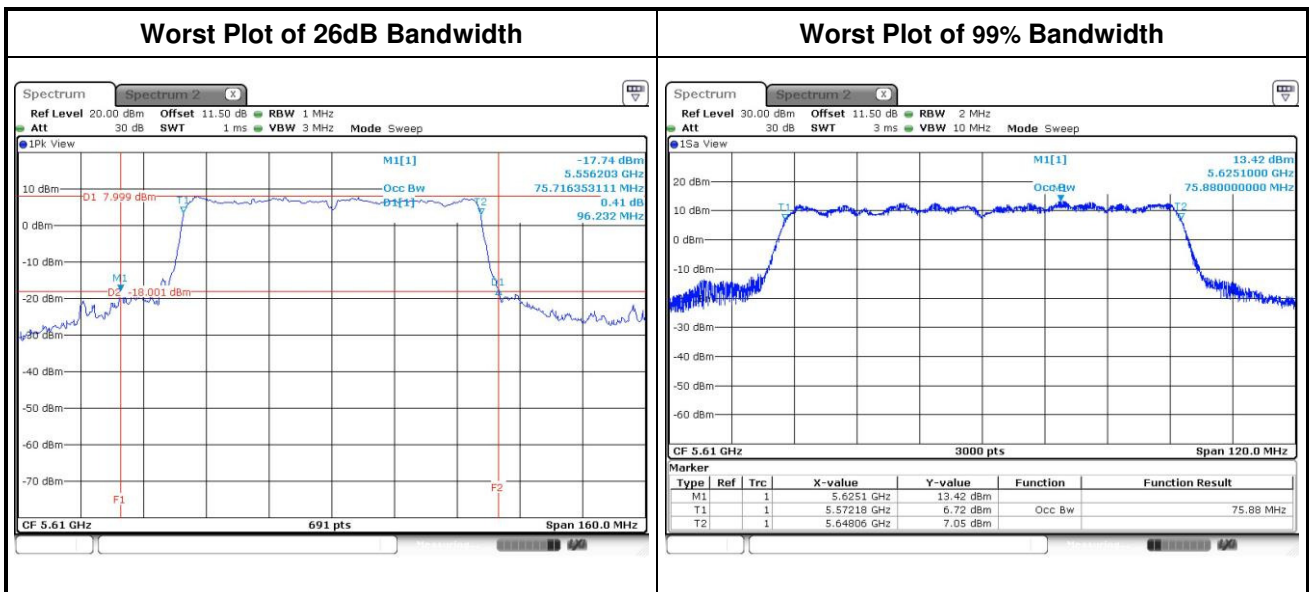

For Frequency band 5725-5850 MHz											
Emission Bandwidth											
Mode	N _{TX}	Freq. (MHz)	OBW Bandwidth (MHz)				6dB Bandwidth (MHz)				6dB BW Limit (MHz)
			Chain 0	Chain 1	Chain 2	Chain 3	Chain 0	Chain 1	Chain 2	Chain 3	
11a	4	5745	16.91	17.03	16.97	16.94	16.35	16.35	16.35	16.41	0.5
11a	4	5785	16.94	17.04	17.01	16.95	16.35	16.35	16.35	16.41	0.5
11a	4	5825	16.93	17.01	16.99	16.95	16.41	16.41	16.41	16.41	0.5
VHT20	4	5745	16.91	17.03	16.99	16.94	17.62	17.62	17.62	17.68	0.5
VHT20	4	5785	16.94	17.05	17.00	16.95	17.57	17.57	17.57	17.68	0.5
VHT20	4	5825	16.94	17.04	16.98	16.94	17.57	17.57	17.57	17.57	0.5
VHT40	4	5755	37.08	36.84	37.02	36.82	36.40	36.40	36.40	36.17	0.5
VHT40	4	5795	37.28	37.04	37.08	36.92	36.40	36.40	36.40	36.40	0.5
VHT80	4	5775	75.68	75.40	75.64	75.84	75.13	75.13	75.13	75.13	0.5

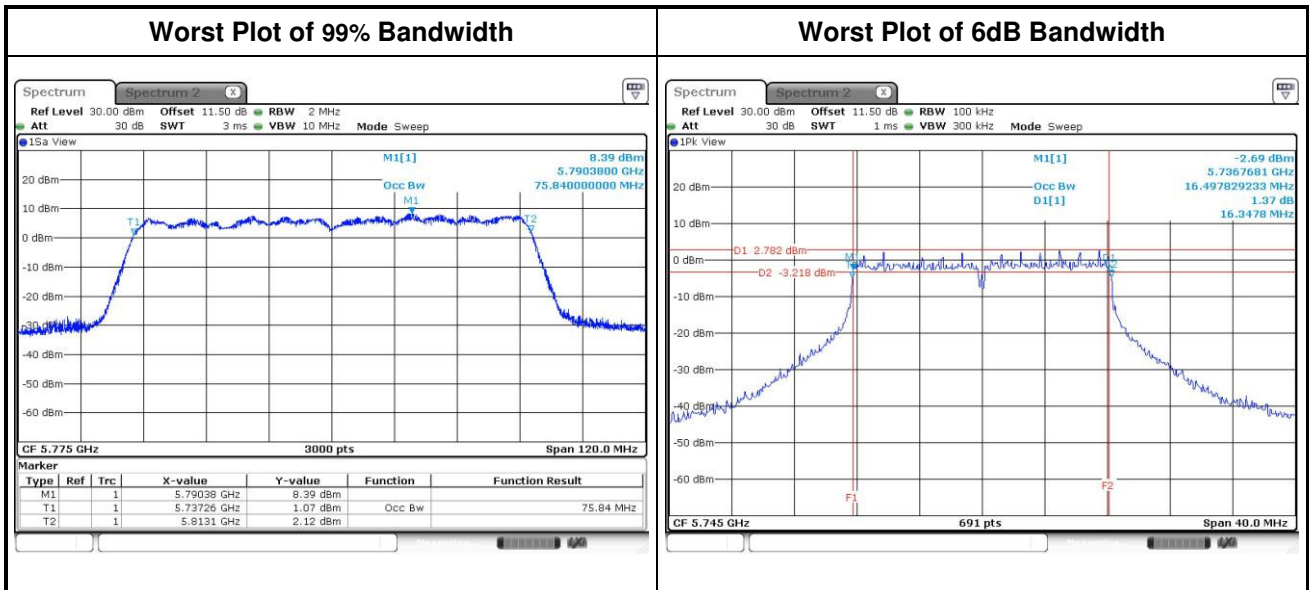

Beamforming mode

For Frequency band 5150~5250 MHz										
Emission Bandwidth										
Mode	N _{TX}	Freq. (MHz)	26dB Bandwidth (MHz)				99% Bandwidth (MHz)			
			Chain 0	Chain 1	Chain 2	Chain 3	Chain 0	Chain 1	Chain 2	Chain 3
VHT20	4	5180	25.97	26.26	25.68	25.79	18.60	18.49	18.46	18.47
VHT20	4	5200	26.20	25.80	25.62	25.91	18.42	18.59	18.47	18.52
VHT20	4	5240	25.97	25.97	25.80	25.86	18.47	18.47	18.47	18.53
VHT40	4	5190	44.06	44.75	44.17	44.75	37.10	37.12	37.04	37.08
VHT40	4	5230	44.99	43.59	43.13	44.64	37.18	37.20	37.12	37.16
VHT80	4	5210	81.62	80.93	82.09	80.70	76.44	76.40	76.36	75.68

For Frequency band 5250~5350 MHz											
Mode	N _{TX}	Freq. (MHz)	26dB Bandwidth (MHz)				99% Bandwidth (MHz)				Power Limit (dBm)
			Chain 0	Chain 1	Chain 2	Chain 3	Chain 0	Chain 1	Chain 2	Chain 3	
VHT20	4	5260	25.91	25.80	25.68	25.86	18.50	18.49	18.43	18.52	24.00
VHT20	4	5300	26.03	25.57	25.62	25.28	18.65	18.59	18.47	18.60	24.00
VHT20	4	5320	25.74	25.86	25.62	25.86	18.47	18.49	18.47	18.48	24.00
VHT40	4	5270	44.52	44.75	43.59	44.40	37.08	37.14	37.12	37.14	24.00
VHT40	4	5310	43.48	44.17	43.71	43.01	37.18	37.06	37.14	37.14	24.00
VHT80	4	5290	83.48	82.55	80.93	83.01	76.44	76.24	76.12	76.08	24.00

For Frequency band 5470~5725 MHz

Mode	N _{TX}	Freq. (MHz)	26dB Bandwidth (MHz)				99% Bandwidth (MHz)				Power Limit (dBm)
			Chain 0	Chain 1	Chain 2	Chain 3	Chain 0	Chain 1	Chain 2	Chain 3	
VHT20	4	5500	25.74	25.74	25.74	25.74	18.66	18.48	18.39	18.44	24.00
VHT20	4	5580	25.74	25.91	25.74	25.39	18.43	18.47	18.49	18.46	24.00
VHT20	4	5700	25.68	25.57	25.68	25.97	18.46	18.46	18.45	18.46	24.00
VHT40	4	5510	43.94	44.52	44.75	44.52	37.16	37.12	37.14	37.20	24.00
VHT40	4	5590	44.75	44.52	44.64	44.41	37.14	37.06	37.14	37.04	24.00
VHT40	4	5670	44.99	44.41	44.87	44.87	37.18	37.24	37.10	37.18	24.00
VHT80	4	5530	80.93	82.55	83.71	82.32	76.48	76.36	76.36	76.52	24.00
VHT80	4	5610	82.09	83.25	82.09	83.94	76.36	76.36	76.40	76.52	24.00

Worst Plot of 26dB Bandwidth

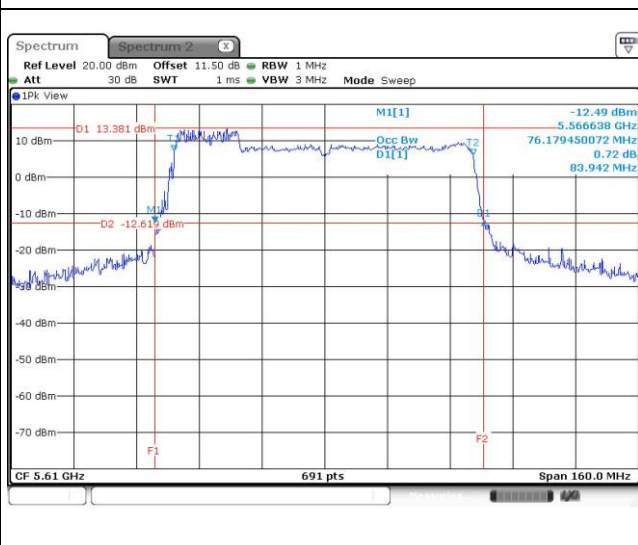

Worst Plot of 99% Bandwidth

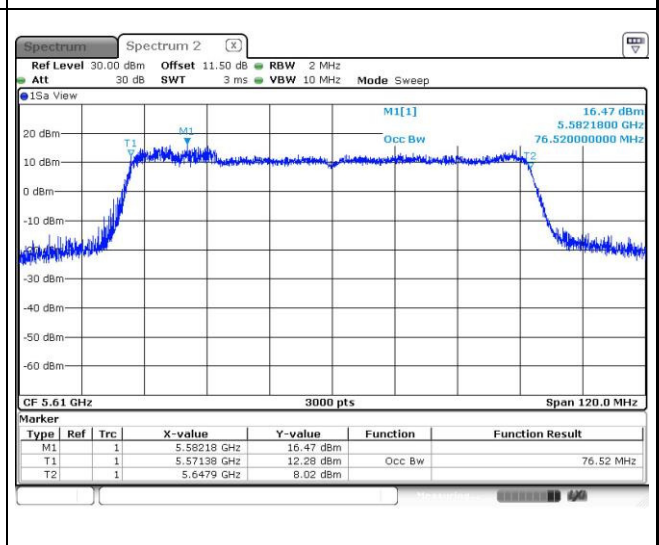

Channel that extends across the 5.725 GHz boundary

UNII Emission Bandwidth Result (Within 5470-5725MHz band)											
Mode	N _{TX}	Freq. (MHz)	26dB Bandwidth (MHz)				99% Bandwidth (MHz)				Power Limit (dBm)
			Chain 0	Chain 1	Chain 2	Chain 3	Chain 0	Chain 1	Chain 2	Chain 3	
VHT20	4	5720	18.54	17.99	18.36	18.05	14.27	14.23	14.22	14.27	23.55
VHT40	4	5710	37.44	37.64	37.64	37.23	33.61	33.61	33.65	33.59	24.00
VHT80	4	5690	74.78	75.00	75.00	75.00	72.70	72.66	72.66	72.62	24.00

UNII Emission Bandwidth Result (Extends across 5725MHz band)											
Mode	N _{TX}	Freq. (MHz)	26dB Bandwidth (MHz)				99% Bandwidth (MHz)				
			Chain 0	Chain 1	Chain 2	Chain 3	Chain 0	Chain 1	Chain 2	Chain 3	
VHT20	4	5720	7.67	7.76	7.98	7.83	4.22	4.23	4.24	4.26	
VHT40	4	5710	12.70	12.52	12.52	9.68	3.49	3.49	3.55	3.57	
VHT80	4	5690	15.04	7.30	12.70	7.57	2.78	2.70	2.78	2.82	

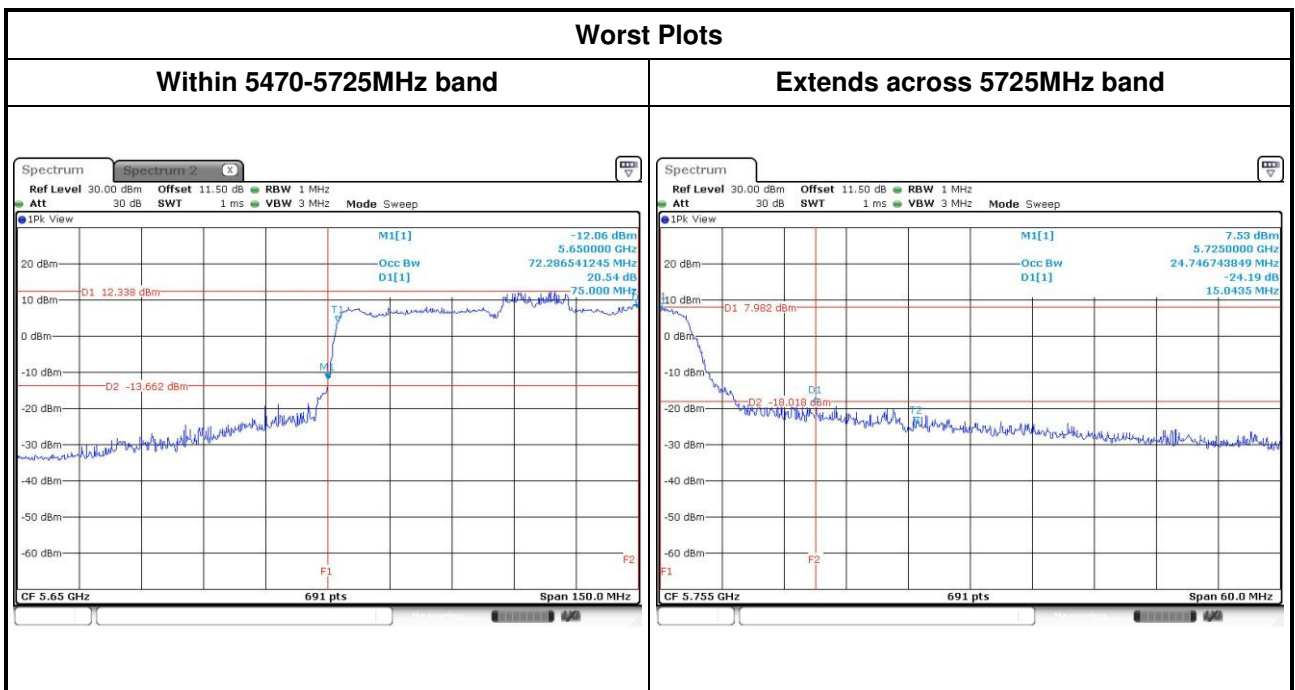

For Frequency band 5725-5850 MHz

Emission Bandwidth

Mode	N _{TX}	Freq. (MHz)	OBW Bandwidth (MHz)				6dB Bandwidth (MHz)				6dB BW Limit (MHz)
			Chain 0	Chain 1	Chain 2	Chain 3	Chain 0	Chain 1	Chain 2	Chain 3	
VHT20	4	5745	18.45	18.47	18.45	18.44	17.62	17.62	17.62	17.62	0.5
VHT20	4	5785	18.77	18.67	18.65	18.54	17.68	17.62	17.57	17.62	0.5
VHT20	4	5825	18.44	18.51	18.53	18.45	17.57	17.57	17.62	17.57	0.5
VHT40	4	5755	37.10	37.14	37.12	37.12	36.17	36.17	35.83	36.52	0.5
VHT40	4	5795	37.24	37.22	37.22	37.26	35.83	36.17	35.94	36.52	0.5
VHT80	4	5775	76.36	76.40	76.28	76.44	74.90	73.28	73.28	74.67	0.5

Worst Plot of 99% Bandwidth

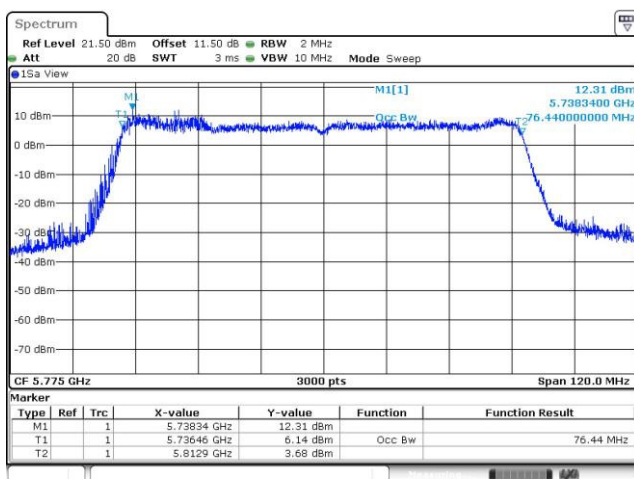

Worst Plot of 6dB Bandwidth

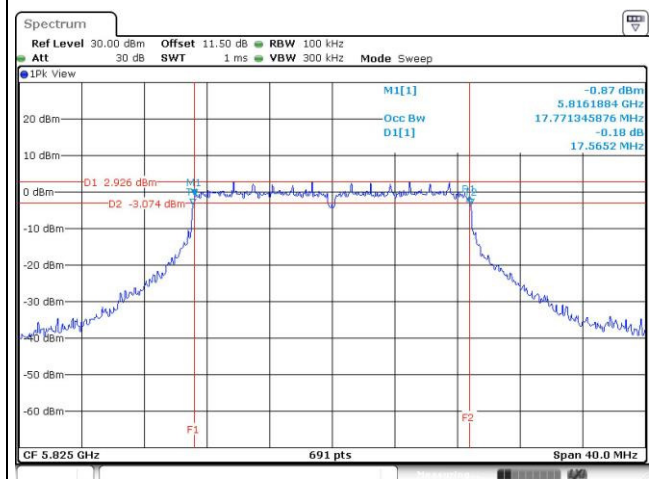

3.3 RF Output Power

3.3.1 Limit of RF Output Power

Frequency band 5150-5250 MHz	
Operating Mode	Limit
<input type="checkbox"/> Outdoor access point	Conducted Power: 1 W The maximum e.i.r.p. at any elevation angle above 30 degrees as measured from the horizon must not exceed 125 mW (21 dBm)
<input checked="" type="checkbox"/> Indoor access point	Conducted Power: 1 W
<input type="checkbox"/> Fixed point-to-point access points	Conducted Power: 1 W
<input type="checkbox"/> Mobile and portable client devices	Conducted Power: 250 mW

Frequency Band (MHz)	Limit
<input checked="" type="checkbox"/> 5250 ~ 5350	250mW or 11dBm+10 log B
<input checked="" type="checkbox"/> 5470 ~ 5725	250mW or 11dBm+10 log B
<input checked="" type="checkbox"/> 5725 ~ 5850	1 W

Note: "B" is the 26dB emission bandwidth in MHz.

3.3.2 Test Procedures

- Power meter (For channel that does not extends across the 5.725 GHz boundary)
 - Measurements is performed using a wideband gated RF power meter provided that the gate parameters are adjusted such that the power is measured only when the EUT is transmitting at its maximum power control level. Since the measurement is made only during the ON time of the transmitter, no duty cycle correction factor is required
- Spectrum analyzer (For channel that extends across the 5.725 GHz boundary)
 1. Set RBW=1MHz, VBW=3MHz , Sweep time= Auto, Detector = RMS
 2. Trace average at least 100 traces in power averaging mode
 3. Compute power by integrating the spectrum across the 26 dB EBW

3.3.3 Test Setup

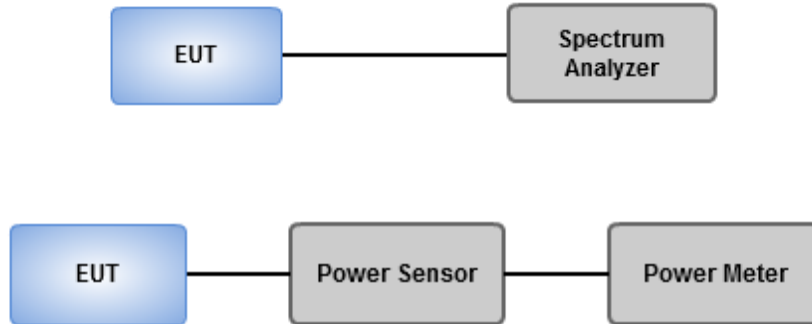

3.3.4 Test Result of Maximum Conducted Output Power

Non-beamforming mode

For Frequency band 5470~5725 MHz									
Mode	N _{TX}	Freq. (MHz)	Conducted Power (dBm)				Total Power (mW)	Total Power (dBm)	Limit (dBm)
			Chain 0	Chain 1	Chain 2	Chain 3			
HT40	4	5590	17.55	17.41	17.28	17.51	221.786	23.46	24.00
VHT40	4	5590	17.62	17.45	17.32	17.60	224.895	23.52	24.00
VHT80	4	5610	16.92	16.93	17.26	17.12	203.255	23.08	24.00

For Frequency band 5725-5850 MHz									
Mode	N _{TX}	Freq. (MHz)	Conducted Power (dBm)				Total Power (mW)	Total Power (dBm)	Limit (dBm)
			Chain 0	Chain 1	Chain 2	Chain 3			
11a	4	5745	15.12	14.58	15.42	14.56	124.626	20.96	30.00
11a	4	5785	15.84	15.65	16.05	15.75	152.954	21.85	30.00
11a	4	5825	14.75	14.58	14.72	14.47	116.200	20.65	30.00
HT20	4	5745	15.12	15.03	15.36	15.04	130.622	21.16	30.00
HT20	4	5785	18.01	17.86	18.12	17.65	247.409	23.93	30.00
HT20	4	5825	17.75	17.62	17.95	17.68	238.363	23.77	30.00
HT40	4	5755	14.46	14.21	14.45	13.62	105.164	20.22	30.00
HT40	4	5795	18.03	18.01	17.96	17.81	249.686	23.97	30.00
VHT20	4	5745	15.24	15.06	15.51	15.11	133.479	21.25	30.00
VHT20	4	5785	18.05	17.91	18.30	17.74	252.666	24.03	30.00
VHT20	4	5825	17.85	17.79	18.04	17.80	245.007	23.89	30.00
VHT40	4	5755	14.52	14.29	14.51	13.76	107.185	20.30	30.00
VHT40	4	5795	18.12	18.06	18.07	17.83	253.632	24.04	30.00
VHT80	4	5775	13.05	12.78	13.09	12.70	78.142	18.93	30.00

Beamforming mode

For Frequency band 5150~5250 MHz									
Mode	N _{TX}	Freq. (MHz)	Conducted Power (dBm)				Total Power (mW)	Total Power (dBm)	Limit (dBm)
			Chain 0	Chain 1	Chain 2	Chain 3			
VHT20	4	5180	8.02	8.28	7.42	8.72	26.037	14.16	29.98
VHT20	4	5200	7.65	7.31	7.33	8.75	24.110	13.82	29.98
VHT20	4	5240	8.56	8.08	7.82	8.84	27.314	14.36	29.98
VHT40	4	5190	9.58	9.49	10.08	9.98	38.110	15.81	29.98
VHT40	4	5230	9.77	9.07	9.86	9.81	36.811	15.66	29.98
VHT80	4	5210	10.12	8.65	9.34	9.85	35.859	15.55	29.98

Note:

- Correlated antenna gain is 6.02dBi > 6 dBi.
Limit shall be reduced to 30 dBm – (6.02 dBi – 6 dBi) = 29.98 dBm.

For Frequency band 5250~5350 MHz									
Mode	N _{TX}	Freq. (MHz)	Conducted Power (dBm)				Total Power (mW)	Total Power (dBm)	Limit (dBm)
			Chain 0	Chain 1	Chain 2	Chain 3			
VHT20	4	5260	16.32	16.14	15.32	16.19	159.602	22.03	23.98
VHT20	4	5300	16.02	16.14	15.44	15.81	154.211	21.88	23.98
VHT20	4	5320	15.96	15.98	15.62	15.92	154.633	21.89	23.98
VHT40	4	5270	16.62	15.78	16.55	16.52	173.824	22.40	23.98
VHT40	4	5310	13.85	13.54	13.84	13.69	94.459	19.75	23.98
VHT80	4	5290	10.88	9.45	10.16	10.92	43.791	16.41	23.98

Note:

- Correlated antenna gain is 6.02dBi > 6 dBi.
Limit shall be reduced to 24 dBm – (6.02 dBi – 6 dBi) = 23.98 dBm.

For Frequency band 5470~5725 MHz									
Mode	N _{TX}	Freq. (MHz)	Conducted Power (dBm)				Total Power (mW)	Total Power (dBm)	Limit (dBm)
			Chain 0	Chain 1	Chain 2	Chain 3			
VHT20	4	5500	15.12	15.24	15.11	15.02	130.131	21.14	23.98
VHT20	4	5580	15.11	15.34	15.52	15.64	138.921	21.43	23.98
VHT20	4	5700	14.30	14.26	14.37	14.05	106.346	20.27	23.98
VHT40	4	5510	12.10	11.71	12.32	11.92	63.664	18.04	23.98
VHT40	4	5590	17.05	17.24	17.16	17.14	207.426	23.17	23.98
VHT40	4	5670	15.98	15.74	16.33	16.49	164.644	22.17	23.98
VHT80	4	5530	10.75	10.02	10.25	10.59	43.979	16.43	23.98
VHT80	4	5610	17.21	16.89	16.82	17.61	207.228	23.16	23.98

Note:

- Correlated antenna gain is 6.02dBi > 6 dBi.
- Limit shall be reduced to 24 dBm – (6.02 dBi – 6 dBi) = 23.98 dBm.

Channel that extends across the 5.725 GHz boundary

Maximum Conducted Output Power (Within 5470-5725MHz band)											
Mode	N _{TX}	Freq. (MHz)	Conducted Power without duty factor					Duty factor (dB)	Total Power (mW)	Total Power (dBm)	Limit (dBm)
			Chain 0	Chain 1	Chain 2	Chain 3	Total Power (dBm)				
VHT20	4	5720	15.02	14.62	15.08	14.63	20.86	0.19	127.449	21.05	23.53
VHT40	4	5710	16.74	16.49	16.57	16.18	22.52	0.20	187.082	22.72	23.98
VHT80	4	5690	16.59	16.40	16.98	16.83	22.73	0.13	193.031	22.86	23.98

Note: Correlated antenna gain is 6.02dBi > 6 dBi. Limit shall be reduced 0.02 dB.

Maximum Conducted Output Power (Extends across 5725MHz band)											
Mode	N _{TX}	Freq. (MHz)	Conducted Power without duty factor					Duty factor (dB)	Total Power (mW)	Total Power (dBm)	Limit (dBm)
			Chain 0	Chain 1	Chain 2	Chain 3	Total Power (dBm)				
VHT20	4	5720	9.52	9.23	9.62	9.14	15.40	0.19	36.246	15.59	29.88
VHT40	4	5710	6.98	6.70	6.76	6.63	12.79	0.20	19.907	12.99	29.88
VHT80	4	5690	2.90	2.83	3.36	3.51	9.18	0.13	8.532	9.31	29.88

Note: Correlated antenna gain is 6.12dBi > 6 dBi. Limit shall be reduced to 30 dBm – (6.12 dBi – 6 dBi) = 29.88 dBm.

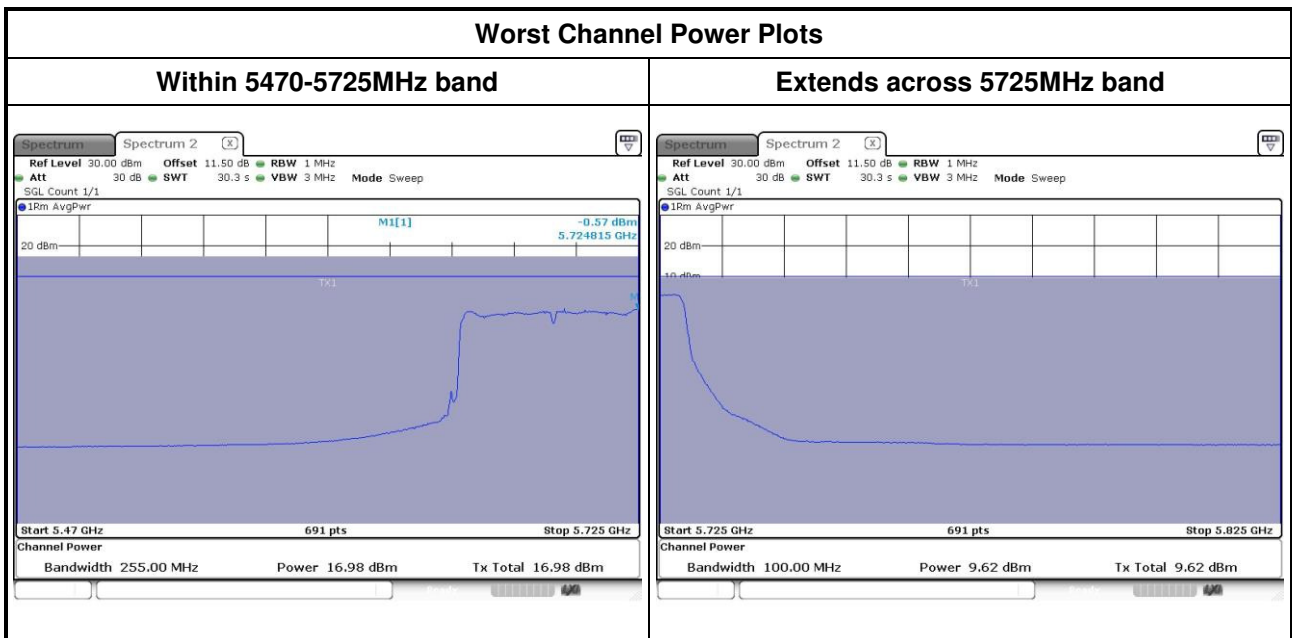

Note: Above plots are without duty factor.

For Frequency band 5725-5850 MHz									
Mode	N _{TX}	Freq. (MHz)	Conducted Power (dBm)				Total Power (mW)	Total Power (dBm)	Limit (dBm)
			Chain 0	Chain 1	Chain 2	Chain 3			
VHT20	4	5745	14.28	13.16	14.52	13.58	98.610	19.94	29.88
VHT20	4	5785	17.50	18.25	17.82	18.15	248.916	23.96	29.88
VHT20	4	5825	15.32	14.83	14.78	15.62	130.986	21.17	29.88
VHT40	4	5755	12.80	12.04	12.68	12.96	73.355	18.65	29.88
VHT40	4	5795	17.85	16.95	17.57	16.64	213.778	23.30	29.88
VHT80	4	5775	12.58	12.39	12.95	12.82	74.318	18.71	29.88

Note:

- Correlated antenna gain is 6.12dBi > 6 dBi.
Limit shall be reduced to 30 dBm – (6.12 dBi – 6 dBi) = 29.88 dBm.

3.4 Peak Power Spectral Density

3.4.1 Limit of Peak Power Spectral Density

Frequency band 5150-5250 MHz		
Operating Mode		Limit
<input type="checkbox"/>	Outdoor access point	17 dBm / MHz
<input checked="" type="checkbox"/>	Indoor access point	17 dBm / MHz
<input type="checkbox"/>	Fixed point-to-point access points	17 dBm / MHz
<input type="checkbox"/>	Mobile and portable client devices	11 dBm / MHz

Frequency Band (MHz)		Limit
<input checked="" type="checkbox"/>	5250 ~ 5350	11 dBm / MHz
<input checked="" type="checkbox"/>	5470 ~ 5725	11 dBm / MHz
<input checked="" type="checkbox"/>	5725 ~ 5850	30 dBm /500 kHz

3.4.2 Test Procedures

For 5150~5250 MHz, 5250~5350 MHz, 5470~5725 MHz

- Method SA-1 (For non-beamforming 11ac VHT40)
 1. Set RBW = 1 MHz, VBW = 3 MHz, Sweep time = auto, Detector = RMS.
 2. Trace average 100 traces.
 3. Use the peak marker function to determine the maximum amplitude level.
- Method SA-2 Alternative (For non-beamforming 11ac VHT80, Beamforming: all modes)
 1. Set RBW = 1 MHz, VBW = 3 MHz, Detector = RMS.
 2. Set sweep time $\geq 10 * (\text{number of points in sweep}) * (\text{total on/off period of the transmitted signal})$.
 3. Perform a single sweep.
 4. Use the peak marker function to determine the maximum amplitude level.
 5. Add $10 \log(1/x)$, where x is the duty cycle.

For 5725~5850 MHz

- Method SA-1 (For non-beamforming 11a / 11ac VHT20 / VHT40)
 1. Set RBW = 500 kHz, VBW = 2 MHz, Sweep time = auto, Detector = RMS.
 2. Trace average 100 traces.
 3. Use the peak marker function to determine the maximum amplitude level.
- Method SA-2 Alternative (For non-beamforming 11ac VHT80 , Beamforming: all modes)
 1. Set RBW = 500 kHz, VBW = 2 MHz, Detector = RMS.
 2. Set sweep time $\geq 10 * (\text{number of points in sweep}) * (\text{total on/off period of the transmitted signal})$.
 3. Perform a single sweep.
 4. Use the peak marker function to determine the maximum amplitude level.
 5. Add $10 \log(1/x)$, where x is the duty cycle.

3.4.3 Test Setup

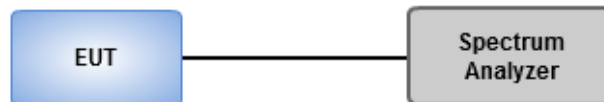

3.4.4 Test Result of Peak Power Spectral Density

Non-beamforming mode

Frequency band			5470~5725 MHz			
Condition			Peak Power Spectral Density (dBm/MHz)			
Mode	N _{TX}	Freq. (MHz)	PPSD w/o D.F (dBm/MHz)	Duty Factor (dB)	PPSD with D.F (dBm/MHz)	PPSD Limit (dBm/MHz)
VHT40	4	5590	6.96	0.00	6.96	10.98
VHT80	4	5690	4.07	0.21	4.28	10.98

Note:

1. D.F is duty factor.
2. Test result is bin-by-bin summing measured value of each TX port.
3. Correlated antenna gain is 6.02dBi > 6 dBi.
Limit shall be reduced to 11 dBm – (6.02 dBi – 6 dBi) = 10.98 dBm

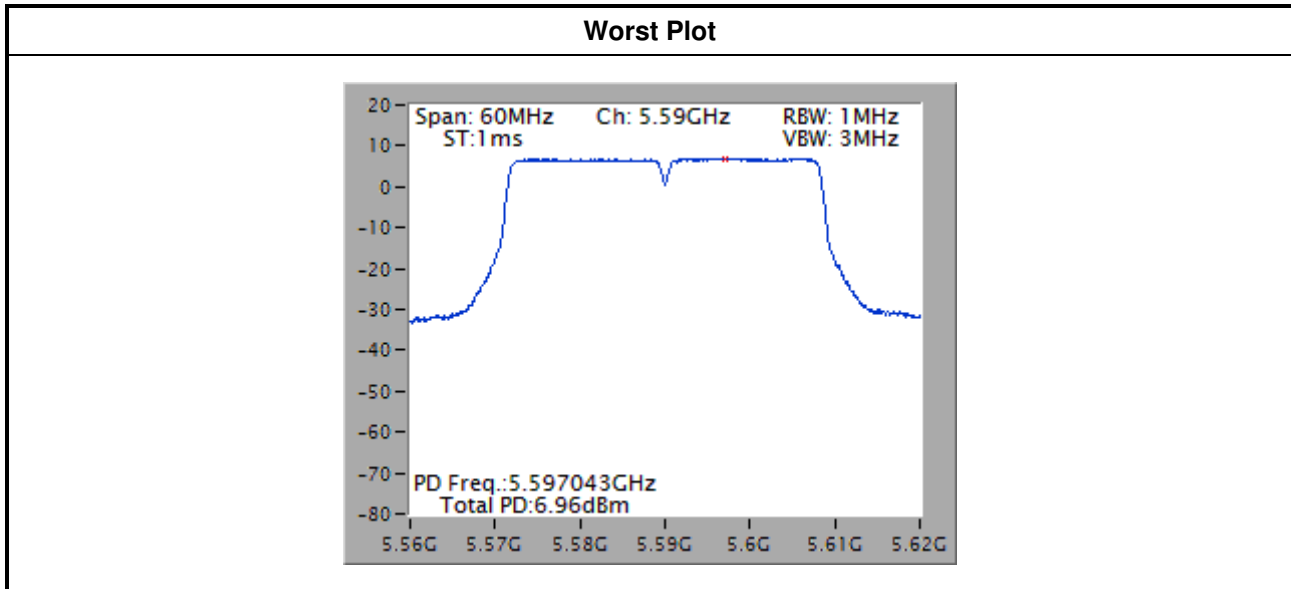

For Frequency band 5725-5850 MHz						
Condition			Peak Power Spectral Density (dBm/500kHz)			
Modulation Mode	N _{TX}	Freq. (MHz)	PPSD w/o D.F (dBm/500kHz)	Duty Factor (dB)	PPSD with D.F (dBm/500kHz)	PPSD Limit (dBm/500kHz)
11a	4	5745	6.24	0.00	6.24	29.88
11a	4	5785	7.10	0.00	7.10	29.88
11a	4	5825	5.89	0.00	5.89	29.88
VHT20	4	5745	6.36	0.00	6.36	29.88
VHT20	4	5785	9.09	0.00	9.09	29.88
VHT20	4	5825	8.79	0.00	8.79	29.88
VHT40	4	5755	2.31	0.00	2.31	29.88
VHT40	4	5795	6.19	0.00	6.19	29.88
VHT80	4	5775	-1.66	0.21	-1.45	29.88

Note:

1. D.F is duty factor.
2. Test result is bin-by-bin summing measured value of each TX port.
3. Correlated antenna gain is 6.12dBi > 6 dBi.

Limit shall be reduced to 30 dBm – (6.12 dBi – 6 dBi) = 29.88 dBm

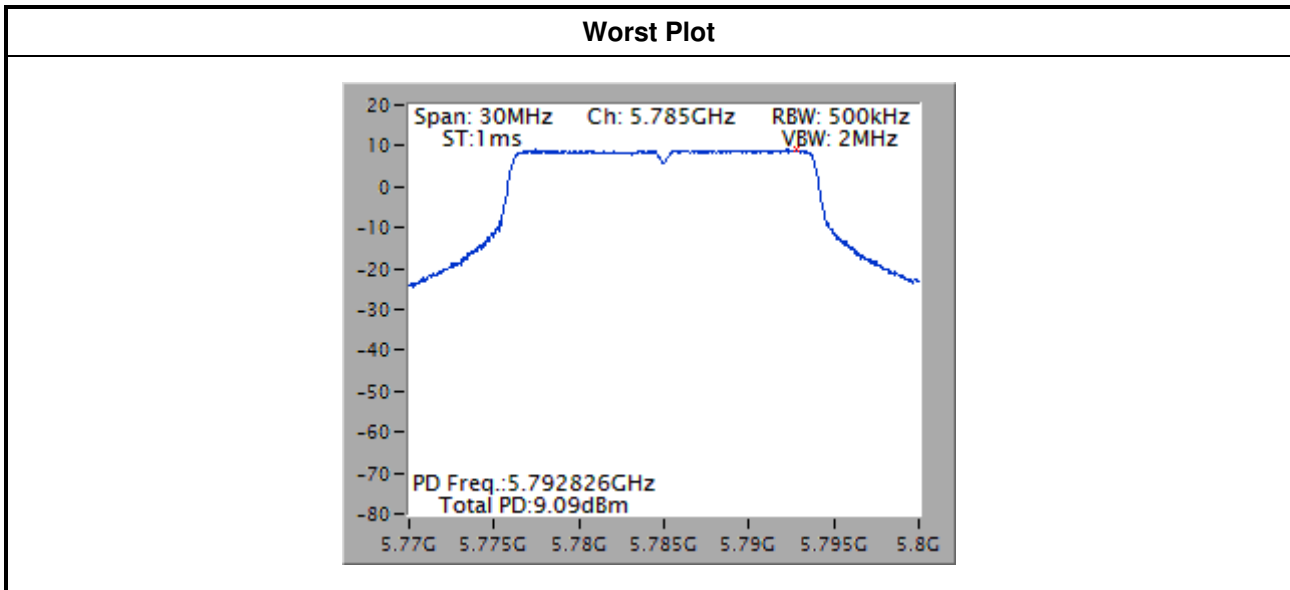

Beamforming mode

Frequency band			5150~5250 MHz / 5250~5350 MHz			
Condition			Peak Power Spectral Density (dBm/MHz)			
Mode	N _{TX}	Freq. (MHz)	PPSD w/o D.F (dBm/MHz)	Duty Factor (dB)	PPSD with D.F (dBm/MHz)	PPSD Limit (dBm/MHz)
VHT20	4	5180	-0.36	0.19	-0.17	16.98
VHT20	4	5200	-0.43	0.19	-0.24	16.98
VHT20	4	5240	-0.67	0.19	-0.48	16.98
VHT40	4	5190	-1.58	0.20	-1.38	16.98
VHT40	4	5230	-1.72	0.20	-1.52	16.98
VHT80	4	5210	-3.85	0.13	-3.72	16.98
VHT20	4	5260	8.04	0.19	8.23	10.98
VHT20	4	5300	8.11	0.19	8.30	10.98
VHT20	4	5320	7.86	0.19	8.05	10.98
VHT40	4	5270	5.21	0.20	5.41	10.98
VHT40	4	5310	2.95	0.20	3.15	10.98
VHT80	4	5290	-2.73	0.13	-2.60	10.98

Frequency band			5470~5725 MHz			
Condition			Peak Power Spectral Density (dBm/MHz)			
Mode	N _{TX}	Freq. (MHz)	PPSD w/o D.F (dBm/MHz)	Duty Factor (dB)	PPSD with D.F (dBm/MHz)	PPSD Limit (dBm/MHz)
VHT20	4	5500	7.61	0.19	7.80	10.98
VHT20	4	5580	7.53	0.19	7.72	10.98
VHT20	4	5700	6.42	0.19	6.61	10.98
VHT20	4	5720	8.20	0.19	8.39	10.98
VHT40	4	5510	1.17	0.20	1.37	10.98
VHT40	4	5590	6.68	0.20	6.88	10.98
VHT40	4	5670	5.27	0.20	5.47	10.98
VHT40	4	5710	1.04	0.20	1.24	10.98
VHT80	4	5530	-2.26	0.13	-2.13	10.98
VHT80	4	5610	4.60	0.13	4.73	10.98
VHT80	4	5690	4.08	0.13	4.21	10.98

Note:

1. D.F is duty factor.
2. Test result is bin-by-bin summing measured value of each TX port.
3. Correlated antenna gain for 5150~5350MHz is 6.02dBi > 6 dBi.
 For 5150~5250MHz, limit shall be reduced to 17 dBm – (6.02 dBi – 6 dBi) = 16.98 dBm.
 For 5250~5350MHz, and 5470~5725MHz, limit shall be reduced to 11 dBm – (6.02 dBi – 6 dBi) = 10.98 dBm.

Worst Plot

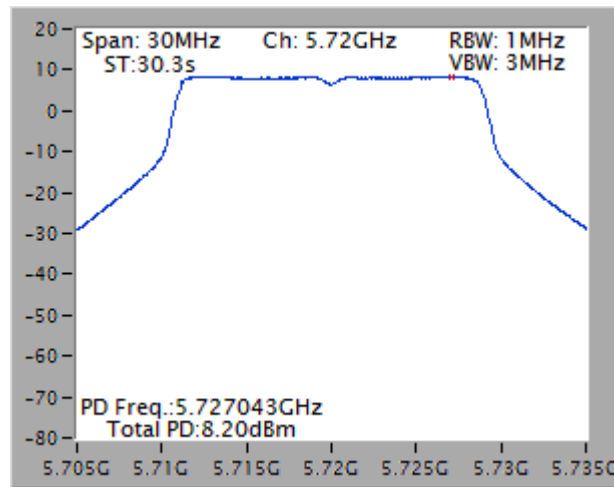

Note: Power density plot without duty factor.

For Frequency band 5725-5850 MHz						
Condition			Peak Power Spectral Density (dBm/500kHz)			
Modulation Mode	N _{TX}	Freq. (MHz)	PPSD w/o D.F (dBm/500kHz)	Duty Factor (dB)	PPSD with D.F (dBm/500kHz)	PPSD Limit (dBm/500kHz)
VHT20	4	5745	4.77	0.19	4.96	29.88
VHT20	4	5785	8.36	0.19	8.55	29.88
VHT20	4	5825	5.54	0.19	5.73	29.88
VHT40	4	5755	0.54	0.20	0.74	29.88
VHT40	4	5795	4.61	0.20	4.81	29.88
VHT80	4	5775	-1.43	0.13	-1.30	29.88

Note:

1. D.F is duty factor.
2. Test result is bin-by-bin summing measured value of each TX port.
3. Correlated antenna gain for 5725~5850MHz is 6.12dBi > 6 dBi.
Limit shall be reduced to 30 dBm – (6.12 dBi – 6 dBi) = 29.88 dBm

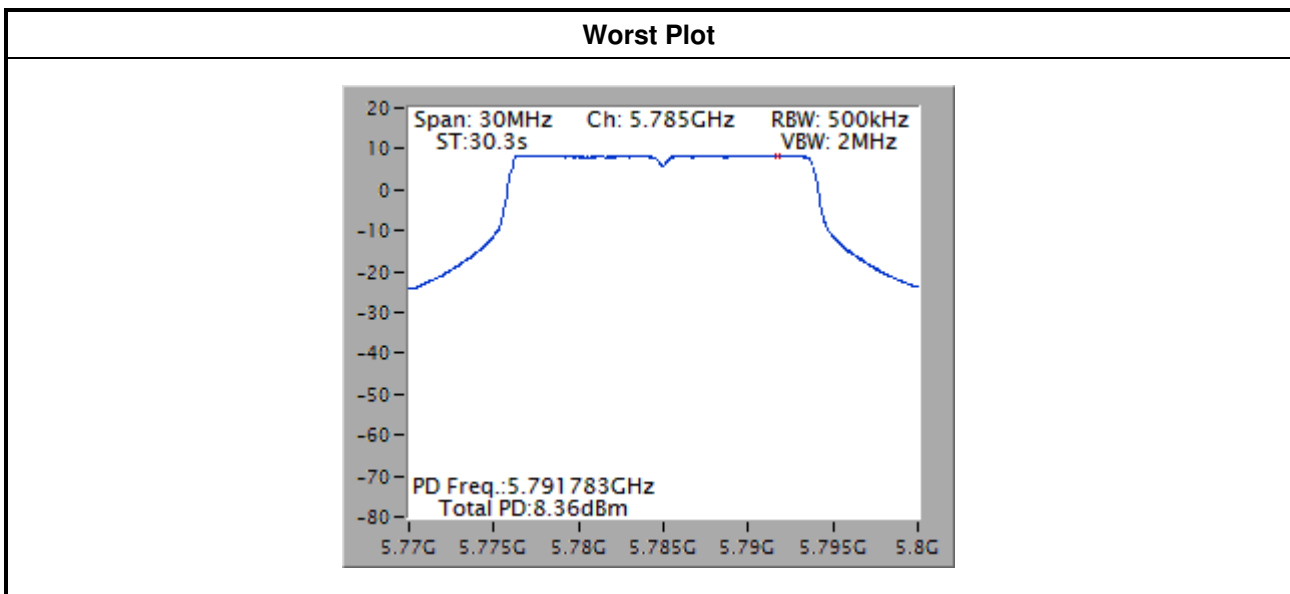

Note: Power density plot without duty factor.

3.5 Transmitter Radiated and Band Edge Emissions

3.5.1 Limit of Transmitter Radiated and Band Edge Emissions

Restricted Band Emissions Limit			
Frequency Range (MHz)	Field Strength (uV/m)	Field Strength (dBuV/m)	Measure Distance (m)
0.009~0.490	2400/F(kHz)	48.5 - 13.8	300
0.490~1.705	24000/F(kHz)	33.8 - 23	30
1.705~30.0	30	29	30
30~88	100	40	3
88~216	150	43.5	3
216~960	200	46	3
Above 960	500	54	3

Note 1:
Qusai-Peak value is measured for frequency below 1GHz except for 9–90 kHz, 110–490 kHz frequency band. Peak and average value are measured for frequency above 1GHz. The limit on average radio frequency emission is as above table. The limit on peak radio frequency emissions is 20 dB above the maximum permitted average emission limit

Note 2:
Measurements may be performed at a distance other than what is specified provided. When performing measurements at a distance other than that specified, the results shall be extrapolated to the specified distance using an extrapolation factor as below, Frequency at or above 30 MHz: 20 dB/decade Frequency below 30 MHz: 40 dB/decade.

Un-restricted band emissions above 1GHz Limit	
Operating Band	Limit
5.15 - 5.25 GHz 5.25 - 5.35 GHz 5.47 - 5.725 GHz	e.i.r.p. -27 dBm [68.2 dBuV/m@3m]
5.725 - 5.850 GHz	<input checked="" type="checkbox"/> 15.407(b)(4)(i) All emissions shall be limited to a level of -27 dBm/MHz at 75 MHz or more above or below the band edge increasing linearly to 10 dBm/MHz at 25 MHz above or below the band edge, and from 25 MHz above or below the band edge increasing linearly to a level of 15.6 dBm/MHz at 5 MHz above or below the band edge, and from 5 MHz above or below the band edge increasing linearly to a level of 27 dBm/MHz at the band edge.
	<input type="checkbox"/> 15.407(b)(4)(ii) ,compliance with the emission limits in § 15.247(d) Shall be at least 30dB below that in the 100 kHz bandwidth within the band that contains the highest level of the desired power,. Attenuation below the general limits specified in §15.209(a) is not required. In addition,radiated emissions which fall in the restricted bands, as defined in §15.205(a), must also comply with the radiated emission limits specified in §15.209(a) (see § 15.205(c))

Note 1: Measurements may be performed at a distance other than the limit distance provided they are not performed in the near field and the emissions to be measured can be detected by the measurement equipment. When performing measurements at a distance other than that specified, the results shall be extrapolated to the specified distance using an extrapolation factor of 20 dB/decade (inverse of linear distance for field-strength measurements, inverse of linear distance-squared for power-density measurements).

3.5.2 Test Procedures

1. Measurement is made at a semi-anechoic chamber that incorporates a turntable allowing a EUT rotation of 360°. A continuously-rotating, remotely-controlled turntable is installed at the test site to support the EUT and facilitate determination of the direction of maximum radiation for each EUT emission frequency. The EUT is placed at test table. For emissions testing at or below 1 GHz, the table height is 80 cm above the reference ground plane. For emission measurements above 1 GHz, the table height is 1.5 m
2. Measurement is made with the antenna positioned in both the horizontal and vertical planes of polarization. The measurement antenna is varied in height (1 m ~ 4m) above the reference ground plane to obtain the maximum signal strength. Distance between EUT and antenna is 3 m.
3. This investigation is performed with the EUT rotated 360°, the antenna height scanned between 1 m and 4 m, and the antenna rotated to repeat the measurements for both the horizontal and vertical antenna polarizations.

Note:

1. 120kHz measurement bandwidth of test receiver and Quasi-peak detector is for radiated emission below 1GHz.
2. RBW=1MHz, VBW=3MHz and Peak detector is for peak measured value of radiated emission above 1GHz.
3. RBW=1MHz, VBW=1/T and Peak detector is for average measured value of radiated emission above 1GHz.

3.5.3 Test Setup

Radiated Emissions below 1 GHz

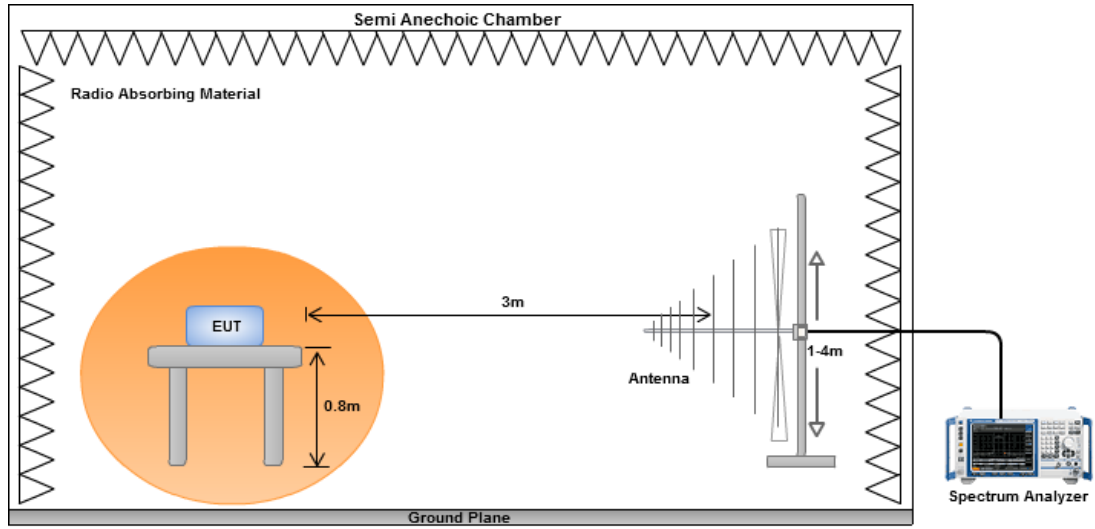

Radiated Emissions above 1 GHz

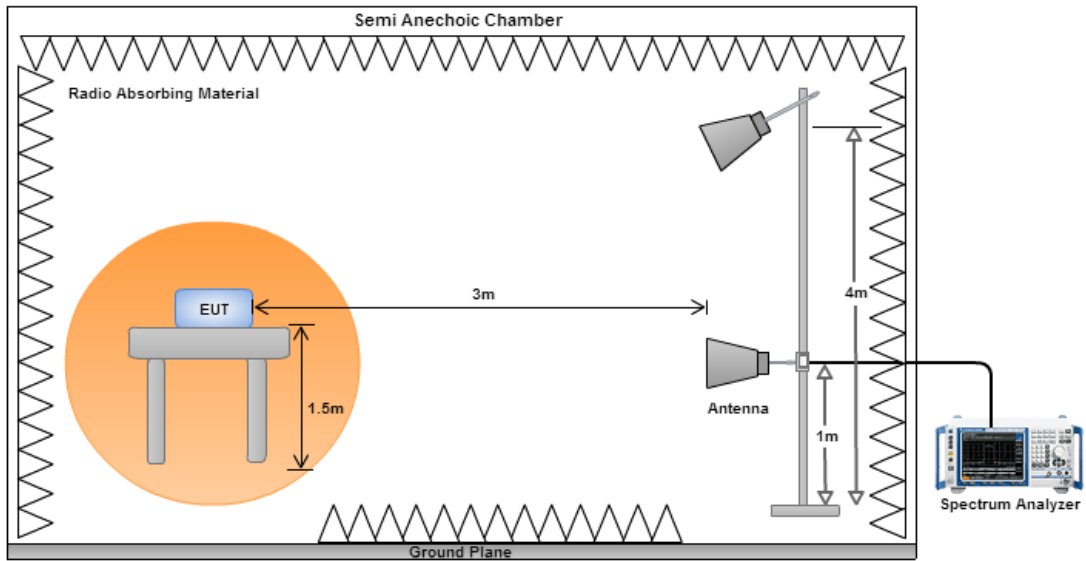

Non- beamforming mode

3.5.4 Transmitter Radiated Band Edge for 11a

Modulation	11a	Test Freq. (MHz)	5745
Polarization	Horizontal		

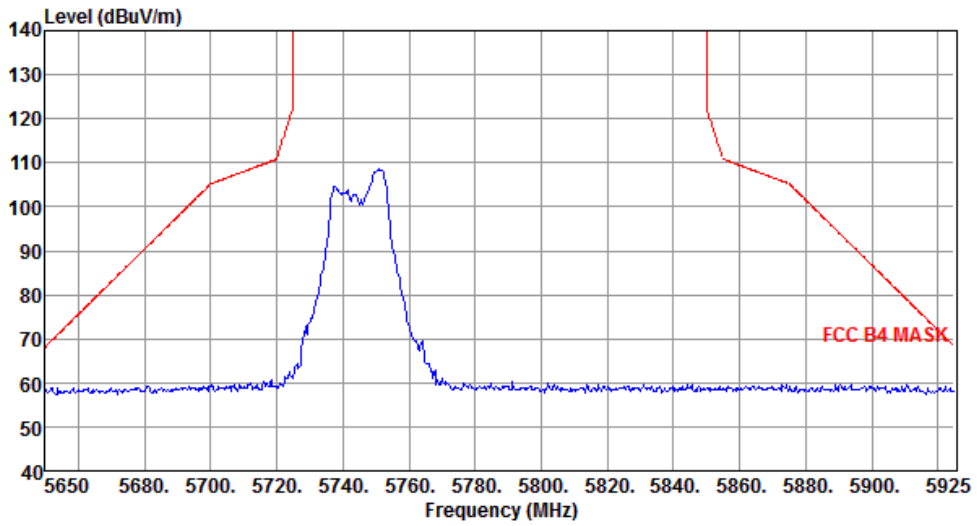

Modulation	11a	Test Freq. (MHz)	5745
Polarization	Vertical		

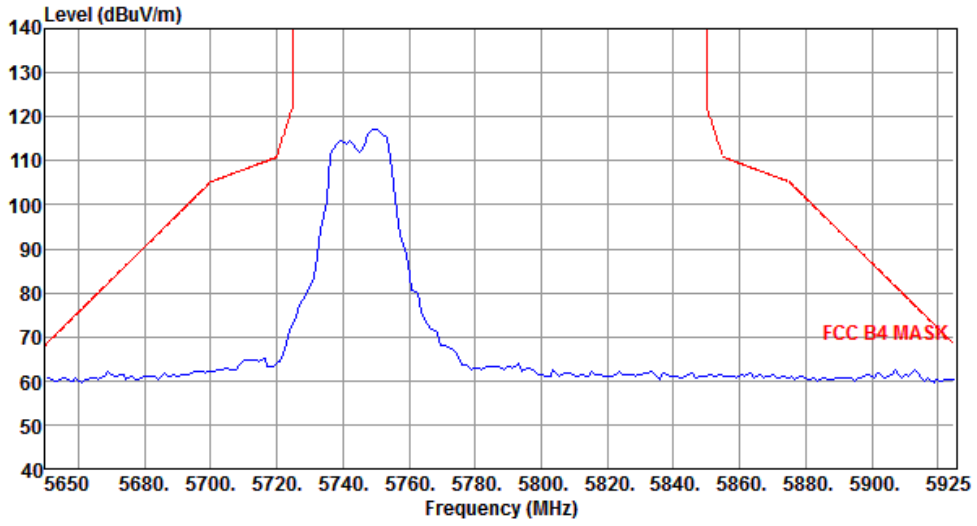

Modulation	11a	Test Freq. (MHz)	5785
Polarization	Horizontal		

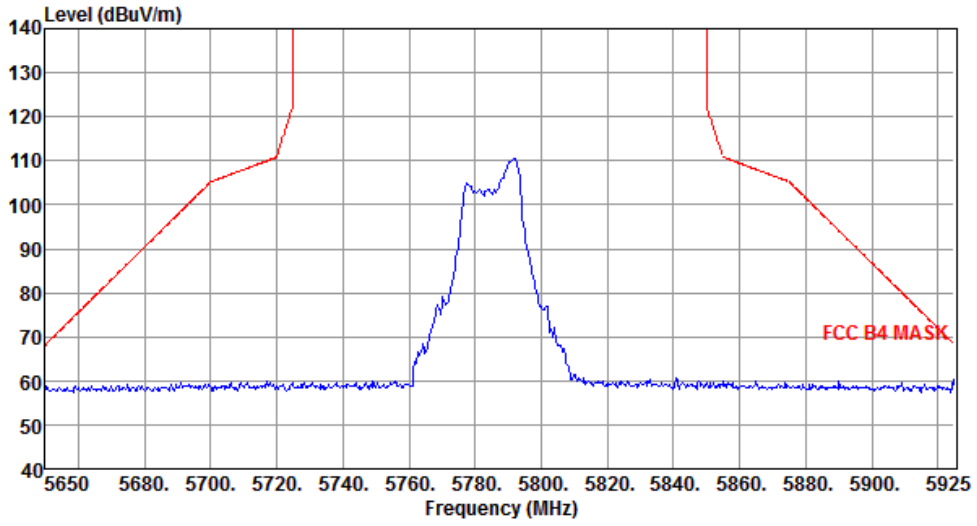

Modulation	11a	Test Freq. (MHz)	5785
Polarization	Vertical		

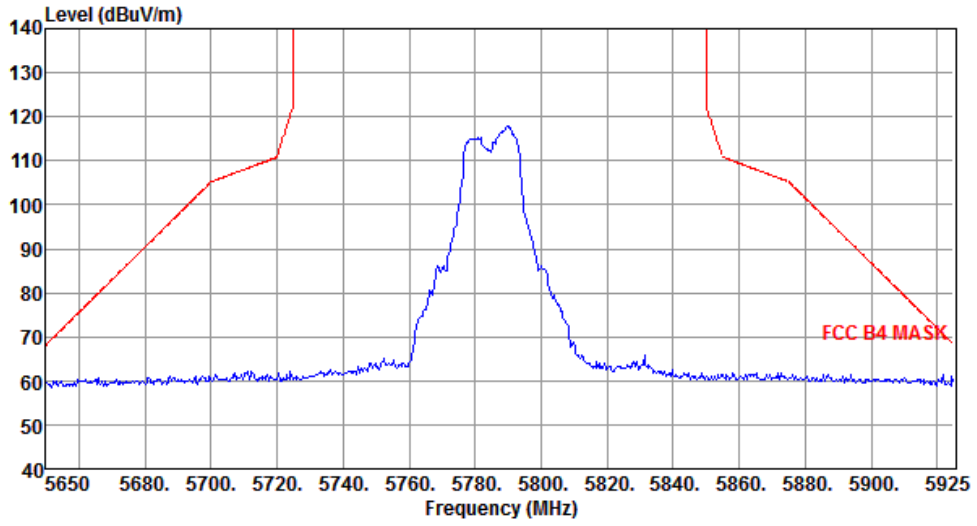

Modulation	11a	Test Freq. (MHz)	5825
Polarization	Horizontal		

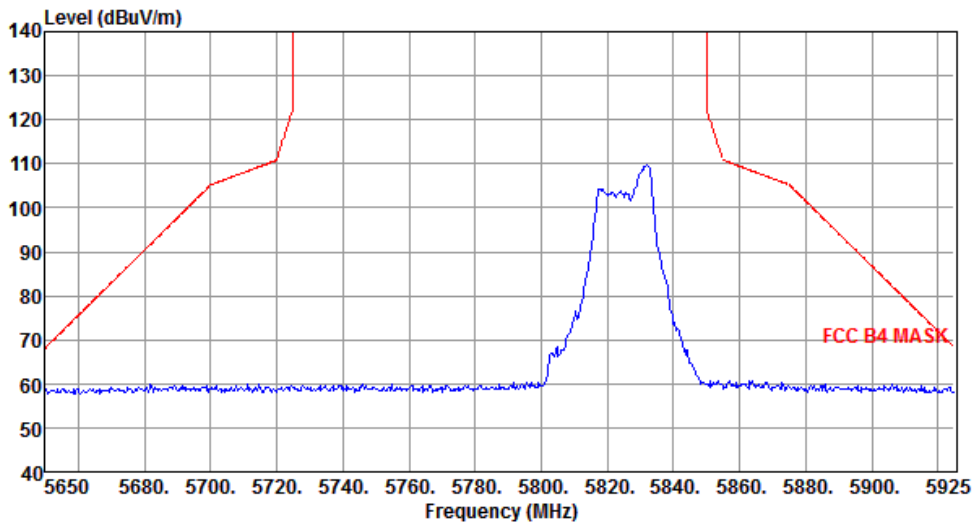

Modulation	11a	Test Freq. (MHz)	5825
Polarization	Vertical		

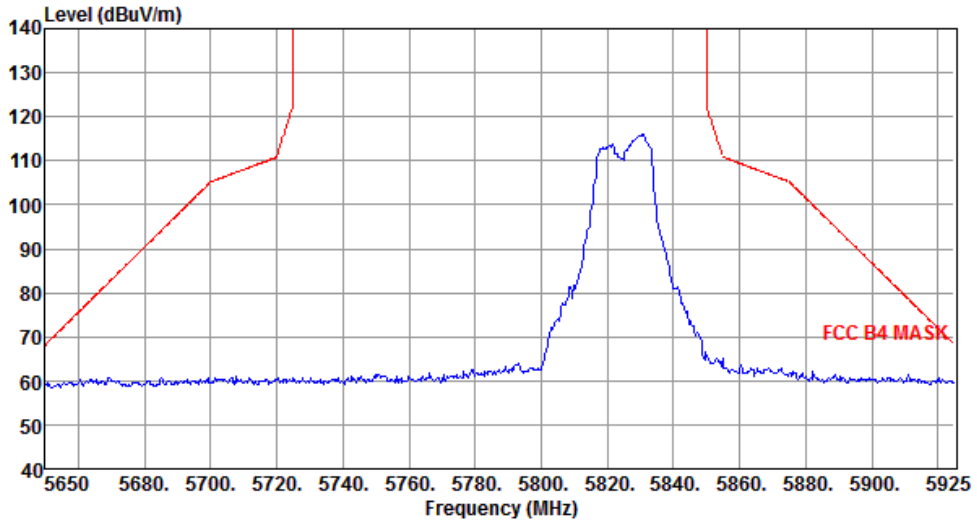

3.5.5 Transmitter Radiated Band Edge for VHT20

Modulation	VHT20	Test Freq. (MHz)	5745
Polarization	Horizontal		

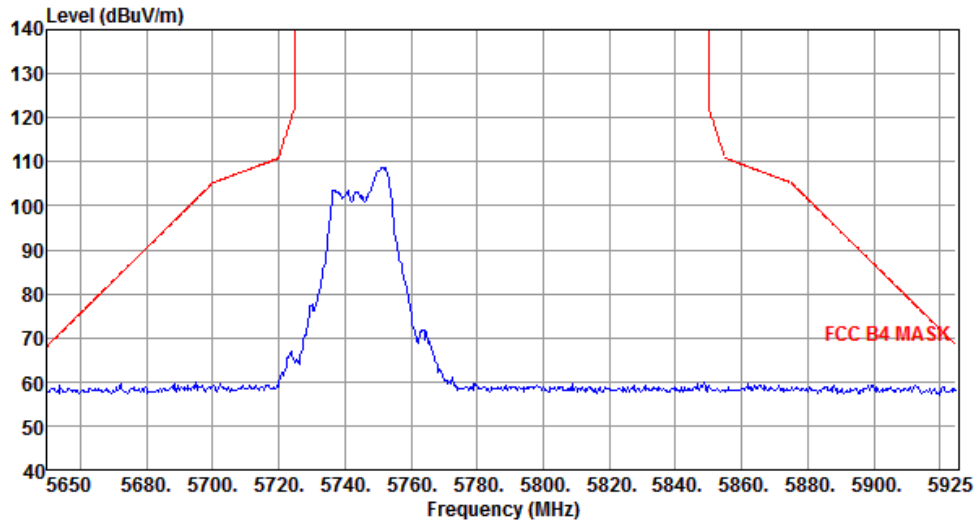

Modulation	VHT20	Test Freq. (MHz)	5745
Polarization	Vertical		

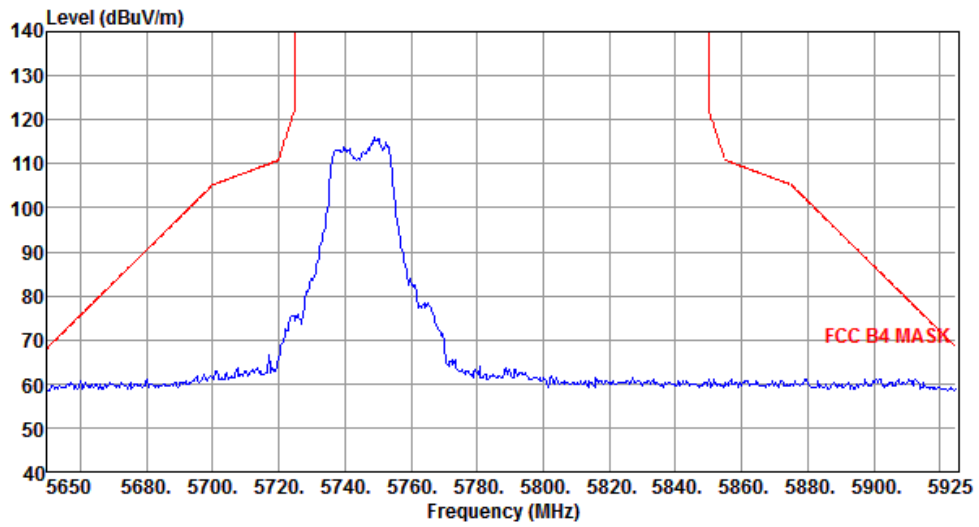

Modulation	VHT20	Test Freq. (MHz)	5785
Polarization	Horizontal		

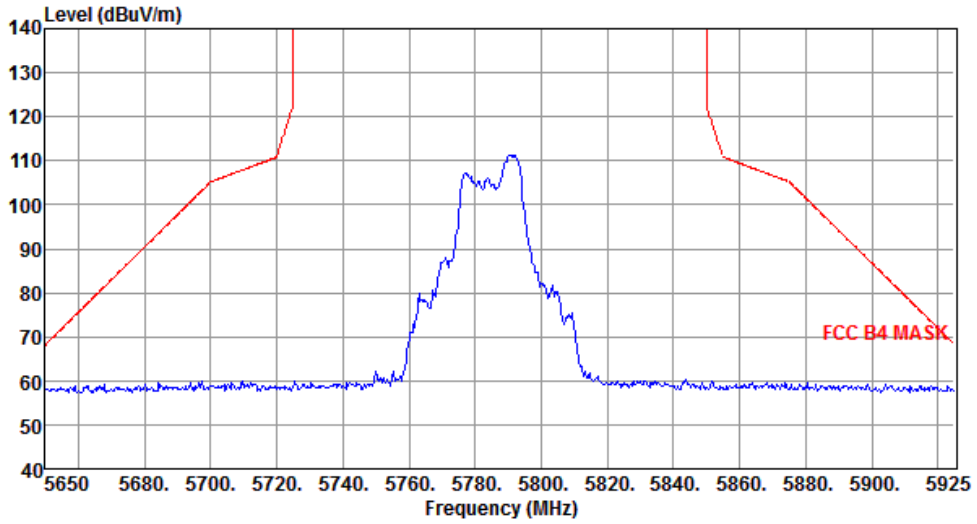

Modulation	VHT20	Test Freq. (MHz)	5785
Polarization	Vertical		

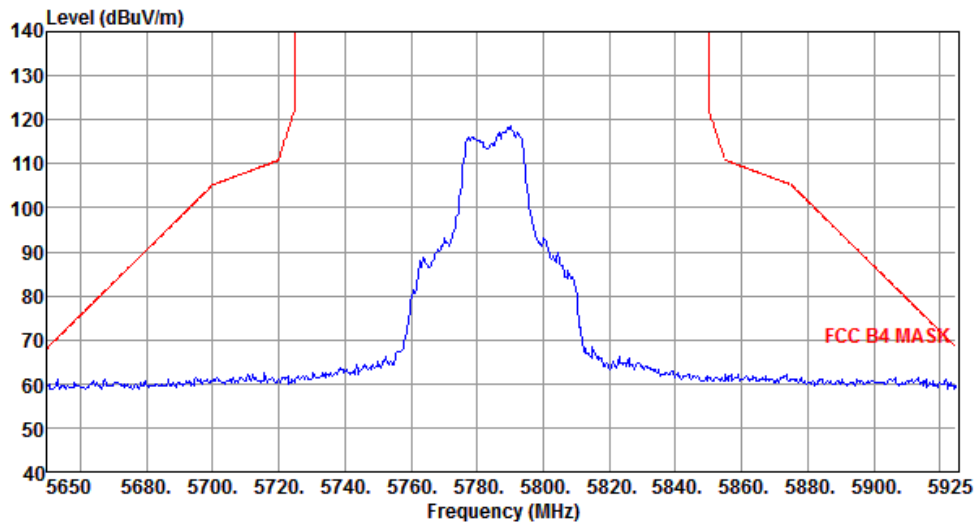

Modulation	VHT20	Test Freq. (MHz)	5825
Polarization	Horizontal		

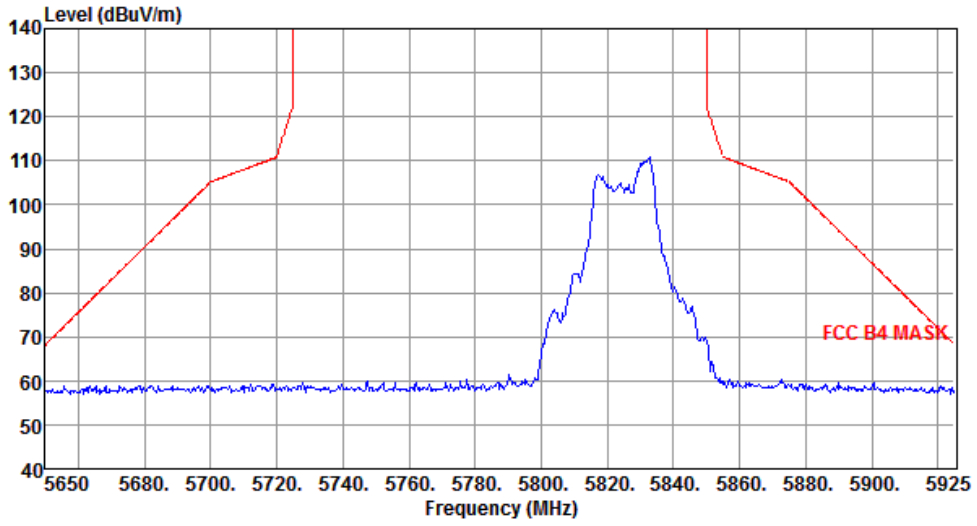

Modulation	VHT20	Test Freq. (MHz)	5825
Polarization	Vertical		

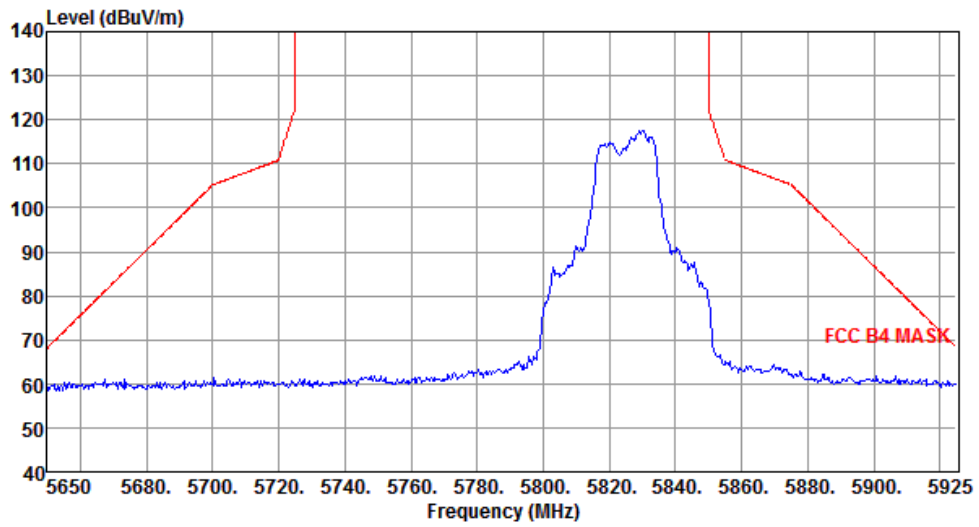

3.5.6 Transmitter Radiated Band Edge for VHT40

Modulation	VHT40	Test Freq. (MHz)	5755
Polarization	Horizontal		

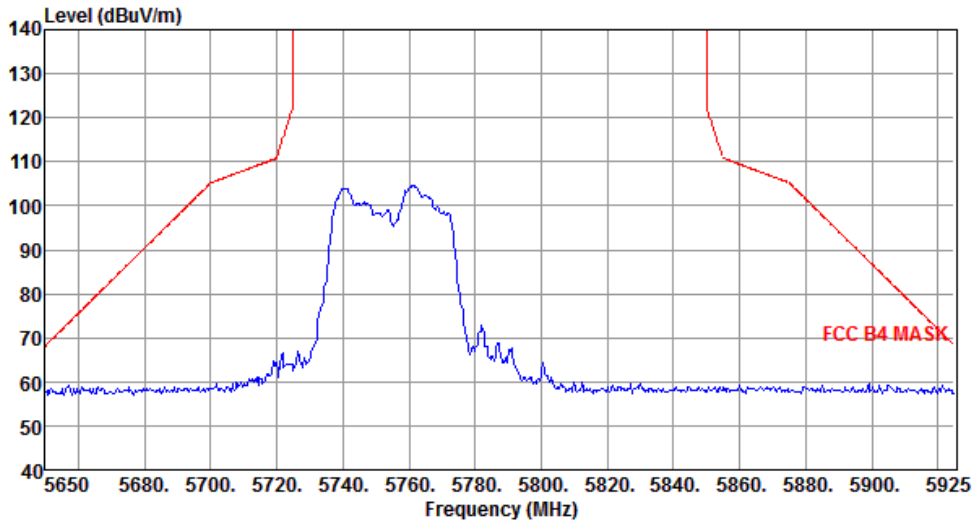

Modulation	VHT40	Test Freq. (MHz)	5755
Polarization	Vertical		

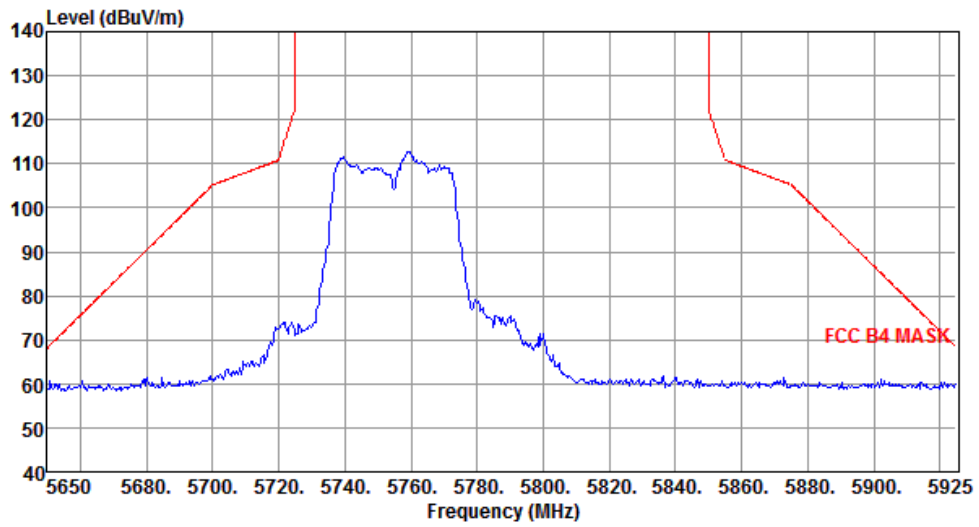

Modulation	VHT40	Test Freq. (MHz)	5795
Polarization	Horizontal		

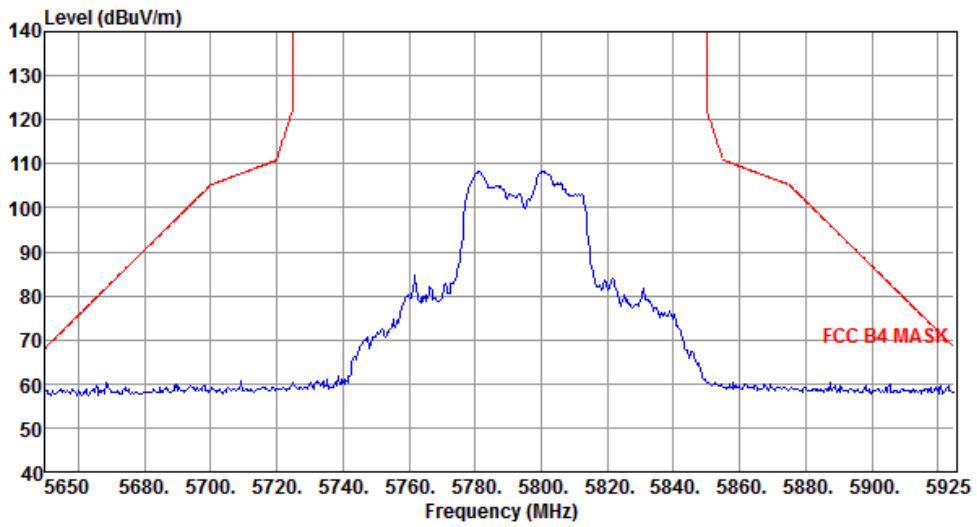

Modulation	VHT40	Test Freq. (MHz)	5795
Polarization	Vertical		

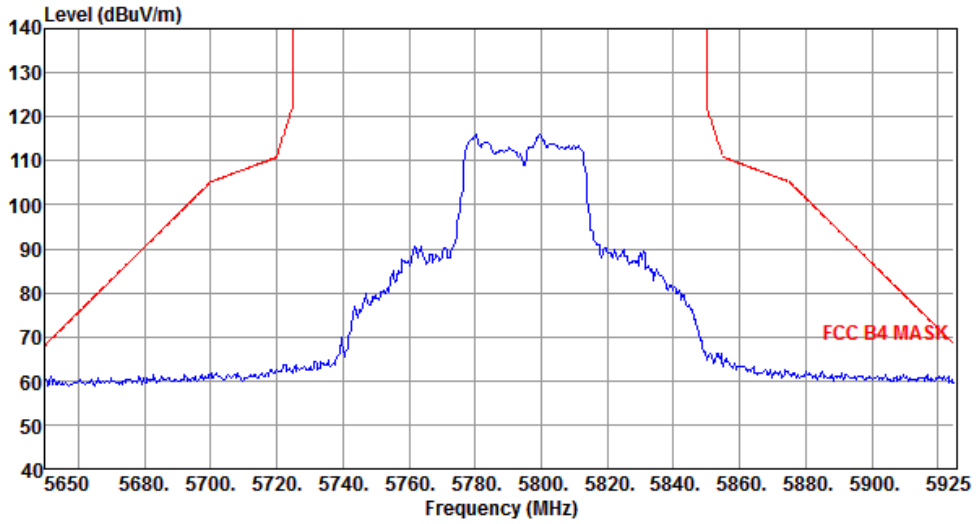

3.5.7 Transmitter Radiated Band Edge for VHT80

Modulation	VHT80	Test Freq. (MHz)	5775
Polarization	Horizontal		

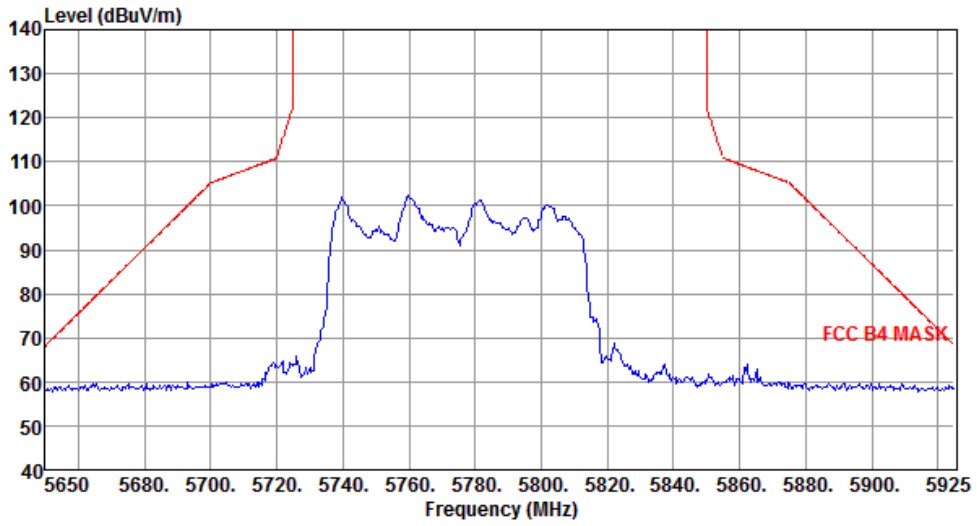

Modulation	VHT80	Test Freq. (MHz)	5775
Polarization	Vertical		

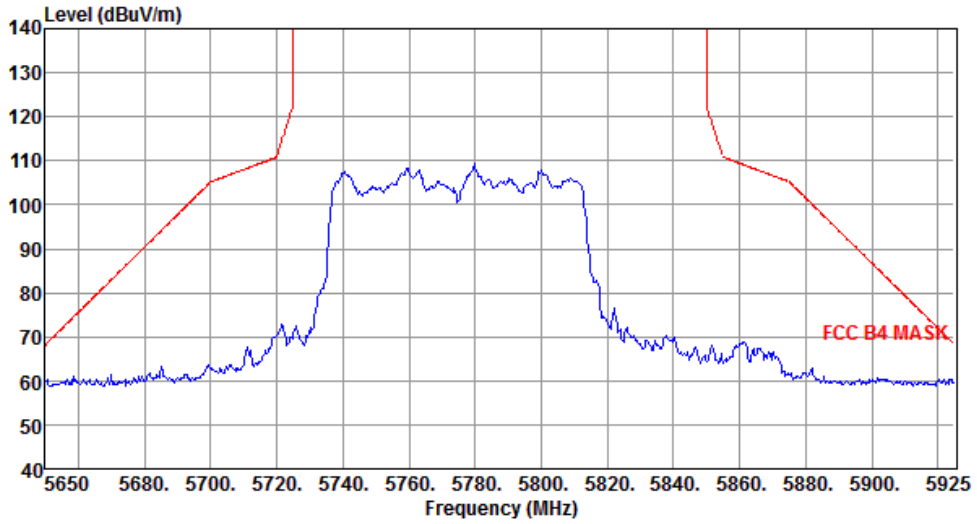

3.5.8 Transmitter Radiated Unwanted Emissions (Below 1GHz)

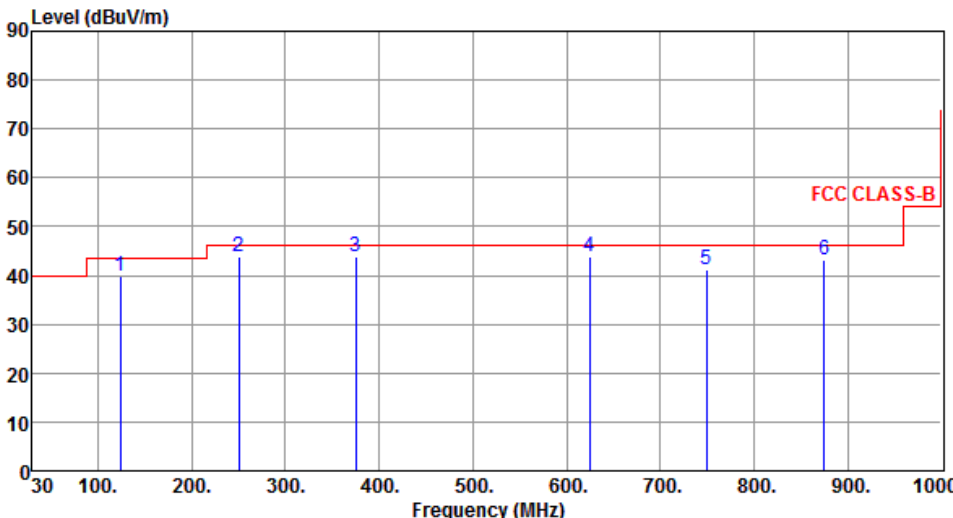
Modulation	VHT40	Test Freq. (MHz)	5590																																																															
Polarization	Horizontal																																																																	
																																																																		
	<table border="1"> <thead> <tr> <th>Freq. MHz</th> <th>Emission level dBuV/m</th> <th>Limit dBuV/m</th> <th>Margin dB</th> <th>SA reading dBuV</th> <th>Factor dB</th> <th>Remark</th> <th>ANT High cm</th> <th>Turn Table deg</th> </tr> </thead> <tbody> <tr> <td>1</td> <td>124.09</td> <td>39.92</td> <td>43.50</td> <td>-3.58</td> <td>58.42</td> <td>-18.50</td> <td>Peak</td> <td>---</td> </tr> <tr> <td>2</td> <td>249.99</td> <td>43.98</td> <td>46.00</td> <td>-2.02</td> <td>61.70</td> <td>-17.72</td> <td>QP</td> <td>100</td> </tr> <tr> <td>3</td> <td>374.99</td> <td>43.75</td> <td>46.00</td> <td>-2.25</td> <td>57.86</td> <td>-14.11</td> <td>QP</td> <td>100</td> </tr> <tr> <td>4</td> <td>624.99</td> <td>43.90</td> <td>46.00</td> <td>-2.10</td> <td>53.00</td> <td>-9.10</td> <td>QP</td> <td>135</td> </tr> <tr> <td>5</td> <td>749.74</td> <td>41.17</td> <td>46.00</td> <td>-4.83</td> <td>48.11</td> <td>-6.94</td> <td>Peak</td> <td>---</td> </tr> <tr> <td>6</td> <td>874.99</td> <td>43.24</td> <td>46.00</td> <td>-2.76</td> <td>48.80</td> <td>-5.56</td> <td>QP</td> <td>100</td> </tr> </tbody> </table>	Freq. MHz	Emission level dBuV/m	Limit dBuV/m	Margin dB	SA reading dBuV	Factor dB	Remark	ANT High cm	Turn Table deg	1	124.09	39.92	43.50	-3.58	58.42	-18.50	Peak	---	2	249.99	43.98	46.00	-2.02	61.70	-17.72	QP	100	3	374.99	43.75	46.00	-2.25	57.86	-14.11	QP	100	4	624.99	43.90	46.00	-2.10	53.00	-9.10	QP	135	5	749.74	41.17	46.00	-4.83	48.11	-6.94	Peak	---	6	874.99	43.24	46.00	-2.76	48.80	-5.56	QP	100		
Freq. MHz	Emission level dBuV/m	Limit dBuV/m	Margin dB	SA reading dBuV	Factor dB	Remark	ANT High cm	Turn Table deg																																																										
1	124.09	39.92	43.50	-3.58	58.42	-18.50	Peak	---																																																										
2	249.99	43.98	46.00	-2.02	61.70	-17.72	QP	100																																																										
3	374.99	43.75	46.00	-2.25	57.86	-14.11	QP	100																																																										
4	624.99	43.90	46.00	-2.10	53.00	-9.10	QP	135																																																										
5	749.74	41.17	46.00	-4.83	48.11	-6.94	Peak	---																																																										
6	874.99	43.24	46.00	-2.76	48.80	-5.56	QP	100																																																										
<p>Note 1: Emission Level (dBuV/m) = SA Reading (dBuV/m) + Factor* (dB) *Factor includes antenna factor , cable loss and amplifier gain Note 2: Margin (dB) = Emission level (dBuV/m) – Limit (dBuV/m). Note 3: All spurious emissions below 30MHz are more than 20 dB below the limit.</p>																																																																		

Modulation	VHT40	Test Freq. (MHz)	5590
Polarization	Vertical		

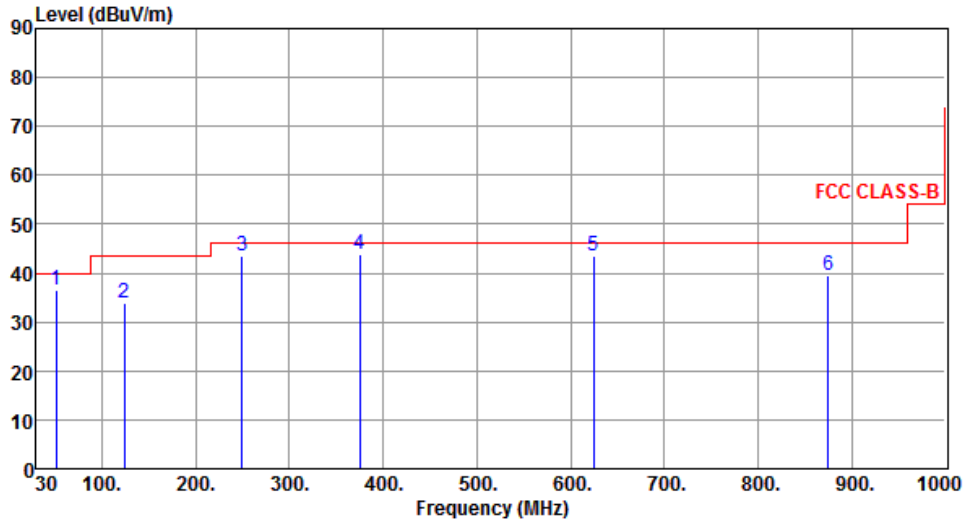

	Freq. MHz	Emission level dBuV/m	Limit dBuV/m	Margin dB	SA reading dBuV	Factor dB	Remark	ANT High cm	Turn Table deg
1	51.34	36.64	40.00	-3.36	53.16	-16.52	Peak	---	---
2	124.09	34.00	43.50	-9.50	52.50	-18.50	Peak	---	---
3	249.22	43.40	46.00	-2.60	61.14	-17.74	Peak	---	---
4	374.99	43.86	46.00	-2.14	57.97	-14.11	QP	136	155
5	624.61	43.55	46.00	-2.45	52.66	-9.11	Peak	---	---
6	874.87	39.61	46.00	-6.39	45.17	-5.56	Peak	---	---

Note 1: Emission Level (dBuV/m) = SA Reading (dBuV/m) + Factor* (dB)

*Factor includes antenna factor , cable loss and amplifier gain

Note 2: Margin (dB) = Emission level (dBuV/m) – Limit (dBuV/m).

Note 3: All spurious emissions below 30MHz are more than 20 dB below the limit.

Modulation	VHT80	Test Freq. (MHz)	5610
Polarization	Horizontal		

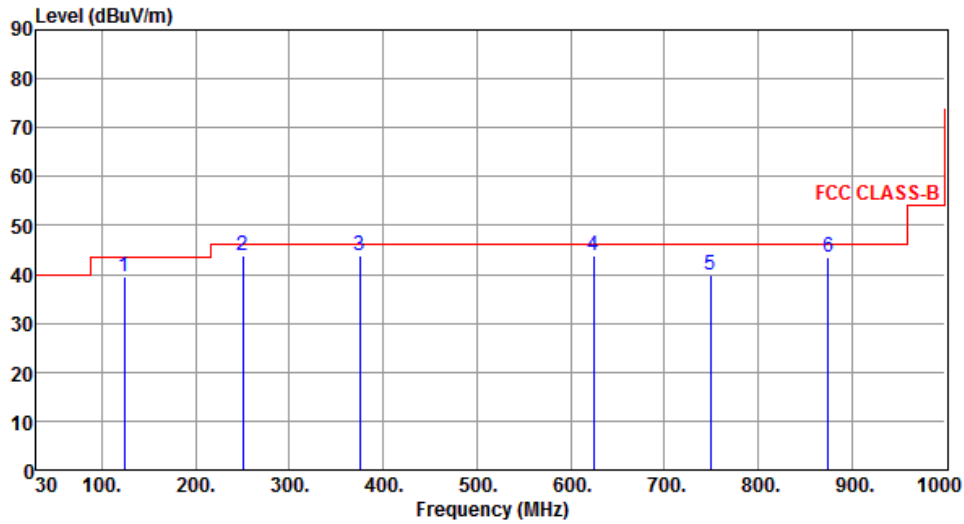

	Freq. MHz	Emission level dBuV/m	Limit dBuV/m	Margin dB	SA reading dBuV	Factor dB	Remark	ANT High cm	Turn Table deg
1	124.09	39.53	43.50	-3.97	58.03	-18.50	Peak	---	---
2	249.99	43.89	46.00	-2.11	61.61	-17.72	QP	100	228
3	374.99	43.86	46.00	-2.14	57.97	-14.11	QP	100	222
4	624.99	43.94	46.00	-2.06	53.04	-9.10	QP	132	210
5	749.74	39.88	46.00	-6.12	46.82	-6.94	Peak	---	---
6	874.87	43.36	46.00	-2.64	48.92	-5.56	Peak	---	---

Note 1: Emission Level (dBuV/m) = SA Reading (dBuV/m) + Factor* (dB)

*Factor includes antenna factor , cable loss and amplifier gain

Note 2: Margin (dB) = Emission level (dBuV/m) – Limit (dBuV/m).

Note 3: All spurious emissions below 30MHz are more than 20 dB below the limit.

Modulation	VHT80	Test Freq. (MHz)	5610
Polarization	Vertical		

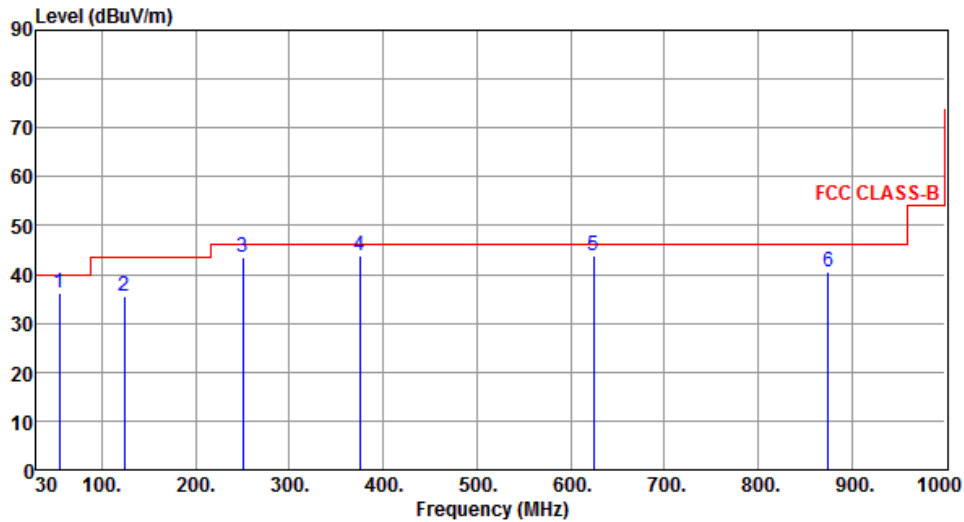

	Freq. MHz	Emission level dBuV/m	Limit dBuV/m	Margin dB	SA reading dBuV	Factor dB	Remark	ANT High cm	Turn Table deg
1	54.26	36.05	40.00	-3.95	52.90	-16.85	QP	100	20
2	124.09	35.70	43.50	-7.80	54.20	-18.50	Peak	---	---
3	249.99	43.61	46.00	-2.39	61.33	-17.72	QP	170	194
4	374.99	43.91	46.00	-2.09	58.02	-14.11	QP	114	154
5	624.99	43.97	46.00	-2.03	53.07	-9.10	QP	100	245
6	874.87	40.46	46.00	-5.54	46.02	-5.56	Peak	---	---

Note 1: Emission Level (dBuV/m) = SA Reading (dBuV/m) + Factor* (dB)

*Factor includes antenna factor , cable loss and amplifier gain

Note 2: Margin (dB) = Emission level (dBuV/m) – Limit (dBuV/m).

Note 3: All spurious emissions below 30MHz are more than 20 dB below the limit.

Modulation	VHT40	Test Freq. (MHz)	5795
Polarization	Horizontal		

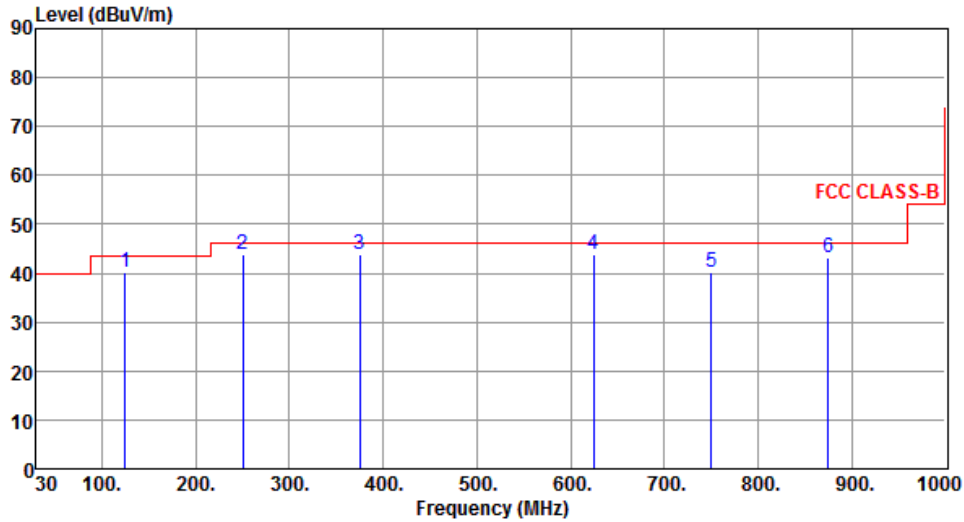

	Freq. MHz	Emission level dBuV/m	Limit dBuV/m	Margin dB	SA reading dBuV	Factor dB	Remark	ANT High cm	Turn Table deg
1	124.38	40.04	43.50	-3.46	58.52	-18.48	Peak	---	---
2	249.99	43.80	46.00	-2.20	61.52	-17.72	QP	100	262
3	374.99	43.95	46.00	-2.05	58.06	-14.11	QP	100	223
4	624.99	43.89	46.00	-2.11	52.99	-9.10	QP	121	221
5	749.82	40.16	46.00	-5.84	47.09	-6.93	Peak	---	---
6	874.99	43.25	46.00	-2.75	48.81	-5.56	QP	100	207

Note 1: Emission Level (dBuV/m) = SA Reading (dBuV/m) + Factor* (dB)

*Factor includes antenna factor , cable loss and amplifier gain

Note 2: Margin (dB) = Emission level (dBuV/m) – Limit (dBuV/m).

Note 3: All spurious emissions below 30MHz are more than 20 dB below the limit.

Modulation	VHT40	Test Freq. (MHz)	5795
Polarization	Vertical		

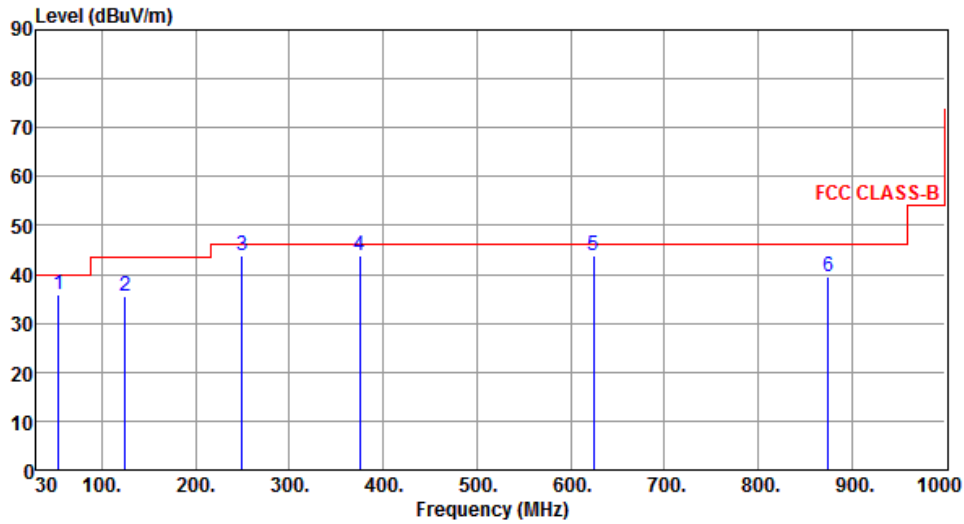

	Freq. MHz	Emission level dBuV/m	Limit dBuV/m	Margin dB	SA reading dBuV	Factor dB	Remark	ANT High cm	Turn Table deg
1	53.79	35.81	40.00	-4.19	52.60	-16.79	QP	100	13
2	124.38	35.56	43.50	-7.94	54.04	-18.48	Peak	---	---
3	249.47	43.79	46.00	-2.21	61.52	-17.73	Peak	---	---
4	374.99	43.87	46.00	-2.13	57.98	-14.11	QP	122	162
5	624.99	43.92	46.00	-2.08	53.02	-9.10	QP	100	249
6	874.91	39.55	46.00	-6.45	45.11	-5.56	Peak	---	---

Note 1: Emission Level (dBuV/m) = SA Reading (dBuV/m) + Factor* (dB)

*Factor includes antenna factor , cable loss and amplifier gain

Note 2: Margin (dB) = Emission level (dBuV/m) – Limit (dBuV/m).

Note 3: All spurious emissions below 30MHz are more than 20 dB below the limit.

3.5.9 Transmitter Radiated Unwanted Emissions (Above 1GHz) for 11a

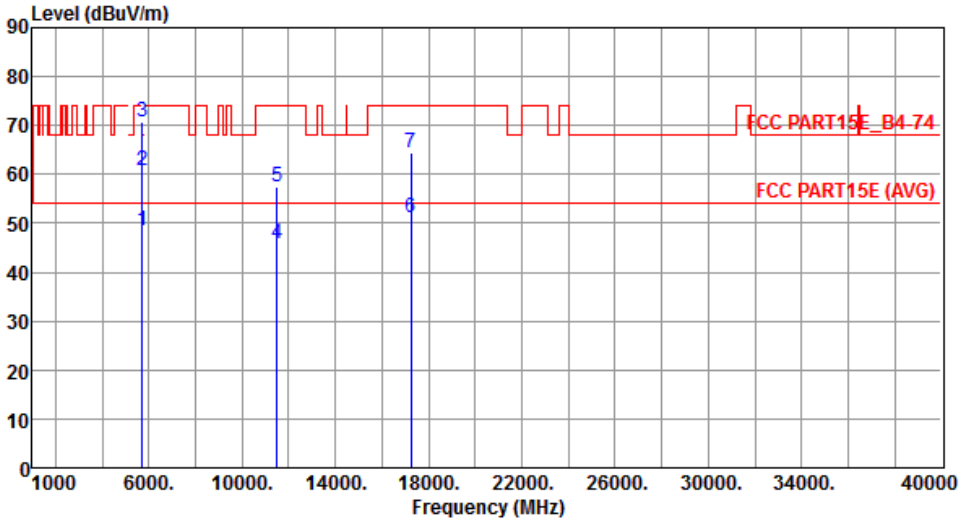
Modulation	11a	Test Freq. (MHz)	5745						
Polarization	Horizontal								
									
Freq.	Emission level	Limit	Margin	SA reading	Factor	Remark	ANT High	Turn Table	
MHz	dBuV/m	dBuV/m	dB	dBuV	dB		cm	deg	
1	5715.00	48.52	54.00	-5.48	43.42	5.10	Average	100	138
2	5715.00	60.76	74.00	-13.24	55.66	5.10	Peak	100	138
3	5725.00	70.59	78.20	-7.61	65.50	5.09	Peak	100	138
4	11490.00	45.83	54.00	-8.17	30.30	15.53	Average	219	39
5	11490.00	57.32	74.00	-16.68	41.79	15.53	Peak	219	39
6	17235.00	51.11	54.00	-2.89	32.24	18.87	Average	156	114
7	17235.00	64.29	74.00	-9.71	45.42	18.87	Peak	156	114
<p>Note 1: Emission Level (dBuV/m) = SA Reading (dBuV/m) + Factor* (dB) *Factor includes antenna factor , cable loss and amplifier gain Note 2: Margin (dB) = Emission level (dBuV/m) – Limit (dBuV/m).</p>									

Modulation	11a	Test Freq. (MHz)	5745
Polarization	Vertical		

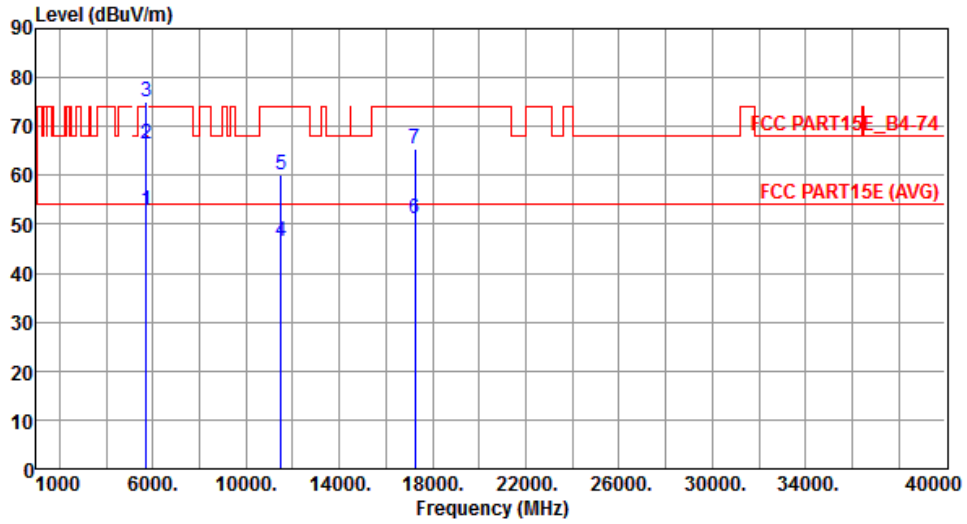

	Freq. MHz	Emission level dBuV/m	Limit dBuV/m	Margin dB	SA reading dBuV	Factor dB	Remark	ANT High cm	Turn Table deg
1	5715.00	52.92	54.00	-1.08	47.82	5.10	Average	193	183
2	5715.00	66.51	74.00	-7.49	61.41	5.10	Peak	193	183
3	5725.00	75.07	78.20	-3.13	69.98	5.09	Peak	193	183
4	11490.00	46.65	54.00	-7.35	31.12	15.53	Average	221	47
5	11490.00	60.16	74.00	-13.84	44.63	15.53	Peak	221	47
6	17235.00	50.98	54.00	-3.02	32.11	18.87	Average	151	103
7	17235.00	65.32	74.00	-8.68	46.45	18.87	Peak	151	103

Note 1: Emission Level (dBuV/m) = SA Reading (dBuV/m) + Factor* (dB)

*Factor includes antenna factor , cable loss and amplifier gain

Note 2: Margin (dB) = Emission level (dBuV/m) – Limit (dBuV/m).

Modulation	11a	Test Freq. (MHz)	5785
Polarization	Horizontal		

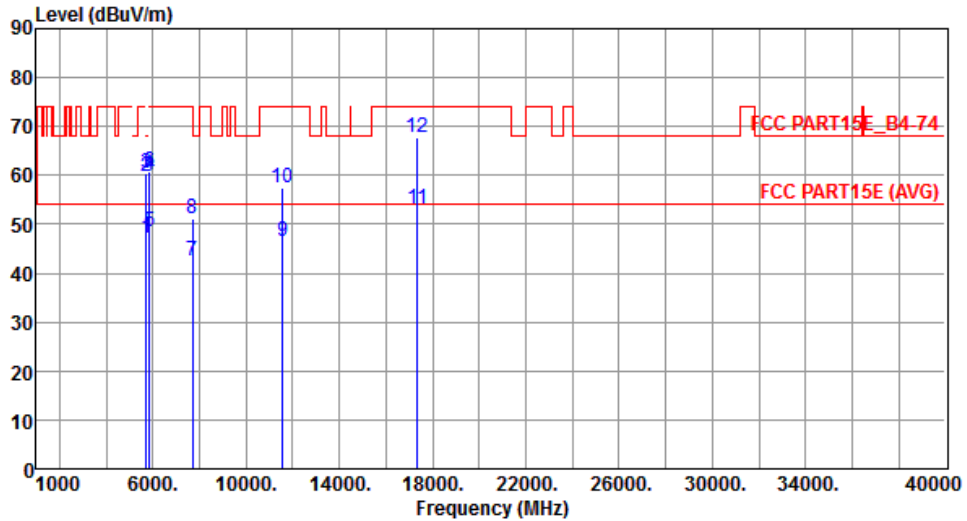

	Freq. MHz	Emission level dBuV/m	Limit dBuV/m	Margin dB	SA reading dBuV	Factor dB	Remark	ANT High cm	Turn Table deg
1	5715.00	47.26	54.00	-6.74	42.16	5.10	Average	274	142
2	5715.00	59.88	74.00	-14.12	54.78	5.10	Peak	274	142
3	5725.00	60.36	78.20	-17.84	55.27	5.09	Peak	274	142
4	5850.00	60.26	78.20	-17.94	55.00	5.26	Peak	274	142
5	5860.00	48.36	54.00	-5.64	43.09	5.27	Average	274	142
6	5860.00	60.62	74.00	-13.38	55.35	5.27	Peak	274	142
7	7713.33	42.48	54.00	-11.52	33.74	8.74	Average	212	252
8	7713.33	51.27	74.00	-22.73	42.53	8.74	Peak	212	252
9	11570.00	46.40	54.00	-7.60	31.07	15.33	Average	213	42
10	11570.00	57.41	74.00	-16.59	42.08	15.33	Peak	213	42
11	17355.00	52.99	54.00	-1.01	33.78	19.21	Average	237	114
12	17355.00	67.86	74.00	-6.14	48.65	19.21	Peak	237	114

Note 1: Emission Level (dBuV/m) = SA Reading (dBuV/m) + Factor* (dB)

*Factor includes antenna factor , cable loss and amplifier gain

Note 2: Margin (dB) = Emission level (dBuV/m) – Limit (dBuV/m).

Modulation	11a	Test Freq. (MHz)	5785
Polarization	Vertical		

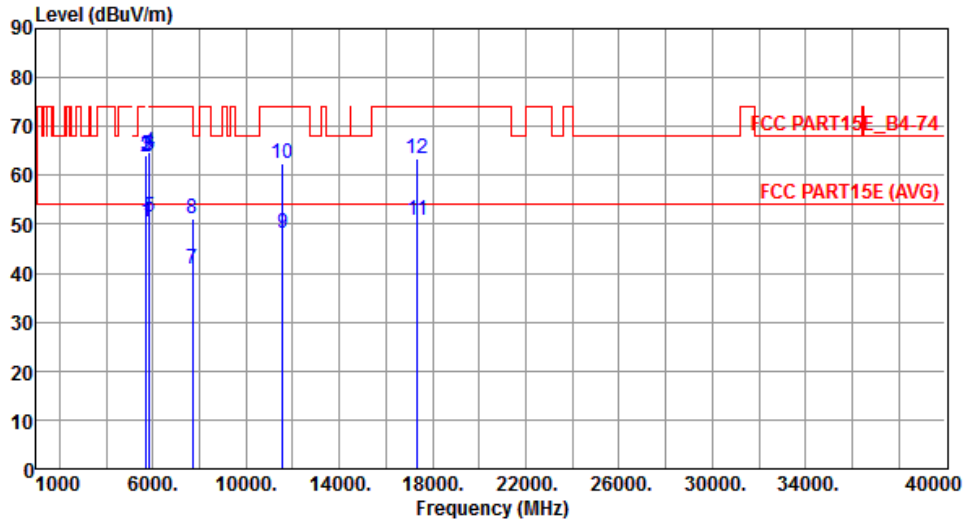

	Freq. MHz	Emission level dBuV/m	Limit dBuV/m	Margin dB	SA reading dBuV	Factor dB	Remark	ANT High cm	Turn Table deg
1	5715.00	50.56	54.00	-3.44	45.46	5.10	Average	172	185
2	5715.00	63.91	74.00	-10.09	58.81	5.10	Peak	172	185
3	5725.00	64.06	78.20	-14.14	58.97	5.09	Peak	172	185
4	5850.00	64.81	78.20	-13.39	59.55	5.26	Peak	172	185
5	5860.00	51.63	54.00	-2.37	46.36	5.27	Average	172	185
6	5860.00	64.00	74.00	-10.00	58.73	5.27	Peak	172	185
7	7713.33	40.84	54.00	-13.16	32.10	8.74	Average	205	281
8	7713.33	51.03	74.00	-22.97	42.29	8.74	Peak	205	281
9	11570.00	48.05	54.00	-5.95	32.72	15.33	Average	236	49
10	11570.00	62.55	74.00	-11.45	47.22	15.33	Peak	236	49
11	17355.00	50.73	54.00	-3.27	31.52	19.21	Average	194	287
12	17355.00	63.46	74.00	-10.54	44.25	19.21	Peak	194	287

Note 1: Emission Level (dBuV/m) = SA Reading (dBuV/m) + Factor* (dB)

*Factor includes antenna factor , cable loss and amplifier gain

Note 2: Margin (dB) = Emission level (dBuV/m) – Limit (dBuV/m).

Modulation	11a	Test Freq. (MHz)	5825
Polarization	Horizontal		

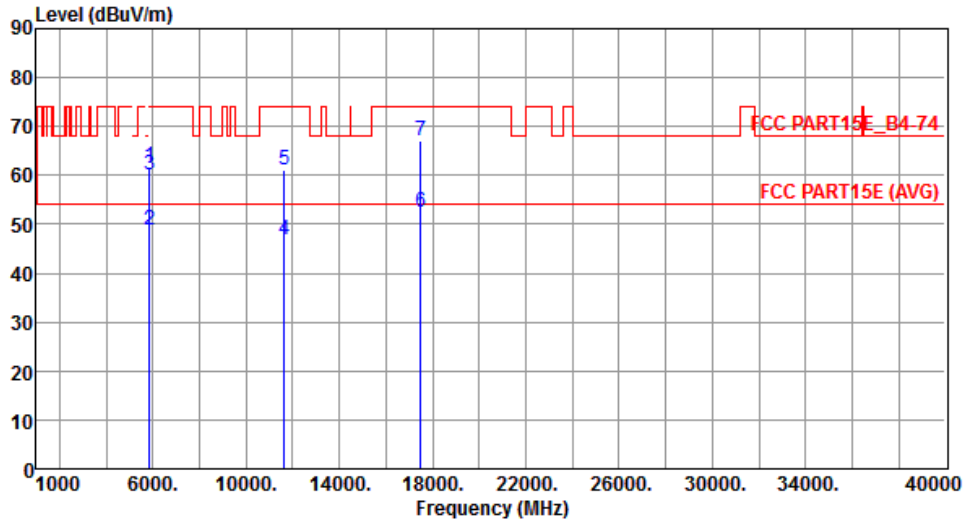

	Freq. MHz	Emission level dBuV/m	Limit dBuV/m	Margin dB	SA reading dBuV	Factor dB	Remark	ANT High cm	Turn Table deg
1	5850.00	61.90	78.20	-16.30	56.64	5.26	Peak	195	135
2	5860.00	48.81	54.00	-5.19	43.54	5.27	Average	195	135
3	5860.00	60.27	74.00	-13.73	55.00	5.27	Peak	195	135
4	11650.00	46.81	54.00	-7.19	31.72	15.09	Average	168	168
5	11650.00	61.27	74.00	-12.73	46.18	15.09	Peak	168	168
6	17475.00	52.41	54.00	-1.59	32.86	19.55	Average	144	108
7	17475.00	67.20	74.00	-6.80	47.65	19.55	Peak	144	108

Note 1: Emission Level (dBuV/m) = SA Reading (dBuV/m) + Factor* (dB)

*Factor includes antenna factor , cable loss and amplifier gain

Note 2: Margin (dB) = Emission level (dBuV/m) – Limit (dBuV/m).

Modulation	11a	Test Freq. (MHz)	5825
Polarization	Vertical		

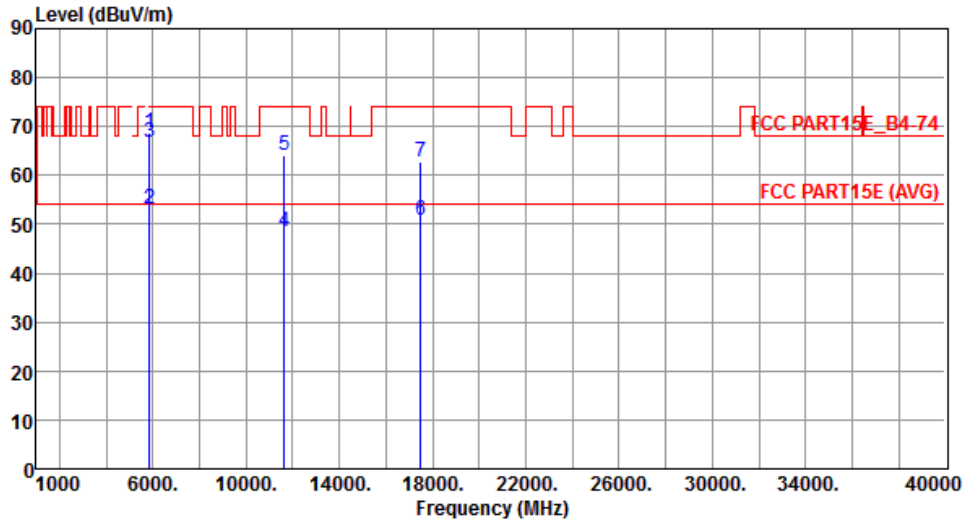

	Freq. MHz	Emission level dBuV/m	Limit dBuV/m	Margin dB	SA reading dBuV	Factor dB	Remark	ANT High cm	Turn Table deg
1	5850.00	68.89	78.20	-9.31	63.63	5.26	Peak	187	178
2	5860.00	52.98	54.00	-1.02	47.71	5.27	Average	187	178
3	5860.00	66.84	74.00	-7.16	61.57	5.27	Peak	187	178
4	11650.00	48.43	54.00	-5.57	33.34	15.09	Average	142	0
5	11650.00	63.99	74.00	-10.01	48.90	15.09	Peak	142	0
6	17475.00	50.77	54.00	-3.23	31.22	19.55	Average	142	0
7	17475.00	62.87	74.00	-11.13	43.32	19.55	Peak	137	98

Note 1: Emission Level (dBuV/m) = SA Reading (dBuV/m) + Factor* (dB)

*Factor includes antenna factor , cable loss and amplifier gain

Note 2: Margin (dB) = Emission level (dBuV/m) – Limit (dBuV/m).

3.5.10 Transmitter Radiated Unwanted Emissions (Above 1GHz) for VHT20

Modulation	VHT20	Test Freq. (MHz)	5745																																																																																						
Polarization	Horizontal																																																																																								
	<table border="1"> <thead> <tr> <th>Freq.</th> <th>Emission level</th> <th>Limit</th> <th>Margin</th> <th>SA reading</th> <th>Factor</th> <th>Remark</th> <th>ANT High</th> <th>Turn Table</th> </tr> <tr> <th>MHz</th> <th>dBuV/m</th> <th>dBuV/m</th> <th>dB</th> <th>dBuV</th> <th>dB</th> <th></th> <th>cm</th> <th>deg</th> </tr> </thead> <tbody> <tr> <td>1</td> <td>5715.00</td> <td>47.97</td> <td>54.00</td> <td>-6.03</td> <td>42.87</td> <td>5.10</td> <td>Average</td> <td>100 138</td> </tr> <tr> <td>2</td> <td>5715.00</td> <td>60.56</td> <td>74.00</td> <td>-13.44</td> <td>55.46</td> <td>5.10</td> <td>Peak</td> <td>100 138</td> </tr> <tr> <td>3</td> <td>5725.00</td> <td>74.14</td> <td>78.20</td> <td>-4.06</td> <td>69.05</td> <td>5.09</td> <td>Peak</td> <td>100 138</td> </tr> <tr> <td>4</td> <td>11490.00</td> <td>45.41</td> <td>54.00</td> <td>-8.59</td> <td>29.88</td> <td>15.53</td> <td>Average</td> <td>230 39</td> </tr> <tr> <td>5</td> <td>11490.00</td> <td>58.00</td> <td>74.00</td> <td>-16.00</td> <td>42.47</td> <td>15.53</td> <td>Peak</td> <td>230 39</td> </tr> <tr> <td>6</td> <td>17235.00</td> <td>49.07</td> <td>54.00</td> <td>-4.93</td> <td>30.20</td> <td>18.87</td> <td>Average</td> <td>156 115</td> </tr> <tr> <td>7</td> <td>17235.00</td> <td>63.65</td> <td>74.00</td> <td>-10.35</td> <td>44.78</td> <td>18.87</td> <td>Peak</td> <td>156 115</td> </tr> </tbody> </table>	Freq.	Emission level	Limit	Margin	SA reading	Factor	Remark	ANT High	Turn Table	MHz	dBuV/m	dBuV/m	dB	dBuV	dB		cm	deg	1	5715.00	47.97	54.00	-6.03	42.87	5.10	Average	100 138	2	5715.00	60.56	74.00	-13.44	55.46	5.10	Peak	100 138	3	5725.00	74.14	78.20	-4.06	69.05	5.09	Peak	100 138	4	11490.00	45.41	54.00	-8.59	29.88	15.53	Average	230 39	5	11490.00	58.00	74.00	-16.00	42.47	15.53	Peak	230 39	6	17235.00	49.07	54.00	-4.93	30.20	18.87	Average	156 115	7	17235.00	63.65	74.00	-10.35	44.78	18.87	Peak	156 115							
Freq.	Emission level	Limit	Margin	SA reading	Factor	Remark	ANT High	Turn Table																																																																																	
MHz	dBuV/m	dBuV/m	dB	dBuV	dB		cm	deg																																																																																	
1	5715.00	47.97	54.00	-6.03	42.87	5.10	Average	100 138																																																																																	
2	5715.00	60.56	74.00	-13.44	55.46	5.10	Peak	100 138																																																																																	
3	5725.00	74.14	78.20	-4.06	69.05	5.09	Peak	100 138																																																																																	
4	11490.00	45.41	54.00	-8.59	29.88	15.53	Average	230 39																																																																																	
5	11490.00	58.00	74.00	-16.00	42.47	15.53	Peak	230 39																																																																																	
6	17235.00	49.07	54.00	-4.93	30.20	18.87	Average	156 115																																																																																	
7	17235.00	63.65	74.00	-10.35	44.78	18.87	Peak	156 115																																																																																	
<p>Note 1: Emission Level (dBuV/m) = SA Reading (dBuV/m) + Factor* (dB) *Factor includes antenna factor , cable loss and amplifier gain Note 2: Margin (dB) = Emission level (dBuV/m) – Limit (dBuV/m).</p>																																																																																									

Modulation	VHT20	Test Freq. (MHz)	5745
Polarization	Vertical		

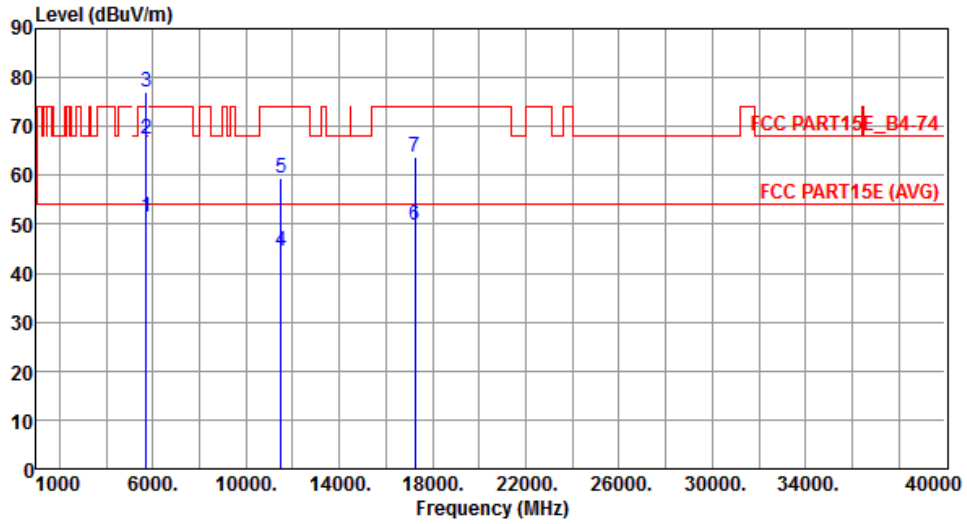

	Freq. MHz	Emission level dBuV/m	Limit dBuV/m	Margin dB	SA reading dBuV	Factor dB	Remark	ANT High cm	Turn Table deg
1	5715.00	51.48	54.00	-2.52	46.38	5.10	Average	190	184
2	5715.00	67.29	74.00	-6.71	62.19	5.10	Peak	190	184
3	5725.00	77.18	78.20	-1.02	72.09	5.09	Peak	190	152
4	11490.00	44.34	54.00	-9.66	28.81	15.53	Average	222	47
5	11490.00	59.47	74.00	-14.53	43.94	15.53	Peak	222	47
6	17235.00	49.78	54.00	-4.22	30.91	18.87	Average	150	103
7	17235.00	63.78	74.00	-10.22	44.91	18.87	Peak	150	103

Note 1: Emission Level (dBuV/m) = SA Reading (dBuV/m) + Factor* (dB)

*Factor includes antenna factor , cable loss and amplifier gain

Note 2: Margin (dB) = Emission level (dBuV/m) – Limit (dBuV/m).

Modulation	VHT20	Test Freq. (MHz)	5785
Polarization	Horizontal		

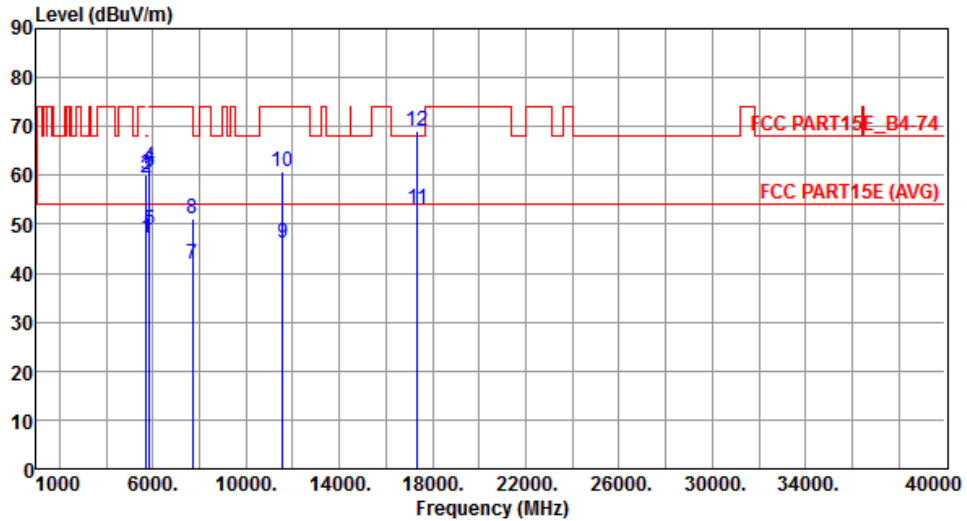

	Freq. MHz	Emission level dBuV/m	Limit dBuV/m	Margin dB	SA reading dBuV	Factor dB	Remark	ANT High cm	Turn Table deg
1	5715.00	47.32	54.00	-6.68	42.22	5.10	Average	276	141
2	5715.00	59.59	74.00	-14.41	54.49	5.10	Peak	276	141
3	5725.00	59.96	78.20	-18.24	54.87	5.09	Peak	276	141
4	5850.00	61.72	78.20	-16.48	56.46	5.26	Peak	276	141
5	5860.00	48.86	54.00	-5.14	43.59	5.27	Average	276	141
6	5860.00	60.82	74.00	-13.18	55.55	5.27	Peak	276	141
7	7713.33	41.89	54.00	-12.11	33.15	8.74	Average	207	252
8	7713.33	51.28	74.00	-22.72	42.54	8.74	Peak	207	252
9	11570.00	46.17	54.00	-7.83	30.84	15.33	Average	211	43
10	11570.00	60.64	74.00	-13.36	45.31	15.33	Peak	211	43
11	17355.00	53.00	54.00	-1.00	33.79	19.21	Average	237	113
12	17355.00	68.98	74.00	-5.02	49.77	19.21	Peak	237	113

Note 1: Emission Level (dBuV/m) = SA Reading (dBuV/m) + Factor* (dB)

*Factor includes antenna factor , cable loss and amplifier gain

Note 2: Margin (dB) = Emission level (dBuV/m) – Limit (dBuV/m).

Modulation	VHT20	Test Freq. (MHz)	5785
Polarization	Vertical		

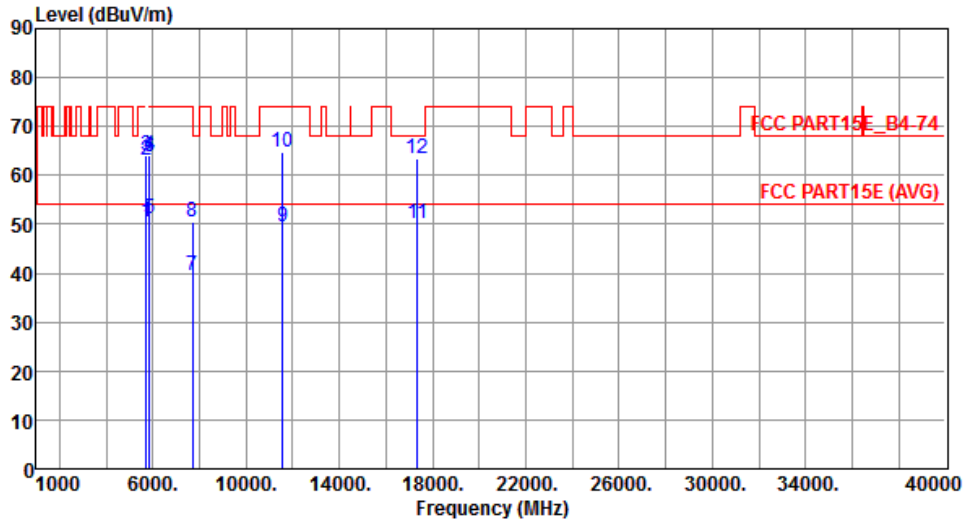

	Freq. MHz	Emission level dBuV/m	Limit dBuV/m	Margin dB	SA reading dBuV	Factor dB	Remark	ANT High cm	Turn Table deg
1	5715.00	50.58	54.00	-3.42	45.48	5.10	Average	202	188
2	5715.00	63.22	74.00	-10.78	58.12	5.10	Peak	202	188
3	5725.00	63.96	78.20	-14.24	58.87	5.09	Peak	202	188
4	5850.00	64.26	78.20	-13.94	59.00	5.26	Peak	202	188
5	5860.00	51.21	54.00	-2.79	45.94	5.27	Average	202	188
6	5860.00	63.69	74.00	-10.31	58.42	5.27	Peak	202	188
7	7713.33	39.54	54.00	-14.46	30.80	8.74	Average	207	282
8	7713.33	50.64	74.00	-23.36	41.90	8.74	Peak	207	282
9	11570.00	49.36	54.00	-4.64	34.03	15.33	Average	241	49
10	11570.00	64.64	74.00	-9.36	49.31	15.33	Peak	241	49
11	17355.00	50.12	54.00	-3.88	30.91	19.21	Average	202	287
12	17355.00	63.44	74.00	-10.56	44.23	19.21	Peak	202	287

Note 1: Emission Level (dBuV/m) = SA Reading (dBuV/m) + Factor* (dB)

*Factor includes antenna factor , cable loss and amplifier gain

Note 2: Margin (dB) = Emission level (dBuV/m) – Limit (dBuV/m).

Modulation	VHT20	Test Freq. (MHz)	5825
Polarization	Horizontal		

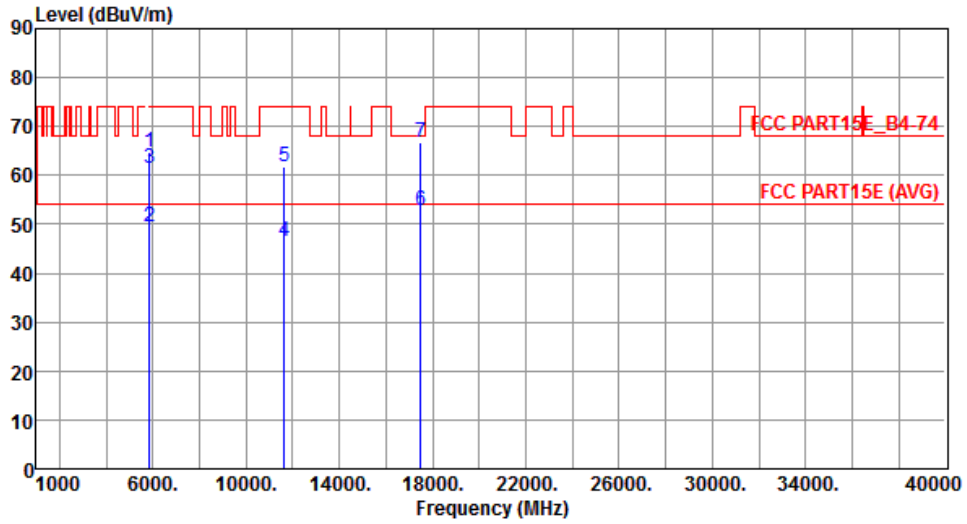

	Freq. MHz	Emission level dBuV/m	Limit dBuV/m	Margin dB	SA reading dBuV	Factor dB	Remark	ANT High cm	Turn Table deg
1	5850.00	64.68	78.20	-13.52	59.42	5.26	Peak	182	135
2	5860.00	49.55	54.00	-4.45	44.28	5.27	Average	182	135
3	5860.00	61.46	74.00	-12.54	56.19	5.27	Peak	182	135
4	11650.00	46.45	54.00	-7.55	31.36	15.09	Average	165	168
5	11650.00	61.84	74.00	-12.16	46.75	15.09	Peak	165	168
6	17475.00	52.80	54.00	-1.20	33.25	19.55	Average	149	107
7	17475.00	66.84	74.00	-7.16	47.29	19.55	Peak	149	107

Note 1: Emission Level (dBuV/m) = SA Reading (dBuV/m) + Factor* (dB)

*Factor includes antenna factor , cable loss and amplifier gain

Note 2: Margin (dB) = Emission level (dBuV/m) – Limit (dBuV/m).

Modulation	VHT20	Test Freq. (MHz)	5825
Polarization	Vertical		

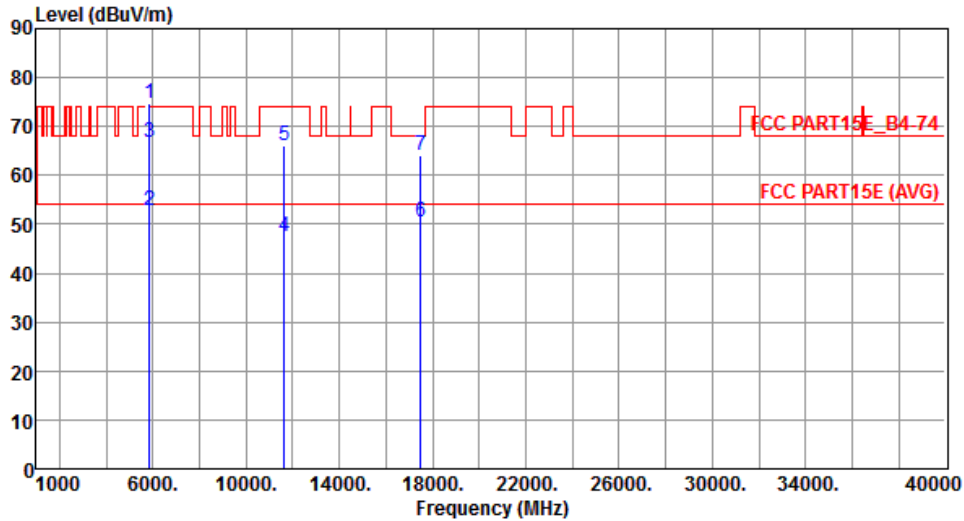

	Freq. MHz	Emission level dBuV/m	Limit dBuV/m	Margin dB	SA reading dBuV	Factor dB	Remark	ANT High cm	Turn Table deg
1	5850.00	74.59	78.20	-3.61	69.33	5.26	Peak	197	181
2	5860.00	52.80	54.00	-1.20	47.53	5.27	Average	280	181
3	5860.00	66.66	74.00	-7.34	61.39	5.27	Peak	280	181
4	11650.00	47.61	54.00	-6.39	32.52	15.09	Average	149	0
5	11650.00	66.07	74.00	-7.93	50.98	15.09	Peak	149	0
6	17475.00	50.57	54.00	-3.43	31.02	19.55	Average	149	103
7	17475.00	64.02	74.00	-9.98	44.47	19.55	Peak	149	103

Note 1: Emission Level (dBuV/m) = SA Reading (dBuV/m) + Factor* (dB)

*Factor includes antenna factor , cable loss and amplifier gain

Note 2: Margin (dB) = Emission level (dBuV/m) – Limit (dBuV/m).

3.5.11 Transmitter Radiated Unwanted Emissions (Above 1GHz) for VHT40

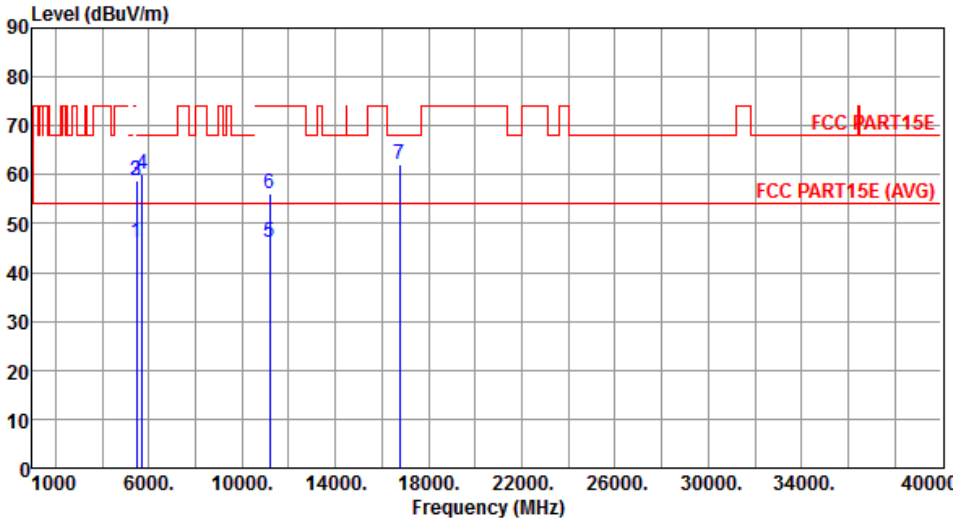
Modulation	VHT40	Test Freq. (MHz)	5590						
Polarization	Horizontal								
									
	Freq.	Emission level	Limit	Margin	SA reading	Factor	Remark	ANT High	Turn Table
	MHz	dBuV/m	dBuV/m	dB	dBuV	dB		cm	deg
1	5460.00	46.27	54.00	-7.73	41.49	4.78	Average	110	136
2	5460.00	58.75	74.00	-15.25	53.97	4.78	Peak	110	136
3	5470.00	58.64	68.20	-9.56	53.85	4.79	Peak	110	136
4	5725.00	59.98	68.20	-8.22	54.89	5.09	Peak	110	136
5	11180.00	46.11	54.00	-7.89	30.88	15.23	Average	100	110
6	11180.00	56.09	74.00	-17.91	40.86	15.23	Peak	100	110
7	16770.00	62.03	68.20	-6.17	44.65	17.38	Peak	100	359
<p>Note 1: Emission Level (dBuV/m) = SA Reading (dBuV/m) + Factor* (dB) *Factor includes antenna factor , cable loss and amplifier gain Note 2: Margin (dB) = Emission level (dBuV/m) – Limit (dBuV/m).</p>									

Modulation	VHT40	Test Freq. (MHz)	5590
Polarization	Vertical		

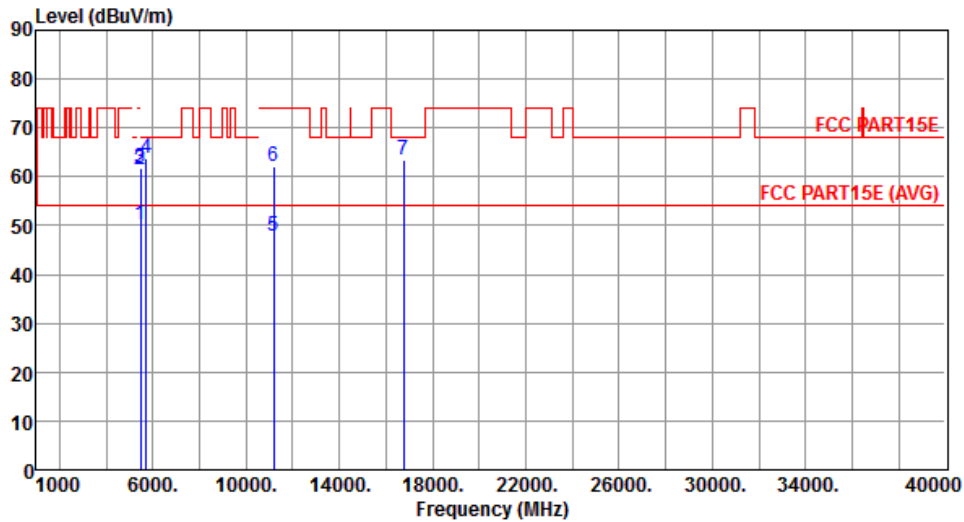

	Freq. MHz	Emission level dBuV/m	Limit dBuV/m	Margin dB	SA reading dBuV	Factor dB	Remark	ANT High cm	Turn Table deg
1	5460.00	50.22	54.00	-3.78	45.44	4.78	Average	185	55
2	5460.00	61.32	74.00	-12.68	56.54	4.78	Peak	185	55
3	5470.00	61.82	68.20	-6.38	57.03	4.79	Peak	185	55
4	5725.00	63.65	68.20	-4.55	58.56	5.09	Peak	185	55
5	11180.00	47.67	54.00	-6.33	32.44	15.23	Average	144	346
6	11180.00	62.15	74.00	-11.85	46.92	15.23	Peak	144	346
7	16770.00	63.46	68.20	-4.74	46.08	17.38	Peak	155	96

Note 1: Emission Level (dBuV/m) = SA Reading (dBuV/m) + Factor* (dB)

*Factor includes antenna factor , cable loss and amplifier gain

Note 2: Margin (dB) = Emission level (dBuV/m) – Limit (dBuV/m).

Modulation	VHT40	Test Freq. (MHz)	5755
Polarization	Horizontal		

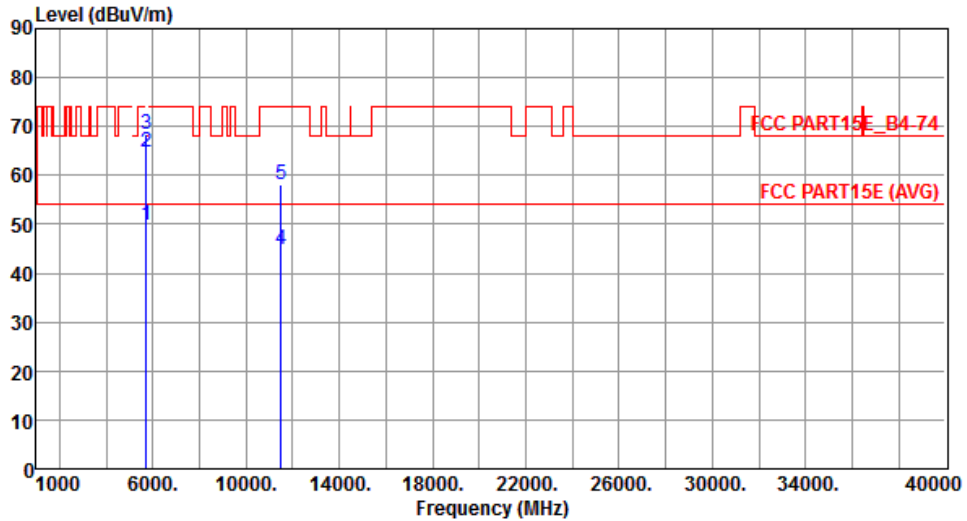

	Freq. MHz	Emission level dBuV/m	Limit dBuV/m	Margin dB	SA reading dBuV	Factor dB	Remark	ANT High cm	Turn Table deg
1	5715.00	49.95	54.00	-4.05	44.85	5.10	Average	282	142
2	5715.00	64.69	74.00	-9.31	59.59	5.10	Peak	282	142
3	5725.00	68.43	78.20	-9.77	63.34	5.09	Peak	282	142
4	11510.00	44.82	54.00	-9.18	29.31	15.51	Average	220	43
5	11510.00	58.16	74.00	-15.84	42.65	15.51	Peak	220	43

Note 1: Emission Level (dBuV/m) = SA Reading (dBuV/m) + Factor* (dB)

*Factor includes antenna factor , cable loss and amplifier gain

Note 2: Margin (dB) = Emission level (dBuV/m) – Limit (dBuV/m).

Modulation	VHT40	Test Freq. (MHz)	5755
Polarization	Vertical		

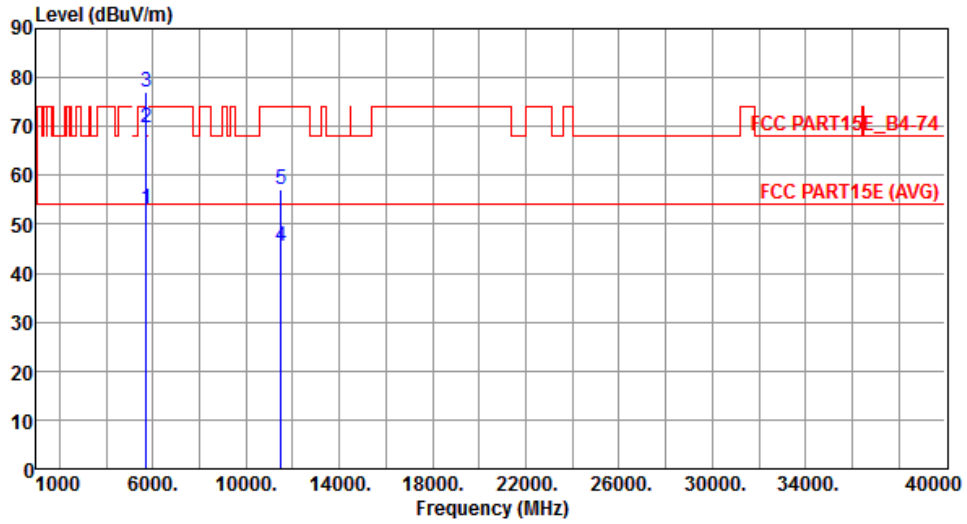

	Freq. MHz	Emission level dBuV/m	Limit dBuV/m	Margin dB	SA reading dBuV	Factor dB	Remark	ANT High cm	Turn Table deg
1	5715.00	52.98	54.00	-1.02	47.88	5.10	Average	192	191
2	5715.00	69.69	74.00	-4.31	64.59	5.10	Peak	192	191
3	5725.00	77.19	78.20	-1.01	72.10	5.09	Peak	192	191
4	11510.00	45.34	54.00	-8.66	29.83	15.51	Average	200	39
5	11510.00	56.96	74.00	-17.04	41.45	15.51	Peak	200	39

Note 1: Emission Level (dBuV/m) = SA Reading (dBuV/m) + Factor* (dB)

*Factor includes antenna factor , cable loss and amplifier gain

Note 2: Margin (dB) = Emission level (dBuV/m) – Limit (dBuV/m).

Modulation	VHT40	Test Freq. (MHz)	5795
Polarization	Horizontal		

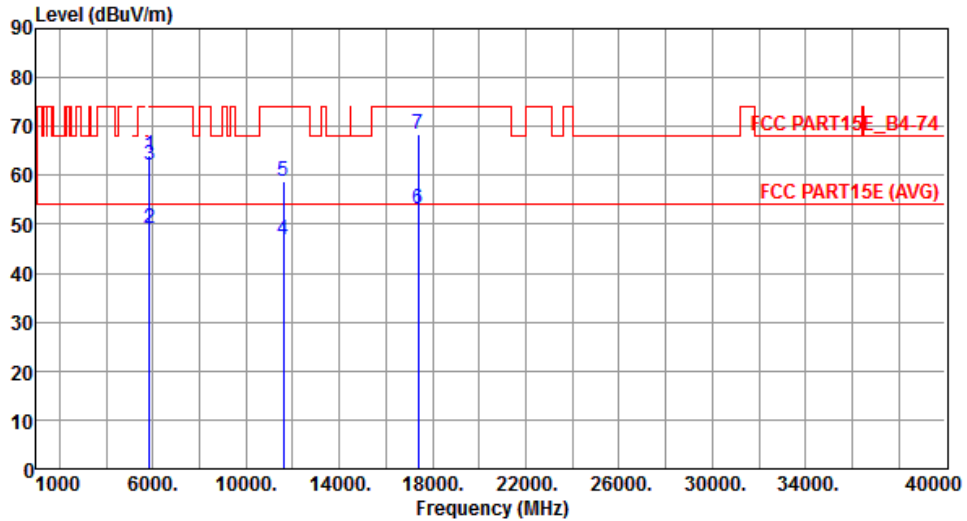

	Freq. MHz	Emission level dBuV/m	Limit dBuV/m	Margin dB	SA reading dBuV	Factor dB	Remark	ANT High cm	Turn Table deg
1	5850.00	64.26	78.20	-13.94	59.00	5.26	Peak	202	141
2	5860.00	49.08	54.00	-4.92	43.81	5.27	Average	202	141
3	5860.00	62.11	74.00	-11.89	56.84	5.27	Peak	202	141
4	11590.00	46.78	54.00	-7.22	31.51	15.27	Average	238	40
5	11590.00	58.71	74.00	-15.29	43.44	15.27	Peak	238	40
6	17385.00	52.99	54.00	-1.01	33.70	19.29	Average	238	115
7	17385.00	68.30	74.00	-5.70	49.01	19.29	Peak	238	115

Note 1: Emission Level (dBuV/m) = SA Reading (dBuV/m) + Factor* (dB)

*Factor includes antenna factor , cable loss and amplifier gain

Note 2: Margin (dB) = Emission level (dBuV/m) – Limit (dBuV/m).

Modulation	VHT40	Test Freq. (MHz)	5795
Polarization	Vertical		

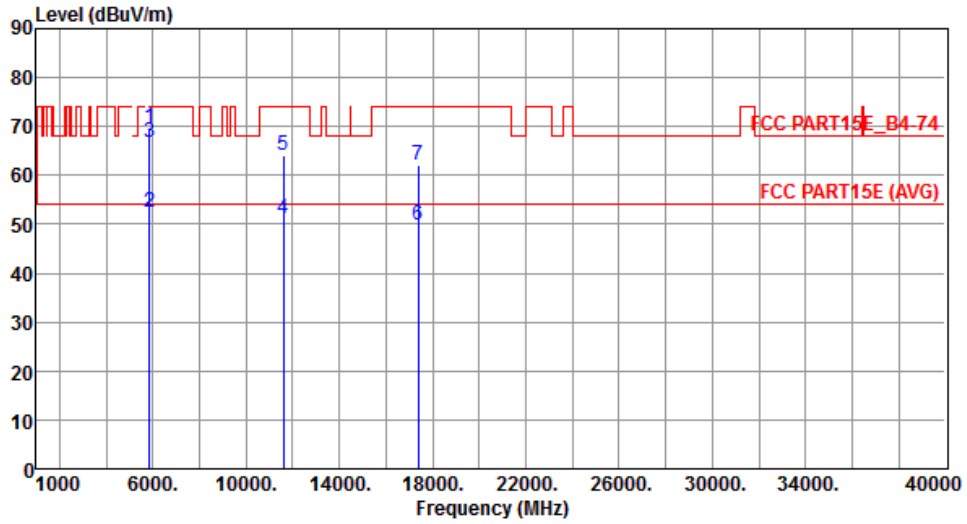

	Freq. MHz	Emission level dBuV/m	Limit dBuV/m	Margin dB	SA reading dBuV	Factor dB	Remark	ANT High cm	Turn Table deg
1	5850.00	69.83	78.20	-8.37	64.57	5.26	Peak	176	184
2	5860.00	52.48	54.00	-1.52	47.21	5.27	Average	176	184
3	5860.00	66.78	74.00	-7.22	61.51	5.27	Peak	176	184
4	11590.00	50.99	54.00	-3.01	35.72	15.27	Average	238	46
5	11590.00	64.03	74.00	-9.97	48.76	15.27	Peak	238	46
6	17385.00	49.95	54.00	-4.05	30.66	19.29	Average	200	289
7	17385.00	62.08	74.00	-11.92	42.79	19.29	Peak	200	289

Note 1: Emission Level (dBuV/m) = SA Reading (dBuV/m) + Factor* (dB)

*Factor includes antenna factor , cable loss and amplifier gain

Note 2: Margin (dB) = Emission level (dBuV/m) – Limit (dBuV/m).

3.5.12 Transmitter Radiated Unwanted Emissions (Above 1GHz) for VHT80

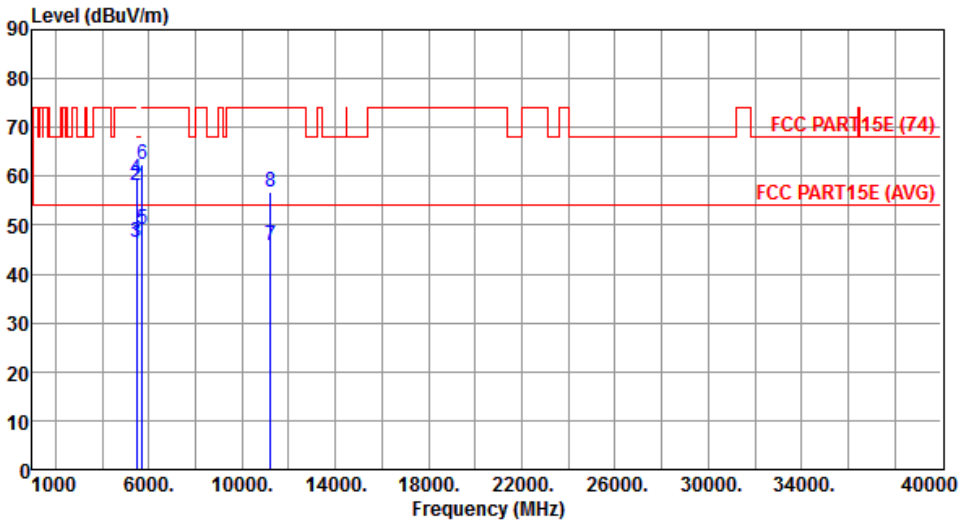
Modulation	VHT80	Test Freq. (MHz)	5610						
Polarization	Horizontal								
									
	Freq.	Emission level	Limit	Margin	SA reading	Factor	Remark	ANT High	Turn Table
	MHz	dBuV/m	dBuV/m	dB	dBuV	dB		cm	deg
1	5460.00	46.01	54.00	-7.99	41.23	4.78	Average	196	143
2	5460.00	58.04	74.00	-15.96	53.26	4.78	Peak	196	143
3	5470.00	46.45	54.00	-7.55	41.66	4.79	Average	196	143
4	5470.00	59.35	74.00	-14.65	54.56	4.79	Peak	196	143
5	5725.00	49.11	54.00	-4.89	44.02	5.09	Average	196	143
6	5725.00	62.35	74.00	-11.65	57.26	5.09	Peak	196	143
7	11220.00	45.73	54.00	-8.27	30.46	15.27	Average	100	173
8	11220.00	56.83	74.00	-17.17	41.56	15.27	Peak	100	173

Note 1: Emission Level (dBuV/m) = SA Reading (dBuV/m) + Factor* (dB)
*Factor includes antenna factor , cable loss and amplifier gain
Note 2: Margin (dB) = Emission level (dBuV/m) – Limit (dBuV/m).

Modulation	VHT80	Test Freq. (MHz)	5610
Polarization	Vertical		

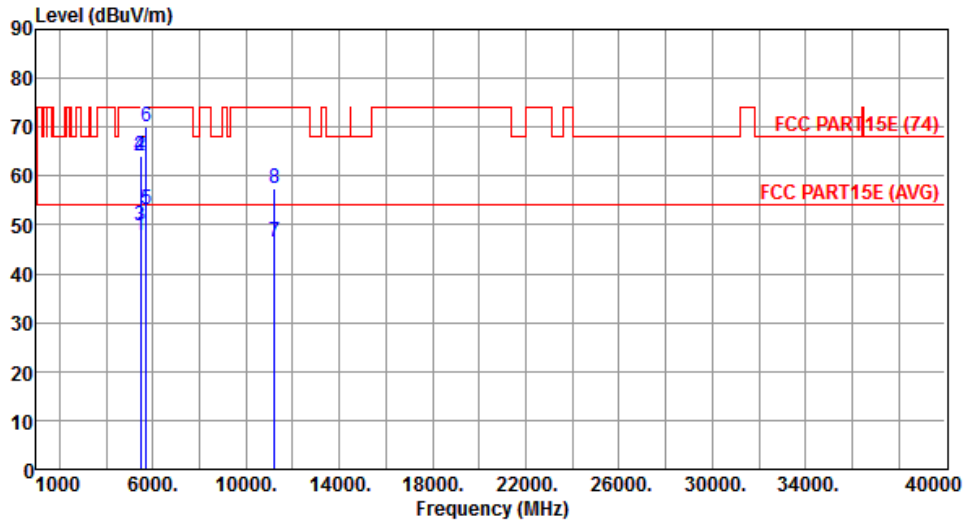

	Freq. MHz	Emission level dBuV/m	Limit dBuV/m	Margin dB	SA reading dBuV	Factor dB	Remark	ANT High cm	Turn Table deg
1	5460.00	47.89	54.00	-6.11	43.11	4.78	Average	177	178
2	5460.00	64.04	74.00	-9.96	59.26	4.78	Peak	177	178
3	5470.00	49.84	54.00	-4.16	45.05	4.79	Average	177	178
4	5470.00	64.09	74.00	-9.91	59.30	4.79	Peak	177	178
5	5725.00	52.98	54.00	-1.02	47.89	5.09	Average	177	178
6	5725.00	70.15	74.00	-3.85	65.06	5.09	Peak	177	178
7	11220.00	46.48	54.00	-7.52	31.21	15.27	Average	100	165
8	11220.00	57.50	74.00	-16.50	42.23	15.27	Peak	100	165

Note 1: Emission Level (dBuV/m) = SA Reading (dBuV/m) + Factor* (dB)

*Factor includes antenna factor , cable loss and amplifier gain

Note 2: Margin (dB) = Emission level (dBuV/m) – Limit (dBuV/m).

Modulation	VHT80	Test Freq. (MHz)	5775
Polarization	Horizontal		

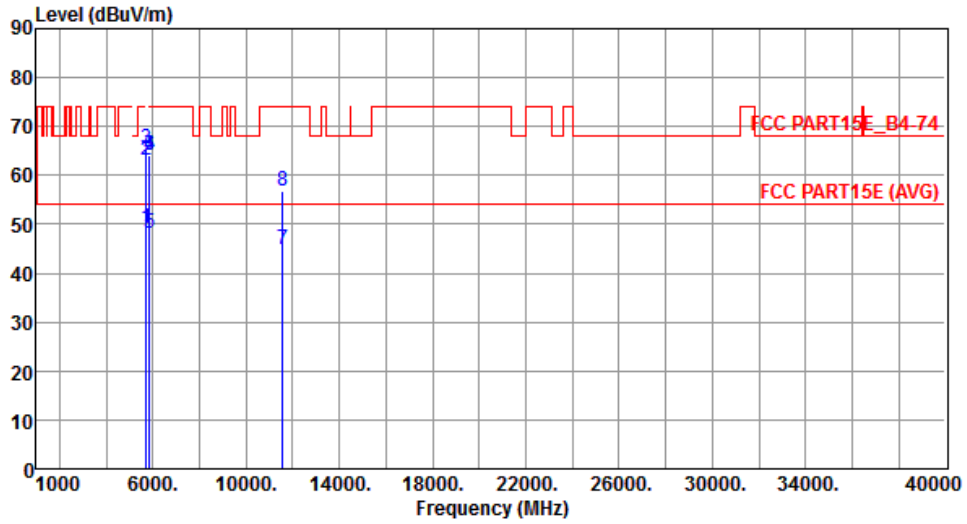

	Freq. MHz	Emission level dBuV/m	Limit dBuV/m	Margin dB	SA reading dBuV	Factor dB	Remark	ANT High cm	Turn Table deg
1	5715.00	49.22	54.00	-4.78	44.12	5.10	Average	201	136
2	5715.00	63.13	74.00	-10.87	58.03	5.10	Peak	201	136
3	5725.00	65.49	78.20	-12.71	60.40	5.09	Peak	201	136
4	5850.00	64.01	78.20	-14.19	58.75	5.26	Peak	201	136
5	5860.00	48.08	54.00	-5.92	42.81	5.27	Average	201	136
6	5860.00	64.14	74.00	-9.86	58.87	5.27	Peak	201	136
7	11550.00	44.95	54.00	-9.05	29.55	15.40	Average	100	218
8	11550.00	56.72	74.00	-17.28	41.32	15.40	Peak	100	218

Note 1: Emission Level (dBuV/m) = SA Reading (dBuV/m) + Factor* (dB)

*Factor includes antenna factor , cable loss and amplifier gain

Note 2: Margin (dB) = Emission level (dBuV/m) – Limit (dBuV/m).

Modulation	VHT80	Test Freq. (MHz)	5775
Polarization	Vertical		

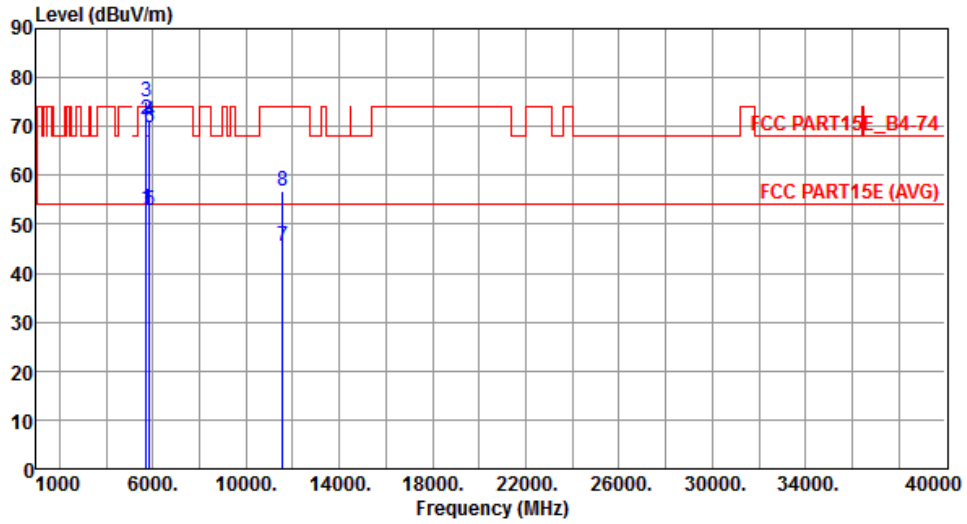

	Freq. MHz	Emission level dBuV/m	Limit dBuV/m	Margin dB	SA reading dBuV	Factor dB	Remark	ANT High cm	Turn Table deg
1	5715.00	52.99	54.00	-1.01	47.89	5.10	Average	174	180
2	5715.00	71.37	74.00	-2.63	66.27	5.10	Peak	174	180
3	5725.00	75.07	78.20	-3.13	69.98	5.09	Peak	206	298
4	5850.00	71.05	78.20	-7.15	65.79	5.26	Peak	206	188
5	5860.00	52.95	54.00	-1.05	47.68	5.27	Average	206	188
6	5860.00	69.72	74.00	-4.28	64.45	5.27	Peak	206	188
7	11550.00	45.35	54.00	-8.65	29.95	15.40	Average	123	156
8	11550.00	56.87	74.00	-17.13	41.47	15.40	Peak	123	156

Note 1: Emission Level (dBuV/m) = SA Reading (dBuV/m) + Factor* (dB)

*Factor includes antenna factor , cable loss and amplifier gain

Note 2: Margin (dB) = Emission level (dBuV/m) – Limit (dBuV/m).

Beamforming mode

3.5.13 Transmitter Radiated Band Edge for VHT20

Modulation	VHT20	Test Freq. (MHz)	5745
Polarization	Horizontal		

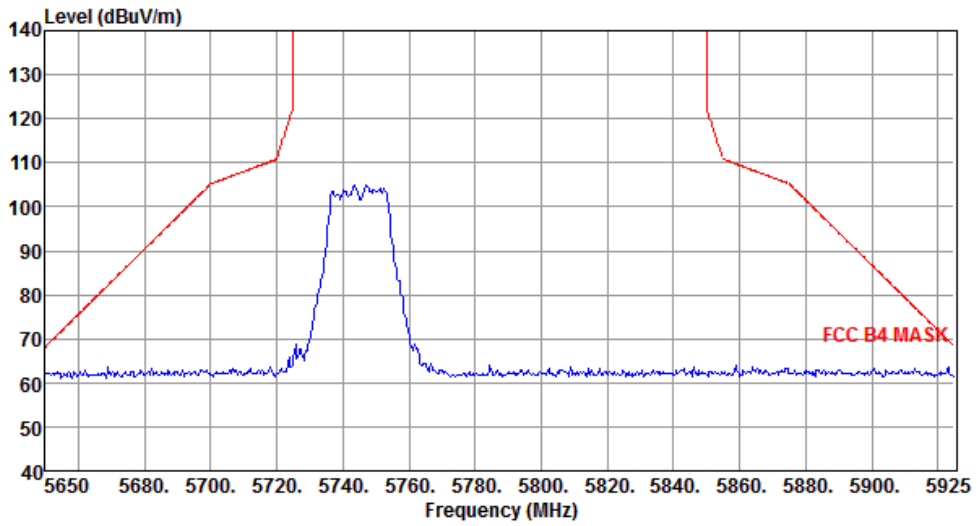

Modulation	VHT20	Test Freq. (MHz)	5745
Polarization	Vertical		

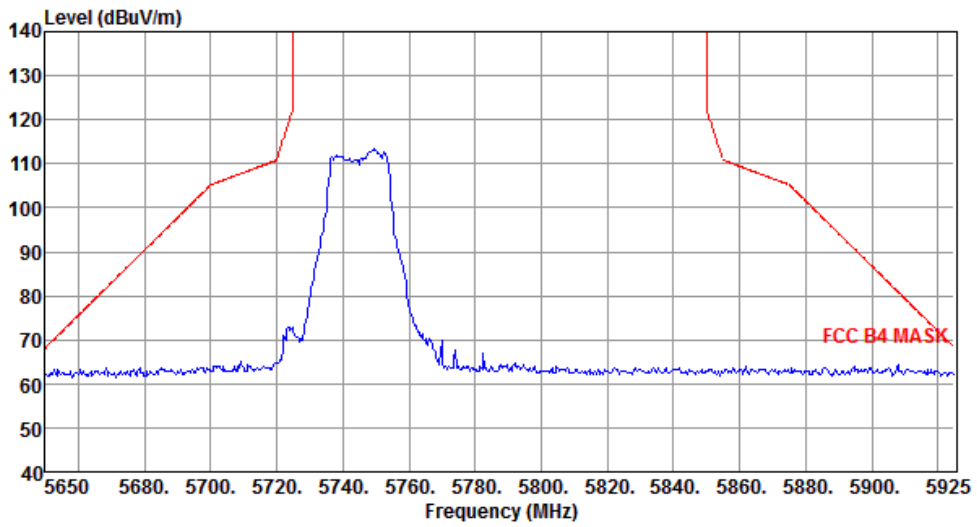

Modulation	VHT20	Test Freq. (MHz)	5785
Polarization	Horizontal		

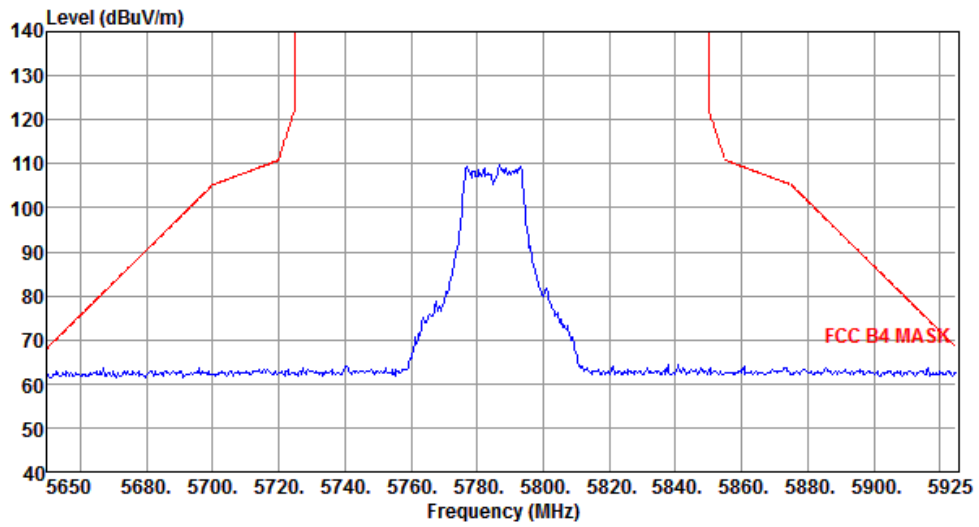

Modulation	VHT20	Test Freq. (MHz)	5785
Polarization	Vertical		

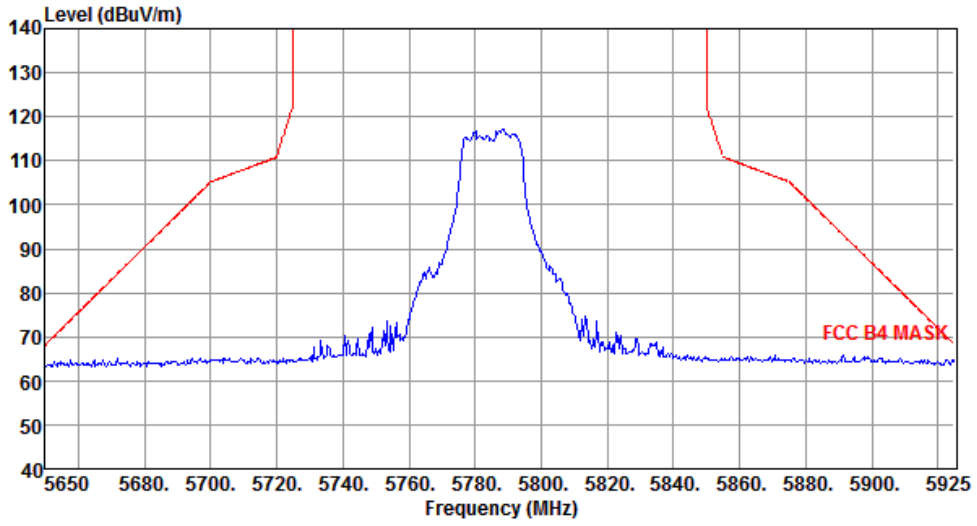

Modulation	VHT20	Test Freq. (MHz)	5825
Polarization	Horizontal		

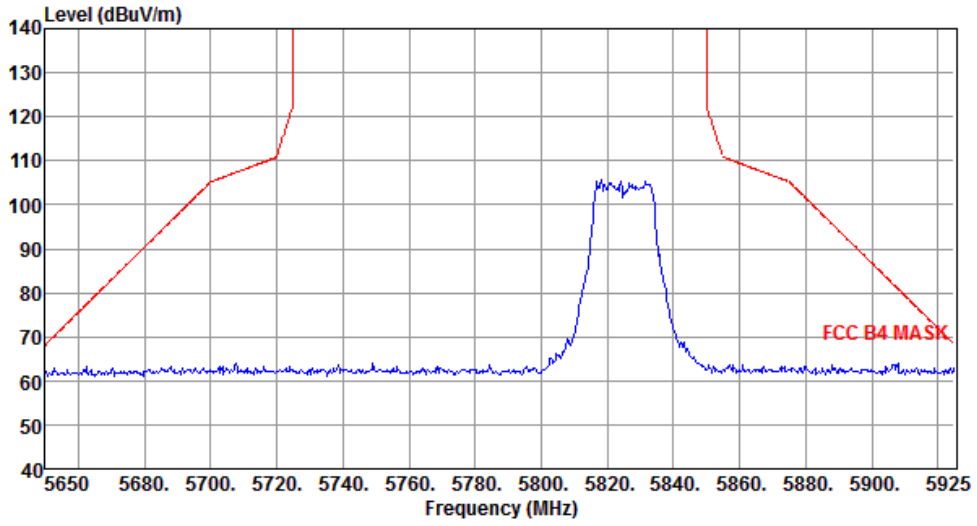

Modulation	VHT20	Test Freq. (MHz)	5825
Polarization	Vertical		

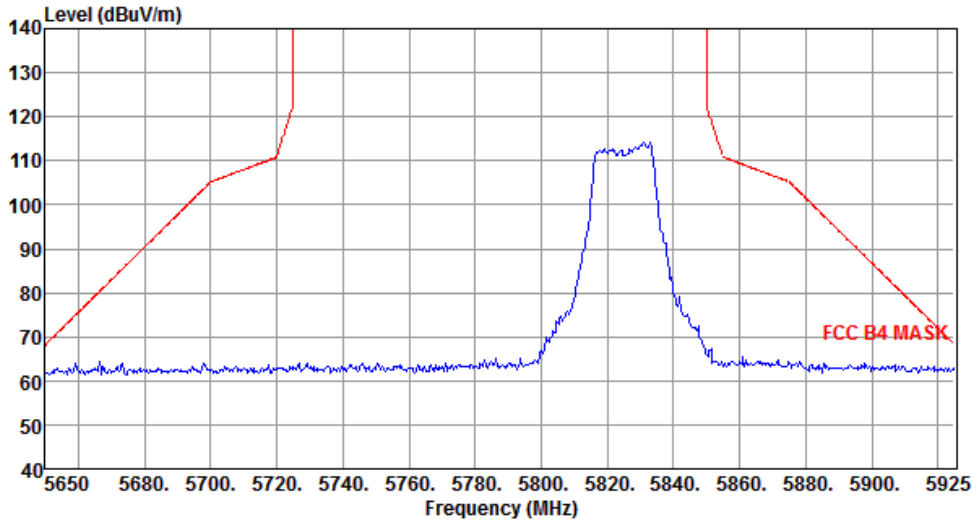

3.5.14 Transmitter Radiated Band Edge for VHT40

Modulation	VHT40	Test Freq. (MHz)	5755
Polarization	Horizontal		

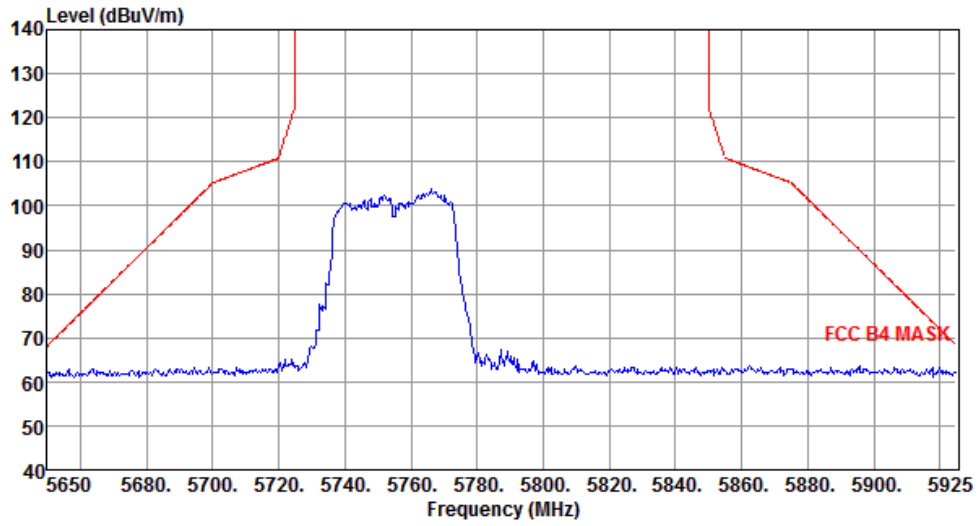

Modulation	VHT40	Test Freq. (MHz)	5755
Polarization	Vertical		

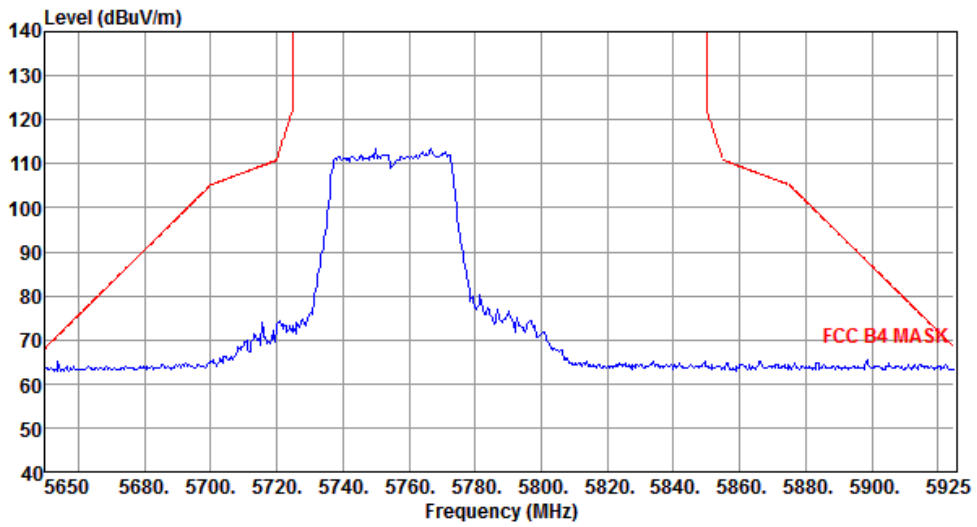

Modulation	VHT40	Test Freq. (MHz)	5795
Polarization	Horizontal		

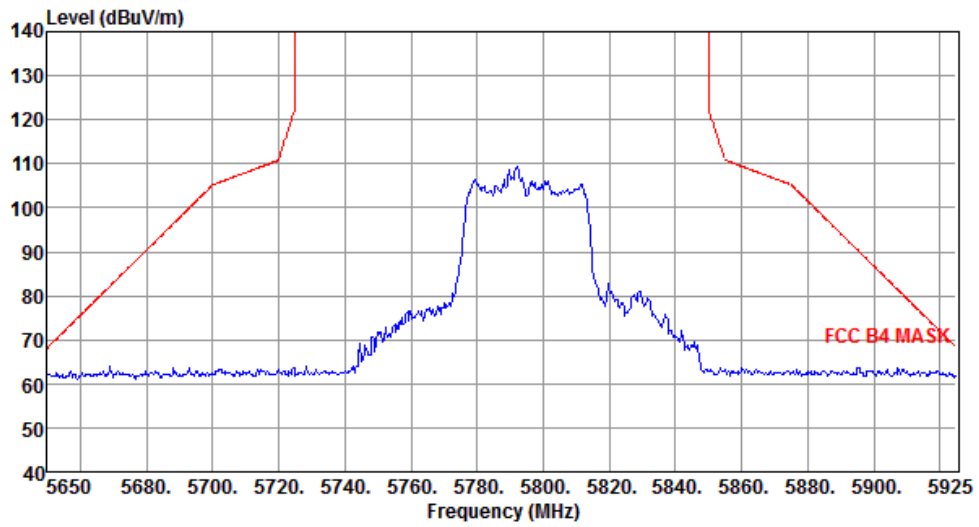

Modulation	VHT40	Test Freq. (MHz)	5795
Polarization	Vertical		

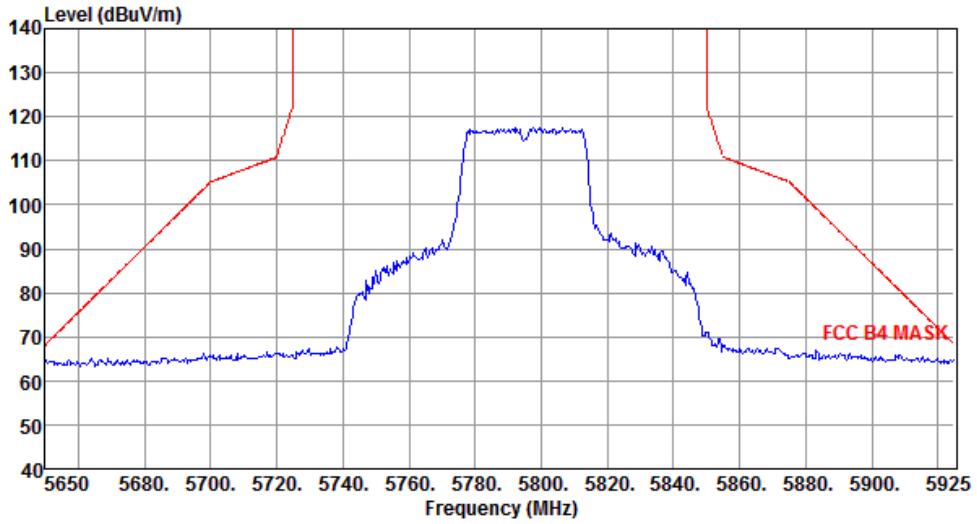

3.5.15 Transmitter Radiated Band Edge for VHT80

Modulation	VHT80	Test Freq. (MHz)	5775
Polarization	Horizontal		

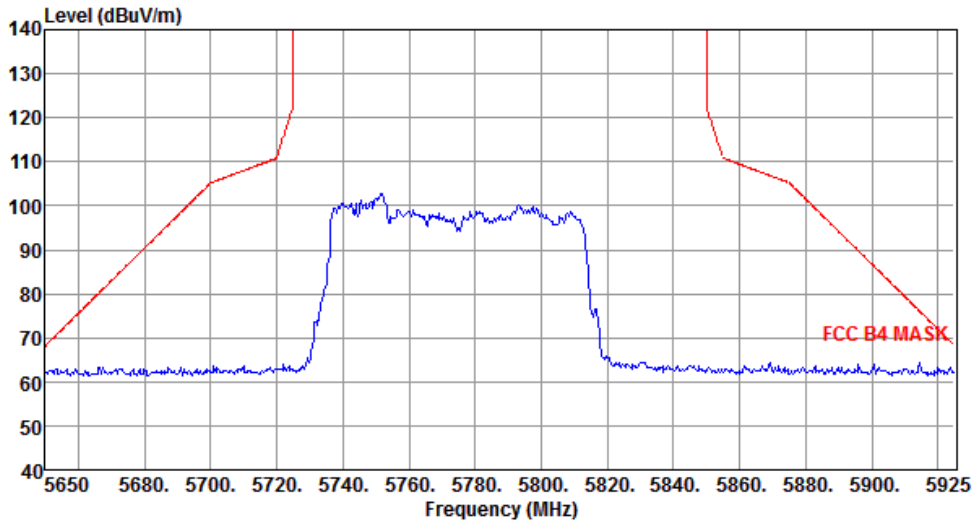

Modulation	VHT80	Test Freq. (MHz)	5775
Polarization	Vertical		

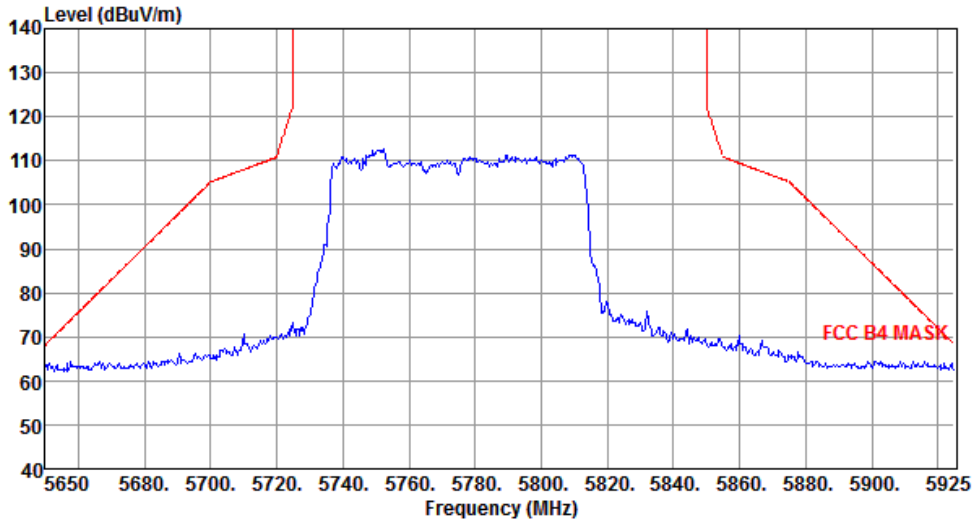

3.5.16 Transmitter Radiated Unwanted Emissions (Below 1GHz)

Modulation	VHT40	Test Freq. (MHz)	5590
Polarization	Horizontal		

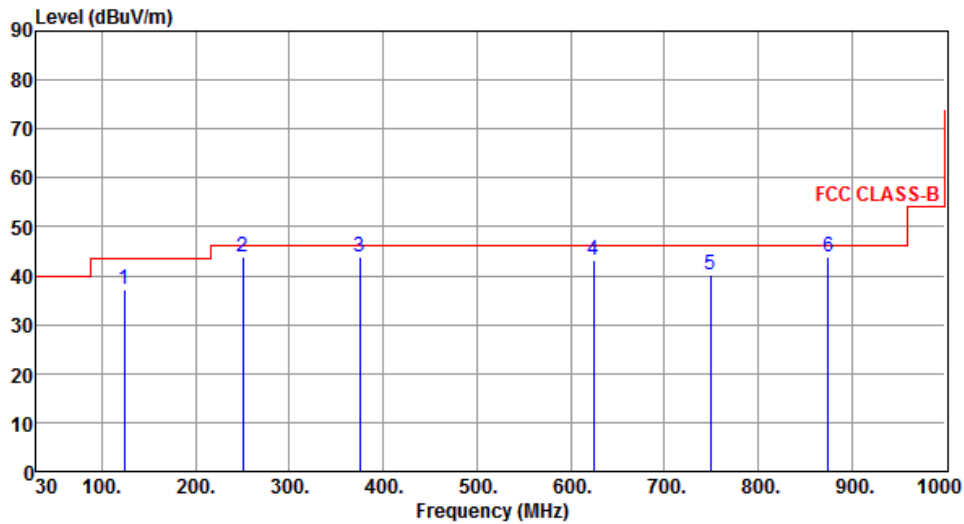

	Freq. MHz	Emission level dBuV/m	Limit dBuV/m	Margin dB	SA reading dBuV	Factor dB	Remark	ANT High cm	Turn Table deg
1	124.09	37.11	43.50	-6.39	55.61	-18.50	Peak	---	---
2	249.99	43.88	46.00	-2.12	61.60	-17.72	QP	100	239
3	375.00	43.97	46.00	-2.03	58.08	-14.11	QP	100	224
4	624.61	43.28	46.00	-2.72	52.39	-9.11	Peak	---	---
5	749.74	40.05	46.00	-5.95	46.99	-6.94	Peak	---	---
6	874.99	43.68	46.00	-2.32	49.24	-5.56	QP	100	255

Note 1: Emission Level (dBuV/m) = SA Reading (dBuV/m) + Factor* (dB)

*Factor includes antenna factor , cable loss and amplifier gain

Note 2: Margin (dB) = Emission level (dBuV/m) – Limit (dBuV/m).

Note 3: All spurious emissions below 30MHz are more than 20 dB below the limit.

Modulation	VHT40	Test Freq. (MHz)	5590
Polarization	Vertical		

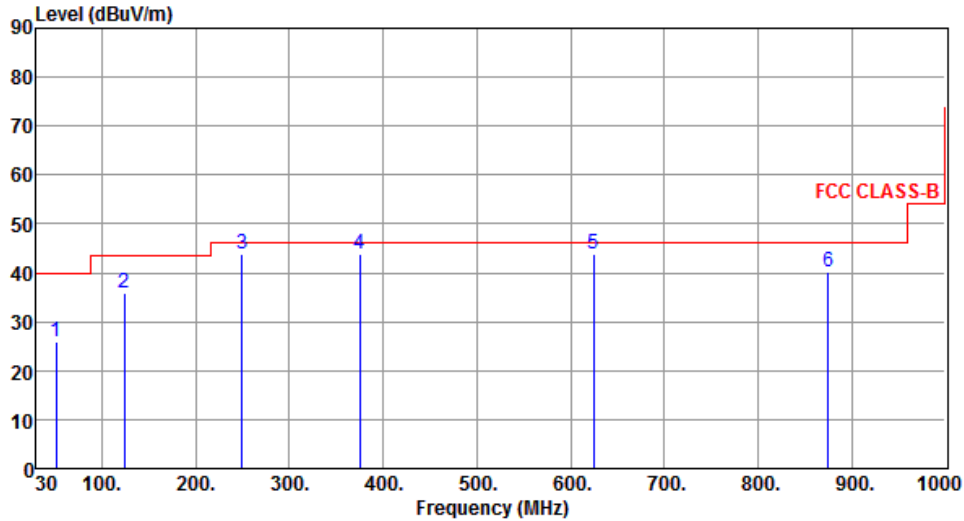

	Freq. MHz	Emission level dBuV/m	Limit dBuV/m	Margin dB	SA reading dBuV	Factor dB	Remark	ANT High cm	Turn Table deg
1	50.98	26.00	40.00	-14.00	42.48	-16.48	QP	100	71
2	124.09	35.72	43.50	-7.78	54.22	-18.50	Peak	---	---
3	249.22	43.82	46.00	-2.18	61.56	-17.74	Peak	---	---
4	374.99	43.90	46.00	-2.10	58.01	-14.11	QP	100	215
5	625.00	43.86	46.00	-2.14	52.96	-9.10	QP	121	271
6	874.87	40.03	46.00	-5.97	45.59	-5.56	Peak	---	---

Note 1: Emission Level (dBuV/m) = SA Reading (dBuV/m) + Factor* (dB)

*Factor includes antenna factor , cable loss and amplifier gain

Note 2: Margin (dB) = Emission level (dBuV/m) – Limit (dBuV/m).

Note 3: All spurious emissions below 30MHz are more than 20 dB below the limit.

Modulation	VHT20	Test Freq. (MHz)	5785
Polarization	Horizontal		

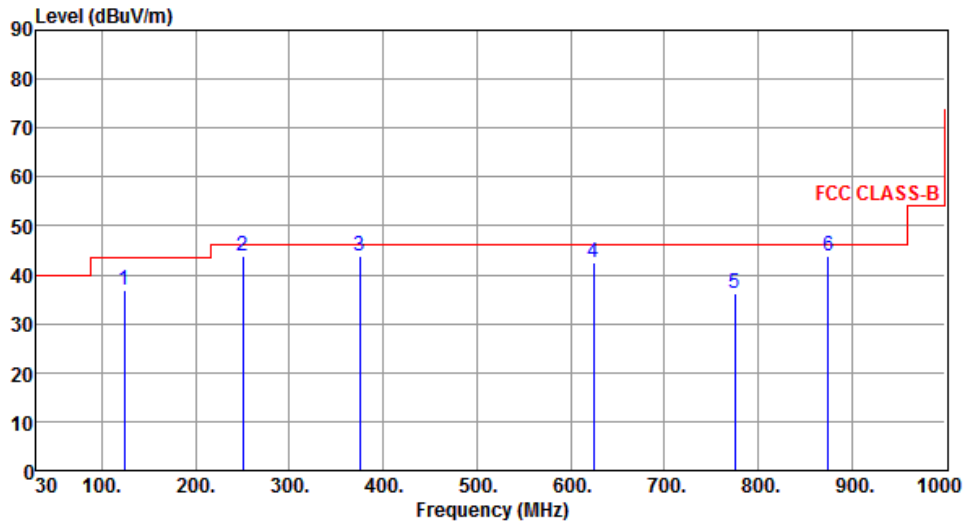

	Freq. MHz	Emission level dBuV/m	Limit dBuV/m	Margin dB	SA reading dBuV	Factor dB	Remark	ANT High cm	Turn Table deg
1	124.09	36.93	43.50	-6.57	55.43	-18.50	Peak	---	---
2	250.00	43.78	46.00	-2.22	61.50	-17.72	QP	100	236
3	374.99	43.92	46.00	-2.08	58.03	-14.11	QP	100	220
4	624.61	42.45	46.00	-3.55	51.56	-9.11	Peak	---	---
5	774.96	36.27	46.00	-9.73	43.00	-6.73	Peak	---	---
6	874.98	43.94	46.00	-2.06	49.50	-5.56	QP	100	251

Note 1: Emission Level (dBuV/m) = SA Reading (dBuV/m) + Factor* (dB)

*Factor includes antenna factor , cable loss and amplifier gain

Note 2: Margin (dB) = Emission level (dBuV/m) – Limit (dBuV/m).

Note 3: All spurious emissions below 30MHz are more than 20 dB below the limit.

Modulation	VHT20	Test Freq. (MHz)	5785
Polarization	Vertical		

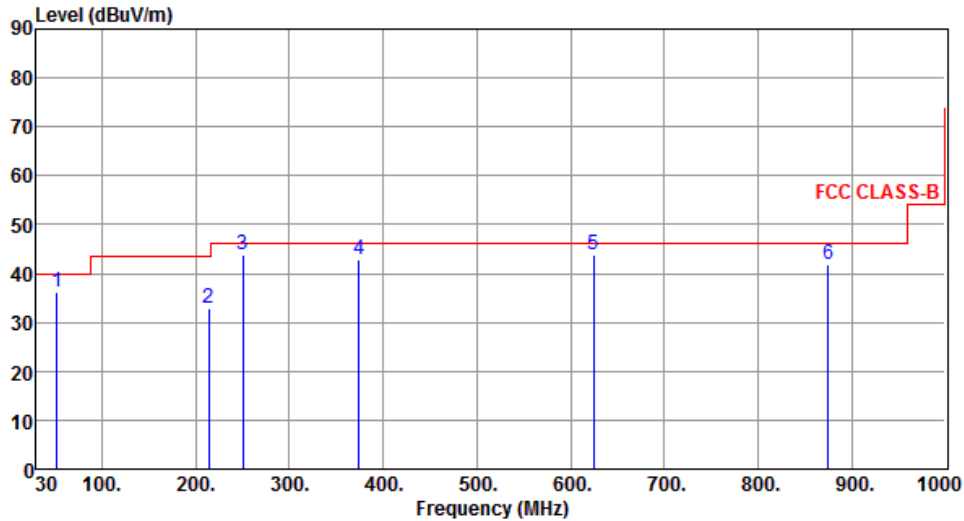

	Freq. MHz	Emission level dBuV/m	Limit dBuV/m	Margin dB	SA reading dBuV	Factor dB	Remark	ANT High cm	Turn Table deg
1	52.01	36.21	40.00	-3.79	52.80	-16.59	QP	100	13
2	214.30	32.88	43.50	-10.62	52.08	-19.20	Peak	---	---
3	249.99	43.95	46.00	-2.05	61.67	-17.72	QP	100	217
4	374.35	42.69	46.00	-3.31	56.82	-14.13	Peak	---	---
5	624.99	43.91	46.00	-2.09	53.01	-9.10	QP	100	245
6	874.87	41.94	46.00	-4.06	47.50	-5.56	Peak	---	---

Note 1: Emission Level (dBuV/m) = SA Reading (dBuV/m) + Factor* (dB)

*Factor includes antenna factor , cable loss and amplifier gain

Note 2: Margin (dB) = Emission level (dBuV/m) – Limit (dBuV/m).

Note 3: All spurious emissions below 30MHz are more than 20 dB below the limit.

3.5.17 Transmitter Radiated Unwanted Emissions (Above 1GHz) for VHT20

Modulation	VHT20	Test Freq. (MHz)	5180
Polarization	Horizontal		

	Freq. MHz	Emission level dBuV/m	Limit dBuV/m	Margin dB	SA reading dBuV	Factor dB	Remark	ANT High cm	Turn Table deg
1	5150.00	43.55	54.00	-10.45	39.15	4.40	Average	202	292
2	5150.00	55.90	74.00	-18.10	51.50	4.40	Peak	202	292
3	6906.70	53.74	68.20	-14.46	46.00	7.74	Peak	174	246
4	10360.00	55.65	68.20	-12.55	41.45	14.20	Peak	153	146

Note 1: Emission Level (dBuV/m) = SA Reading (dBuV/m) + Factor* (dB)
*Factor includes antenna factor , cable loss and amplifier gain
Note 2: Margin (dB) = Emission level (dBuV/m) – Limit (dBuV/m).

Modulation	VHT20	Test Freq. (MHz)	5180
Polarization	Vertical		

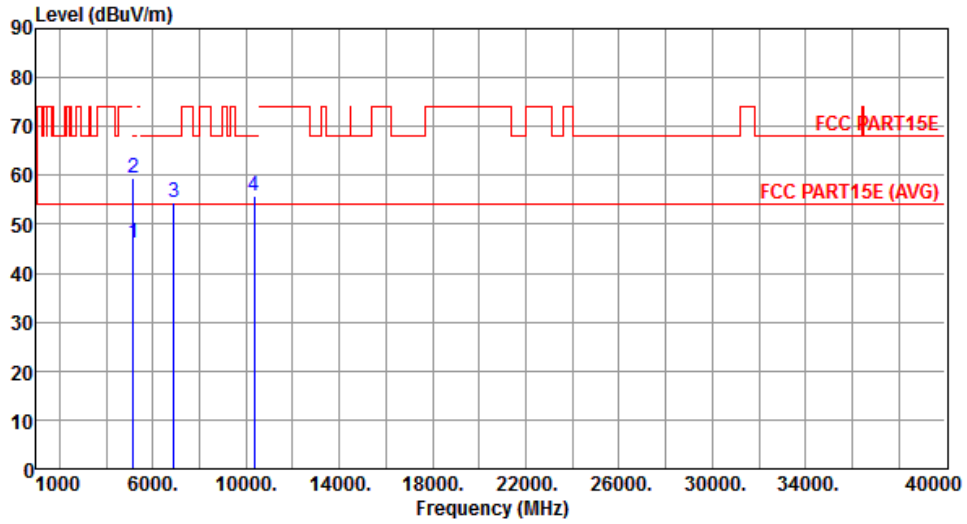

	Freq. MHz	Emission level dBuV/m	Limit dBuV/m	Margin dB	SA reading dBuV	Factor dB	Remark	ANT High cm	Turn Table deg
1	5150.00	46.17	54.00	-7.83	41.77	4.40	Average	201	289
2	5150.00	59.36	74.00	-14.64	54.96	4.40	Peak	201	289
3	6906.70	54.55	68.20	-13.65	46.81	7.74	Peak	180	217
4	10360.00	55.92	68.20	-12.28	41.72	14.20	Peak	155	229

Note 1: Emission Level (dBuV/m) = SA Reading (dBuV/m) + Factor* (dB)

*Factor includes antenna factor , cable loss and amplifier gain

Note 2: Margin (dB) = Emission level (dBuV/m) – Limit (dBuV/m).

Modulation	VHT20	Test Freq. (MHz)	5200
Polarization	Horizontal		

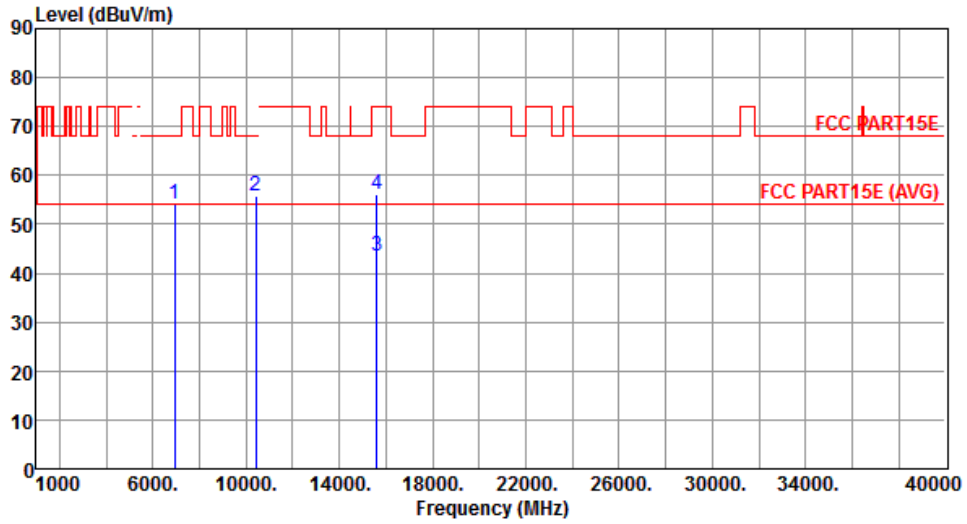

	Freq. MHz	Emission level dBuV/m	Limit dBuV/m	Margin dB	SA reading dBuV	Factor dB	Remark	ANT High cm	Turn Table deg
1	6933.30	54.08	68.20	-14.12	46.31	7.77	Peak	168	245
2	10400.00	55.74	68.20	-12.46	41.46	14.28	Peak	159	142
3	15600.00	43.39	54.00	-10.61	28.37	15.02	Average	313	274
4	15600.00	56.17	74.00	-17.83	41.15	15.02	Peak	313	274

Note 1: Emission Level (dBuV/m) = SA Reading (dBuV/m) + Factor* (dB)

*Factor includes antenna factor , cable loss and amplifier gain

Note 2: Margin (dB) = Emission level (dBuV/m) – Limit (dBuV/m).

Modulation	VHT20	Test Freq. (MHz)	5200
Polarization	Vertical		

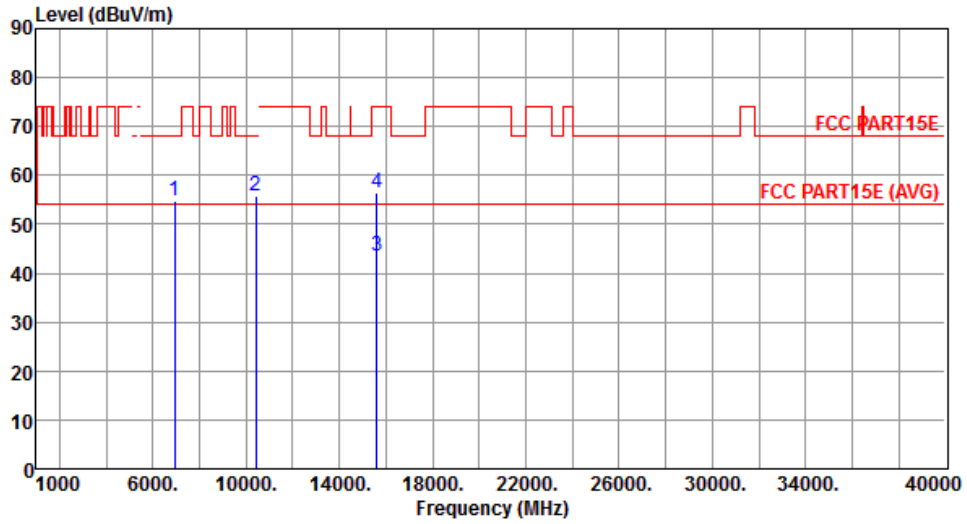

	Freq. MHz	Emission level dBuV/m	Limit dBuV/m	Margin dB	SA reading dBuV	Factor dB	Remark	ANT High cm	Turn Table deg
1	6933.30	54.86	68.20	-13.34	47.09	7.77	Peak	173	212
2	10400.00	55.65	68.20	-12.55	41.37	14.28	Peak	159	225
3	15600.00	43.44	54.00	-10.56	28.42	15.02	Average	218	335
4	15600.00	56.58	74.00	-17.42	41.56	15.02	Peak	218	335

Note 1: Emission Level (dBuV/m) = SA Reading (dBuV/m) + Factor* (dB)

*Factor includes antenna factor , cable loss and amplifier gain

Note 2: Margin (dB) = Emission level (dBuV/m) – Limit (dBuV/m).

Modulation	VHT20	Test Freq. (MHz)	5240
Polarization	Horizontal		

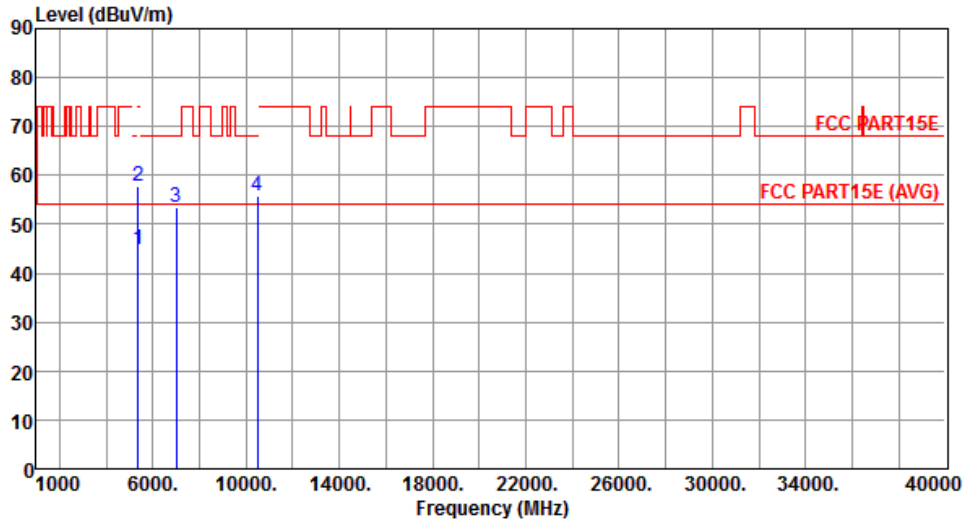

	Freq. MHz	Emission level dBuV/m	Limit dBuV/m	Margin dB	SA reading dBuV	Factor dB	Remark	ANT High cm	Turn Table deg
1	5350.00	44.95	54.00	-9.05	40.31	4.64	Average	103	256
2	5350.00	57.75	74.00	-16.25	53.11	4.64	Peak	103	256
3	6986.70	53.55	68.20	-14.65	45.71	7.84	Peak	178	245
4	10480.00	55.90	68.20	-12.30	41.47	14.43	Peak	158	143

Note 1: Emission Level (dBuV/m) = SA Reading (dBuV/m) + Factor* (dB)

*Factor includes antenna factor , cable loss and amplifier gain

Note 2: Margin (dB) = Emission level (dBuV/m) – Limit (dBuV/m).

Modulation	VHT20	Test Freq. (MHz)	5240
Polarization	Vertical		

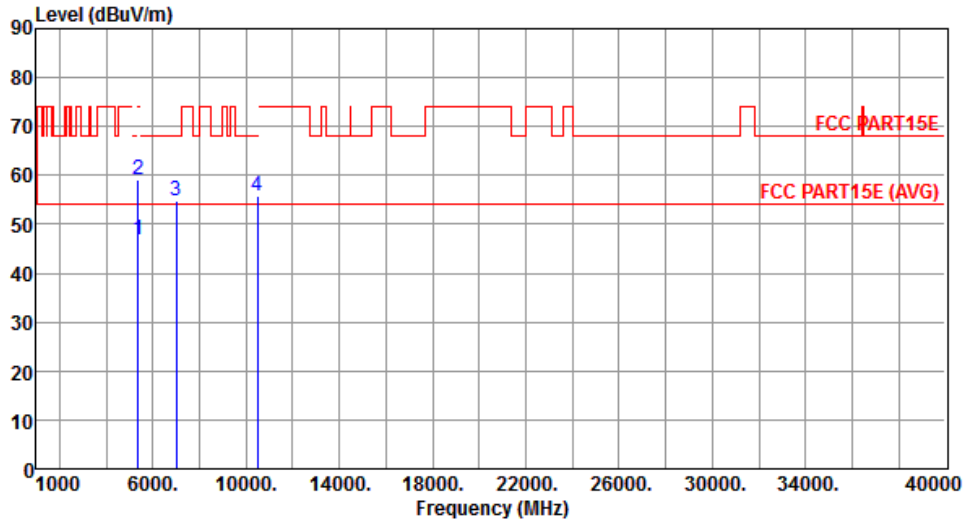

	Freq. MHz	Emission level dBuV/m	Limit dBuV/m	Margin dB	SA reading dBuV	Factor dB	Remark	ANT High cm	Turn Table deg
1	5350.00	46.82	54.00	-7.18	42.18	4.64	Average	173	285
2	5350.00	59.09	74.00	-14.91	54.45	4.64	Peak	173	285
3	6986.70	54.84	68.20	-13.36	47.00	7.84	Peak	176	211
4	10480.00	55.63	68.20	-12.57	41.20	14.43	Peak	152	224

Note 1: Emission Level (dBuV/m) = SA Reading (dBuV/m) + Factor* (dB)

*Factor includes antenna factor , cable loss and amplifier gain

Note 2: Margin (dB) = Emission level (dBuV/m) – Limit (dBuV/m).

Modulation	VHT20	Test Freq. (MHz)	5260
Polarization	Horizontal		

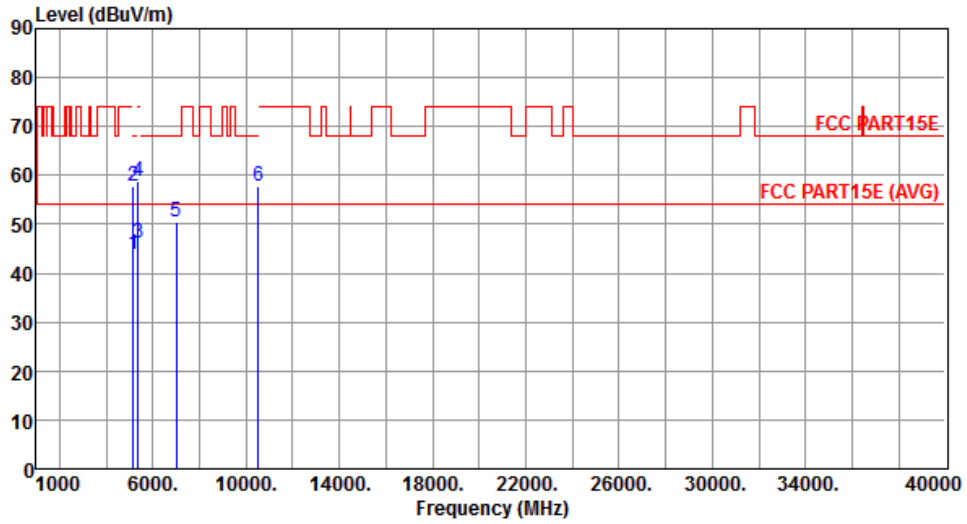

	Freq. MHz	Emission level dBuV/m	Limit dBuV/m	Margin dB	SA reading dBuV	Factor dB	Remark	ANT High cm	Turn Table deg
1	5150.00	43.91	54.00	-10.09	39.51	4.40	Average	273	210
2	5150.00	57.84	74.00	-16.16	53.44	4.40	Peak	273	210
3	5350.00	46.01	54.00	-7.99	41.37	4.64	Average	273	210
4	5350.00	58.85	74.00	-15.15	54.21	4.64	Peak	273	210
5	7013.30	50.32	68.20	-17.88	42.42	7.90	Peak	164	242
6	10520.00	57.64	68.20	-10.56	43.14	14.50	Peak	169	73

Note 1: Emission Level (dBuV/m) = SA Reading (dBuV/m) + Factor* (dB)

*Factor includes antenna factor , cable loss and amplifier gain

Note 2: Margin (dB) = Emission level (dBuV/m) – Limit (dBuV/m).

Modulation	VHT20	Test Freq. (MHz)	5260
Polarization	Vertical		

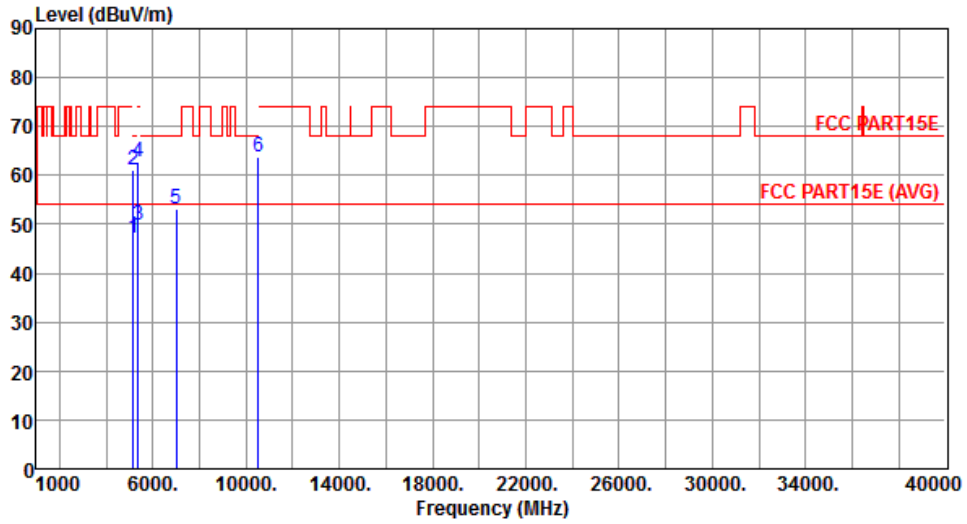

	Freq. MHz	Emission level dBuV/m	Limit dBuV/m	Margin dB	SA reading dBuV	Factor dB	Remark	ANT High cm	Turn Table deg
1	5150.00	47.05	54.00	-6.95	42.65	4.40	Average	184	278
2	5150.00	61.16	74.00	-12.84	56.76	4.40	Peak	184	278
3	5350.00	49.67	54.00	-4.33	45.03	4.64	Average	184	278
4	5350.00	62.86	74.00	-11.14	58.22	4.64	Peak	184	278
5	7013.30	53.12	68.20	-15.08	45.22	7.90	Peak	168	342
6	10520.00	63.67	68.20	-4.53	49.17	14.50	Peak	152	188

Note 1: Emission Level (dBuV/m) = SA Reading (dBuV/m) + Factor* (dB)

*Factor includes antenna factor , cable loss and amplifier gain

Note 2: Margin (dB) = Emission level (dBuV/m) – Limit (dBuV/m).

Modulation	VHT20	Test Freq. (MHz)	5300
Polarization	Horizontal		

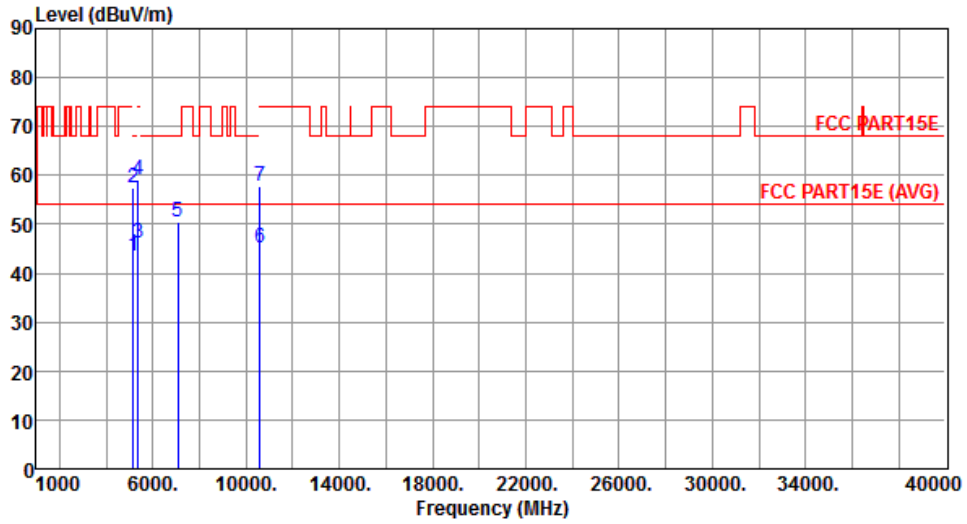

	Freq. MHz	Emission level dBuV/m	Limit dBuV/m	Margin dB	SA reading dBuV	Factor dB	Remark	ANT High cm	Turn Table deg
1	5150.00	43.60	54.00	-10.40	39.20	4.40	Average	104	139
2	5150.00	57.50	74.00	-16.50	53.10	4.40	Peak	104	139
3	5350.00	46.10	54.00	-7.90	41.46	4.64	Average	104	139
4	5350.00	59.05	74.00	-14.95	54.41	4.64	Peak	104	139
5	7066.70	50.58	68.20	-17.62	42.55	8.03	Peak	163	249
6	10600.00	45.15	54.00	-8.85	30.56	14.59	Average	169	82
7	10600.00	57.95	74.00	-16.05	43.36	14.59	Peak	169	82

Note 1: Emission Level (dBuV/m) = SA Reading (dBuV/m) + Factor* (dB)

*Factor includes antenna factor , cable loss and amplifier gain

Note 2: Margin (dB) = Emission level (dBuV/m) – Limit (dBuV/m).

Modulation	VHT20	Test Freq. (MHz)	5300
Polarization	Vertical		

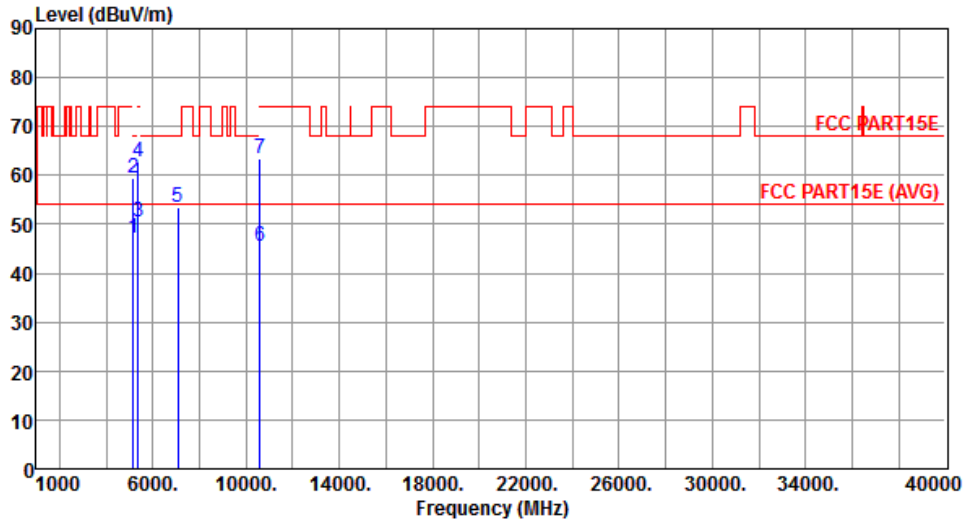

	Freq. MHz	Emission level dBuV/m	Limit dBuV/m	Margin dB	SA reading dBuV	Factor dB	Remark	ANT High cm	Turn Table deg
1	5150.00	47.27	54.00	-6.73	42.87	4.40	Average	198	3
2	5150.00	59.50	74.00	-14.50	55.10	4.40	Peak	198	3
3	5350.00	50.40	54.00	-3.60	45.76	4.64	Average	198	3
4	5350.00	62.83	74.00	-11.17	58.19	4.64	Peak	198	3
5	7066.70	53.33	68.20	-14.87	45.30	8.03	Peak	162	351
6	10600.00	45.53	54.00	-8.47	30.94	14.59	Average	158	181
7	10600.00	63.33	74.00	-10.67	48.74	14.59	Peak	158	181

Note 1: Emission Level (dBuV/m) = SA Reading (dBuV/m) + Factor* (dB)

*Factor includes antenna factor , cable loss and amplifier gain

Note 2: Margin (dB) = Emission level (dBuV/m) – Limit (dBuV/m).

Modulation	VHT20	Test Freq. (MHz)	5320
Polarization	Horizontal		

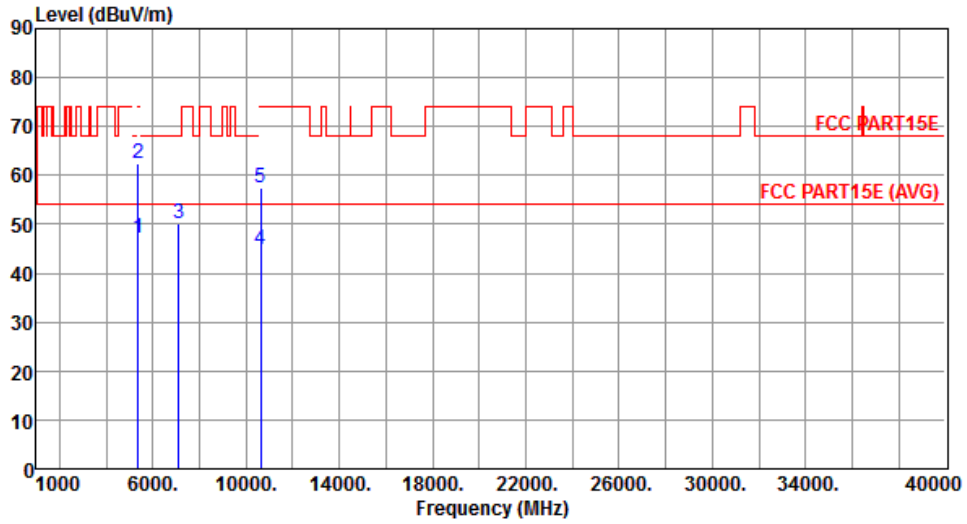

	Freq. MHz	Emission level dBuV/m	Limit dBuV/m	Margin dB	SA reading dBuV	Factor dB	Remark	ANT High cm	Turn Table deg
1	5350.00	47.20	54.00	-6.80	42.56	4.64	Average	322	222
2	5350.00	62.43	74.00	-11.57	57.79	4.64	Peak	322	222
3	7093.30	50.20	68.20	-18.00	42.09	8.11	Peak	169	244
4	10640.00	44.89	54.00	-9.11	30.25	14.64	Average	163	85
5	10640.00	57.61	74.00	-16.39	42.97	14.64	Peak	163	85

Note 1: Emission Level (dBuV/m) = SA Reading (dBuV/m) + Factor* (dB)

*Factor includes antenna factor , cable loss and amplifier gain

Note 2: Margin (dB) = Emission level (dBuV/m) – Limit (dBuV/m).

Modulation	VHT20	Test Freq. (MHz)	5320
Polarization	Vertical		

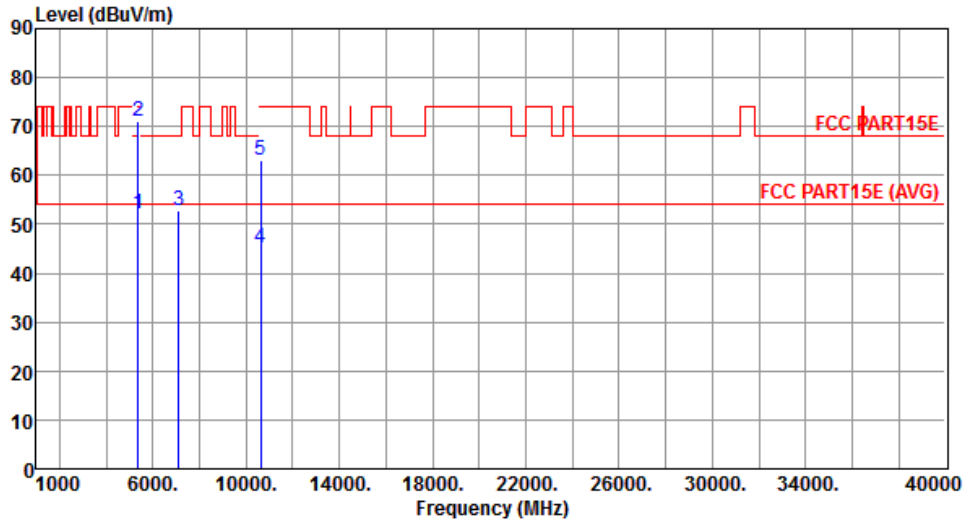

	Freq. MHz	Emission level dBuV/m	Limit dBuV/m	Margin dB	SA reading dBuV	Factor dB	Remark	ANT High cm	Turn Table deg
1	5350.00	52.31	54.00	-1.69	47.67	4.64	Average	197	285
2	5350.00	71.05	74.00	-2.95	66.41	4.64	Peak	197	285
3	7093.30	52.71	68.20	-15.49	44.60	8.11	Peak	168	356
4	10640.00	45.30	54.00	-8.70	30.66	14.64	Average	153	185
5	10640.00	62.99	74.00	-11.01	48.35	14.64	Peak	153	185

Note 1: Emission Level (dBuV/m) = SA Reading (dBuV/m) + Factor* (dB)

*Factor includes antenna factor , cable loss and amplifier gain

Note 2: Margin (dB) = Emission level (dBuV/m) – Limit (dBuV/m).

Modulation	VHT20	Test Freq. (MHz)	5500
Polarization	Horizontal		

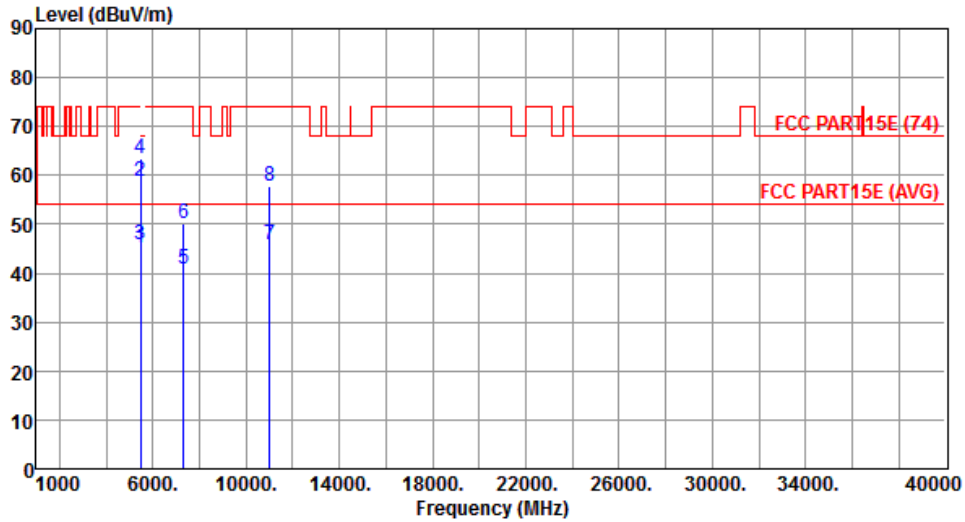

	Freq. MHz	Emission level dBuV/m	Limit dBuV/m	Margin dB	SA reading dBuV	Factor dB	Remark	ANT High cm	Turn Table deg
1	5460.00	45.24	54.00	-8.76	40.46	4.78	Average	194	260
2	5460.00	58.67	74.00	-15.33	53.89	4.78	Peak	194	260
3	5470.00	45.70	54.00	-8.30	40.91	4.79	Average	194	260
4	5470.00	63.48	74.00	-10.52	58.69	4.79	Peak	194	260
5	7333.30	40.79	54.00	-13.21	32.36	8.43	Average	190	334
6	7333.30	50.14	74.00	-23.86	41.71	8.43	Peak	190	334
7	11000.00	45.76	54.00	-8.24	30.70	15.06	Average	233	82
8	11000.00	57.92	74.00	-16.08	42.86	15.06	Peak	233	82

Note 1: Emission Level (dBuV/m) = SA Reading (dBuV/m) + Factor* (dB)

*Factor includes antenna factor , cable loss and amplifier gain

Note 2: Margin (dB) = Emission level (dBuV/m) – Limit (dBuV/m).

Modulation	VHT20	Test Freq. (MHz)	5500
Polarization	Vertical		

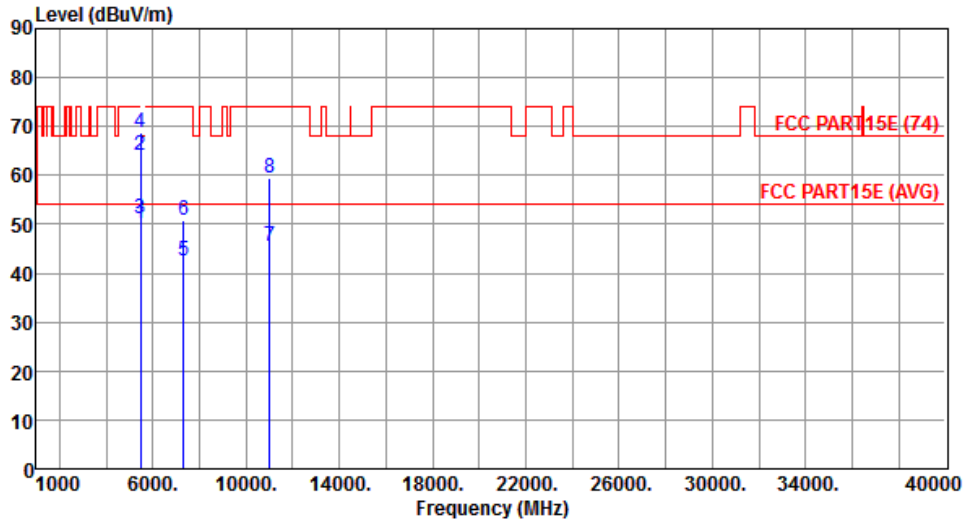

	Freq. MHz	Emission level dBuV/m	Limit dBuV/m	Margin dB	SA reading dBuV	Factor dB	Remark	ANT High cm	Turn Table deg
1	5460.00	50.13	54.00	-3.87	45.35	4.78	Average	197	1
2	5460.00	64.07	74.00	-9.93	59.29	4.78	Peak	197	1
3	5470.00	51.09	54.00	-2.91	46.30	4.79	Average	197	1
4	5470.00	68.64	74.00	-5.36	63.85	4.79	Peak	197	1
5	7333.30	42.47	54.00	-11.53	34.04	8.43	Average	167	350
6	7333.30	50.76	74.00	-23.24	42.33	8.43	Peak	167	350
7	11000.00	45.53	54.00	-8.47	30.47	15.06	Average	170	109
8	11000.00	59.56	74.00	-14.44	44.50	15.06	Peak	170	109

Note 1: Emission Level (dBuV/m) = SA Reading (dBuV/m) + Factor* (dB)

*Factor includes antenna factor , cable loss and amplifier gain

Note 2: Margin (dB) = Emission level (dBuV/m) – Limit (dBuV/m).

Modulation	VHT20	Test Freq. (MHz)	5580
Polarization	Horizontal		

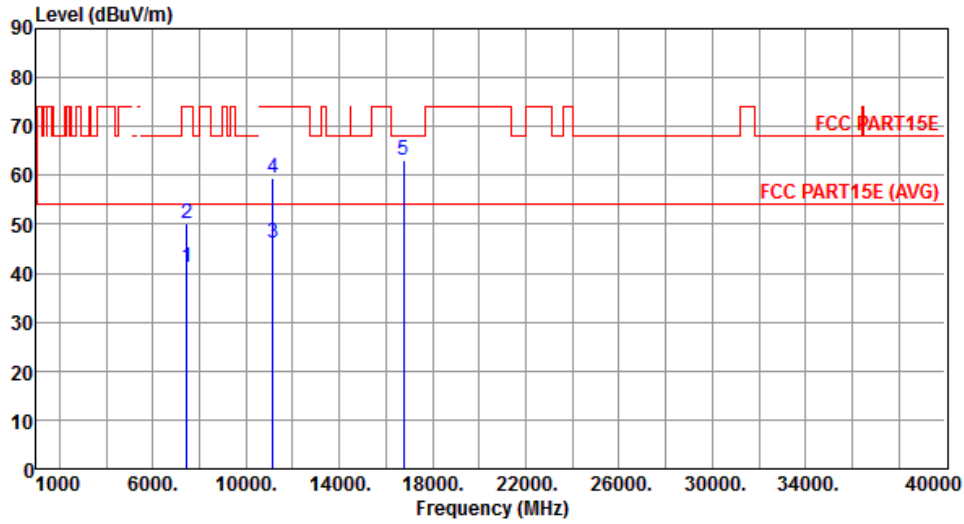

	Freq. MHz	Emission level dBuV/m	Limit dBuV/m	Margin dB	SA reading dBuV	Factor dB	Remark	ANT High cm	Turn Table deg
1	7440.00	41.10	54.00	-12.90	32.54	8.56	Average	163	240
2	7440.00	50.18	74.00	-23.82	41.62	8.56	Peak	163	240
3	11160.00	46.32	54.00	-7.68	31.11	15.21	Average	172	135
4	11160.00	59.31	74.00	-14.69	44.10	15.21	Peak	172	135
5	16740.00	63.09	68.20	-5.11	45.83	17.26	Peak	145	117

Note 1: Emission Level (dBuV/m) = SA Reading (dBuV/m) + Factor* (dB)

*Factor includes antenna factor , cable loss and amplifier gain

Note 2: Margin (dB) = Emission level (dBuV/m) – Limit (dBuV/m).

Modulation	VHT20	Test Freq. (MHz)	5580
Polarization	Vertical		

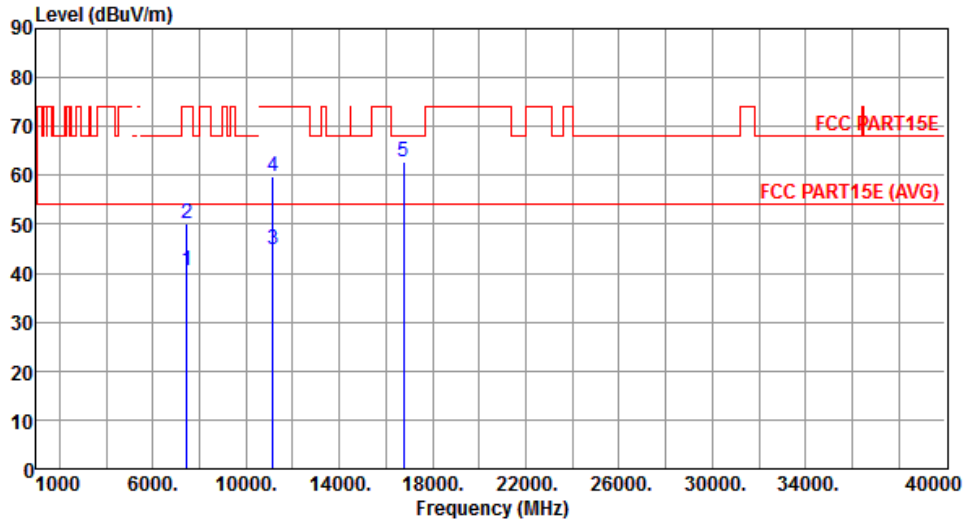

	Freq. MHz	Emission level dBuV/m	Limit dBuV/m	Margin dB	SA reading dBuV	Factor dB	Remark	ANT High cm	Turn Table deg
1	7440.00	40.54	54.00	-13.46	31.98	8.56	Average	164	0
2	7440.00	50.04	74.00	-23.96	41.48	8.56	Peak	164	0
3	11160.00	44.83	54.00	-9.17	29.62	15.21	Average	305	6
4	11160.00	59.72	74.00	-14.28	44.51	15.21	Peak	305	6
5	16740.00	62.92	68.20	-5.28	45.66	17.26	Peak	160	83

Note 1: Emission Level (dBuV/m) = SA Reading (dBuV/m) + Factor* (dB)

*Factor includes antenna factor , cable loss and amplifier gain

Note 2: Margin (dB) = Emission level (dBuV/m) – Limit (dBuV/m).

Modulation	VHT20	Test Freq. (MHz)	5700
Polarization	Horizontal		

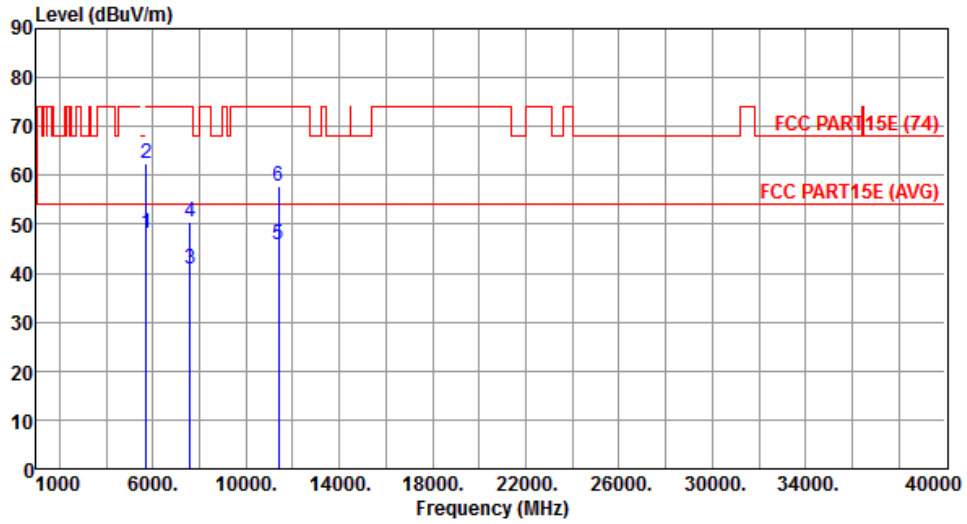

	Freq. MHz	Emission level dBuV/m	Limit dBuV/m	Margin dB	SA reading dBuV	Factor dB	Remark	ANT High cm	Turn Table deg
1	5725.00	48.20	54.00	-5.80	43.11	5.09	Average	188	260
2	5725.00	62.55	74.00	-11.45	57.46	5.09	Peak	188	260
3	7600.00	40.96	54.00	-13.04	32.12	8.84	Average	194	332
4	7600.00	50.42	74.00	-23.58	41.58	8.84	Peak	194	332
5	11400.00	45.88	54.00	-8.12	30.44	15.44	Average	225	71
6	11400.00	57.64	74.00	-16.36	42.20	15.44	Peak	225	71

Note 1: Emission Level (dBuV/m) = SA Reading (dBuV/m) + Factor* (dB)

*Factor includes antenna factor , cable loss and amplifier gain

Note 2: Margin (dB) = Emission level (dBuV/m) – Limit (dBuV/m).

Modulation	VHT20	Test Freq. (MHz)	5700
Polarization	Vertical		

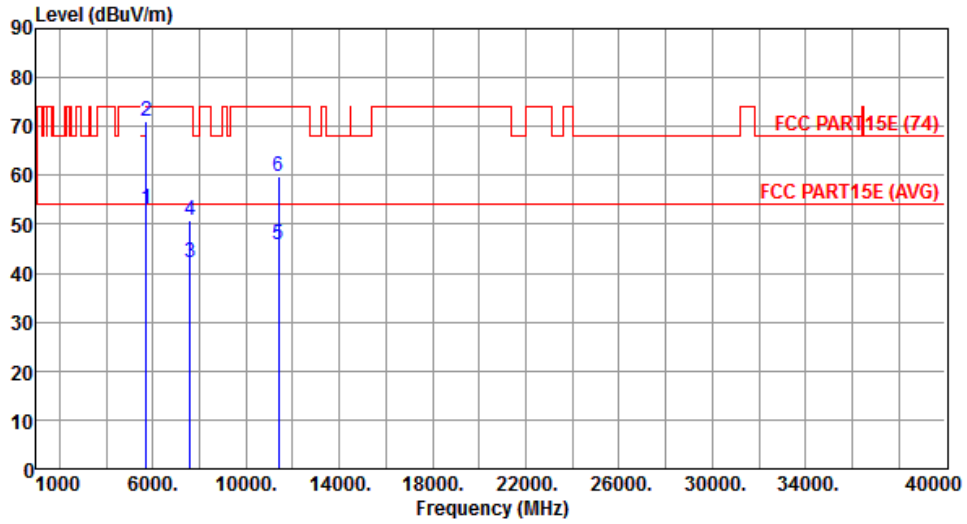

	Freq. MHz	Emission level dBuV/m	Limit dBuV/m	Margin dB	SA reading dBuV	Factor dB	Remark	ANT High cm	Turn Table deg
1	5725.00	52.98	54.00	-1.02	47.89	5.09	Average	223	178
2	5725.00	70.96	74.00	-3.04	65.87	5.09	Peak	223	178
3	7600.00	42.24	54.00	-11.76	33.40	8.84	Average	162	351
4	7600.00	50.80	74.00	-23.20	41.96	8.84	Peak	162	351
5	11400.00	45.83	54.00	-8.17	30.39	15.44	Average	178	103
6	11400.00	59.94	74.00	-14.06	44.50	15.44	Peak	178	103

Note 1: Emission Level (dBuV/m) = SA Reading (dBuV/m) + Factor* (dB)

*Factor includes antenna factor , cable loss and amplifier gain

Note 2: Margin (dB) = Emission level (dBuV/m) – Limit (dBuV/m).

Modulation	VHT20	Test Freq. (MHz)	5720
Polarization	Horizontal		

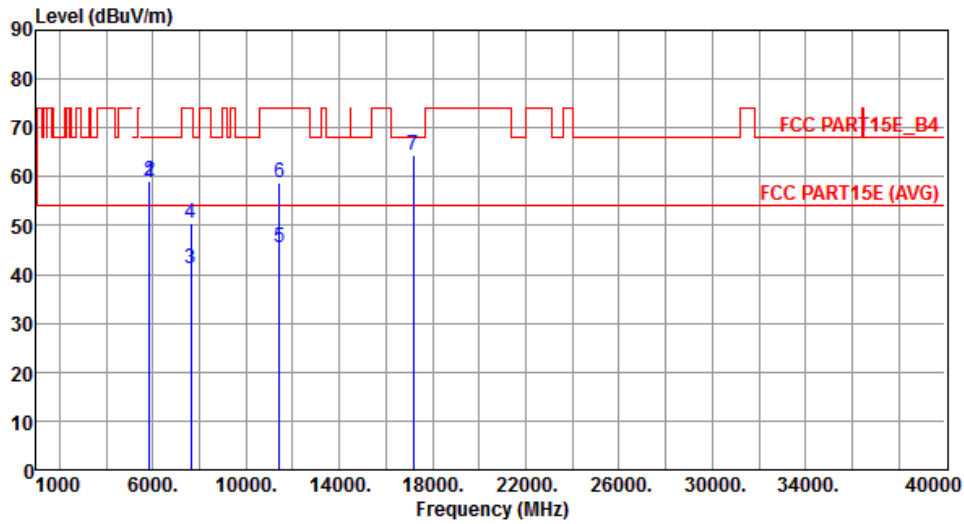

	Freq. MHz	Emission level dBuV/m	Limit dBuV/m	Margin dB	SA reading dBuV	Factor dB	Remark	ANT High cm	Turn Table deg
1	5850.00	58.64	78.20	-19.56	53.38	5.26	Peak	289	255
2	5860.00	59.14	68.20	-9.06	53.87	5.27	Peak	289	255
3	7626.66	41.29	54.00	-12.71	32.47	8.82	Average	218	244
4	7626.66	50.52	74.00	-23.48	41.70	8.82	Peak	218	244
5	11440.00	45.49	54.00	-8.51	30.00	15.49	Average	194	18
6	11440.00	58.63	74.00	-15.37	43.14	15.49	Peak	194	18
7	17160.00	64.28	68.20	-3.92	45.61	18.67	Peak	179	8

Note 1: Emission Level (dBuV/m) = SA Reading (dBuV/m) + Factor* (dB)

*Factor includes antenna factor , cable loss and amplifier gain

Note 2: Margin (dB) = Emission level (dBuV/m) – Limit (dBuV/m).

Modulation	VHT20	Test Freq. (MHz)	5720
Polarization	Vertical		

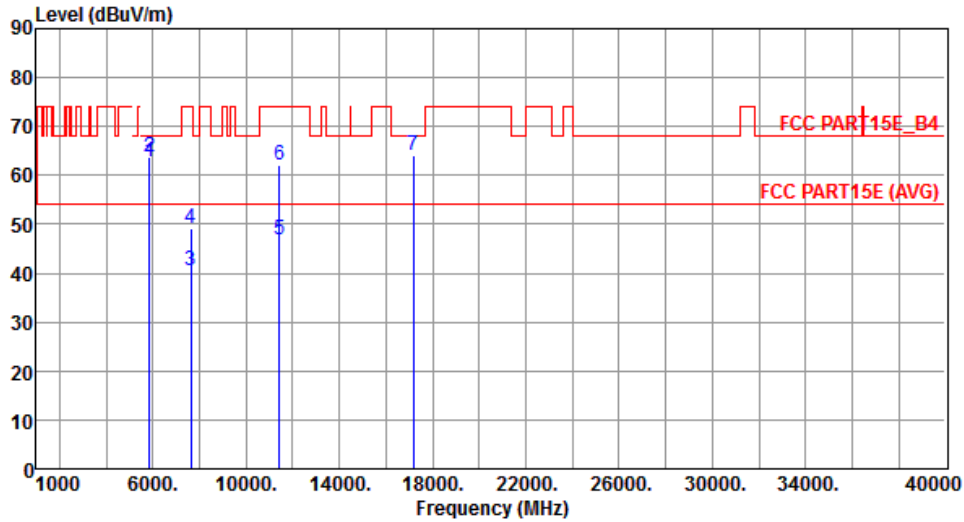

	Freq. MHz	Emission level dBuV/m	Limit dBuV/m	Margin dB	SA reading dBuV	Factor dB	Remark	ANT High cm	Turn Table deg
1	5850.00	62.91	78.20	-15.29	57.65	5.26	Peak	198	176
2	5860.00	63.92	68.20	-4.28	58.65	5.27	Peak	198	176
3	7626.66	40.37	54.00	-13.63	31.55	8.82	Average	203	109
4	7626.66	49.30	74.00	-24.70	40.48	8.82	Peak	203	109
5	11440.00	46.91	54.00	-7.09	31.42	15.49	Average	197	235
6	11440.00	62.19	74.00	-11.81	46.70	15.49	Peak	197	235
7	17160.00	64.19	68.20	-4.01	45.52	18.67	Peak	196	106

Note 1: Emission Level (dBuV/m) = SA Reading (dBuV/m) + Factor* (dB)

*Factor includes antenna factor , cable loss and amplifier gain

Note 2: Margin (dB) = Emission level (dBuV/m) – Limit (dBuV/m).

Modulation	VHT20	Test Freq. (MHz)	5745
Polarization	Horizontal		

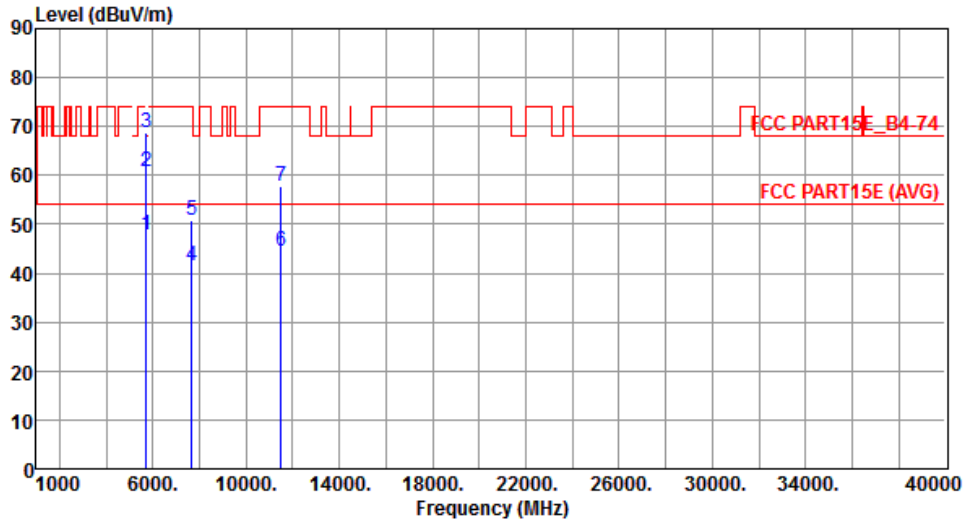

	Freq. MHz	Emission level dBuV/m	Limit dBuV/m	Margin dB	SA reading dBuV	Factor dB	Remark	ANT High cm	Turn Table deg
1	5715.00	47.83	54.00	-6.17	42.73	5.10	Average	172	136
2	5715.00	60.78	74.00	-13.22	55.68	5.10	Peak	172	136
3	5725.00	68.60	78.20	-9.60	63.51	5.09	Peak	172	136
4	7660.00	41.53	54.00	-12.47	32.74	8.79	Average	217	242
5	7660.00	50.86	74.00	-23.14	42.07	8.79	Peak	217	242
6	11490.00	44.66	54.00	-9.34	29.13	15.53	Average	284	182
7	11490.00	57.63	74.00	-16.37	42.10	15.53	Peak	284	182

Note 1: Emission Level (dBuV/m) = SA Reading (dBuV/m) + Factor* (dB)

*Factor includes antenna factor , cable loss and amplifier gain

Note 2: Margin (dB) = Emission level (dBuV/m) – Limit (dBuV/m).

Modulation	VHT20	Test Freq. (MHz)	5745
Polarization	Vertical		

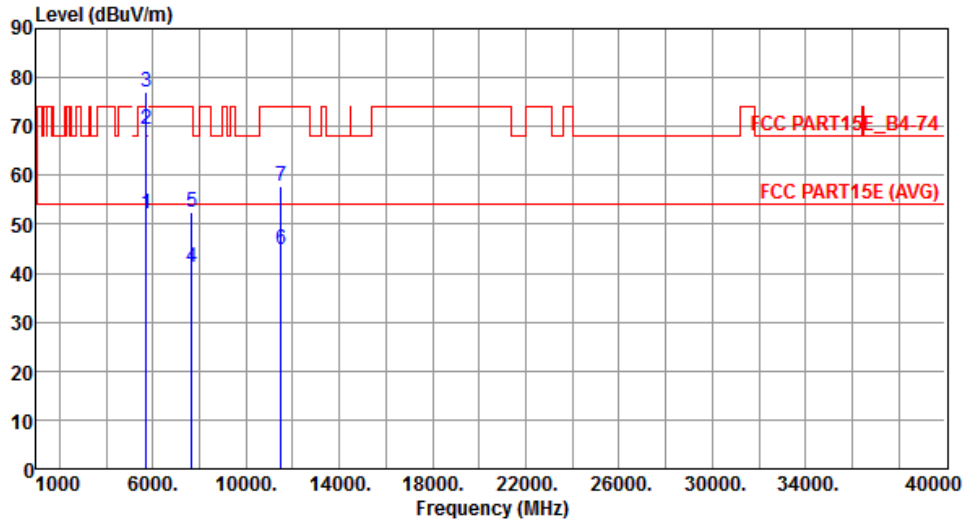

	Freq. MHz	Emission level dBuV/m	Limit dBuV/m	Margin dB	SA reading dBuV	Factor dB	Remark	ANT High cm	Turn Table deg
1	5715.00	52.09	54.00	-1.91	46.99	5.10	Average	202	169
2	5715.00	69.47	74.00	-4.53	64.37	5.10	Peak	202	169
3	5725.00	76.94	78.20	-1.26	71.85	5.09	Peak	202	169
4	7660.00	41.17	54.00	-12.83	32.38	8.79	Average	219	63
5	7660.00	52.49	74.00	-21.51	43.70	8.79	Peak	219	63
6	11490.00	44.86	54.00	-9.14	29.33	15.53	Average	255	347
7	11490.00	57.71	74.00	-16.29	42.18	15.53	Peak	255	347

Note 1: Emission Level (dBuV/m) = SA Reading (dBuV/m) + Factor* (dB)

*Factor includes antenna factor , cable loss and amplifier gain

Note 2: Margin (dB) = Emission level (dBuV/m) – Limit (dBuV/m).

Modulation	VHT20	Test Freq. (MHz)	5785
Polarization	Horizontal		

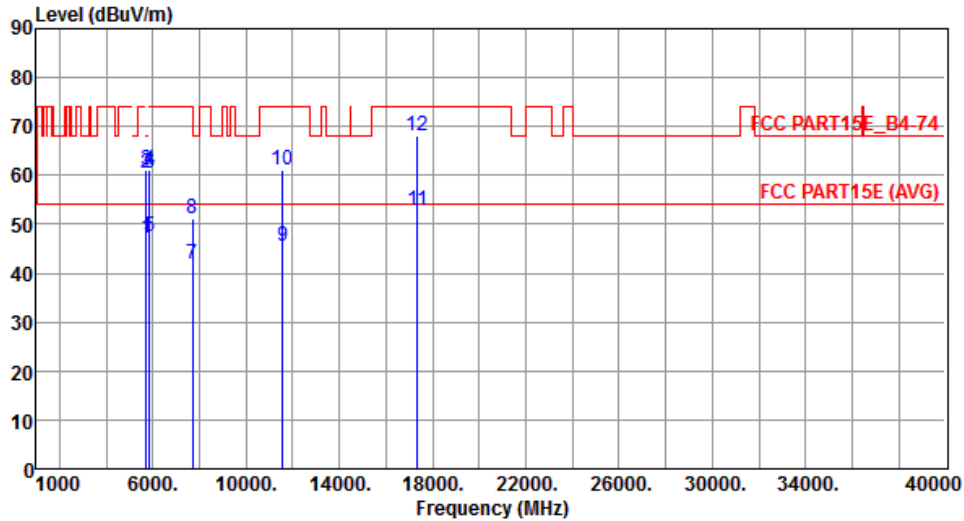

	Freq. MHz	Emission level dBuV/m	Limit dBuV/m	Margin dB	SA reading dBuV	Factor dB	Remark	ANT High cm	Turn Table deg
1	5715.00	47.19	54.00	-6.81	42.09	5.10	Average	166	133
2	5715.00	60.39	74.00	-13.61	55.29	5.10	Peak	166	133
3	5725.00	61.09	78.20	-17.11	56.00	5.09	Peak	166	133
4	5850.00	61.16	78.20	-17.04	55.90	5.26	Peak	166	133
5	5860.00	47.58	54.00	-6.42	42.31	5.27	Average	166	133
6	5860.00	60.49	74.00	-13.51	55.22	5.27	Peak	166	133
7	7713.30	41.68	54.00	-12.32	32.94	8.74	Average	218	252
8	7713.30	51.18	74.00	-22.82	42.44	8.74	Peak	218	252
9	11570.00	45.63	54.00	-8.37	30.30	15.33	Average	127	201
10	11570.00	61.05	74.00	-12.95	45.72	15.33	Peak	127	201
11	17355.00	52.96	54.00	-1.04	33.75	19.21	Average	138	105
12	17355.00	68.22	74.00	-5.78	49.01	19.21	Peak	138	105

Note 1: Emission Level (dBuV/m) = SA Reading (dBuV/m) + Factor* (dB)

*Factor includes antenna factor , cable loss and amplifier gain

Note 2: Margin (dB) = Emission level (dBuV/m) – Limit (dBuV/m).

Modulation	VHT20	Test Freq. (MHz)	5785
Polarization	Vertical		

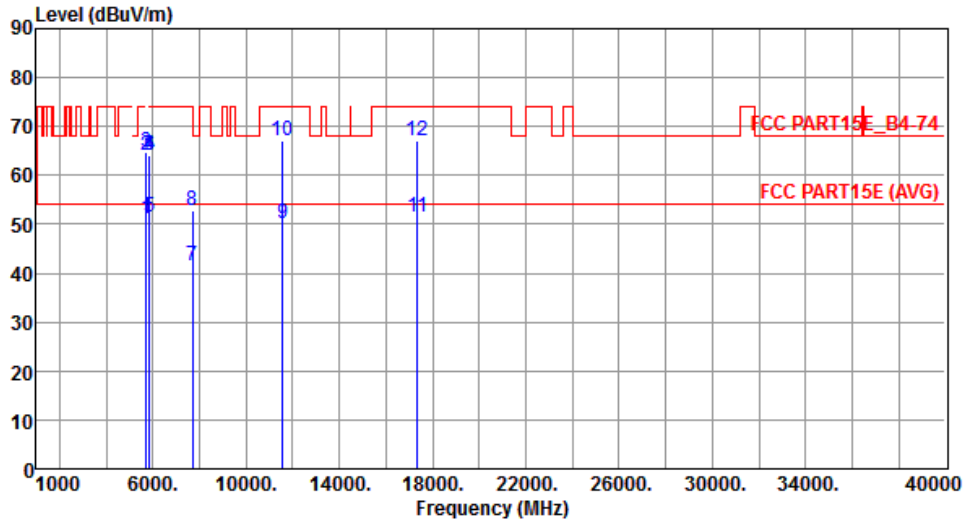

	Freq. MHz	Emission level dBuV/m	Limit dBuV/m	Margin dB	SA reading dBuV	Factor dB	Remark	ANT High cm	Turn Table deg
1	5715.00	51.11	54.00	-2.89	46.01	5.10	Average	173	0
2	5715.00	64.23	74.00	-9.77	59.13	5.10	Peak	173	0
3	5725.00	64.91	78.20	-13.29	59.82	5.09	Peak	173	0
4	5850.00	64.25	78.20	-13.95	58.99	5.26	Peak	173	0
5	5860.00	51.43	54.00	-2.57	46.16	5.27	Average	173	0
6	5860.00	64.22	74.00	-9.78	58.95	5.27	Peak	173	0
7	7713.30	41.42	54.00	-12.58	32.68	8.74	Average	151	281
8	7713.30	52.91	74.00	-21.09	44.17	8.74	Peak	151	281
9	11570.00	50.03	54.00	-3.97	34.70	15.33	Average	206	237
10	11570.00	67.17	74.00	-6.83	51.84	15.33	Peak	206	237
11	17355.00	51.32	54.00	-2.68	32.11	19.21	Average	266	100
12	17355.00	67.19	74.00	-6.81	47.98	19.21	Peak	266	100

Note 1: Emission Level (dBuV/m) = SA Reading (dBuV/m) + Factor* (dB)

*Factor includes antenna factor , cable loss and amplifier gain

Note 2: Margin (dB) = Emission level (dBuV/m) – Limit (dBuV/m).

Modulation	VHT20	Test Freq. (MHz)	5825
Polarization	Horizontal		

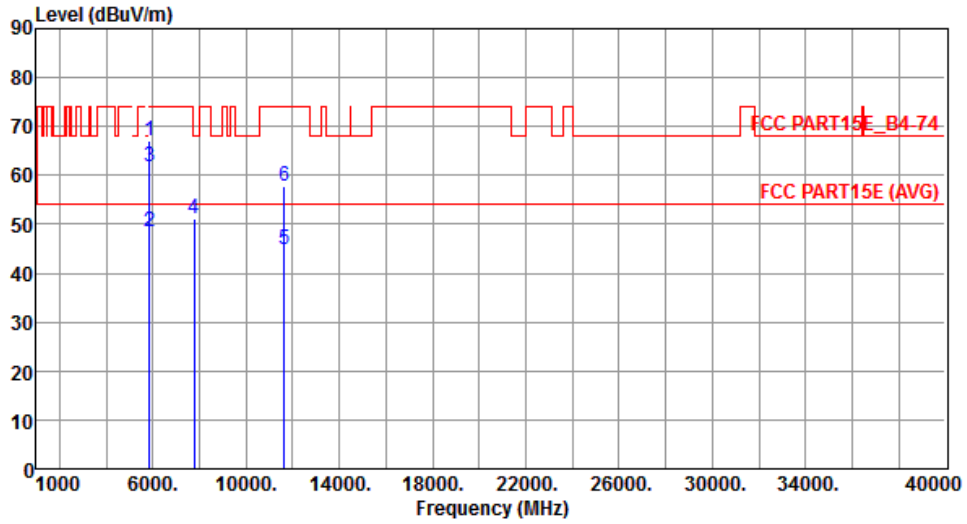

	Freq. MHz	Emission level dBuV/m	Limit dBuV/m	Margin dB	SA reading dBuV	Factor dB	Remark	ANT High cm	Turn Table deg
1	5850.00	67.00	78.20	-11.20	61.74	5.26	Peak	175	137
2	5860.00	48.47	54.00	-5.53	43.20	5.27	Average	175	137
3	5860.00	61.87	74.00	-12.13	56.60	5.27	Peak	175	137
4	7766.70	51.15	68.20	-17.05	42.46	8.69	Peak	213	248
5	11650.00	44.82	54.00	-9.18	29.73	15.09	Average	255	186
6	11650.00	57.87	74.00	-16.13	42.78	15.09	Peak	255	186

Note 1: Emission Level (dBuV/m) = SA Reading (dBuV/m) + Factor* (dB)

*Factor includes antenna factor , cable loss and amplifier gain

Note 2: Margin (dB) = Emission level (dBuV/m) – Limit (dBuV/m).

Modulation	VHT20	Test Freq. (MHz)	5825
Polarization	Vertical		

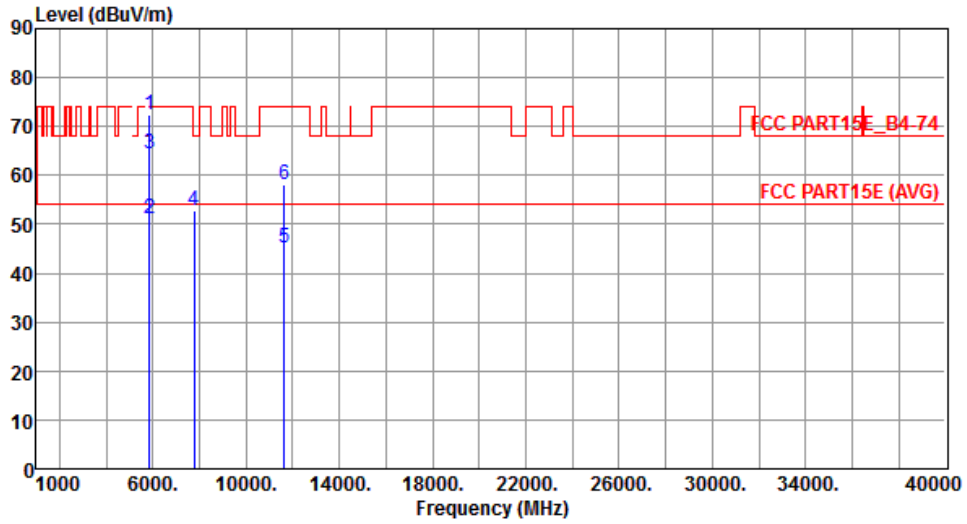

	Freq. MHz	Emission level dBuV/m	Limit dBuV/m	Margin dB	SA reading dBuV	Factor dB	Remark	ANT High cm	Turn Table deg
1	5850.00	72.38	78.20	-5.82	67.12	5.26	Peak	186	5
2	5860.00	51.21	54.00	-2.79	45.94	5.27	Average	186	5
3	5860.00	64.54	74.00	-9.46	59.27	5.27	Peak	186	5
4	7766.70	52.83	68.20	-15.37	44.14	8.69	Peak	215	58
5	11650.00	45.12	54.00	-8.88	30.03	15.09	Average	243	344
6	11650.00	58.05	74.00	-15.95	42.96	15.09	Peak	243	344

Note 1: Emission Level (dBuV/m) = SA Reading (dBuV/m) + Factor* (dB)

*Factor includes antenna factor , cable loss and amplifier gain

Note 2: Margin (dB) = Emission level (dBuV/m) – Limit (dBuV/m).

3.5.18 Transmitter Radiated Unwanted Emissions (Above 1GHz) for VHT40

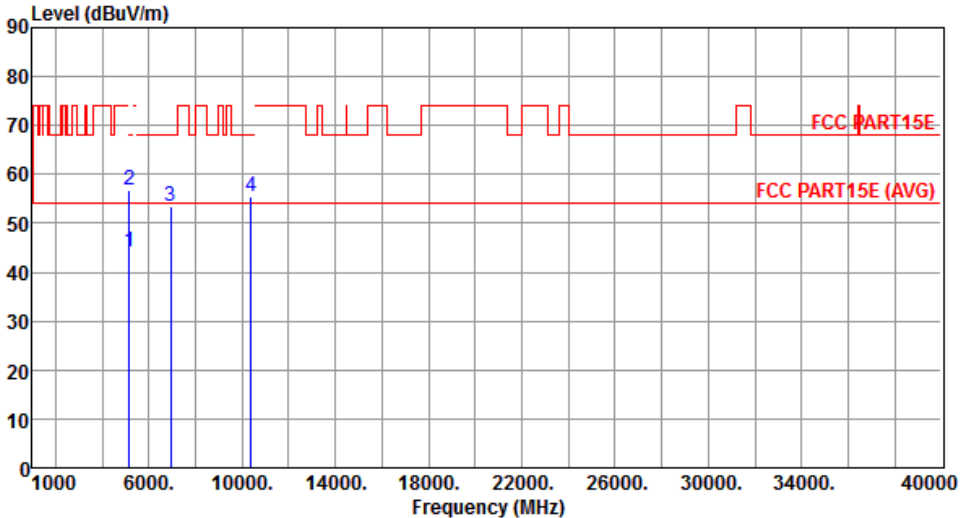
Modulation	VHT40	Test Freq. (MHz)	5190																																																											
Polarization	Horizontal																																																													
																																																														
	<table border="1"> <thead> <tr> <th>Freq.</th> <th>Emission level</th> <th>Limit</th> <th>Margin</th> <th>SA reading</th> <th>Factor</th> <th>Remark</th> <th>ANT High</th> <th>Turn Table</th> </tr> <tr> <th>MHz</th> <th>dBuV/m</th> <th>dBuV/m</th> <th>dB</th> <th>dBuV</th> <th>dB</th> <th></th> <th>cm</th> <th>deg</th> </tr> </thead> <tbody> <tr> <td>1</td> <td>5150.00</td> <td>44.14</td> <td>54.00</td> <td>-9.86</td> <td>39.74</td> <td>4.40</td> <td>Average</td> <td>187</td> <td>228</td> </tr> <tr> <td>2</td> <td>5150.00</td> <td>56.65</td> <td>74.00</td> <td>-17.35</td> <td>52.25</td> <td>4.40</td> <td>Peak</td> <td>187</td> <td>228</td> </tr> <tr> <td>3</td> <td>6920.00</td> <td>53.49</td> <td>68.20</td> <td>-14.71</td> <td>45.73</td> <td>7.76</td> <td>Peak</td> <td>187</td> <td>220</td> </tr> <tr> <td>4</td> <td>10380.00</td> <td>55.33</td> <td>68.20</td> <td>-12.87</td> <td>41.08</td> <td>14.25</td> <td>Peak</td> <td>155</td> <td>168</td> </tr> </tbody> </table>	Freq.	Emission level	Limit	Margin	SA reading	Factor	Remark	ANT High	Turn Table	MHz	dBuV/m	dBuV/m	dB	dBuV	dB		cm	deg	1	5150.00	44.14	54.00	-9.86	39.74	4.40	Average	187	228	2	5150.00	56.65	74.00	-17.35	52.25	4.40	Peak	187	228	3	6920.00	53.49	68.20	-14.71	45.73	7.76	Peak	187	220	4	10380.00	55.33	68.20	-12.87	41.08	14.25	Peak	155	168			
Freq.	Emission level	Limit	Margin	SA reading	Factor	Remark	ANT High	Turn Table																																																						
MHz	dBuV/m	dBuV/m	dB	dBuV	dB		cm	deg																																																						
1	5150.00	44.14	54.00	-9.86	39.74	4.40	Average	187	228																																																					
2	5150.00	56.65	74.00	-17.35	52.25	4.40	Peak	187	228																																																					
3	6920.00	53.49	68.20	-14.71	45.73	7.76	Peak	187	220																																																					
4	10380.00	55.33	68.20	-12.87	41.08	14.25	Peak	155	168																																																					
<p>Note 1: Emission Level (dBuV/m) = SA Reading (dBuV/m) + Factor* (dB) *Factor includes antenna factor , cable loss and amplifier gain Note 2: Margin (dB) = Emission level (dBuV/m) – Limit (dBuV/m).</p>																																																														

Modulation	VHT40	Test Freq. (MHz)	5190
Polarization	Vertical		

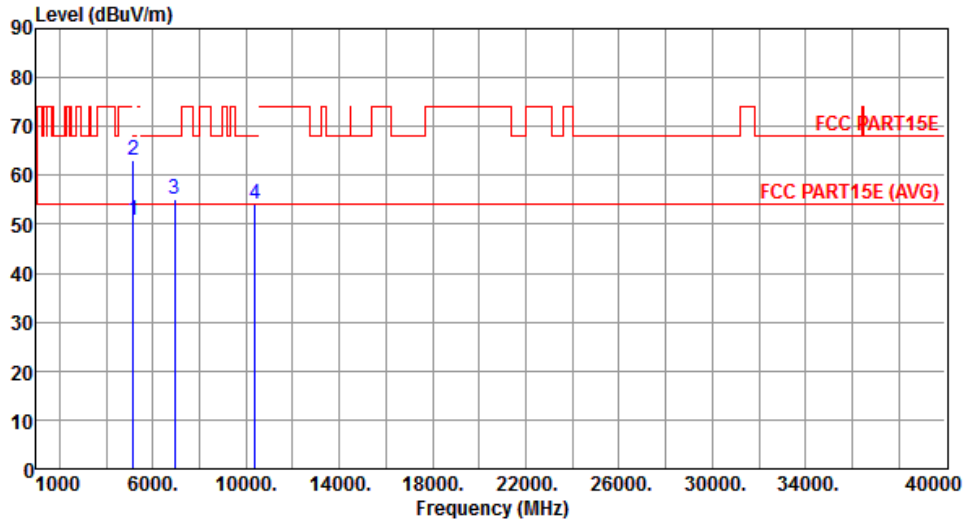

	Freq. MHz	Emission level dBuV/m	Limit dBuV/m	Margin dB	SA reading dBuV	Factor dB	Remark	ANT High cm	Turn Table deg
1	5150.00	50.71	54.00	-3.29	46.31	4.40	Average	202	219
2	5150.00	63.18	74.00	-10.82	58.78	4.40	Peak	202	219
3	6920.00	54.97	68.20	-13.23	47.21	7.76	Peak	168	218
4	10380.00	54.28	68.20	-13.92	40.03	14.25	Peak	187	165

Note 1: Emission Level (dBuV/m) = SA Reading (dBuV/m) + Factor* (dB)

*Factor includes antenna factor , cable loss and amplifier gain

Note 2: Margin (dB) = Emission level (dBuV/m) – Limit (dBuV/m).

Modulation	VHT40	Test Freq. (MHz)	5230
Polarization	Horizontal		

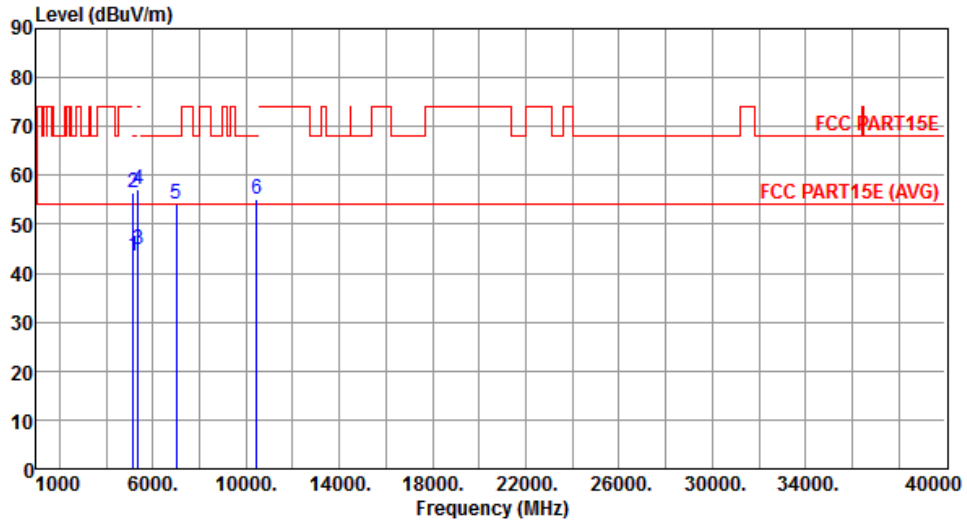

	Freq. MHz	Emission level dBuV/m	Limit dBuV/m	Margin dB	SA reading dBuV	Factor dB	Remark	ANT High cm	Turn Table deg
1	5150.00	43.63	54.00	-10.37	39.23	4.40	Average	188	215
2	5150.00	56.56	74.00	-17.44	52.16	4.40	Peak	188	215
3	5350.00	44.77	54.00	-9.23	40.13	4.64	Average	188	215
4	5350.00	57.10	74.00	-16.90	52.46	4.64	Peak	188	215
5	6986.66	54.05	68.20	-14.15	46.21	7.84	Peak	185	216
6	10460.00	55.07	68.20	-13.13	40.67	14.40	Peak	164	162

Note 1: Emission Level (dBuV/m) = SA Reading (dBuV/m) + Factor* (dB)

*Factor includes antenna factor , cable loss and amplifier gain

Note 2: Margin (dB) = Emission level (dBuV/m) – Limit (dBuV/m).

Modulation	VHT40	Test Freq. (MHz)	5230
Polarization	Vertical		

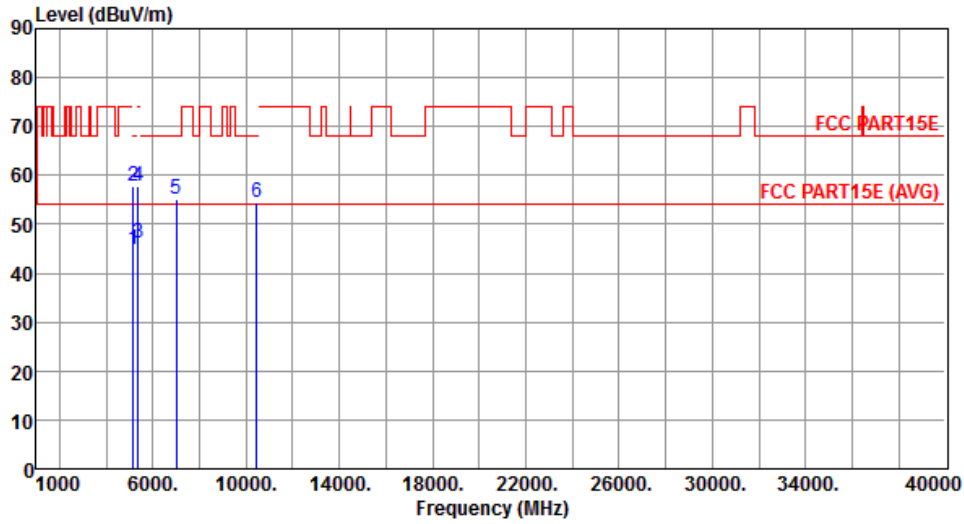

	Freq. MHz	Emission level dBuV/m	Limit dBuV/m	Margin dB	SA reading dBuV	Factor dB	Remark	ANT High cm	Turn Table deg
1	5150.00	44.93	54.00	-9.07	40.53	4.40	Average	200	218
2	5150.00	57.65	74.00	-16.35	53.25	4.40	Peak	200	218
3	5350.00	46.30	54.00	-7.70	41.66	4.64	Average	200	218
4	5350.00	57.77	74.00	-16.23	53.13	4.64	Peak	200	218
5	6986.66	54.96	68.20	-13.24	47.12	7.84	Peak	166	215
6	10460.00	54.62	68.20	-13.58	40.22	14.40	Peak	176	178

Note 1: Emission Level (dBuV/m) = SA Reading (dBuV/m) + Factor* (dB)

*Factor includes antenna factor , cable loss and amplifier gain

Note 2: Margin (dB) = Emission level (dBuV/m) – Limit (dBuV/m).

Modulation	VHT40	Test Freq. (MHz)	5270
Polarization	Horizontal		

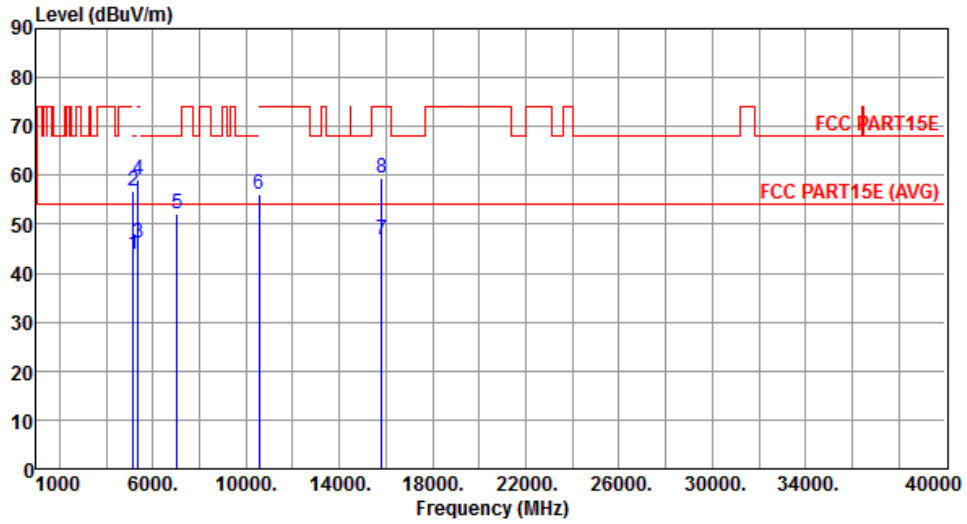

	Freq. MHz	Emission level dBuV/m	Limit dBuV/m	Margin dB	SA reading dBuV	Factor dB	Remark	ANT High cm	Turn Table deg
1	5150.00	43.90	54.00	-10.10	39.50	4.40	Average	189	229
2	5150.00	56.77	74.00	-17.23	52.37	4.40	Peak	189	229
3	5350.00	46.01	54.00	-7.99	41.37	4.64	Average	189	229
4	5350.00	59.09	74.00	-14.91	54.45	4.64	Peak	189	229
5	7026.66	52.25	68.20	-15.95	44.32	7.93	Peak	174	246
6	10540.00	56.16	68.20	-12.04	41.64	14.52	Peak	189	7
7	15810.00	46.70	54.00	-7.30	31.95	14.75	Average	210	13
8	15810.00	59.40	74.00	-14.60	44.65	14.75	Peak	210	13

Note 1: Emission Level (dBuV/m) = SA Reading (dBuV/m) + Factor* (dB)

*Factor includes antenna factor , cable loss and amplifier gain

Note 2: Margin (dB) = Emission level (dBuV/m) – Limit (dBuV/m).

Modulation	VHT40	Test Freq. (MHz)	5270
Polarization	Vertical		

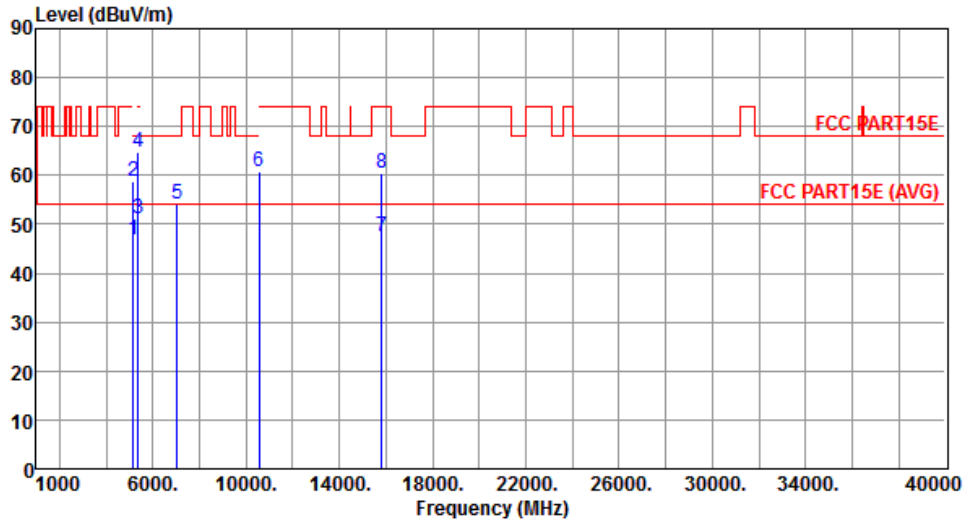

	Freq. MHz	Emission level dBuV/m	Limit dBuV/m	Margin dB	SA reading dBuV	Factor dB	Remark	ANT High cm	Turn Table deg
1	5150.00	46.92	54.00	-7.08	42.52	4.40	Average	198	221
2	5150.00	58.85	74.00	-15.15	54.45	4.40	Peak	198	221
3	5350.00	51.25	54.00	-2.75	46.61	4.64	Average	198	221
4	5350.00	64.88	74.00	-9.12	60.24	4.64	Peak	198	221
5	7026.66	54.16	68.20	-14.04	46.23	7.93	Peak	110	349
6	10540.00	60.77	68.20	-7.43	46.25	14.52	Peak	135	184
7	15810.00	47.60	54.00	-6.40	32.85	14.75	Average	110	349
8	15810.00	60.29	74.00	-13.71	45.54	14.75	Peak	110	349

Note 1: Emission Level (dBuV/m) = SA Reading (dBuV/m) + Factor* (dB)

*Factor includes antenna factor , cable loss and amplifier gain

Note 2: Margin (dB) = Emission level (dBuV/m) – Limit (dBuV/m).

Modulation	VHT40	Test Freq. (MHz)	5310
Polarization	Horizontal		

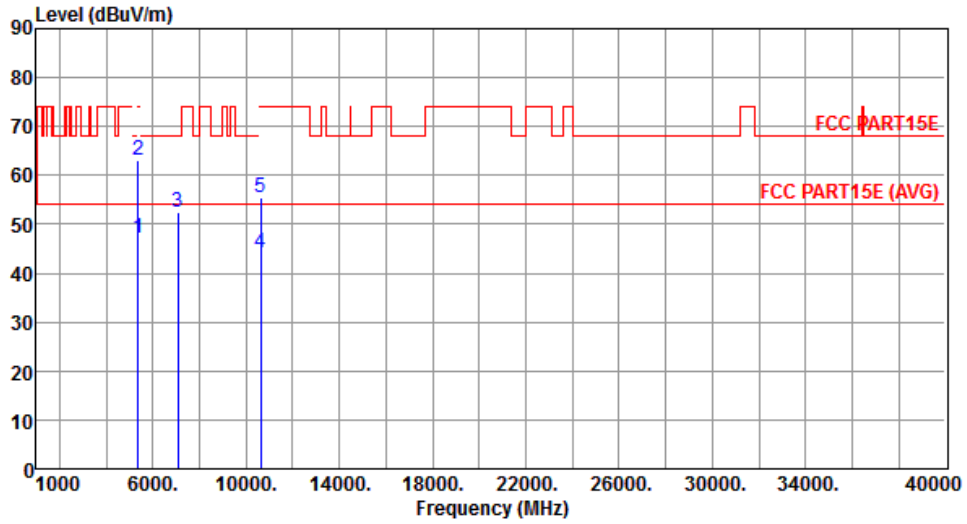

	Freq. MHz	Emission level dBuV/m	Limit dBuV/m	Margin dB	SA reading dBuV	Factor dB	Remark	ANT High cm	Turn Table deg
1	5350.00	47.04	54.00	-6.96	42.40	4.64	Average	222	225
2	5350.00	63.03	74.00	-10.97	58.39	4.64	Peak	222	225
3	7080.00	52.60	68.20	-15.60	44.53	8.07	Peak	174	255
4	10620.00	44.09	54.00	-9.91	29.48	14.61	Average	166	168
5	10620.00	55.32	74.00	-18.68	40.71	14.61	Peak	166	168

Note 1: Emission Level (dBuV/m) = SA Reading (dBuV/m) + Factor* (dB)

*Factor includes antenna factor , cable loss and amplifier gain

Note 2: Margin (dB) = Emission level (dBuV/m) – Limit (dBuV/m).

Modulation	VHT40	Test Freq. (MHz)	5310
Polarization	Vertical		

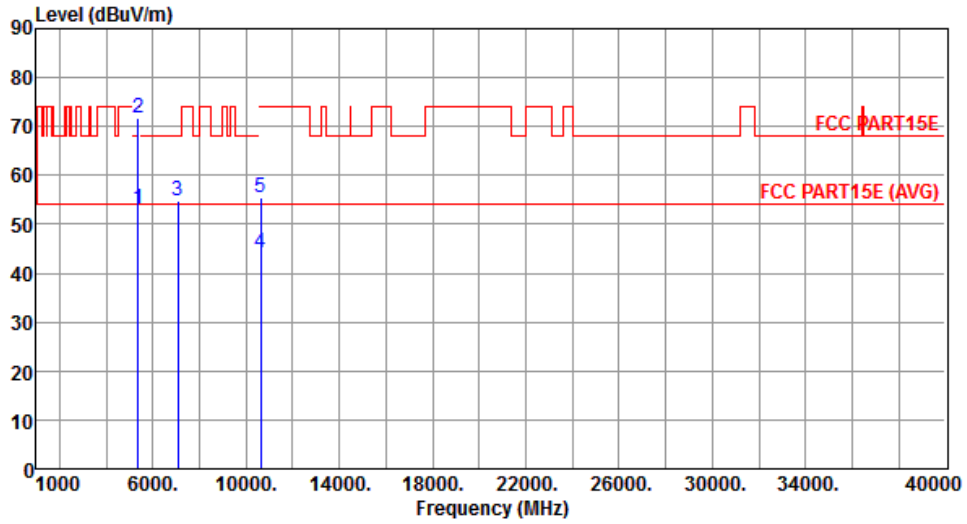

	Freq. MHz	Emission level dBuV/m	Limit dBuV/m	Margin dB	SA reading dBuV	Factor dB	Remark	ANT High cm	Turn Table deg
1	5350.00	52.99	54.00	-1.01	48.35	4.64	Average	199	286
2	5350.00	71.77	74.00	-2.23	67.13	4.64	Peak	199	286
3	7080.00	54.82	68.20	-13.38	46.75	8.07	Peak	165	349
4	10620.00	44.15	54.00	-9.85	29.54	14.61	Average	188	256
5	10620.00	55.57	74.00	-18.43	40.96	14.61	Peak	188	256

Note 1: Emission Level (dBuV/m) = SA Reading (dBuV/m) + Factor* (dB)

*Factor includes antenna factor , cable loss and amplifier gain

Note 2: Margin (dB) = Emission level (dBuV/m) – Limit (dBuV/m).

Modulation	VHT40	Test Freq. (MHz)	5510
Polarization	Horizontal		

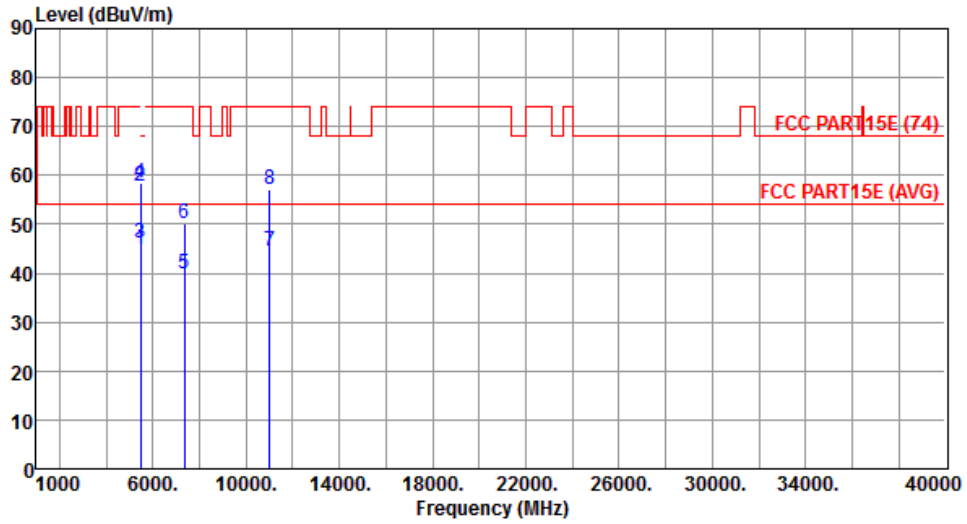

	Freq. MHz	Emission level dBuV/m	Limit dBuV/m	Margin dB	SA reading dBuV	Factor dB	Remark	ANT High cm	Turn Table deg
1	5460.00	44.88	54.00	-9.12	40.10	4.78	Average	148	131
2	5460.00	57.88	74.00	-16.12	53.10	4.78	Peak	148	131
3	5470.00	46.13	54.00	-7.87	41.34	4.79	Average	148	131
4	5470.00	58.54	74.00	-15.46	53.75	4.79	Peak	148	131
5	7346.70	39.98	54.00	-14.02	31.54	8.44	Average	189	318
6	7346.70	50.30	74.00	-23.70	41.86	8.44	Peak	189	318
7	11020.00	44.56	54.00	-9.44	29.48	15.08	Average	176	332
8	11020.00	57.11	74.00	-16.89	42.03	15.08	Peak	176	332

Note 1: Emission Level (dBuV/m) = SA Reading (dBuV/m) + Factor* (dB)

*Factor includes antenna factor , cable loss and amplifier gain

Note 2: Margin (dB) = Emission level (dBuV/m) – Limit (dBuV/m).

Modulation	VHT40	Test Freq. (MHz)	5510
Polarization	Vertical		

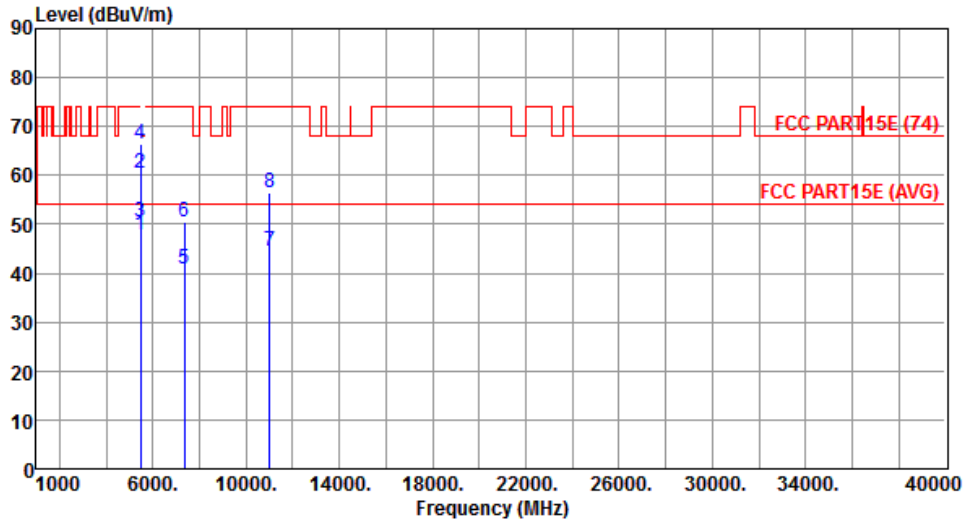

	Freq. MHz	Emission level dBuV/m	Limit dBuV/m	Margin dB	SA reading dBuV	Factor dB	Remark	ANT High cm	Turn Table deg
1	5460.00	47.97	54.00	-6.03	43.19	4.78	Average	191	14
2	5460.00	60.60	74.00	-13.40	55.82	4.78	Peak	191	14
3	5470.00	50.50	54.00	-3.50	45.71	4.79	Average	191	14
4	5470.00	66.48	74.00	-7.52	61.69	4.79	Peak	191	14
5	7346.70	40.70	54.00	-13.30	32.26	8.44	Average	158	0
6	7346.70	50.55	74.00	-23.45	42.11	8.44	Peak	158	0
7	11020.00	44.38	54.00	-9.62	29.30	15.08	Average	234	157
8	11020.00	56.34	74.00	-17.66	41.26	15.08	Peak	234	157

Note 1: Emission Level (dBuV/m) = SA Reading (dBuV/m) + Factor* (dB)

*Factor includes antenna factor , cable loss and amplifier gain

Note 2: Margin (dB) = Emission level (dBuV/m) – Limit (dBuV/m).

Modulation	VHT40	Test Freq. (MHz)	5590
Polarization	Horizontal		

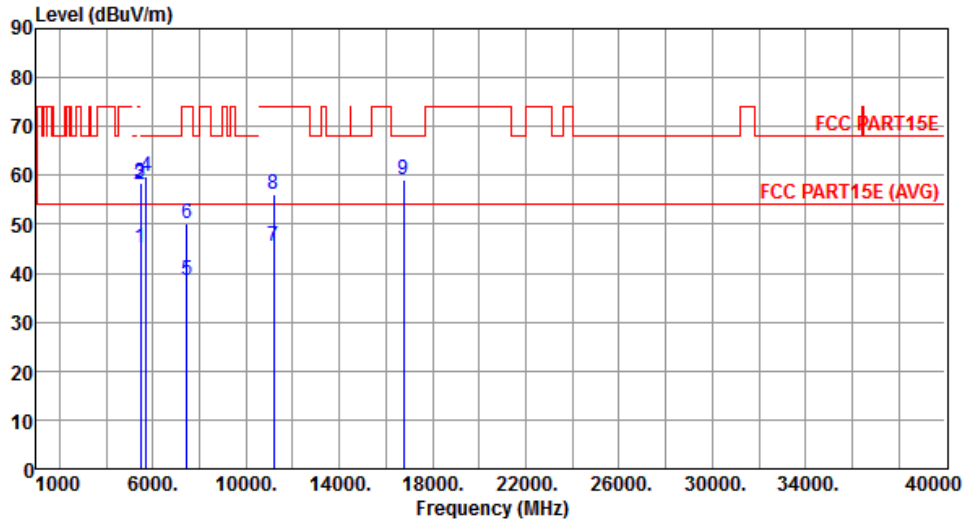

	Freq. MHz	Emission level dBuV/m	Limit dBuV/m	Margin dB	SA reading dBuV	Factor dB	Remark	ANT High cm	Turn Table deg
1	5460.00	45.23	54.00	-8.77	40.45	4.78	Average	164	260
2	5460.00	58.18	74.00	-15.82	53.40	4.78	Peak	164	260
3	5470.00	58.32	68.20	-9.88	53.53	4.79	Peak	164	260
4	5725.00	59.67	68.20	-8.53	54.58	5.09	Peak	164	260
5	7453.33	38.56	54.00	-15.44	29.97	8.59	Average	155	213
6	7453.33	50.15	74.00	-23.85	41.56	8.59	Peak	155	213
7	11180.00	45.50	54.00	-8.50	30.27	15.23	Average	181	135
8	11180.00	55.99	74.00	-18.01	40.76	15.23	Peak	181	135
9	16770.00	59.20	68.20	-9.00	41.82	17.38	Peak	168	120

Note 1: Emission Level (dBuV/m) = SA Reading (dBuV/m) + Factor* (dB)

*Factor includes antenna factor , cable loss and amplifier gain

Note 2: Margin (dB) = Emission level (dBuV/m) – Limit (dBuV/m).

Modulation	VHT40	Test Freq. (MHz)	5590
Polarization	Vertical		

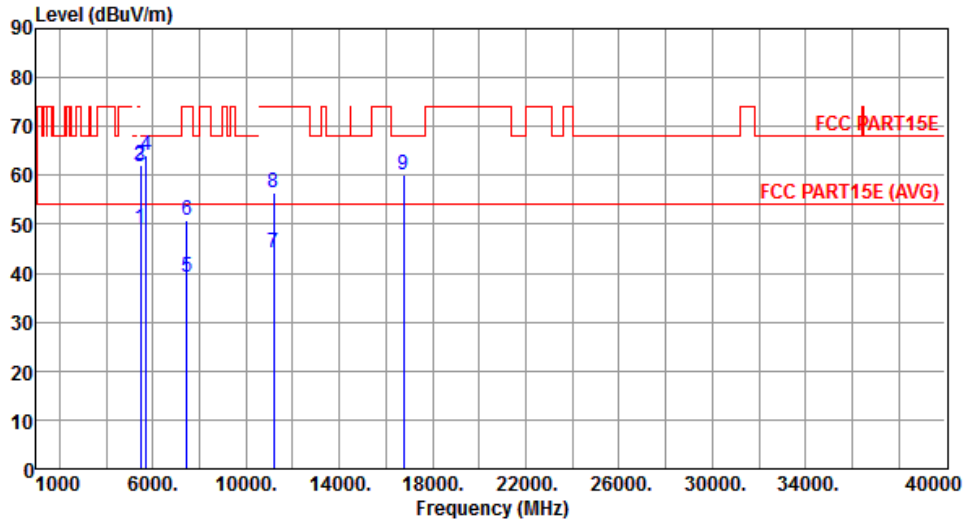

	Freq. MHz	Emission level dBuV/m	Limit dBuV/m	Margin dB	SA reading dBuV	Factor dB	Remark	ANT High cm	Turn Table deg
1	5460.00	49.05	54.00	-4.95	44.27	4.78	Average	180	4
2	5460.00	62.24	74.00	-11.76	57.46	4.78	Peak	180	4
3	5470.00	61.79	68.20	-6.41	57.00	4.79	Peak	180	4
4	5725.00	64.14	68.20	-4.06	59.05	5.09	Peak	180	4
5	7453.33	39.27	54.00	-14.73	30.68	8.59	Average	165	163
6	7453.33	50.87	74.00	-23.13	42.28	8.59	Peak	165	163
7	11180.00	44.31	54.00	-9.69	29.08	15.23	Average	176	37
8	11180.00	56.29	74.00	-17.71	41.06	15.23	Peak	176	37
9	16770.00	60.12	68.20	-8.08	42.74	17.38	Peak	172	207

Note 1: Emission Level (dBuV/m) = SA Reading (dBuV/m) + Factor* (dB)

*Factor includes antenna factor , cable loss and amplifier gain

Note 2: Margin (dB) = Emission level (dBuV/m) – Limit (dBuV/m).

Modulation	VHT40	Test Freq. (MHz)	5670
Polarization	Horizontal		

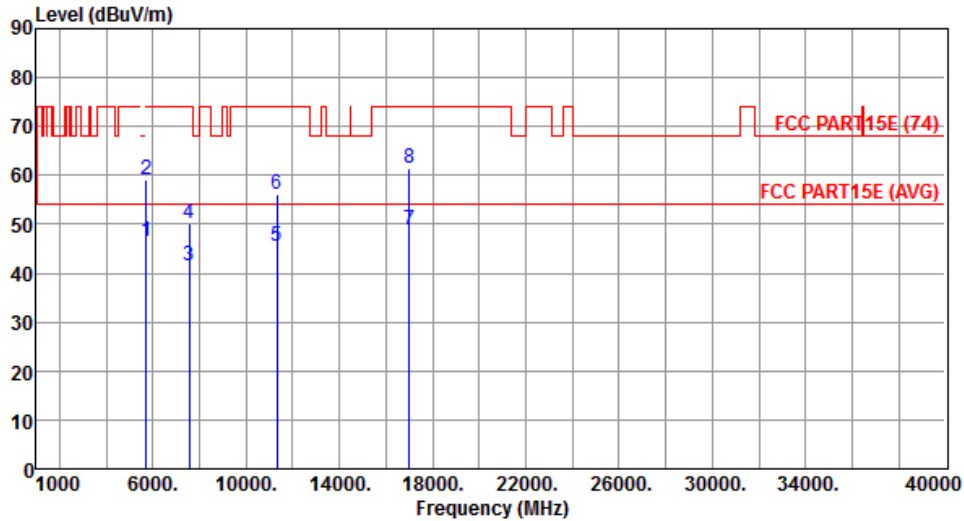

	Freq. MHz	Emission level dBuV/m	Limit dBuV/m	Margin dB	SA reading dBuV	Factor dB	Remark	ANT High cm	Turn Table deg
1	5725.00	46.65	54.00	-7.35	41.56	5.09	Average	195	260
2	5725.00	59.01	74.00	-14.99	53.92	5.09	Peak	195	260
3	7560.00	41.64	54.00	-12.36	32.86	8.78	Average	183	240
4	7560.00	50.07	74.00	-23.93	41.29	8.78	Peak	183	240
5	11340.00	45.60	54.00	-8.40	30.21	15.39	Average	188	120
6	11340.00	56.05	74.00	-17.95	40.66	15.39	Peak	188	120
7	17010.00	48.81	54.00	-5.19	30.56	18.25	Average	188	16
8	17010.00	61.56	74.00	-12.44	43.31	18.25	Peak	188	16

Note 1: Emission Level (dBuV/m) = SA Reading (dBuV/m) + Factor* (dB)

*Factor includes antenna factor , cable loss and amplifier gain

Note 2: Margin (dB) = Emission level (dBuV/m) – Limit (dBuV/m).

Modulation	VHT40	Test Freq. (MHz)	5670
Polarization	Vertical		

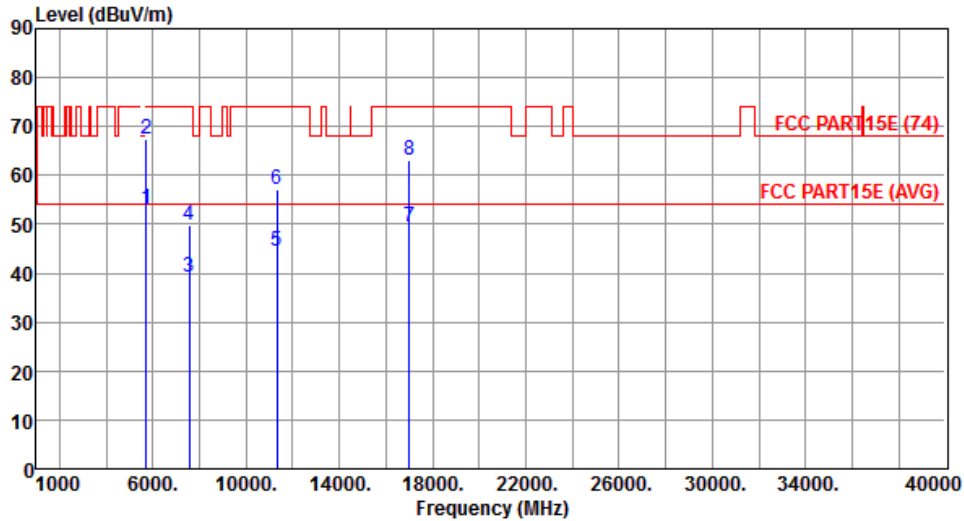

	Freq. MHz	Emission level dBuV/m	Limit dBuV/m	Margin dB	SA reading dBuV	Factor dB	Remark	ANT High cm	Turn Table deg
1	5725.00	53.00	54.00	-1.00	47.91	5.09	Average	191	178
2	5725.00	67.48	74.00	-6.52	62.39	5.09	Peak	191	178
3	7560.00	39.23	54.00	-14.77	30.45	8.78	Average	176	216
4	7560.00	49.92	74.00	-24.08	41.14	8.78	Peak	176	216
5	11340.00	44.40	54.00	-9.60	29.01	15.39	Average	155	327
6	11340.00	57.12	74.00	-16.88	41.73	15.39	Peak	155	327
7	17010.00	49.49	54.00	-4.51	31.24	18.25	Average	157	108
8	17010.00	63.19	74.00	-10.81	44.94	18.25	Peak	157	108

Note 1: Emission Level (dBuV/m) = SA Reading (dBuV/m) + Factor* (dB)

*Factor includes antenna factor , cable loss and amplifier gain

Note 2: Margin (dB) = Emission level (dBuV/m) – Limit (dBuV/m).

Modulation	VHT40	Test Freq. (MHz)	5710
Polarization	Horizontal		

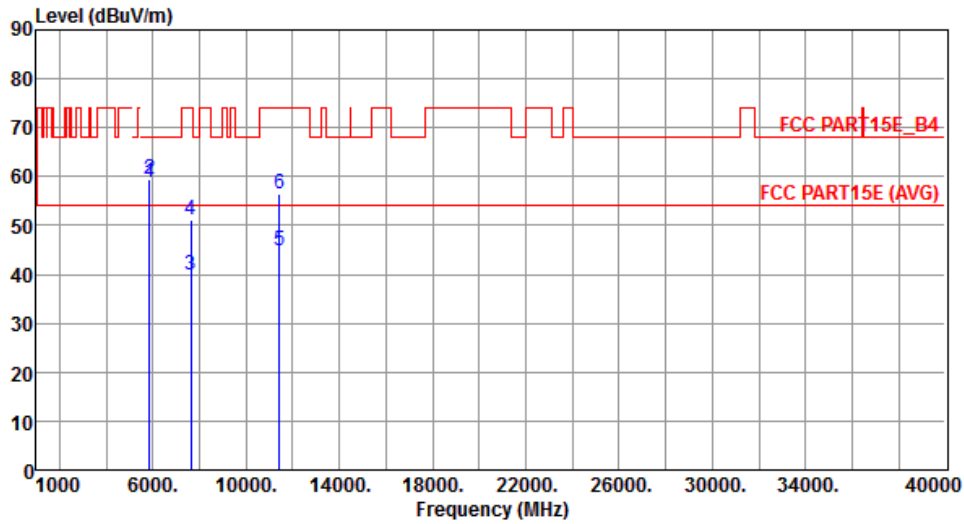

	Freq. MHz	Emission level dBuV/m	Limit dBuV/m	Margin dB	SA reading dBuV	Factor dB	Remark	ANT High cm	Turn Table deg
1	5850.00	58.67	78.20	-19.53	53.41	5.26	Peak	209	261
2	5860.00	59.59	68.20	-8.61	54.32	5.27	Peak	209	261
3	7613.33	39.85	54.00	-14.15	31.03	8.82	Average	182	153
4	7613.33	51.08	74.00	-22.92	42.26	8.82	Peak	182	153
5	11420.00	44.97	54.00	-9.03	29.51	15.46	Average	166	173
6	11420.00	56.48	74.00	-17.52	41.02	15.46	Peak	166	173

Note 1: Emission Level (dBuV/m) = SA Reading (dBuV/m) + Factor* (dB)

*Factor includes antenna factor , cable loss and amplifier gain

Note 2: Margin (dB) = Emission level (dBuV/m) – Limit (dBuV/m).

Modulation	VHT40	Test Freq. (MHz)	5710
Polarization	Vertical		

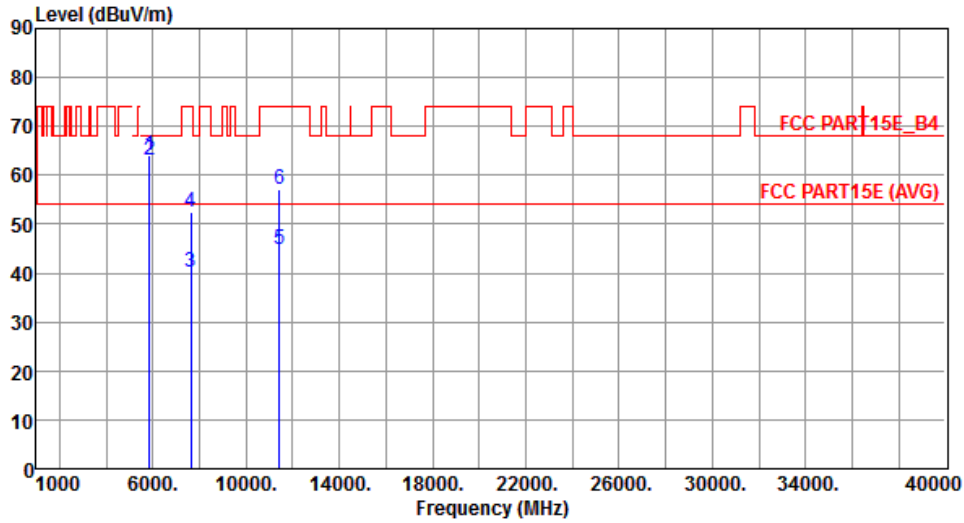

	Freq. MHz	Emission level dBuV/m	Limit dBuV/m	Margin dB	SA reading dBuV	Factor dB	Remark	ANT High cm	Turn Table deg
1	5850.00	63.97	78.20	-14.23	58.71	5.26	Peak	201	178
2	5860.00	63.20	68.20	-5.00	57.93	5.27	Peak	201	178
3	7613.33	40.35	54.00	-13.65	31.53	8.82	Average	155	130
4	7613.33	52.39	74.00	-21.61	43.57	8.82	Peak	155	130
5	11420.00	44.99	54.00	-9.01	29.53	15.46	Average	162	214
6	11420.00	57.08	74.00	-16.92	41.62	15.46	Peak	162	214

Note 1: Emission Level (dBuV/m) = SA Reading (dBuV/m) + Factor* (dB)

*Factor includes antenna factor, cable loss and amplifier gain

Note 2: Margin (dB) = Emission level (dBuV/m) – Limit (dBuV/m).

Modulation	VHT40	Test Freq. (MHz)	5755
Polarization	Horizontal		

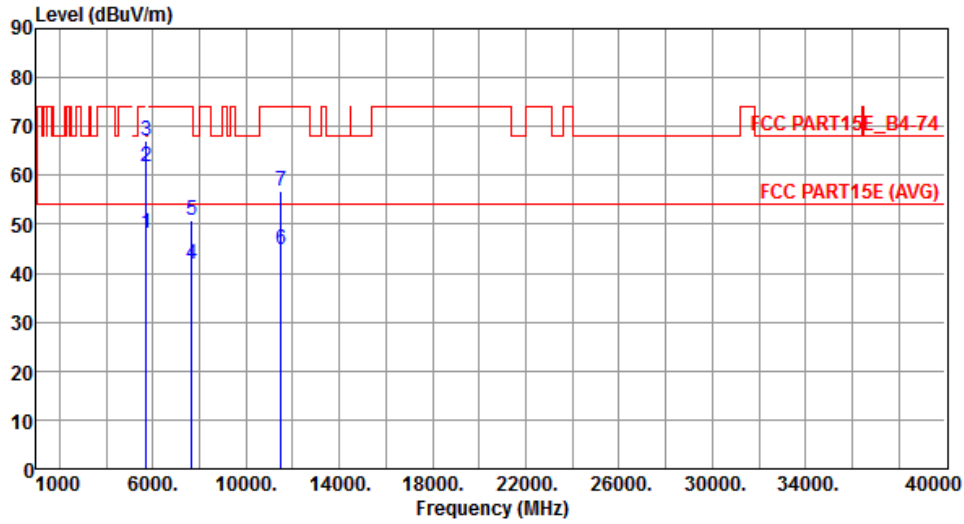

	Freq. MHz	Emission level dBuV/m	Limit dBuV/m	Margin dB	SA reading dBuV	Factor dB	Remark	ANT High cm	Turn Table deg
1	5715.00	48.30	54.00	-5.70	43.20	5.10	Average	197	261
2	5715.00	61.81	74.00	-12.19	56.71	5.10	Peak	197	261
3	5725.00	67.20	78.20	-11.00	62.11	5.09	Peak	197	261
4	7673.30	41.87	54.00	-12.13	33.09	8.78	Average	214	249
5	7673.30	50.69	74.00	-23.31	41.91	8.78	Peak	214	249
6	11510.00	44.91	54.00	-9.09	29.40	15.51	Average	194	126
7	11510.00	56.81	74.00	-17.19	41.30	15.51	Peak	194	126

Note 1: Emission Level (dBuV/m) = SA Reading (dBuV/m) + Factor* (dB)

*Factor includes antenna factor , cable loss and amplifier gain

Note 2: Margin (dB) = Emission level (dBuV/m) – Limit (dBuV/m).

Modulation	VHT40	Test Freq. (MHz)	5755
Polarization	Vertical		

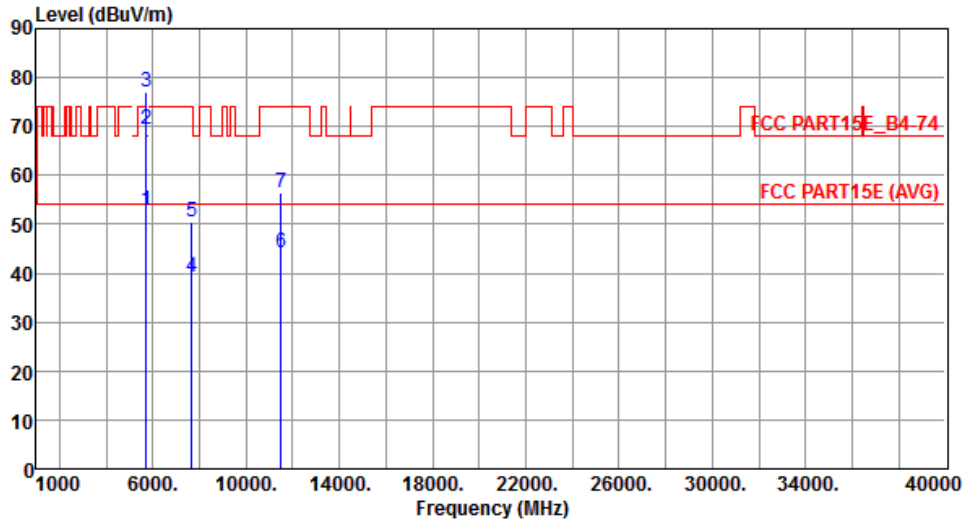

	Freq. MHz	Emission level dBuV/m	Limit dBuV/m	Margin dB	SA reading dBuV	Factor dB	Remark	ANT High cm	Turn Table deg
1	5715.00	52.97	54.00	-1.03	47.87	5.10	Average	162	16
2	5715.00	69.28	74.00	-4.72	64.18	5.10	Peak	162	16
3	5725.00	76.90	78.20	-1.30	71.81	5.09	Peak	162	16
4	7673.30	39.19	54.00	-14.81	30.41	8.78	Average	138	290
5	7673.30	50.36	74.00	-23.64	41.58	8.78	Peak	138	290
6	11510.00	44.21	54.00	-9.79	28.70	15.51	Average	210	324
7	11510.00	56.61	74.00	-17.39	41.10	15.51	Peak	210	324

Note 1: Emission Level (dBuV/m) = SA Reading (dBuV/m) + Factor* (dB)

*Factor includes antenna factor , cable loss and amplifier gain

Note 2: Margin (dB) = Emission level (dBuV/m) – Limit (dBuV/m).

Modulation	VHT40	Test Freq. (MHz)	5795
Polarization	Horizontal		

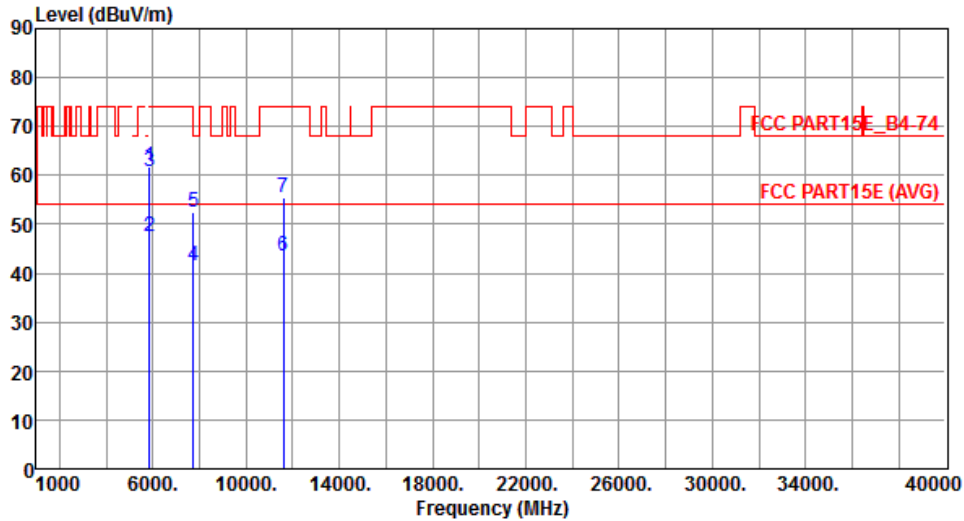

	Freq. MHz	Emission level dBuV/m	Limit dBuV/m	Margin dB	SA reading dBuV	Factor dB	Remark	ANT High cm	Turn Table deg
1	5850.00	61.81	78.20	-16.39	56.55	5.26	Peak	286	254
2	5860.00	47.39	54.00	-6.61	42.12	5.27	Average	286	254
3	5860.00	60.80	74.00	-13.20	55.53	5.27	Peak	286	254
4	7726.70	41.68	54.00	-12.32	32.96	8.72	Average	213	271
5	7726.70	52.39	74.00	-21.61	43.67	8.72	Peak	213	271
6	11590.00	43.59	54.00	-10.41	28.32	15.27	Average	227	339
7	11590.00	55.38	74.00	-18.62	40.11	15.27	Peak	227	339

Note 1: Emission Level (dBuV/m) = SA Reading (dBuV/m) + Factor* (dB)

*Factor includes antenna factor , cable loss and amplifier gain

Note 2: Margin (dB) = Emission level (dBuV/m) – Limit (dBuV/m).

Modulation	VHT40	Test Freq. (MHz)	5795
Polarization	Vertical		

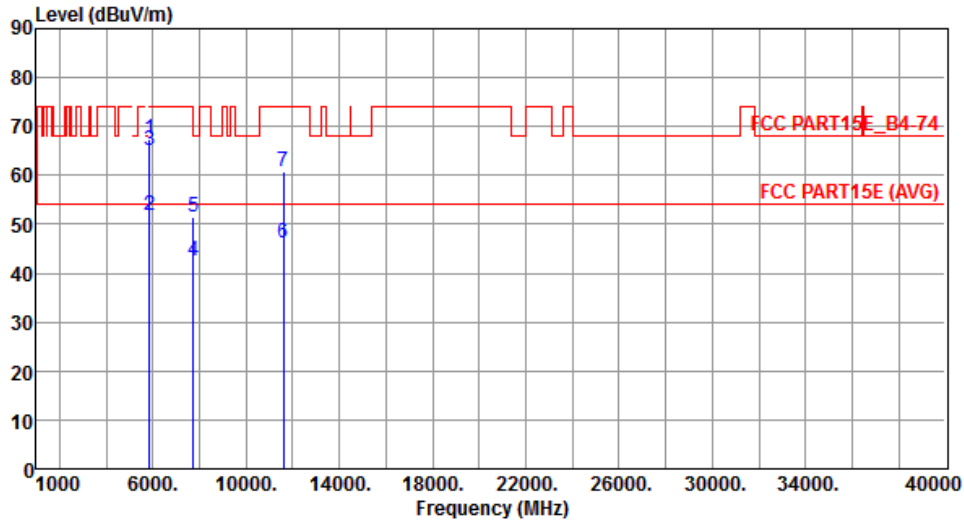

	Freq. MHz	Emission level dBuV/m	Limit dBuV/m	Margin dB	SA reading dBuV	Factor dB	Remark	ANT High cm	Turn Table deg
1	5850.00	67.43	78.20	-10.77	62.17	5.26	Peak	214	171
2	5860.00	51.82	54.00	-2.18	46.55	5.27	Average	214	171
3	5860.00	65.12	74.00	-8.88	59.85	5.27	Peak	214	171
4	7726.70	42.53	54.00	-11.47	33.81	8.72	Average	237	112
5	7726.70	51.37	74.00	-22.63	42.65	8.72	Peak	237	112
6	11590.00	46.01	54.00	-7.99	30.74	15.27	Average	150	326
7	11590.00	60.66	74.00	-13.34	45.39	15.27	Peak	150	326

Note 1: Emission Level (dBuV/m) = SA Reading (dBuV/m) + Factor* (dB)

*Factor includes antenna factor , cable loss and amplifier gain

Note 2: Margin (dB) = Emission level (dBuV/m) – Limit (dBuV/m).

3.5.19 Transmitter Radiated Unwanted Emissions (Above 1GHz) for VHT80

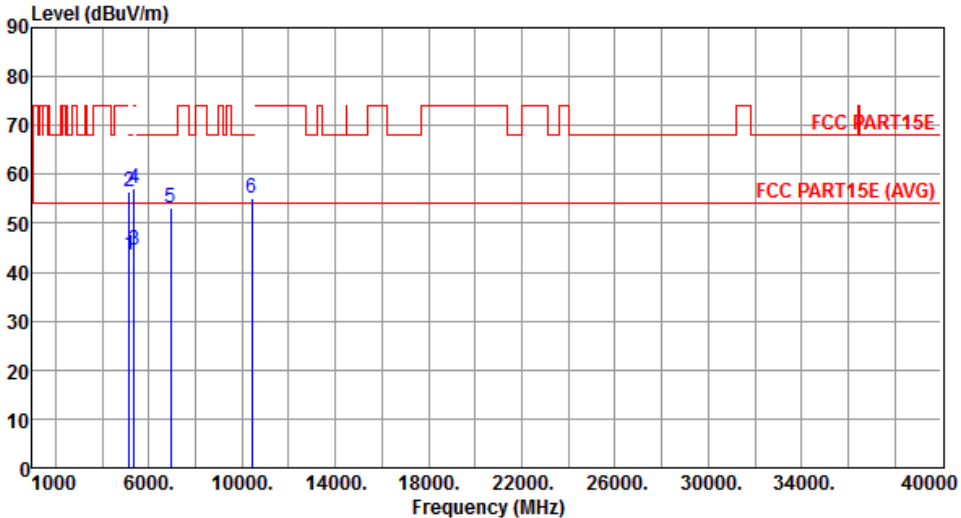
Modulation	VHT80	Test Freq. (MHz)	5210																																																																																			
Polarization	Horizontal																																																																																					
																																																																																						
	<table border="1"> <thead> <tr> <th>Freq.</th> <th>Emission level</th> <th>Limit</th> <th>Margin</th> <th>SA reading</th> <th>Factor</th> <th>Remark</th> <th>ANT High</th> <th>Turn Table</th> </tr> <tr> <th>MHz</th> <th>dBuV/m</th> <th>dBuV/m</th> <th>dB</th> <th>dBuV</th> <th>dB</th> <th></th> <th>cm</th> <th>deg</th> </tr> </thead> <tbody> <tr> <td>1</td> <td>5150.00</td> <td>43.63</td> <td>54.00</td> <td>-10.37</td> <td>39.23</td> <td>4.40</td> <td>Average</td> <td>227</td> <td>228</td> </tr> <tr> <td>2</td> <td>5150.00</td> <td>56.57</td> <td>74.00</td> <td>-17.43</td> <td>52.17</td> <td>4.40</td> <td>Peak</td> <td>227</td> <td>228</td> </tr> <tr> <td>3</td> <td>5350.00</td> <td>44.66</td> <td>54.00</td> <td>-9.34</td> <td>40.02</td> <td>4.64</td> <td>Average</td> <td>227</td> <td>228</td> </tr> <tr> <td>4</td> <td>5350.00</td> <td>57.11</td> <td>74.00</td> <td>-16.89</td> <td>52.47</td> <td>4.64</td> <td>Peak</td> <td>227</td> <td>228</td> </tr> <tr> <td>5</td> <td>6946.66</td> <td>53.20</td> <td>68.20</td> <td>-15.00</td> <td>45.41</td> <td>7.79</td> <td>Peak</td> <td>188</td> <td>201</td> </tr> <tr> <td>6</td> <td>10420.00</td> <td>54.97</td> <td>68.20</td> <td>-13.23</td> <td>40.65</td> <td>14.32</td> <td>Peak</td> <td>172</td> <td>138</td> </tr> </tbody> </table>	Freq.	Emission level	Limit	Margin	SA reading	Factor	Remark	ANT High	Turn Table	MHz	dBuV/m	dBuV/m	dB	dBuV	dB		cm	deg	1	5150.00	43.63	54.00	-10.37	39.23	4.40	Average	227	228	2	5150.00	56.57	74.00	-17.43	52.17	4.40	Peak	227	228	3	5350.00	44.66	54.00	-9.34	40.02	4.64	Average	227	228	4	5350.00	57.11	74.00	-16.89	52.47	4.64	Peak	227	228	5	6946.66	53.20	68.20	-15.00	45.41	7.79	Peak	188	201	6	10420.00	54.97	68.20	-13.23	40.65	14.32	Peak	172	138							
Freq.	Emission level	Limit	Margin	SA reading	Factor	Remark	ANT High	Turn Table																																																																														
MHz	dBuV/m	dBuV/m	dB	dBuV	dB		cm	deg																																																																														
1	5150.00	43.63	54.00	-10.37	39.23	4.40	Average	227	228																																																																													
2	5150.00	56.57	74.00	-17.43	52.17	4.40	Peak	227	228																																																																													
3	5350.00	44.66	54.00	-9.34	40.02	4.64	Average	227	228																																																																													
4	5350.00	57.11	74.00	-16.89	52.47	4.64	Peak	227	228																																																																													
5	6946.66	53.20	68.20	-15.00	45.41	7.79	Peak	188	201																																																																													
6	10420.00	54.97	68.20	-13.23	40.65	14.32	Peak	172	138																																																																													
<p>Note 1: Emission Level (dBuV/m) = SA Reading (dBuV/m) + Factor* (dB) *Factor includes antenna factor , cable loss and amplifier gain Note 2: Margin (dB) = Emission level (dBuV/m) – Limit (dBuV/m).</p>																																																																																						

Modulation	VHT80	Test Freq. (MHz)	5210
Polarization	Vertical		

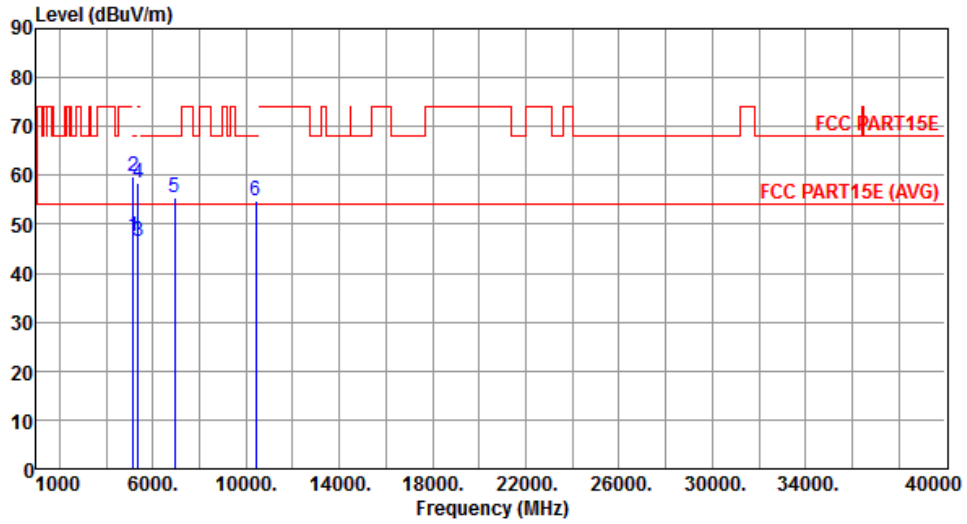

	Freq. MHz	Emission level dBuV/m	Limit dBuV/m	Margin dB	SA reading dBuV	Factor dB	Remark	ANT High cm	Turn Table deg
1	5150.00	47.42	54.00	-6.58	43.02	4.40	Average	186	224
2	5150.00	59.90	74.00	-14.10	55.50	4.40	Peak	186	224
3	5350.00	46.42	54.00	-7.58	41.78	4.64	Average	186	224
4	5350.00	58.42	74.00	-15.58	53.78	4.64	Peak	186	224
5	6946.66	55.44	68.20	-12.76	47.65	7.79	Peak	188	215
6	10420.00	54.85	68.20	-13.35	40.53	14.32	Peak	156	165

Note 1: Emission Level (dBuV/m) = SA Reading (dBuV/m) + Factor* (dB)

*Factor includes antenna factor , cable loss and amplifier gain

Note 2: Margin (dB) = Emission level (dBuV/m) – Limit (dBuV/m).

Modulation	VHT80	Test Freq. (MHz)	5290
Polarization	Horizontal		

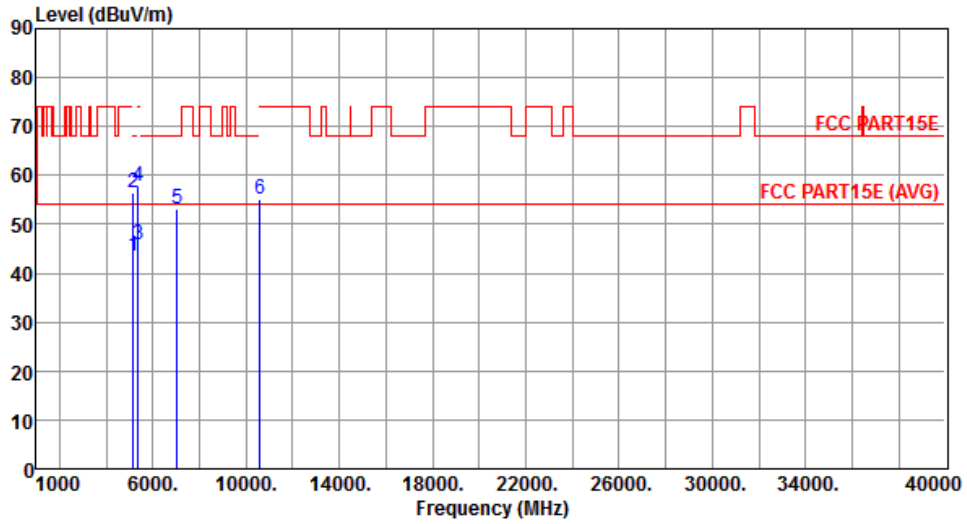

	Freq. MHz	Emission level dBuV/m	Limit dBuV/m	Margin dB	SA reading dBuV	Factor dB	Remark	ANT High cm	Turn Table deg
1	5150.00	43.45	54.00	-10.55	39.05	4.40	Average	209	242
2	5150.00	56.54	74.00	-17.46	52.14	4.40	Peak	209	242
3	5350.00	45.88	54.00	-8.12	41.24	4.64	Average	209	242
4	5350.00	57.81	74.00	-16.19	53.17	4.64	Peak	209	242
5	7053.33	53.12	68.20	-15.08	45.11	8.01	Peak	186	199
6	10580.00	55.29	68.20	-12.91	40.73	14.56	Peak	200	177

Note 1: Emission Level (dBuV/m) = SA Reading (dBuV/m) + Factor* (dB)

*Factor includes antenna factor , cable loss and amplifier gain

Note 2: Margin (dB) = Emission level (dBuV/m) – Limit (dBuV/m).

Modulation	VHT80	Test Freq. (MHz)	5290
Polarization	Vertical		

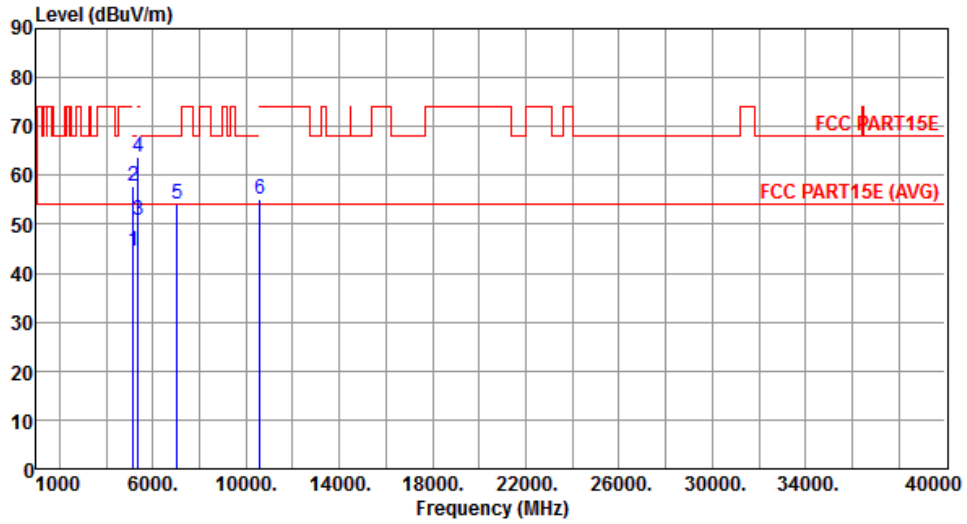

	Freq. MHz	Emission level dBuV/m	Limit dBuV/m	Margin dB	SA reading dBuV	Factor dB	Remark	ANT High cm	Turn Table deg
1	5150.00	44.37	54.00	-9.63	39.97	4.40	Average	197	287
2	5150.00	57.68	74.00	-16.32	53.28	4.40	Peak	197	287
3	5350.00	50.69	54.00	-3.31	46.05	4.64	Average	197	287
4	5350.00	63.71	74.00	-10.29	59.07	4.64	Peak	197	287
5	7053.33	54.25	68.20	-13.95	46.24	8.01	Peak	185	206
6	10580.00	55.28	68.20	-12.92	40.72	14.56	Peak	185	213

Note 1: Emission Level (dBuV/m) = SA Reading (dBuV/m) + Factor* (dB)

*Factor includes antenna factor , cable loss and amplifier gain

Note 2: Margin (dB) = Emission level (dBuV/m) – Limit (dBuV/m).

Modulation	VHT80	Test Freq. (MHz)	5530
Polarization	Horizontal		

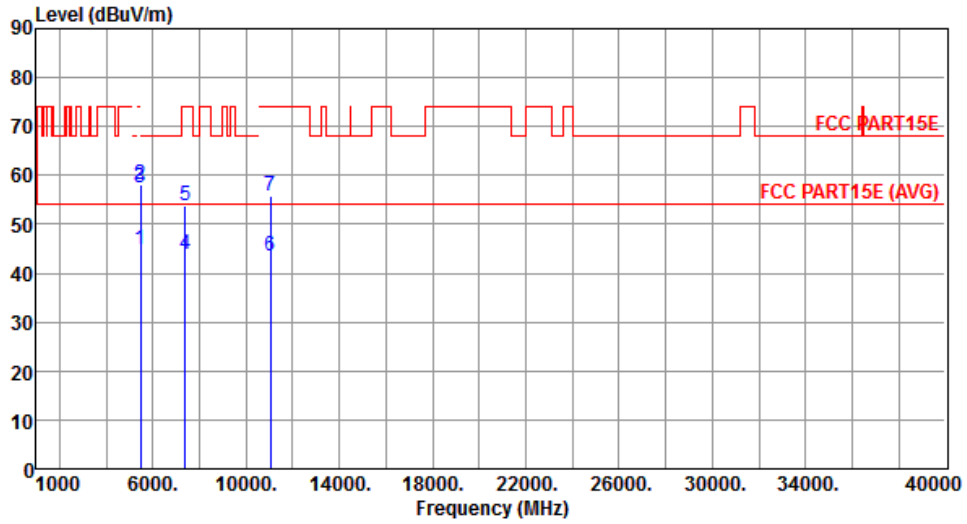

	Freq. MHz	Emission level dBuV/m	Limit dBuV/m	Margin dB	SA reading dBuV	Factor dB	Remark	ANT High cm	Turn Table deg
1	5460.00	44.76	54.00	-9.24	39.98	4.78	Average	179	247
2	5460.00	58.03	74.00	-15.97	53.25	4.78	Peak	179	247
3	5470.00	57.45	68.20	-10.75	52.66	4.79	Peak	179	247
4	7373.33	43.69	54.00	-10.31	35.23	8.46	Average	188	213
5	7373.33	53.70	74.00	-20.30	45.24	8.46	Peak	188	213
6	11060.00	43.54	54.00	-10.46	28.43	15.11	Average	155	242
7	11060.00	55.65	74.00	-18.35	40.54	15.11	Peak	155	242

Note 1: Emission Level (dBuV/m) = SA Reading (dBuV/m) + Factor* (dB)

*Factor includes antenna factor , cable loss and amplifier gain

Note 2: Margin (dB) = Emission level (dBuV/m) – Limit (dBuV/m).

Modulation	VHT80	Test Freq. (MHz)	5530
Polarization	Vertical		

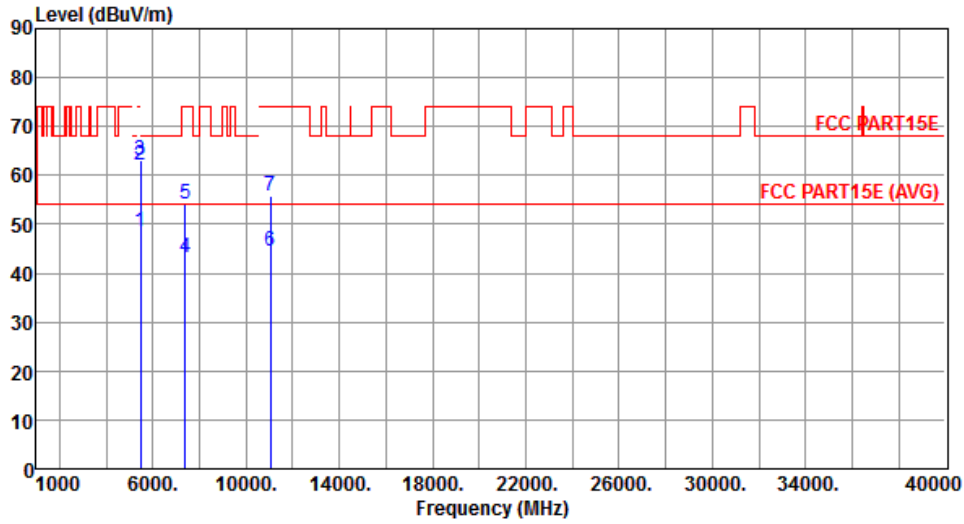

	Freq. MHz	Emission level dBuV/m	Limit dBuV/m	Margin dB	SA reading dBuV	Factor dB	Remark	ANT High cm	Turn Table deg
1	5460.00	48.40	54.00	-5.60	43.62	4.78	Average	177	0
2	5460.00	62.23	74.00	-11.77	57.45	4.78	Peak	177	0
3	5470.00	63.15	68.20	-5.05	58.36	4.79	Peak	177	0
4	7373.33	43.07	54.00	-10.93	34.61	8.46	Average	185	162
5	7373.33	54.17	74.00	-19.83	45.71	8.46	Peak	185	162
6	11060.00	44.54	54.00	-9.46	29.43	15.11	Average	175	202
7	11060.00	55.65	74.00	-18.35	40.54	15.11	Peak	175	202

Note 1: Emission Level (dBuV/m) = SA Reading (dBuV/m) + Factor* (dB)

*Factor includes antenna factor , cable loss and amplifier gain

Note 2: Margin (dB) = Emission level (dBuV/m) – Limit (dBuV/m).

Modulation	VHT80	Test Freq. (MHz)	5610
Polarization	Horizontal		

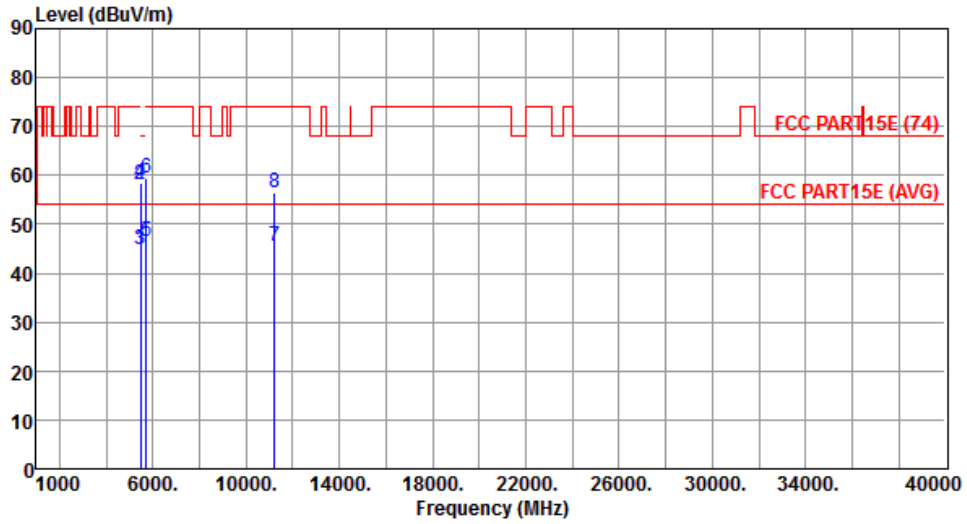

	Freq. MHz	Emission level dBuV/m	Limit dBuV/m	Margin dB	SA reading dBuV	Factor dB	Remark	ANT High cm	Turn Table deg
1	5460.00	44.82	54.00	-9.18	40.04	4.78	Average	202	140
2	5460.00	57.98	74.00	-16.02	53.20	4.78	Peak	202	140
3	5470.00	44.92	54.00	-9.08	40.13	4.79	Average	202	140
4	5470.00	58.45	74.00	-15.55	53.66	4.79	Peak	202	140
5	5725.00	46.51	54.00	-7.49	41.42	5.09	Average	202	140
6	5725.00	59.29	74.00	-14.71	54.20	5.09	Peak	202	140
7	11220.00	45.50	54.00	-8.50	30.23	15.27	Average	188	193
8	11220.00	56.33	74.00	-17.67	41.06	15.27	Peak	188	193

Note 1: Emission Level (dBuV/m) = SA Reading (dBuV/m) + Factor* (dB)

*Factor includes antenna factor , cable loss and amplifier gain

Note 2: Margin (dB) = Emission level (dBuV/m) – Limit (dBuV/m).

Modulation	VHT80	Test Freq. (MHz)	5610
Polarization	Vertical		

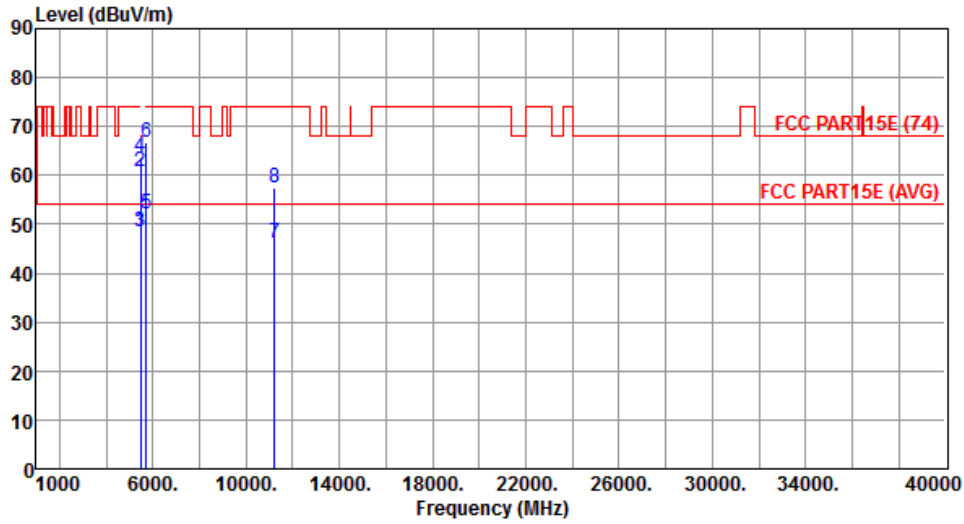

	Freq. MHz	Emission level dBuV/m	Limit dBuV/m	Margin dB	SA reading dBuV	Factor dB	Remark	ANT High cm	Turn Table deg
1	5460.00	48.57	54.00	-5.43	43.79	4.78	Average	198	3
2	5460.00	60.61	74.00	-13.39	55.83	4.78	Peak	198	3
3	5470.00	48.63	54.00	-5.37	43.84	4.79	Average	198	3
4	5470.00	63.80	74.00	-10.20	59.01	4.79	Peak	198	3
5	5725.00	52.05	54.00	-1.95	46.96	5.09	Average	198	3
6	5725.00	66.85	74.00	-7.15	61.76	5.09	Peak	198	3
7	11220.00	46.29	54.00	-7.71	31.02	15.27	Average	186	186
8	11220.00	57.52	74.00	-16.48	42.25	15.27	Peak	186	186

Note 1: Emission Level (dBuV/m) = SA Reading (dBuV/m) + Factor* (dB)

*Factor includes antenna factor , cable loss and amplifier gain

Note 2: Margin (dB) = Emission level (dBuV/m) – Limit (dBuV/m).

Modulation	VHT80	Test Freq. (MHz)	5690
Polarization	Horizontal		

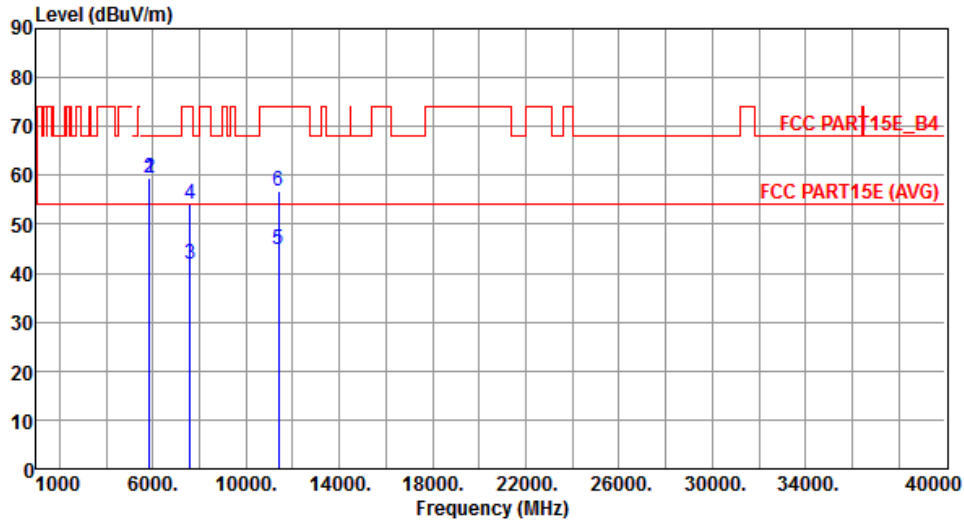

	Freq. MHz	Emission level dBuV/m	Limit dBuV/m	Margin dB	SA reading dBuV	Factor dB	Remark	ANT High cm	Turn Table deg
1	5850.00	59.39	78.20	-18.81	54.13	5.26	Peak	280	258
2	5860.00	59.39	68.20	-8.81	54.12	5.27	Peak	280	258
3	7586.66	41.94	54.00	-12.06	33.12	8.82	Average	200	196
4	7586.66	54.03	74.00	-19.97	45.21	8.82	Peak	200	196
5	11380.00	44.87	54.00	-9.13	29.45	15.42	Average	173	268
6	11380.00	56.95	74.00	-17.05	41.53	15.42	Peak	173	268

Note 1: Emission Level (dBuV/m) = SA Reading (dBuV/m) + Factor* (dB)

*Factor includes antenna factor , cable loss and amplifier gain

Note 2: Margin (dB) = Emission level (dBuV/m) – Limit (dBuV/m).

Modulation	VHT80	Test Freq. (MHz)	5690
Polarization	Vertical		

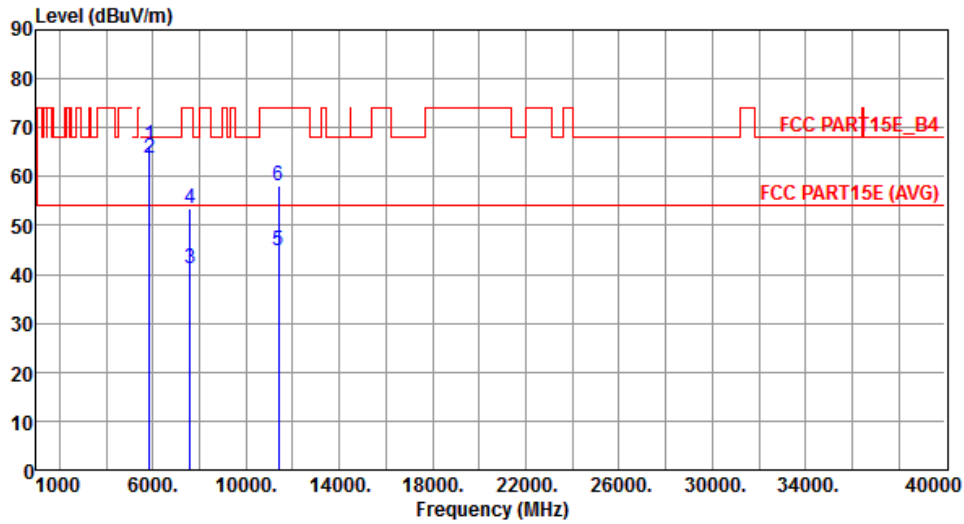

	Freq. MHz	Emission level dBuV/m	Limit dBuV/m	Margin dB	SA reading dBuV	Factor dB	Remark	ANT High cm	Turn Table deg
1	5850.00	66.46	78.20	-11.74	61.20	5.26	Peak	215	183
2	5860.00	63.73	68.20	-4.47	58.46	5.27	Peak	215	183
3	7586.66	41.33	54.00	-12.67	32.51	8.82	Average	177	216
4	7586.66	53.55	74.00	-20.45	44.73	8.82	Peak	177	216
5	11380.00	44.97	54.00	-9.03	29.55	15.42	Average	150	138
6	11380.00	57.95	74.00	-16.05	42.53	15.42	Peak	150	138

Note 1: Emission Level (dBuV/m) = SA Reading (dBuV/m) + Factor* (dB)

*Factor includes antenna factor , cable loss and amplifier gain

Note 2: Margin (dB) = Emission level (dBuV/m) – Limit (dBuV/m).

Modulation	VHT80	Test Freq. (MHz)	5775
Polarization	Horizontal		

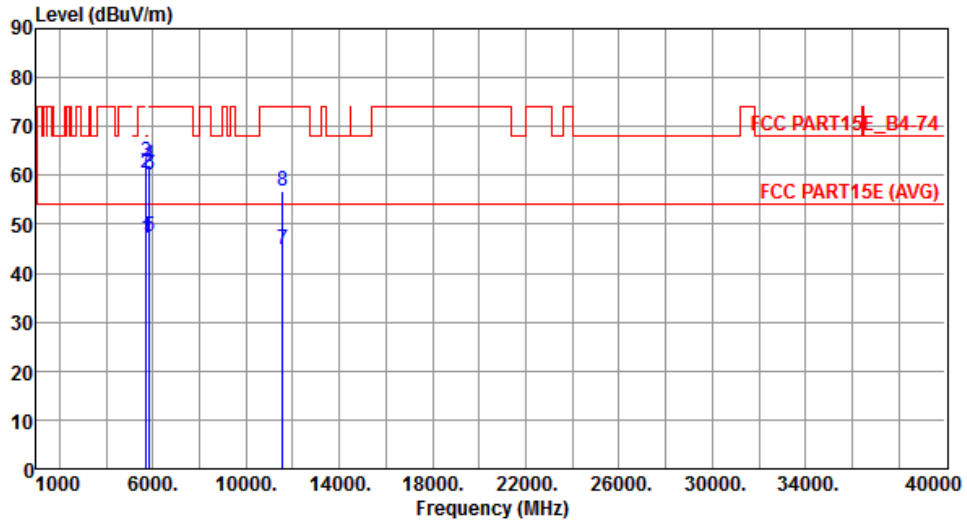

	Freq. MHz	Emission level dBuV/m	Limit dBuV/m	Margin dB	SA reading dBuV	Factor dB	Remark	ANT High cm	Turn Table deg
1	5715.00	47.09	54.00	-6.91	41.99	5.10	Average	189	260
2	5715.00	60.28	74.00	-13.72	55.18	5.10	Peak	189	260
3	5725.00	62.60	78.20	-15.60	57.51	5.09	Peak	189	260
4	5850.00	62.20	78.20	-16.00	56.94	5.26	Peak	189	260
5	5860.00	47.62	54.00	-6.38	42.35	5.27	Average	189	260
6	5860.00	60.07	74.00	-13.93	54.80	5.27	Peak	189	260
7	11550.00	44.70	54.00	-9.30	29.30	15.40	Average	156	213
8	11550.00	56.84	74.00	-17.16	41.44	15.40	Peak	156	213

Note 1: Emission Level (dBuV/m) = SA Reading (dBuV/m) + Factor* (dB)

*Factor includes antenna factor , cable loss and amplifier gain

Note 2: Margin (dB) = Emission level (dBuV/m) – Limit (dBuV/m).

Modulation	VHT80	Test Freq. (MHz)	5775
Polarization	Vertical		

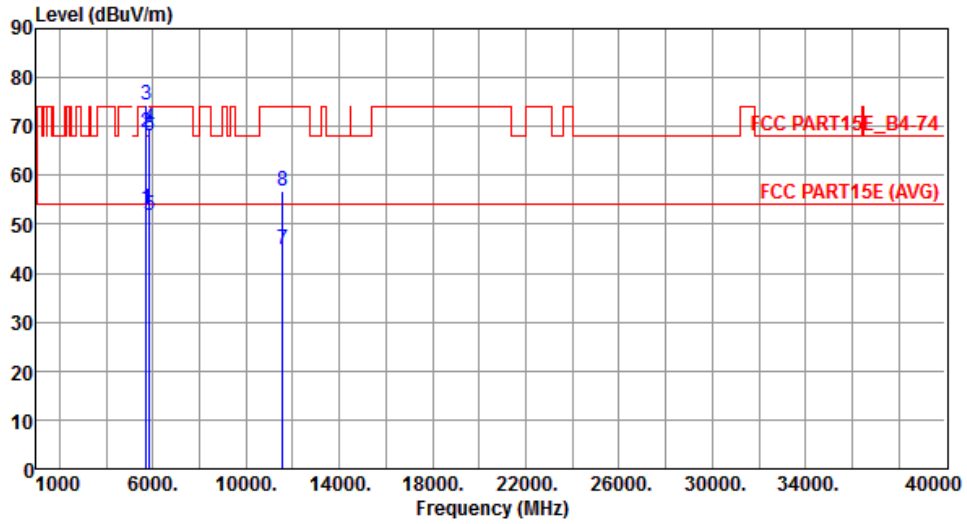

	Freq. MHz	Emission level dBuV/m	Limit dBuV/m	Margin dB	SA reading dBuV	Factor dB	Remark	ANT High cm	Turn Table deg
1	5715.00	52.99	54.00	-1.01	47.89	5.10	Average	188	220
2	5715.00	68.91	74.00	-5.09	63.81	5.10	Peak	188	220
3	5725.00	74.29	78.20	-3.91	69.20	5.09	Peak	188	220
4	5850.00	69.86	78.20	-8.34	64.60	5.26	Peak	188	220
5	5860.00	51.86	54.00	-2.14	46.59	5.27	Average	188	220
6	5860.00	68.11	74.00	-5.89	62.84	5.27	Peak	188	220
7	11550.00	44.84	54.00	-9.16	29.44	15.40	Average	172	136
8	11550.00	56.77	74.00	-17.23	41.37	15.40	Peak	172	136

Note 1: Emission Level (dBuV/m) = SA Reading (dBuV/m) + Factor* (dB)

*Factor includes antenna factor , cable loss and amplifier gain

Note 2: Margin (dB) = Emission level (dBuV/m) – Limit (dBuV/m).

3.6 Frequency Stability

3.6.1 Limit of Frequency Stability

Manufacturers of U-NII devices are responsible for ensuring frequency stability such that an emission is maintained within the band of operation under all conditions of normal operation as specified in the user's manual.

3.6.2 Test Procedures

1. The EUT is installed in an environment test chamber with external power source.
2. Set the chamber to operate at 50 centigrade and external power source to output at nominal voltage of EUT.
3. A sufficient stabilization period at each temperature is used prior to each frequency measurement.
4. When temperature is stabled, measure the frequency stability.
5. The test shall be performed under -30 to 50 centigrade and 85 to 115 percent of the nominal voltage. Change setting of chamber and external power source to complete all conditions.

3.6.3 Test Setup

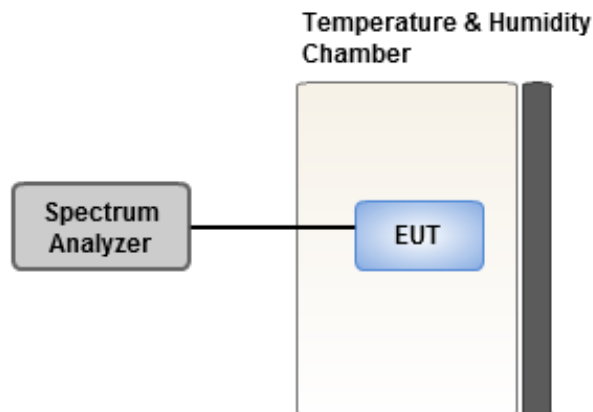

3.6.4 Test Result of Frequency Stability

Non-beamforming mode

Frequency: 5785 MHz	Frequency Drift (ppm)			
Temperature (°C)	0 minute	2 minutes	5 minutes	10 minutes
T20°CVmax	5.40	4.64	5.22	5.06
T20°CVmin	4.08	3.95	3.94	4.43
T50CVnom	4.11	3.43	4.07	3.74
T40°CVnom	3.84	3.76	3.95	3.95
T30°CVnom	2.33	2.57	2.74	2.64
T20°CVnom	2.56	2.32	2.26	2.39
T10°CVnom	2.73	2.49	2.95	2.20
T0°CVnom	3.18	2.97	2.67	2.94
T-10°CVnom	1.69	1.59	1.69	1.42
T-20°CVnom	1.52	1.15	1.09	1.33
T-30°CVnom	0.26	0.70	0.68	0.39
Vnom [Vac]: 120		Vmax [Vac]: 138		Vmin [Vac]: 102
Tnom [°C]: 20		Tmax [°C]: 50		Tmin [°C]: -30

Beamforming mode

Frequency: 5785 MHz	Frequency Drift (ppm)			
Temperature (°C)	0 minute	2 minutes	5 minutes	10 minutes
T20°CVmax	5.89	5.96	5.88	5.86
T20°CVmin	4.77	4.83	4.87	4.80
T50CVnom	4.67	4.72	4.79	4.70
T40°CVnom	3.92	3.93	3.99	4.03
T30°CVnom	4.51	4.49	4.42	4.43
T20°CVnom	3.44	3.44	3.53	3.57
T10°CVnom	3.50	3.55	3.48	3.56
T0°CVnom	3.16	3.19	3.20	3.30
T-10°CVnom	1.42	1.44	1.52	1.61
T-20°CVnom	1.55	1.69	1.76	1.77
T-30°CVnom	2.50	2.49	2.52	2.64
Vnom [Vac]: 120		Vmax [Vac]: 138		Vmin [Vac]: 102
Tnom [°C]: 20		Tmax [°C]: 50		Tmin [°C]: -30

4 Test laboratory information

Established in 2012, ICC provides foremost EMC & RF Testing and advisory consultation services by our skilled engineers and technicians. Our services employ a wide variety of advanced edge test equipment and one of the widest certification extents in the business.

International Certification Corp, it is our definitive objective is to institute long term, trust-based associations with our clients. The expectation we set up with our clients is based on outstanding service, practical expertise and devotion to a certified value structure. Our passion is to grant our clients with best EMC / RF services by oriented knowledgeable and accommodating staff.

Our Test sites are located at Linkou District and Kwei Shan Hsiang. Location map can be found on our website <http://www.icertifi.com.tw>.

Linkou

Tel: 886-2-2601-1640

No. 30-2, Ding Fwu Tsuen, Lin Kou
District, New Taipei City, Taiwan,
R.O.C.

Kwei Shan

Tel: 886-3-271-8666

No. 3-1, Lane 6, Wen San 3rd
St., Kwei Shan Hsiang, Tao Yuan
Hsien 333, Taiwan, R.O.C.

Kwei Shan Site II

Tel: 886-3-271-8640

No. 14-1, Lane 19, Wen San 3rd
St., Kwei Shan Hsiang, Tao Yuan
Hsien 333, Taiwan, R.O.C.

If you have any suggestion, please feel free to contact us as below information

Tel: 886-3-271-8666

Fax: 886-3-318-0155

Email: ICC_Service@icertifi.com.tw

==END==