



MET Laboratories, Inc. *Safety Certification - EMI - Telecom Environmental Simulation*

914 WEST PATAPSCO AVENUE • BALTIMORE, MARYLAND 21230-3432 • PHONE (410) 354-3300 • FAX (410) 354-3313
33439 WESTERN AVENUE • UNION CITY, CALIFORNIA 94587 • PHONE (510) 489-6300 • FAX (510) 489-6372
3162 BELICK STREET • SANTA CLARA, CALIFORNIA 95054 • PHONE (408) 748-3585 • FAX (510) 489-6372
13301 MCCALLEN PASS • AUSTIN, TEXAS 78753 • PHONE (512) 287-2500 • FAX (512) 287-2513

December 8, 2014

ARRIS Group
6450 Sequence Dr.
San Diego, CA 92121

Dear Joni Washek,

Enclosed is the EMC Wireless test report for compliance testing of the ARRIS Group, VAP3400 as tested to the requirements of Title 47 of the CFR, Ch. 1 (10-1-06 ed.), Title 47 of the CFR, Part 15.407 and Industry Canada RSS-210 Issue 8 December 2010 for Intentional Radiators DFS Bands.

Thank you for using the services of MET Laboratories, Inc. If you have any questions regarding these results or if MET can be of further service to you, please feel free to contact me.

Sincerely yours,
MET LABORATORIES, INC.

Jennifer Warnell
Documentation Department

Reference: (\ARRIS Group\EMCS83255B-DFS Rev2)

Certificates and reports shall not be reproduced except in full, without the written permission of MET Laboratories, Inc.



MET Laboratories, Inc. *Safety Certification - EMI - Telecom Environmental Simulation*

914 WEST PATAPSCO AVENUE • BALTIMORE, MARYLAND 21230-3432 • PHONE (410) 354-3300 • FAX (410) 354-3313

33439 WESTERN AVENUE • UNION CITY, CALIFORNIA 94587 • PHONE (510) 489-6300 • FAX (510) 489-6372

3162 BELICK STREET • SANTA CLARA, CALIFORNIA 95054 • PHONE (408) 748-3585 • FAX (510) 489-6372

13301 MCCALLEN PASS • AUSTIN, TEXAS 78753 • PHONE (512) 287-2500 • FAX (512) 287-2513

**Electromagnetic Compatibility Criteria
Test Report**

for the

**ARRIS Group
Model VAP3400**

Tested under
the Certification Rules
contained in

Title 47 of the CFR, Part 15.407
and RSS-210 Issue 8 December 2010
for Intentional Radiators DFS Bands

MET Report: EMCS83255B-DFS Rev2

December 8, 2014

Prepared For:

**ARRIS Group
6450 Sequence Dr.
San Diego, CA 92121**

Prepared By:
MET Laboratories, Inc.
914 W. Patapsco Ave.
Baltimore, MD 21230

Electromagnetic Compatibility Criteria Test Report

for the

**ARRIS Group
Model VAP3400**

**Tested under
the Certification Rules
contained in**

Title 47 of the CFR, Part 15.407
and RSS-210 Issue 8 December 2010
for Intentional Radiators DFS Bands



Andy Shen, Project Engineer
Electromagnetic Compatibility Lab



Jennifer Warnell
Documentation Department

Engineering Statement: The measurements shown in this report were made in accordance with the procedures indicated, and the emissions from this equipment were found to be within the limits applicable. I assume full responsibility for the accuracy and completeness of these measurements, and for the qualifications of all persons taking them. It is further stated that upon the basis of the measurements made, the equipment tested is capable of operation in accordance with the requirements of Part 15.407 DFS Bands of the FCC Rules and Industry Canada standards RSS-210 Issue 8 December 2010 under normal use and maintenance.



Asad Bajwa, Director
Electromagnetic Compatibility Lab

Report Status Sheet

Revision	Report Date	Reason for Revision
∅	October 24, 2014	Initial Issue.
1	November 14, 2014	Retested with -64 dBm threshold
2	December 8, 2014	Revised to correct 802.11n 80 MHz to 802.11ac 80 MHz.

Table of Contents

I.	Executive Summary	1
	A. Purpose of Test	2
	B. Executive Summary	2
II.	Equipment Configuration	3
	A. Overview.....	4
	B. References.....	4
	C. Test Site	5
	D. Description of Test Sample.....	5
	E. Equipment Configuration.....	5
	F. Support Equipment	5
	G. Ports and Cabling Information.....	5
	H. Mode of Operation.....	7
	I. Method of Monitoring EUT Operation	8
	J. Modifications	8
	a) Modifications to EUT.....	8
	b) Modifications to Test Standard.....	8
	K. Disposition of EUT	8
III.	DFS Requirements and Radar Waveform Description & Calibration	9
	A. DFS Requirements	10
	B. Radar Test Waveforms	12
	C. Radar Waveform Calibration	15
IV.	DFS Test Procedure and Test Results	23
	A. DFS Test Setup	24
	B. UNII Detection Bandwidth	26
	C. Initial Channel Availability Check Time	32
	D. Radar Burst at the Beginning of Channel Availability Check Time	33
	E. Radar Burst at the End of Channel Availability Check Time	34
	F. In-Service Monitoring for Channel Move Time, Channel Closing Time, and Non-Occupancy.....	35
	G. Statistical Performance Check	38
V.	Test Equipment	60
VI.	Certification & User's Manual Information	62
	A. Certification Information	63
	B. Label and User's Manual Information	67

List of Tables

Table 1. Executive Summary of EMC Part 15.407 Compliance Testing	2
Table 2. EUT Summary.....	4
Table 3. References	4
Table 4. Equipment Configuration	5
Table 5. Support Equipment.....	5
Table 6. Ports and Cabling Information	5
Table 7. Applicability of DFS Requirements Prior to Use of a Channel.....	10
Table 8. Applicability of DFS Requirements During Normal Operation	10
Table 9. DFS Detection Thresholds for Master or Client Devices Incorporating DFS	11
Table 10. DFS Response Requirement Values.....	11
Table 11. UNII Detection Bandwidth, Test Results, 5290 MHz, 80 MHz.....	28
Table 12. UNII Detection Bandwidth, Test Results, 5300 MHz, 20 MHz.....	29
Table 13. UNII Detection Bandwidth, Test Results, 5510 MHz, 40 MHz.....	30
Table 14. Statistical Performance Check – Radar Type 0, 802.11n 20 MHz	39
Table 15. Statistical Performance Check – Radar Type 1, 802.11n 20 MHz	40
Table 16. Statistical Performance Check – Radar Type 2, 802.11n 20 MHz	41
Table 17. Statistical Performance Check – Radar Type 3, 802.11n 20 MHz	42
Table 18. Statistical Performance Check – Radar Type 4, 802.11n 20 MHz	43
Table 19. Statistical Performance Check – Radar Type 5, 802.11n 20 MHz	44
Table 20. Statistical Performance Check – Radar Type 6, 802.11n 20 MHz	45
Table 21. Statistical Performance Check – Radar Type 0, 802.11n 40 MHz	46
Table 22. Statistical Performance Check – Radar Type 1, 802.11n 40 MHz	47
Table 23. Statistical Performance Check – Radar Type 2, 802.11n 40 MHz	48
Table 24. Statistical Performance Check – Radar Type 3, 802.11n 40 MHz	49
Table 25. Statistical Performance Check – Radar Type 4, 802.11n 40 MHz	50
Table 26. Statistical Performance Check – Radar Type 5, 802.11n 40 MHz	51
Table 27. Statistical Performance Check – Radar Type 6, 802.11n 40 MHz	52
Table 28. Statistical Performance Check – Radar Type 0, 802.11ac 80 MHz.....	53
Table 29. Statistical Performance Check – Radar Type 1, 802.11ac 80 MHz.....	54
Table 30. Statistical Performance Check – Radar Type 2, 802.11ac 80 MHz.....	55
Table 31. Statistical Performance Check – Radar Type 3, 802.11ac 80 MHz.....	56
Table 32. Statistical Performance Check – Radar Type 4, 802.11ac 80 MHz.....	57
Table 33. Statistical Performance Check – Radar Type 5, 802.11ac 80 MHz.....	58
Table 34. Statistical Performance Check – Radar Type 6, 802.11ac 80 MHz.....	59
Table 35. DFS Test Equipment List	61

List of Figures

Figure 1. Block Diagram of Equipment Configuration	6
Figure 2. Long Pulse Radar Test Signal Waveform.....	14
Figure 3. Calibration Test setup	15
Figure 4. Test Setup Diagram.....	24

List of Photographs

Photograph 1. DFS Radar Test Signal Generator	15
Photograph 2. DFS, Test Setup	25

List of Plots

Plot 1. Radar Type 0 Calibration, 5290 MHz	16
Plot 2. Radar Type 0 Calibration, 5300 MHz	16
Plot 3. Radar Type 0 Calibration, 5510 MHz	16
Plot 4. Radar Type 1 Calibration, 5290 MHz	17
Plot 5. Radar Type 1 Calibration, 5300 MHz	17
Plot 6. Radar Type 1 Calibration, 5510 MHz	17
Plot 7. Radar Type 2 Calibration, 5290 MHz	18
Plot 8. Radar Type 2 Calibration, 5300 MHz	18
Plot 9. Radar Type 2 Calibration, 5510 MHz	18
Plot 10. Radar Type 3 Calibration, 5290 MHz	19
Plot 11. Radar Type 3 Calibration, 5300 MHz	19
Plot 12. Radar Type 3 Calibration, 5510 MHz	19
Plot 13. Radar Type 4 Calibration, 5290 MHz	20
Plot 14. Radar Type 4 Calibration, 5300 MHz	20
Plot 15. Radar Type 4 Calibration, 5510 MHz	20
Plot 16. Radar Type 5 Calibration, 5290 MHz	21
Plot 17. Radar Type 5 Calibration, 5300 MHz	21
Plot 18. Radar Type 5 Calibration, 5510 MHz	21
Plot 19. Radar Type 6 Calibration, 5290 MHz	22
Plot 20. Radar Type 6 Calibration, 5300 MHz	22
Plot 21. Radar Type 6 Calibration, 5510 MHz	22
Plot 22. Occupied Bandwidth, 802.11n 20 MHz, Lower Band, Port JA1	31
Plot 23. Occupied Bandwidth, 802.11n 40 MHz, Upper Band, Port JA1	31
Plot 24. Occupied Bandwidth, 802.11ac 80 MHz, Lower Band, Port JA1	31
Plot 25. Channel Closing Transmission Time Aggregate, Port JA1	36
Plot 26. Channel Move Time, 1 second, Port JA1	36
Plot 27. Channel Move Time, 10 second, Port JA1	36
Plot 28. Non-Occupancy Period, 30minutes	37

List of Terms and Abbreviations

AC	Alternating Current
ACF	Antenna Correction Factor
Cal	Calibration
<i>d</i>	Measurement Distance
dB	Decibels
dB μ A	Decibels above one microamp
dB μ V	Decibels above one microvolt
dB μ A/m	Decibels above one microamp per meter
dB μ V/m	Decibels above one microvolt per meter
DC	Direct Current
E	Electric Field
DSL	Digital Subscriber Line
ESD	Electrostatic Discharge
EUT	Equipment Under Test
<i>f</i>	Frequency
FCC	Federal Communications Commission
GRP	Ground Reference Plane
H	Magnetic Field
HCP	Horizontal Coupling Plane
Hz	Hertz
IEC	International Electrotechnical Commission
kHz	kilohertz
kPa	kilopascal
kV	kilovolt
LISN	Line Impedance Stabilization Network
MHz	Megahertz
μ H	microhenry
μ	microfarad
μ s	microseconds
PRF	Pulse Repetition Frequency
RF	Radio Frequency
RMS	Root-Mean-Square
TWT	Traveling Wave Tube
V/m	Volts per meter
VCP	Vertical Coupling Plane

I. Executive Summary

A. Purpose of Test

An EMC evaluation was performed to determine compliance of the ARRIS Group VAP3400, with the requirements of Part 15, §15.407. All references are to the most current version of Title 47 of the Code of Federal Regulations in effect. In accordance with §2.1033, the following data is presented in support of the Certification of the VAP3400. ARRIS Group should retain a copy of this document which should be kept on file for at least two years after the manufacturing of the VAP3400, has been **permanently** discontinued.

B. Executive Summary

The following tests were conducted on a sample of the equipment for the purpose of demonstrating compliance with Part 15, §15.407, in accordance with ARRIS Group, purchase order number AR1046014. All tests were conducted using measurement procedure ANSI C63.4-2003.

FCC Reference	IC Reference	Description	Results
15.407 (h)	A9.3(a)	DFS Calibration	Compliant
15.407 (h)	NA	DFS Channel Bandwidth	Compliant
15.407 (h)(2)(ii)	A9.3(b)(ii)	Initial Channel Availability Check Time (CACT)	NA
15.407 (h)(2)(ii)	A9.3(b)(ii)	Radar Burst at the Beginning of CACT	NA
15.407 (h)(2)(ii)	A9.3(b)(ii)	Radar Burst at the End of CACT	NA
15.407 (h)(2)(iii)	A9.3(b)(iii), (iv)	Channel Move Time and Channel Closing Time	Compliant
15.407 (h)(2)(iv)	A9.3(b)(v)	Non-Occupancy Period	Compliant
15.407 (h)(2)	NA	Statistical Performance Check	Compliant

Table 1. Executive Summary of EMC Part 15.407 Compliance Testing

II. Equipment Configuration

A. Overview

MET Laboratories, Inc. was contracted by ARRIS Group to perform testing on the VAP3400, under ARRIS Group's purchase order number AR1046014.

This document describes the test setups, test methods, required test equipment, and the test limit criteria used to perform compliance testing of the ARRIS Group VAP3400.

The results obtained relate only to the item(s) tested.

Model(s) Tested:	VAP3400	
Model(s) Covered:	VAP3400	
EUT Specifications:	Primary Power: 120 VAC, 60 Hz	
	FCC ID: ACQ-VAP3400 IC: 109AS-VAP3400	
	Type of Modulations:	OFDM
	Equipment Code:	NII
	Peak RF Output Power:	EIRP > 200 mW
	EUT Frequency Ranges:	5250-5350 MHz; 5470-5725 MHz
Analysis:	The results obtained relate only to the item(s) tested.	
Environmental Test Conditions:	Temperature: 15-35° C	
	Relative Humidity: 30-60%	
	Barometric Pressure: 860-1060 mbar	
Evaluated by:	Andy Shen	
Report Date(s):	December 8, 2014	

Table 2. EUT Summary

Note: This device can be configured as a Master and also as a Client with radar detection capability. This test report is for the Client side.

B. References

CFR 47, Part 15, Subpart B	Electromagnetic Compatibility: Criteria for Radio Frequency Devices
CFR 47, Part 15, Subpart E	Unlicensed National Information Infrastructure Devices (UNII)
RSS-210, Issue 8, Dec. 2010	Low-power Licence-exempt Radiocommunications Devices (All Frequency Bands): Category I Equipment
ANSI C63.4:2003	Methods and Measurements of Radio-Noise Emissions from Low-Voltage Electrical And Electronic Equipment in the Range of 9 kHz to 40 GHz
ISO/IEC 17025:2005	General Requirements for the Competence of Testing and Calibration Laboratories

Table 3. References

C. Test Site

All testing was performed at MET Laboratories, Inc., 3162 Belick St., Santa Clara, CA 95054. All equipment used in making physical determinations is accurate and bears recent traceability to the National Institute of Standards and Technology.

Radiated Emissions measurements were performed in a 10 meter semi-anechoic chamber (equivalent to an Open Area Test Site). In accordance with §2.948(a)(3), a complete site description is contained at MET Laboratories.

D. Description of Test Sample

The ARRIS Group VAP3400, is an 802.11ac based video bridge product designed to operate inside residences and businesses. It includes a 10/100/1000BaseT Ethernet port and a 4x4 5 GHz RF Wi-Fi port. It includes a web GUI for configuration and status and a remote management application based on the TR-069 standard.

- VAP3400 802.11ac 1 Gigabit Ethernet Port Video Access Point (Dongle)
- VAP3400 802.11ac 1 Gigabit Ethernet Port AP (dongle) and CLIENT (dongle) as a pair

E. Equipment Configuration

All cards, racks, etc., incorporated as part of the EUT is included in the following list.

Ref. ID	Name / Description	Model Number	Part Number	Serial Number	Revision
N/A	VAP3400	VAP3400	N/A	M91422SA05Q	N/A
N/A	VAP3400	VAP3400	N/A	M91422SA0M44	N/A

Table 4. Equipment Configuration

F. Support Equipment

ARRIS Group supplied support equipment necessary for the operation and testing of the VAP3400. All support equipment supplied is listed in the following Support Equipment List.

Ref. ID	Name / Description	Manufacturer	Model Number
N/A	AC Adapter	Asian Power Devices INC,	WA-12M12FU
N/A	AC Adapter	Asian Power Devices INC,	WA-12M12FU
N/A	ETHERNET CABLE	N/A	N/A
N/A	ETHERNET CABLE	N/A	N/A

Table 5. Support Equipment

G. Ports and Cabling Information

Ref. ID	Port Name on EUT	Cable Description	Qty.	Length (m)	Shielded (Y/N)	Termination Point
1	Ethernet RJ-45	Standard Cat-5 Ethernet cable	1	1.8	Y	N/A
2	VDC Power	Included power supply	1	1.8	Y	N/A

Table 6. Ports and Cabling Information

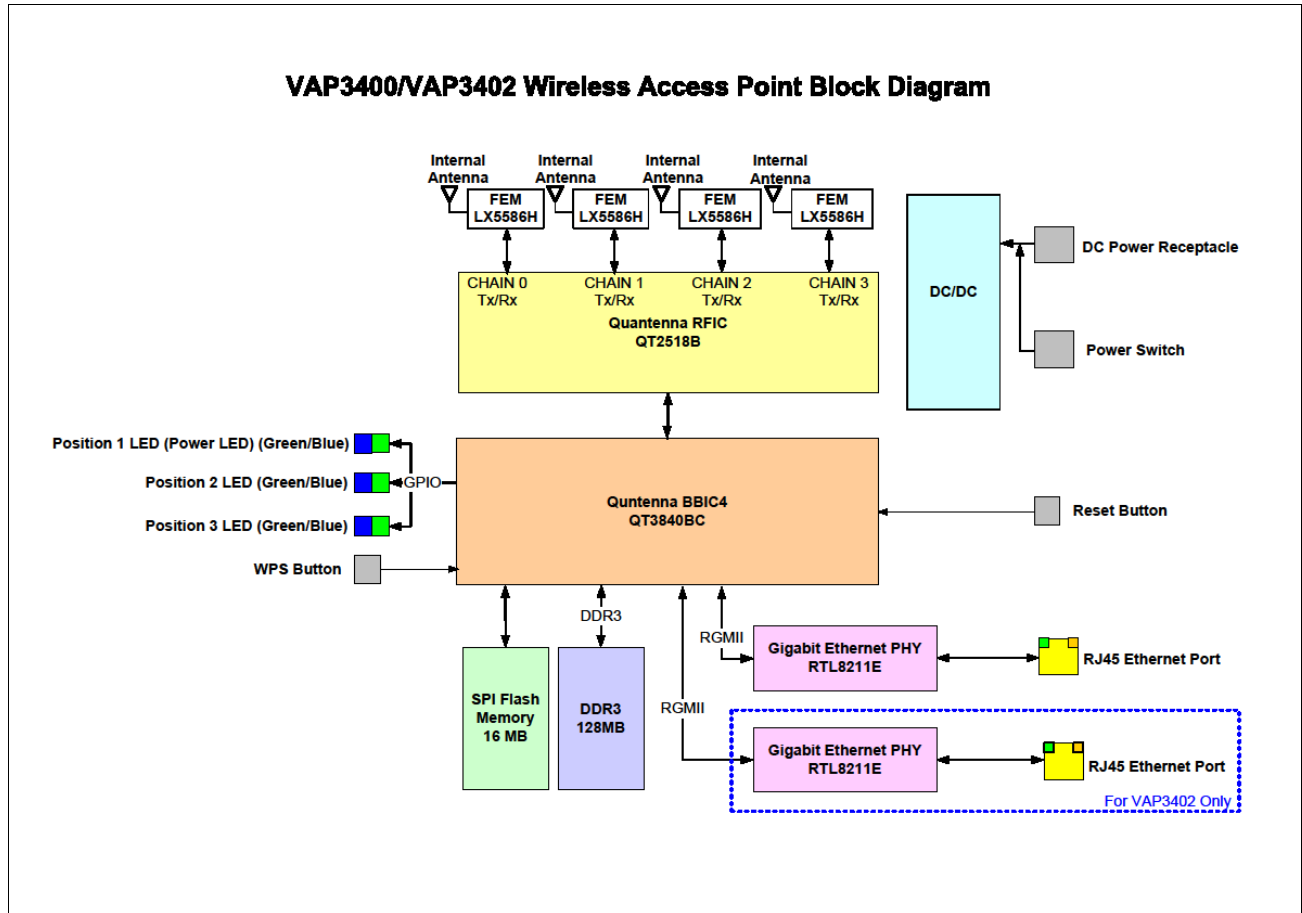

Figure 1. Block Diagram of Equipment Configuration

H. Mode of Operation

The VAP340n will automatically configure itself as either an AP or a STA as part of its power-on and initialization process.

AP mode:

The VAP340n will bridge IP packets from a source through the Ethernet port and then out the RF WiFi interface. In order to operate as an AP it must be connected via Ethernet to a router/gateway or other device that supports DHCP.

STA mode:

The VAP340n will bridge IP packets from a source through the RF Wi-Fi interface and then out the Ethernet port. In order to operate as a STA it must be associated to the AP and the AP must be connected to a DHCP server (router/gateway or other equipment).

The main application for the VAP340N is for the IPTV network operators to be able to use 802.11n wireless connectivity to distribute video within the home. Key benefits of doing so are reduced installation time, easier installation and reduced clutter (no wiring).

The typical home setup will consist of one or more wireless STBs (VIP2200W) that communicates wirelessly with the access point (VAP340N). The AP, in turn, connects to the IPTV network through a residential gateway. There may be other wired STB's present (e.g. VIP2200/ VIP2250) in the LAN. Further, the same VAP340N device can operate as either an AP, when connected to the residential gateway or as a client, when connected to a non-wireless STB.

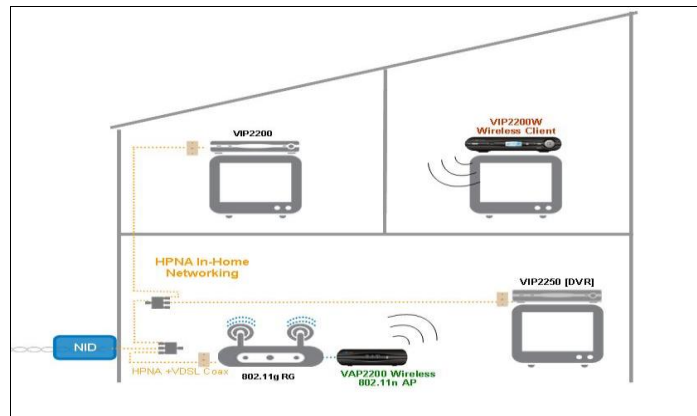

I. Method of Monitoring EUT Operation

The VAP340n's Ethernet port has standard link and traffic LEDs that can be monitored. The Wi-Fi status LED on the front panel indicates the relative signal strength being received by the STA on the other end of the RF link. Green is good, cyan is minimally acceptable, blue is bad.

J. Modifications

a) Modifications to EUT

No modifications were made to the EUT.

b) Modifications to Test Standard

No modifications were made to the test standard.

K. Disposition of EUT

The test sample including all support equipment submitted to the Electro-Magnetic Compatibility Lab for testing was returned to ARRIS Group upon completion of testing.

III. DFS Requirements and Radar Waveform Description & Calibration

A. DFS Requirements

Requirement	Operational Mode		
	Master	Client Without Radar Detection	Client With Radar Detection
<i>Non-Occupancy Period</i>	Yes	Not required	Yes
<i>DFS Detection Threshold</i>	Yes	Not required	Yes
<i>Channel Availability Check Time</i>	Yes	Not required	Not required
<i>U-NII Detection Bandwidth</i>	Yes	Not required	Yes

Table 7. Applicability of DFS Requirements Prior to Use of a Channel

Requirement	Operational Mode	
	Master Device or Client with Radar Detection	Client Without Radar Detection
<i>DFS Detection Threshold</i>	Yes	Not required
<i>Channel Closing Transmission Time</i>	Yes	Yes
<i>Channel Move Time</i>	Yes	Yes
<i>U-NII Detection Bandwidth</i>	Yes	Not required
Additional requirements for devices with multiple bandwidth modes	Master Device or Client with Radar Detection	Client Without Radar Detection
<i>U-NII Detection Bandwidth and Statistical Performance Check</i>	All BW modes must be tested	Not required
<i>Channel Move Time and Channel Closing Transmission Time</i>	Test using widest BW mode available	Test using the widest BW mode available for the link
<i>All other tests</i>	Any single BW mode	Not required
Note: Frequencies selected for statistical performance check (Section 7.8.4) should include several frequencies within the radar detection bandwidth and frequencies near the edge of the radar detection bandwidth. For 802.11 devices it is suggested to select frequencies in each of the bonded 20 MHz channels and the channel center frequency.		

Table 8. Applicability of DFS Requirements During Normal Operation

Maximum Transmit Power	Value (See Notes 1, 2, and 3)
EIRP \geq 200 milliwatt	-64 dBm
EIRP < 200 milliwatt and power spectral density < 10 dBm/MHz	-62 dBm
EIRP < 200 milliwatt that do not meet the power spectral density requirement	-64 dBm
<p>Note 1: This is the level at the input of the receiver assuming a 0 dBi receive antenna. Note 2: Throughout these test procedures an additional 1 dB has been added to the amplitude of the test transmission waveforms to account for variations in measurement equipment. This will ensure that the test signal is at or above the detection threshold level to trigger a DFS response. Note 3: EIRP is based on the highest antenna gain. For MIMO devices refer to KDB Publication 662911 D01.</p>	

Table 9. DFS Detection Thresholds for Master or Client Devices Incorporating DFS

Parameter	Value
<i>Non-occupancy period</i>	Minimum 30 minutes
<i>Channel Availability Check Time</i>	60 seconds
<i>Channel Move Time</i>	10 seconds See Note 1.
<i>Channel Closing Transmission Time</i>	200 milliseconds + an aggregate of 60 milliseconds over remaining 10 second period. See Notes 1 and 2.
<i>U-NII Detection Bandwidth</i>	Minimum 100% of the U- NII 99% transmission power bandwidth. See Note 3.
<p>Note 1: <i>Channel Move Time</i> and the <i>Channel Closing Transmission Time</i> should be performed with Radar Type 0. The measurement timing begins at the end of the Radar Type 0 burst. Note 2: The <i>Channel Closing Transmission Time</i> is comprised of 200 milliseconds starting at the beginning of the <i>Channel Move Time</i> plus any additional intermittent control signals required to facilitate a <i>Channel move</i> (an aggregate of 60 milliseconds) during the remainder of the 10 second period. The aggregate duration of control signals will not count quiet periods in between transmissions. Note 3: During the <i>U-NII Detection Bandwidth</i> detection test, radar type 0 should be used. For each frequency step the minimum percentage of detection is 90 percent. Measurements are performed with no data traffic.</p>	

Table 10. DFS Response Requirement Values

Radar Test Waveforms

This section provides the parameters for required test waveforms, minimum percentage of successful detections, and the minimum number of trials that must be used for determining DFS conformance. Step intervals of 0.1 microsecond for Pulse Width, 1 microsecond for PRI, 1 MHz for chirp width and 1 for the number of pulses will be utilized for the random determination of specific test waveforms.

Short Pulse Radar Test Waveforms

Radar Type	Pulse Width (μsec)	PRI (μsec)	Number of Pulses	Minimum Percentage of Successful Detection	Minimum Number of Trials
0	1	1428	18	See Note 1	See Note 1
1	1	Test A: 15 unique PRI values randomly selected from the list of 23 PRI values in Table 5a	Roundup $\left\{ \begin{array}{l} \left(\frac{1}{360} \right) \\ \left(\frac{19 \cdot 10^6}{\text{PRI}_{\mu\text{sec}}} \right) \end{array} \right\}$	60%	30
		Test B: 15 unique PRI values randomly selected within the range of 518-3066 μsec, with a minimum increment of 1 μsec, excluding PRI values selected in Test A			
2	1-5	150-230	23-29	60%	30
3	6-10	200-500	16-18	60%	30
4	11-20	200-500	12-16	60%	30
Aggregate (Radar Types 1-4)				80%	120
Note 1: Short Pulse Radar Type 0 should be used for the detection bandwidth test, channel move time, and channel closing time tests.					

A minimum of 30 unique waveforms are required for each of the short pulse radar types 2 through 4. For short pulse radar type 1, the same waveform is used a minimum of 30 times. If more than 30 waveforms are used for short pulse radar types 2 through 4, then each additional waveform must also be unique and not repeated from the previous waveforms. The aggregate is the average of the percentage of successful detections of short pulse radar types 1-4.

Long Pulse Radar Test Waveform

Radar Type	Pulse Width (µsec)	Chirp Width (MHz)	PRI (µsec)	Number of Pulses per Bursts	Number of Bursts	Minimum Percentage of Successful Detection	Minimum Trials
5	50-100	5-20	1000-2000	1-3	8-20	80%	30

The parameters for this waveform are randomly chosen. Thirty unique waveforms are required for the Long Pulse radar test signal. If more than 30 waveforms are used for the Long Pulse radar test signal, then each additional waveform must also be unique and not repeated from the previous waveforms.

Each waveform is defined as follows:

- 1) The transmission period for the Long Pulse Radar test signal is 12 seconds.
- 2) There are a total of 8 to 20 Bursts in the 12 second period, with the number of Bursts being randomly chosen. This number is Burst_Count.
- 3) Each Burst consists of 1 to 3 pulses, with the number of pulses being randomly chosen. Each Burst within the 12 second sequence may have a different number of pulses.
- 4) The pulse width is between 50 and 100 microseconds, with the pulse width being randomly chosen. Each pulse within a Burst will have the same pulse width. Pulses in different Bursts may have different pulse widths.
- 5) Each pulse has a linear FM chirp between 5 and 20 MHz, with the chirp width being randomly chosen. Each pulse within a Burst will have the same chirp width. Pulses in different Bursts may have different chirp widths. The chirp is centered on the pulse. For example, with radar frequency of 5300 MHz and a 20 MHz chirped signal, the chirp starts at 5290 MHz and ends at 5310 MHz.
- 6) If more than one pulse is present in a Burst, the time between the pulses will be between 1000 and 2000 microseconds, with the time being randomly chosen. If three pulses are present in a Burst, the time between the first and second pulses is chosen independently of the time between the second and third pulses.
- 7) The 12 second transmission period is divided into even intervals. The number of intervals is equal to Burst_Count. Each interval is of length $(12,000,000 / \text{Burst_Count})$ microseconds. Each interval contains one Burst. The start time for the Burst, relative to the beginning of the interval, is between 1 and $[(12,000,000 / \text{Burst_Count}) - (\text{Total Burst Length}) + (\text{One Random PRI Interval})]$ microseconds, with the start time being randomly chosen. The step interval for the start time is 1 microsecond. The start time for each Burst is chosen independently.

A representative example of a Long Pulse radar test waveform:

- 1) The total test signal length is 12 seconds.
- 2) 8 Bursts are randomly generated for the Burst_Count.
- 3) Burst 1 has 2 randomly generated pulses.
- 4) The pulse width (for both pulses) is randomly selected to be 75 microseconds.
- 5) The PRI is randomly selected to be at 1213 microseconds.
- 6) Bursts 2 through 8 are generated using steps 3 – 5.
- 7) Each Burst is contained in even intervals of 1,500,000 microseconds. The starting location for Pulse 1, Burst 1 is randomly generated (1 to 1,500,000 minus the total Burst 1 length + 1 random PRI interval) at the 325,001 microsecond step. Bursts 2 through 8 randomly fall in successive 1,500,000 microsecond intervals (i.e. Burst 2 falls in the 1,500,001 – 3,000,000 microsecond range).

Graphical Representation of a Long Pulse radar Test Waveform

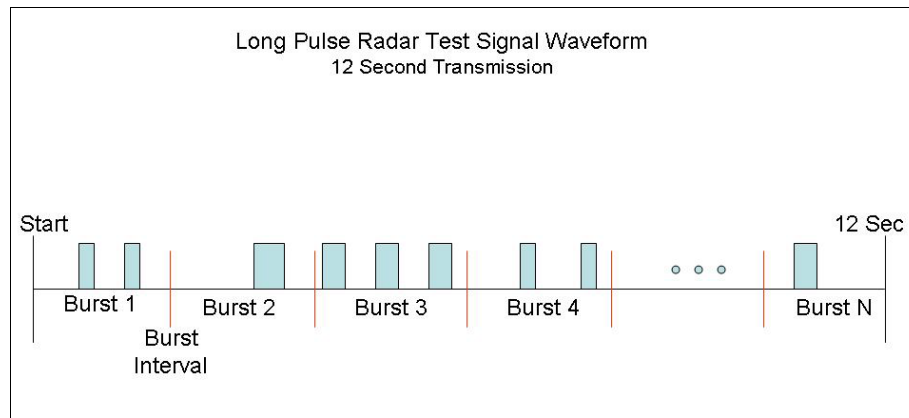

Figure 2. Long Pulse Radar Test Signal Waveform

Frequency Hopping Radar Test Waveform

Radar Type	Pulse Width (µsec)	PRI (µsec)	Pulses per Hop	Hopping Rate (kHz)	Hopping Sequence Length (msec)	Minimum Percentage of Successful Detection	Minimum Trials
6	1	333	9	.333	300	70%	30

For the Frequency Hopping Radar Type, the same *Burst* parameters are used for each waveform. The hopping sequence is different for each waveform and a 100-length segment is selected from the hopping sequence defined by the following algorithm:

The first frequency in a hopping sequence is selected randomly from the group of 475 integer frequencies from 5250 – 5724 MHz. Next, the frequency that was just chosen is removed from the group and a frequency is randomly selected from the remaining 474 frequencies in the group. This process continues until all 475 frequencies are chosen for the set. For selection of a random frequency, the frequencies remaining within the group are always treated as equally likely.

B. Radar Waveform Calibration

The following equipment setup was used to calibrate the radiated Radar Waveform. A spectrum analyzer was used to establish the test signal level for each radar type. During this process there were no transmissions by either the Master or Client Device. The spectrum analyzer was switched to the zero span (Time Domain) mode at the frequency of the Radar Waveform generator. Peak detection was utilized. The spectrum analyzer's resolution bandwidth (RBW) was set to 3 MHz and the video bandwidth (VBW) was set to 3 MHz. The calibration setup is diagrammed in Figure 3, and the radar test signal generator is shown in Photograph 1.

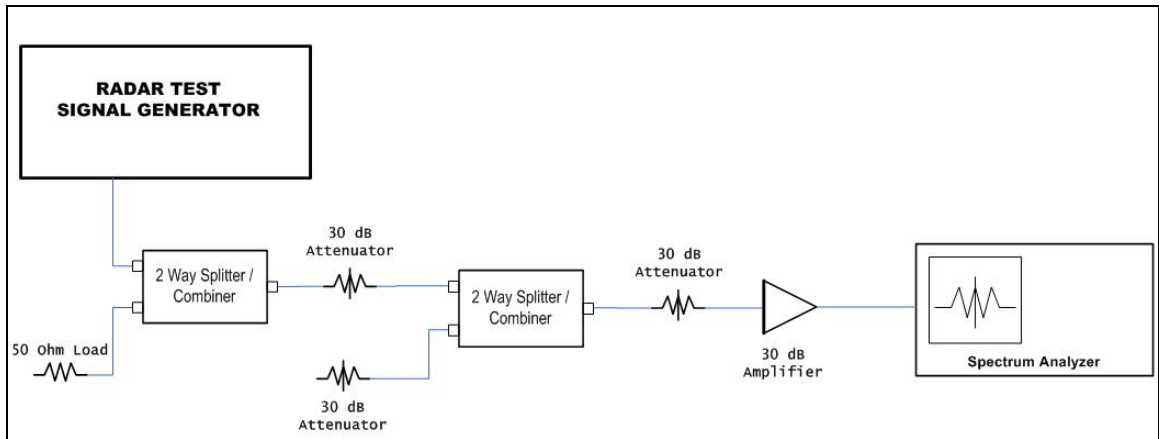
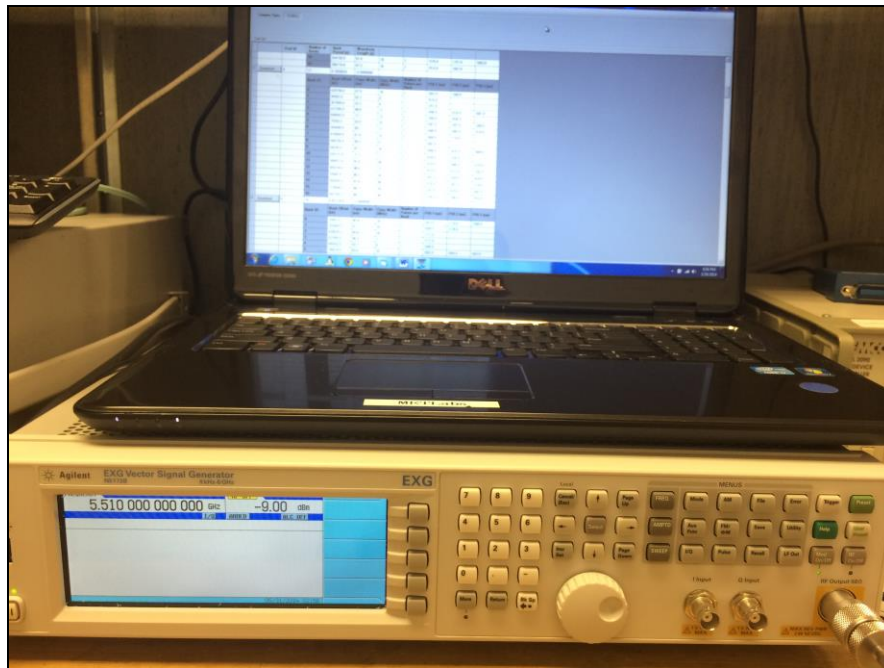
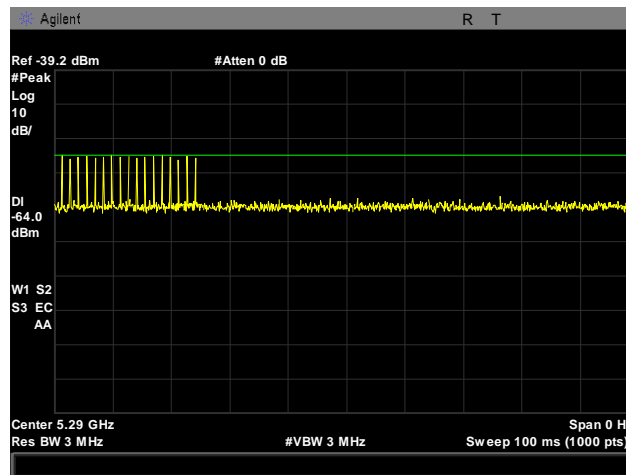

Figure 3. Calibration Test setup



Photograph 1. DFS Radar Test Signal Generator

Radar Waveform Calibration, Type 0



Plot 1. Radar Type 0 Calibration, 5290 MHz

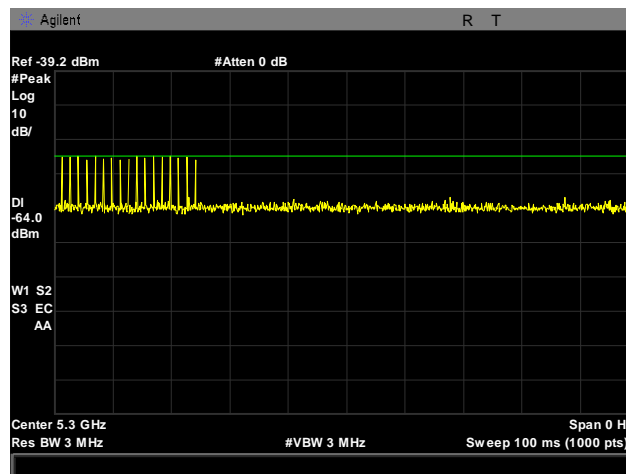

Plot 2. Radar Type 0 Calibration, 5300 MHz

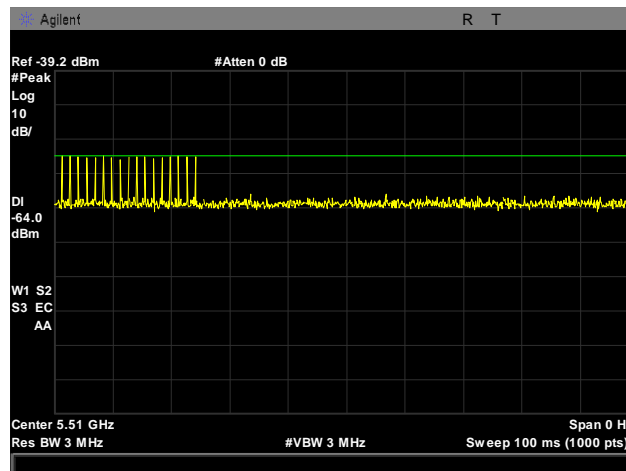

Plot 3. Radar Type 0 Calibration, 5510 MHz

Radar Waveform Calibration, Type 1

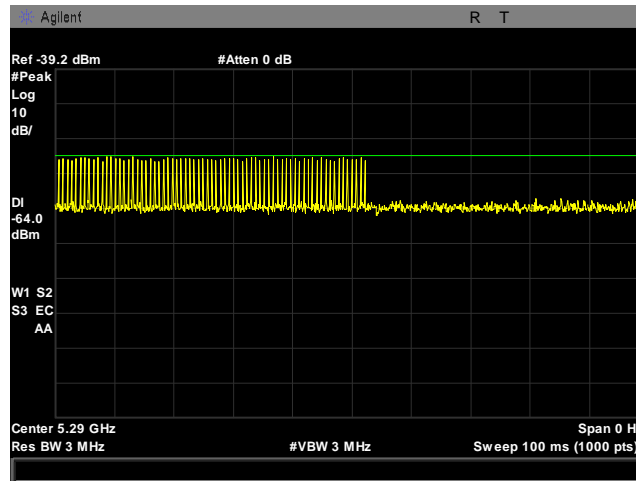

Plot 4. Radar Type 1 Calibration, 5290 MHz

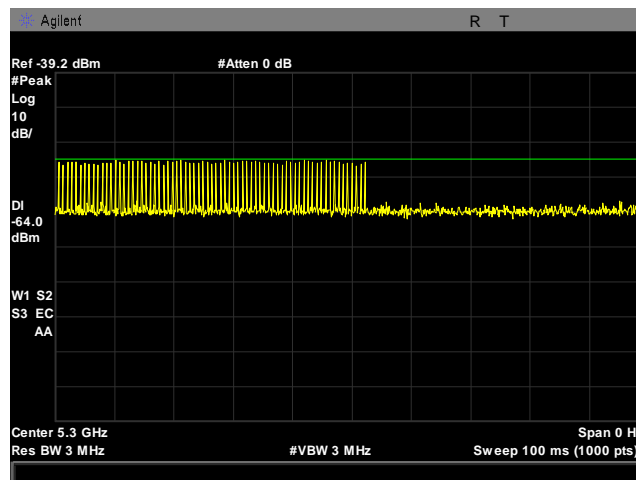

Plot 5. Radar Type 1 Calibration, 5300 MHz

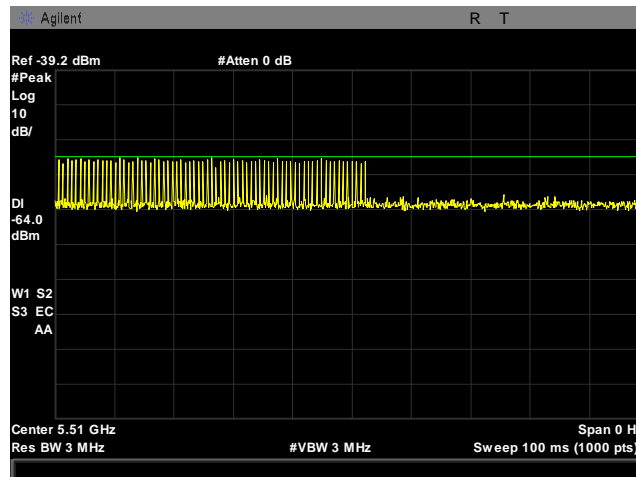

Plot 6. Radar Type 1 Calibration, 5510 MHz

Radar Waveform Calibration, Type 2

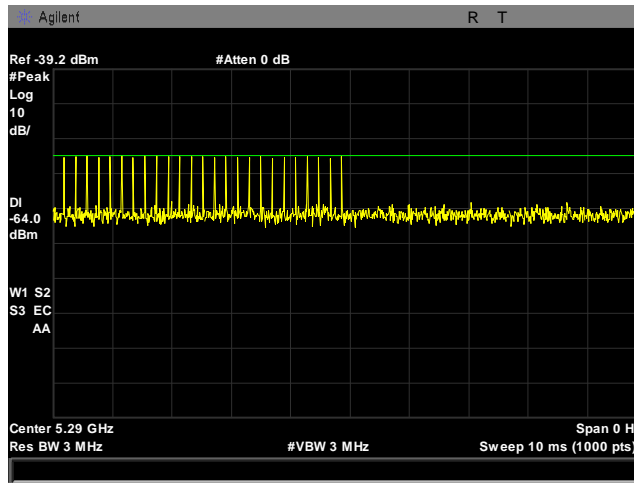

Plot 7. Radar Type 2 Calibration, 5290 MHz

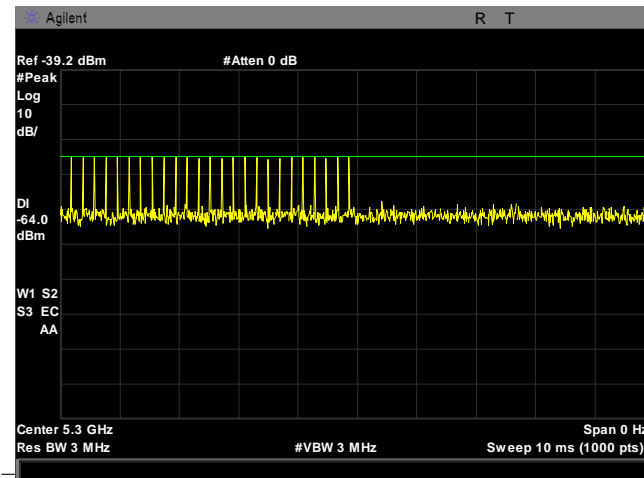

Plot 8. Radar Type 2 Calibration, 5300 MHz

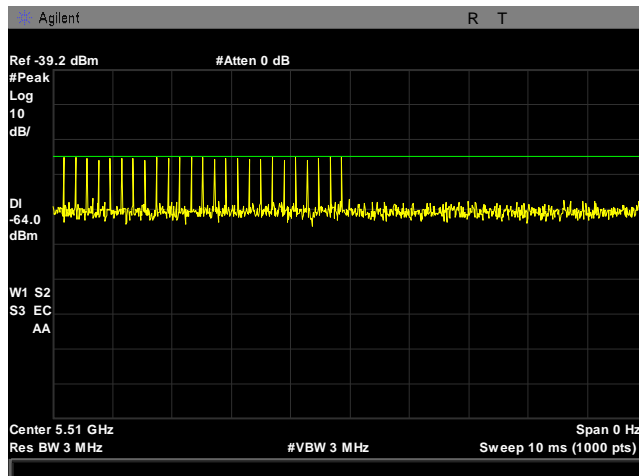

Plot 9. Radar Type 2 Calibration, 5510 MHz

Radar Waveform Calibration, Type 3

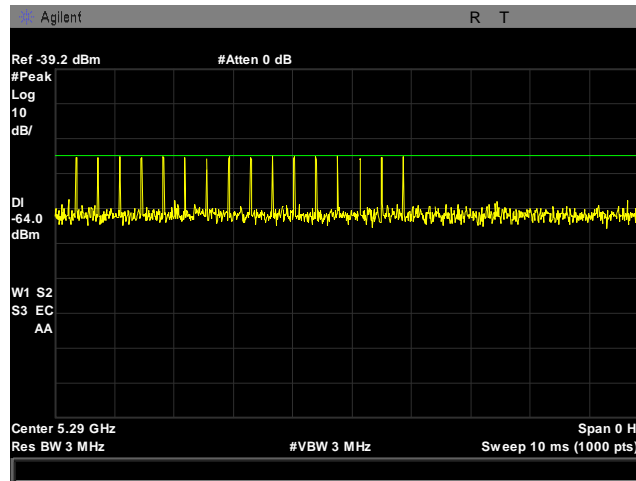

Plot 10. Radar Type 3 Calibration, 5290 MHz

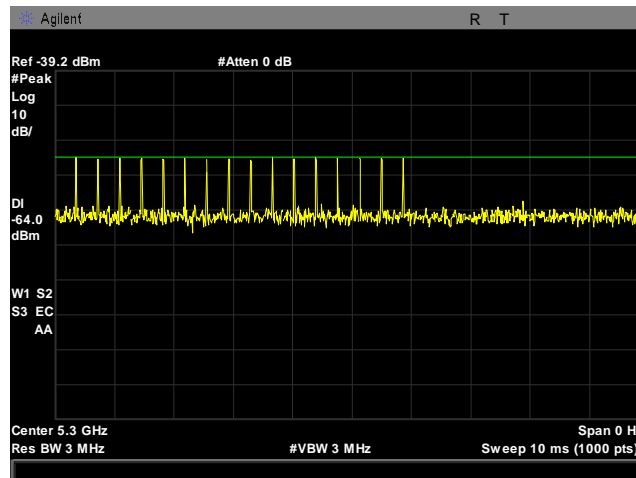

Plot 11. Radar Type 3 Calibration, 5300 MHz

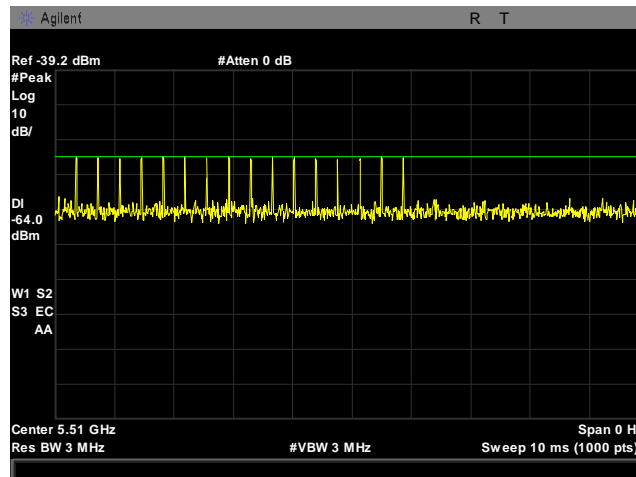

Plot 12. Radar Type 3 Calibration, 5510 MHz

Radar Waveform Calibration, Type 4

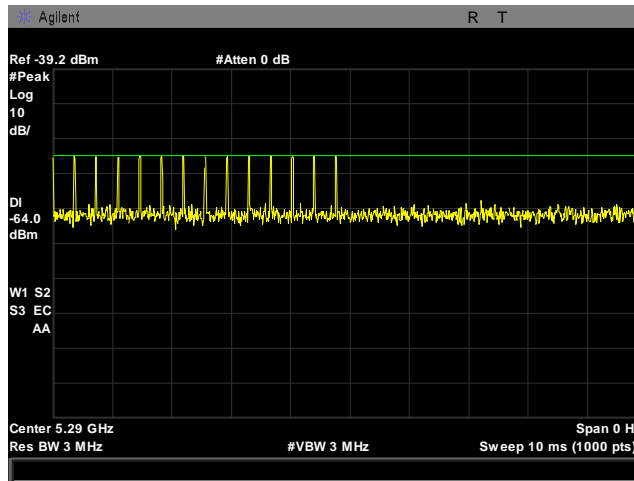

Plot 13. Radar Type 4 Calibration, 5290 MHz

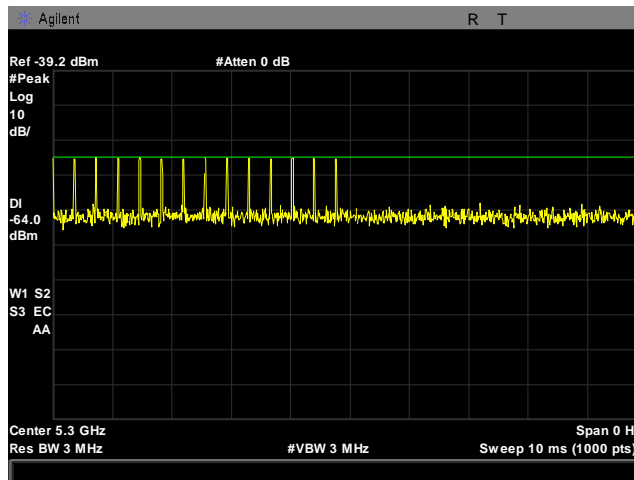

Plot 14. Radar Type 4 Calibration, 5300 MHz

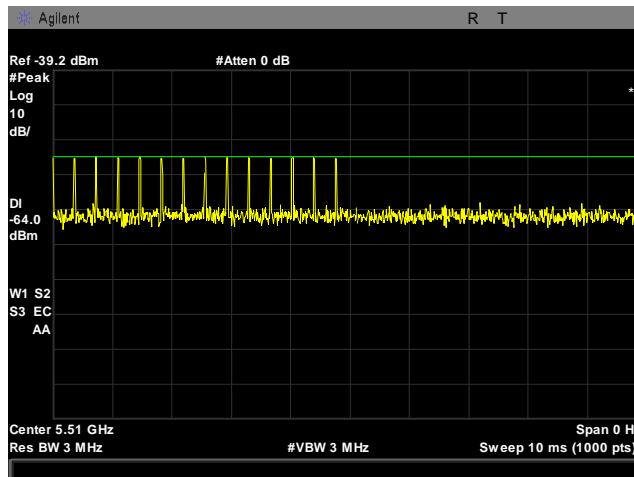

Plot 15. Radar Type 4 Calibration, 5510 MHz

Radar Waveform Calibration, Type 5

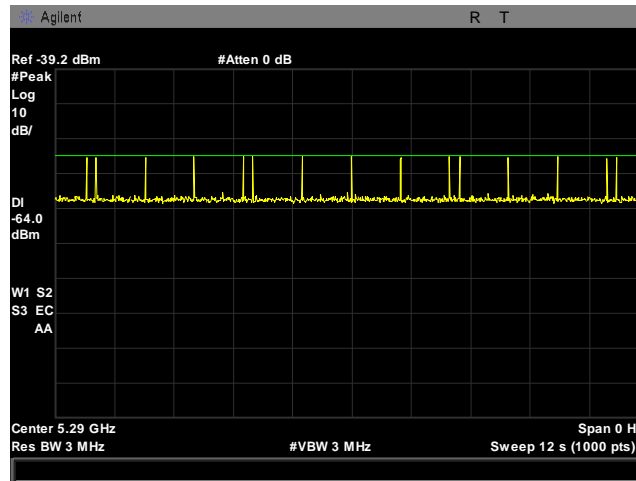

Plot 16. Radar Type 5 Calibration, 5290 MHz

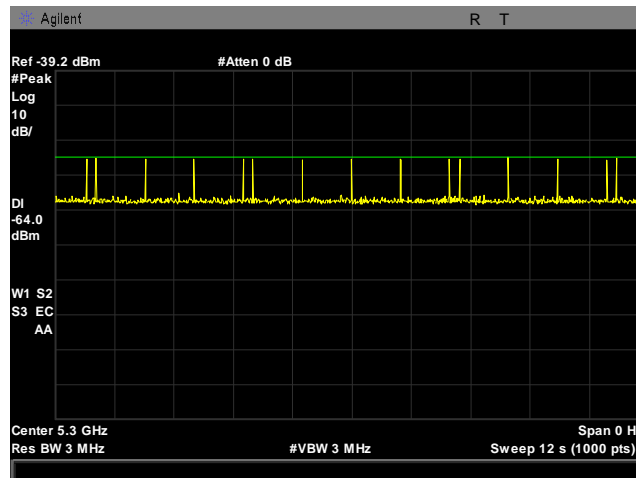

Plot 17. Radar Type 5 Calibration, 5300 MHz

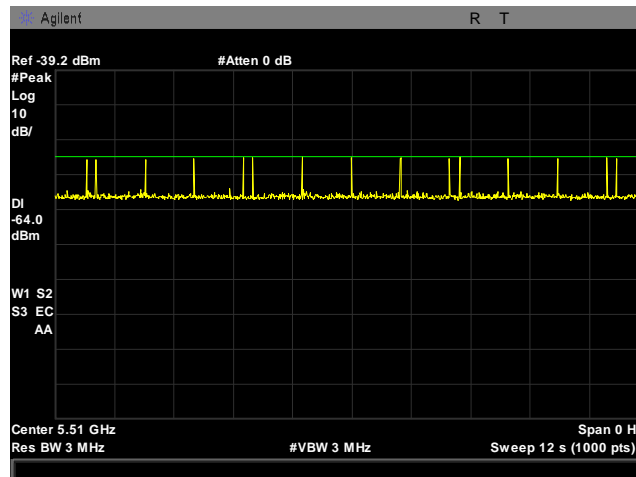

Plot 18. Radar Type 5 Calibration, 5510 MHz

Radar Waveform Calibration, Type 6

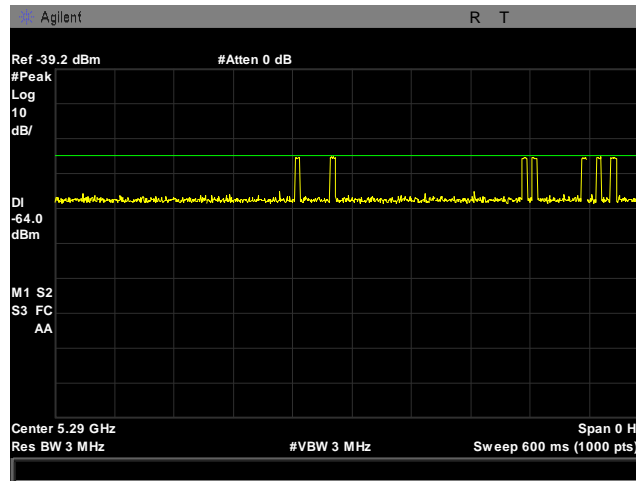

Plot 19. Radar Type 6 Calibration, 5290 MHz

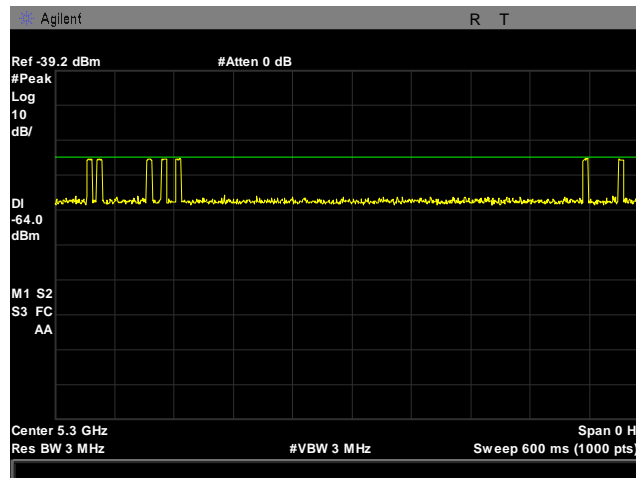

Plot 20. Radar Type 6 Calibration, 5300 MHz

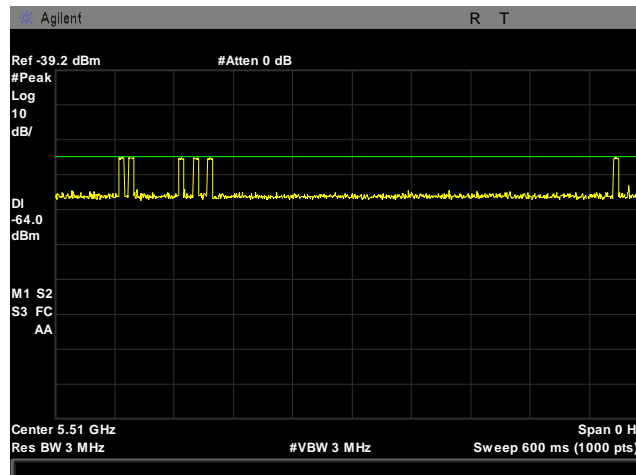

Plot 21. Radar Type 6 Calibration, 5510 MHz

IV. DFS Test Procedure and Test Results

A. DFS Test Setup

1. A spectrum analyzer is used as a monitor to verify that the Unit Under Test (UUT) has vacated the Channel within the Channel Closing Transmission Time and Channel Move Time, and does not transmit on a Channel during the Non-Occupancy Period after the detection and subsequent Channel move. It is also used to monitor UUT transmissions during the Channel Availability Check Time.
2. The test setup, which consists of test equipment and equipment under test (EUT), is diagrammed in Figure 4 and pictured in Photograph 2.

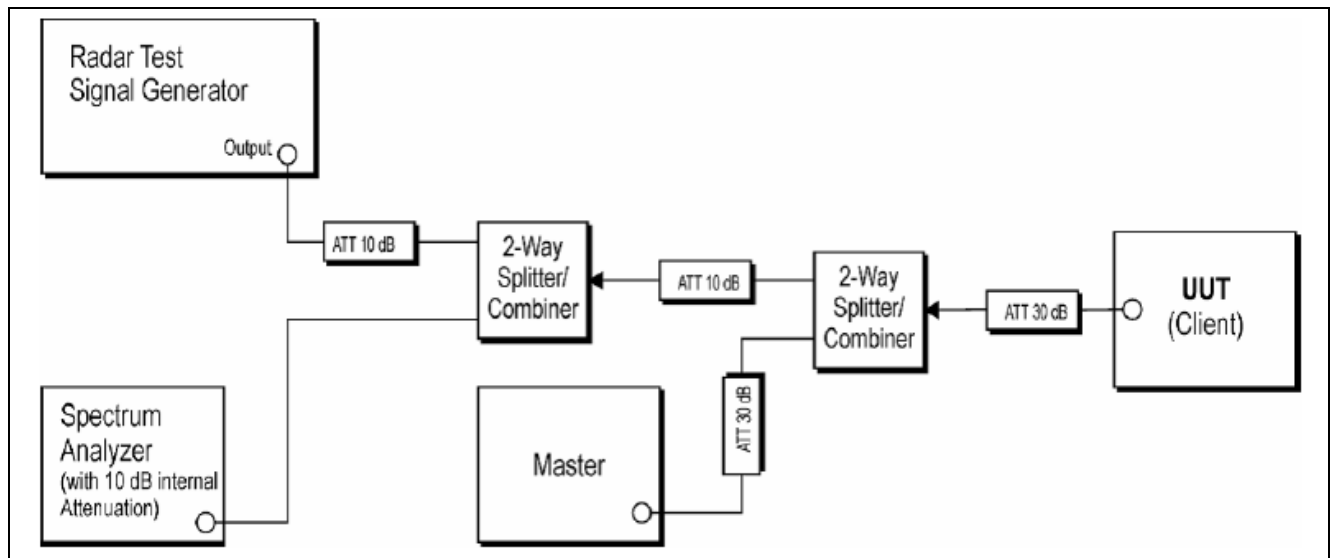

Figure 4. Test Setup Diagram



Photograph 2. DFS, Test Setup

B. UNII Detection Bandwidth

Test Requirement(s): § 15.407 A minimum 100% detection rate is required across an EUT's 99% bandwidth.

Test Procedure: All UNII channels for this device have identical channel bandwidths.

A single burst of the short pulse radar type 1 is produced at 5500 MHz, 5300MHz, and 5290MHz at the -63dBm test level. The UUT is set up as a standalone device (no associated client, and no data traffic).

A single radar burst is generated for a minimum of 10 trials, and the response of the UUT is recorded. The UUT must detect the radar waveform 90% or more of the time.

The radar frequency is increased in 1 MHz steps, repeating the above test sequence, until the detection rate falls below 90%. The highest frequency at which detection is greater than or equal to 90% is denoted F_H .

The radar frequency is decreased in 1 MHz steps, repeating the above test sequence, until the detection rate falls below 90%. The lowest frequency at which detection is greater than or equal to 90% is denoted F_L .

The U-NII Detection Bandwidth is calculated as follows:

$$\text{U-NII Detection Bandwidth} = F_H - F_L$$

Test Results: The EUT was compliant with the requirements of this section.

Test Engineer: Andy Shen

Test Date: 09/22/14

UNII Detection Bandwidth – Test Results

EUT Frequency- 5290MHz											
Radar Frequency (MHz)	DFS Detection Trials (1=Detection, 0= No Detection)										Detection Rate (%)
	1	2	3	4	5	6	7	8	9	10	
5252	0	0	0	0	0	0	0	0	0	0	0
5253.9(FL)	1	1	1	1	1	1	1	1	1	1	1
5254	1	1	1	1	1	1	1	1	1	1	1
5255	1	1	1	1	1	1	1	1	1	1	1
5256	1	1	1	1	1	1	1	1	1	1	1
5257	1	1	1	1	1	1	1	1	1	1	1
5258	1	1	1	1	1	1	1	1	1	1	1
5259	1	1	1	1	1	1	1	1	1	1	1
6260	1	1	1	1	1	1	1	1	1	1	1
5261	1	1	1	1	1	1	1	1	1	1	1
5262	1	1	1	1	1	1	1	1	1	1	1
5263	1	1	1	1	1	1	1	1	1	1	1
5264	1	1	1	1	1	1	1	1	1	1	1
5265	1	1	1	1	1	1	1	1	1	1	1
5266	1	1	1	1	1	1	1	1	1	1	1
5267	1	1	1	1	1	1	1	1	1	1	1
5268	1	1	1	1	1	1	1	1	1	1	1
5269	1	1	1	1	1	1	1	1	1	1	1
5270	1	1	1	1	1	1	1	1	1	1	1
5271	1	1	1	1	1	1	1	1	1	1	1
5272	1	1	1	1	1	1	1	1	1	1	1
5273	1	1	1	1	1	1	1	1	1	1	1
5274	1	1	1	1	1	1	1	1	1	1	1
5275	1	1	1	1	1	1	1	1	1	1	1
5276	1	1	1	1	1	1	1	1	1	1	1
5277	1	1	1	1	1	1	1	1	1	1	1
5278	1	1	1	1	1	1	1	1	1	1	1
5279	1	1	1	1	1	1	1	1	1	1	1
5280	1	1	1	1	1	1	1	1	1	1	1
5281	1	1	1	1	1	1	1	1	1	1	1
5282	1	1	1	1	1	1	1	1	1	1	1
5283	1	1	1	1	1	1	1	1	1	1	1
5284	1	1	1	1	1	1	1	1	1	1	1
5285	1	1	1	1	1	1	1	1	1	1	1
5286	1	1	1	1	1	1	1	1	1	1	1
5287	1	1	1	1	1	1	1	1	1	1	1
5288	1	1	1	1	1	1	1	1	1	1	1
5289	1	1	1	1	1	1	1	1	1	1	1
5290	1	1	1	1	1	1	1	1	1	1	1
5291	1	1	1	1	1	1	1	1	1	1	1
5292	1	1	1	1	1	1	1	1	1	1	1
5293	1	1	1	1	1	1	1	1	1	1	1
5294	1	1	1	1	1	1	1	1	1	1	1
5295	1	1	1	1	1	1	1	1	1	1	1
5296	1	1	1	1	1	1	1	1	1	1	1
5297	1	1	1	1	1	1	1	1	1	1	1
5298	1	1	1	1	1	1	1	1	1	1	1

EUT Frequency- 5290MHz											
DFS Detection Trials (1=Detection, 0= No Detection)											
Radar Frequency (MHz)	1	2	3	4	5	6	7	8	9	10	Detection Rate (%)
5299	1	1	1	1	1	1	1	1	1	1	100
5300	1	1	1	1	1	1	1	1	1	1	100
5301	1	1	1	1	1	1	1	1	1	1	100
5302	1	1	1	1	1	1	1	1	1	1	100
5303	1	1	1	1	1	1	1	1	1	1	100
5304	1	1	1	1	1	1	1	1	1	1	100
5305	1	1	1	1	1	1	1	1	1	1	100
5306	1	1	1	1	1	1	1	1	1	1	100
5307	1	1	1	1	1	1	1	1	1	1	100
5308	1	1	1	1	1	1	1	1	1	1	100
5309	1	1	1	1	1	1	1	1	1	1	100
5310	1	1	1	1	1	1	1	1	1	1	100
5311	1	1	1	1	1	1	1	1	1	1	100
5312	1	1	1	1	1	1	1	1	1	1	100
5313	1	1	1	1	1	1	1	1	1	1	100
5314	1	1	1	1	1	1	1	1	1	1	100
5315	1	1	1	1	1	1	1	1	1	1	100
5316	1	1	1	1	1	1	1	1	1	1	100
5317	1	1	1	1	1	1	1	1	1	1	100
5318	1	1	1	1	1	1	1	1	1	1	100
5319	1	1	1	1	1	1	1	1	1	1	100
5320	1	1	1	1	1	1	1	1	1	1	100
5321	1	1	1	1	1	1	1	1	1	1	100
5322	1	1	1	1	1	1	1	1	1	1	100
5323	1	1	1	1	1	1	1	1	1	1	100
5324	1	1	1	1	1	1	1	1	1	1	100
5325	1	1	1	1	1	1	1	1	1	1	100
5326	1	1	1	1	1	1	1	1	1	1	100
5327	1	1	1	1	1	1	1	1	1	1	100
5328	1	1	1	1	1	1	1	1	1	1	100
5329(FH)	1	1	1	1	1	1	1	1	1	1	100
5330	0	0	0	0	0	0	0	0	0	0	0
Overall Detection Percentage											%
Detection Bandwidth = $f_h - f_l = 5329\text{MHz} - 5253.9\text{MHz} = 75.1\text{MHz}$											
EUT 99% Bandwidth = 74.0825											
OBW* 100% = 74.0825											

Table 11. UNII Detection Bandwidth, Test Results, 5290 MHz, 80 MHz

EUT Frequency- 5300MHz											
DFS Detection Trials (1=Detection, 0= No Detection)											
Radar Frequency (MHz)	1	2	3	4	5	6	7	8	9	10	Detection Rate (%)
5289	0	0	0	0	0	0	0	0	0	0	0
5290.43 (FL)	1	1	1	1	1	1	1	1	1	1	100
5291	1	1	1	1	1	1	1	1	1	1	100
5292	1	1	1	1	1	1	1	1	1	1	100
5293	1	1	1	1	1	1	1	1	1	1	100
5294	1	1	1	1	1	1	1	1	1	1	100
5295	1	1	1	1	1	1	1	1	1	1	100
5296	1	1	1	1	1	1	1	1	1	1	100
5297	1	1	1	1	1	1	1	1	1	1	100
5298	1	1	1	1	1	1	1	1	1	1	100
5299	1	1	1	1	1	1	1	1	1	1	100
5300	1	1	1	1	1	1	1	1	1	1	100
5301	1	1	1	1	1	1	1	1	1	1	100
5302	1	1	1	1	1	1	1	1	1	1	100
5303	1	1	1	1	1	1	1	1	1	1	100
5304	1	1	1	1	1	1	1	1	1	1	100
5305	1	1	1	1	1	1	1	1	1	1	100
5306	1	1	1	1	1	1	1	1	1	1	100
5307	1	1	1	1	1	1	1	1	1	1	100
5308	1	1	1	1	1	1	1	1	1	1	100
5309.75 (FH)	1	1	1	1	1	1	1	1	1	1	100
5310	0	0	0	0	0	0	0	0	0	0	60
Overall Detection Percentage											%
Detection Bandwidth = $f_h - f_l = 5309.75\text{MHz} - 5290.43\text{MHz} = 19.32\text{MHz}$											
EUT 99% Bandwidth = 19.14MHz											
OBW* 100% = 19.14											

Table 12. UNII Detection Bandwidth, Test Results, 5300 MHz, 20 MHz

EUT Frequency- 5510MHz											
DFS Detection Trials (1=Detection, 0= No Detection)											
Radar Frequency (MHz)	1	2	3	4	5	6	7	8	9	10	Detection Rate (%)
5490	0	0	0	0	0	0	0	0	0	0	0
5491.535(FL)	1	1	1	1	1	1	1	1	1	1	100
5492	1	1	1	1	1	1	1	1	1	1	100
5493	1	1	1	1	1	1	1	1	1	1	100
5494	1	1	1	1	1	1	1	1	1	1	100
5495	1	1	1	1	1	1	1	1	1	1	100
5496	1	1	1	1	1	1	1	1	1	1	100
5497	1	1	1	1	1	1	1	1	1	1	100
5498	1	1	1	1	1	1	1	1	0	1	90
5499	1	1	1	1	1	1	1	1	1	1	100
5500	1	1	1	1	1	1	1	1	1	1	100
5501	1	1	1	1	1	1	1	1	1	1	100
5502	1	1	1	1	1	1	1	1	1	1	100
5503	1	1	1	1	1	1	1	1	1	1	100
5504	1	1	1	1	1	1	1	1	1	1	100
5505	1	1	1	1	1	1	1	1	1	1	100
5506	1	1	1	1	1	1	1	1	1	1	100
5507	1	1	1	1	1	1	1	1	1	1	100
5508	1	1	1	1	1	1	1	1	1	1	100
5509	1	1	1	1	1	1	1	1	1	1	100
5510	1	1	1	1	1	1	1	1	1	1	100
5511	1	1	1	1	1	1	1	1	1	1	100
5512	1	1	1	1	1	1	1	1	1	1	100
5513	1	1	1	1	1	1	1	0	1	1	90
5514	1	1	1	1	1	1	1	1	1	1	100
5515	1	1	1	1	1	1	1	1	1	1	100
5516	1	1	1	1	1	1	1	1	1	1	100
5517	1	1	1	1	1	1	1	1	1	1	100
5518	1	1	1	1	1	1	1	1	1	1	100
5519	1	1	1	1	1	1	1	1	1	1	100
5520	1	1	1	1	1	1	1	1	1	1	100
5521	1	1	1	1	1	1	1	1	1	1	100
5522	1	1	1	1	1	1	1	1	1	1	100
5523	1	1	1	1	1	1	1	1	1	1	100
5524	1	1	1	1	1	1	1	1	1	1	100
5525	1	1	1	1	1	1	1	1	1	1	100
5526	1	1	1	1	1	1	1	1	1	1	100
5527	1	1	1	1	1	1	1	1	1	1	100
5528.465(FH)	1	1	1	1	1	1	1	1	1	1	100
5529	0	0	0	0	0	0	0	0	0	0	0
Overall Detection Percentage											%
Detection Bandwidth = $f_h - f_l = 5528.465\text{MHz} - 5491.535\text{MHz} = 36.93\text{MHz}$											
EUT 99% Bandwidth = 36.93											
OBW* 100% = 36.93											

Table 13. UNII Detection Bandwidth, Test Results, 5510 MHz, 40 MHz

UNII Detection Bandwidth Plots

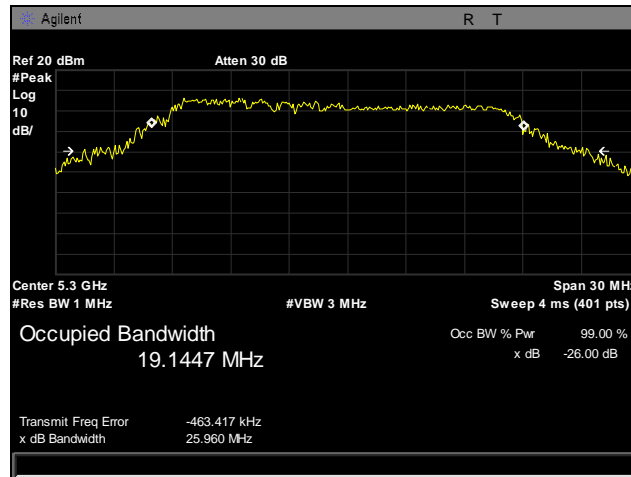

Plot 22. Occupied Bandwidth, 802.11n 20 MHz, Lower Band, Port JA1

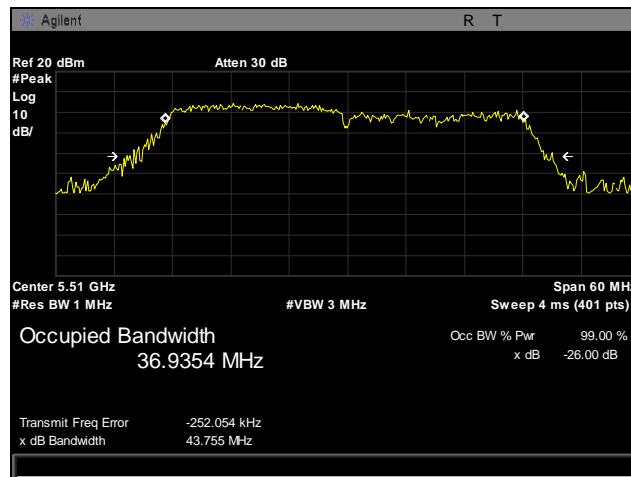

Plot 23. Occupied Bandwidth, 802.11n 40 MHz, Upper Band, Port JA1

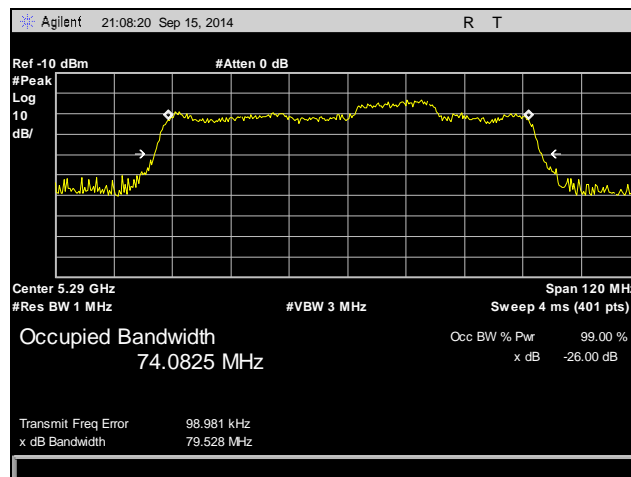

Plot 24. Occupied Bandwidth, 802.11ac 80 MHz, Lower Band, Port JA1

C. Initial Channel Availability Check Time

Test Requirements: § 15.407 The Initial Channel Availability Check Time tests that the UUT does not emit beacon, control, or data signals on the test channel until the power-up sequence has been completed and the U-NII device has checked for radar waveforms, for one minute, on the test channel. This test does not use any of the radar waveforms and only needs to be performed once.

The UUT should not make any transmissions over the test channel, for at least 1 minute after completion of its power-on cycle.

Test Procedure: The U-NII device is powered on and instructed to operate at 5300 MHz. At the same time the UUT is powered on, the spectrum analyzer is set to 5300MHz with a zero span and a 2.5 minute sweep time. The analyzer is triggered at the same time power is applied to the U-NII device.

Test Results: The Equipment was not applicable with § 15.407 Initial Channel Availability Check Time.

D. Radar Burst at the Beginning of Channel Availability Check Time

Test Requirements: § 15.407 A Radar Burst at the Beginning of the Channel Availability Check Time tests that the UUT does not emit beacon, control, or data signals on the test Channel if it has detected a radar burst during that time period until the power-up sequence has been completed and the U-NII device checks for Radar Waveforms for one minute on the test Channel. The steps below define the procedure to verify successful radar detection on the selected Channel during a period equal to the Channel Availability Check Time and avoidance of operation on that Channel when a radar Burst with a level equal to the DFS Detection Threshold + 1 dB (-63dBm) occurs at the beginning of the Channel Availability Check Time.

Test Procedure: The UUT is powered on at T0. T1 denotes the instant when the UUT has completed its power-up sequence. The Channel Availability Check Time commences at instant T1 and will end no sooner than T1 + 60 seconds.

A single Burst of short pulse radar type 1, at -63 dBm, will commence within a 6 second window starting at T1.

Visual indication of the UUT of successful detection of the radar Burst will be recorded and reported. Observation of transmission at 5500MHz will continue for 2.5 minutes after the radar Burst has been generated.

Verify that during the 2.5 minute measurement window, no UUT transmissions occur at 5500MHz.

Test Results The equipment was not applicable with § 15.407 Radar Burst at the Beginning of the Channel Availability Check Time.

Radar Burst at the End of Channel Availability Check Time

Test Requirements: § 15.407 A Radar Burst at the End of the Channel Availability Check Time tests that the UUT does not emit beacon, control, or data signals on the test Channel if it has detected a radar burst during that time period until the power-up sequence has been completed and the U-NII device checks for Radar Waveforms for one minute on the test Channel. The steps below define the procedure to verify successful radar detection on the selected Channel during a period equal to the Channel Availability Check Time and avoidance of operation on that Channel when a radar Burst with a level equal to the DFS Detection Threshold + 1 dB (-63dBm) occurs at the end of the Channel Availability Check Time.

Test Procedure: The steps below define the procedure to verify successful radar detection on the selected Channel during a period equal to the Channel Availability Check Time and avoidance of operation on that Channel when a radar Burst with a level equal to the DFS Detection Threshold + 1 dB (-63dBm) occurs at the end of the Channel Availability Check Time.

The UUT is powered on at T0. T1 denotes the instant when the UUT has completed its power-up sequence. The Channel Availability Check Time commences at instant T1 and will end no sooner than T1 + 60 seconds.

A single Burst of short pulse of radar type 1 at -63 dBm will commence within a 6 second window starting at T1+ 54 seconds.

Visual indication on the UUT of successful detection of the radar Burst will be recorded and reported. Observation of emissions at 5500MHz will continue for 2.5 minutes after the radar Burst has been generated.

Verify that during the 2.5 minute measurement window no UUT transmissions occurred at 5500MHz.

Test Results: The equipment was not applicable with § 15.407 Radar Burst at the End of the Channel Availability Check Time.

In-Service Monitoring for Channel Move Time, Channel Closing Transmission Time, and Non-Occupancy Period

Test Requirements: § 15.407 (Refer to DFS Response Requirement Values table in section III-A of this report.) The UUT shall continuously monitor for radar transmissions in the operating test channel. When a radar burst occurs in the test channel, it has 10 seconds to move to another channel. This 10 second window is termed Channel Move Time (CMT).

When a radar burst occurs, the UUT has 200 milliseconds, plus an aggregate of 60 milliseconds, to cease transmission in the operating test channel. This 200 ms + 60 ms requirement is termed Channel Closing Transmission Time (CCT).

After radar burst and subsequent move to another channel, the UUT shall not resume transmission, on the channel it moved from, for a period of 30 minutes. This requirement is termed Non-Occupancy Period (NOP).

Test Procedure: These tests define how the following DFS parameters are verified during In-Service Monitoring: Channel Closing Transmission Time, Channel Move Time, and Non-Occupancy Period.

The steps below define the procedure to determine the above mentioned parameters when a radar Burst with a level equal to the DFS Detection Threshold + 1dB (-63dBm) is generated on the Operating Channel of the U-NII device.

A U-NII device operating as a Client Device will associate with the UUT (Master) at 5500 MHz. Stream the MPEG test file from the Master Device to the Client Device on the selected Channel for the entire period of the test.

At time T0 the Radar Waveform generator sends a Burst of pulses for each of the radar types at -63dBm.

Observe the transmissions of the UUT at the end of the radar Burst on the Operating Channel for duration greater than 10 seconds. Measure and record the transmissions from the UUT during the observation time (Channel Move Time). Compare the Channel Move Time and Channel Closing Transmission Time results to the limits defined in the *DFS Response Requirement Values table*.

Test Results: The EUT was compliant with § 15.407 In-Service Monitoring for Channel Move Time, Channel Closing Transmission Time, and Non-Occupancy Period.

Test Engineer: Andy Shen

Test Date: 09/18/14

Channel Move Time – Plots

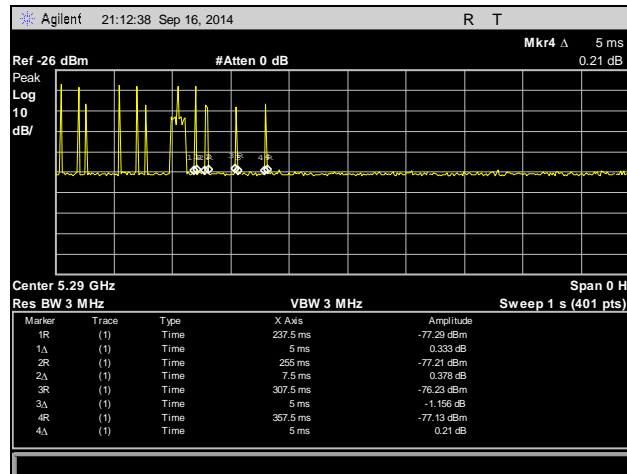

Plot 25. Channel Closing Transmission Time Aggregate, Port JA1

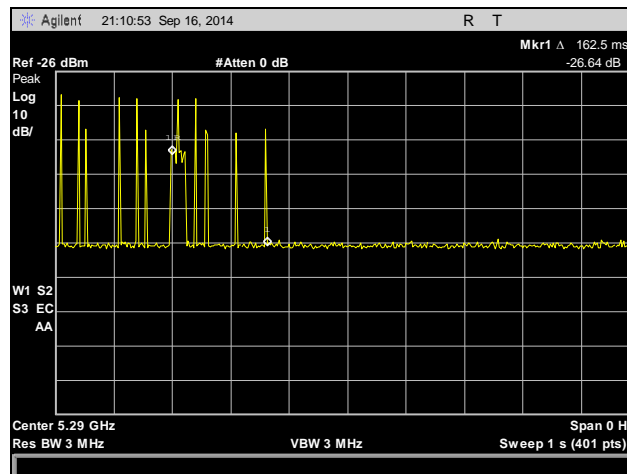

Plot 26. Channel Move Time, 1 second, Port JA1

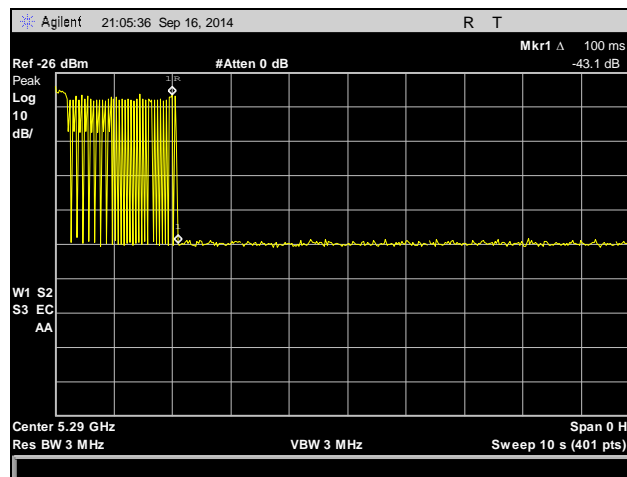

Plot 27. Channel Move Time, 10 second, Port JA1

Non-Occupancy Period – Plot

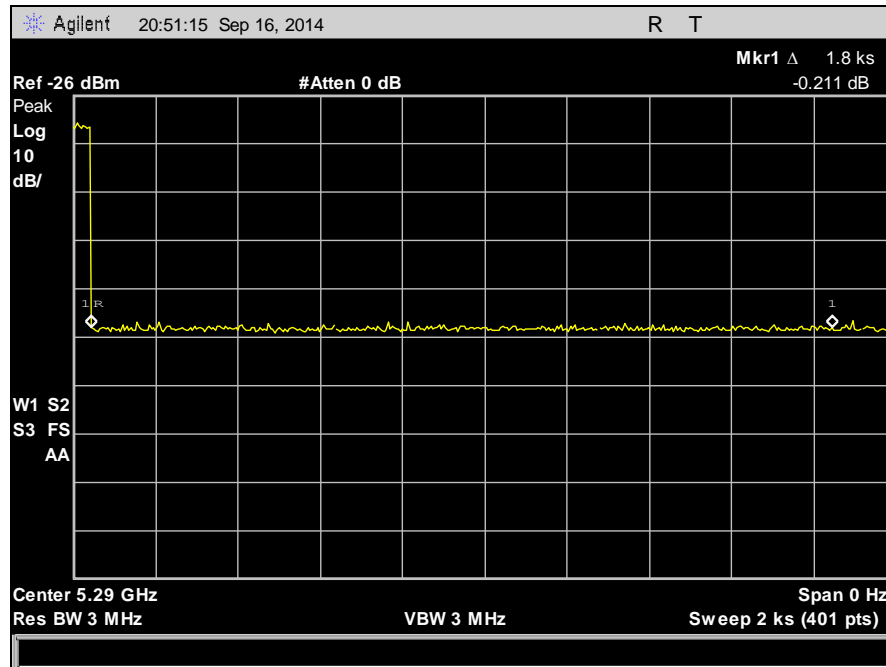

Plot 28. Non-Occupancy Period, 30minutes

E. Statistical Performance Check

Test Requirements: § 15.407 During In-Service Monitoring, the EUT requires a minimum percentage of successful radar detections from all required radar waveforms at a level equal to the DFS Detection Threshold + 1dB.

Test Procedure: Stream the MPEG test file from the Master Device to the Client Device on the selected Channel for the entire period of the test. The Radar Waveform generator sends the individual waveform for each of the radar types 1-6 at -63dbm. Statistical data is gathered to determine the ability of the device to detect the radar test waveforms. The device can utilize a test mode to demonstrate when detection occurs to prevent the need to reset the device between trial runs. The percentage of successful detection is calculated by:

$$\frac{\text{TotalWaveformDetections}}{\text{TotalWaveformTrials}} \times 100$$

The Minimum number of trails, minimum percentage of successful detection and the average minimum percentage of successful detection are found in the Radar Test Waveforms section.

Test Results: The equipment was compliant with § 15.407 Statistical Performance Check.

Test Engineer: Andy Shen

Test Date: 09/22/14

Statistical Performance Check – 20 MHz

Radar Type	Trial #	Pulses per Burst	Pulse Width (μsec)	PRI (μsec)	Detection
					1 = Yes, 0 = No
0	1	18	1	1428	1
	2	18	1	1428	1
	3	18	1	1428	1
	4	18	1	1428	1
	5	18	1	1428	1
	6	18	1	1428	1
	7	18	1	1428	1
	8	18	1	1428	1
	9	18	1	1428	1
	10	18	1	1428	1
	11	18	1	1428	1
	12	18	1	1428	1
	13	18	1	1428	1
	14	18	1	1428	1
	15	18	1	1428	1
	16	18	1	1428	1
	17	18	1	1428	1
	18	18	1	1428	1
	19	18	1	1428	1
	20	18	1	1428	1
	21	18	1	1428	1
	22	18	1	1428	1
	23	18	1	1428	1
	24	18	1	1428	1
	25	18	1	1428	1
	26	18	1	1428	1
	27	18	1	1428	1
	28	18	1	1428	1
	29	18	1	1428	1
	30	18	1	1428	1
Detection Percentage					100% (> 60%)

Table 14. Statistical Performance Check – Radar Type 0, 802.11n 20 MHz

Radar Type	Trial #	Pulses per Burst	Pulse Width (μsec)	PRI (μsec)	Detection
					1 = Yes, 0 = No
1	1	86	1	618	0
	2	72	1	738	1
	3	102	1	518	1
	4	67	1	798	1
	5	58	1	918	1
	6	61	1	878	1
	7	59	1	898	1
	8	78	1	678	1
	9	63	1	838	1
	10	62	1	858	1
	11	83	1	638	1
	12	70	1	758	1
	13	95	1	558	1
	14	57	1	938	1
	15	89	1	598	0
	16	20	1	1603	0
	17	92	1	2771	0
	18	75	1	574	0
	19	33	1	713	0
	20	22	1	1625	1
	21	80	1	2436	1
	22	53	1	666	1
	23	25	1	998	0
	24	67	1	2196	1
	25	52	1	790	0
	26	40	1	1028	0
	27	27	1	1332	1
	28	19	1	2021	0
	29	25	1	2884	0
	30	23	1	2113	1
Detection Percentage					63% (> 60%)

Table 15. Statistical Performance Check – Radar Type 1, 802.11n 20 MHz

Radar Type	Trial #	Pulse Width 1 to 5 μ sec	PRI 150 to 230 μ sec	Pulses per Burst 23 to 29	Detection
					1 = Yes, 0 = No
2	1	1.9	155	28	1
	2	4.8	185	29	1
	3	3.3	163	29	1
	4	4.8	158	28	1
	5	1.7	204	26	1
	6	1.5	230	28	1
	7	1.2	181	26	1
	8	1.4	194	28	1
	9	1.2	194	28	1
	10	3.6	197	23	1
	11	2.5	213	29	1
	12	1.7	190	29	1
	13	1.2	206	27	1
	14	3.5	193	24	1
	15	1.4	169	24	1
	16	1.4	182	23	1
	17	4.7	221	25	1
	18	4	197	29	1
	19	1.5	230	23	1
	20	3.2	178	23	1
	21	3.7	158	25	1
	22	3.1	150	27	1
	23	2.3	217	27	1
	24	3.3	164	29	1
	25	5	195	25	1
	26	4.9	162	26	1
	27	3.5	164	24	1
	28	3.8	201	29	1
	29	4.8	162	25	1
	30	1.2	151	23	1
Detection Percentage					100% (> 60%)

Table 16. Statistical Performance Check – Radar Type 2, 802.11n 20 MHz

Radar Type	Trial #	Pulse Width 6 to 10 μ sec	PRI 200 to 500 μ sec	Pulses per Burst 16 to 18	Detection
					1 = Yes, 0 = No
3	1	9.3	255	17	1
	2	6.7	423	18	1
	3	6.9	494	16	1
	4	7	341	18	1
	5	9.9	211	18	1
	6	8.6	337	17	1
	7	9.2	322	18	1
	8	7.8	228	16	1
	9	8.4	203	17	1
	10	8.3	284	16	1
	11	7.7	362	18	1
	12	6.5	233	17	1
	13	8	432	16	1
	14	9.9	238	17	1
	15	8.4	304	17	1
	16	9.2	488	16	1
	17	7	415	17	1
	18	8.5	273	17	1
	19	8	269	18	1
	20	6.7	422	18	1
	21	6.2	401	18	1
	22	7.9	378	16	1
	23	9.1	387	16	1
	24	8	322	18	1
	25	7.5	401	18	1
	26	6	355	16	1
	27	6.4	497	18	1
	28	8.5	237	18	1
	29	7.8	223	16	1
	30	8.8	289	16	1
Detection Percentage					100% (> 60%)

Table 17. Statistical Performance Check – Radar Type 3, 802.11n 20 MHz

Radar Type	Trial #	Pulse Width 11 to 20 μ sec	PRI 200 to 500 μ sec	Pulses per Burst 12 to 16	Detection
					1 = Yes, 0 = No
4	1	17.6	273	15	1
	2	15.9	310	16	1
	3	18.4	494	15	1
	4	16	333	15	1
	5	15.9	302	14	1
	6	16.9	354	15	1
	7	12.3	331	14	1
	8	13	307	14	1
	9	15.8	436	12	1
	10	18	277	16	1
	11	16.4	272	15	1
	12	15.3	420	16	1
	13	13.4	440	14	1
	14	17.3	224	16	1
	15	11.3	426	13	1
	16	13	250	14	1
	17	11.1	271	16	1
	18	13	238	16	1
	19	13.4	270	13	1
	20	17.1	205	13	1
	21	19.6	297	14	1
	22	15.8	355	12	1
	23	14.2	222	15	1
	24	19.1	296	12	1
	25	13.3	310	14	1
	26	16.2	293	13	1
	27	12.1	402	12	1
	28	13.9	266	16	1
	29	16.8	278	13	1
	30	15.4	461	13	1
Detection Percentage					100% (> 60%)

Table 18. Statistical Performance Check – Radar Type 4, 802.11n 20 MHz

Radar Type	Trial #	Filename*	Detection
			1 = Yes, 0 = No
5	1	bin5-trial 1	1
	2	bin5-trial 2	1
	3	bin5-trial 3	1
	4	bin5-trial 4	0
	5	bin5-trial 5	1
	6	bin5-trial 6	1
	7	bin5-trial 7	1
	8	bin5-trial 8	1
	9	bin5-trial 9	1
	10	bin5-trial 10	1
	11	bin5-trial 11	1
	12	bin5-trial 12	0
	13	bin5-trial 13	1
	14	bin5-trial 14	1
	15	bin5-trial 15	1
	16	bin5-trial 16	1
	17	bin5-trial 17	1
	18	bin5-trial 18	0
	19	bin5-trial 19	1
	20	bin5-trial 20	1
	21	bin5-trial 21	1
	22	bin5-trial 22	1
	23	bin5-trial 23	1
	24	bin5-trial 24	1
	25	bin5-trial 25	1
	26	bin5-trial 26	1
	27	bin5-trial 27	1
	28	bin5-trial 28	1
	29	bin5-trial 29	1
	30	bin5-trial 30	1
Detection Percentage			90% (> 80%)

Table 19. Statistical Performance Check – Radar Type 5, 802.11n 20 MHz

Note: See Appendix for Bin 5 test data.

Radar Type	Trial #	Frequency (MHz)	Pulses/Hop	Pulse Width (µsec)	PRI (µsec)	Detection
						1 = Yes, 0 = No
6	1		9	1	333	1
	2		9	1	333	1
	3		9	1	333	1
	4		9	1	333	0
	5		9	1	333	1
	6		9	1	333	1
	7		9	1	333	1
	8		9	1	333	1
	9		9	1	333	1
	10		9	1	333	1
	11		9	1	333	1
	12		9	1	333	1
	13		9	1	333	1
	14		9	1	333	1
	15		9	1	333	0
	16		9	1	333	1
	17		9	1	333	1
	18		9	1	333	1
	19		9	1	333	1
	20		9	1	333	0
	21		9	1	333	1
	22		9	1	333	1
	23		9	1	333	1
	24		9	1	333	0
	25		9	1	333	1
	26		9	1	333	1
	27		9	1	333	1
	28		9	1	333	0
	29		9	1	333	1
	30		9	1	333	1
Detection Percentage						83% (> 60%)

Table 20. Statistical Performance Check – Radar Type 6, 802.11n 20 MHz

Statistical Performance Check – 40 MHz

Radar Type	Trial #	Pulses per Burst	Pulse Width (μsec)	PRI (μsec)	Detection
					1 = Yes, 0 = No
0	1	18	1	1428	1
	2	18	1	1428	1
	3	18	1	1428	1
	4	18	1	1428	1
	5	18	1	1428	1
	6	18	1	1428	1
	7	18	1	1428	1
	8	18	1	1428	1
	9	18	1	1428	1
	10	18	1	1428	1
	11	18	1	1428	1
	12	18	1	1428	1
	13	18	1	1428	1
	14	18	1	1428	1
	15	18	1	1428	1
	16	18	1	1428	1
	17	18	1	1428	1
	18	18	1	1428	1
	19	18	1	1428	1
	20	18	1	1428	1
	21	18	1	1428	1
	22	18	1	1428	1
	23	18	1	1428	1
	24	18	1	1428	1
	25	18	1	1428	1
	26	18	1	1428	1
	27	18	1	1428	1
	28	18	1	1428	1
	29	18	1	1428	1
	30	18	1	1428	1
Detection Percentage					100% (> 60%)

Table 21. Statistical Performance Check – Radar Type 0, 802.11n 40 MHz

Radar Type	Trial #	Pulses per Burst	Pulse Width (μsec)	PRI (μsec)	Detection
					1 = Yes, 0 = No
1	1	86	1	618	1
	2	72	1	738	0
	3	102	1	518	1
	4	67	1	798	1
	5	58	1	918	1
	6	61	1	878	1
	7	59	1	898	1
	8	78	1	678	1
	9	63	1	838	1
	10	62	1	858	1
	11	83	1	638	1
	12	70	1	758	1
	13	95	1	558	1
	14	57	1	938	1
	15	89	1	598	0
	16	20	1	1603	1
	17	92	1	2771	0
	18	75	1	574	1
	19	33	1	713	0
	20	22	1	1625	1
	21	80	1	2436	1
	22	53	1	666	1
	23	25	1	998	0
	24	67	1	2196	0
	25	52	1	790	1
	26	40	1	1028	0
	27	27	1	1332	1
	28	19	1	2021	1
	29	25	1	2884	1
	30	23	1	2113	1
Detection Percentage					76% (> 60%)

Table 22. Statistical Performance Check – Radar Type 1, 802.11n 40 MHz

Radar Type	Trial #	Pulse Width 1 to 5 μ sec	PRI 150 to 230 μ sec	Pulses per Burst 23 to 29	Detection
					1 = Yes, 0 = No
2	1	1.9	155	28	1
	2	4.8	185	29	1
	3	3.3	163	29	1
	4	4.8	158	28	1
	5	1.7	204	26	1
	6	1.5	230	28	1
	7	1.2	181	26	1
	8	1.4	194	28	1
	9	1.2	194	28	1
	10	3.6	197	23	1
	11	2.5	213	29	1
	12	1.7	190	29	1
	13	1.2	206	27	1
	14	3.5	193	24	1
	15	1.4	169	24	1
	16	1.4	182	23	1
	17	4.7	221	25	1
	18	4	197	29	1
	19	1.5	230	23	1
	20	3.2	178	23	1
	21	3.7	158	25	1
	22	3.1	150	27	1
	23	2.3	217	27	1
	24	3.3	164	29	1
	25	5	195	25	1
	26	4.9	162	26	1
	27	3.5	164	24	1
	28	3.8	201	29	1
	29	4.8	162	25	1
	30	1.2	151	23	1
Detection Percentage					100% (> 60%)

Table 23. Statistical Performance Check – Radar Type 2, 802.11n 40 MHz

Radar Type	Trial #	Pulse Width 6 to 10 μ sec	PRI 200 to 500 μ sec	Pulses per Burst 16 to 18	Detection
					1 = Yes, 0 = No
3	1	9.3	255	17	1
	2	6.7	423	18	1
	3	6.9	494	16	1
	4	7	341	18	1
	5	9.9	211	18	1
	6	8.6	337	17	1
	7	9.2	322	18	1
	8	7.8	228	16	1
	9	8.4	203	17	1
	10	8.3	284	16	1
	11	7.7	362	18	1
	12	6.5	233	17	1
	13	8	432	16	1
	14	9.9	238	17	1
	15	8.4	304	17	1
	16	9.2	488	16	1
	17	7	415	17	1
	18	8.5	273	17	1
	19	8	269	18	1
	20	6.7	422	18	1
	21	6.2	401	18	1
	22	7.9	378	16	1
	23	9.1	387	16	1
	24	8	322	18	1
	25	7.5	401	18	1
	26	6	355	16	1
	27	6.4	497	18	1
	28	8.5	237	18	1
	29	7.8	223	16	1
	30	8.8	289	16	1
Detection Percentage					100% (> 60%)

Table 24. Statistical Performance Check – Radar Type 3, 802.11n 40 MHz

Radar Type	Trial #	Pulse Width 11 to 20 μ sec	PRI 200 to 500 μ sec	Pulses per Burst 12 to 16	Detection
					1 = Yes, 0 = No
4	1	17.6	273	15	1
	2	15.9	310	16	1
	3	18.4	494	15	1
	4	16	333	15	1
	5	15.9	302	14	1
	6	16.9	354	15	1
	7	12.3	331	14	1
	8	13	307	14	1
	9	15.8	436	12	1
	10	18	277	16	1
	11	16.4	272	15	1
	12	15.3	420	16	1
	13	13.4	440	14	1
	14	17.3	224	16	1
	15	11.3	426	13	1
	16	13	250	14	1
	17	11.1	271	16	1
	18	13	238	16	1
	19	13.4	270	13	1
	20	17.1	205	13	1
	21	19.6	297	14	1
	22	15.8	355	12	1
	23	14.2	222	15	1
	24	19.1	296	12	1
	25	13.3	310	14	1
	26	16.2	293	13	1
	27	12.1	402	12	1
	28	13.9	266	16	1
	29	16.8	278	13	1
	30	15.4	461	13	1
Detection Percentage					100% (> 60%)

Table 25. Statistical Performance Check – Radar Type 4, 802.11n 40 MHz

Radar Type	Trial #	Filename*	Detection
			1 = Yes, 0 = No
5	1	bin5-trial 1	1
	2	bin5-trial 2	1
	3	bin5-trial 3	1
	4	bin5-trial 4	1
	5	bin5-trial 5	1
	6	bin5-trial 6	1
	7	bin5-trial 7	1
	8	bin5-trial 8	1
	9	bin5-trial 9	1
	10	bin5-trial 10	1
	11	bin5-trial 11	1
	12	bin5-trial 12	1
	13	bin5-trial 13	1
	14	bin5-trial 14	1
	15	bin5-trial 15	1
	16	bin5-trial 16	1
	17	bin5-trial 17	1
	18	bin5-trial 18	1
	19	bin5-trial 19	1
	20	bin5-trial 20	1
	21	bin5-trial 21	1
	22	bin5-trial 22	1
	23	bin5-trial 23	1
	24	bin5-trial 24	1
	25	bin5-trial 25	1
	26	bin5-trial 26	1
	27	bin5-trial 27	1
	28	bin5-trial 28	1
	29	bin5-trial 29	1
	30	bin5-trial 30	1
Detection Percentage			100% (> 80%)

Table 26. Statistical Performance Check – Radar Type 5, 802.11n 40 MHz

Note: See Appendix for Bin 5 test data.

Radar Type	Trial #	Frequency (MHz)	Pulses/Hop	Pulse Width (µsec)	PRI (µsec)	Detection
						1 = Yes, 0 = No
6	1		9	1	333	1
	2		9	1	333	1
	3		9	1	333	1
	4		9	1	333	1
	5		9	1	333	1
	6		9	1	333	1
	7		9	1	333	1
	8		9	1	333	1
	9		9	1	333	0
	10		9	1	333	0
	11		9	1	333	1
	12		9	1	333	1
	13		9	1	333	0
	14		9	1	333	1
	15		9	1	333	0
	16		9	1	333	1
	17		9	1	333	0
	18		9	1	333	1
	19		9	1	333	1
	20		9	1	333	1
	21		9	1	333	0
	22		9	1	333	1
	23		9	1	333	1
	24		9	1	333	1
	25		9	1	333	0
	26		9	1	333	1
	27		9	1	333	1
	28		9	1	333	0
	29		9	1	333	1
	30		9	1	333	0
Detection Percentage						70% (> 60%)

Table 27. Statistical Performance Check – Radar Type 6, 802.11n 40 MHz

Statistical Performance Check – 80 MHz

Radar Type	Trial #	Pulses per Burst	Pulse Width (μsec)	PRI (μsec)	Detection
					1 = Yes, 0 = No
0	1	18	1	1428	1
	2	18	1	1428	1
	3	18	1	1428	1
	4	18	1	1428	1
	5	18	1	1428	1
	6	18	1	1428	1
	7	18	1	1428	1
	8	18	1	1428	1
	9	18	1	1428	1
	10	18	1	1428	1
	11	18	1	1428	1
	12	18	1	1428	1
	13	18	1	1428	1
	14	18	1	1428	1
	15	18	1	1428	1
	16	18	1	1428	1
	17	18	1	1428	1
	18	18	1	1428	1
	19	18	1	1428	1
	20	18	1	1428	1
	21	18	1	1428	1
	22	18	1	1428	1
	23	18	1	1428	1
	24	18	1	1428	1
	25	18	1	1428	1
	26	18	1	1428	1
	27	18	1	1428	1
	28	18	1	1428	1
	29	18	1	1428	1
	30	18	1	1428	1
Detection Percentage					100% (> 60%)

Table 28. Statistical Performance Check – Radar Type 0, 802.11ac 80 MHz

Radar Type	Trial #	Pulses per Burst	Pulse Width (μsec)	PRI (μsec)	Detection
					1 = Yes, 0 = No
1	1	86	1	618	1
	2	72	1	738	0
	3	102	1	518	1
	4	67	1	798	1
	5	58	1	918	1
	6	61	1	878	1
	7	59	1	898	1
	8	78	1	678	1
	9	63	1	838	1
	10	62	1	858	1
	11	83	1	638	1
	12	70	1	758	1
	13	95	1	558	1
	14	57	1	938	1
	15	89	1	598	0
	16	20	1	1603	1
	17	92	1	2771	0
	18	75	1	574	1
	19	33	1	713	1
	20	22	1	1625	0
	21	80	1	2436	1
	22	53	1	666	1
	23	25	1	998	0
	24	67	1	2196	0
	25	52	1	790	1
	26	40	1	1028	0
	27	27	1	1332	1
	28	19	1	2021	1
	29	25	1	2884	1
	30	23	1	2113	1
Detection Percentage					76% (> 60%)

Table 29. Statistical Performance Check – Radar Type 1, 802.11ac 80 MHz

Radar Type	Trial #	Pulse Width 1 to 5 μ sec	PRI 150 to 230 μ sec	Pulses per Burst 23 to 29	Detection
					1 = Yes, 0 = No
2	1	1.9	155	28	1
	2	4.8	185	29	1
	3	3.3	163	29	1
	4	4.8	158	28	1
	5	1.7	204	26	1
	6	1.5	230	28	1
	7	1.2	181	26	1
	8	1.4	194	28	1
	9	1.2	194	28	1
	10	3.6	197	23	1
	11	2.5	213	29	1
	12	1.7	190	29	1
	13	1.2	206	27	1
	14	3.5	193	24	1
	15	1.4	169	24	1
	16	1.4	182	23	1
	17	4.7	221	25	1
	18	4	197	29	1
	19	1.5	230	23	1
	20	3.2	178	23	1
	21	3.7	158	25	1
	22	3.1	150	27	1
	23	2.3	217	27	1
	24	3.3	164	29	1
	25	5	195	25	1
	26	4.9	162	26	1
	27	3.5	164	24	1
	28	3.8	201	29	1
	29	4.8	162	25	1
	30	1.2	151	23	1
Detection Percentage					100% (> 60%)

Table 30. Statistical Performance Check – Radar Type 2, 802.11ac 80 MHz

Radar Type	Trial #	Pulse Width 6 to 10 μ sec	PRI 200 to 500 μ sec	Pulses per Burst 16 to 18	Detection
					1 = Yes, 0 = No
3	1	9.3	255	17	1
	2	6.7	423	18	1
	3	6.9	494	16	1
	4	7	341	18	1
	5	9.9	211	18	1
	6	8.6	337	17	1
	7	9.2	322	18	1
	8	7.8	228	16	1
	9	8.4	203	17	1
	10	8.3	284	16	1
	11	7.7	362	18	1
	12	6.5	233	17	1
	13	8	432	16	1
	14	9.9	238	17	1
	15	8.4	304	17	1
	16	9.2	488	16	1
	17	7	415	17	1
	18	8.5	273	17	1
	19	8	269	18	1
	20	6.7	422	18	1
	21	6.2	401	18	1
	22	7.9	378	16	1
	23	9.1	387	16	1
	24	8	322	18	1
	25	7.5	401	18	1
	26	6	355	16	1
	27	6.4	497	18	1
	28	8.5	237	18	1
	29	7.8	223	16	1
	30	8.8	289	16	1
Detection Percentage					100% (> 60%)

Table 31. Statistical Performance Check – Radar Type 3, 802.11ac 80 MHz

Radar Type	Trial #	Pulse Width 11 to 20 μ sec	PRI 200 to 500 μ sec	Pulses per Burst 12 to 16	Detection
					1 = Yes, 0 = No
4	1	17.6	273	15	1
	2	15.9	310	16	1
	3	18.4	494	15	1
	4	16	333	15	1
	5	15.9	302	14	1
	6	16.9	354	15	1
	7	12.3	331	14	1
	8	13	307	14	1
	9	15.8	436	12	1
	10	18	277	16	1
	11	16.4	272	15	1
	12	15.3	420	16	1
	13	13.4	440	14	1
	14	17.3	224	16	1
	15	11.3	426	13	1
	16	13	250	14	1
	17	11.1	271	16	1
	18	13	238	16	1
	19	13.4	270	13	1
	20	17.1	205	13	1
	21	19.6	297	14	1
	22	15.8	355	12	1
	23	14.2	222	15	1
	24	19.1	296	12	1
	25	13.3	310	14	1
	26	16.2	293	13	1
	27	12.1	402	12	1
	28	13.9	266	16	1
	29	16.8	278	13	1
	30	15.4	461	13	1
Detection Percentage					100% (> 60%)

Table 32. Statistical Performance Check – Radar Type 4, 802.11ac 80 MHz

Radar Type	Trial #	Filename*	Detection
			1 = Yes, 0 = No
5	1	bin5-trial 1	1
	2	bin5-trial 2	1
	3	bin5-trial 3	1
	4	bin5-trial 4	1
	5	bin5-trial 5	1
	6	bin5-trial 6	1
	7	bin5-trial 7	1
	8	bin5-trial 8	1
	9	bin5-trial 9	1
	10	bin5-trial 10	1
	11	bin5-trial 11	1
	12	bin5-trial 12	1
	13	bin5-trial 13	1
	14	bin5-trial 14	1
	15	bin5-trial 15	1
	16	bin5-trial 16	1
	17	bin5-trial 17	1
	18	bin5-trial 18	1
	19	bin5-trial 19	1
	20	bin5-trial 20	1
	21	bin5-trial 21	1
	22	bin5-trial 22	1
	23	bin5-trial 23	1
	24	bin5-trial 24	1
	25	bin5-trial 25	1
	26	bin5-trial 26	1
	27	bin5-trial 27	1
	28	bin5-trial 28	1
	29	bin5-trial 29	1
	30	bin5-trial 30	1
Detection Percentage			100% (> 80%)

Table 33. Statistical Performance Check – Radar Type 5, 802.11ac 80 MHz

Note: See Appendix for Bin 5 test data.

Radar Type	Trial #	Frequency (MHz)	Pulses/Hop	Pulse Width (µsec)	PRI (µsec)	Detection
						1 = Yes, 0 = No
6	1		9	1	333	1
	2		9	1	333	1
	3		9	1	333	1
	4		9	1	333	1
	5		9	1	333	1
	6		9	1	333	0
	7		9	1	333	1
	8		9	1	333	1
	9		9	1	333	0
	10		9	1	333	1
	11		9	1	333	1
	12		9	1	333	1
	13		9	1	333	1
	14		9	1	333	0
	15		9	1	333	1
	16		9	1	333	1
	17		9	1	333	1
	18		9	1	333	1
	19		9	1	333	1
	20		9	1	333	1
	21		9	1	333	1
	22		9	1	333	1
	23		9	1	333	1
	24		9	1	333	1
	25		9	1	333	1
	26		9	1	333	1
	27		9	1	333	1
	28		9	1	333	1
	29		9	1	333	1
	30		9	1	333	1
Detection Percentage						90% (> 60%)

Table 34. Statistical Performance Check – Radar Type 6, 802.11ac 80 MHz

IV. Test Equipment

Test Equipment

Calibrated test equipment utilized during testing was maintained in a current state of calibration per the requirements of ISO/IEC 17025:2005.

Asset	Equipment	Manufacturer	Model	Calibration Date	Calibration Due Date
1T4871	VECTOR SIGNAL GENERATOR	AGILENT	N5172B	6/16/2014	12/16/2015
1S2460	1-26GHZ SPECTRUM ANALYZER	AGILENT TECHNOLOGIES	E4407B	2/27/2014	8/27/2015

Table 35. DFS Test Equipment List

V. Certification & User's Manual Information

Certification & User's Manual Information

A. Certification Information

The following is extracted from Title 47 of the Code of Federal Regulations, Part 2, Subpart I — Marketing of Radio frequency devices:

§ 2.801 Radio-frequency device defined.

As used in this part, a radio-frequency device is any device which in its operation is capable of Emitting radio-frequency energy by radiation, conduction, or other means. Radio- frequency devices include, but are not limited to:

- (a) The various types of radio communication transmitting devices described throughout this chapter.
- (b) *The incidental, unintentional and intentional radiators defined in Part 15 of this chapter.*
- (c) The industrial, scientific, and medical equipment described in Part 18 of this chapter.
- (d) Any part or component thereof which in use emits radio-frequency energy by radiation, conduction, or other means.

§ 2.803 Marketing of radio frequency devices prior to equipment authorization.

- (a) Except as provided elsewhere in this chapter, no person shall sell or lease, or offer for sale or lease (including advertising for sale or lease), or import, ship or distribute for the purpose of selling or leasing or offering for sale or lease, any radio frequency device unless:
 - (1) In the case of a device subject to certification, such device has been authorized by the Commission in accordance with the rules in this chapter and is properly identified and labeled as required by §2.925 and other relevant sections in this chapter; or
 - (2) In the case of a device that is not required to have a grant of equipment authorization issued by the Commission, but which must comply with the specified technical standards prior to use, such device also complies with all applicable administrative (including verification of the equipment or authorization under a Declaration of Conformity, where required), technical, labeling and identification requirements specified in this chapter.
- (d) Notwithstanding the provisions of paragraph (a) of this section, the offer for sale solely to business, commercial, industrial, scientific or medical users (but not an offer for sale to other parties or to end users located in a residential environment) of a radio frequency device that is in the conceptual, developmental, design or pre-production stage is permitted prior to equipment authorization or, for devices not subject to the equipment authorization requirements, prior to a determination of compliance with the applicable technical requirements *provided* that the prospective buyer is advised in writing at the time of the offer for sale that the equipment is subject to the FCC rules and that the equipment will comply with the appropriate rules before delivery to the buyer or to centers of distribution.

- (e)(1) Notwithstanding the provisions of paragraph (a) of this section, prior to equipment authorization or determination of compliance with the applicable technical requirements any radio frequency device may be operated, but not marketed, for the following purposes and under the following conditions:
- (i) *Compliance testing;*
 - (ii) Demonstrations at a trade show provided the notice contained in paragraph (c) of this section is displayed in a conspicuous location on, or immediately adjacent to, the device;
 - (iii) Demonstrations at an exhibition conducted at a business, commercial, industrial, scientific or medical location, but excluding locations in a residential environment, provided the notice contained in paragraphs (c) or (d) of this section, as appropriate, is displayed in a conspicuous location on, or immediately adjacent to, the device;
 - (iv) Evaluation of product performance and determination of customer acceptability, provided such operation takes place at the manufacturer's facilities during developmental, design or pre-production states; or
 - (v) Evaluation of product performance and determination of customer acceptability where customer acceptability of a radio frequency device cannot be determined at the manufacturer's facilities because of size or unique capability of the device, provided the device is operated at a business, commercial, industrial, scientific or medical user's site, but not at a residential site, during the development, design or pre-production stages.
- (e)(2) For the purpose of paragraphs (e)(1)(iv) and (e)(1)(v) of this section, the term *manufacturer's facilities* includes the facilities of the party responsible for compliance with the regulations and the manufacturer's premises, as well as the facilities of other entities working under the authorization of the responsible party in connection with the development and manufacture, but not the marketing, of the equipment.
- (f) For radio frequency devices subject to verification and sold solely to business, commercial, industrial, scientific and medical users (excluding products sold to other parties or for operation in a residential environment), parties responsible for verification of the devices shall have the option of ensuring compliance with the applicable technical specifications of this chapter at each end user's location after installation, provided that the purchase or lease agreement includes a proviso that such a determination of compliance be made and is the responsibility of the party responsible for verification of the equipment.

Certification & User's Manual Information

The following is extracted from Title 47 of the Code of Federal Regulations, Part 2, Subpart J — Equipment Authorization Procedures:

§ 2.901 Basis and Purpose

- (a) In order to carry out its responsibilities under the Communications Act and the various treaties and international regulations, and in order to promote efficient use of the radio spectrum, the Commission has developed technical standards for radio frequency equipment and parts or components thereof. The technical standards applicable to individual types of equipment are found in that part of the rules governing the service wherein the equipment is to be operated.¹ *In addition to the technical standards provided, the rules governing the service may require that such equipment be verified by the manufacturer or importer, be authorized under a Declaration of Conformity, or receive an equipment authorization from the Commission by one of the following procedures: certification or registration.*
- (b) The following sections describe the verification procedure, the procedure for a Declaration of Conformity, and the procedures to be followed in obtaining certification from the Commission and the conditions attendant to such a grant.

§ 2.907 Certification.

- (a) Certification is an equipment authorization issued by the Commission, based on representation and test data submitted by the applicant.
- (b) Certification attaches to all units subsequently marketed by the grantee which are identical (see Section 2.908) to the sample tested except for permissive changes or other variations authorized by the Commission pursuant to Section 2.1043.

¹ In this case, the equipment is subject to the rules of Part 15. More specifically, the equipment falls under Subpart B (of Part 15), which deals with unintentional radiators.

Certification & User's Manual Information

§ 2.948 Description of measurement facilities.

- (a) Each party making measurements of equipment that is subject to an equipment authorization under Part 15 or Part 18 of this chapter, regardless of whether the measurements are filed with the Commission or kept on file by the party responsible for compliance of equipment marketed within the U.S. or its possessions, shall compile a description of the measurement facilities employed.
 - (1) If the measured equipment is subject to the verification procedure, the description of the measurement facilities shall be retained by the party responsible for verification of the equipment.
 - (i) *If the equipment is verified through measurements performed by an independent laboratory, it is acceptable for the party responsible for verification of the equipment to rely upon the description of the measurement facilities retained by or placed on file with the Commission by that laboratory. In this situation, the party responsible for the verification of the equipment is not required to retain a duplicate copy of the description of the measurement facilities.*
 - (ii) If the equipment is verified based on measurements performed at the installation site of the equipment, no specific site calibration data is required. It is acceptable to retain the description of the measurement facilities at the site at which the measurements were performed.
 - (2) If the equipment is to be authorized by the Commission under the certification procedure, the description of the measurement facilities shall be filed with the Commission's Laboratory in Columbia, Maryland. The data describing the measurement facilities need only be filed once but must be updated as changes are made to the measurement facilities or as otherwise described in this section. At least every three years, the organization responsible for filing the data with the Commission shall certify that the data on file is current.

Certification & User's Manual Information

Label and User's Manual Information

The following is extracted from Title 47 of the Code of Federal Regulations, Part 15, Subpart A — General:

§ 15.19 Labeling requirements.

(a) *In addition to the requirements in Part 2 of this chapter, a device subject to certification or verification shall be labeled as follows:*

- (1) Receivers associated with the operation of a licensed radio service, e.g., FM broadcast under Part 73 of this chapter, land mobile operation under Part 90, etc., shall bear the following statement in a conspicuous location on the device:

This device complies with Part 15 of the FCC Rules. Operation is subject to the condition that this device does not cause harmful interference.

- (2) A stand-alone cable input selector switch, shall bear the following statement in a conspicuous location on the device:

This device is verified to comply with Part 15 of the FCC Rules for use with cable television service.

- (3) All other devices shall bear the following statement in a conspicuous location on the device:

This device complies with Part 15 of the FCC Rules. Operation is subject to the following two conditions: (1) This device may not cause harmful interference, and (2) this device must accept any interference received, including interference that may cause undesired operation.

- (4) Where a device is constructed in two or more sections connected by wires and marketed together, the statement specified under paragraph (a) of this section is required to be affixed only to the main control unit.

- (5) When the device is so small or for such use that it is not practicable to place the statement specified under paragraph (a) of this section on it, the information required by this paragraph shall be placed in a prominent location in the instruction manual or pamphlet supplied to the user or, alternatively, shall be placed on the container in which the device is marketed. However, the FCC identifier or the unique identifier, as appropriate, must be displayed on the device.

§ 15.21 Information to user.

The users manual or instruction manual for an intentional or unintentional radiator shall caution the user that changes or modifications not expressly approved by the party responsible for compliance could void the user's authority to operate the equipment.

Verification & User's Manual Information

The following is extracted from Title 47 of the Code of Federal Regulations, Part 15, Subpart B — Unintentional Radiators:

§ 15.105 Information to the user.

- (a) For a Class A digital device or peripheral, the instructions furnished the user shall include the following or similar statement, placed in a prominent location in the text of the manual:

Note: This equipment has been tested and found to comply with the limits for a Class A digital device, pursuant to Part 15 of the FCC Rules. These limits are designed to provide reasonable protection against harmful interference when the equipment is operated in a commercial environment. This equipment generates, uses, and can radiate radio frequency energy and, if not installed and used in accordance with the instruction manual, may cause harmful interference to radio communications. Operation of this equipment in a residential area is likely to cause harmful interference in which case the user will be required to correct the interference at own expense.

- (b) For a Class B digital device or peripheral, the instructions furnished the user shall include the following or similar statement, placed in a prominent location in the text of the manual:

Note: This equipment has been tested and found to comply with the limits for a Class B digital device, pursuant to Part 15 of the FCC Rules. These limits are designed to provide reasonable protection against harmful interference when the equipment is operated in a residential environment. This equipment generates, uses, and can radiate radio frequency energy and, if not installed and used in accordance with the instruction manual, may cause harmful interference to radio communications. However, there is no guarantee that interference will not occur in a particular installation. If this equipment does cause harmful interference to radio or television reception, which can be determined by turning the equipment off and on, the user is encouraged to try to correct the interference by one or more of the following measures:

- Reorient or relocate the receiving antenna.
- Increase the separation between the equipment and receiver.
- Connect the equipment into an outlet on a circuit different from that to which the receiver is connected.
- Consult the dealer or an experienced radio/TV technician for help.



End of Report