

EMC Test Report

Industry Canada RSS-Gen Issue 3 / RSS 210 Issue 8 FCC Part 15, Subpart E

Model: VAP2500

IC CERTIFICATION #: 109AS-VAP2500
FCC ID: ACQ-VAP2500

APPLICANT: Motorola Mobility
6450 Sequence Drive
San Diego, CA 92121

TEST SITE(S): National Technical Systems - Silicon Valley
41039 Boyce Road.
Fremont, CA. 94538-2435

IC SITE REGISTRATION #: 2845B-3; 2845B-4, 2845B-5, 2845B-7

REPORT DATE: May 7, 2013

FINAL TEST DATES: May 11, 14, 15, 16, 21, 22, 23, 25, June 18, 19,
20 and 25, 2012

TOTAL NUMBER OF PAGES: 183

PROGRAM MGR /
TECHNICAL REVIEWER:

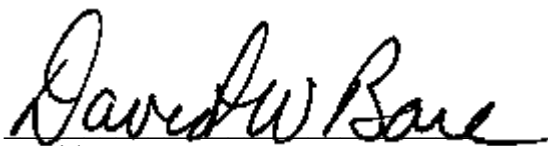

David W. Bare
Chief Engineer

QUALITY ASSURANCE DELEGATE /
FINAL REPORT PREPARER:



David Guidotti
Senior Technical Writer



National Technical Systems - Silicon Valley is accredited by the A2LA, certificate number 0214.26, to perform the test(s) listed in this report, except where noted otherwise. This report and the information contained herein represent the results of testing test articles identified and selected by the client performed to specifications and/or procedures selected by the client. National Technical Systems (NTS) makes no representations, expressed or implied, that such testing is adequate (or inadequate) to demonstrate efficiency, performance, reliability, or any other characteristic of the articles being tested, or similar products. This report should not be relied upon as an endorsement or certification by NTS of the equipment tested, nor does it represent any statement whatsoever as to its merchantability or fitness of the test article, or similar products, for a particular purpose. This report shall not be reproduced except in full

REVISION HISTORY

Rev#	Date	Comments	Modified By
-	05-07-2013	First release	

TABLE OF CONTENTS

REVISION HISTORY2

TABLE OF CONTENTS3

SCOPE.....4

OBJECTIVE5

STATEMENT OF COMPLIANCE.....5

DEVIATIONS FROM THE STANDARDS.....5

TEST RESULTS SUMMARY6

 UNII / LELAN DEVICES6

 GENERAL REQUIREMENTS APPLICABLE TO ALL BANDS.....8

 MEASUREMENT UNCERTAINTIES.....9

EQUIPMENT UNDER TEST (EUT) DETAILS.....10

 GENERAL.....10

 OTHER EUT DETAILS.....10

 ENCLOSURE.....10

 MODIFICATIONS.....10

 SUPPORT EQUIPMENT.....10

 EUT INTERFACE PORTS.....11

 EUT OPERATION.....11

TEST SITE.....12

 GENERAL INFORMATION.....12

 CONDUCTED EMISSIONS CONSIDERATIONS.....12

 RADIATED EMISSIONS CONSIDERATIONS.....12

MEASUREMENT INSTRUMENTATION13

 RECEIVER SYSTEM.....13

 INSTRUMENT CONTROL COMPUTER.....13

 LINE IMPEDANCE STABILIZATION NETWORK (LISN).....13

 FILTERS/ATTENUATORS.....14

 ANTENNAS.....14

 ANTENNA MAST AND EQUIPMENT TURNTABLE.....14

 INSTRUMENT CALIBRATION.....14

TEST PROCEDURES15

 EUT AND CABLE PLACEMENT.....15

 CONDUCTED EMISSIONS.....15

 RADIATED EMISSIONS.....16

 CONDUCTED EMISSIONS FROM ANTENNA PORT.....18

 BANDWIDTH MEASUREMENTS.....18

 SPECIFICATION LIMITS AND SAMPLE CALCULATIONS.....19

 CONDUCTED EMISSIONS SPECIFICATION LIMITS: FCC 15.207; FCC 15.107(A), RSS GEN.....19

 GENERAL TRANSMITTER RADIATED EMISSIONS SPECIFICATION LIMITS.....20

 RECEIVER RADIATED SPURIOUS EMISSIONS SPECIFICATION LIMITS.....20

 FCC 15.407 (A) OUTPUT POWER LIMITS.....21

 OUTPUT POWER LIMITS –LELAN DEVICES.....21

 SPURIOUS EMISSIONS LIMITS –UNII AND LELAN DEVICES.....22

 SAMPLE CALCULATIONS - CONDUCTED EMISSIONS.....22

 SAMPLE CALCULATIONS - RADIATED EMISSIONS.....22

 SAMPLE CALCULATIONS - FIELD STRENGTH TO EIRP CONVERSION.....23

APPENDIX A TEST EQUIPMENT CALIBRATION DATA24

APPENDIX B TEST DATA27

END OF REPORT183

SCOPE

An electromagnetic emissions test has been performed on the Motorola Mobility model VAP2500, pursuant to the following rules:

Industry Canada RSS-Gen Issue 3

RSS 210 Issue 8 “Low-power Licence-exempt Radiocommunication Devices (All Frequency Bands): Category I Equipment”

FCC Part 15, Subpart E requirements for UNII Devices

Conducted and radiated emissions data has been collected, reduced, and analyzed within this report in accordance with measurement guidelines set forth in the following reference standards and as outlined in National Technical Systems - Silicon Valley test procedures:

ANSI C63.4:2003

FCC UNII test procedure KDB 789033

The intentional radiator above has been tested in a simulated typical installation to demonstrate compliance with the relevant Industry Canada performance and procedural standards.

Final system data was gathered in a mode that tended to maximize emissions by varying orientation of EUT, orientation of power and I/O cabling, antenna search height, and antenna polarization.

Every practical effort was made to perform an impartial test using appropriate test equipment of known calibration. All pertinent factors have been applied to reach the determination of compliance.

OBJECTIVE

The primary objective of the manufacturer is compliance with the regulations outlined in the previous section.

Prior to marketing in the USA, all unlicensed transmitters and transceivers require certification. Receive-only devices operating between 30 MHz and 960 MHz are subject to either certification or a manufacturer's declaration of conformity, with all other receive-only devices exempt from the technical requirements.

Prior to marketing in Canada, Class I transmitters, receivers and transceivers require certification. Class II devices are required to meet the appropriate technical requirements but are exempt from certification requirements.

Certification is a procedure where the manufacturer submits test data and technical information to a certification body and receives a certificate or grant of equipment authorization upon successful completion of the certification body's review of the submitted documents. Once the equipment authorization has been obtained, the label indicating compliance must be attached to all identical units, which are subsequently manufactured.

Maintenance of compliance is the responsibility of the manufacturer. Any modification of the product which may result in increased emissions should be checked to ensure compliance has been maintained (i.e., printed circuit board layout changes, different line filter, different power supply, harnessing or I/O cable changes, etc.).

STATEMENT OF COMPLIANCE

The tested sample of Motorola Mobility model VAP2500 complied with the requirements of the following regulations:

RSS 210 Issue 8 "Low-power Licence-exempt Radiocommunication Devices (All Frequency Bands): Category I Equipment"
FCC Part 15, Subpart E requirements for UNII Devices

Maintenance of compliance is the responsibility of the manufacturer. Any modifications to the product should be assessed to determine their potential impact on the compliance status of the device with respect to the standards detailed in this test report.

The test results recorded herein are based on a single type test of Motorola Mobility model VAP2500 and therefore apply only to the tested sample. The sample was selected and prepared by Herman Huang of Motorola Mobility.

DEVIATIONS FROM THE STANDARDS

No deviations were made from the published requirements listed in the scope of this report.

TEST RESULTS SUMMARY**UNII / LELAN DEVICES****Operation in the 5.15 – 5.25 GHz Band**

FCC Rule Part	RSS Rule Part	Description	Measured Value / Comments	Limit / Requirement	Result
15.407(e)	A9.2(1)	Indoor operation only	Refer to user's manual	N/A	Complies
15.407(a)(2)	A9.2(1)	26dB Bandwidth	> 20MHz for all modes	N/A – limits output power if < 20MHz	N/A
15.407(a)(1)	A9.2(1)	Output Power	802.11a: 46 mW n20: 47 mW n40: 42 mW (Max eirp: 186 mW)	17 dBm	Complies
15.407(a)(1)	-	Power Spectral Density	802.11a: 3.9 dBm/MHz	4 dBm/MHz	Complies
-	A9.2(1) / A9.4(2)		n20: 3.8 dBm/MHz n40: 0.2 dBm/MHz	4 dBm/MHz	Complies

Operation in the 5.25 – 5.35 GHz Band

FCC Rule Part	RSS Rule Part	Description	Measured Value / Comments	Limit / Requirement	Result (margin)
15.407(a)(2)	A9.2(2)	26dB Bandwidth	> 20MHz for all modes	N/A – limits output power if < 20MHz	N/A
15.407(a)(2)	A9.2(2)	Output Power	802.11a: 127 mW n20: 124 mW n40: 107 mW (Max eirp: 506 mW)	24 dBm (250mW) EIRP < 30dBm	Complies
15.407(a)(2)	-	Power Spectral Density	802.11a: 8.2 dBm/MHz	11 dBm/MHz	Complies
-	A9.2(2) / A9.4(2)	Power Spectral Density	n20: 7.9 dBm/MHz n40: 4.1 dBm/MHz	11 dBm / MHz	Complies

Operation in the 5.47 – 5.725 GHz Band

FCC Rule Part	RSS Rule Part	Description	Measured Value / Comments	Limit / Requirement	Result (margin)
15.407(a)(2)	A9.2(3)	26dB Bandwidth	> 20MHz for all modes	N/A – limits output power if < 20MHz	N/A
15.407(a)(2)	A9.2(3)	Output Power	802.11a: 161 mW n20: 206 mW n40: 150 mW (Max eirp: 872 mW)	23.7 dBm (234mW) EIRP < 30dBm	Complies
15.407(a)(2)	-	Power Spectral Density	802.11a: 9.4 dBm/MHz	10.7 dBm/MHz	Complies
-	A9.2(3) / A9.4(2)	Power Spectral Density	n20: 10.1 dBm/MHz n40: 5.7 dBm/MHz	11 dBm / MHz	Complies
KDB 443999	A9.2(3)	Non-operation in 5600 – 5650 MHz sub band	Device cannot operate in the 5600 – 5650 MHz band –refer to Operational Description and 20dB BW plots		Complies

Requirements for all U-NII/LELAN bands

FCC Rule Part	RSS Rule Part	Description	Measured Value / Comments	Limit / Requirement	Result
15.407	A9.4(1)	Modulation	OFDM Digital Modulation is used	Digital modulation is required	Complies
15.407(b) (5) / 15.209	A9.2	Spurious Emissions below 1GHz	68.2 dB μ V/m @ 5469.1 MHz (-0.1 dB)	Refer to page 22	Complies
15.407(b) (5) / 15.209	A9.2	Spurious Emissions above 1GHz	53.4dB μ V/m @ 5350.9MHz (-0.6dB)		Complies
15.407(a)(6)	-	Peak Excursion Ratio	802.11a: 8.3 dB 802.11n 20MHz: 8.4 dB 802.11n n40MHz: 7.8 dB	< 13dB	Complies
	A9.4(3)	Channel Selection	Spurious emissions tested at outermost channels in each band	Device was tested on the top, bottom and center channels in each band	N/A
15			Measurements on three channels in each band		
15.407 (c)	A9.4(4)	Operation in the absence of information to transmit	Operation is discontinued in the absence of information (Refer to Operational Description)	Device shall automatically discontinue operation in the absence of information to transmit	Complies
15.407 (g)		Frequency Stability	Refer to Operational Description	Signal shall remain within the allocated band	Complies
15.407 (h1)	A9.2(2) & (3)	Transmit Power Control	TPC is not required as the device operates at below 500mW eirp	The U-NII device shall have the capability to operate with a mean EIRP value lower than 24dBm (250mW)	Complies
15.407 (h2)	A9.3	Dynamic frequency Selection (device with radar detection)	Refer to separate test report, reference R87702	Threshold -62dBm (-64dBm if eirp > 200mW) Channel Availability Check > 60s Channel closing transmission time < 260ms Channel move time < 10s Non occupancy period > 30minutes	Complies
	A9.4(6)	User Manual information	Refer to user manual for details	Indoor use and antenna gain statements	Complies
	A9.4(7)	User Manual information	Refer to user manual for details	Warning regarding interference from Satellite Systems	Complies

GENERAL REQUIREMENTS APPLICABLE TO ALL BANDS

FCC Rule Part	RSS Rule part	Description	Measured Value / Comments	Limit / Requirement	Result (margin)
15.203	-	RF Connector	Integral antennas	Unique or integral antenna required	Complies
15.207	RSS GEN Table 2	AC Conducted Emissions	35.4 dB μ V @ 0.406MHz (-12.3 dB) 44.4dBuV @ 0.379MHz (-3.9 dB)	Refer to page 19	Complies
15.247 (b) (5) 15.407 (f)	RSS 102	RF Exposure Requirements	Refer to MPE calculations in separate exhibit, RSS 102 declaration and User Manual statements.	Refer to OET 65, FCC Part 1 and RSS 102	Complies
-	RSP 100 RSS GEN 7.1.5	User Manual	Refer to user manual	Statement required regarding non-interference	Complies
-	RSP 100 RSS GEN 7.1.5	User Manual	Integral antenna	Statement for products with detachable antenna	Complies
-	RSP 100 RSS GEN 4.4.1	99% Bandwidth	802.11a: 17.1 MHz 802.11n 20MHz: 30.9 MHz 802.11n n40MHz: 43.8 MHz	Information only	N/A

MEASUREMENT UNCERTAINTIES

ISO/IEC 17025 requires that an estimate of the measurement uncertainties associated with the emissions test results be included in the report. The measurement uncertainties given below are based on a 95% confidence level and were calculated in accordance with UKAS document LAB 34.

Measurement Type	Measurement Unit	Frequency Range	Expanded Uncertainty
RF power, conducted (power meter)	dBm	25 to 7000 MHz	± 0.52 dB
RF power, conducted (Spectrum analyzer)	dBm	25 to 7000 MHz	± 0.7 dB
Conducted emission of transmitter	dBm	25 to 26500 MHz	± 0.7 dB
Conducted emission of receiver	dBm	25 to 26500 MHz	± 0.7 dB
Radiated emission (substitution method)	dBm	25 to 26500 MHz	± 2.5 dB
Radiated emission (field strength)	dB μ V/m	25 to 1000 MHz	± 3.6 dB
		1000 to 40000 MHz	± 6.0 dB
Conducted Emissions (AC Power)	dB μ V	0.15 to 30 MHz	± 2.4 dB

EQUIPMENT UNDER TEST (EUT) DETAILS**GENERAL**

The Motorola Mobility model VAP2500 is a Video Access Point/Client that is designed to operate either as a wireless access point or wireless client in a network. Since the EUT would be placed on a table top during operation, the EUT was treated as table-top equipment during testing to simulate the end-user environment. The electrical rating of the EUT is 120 Volts , 60 Hz, 12VDC/1Amp.

The sample was received on April 16, 2012 and tested on May 11, 14, 15, 16, 21, 22, 23, 25, June 18, 19, 20 and 25, 2012. The EUT consisted of the following component(s):

Company	Model	Description	Serial Number	FCC ID
Motorola	VAP2500	Video Access Point/Client	M91215YA007 D	ACQ-VAP2500
Leader Electronics Inc	MT12-Y120100-A1	I.T.E Power Supply	-	-
Asian Power Device	WA-12M12FU-AFAA	Power supply	-	-

OTHER EUT DETAILS

The EUT operates in the 5 GHz DTS and UNII bands using OFDM modulations (802.11a/n20/n40). It has four integral dipole antennas (2.0dBi).

ENCLOSURE

The EUT enclosure is primarily constructed of plastic. It measures approximately 3.5 cm wide by 10 cm deep by 14.5 cm high.

MODIFICATIONS

No modifications were made to the EUT during the time the product was at National Technical Systems - Silicon Valley.

SUPPORT EQUIPMENT

No local support equipment was used during testing.

The following equipment was used as remote support equipment for emissions testing:

Company	Model	Description	Serial Number	FCC ID
Hewlett Packard	EliteBook 6930p	Laptop	2CE940KDKY	-

EUT INTERFACE PORTS

The I/O cabling configuration during testing was as follows:

Port	Connected To	Description	Cable(s)	
			Shielded or Unshielded	Length(m)
Ethernet	PC Laptop	Cat 5	Unshielded	10
AC Power	AC Mains	2 Wire	Unshielded	2

EUT OPERATION

During emissions testing the EUT was set to continuously transmit on the desired channel at the selected power level.

TEST SITE**GENERAL INFORMATION**

Final test measurements were taken at the test sites listed below. Pursuant to section 2.948 of the FCC's Rules and section 3.3 of RSP-100, construction, calibration, and equipment data has been filed with the Commission and with industry Canada.

Site	Registration Numbers		Location
	FCC	Canada	
Chamber 3	769238	2845B-3	41039 Boyce Road Fremont, CA 94538-2435
Chamber 4	211948	2845B-4	
Chamber 5	211948	2845B-5	
Chamber 7	A2LA accreditation	2845B-7	

ANSI C63.4:2003 recommends that ambient noise at the test site be at least 6 dB below the allowable limits. Ambient levels are below this requirement. The test site(s) contain separate areas for radiated and conducted emissions testing. Considerable engineering effort has been expended to ensure that the facilities conform to all pertinent requirements of ANSI C63.4:2003.

CONDUCTED EMISSIONS CONSIDERATIONS

Conducted emissions testing is performed in conformance with ANSI C63.4:2003. Measurements are made with the EUT connected to the public power network through a nominal, standardized RF impedance, which is provided by a line impedance stabilization network, known as a LISN. A LISN is inserted in series with each current-carrying conductor in the EUT power cord.

RADIATED EMISSIONS CONSIDERATIONS

The FCC has determined that radiation measurements made in a shielded enclosure are not suitable for determining levels of radiated emissions. Radiated measurements are performed in an open field environment or in a semi-anechoic chamber. The test sites are maintained free of conductive objects within the CISPR defined elliptical area incorporated in ANSI C63.4:2003 guidelines and meet the Normalized Site Attenuation (NSA) requirements of ANSI C63.4:2003.

MEASUREMENT INSTRUMENTATION

RECEIVER SYSTEM

An EMI receiver as specified in CISPR 16-1-1 is used for emissions measurements. The receivers used can measure over the frequency range of 9 kHz up to 2000 MHz. These receivers allow both ease of measurement and high accuracy to be achieved. The receivers have Peak, Average, and CISPR (Quasi-peak) detectors built into their design so no external adapters are necessary. The receiver automatically sets the required bandwidth for the CISPR detector used during measurements. If the repetition frequency of the signal being measured is below 20Hz, peak measurements are made in lieu of Quasi-Peak measurements.

For measurements above the frequency range of the receivers, a spectrum analyzer is utilized because it provides visibility of the entire spectrum along with the precision and versatility required to support engineering analysis. Average measurements above 1000MHz are performed on the spectrum analyzer using the linear-average method with a resolution bandwidth of 1 MHz and a video bandwidth of 10 Hz, unless the signal is pulsed in which case the average (or video) bandwidth of the measuring instrument is reduced to onset of pulse desensitization and then increased.

INSTRUMENT CONTROL COMPUTER

The receivers utilize either a Rohde & Schwarz EZM Spectrum Monitor/Controller or contain an internal Spectrum Monitor/Controller to view and convert the receiver measurements to the field strength at an antenna or voltage developed at the LISN measurement port, which is then compared directly with the appropriate specification limit. This provides faster, more accurate readings by performing the conversions described under Sample Calculations within the Test Procedures section of this report. Results are printed in a graphic and/or tabular format, as appropriate. A personal computer is used to record all measurements made with the receivers.

The Spectrum Monitor provides a visual display of the signal being measured. In addition, the controller or a personal computer run automated data collection programs which control the receivers. This provides added accuracy since all site correction factors, such as cable loss and antenna factors are added automatically.

LINE IMPEDANCE STABILIZATION NETWORK (LISN)

Line conducted measurements utilize a fifty microhenry Line Impedance Stabilization Network as the monitoring point. The LISN used also contains a 250 uH CISPR adapter. This network provides for calibrated radio frequency noise measurements by the design of the internal low pass and high pass filters on the EUT and measurement ports, respectively.

FILTERS/ATTENUATORS

External filters and precision attenuators are often connected between the receiving antenna or LISN and the receiver. This eliminates saturation effects and non-linear operation due to high amplitude transient events.

ANTENNAS

A loop antenna is used below 30 MHz. For the measurement range 30 MHz to 1000 MHz either a combination of a biconical antenna and a log periodic or a bi-log antenna is used. Above 1000 MHz, horn antennas are used. The antenna calibration factors to convert the received voltage to an electric field strength are included with appropriate cable loss and amplifier gain factors to determine an overall site factor, which is then programmed into the test receivers or incorporated into the test software.

ANTENNA MAST AND EQUIPMENT TURNTABLE

The antennas used to measure the radiated electric field strength are mounted on a non-conductive antenna mast equipped with a motor-drive to vary the antenna height. Measurements below 30 MHz are made with the loop antenna at a fixed height of 1m above the ground plane.

ANSI C63.4:2003 specifies that the test height above ground for table mounted devices shall be 80 centimeters. Floor mounted equipment shall be placed on the ground plane if the device is normally used on a conductive floor or separated from the ground plane by insulating material from 3 to 12 mm if the device is normally used on a non-conductive floor. During radiated measurements, the EUT is positioned on a motorized turntable in conformance with this requirement.

INSTRUMENT CALIBRATION

All test equipment is regularly checked to ensure that performance is maintained in accordance with the manufacturer's specifications. All antennas are calibrated at regular intervals with respect to tuned half-wave dipoles. An exhibit of this report contains the list of test equipment used and calibration information.

TEST PROCEDURES

EUT AND CABLE PLACEMENT

The regulations require that interconnecting cables be connected to the available ports of the unit and that the placement of the unit and the attached cables simulate the worst case orientation that can be expected from a typical installation, so far as practicable. To this end, the position of the unit and associated cabling is varied within the guidelines of ANSI C63.4:2003, and the worst-case orientation is used for final measurements.

CONDUCTED EMISSIONS

Conducted emissions are measured at the plug end of the power cord supplied with the EUT. Excess power cord length is wrapped in a bundle between 30 and 40 centimeters in length near the center of the cord. Preliminary measurements are made to determine the highest amplitude emission relative to the specification limit for all the modes of operation. Placement of system components and varying of cable positions are performed in each mode. A final peak mode scan is then performed in the position and mode for which the highest emission was noted on all current carrying conductors of the power cord.

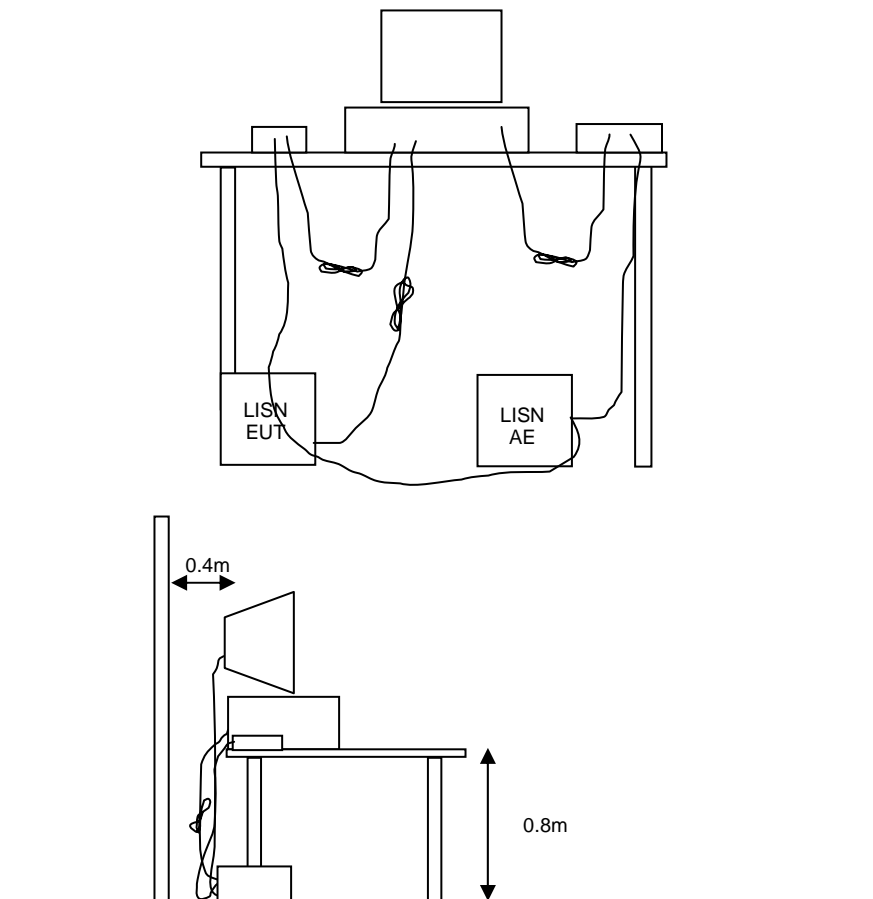

Figure 1 Typical Conducted Emissions Test Configuration

RADIATED EMISSIONS

A preliminary scan of the radiated emissions is performed in which all significant EUT frequencies are identified with the system in a nominal configuration. At least two scans are performed, one scan for each antenna polarization (horizontal and vertical; loop parallel and perpendicular to the EUT). During the preliminary scans, the EUT is rotated through 360°, the antenna height is varied (for measurements above 30 MHz) and cable positions are varied to determine the highest emission relative to the limit. Preliminary scans may be performed in a fully anechoic chamber for the purposes of identifying the frequencies of the highest emissions from the EUT.

A speaker is provided in the receiver to aid in discriminating between EUT and ambient emissions. Other methods used during the preliminary scan for EUT emissions involve scanning with near field magnetic loops, monitoring I/O cables with RF current clamps, and cycling power to the EUT.

Final maximization is a phase in which the highest amplitude emissions identified in the spectral search are viewed while the EUT azimuth angle is varied from 0 to 360 degrees relative to the receiving antenna. The azimuth, which results in the highest emission is then maintained while varying the antenna height from one to four meters (for measurements above 30 MHz, measurements below 30 MHz are made with the loop antenna at a fixed height of 1m). The result is the identification of the highest amplitude for each of the highest peaks. Each recorded level is corrected in the receiver using appropriate factors for cables, connectors, antennas, and preamplifier gain.

When testing above 18 GHz, the receive antenna is located at 1 meter from the EUT and the antenna height is restricted to a maximum of 2.5 meters.

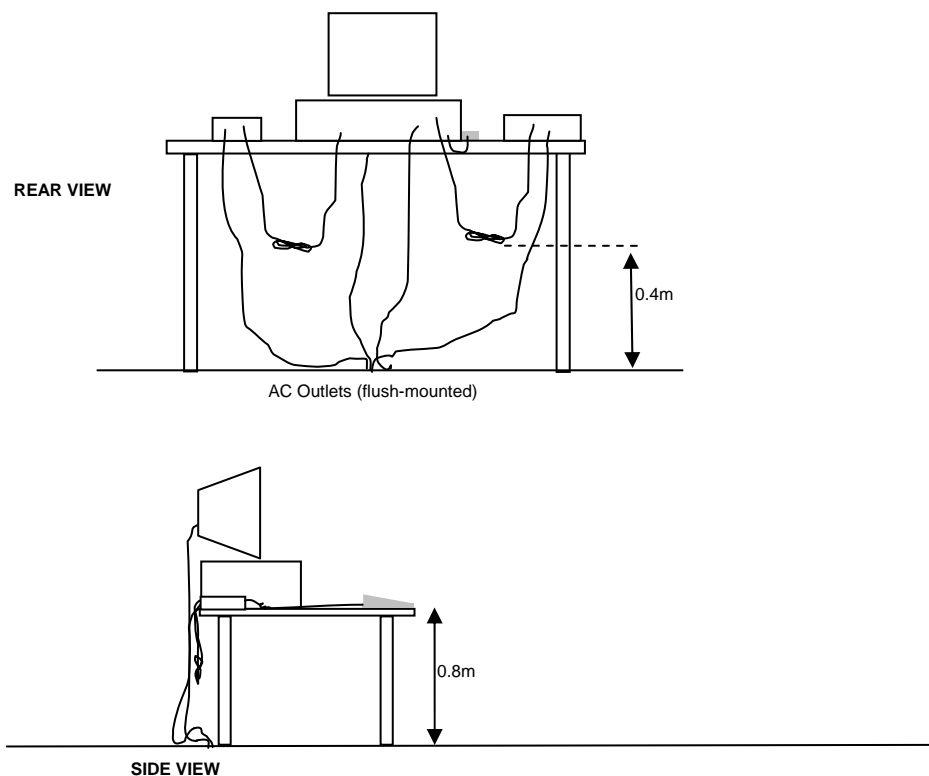

Typical Test Configuration for Radiated Field Strength Measurements

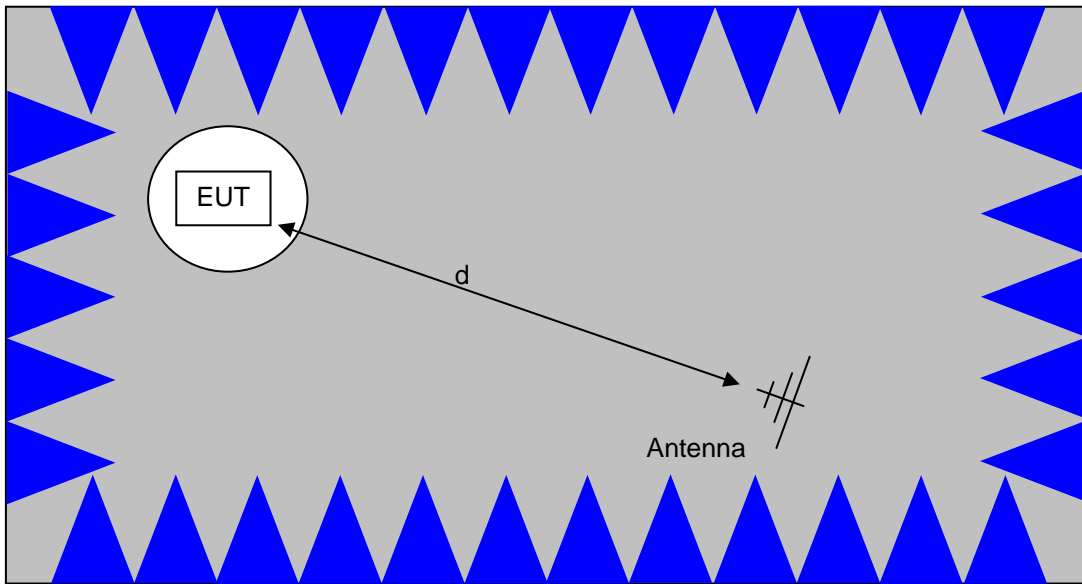

The anechoic materials on the walls and ceiling ensure compliance with the normalized site attenuation requirements of CISPR 16 / CISPR 22 / ANSI C63.4 for an alternate test site at the measurement distances used.

Floor-standing equipment is placed on the floor with insulating supports between the unit and the ground plane.

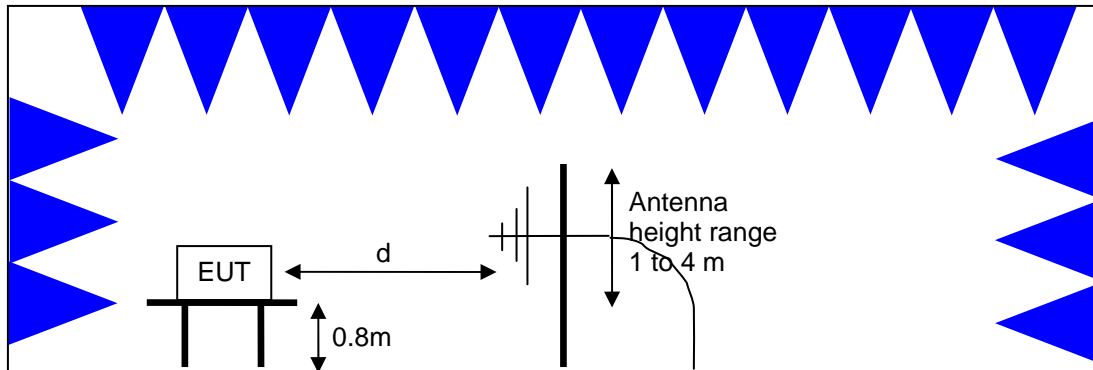

Test Configuration for Radiated Field Strength Measurements
Semi-Anechoic Chamber, Plan and Side Views

CONDUCTED EMISSIONS FROM ANTENNA PORT

Direct measurements of power, bandwidth and power spectral density are performed, where possible, with the antenna port of the EUT connected to either the power meter or spectrum analyzer via a suitable attenuator and/or filter. These are used to ensure that the front end of the measurement instrument is not overloaded by the fundamental transmission.

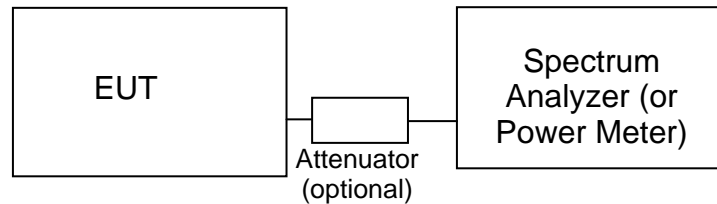
**Test Configuration for Antenna Port Measurements**

Measurement bandwidths (video and resolution) are set in accordance with the relevant standards and National Technical Systems - Silicon Valley's test procedures for the type of radio being tested. When power measurements are made using a resolution bandwidth less than the signal bandwidth the power is calculated by summing the power across the signal bandwidth using either the analyzer channel power function or by capturing the trace data and calculating the power using software. In both cases the summed power is corrected to account for the equivalent noise bandwidth (ENBW) of the resolution bandwidth used.

If power averaging is used (typically for certain digital modulation techniques), the EUT is configured to transmit continuously. Power averaging is performed using either the built-in function of the analyzer or, if the analyzer does not feature power averaging, using external software. In both cases the average power is calculated over a number of sweeps (typically 100). When the EUT cannot be configured to continuously transmit then either the analyzer is configured to perform a gated sweep to ensure that the power is averaged over periods that the device is transmitting or power averaging is disabled and a max-hold feature is used.

If a power meter is used to make output power measurements the sensor head type (peak or average) is stated in the test data table.

BANDWIDTH MEASUREMENTS

The 6dB, 20dB and/or 26dB signal bandwidth is measured in using the bandwidths recommended by ANSI C63.4. When required, the 99% bandwidth is measured using the methods detailed in RSS GEN.

SPECIFICATION LIMITS AND SAMPLE CALCULATIONS

The limits for conducted emissions are given in units of microvolts, and the limits for radiated emissions are given in units of microvolts per meter at a specified test distance. Data is measured in the logarithmic form of decibels relative to one microvolt, or dB microvolts (dBuV). For radiated emissions, the measured data is converted to the field strength at the antenna in dB microvolts per meter (dBuV/m). The results are then converted to the linear forms of uV and uV/m for comparison to published specifications.

For reference, converting the specification limits from linear to decibel form is accomplished by taking the base ten logarithm, then multiplying by 20. These limits in both linear and logarithmic form are as follows:

CONDUCTED EMISSIONS SPECIFICATION LIMITS: FCC 15.207; FCC 15.107(a), RSS GEN

The table below shows the limits for the emissions on the AC power line from an intentional radiator and a receiver.

Frequency (MHz)	Average Limit (dBuV)	Quasi Peak Limit (dBuV)
0.150 to 0.500	Linear decrease on logarithmic frequency axis between 56.0 and 46.0	Linear decrease on logarithmic frequency axis between 66.0 and 56.0
0.500 to 5.000	46.0	56.0
5.000 to 30.000	50.0	60.0

GENERAL TRANSMITTER RADIATED EMISSIONS SPECIFICATION LIMITS

The table below shows the limits for the spurious emissions from transmitters that fall in restricted bands¹ (with the exception of transmitters operating under FCC Part 15 Subpart D and RSS 210 Annex 9), the limits for all emissions from a low power device operating under the general rules of RSS 310 (tables 3 and 4), RSS 210 (table 2) and FCC Part 15 Subpart C section 15.209.

Frequency Range (MHz)	Limit (uV/m)	Limit (dBuV/m @ 3m)
0.009-0.490	2400/F _{KHz} @ 300m	67.6-20*log ₁₀ (F _{KHz}) @ 300m
0.490-1.705	24000/F _{KHz} @ 30m	87.6-20*log ₁₀ (F _{KHz}) @ 30m
1.705 to 30	30 @ 30m	29.5 @ 30m
30 to 88	100 @ 3m	40 @ 3m
88 to 216	150 @ 3m	43.5 @ 3m
216 to 960	200 @ 3m	46.0 @ 3m
Above 960	500 @ 3m	54.0 @ 3m

RECEIVER RADIATED SPURIOUS EMISSIONS SPECIFICATION LIMITS

The table below shows the limits for the spurious emissions from receivers as detailed in FCC Part 15.109, RSS 210 Table 2, RSS GEN Table 1 and RSS 310 Table 3. Note that receivers operating outside of the frequency range 30 MHz – 960 MHz are exempt from the requirements of 15.109.

Frequency Range (MHz)	Limit (uV/m @ 3m)	Limit (dBuV/m @ 3m)
30 to 88	100	40
88 to 216	150	43.5
216 to 960	200	46.0
Above 960	500	54.0

¹ The restricted bands are detailed in FCC 15.203, RSS 210 Table 1 and RSS 310 Table 2

FCC 15.407 (a) OUTPUT POWER LIMITS

The table below shows the limits for output power and output power density. Where the signal bandwidth is less than 20 MHz the maximum output power is reduced to the power spectral density limit plus 10 times the log of the bandwidth (in MHz).

Operating Frequency (MHz)	Output Power	Power Spectral Density
5150 – 5250	50mW (17 dBm)	4 dBm/MHz
5250 – 5350	250 mW (24 dBm)	11 dBm/MHz
5725 – 5825	1 Watts (30 dBm)	17 dBm/MHz

For system using antennas with gains exceeding 6dBi, the output power and power spectral density limits are reduced by 1dB for every dB the antenna gain exceeds 6dBi. Fixed point-to-point applications using the 5725 – 5825 MHz band may use antennas with gains of up to 23dBi without this limitation. If the gain exceeds 23dBi then the output power limit of 1 Watt is reduced by 1dB for every dB the gain exceeds 23dBi.

The peak excursion envelope is limited to 13dB.

OUTPUT POWER LIMITS –LELAN DEVICES

The table below shows the limits for output power and output power density defined by RSS 210. Where the signal bandwidth is less than 20 MHz the maximum output power is reduced to the power spectral density limit plus 10 times the log of the bandwidth (in MHz).

Operating Frequency (MHz)	Output Power	Power Spectral Density
5150 – 5250	200mW (23 dBm) eirp	10 dBm/MHz eirp
5250 – 5350	250 mW (24 dBm) ² 1W (30dBm) eirp	11 dBm/MHz
5470 – 5725	250 mW (24 dBm) ³ 1W (30dBm) eirp	11 dBm/MHz
5725 – 5825	1 Watts (30 dBm) 4W eirp	17 dBm/MHz

In addition, the power spectral density limit shall be reduced by 1dB for every dB the highest power spectral density exceeds the “average” power spectral density) by more than 3dB. The “average” power spectral density is determined by dividing the output power by $10\log(\text{EBW})$ where EBW is the 99% power bandwidth.

Fixed point-to-point applications using the 5725 – 5825 MHz band may use antennas with gains of up to 23dBi without this limitation. If the gain exceeds 23dBi then the output power limit of 1 Watt is reduced by 1dB for every dB the gain exceeds 23dBi.

² If EIRP exceeds 500mW the device must employ TPC

³ If EIRP exceeds 500mW the device must employ TPC

SPURIOUS EMISSIONS LIMITS –UNII and LELAN DEVICES

The spurious emissions limits for signals below 1GHz are the FCC/RSS-GEN general limits. For emissions above 1GHz, signals in restricted bands are subject to the FCC/RSS GEN general limits. All other signals have a limit of –27dBm/MHz, which is a field strength of 68.3dBuV/m/MHz at a distance of 3m. This is a peak limit. For devices operating in the 5725-5850Mhz bands under the LELAN/UNII rules, the limit within 10Mhz of the allocated band is increased to –17dBm/MHz.

SAMPLE CALCULATIONS - CONDUCTED EMISSIONS

Receiver readings are compared directly to the conducted emissions specification limit (decibel form) as follows:

$$R_r - S = M$$

where:

R_r = Receiver Reading in dBuV

S = Specification Limit in dBuV

M = Margin to Specification in +/- dB

SAMPLE CALCULATIONS - RADIATED EMISSIONS

Receiver readings are compared directly to the specification limit (decibel form). The receiver internally corrects for cable loss, preamplifier gain, and antenna factor. The calculations are in the reverse direction of the actual signal flow, thus cable loss is added and the amplifier gain is subtracted. The Antenna Factor converts the voltage at the antenna coaxial connector to the field strength at the antenna elements.

A distance factor, when used for electric field measurements above 30MHz, is calculated by using the following formula:

$$F_d = 20 * \text{LOG}_{10} (D_m/D_s)$$

where:

F_d = Distance Factor in dB

D_m = Measurement Distance in meters

D_s = Specification Distance in meters

For electric field measurements below 30MHz the extrapolation factor is either determined by making measurements at multiple distances or a theoretical value is calculated using the formula:

$$F_d = 40 * \text{LOG}_{10} (D_m/D_s)$$

Measurement Distance is the distance at which the measurements were taken and Specification Distance is the distance at which the specification limits are based. The antenna factor converts the voltage at the antenna coaxial connector to the field strength at the antenna elements.

The margin of a given emission peak relative to the limit is calculated as follows:

$$R_c = R_r + F_d$$

and

$$M = R_c - L_s$$

where:

R_r = Receiver Reading in dBuV/m

F_d = Distance Factor in dB

R_c = Corrected Reading in dBuV/m

L_s = Specification Limit in dBuV/m

M = Margin in dB Relative to Spec

SAMPLE CALCULATIONS - FIELD STRENGTH TO EIRP CONVERSION

Where the radiated electric field strength is expressed in terms of the equivalent isotropic radiated power (eirp), or where a field strength measurement of output power is made in lieu of a direct measurement, the following formula is used to convert between eirp and field strength at a distance of d (meters) from the equipment under test:

$$E = \frac{1000000 \sqrt{30 P}}{d} \quad \text{microvolts per meter}$$

where P is the eirp (Watts)

For a measurement at 3m the conversion from a logarithmic value for field strength (dBuV/m) to an eirp power (dBm) is -95.3dB.

Appendix A Test Equipment Calibration Data**Radiated Emissions, 1000 - 6,500 MHz, 1-May-12**

<u>Manufacturer</u>	<u>Description</u>	<u>Model</u>	<u>Asset #</u>	<u>Cal Due</u>
EMCO	Antenna, Horn, 1-18 GHz (SA40-Red)	3115	1142	8/2/2012
Rohde & Schwarz	EMI Test Receiver, 20 Hz-7 GHz	ESIB7	1756	5/25/2012

Radiated Emissions, 30 - 1,000 MHz, 14-May-12

<u>Manufacturer</u>	<u>Description</u>	<u>Model</u>	<u>Asset #</u>	<u>Cal Due</u>
Sunol Sciences	Biconilog, 30-3000 MHz	JB3	1657	5/28/2012
Com-Power Corp.	Preamplifier, 30-1000 MHz	PA-103A	2359	2/14/2013
Rohde & Schwarz	EMI Test Receiver, 20 Hz-40 GHz	ESIB40 (1088.7490.40)	2493	12/9/2012

Conducted Emissions - AC Power Ports, 14-May-12

<u>Manufacturer</u>	<u>Description</u>	<u>Model</u>	<u>Asset #</u>	<u>Cal Due</u>
Rohde & Schwarz	Pulse Limiter	ESH3 Z2	1594	5/17/2012
Fischer Custom Comm	LISN, 25A, 150kHz to 30MHz, 25 Amp,	FCC-LISN-50-25-2- 09	2001	2/15/2013
Rohde & Schwarz	EMI Test Receiver, 20 Hz-40 GHz	ESIB40 (1088.7490.40)	2493	12/9/2012

Radiated Emissions, 1,000 - 10,000 MHz, 14-May-12

<u>Manufacturer</u>	<u>Description</u>	<u>Model</u>	<u>Asset #</u>	<u>Cal Due</u>
EMCO	Antenna, Horn, 1-18 GHz (SA40-Red)	3115	1142	8/2/2012
Rohde & Schwarz	EMI Test Receiver, 20 Hz-7 GHz	ESIB7	1756	5/25/2012
Hewlett Packard	Microwave Preamplifier, 1- 26.5GHz	8449B	2199	2/23/2013
Micro-Tronics	Band Reject Filter, 5150-5350 MHz	BRC50703-02	2239	10/4/2012
Hewlett Packard	SpecAn 9 kHz - 40 GHz, (SA40) Purple	8564E (84125C)	2415	7/28/2012

Radiated Emissions, 1000 - 40,000 MHz, 15-May-12

<u>Manufacturer</u>	<u>Description</u>	<u>Model</u>	<u>Asset #</u>	<u>Cal Due</u>
Hewlett Packard	Microwave Preamplifier, 1- 26.5GHz	8449B	263	3/29/2013
EMCO	Antenna, Horn, 1-18 GHz (SA40-Blu)	3115	1386	9/21/2012
Hewlett Packard	SpecAn 9 kHz - 40 GHz, FT (SA40) Blue	8564E (84125C)	1393	5/1/2013
Micro-Tronics	Band Reject Filter, 5150-5350 MHz	BRC50703-02	2239	10/4/2012

Radiated Emissions, 1000 - 26,500 MHz, 16-May-12

<u>Manufacturer</u>	<u>Description</u>	<u>Model</u>	<u>Asset #</u>	<u>Cal Due</u>
EMCO	Antenna, Horn, 1-18 GHz	3115	1561	6/22/2012
Micro-Tronics	Band Reject Filter, 5470-5725 MHz	BRC50704-02	1681	9/8/2012
Hewlett Packard	Head (Inc W1-W4, 1946, 1947) Purple	84125C	1772	5/1/2013
A.H. Systems	Purple System Horn, 18-40GHz	SAS-574, p/n: 2581	2160	4/17/2013
Hewlett Packard	Microwave Preamplifier, 1- 26.5GHz	8449B	2199	2/23/2013
Micro-Tronics	Band Reject Filter, 5150-5350 MHz	BRC50703-02	2251	10/11/2012

Hewlett Packard	SpecAn 9 kHz - 40 GHz, (SA40) Purple	8564E (84125C)	2415	7/28/2012
-----------------	--------------------------------------	----------------	------	-----------

Radiated Emissions, 1000 - 6,500 MHz, 16-May-12

<u>Manufacturer</u>	<u>Description</u>	<u>Model</u>	<u>Asset #</u>	<u>Cal Due</u>
EMCO	Antenna, Horn, 1-18 GHz	3115	786	12/19/2013
Rohde & Schwarz	EMI Test Receiver, 20 Hz-7 GHz	ESIB7	1630	6/8/2012

Radiated Emissions, 1000 - 6,500 MHz, 27-May-12

<u>Manufacturer</u>	<u>Description</u>	<u>Model</u>	<u>Asset #</u>	<u>Cal Due</u>
EMCO	Antenna, Horn, 1-18 GHz	3115	1561	6/22/2012
Rohde & Schwarz	EMI Test Receiver, 20 Hz-40 GHz	ESIB40 (1088.7490.40)	2493	12/9/2012

Radiated Emissions, 1000 - 40,000 MHz, 21-May-12

<u>Manufacturer</u>	<u>Description</u>	<u>Model</u>	<u>Asset #</u>	<u>Cal Due</u>
Hewlett Packard	Microwave Preamplifier, 1-26.5GHz	8449B	263	3/29/2013
EMCO	Antenna, Horn, 1-18 GHz (SA40-Blu)	3115	1386	9/21/2012
Hewlett Packard	High Pass filter, 8.2 GHz (Blu System)	P/N 84300-80039 (84125C)	1392	5/18/2013
Hewlett Packard	SpecAn 9 kHz - 40 GHz, FT (SA40) Blue	8564E (84125C)	1393	5/1/2013
Micro-Tronics	Band Reject Filter, 5150-5350 MHz	BRC50703-02	1729	8/5/2012

Radiated Emissions, 1000 - 40,000 MHz, 22-May-12

<u>Manufacturer</u>	<u>Description</u>	<u>Model</u>	<u>Asset #</u>	<u>Cal Due</u>
Hewlett Packard	High Pass filter, 8.2 GHz (Blu System)	P/N 84300-80039 (84125C)	1392	5/18/2013
EMCO	Antenna, Horn, 1-18 GHz	3115	1561	6/22/2012
Micro-Tronics	Band Reject Filter, 5150-5350 MHz	BRC50703-02	1729	8/5/2012
Hewlett Packard	Microwave Preamplifier, 1-26.5GHz	8449B	2199	2/23/2013
Hewlett Packard	SpecAn 9 kHz - 40 GHz, (SA40) Purple	8564E (84125C)	2415	7/28/2012

Radiated Emissions, 1000 - 18,000 MHz, 23-May-12

<u>Manufacturer</u>	<u>Description</u>	<u>Model</u>	<u>Asset #</u>	<u>Cal Due</u>
EMCO	Antenna, Horn, 1-18 GHz	3115	1561	6/22/2012
Micro-Tronics	Band Reject Filter, 5470-5725 MHz	BRC50704-02	1681	9/8/2012
Hewlett Packard	Microwave Preamplifier, 1-26.5GHz	8449B	2199	2/23/2013
Micro-Tronics	Band Reject Filter, 5725-5875 MHz	BRC50705-02	2241	10/4/2012
Hewlett Packard	SpecAn 9 kHz - 40 GHz, (SA40) Purple	8564E (84125C)	2415	7/28/2012

Radiated Emissions, 18,000 - 40,000 MHz, 23-May-12

<u>Manufacturer</u>	<u>Description</u>	<u>Model</u>	<u>Asset #</u>	<u>Cal Due</u>
Hewlett Packard	Head (Inc W1-W4, 1946, 1947) Purple	84125C	1772	5/1/2013
A.H. Systems	Purple System Horn, 18-40GHz	SAS-574, p/n: 2581	2160	4/17/2013
Hewlett Packard	SpecAn 9 kHz - 40 GHz, (SA40) Purple	8564E (84125C)	2415	7/28/2012

Radio Antenna Port (Power), 29-May-12 to 30-May-12

<u>Manufacturer</u>	<u>Description</u>	<u>Model</u>	<u>Asset #</u>	<u>Cal Due</u>
Anritsu	Anritsu 68347C Signal Generator, 10MHz-20GHz	68347C	1785	11/16/2012
Agilent	PSA, Spectrum Analyzer, (installed options, 111, 115, 123, 1DS, B7J, HYX,	E4446A	2139	2/23/2013

Radio Antenna Port (Power and Spurious Emissions), 18-Jun-12 to 20-Jun-12

<u>Manufacturer</u>	<u>Description</u>	<u>Model</u>	<u>Asset #</u>	<u>Cal Due</u>
Rohde & Schwarz	Power Meter, Single Channel	NRVS	1290	12/5/2012
Rohde & Schwarz	Power Sensor 100 uW - 2 Watts use with 20dB attenuator sn:100059 only	NRV-Z32	1423	9/1/2012
Rohde & Schwarz	Pwr Sensor 300 uW - 30 Watts (+ 25dB pad)	NRV-Z54	1788	7/29/2012
Agilent	PSA, Spectrum Analyzer, (installed options, 111, 115, 123, 1DS, B7J, HYX,	E4446A	2139	2/23/2013

Radiated Emissions, 1,000 - 40,000 MHz, 20-Jun-12

<u>Manufacturer</u>	<u>Description</u>	<u>Model</u>	<u>Asset #</u>	<u>Cal Due</u>
EMCO	Antenna, Horn, 1-18 GHz (SA40-Blu)	3115	1386	9/21/2012
Hewlett Packard	Head (Inc flex cable, (1742,1743) Blue	84125C	1620	5/17/2013
Micro-Tronics	Band Reject Filter, 5150-5350 MHz	BRC50703-02	1729	8/5/2012
Micro-Tronics	Band Reject Filter, 5470-5725 MHz	BRC50704-02	1730	8/5/2012
Hewlett Packard	Microwave Preamplifier, 1-26.5GHz	8449B	1780	11/22/2012
A.H. Systems	Spare System Horn, 18-40GHz	SAS-574, p/n: 2581	2162	5/8/2013
Hewlett Packard	SpecAn 9 kHz - 40 GHz, (SA40) Purple	8564E (84125C)	2415	7/28/2012

Radiated Emissions, 30 - 1,000 MHz & Conducted Emissions Asian power Supply, 25-Jun-12

<u>Manufacturer</u>	<u>Description</u>	<u>Model</u>	<u>Asset #</u>	<u>Cal Due</u>
Rohde & Schwarz	EMI Test Receiver, 20 Hz-7 GHz	ESIB7	1538	12/6/2012
Sunol Sciences	Biconilog, 30-3000 MHz	JB3	1657	6/4/2014
Fischer Custom Comm	LISN, 25A, 150kHz to 30MHz, 25 Amp,	FCC-LISN-50-25-2-09	2001	2/15/2013
Hewlett Packard	9KHz-1300MHz pre-amp	8447F	2328	5/2/2013

Appendix B Test Data

T87276 Pages 28 - 182



EMC Test Data

Client:	Motorola	Job Number:	J87247
Model:	VAP2500	T-Log Number:	T87276
		Account Manager:	Christine Krebill
Contact:	Rob Linebarger		
Emissions Standard(s):	FCC	Class:	B
Immunity Standard(s):	-	Environment:	-

EMC Test Data

For The

Motorola

Model

VAP2500

Date of Last Test: 8/3/2012



EMC Test Data

Client: Motorola	Job Number: J87247
Model: VAP2500	T-Log Number: T87276
Contact: Rob Linebarger	Account Manger: Christine Krebill
Emissions Standard(s): FCC	Class: B
Immunity Standard(s): -	Environment: -

Power vs. Data Rate

In normal operating modes the card uses power settings stored on EEPROM to set the output power. For a given nominal output power the actual transmit power is reduced as the data rate increases, therefore testing was performed at the lowest data rate in each mode as this data rate to determine compliance with the requirements at the highest power setting.

The following power measurements were made using an average power meter and the with the device configured in a continuous transmit mode on Chain A at the various data rates in each mode to verify this:

Date of Test: 5/31/2012 Config. Used: 1
 Test Engineer: Rafael Varelas Config Change: None
 Test Location: FT Lab #4 Host Unit Voltage 120V/60Hz

Using Avg power meter

802.11 DTS 5GHz Chain 1

Mode	Data Rate	Power (dBm)	Power setting	Data Rate Setting
802.11a	6	16.0	17.0	0
	9	15.8		1
	12	15.6		2
	18	15.6		3
	24	15.4		4
	36	15.4		5
	48	15.4		6
	54	15.3		7
802.11n 20MHz	6.5	15.9	17.0	0
	13	15.7		1
	19.5	15.7		2
	26	15.7		3
	39	15.6		4
	52	15.5		5
	58.5	15.4		6
	65	15.3		7
802.11n 40MHz	13.5	15.8	17.0	0
	27	15.7		1
	40.5	15.6		2
	54	15.5		3
	81	15.4		4
	108	15.3		5
	121.5	14.7		6
	135	14.6		7

Note : Power setting - the software power setting used during testing, included for reference only.

Client: Motorola	Job Number: J87247
Model: VAP2500	T-Log Number: T87276
	Account Manager: Christine Krebill
Contact: Rob Linebarger	
Standard: FCC	Class: N/A

RSS-210 (LELAN) and FCC 15.407(UNII)
Antenna Port Measurements
Power, PSD, Peak Excursion, Bandwidth and Spurious Emissions

Test Specific Details

Objective: The objective of this test session is to perform final qualification testing of the EUT with respect to the specification listed above.

Date of Test: 6/18/12~6/20/12	Config. Used: 1
Test Engineer: R. Varelas, M. Birgani, J. Liu	Config Change: None
Test Location: FT Lab 4	EUT Voltage: 120V/60Hz

General Test Configuration

When measuring the conducted emissions from the EUT's antenna port, the antenna port of the EUT was connected to the spectrum analyzer or power meter via a suitable attenuator to prevent overloading the measurement system. All measurements are corrected to allow for the external attenuators and cables used.

Ambient Conditions:	Temperature:	20.8 °C
	Rel. Humidity:	34 %

Modifications Made During Testing

No modifications were made to the EUT during testing

Deviations From The Standard

No deviations were made from the requirements of the standard.

Client: Motorola	Job Number: J87247
Model: VAP2500	T-Log Number: T87276
	Account Manager: Christine Krebill
Contact: Rob Linebarger	
Standard: FCC	Class: N/A

Summary of Results

Run #	Test Performed	Limit	Pass / Fail	Result / Margin
1	Power, 5150 - 5250MHz	15.407(a) (1), (2)	Pass	802.11a: 46 mW 802.11n 20MHz: 47 mW 802.11n n40MHz: 42 mW
1	PSD, 5150 - 5250MHz	15.407(a) (1), (2)	Pass	802.11a: 3.9 dBm/MHz 802.11n 20MHz: 3.8 dBm/MHz 802.11n n40MHz: 0.2 dBm/MHz
1	Power, 5250 - 5350MHz	15.407(a) (1), (2)	Pass	802.11a: 127 mW 802.11n 20MHz: 124 mW 802.11n n40MHz: 107 mW
1	PSD, 5250 - 5350MHz	15.407(a) (1), (2)	Pass	802.11a: 8.2 dBm/MHz 802.11n 20MHz: 7.9 dBm/MHz 802.11n n40MHz: 4.1 dBm/MHz
1	Low Power Setting Max EIRP 5250 - 5350MHz	TPC required if EIRP ≥ 500mW (27dBm). EIRP ≥ 200mW (23dBm) DFS threshold = -64dBm	TPC Not required	EIRP = 23.0 dBm (201 mW)
1	Power, 5470 - 5725MHz	15.407(a) (1), (2)	Pass	802.11a: 161 mW 802.11n 20MHz: 206 mW 802.11n n40MHz: 150 mW
1	PSD, 5470 - 5725MHz	15.407(a) (1), (2)	Pass	802.11a: 9.4 dBm/MHz 802.11n 20MHz: 10.1 dBm/MHz 802.11n n40MHz: 5.7 dBm/MHz
1	Low Power Setting Max EIRP 5470 - 5725MHz	TPC required if EIRP ≥ 500mW (27dBm). EIRP ≥ 200mW (23dBm) DFS threshold = -64dBm	TPC Not required	EIRP = 25.1 dBm (327 mW)
1	26dB Bandwidth	15.407 (Information only)	-	> 20MHz for all modes
1	99% Bandwidth	RSS 210 (Information only)	N/A	802.11a: 17.1 MHz 802.11n 20MHz: 30.9 MHz 802.11n n40MHz: 43.8 MHz
2	Peak Excursion Envelope	15.407(a) (6) 13dB	Pass	802.11a: 8.3 dB 802.11n 20MHz: 9.0 dB 802.11n n40MHz: 7.8 dB
3	Antenna Conducted - Out of Band Spurious	15.407(b) -27dBm/MHz	Pass	All emissions below the -27dBm/MHz limit

Client: Motorola	Job Number: J87247
Model: VAP2500	T-Log Number: T87276
	Account Manager: Christine Krebill
Contact: Rob Linebarger	
Standard: FCC	Class: N/A

Run #1: Bandwidth, Output Power and Power Spectral Density - Multichain Systems

Note 1:	Output power measured using a spectrum analyzer (see plots below). RBW=1MHz, VB=3 MHz, # of points in sweep $\geq 2 \times \text{span} / \text{RBW}$, sample RMS detector, power averaging on (transmitted signal was continuous) and power integration over 40 MHz (method SA-1 of KDB 789033).
Note 2:	Measured using the same analyzer settings used for output power.
Note 3:	For RSS-210 the limit for the 5150 - 5250 MHz band accounts for the antenna gain as the maximum eirp allowed is 10dBm/MHz. The limits are also corrected for instances where the highest measured value of the PSD exceeds the average PSD (calculated from the measured power divided by the measured 99% bandwidth) by more than 3dB by the amount that the measured value exceeds the average by more than 3dB.
Note 4:	99% Bandwidth measured in accordance with RSS GEN - RB > 1% of span and VB $\geq 3 \times \text{RB}$
Note 5:	For Multichain systems the total output power and total PSD are calculated from the sum of the powers of the individual chains (in linear terms). The antenna gain used to determine the EIRP and limits for PSD/Output power depends on the operating mode of the Multichain device. If the signals on the non-coherent between the transmit chains then the gain used to determine the limits is the highest gain of the individual chains and the EIRP is the sum of the products of gain and power on each chain. If the signals are coherent then the effective antenna gain is the sum (in linear terms) of the gains for each chain and the EIRP is the product of the effective gain and total power.

Multichain Device - 5150-5250 MHz Band

	Chain 1	Chain 2	Chain 3	Chain 4	Coherent	Effective ⁵	EIRP (mW)	EIRP (dBm)
Antenna Gain (dBi):	-1.0	-0.5	-0.1	1.3	Yes	6.0	185.9	22.7

Power

Mode: 802.11a

Frequency (MHz)	Chain	Software Setting	26dB BW (MHz)	Duty Cycle %	Power dBm	Total Power ¹ mW	Total Power ¹ dBm	Limit dBm	Max Power (W)	Result
5180	1	12	31.8	98.4	10.6	46.2	16.6	17.0	0.046	Pass
	3				11.7					
	4				10.3					
	2				9.5					
5200	1	12	31.8	98.4	10.2	42.8	16.3	17.0		Pass
	3				11.6					
	4				9.9					
	2				9.2					
5240	1	12	31.8	98.4	9.7	43.1	16.3	17.0		Pass
	3				11.3					
	4				10.5					
	2				9.5					

Client: Motorola	Job Number: J87247
Model: VAP2500	T-Log Number: T87276
	Account Manager: Christine Krebill
Contact: Rob Linebarger	
Standard: FCC	Class: N/A

Mode: 802.11n20

Frequency (MHz)	Chain	Software Setting	26dB BW (MHz)	Duty Cycle %	Power dBm	Total Power ¹		Limit dBm	Max Power (W)	Result
						mW	dBm			
5180	1	12	30.9	98	10.8	46.8	16.7	17.0	0.047	Pass
	3				11.8					
	4				10.2					
	2				9.7					
5200	1	12	30.9	98	10.2	44.3	16.5	17.0		Pass
	3				11.6					
	4				10.0					
	2				9.6					
5240	1	12	30.9	98	9.3	42.0	16.2	17.0		Pass
	3				11.5					
	4				10.3					
	2				9.4					

Mode: 802.11n40

Frequency (MHz)	Chain	Software Setting	26dB BW (MHz)	Duty Cycle %	Power dBm	Total Power ¹		Limit dBm	Max Power (W)	Result
						mW	dBm			
5190	1	12	43.8	98	9.6	42.5	16.3	17.0	0.042	Pass
	3				11.2					
	4				10.4					
	2				9.2					
5230	1	12	43.8	98	9.3	41.1	16.1	17.0		Pass
	3				11.3					
	4				10.3					
	2				8.8					

Client: Motorola	Job Number: J87247
Model: VAP2500	T-Log Number: T87276
	Account Manager: Christine Krebill
Contact: Rob Linebarger	
Standard: FCC	Class: N/A

PSD

Mode: 802.11a

Frequency (MHz)	Chain	Software Setting	99% BW (MHz)	Duty Cycle %	PSD dBm/MHz	Total PSD ¹ mW/MHz	Total PSD ¹ dBm/MHz	FCC Limit dBm/MHz	IC Limit dBm/MHz	Result
5180	1	12	16.9	98.4	-2.1	2.4	3.9	4.0	4.0	Pass
	3				-1.0					
	4				-2.6					
	2				-3.2					
5200	1	12	16.9	98.4	-2.5	2.2	3.4	4.0	4.0	Pass
	3				-1.4					
	4				-3.2					
	2				-3.7					
5240	1	12	16.9	98.4	-3.3	2.2	3.5	4.0	4.0	Pass
	3				-1.6					
	4				-2.3					
	2				-3.3					

Mode: 802.11n20

Frequency (MHz)	Chain	Software Setting	99% BW (MHz)	Duty Cycle %	PSD dBm/MHz	Total PSD ¹ mW/MHz	Total PSD ¹ dBm/MHz	FCC Limit dBm/MHz	IC Limit dBm/MHz	Result
5180	1	12	30.9	98	-2.1	2.4	3.8	4.0	4.0	Pass
	3				-1.1					
	4				-2.8					
	2				-3.1					
5200	1	12	30.9	98	-2.8	2.2	3.4	4.0	4.0	Pass
	3				-1.5					
	4				-3.1					
	2				-3.3					
5240	1	12	30.9	98	-3.7	2.1	3.2	4.0	4.0	Pass
	3				-1.8					
	4				-2.7					
	2				-3.5					



EMC Test Data

Client: Motorola	Job Number: J87247
Model: VAP2500	T-Log Number: T87276
	Account Manager: Christine Krebill
Contact: Rob Linebarger	
Standard: FCC	Class: N/A

Mode: 802.11n40

Frequency (MHz)	Chain	Software Setting	99% BW (MHz)	Duty Cycle %	PSD dBm/MHz	Total PSD ¹ mW/MHz	Total PSD ¹ dBm/MHz	FCC Limit dBm/MHz	IC Limit dBm/MHz	Result
5190	1	12	36.3	98	-6.4	1.0	0.2	4.0	4.0	Pass
	3				-5.0					
	4				-5.7					
	2				-6.8					
5230	1	12	43.8	98	-6.8	1.0	0.0	4.0	4.0	Pass
	3				-5.1					
	4				-5.8					
	2				-7.3					

Multichain Device - 5250-5350 MHz Band

	Chain 1	Chain 2	Chain 3	Chain 4	Coherent	Effective ⁵	EIRP (mW)	EIRP (dBm)
Antenna Gain (dBi):	-1.0	-0.5	-0.1	1.3	Yes	6.0	506.1	27.0

Power

Mode: 802.11a

Frequency (MHz)	Chain	Software Setting	26dB BW (MHz)	Duty Cycle %	Power dBm	Total Power ¹ mW	Total Power ¹ dBm	Limit dBm	Max Power (W)	Result
5260	1	17	32	98.4	14.1	115.4	20.6	24.0	0.127	Pass
	3				15.4					
	4				14.7					
	2				14.1					
5300	1	17	30.1	98.4	14.1	118.8	20.7	24.0	0.127	Pass
	3				15.6					
	4				15.0					
	2				14.1					
5320	1	17	28.6	98.4	14.5	126.8	21.0	24.0	0.127	Pass
	3				15.7					
	4				15.0					
	2				14.7					



EMC Test Data

Client: Motorola	Job Number: J87247
Model: VAP2500	T-Log Number: T87276
	Account Manager: Christine Krebill
Contact: Rob Linebarger	
Standard: FCC	Class: N/A

Mode: 802.11n20

Frequency (MHz)	Chain	Software Setting	26dB BW (MHz)	Duty Cycle %	Power dBm	Total Power ¹ mW	Total Power ¹ dBm	Limit dBm	Max Power (W)	Result	
5260	1	17	30	98	14.5	118.9	20.8	24.0	0.124	Pass	
	3				15.2						
	4				15.0						
	2				14.2						
5300	1	17	29.2	98	14.5	123.7	20.9	24.0		0.124	Pass
	3				15.4						
	4				15.1						
	2				14.5						
5320	1	16	31	98	13.6	106.2	20.3	24.0		0.124	Pass
	3				15.1						
	4				14.5						
	2				13.6						

Mode: 802.11n40

Frequency (MHz)	Chain	Software Setting	26dB BW (MHz)	Duty Cycle %	Power dBm	Total Power ¹ mW	Total Power ¹ dBm	Limit dBm	Max Power (W)	Result	
5270	1	17	43.5	98	14.0	107.3	20.3	24.0	0.107	Pass	
	3				14.6						
	4				14.6						
	2				13.9						
5310	1	13	43.7	98	10.1	48.2	16.8	24.0		0.107	Pass
	3				12.0						
	4				10.9						
	2				10.0						



EMC Test Data

Client: Motorola	Job Number: J87247
Model: VAP2500	T-Log Number: T87276
	Account Manager: Christine Krebill
Contact: Rob Linebarger	
Standard: FCC	Class: N/A

PSD

Mode: 802.11a

Frequency (MHz)	Chain	Software Setting	99% BW (MHz)	Duty Cycle %	PSD dBm/MHz	Total PSD ¹ mW/MHz	Total PSD ¹ dBm/MHz	FCC Limit dBm/MHz	IC Limit dBm/MHz	Result
5260	1	17	17.1	98.4	1.4	6.0	7.8	11.0	11.0	Pass
	3				2.5					
	4				1.8					
	2				1.4					
5300	1	17	17	98.4	1.3	6.2	7.9	11.0	11.0	Pass
	3				2.7					
	4				2.2					
	2				1.3					
5320	1	17	17	98.4	1.8	6.6	8.2	11.0	11.0	Pass
	3				2.8					
	4				2.3					
	2				1.9					

Mode: 802.11n20

Frequency (MHz)	Chain	Software Setting	99% BW (MHz)	Duty Cycle %	PSD dBm/MHz	Total PSD ¹ mW/MHz	Total PSD ¹ dBm/MHz	FCC Limit dBm/MHz	IC Limit dBm/MHz	Result
5260	1	17	18.3	98	1.5	5.9	7.7	11.0	11.0	Pass
	3				2.2					
	4				1.9					
	2				1.1					
5300	1	17	18.2	98	1.6	6.2	7.9	11.0	11.0	Pass
	3				2.3					
	4				2.0					
	2				1.7					
5320	1	16	18.2	98	0.5	5.2	7.1	11.0	11.0	Pass
	3				1.9					
	4				1.3					
	2				0.6					



EMC Test Data

Client: Motorola	Job Number: J87247
Model: VAP2500	T-Log Number: T87276
	Account Manager: Christine Krebill
Contact: Rob Linebarger	
Standard: FCC	Class: N/A

Mode: 802.11n40

Frequency (MHz)	Chain	Software Setting	99% BW (MHz)	Duty Cycle %	PSD dBm/MHz	Total PSD ¹ mW/MHz	Total PSD ¹ dBm/MHz	FCC Limit dBm/MHz	IC Limit dBm/MHz	Result
5270	1	17	36.5	98	-2.3	2.6	4.1	11.0	11.0	Pass
	3				-1.6					
	4				-1.6					
	2				-2.3					
5310	1	13	36.3	98	-6.1	1.2	0.7	11.0	11.0	Pass
	3				-4.2					
	4				-5.3					
	2				-6.1					

Multichain Device - 5470-5725 MHz Band

	Chain 1	Chain 2	Chain 3	Chain 4	Coherent	Effective ⁵	EIRP (mW)	EIRP (dBm)
Antenna Gain (dBi):	-1.1	1.6	-4.9	3.3	Yes	6.3	872.0	29.4

Power

Mode: 802.11a

Frequency (MHz)	Chain	Software Setting	26dB BW (MHz)	Duty Cycle %	Power dBm	Total Power ¹ mW	Total Power ¹ dBm	Limit dBm	Max Power (W)	Result
5500	1	13	30.3	98.4	12.0	65.6	18.2	23.7	0.161	Pass
	3				13.1					
	4				11.9					
	2				11.5					
5580	1	18	31.2	98.4	16.0	161.3	22.1	23.7	0.161	Pass
	3				16.2					
	4				16.3					
	2				15.7					
5700	1	13	27.6	98.4	11.1	49.7	17.0	23.7	0.161	Pass
	3				11.2					
	4				9.8					
	2				11.5					

Client: Motorola	Job Number: J87247
Model: VAP2500	T-Log Number: T87276
	Account Manager: Christine Krebill
Contact: Rob Linebarger	
Standard: FCC	Class: N/A

Mode: 802.11n20

Frequency (MHz)	Chain	Software Setting	26dB BW (MHz)	Duty Cycle %	Power dBm	Total Power ¹ mW	Total Power ¹ dBm	Limit dBm	Max Power (W)	Result
5500	1	12	32.3	98	11.3	55.4	17.4	23.7	0.206	Pass
	3				12.3					
	4				11.1					
	2				10.8					
5580	1	18	31	98	16.8	206.0	23.1	23.7		Pass
	3				17.5					
	4				17.5					
	2				16.6					
5700	1	12	28.8	98	10.7	44.4	16.5	23.7		Pass
	3				10.6					
	4				9.4					
	2				11.0					

Mode: 802.11n40

Frequency (MHz)	Chain	Software Setting	26dB BW (MHz)	Duty Cycle %	Power dBm	Total Power ¹ mW	Total Power ¹ dBm	Limit dBm	Max Power (W)	Result
5510	1	10	43.5	98	9.1	34.4	15.4	23.7	0.150	Pass
	3				10.8					
	4				8.1					
	2				8.9					
5550	1	18	44	98	15.6	149.6	21.7	23.7		Pass
	3				16.0					
	4				15.9					
	2				15.4					
5670	1	15	43.5	98	14.4	101.8	20.1	23.7		Pass
	3				14.7					
	4				13.4					
	2				13.6					



EMC Test Data

Client: Motorola	Job Number: J87247
Model: VAP2500	T-Log Number: T87276
	Account Manager: Christine Krebill
Contact: Rob Linebarger	
Standard: FCC	Class: N/A

PSD
Mode: 802.11a

Frequency (MHz)	Chain	Software Setting	99% BW (MHz)	Duty Cycle %	PSD dBm/MHz	Total PSD ¹ mW/MHz	Total PSD ¹ dBm/MHz	FCC Limit dBm/MHz	IC Limit dBm/MHz	Result
5500	1	13	16.9	98.4	-1.0	3.3	5.2	10.7	11.0	Pass
	3				0.1					
	4				-1.1					
	2				-1.3					
5580	1	18	17	98.4	3.4	8.7	9.4	10.7	11.0	Pass
	3				3.6					
	4				3.3					
	2				3.2					
5700	1	13	16.9	98.4	-1.5	2.6	4.2	10.7	11.0	Pass
	3				-1.6					
	4				-3.1					
	2				-1.4					

Mode: 802.11n20

Frequency (MHz)	Chain	Software Setting	99% BW (MHz)	Duty Cycle %	PSD dBm/MHz	Total PSD ¹ mW/MHz	Total PSD ¹ dBm/MHz	FCC Limit dBm/MHz	IC Limit dBm/MHz	Result
5500	1	12	18.1	98	-1.8	2.7	4.3	10.7	11.0	Pass
	3				-0.8					
	4				-1.9					
	2				-2.4					
5580	1	18	18.2	98	3.8	10.3	10.1	10.7	11.0	Pass
	3				4.4					
	4				4.3					
	2				3.9					
5700	1	12	18.1	98	-2.3	2.2	3.5	10.7	11.0	Pass
	3				-2.4					
	4				-3.9					
	2				-1.9					



EMC Test Data

Client: Motorola	Job Number: J87247
Model: VAP2500	T-Log Number: T87276
	Account Manager: Christine Krebill
Contact: Rob Linebarger	
Standard: FCC	Class: N/A

Mode: 802.11n40

Frequency (MHz)	Chain	Software Setting	99% BW (MHz)	Duty Cycle %	PSD dBm/MHz	Total PSD ¹ mW/MHz	Total PSD ¹ dBm/MHz	FCC Limit dBm/MHz	IC Limit dBm/MHz	Result
5510	1	10	36.3	98	-7.0	0.8	-0.8	10.7	11.0	Pass
	3				-5.4					
	4				-8.1					
	2				-7.1					
5550	1	18	36.3	98	-0.3	3.7	5.7	10.7	11.0	Pass
	3				-0.2					
	4				-0.3					
	2				-0.4					
5670	1	15	36.5	98	-1.7	2.5	3.9	10.7	11.0	Pass
	3				-1.4					
	4				-2.8					
	2				-2.6					

Client: Motorola	Job Number: J87247
Model: VAP2500	T-Log Number: T87276
	Account Manager: Christine Krebill
Contact: Rob Linebarger	
Standard: FCC	Class: N/A

Run #2: Peak Excursion Measurement

Mode: 802.11a

Device meets the requirement for the peak excursion

Peak Excursion(dB)			Peak Excursion(dB)			Peak Excursion(dB)		
Freq	Value	Limit	Freq	Value	Limit	Freq	Value	Limit
(MHz)			(MHz)			(MHz)		
5180	8.0	13.0	5260	7.8	13.0	5500	6.8	13.0
5200	7.9	13.0	5300	7.8	13.0	5580	7.7	13.0
5240	8.1	13.0	5320	7.7	13.0	5700	8.3	13.0

Mode: 802.11n20

Device meets the requirement for the peak excursion

Peak Excursion(dB)			Peak Excursion(dB)			Peak Excursion(dB)		
Freq	Value	Limit	Freq	Value	Limit	Freq	Value	Limit
(MHz)			(MHz)			(MHz)		
5180	8.4	13.0	5260	8.0	13.0	5500	7.6	13.0
5200	8.1	13.0	5300	8.0	13.0	5580	8.2	13.0
5240	8.4	13.0	5320	8.4	13.0	5700	8.4	13.0

Mode: 802.11n40

Device meets the requirement for the peak excursion

Peak Excursion(dB)			Peak Excursion(dB)			Peak Excursion(dB)		
Freq	Value	Limit	Freq	Value	Limit	Freq	Value	Limit
(MHz)			(MHz)			(MHz)		
5190	8.0	13.0	5270	8.2	13.0	5510	7.0	13.0
5230	7.5	13.0	5310	7.6	13.0	5550	7.6	13.0
						5670	7.1	13.0

Plots Showing Peak Excursion

Trace A: RBW = 1MHz, VBW = 3MHz, Peak hold

Trace B: Same settings as used for power/PSD measurements (RBW = 1 MHz, VBW = 3MHz, Integrated average power)

Client: Motorola	Job Number: J87247
Model: VAP2500	T-Log Number: T87276
	Account Manager: Christine Krebill
Contact: Rob Linebarger	
Standard: FCC	Class: N/A

Run #3: Out Of Band Spurious Emissions - Antenna Conducted

Multichain Devices: Antenna gain used is the effective gain calculated in the power section of this data sheet. The plots were obtained for each chain individually and the limit was adjusted to account for all chains transmitting simultaneously.

Number of transmit chains:	4
Maximum Antenna Gain:	2.0 dBi
Spurious Limit:	-27.0 dBm/MHz eirp
Adjustment for 4 chains:	-6.0 dB adjustment for multiple chains.
Limit Used On Plots ^{Note 1} :	-35.0 dBm/MHz Peak Limit (RB=VB=1MHz)

- Note 1: The -27dBm/MHz limit is an eirp limit. The limit for antenna port conducted measurements is adjusted to take into consideration the maximum antenna gain (limit = -27dBm - antenna gain). Radiated field strength measurements for signals more than 50MHz from the bands and that are close to the limit are made to determine compliance as the antenna gain is not known at these frequencies.
- Note 2: All spurious signals below 1GHz are measured during digital device radiated emissions test.
- Note 3: Signals within 10MHz of the 5.725 or 5.825 Band edge are subject to a limit of -17dBm EIRP
- Note 4: If the device is for outdoor use then the -27dBm eirp limit also applies in the 5150 - 5250 MHz band.
- Note 5: Signals that fall in the restricted bands of 15.205 are subject to the limit of 15.209.

Plots Showing Out-Of-Band Emissions (RBW=VBW=1MHz)

Run #3a - Out Of Band Spurious Emissions - Antenna Conducted - 802.11a mode
 Low channel, 5150 - 5250 MHz Band

Compliance with the radiated limits for the restricted band immediately below 5150MHz is demonstrated through the radiated emissions tests.

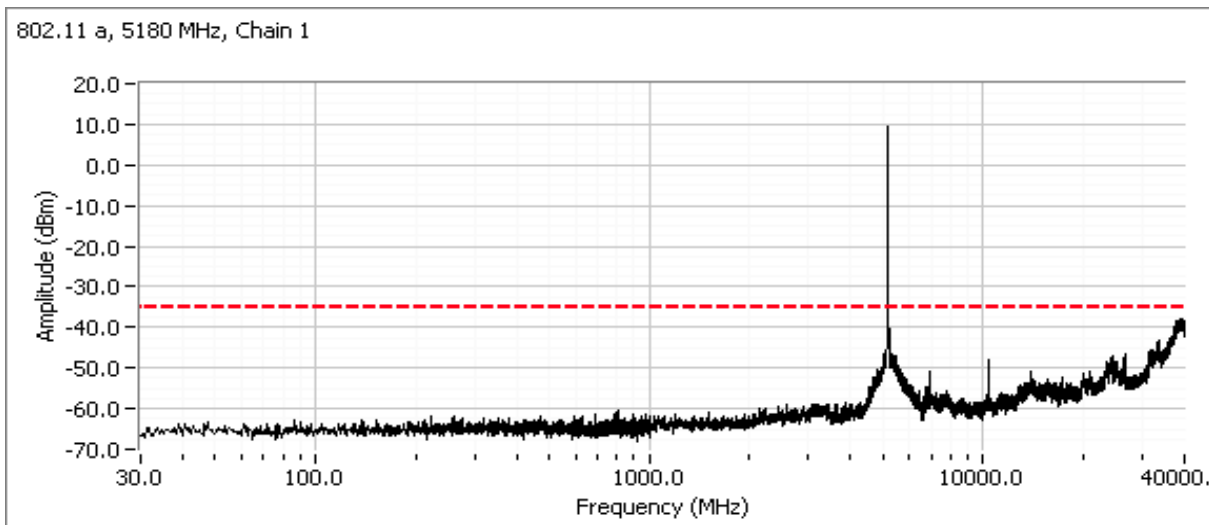

Client: Motorola	Job Number: J87247
Model: VAP2500	T-Log Number: T87276
	Account Manager: Christine Krebill
Contact: Rob Linebarger	
Standard: FCC	Class: N/A

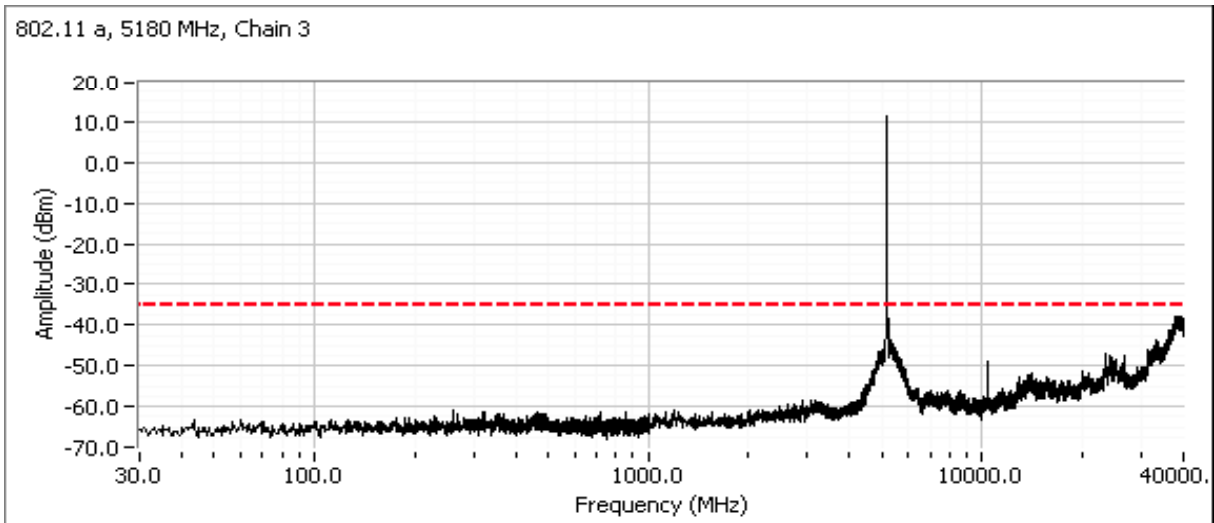
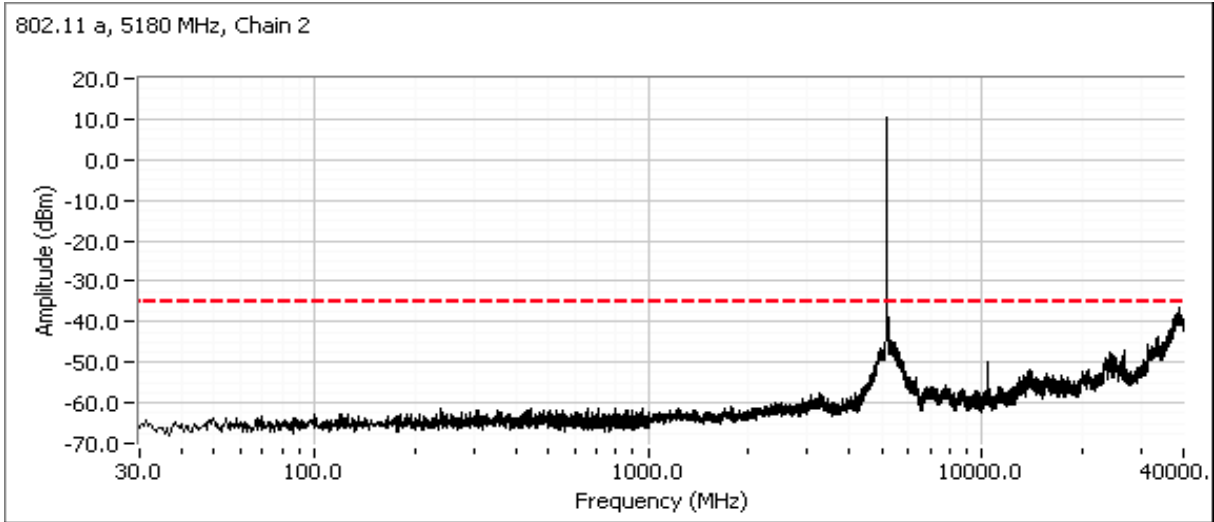

Client: Motorola	Job Number: J87247
Model: VAP2500	T-Log Number: T87276
	Account Manager: Christine Krebill
Contact: Rob Linebarger	
Standard: FCC	Class: N/A

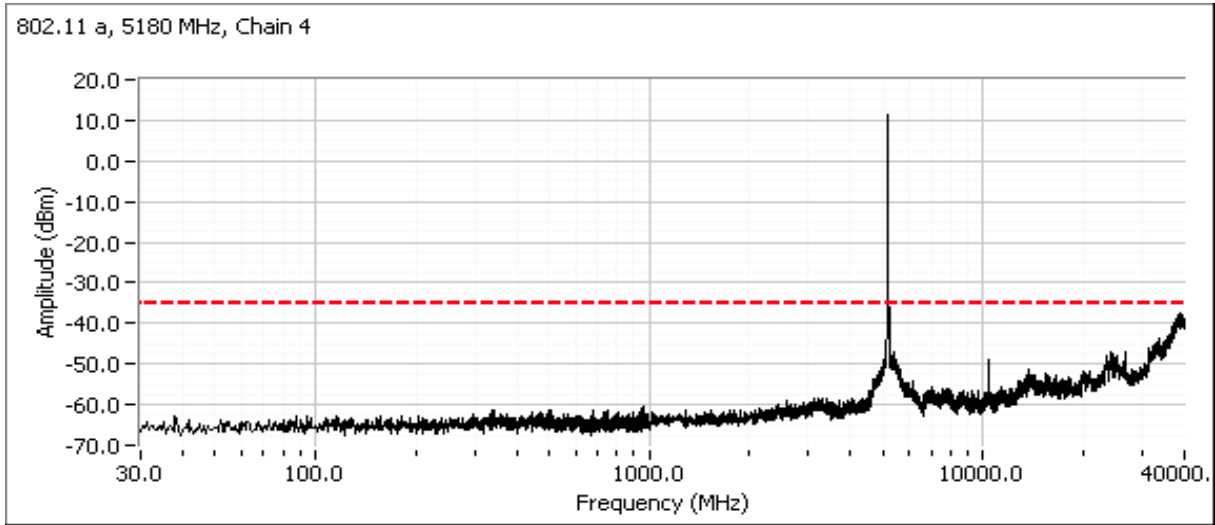

Center channel, 5150 - 5250 MHz Band

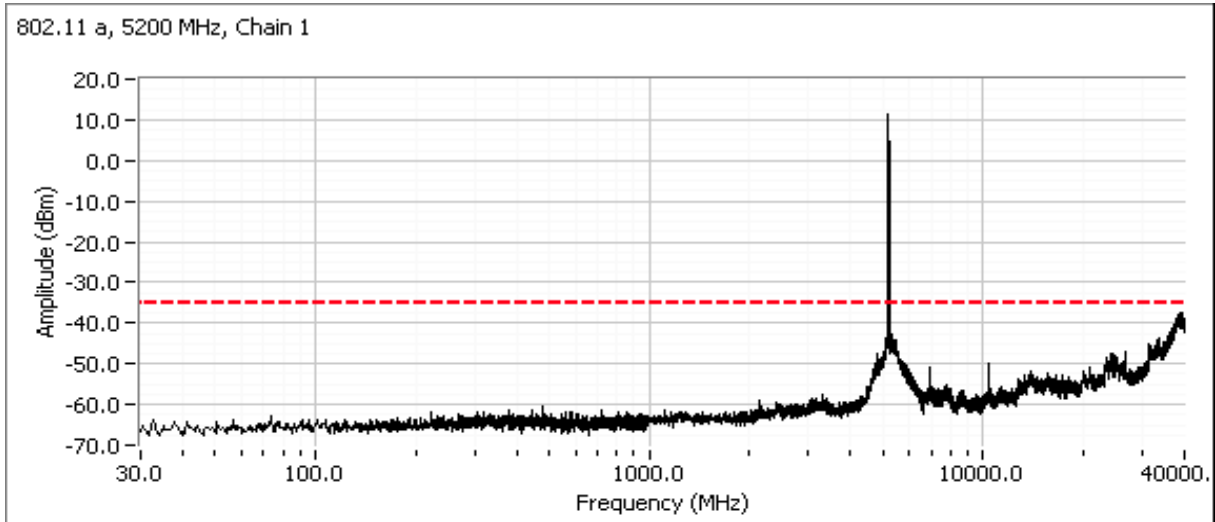

Client: Motorola	Job Number: J87247
Model: VAP2500	T-Log Number: T87276
	Account Manager: Christine Krebill
Contact: Rob Linebarger	
Standard: FCC	Class: N/A

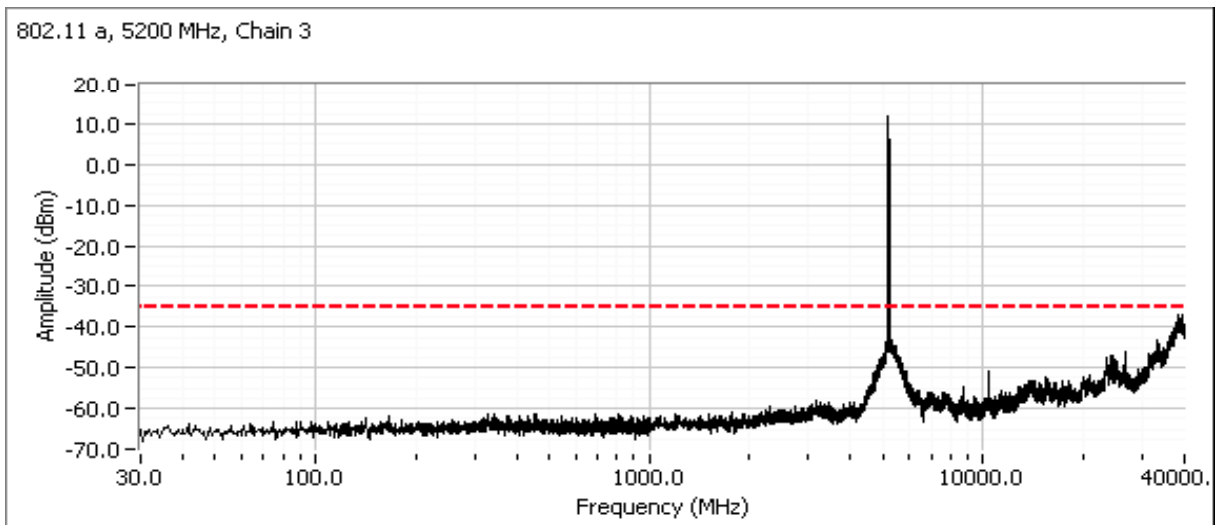
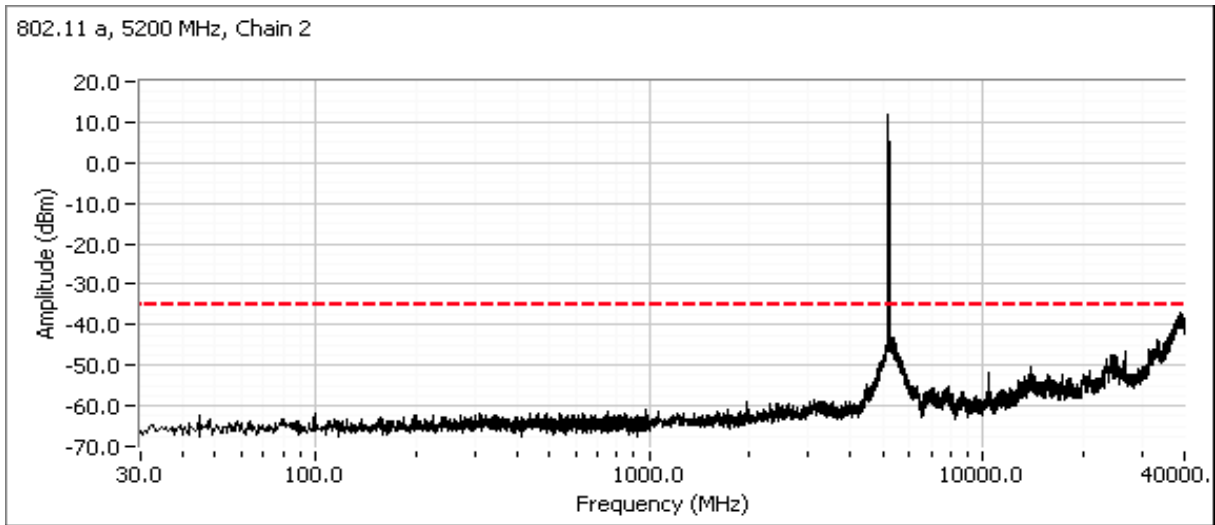

Client: Motorola	Job Number: J87247
Model: VAP2500	T-Log Number: T87276
	Account Manager: Christine Krebill
Contact: Rob Linebarger	
Standard: FCC	Class: N/A

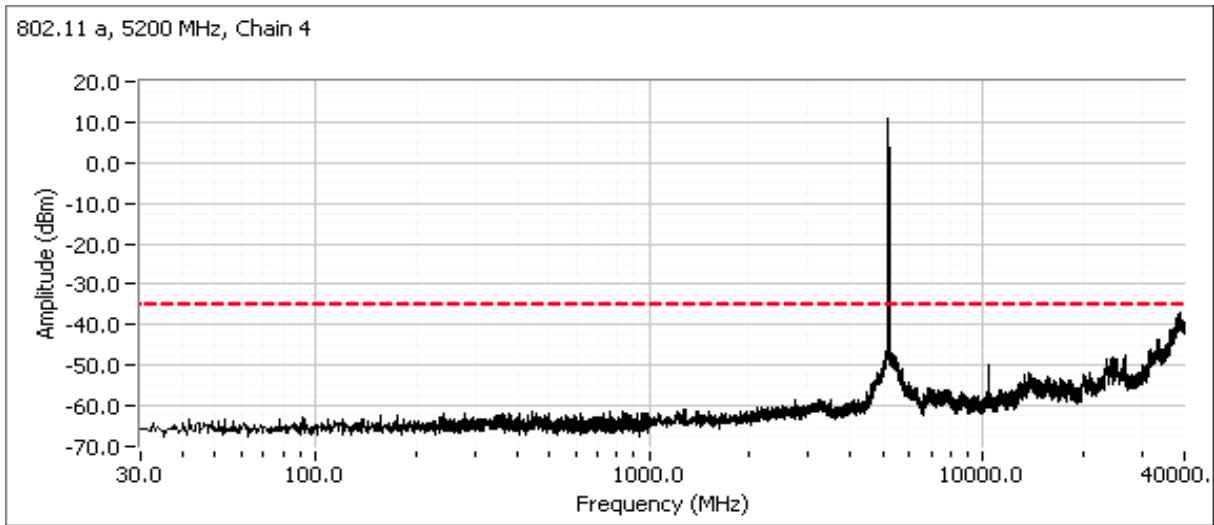

High channel, 5150 - 5250 MHz Band

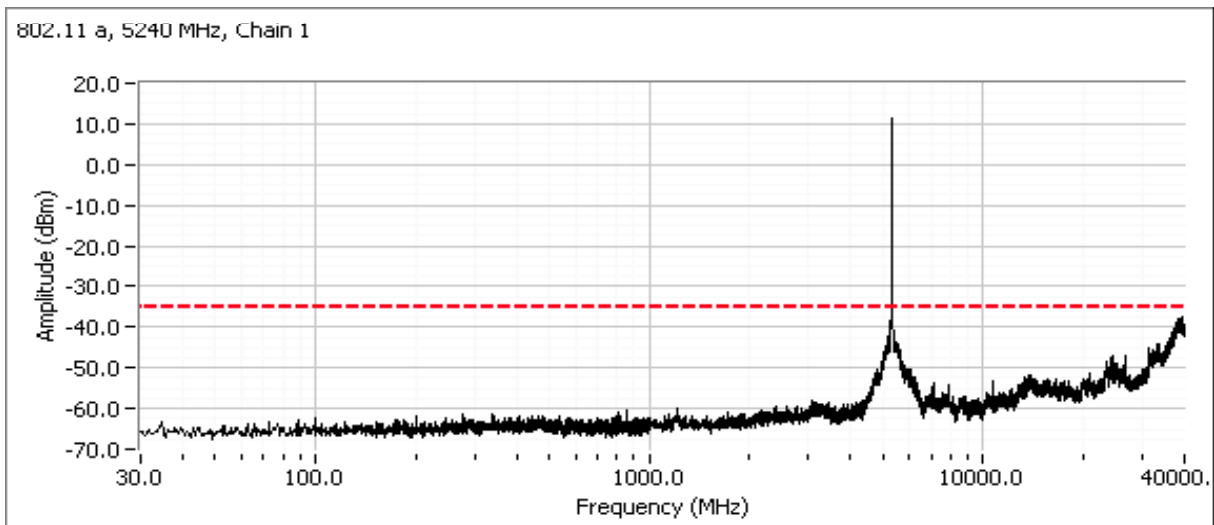

Client: Motorola	Job Number: J87247
Model: VAP2500	T-Log Number: T87276
	Account Manager: Christine Krebill
Contact: Rob Linebarger	
Standard: FCC	Class: N/A

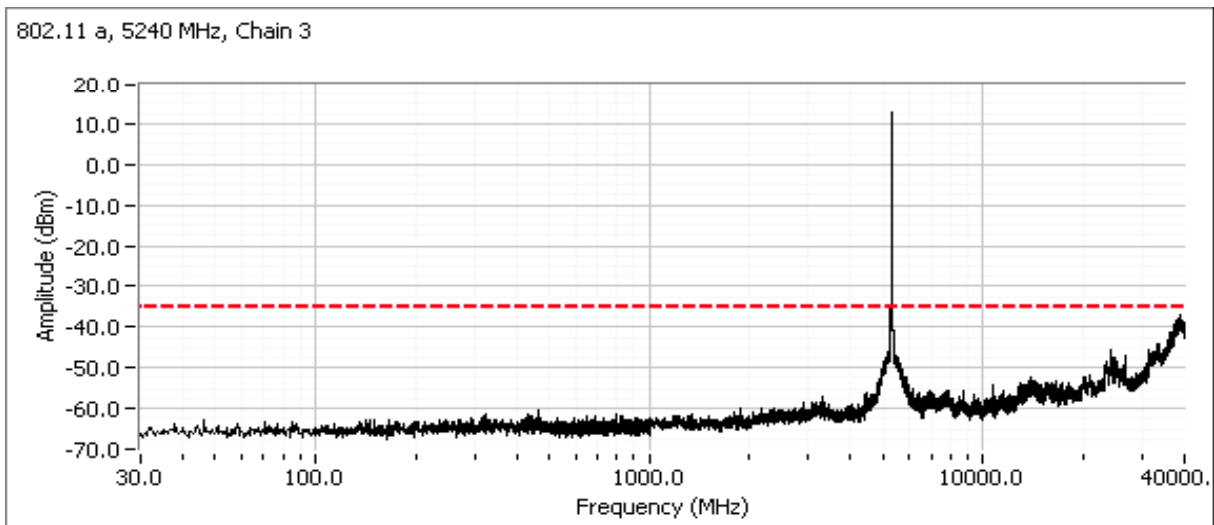
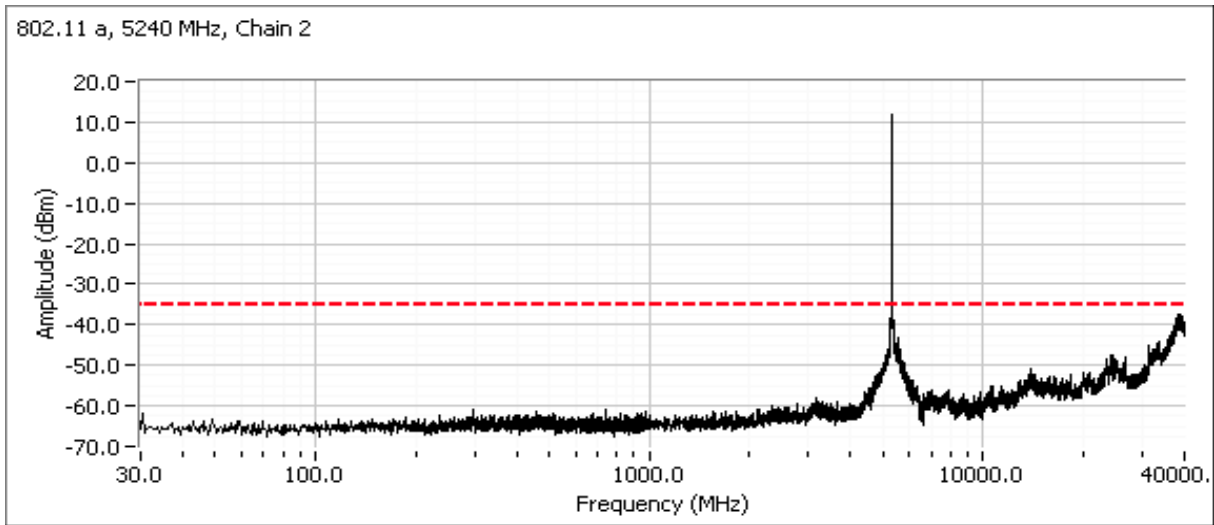

Client: Motorola	Job Number: J87247
Model: VAP2500	T-Log Number: T87276
Contact: Rob Linebarger	Account Manager: Christine Krebill
Standard: FCC	Class: N/A

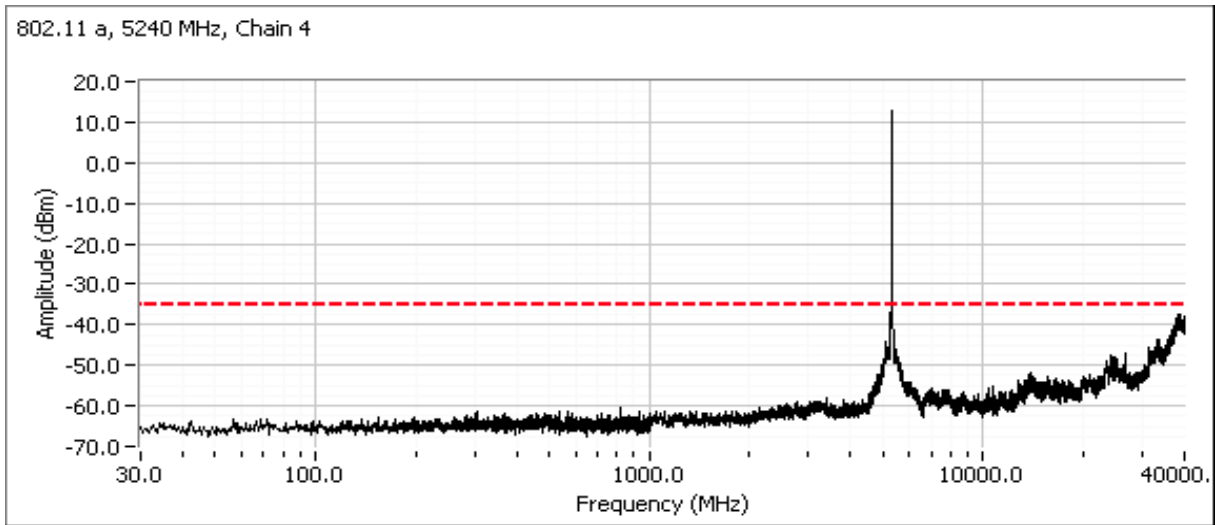

Low channel, 5250 - 5350 MHz Band

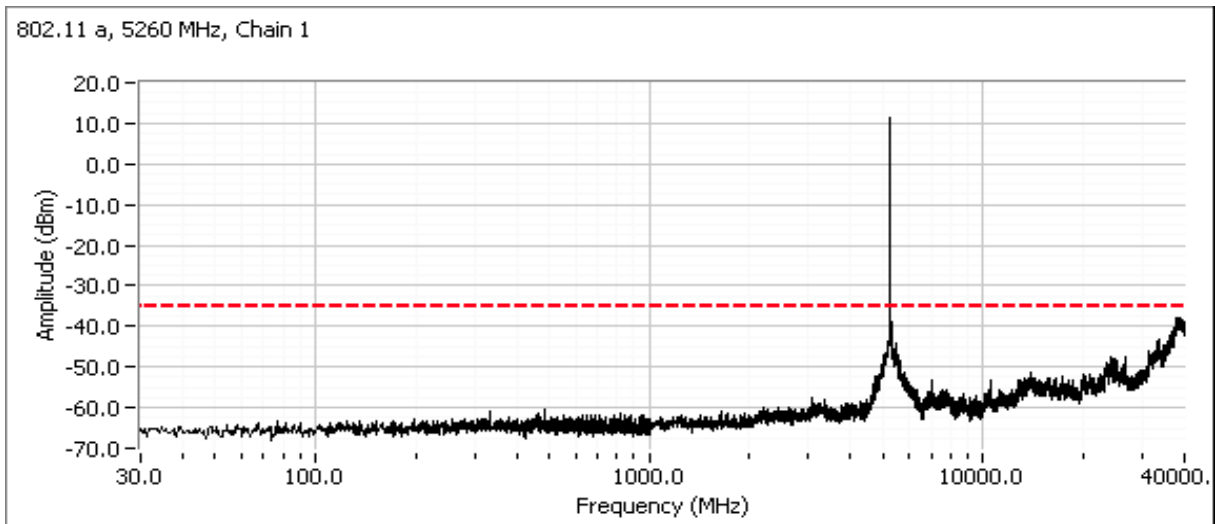

Client: Motorola	Job Number: J87247
Model: VAP2500	T-Log Number: T87276
	Account Manager: Christine Krebill
Contact: Rob Linebarger	
Standard: FCC	Class: N/A

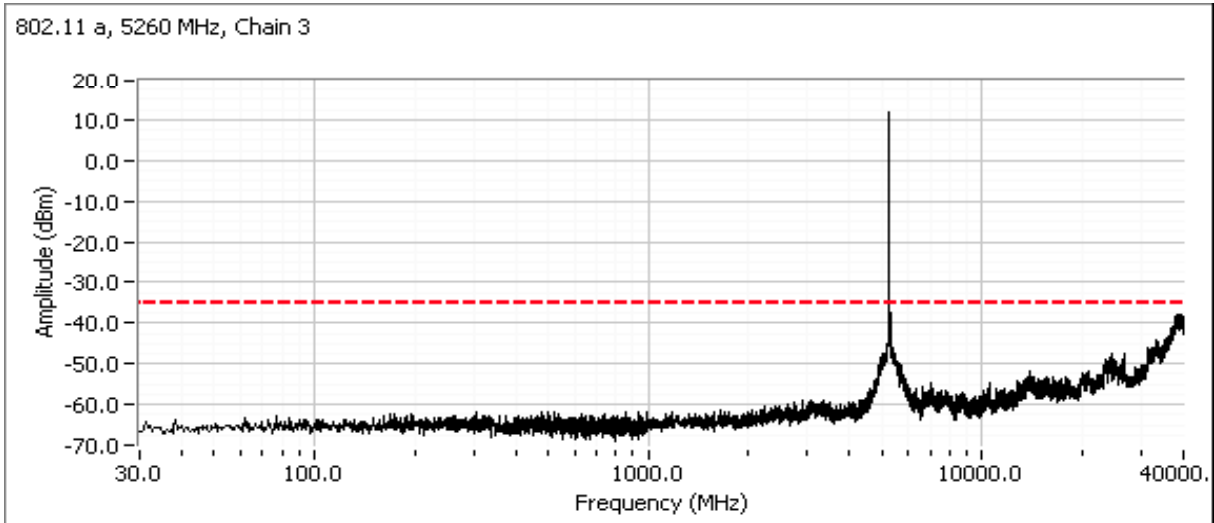
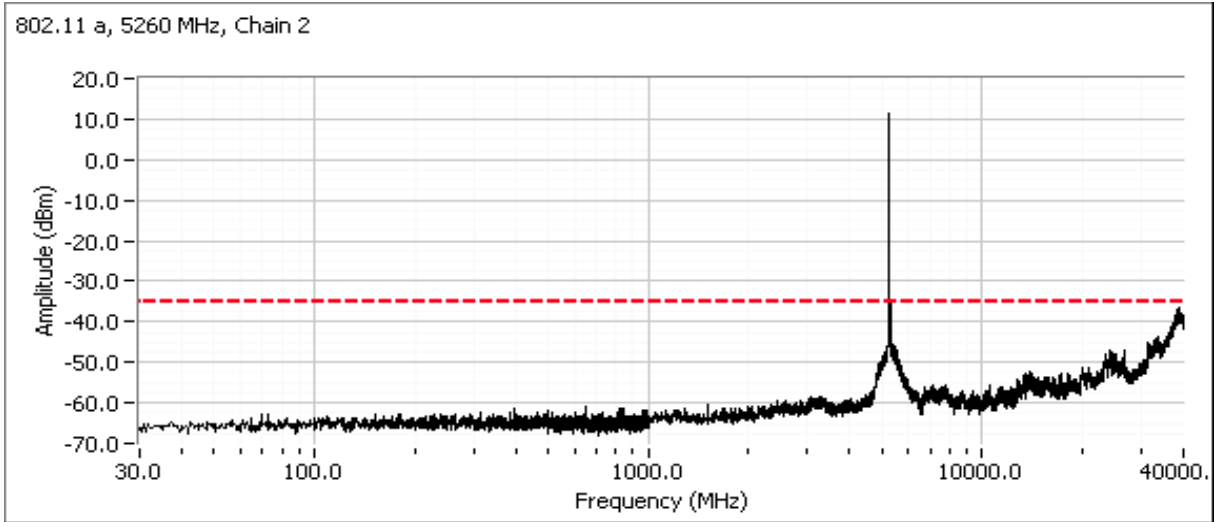

Client: Motorola	Job Number: J87247
Model: VAP2500	T-Log Number: T87276
	Account Manager: Christine Krebill
Contact: Rob Linebarger	
Standard: FCC	Class: N/A

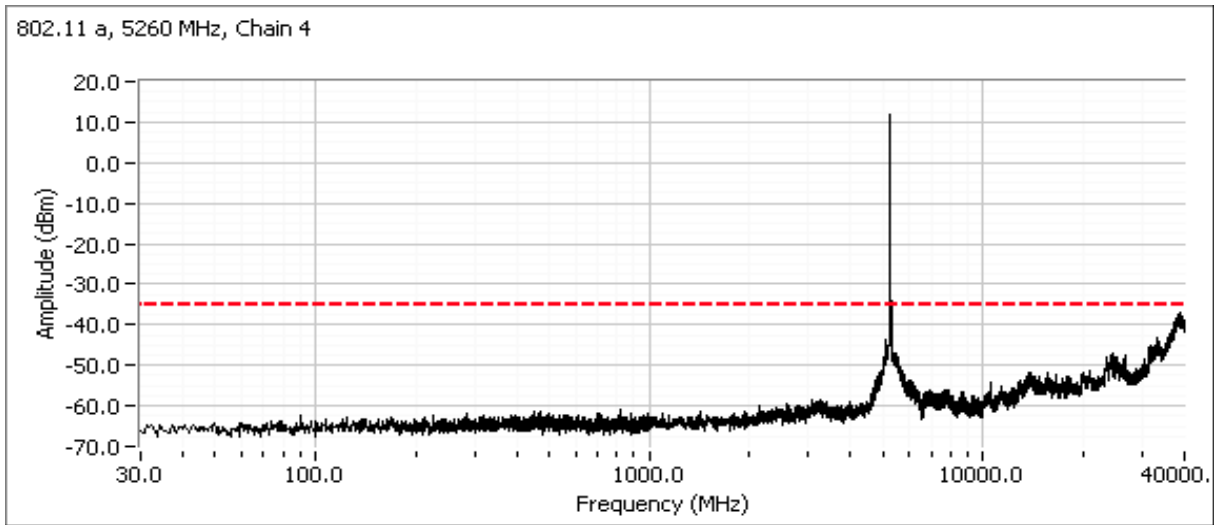

Center channel, 5250 - 5350 MHz Band

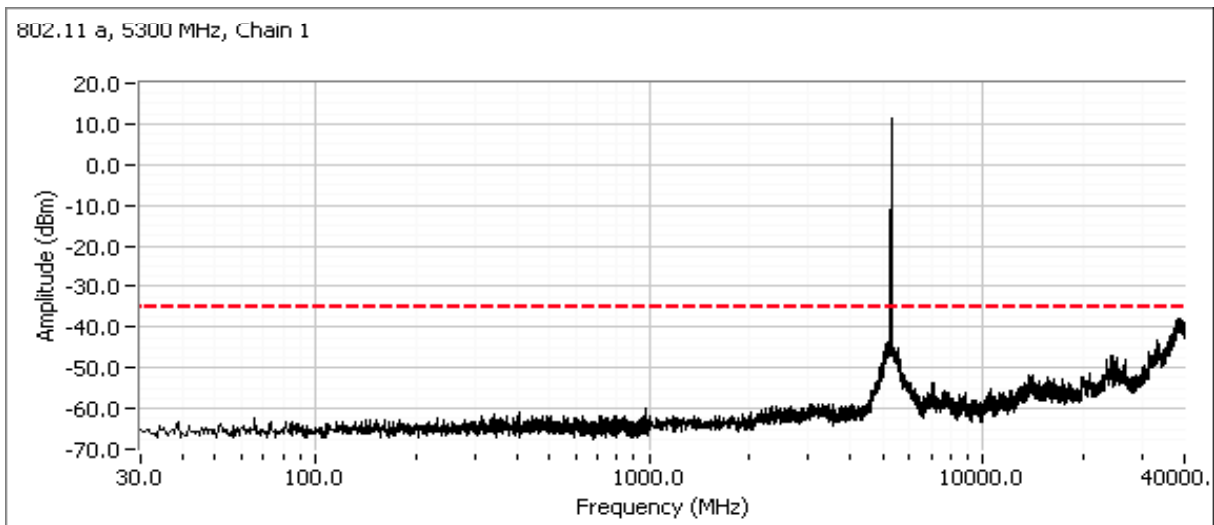

Client: Motorola	Job Number: J87247
Model: VAP2500	T-Log Number: T87276
	Account Manager: Christine Krebill
Contact: Rob Linebarger	
Standard: FCC	Class: N/A

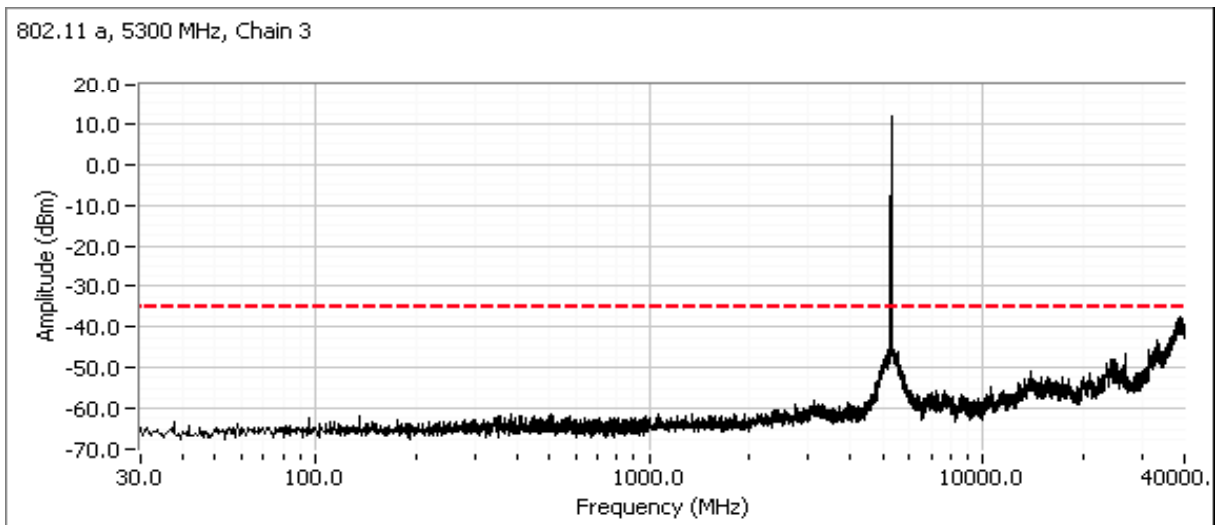
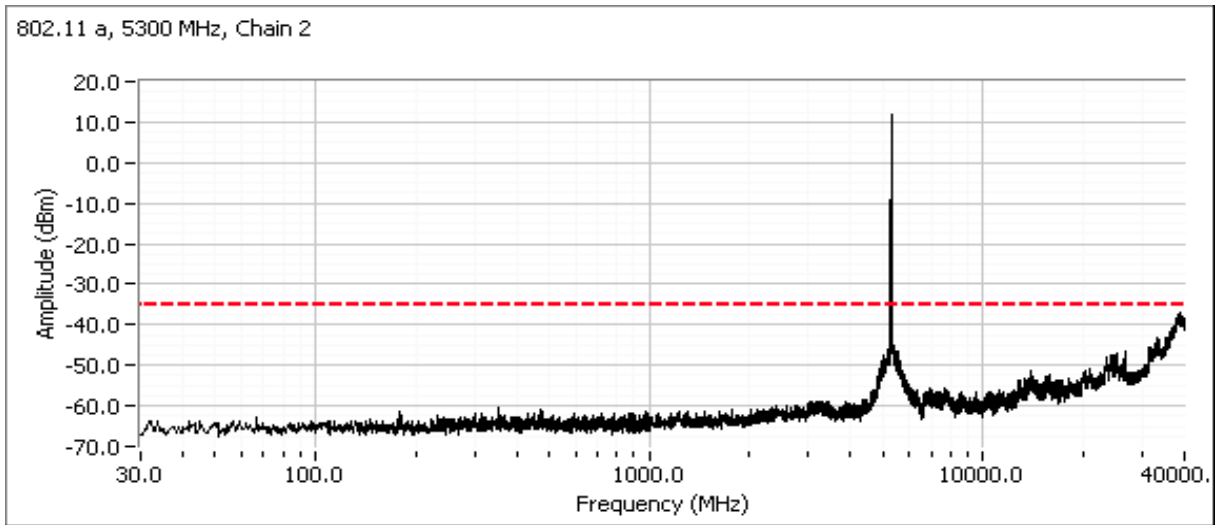

Client: Motorola	Job Number: J87247
Model: VAP2500	T-Log Number: T87276
	Account Manager: Christine Krebill
Contact: Rob Linebarger	
Standard: FCC	Class: N/A

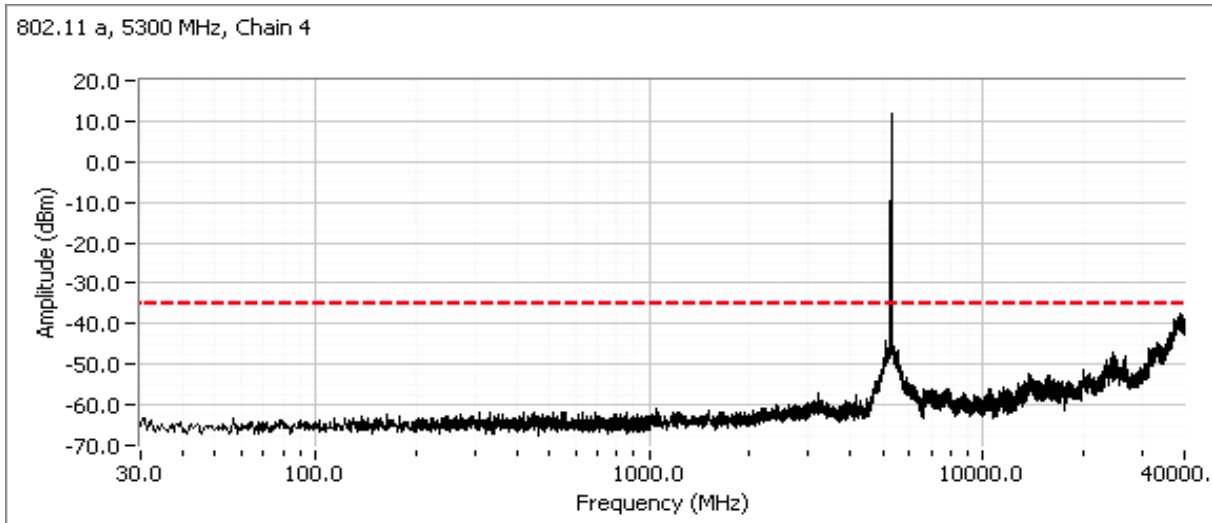

High channel, 5250 - 5350 MHz Band

Note - compliance with the radiated limits for the restricted band immediately above 5350MHz is demonstrated through the radiated emissions tests.

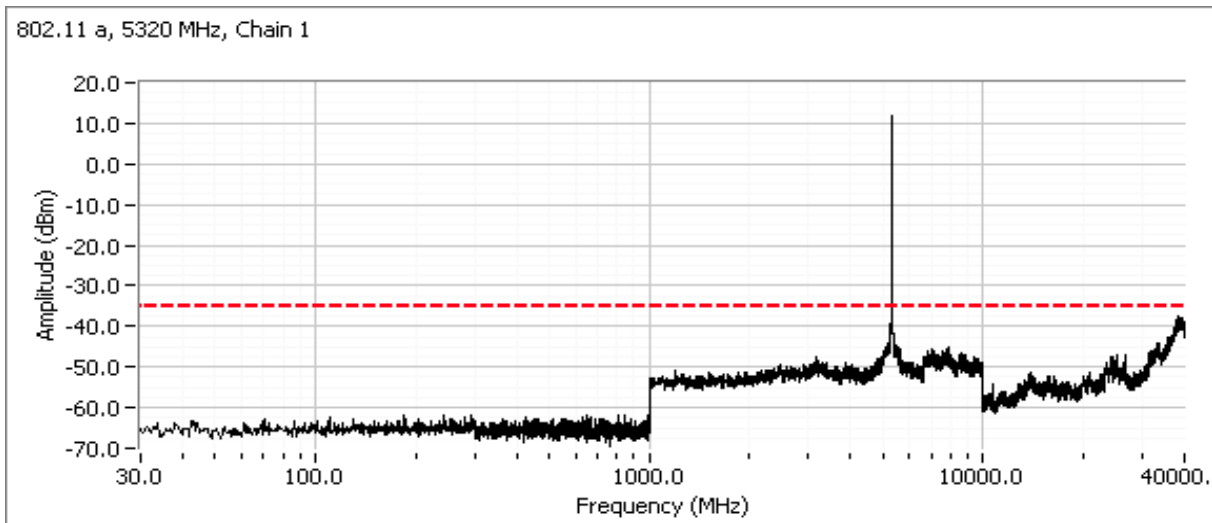

Client: Motorola	Job Number: J87247
Model: VAP2500	T-Log Number: T87276
	Account Manager: Christine Krebill
Contact: Rob Linebarger	
Standard: FCC	Class: N/A

802.11 a, 5320 MHz, Chain 2

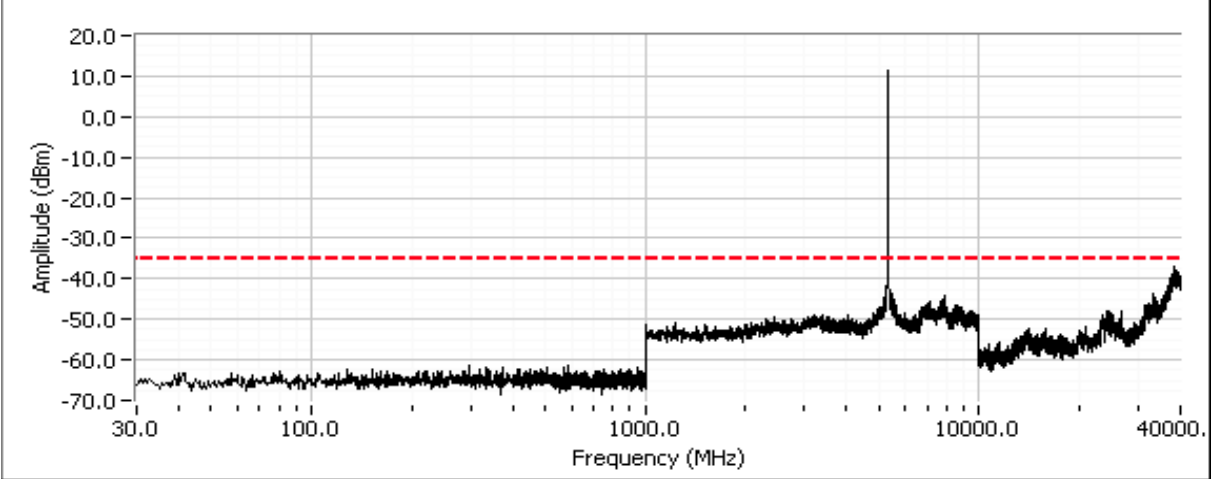

802.11 a, 5320 MHz, Chain 3

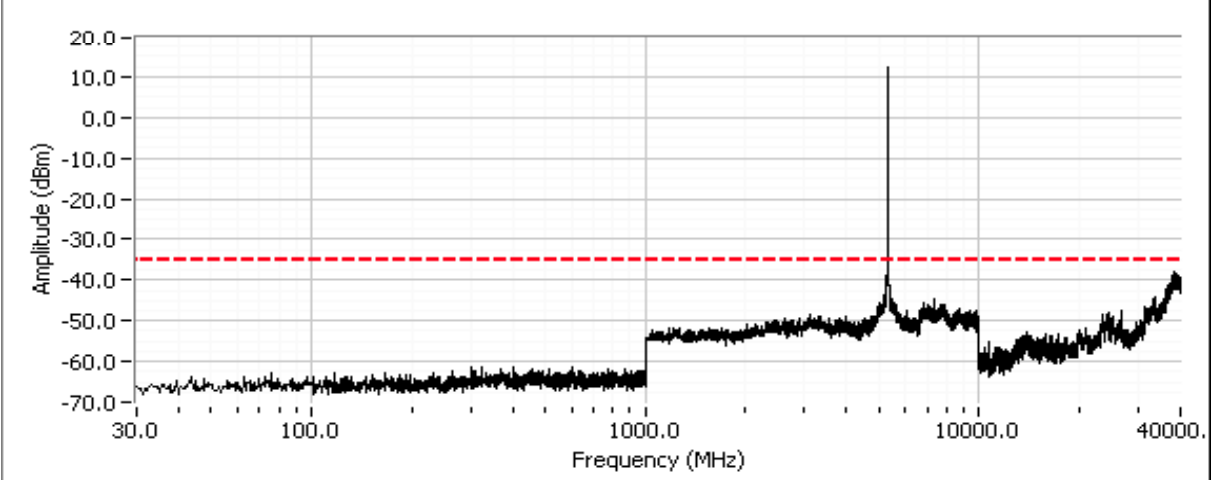

Client: Motorola	Job Number: J87247
Model: VAP2500	T-Log Number: T87276
Contact: Rob Linebarger	Account Manager: Christine Krebill
Standard: FCC	Class: N/A

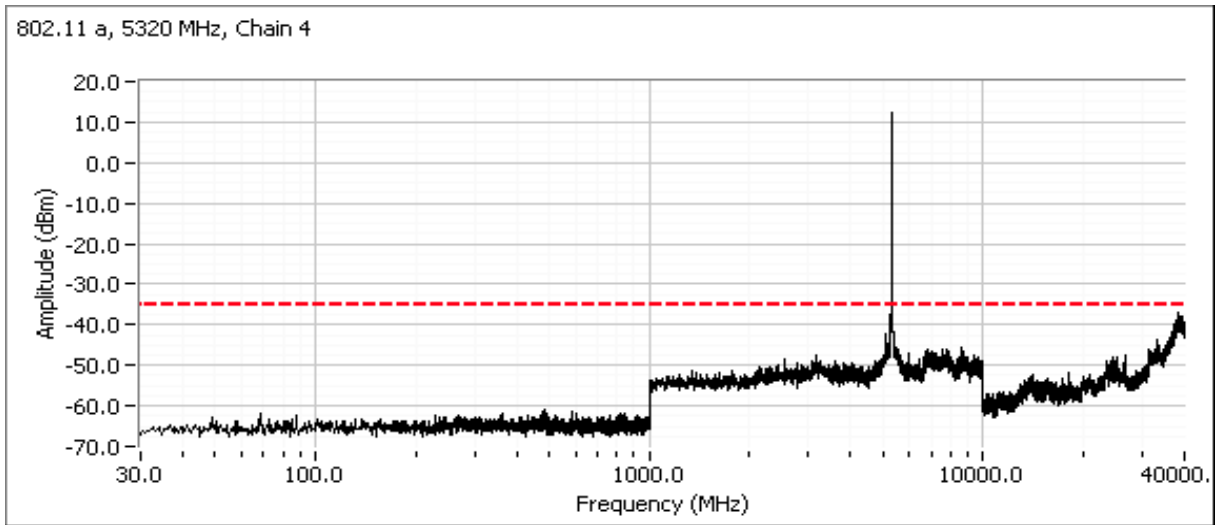

Low channel, 5470 - 5725 MHz Band

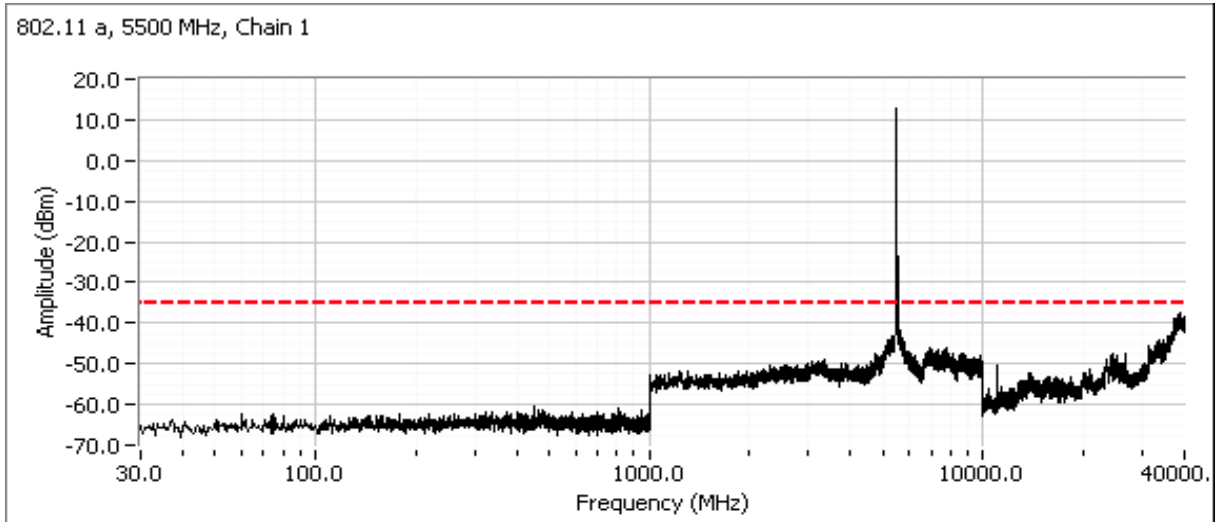

Client: Motorola	Job Number: J87247
Model: VAP2500	T-Log Number: T87276
	Account Manager: Christine Krebill
Contact: Rob Linebarger	
Standard: FCC	Class: N/A

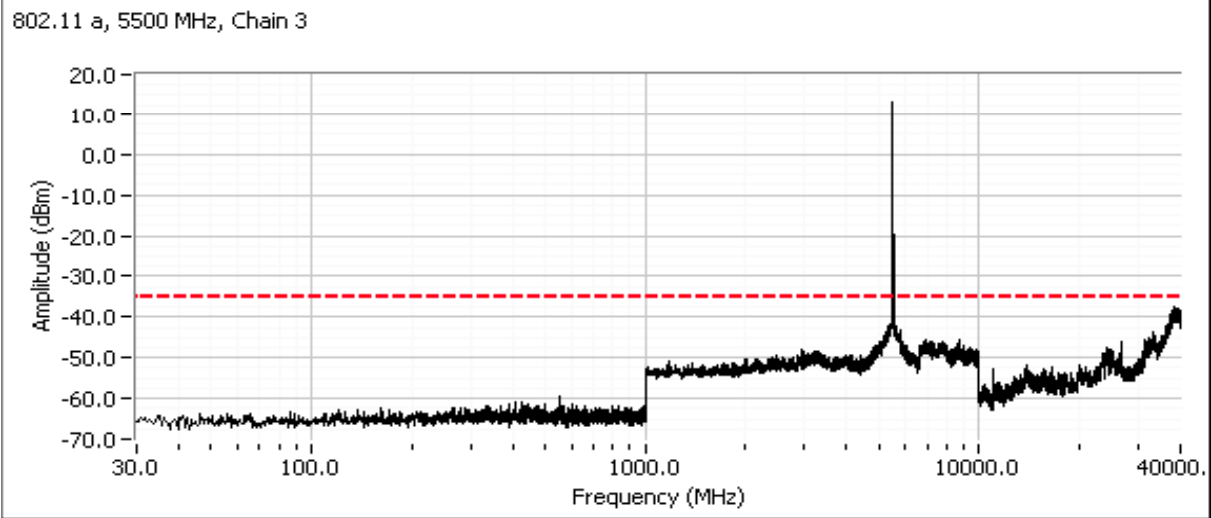
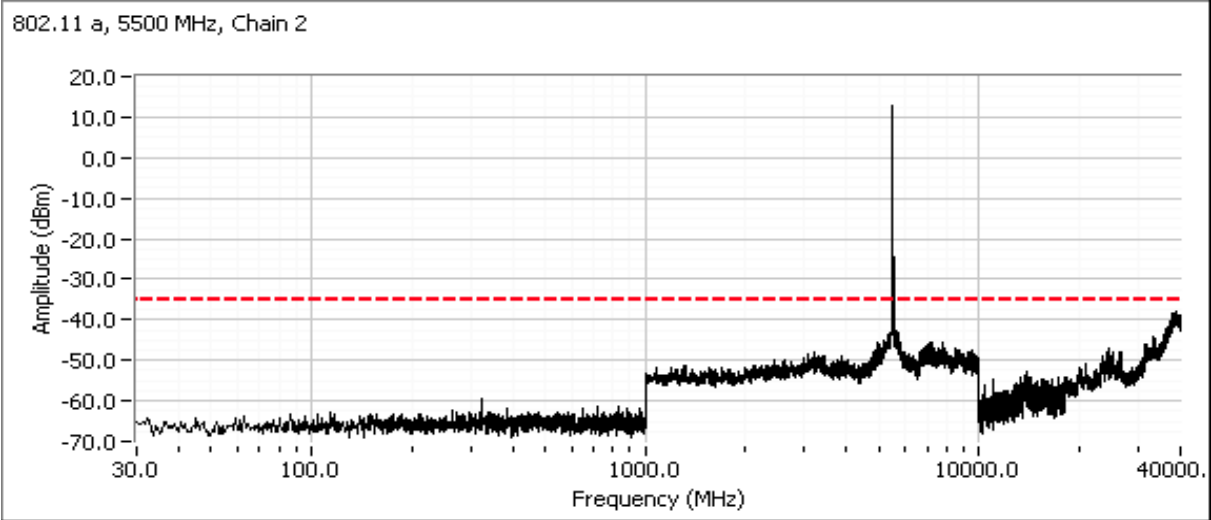

Client: Motorola	Job Number: J87247
Model: VAP2500	T-Log Number: T87276
Contact: Rob Linebarger	Account Manager: Christine Krebill
Standard: FCC	Class: N/A

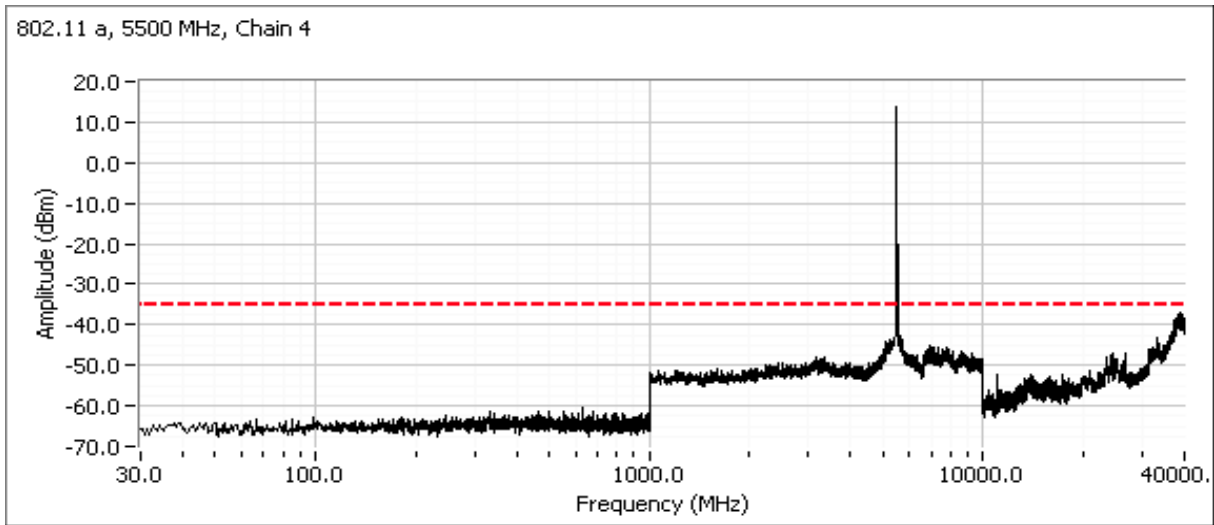

Center channel, 5470 - 5725 MHz Band

For master devices - This plot is showing that the 20dB bandwidth of the channel closest to 5600 MHz does not spill into the 5600-5650 MHz band. RB > 1% of OBW. Span 2-5 times OBW.

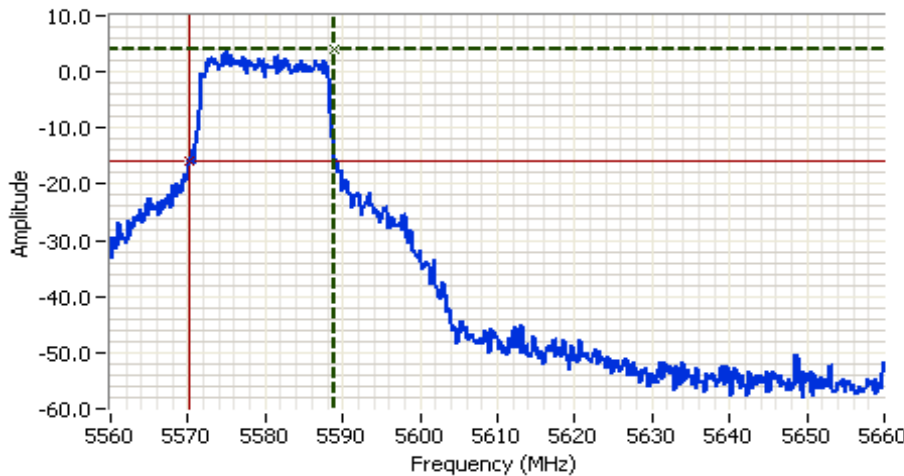

Analyzer Settings

Agilent Technologies, E4446A
 CF: 5610.000 MHz
 SPAN: 100.000 MHz
 RB: 200 kHz
 VB: 620 kHz
 Detector: POS
 Attn: 10 DB
 RL Offset: 11.0 DB
 Sweep Time: 2.4ms
 Ref Lvl: 8.0 DBM

Comments

20dB BW: 18.833 MHz
 FH: 5589.0000 MHz
 802.11a, Chain 1

Cursor 1	5589.0000	4.17	
Cursor 2	5570.1667	-15.84	

Delta Freq. 18.833
 Delta Amplitude 20.00

Client: Motorola	Job Number: J87247
Model: VAP2500	T-Log Number: T87276
Contact: Rob Linebarger	Account Manager: Christine Krebill
Standard: FCC	Class: N/A

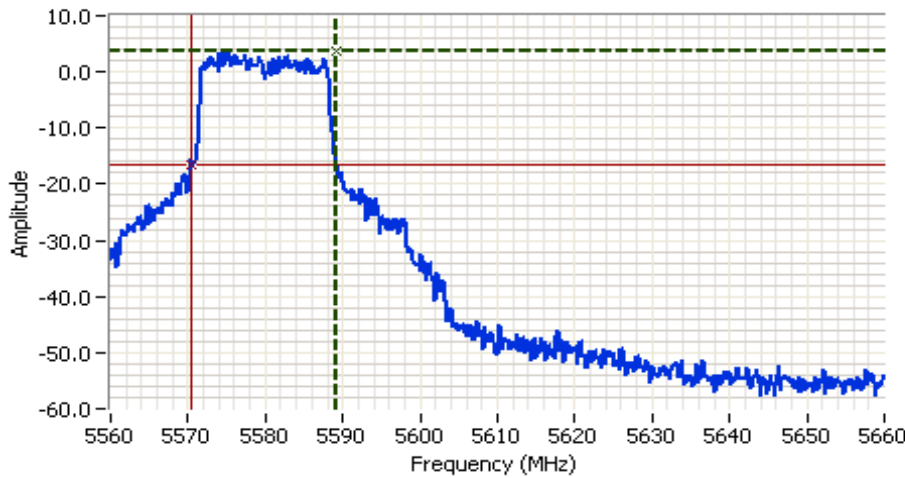

Analyzer Settings
 Agilent Technologies, E4446A
 CF: 5610.000 MHz
 SPAN: 100.000 MHz
 RB: 200 kHz
 VB: 620 kHz
 Detector: POS
 Attn: 10 DB
 RL Offset: 11.0 DB
 Sweep Time: 2.4ms
 Ref Lvl: 8.0 DBM

Comments
 20dB BW: 18.833 MHz
 FH: 5589.1667 MHz
 802.11a, Chain 2

Cursor 1 5589.1667 3.59
 Cursor 2 5570.3333 -16.41

Delta Freq. 18.833
 Delta Amplitude 20.00

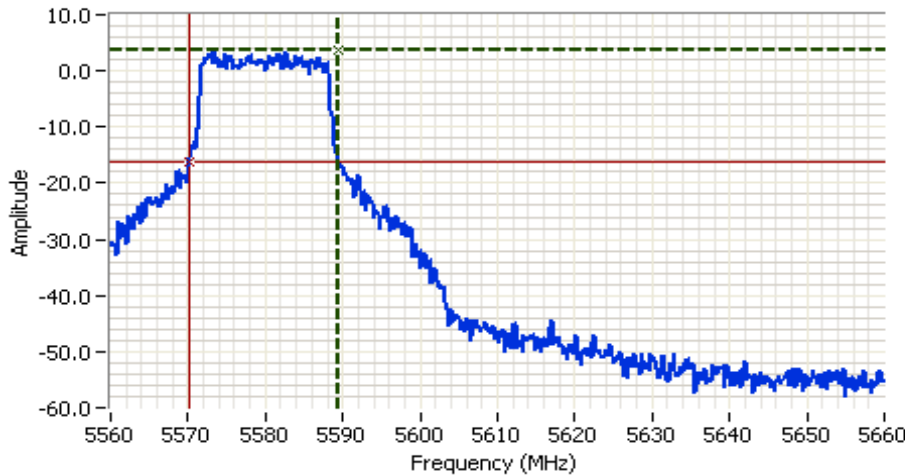

Analyzer Settings
 Agilent Technologies, E4446A
 CF: 5610.000 MHz
 SPAN: 100.000 MHz
 RB: 200 kHz
 VB: 620 kHz
 Detector: POS
 Attn: 10 DB
 RL Offset: 11.0 DB
 Sweep Time: 2.4ms
 Ref Lvl: 8.0 DBM

Comments
 20dB BW: 19.167 MHz
 FH: 5589.3333 MHz
 802.11a, Chain 3

Cursor 1 5589.3333 3.86
 Cursor 2 5570.1667 -16.14

Delta Freq. 19.167
 Delta Amplitude 20.00



Client: Motorola	Job Number: J87247
Model: VAP2500	T-Log Number: T87276
Contact: Rob Linebarger	Account Manager: Christine Krebill
Standard: FCC	Class: N/A

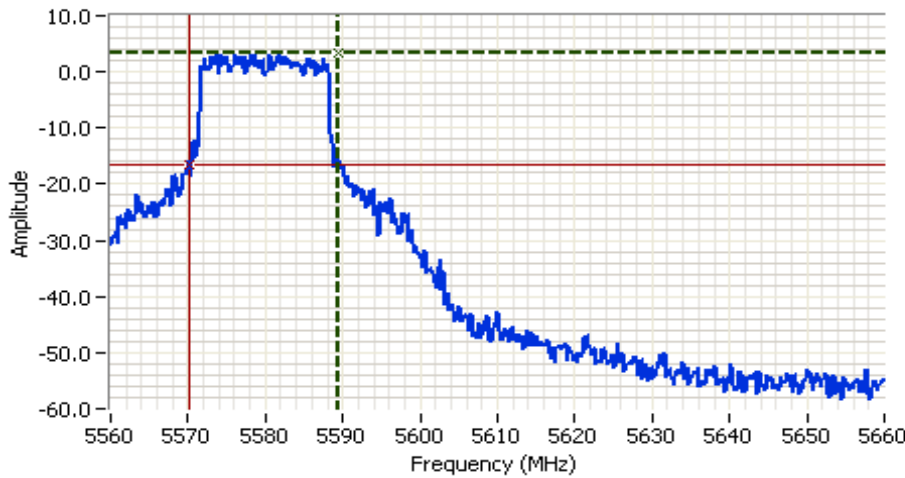

Analyzer Settings

Agilent Technologies, E4446A
 CF: 5610.000 MHz
 SPAN: 100.000 MHz
 RB: 200 kHz
 VB: 620 kHz
 Detector: POS
 Attn: 10 DB
 RL Offset: 11.0 DB
 Sweep Time: 2.4ms
 Ref Lvl: 8.0 DBM

Comments

20dB BW: 19.333 MHz
 FH: 5589.5000 MHz
 802.11a, Chain 4

Cursor 1: 5589.5000, 3.34
 Delta Freq: 19.333

Cursor 2: 5570.1667, -16.66
 Delta Amplitude: 20.00



Wide-band plot, RB=VB=1MHz (Peak measurements versus limit).

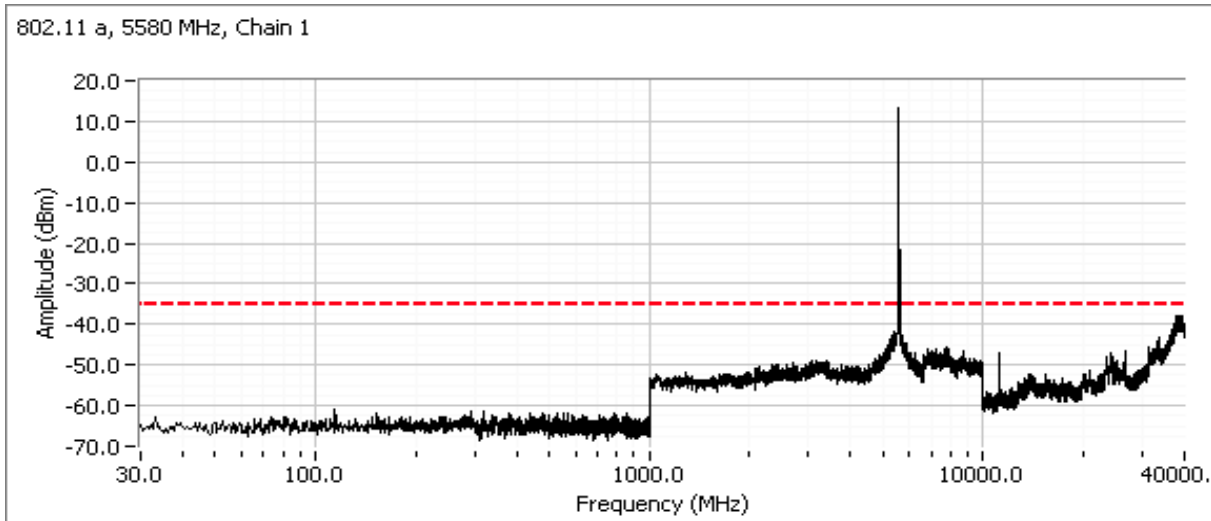

Client: Motorola	Job Number: J87247
Model: VAP2500	T-Log Number: T87276
	Account Manager: Christine Krebill
Contact: Rob Linebarger	
Standard: FCC	Class: N/A

802.11 a, 5580 MHz, Chain 2

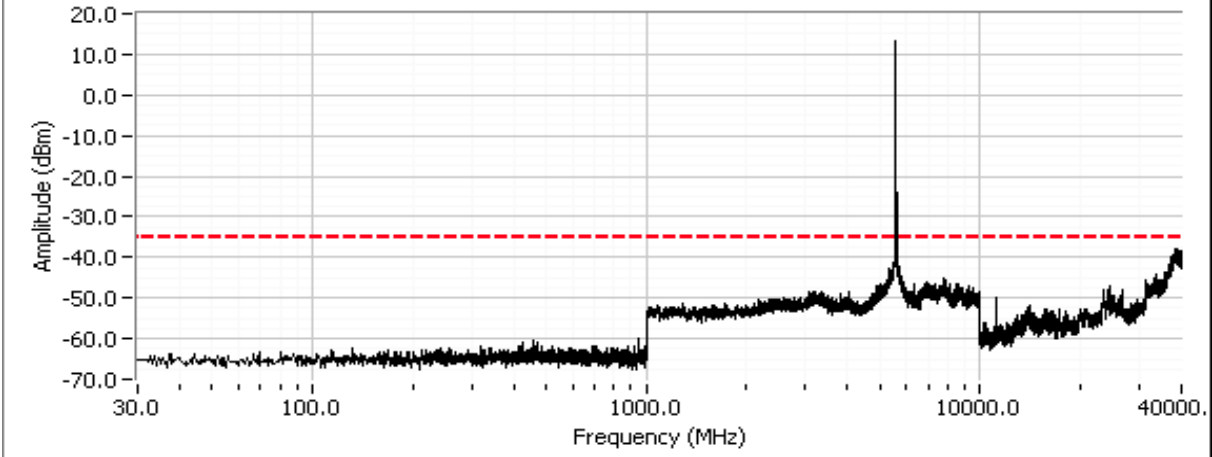

802.11 a, 5580 MHz, Chain 3

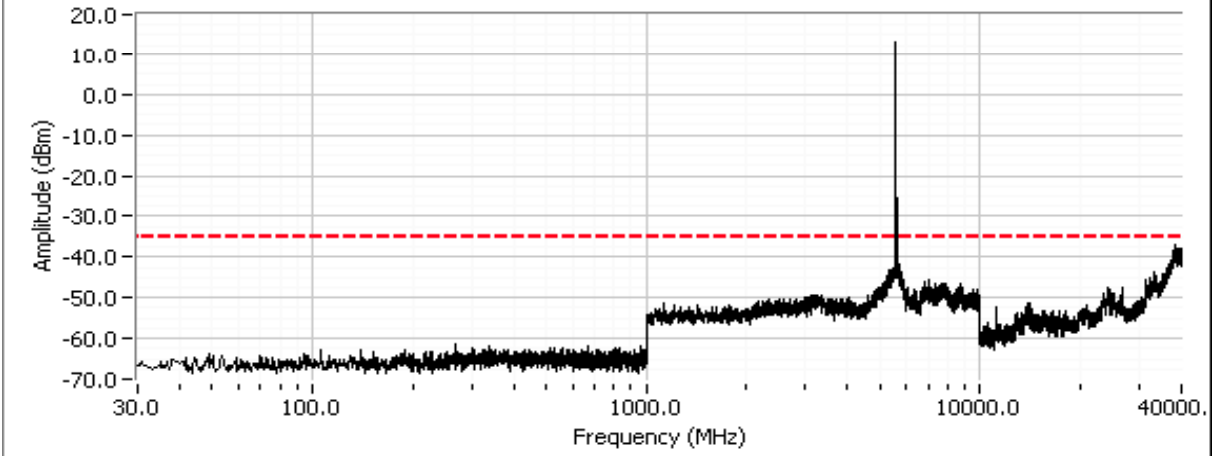

Client: Motorola	Job Number: J87247
Model: VAP2500	T-Log Number: T87276
Contact: Rob Linebarger	Account Manager: Christine Krebill
Standard: FCC	Class: N/A

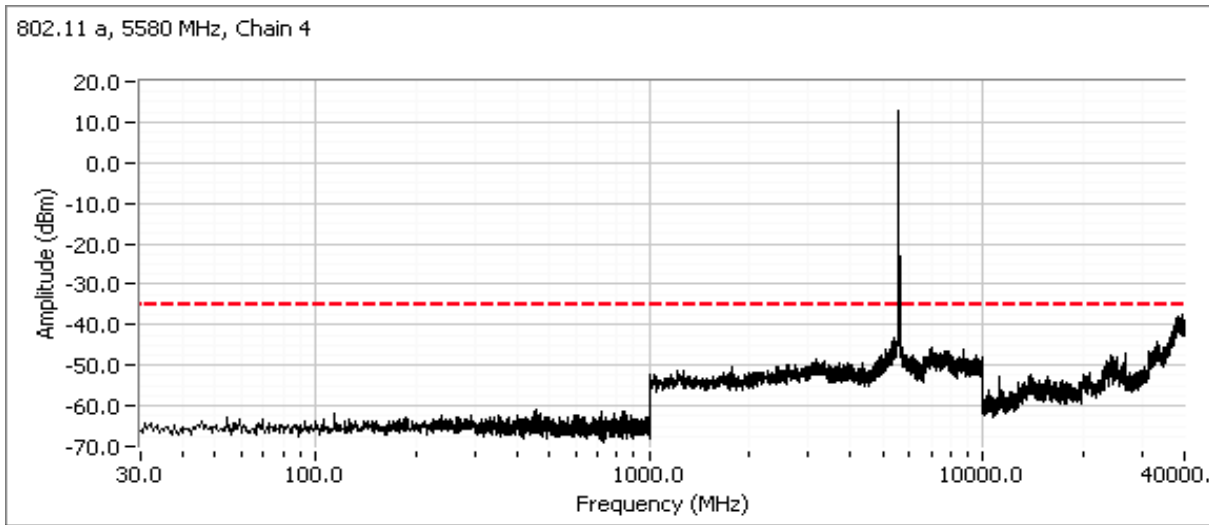

Channel adjacent to 5650 MHz (Master Device)

Plots showing that the 20dB bandwidth of the channel closest to 5650 MHz does not spill into the 5600-5650 MHz band. RB > 1% of OBW. Span is 2-5 times OBW.

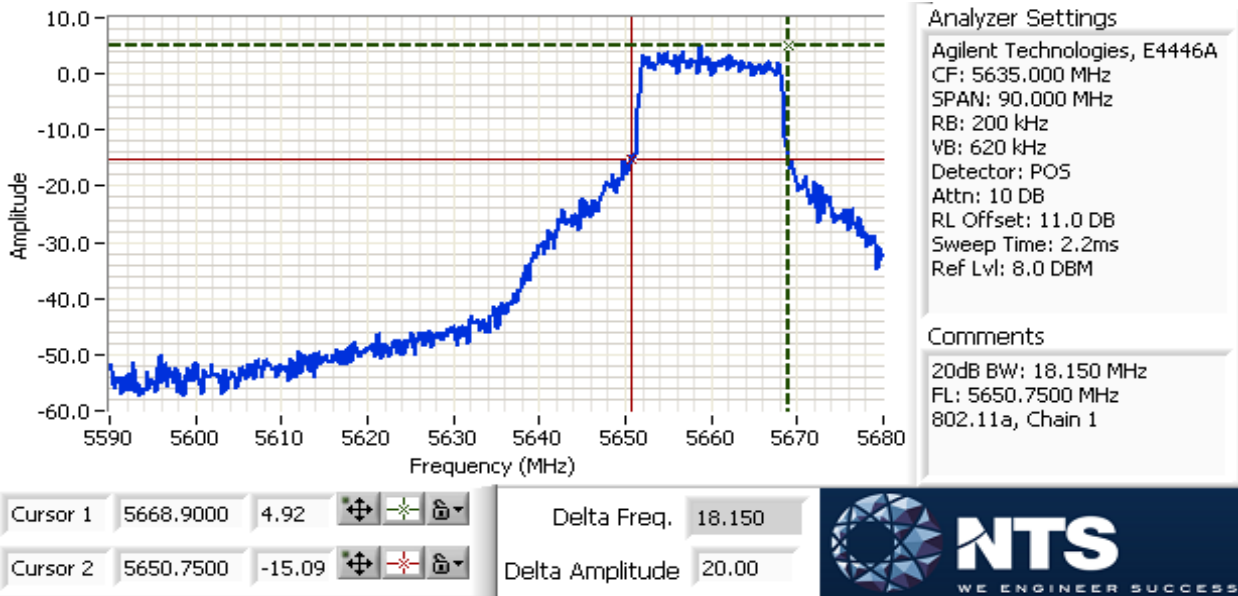

Client: Motorola	Job Number: J87247
Model: VAP2500	T-Log Number: T87276
Contact: Rob Linebarger	Account Manager: Christine Krebill
Standard: FCC	Class: N/A

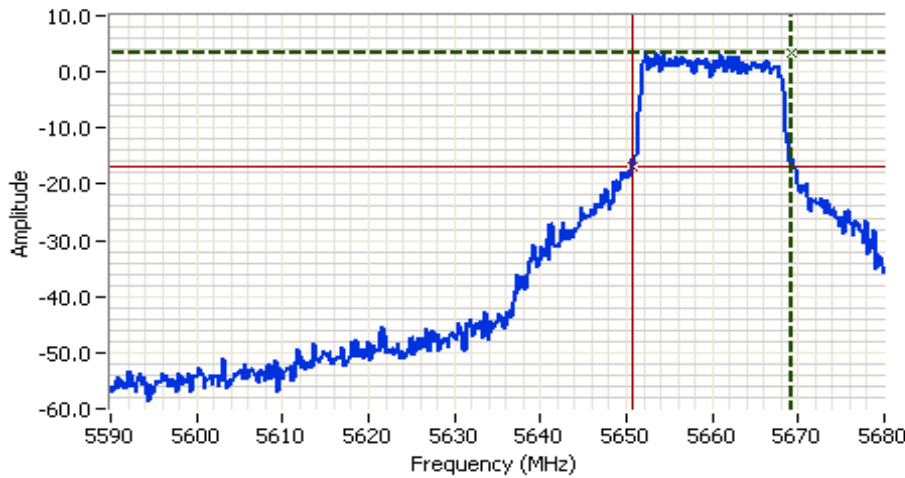

Analyzer Settings
 Agilent Technologies, E4446A
 CF: 5635.000 MHz
 SPAN: 90.000 MHz
 RB: 200 kHz
 VB: 620 kHz
 Detector: POS
 Attn: 10 DB
 RL Offset: 11.0 DB
 Sweep Time: 2.2ms
 Ref Lvl: 8.0 DBM

Comments
 20dB BW: 18.450 MHz
 FL: 5650.7500 MHz
 802.11a, Chain 2

Cursor 1 5669.2000 3.25
 Cursor 2 5650.7500 -16.75

Delta Freq. 18.450
 Delta Amplitude 20.00

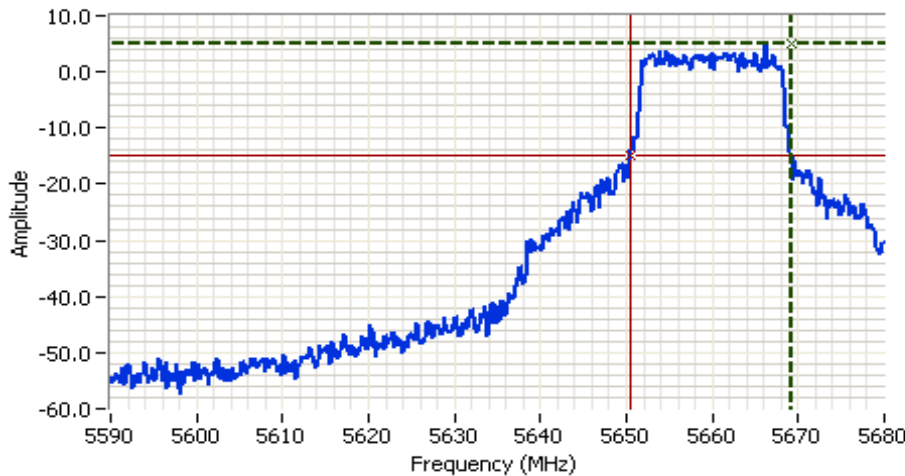

Analyzer Settings
 Agilent Technologies, E4446A
 CF: 5635.000 MHz
 SPAN: 90.000 MHz
 RB: 200 kHz
 VB: 620 kHz
 Detector: POS
 Attn: 10 DB
 RL Offset: 11.0 DB
 Sweep Time: 2.2ms
 Ref Lvl: 8.0 DBM

Comments
 20dB BW: 18.750 MHz
 FL: 5650.4500 MHz
 802.11a, Chain 3

Cursor 1 5669.2000 4.96
 Cursor 2 5650.4500 -15.04

Delta Freq. 18.750
 Delta Amplitude 20.00



Client: Motorola	Job Number: J87247
Model: VAP2500	T-Log Number: T87276
Contact: Rob Linebarger	Account Manager: Christine Krebill
Standard: FCC	Class: N/A

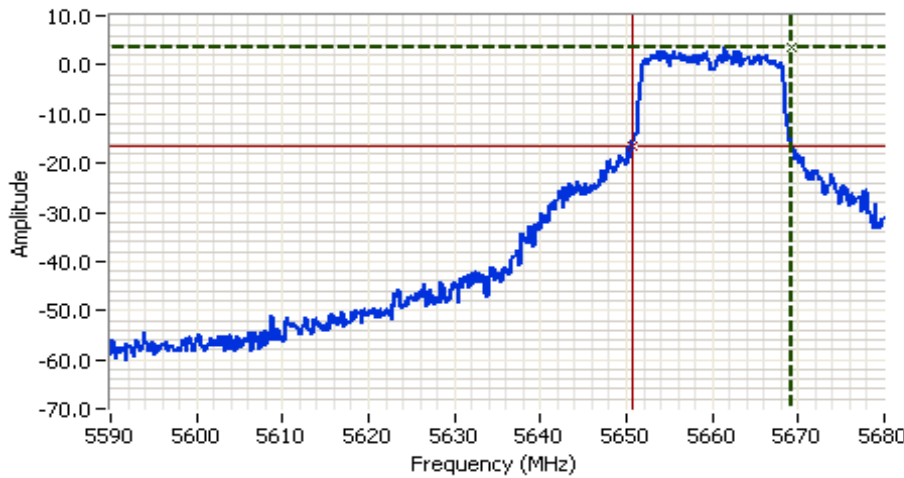

Analyzer Settings
 Agilent Technologies, E4446A
 CF: 5635.000 MHz
 SPAN: 90.000 MHz
 RB: 200 kHz
 VB: 620 kHz
 Detector: POS
 Attn: 10 DB
 RL Offset: 11.0 DB
 Sweep Time: 2.2ms
 Ref Lvl: 8.0 DBM

Comments
 20dB BW: 18.450 MHz
 FL: 5650.7500 MHz
 802.11a, Chain 4

Cursor 1: 5669.2000, 3.45
 Cursor 2: 5650.7500, -16.55
 Delta Freq: 18.450
 Delta Amplitude: 20.00



High channel, 5470 - 5725 MHz Band

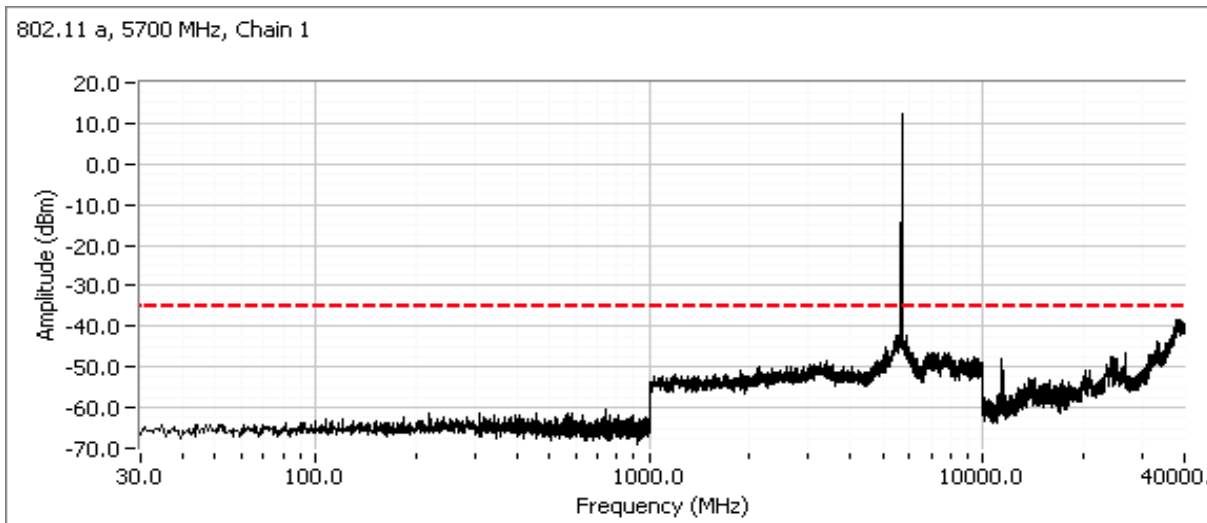

Client: Motorola	Job Number: J87247
Model: VAP2500	T-Log Number: T87276
	Account Manager: Christine Krebill
Contact: Rob Linebarger	
Standard: FCC	Class: N/A

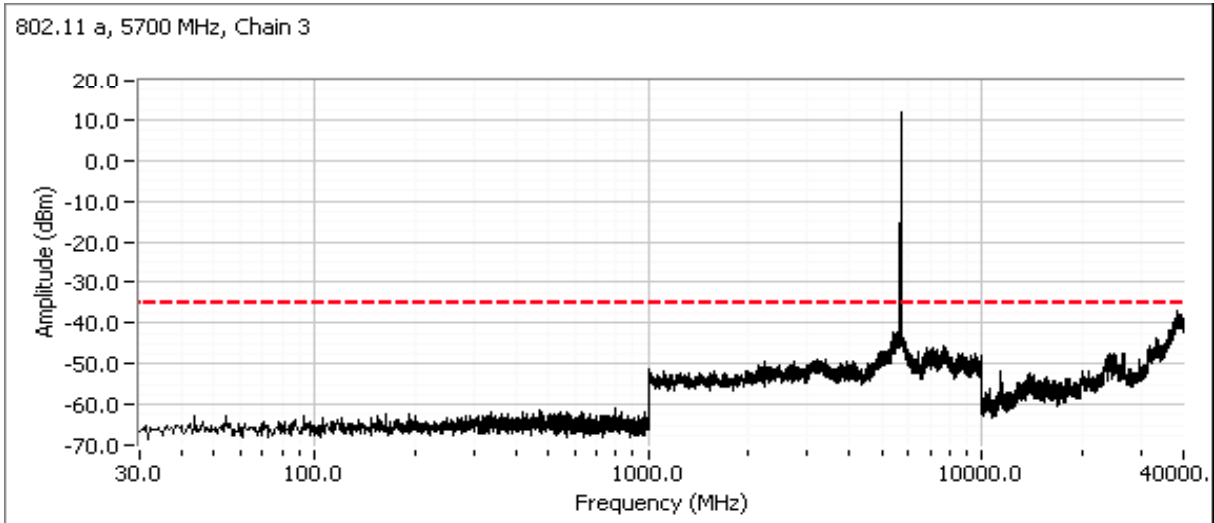
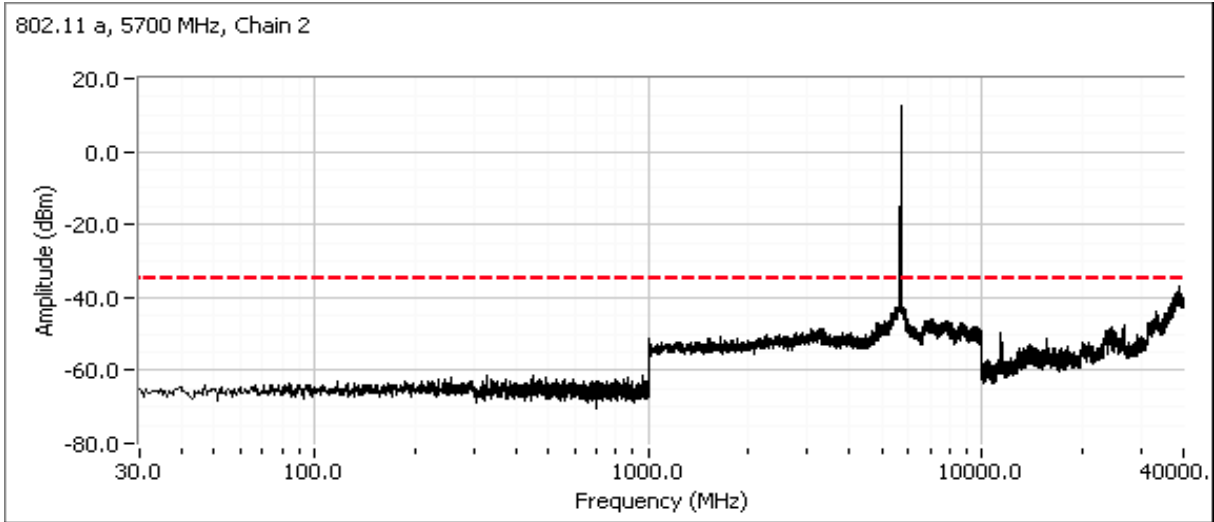

Client: Motorola	Job Number: J87247
Model: VAP2500	T-Log Number: T87276
Contact: Rob Linebarger	Account Manager: Christine Krebill
Standard: FCC	Class: N/A

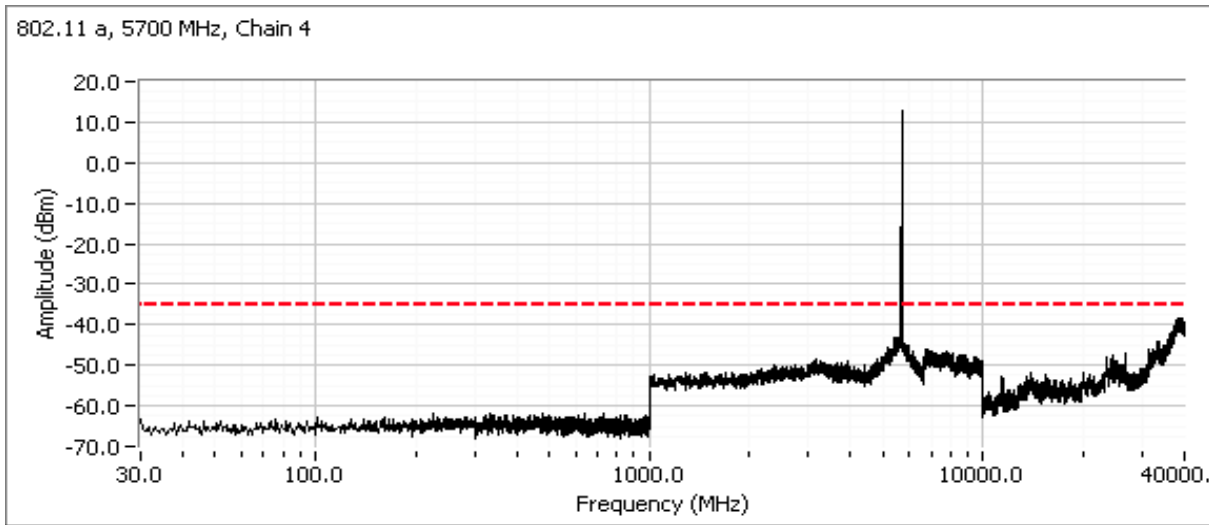

Run #3b: Out Of Band Spurious Emissions - Antenna Conducted - 802.n20 mode

Multichain Devices: Antenna gain used is the effective gain calculated in the power section of this data sheet. The plots were obtained for each chain individually and the limit was adjusted to account for all chains transmitting simultaneously.

Number of transmit chains: 4
 Maximum Antenna Gain: 2.0 dBi
 Spurious Limit: -27.0 dBm/MHz eirp
 Adjustment for 4 chains: -6.0 dB adjustment for multiple chains.
 Limit Used On Plots ^{Note 1}: -35.0 dBm/MHz Peak Limit (RB=VB=1MHz)

Note 1:	The -27dBm/MHz limit is an eirp limit. The limit for antenna port conducted measurements is adjusted to take into consideration the maximum antenna gain (limit = -27dBm - antenna gain). Radiated field strength measurements for signals more than 50MHz from the bands and that are close to the limit are made to determine compliance as the antenna gain is not known at these frequencies.
Note 2:	All spurious signals below 1GHz are measured during digital device radiated emissions test.
Note 3:	Signals within 10MHz of the 5.725 or 5.825 Band edge are subject to a limit of -17dBm EIRP
Note 4:	If the device is for outdoor use then the -27dBm eirp limit also applies in the 5150 - 5250 MHz band.
Note 5:	Signals that fall in the restricted bands of 15.205 are subject to the limit of 15.209.

Plots Showing Out-Of-Band Emissions (RBW=VBW=1MHz)

Low channel, 5150 - 5250 MHz Band

Compliance with the radiated limits for the restricted band immediately below 5150MHz is demonstrated through the radiated emissions tests.

Client: Motorola	Job Number: J87247
Model: VAP2500	T-Log Number: T87276
	Account Manager: Christine Krebill
Contact: Rob Linebarger	
Standard: FCC	Class: N/A

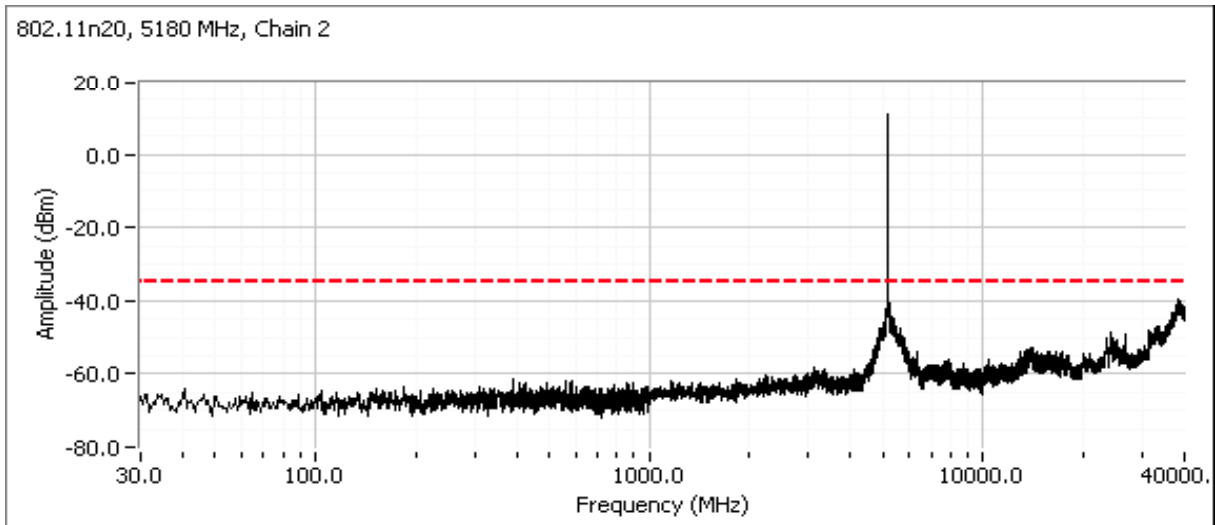
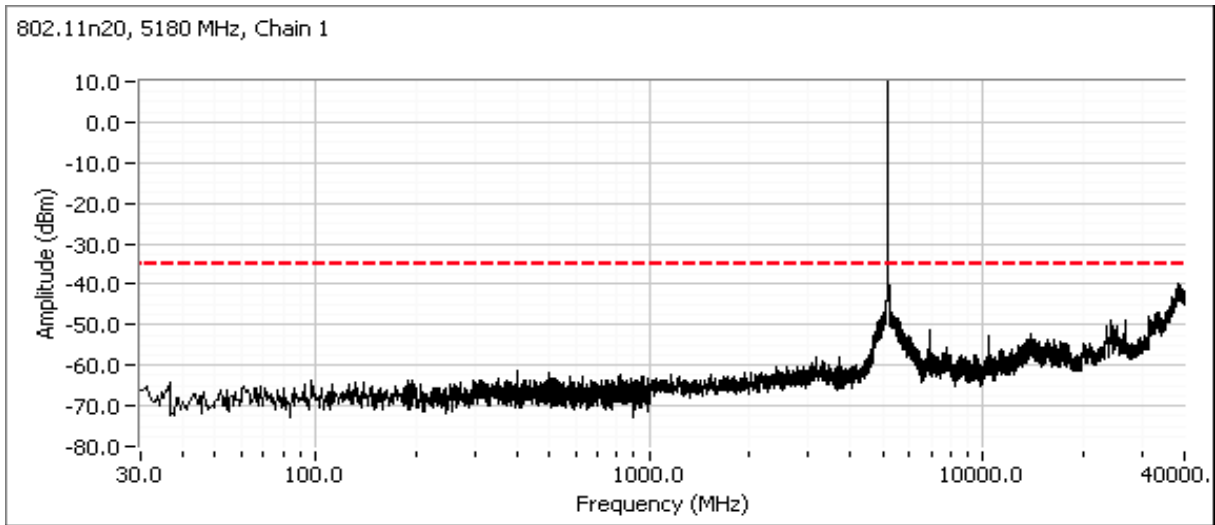

Client: Motorola	Job Number: J87247
Model: VAP2500	T-Log Number: T87276
	Account Manager: Christine Krebill
Contact: Rob Linebarger	
Standard: FCC	Class: N/A

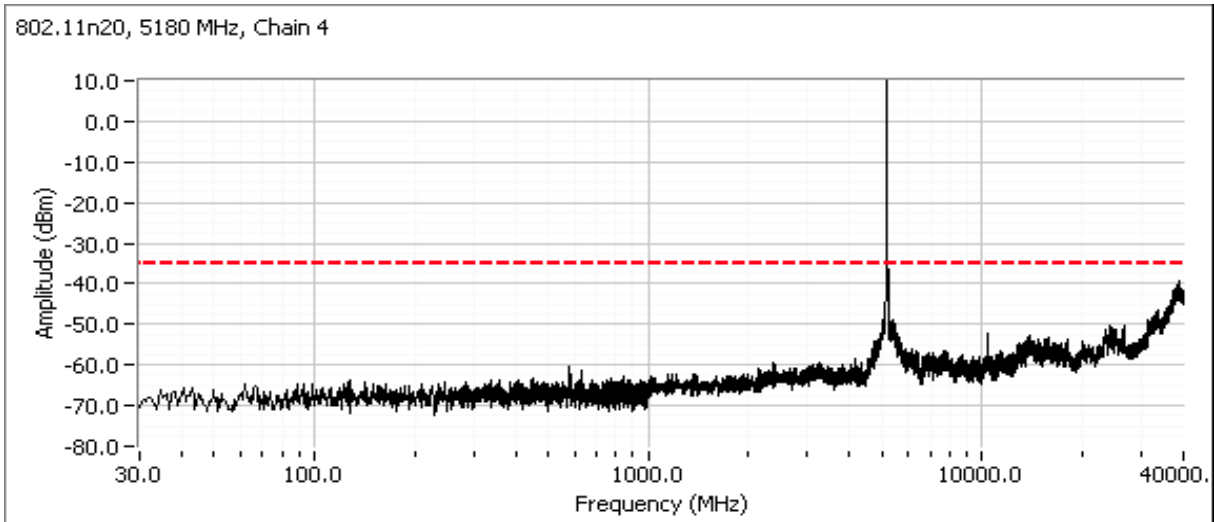
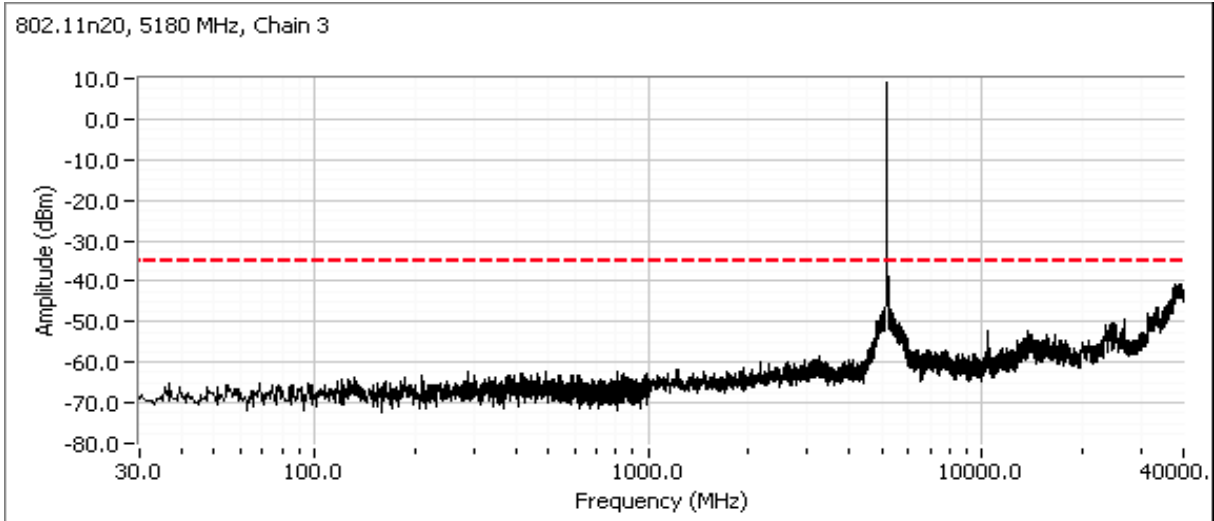

Client: Motorola	Job Number: J87247
Model: VAP2500	T-Log Number: T87276
	Account Manager: Christine Krebill
Contact: Rob Linebarger	
Standard: FCC	Class: N/A

Center channel, 5150 - 5250 MHz Band

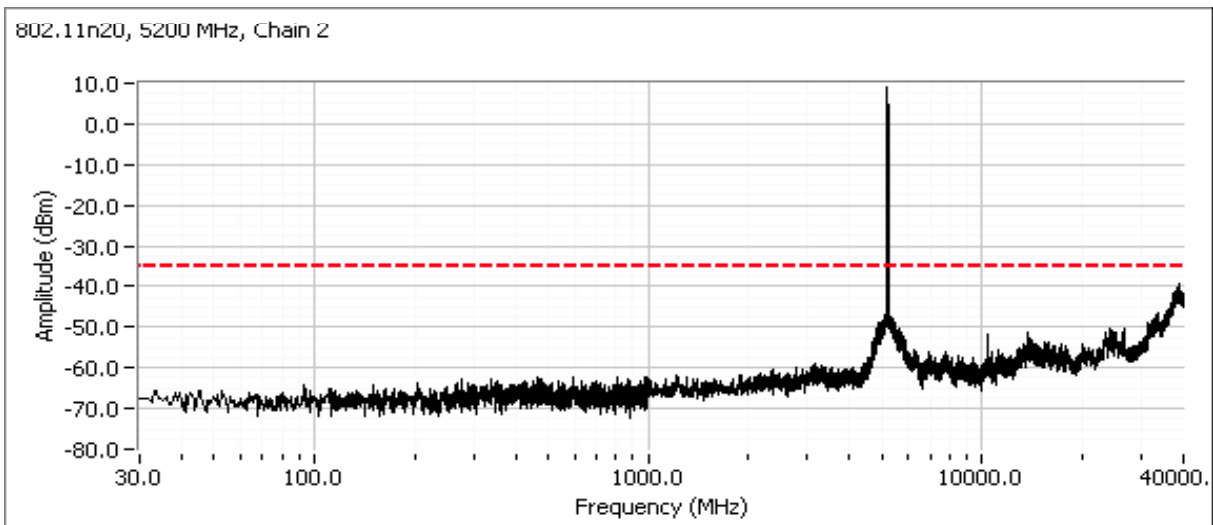
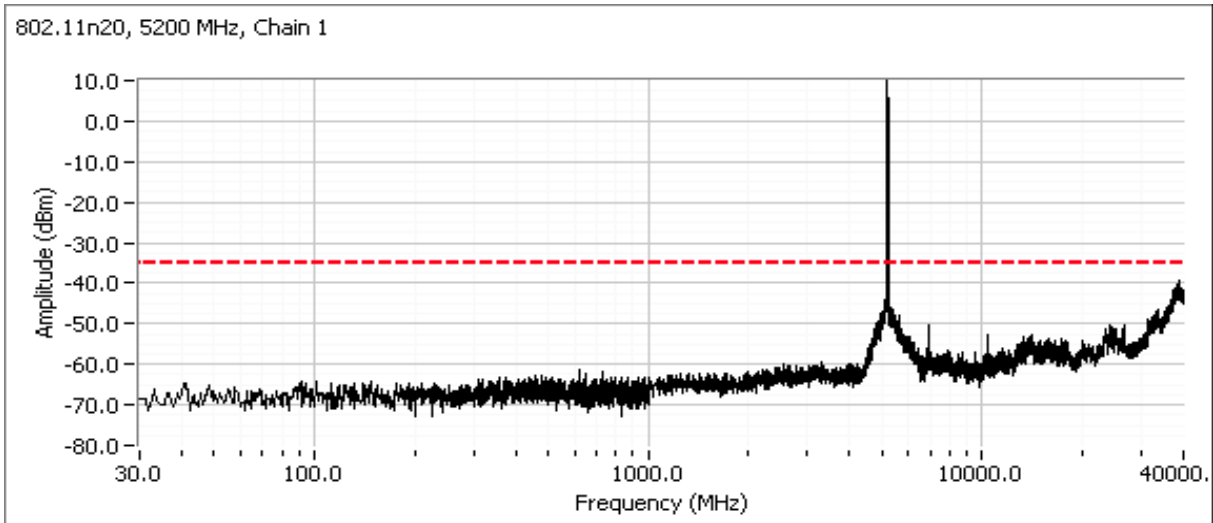

Client: Motorola	Job Number: J87247
Model: VAP2500	T-Log Number: T87276
	Account Manager: Christine Krebill
Contact: Rob Linebarger	
Standard: FCC	Class: N/A

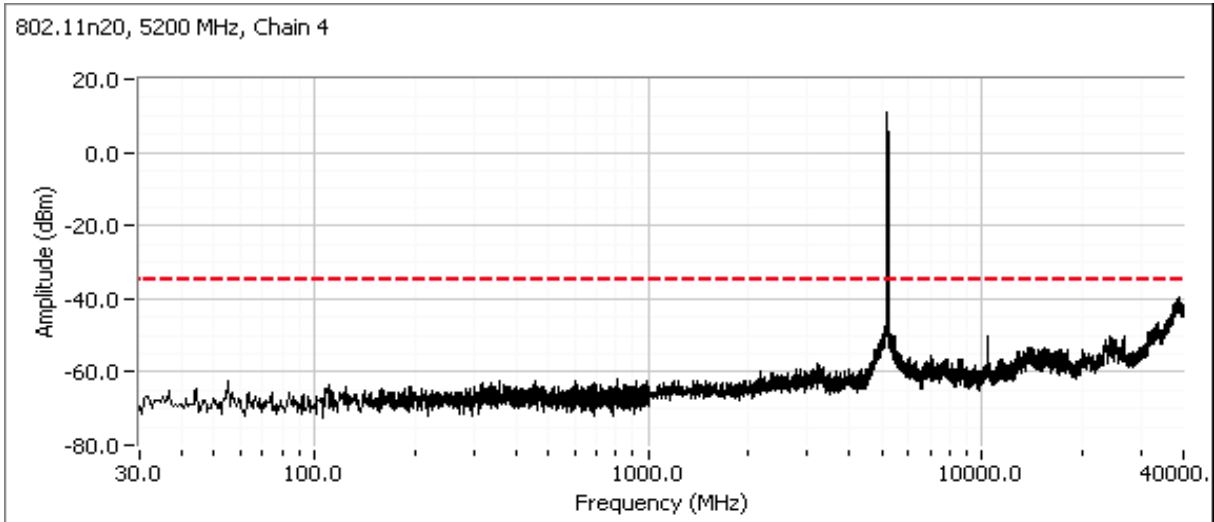
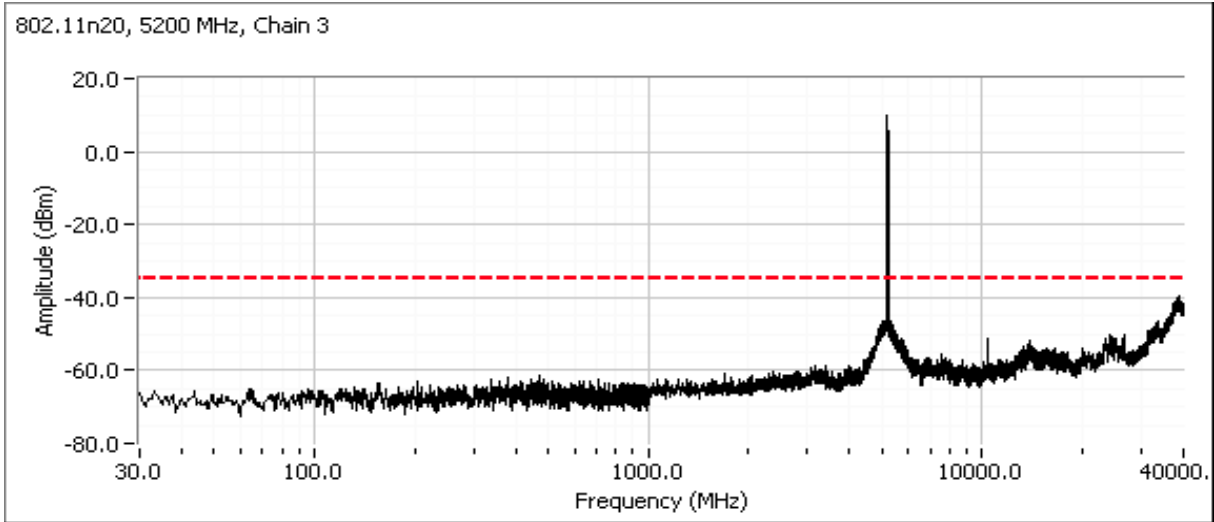

Client: Motorola	Job Number: J87247
Model: VAP2500	T-Log Number: T87276
	Account Manager: Christine Krebill
Contact: Rob Linebarger	
Standard: FCC	Class: N/A

High channel, 5150 - 5250 MHz Band

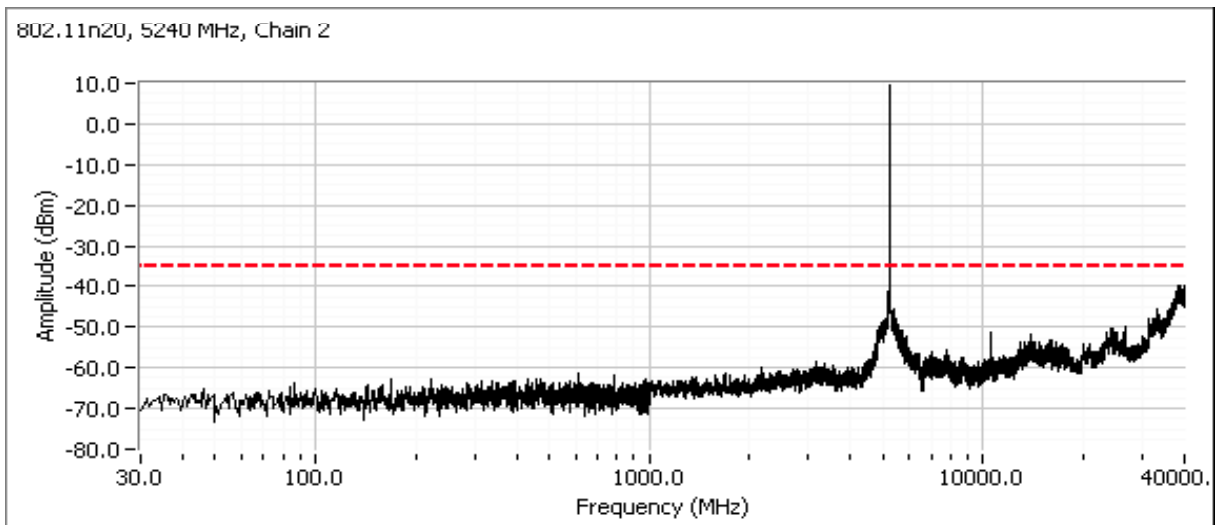
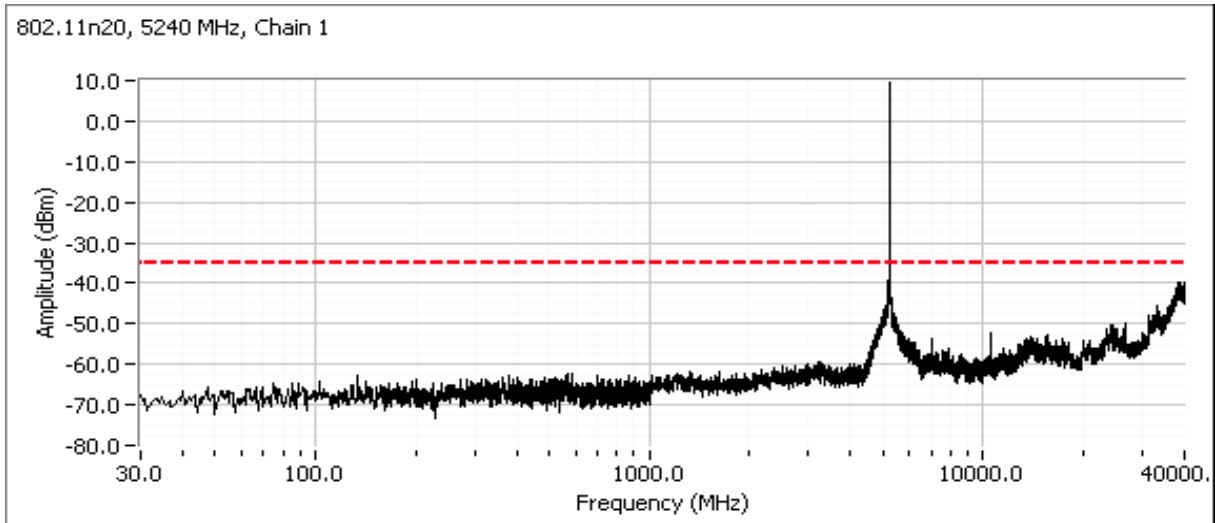

Client: Motorola	Job Number: J87247
Model: VAP2500	T-Log Number: T87276
	Account Manager: Christine Krebill
Contact: Rob Linebarger	
Standard: FCC	Class: N/A

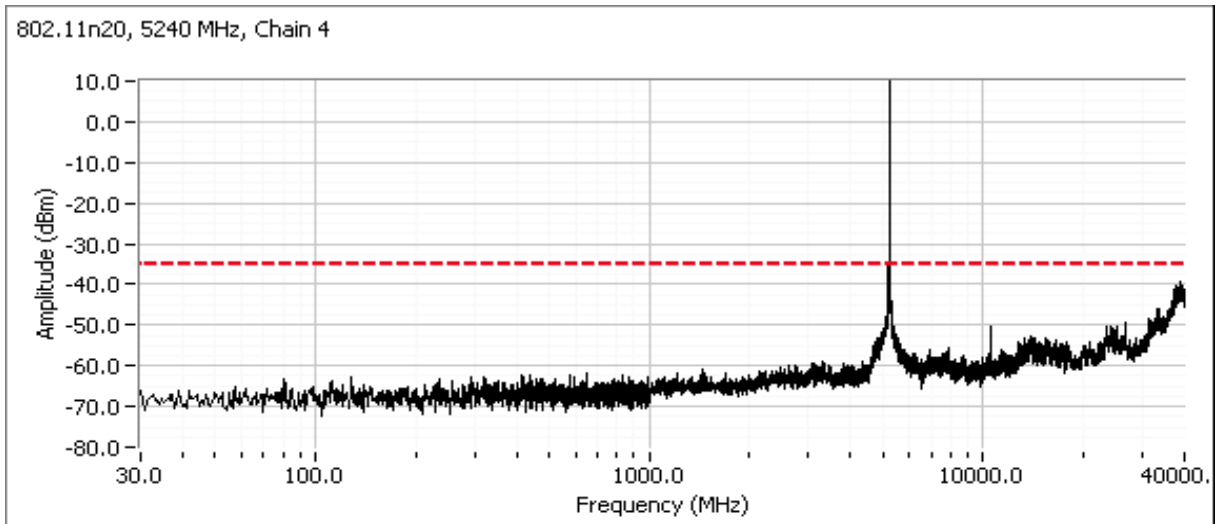
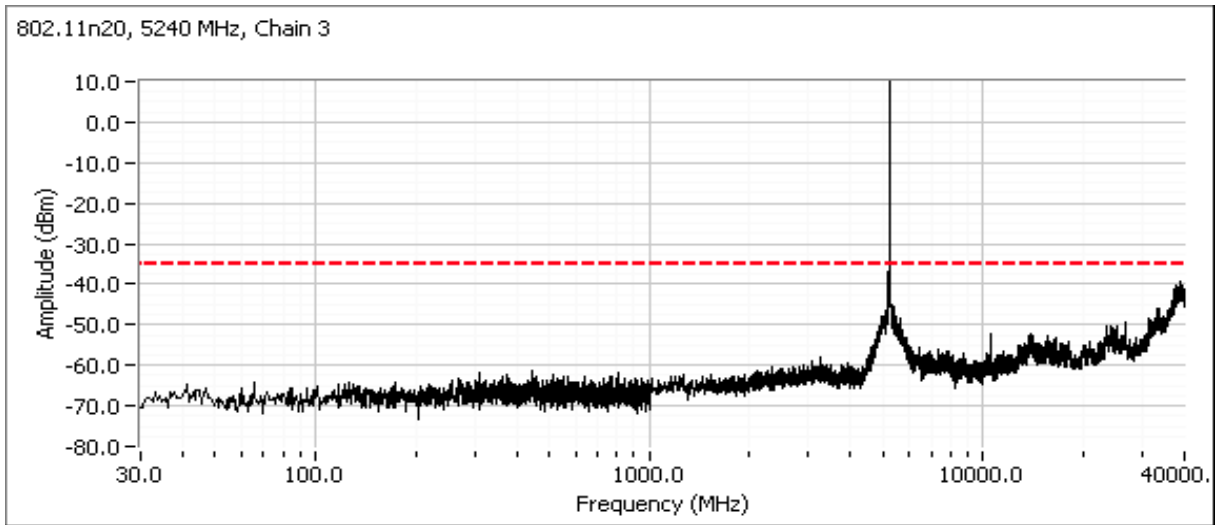

Client: Motorola	Job Number: J87247
Model: VAP2500	T-Log Number: T87276
Contact: Rob Linebarger	Account Manager: Christine Krebill
Standard: FCC	Class: N/A

Low channel, 5250 - 5350 MHz Band

Wide-band plot, RB=VB=1MHz (Peak measurements versus limit).

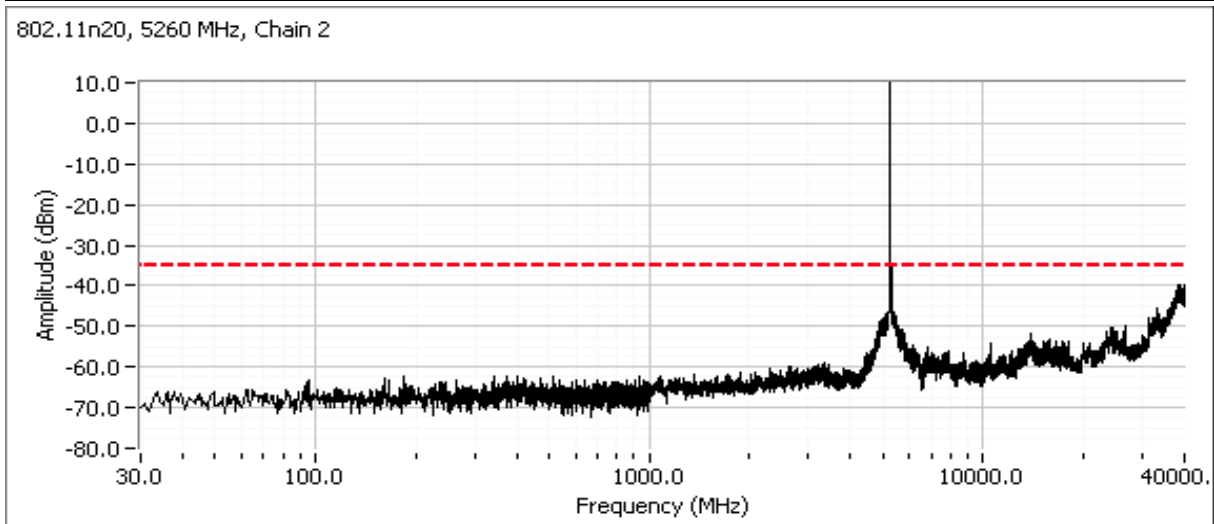
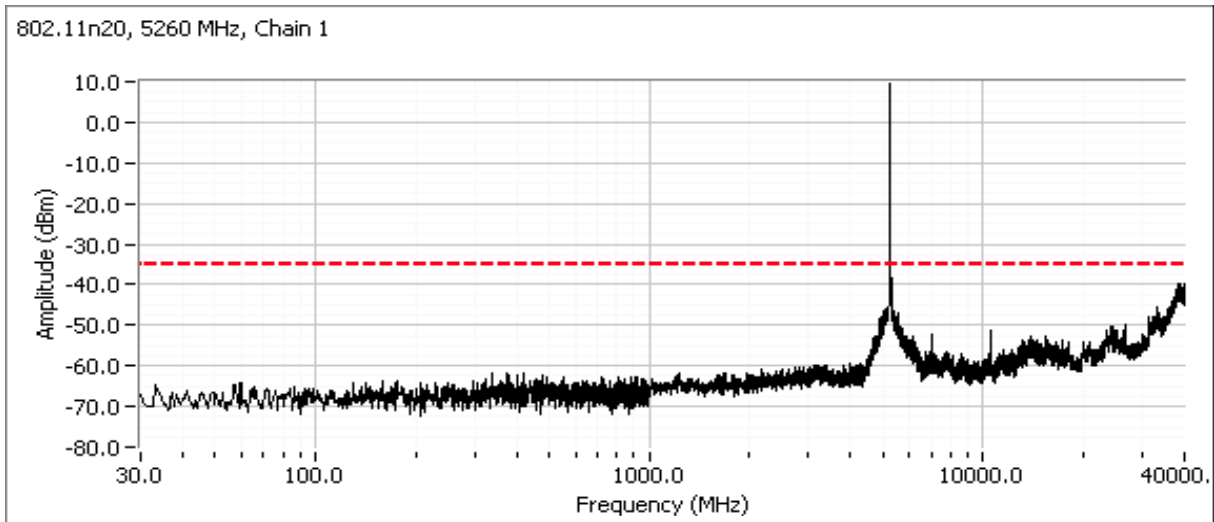

Client: Motorola	Job Number: J87247
Model: VAP2500	T-Log Number: T87276
	Account Manager: Christine Krebill
Contact: Rob Linebarger	
Standard: FCC	Class: N/A

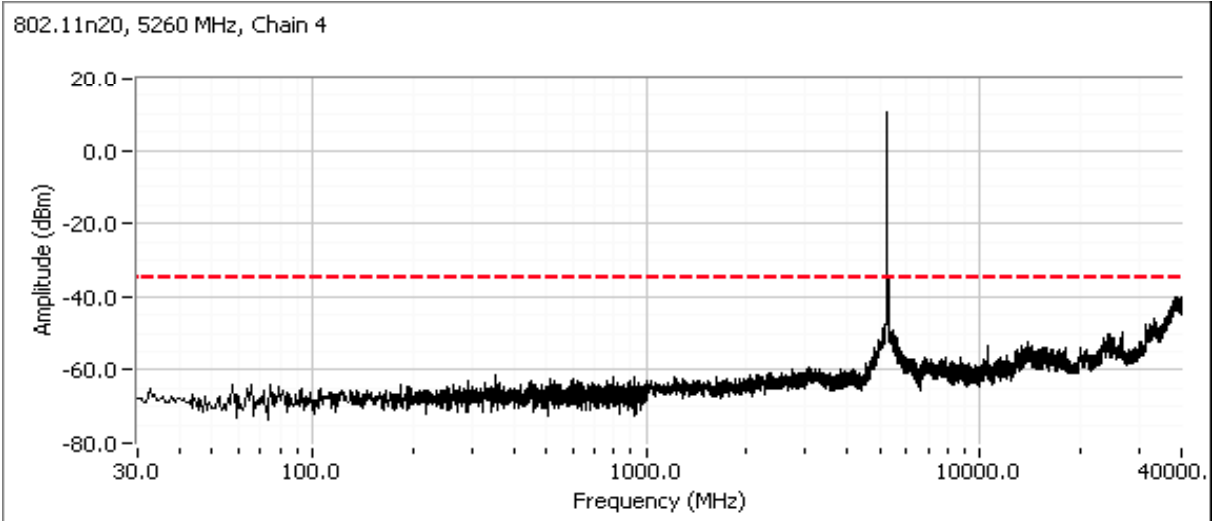
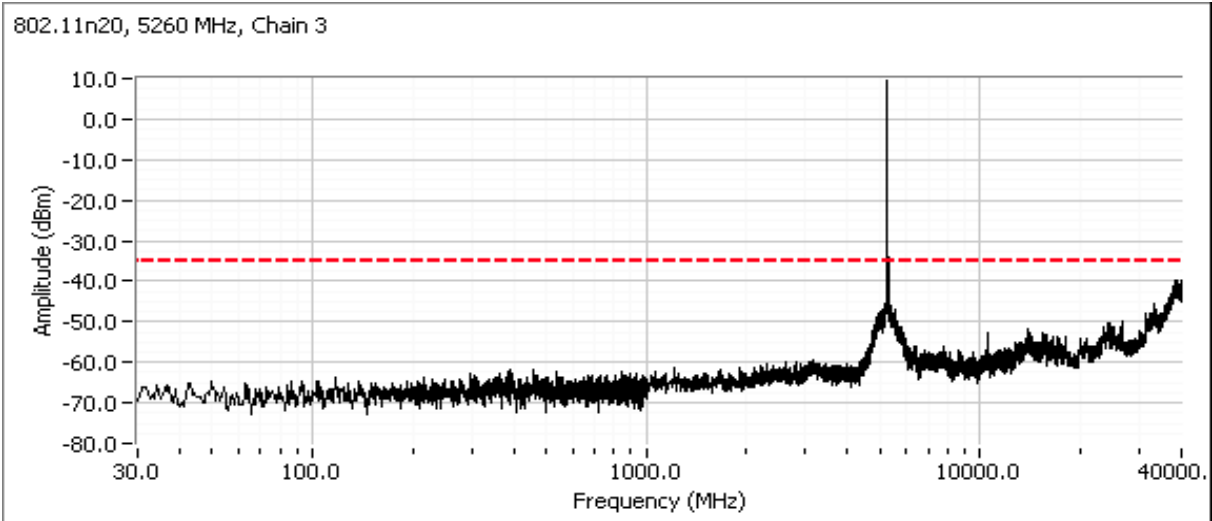

Client: Motorola	Job Number: J87247
Model: VAP2500	T-Log Number: T87276
Contact: Rob Linebarger	Account Manager: Christine Krebill
Standard: FCC	Class: N/A

Center channel, 5250 - 5350 MHz Band

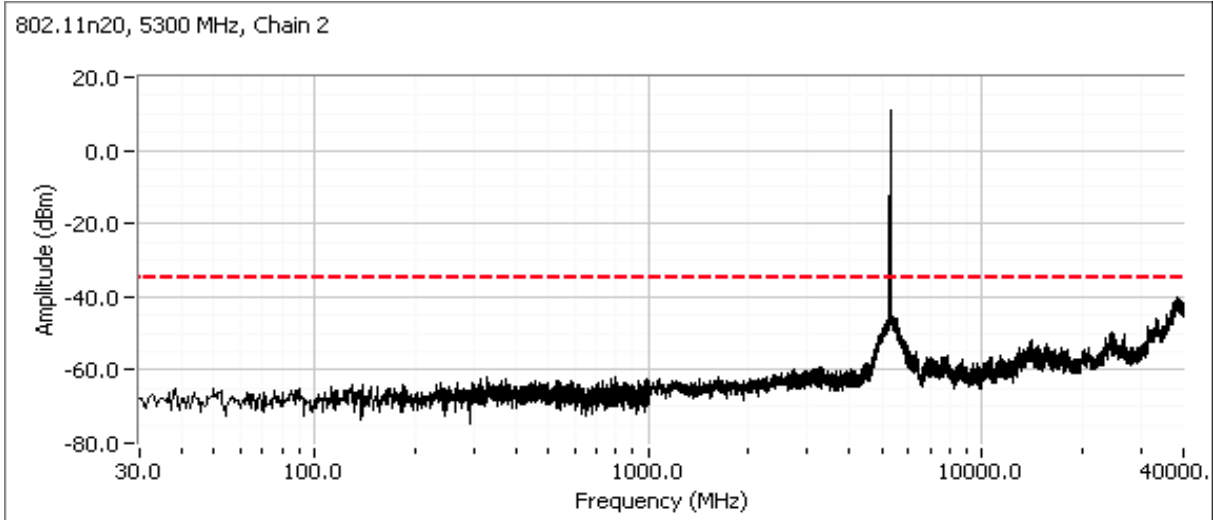
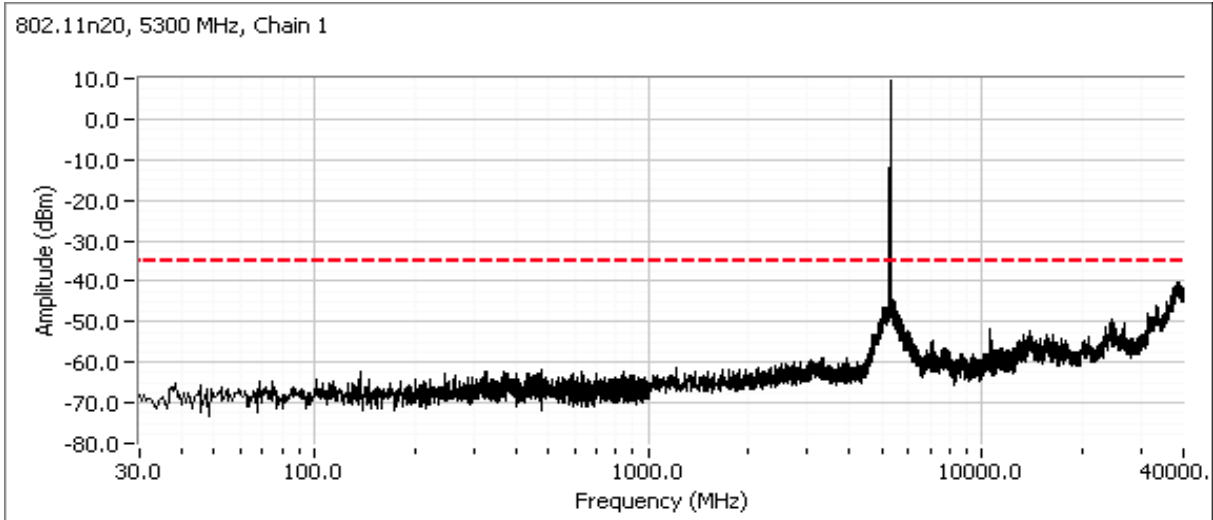

Client: Motorola	Job Number: J87247
Model: VAP2500	T-Log Number: T87276
	Account Manager: Christine Krebill
Contact: Rob Linebarger	
Standard: FCC	Class: N/A

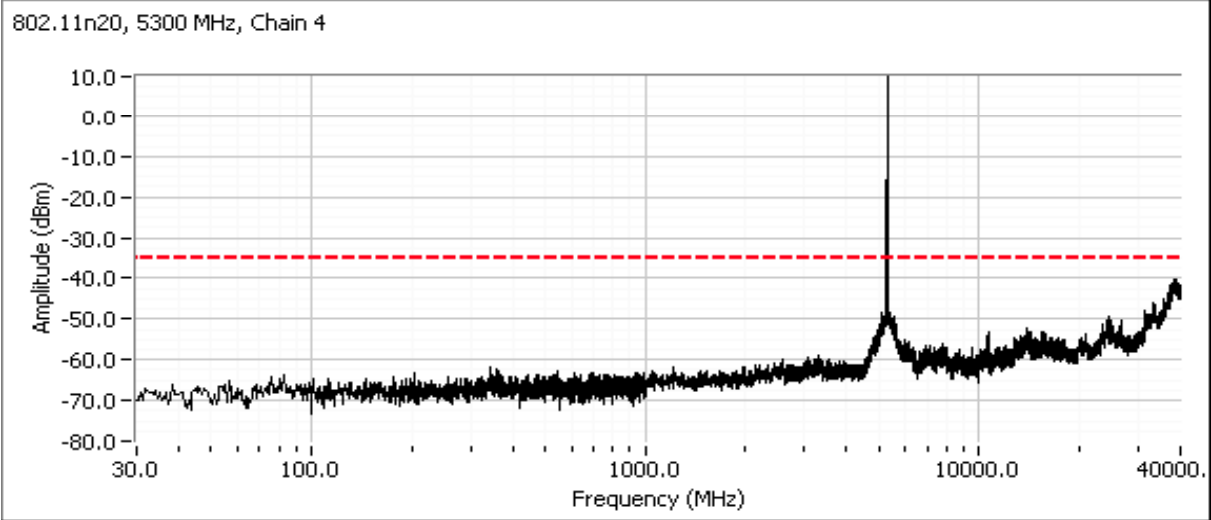
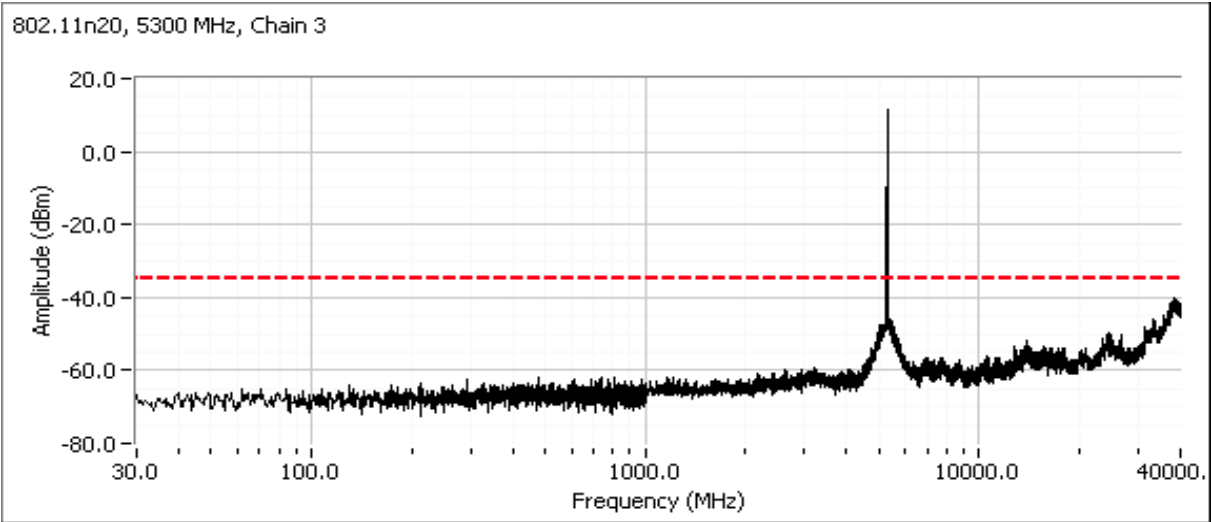

Client: Motorola	Job Number: J87247
Model: VAP2500	T-Log Number: T87276
	Account Manager: Christine Krebill
Contact: Rob Linebarger	
Standard: FCC	Class: N/A

High channel, 5250 - 5350 MHz Band

Note - compliance with the radiated limits for the restricted band immediately above 5350MHz is demonstrated through the radiated emissions tests.

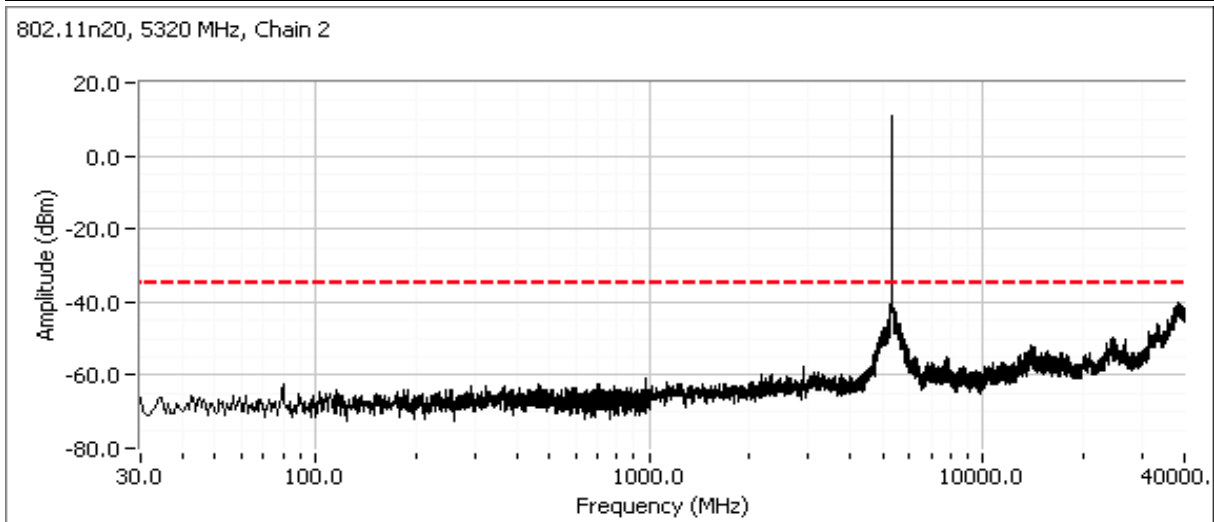
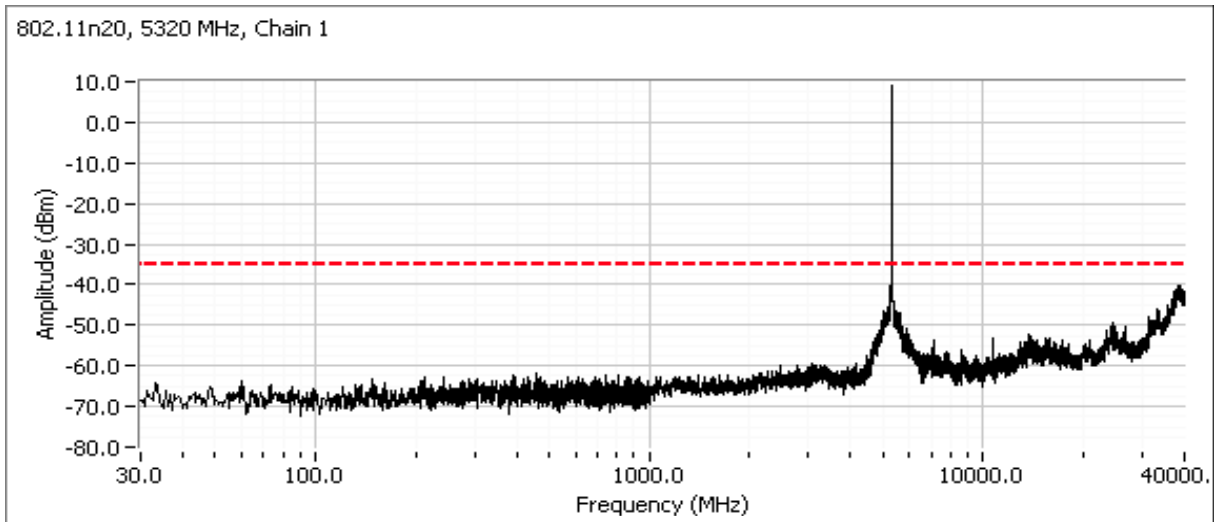

Client: Motorola	Job Number: J87247
Model: VAP2500	T-Log Number: T87276
	Account Manager: Christine Krebill
Contact: Rob Linebarger	
Standard: FCC	Class: N/A

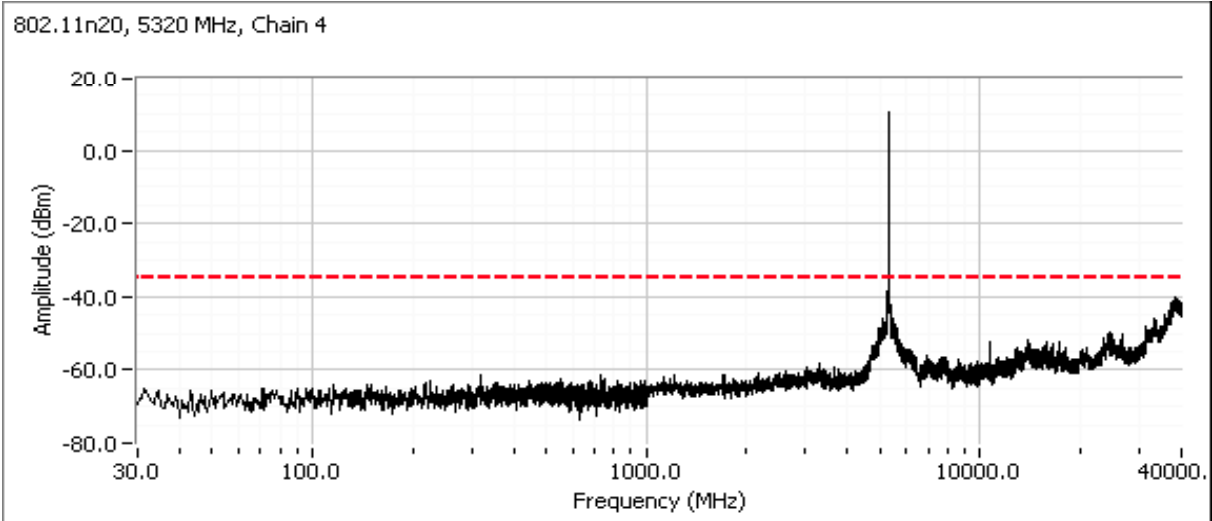
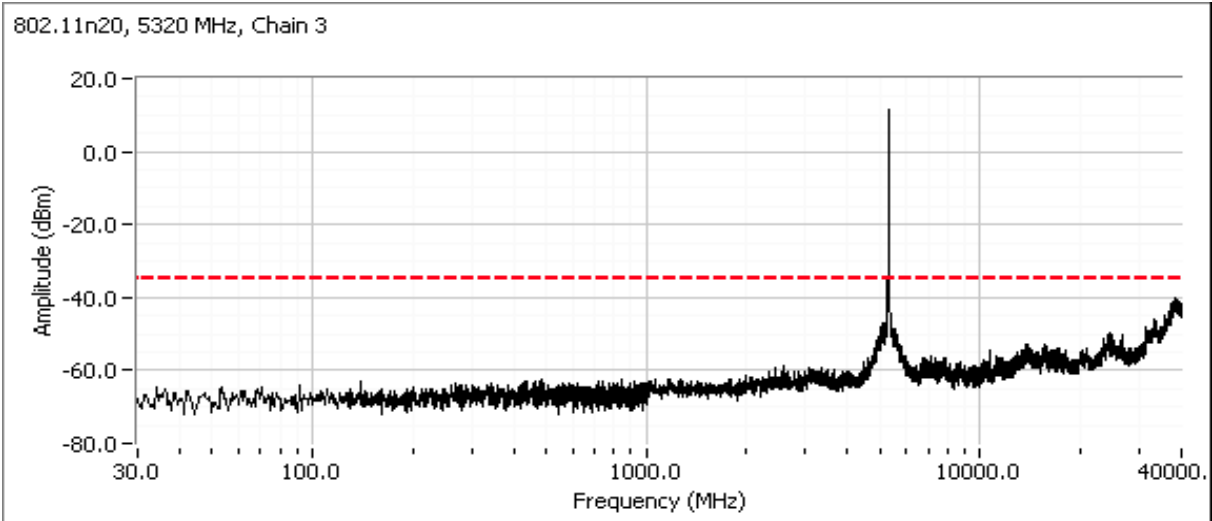

Client: Motorola	Job Number: J87247
Model: VAP2500	T-Log Number: T87276
	Account Manager: Christine Krebill
Contact: Rob Linebarger	
Standard: FCC	Class: N/A

Low channel, 5470 - 5725 MHz Band

Wide-band plot, RB=VB=1MHz (Peak measurements versus limit).

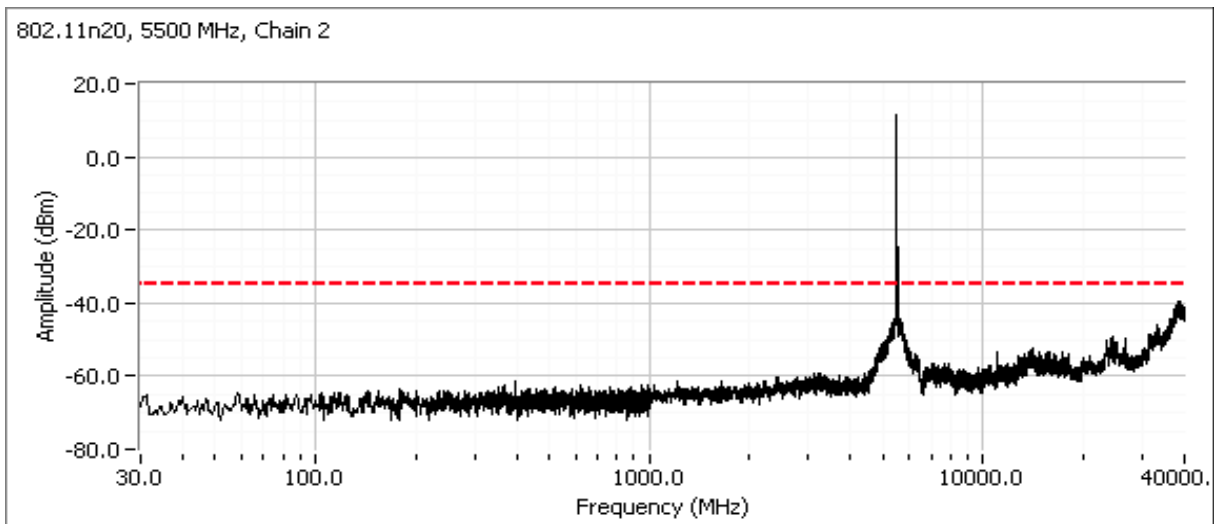
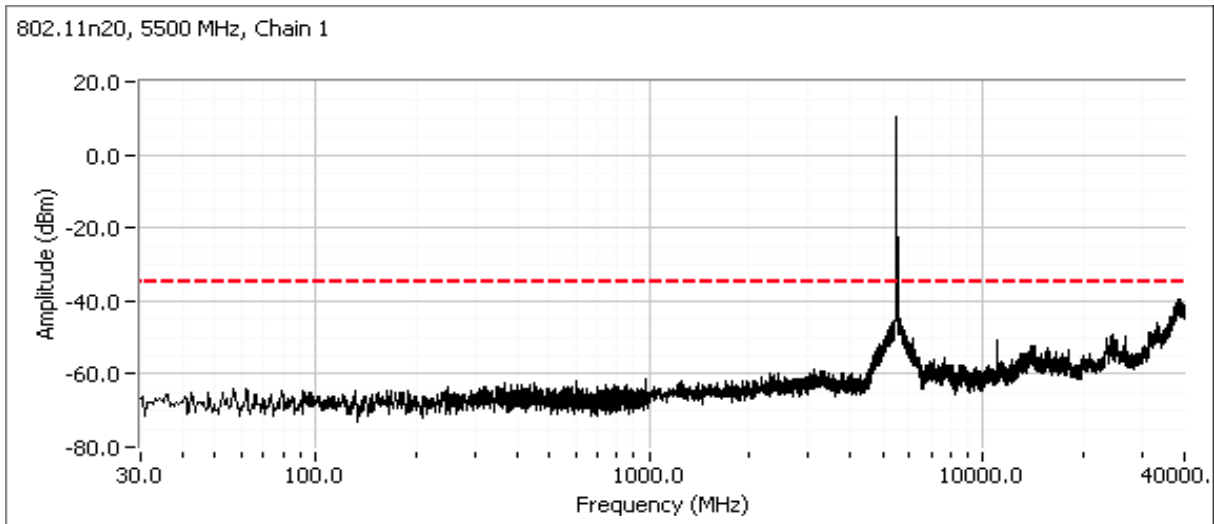

Client: Motorola	Job Number: J87247
Model: VAP2500	T-Log Number: T87276
	Account Manager: Christine Krebill
Contact: Rob Linebarger	
Standard: FCC	Class: N/A

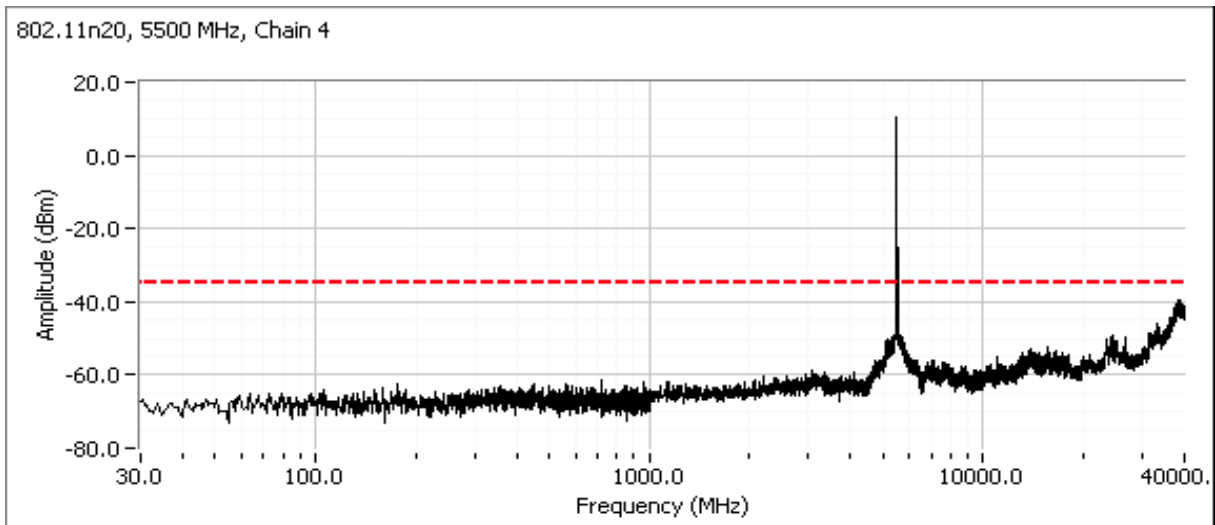
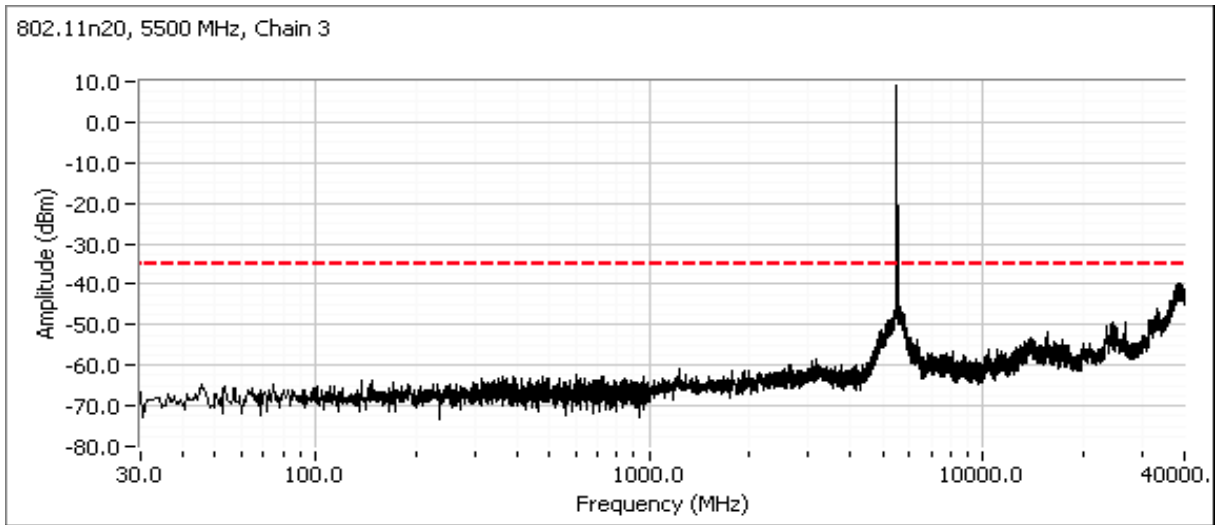

Client: Motorola	Job Number: J87247
Model: VAP2500	T-Log Number: T87276
Contact: Rob Linebarger	Account Manager: Christine Krebill
Standard: FCC	Class: N/A

Center channel, 5470 - 5725 MHz Band

For master devices - This plot is showing that the 20dB bandwidth of the channel closest to 5600 MHz does not spill into the 5600-5650 MHz band. RB > 1% of OBW. Span 2-5 times OBW.

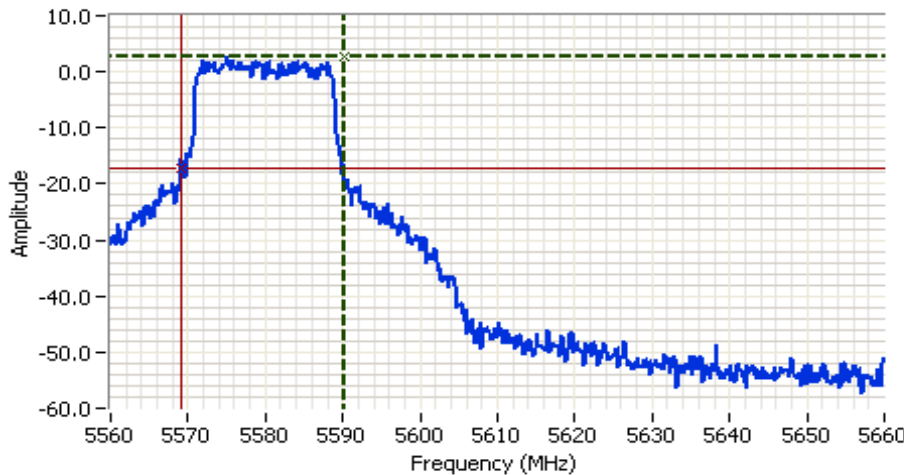

Analyzer Settings
 Agilent Technologies, E4446A
 CF: 5610.000 MHz
 SPAN: 100.000 MHz
 RB: 200 kHz
 VB: 620 kHz
 Detector: POS
 Attn: 10 DB
 RL Offset: 11.0 DB
 Sweep Time: 2.4ms
 Ref Lvl: 8.0 DBM

Comments
 20dB BW: 21.000 MHz
 FH: 5590.1667 MHz
 802.11n20, Chain 1

Cursor 1 5590.1667 2.84
 Cursor 2 5569.1667 -17.16

Delta Freq. 21.000
 Delta Amplitude 20.00

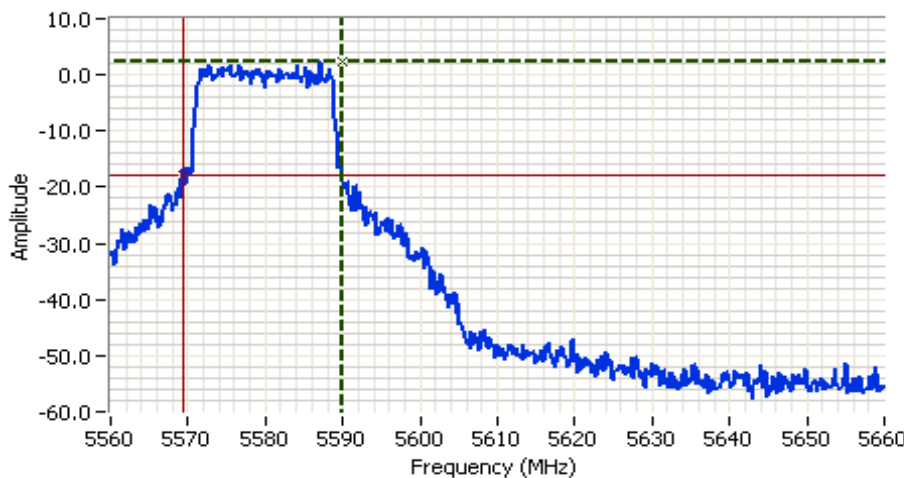

Analyzer Settings
 Agilent Technologies, E4446A
 CF: 5610.000 MHz
 SPAN: 100.000 MHz
 RB: 200 kHz
 VB: 620 kHz
 Detector: POS
 Attn: 10 DB
 RL Offset: 11.0 DB
 Sweep Time: 2.4ms
 Ref Lvl: 8.0 DBM

Comments
 20dB BW: 20.500 MHz
 FH: 5589.8333 MHz
 802.11n20, Chain 2

Cursor 1 5589.8333 2.22
 Cursor 2 5569.3333 -17.78

Delta Freq. 20.500
 Delta Amplitude 20.00

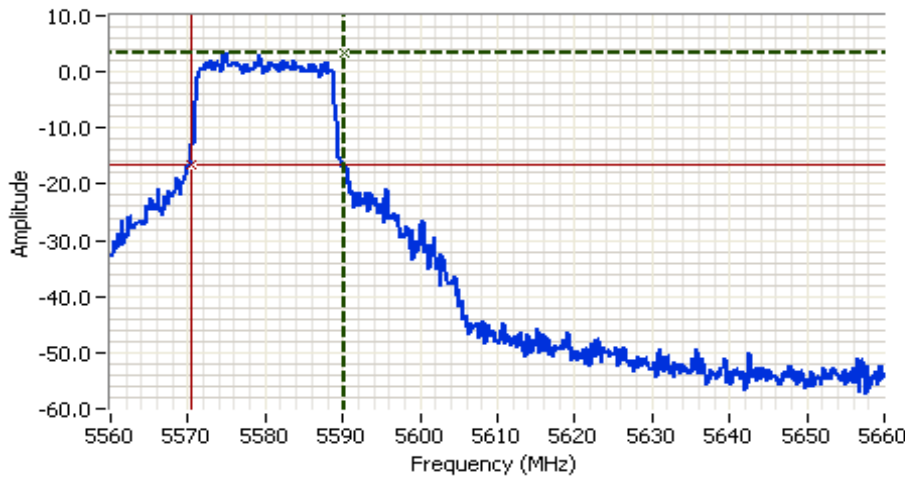

Client: Motorola	Job Number: J87247
Model: VAP2500	T-Log Number: T87276
Contact: Rob Linebarger	Account Manager: Christine Krebill
Standard: FCC	Class: N/A

Analyzer Settings

Agilent Technologies, E4446A
 CF: 5610.000 MHz
 SPAN: 100.000 MHz
 RB: 200 kHz
 VB: 620 kHz
 Detector: POS
 Attn: 10 DB
 RL Offset: 11.0 DB
 Sweep Time: 2.4ms
 Ref Lvl: 8.0 DBM

Comments

20dB BW: 19.833 MHz
 FH: 5590.1667 MHz
 802.11n20, Chain 3

Cursor 1	5590.1667	3.47	
Cursor 2	5570.3333	-16.53	

Delta Freq. 19.833

Delta Amplitude 20.00

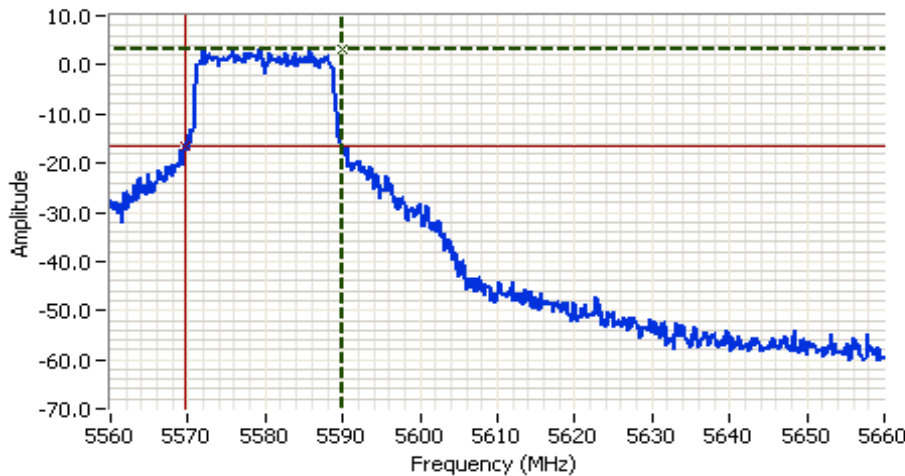
Analyzer Settings

Agilent Technologies, E4446A
 CF: 5610.000 MHz
 SPAN: 100.000 MHz
 RB: 200 kHz
 VB: 620 kHz
 Detector: POS
 Attn: 10 DB
 RL Offset: 11.0 DB
 Sweep Time: 2.4ms
 Ref Lvl: 8.0 DBM

Comments

20dB BW: 20.167 MHz
 FH: 5589.8333 MHz
 802.11n20, Chain 4

Cursor 1	5589.8333	3.29	
Cursor 2	5569.6667	-16.71	

Delta Freq. 20.167

Delta Amplitude 20.00



Client: Motorola	Job Number: J87247
Model: VAP2500	T-Log Number: T87276
	Account Manager: Christine Krebill
Contact: Rob Linebarger	
Standard: FCC	Class: N/A

Wide-band plot, RB=VB=1MHz (Peak measurements versus limit).

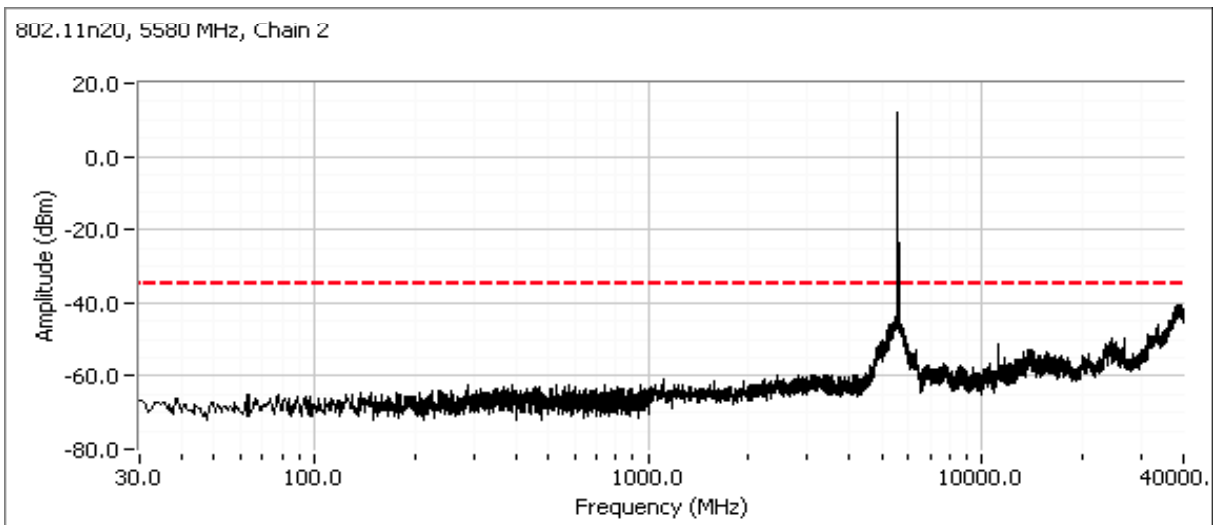
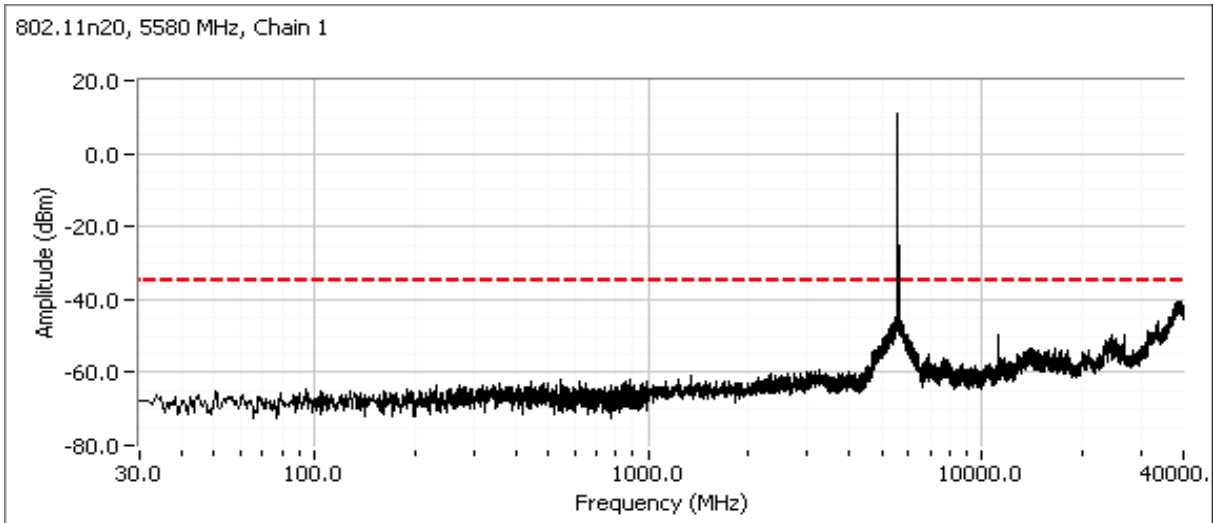

Client: Motorola	Job Number: J87247
Model: VAP2500	T-Log Number: T87276
	Account Manager: Christine Krebill
Contact: Rob Linebarger	
Standard: FCC	Class: N/A

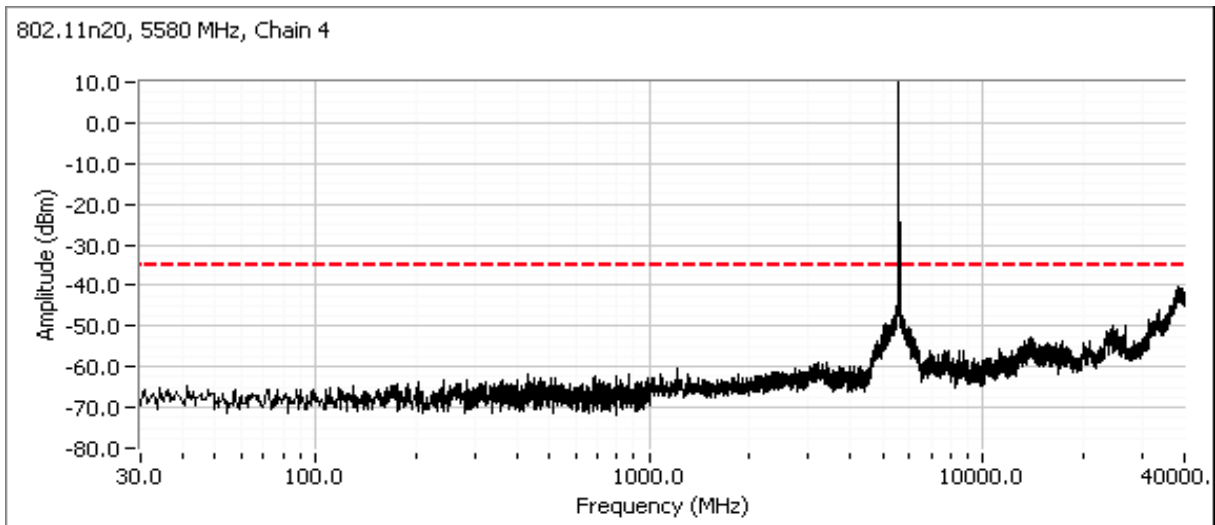
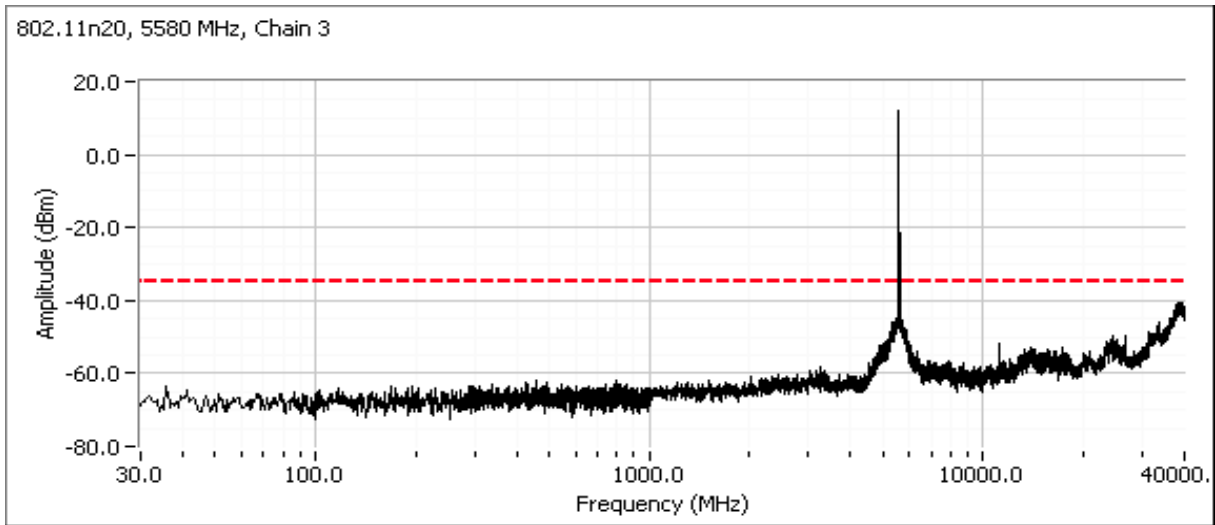

Client: Motorola	Job Number: J87247
Model: VAP2500	T-Log Number: T87276
Contact: Rob Linebarger	Account Manager: Christine Krebill
Standard: FCC	Class: N/A

Channel adjacent to 5650 MHz (Master Device)

Plots showing that the 20dB bandwidth of the channel closest to 5650 MHz does not spill into the 5600-5650 MHz band. RB > 1% of OBW. Span is 2-5 times OBW.



Analyzer Settings
 Agilent Technologies, E4446A
 CF: 5635.000 MHz
 SPAN: 90.000 MHz
 RB: 200 kHz
 VB: 620 kHz
 Detector: POS
 Attn: 10 DB
 RL Offset: 11.0 DB
 Sweep Time: 2.2ms
 Ref Lvl: 8.0 DBM

Comments
 20dB BW: 19.500 MHz
 FL: 5650.3000 MHz
 802.11n20, Chain 1

Cursor 1	5669.8000	4.45		Delta Freq.	19.500
Cursor 2	5650.3000	-15.55		Delta Amplitude	20.00

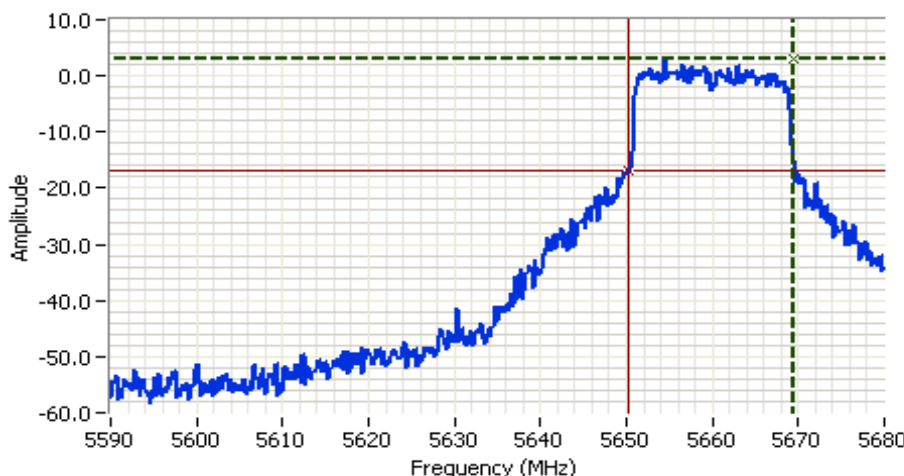

Analyzer Settings
 Agilent Technologies, E4446A
 CF: 5635.000 MHz
 SPAN: 90.000 MHz
 RB: 200 kHz
 VB: 620 kHz
 Detector: POS
 Attn: 10 DB
 RL Offset: 11.0 DB
 Sweep Time: 2.2ms
 Ref Lvl: 8.0 DBM

Comments
 20dB BW: 19.350 MHz
 FL: 5650.1500 MHz
 802.11n20, Chain 2

Cursor 1	5669.5000	3.02		Delta Freq.	19.350
Cursor 2	5650.1500	-16.98		Delta Amplitude	20.00



Client: Motorola	Job Number: J87247
Model: VAP2500	T-Log Number: T87276
Contact: Rob Linebarger	Account Manager: Christine Krebill
Standard: FCC	Class: N/A

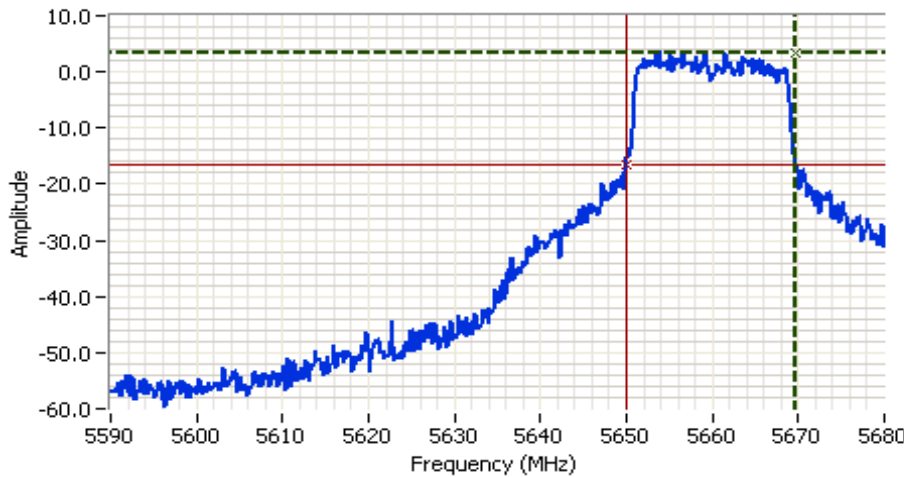

Analyzer Settings
 Agilent Technologies, E4446A
 CF: 5635.000 MHz
 SPAN: 90.000 MHz
 RB: 200 kHz
 VB: 620 kHz
 Detector: POS
 Attn: 10 DB
 RL Offset: 11.0 DB
 Sweep Time: 2.2ms
 Ref Lvl: 8.0 DBM

Comments
 20dB BW: 19.800 MHz
 FL: 5650.0000 MHz
 802.11n20, Chain 3

Cursor 1 5669.8000 3.40
 Cursor 2 5650.0000 -16.59
 Delta Freq. 19.800
 Delta Amplitude 20.00



Close up plot

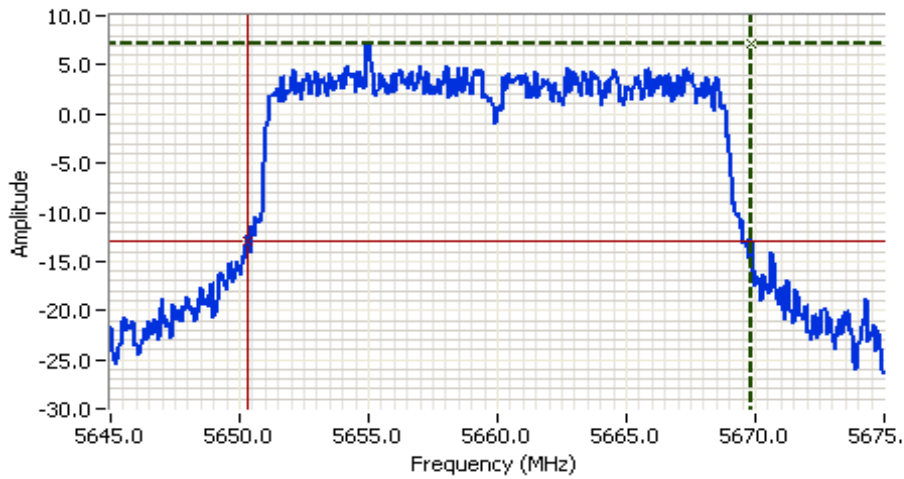

Analyzer Settings
 Agilent Technologies, E4446A
 CF: 5660.000 MHz
 SPAN: 30.000 MHz
 RB: 200 kHz
 VB: 620 kHz
 Detector: POS
 Attn: 10 DB
 RL Offset: 11.0 DB
 Sweep Time: 1.0ms
 Ref Lvl: 8.9 DBM

Comments
 20dB BW: 19.550 MHz
 FL: 5650.3000 MHz
 802.11n20, Chain 3

Cursor 1 5669.8500 7.11
 Cursor 2 5650.3000 -12.89
 Delta Freq. 19.550
 Delta Amplitude 20.00



Client: Motorola	Job Number: J87247
Model: VAP2500	T-Log Number: T87276
Contact: Rob Linebarger	Account Manager: Christine Krebill
Standard: FCC	Class: N/A

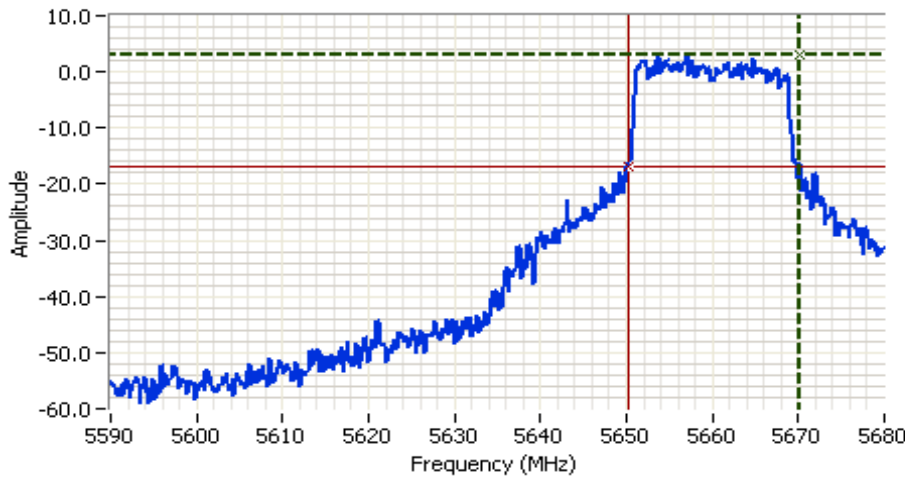

Analyzer Settings

Agilent Technologies, E4446A
 CF: 5635.000 MHz
 SPAN: 90.000 MHz
 RB: 200 kHz
 VB: 620 kHz
 Detector: POS
 Attn: 10 DB
 RL Offset: 11.0 DB
 Sweep Time: 2.2ms
 Ref Lvl: 8.0 DBM

Comments

20dB BW: 20.100 MHz
 FL: 5650.1500 MHz
 802.11n20, Chain 4

Cursor 1	5670.2500	3.14		Delta Freq.	20.100
Cursor 2	5650.1500	-16.86		Delta Amplitude	20.00

Client: Motorola	Job Number: J87247
Model: VAP2500	T-Log Number: T87276
	Account Manager: Christine Krebill
Contact: Rob Linebarger	
Standard: FCC	Class: N/A

High channel, 5470 - 5725 MHz Band

Wide-band plot, RB=VB=1MHz (Peak measurements versus limit).

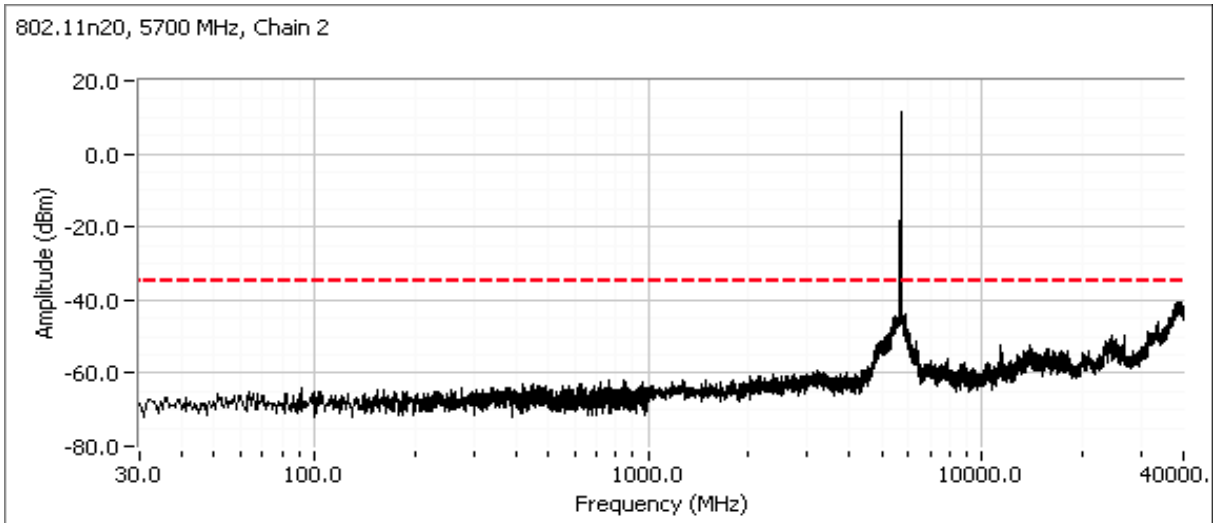
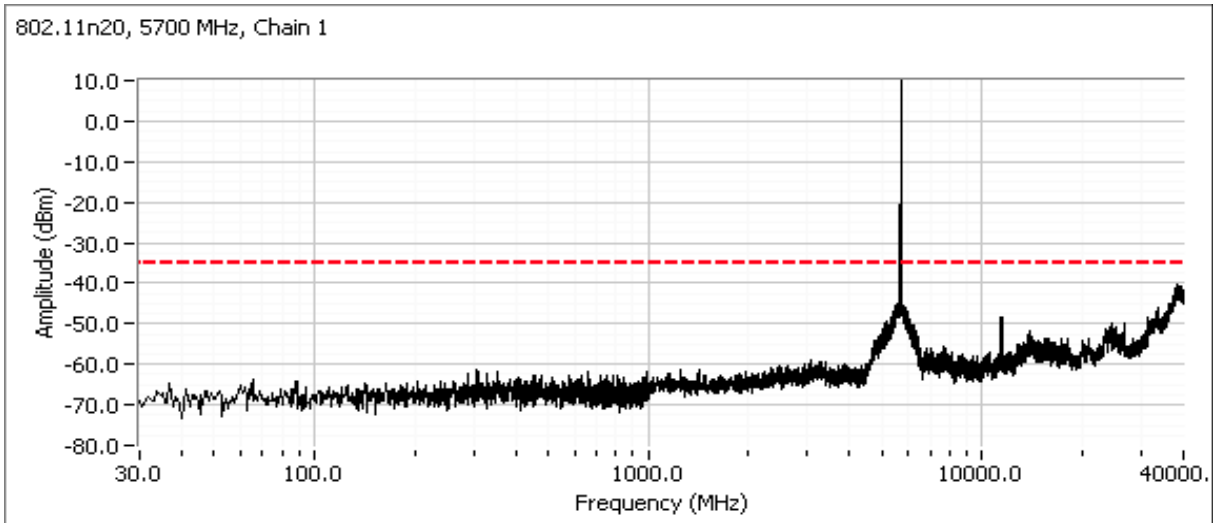

Client: Motorola	Job Number: J87247
Model: VAP2500	T-Log Number: T87276
	Account Manager: Christine Krebill
Contact: Rob Linebarger	
Standard: FCC	Class: N/A

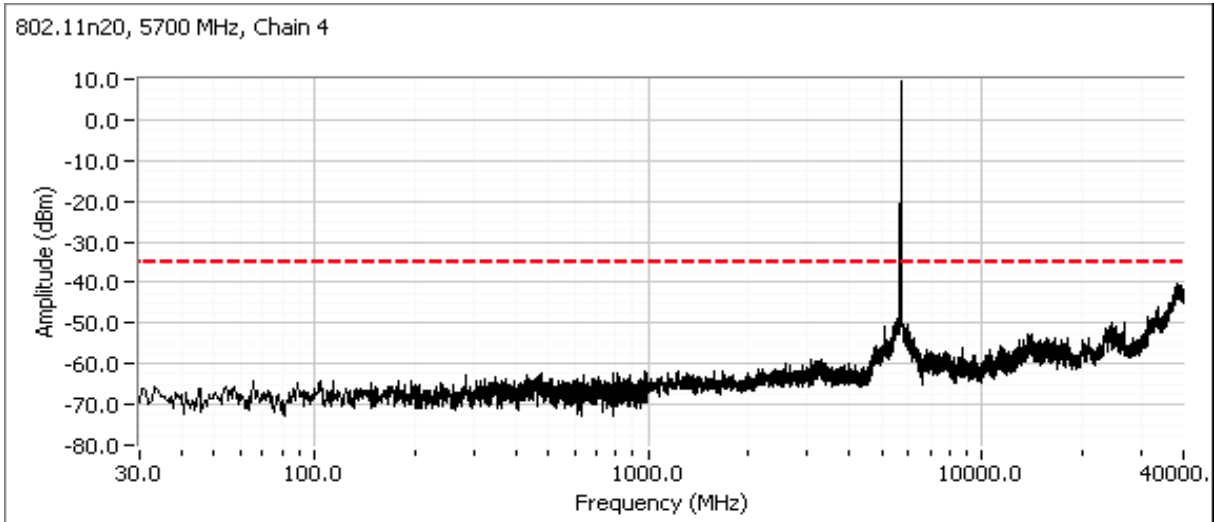
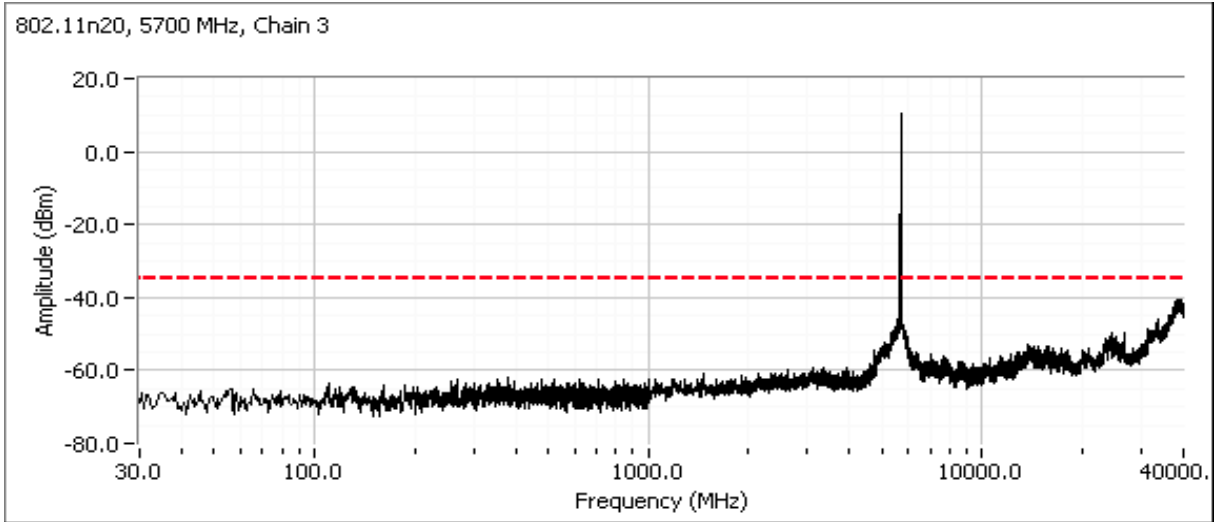

Client: Motorola	Job Number: J87247
Model: VAP2500	T-Log Number: T87276
Contact: Rob Linebarger	Account Manager: Christine Krebill
Standard: FCC	Class: N/A

Run #3c: Out Of Band Spurious Emissions - Antenna Conducted - 802.11n40 mode

Multichain Devices: Antenna gain used is the effective gain calculated in the power section of this data sheet. The plots were obtained for each chain individually and the limit was adjusted to account for all chains transmitting simultaneously.

Number of transmit chains:	4
Maximum Antenna Gain:	2.0 dBi
Spurious Limit:	-27.0 dBm/MHz eirp
Adjustment for 4 chains:	-6.0 dB adjustment for multiple chains.
Limit Used On Plots ^{Note 1} :	-35.0 dBm/MHz Peak Limit (RB=VB=1MHz)

- Note 1: The -27dBm/MHz limit is an eirp limit. The limit for antenna port conducted measurements is adjusted to take into consideration the maximum antenna gain (limit = -27dBm - antenna gain). Radiated field strength measurements for signals more than 50MHz from the bands and that are close to the limit are made to determine compliance as the antenna gain is not known at these frequencies.
- Note 2: All spurious signals below 1GHz are measured during digital device radiated emissions test.
- Note 3: Signals within 10MHz of the 5.725 or 5.825 Band edge are subject to a limit of -17dBm EIRP
- Note 4: If the device is for outdoor use then the -27dBm eirp limit also applies in the 5150 - 5250 MHz band.
- Note 5: Signals that fall in the restricted bands of 15.205 are subject to the limit of 15.209.

Plots Showing Out-Of-Band Emissions (RBW=VBW=1MHz)

Low channel, 5150 - 5250 MHz Band

Compliance with the radiated limits for the restricted band immediately below 5150MHz is demonstrated through the radiated emissions tests.

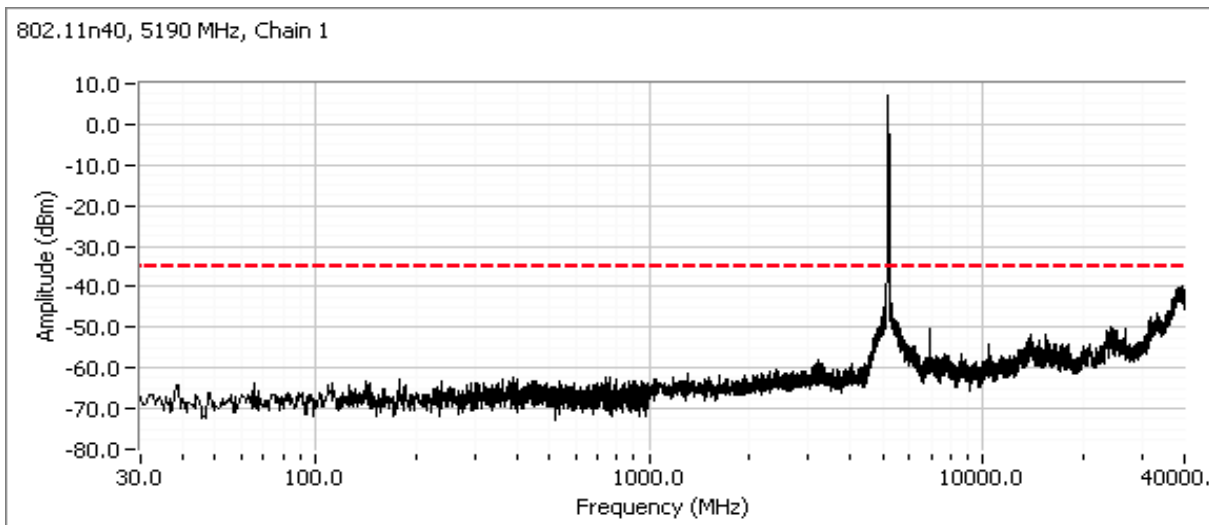

Client: Motorola	Job Number: J87247
Model: VAP2500	T-Log Number: T87276
	Account Manager: Christine Krebill
Contact: Rob Linebarger	
Standard: FCC	Class: N/A

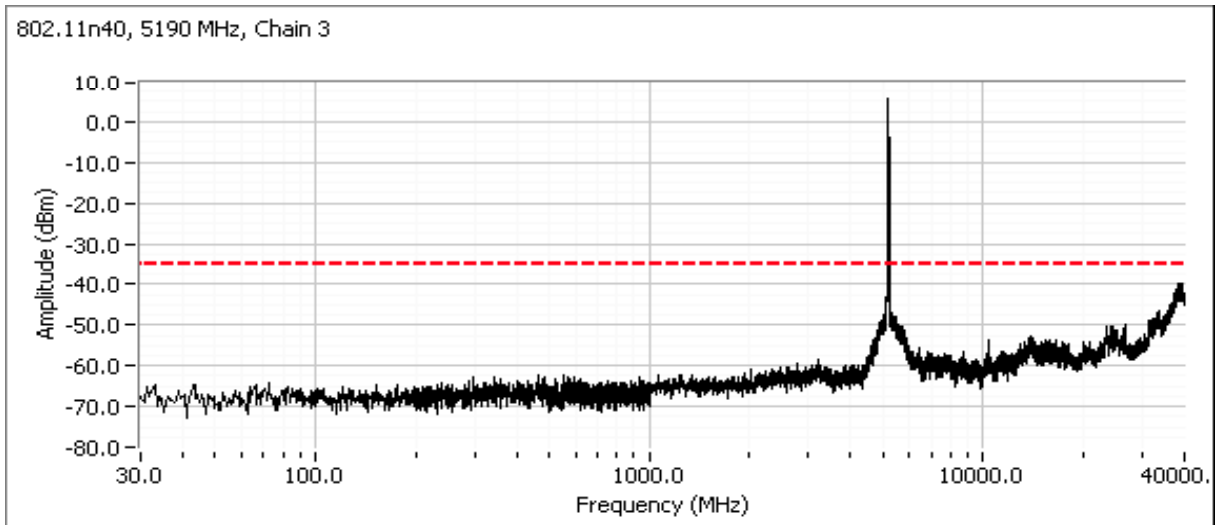
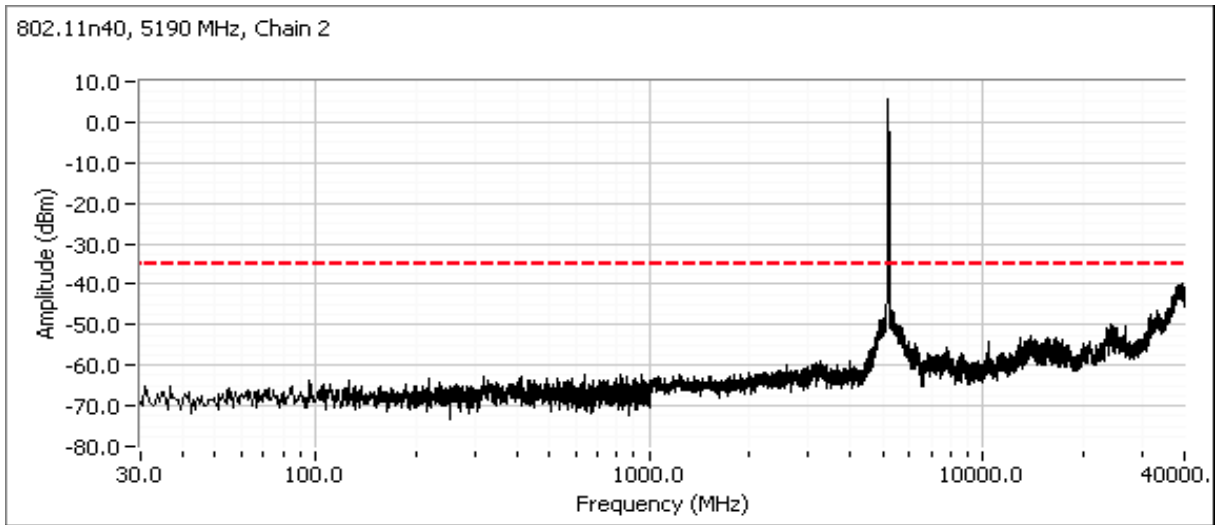

Client: Motorola	Job Number: J87247
Model: VAP2500	T-Log Number: T87276
	Account Manager: Christine Krebill
Contact: Rob Linebarger	
Standard: FCC	Class: N/A

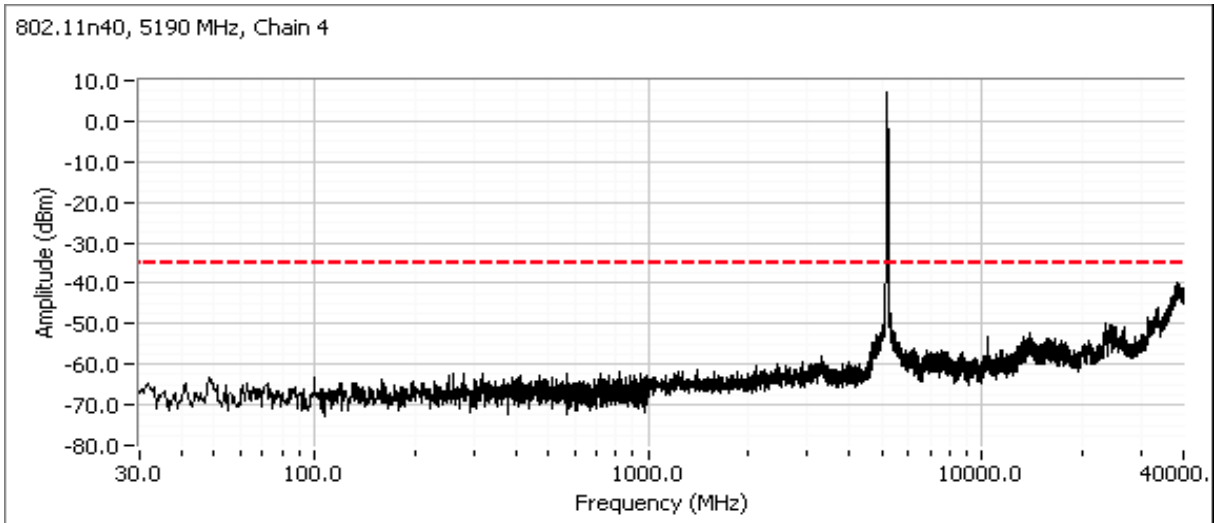

High channel, 5150 - 5250 MHz Band

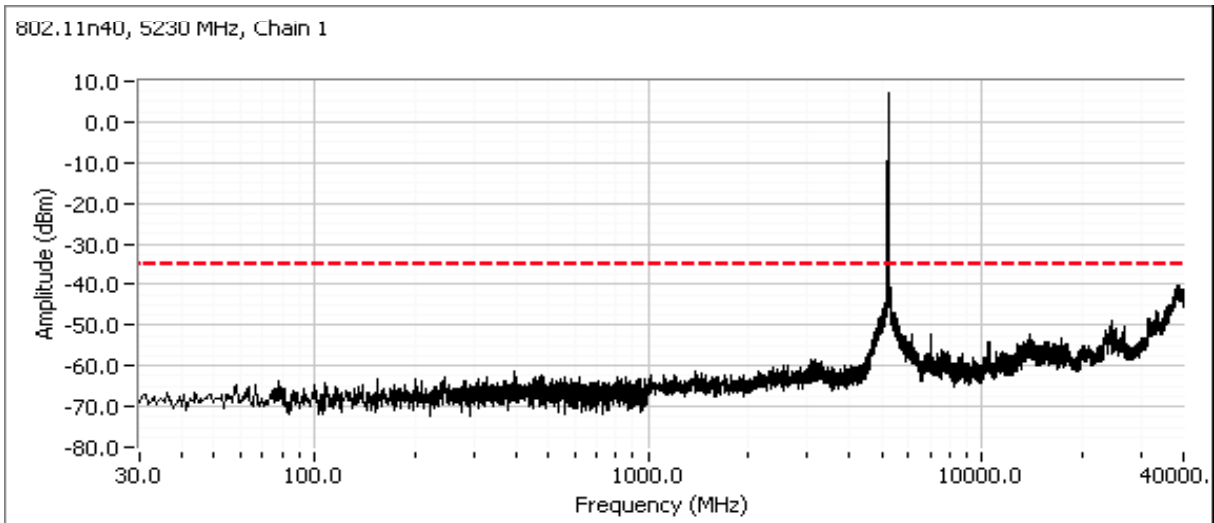

Client: Motorola	Job Number: J87247
Model: VAP2500	T-Log Number: T87276
	Account Manager: Christine Krebill
Contact: Rob Linebarger	
Standard: FCC	Class: N/A

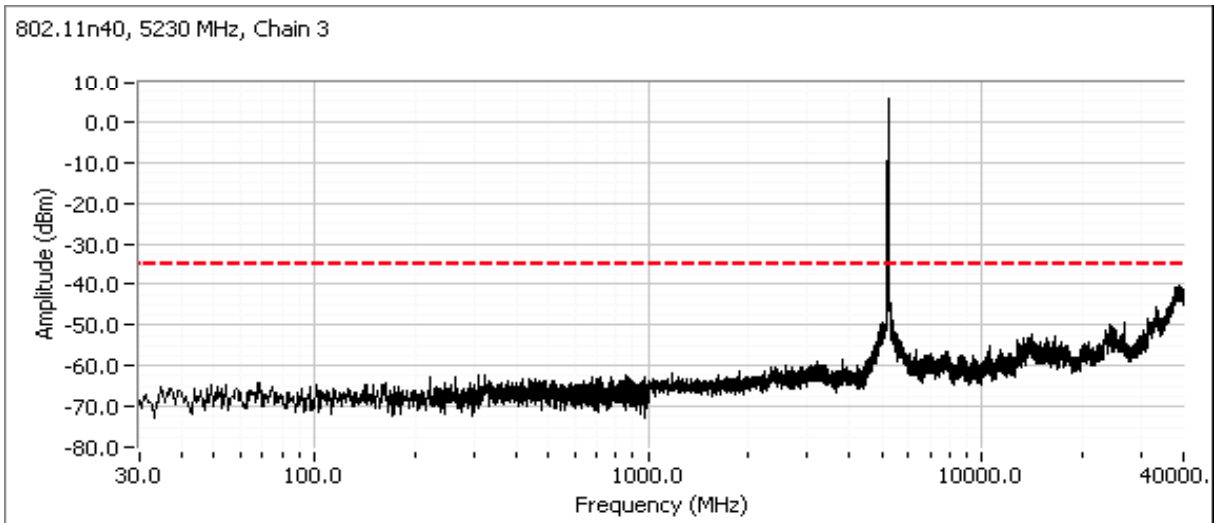
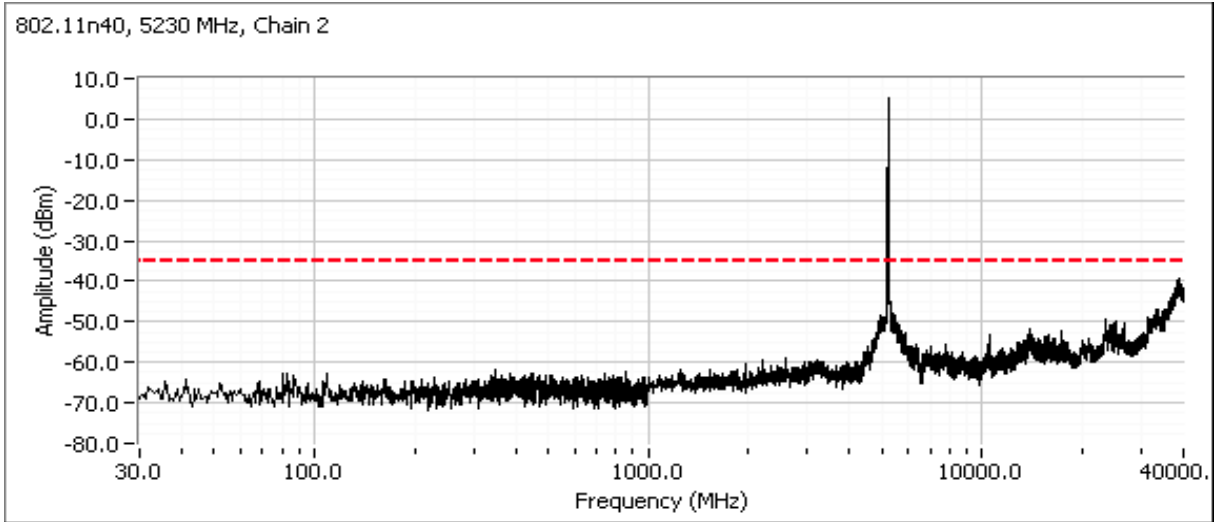

Client: Motorola	Job Number: J87247
Model: VAP2500	T-Log Number: T87276
Contact: Rob Linebarger	Account Manager: Christine Krebill
Standard: FCC	Class: N/A

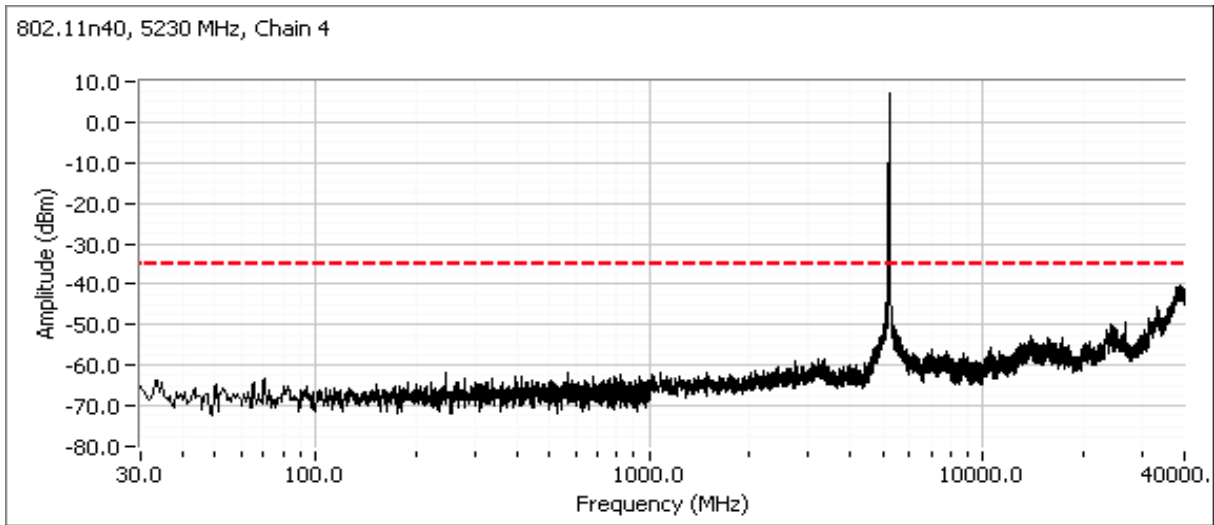

Low channel, 5250 - 5350 MHz Band

Wide-band plot, RB=VB=1MHz (Peak measurements versus limit).

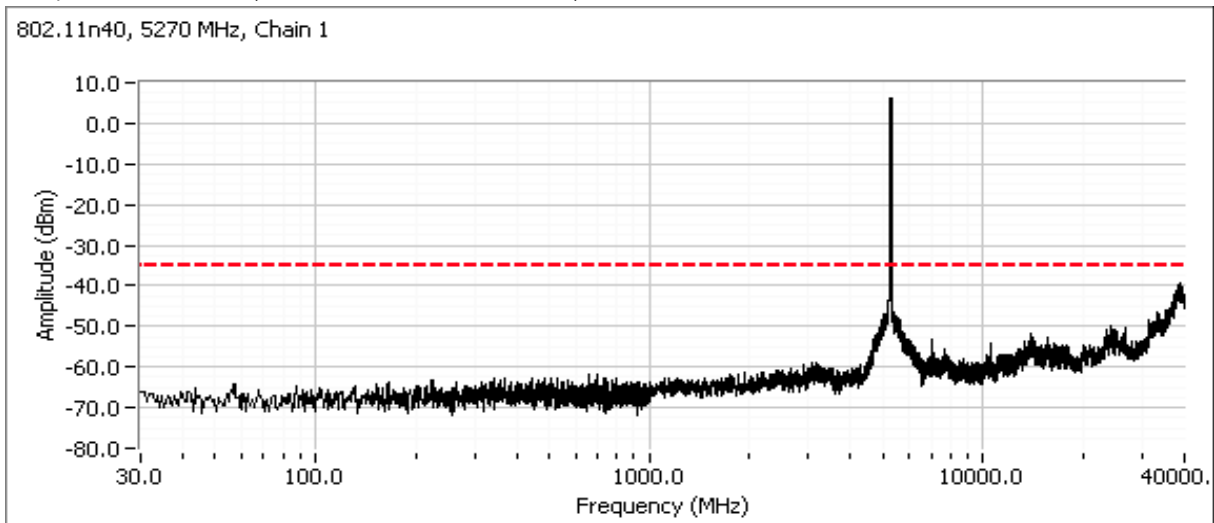

Client: Motorola	Job Number: J87247
Model: VAP2500	T-Log Number: T87276
	Account Manager: Christine Krebill
Contact: Rob Linebarger	
Standard: FCC	Class: N/A

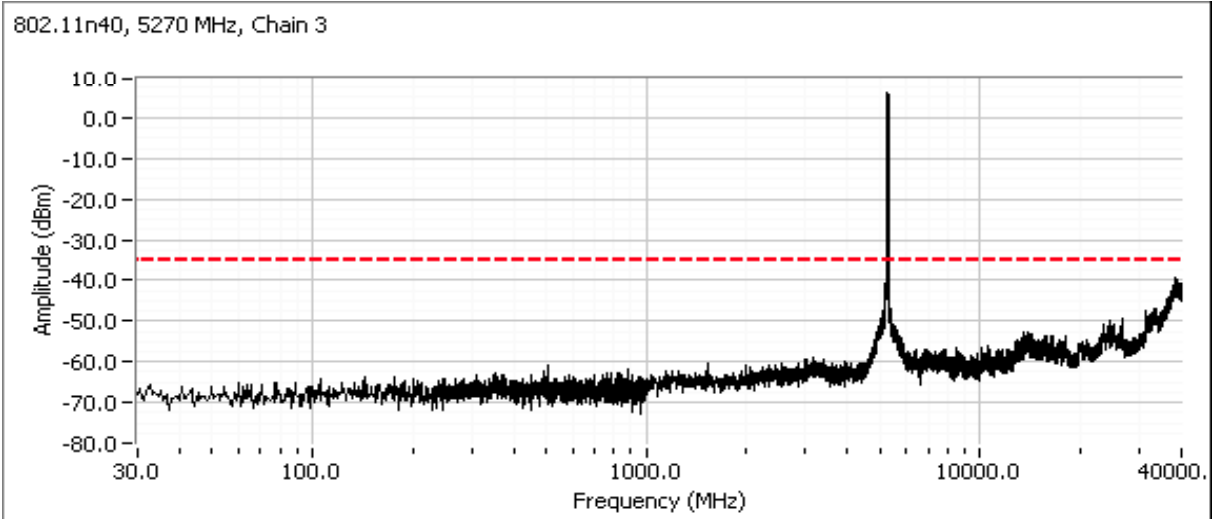
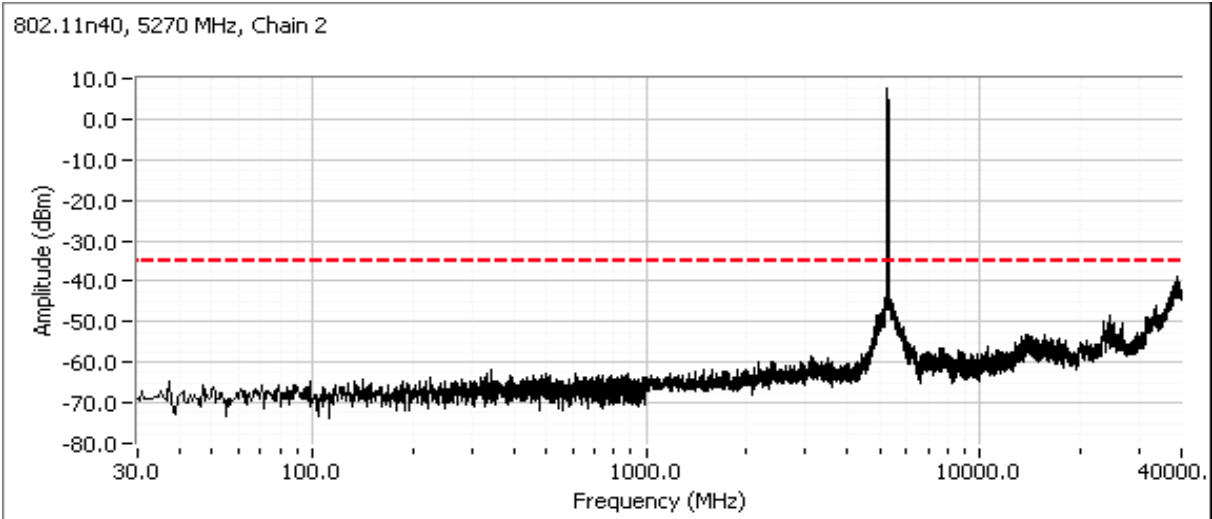

Client: Motorola	Job Number: J87247
Model: VAP2500	T-Log Number: T87276
	Account Manager: Christine Krebill
Contact: Rob Linebarger	
Standard: FCC	Class: N/A

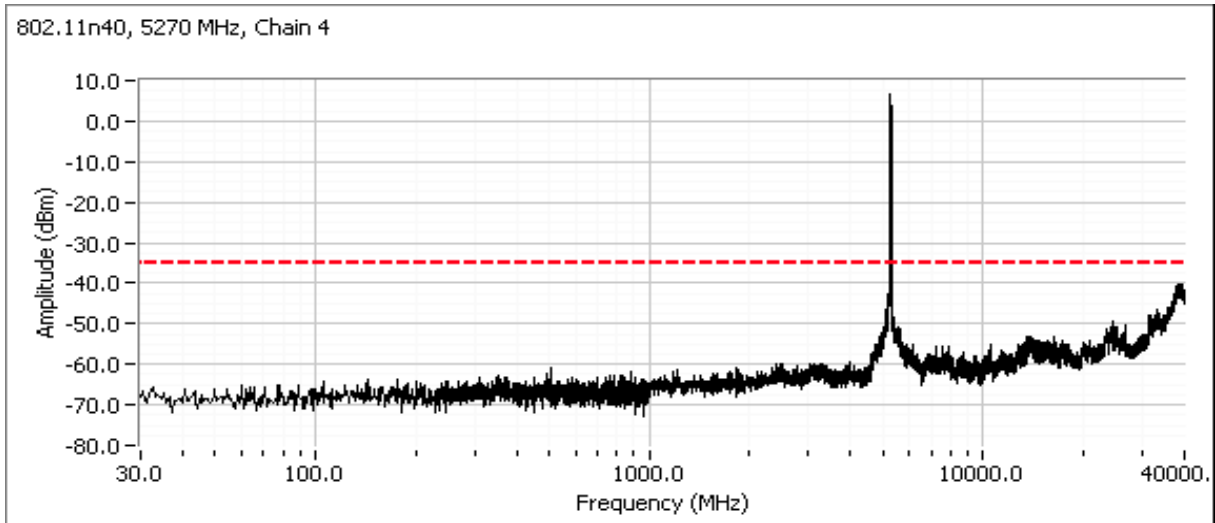

High channel, 5250 - 5350 MHz Band

Note - compliance with the radiated limits for the restricted band immediately above 5350MHz is demonstrated through the radiated emissions tests.

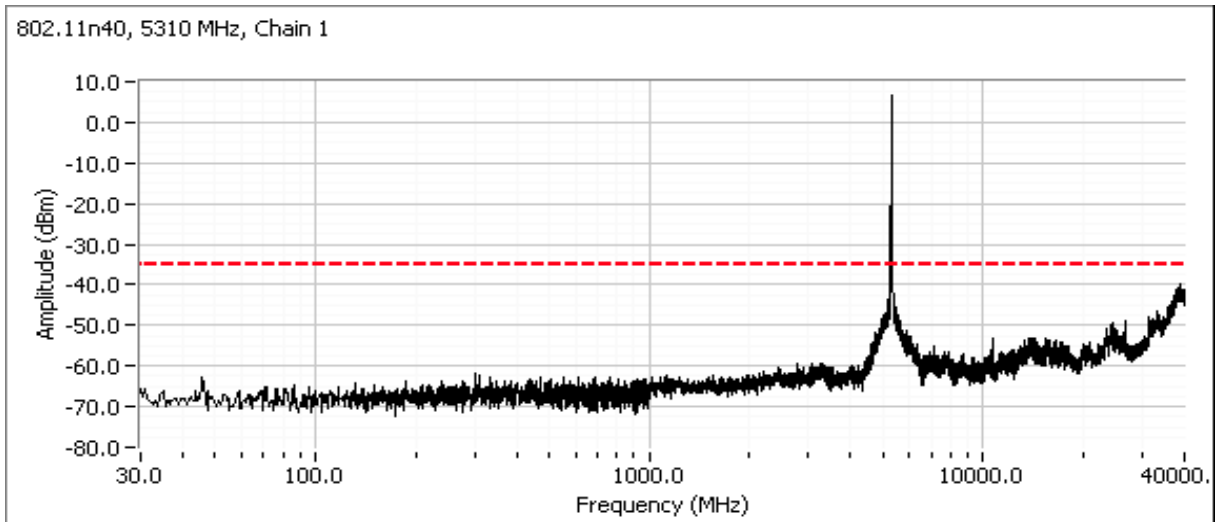

Client: Motorola	Job Number: J87247
Model: VAP2500	T-Log Number: T87276
	Account Manager: Christine Krebill
Contact: Rob Linebarger	
Standard: FCC	Class: N/A

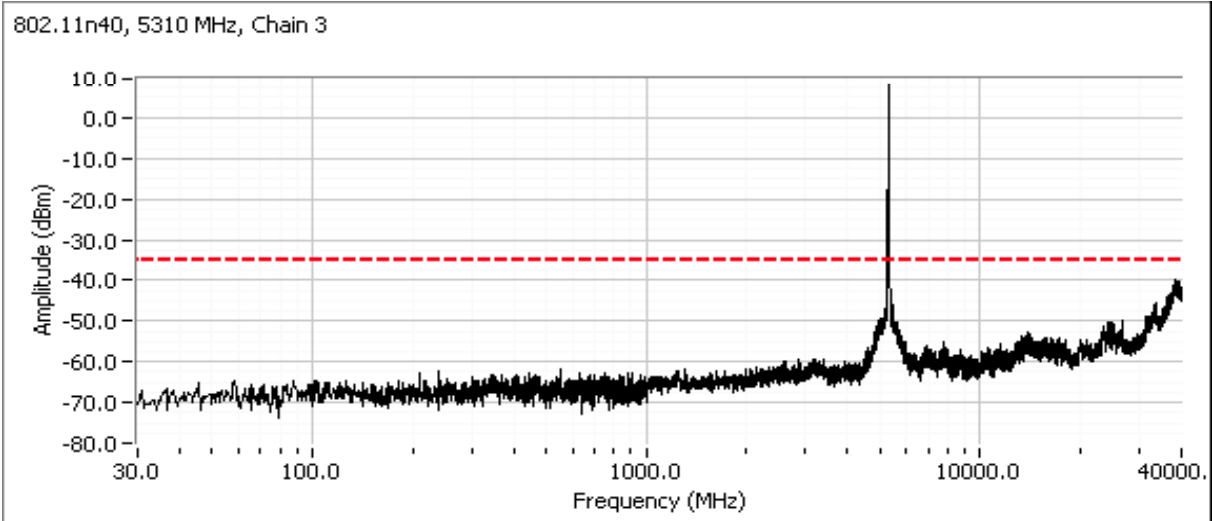
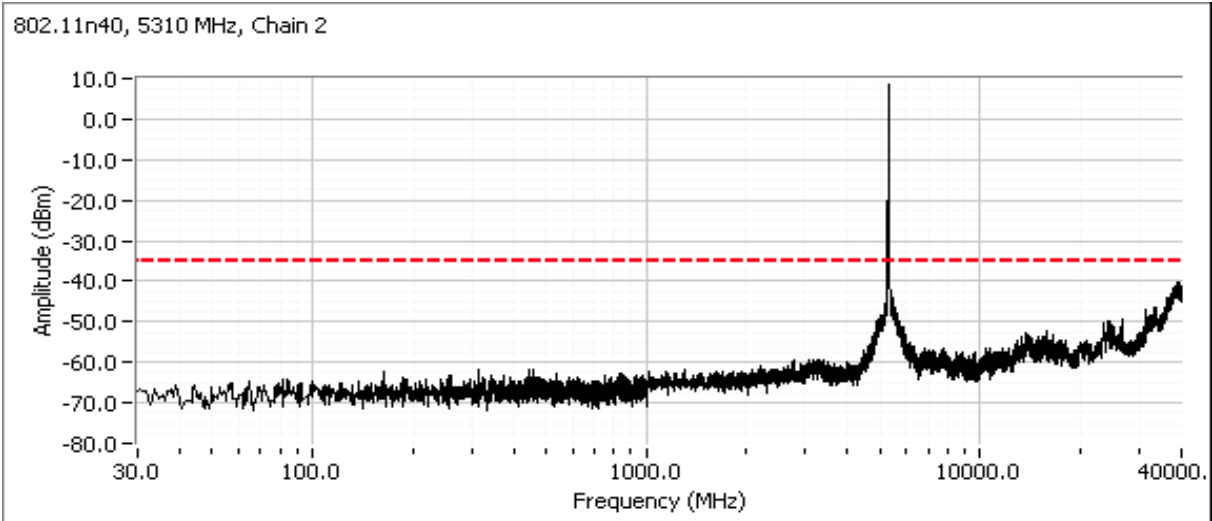

Client: Motorola	Job Number: J87247
Model: VAP2500	T-Log Number: T87276
	Account Manager: Christine Krebill
Contact: Rob Linebarger	
Standard: FCC	Class: N/A

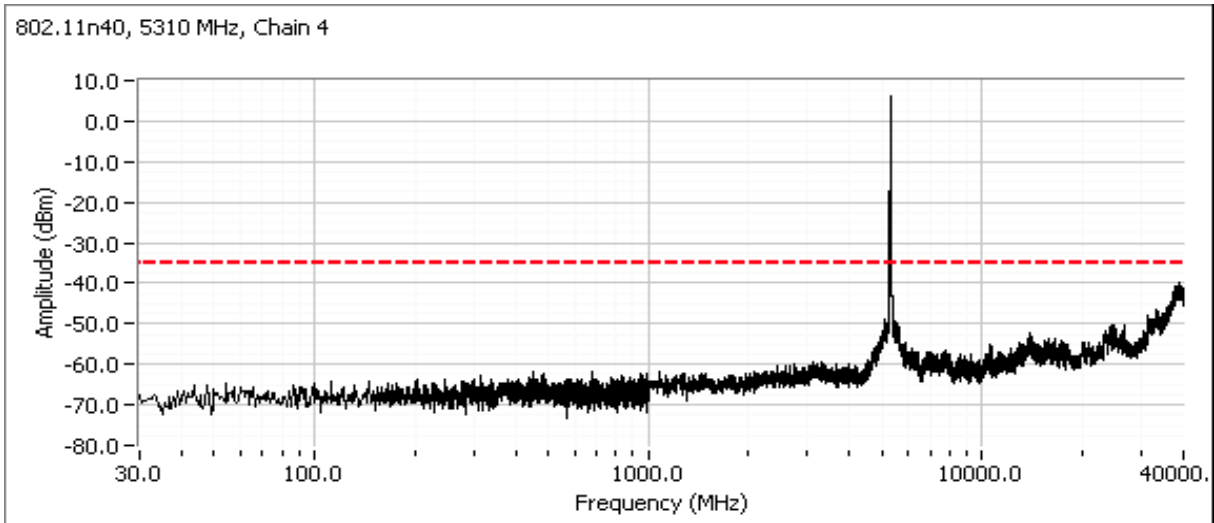

Low channel, 5470 - 5725 MHz Band

Wide-band plot, RB=VB=1MHz (Peak measurements versus limit).

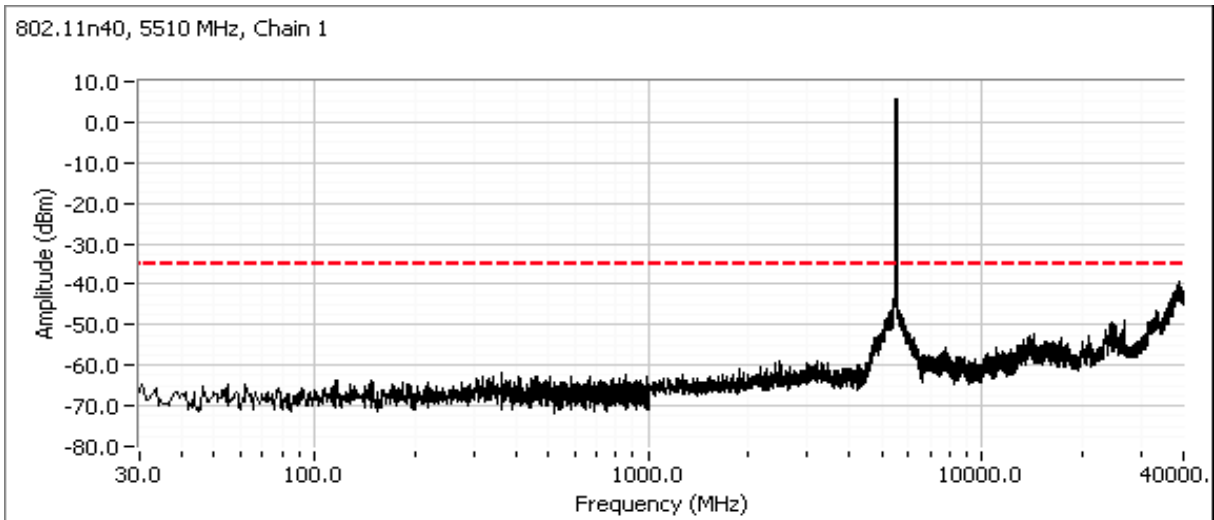

Client: Motorola	Job Number: J87247
Model: VAP2500	T-Log Number: T87276
	Account Manager: Christine Krebill
Contact: Rob Linebarger	
Standard: FCC	Class: N/A

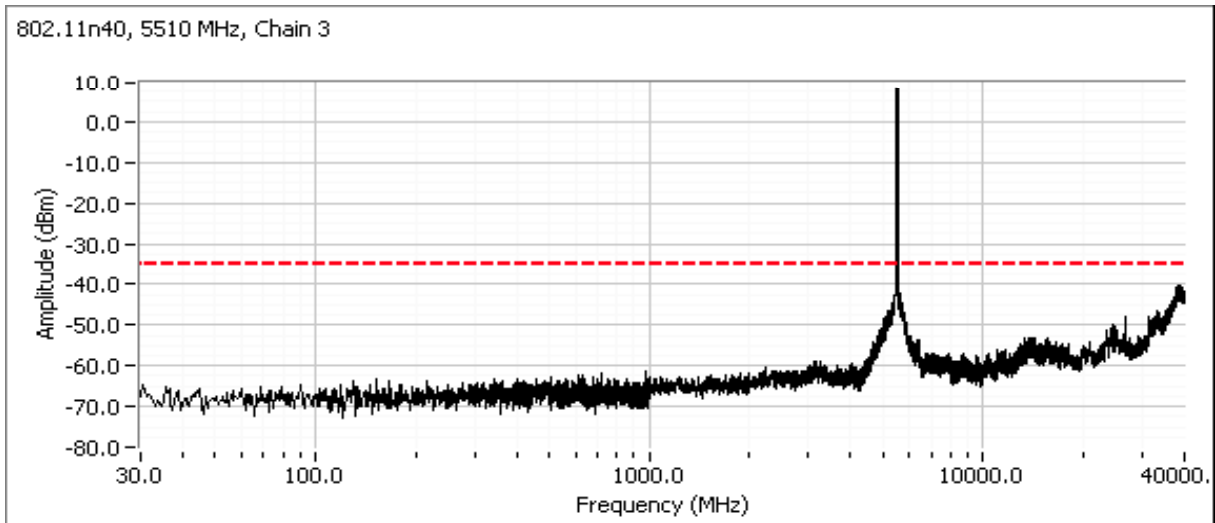
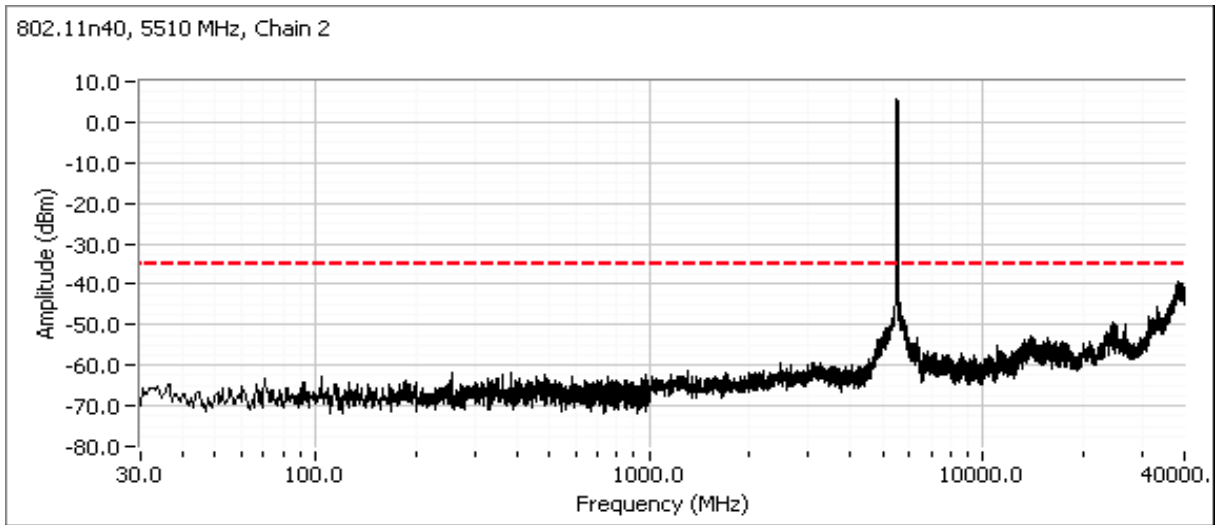

Client: Motorola	Job Number: J87247
Model: VAP2500	T-Log Number: T87276
Contact: Rob Linebarger	Account Manager: Christine Krebill
Standard: FCC	Class: N/A

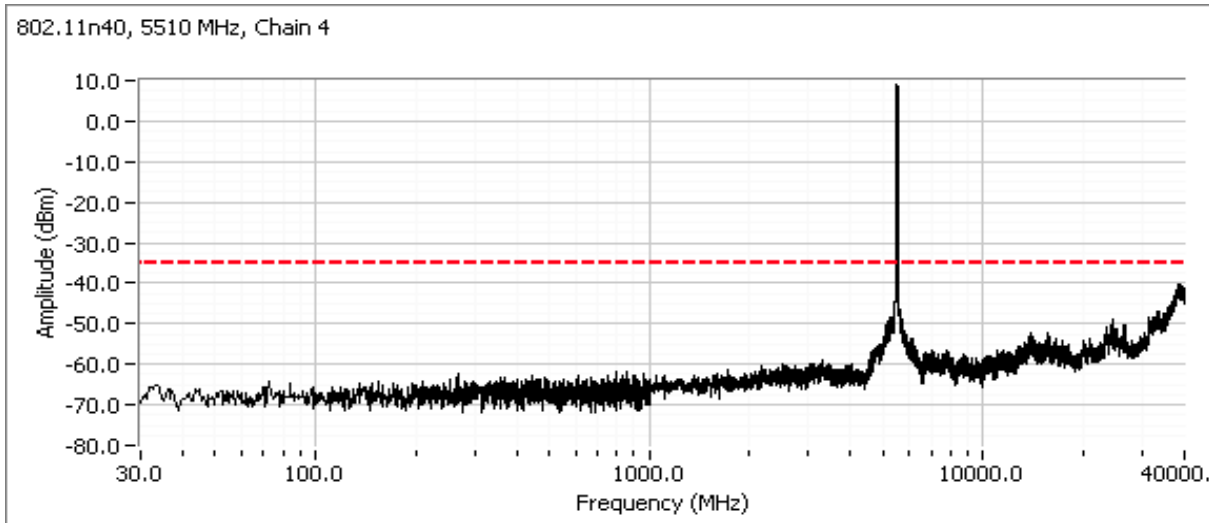

Center channel, 5470 - 5725 MHz Band

For master devices - This plot is showing that the 20dB bandwidth of the channel closest to 5600 MHz does not spill into the 5600-5650 MHz band. RB > 1% of OBW. Span 2-5 times OBW.

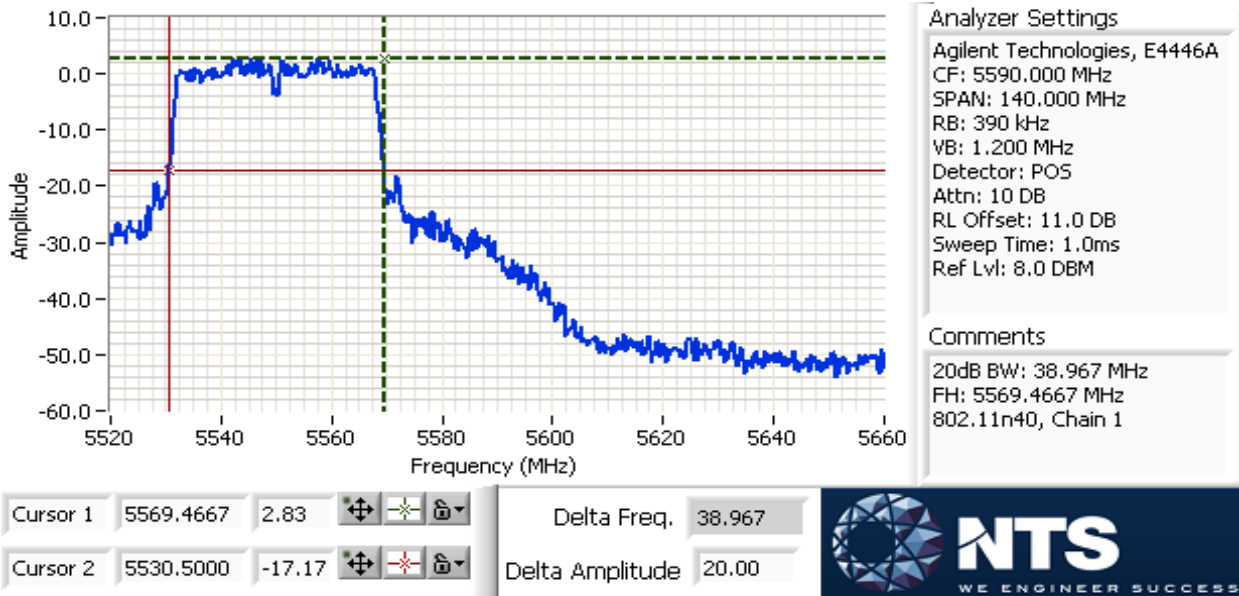

Client: Motorola	Job Number: J87247
Model: VAP2500	T-Log Number: T87276
Contact: Rob Linebarger	Account Manager: Christine Krebill
Standard: FCC	Class: N/A

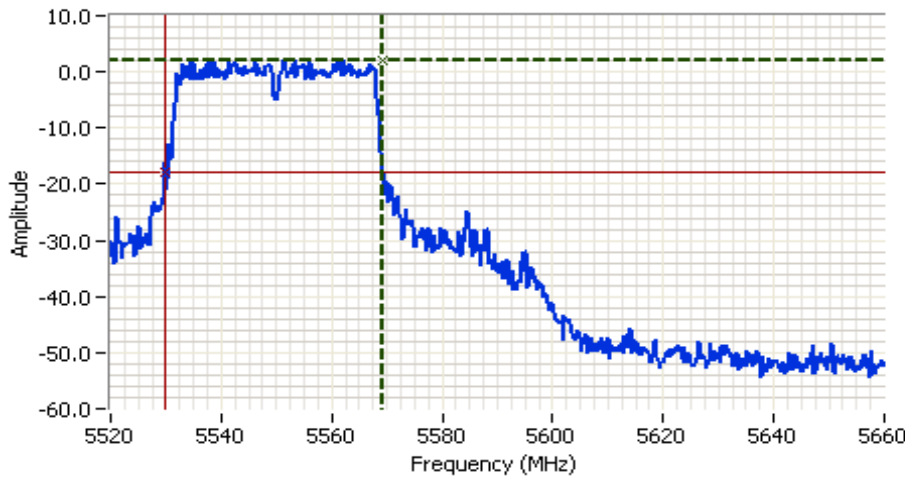

Analyzer Settings
 Agilent Technologies, E4446A
 CF: 5590.000 MHz
 SPAN: 140.000 MHz
 RB: 390 kHz
 VB: 1.200 MHz
 Detector: POS
 Attn: 10 DB
 RL Offset: 11.0 DB
 Sweep Time: 1.0ms
 Ref Lvl: 8.0 DBM

Comments
 20dB BW: 39.433 MHz
 FH: 5569.2333 MHz
 802.11n40, Chain 2

Cursor 1 5569.2333 2.05  Delta Freq. 39.433
 Cursor 2 5529.8000 -17.95  Delta Amplitude 20.00

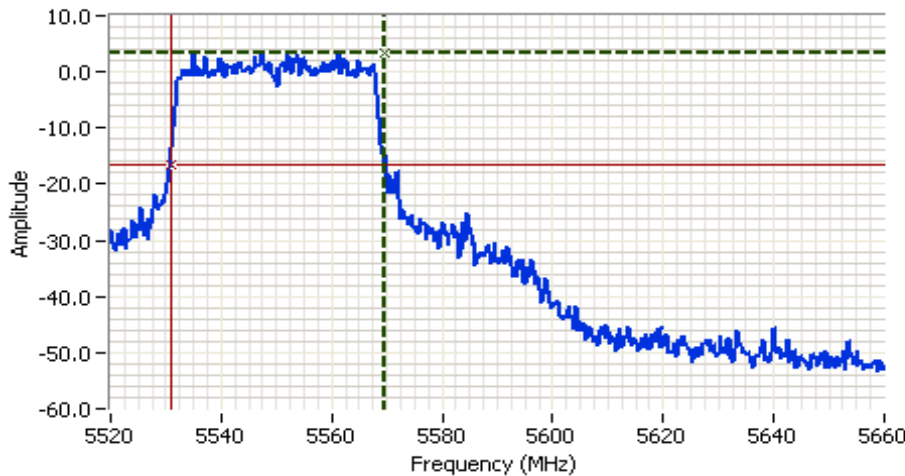

Analyzer Settings
 Agilent Technologies, E4446A
 CF: 5590.000 MHz
 SPAN: 140.000 MHz
 RB: 390 kHz
 VB: 1.200 MHz
 Detector: POS
 Attn: 10 DB
 RL Offset: 11.0 DB
 Sweep Time: 1.0ms
 Ref Lvl: 8.0 DBM

Comments
 20dB BW: 38.733 MHz
 FH: 5569.7000 MHz
 802.11n40, Chain 3

Cursor 1 5569.7000 3.30  Delta Freq. 38.733
 Cursor 2 5530.9667 -16.70  Delta Amplitude 20.00



Client: Motorola	Job Number: J87247
Model: VAP2500	T-Log Number: T87276
Contact: Rob Linebarger	Account Manager: Christine Krebill
Standard: FCC	Class: N/A

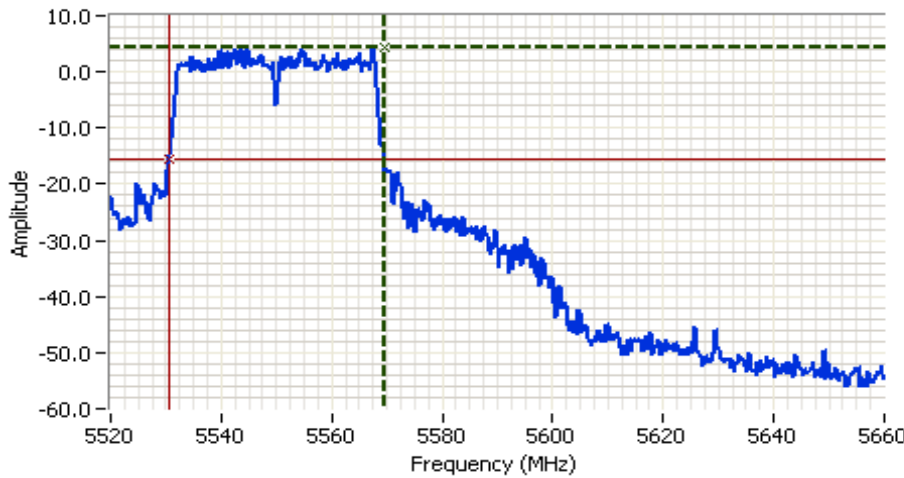

Analyzer Settings
 Agilent Technologies, E4446A
 CF: 5590.000 MHz
 SPAN: 140.000 MHz
 RB: 390 kHz
 VB: 1.200 MHz
 Detector: POS
 Attn: 10 DB
 RL Offset: 11.0 DB
 Sweep Time: 1.0ms
 Ref Lvl: 8.0 DBM

Comments
 20dB BW: 38.733 MHz
 FH: 5569.4667 MHz
 802.11n40, Chain 4

Cursor 1 5569.4667 4.49 Delta Freq. 38.733
 Cursor 2 5530.7333 -15.51 Delta Amplitude 20.00



Wide-band plot, RB=VB=1MHz (Peak measurements versus limit).

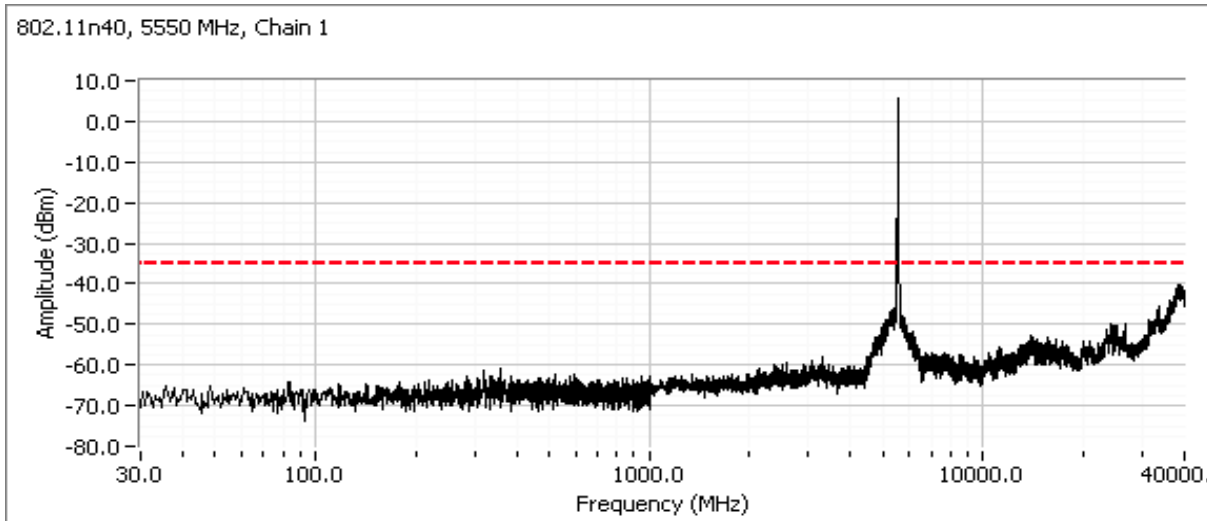

Client: Motorola	Job Number: J87247
Model: VAP2500	T-Log Number: T87276
	Account Manager: Christine Krebill
Contact: Rob Linebarger	
Standard: FCC	Class: N/A

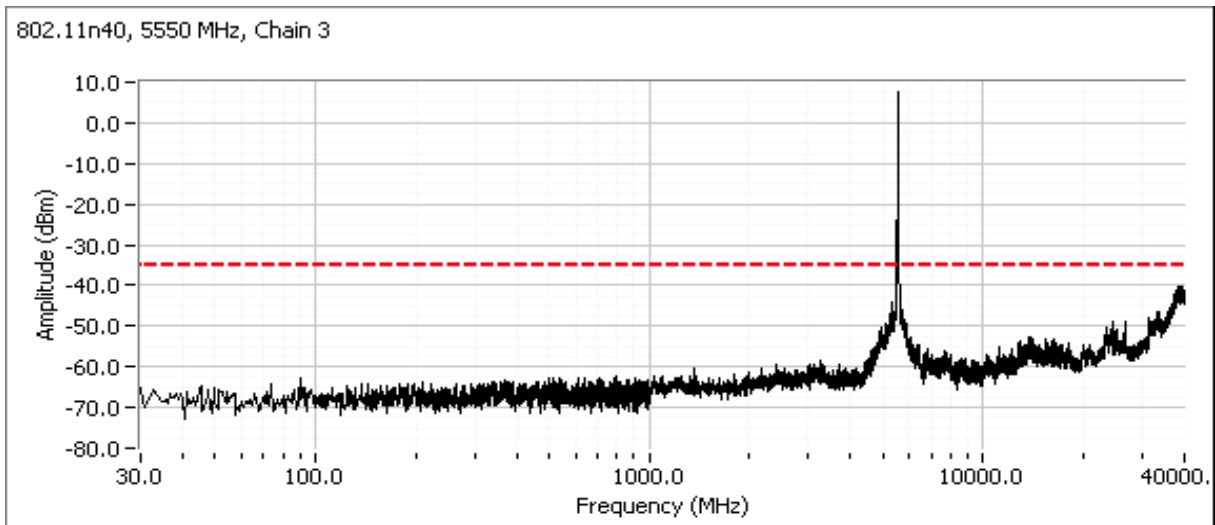
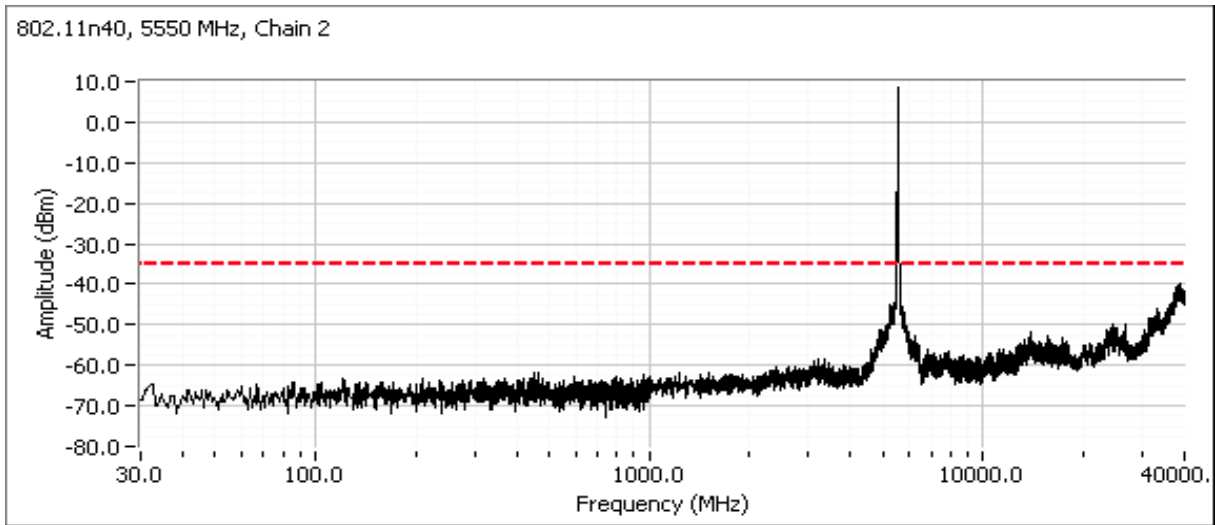

Client: Motorola	Job Number: J87247
Model: VAP2500	T-Log Number: T87276
Contact: Rob Linebarger	Account Manager: Christine Krebill
Standard: FCC	Class: N/A

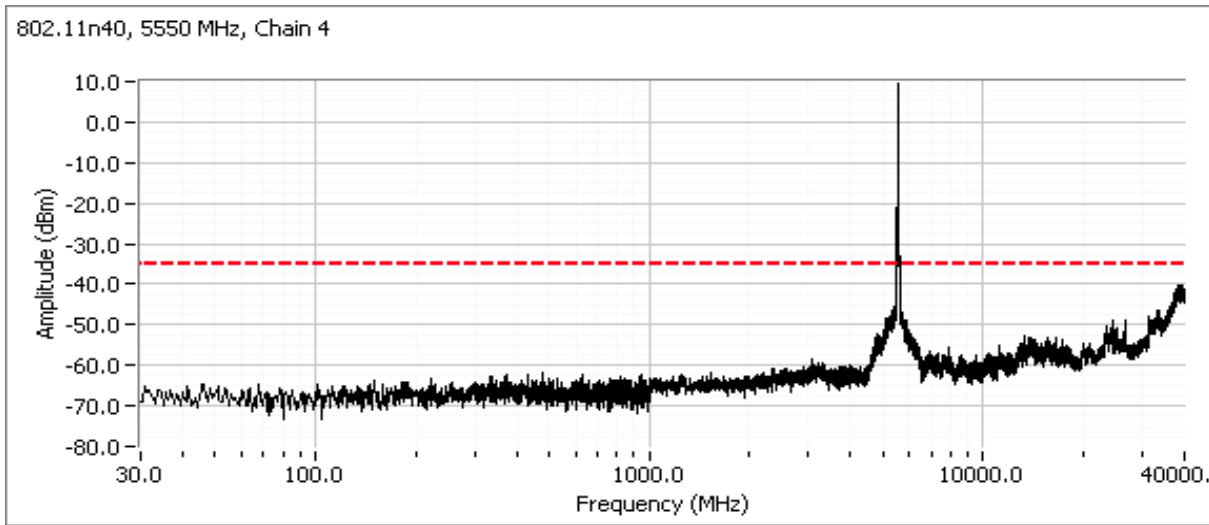

Channel adjacent to 5650 MHz (Master Device)

Plots showing that the 20dB bandwidth of the channel closest to 5650 MHz does not spill into the 5600-5650 MHz band. RB > 1% of OBW. Span is 2-5 times OBW.

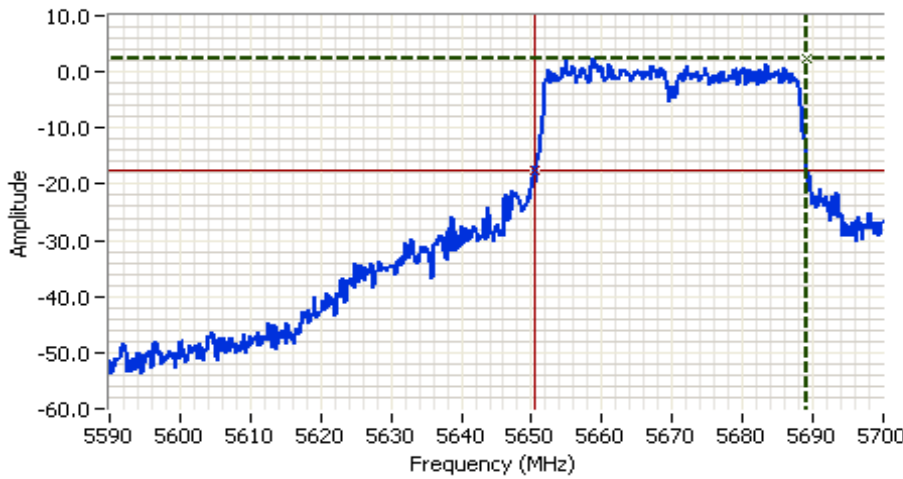

Analyzer Settings

Agilent Technologies, E4446A
 CF: 5645.000 MHz
 SPAN: 110.000 MHz
 RB: 390 kHz
 VB: 1.200 MHz
 Detector: POS
 Attn: 10 DB
 RL Offset: 11.0 DB
 Sweep Time: 1.0ms
 Ref Lvl: 8.0 DBM

Comments

20dB BW: 38.500 MHz
 FL: 5650.5000 MHz
 802.11n40, Chain 1

Cursor 1	5689.0000	2.50	
Cursor 2	5650.5000	-17.50	

Delta Freq. 38.500

Delta Amplitude 20.00

Client: Motorola	Job Number: J87247
Model: VAP2500	T-Log Number: T87276
Contact: Rob Linebarger	Account Manager: Christine Krebill
Standard: FCC	Class: N/A

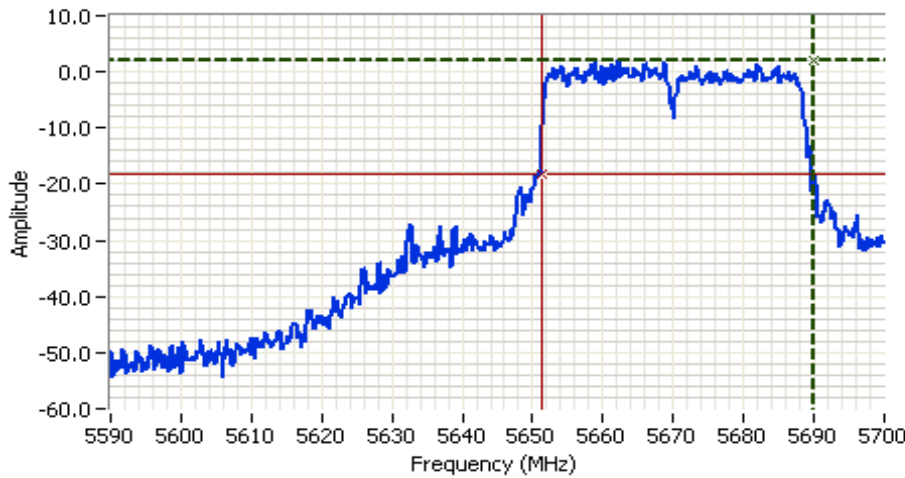

Analyzer Settings
 Agilent Technologies, E4446A
 CF: 5645.000 MHz
 SPAN: 110.000 MHz
 RB: 390 kHz
 VB: 1.200 MHz
 Detector: POS
 Attn: 10 DB
 RL Offset: 11.0 DB
 Sweep Time: 1.0ms
 Ref Lvl: 8.0 DBM

Comments
 20dB BW: 38.867 MHz
 FL: 5651.2333 MHz
 802.11n40, Chain 2

Cursor 1 5690.1000 1.91
 Cursor 2 5651.2333 -18.09

Delta Freq. 38.867
 Delta Amplitude 20.00

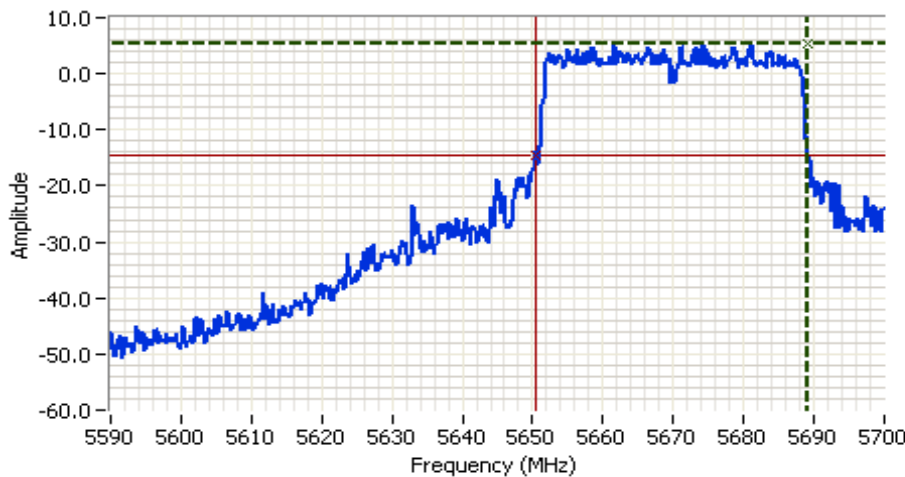

Analyzer Settings
 Agilent Technologies, E4446A
 CF: 5645.000 MHz
 SPAN: 110.000 MHz
 RB: 390 kHz
 VB: 1.200 MHz
 Detector: POS
 Attn: 10 DB
 RL Offset: 11.0 DB
 Sweep Time: 1.0ms
 Ref Lvl: 8.0 DBM

Comments
 20dB BW: 38.683 MHz
 FL: 5650.5000 MHz
 802.11n40, Chain 3

Cursor 1 5689.1833 5.39
 Cursor 2 5650.5000 -14.61

Delta Freq. 38.683
 Delta Amplitude 20.00



Client: Motorola	Job Number: J87247
Model: VAP2500	T-Log Number: T87276
Contact: Rob Linebarger	Account Manager: Christine Krebill
Standard: FCC	Class: N/A

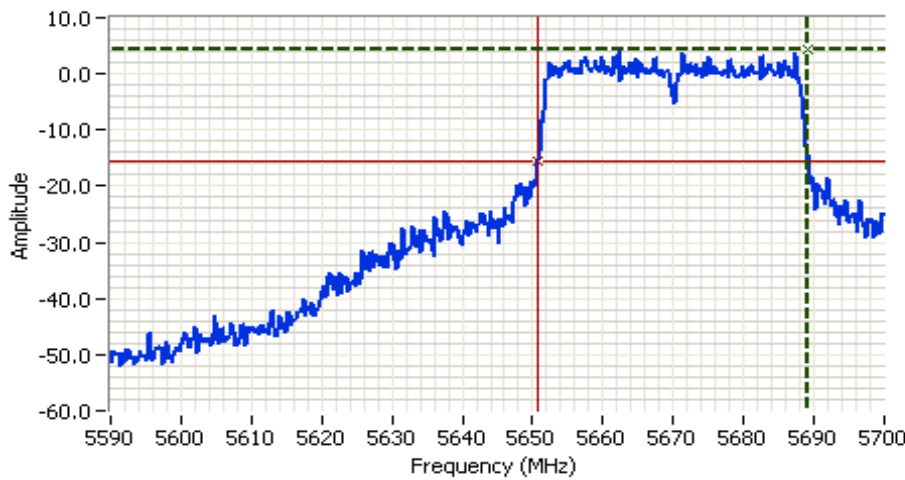

Analyzer Settings
 Agilent Technologies, E4446A
 CF: 5645.000 MHz
 SPAN: 110.000 MHz
 RB: 390 kHz
 VB: 1.200 MHz
 Detector: POS
 Attn: 10 DB
 RL Offset: 11.0 DB
 Sweep Time: 1.0ms
 Ref Lvl: 8.0 DBM

Comments
 20dB BW: 38.500 MHz
 FL: 5650.6833 MHz
 802.11n40, Chain 4

Cursor 1: 5689.1833, 4.49
 Cursor 2: 5650.6833, -15.52
 Delta Freq: 38.500
 Delta Amplitude: 20.00



High channel, 5470 - 5725 MHz Band

Wide-band plot, RB=VB=1MHz (Peak measurements versus limit).

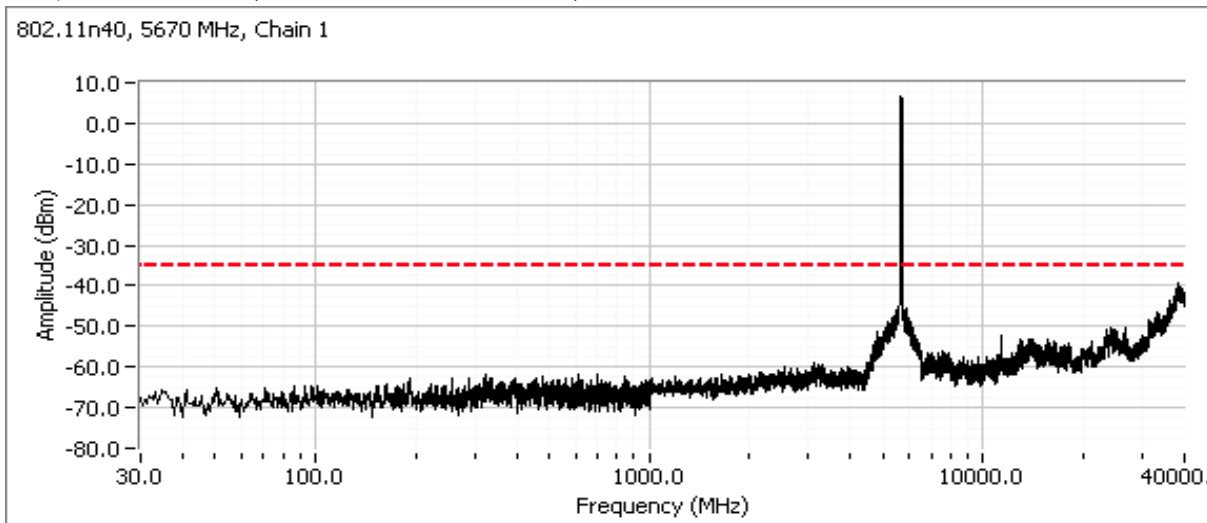

Client: Motorola	Job Number: J87247
Model: VAP2500	T-Log Number: T87276
Contact: Rob Linebarger	Account Manager: Christine Krebill
Standard: FCC	Class: N/A

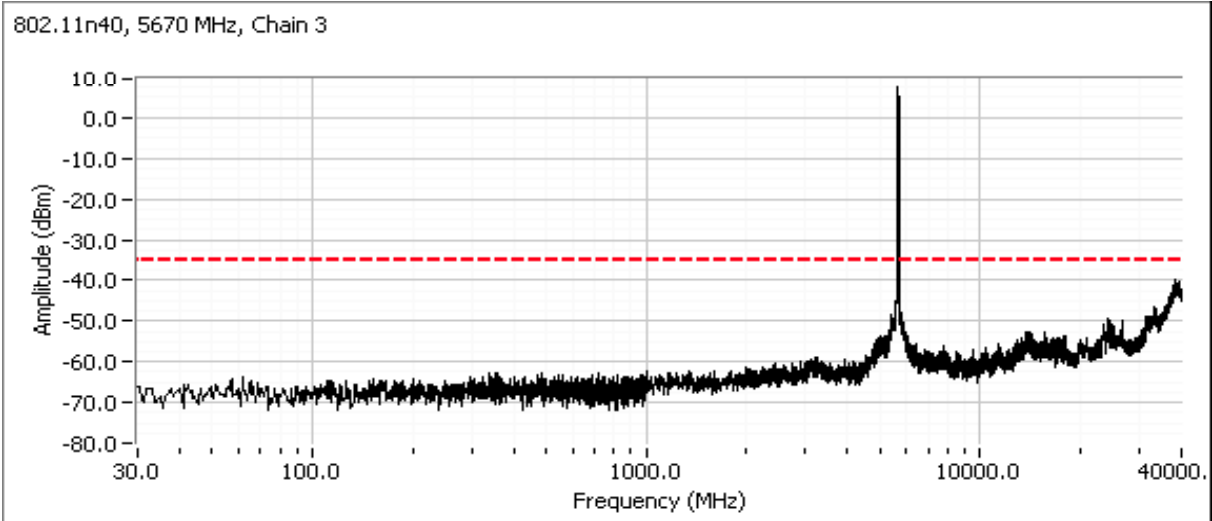
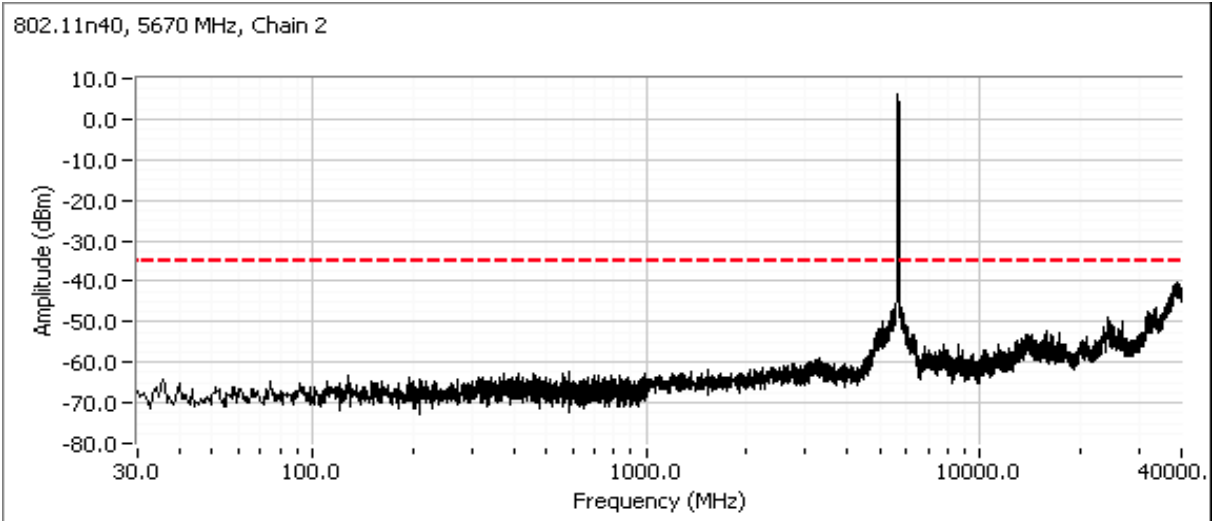

Client: Motorola	Job Number: J87247
Model: VAP2500	T-Log Number: T87276
	Account Manager: Christine Krebill
Contact: Rob Linebarger	
Standard: FCC	Class: N/A

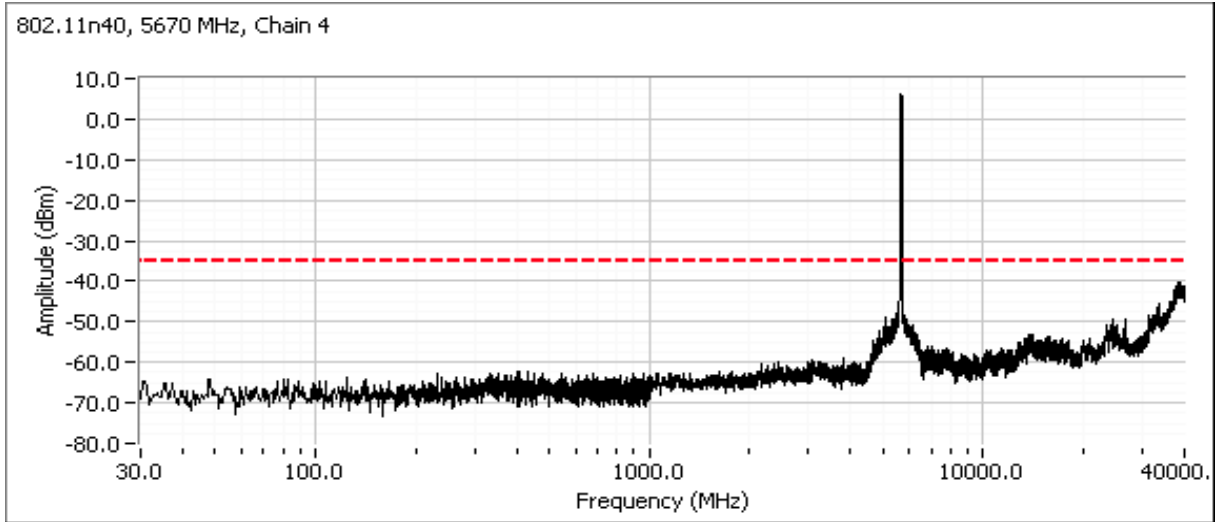



EMC Test Data

Client: Motorola	Job Number: J87247
Model: VAP2500	T-Log Number: T87276
Contact: Rob Linebarger	Account Manager: Christine Krebill
Standard: FCC	Class: N/A

RSS 210 and FCC 15.407 (NII) Radiated Spurious Emissions

Test Specific Details

Objective: The objective of this test session is to perform final qualification testing of the EUT with respect to the specification listed above.

General Test Configuration

The EUT and all local support equipment were located on the turntable for radiated spurious emissions testing. All remote support equipment was located approximately 30 meters from the EUT with all I/O connections running on top of the groundplane or routed in overhead in the GR-1089 test configuration.

For radiated emissions testing the measurement antenna was located 3 meters from the EUT.

Ambient Conditions:

Temperature: 23 °C
Rel. Humidity: 37 %

Software version: v1.10.3

Measured power listed obtained using average power meter

Summary of Results - Device Operating in the 5150-5350 MHz Band

Run #	Mode	Channel	Power Setting	Measured Power	Test Performed	Limit	Result / Margin
Run # 1	802.11a	#36 5180MHz	17.0	22.2	Restricted Band Edge at 5150 MHz	15.209	52.9 dBµV/m @ 5146.7 MHz (-1.1 dB)
		#64 5320MHz	17.0	22.3	Restricted Band Edge at 5350 MHz	15.209	52.6 dBµV/m @ 5353.0 MHz (-1.4 dB)
Run # 2	802.11n20	#36 5180MHz	17.0	22.4	Restricted Band Edge at 5150 MHz	15.209	53.7 dBµV/m @ 5146.3 MHz (-0.3 dB)
		#64 5320MHz	16.0	21.7	Restricted Band Edge at 5350 MHz	15.209	53.2 dBµV/m @ 5351.9 MHz (-0.8 dB)
Run # 3	802.11n40	#38 5190MHz	13.0	18.3	Restricted Band Edge at 5150 MHz	15.209	52.6 dBµV/m @ 5149.8 MHz (-1.4 dB)
		#54 5270MHz	17.0	22.1	Restricted Band Edge at 5350 MHz	15.209	52.6 dBµV/m @ 5350.0 MHz (-1.4 dB)
		#62 5310MHz	13.0	18.3	Restricted Band Edge at 5350 MHz	15.209	53.5 dBµV/m @ 5350.0 MHz (-0.5 dB)



EMC Test Data

Client: Motorola	Job Number: J87247
Model: VAP2500	T-Log Number: T87276
Contact: Rob Linebarger	Account Manager: Christine Krebill
Standard: FCC	Class: N/A

Summary of Results - Device Operating in the 5470-5725 MHz Band

Run #	Mode	Channel	Power Setting	Measured Power	Test Performed	Limit	Result / Margin
Run # 4	802.11a	#100 5500MHz	18.0	23.4	Restricted Band Edge at 5460 MHz	15.209	53.1 dBµV/m @ 5460.0 MHz (-0.9 dB)
			13.0	19.1	Band Edge at 5470 MHz	15.407	67.9 dBµV/m @ 5466.2 MHz (-0.4 dB)
		#104 5520MHz	18.0	24.0	Band Edge at 5470 MHz	15.407	64.3 dBµV/m @ 5470.0 MHz (-4.0 dB)
		#140 5700MHz	13.0	18.3	Band Edge at 5725 MHz	15.407	67.1 dBµV/m @ 5726.0 MHz (-1.2 dB)
		#136 5680MHz	18.0	23.7	Band Edge at 5725 MHz	15.407	65.9 dBµV/m @ 5727.3 MHz (-2.4 dB)
Run # 5	802.11n20	#100 5500MHz	17.0	22.9	Restricted Band Edge at 5460 MHz	15.209	53.0 dBµV/m @ 5459.9 MHz (-1.0 dB)
			12.0	18.5	Band Edge at 5470 MHz	15.407	67.0 dBµV/m @ 5465.5 MHz (-1.3 dB)
		#104 5520MHz	17.0	23.3	Band Edge at 5470 MHz	15.407	67.8 dBµV/m @ 5468.2 MHz (-0.5 dB)
		#140 5700MHz	12.0	17.4	Band Edge at 5725 MHz	15.407	67.7 dBµV/m @ 5725.2 MHz (-0.6 dB)
		#136 5680MHz	16.0	22.0	Band Edge at 5725 MHz	15.407	67.2 dBµV/m @ 5726.6 MHz (-1.1 dB)



EMC Test Data

Client: Motorola	Job Number: J87247
Model: VAP2500	T-Log Number: T87276
Contact: Rob Linebarger	Account Manager: Christine Krebill
Standard: FCC	Class: N/A

Summary of Results - Device Operating in the 5470-5725 MHz Band

Run #	Mode	Channel	Power Setting	Measured Power	Test Performed	Limit	Result / Margin
Run # 6	802.11n40	#102 5510MHz	14.0	19.6	Restricted Band Edge at 5460 MHz	15.209	52.2 dBµV/m @ 5459.9 MHz (-1.8 dB)
			10.0	16.4	Band Edge at 5470 MHz	15.407	68.2 dBµV/m @ 5469.1 MHz (-0.1 dB)
		#110 5550MHz	18.0	23.8	Band Edge at 5460 MHz	15.209	52.9 dBµV/m @ 5456.7 MHz (-1.1 dB)
			18.0	23.8	Band Edge at 5470 MHz	15.407	65.9 dBµV/m @ 5468.0 MHz (-2.4 dB)
			18.0	23.8	Band Edge at 5725 MHz	15.407	59.0 dBµV/m @ 5735.5 MHz (-9.3 dB)
		#134 5670MHz	15.0	20.7	Band Edge at 5725 MHz	15.407	67.8 dBµV/m @ 5725.4 MHz (-0.5 dB)

Modifications Made During Testing

No modifications were made to the EUT during testing

Deviations From The Standard

No deviations were made from the requirements of the standard.

Notes



EMC Test Data

Client: Motorola	Job Number: J87247
Model: VAP2500	T-Log Number: T87276
Contact: Rob Linebarger	Account Manager: Christine Krebill
Standard: FCC	Class: N/A

Run # 1, Band Edge Field Strength - 802.11a
 Date of Test: 5/16/2012 Test Location: FT#7
 Test Engineer: Joseph Cadigal Config Change: none
 Run # 1a, EUT on Channel #36 5180MHz - 802.11a

Software Setting	Target (dBm), Chain					Power Settings					Measured (dBm), Chain				
	A	B	C	D	Total	A	B	C	D	Total	A	B	C	D	Total
17	-	-	-	-			16.1	15.4	16.6	16.6	22.2				

5150 MHz Band Edge Signal Field Strength

Frequency	Level	Pol	15.209 / 15.247		Detector	Azimuth	Height	Comments
MHz	dB μ V/m	v/h	Limit	Margin	Pk/QP/Avg	degrees	meters	
5146.670	52.9	V	54.0	-1.1	AVG	298	1.1	setting = 17
5148.240	67.5	V	74.0	-6.5	PK	298	1.1	setting = 17
5140.380	51.6	H	54.0	-2.4	AVG	226	1.0	setting = 17
5148.440	63.1	H	74.0	-10.9	PK	226	1.0	setting = 17

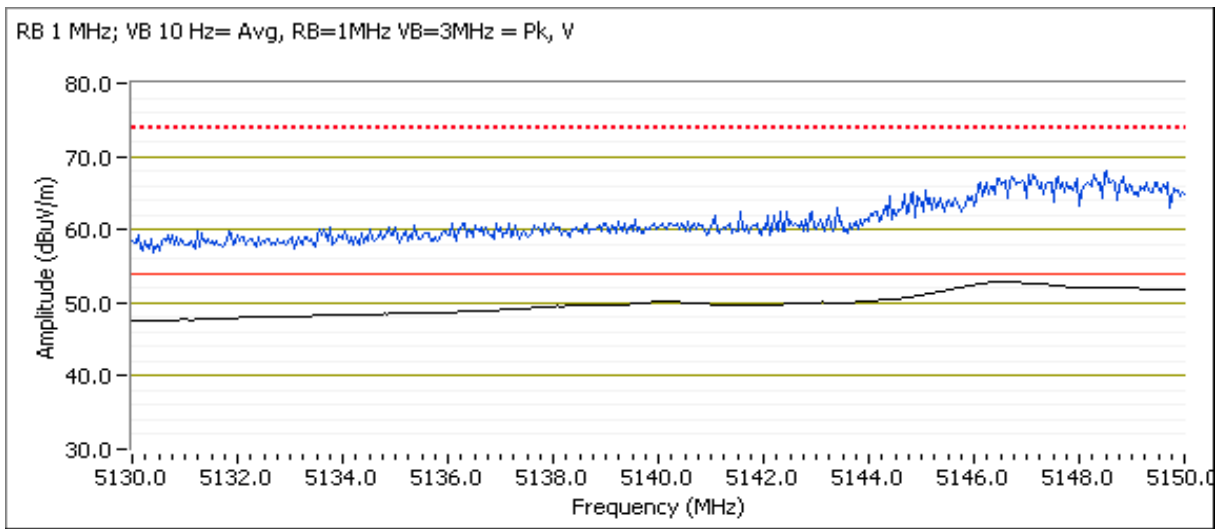



EMC Test Data

Client: Motorola	Job Number: J87247
Model: VAP2500	T-Log Number: T87276
Contact: Rob Linebarger	Account Manager: Christine Krebill
Standard: FCC	Class: N/A

Run # 1b, EUT on Channel #64 5320MHz - 802.11a
 Date of Test: 5/16/2012 Test Location: FT#7
 Test Engineer: Joseph Cadigal Config Change: none

Software Setting	Power Settings					Measured (dBm), Chain				
	Target (dBm), Chain									
	A	B	C	D	Total	A	B	C	D	Total
17	-	-	-	-		16.1	15.8	16.6	16.6	22.3

5350 MHz Band Edge Signal Radiated Field Strength

Frequency	Level	Pol	15.209 / 15.247		Detector	Azimuth	Height	Comments
MHz	dB μ V/m	v/h	Limit	Margin	Pk/QP/Avg	degrees	meters	
5352.970	52.6	V	54.0	-1.4	AVG	360	1.0	setting = 17
5352.520	66.2	V	74.0	-7.8	PK	360	1.0	setting = 17
5351.320	51.5	H	54.0	-2.5	AVG	163	1.0	setting = 17
5369.400	63.3	H	74.0	-10.7	PK	163	1.0	setting = 17

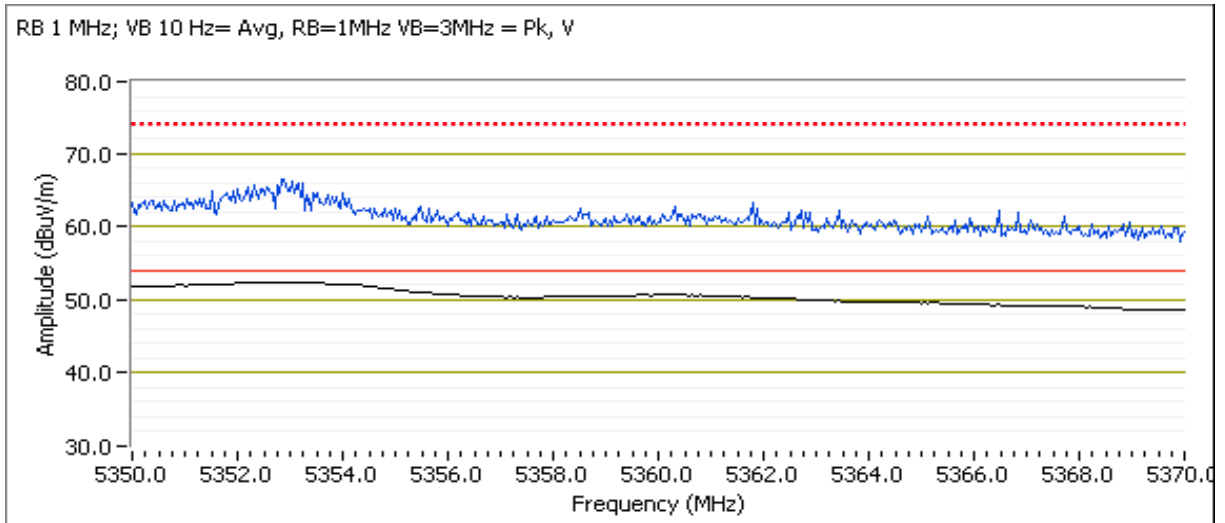



EMC Test Data

Client: Motorola	Job Number: J87247
Model: VAP2500	T-Log Number: T87276
Contact: Rob Linebarger	Account Manager: Christine Krebill
Standard: FCC	Class: N/A

Run # 2, Band Edge Field Strength - 802.11n20
 Date of Test: 5/16/2012 Test Location: FT#7
 Test Engineer: Joseph Cadigal Config Change: none
 Run # 2a, EUT on Channel #36 5180MHz - 802.11n20

Software Setting	Target (dBm), Chain					Power Settings					Measured (dBm), Chain				
	A	B	C	D	Total	A	B	C	D	Total	A	B	C	D	Total
17	-	-	-	-			16.1	15.8	16.5	16.9	22.4				

5150 MHz Band Edge Signal Field Strength

Frequency	Level	Pol	15.209 / 15.247		Detector	Azimuth	Height	Comments
MHz	dB μ V/m	v/h	Limit	Margin	Pk/QP/Avg	degrees	meters	
5146.310	53.7	V	54.0	-0.3	AVG	291	1.2	setting = 17
5147.190	68.8	V	74.0	-5.2	PK	291	1.2	setting = 17
5150.000	45.2	H	54.0	-8.8	AVG	259	1.0	setting = 17
5149.760	56.7	H	74.0	-17.3	PK	259	1.0	setting = 17

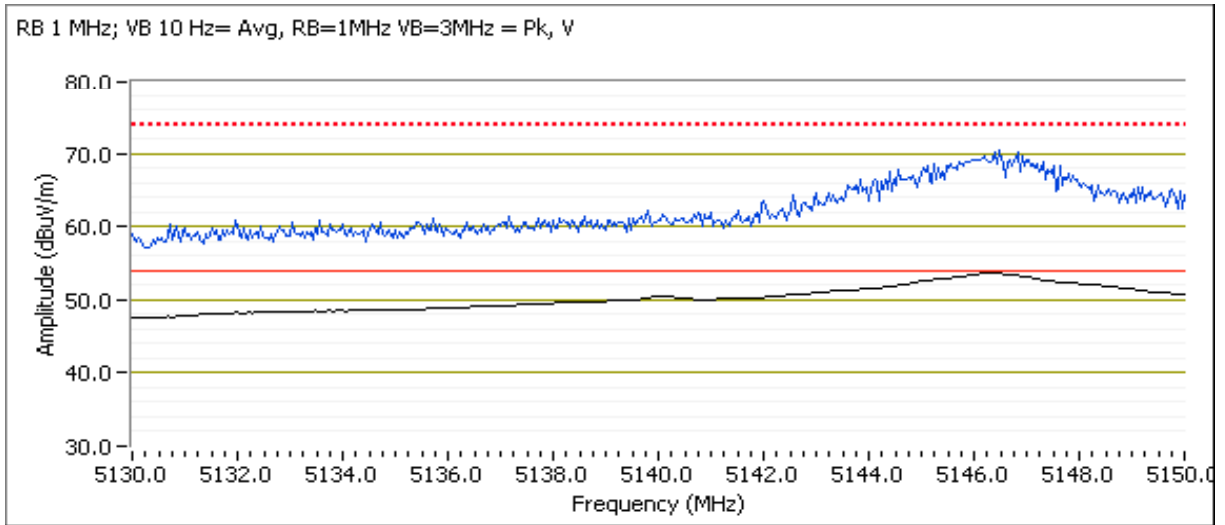



EMC Test Data

Client: Motorola	Job Number: J87247
Model: VAP2500	T-Log Number: T87276
Contact: Rob Linebarger	Account Manager: Christine Krebill
Standard: FCC	Class: N/A

Run # 2b, EUT on Channel #64 5320MHz - 802.11n20
 Date of Test: 5/16/2012 Test Location: FT#7
 Test Engineer: Joseph Cadigal Config Change: none

Software Setting	Power Settings					Measured (dBm), Chain				
	Target (dBm), Chain									
	A	B	C	D	Total	A	B	C	D	Total
17	-	-	-	-		15.5	14.8	15.8	16.3	21.7

5350 MHz Band Edge Signal Radiated Field Strength

Frequency	Level	Pol	15.209 / 15.247		Detector	Azimuth	Height	Comments
MHz	dB μ V/m	v/h	Limit	Margin	Pk/QP/Avg	degrees	meters	
5351.880	53.2	V	54.0	-0.8	AVG	360	1.1	setting = 17
5353.170	64.6	V	74.0	-9.4	PK	360	1.1	setting = 17
5351.360	44.4	H	54.0	-9.6	AVG	161	1.0	setting = 17
5353.090	55.5	H	74.0	-18.5	PK	161	1.0	setting = 17

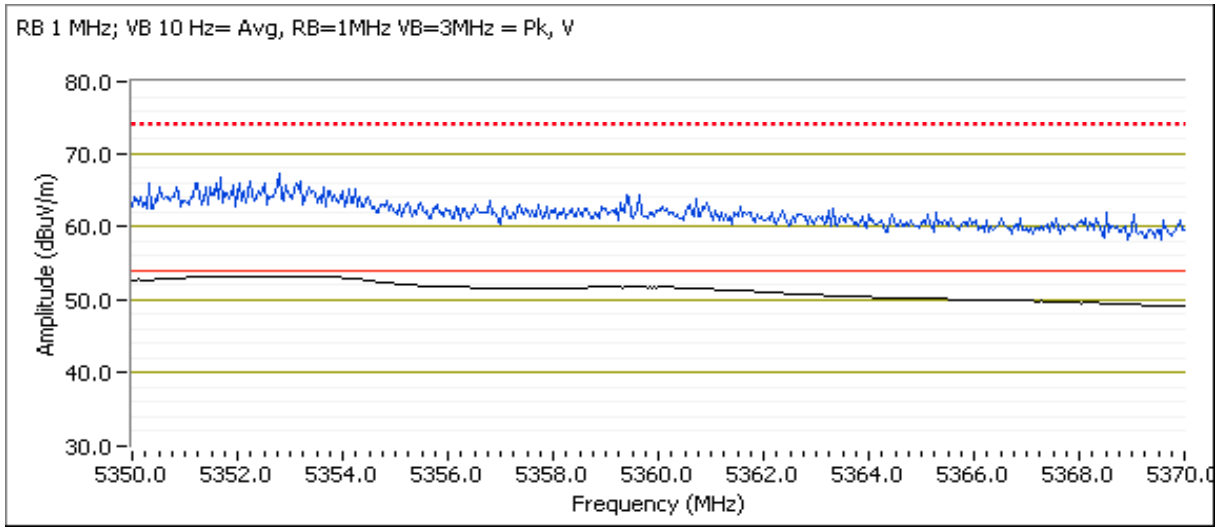



EMC Test Data

Client: Motorola	Job Number: J87247
Model: VAP2500	T-Log Number: T87276
Contact: Rob Linebarger	Account Manager: Christine Krebill
Standard: FCC	Class: N/A

Run # 3, Band Edge Field Strength - 802.11n40
 Date of Test: 5/16/2012 Test Location: FT#7
 Test Engineer: Joseph Cadigal Config Change: none
 Run # 3a, EUT on Channel #38 5190MHz - 802.11n40

Software Setting	Target (dBm), Chain					Power Settings					Measured (dBm), Chain				
	A	B	C	D	Total	A	B	C	D	Total	A	B	C	D	Total
13	-	-	-	-	-						12.2	11.2	12.6	13.0	18.3

5150 MHz Band Edge Signal Field Strength

Frequency	Level	Pol	15.209 / 15.247		Detector	Azimuth	Height	Comments
MHz	dB μ V/m	v/h	Limit	Margin	Pk/QP/Avg	degrees	meters	
5149.760	52.6	V	54.0	-1.4	AVG	360	1.0	setting = 13
5148.240	67.3	V	74.0	-6.7	PK	360	1.0	setting = 13
5149.040	51.9	H	54.0	-2.1	AVG	262	1.0	setting = 13
5149.840	63.5	H	74.0	-10.5	PK	262	1.0	setting = 13

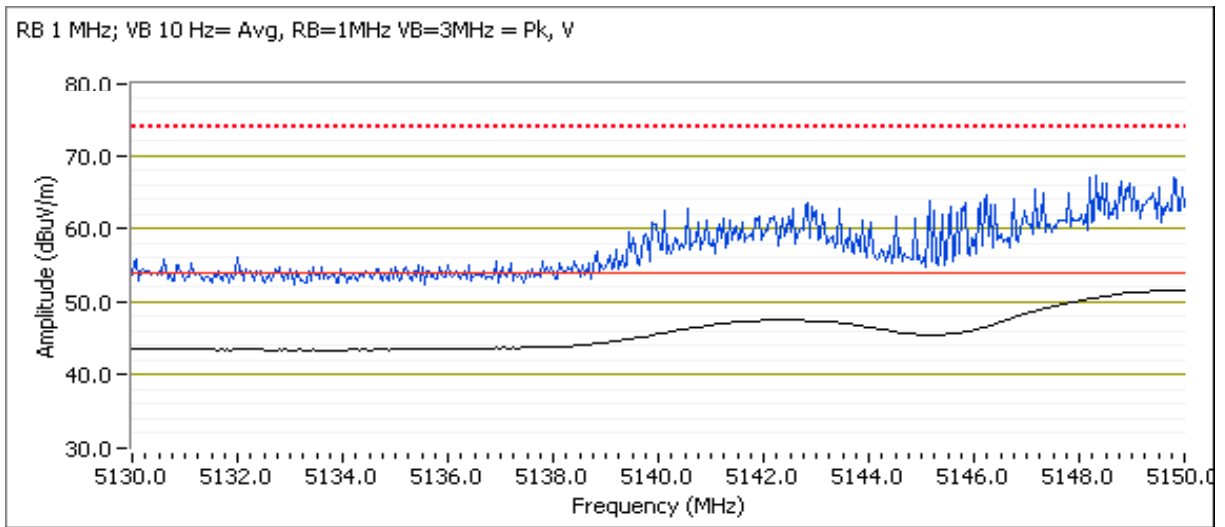



EMC Test Data

Client: Motorola	Job Number: J87247
Model: VAP2500	T-Log Number: T87276
Contact: Rob Linebarger	Account Manager: Christine Krebill
Standard: FCC	Class: N/A

Run # 3b, EUT on Channel #54 5270MHz - 802.11n40
 Date of Test: 5/25/2012 Test Location: FT5
 Test Engineer: Rafael Varelas Config Change: none

Software Setting	Power Settings					Measured (dBm), Chain				
	Target (dBm), Chain					Measured (dBm), Chain				
	A	B	C	D	Total	A	B	C	D	Total
17	-	-	-	-		15.7	15.9	16.7	16.1	22.1

5350 MHz Band Edge Signal Radiated Field Strength

Frequency	Level	Pol	15.209 / 15.247		Detector	Azimuth	Height	Comments
MHz	dB μ V/m	v/h	Limit	Margin	Pk/QP/Avg	degrees	meters	
5350.010	52.6	V	54.0	-1.4	AVG	212	1.0	POS; RB 1 MHz; VB: 10 Hz
5350.500	64.4	V	74.0	-9.6	PK	212	1.0	POS; RB 1 MHz; VB: 3 MHz
5352.120	45.9	H	54.0	-8.1	AVG	225	1.0	POS; RB 1 MHz; VB: 10 Hz
5365.590	57.9	H	74.0	-16.1	PK	225	1.0	POS; RB 1 MHz; VB: 3 MHz

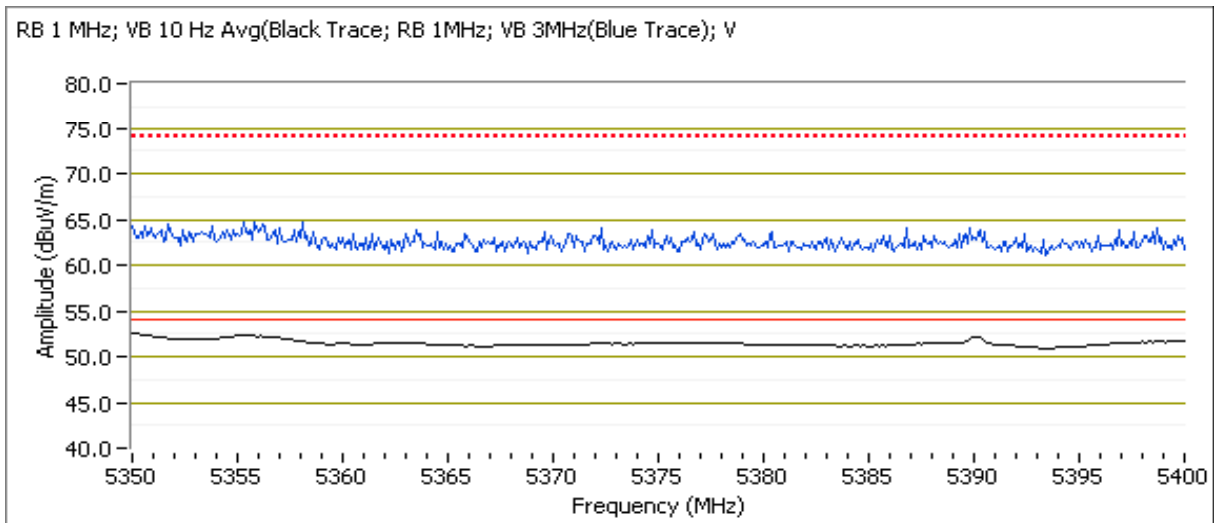



EMC Test Data

Client: Motorola	Job Number: J87247
Model: VAP2500	T-Log Number: T87276
Contact: Rob Linebarger	Account Manager: Christine Krebill
Standard: FCC	Class: N/A

Run # 3c, EUT on Channel #62 5310MHz - 802.11n40
 Date of Test: 5/11/2012 Test Location: FT7
 Test Engineer: Jack Liu Config Change: none

Software Setting	Power Settings					Measured (dBm), Chain				
	Target (dBm), Chain									
	A	B	C	D	Total	A	B	C	D	Total
13	-	-	-	-		12.0	11.5	12.3	13.0	18.3

5350 MHz Band Edge Signal Radiated Field Strength

Frequency	Level	Pol	15.209 / 15.247		Detector	Azimuth	Height	Comments
MHz	dB μ V/m	v/h	Limit	Margin	Pk/QP/Avg	degrees	meters	
5350.000	53.5	V	54.0	-0.5	AVG	0	1.9	
5350.900	65.4	V	74.0	-8.6	PK	0	1.9	
5350.000	48.4	H	54.0	-5.6	AVG	36	1.0	
5350.000	61.2	H	74.0	-12.8	PK	36	1.0	

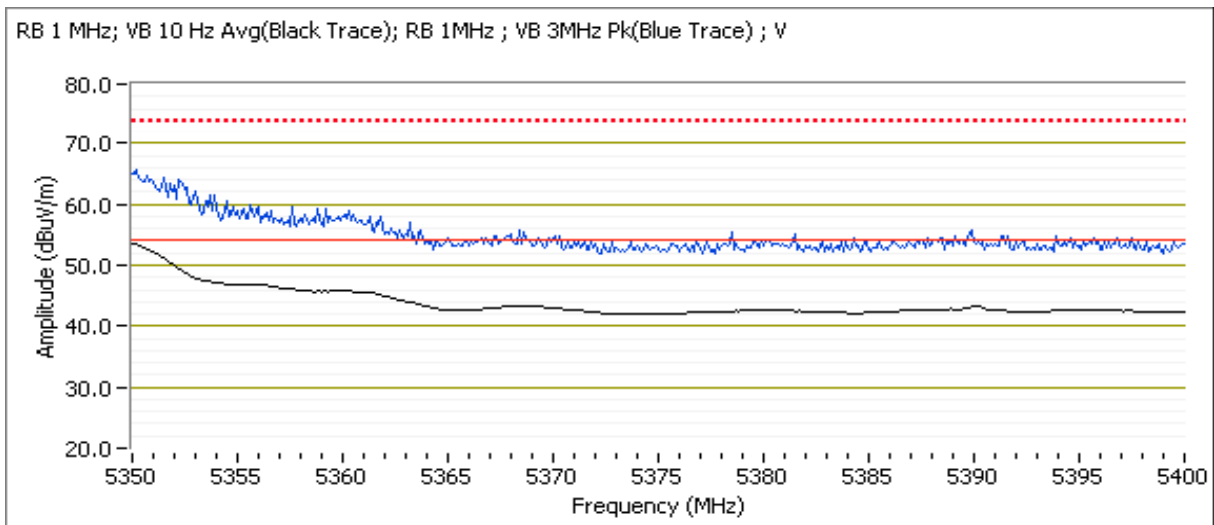



EMC Test Data

Client: Motorola	Job Number: J87247
Model: VAP2500	T-Log Number: T87276
Contact: Rob Linebarger	Account Manager: Christine Krebill
Standard: FCC	Class: N/A

Run # 4, Band Edge Field Strength - 802.11a

Date of Test: 5/16/2012
 Test Engineer: Joseph Cadigal

Test Location: FT#7
 Config Change: none

Run # 4a, EUT on Channel #100 5500MHz - 802.11a

Software Setting	Target (dBm), Chain					Power Settings					Measured (dBm), Chain				
	A	B	C	D	Total	A	B	C	D	Total	A	B	C	D	Total
18	-	-	-	-	-	-	17.6	16.8	17.4	17.8	23.4				

5460 MHz Band Edge Signal Field Strength

Frequency	Level	Pol	15.209 / 15.247		Detector	Azimuth	Height	Comments
MHz	dB μ V/m	v/h	Limit	Margin	Pk/QP/Avg	degrees	meters	
5459.960	53.1	V	54.0	-0.9	AVG	360	1.0	setting = 18
5458.600	63.4	V	74.0	-10.6	PK	360	1.0	setting = 18
5460.000	52.4	H	54.0	-1.6	AVG	335	1.0	setting = 18
5453.110	63.9	H	74.0	-10.1	PK	335	1.0	setting = 18

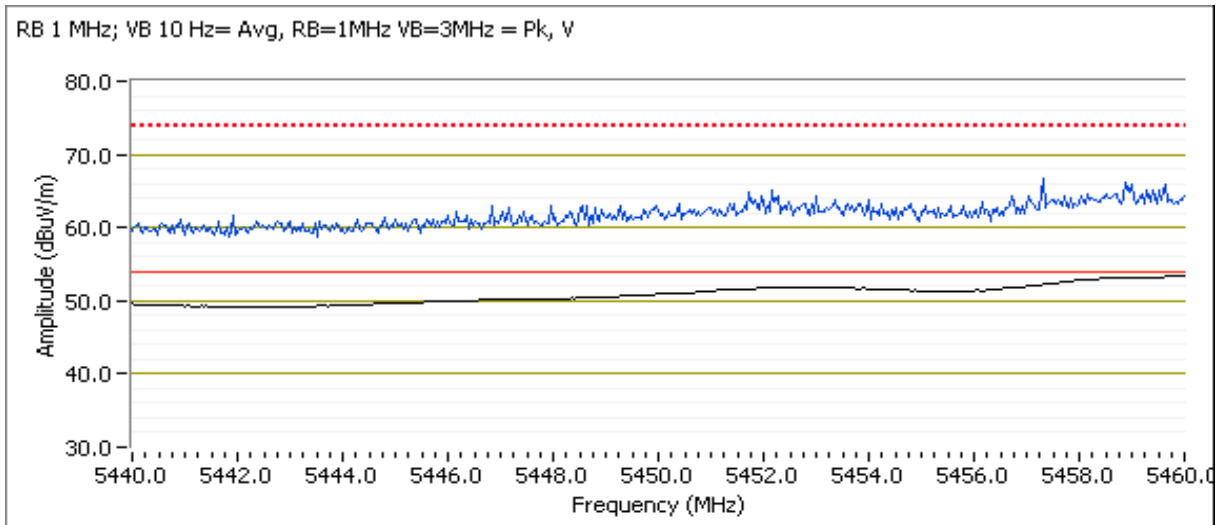



EMC Test Data

Client: Motorola	Job Number: J87247
Model: VAP2500	T-Log Number: T87276
Contact: Rob Linebarger	Account Manager: Christine Krebill
Standard: FCC	Class: N/A

Run # 4b, EUT on Channel #100 5500MHz - 802.11a
 Date of Test: 5/25/2012 Test Location: FT#5
 Test Engineer: Jack Liu Config Change: none

Software Setting	Power Settings					Measured (dBm), Chain				
	Target (dBm), Chain					Measured (dBm), Chain				
	A	B	C	D	Total	A	B	C	D	Total
13	-	-	-	-		12.3	13.0	13.9	12.8	19.1

5470 MHz Band Edge Signal Field Strength (power setting = 13)

Frequency	Level	Pol	15.209 / 15.247		Detector	Azimuth	Height	Comments
MHz	dB μ V/m	v/h	Limit	Margin	Pk/QP/Avg	degrees	meters	
5466.150	67.9	V	68.3	-0.4	PK	207	1.0	POS; RB 1 MHz; VB: 3 MHz
5468.600	58.6	H	68.3	-9.7	PK	193	1.0	POS; RB 1 MHz; VB: 3 MHz

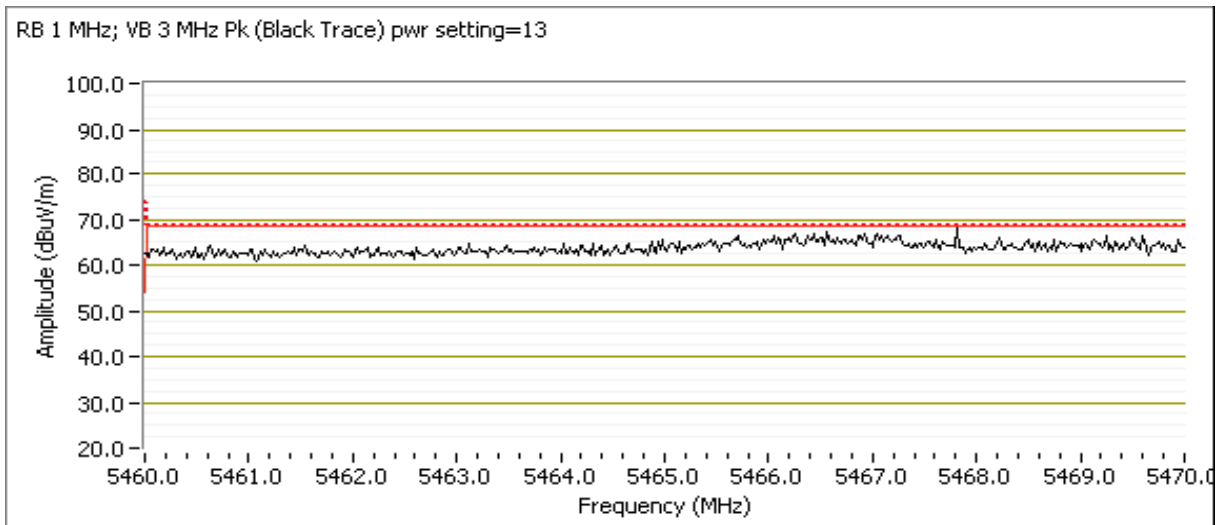



EMC Test Data

Client: Motorola	Job Number: J87247
Model: VAP2500	T-Log Number: T87276
Contact: Rob Linebarger	Account Manager: Christine Krebill
Standard: FCC	Class: N/A

Run # 4c, EUT on Channel #104 5520MHz - 802.11a
 Date of Test: 5/25/2012 Test Location: FT#5
 Test Engineer: Rafael Varelas Config Change: none

Software Setting	Power Settings					Measured (dBm), Chain				
	Target (dBm), Chain									
18	A	B	C	D	Total	A	B	C	D	Total
	-	-	-	-		17.9	17.5	17.9	18.4	24.0

5470 MHz Band Edge Signal Field Strength (power setting = 18)

Frequency	Level	Pol	15.209 / 15.247		Detector	Azimuth	Height	Comments
MHz	dB μ V/m	v/h	Limit	Margin	Pk/QP/Avg	degrees	meters	
5469.990	64.3	V	68.3	-4.0	PK	216	1.0	POS; RB 1 MHz; VB: 3 MHz
5466.350	58.4	H	68.3	-9.9	PK	44	1.0	POS; RB 1 MHz; VB: 3 MHz

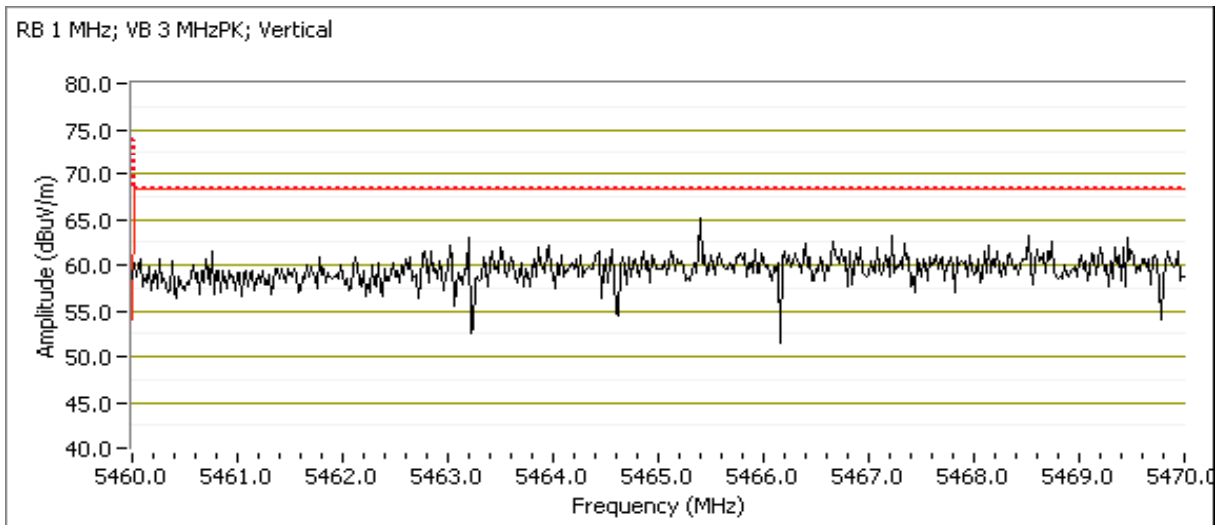



EMC Test Data

Client: Motorola	Job Number: J87247
Model: VAP2500	T-Log Number: T87276
Contact: Rob Linebarger	Account Manager: Christine Krebill
Standard: FCC	Class: N/A

Run # 4d, EUT on Channel #140 5700MHz - 802.11a
 Date of Test: 5/25/2012 Test Location: FT#5
 Test Engineer: Jack Liu Config Change: none

Software Setting	Power Settings					Measured (dBm), Chain				
	Target (dBm), Chain									
13	A	B	C	D	Total	A	B	C	D	Total
	-	-	-	-		12.0	12.3	11.9	12.8	18.3

5725 MHz Band Edge Signal Field Strength

Frequency	Level	Pol	15.209 / 15.247		Detector	Azimuth	Height	Comments
MHz	dB μ V/m	v/h	Limit	Margin	Pk/QP/Avg	degrees	meters	
5725.960	67.1	V	68.3	-1.2	PK	207	1.2	Pwr setting= 13
5732.700	58.2	H	68.3	-10.1	PK	342	1.0	Pwr setting= 13

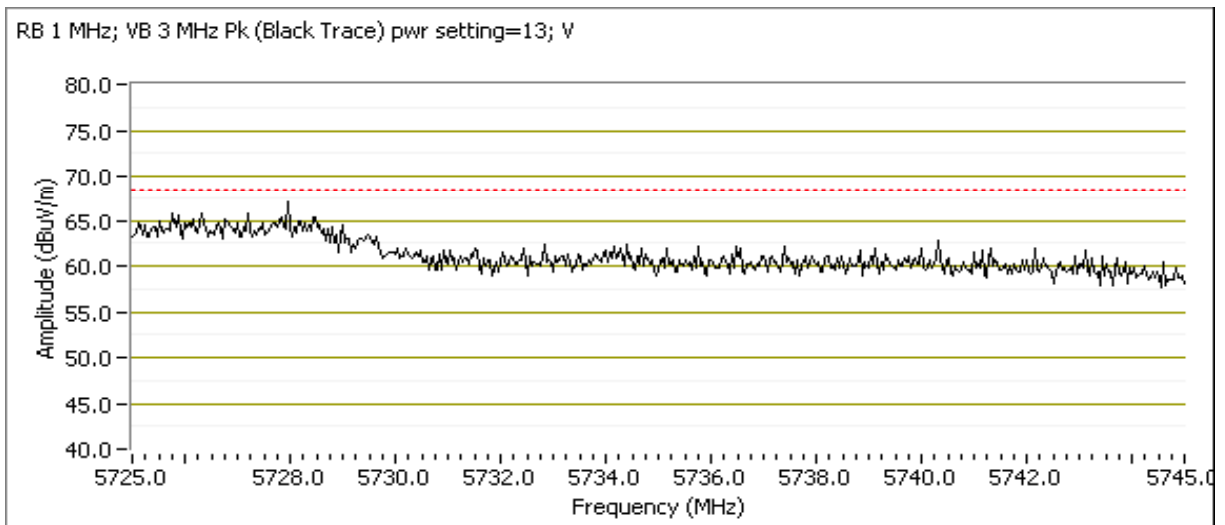



EMC Test Data

Client: Motorola	Job Number: J87247
Model: VAP2500	T-Log Number: T87276
Contact: Rob Linebarger	Account Manager: Christine Krebill
Standard: FCC	Class: N/A

Run # 4e, EUT on Channel #136 5680MHz - 802.11a
 Date of Test: 5/25/2012 Test Location: FT#5
 Test Engineer: Rafael Varelas Config Change: none

Software Setting	Power Settings					Measured (dBm), Chain				
	Target (dBm), Chain					Measured (dBm), Chain				
	A	B	C	D	Total	A	B	C	D	Total
18	-	-	-	-		17.8	17.3	17.7	18.1	23.7

5725 MHz Band Edge Signal Field Strength

Frequency	Level	Pol	15.209 / 15.247		Detector	Azimuth	Height	Comments
MHz	dB μ V/m	v/h	Limit	Margin	Pk/QP/Avg	degrees	meters	
5727.280	65.9	V	68.3	-2.4	PK	197	1.1	POS; RB 1 MHz; VB: 3 MHz
5727.950	59.1	H	68.3	-9.2	PK	0	1.0	POS; RB 1 MHz; VB: 3 MHz

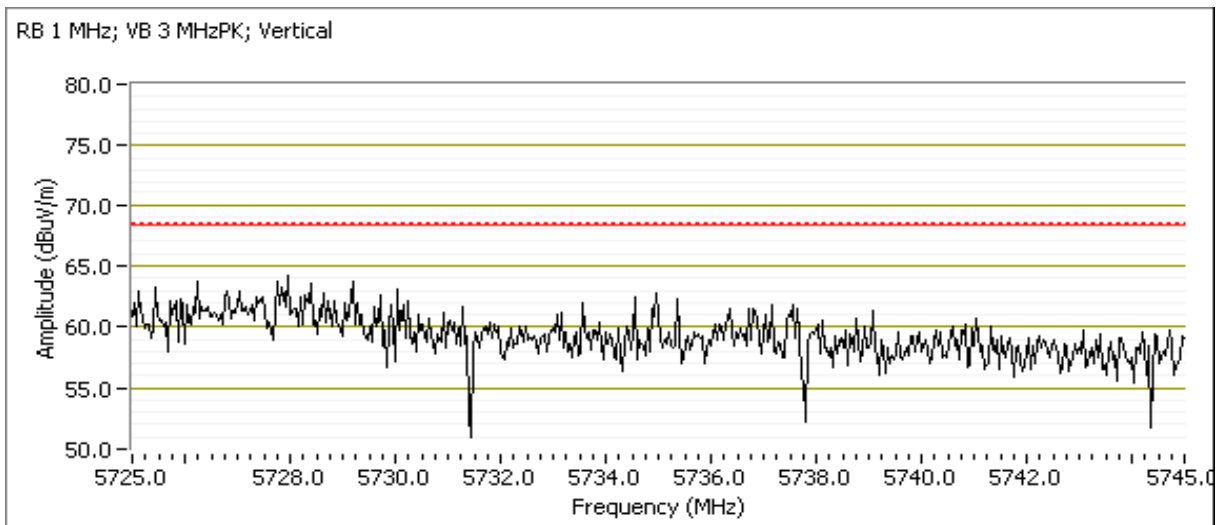



EMC Test Data

Client: Motorola	Job Number: J87247
Model: VAP2500	T-Log Number: T87276
Contact: Rob Linebarger	Account Manager: Christine Krebill
Standard: FCC	Class: N/A

Run # 5, Band Edge Field Strength - 802.11n20
 Date of Test: 5/16/2012 Test Location: FT#7
 Test Engineer: Joseph Cadigal Config Change: none
 Run # 5a, EUT on Channel #100 5500MHz - 802.11n20

Software Setting	Target (dBm), Chain					Power Settings					Measured (dBm), Chain				
	A	B	C	D	Total	A	B	C	D	Total	A	B	C	D	Total
17	-	-	-	-			16.8	16.1	17.0	17.4	22.9				

5460 MHz Band Edge Signal Field Strength

Frequency	Level	Pol	15.209 / 15.247		Detector	Azimuth	Height	Comments
MHz	dB μ V/m	v/h	Limit	Margin	Pk/QP/Avg	degrees	meters	
5459.880	53.0	V	54.0	-1.0	AVG	360	1.0	setting = 17
5456.550	66.0	V	74.0	-8.0	PK	360	1.0	setting = 17
5460.000	46.2	H	54.0	-7.8	AVG	338	1.0	setting = 17
5459.600	57.1	H	74.0	-16.9	PK	338	1.0	setting = 17

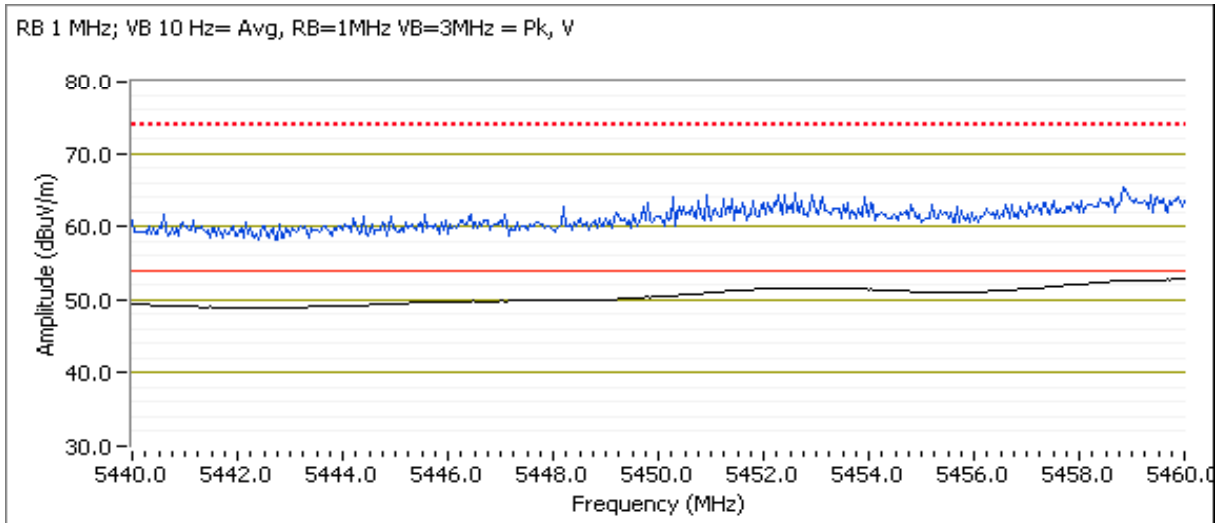



EMC Test Data

Client: Motorola	Job Number: J87247
Model: VAP2500	T-Log Number: T87276
Contact: Rob Linebarger	Account Manager: Christine Krebill
Standard: FCC	Class: N/A

Run # 5b, EUT on Channel #100 5500MHz - 802.11n20
 Date of Test: 5/25/2012 Test Location: FT#5
 Test Engineer: Jack Liu Config Change: none

Software Setting	Power Settings					Measured (dBm), Chain				
	Target (dBm), Chain									
12	A	B	C	D	Total	A	B	C	D	Total
	-	-	-	-		12.0	12.0	12.7	13.2	18.5

5470 MHz Band Edge Signal Field Strength

Frequency	Level	Pol	15.209 / 15.247		Detector	Azimuth	Height	Comments
MHz	dB μ V/m	v/h	Limit	Margin	Pk/QP/Avg	degrees	meters	
5465.450	67.0	V	68.3	-1.3	PK	204	1.0	Pwr setting= 12
5468.280	59.3	H	68.3	-9.0	PK	217	1.0	Pwr setting= 12

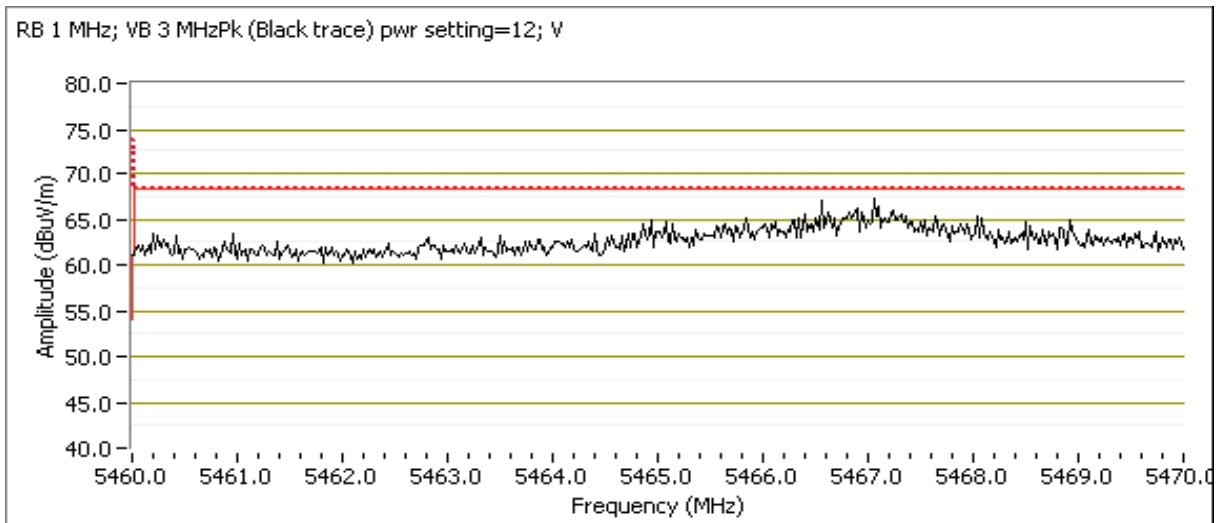



EMC Test Data

Client: Motorola	Job Number: J87247
Model: VAP2500	T-Log Number: T87276
Contact: Rob Linebarger	Account Manager: Christine Krebill
Standard: FCC	Class: N/A

Run # 5c, EUT on Channel #104 5520MHz - 802.11n20
 Date of Test: 5/25/2012 Test Location: FT#5
 Test Engineer: Jack Liu Config Change: none

Software Setting	Power Settings					Measured (dBm), Chain				
	Target (dBm), Chain					Measured (dBm), Chain				
17	A	B	C	D	Total	A	B	C	D	Total
	-	-	-	-		17.1	16.8	17.4	17.8	23.3

5470 MHz Band Edge Signal Field Strength

Frequency	Level	Pol	15.209 / 15.247		Detector	Azimuth	Height	Comments
MHz	dB μ V/m	v/h	Limit	Margin	Pk/QP/Avg	degrees	meters	
5468.220	67.8	V	68.3	-0.5	PK	204	1.0	POS; RB 1 MHz; VB: 3 MHz
5468.400	59.9	H	68.3	-8.4	PK	205	1.0	POS; RB 1 MHz; VB: 3 MHz

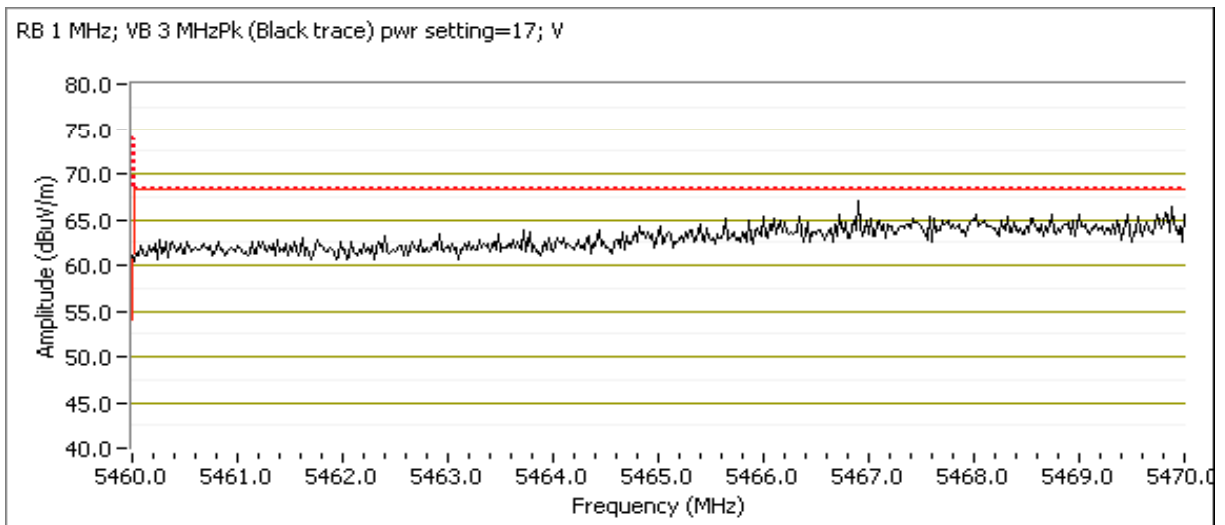



EMC Test Data

Client: Motorola	Job Number: J87247
Model: VAP2500	T-Log Number: T87276
Contact: Rob Linebarger	Account Manager: Christine Krebill
Standard: FCC	Class: N/A

Run # 5d, EUT on Channel #140 5700MHz - 802.11n20
 Date of Test: 5/25/2012 Test Location: FT#5
 Test Engineer: Jack Liu Config Change: none

Software Setting	Power Settings					Measured (dBm), Chain				
	Target (dBm), Chain					Measured (dBm), Chain				
	A	B	C	D	Total	A	B	C	D	Total
12	-	-	-	-		10.8	11.4	11.0	12.3	17.4

5725 MHz Band Edge Signal Field Strength

Frequency	Level	Pol	15.209 / 15.247		Detector	Azimuth	Height	Comments
MHz	dB μ V/m	v/h	Limit	Margin	Pk/QP/Avg	degrees	meters	
5725.160	67.7	V	68.3	-0.6	PK	217	1.0	Pwr setting= 12
5731.570	60.1	H	68.3	-8.2	PK	348	1.0	Pwr setting= 12

RB 1 MHz; VB 3 MHz Pk (Black Trace) pwr setting=12; V

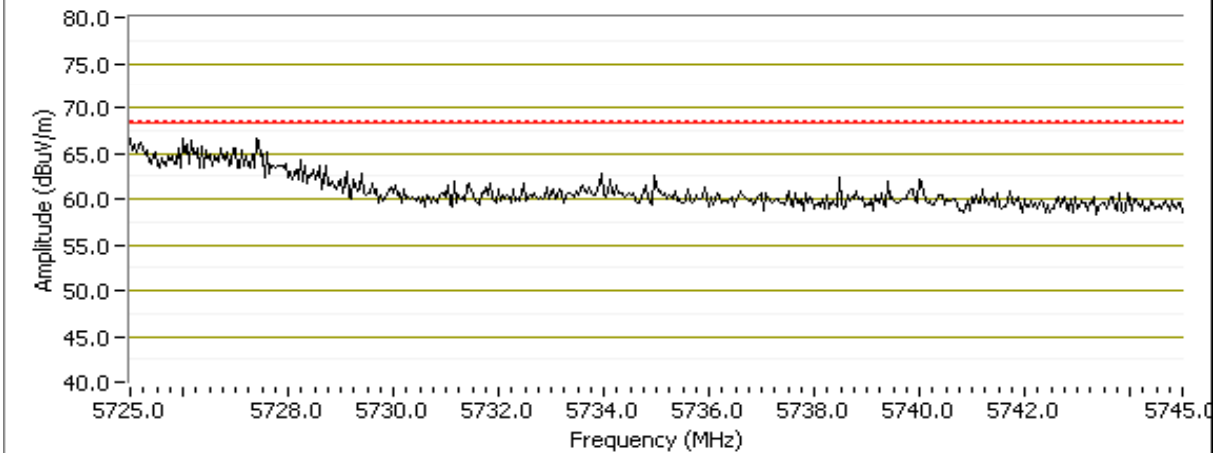



EMC Test Data

Client: Motorola	Job Number: J87247
Model: VAP2500	T-Log Number: T87276
Contact: Rob Linebarger	Account Manager: Christine Krebill
Standard: FCC	Class: N/A

Run # 5e, EUT on Channel #136 5680MHz - 802.11n20
 Date of Test: 5/25/2012 Test Location: FT#5
 Test Engineer: Jack Liu Config Change: none

Software Setting	Power Settings					Measured (dBm), Chain				
	Target (dBm), Chain									
	A	B	C	D	Total	A	B	C	D	Total
16	-	-	-	-		15.8	15.7	16.1	16.4	22.0

5725 MHz Band Edge Signal Field Strength

Frequency	Level	Pol	15.209 / 15.247		Detector	Azimuth	Height	Comments
MHz	dB μ V/m	v/h	Limit	Margin	Pk/QP/Avg	degrees	meters	
5726.560	67.2	V	68.3	-1.1	PK	204	1.0	Pwr setting= 16
5727.690	60.1	H	68.3	-8.2	PK	352	1.0	Pwr setting= 16

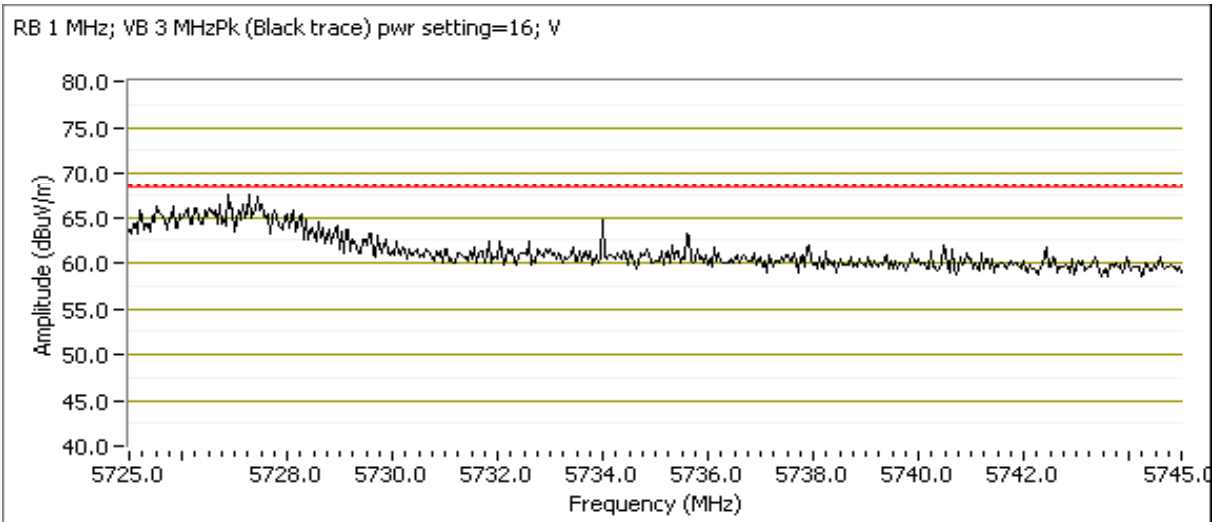



EMC Test Data

Client: Motorola	Job Number: J87247
Model: VAP2500	T-Log Number: T87276
Contact: Rob Linebarger	Account Manager: Christine Krebill
Standard: FCC	Class: N/A

Run # 6, Band Edge Field Strength - 802.11n40
 Date of Test: 5/14/2012 Test Location: FT7
 Test Engineer: Jack Liu Config Change: None

Run # 6a, EUT on Channel #102 5510MHz - 802.11n40

Software Setting	Target (dBm), Chain					Power Settings					Measured (dBm), Chain				
	A	B	C	D	Total	A	B	C	D	Total	A	B	C	D	Total
14	-	-	-	-							13.7	12.8	13.7	13.9	19.6

5460 MHz Band Edge Signal Field Strength

Frequency	Level	Pol	15.209 / 15.247		Detector	Azimuth	Height	Comments
MHz	dB μ V/m	v/h	Limit	Margin	Pk/QP/Avg	degrees	meters	
5459.880	52.2	V	54.0	-1.8	AVG	126	1.1	
5459.520	65.5	V	74.0	-8.5	PK	126	1.1	
5460.000	52.0	H	54.0	-2.0	AVG	270	1.1	
5459.840	63.1	H	74.0	-10.9	PK	270	1.1	

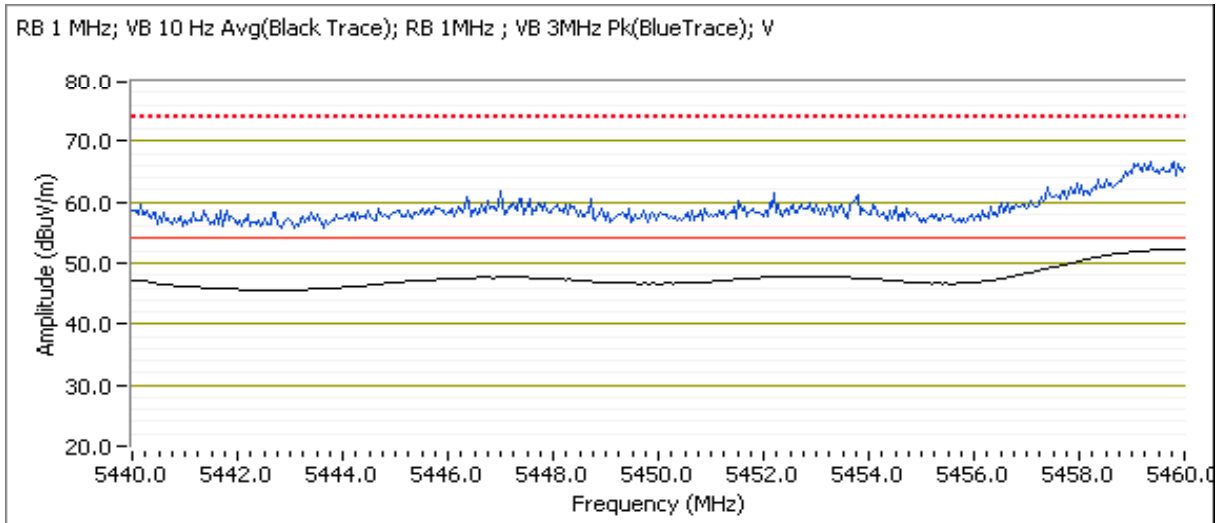



EMC Test Data

Client: Motorola	Job Number: J87247
Model: VAP2500	T-Log Number: T87276
Contact: Rob Linebarger	Account Manager: Christine Krebill
Standard: FCC	Class: N/A

Date of Test: 5/25/2012
 Test Engineer: Jack Liu

Test Location: FT#5
 Config Change: none

Software Setting	Power Settings					Measured (dBm), Chain				
	Target (dBm), Chain					Measured (dBm), Chain				
	A	B	C	D	Total	A	B	C	D	Total
10	-	-	-	-		9.8	10.0	10.5	11.1	16.4

5470 MHz Band Edge Signal Field Strength

Frequency	Level	Pol	15.209 / 15.247		Detector	Azimuth	Height	Comments
MHz	dB μ V/m	v/h	Limit	Margin	Pk/QP/Avg	degrees	meters	
5469.100	68.2	V	68.3	-0.1	PK	224	1.0	Pwr setting= 10
5467.150	60.9	H	68.3	-7.4	PK	32	1.1	POS; RB 1 MHz; VB: 3 MHz

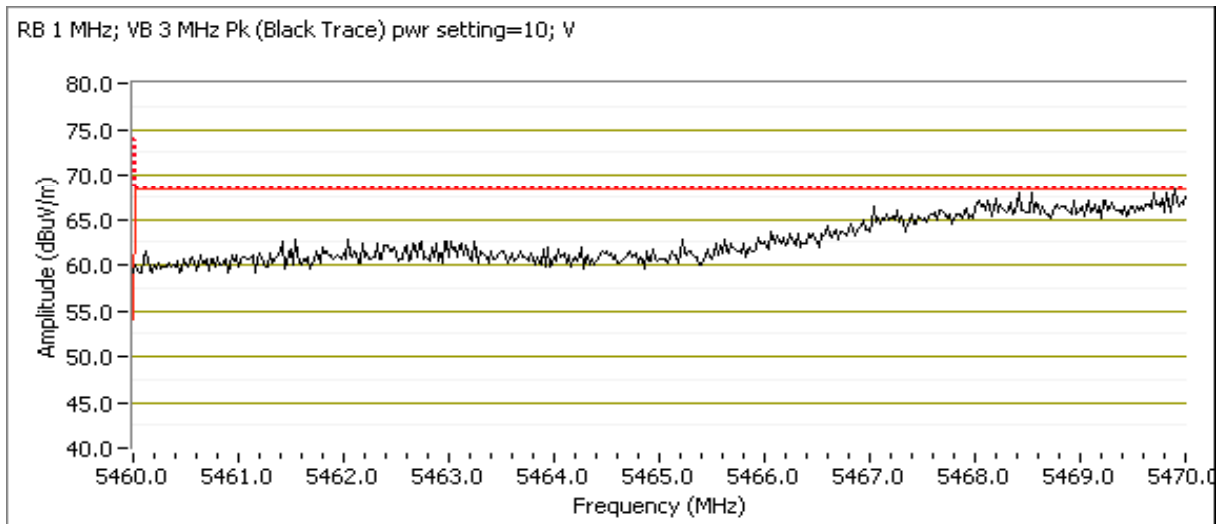



EMC Test Data

Client: Motorola	Job Number: J87247
Model: VAP2500	T-Log Number: T87276
Contact: Rob Linebarger	Account Manager: Christine Krebill
Standard: FCC	Class: N/A

Run # 6b, EUT on Channel #110 5550MHz - 802.11n40
 Date of Test: 5/25/2012 Test Location: FT5
 Test Engineer: Rafael Varelas Config Change: None

Software Setting	Power Settings					Measured (dBm), Chain				
	Target (dBm), Chain					Measured (dBm), Chain				
18	A	B	C	D	Total	A	B	C	D	Total
	-	-	-	-		17.8	17.4	17.8	18.1	23.8

5460 MHz Band Edge Signal Field Strength

Frequency	Level	Pol	15.209 / 15.247		Detector	Azimuth	Height	Comments
MHz	dB μ V/m	v/h	Limit	Margin	Pk/QP/Avg	degrees	meters	
5456.710	52.9	V	54.0	-1.1	AVG	206	1.0	POS; RB 1 MHz; VB: 10 Hz
5457.260	66.2	V	74.0	-7.8	PK	206	1.0	POS; RB 1 MHz; VB: 3 MHz
5459.790	46.3	H	54.0	-7.7	AVG	47	1.0	POS; RB 1 MHz; VB: 10 Hz
5459.440	57.4	H	74.0	-16.6	PK	47	1.0	POS; RB 1 MHz; VB: 3 MHz

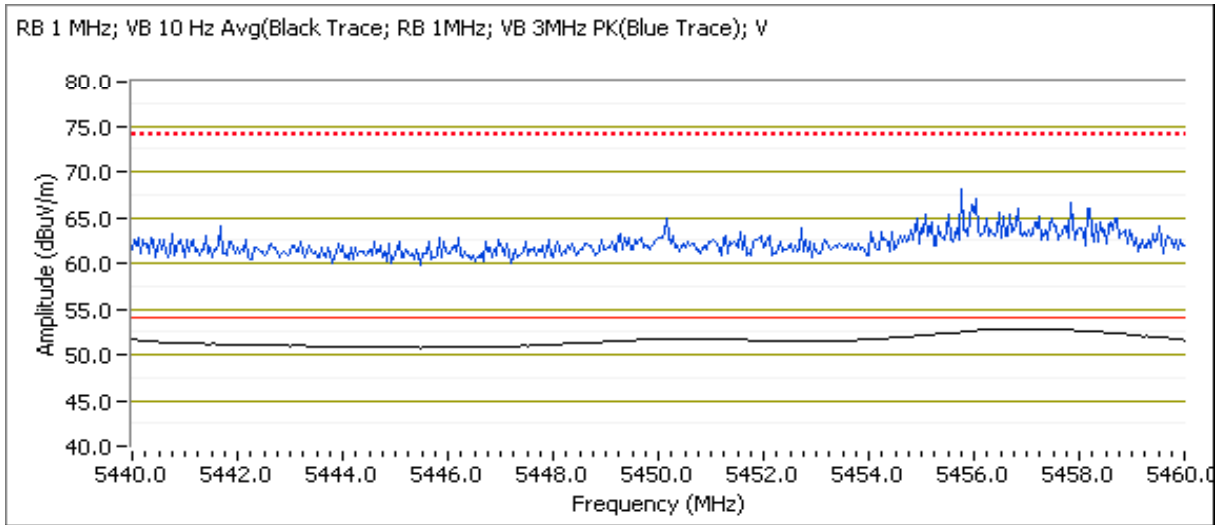



EMC Test Data

Client: Motorola	Job Number: J87247
Model: VAP2500	T-Log Number: T87276
Contact: Rob Linebarger	Account Manager: Christine Krebill
Standard: FCC	Class: N/A

5470 MHz Band Edge Signal Field Strength

Frequency	Level	Pol	15.209 / 15.247		Detector	Azimuth	Height	Comments
MHz	dB μ V/m	v/h	Limit	Margin	PK/QP/Avg	degrees	meters	
5468.000	65.9	V	68.3	-2.4	PK	225	1.0	POS; RB 1 MHz; VB: 3 MHz
5467.200	57.7	H	68.3	-10.6	PK	45	1.0	POS; RB 1 MHz; VB: 3 MHz

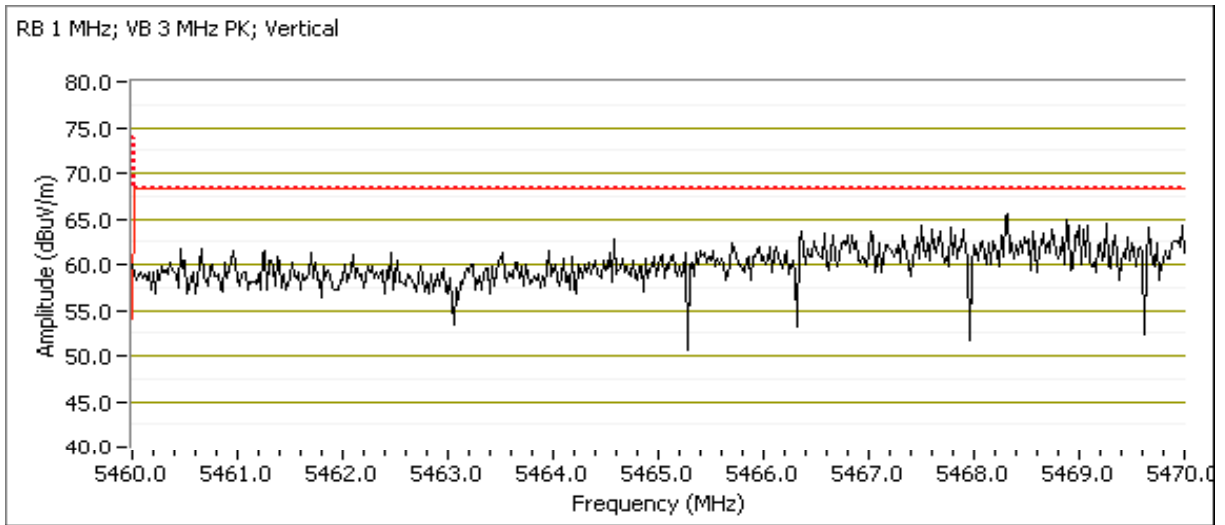



EMC Test Data

Client: Motorola	Job Number: J87247
Model: VAP2500	T-Log Number: T87276
Contact: Rob Linebarger	Account Manager: Christine Krebill
Standard: FCC	Class: N/A

5725 MHz Band Edge Signal Field Strength

Frequency	Level	Pol	15.209 / 15.247		Detector	Azimuth	Height	Comments
MHz	dB μ V/m	v/h	Limit	Margin	PK/QP/Avg	degrees	meters	
5735.500	59.0	V	68.3	-9.3	PK	353	1.0	POS; RB 1 MHz; VB: 3 MHz
5725.160	58.4	H	68.3	-9.9	PK	346	1.0	POS; RB 1 MHz; VB: 3 MHz

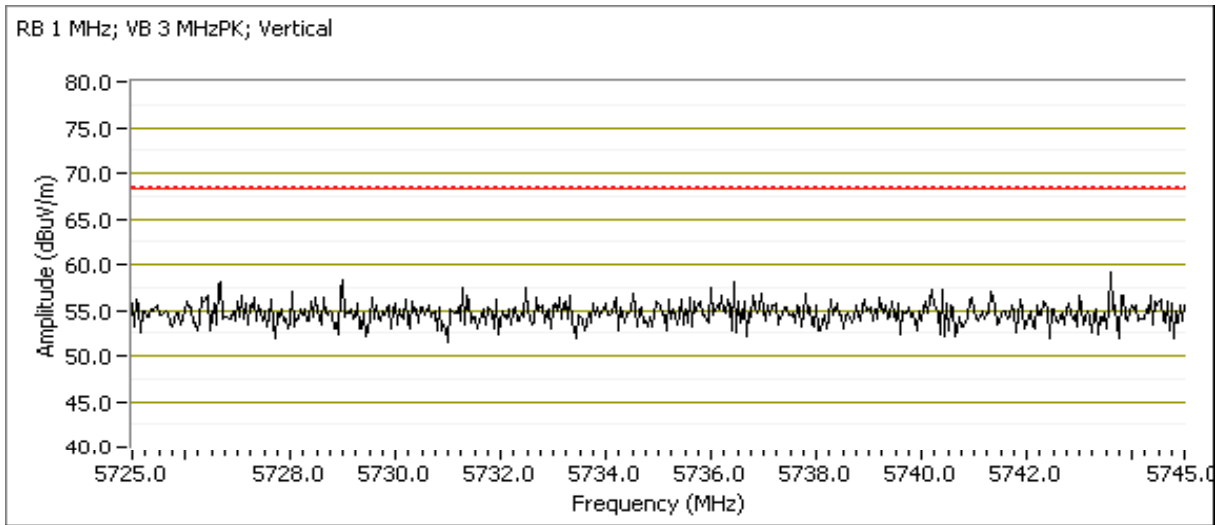



EMC Test Data

Client: Motorola	Job Number: J87247
Model: VAP2500	T-Log Number: T87276
Contact: Rob Linebarger	Account Manager: Christine Krebill
Standard: FCC	Class: N/A

Run # 6c, EUT on Channel #134 5670MHz - 802.11n40

Software Setting	Target (dBm), Chain					Power Settings					Measured (dBm), Chain					
	A	B	C	D	Total	A	B	C	D	Total	A	B	C	D	Total	
15	-	-	-	-	-		14.5	14.2	14.8	15.1	20.7					

5725 MHz Band Edge Signal Field Strength

Frequency	Level	Pol	15.209 / 15.247		Detector	Azimuth	Height	Comments
MHz	dB μ V/m	v/h	Limit	Margin	Pk/QP/Avg	degrees	meters	
5725.360	67.8	V	68.3	-0.5	PK	303	1.1	Pwr setting= 15
5725.560	60.6	H	68.3	-7.7	PK	165	1.0	Pwr setting= 15

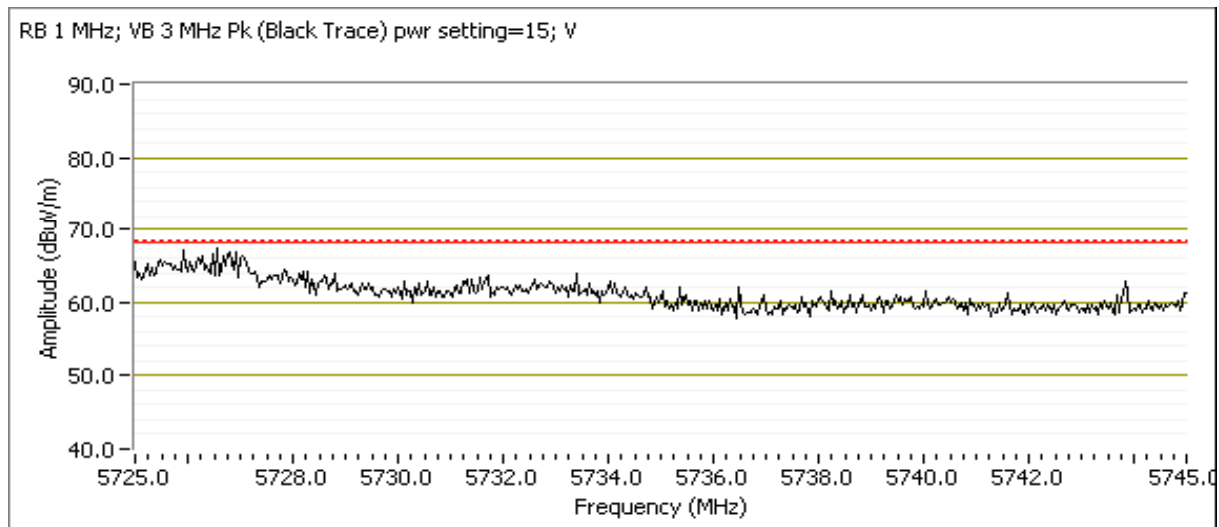



EMC Test Data

Client: Motorola	Job Number: J87247
Model: VAP2500	T-Log Number: T87276
	Account Manager: Christine Krebill
Contact: Rob Linebarger	
Standard: FCC	Class: N/A

RSS 210 and FCC 15.407 (UNII) Radiated Spurious Emissions

Test Specific Details

Objective: The objective of this test session is to perform final qualification testing of the EUT with respect to the specification listed above.

Date of Test: See below
Test Engineer: See below
Test Location: See below

Config. Used: 1
Config Change: None
EUT Voltage: 120V/60Hz

General Test Configuration

The EUT and all local support equipment were located on the turntable for radiated spurious emissions testing. All remote support equipment was located outside the chamber.

For radiated emissions testing the measurement antenna was located 3 meters from the EUT.

Ambient Conditions:	Temperature:	18-23 °C
	Rel. Humidity:	32-45 %

Modifications Made During Testing

No modifications were made to the EUT during testing

Deviations From The Standard

No deviations were made from the requirements of the standard.

Test Procedure Comments:

Unless otherwise noted, average measurements above 1GHz were performed as documented in FCC KDB 789033 G) 6) d) Method VB.

Antenna: antenna(s) connected
Duty Cycle: 98.4%



EMC Test Data

Client: Motorola	Job Number: J87247
Model: VAP2500	T-Log Number: T87276
Contact: Rob Linebarger	Account Manager: Christine Krebill
Standard: FCC	Class: N/A

Summary of Results

Run #	Mode	Channel	Power Setting	Measured Power	Test Performed	Limit	Result / Margin	
Scans on center channel in all three OFDM modes in each operating band were used to determine the worst case.								
Run #1 (5150-5250MHz Band)	802.11a	#40 5200MHz	17.0	22.6	Radiated Emissions, 1 - 40 GHz	FCC 15.209 / 15 E	49.0dBµV/m @ 20800.05MHz (-5.0dB)	
	802.11n20	#40 5200MHz	17.0	22.7			48.5dBµV/m @ 20800.01MHz (-5.5dB)	
	802.11n40	#38 5190MHz	13.0	18.7			49.4dBµV/m @ 5421.62MHz (-4.6dB)	
	Worst case mode - top and bottom channels. The worst case mode was 802.11n40MHz, in addition, 5230MHz in n40 mode was evaluated for high channel, 5180MHz in n20 mode was evaluated for the low channel and 5240MHz in n20							
	802.11n20	#36 5180MHz	#48 5240MHz	17.0	22.6	Radiated Emissions, 1 - 40 GHz	FCC 15.209 / 15 E	48.1dBµV/m @ 20719.95MHz (-5.9dB)
				17.0	22.8			47.8dBµV/m @ 20959.13MHz (-6.2dB)
		802.11n40	#46 5230MHz	13.0	18.7			48.8dBµV/m @ 20919.98MHz (-5.2dB)
Run #2 (5250-5350MHz Band)	802.11a	#60 5300MHz	17.0	22.5	Radiated Emissions, 1 - 40 GHz	FCC 15.209 / 15 E	48.9dBµV/m @ 21200.02MHz (-5.1dB)	
	802.11n20	#60 5300MHz	17.0	22.6			48.6dBµV/m @ 5452.5MHz (-5.4dB)	
	802.11n40	#62 5310MHz	16.0	21.5			47.9dBµV/m @ 21239.97MHz (-6.1dB)	
	Worst case mode - top and bottom channels. As the worst case mode was 802.11a, 5260MHz in a mode was evaluated for the low channel and 5320MHz in a mode was evaluated as high channel.							
	802.11a	#52 5260MHz	#64 5320MHz	17.0	22.6	Radiated Emissions, 1 - 40 GHz	FCC 15.209 / 15 E	49.1dBµV/m @ 4960.08MHz (-4.9dB)
				17.0	22.6			50.0dBµV/m @ 5440.07MHz (-4.0dB)
	Run #3 (5470-5725MHz Band)	802.11a	#116 5580MHz	18.0	23.9	Radiated Emissions, 1 - 40 GHz	FCC 15.209 / 15 E	53.8dBµV/m @ 5351.3MHz (-0.2dB)
802.11n20		#116 5580MHz	18.0	23.9	51.6dBµV/m @ 11162.8MHz (-2.4dB)			
802.11n40		#110 5550MHz	18.0	23.5	52.8dBµV/m @ 5359.9MHz (-1.2dB)			
Worst case mode - top and bottom channels. As the worst case mode was 802.11a, 5500MHz in a mode was evaluated for the low channel and 5700MHz in a mode was evaluated as high channel.								
802.11a		#100 5500MHz	#140 5700MHz	18.0	23.8	Radiated Emissions, 1 - 40 GHz	FCC 15.209 / 15 E	53.4dBµV/m @ 5350.9MHz (-0.6dB)
	18.0			23.0	52.7dBµV/m @ 5351.0MHz (-1.3dB)			



EMC Test Data

Client: Motorola	Job Number: J87247
Model: VAP2500	T-Log Number: T87276
Contact: Rob Linebarger	Account Manager: Christine Krebill
Standard: FCC	Class: N/A

Run #1, Radiated Spurious Emissions, 1,000 - 40,000 MHz. Operation in the 5150-5250 MHz Band
 Date of Test: 5/21 and 23/2012 Test Location: FT CH#4; and 5
 Test Engineer: D. Demirci; M. Birgani

Software Setting	Power Settings					Measured (dBm), Chain				
	Target (dBm), Chain									
17	A	B	C	D	Total	A	B	C	D	Total
	16.0	16.0	16.0	16.0	22.0	16.1	15.9	17.1	17.1	22.6

Run #1a: Channel #40 5200MHz - 802.11a

Spurious Radiated Emissions:

Frequency MHz	Level dB μ V/m	Pol v/h	15.209 / 15E		Detector Pk/QP/Avg	Azimuth degrees	Height meters	Comments
			Limit	Margin				
1902.880	37.3	V	68.3	-31.0	PK	223	1.0	RB 1 MHz;VB 3 MHz;Peak
5034.830	42.6	V	54.0	-11.4	AVG	14	1.0	RB 1 MHz;VB 10 Hz;Peak
5034.370	55.3	V	74.0	-18.7	PK	14	1.0	RB 1 MHz;VB 3 MHz;Peak
5417.960	41.0	V	54.0	-13.0	AVG	17	1.5	RB 1 MHz;VB 10 Hz;Peak
5417.770	53.1	V	74.0	-20.9	PK	17	1.5	RB 1 MHz;VB 3 MHz;Peak
10400.520	51.9	V	68.3	-16.4	PK	58	1.0	RB 1 MHz;VB 3 MHz;Peak
20800.050	49.0	V	54.0	-5.0	AVG	91	1.0	RB 1 MHz;VB 10 Hz;Peak
20800.050	52.2	V	74.0	-21.8	PK	91	1.0	RB 1 MHz;VB 3 MHz;Peak

- Note 1: For emissions in restricted bands, the limit of 15.209 was used which requires average and peak measurements.
- Note 2: For emissions outside of the restricted bands the limit is -27dBm/MHz eirp (68.3dBuV/m). The measurement method required is a peak measurement (RB=1MHz, VB \geq 3MHz, peak detector).
- Note 3: Scans made between 26 - 40GHz with the measurement antenna moved around the device and its antennas 20-50cm from the device indicated there were no significant emissions in this frequency range

Client: Motorola	Job Number: J87247
Model: VAP2500	T-Log Number: T87276
Contact: Rob Linebarger	Account Manager: Christine Krebill
Standard: FCC	Class: N/A

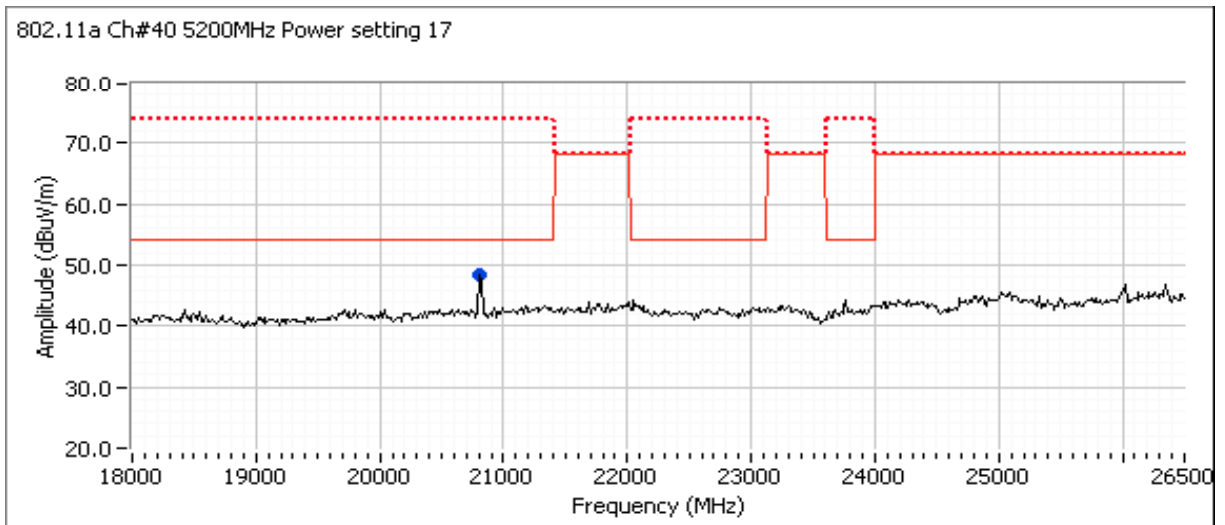
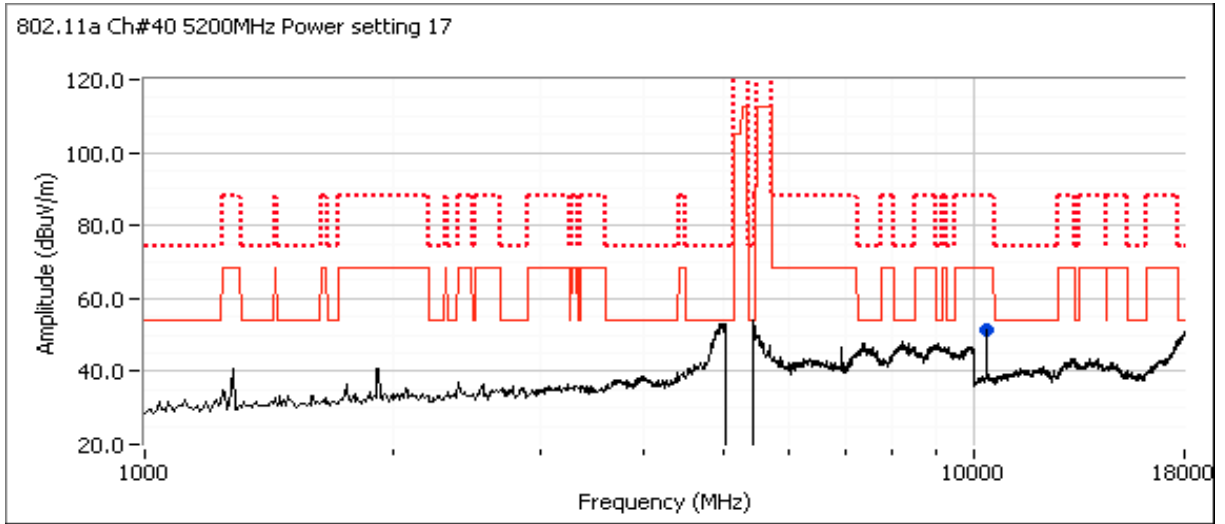



EMC Test Data

Client: Motorola	Job Number: J87247
Model: VAP2500	T-Log Number: T87276
Contact: Rob Linebarger	Account Manager: Christine Krebill
Standard: FCC	Class: N/A

Run #1b: Channel #40 5200MHz - 802.11n20

Software Setting	Target (dBm), Chain					Power Settings					Measured (dBm), Chain				
	A	B	C	D	Total	A	B	C	D	Total	A	B	C	D	Total
17	16.0	16.0	16.0	16.0	22.0	16.1	15.9	17.2	17.3	22.7					

Spurious Radiated Emissions:

Frequency	Level	Pol	15.209 / 15E		Detector	Azimuth	Height	Comments
MHz	dBuV/m	v/h	Limit	Margin	Pk/QP/Avg	degrees	meters	
1920.020	44.1	V	68.3	-24.2	PK	271	2.0	RB 1 MHz;VB 3 MHz;Peak
4965.270	46.5	V	54.0	-7.5	AVG	116	1.0	RB 1 MHz;VB 10 Hz;Peak
4967.480	57.5	V	74.0	-16.5	PK	116	1.0	RB 1 MHz;VB 3 MHz;Peak
5419.800	46.0	V	54.0	-8.0	AVG	17	1.0	RB 1 MHz;VB 10 Hz;Peak
5419.320	57.3	V	74.0	-16.7	PK	17	1.0	RB 1 MHz;VB 3 MHz;Peak
10400.630	54.9	V	68.3	-13.4	PK	60	1.1	RB 1 MHz;VB 3 MHz;Peak
20800.010	48.5	V	54.0	-5.5	AVG	94	1.0	RB 1 MHz;VB 10 Hz;Peak
20799.960	52.6	V	74.0	-21.4	PK	94	1.0	RB 1 MHz;VB 3 MHz;Peak

Note 1: For emissions in restricted bands, the limit of 15.209 was used which requires average and peak measurements.

Note 2: For emissions outside of the restricted bands the limit is -27dBm/MHz eirp (68.3dBuV/m). The measurement method required is a peak measurement (RB=1MHz, VB≥3MHz, peak detector).

Client: Motorola	Job Number: J87247
Model: VAP2500	T-Log Number: T87276
Contact: Rob Linebarger	Account Manager: Christine Krebill
Standard: FCC	Class: N/A

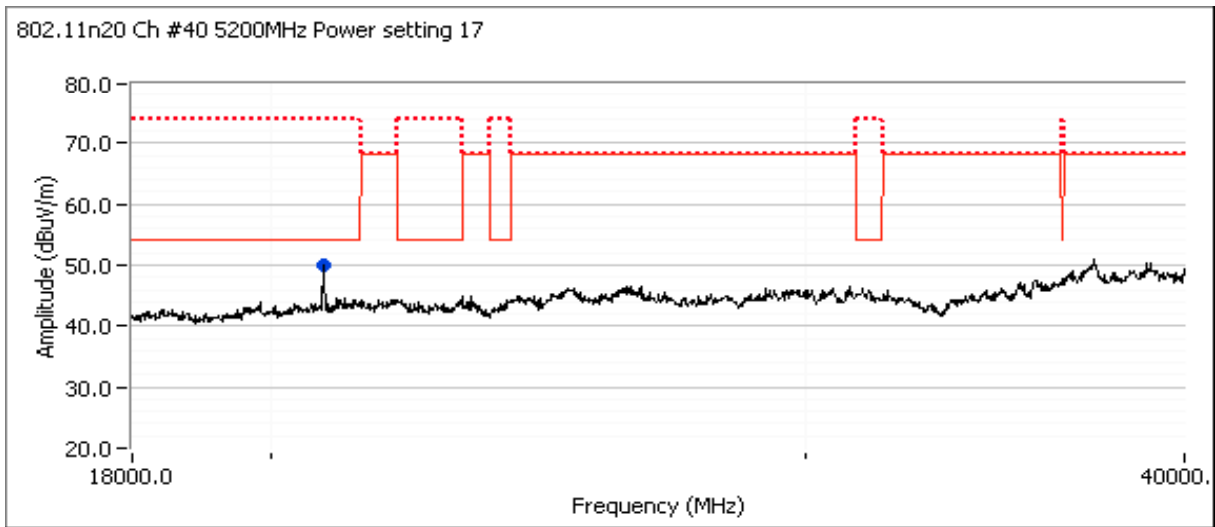
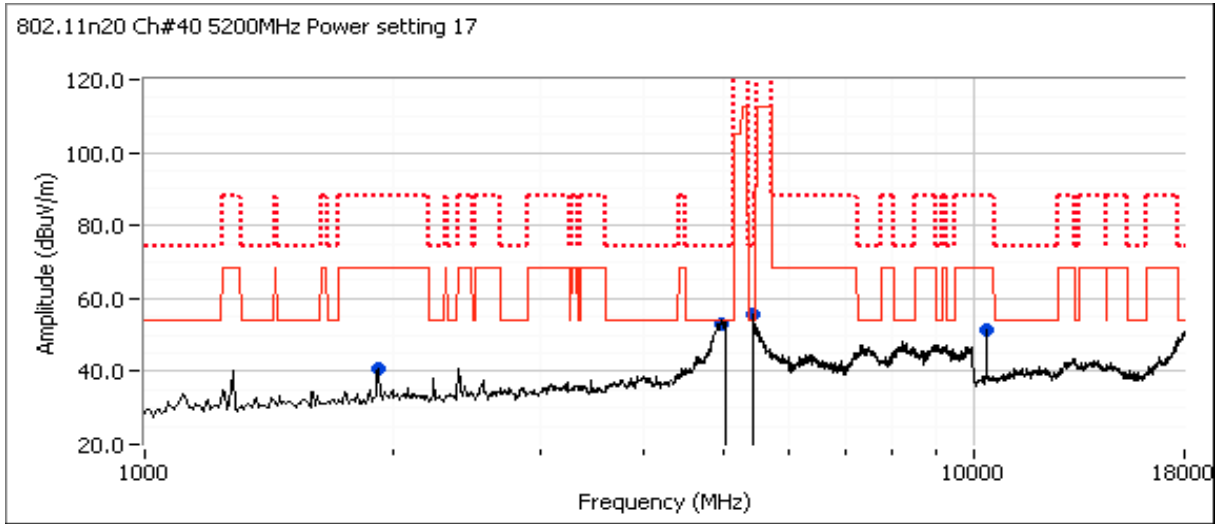



EMC Test Data

Client: Motorola	Job Number: J87247
Model: VAP2500	T-Log Number: T87276
Contact: Rob Linebarger	Account Manager: Christine Krebill
Standard: FCC	Class: N/A

Run #1c: Channel #38 5190MHz - 802.11n40

Software Setting	Target (dBm), Chain					Power Settings					Measured (dBm), Chain				
	A	B	C	D	Total	A	B	C	D	Total	A	B	C	D	Total
13	13.0	13.0	13.0	13.0	19.0	12.0	11.7	13.5	13.2	18.7					

Spurious Radiated Emissions:

Frequency	Level	Pol	15.209 / 15E		Detector	Azimuth	Height	Comments
MHz	dB μ V/m	v/h	Limit	Margin	Pk/QP/Avg	degrees	meters	
1919.900	48.1	V	68.3	-20.2	PK	235	1.3	RB 1 MHz;VB 3 MHz;Peak
5028.510	46.2	V	54.0	-7.8	AVG	215	1.0	RB 1 MHz;VB 10 Hz;Peak
5030.130	59.8	V	74.0	-14.2	PK	215	1.0	RB 1 MHz;VB 3 MHz;Peak
5421.620	49.4	V	54.0	-4.6	AVG	193	1.0	RB 1 MHz;VB 10 Hz;Peak
5420.920	61.4	V	74.0	-12.6	PK	193	1.0	RB 1 MHz;VB 3 MHz;Peak
10379.530	45.0	V	68.3	-23.3	PK	100	1.0	RB 1 MHz;VB 3 MHz;Peak
20760.000	48.6	V	54.0	-5.4	AVG	124	1.0	RB 1 MHz;VB 10 Hz;Peak
20759.950	52.5	V	74.0	-21.5	PK	124	1.0	RB 1 MHz;VB 3 MHz;Peak

- Note 1: For emissions in restricted bands, the limit of 15.209 was used which requires average and peak measurements.
- Note 2: For emissions outside of the restricted bands the limit is -27dBm/MHz eirp (68.3dBuV/m). The measurement method required is a peak measurement (RB=1MHz, VB \geq 3MHz, peak detector).
- Note 3: Scans made between 26 - 40GHz with the measurement antenna moved around the device and its antennas 20-50cm from the device indicated there were no significant emissions in this frequency range

Client: Motorola	Job Number: J87247
Model: VAP2500	T-Log Number: T87276
Contact: Rob Linebarger	Account Manager: Christine Krebill
Standard: FCC	Class: N/A

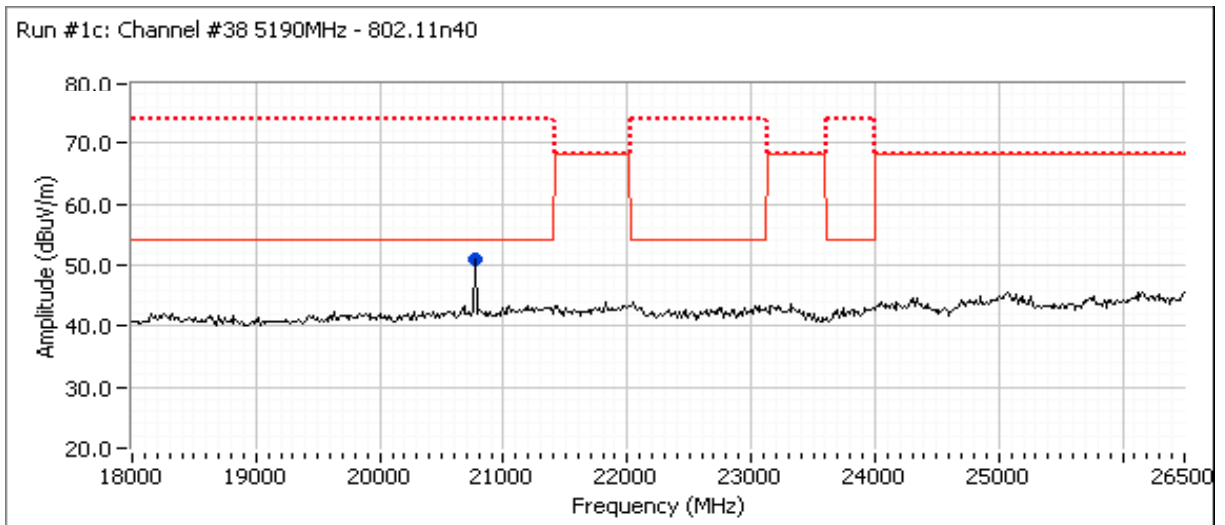
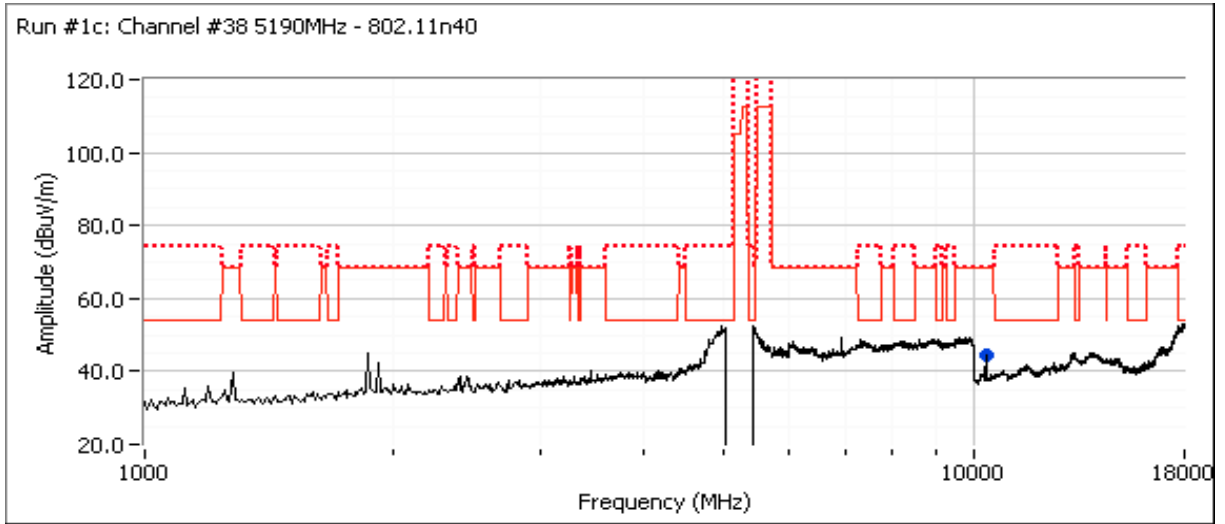



EMC Test Data

Client: Motorola	Job Number: J87247
Model: VAP2500	T-Log Number: T87276
Contact: Rob Linebarger	Account Manager: Christine Krebill
Standard: FCC	Class: N/A

Run #1d: Channel #36 5180MHz - 802.11n20

Software Setting	Target (dBm), Chain					Power Settings					Measured (dBm), Chain				
	A	B	C	D	Total	A	B	C	D	Total	A	B	C	D	Total
17	16.0	16.0	16.0	16.0	22.0	16.2	15.6	17.1	17.2	22.6					

Spurious Radiated Emissions:

Frequency	Level	Pol	15.209 / 15E		Detector	Azimuth	Height	Comments
MHz	dB μ V/m	v/h	Limit	Margin	Pk/QP/Avg	degrees	meters	
1919.990	47.2	V	68.3	-21.1	PK	245	1.2	RB 1 MHz;VB 3 MHz;Peak
4959.930	47.5	V	54.0	-6.5	AVG	208	1.2	RB 1 MHz;VB 10 Hz;Peak
4960.530	57.9	V	74.0	-16.1	PK	208	1.2	RB 1 MHz;VB 3 MHz;Peak
5472.200	45.4	V	112.3	-66.9	AVG	203	1.1	RB 1 MHz;VB 10 Hz;Peak
5450.000	57.4	V	74.0	-16.6	PK	203	1.1	RB 1 MHz;VB 3 MHz;Peak
10361.380	49.5	V	68.3	-18.8	PK	355	1.0	RB 1 MHz;VB 3 MHz;Peak
20719.950	48.1	V	54.0	-5.9	AVG	57	1.1	RB 1 MHz;VB 10 Hz;Peak
20719.940	52.0	V	74.0	-22.0	PK	57	1.1	RB 1 MHz;VB 3 MHz;Peak

- Note 1: For emissions in restricted bands, the limit of 15.209 was used which requires average and peak measurements.
- Note 2: For emissions outside of the restricted bands the limit is -27dBm/MHz eirp (68.3dBuV/m). The measurement method required is a peak measurement (RB=1MHz, VB \geq 3MHz, peak detector).
- Note 3: Scans made between 26 - 40GHz with the measurement antenna moved around the device and its antennas 20-50cm from the device indicated there were no significant emissions in this frequency range

Client: Motorola	Job Number: J87247
Model: VAP2500	T-Log Number: T87276
Contact: Rob Linebarger	Account Manager: Christine Krebill
Standard: FCC	Class: N/A

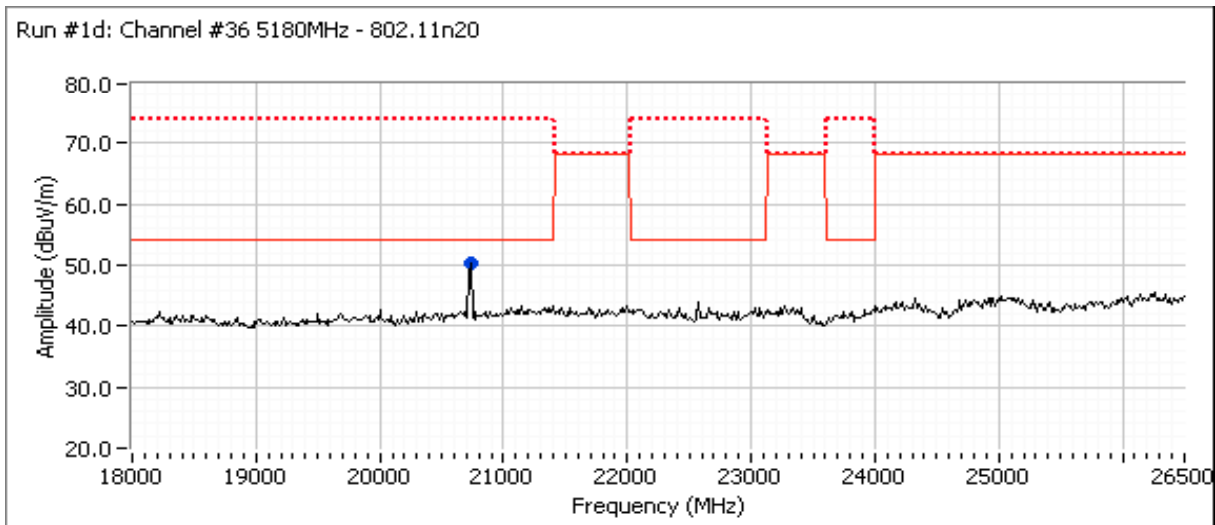
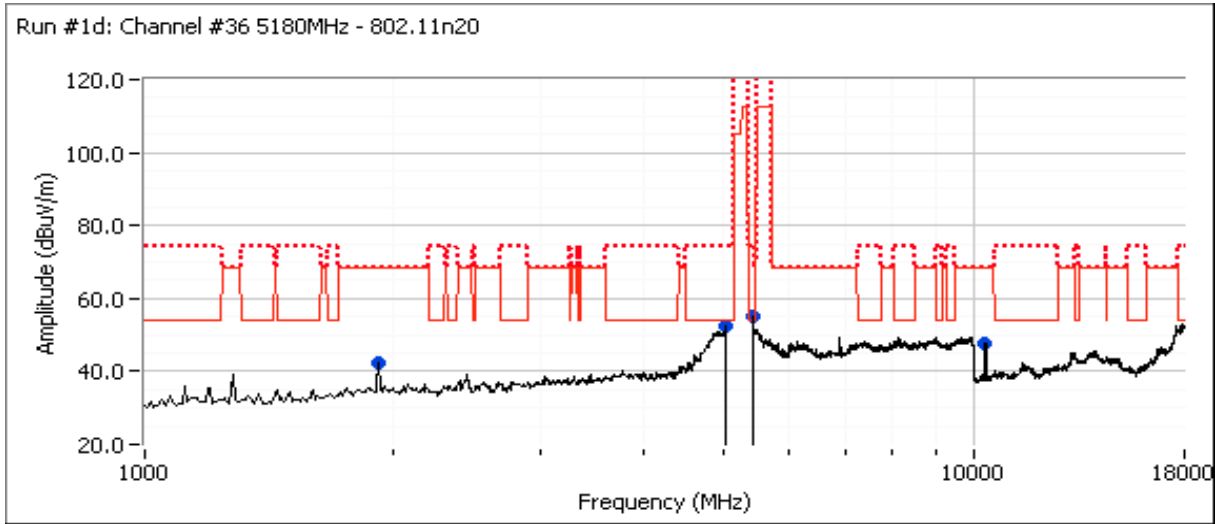



EMC Test Data

Client: Motorola	Job Number: J87247
Model: VAP2500	T-Log Number: T87276
Contact: Rob Linebarger	Account Manager: Christine Krebill
Standard: FCC	Class: N/A

Run #1e: Channel #48 5240MHz - 802.11n20

Software Setting	Target (dBm), Chain					Power Settings					Measured (dBm), Chain				
	A	B	C	D	Total	A	B	C	D	Total	A	B	C	D	Total
17	16.0	16.0	16.0	16.0	22.0	16.3	16.0	17.3	17.3	22.8					

Spurious Radiated Emissions:

Frequency	Level	Pol	15.209 / 15E		Detector	Azimuth	Height	Comments
MHz	dB μ V/m	v/h	Limit	Margin	Pk/QP/Avg	degrees	meters	
1919.900	48.3	V	68.3	-20.0	PK	245	1.2	RB 1 MHz;VB 3 MHz;Peak
4999.870	46.2	V	54.0	-7.8	AVG	26	1.0	RB 1 MHz;VB 10 Hz;Peak
4976.200	57.9	V	74.0	-16.1	PK	26	1.0	RB 1 MHz;VB 3 MHz;Peak
5462.270	44.8	V	68.3	-23.5	AVG	173	1.0	RB 1 MHz;VB 10 Hz;Peak
5463.670	56.5	V	68.3	-11.8	PK	173	1.0	RB 1 MHz;VB 3 MHz;Peak
10481.330	52.7	V	68.3	-15.6	PK	75	1.1	RB 1 MHz;VB 3 MHz;Peak
20959.130	47.8	V	54.0	-6.2	AVG	100	1.0	RB 1 MHz;VB 10 Hz;Peak
20959.980	51.7	V	74.0	-22.3	PK	100	1.0	RB 1 MHz;VB 3 MHz;Peak

- Note 1: For emissions in restricted bands, the limit of 15.209 was used which requires average and peak measurements.
- Note 2: For emissions outside of the restricted bands the limit is -27dBm/MHz eirp (68.3dBuV/m). The measurement method required is a peak measurement (RB=1MHz, VB \geq 3MHz, peak detector).
- Note 3: Scans made between 26 - 40GHz with the measurement antenna moved around the device and its antennas 20-50cm from the device indicated there were no significant emissions in this frequency range

Client: Motorola	Job Number: J87247
Model: VAP2500	T-Log Number: T87276
Contact: Rob Linebarger	Account Manager: Christine Krebill
Standard: FCC	Class: N/A

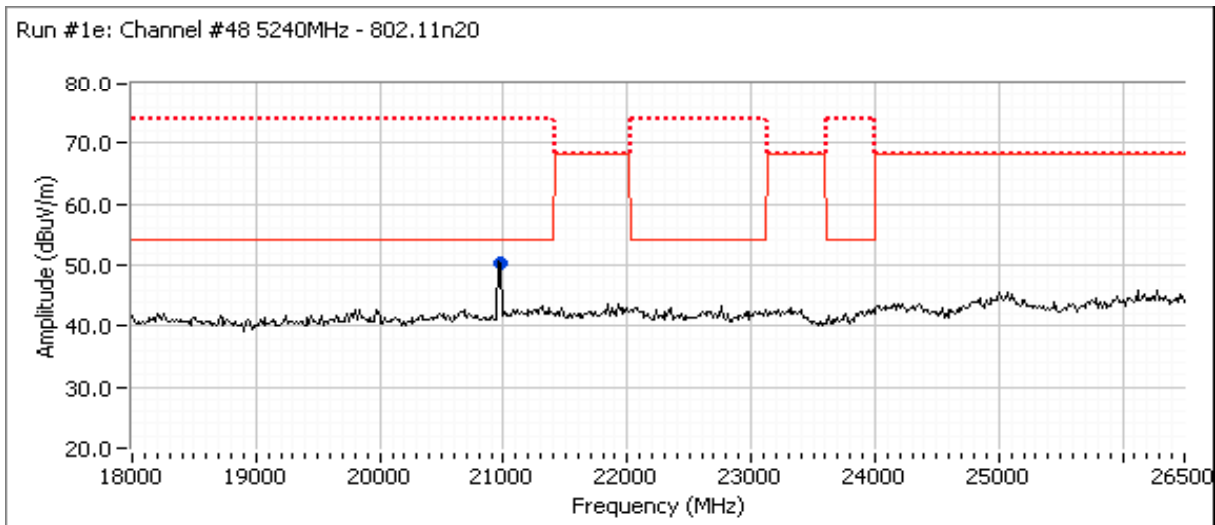
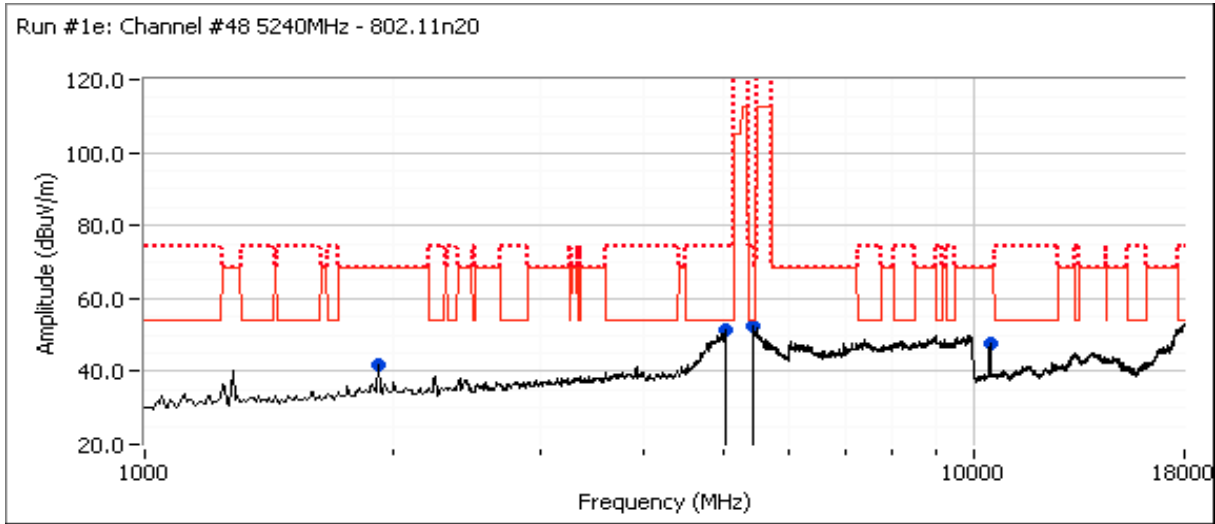



EMC Test Data

Client: Motorola	Job Number: J87247
Model: VAP2500	T-Log Number: T87276
Contact: Rob Linebarger	Account Manager: Christine Krebill
Standard: FCC	Class: N/A

Run #1f: Channel #46 5230MHz - 802.11n40

Software Setting	Target (dBm), Chain					Power Settings					Measured (dBm), Chain				
	A	B	C	D	Total	A	B	C	D	Total	A	B	C	D	Total
13	13.0	13.0	13.0	13.0	19.0	12.2	11.4	13.5	13.3	18.7					

Spurious Radiated Emissions:

Frequency	Level	Pol	15.209 / 15E		Detector	Azimuth	Height	Comments
MHz	dB μ V/m	v/h	Limit	Margin	Pk/QP/Avg	degrees	meters	
1919.950	48.6	V	68.3	-19.7	PK	239	1.6	RB 1 MHz;VB 3 MHz;Peak
4984.780	43.8	V	54.0	-10.2	AVG	102	1.2	RB 1 MHz;VB 10 Hz;Peak
4992.050	56.6	V	74.0	-17.4	PK	102	1.2	RB 1 MHz;VB 3 MHz;Peak
5449.950	43.2	V	54.0	-10.8	AVG	217	1.1	RB 1 MHz;VB 10 Hz;Peak
5454.900	56.3	V	74.0	-17.7	PK	217	1.1	RB 1 MHz;VB 3 MHz;Peak
10460.450	46.5	V	68.3	-21.8	PK	107	1.0	RB 1 MHz;VB 3 MHz;Peak
20919.980	48.8	V	54.0	-5.2	AVG	109	1.0	RB 1 MHz;VB 10 Hz;Peak
20919.950	52.9	V	74.0	-21.1	PK	109	1.0	RB 1 MHz;VB 3 MHz;Peak

- Note 1: For emissions in restricted bands, the limit of 15.209 was used which requires average and peak measurements.
- Note 2: For emissions outside of the restricted bands the limit is -27dBm/MHz eirp (68.3dBuV/m). The measurement method required is a peak measurement (RB=1MHz, VB \geq 3MHz, peak detector).
- Note 3: Scans made between 26 - 40GHz with the measurement antenna moved around the device and its antennas 20-50cm from the device indicated there were no significant emissions in this frequency range

Client: Motorola	Job Number: J87247
Model: VAP2500	T-Log Number: T87276
Contact: Rob Linebarger	Account Manager: Christine Krebill
Standard: FCC	Class: N/A

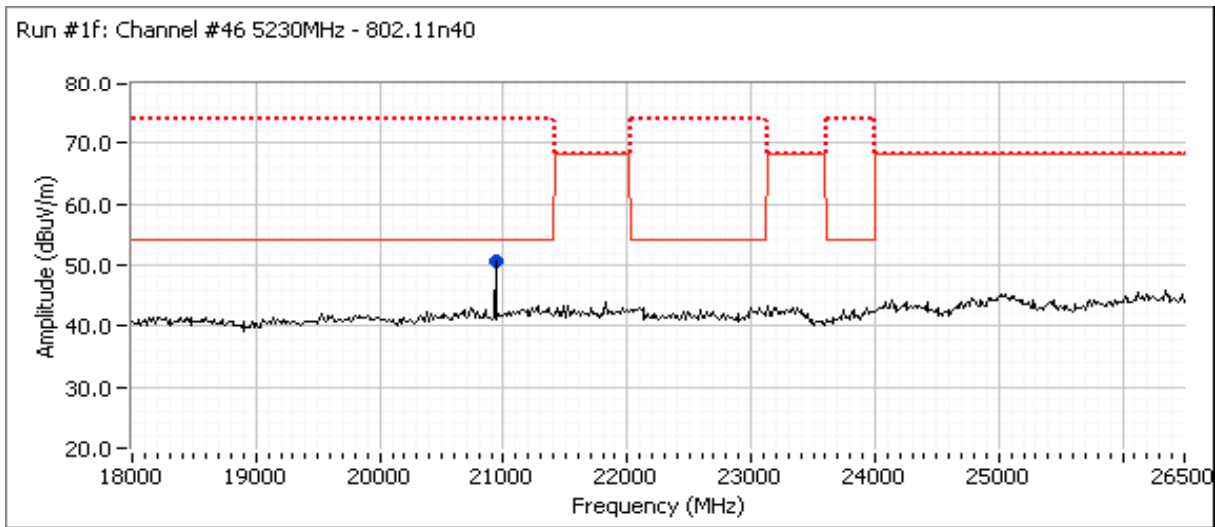
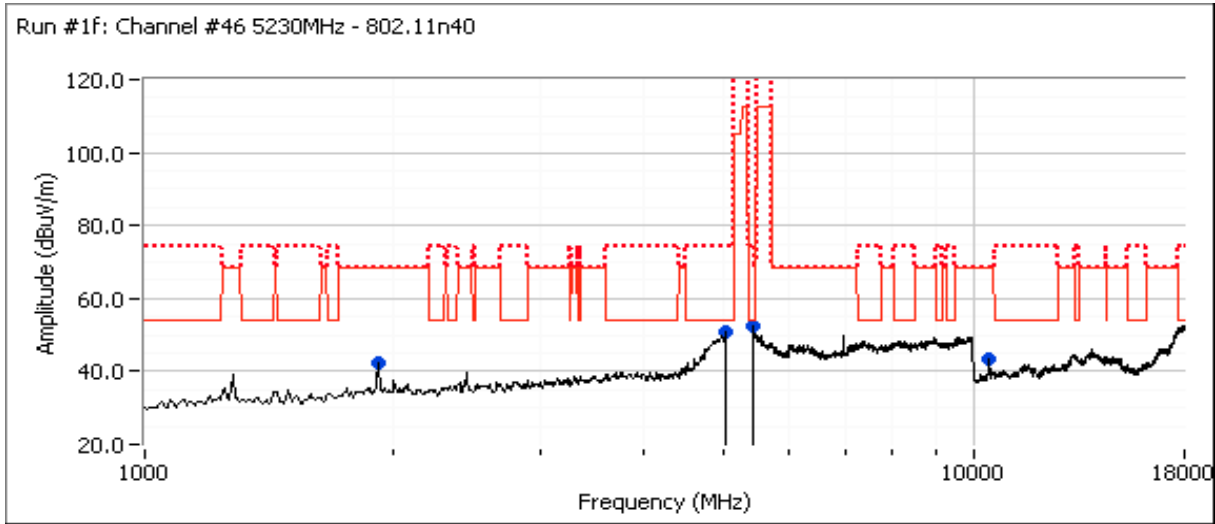



EMC Test Data

Client: Motorola	Job Number: J87247
Model: VAP2500	T-Log Number: T87276
Contact: Rob Linebarger	Account Manager: Christine Krebill
Standard: FCC	Class: N/A

Run #2, Radiated Spurious Emissions, 1,000 - 40,000 MHz. Operation in the 5250-5350 MHz Band
 Date of Test: 5/22/2012
 Test Engineer: Deniz
 Test Location: FT Ch#5

Software Setting	Power Settings					Measured (dBm), Chain				
	Target (dBm), Chain									
	A	B	C	D	Total	A	B	C	D	Total
16	16.0	16.0	16.0	16.0	22.0	16.3	15.7	16.8	17.0	22.5

Run #2a: Channel #60 5300MHz - 802.11a

Spurious Radiated Emissions:

Frequency	Level	Pol	15.209 / 15E		Detector	Azimuth	Height	Comments
MHz	dB μ V/m	v/h	Limit	Margin	Pk/QP/Avg	degrees	meters	
1919.950	46.3	H	68.3	-22.0	PK	325	1.0	RB 1 MHz;VB 3 MHz;Peak
4960.180	47.2	V	54.0	-6.8	AVG	105	1.1	RB 1 MHz;VB 10 Hz;Peak
4964.520	58.6	V	74.0	-15.4	PK	105	1.1	RB 1 MHz;VB 3 MHz;Peak
5455.540	48.8	V	54.0	-5.2	AVG	176	1.0	RB 1 MHz;VB 10 Hz;Peak
5448.820	60.5	V	74.0	-13.5	PK	176	1.0	RB 1 MHz;VB 3 MHz;Peak
7066.600	52.2	V	68.3	-16.1	PK	38	1.0	RB 1 MHz;VB 3 MHz;Peak
10600.140	45.2	V	54.0	-8.8	AVG	62	1.0	RB 1 MHz;VB 10 Hz;Peak
10600.740	56.4	V	74.0	-17.6	PK	62	1.0	RB 1 MHz;VB 3 MHz;Peak
21200.020	48.9	V	54.0	-5.1	AVG	96	1.0	RB 1 MHz;VB 10 Hz;Peak
21200.050	51.9	V	74.0	-22.1	PK	96	1.0	RB 1 MHz;VB 3 MHz;Peak

- Note 1: For emissions in restricted bands, the limit of 15.209 was used which requires average and peak measurements.
- Note 2: For emissions outside of the restricted bands the limit is -27dBm/MHz eirp (68.3dBuV/m). The measurement method required is a peak measurement (RB=1MHz, VB \geq 3MHz, peak detector).
- Note 3: Scans made between 26 - 40GHz with the measurement antenna moved around the device and its antennas 20-50cm from the device indicated there were no significant emissions in this frequency range



EMC Test Data

Client: Motorola	Job Number: J87247
Model: VAP2500	T-Log Number: T87276
Contact: Rob Linebarger	Account Manager: Christine Krebill
Standard: FCC	Class: N/A

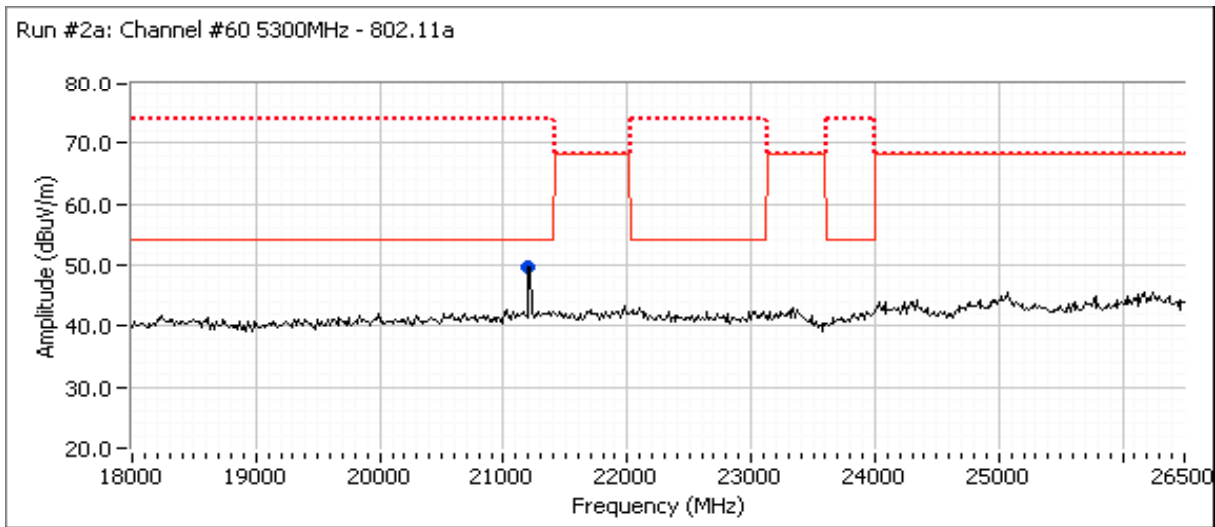
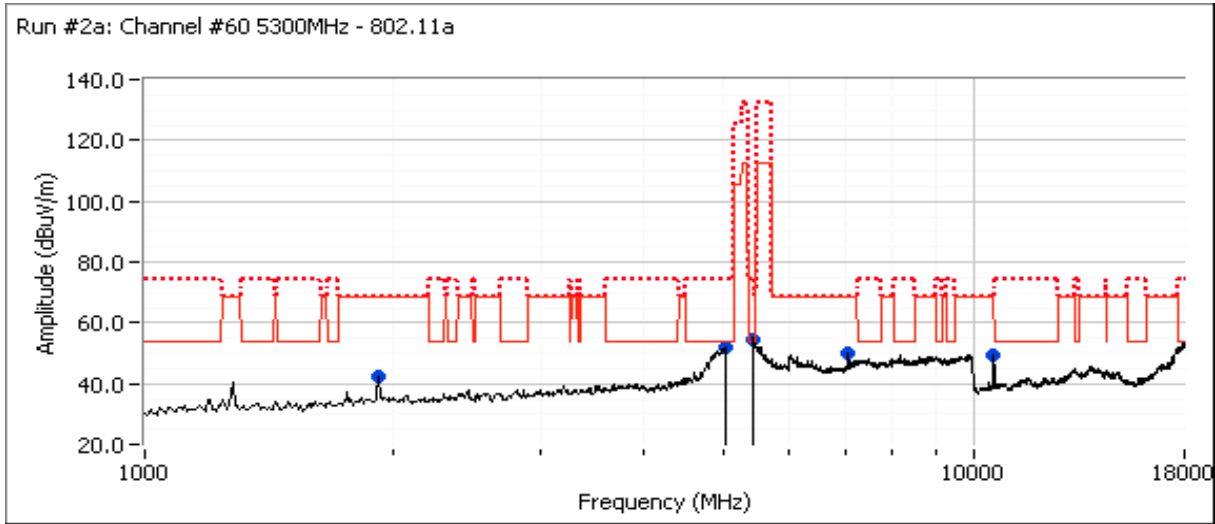



EMC Test Data

Client: Motorola	Job Number: J87247
Model: VAP2500	T-Log Number: T87276
Contact: Rob Linebarger	Account Manager: Christine Krebill
Standard: FCC	Class: N/A

Run #2b: Channel #60 5300MHz - 802.11n20
 Date of Test: 6/20/2012
 Test Engineer: Rafael Varelas
 Test Location: FT7

Software Setting	Power Settings					Measured (dBm), Chain				
	Target (dBm), Chain					Measured (dBm), Chain				
17	A	B	C	D	Total	A	B	C	D	Total
	17.0	17.0	17.0	17.0	23.0	16.1	16.1	16.8	17.1	22.6

Spurious Radiated Emissions:

Frequency MHz	Level dB μ V/m	Pol v/h	15.209 / 15E		Detector Pk/QP/Avg	Azimuth degrees	Height meters	Comments
			Limit	Margin				
5452.530	48.6	V	54.0	-5.4	AVG	346	1.0	RB 1 MHz;VB 10 Hz;Peak
5459.950	61.0	V	74.0	-13.0	PK	346	1.0	RB 1 MHz;VB 3 MHz;Peak
10603.510	45.7	V	54.0	-8.3	AVG	270	1.0	RB 1 MHz;VB 10 Hz;Peak
10601.140	57.3	V	74.0	-16.7	PK	270	1.0	RB 1 MHz;VB 3 MHz;Peak
1500.010	40.0	V	54.0	-14.0	AVG	188	1.0	RB 1 MHz;VB 10 Hz;Peak
1500.140	47.3	V	74.0	-26.7	PK	188	1.0	RB 1 MHz;VB 3 MHz;Peak
4942.950	47.9	V	54.0	-6.1	AVG	94	1.0	RB 1 MHz;VB 10 Hz;Peak
4971.690	60.0	V	74.0	-14.0	PK	94	1.0	RB 1 MHz;VB 3 MHz;Peak

Client: Motorola	Job Number: J87247
Model: VAP2500	T-Log Number: T87276
Contact: Rob Linebarger	Account Manager: Christine Krebill
Standard: FCC	Class: N/A

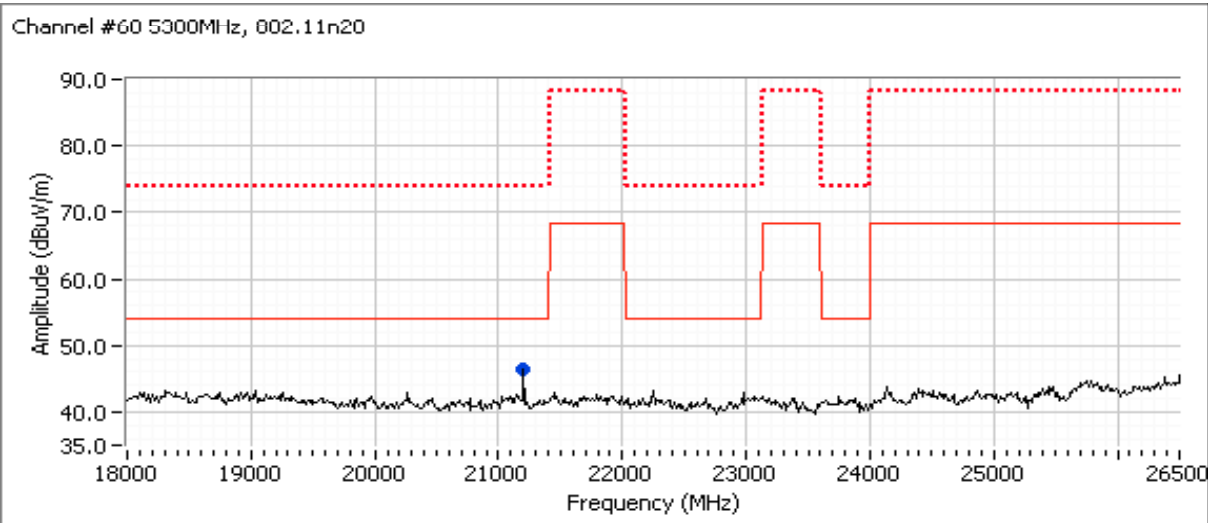
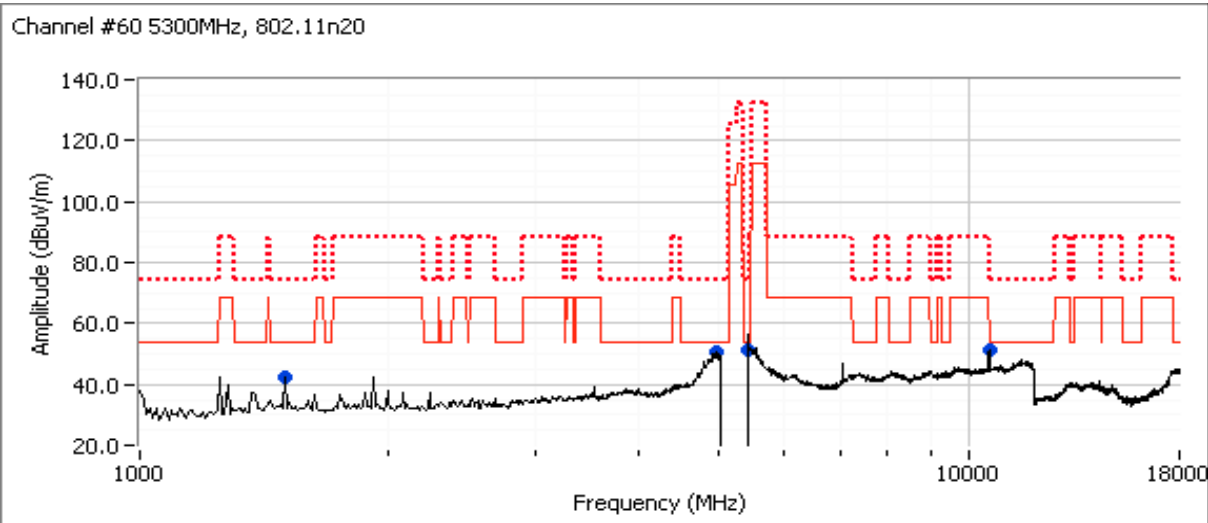



EMC Test Data

Client: Motorola	Job Number: J87247
Model: VAP2500	T-Log Number: T87276
Contact: Rob Linebarger	Account Manager: Christine Krebill
Standard: FCC	Class: N/A

Run #2c: Channel #62 5310MHz - 802.11n40
 Date of Test: 5/15/2012
 Test Engineer: Rafael Varelas
 Test Location: FT7

Software Setting	Power Settings					Measured (dBm), Chain				
	Target (dBm), Chain					Measured (dBm), Chain				
16	A	B	C	D	Total	A	B	C	D	Total
	16.0	16.0	16.0	16.0	22.0	15.3	14.5	16.1	15.8	21.5

Spurious Radiated Emissions:

Frequency MHz	Level dB μ V/m	Pol v/h	15.209 / 15E		Detector Pk/QP/Avg	Azimuth degrees	Height meters	Comments
			Limit	Margin				
5439.650	47.3	V	54.0	-6.7	AVG	312	1.2	RB 1 MHz;VB 10 Hz;Peak
5446.450	58.4	V	74.0	-15.6	PK	312	1.2	RB 1 MHz;VB 3 MHz;Peak
10620.000	46.5	V	54.0	-7.5	AVG	70	1.2	RB 1 MHz;VB 10 Hz;Peak
10620.530	56.0	V	74.0	-18.0	PK	70	1.2	RB 1 MHz;VB 3 MHz;Peak
5000.230	44.4	V	54.0	-9.6	AVG	104	1.0	RB 1 MHz;VB 10 Hz;Peak
5001.150	54.2	V	74.0	-19.8	PK	104	1.0	RB 1 MHz;VB 3 MHz;Peak
2240.340	37.2	V	54.0	-16.8	PK	269	1.0	RB 1 MHz;VB 3 MHz;Peak
7079.900	48.8	H	68.3	-19.5	PK	139	1.0	RB 1 MHz;VB 3 MHz;Peak
21239.970	47.9	V	54.0	-6.1	AVG	103	1.0	RB 1 MHz;VB 10 Hz;Peak
21240.120	52.7	V	74.0	-21.3	PK	103	1.0	RB 1 MHz;VB 3 MHz;Peak

- Note 1: For emissions in restricted bands, the limit of 15.209 was used which requires average and peak measurements.
- Note 2: For emissions outside of the restricted bands the limit is -27dBm/MHz eirp (68.3dBuV/m). The measurement method required is a peak measurement (RB=1MHz, VB \geq 3MHz, peak detector).
- Note 3: Scans made between 26 - 40GHz with the measurement antenna moved around the device and its antennas 20-50cm from the device indicated there were no significant emissions in this frequency range

Client: Motorola	Job Number: J87247
Model: VAP2500	T-Log Number: T87276
Contact: Rob Linebarger	Account Manager: Christine Krebill
Standard: FCC	Class: N/A

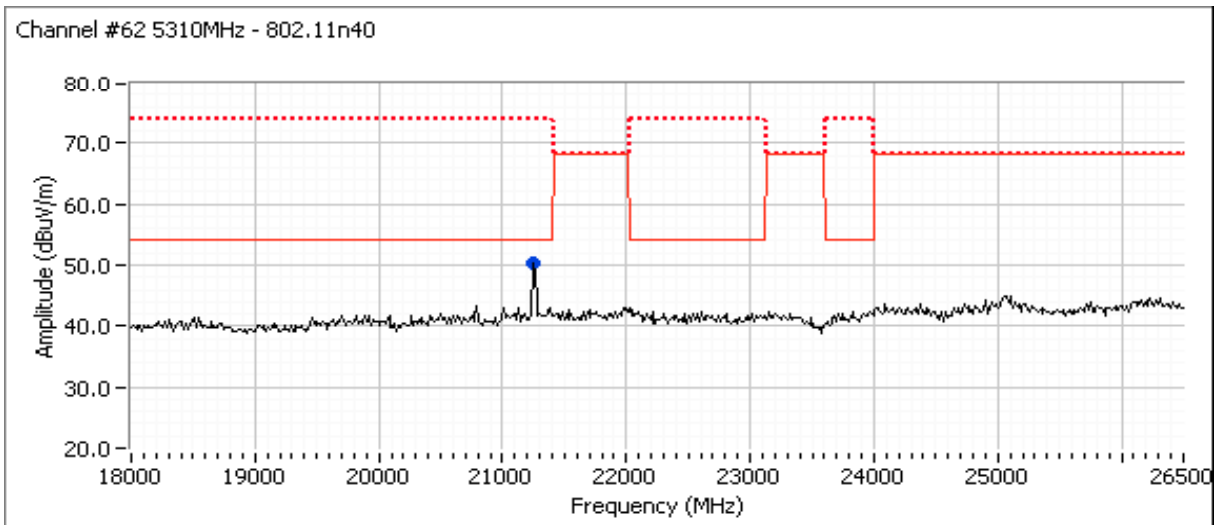
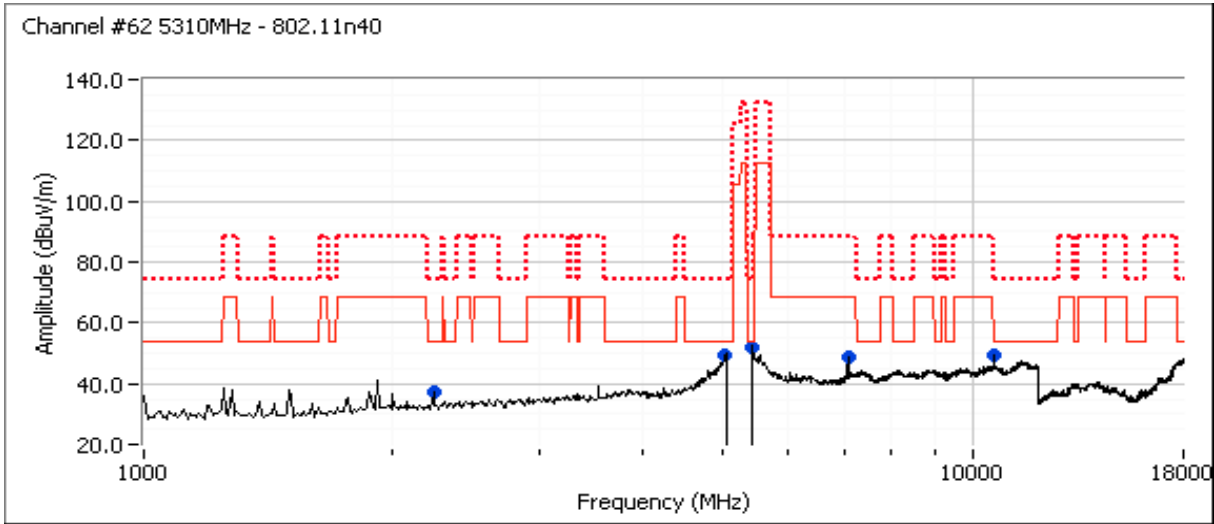



EMC Test Data

Client: Motorola	Job Number: J87247
Model: VAP2500	T-Log Number: T87276
Contact: Rob Linebarger	Account Manager: Christine Krebill
Standard: FCC	Class: N/A

Run #2d: Channel #52 5260MHz - 802.11a

Software Setting	Target (dBm), Chain					Power Settings					Measured (dBm), Chain				
	A	B	C	D	Total	A	B	C	D	Total	A	B	C	D	Total
17	16.0	16.0	16.0	16.0	22.0	16.2	15.5	17.2	17.1	22.6					

Spurious Radiated Emissions:

Frequency	Level	Pol	15.209 / 15E		Detector	Azimuth	Height	Comments
MHz	dB μ V/m	v/h	Limit	Margin	Pk/QP/Avg	degrees	meters	
1920.040	48.3	V	68.3	-20.0	PK	239	1.2	RB 1 MHz;VB 3 MHz;Peak
4960.080	49.1	V	54.0	-4.9	AVG	115	1.1	RB 1 MHz;VB 10 Hz;Peak
4960.030	58.1	V	74.0	-15.9	PK	115	1.1	RB 1 MHz;VB 3 MHz;Peak
5440.140	49.0	V	54.0	-5.0	AVG	222	1.1	RB 1 MHz;VB 10 Hz;Peak
5438.470	58.8	V	74.0	-15.2	PK	222	1.1	RB 1 MHz;VB 3 MHz;Peak
10520.850	56.9	V	68.3	-11.4	PK	73	1.0	RB 1 MHz;VB 3 MHz;Peak
21040.040	48.3	V	54.0	-5.7	AVG	125	1.0	RB 1 MHz;VB 10 Hz;Peak
21039.920	51.3	V	74.0	-22.7	PK	125	1.0	RB 1 MHz;VB 3 MHz;Peak

- Note 1: For emissions in restricted bands, the limit of 15.209 was used which requires average and peak measurements.
- Note 2: For emissions outside of the restricted bands the limit is -27dBm/MHz eirp (68.3dBuV/m). The measurement method required is a peak measurement (RB=1MHz, VB \geq 3MHz, peak detector).
- Note 3: Scans made between 26 - 40GHz with the measurement antenna moved around the device and its antennas 20-50cm from the device indicated there were no significant emissions in this frequency range

Client: Motorola	Job Number: J87247
Model: VAP2500	T-Log Number: T87276
Contact: Rob Linebarger	Account Manager: Christine Krebill
Standard: FCC	Class: N/A

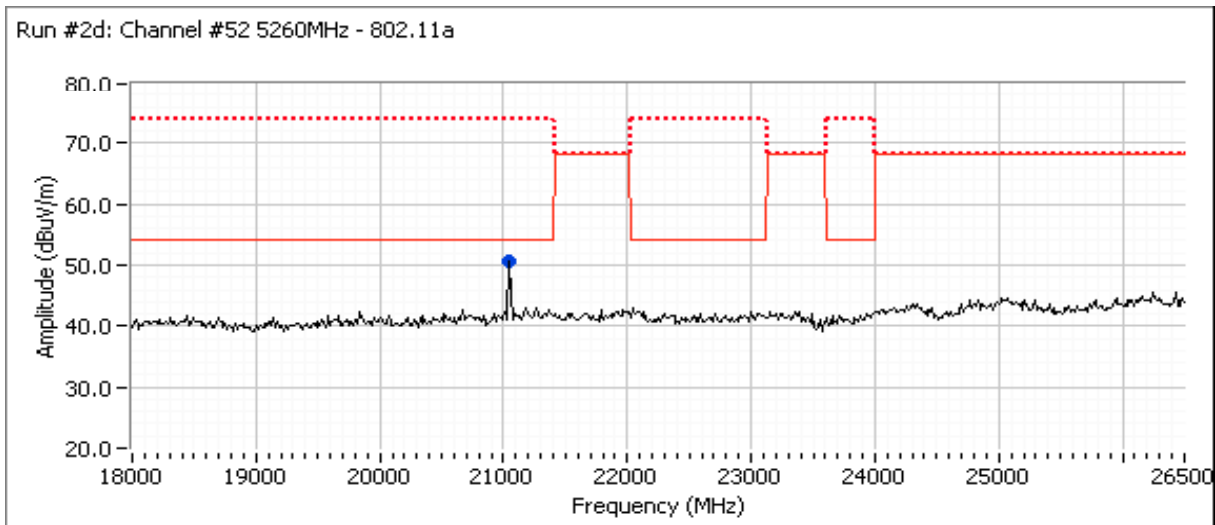
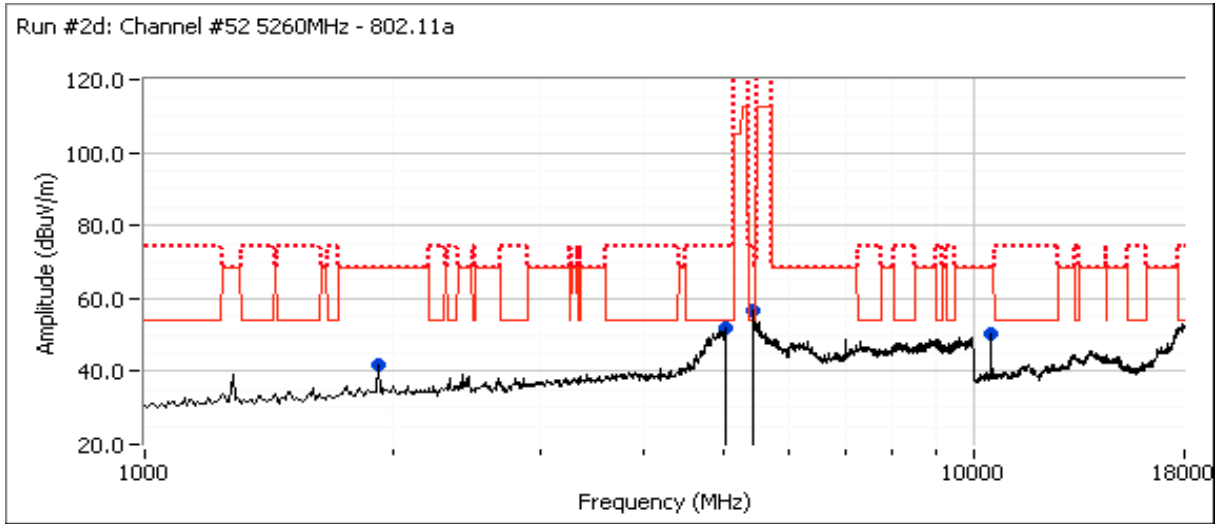



EMC Test Data

Client: Motorola	Job Number: J87247
Model: VAP2500	T-Log Number: T87276
Contact: Rob Linebarger	Account Manager: Christine Krebill
Standard: FCC	Class: N/A

Run #2e: Channel #64 5320MHz - 802.11a

Software Setting	Target (dBm), Chain					Power Settings					Measured (dBm), Chain				
	A	B	C	D	Total	A	B	C	D	Total	A	B	C	D	Total
17	16.0	16.0	16.0	16.0	22.0	16.2	15.8	17.0	17.1	22.6					

Spurious Radiated Emissions:

Frequency	Level	Pol	15.209 / 15E		Detector	Azimuth	Height	Comments
MHz	dB μ V/m	v/h	Limit	Margin	Pk/QP/Avg	degrees	meters	
1920.240	48.6	V	68.3	-19.7	PK	240	1.2	RB 1 MHz;VB 3 MHz;Peak
4992.800	46.4	V	54.0	-7.6	AVG	108	1.2	RB 1 MHz;VB 10 Hz;Peak
4989.460	56.8	V	74.0	-17.2	PK	108	1.2	RB 1 MHz;VB 3 MHz;Peak
5440.070	50.0	V	54.0	-4.0	AVG	211	1.3	RB 1 MHz;VB 10 Hz;Peak
5441.870	59.4	V	74.0	-14.6	PK	211	1.3	RB 1 MHz;VB 3 MHz;Peak
10640.210	46.5	V	54.0	-7.5	AVG	71	1.1	RB 1 MHz;VB 10 Hz;Peak
10640.950	57.7	V	74.0	-16.3	PK	71	1.1	RB 1 MHz;VB 3 MHz;Peak
21280.000	48.4	V	54.0	-5.6	AVG	124	1.1	RB 1 MHz;VB 10 Hz;Peak
21279.920	52.1	V	74.0	-21.9	PK	124	1.1	RB 1 MHz;VB 3 MHz;Peak

- Note 1: For emissions in restricted bands, the limit of 15.209 was used which requires average and peak measurements.
- Note 2: For emissions outside of the restricted bands the limit is -27dBm/MHz eirp (68.3dBuV/m). The measurement method required is a peak measurement (RB=1MHz, VB \geq 3MHz, peak detector).
- Note 3: Scans made between 26 - 40GHz with the measurement antenna moved around the device and its antennas 20-50cm from the device indicated there were no significant emissions in this frequency range

Client: Motorola	Job Number: J87247
Model: VAP2500	T-Log Number: T87276
Contact: Rob Linebarger	Account Manager: Christine Krebill
Standard: FCC	Class: N/A

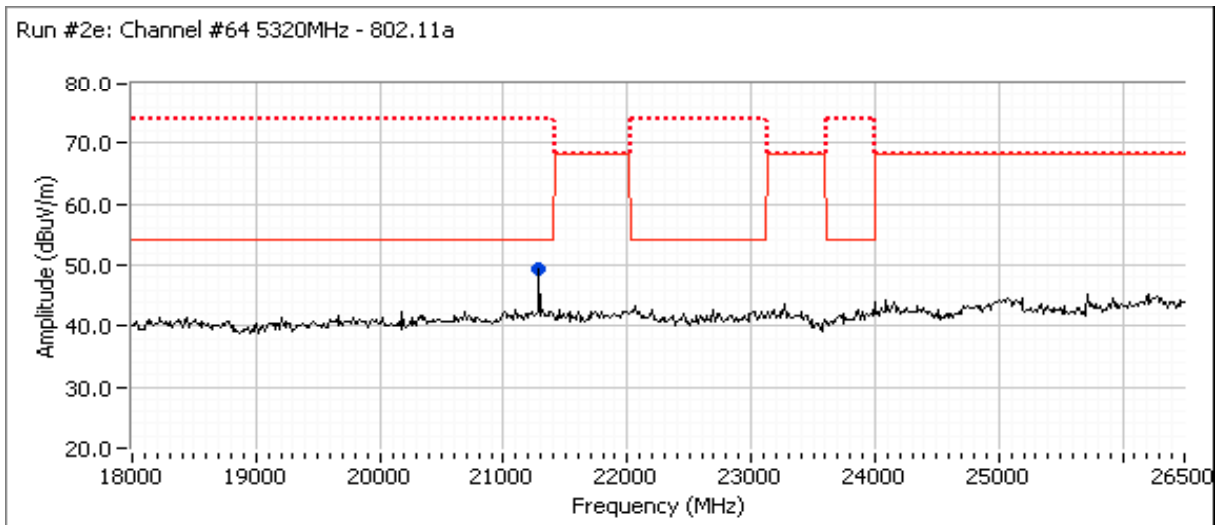
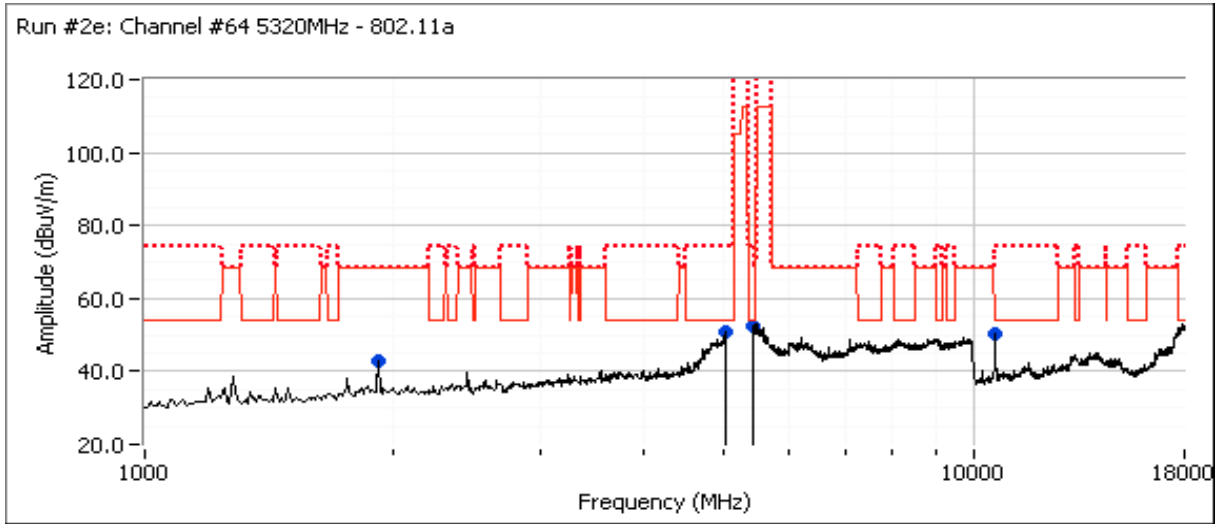



EMC Test Data

Client: Motorola	Job Number: J87247
Model: VAP2500	T-Log Number: T87276
Contact: Rob Linebarger	Account Manager: Christine Krebill
Standard: FCC	Class: N/A

Run #3, Radiated Spurious Emissions, 1,000 - 40,000 MHz. Operation in the 5470-5725 MHz Band
 Date of Test: 5/22/2012
 Test Engineer: Rafael Varelas
 Test Location: FT5

Software Setting	Power Settings					Measured (dBm), Chain				
	Target (dBm), Chain									
18	A	B	C	D	Total	A	B	C	D	Total
	16.0	16.0	16.0	16.0	22.0	17.6	17.5	18.2	18.3	23.9

Run #3a: Channel #116 5580MHz - 802.11a

Spurious Radiated Emissions:

Frequency	Level	Pol	15.209 / 15E		Detector	Azimuth	Height	Comments
MHz	dB μ V/m	v/h	Limit	Margin	Pk/QP/Avg	degrees	meters	
5351.310	53.8	V	54.0	-0.2	AVG	211	1.0	RB 1 MHz;VB 10 Hz;Peak
5354.860	64.8	V	74.0	-9.2	PK	211	1.0	RB 1 MHz;VB 3 MHz;Peak
5120.020	53.7	V	54.0	-0.3	AVG	200	1.0	RB 1 MHz;VB 10 Hz;Peak
5120.100	60.3	V	74.0	-13.7	PK	200	1.0	RB 1 MHz;VB 3 MHz;Peak
11162.260	50.1	V	54.0	-3.9	AVG	98	1.1	RB 1 MHz;VB 10 Hz;Peak
11161.990	60.3	V	74.0	-13.7	PK	98	1.1	RB 1 MHz;VB 3 MHz;Peak
22320.040	46.9	V	54.0	-7.1	AVG	118	1.0	RB 1 MHz;VB 10 Hz;Peak
22319.990	50.4	V	74.0	-23.6	PK	118	1.0	RB 1 MHz;VB 3 MHz;Peak

- Note 1: For emissions in restricted bands, the limit of 15.209 was used which requires average and peak measurements.
- Note 2: For emissions outside of the restricted bands the limit is -27dBm/MHz eirp (68.3dBuV/m). The measurement method required is a peak measurement (RB=1MHz, VB \geq 3MHz, peak detector).
- Note 3: Scans made between 26 - 40GHz with the measurement antenna moved around the device and its antennas 20-50cm from the device indicated there were no significant emissions in this frequency range

Client: Motorola	Job Number: J87247
Model: VAP2500	T-Log Number: T87276
Contact: Rob Linebarger	Account Manager: Christine Krebill
Standard: FCC	Class: N/A

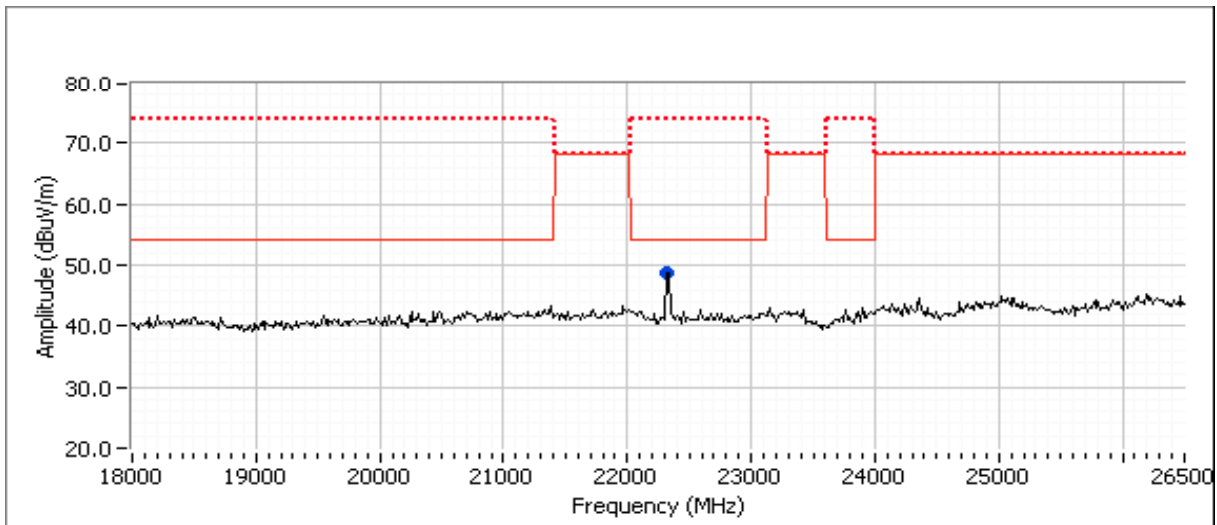
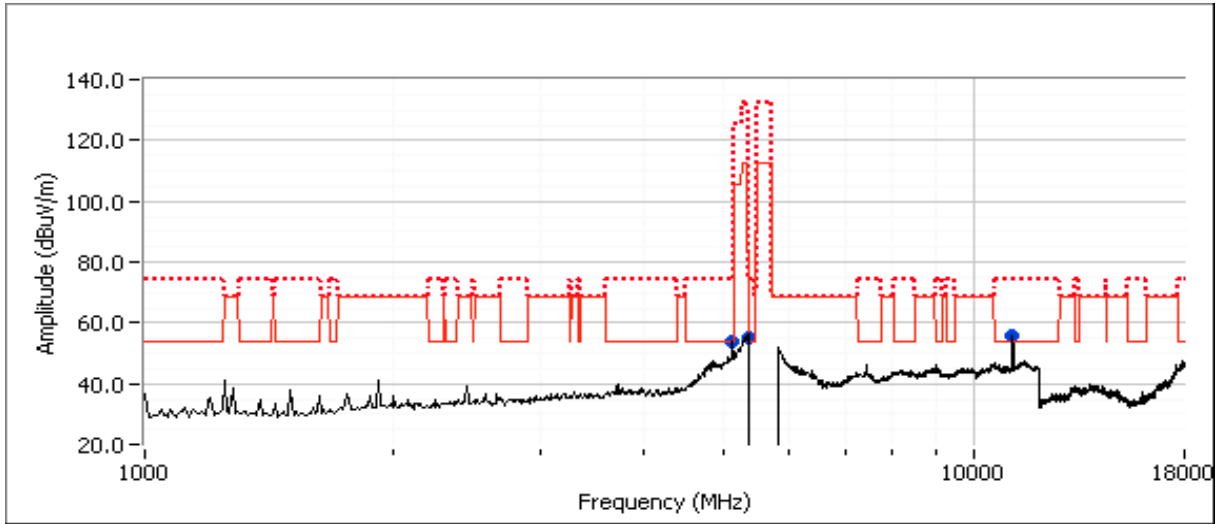



EMC Test Data

Client: Motorola	Job Number: J87247
Model: VAP2500	T-Log Number: T87276
Contact: Rob Linebarger	Account Manager: Christine Krebill
Standard: FCC	Class: N/A

Run #3b: Channel #116 5580MHz - 802.11n20
 Date of Test: 6/20/2012
 Test Engineer: Rafael Varelas
 Test Location: FT7

Software Setting	Power Settings					Measured (dBm), Chain				
	Target (dBm), Chain					Measured (dBm), Chain				
18	A	B	C	D	Total	A	B	C	D	Total
	18.0	18.0	18.0	18.0	24.0	17.7	17.5	18.1	18.3	23.9

Spurious Radiated Emissions:

Frequency MHz	Level dB μ V/m	Pol v/h	15.209 / 15E		Detector Pk/QP/Avg	Azimuth degrees	Height meters	Comments
			Limit	Margin				
11162.820	51.6	V	54.0	-2.4	AVG	90	1.2	RB 1 MHz;VB 10 Hz;Peak
11163.160	63.5	V	74.0	-10.5	PK	90	1.2	RB 1 MHz;VB 3 MHz;Peak
5283.680	65.2	V	68.3	-3.1	PK	206	1.1	RB 1 MHz;VB 3 MHz;Peak
1500.020	40.4	V	54.0	-13.6	AVG	188	1.0	RB 1 MHz;VB 10 Hz;Peak
1500.100	47.5	V	74.0	-26.5	PK	188	1.0	RB 1 MHz;VB 3 MHz;Peak
5120.050	50.8	V	54.0	-3.2	AVG	205	1.2	RB 1 MHz;VB 10 Hz;Peak
5120.400	59.2	V	74.0	-14.8	PK	205	1.2	RB 1 MHz;VB 3 MHz;Peak
22320.830	45.1	V	54.0	-8.9	Peak	70	1.0	

- Note 1: For emissions in restricted bands, the limit of 15.209 was used which requires average and peak measurements.
- Note 2: For emissions outside of the restricted bands the limit is -27dBm/MHz eirp (68.3dBuV/m). The measurement method required is a peak measurement (RB=1MHz, VB \geq 3MHz, peak detector).
- Note 3: Scans made between 26 - 40GHz with the measurement antenna moved around the device and its antennas 20-50cm from the device indicated there were no significant emissions in this frequency range



EMC Test Data

Client: Motorola	Job Number: J87247
Model: VAP2500	T-Log Number: T87276
Contact: Rob Linebarger	Account Manager: Christine Krebill
Standard: FCC	Class: N/A

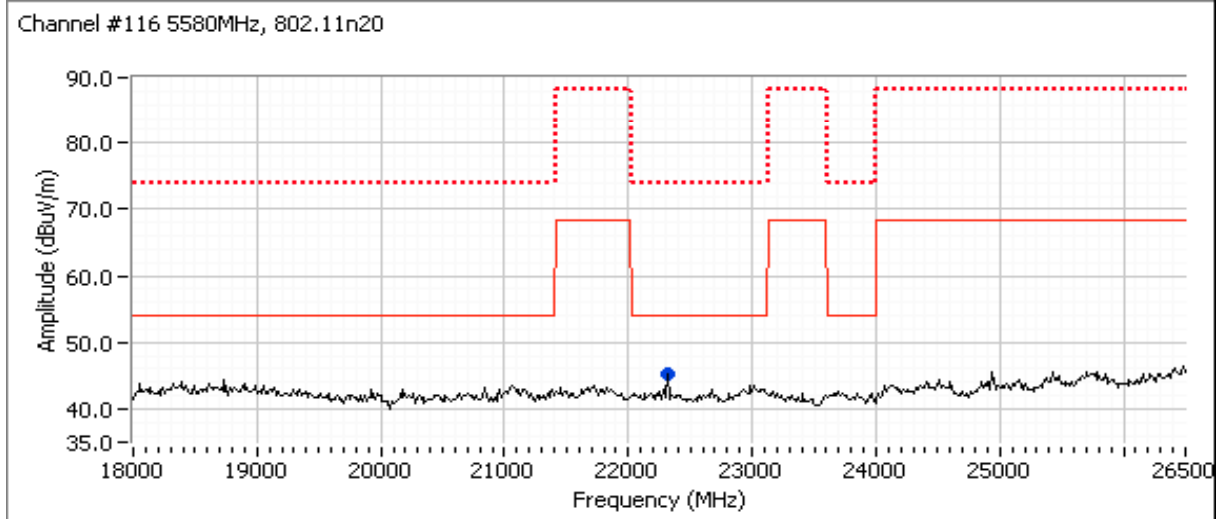
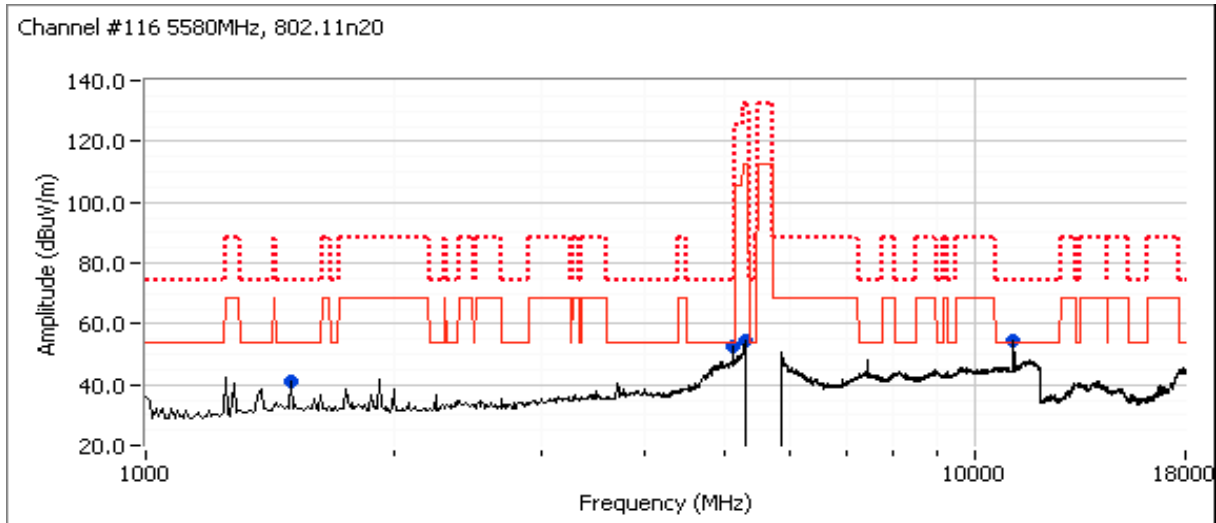



EMC Test Data

Client: Motorola	Job Number: J87247
Model: VAP2500	T-Log Number: T87276
Contact: Rob Linebarger	Account Manager: Christine Krebill
Standard: FCC	Class: N/A

Run #3c: Channel #110 5550MHz - 802.11n40

Software Setting	Target (dBm), Chain					Power Settings					Measured (dBm), Chain				
	A	B	C	D	Total	A	B	C	D	Total	A	B	C	D	Total
18	16.0	16.0	16.0	16.0	22.0	17.3	17.0	17.7	18.0	23.5					

Spurious Radiated Emissions:

Frequency	Level	Pol	15.209 / 15E		Detector	Azimuth	Height	Comments
MHz	dB μ V/m	v/h	Limit	Margin	Pk/QP/Avg	degrees	meters	
5359.920	52.8	V	54.0	-1.2	AVG	40	1.0	RB 1 MHz;VB 10 Hz;Peak
5351.440	63.5	V	74.0	-10.5	PK	40	1.0	RB 1 MHz;VB 3 MHz;Peak
11099.850	48.7	V	54.0	-5.3	AVG	121	1.1	RB 1 MHz;VB 10 Hz;Peak
11099.320	58.9	V	74.0	-15.1	PK	121	1.1	RB 1 MHz;VB 3 MHz;Peak
5120.030	51.1	V	54.0	-2.9	AVG	204	1.0	RB 1 MHz;VB 10 Hz;Peak
5120.040	58.1	V	74.0	-15.9	PK	204	1.0	RB 1 MHz;VB 3 MHz;Peak
22199.960	46.5	V	54.0	-7.5	AVG	107	1.0	RB 1 MHz;VB 10 Hz;Peak
22199.890	51.2	V	74.0	-22.8	PK	107	1.0	RB 1 MHz;VB 3 MHz;Peak

- Note 1: For emissions in restricted bands, the limit of 15.209 was used which requires average and peak measurements.
- Note 2: For emissions outside of the restricted bands the limit is -27dBm/MHz eirp (68.3dBuV/m). The measurement method required is a peak measurement (RB=1MHz, VB \geq 3MHz, peak detector).
- Note 3: Scans made between 26 - 40GHz with the measurement antenna moved around the device and its antennas 20-50cm from the device indicated there were no significant emissions in this frequency range

Client: Motorola	Job Number: J87247
Model: VAP2500	T-Log Number: T87276
Contact: Rob Linebarger	Account Manager: Christine Krebill
Standard: FCC	Class: N/A

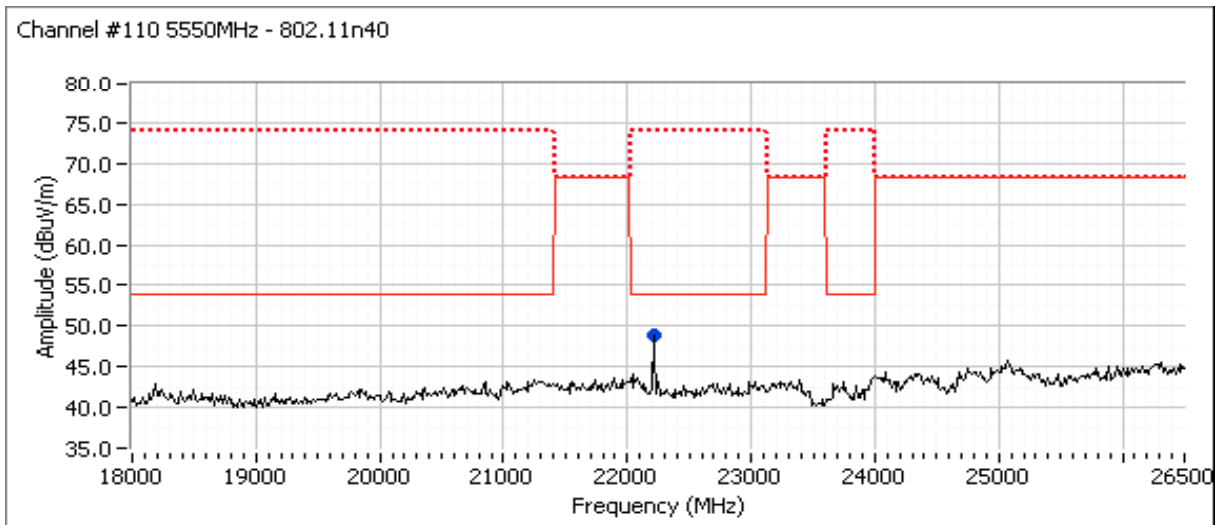
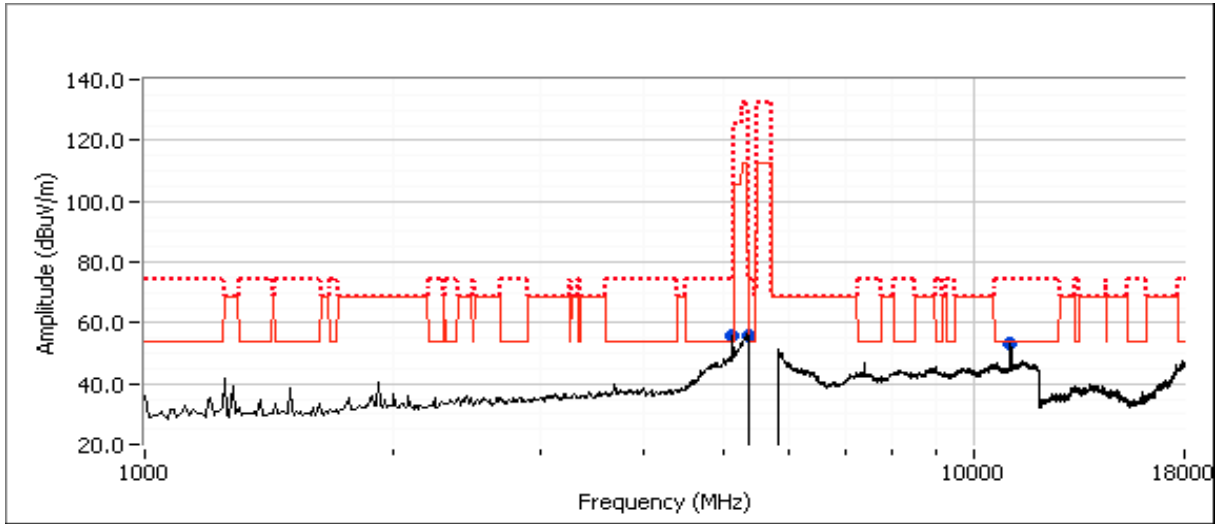



EMC Test Data

Client:	Motorola	Job Number:	J87247
Model:	VAP2500	T-Log Number:	T87276
Contact:	Rob Linebarger	Account Manager:	Christine Krebill
Standard:	FCC	Class:	N/A

Run #3d: Channel #100 5500MHz - 802.11a

Software Setting	Target (dBm), Chain					Power Settings					Measured (dBm), Chain				
	A	B	C	D	Total	A	B	C	D	Total	A	B	C	D	Total
18	16.0	16.0	16.0	16.0	22.0	17.7	17.3	18.0	18.1	23.8					

Spurious Radiated Emissions:

Frequency	Level	Pol	15.209 / 15E		Detector	Azimuth	Height	Comments
MHz	dB μ V/m	v/h	Limit	Margin	Pk/QP/Avg	degrees	meters	
5350.850	53.4	V	54.0	-0.6	AVG	359	1.0	RB 1 MHz;VB 10 Hz;Peak
5351.910	64.8	V	74.0	-9.2	PK	359	1.0	RB 1 MHz;VB 3 MHz;Peak
5120.020	51.3	V	54.0	-2.7	AVG	204	1.0	RB 1 MHz;VB 10 Hz;Peak
5119.980	58.1	V	74.0	-15.9	PK	204	1.0	RB 1 MHz;VB 3 MHz;Peak
7333.280	43.4	H	54.0	-10.6	AVG	138	1.2	RB 1 MHz;VB 10 Hz;Peak
7333.260	52.8	H	74.0	-21.2	PK	138	1.2	RB 1 MHz;VB 3 MHz;Peak
11004.080	48.4	V	54.0	-5.6	AVG	16	1.0	RB 1 MHz;VB 10 Hz;Peak
11002.950	58.9	V	74.0	-15.1	PK	16	1.0	RB 1 MHz;VB 3 MHz;Peak
22000.020	48.9	V	68.3	-19.4	AVG	48	1.0	RB 1 MHz;VB 10 Hz;Peak
22000.090	52.5	V	68.3	-15.8	PK	48	1.0	RB 1 MHz;VB 3 MHz;Peak

- Note 1: For emissions in restricted bands, the limit of 15.209 was used which requires average and peak measurements.
- Note 2: For emissions outside of the restricted bands the limit is -27dBm/MHz eirp (68.3dBuV/m). The measurement method required is a peak measurement (RB=1MHz, VB \geq 3MHz, peak detector).
- Note 3: Scans made between 26 - 40GHz with the measurement antenna moved around the device and its antennas 20-50cm from the device indicated there were no significant emissions in this frequency range

Client: Motorola	Job Number: J87247
Model: VAP2500	T-Log Number: T87276
Contact: Rob Linebarger	Account Manager: Christine Krebill
Standard: FCC	Class: N/A

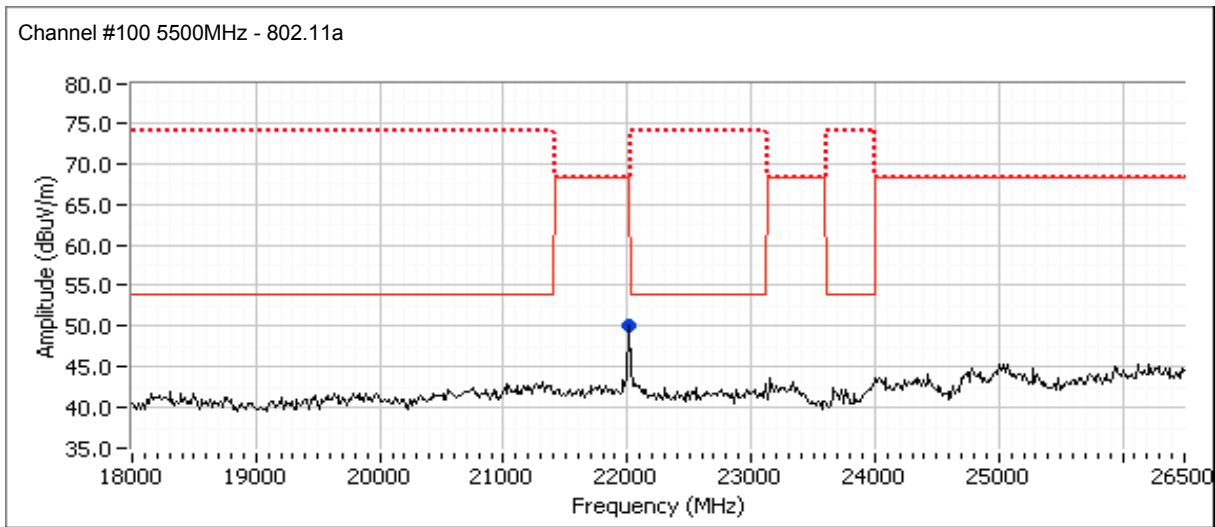
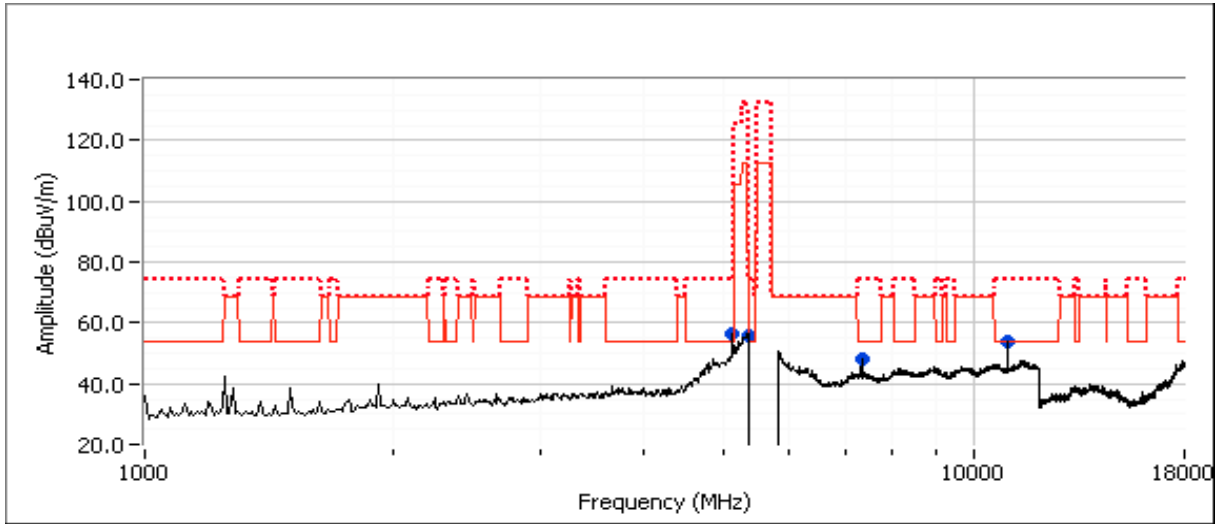



EMC Test Data

Client: Motorola	Job Number: J87247
Model: VAP2500	T-Log Number: T87276
Contact: Rob Linebarger	Account Manager: Christine Krebill
Standard: FCC	Class: N/A

Run #3e: Channel #134 5700MHz - 802.11a

Software Setting	Power Settings					Measured (dBm), Chain				
	Target (dBm), Chain									
18	A	B	C	D	Total	A	B	C	D	Total
	16.0	16.0	16.0	16.0	22.0	16.6	16.8	17.2	17.4	23.0

Spurious Radiated Emissions:

Frequency	Level	Pol	15.209 / 15E		Detector	Azimuth	Height	Comments
MHz	dB μ V/m	v/h	Limit	Margin	Pk/QP/Avg	degrees	meters	
5350.950	52.7	V	54.0	-1.3	AVG	226	1.0	RB 1 MHz;VB 10 Hz;Peak
5350.570	62.8	V	74.0	-11.2	PK	226	1.0	RB 1 MHz;VB 3 MHz;Peak
7628.520	35.6	V	54.0	-18.4	AVG	43	1.0	RB 1 MHz;VB 10 Hz;Peak
7637.650	46.3	V	74.0	-27.7	PK	43	1.0	RB 1 MHz;VB 3 MHz;Peak
11399.910	52.0	V	54.0	-2.0	AVG	122	1.1	RB 1 MHz;VB 10 Hz;Peak
11398.250	62.4	V	74.0	-11.6	PK	122	1.1	RB 1 MHz;VB 3 MHz;Peak
5119.980	49.9	V	54.0	-4.1	AVG	214	1.0	RB 1 MHz;VB 10 Hz;Peak
5120.170	56.3	V	74.0	-17.7	PK	214	1.0	RB 1 MHz;VB 3 MHz;Peak
22800.000	46.9	V	54.0	-7.1	AVG	137	1.0	RB 1 MHz;VB 10 Hz;Peak
22799.870	50.9	V	74.0	-23.1	PK	137	1.0	RB 1 MHz;VB 3 MHz;Peak

- Note 1: For emissions in restricted bands, the limit of 15.209 was used which requires average and peak measurements.
- Note 2: For emissions outside of the restricted bands the limit is -27dBm/MHz eirp (68.3dBuV/m). The measurement method required is a peak measurement (RB=1MHz, VB \geq 3MHz, peak detector).
- Note 3: Scans made between 26 - 40GHz with the measurement antenna moved around the device and its antennas 20-50cm from the device indicated there were no significant emissions in this frequency range

Client: Motorola	Job Number: J87247
Model: VAP2500	T-Log Number: T87276
Contact: Rob Linebarger	Account Manager: Christine Krebill
Standard: FCC	Class: N/A

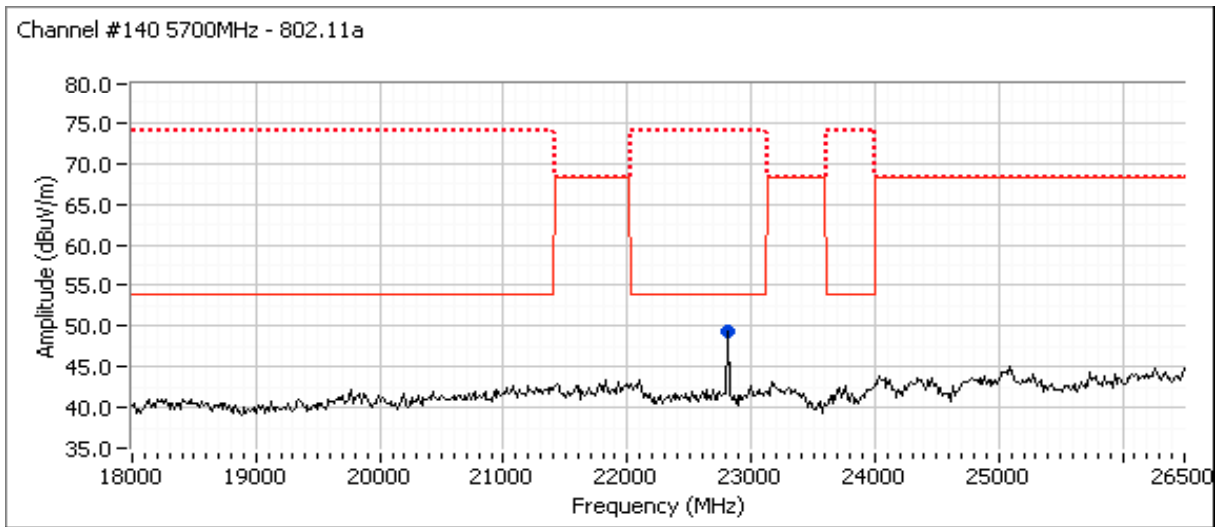
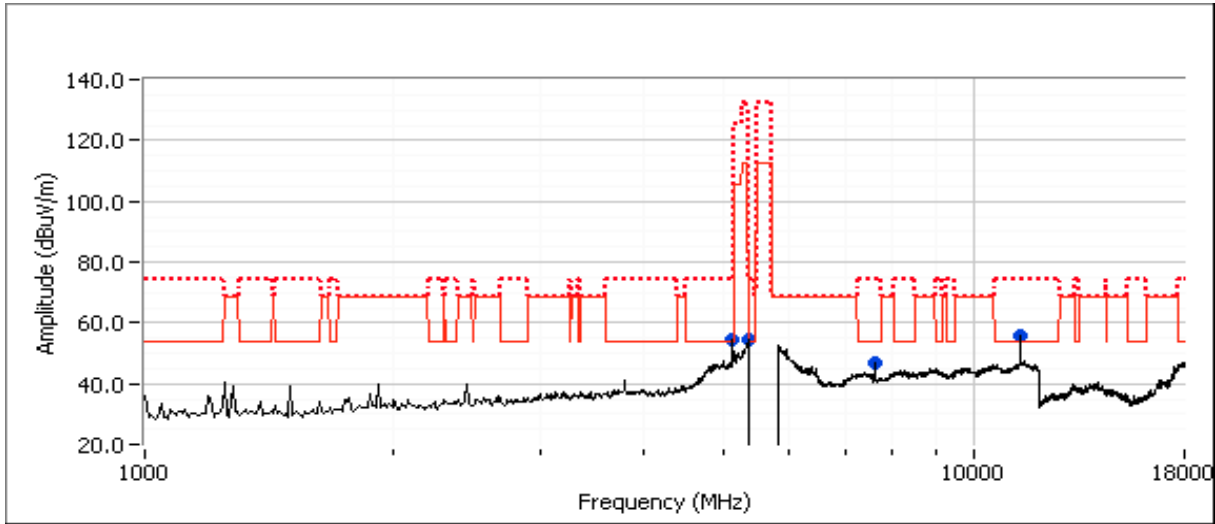



EMC Test Data

Client:	Motorola	Job Number:	J87247
Model:	VAP2500	T-Log Number:	T87276
Contact:	Rob Linebarger	Account Manager:	Christine Krebill
Standard:	FCC	Class:	N/A

Radiated Emissions 30-1000 MHz, (FCC 15.247/RSS 210) (NTS Silicon Valley Fremont Facility, Semi-Anechoic Chamber)

Test Specific Details

Objective: The objective of this test session is to perform final qualification testing of the EUT with respect to the specification listed above.

Date of Test: 5/14/2012
 Test Engineer: Jack Liu
 Test Location: FT5

Config. Used: 1
 Config Change: None
 EUT Voltage: 120v/60Hz

General Test Configuration

The EUT and any local support equipment were located on the turntable for radiated emissions testing.

The test distance and extrapolation factor (if applicable) are detailed under each run description.

Note, preliminary testing indicates that the emissions were maximized by orientation of the EUT and elevation of the measurement antenna. Maximized testing indicated that the emissions were maximized by orientation of the EUT, elevation of the measurement antenna, and manipulation of the EUT's interface cables.

Ambient Conditions:

Temperature: 24 °C
 Rel. Humidity: 35 %

Summary of Results

Run #	Test Performed	Limit	Result	Margin
1	Radiated Emissions 30 - 1000 MHz	FCC 15.209 / RSS 210	Pass	33.5 dBµV/m @ 54.15 MHz (-6.5 dB)
2	Radiated Emissions 30 - 1000 MHz	FCC 15.209 / RSS 210	Pass	32.8 dBµV/m @ 53.55 MHz (-7.2 dB)

Modifications Made During Testing

No modifications were made to the EUT during testing

Deviations From The Standard

No deviations were made from the requirements of the standard.



EMC Test Data

Client: Motorola	Job Number: J87247
Model: VAP2500	T-Log Number: T87276
Contact: Rob Linebarger	Account Manager: Christine Krebill
Standard: FCC	Class: N/A

Run #1: Preliminary Radiated Emissions, 30 - 1000 MHz
 Configured Radio to Tx, 802.11a 11dBm on each chain (settings 11) on channel 36, Leader Electronics Inc Power Supply

Frequency Range	Test Distance	Limit Distance	Extrapolation Factor
30 - 1000 MHz	3	3	0.0

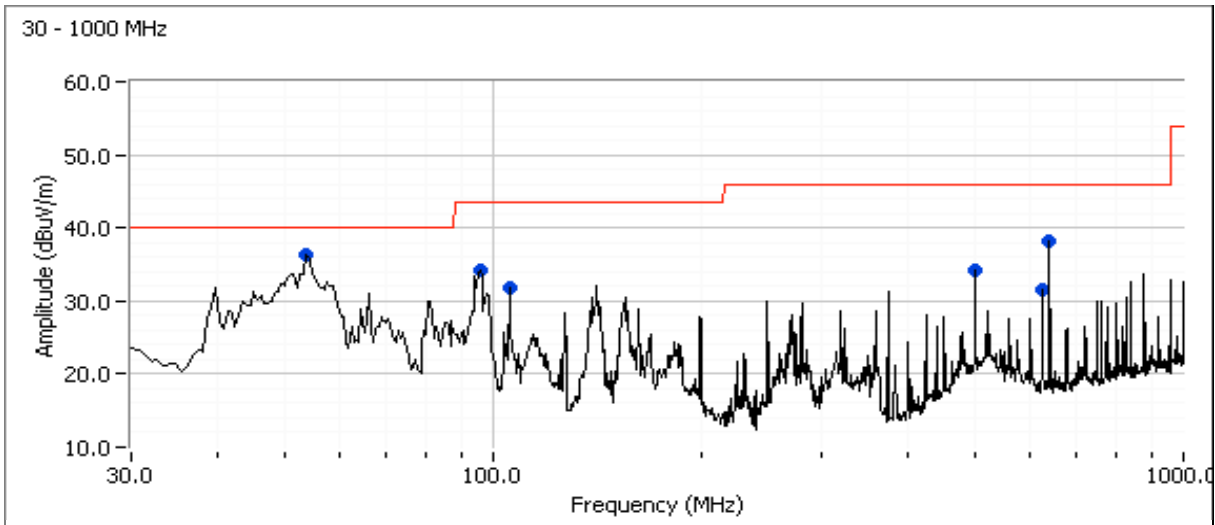

Preliminary peak readings captured during pre-scan

Frequency	Level	Pol	FCC 15.209 / RSS 210		Detector	Azimuth	Height	Comments
MHz	dB μ V/m	v/h	Limit	Margin	Pk/QP/Avg	degrees	meters	
54.153	36.2	V	40.0	-3.8	Peak	0	1.0	
95.769	34.2	V	43.5	-9.3	Peak	257	1.0	
105.684	31.8	V	43.5	-11.7	Peak	173	1.0	
499.998	34.1	V	46.0	-11.9	Peak	161	1.0	
624.988	31.5	V	46.0	-14.5	Peak	44	1.0	
640.009	38.1	V	46.0	-7.9	Peak	254	1.0	

Maximized quasi-peak readings (includes manipulation of EUT interface cables)

Frequency	Level	Pol	FCC 15.209 / RSS 210		Detector	Azimuth	Height	Comments
MHz	dB μ V/m	v/h	Limit	Margin	Pk/QP/Avg	degrees	meters	
54.153	33.5	V	40.0	-6.5	QP	259	1.0	QP (1.00s)
640.009	37.6	V	46.0	-8.4	QP	255	1.0	QP (1.00s)
95.769	33.4	V	43.5	-10.1	QP	253	1.0	QP (1.00s)
499.998	34.0	V	46.0	-12.0	QP	160	1.0	QP (1.00s)
624.988	31.5	V	46.0	-14.5	QP	43	1.0	QP (1.00s)
105.684	26.5	V	43.5	-17.0	QP	175	1.0	QP (1.00s)



EMC Test Data

Client: Motorola	Job Number: J87247
Model: VAP2500	T-Log Number: T87276
Contact: Rob Linebarger	Account Manager: Christine Krebill
Standard: FCC	Class: N/A

Run #2: Preliminary Radiated Emissions, 30 - 1000 MHz

Configured Radio to Tx, 802.11n40 16dBm on each chain (settings 16) on channel 64

Frequency Range	Test Distance	Limit Distance	Extrapolation Factor
30 - 1000 MHz	3	3	0.0

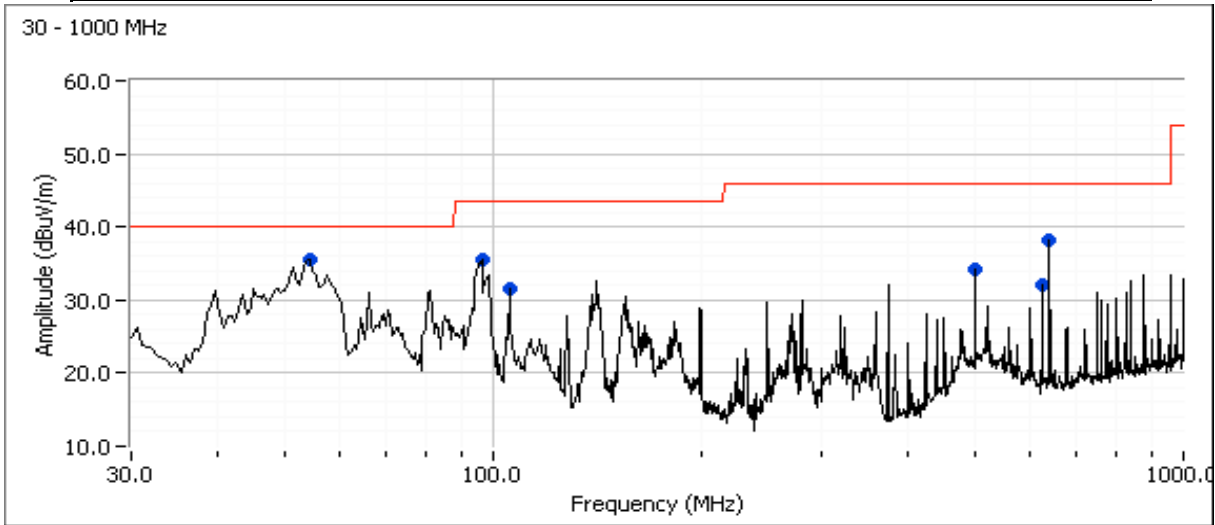

Preliminary peak readings captured during pre-scan

Frequency MHz	Level dB μ V/m	Pol v/h	FCC 15.209 / RSS 210		Detector Pk/QP/Avg	Azimuth degrees	Height meters	Comments
			Limit	Margin				
53.547	35.4	V	40.0	-4.6	Peak	30	1.0	
95.770	35.5	V	43.5	-8.0	Peak	250	1.0	
105.699	31.5	V	43.5	-12.0	Peak	203	1.5	
500.003	34.2	V	46.0	-11.8	Peak	137	1.0	
624.999	32.1	V	46.0	-13.9	Peak	30	1.0	
640.009	38.3	V	46.0	-7.7	Peak	252	1.0	

Maximized quasi-peak readings (includes manipulation of EUT interface cables)

Frequency MHz	Level dB μ V/m	Pol v/h	FCC 15.209 / RSS 210		Detector Pk/QP/Avg	Azimuth degrees	Height meters	Comments
			Limit	Margin				
53.547	32.8	V	40.0	-7.2	QP	29	1.0	
640.009	37.6	V	46.0	-8.4	QP	257	1.0	
95.770	31.6	V	43.5	-11.9	QP	211	1.5	
105.699	30.3	V	43.5	-13.2	QP	205	1.5	
500.003	31.0	V	46.0	-15.0	QP	136	1.0	
624.999	29.4	V	46.0	-16.6	QP	29	1.0	

Note: As the emissions observed below 1GHz were independent of the mode and frequency of the transmitters, additional modes and frequencies were not tested for emissions below 1GHz.



EMC Test Data

Client: Motorola	Job Number: J87247
Model: VAP2500	T-Log Number: T87276
	Account Manager: Christine Krebill
Contact: Rob Linebarger	
Standard: FCC	Class: B

Conducted Emissions(FCC 15.247/RSS 210) (NTS Silicon Valley Fremont Facility, Semi-Anechoic Chamber)

Test Specific Details

Objective: The objective of this test session is to perform final qualification testing of the EUT with respect to the specification listed above.

Date of Test: 5/14/2012	Config. Used: 1
Test Engineer: Jack Liu	Config Change: None
Test Location: FT5	EUT Voltage: 120v/60Hz

General Test Configuration

For tabletop equipment, the EUT was located on a wooden table inside the semi-anechoic chamber, 40 cm from a vertical coupling plane and 80cm from the LISN. A second LISN was used for all local support equipment. Remote support equipment was located outside of the semi-anechoic chamber.

Ambient Conditions: Temperature: 24 °C
 Rel. Humidity: 35 %

Summary of Results

Run #	Test Performed	Limit	Result	Margin
1	CE, AC Power, 120V/60Hz	RSS 210 / 15.207	Pass	44.4 dBµV @ 0.379 MHz (-3.9 dB)

Modifications Made During Testing

No modifications were made to the EUT during testing

Deviations From The Standard

No deviations were made from the requirements of the standard.

Client: Motorola	Job Number: J87247
Model: VAP2500	T-Log Number: T87276
Contact: Rob Linebarger	Account Manager: Christine Krebill
Standard: FCC	Class: B

Run #1: AC Power Port Conducted Emissions, 0.15 - 30MHz, 120V/60Hz
 Leader Electronics Inc Power Supply

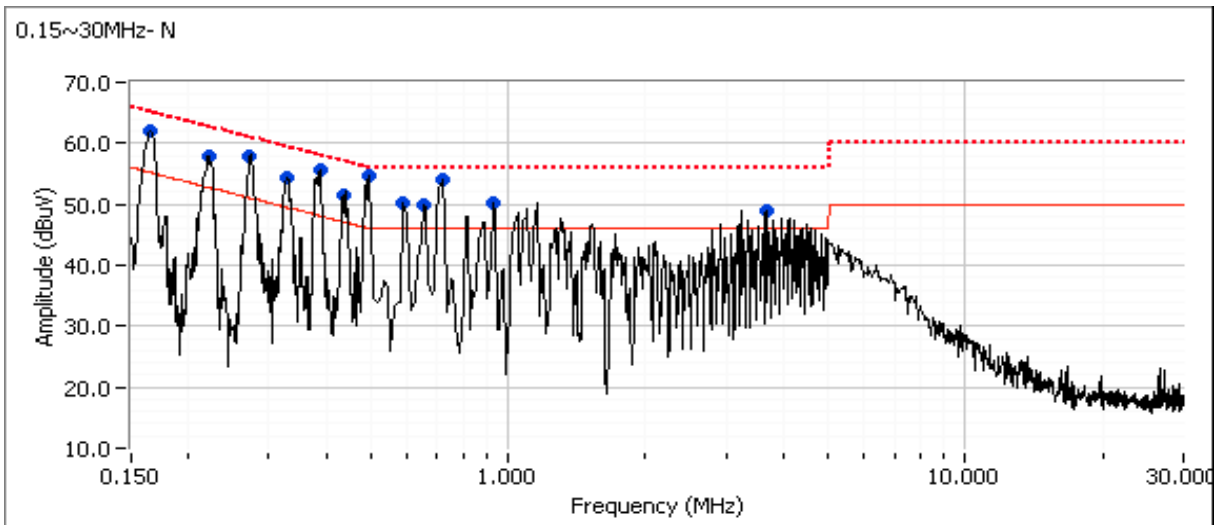
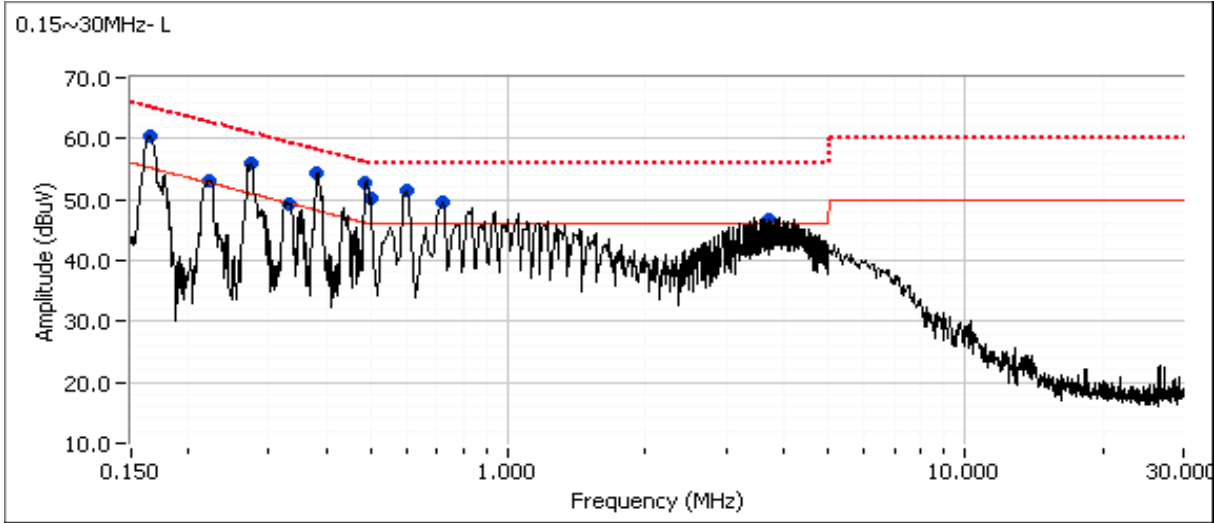



EMC Test Data

Client: Motorola	Job Number: J87247
Model: VAP2500	T-Log Number: T87276
	Account Manager: Christine Krebill
Contact: Rob Linebarger	
Standard: FCC	Class: B

Preliminary peak readings captured during pre-scan (peak readings vs. average limit)

Frequency MHz	Level dB μ V	AC Line	RSS 210 / 15.207		Detector QP/Ave	Comments
			Limit	Margin		
0.163	60.4	Line	55.2	5.2	Peak	
0.218	53.1	Line	52.7	0.4	Peak	
0.272	55.8	Line	51.0	4.8	Peak	
0.332	49.3	Line	49.4	-0.1	Peak	
0.379	54.3	Line	48.2	6.1	Peak	
0.490	52.8	Line	46.2	6.6	Peak	
3.700	46.8	Line	46.0	0.8	Peak	
0.611	51.6	Line	46.0	5.6	Peak	
0.498	50.1	Line	46.0	4.1	Peak	
0.721	49.7	Line	46.0	3.7	Peak	
0.163	61.9	Neutral	55.2	6.7	Peak	
0.219	57.9	Neutral	52.8	5.1	Peak	
0.272	58.0	Neutral	51.0	7.0	Peak	
0.326	54.3	Neutral	49.5	4.8	Peak	
0.386	55.6	Neutral	48.1	7.5	Peak	
0.440	51.5	Neutral	47.1	4.4	Peak	
0.496	54.6	Neutral	46.1	8.5	Peak	
0.708	54.0	Neutral	46.0	8.0	Peak	
0.608	50.0	Neutral	46.0	4.0	Peak	
0.607	50.2	Neutral	46.0	4.2	Peak	
0.936	50.1	Neutral	46.0	4.1	Peak	
3.685	48.8	Neutral	46.0	2.8	Peak	



EMC Test Data

Client: Motorola	Job Number: J87247
Model: VAP2500	T-Log Number: T87276
	Account Manager: Christine Krebill
Contact: Rob Linebarger	
Standard: FCC	Class: B

Final quasi-peak and average readings

Frequency MHz	Level dB μ V	AC Line	RSS 210 / 15.207		Detector QP/Ave	Comments
			Limit	Margin		
0.379	44.4	Line	48.3	-3.9	AVG	AVG (0.10s)
0.496	52.0	Neutral	56.1	-4.1	QP	QP (1.00s)
0.271	56.7	Neutral	61.1	-4.4	QP	QP (1.00s)
0.219	48.3	Neutral	52.9	-4.6	AVG	AVG (0.10s)
0.607	51.4	Neutral	56.0	-4.6	QP	QP (1.00s)
0.162	60.6	Neutral	65.4	-4.8	QP	QP (1.00s)
0.272	46.0	Line	51.1	-5.1	AVG	AVG (0.10s)
0.608	50.8	Neutral	56.0	-5.2	QP	QP (1.00s)
0.490	50.7	Line	56.2	-5.5	QP	QP (1.00s)
0.490	40.6	Line	46.2	-5.6	AVG	AVG (0.10s)
0.379	52.7	Line	58.3	-5.6	QP	QP (1.00s)
0.219	57.2	Neutral	62.9	-5.7	QP	QP (1.00s)
0.386	52.3	Neutral	58.1	-5.8	QP	QP (1.00s)
0.163	59.2	Line	65.3	-6.1	QP	QP (1.00s)
0.272	54.8	Line	61.1	-6.3	QP	QP (1.00s)
0.498	49.7	Line	56.0	-6.3	QP	QP (1.00s)
0.326	43.2	Neutral	49.6	-6.4	AVG	AVG (0.10s)
0.326	53.2	Neutral	59.6	-6.4	QP	QP (1.00s)
0.271	44.6	Neutral	51.1	-6.5	AVG	AVG (0.10s)
0.218	46.3	Line	52.9	-6.6	AVG	AVG (0.10s)
0.707	49.2	Neutral	56.0	-6.8	QP	QP (1.00s)
0.163	48.3	Line	55.3	-7.0	AVG	AVG (0.10s)
0.936	48.6	Neutral	56.0	-7.4	QP	QP (1.00s)
0.707	38.4	Neutral	46.0	-7.6	AVG	AVG (0.10s)
0.162	47.6	Neutral	55.4	-7.8	AVG	AVG (0.10s)
0.721	47.6	Line	56.0	-8.4	QP	QP (1.00s)
0.611	47.4	Line	56.0	-8.6	QP	QP (1.00s)
0.440	48.5	Neutral	57.1	-8.6	QP	QP (1.00s)
0.386	37.9	Neutral	48.1	-10.2	AVG	AVG (0.10s)
0.496	35.9	Neutral	46.1	-10.2	AVG	AVG (0.10s)
0.332	48.8	Line	59.4	-10.6	QP	QP (1.00s)
3.685	45.2	Neutral	56.0	-10.8	QP	QP (1.00s)
0.218	51.9	Line	62.9	-11.0	QP	QP (1.00s)
0.607	33.4	Neutral	46.0	-12.6	AVG	AVG (0.10s)
0.440	34.3	Neutral	47.1	-12.8	AVG	AVG (0.10s)
0.608	32.6	Neutral	46.0	-13.4	AVG	AVG (0.10s)
0.498	32.1	Line	46.0	-13.9	AVG	AVG (0.10s)
0.332	35.1	Line	49.4	-14.3	AVG	AVG (0.10s)
3.685	31.0	Neutral	46.0	-15.0	AVG	AVG (0.10s)

continues



EMC Test Data

Client: Motorola	Job Number: J87247
Model: VAP2500	T-Log Number: T87276
	Account Manager: Christine Krebill
Contact: Rob Linebarger	
Standard: FCC	Class: B

Frequency MHz	Level dB μ V	AC Line	RSS 210 / 15.207		Detector QP/Ave	Comments
			Limit	Margin		
0.936	29.5	Neutral	46.0	-16.5	AVG	AVG (0.10s)
0.611	28.4	Line	46.0	-17.6	AVG	AVG (0.10s)
0.721	28.0	Line	46.0	-18.0	AVG	AVG (0.10s)
3.700	37.1	Line	56.0	-18.9	QP	QP (1.00s)
3.700	23.5	Line	46.0	-22.5	AVG	AVG (0.10s)



EMC Test Data

Client:	Motorola	Job Number:	J87247
Model:	VAP2500	T-Log Number:	T87276
Contact:	Rob Linebarger	Account Manager:	Christine Krebill
Standard:	FCC	Class:	N/A

Radiated Emissions 30-1000 MHz, (FCC 15.247/RSS 210) (NTS Silicon Valley Fremont Facility, Semi-Anechoic Chamber)

Test Specific Details

Objective: The objective of this test session is to perform final qualification testing of the EUT with respect to the specification listed above.

Date of Test: 6/25/2012
 Test Engineer: Michael Findley
 Test Location: FT4

Config. Used: 1
 Config Change: None
 EUT Voltage: 120v/60Hz

General Test Configuration

The EUT and any local support equipment were located on the turntable for radiated emissions testing.

The test distance and extrapolation factor (if applicable) are detailed under each run description.

Note, preliminary testing indicates that the emissions were maximized by orientation of the EUT and elevation of the measurement antenna. Maximized testing indicated that the emissions were maximized by orientation of the EUT, elevation of the measurement

Ambient Conditions:

Temperature: 24 °C
 Rel. Humidity: 35 %

Summary of Results

Run #	Test Performed	Limit	Result	Margin
1	Radiated Emissions 30 - 1000 MHz	FCC 15.209 / RSS 210	Pass	33.5 dBµV/m @ 55.90 MHz (-6.5 dB)

Modifications Made During Testing

No modifications were made to the EUT during testing

Deviations From The Standard

No deviations were made from the requirements of the standard.



EMC Test Data

Client: Motorola	Job Number: J87247
Model: VAP2500	T-Log Number: T87276
Contact: Rob Linebarger	Account Manager: Christine Krebill
Standard: FCC	Class: N/A

Run #1: Preliminary Radiated Emissions, 30 - 1000 MHz
 Configured Radio to Tx, 802.11a, N20, 18dBm on each chain (settings 18) on channel 157, Asian Power Devices Power Supply

Frequency Range	Test Distance	Limit Distance	Extrapolation Factor
30 - 1000 MHz	3	3	0.0

Run #1:

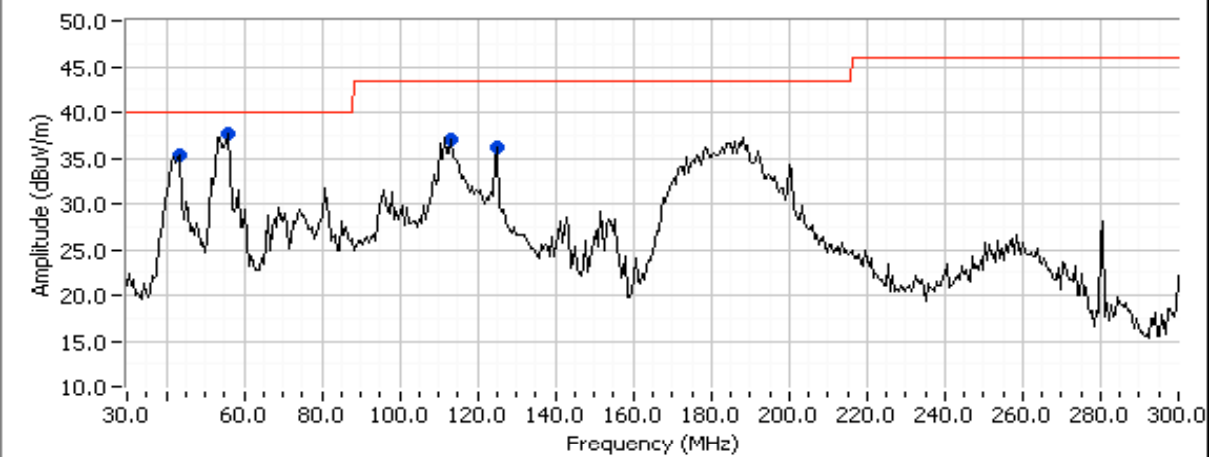

Run #1:

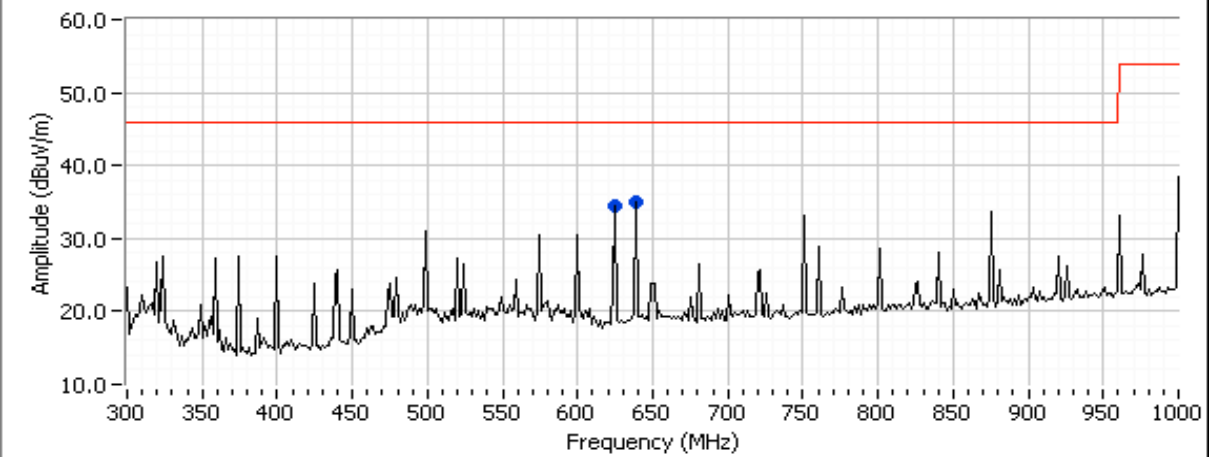



EMC Test Data

Client:	Motorola	Job Number:	J87247
Model:	VAP2500	T-Log Number:	T87276
Contact:	Rob Linebarger	Account Manager:	Christine Krebill
Standard:	FCC	Class:	N/A

Preliminary peak readings captured during pre-scan

Frequency MHz	Level dB μ V/m	Pol v/h	FCC 15.209 / RSS 210		Detector Pk/QP/Avg	Azimuth degrees	Height meters	Comments
			Limit	Margin				
125.006	36.2	V	43.5	-7.3	Peak	340	1.0	
42.985	35.3	V	40.0	-4.7	Peak	306	1.0	
112.194	37.0	V	43.5	-6.5	Peak	303	1.0	
640.009	35.1	V	46.0	-10.9	Peak	276	1.0	
55.897	37.6	V	40.0	-2.4	Peak	107	1.0	
625.005	34.5	V	46.0	-11.5	Peak	57	1.0	

Maximized quasi-peak readings (includes manipulation of EUT interface cables)

Frequency MHz	Level dB μ V/m	Pol v/h	FCC 15.209 / RSS 210		Detector Pk/QP/Avg	Azimuth degrees	Height meters	Comments
			Limit	Margin				
55.897	33.5	V	40.0	-6.5	QP	0	1.0	QP (1.00s)
42.985	31.4	V	40.0	-8.6	QP	360	1.0	QP (1.00s)
125.006	34.6	V	43.5	-8.9	QP	341	1.0	QP (1.00s)
112.194	31.1	V	43.5	-12.4	QP	290	1.0	QP (1.00s)
640.009	33.0	V	46.0	-13.0	QP	277	1.0	QP (1.00s)
625.005	32.3	V	46.0	-13.7	QP	64	1.0	QP (1.00s)



EMC Test Data

Client: Motorola	Job Number: J87247
Model: VAP2500	T-Log Number: T87276
	Account Manager: Christine Krebill
Contact: Rob Linebarger	
Standard: FCC	Class: B

Conducted Emissions(FCC 15.247/RSS 210) (NTS Silicon Valley Fremont Facility, Semi-Anechoic Chamber)

Test Specific Details

Objective: The objective of this test session is to perform final qualification testing of the EUT with respect to the specification listed above.

Date of Test: 6/25/2012	Config. Used: 1
Test Engineer: Michael Findley	Config Change: None
Test Location: FT4	EUT Voltage: 120v/60Hz

General Test Configuration

For tabletop equipment, the EUT was located on a wooden table inside the semi-anechoic chamber, 40 cm from a vertical coupling plane and 80cm from the LISN. A second LISN was used for all local support equipment. Remote support equipment was located

Ambient Conditions: Temperature: 24 °C
 Rel. Humidity: 35 %

Summary of Results

Run #	Test Performed	Limit	Result	Margin
1	CE, AC Power, 120V/60Hz	RSS 210 / 15.207	Pass	35.4 dBµV @ 0.406 MHz (-12.3 dB)

Modifications Made During Testing

No modifications were made to the EUT during testing

Deviations From The Standard

No deviations were made from the requirements of the standard.

Client: Motorola	Job Number: J87247
Model: VAP2500	T-Log Number: T87276
Contact: Rob Linebarger	Account Manager: Christine Krebill
Standard: FCC	Class: B

Run #1: AC Power Port Conducted Emissions, 0.15 - 30MHz, 120V/60Hz
Asian Power Devices Power Supply

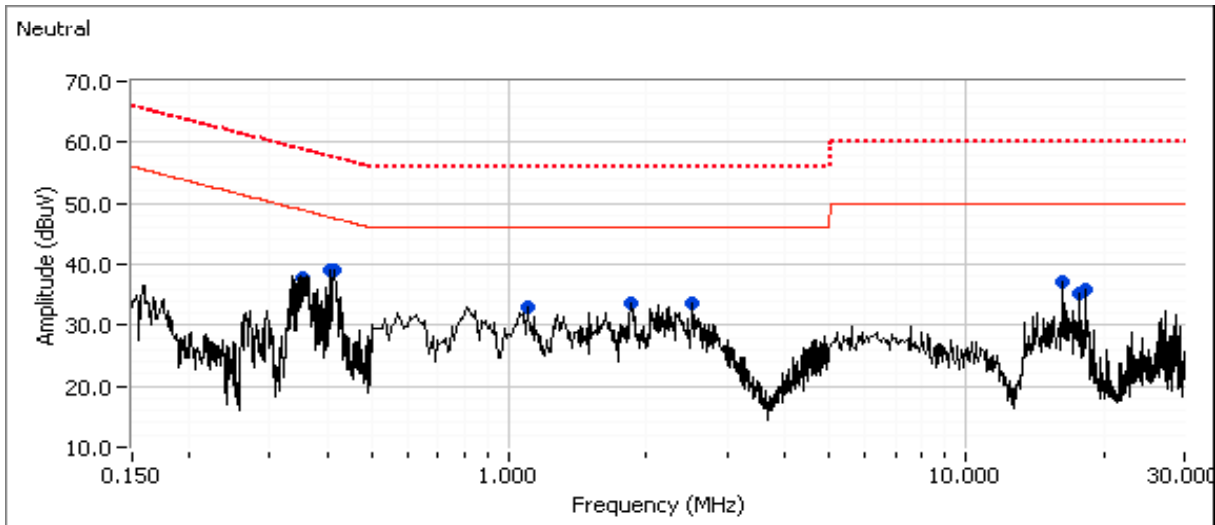
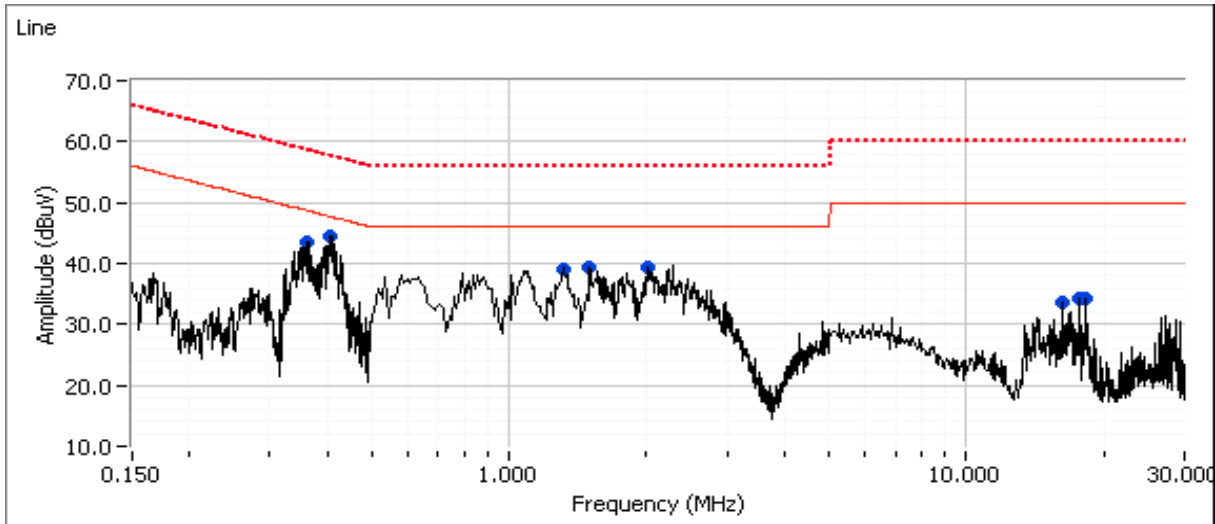



EMC Test Data

Client: Motorola	Job Number: J87247
Model: VAP2500	T-Log Number: T87276
Contact: Rob Linebarger	Account Manager: Christine Krebill
Standard: FCC	Class: B

Preliminary peak readings captured during pre-scan (peak readings vs. average limit)

Frequency MHz	Level dB μ V	AC Line	RSS 210 / 15.207		Detector QP/Ave	Comments
			Limit	Margin		
0.406	44.6	Line 1	47.7	-3.1	Peak	
0.357	43.4	Line 1	48.7	-5.3	Peak	
1.516	39.4	Line 1	46.0	-6.6	Peak	
1.308	39.1	Line 1	46.0	-6.9	Peak	
2.029	39.3	Line 1	46.0	-6.7	Peak	
16.229	33.6	Line 1	50.0	-16.4	Peak	
16.168	33.6	Line 1	50.0	-16.4	Peak	
17.694	34.1	Line 1	50.0	-15.9	Peak	
18.244	34.3	Line 1	50.0	-15.7	Peak	
18.304	34.3	Line 1	50.0	-15.7	Peak	
0.357	37.8	Neutral	48.8	-11.0	Peak	
0.353	37.8	Neutral	48.8	-11.0	Peak	
0.403	39.2	Neutral	47.7	-8.5	Peak	
0.410	38.9	Neutral	47.6	-8.7	Peak	
2.549	33.5	Neutral	46.0	-12.5	Peak	
1.856	33.5	Neutral	46.0	-12.5	Peak	
1.109	33.1	Neutral	46.0	-12.9	Peak	



EMC Test Data

Client: Motorola	Job Number: J87247
Model: VAP2500	T-Log Number: T87276
	Account Manager: Christine Krebill
Contact: Rob Linebarger	
Standard: FCC	Class: B

Final quasi-peak and average readings

Frequency MHz	Level dB μ V	AC Line	RSS 210 / 15.207		Detector QP/Ave	Comments
			Limit	Margin		
0.406	35.4	Line 1	47.7	-12.3	AVG	AVG (0.10s)
0.357	35.6	Line 1	48.8	-13.2	AVG	AVG (0.10s)
0.406	42.6	Line 1	57.7	-15.1	QP	QP (1.00s)
0.357	42.6	Line 1	58.8	-16.2	QP	QP (1.00s)
1.308	28.2	Line 1	46.0	-17.8	AVG	AVG (0.10s)
0.403	30.0	Neutral	47.8	-17.8	AVG	AVG (0.10s)
0.357	30.0	Neutral	48.8	-18.8	AVG	AVG (0.10s)
0.410	28.8	Neutral	47.6	-18.8	AVG	AVG (0.10s)
0.353	29.8	Neutral	48.9	-19.1	AVG	AVG (0.10s)
2.029	26.4	Line 1	46.0	-19.6	AVG	AVG (0.10s)
0.403	37.8	Neutral	57.8	-20.0	QP	QP (1.00s)
1.308	35.8	Line 1	56.0	-20.2	QP	QP (1.00s)
1.516	25.4	Line 1	46.0	-20.6	AVG	AVG (0.10s)
16.229	29.0	Line 1	50.0	-21.0	AVG	AVG (0.10s)
1.516	35.0	Line 1	56.0	-21.0	QP	QP (1.00s)
0.357	37.8	Neutral	58.8	-21.0	QP	QP (1.00s)
0.410	36.6	Neutral	57.6	-21.0	QP	QP (1.00s)
2.029	34.9	Line 1	56.0	-21.1	QP	QP (1.00s)
0.353	37.6	Neutral	58.9	-21.3	QP	QP (1.00s)
16.168	27.8	Line 1	50.0	-22.2	AVG	AVG (0.10s)
17.694	27.5	Line 1	50.0	-22.5	AVG	AVG (0.10s)
18.244	26.7	Line 1	50.0	-23.3	AVG	AVG (0.10s)
1.109	22.1	Neutral	46.0	-23.9	AVG	AVG (0.10s)
18.304	25.1	Line 1	50.0	-24.9	AVG	AVG (0.10s)
1.856	21.1	Neutral	46.0	-24.9	AVG	AVG (0.10s)
16.229	34.5	Line 1	60.0	-25.5	QP	QP (1.00s)
2.549	19.9	Neutral	46.0	-26.1	AVG	AVG (0.10s)
1.109	29.6	Neutral	56.0	-26.4	QP	QP (1.00s)
16.168	33.4	Line 1	60.0	-26.6	QP	QP (1.00s)
1.856	28.4	Neutral	56.0	-27.6	QP	QP (1.00s)
17.694	32.2	Line 1	60.0	-27.8	QP	QP (1.00s)
18.244	31.4	Line 1	60.0	-28.6	QP	QP (1.00s)
2.549	27.4	Neutral	56.0	-28.6	QP	QP (1.00s)
18.304	29.7	Line 1	60.0	-30.3	QP	QP (1.00s)

End of Report

This page is intentionally blank and marks the last page of this test report.