

FCC Test Report

FCC ID : ACQ-MG3OTA
Equipment : Set Top Box
Model No. : MG3-OTA-H, MG3-OTA-L
Brand Name : TiVo
Applicant : ARRIS
Address : 101 Tournament Drive, Horsham
Pennsylvania, United States, 19044
Standard : 47 CFR FCC Part 15.407
Received Date : May 20, 2019
Tested Date : May 24 ~ Jun. 03, 2019

We, International Certification Corp., would like to declare that the tested sample has been evaluated and in compliance with the requirement of the above standards. The test results contained in this report refer exclusively to the product. It may be duplicated completely for legal use with the approval of the applicant. It shall not be reproduced except in full without the written approval of our laboratory.

Reviewed by:



Along Chen / Assistant Manager

Approved by:



Gary Chang / Manager



Table of Contents

1	GENERAL DESCRIPTION	5
1.1	Information.....	5
1.2	Local Support Equipment List	10
1.3	Test Setup Chart	11
1.4	The Equipment List	13
1.5	Testing Applied Standards	14
1.6	Deviation from Test Standard and Measurement Procedure.....	14
1.7	Measurement Uncertainty	15
2	TEST CONFIGURATION	16
2.1	Testing Condition	16
2.2	The Worst Test Modes and Channel Details	16
3	TRANSMITTER TEST RESULTS.....	18
3.1	Conducted Emissions.....	18
3.2	Emission Bandwidth	27
3.3	RF Output Power.....	53
3.4	Peak Power Spectral Density.....	66
3.5	Transmitter Radiated and Band Edge Emissions	94
3.6	Frequency Stability.....	215
4	TEST LABORATORY INFORMATION	217

Release Record

Report No.	Version	Description	Issued Date
FR932003-02AN	Rev. 01	Initial issue	Jun. 14, 2019

Summary of Test Results

FCC Rules	Test Items	Measured	Result
15.207	Conducted Emissions	[dBuV]: 0.162MHz 48.82 (Margin -7.12dB) - AV	Pass
15.407(b) 15.209	Radiated Emissions	[dBuV/m at 3m]: 5350.00MHz 53.75 (Margin -0.25dB) - AV	Pass
15.407(a)	Emission Bandwidth	Meet the requirement of limit	Pass
15.407(e)	6dB bandwidth	Meet the requirement of limit	Pass
15.407(a)	RF Output Power	Max Power [dBm]: Non-beamforming mode 5150~5250MHz: 21.66 5250~5350MHz: 21.91 5470~5725MHz: 23.12 5725~5850MHz: 28.54 Beamforming mode 5150~5250MHz: 18.87 5250~5350MHz: 18.60 5470~5725MHz: 17.96 5725~5850MHz: 25.48	Pass
15.407(a)	Peak Power Spectral Density	Meet the requirement of limit	Pass
15.407(g)	Frequency Stability	Meet the requirement of limit	Pass
15.203	Antenna Requirement	Meet the requirement of limit	Pass

Declaration of Conformity:

The test results with all measurement uncertainty excluded are presented in accordance with the regulation limits or requirements declared by manufacturers.

Comments and Explanations:

The declared of product specification for EUT presented in the report are provided by the manufacturer, and the manufacturer takes all the responsibilities for the accuracy of product specification.

1 General Description

1.1 Information

1.1.1 Product Details

The following models are provided to this EUT.

Model Name	Difference
MG3-OTA-H	ATSC tuner*4, 2TB HDD
MG3-OTA-L	ATSC tuner*2, 500GB HDD

✦ The above models had been covered during the pretest and found that model **MG3-OTA-H** was the worst one and selected for final test and only its data was recorded in this report.

1.1.2 Specification of the Equipment under Test (EUT)

RF General Information					
Frequency Range (MHz)	IEEE Std. 802.11	Ch. Freq. (MHz)	Channel Number	Transmit Chains (N _{TX})	Data Rate / MCS
5150-5250 5250-5350 5470-5725 5725-5850	a	5180-5240 5260-5320 5500-5720 5745-5825	36-48 [4] 52-64 [4] 100-144 [12] 149-165 [5]	4	6-54 Mbps
5150-5250 5250-5350 5470-5725 5725-5850	n (HT20)	5180-5240 5260-5320 5500-5720 5745-5825	36-48 [4] 52-64 [4] 100-144 [12] 149-165 [5]	4	MCS 0-31
5150-5250 5250-5350 5470-5725 5725-5850	n (HT40)	5190-5230 5270-5310 5510-5710 5755-5795	38-46 [2] 54-62 [2] 102-142 [6] 151-159 [2]	4	MCS 0-31
5150-5250 5250-5350 5470-5725 5725-5850	ac (VHT20)	5180-5240 5260-5320 5500-5720 5745-5825	36-48 [4] 52-64 [4] 100-144 [12] 149-165 [5]	4	MCS 0-9
5150-5250 5250-5350 5470-5725 5725-5850	ac (VHT40)	5190-5230 5270-5310 5510-5710 5755-5795	38-46 [2] 54-62 [2] 102-142 [6] 151-159 [2]	4	MCS 0-9
5150-5250 5250-5350 5470-5725 5725-5850	ac (VHT80)	5210 5290 5530~5690 5775	42 [1] 58 [1] 106-138 [3] 155 [1]	4	MCS 0-9

Note 1: RF output power specifies that Maximum Conducted Output Power.
 Note 2: 802.11a/n/ac uses a combination of OFDM-BPSK, QPSK, 16QAM, 64QAM, 256QAM modulation.
 Note 3: 802.11ac supports beamforming function.

1.1.3 Antenna Details

Ant. No.	Model	Type	Connector	Operating Frequencies (MHz) / Antenna Gain (dBi)				
				2400~2483.5	5150~5250	5250~5350	5470~5725	5725~5850
1	M2420ARVS U_G115U	PIFA	UFL	3.2	4.1	4.7	5.1	5.1
2	M2420ARHS U_G55U	PIFA	UFL	3	4.9	4.2	5.3	5.5
3	M2420SDAR VSU_G120U	PIFA	UFL	2.5	5.3	6	5.5	3
4	M2420SDAR VSU_G270U	PIFA	UFL	2.8	4.5	4.5	4.2	2.8

1.1.4 Power Supply Type of Equipment under Test (EUT)

Power Supply Type	12Vdc from adapter
--------------------------	--------------------

1.1.5 Accessories

Accessories		
No.	Equipment	Description
1	Adapter	Brand: TiVo Manufacturer: LITE-ON INC Model: PB-1300-3AR5 Power Rating: I/P: 100-120Vac, 1.0A, 60Hz O/P: 12Vdc, 2.5A Power Line: 1.8m non-shielded without core
2	Adapter	Brand: TiVo Manufacturer: NETBIT ELECTRONICS LTD. Model: NBS36E120250VU Power Rating: I/P: 100-120Vac, 60Hz, 0.8A O/P: 12.0Vdc, 2.5A Power Line: 1.8m non-shielded without core
3	HDMI cable	1.8m shielded without core
4	HDD	Brand: SEAGATE Model: ST2000VT000 Product: Video 2.5 HDD
5	HDD	Brand: SEAGATE Model: ST500VT003 Product: Video 2.5 HDD
6	Remote Control	Brand: REMOTESOLUTION CO.,LTD Model: SBOM_03031_000
7	AA Battery for Remote Control	1.5Vdc *2

1.1.6 Channel List

802.11 a / HT20 / VHT20		HT40 / VHT40	
Channel	Frequency(MHz)	Channel	Frequency(MHz)
36	5180	38	5190
40	5200	46	5230
44	5220	54	5270
48	5240	62	5310
52	5260	102	5510
56	5280	110	5550
60	5300	118	5590
64	5320	126	5630
100	5500	134	5670
104	5520	142	5710
108	5540	151	5755
112	5560	159	5795
116	5580	VHT80	
120	5600	42	5210
124	5620	58	5290
128	5640	106	5530
132	5660	122	5610
136	5680	138	5690
140	5700	155	5775
144	5720	---	---
149	5745	---	---
153	5765	---	---
157	5785	---	---
161	5805	---	---
165	5825	---	---

1.1.7 Test Tool and Duty Cycle

Test Tool	Non-beamforming :Mtool, V3.1.0.3 Beamforming: Putty, V0.6				
Duty Cycle and Duty Factor	Mode	Non-beamforming		Beamforming	
		Duty cycle (%)	Duty factor (dB)	Duty cycle (%)	Duty factor (dB)
	11a	95.70%	0.19	---	---
	VHT20	99.63%	0.02	96.53%	0.15
	VHT40	98.67%	0.06	---	---
VHT80	96.00%	0.18	---	---	

1.1.8 Power Index of Test Tool

Modulation Mode	Test Frequency (MHz)	Power Index	
		Non-Beamforming	Beamforming
11a	5180	48	---
11a	5200	48	---
11a	5240	48	---
11a	5260	48	---
11a	5300	48	---
11a	5320	48	---
11a	5500	48	---
11a	5580	48	---
11a	5700	48	---
11a	5720	48	---
11a	5745	86	---
11a	5785	86	---
11a	5825	86	---

Modulation Mode	Test Frequency (MHz)	Power Index	
		Non-Beamforming	Beamforming
VHT20	5180	48	48
VHT20	5200	48	48
VHT20	5240	48	48
VHT20	5260	48	48
VHT20	5300	48	48
VHT20	5320	48	48
VHT20	5500	48	44
VHT20	5580	48	44
VHT20	5700	48	46
VHT20	5720	48	46
VHT20	5745	86	76
VHT20	5785	86	78
VHT20	5825	86	80
VHT40	5190	60	36
VHT40	5230	60	36
VHT40	5270	62	38
VHT40	5310	62	38
VHT40	5510	58	34
VHT40	5590	62	38
VHT40	5670	62	38
VHT40	5710	62	38
VHT40	5755	91	67
VHT40	5795	91	67
VHT80	5210	58	34
VHT80	5290	52	28
VHT80	5530	56	32
VHT80	5610	68	44
VHT80	5690	68	44
VHT80	5775	80	56

1.2 Local Support Equipment List

Non-beamforming mode

Support Equipment List					
No.	Equipment	Brand	Model	FCC ID	Remarks
1	Notebook	DELL	Latitude E6440	DoC	---
2	TV	CHIMEI	TL-24LF500D	---	---
3	USB Flash	Kingston	DTSE9	---	---
4	USB Flash	Kingston	DTSE9	---	---

Beamforming mode

Support Equipment List					
No.	Equipment	Brand	Model	FCC ID	Remarks
1	Notebook	DELL	Latitude E6440	DoC	---
2	TV	CHIMEI	TL-24LF500D	---	---
3	USB Flash	Kingston	DTSE9	---	---
4	USB Flash	Kingston	DTSE9	---	---
5	Notebook	DELL	Latitude E5470	DoC	---
6	BF Client	TiVo	MG3-R	---	Provided by applicant.

1.3 Test Setup Chart

Non-beamforming mode

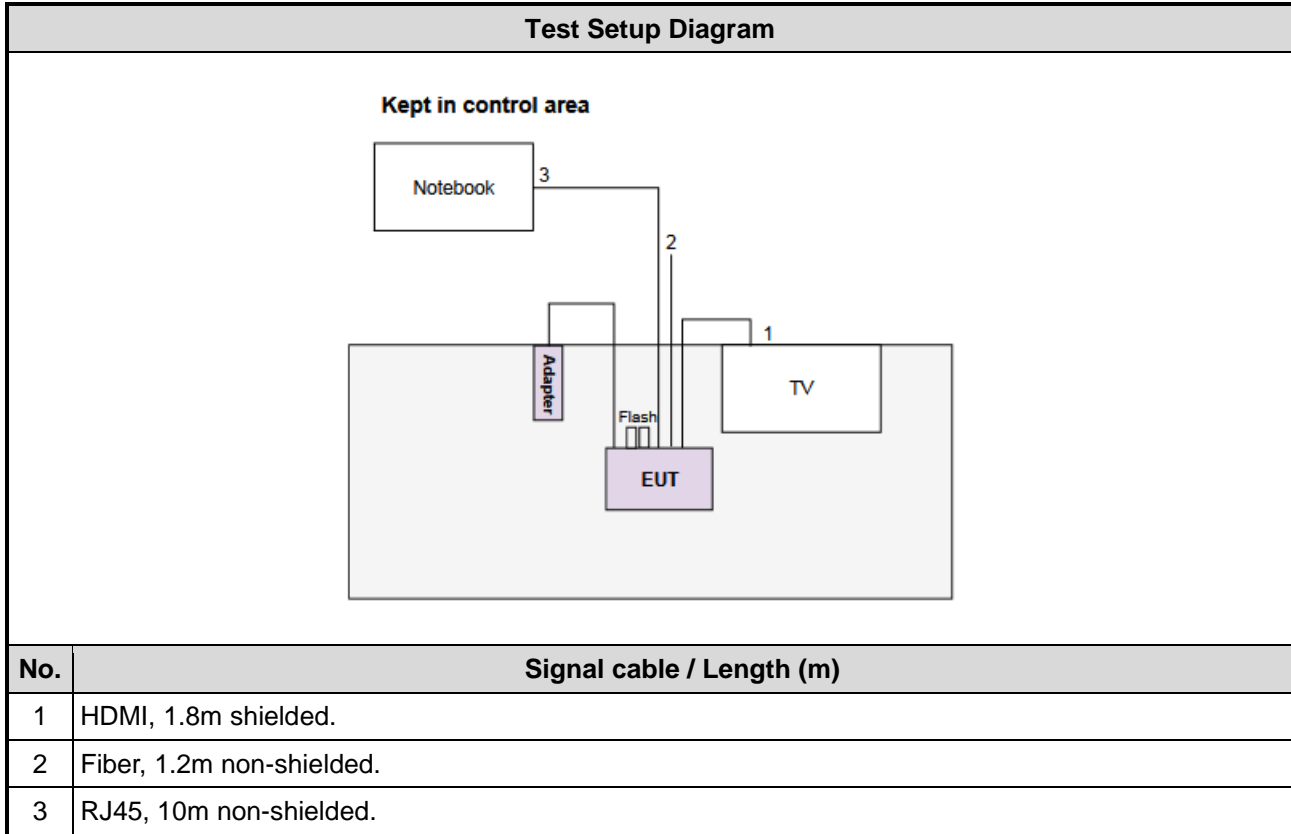

Beamforming mode

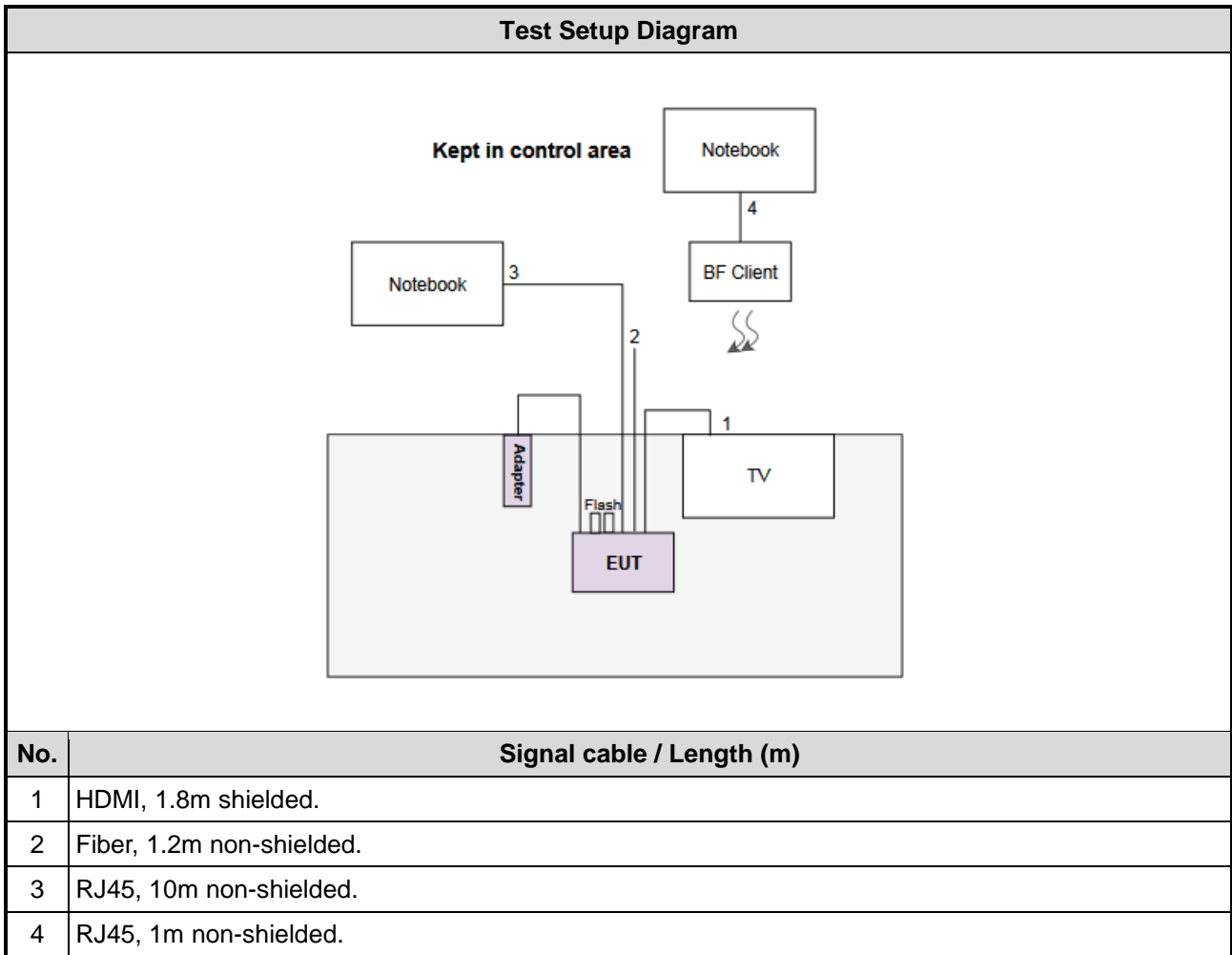

1.4 The Equipment List

Test Item	Conducted Emission				
Test Site	Conduction room 1 / (CO01-WS)				
Instrument	Manufacturer	Model No.	Serial No.	Calibration Date	Calibration Until
Receiver	R&S	ESR3	101657	Jan. 08, 2019	Jan. 07, 2020
LISN	SCHWARZBECK	Schwarzbeck 8127	8127-667	Nov. 05, 2018	Nov. 04, 2019
LISN (Support Unit)	SCHWARZBECK	Schwarzbeck 8127	8127-666	Nov. 29, 2018	Nov. 28, 2019
RF Cable-CON	Woken	CFD200-NL	CFD200-NL-001	Oct. 23, 2018	Oct. 23, 2019
50 ohm terminal (Support Unit)	NA	50	02	Apr. 19, 2019	Apr. 18, 2020
Measurement Software	AUDIX	e3	6.120210k	NA	NA

Note: Calibration Interval of instruments listed above is one year.

Test Item	Radiated Emission				
Test Site	966 chamber 3 / (03CH03-WS)				
Instrument	Manufacturer	Model No.	Serial No.	Calibration Date	Calibration Until
Spectrum Analyzer	R&S	FSV40	101499	Jan. 07, 2019	Jan. 06, 2020
Receiver	R&S	ESR3	101658	Dec. 11, 2018	Dec. 10, 2019
Bilog Antenna	SCHWARZBECK	VULB9168	VULB9168-685	Apr. 17, 2019	Apr. 16, 2020
Horn Antenna 1G-18G	SCHWARZBECK	BBHA 9120 D	BBHA 9120 D 1206	Jan. 07, 2019	Jan. 06, 2020
Horn Antenna 18G-40G	SCHWARZBECK	BBHA 9170	BBHA 9170517	Nov. 15, 2018	Nov. 14, 2019
Loop Antenna	R&S	HFH2-Z2	100330	Nov. 09, 2018	Nov. 08, 2019
Loop Antenna Cable	KOAX KABEL	101354-BW	101354-BW	Oct. 08, 2018	Oct. 07, 2019
Preamplifier	EMC	EMC02325	980187	Aug. 24, 2018	Aug. 23, 2019
Preamplifier	Agilent	83017A	MY53270014	Aug. 09, 2018	Aug. 08, 2019
Preamplifier	EMC	EMC184045B	980192	Aug. 09, 2018	Aug. 08, 2019
RF cable-3M	HUBER+SUHNER	SUCOFLEX104	MY22620/4	Oct. 01, 2018	Sep. 30, 2019
RF cable-8M	EMC	EMC104-SM-SM-80 00	181107	Oct. 01, 2018	Sep. 30, 2019
RF cable-1M	HUBER+SUHNER	SUCOFLEX104	MY22624/4	Oct. 01, 2018	Sep. 30, 2019
LF cable-0.8M	EMC	EMC8D-NM-NM-800	EMC8D-NM-NM-800 -001	Oct. 01, 2018	Sep. 30, 2019
LF cable-3M	EMC	EMC8D-NM-NM-300 0	131103	Oct. 01, 2018	Sep. 30, 2019
LF cable-13M	EMC	EMC8D-NM-NM-130 00	131104	Oct. 01, 2018	Sep. 30, 2019
Measurement Software	AUDIX	e3	6.120210g	NA	NA

Note: Calibration Interval of instruments listed above is one year.

Test Item	RF Conducted				
Test Site	(TH01-WS)				
Instrument	Manufacturer	Model No.	Serial No.	Calibration Date	Calibration Until
Spectrum Analyzer	R&S	FSV40	101063	Apr. 17, 2019	Apr. 16, 2020
TEMP&HUMIDITY CHAMBER	GIANT FORCE	GCT-225-40-SP-SD	MAF1212-002	Dec. 05, 2018	Dec. 04, 2019
Power Meter	Anritsu	ML2495A	1241002	Oct. 09, 2018	Oct. 08, 2019
Power Sensor	Anritsu	MA2411B	1207366	Oct. 09, 2018	Oct. 08, 2019
AC POWER SOURCE	APC	AFC-500W	F312060012	Nov. 29, 2018	Nov. 28, 2019
Measurement Software	SENSE-15407_NII	SENSE-15407_NII	V5.10	NA	NA
Note: Calibration Interval of instruments listed above is one year.					

1.5 Testing Applied Standards

According to the specification of EUT, the EUT must comply with following standards and KDB documents.

47 CFR FCC Part 15.407

ANSI C63.10-2013

FCC KDB 789033 D02 General UNII Test Procedures New Rules v02r01

FCC KDB 662911 D01 Multiple Transmitter Output v02r01

FCC KDB 412172 D01 Determining ERP and EIRP v01r01

1.6 Deviation from Test Standard and Measurement Procedure

None

1.7 Measurement Uncertainty

ISO/IEC 17025 requires that an estimate of the measurement uncertainties associated with the emissions test results be included in the report. The measurement uncertainties given below are based on a 95% confidence level (based on a coverage factor (k=2))

Measurement Uncertainty	
Parameters	Uncertainty
Bandwidth	±34.130 Hz
Conducted power	±0.808 dB
Frequency error	±1×10 ⁻⁹
Power density	±0.583 dB
Conducted emission	±2.715 dB
AC conducted emission	±2.92 dB
Radiated emission ≤ 1GHz	±3.96 dB
Radiated emission > 1GHz	±4.51 dB
Time	±0.1%
Temperature	±0.4 °C

2 Test Configuration

2.1 Testing Condition

Test Item	Test Site	Ambient Condition	Tested By
AC Conduction	CO01-WS	24°C / 65%	Alex Tsai
Radiated Emissions	03CH03-WS	24°C / 63-68%	Roger Lu
RF Conducted	TH01-WS	24°C / 66%	Aska Huang

- FCC Designation No.: TW0009
- FCC site registration No.: 207696
- ISED#: 10807A
- CAB identifier: TW2732

2.2 The Worst Test Modes and Channel Details

Non-beamforming mode

Frequency band 5150~5250 MHz / 5250~5350 MHz / 5470~5725 MHz				
Test item	Modulation Mode	Test Frequency (MHz)	Data Rate (Mbps) / MCS	Test Configuration
Conducted Emissions	VHT80	5690	MCS 0	---
Radiated Emissions \leq 1GHz	VHT80	5690	MCS 0	---
RF Output Power	11a	5180 / 5200 / 5240 / 5260 / 5300 5320 / 5500 / 5580 / 5700 / 5720	6 Mbps	---
Radiated Emissions >1GHz	VHT20	5180 / 5200 / 5240 / 5260 / 5300 5320 / 5500 / 5580 / 5700 / 5720	MCS 0	
Emission Bandwidth	VHT40	5190 / 5230 / 5270 / 5310 / 5510 5590 / 5670 / 5710	MCS 0	
Peak Power Spectral Density	VHT80	5210 / 5290 / 5530 / 5610 / 5690	MCS 0	
Frequency Stability	Un-modulation	5300	---	---
Frequency band 5725-5850 MHz				
Test item	Modulation Mode	Test Frequency (MHz)	Data Rate (Mbps) / MCS	Test Configuration
Conducted Emissions	VHT40	5755	MCS 0	---
Radiated Emissions \leq 1GHz	VHT40	5755	MCS 0	---
RF Output Power	11a	5745 / 5785 / 5825	6 Mbps	---
Radiated Emissions >1GHz	VHT20	5745 / 5785 / 5825	MCS 0	
Emission Bandwidth	VHT40	5755 / 5795	MCS 0	
6dB bandwidth	VHT80	5775	MCS 0	
Peak Power Spectral Density	VHT80	5775	MCS 0	---
Frequency Stability	Un-modulation	5785	---	---

NOTE: Two adapters (LITE-ON & NETBIT) had been covered during the pretest and found that **NETBIT** adapter was the worst case for radiated emission test and **LITE-ON** adapter was the worst case for conducted emission test.

Beamforming mode

Frequency band 5150~5250 MHz / 5250~5350 MHz / 5470~5725 MHz				
Test item	Modulation Mode	Test Frequency (MHz)	Data Rate (Mbps) / MCS	Test Configuration
Conducted Emissions	VHT20	5240	MCS 0	---
Radiated Emissions ≤1GHz	VHT20	5240	MCS 0	---
RF Output Power	VHT20	5180 / 5200 / 5240 / 5260 / 5300 5320 / 5500 / 5580 / 5700 / 5720	MCS 0	---
	VHT40	5190 / 5230 / 5270 / 5310 / 5510 5590 / 5670 / 5710	MCS 0	---
	VHT80	5210 / 5290 / 5530 / 5610 / 5690	MCS 0	---
Radiated Emissions >1GHz Emission Bandwidth Peak Power Spectral Density	VHT20	5180 / 5200 / 5240 / 5260 / 5300 5320 / 5500 / 5580 / 5700 / 5720	MCS 0	---
Frequency band 5725-5850 MHz				
Test item	Modulation Mode	Test Frequency (MHz)	Data Rate (Mbps) / MCS	Test Configuration
Conducted Emissions	VHT20	5785	MCS 0	---
Radiated Emissions ≤1GHz	VHT20	5785	MCS 0	---
RF Output Power	VHT20	5745 / 5785 / 5825	MCS 0	---
	VHT40	5755 / 5795	MCS 0	---
	VHT80	5775	MCS 0	---
Radiated Emissions >1GHz Emission Bandwidth 6dB bandwidth Peak Power Spectral Density	VHT20	5745 / 5785 / 5825	MCS 0	---
NOTE:				
1. Two adapters (LITE-ON & NETBIT) had been covered during the pretest and found that NETBIT adapter was the worst case for radiated emission test and LITE-ON adapter was the worst case for conducted emission test.				
2. VHT40 / 80 mode of beamforming mode is not tested for other items since the output power is lower 6.02 dB than VHT40 / 80 mode of non-beamforming mode.				

3 Transmitter Test Results

3.1 Conducted Emissions

3.1.1 Limit of Conducted Emissions

Conducted Emissions Limit		
Frequency Emission (MHz)	Quasi-Peak	Average
0.15-0.5	66 - 56 *	56 - 46 *
0.5-5	56	46
5-30	60	50

Note 1: * Decreases with the logarithm of the frequency.

3.1.2 Test Procedures

1. The device is placed on a test table, raised 80 cm above the reference ground plane. The vertical conducting plane is located 40 cm to the rear of the device.
2. The device is connected to line impedance stabilization network (LISN) and other accessories are connected to other LISN. Measured levels of AC power line conducted emission are across the 50 Ω LISN port.
3. AC conducted emission measurements is made over frequency range from 150 kHz to 30 MHz.
4. This measurement was performed with AC 120V/60Hz

3.1.3 Test Setup

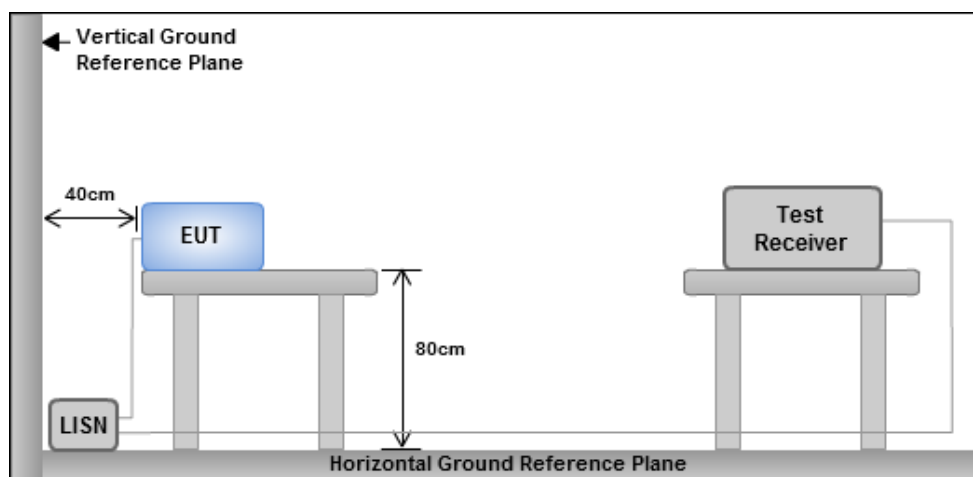

Note: 1. Support units were connected to second LISN.

2. Both of LISNs (AMN) are 80 cm from EUT and at least 80 cm from other units and other metal planes

3.1.4 Test Result of Conducted Emissions

Non-beamforming mode

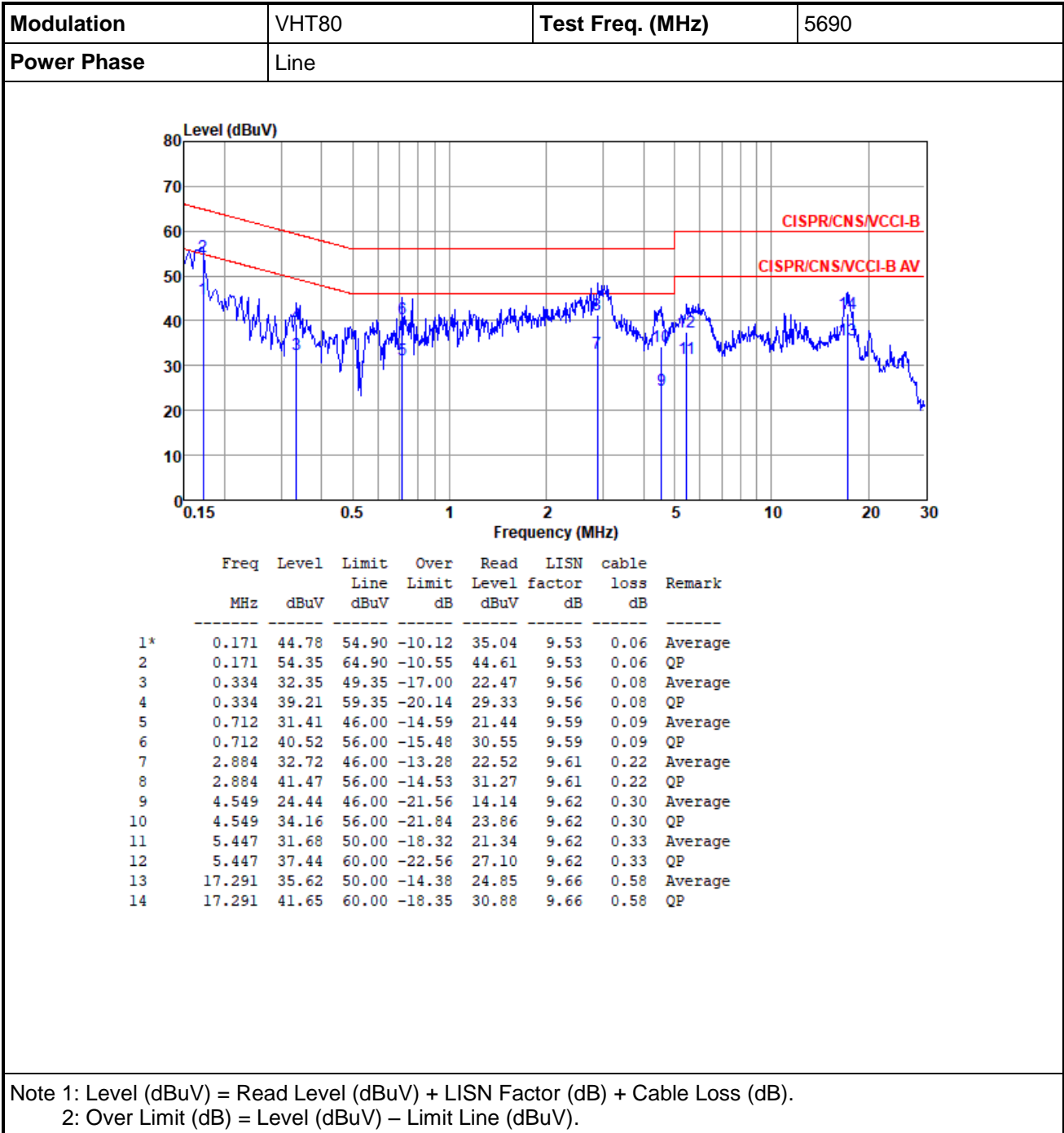

Modulation	VHT80	Test Freq. (MHz)	5690
Power Phase	Neutral		

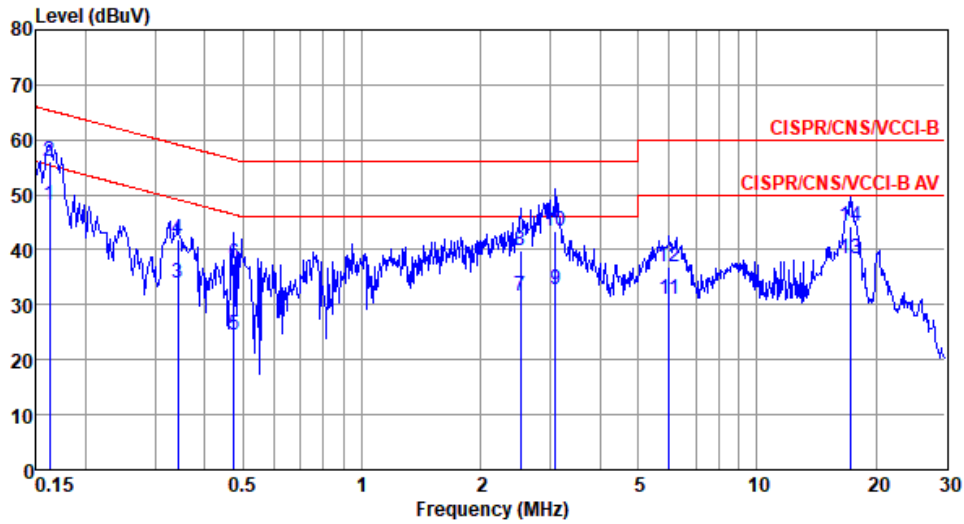

	Freq MHz	Level dBuV	Limit Line dBuV	Over Limit dB	Read Level dBuV	LISN factor dB	cable loss dB	Remark
1*	0.162	48.22	55.34	-7.12	38.47	9.57	0.06	Average
2	0.162	56.04	65.34	-9.30	46.29	9.57	0.06	QP
3	0.343	34.07	49.13	-15.06	24.27	9.60	0.08	Average
4	0.343	41.91	59.13	-17.22	32.11	9.60	0.08	QP
5	0.474	24.47	46.45	-21.98	14.63	9.62	0.08	Average
6	0.474	37.42	56.45	-19.03	27.58	9.62	0.08	QP
7	2.527	31.59	46.00	-14.41	21.49	9.65	0.20	Average
8	2.527	39.77	56.00	-16.23	29.67	9.65	0.20	QP
9	3.090	32.75	46.00	-13.25	22.59	9.66	0.24	Average
10	3.090	43.35	56.00	-12.65	33.19	9.66	0.24	QP
11	5.993	30.89	50.00	-19.11	20.58	9.68	0.35	Average
12	5.993	36.89	60.00	-23.11	26.58	9.68	0.35	QP
13	17.199	38.24	50.00	-11.76	27.48	9.79	0.58	Average
14	17.199	44.34	60.00	-15.66	33.58	9.79	0.58	QP

Note 1: Level (dBuV) = Read Level (dBuV) + LISN Factor (dB) + Cable Loss (dB).
 2: Over Limit (dB) = Level (dBuV) – Limit Line (dBuV).

Modulation	VHT40	Test Freq. (MHz)	5755
Power Phase	Line		

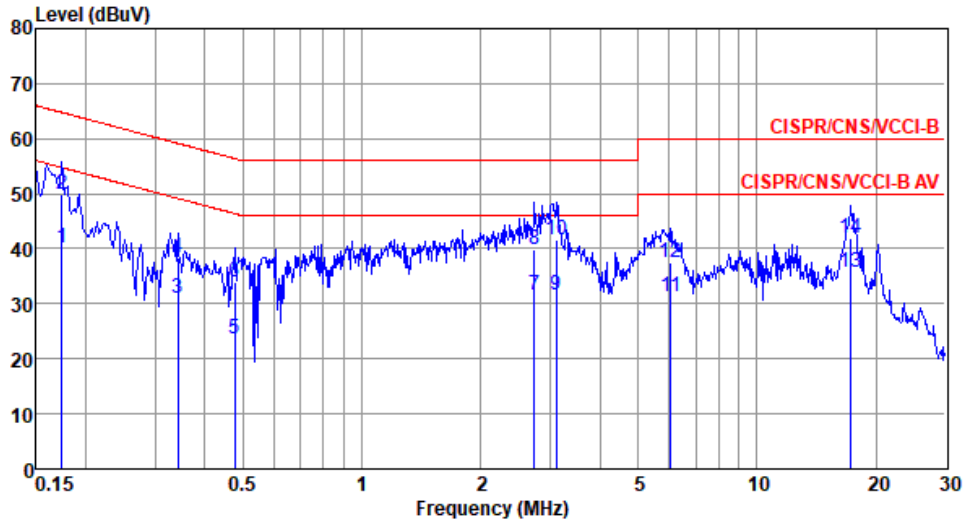

	Freq MHz	Level dBuV	Limit Line dBuV	Over Limit dB	Read Level dBuV	LISN factor dB	cable loss dB	Remark
1	0.174	40.09	54.77	-14.68	30.33	9.54	0.06	Average
2	0.174	50.00	64.77	-14.77	40.24	9.54	0.06	QP
3	0.343	31.10	49.13	-18.03	21.22	9.56	0.08	Average
4	0.343	38.46	59.13	-20.67	28.58	9.56	0.08	QP
5	0.476	23.73	46.41	-22.68	13.80	9.58	0.08	Average
6	0.476	34.07	56.41	-22.34	24.14	9.58	0.08	QP
7	2.736	31.52	46.00	-14.48	21.34	9.60	0.21	Average
8	2.736	39.89	56.00	-16.11	29.71	9.60	0.21	QP
9	3.107	31.60	46.00	-14.40	21.38	9.61	0.24	Average
10	3.107	41.59	56.00	-14.41	31.37	9.61	0.24	QP
11	6.056	31.30	50.00	-18.70	20.93	9.63	0.35	Average
12	6.056	37.45	60.00	-22.55	27.08	9.63	0.35	QP
13*	17.291	35.73	50.00	-14.27	24.96	9.66	0.58	Average
14	17.291	41.90	60.00	-18.10	31.13	9.66	0.58	QP

Note 1: Level (dBuV) = Read Level (dBuV) + LISN Factor (dB) + Cable Loss (dB).
 2: Over Limit (dB) = Level (dBuV) – Limit Line (dBuV).

Modulation	VHT40	Test Freq. (MHz)	5755
Power Phase	Neutral		

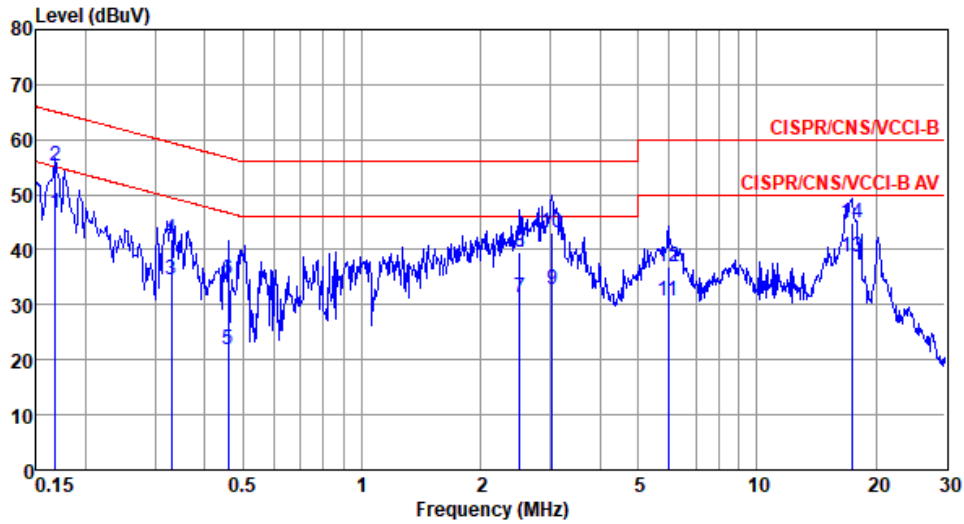

	Freq MHz	Level dBuV	Limit Line dBuV	Over Limit dB	Read Level dBuV	LISN factor dB	cable loss dB	Remark
1*	0.168	46.62	55.08	-8.46	36.87	9.57	0.06	Average
2	0.168	55.08	65.08	-10.00	45.33	9.57	0.06	QP
3	0.330	34.41	49.44	-15.03	24.60	9.60	0.08	Average
4	0.330	41.85	59.44	-17.59	32.04	9.60	0.08	QP
5	0.459	21.83	46.71	-24.88	12.00	9.61	0.08	Average
6	0.459	34.46	56.71	-22.25	24.63	9.61	0.08	QP
7	2.513	31.41	46.00	-14.59	21.31	9.65	0.20	Average
8	2.513	39.68	56.00	-16.32	29.58	9.65	0.20	QP
9	3.025	32.90	46.00	-13.10	22.75	9.66	0.23	Average
10	3.025	43.08	56.00	-12.92	32.93	9.66	0.23	QP
11	5.961	30.58	50.00	-19.42	20.27	9.68	0.35	Average
12	5.961	36.95	60.00	-23.05	26.64	9.68	0.35	QP
13	17.383	38.76	50.00	-11.24	27.99	9.79	0.58	Average
14	17.383	44.94	60.00	-15.06	34.17	9.79	0.58	QP

Note 1: Level (dBuV) = Read Level (dBuV) + LISN Factor (dB) + Cable Loss (dB).
 2: Over Limit (dB) = Level (dBuV) – Limit Line (dBuV).

Beamforming mode

Modulation	VHT20	Test Freq. (MHz)	5240
Power Phase	Line		

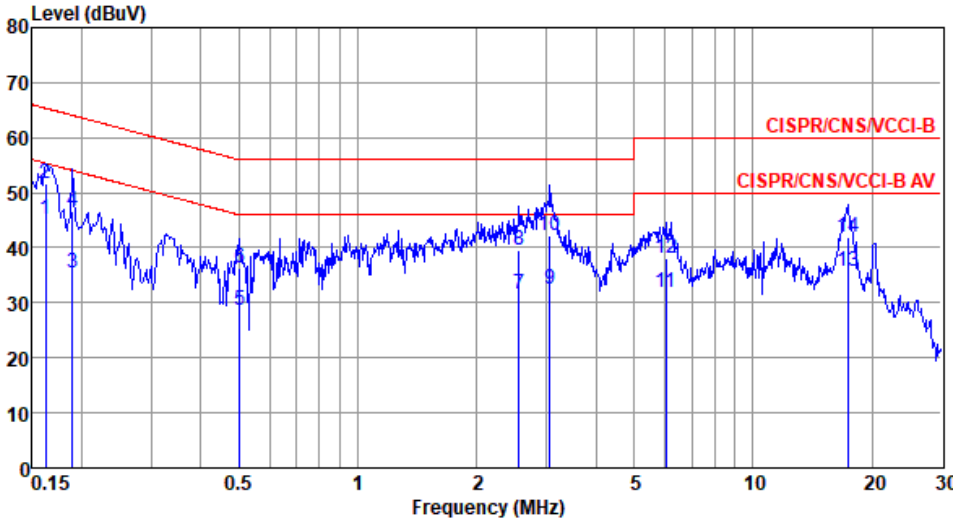

The plot shows a blue signal line fluctuating between approximately 30 and 50 dBuV across a frequency range from 0.15 MHz to 30 MHz. Two red limit lines are shown: 'CISPR/CNS/VCCI-B' (upper) and 'CISPR/CNS/VCCI-B AV' (lower). The signal generally stays below the AV limit but has several peaks that exceed it, particularly at 0.162 MHz, 0.189 MHz, 0.502 MHz, 2.554 MHz, 3.058 MHz, 6.024 MHz, and 17.383 MHz. Vertical blue lines mark these specific frequency points.

	Freq MHz	Level dBuV	Limit Line dBuV	Over Limit dB	Read Level dBuV	LISN factor dB	cable loss dB	Remark
1*	0.162	45.05	55.34	-10.29	35.32	9.53	0.06	Average
2	0.162	51.53	65.34	-13.81	41.80	9.53	0.06	QP
3	0.189	35.42	54.06	-18.64	25.63	9.54	0.07	Average
4	0.189	46.74	64.06	-17.32	36.95	9.54	0.07	QP
5	0.502	28.71	46.00	-17.29	18.78	9.58	0.08	Average
6	0.502	36.44	56.00	-19.56	26.51	9.58	0.08	QP
7	2.554	31.58	46.00	-14.42	21.41	9.60	0.20	Average
8	2.554	39.46	56.00	-16.54	29.29	9.60	0.20	QP
9	3.058	32.51	46.00	-13.49	22.30	9.61	0.23	Average
10	3.058	42.24	56.00	-13.76	32.03	9.61	0.23	QP
11	6.024	31.91	50.00	-18.09	21.54	9.63	0.35	Average
12	6.024	37.97	60.00	-22.03	27.60	9.63	0.35	QP
13	17.383	35.74	50.00	-14.26	24.96	9.66	0.58	Average
14	17.383	41.94	60.00	-18.06	31.16	9.66	0.58	QP

Note 1: Level (dBuV) = Read Level (dBuV) + LISN Factor (dB) + Cable Loss (dB).
 Note 2: Over Limit (dB) = Level (dBuV) – Limit Line (dBuV).

Modulation	VHT20	Test Freq. (MHz)	5240
Power Phase	Neutral		

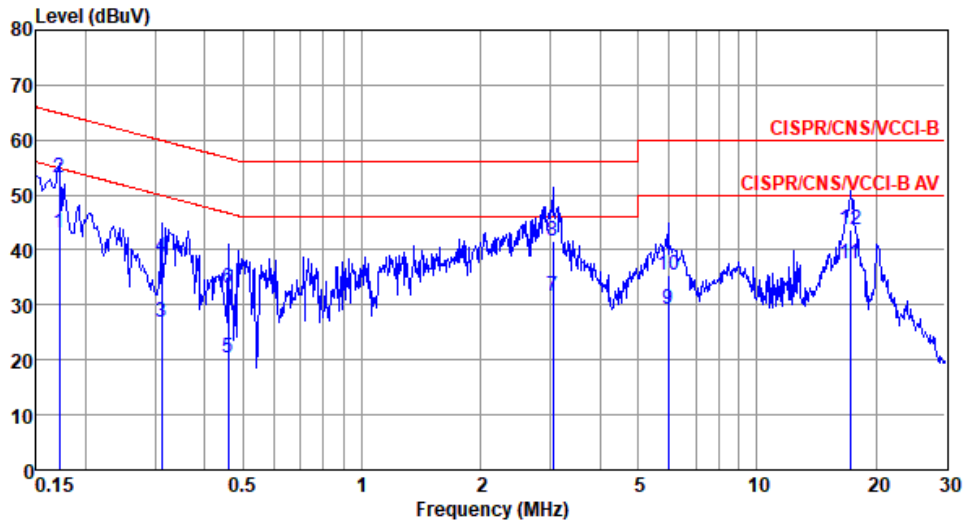

	Freq	Level	Limit	Over	Read	LISN	cable	Remark
	MHz	dBuV	Line	Limit	Level	factor	loss	
			dBuV	dB	dBuV	dB	dB	
1*	0.171	43.23	54.90	-11.67	33.48	9.57	0.06	Average
2	0.171	53.21	64.90	-11.69	43.46	9.57	0.06	QP
3	0.312	26.96	49.93	-22.97	17.15	9.60	0.08	Average
4	0.312	38.73	59.93	-21.20	28.92	9.60	0.08	QP
5	0.459	20.27	46.71	-26.44	10.44	9.61	0.08	Average
6	0.459	33.18	56.71	-23.53	23.35	9.61	0.08	QP
7	3.041	31.61	46.00	-14.39	21.46	9.66	0.23	Average
8	3.041	41.48	56.00	-14.52	31.33	9.66	0.23	QP
9	5.961	29.12	50.00	-20.88	18.81	9.68	0.35	Average
10	5.961	35.29	60.00	-24.71	24.98	9.68	0.35	QP
11	17.199	37.50	50.00	-12.50	26.74	9.79	0.58	Average
12	17.199	43.59	60.00	-16.41	32.83	9.79	0.58	QP

Note 1: Level (dBuV) = Read Level (dBuV) + LISN Factor (dB) + Cable Loss (dB).
 2: Over Limit (dB) = Level (dBuV) – Limit Line (dBuV).

Modulation	VHT20	Test Freq. (MHz)	5785
Power Phase	Line		

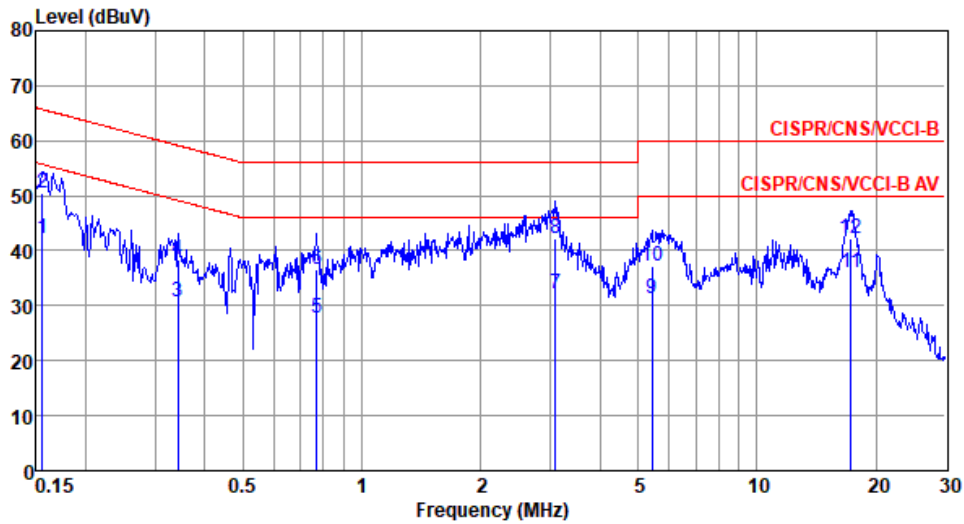

	Freq	Level	Limit	Over	Read	LISN	cable	Remark
	MHz	dBuV	Line	Limit	Level	factor	loss	
			dBuV	dB	dBuV	dB	dB	
1*	0.156	42.33	55.69	-13.36	32.62	9.53	0.05	Average
2	0.156	50.60	65.69	-15.09	40.89	9.53	0.05	QP
3	0.343	30.79	49.13	-18.34	20.91	9.56	0.08	Average
4	0.343	38.45	59.13	-20.68	28.57	9.56	0.08	QP
5	0.767	27.70	46.00	-18.30	17.73	9.59	0.09	Average
6	0.767	36.72	56.00	-19.28	26.75	9.59	0.09	QP
7	3.090	32.04	46.00	-13.96	21.82	9.61	0.24	Average
8	3.090	42.34	56.00	-13.66	32.12	9.61	0.24	QP
9	5.419	31.33	50.00	-18.67	20.99	9.62	0.33	Average
10	5.419	37.32	60.00	-22.68	26.98	9.62	0.33	QP
11	17.291	36.05	50.00	-13.95	25.28	9.66	0.58	Average
12	17.291	42.24	60.00	-17.76	31.47	9.66	0.58	QP

Note 1: Level (dBuV) = Read Level (dBuV) + LISN Factor (dB) + Cable Loss (dB).
 Note 2: Over Limit (dB) = Level (dBuV) – Limit Line (dBuV).

Modulation	VHT20	Test Freq. (MHz)	5785
Power Phase	Neutral		

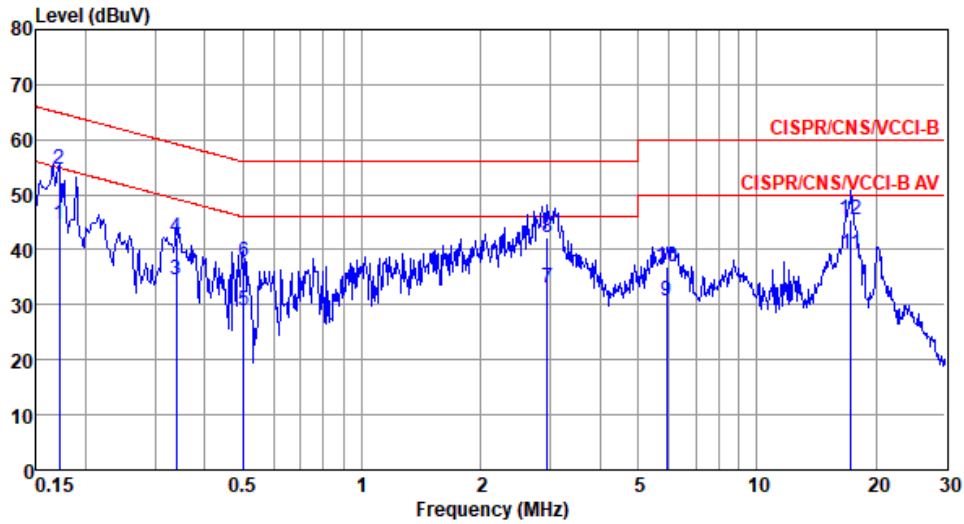

	Freq MHz	Level dBuV	Limit Line dBuV	Over Limit dB	Read Level dBuV	LISN factor dB	cable loss dB	Remark
1*	0.171	44.59	54.90	-10.31	34.84	9.57	0.06	Average
2	0.171	54.48	64.90	-10.42	44.73	9.57	0.06	QP
3	0.339	34.63	49.22	-14.59	24.83	9.60	0.08	Average
4	0.339	42.21	59.22	-17.01	32.41	9.60	0.08	QP
5	0.502	28.99	46.00	-17.01	19.14	9.62	0.08	Average
6	0.502	37.90	56.00	-18.10	28.05	9.62	0.08	QP
7	2.946	33.07	46.00	-12.93	22.92	9.66	0.23	Average
8	2.946	42.25	56.00	-13.75	32.10	9.66	0.23	QP
9	5.898	30.81	50.00	-19.19	20.50	9.68	0.35	Average
10	5.898	36.96	60.00	-23.04	26.65	9.68	0.35	QP
11	17.291	39.16	50.00	-10.84	28.40	9.79	0.58	Average
12	17.291	45.45	60.00	-14.55	34.69	9.79	0.58	QP

Note 1: Level (dBuV) = Read Level (dBuV) + LISN Factor (dB) + Cable Loss (dB).
 Note 2: Over Limit (dB) = Level (dBuV) – Limit Line (dBuV).

3.2 Emission Bandwidth

3.2.1 Limit of Emission Bandwidth

Within the 5.725-5.85 GHz band, the minimum 6 dB bandwidth of U-NII devices shall be at least 500 kHz.

3.2.2 Test Procedures

26dB Bandwidth

1. Set RBW = approximately 1% of the emission bandwidth.
2. Set the VBW > RBW, Detector = Peak.
3. Trace mode = max hold.
4. Measure the maximum width of the emission that is 26 dB down from the peak of the emission.

Occupied Bandwidth

1. Set RBW = 1 % to 5 % of the OBW.
2. Set VBW \geq 3 RBW.
3. Sample detection and single sweep mode shall be used.
4. Use the 99 % power bandwidth function of the instrument.

6dB Bandwidth

1. Set RBW = 100kHz, VBW = 300kHz.
2. Detector = Peak, Trace mode = max hold.
3. Allow the trace to stabilize.
4. Measure the maximum width of the emission that is constrained by the frequencies associated with the two outermost amplitude points (upper and lower frequencies) that are attenuated by 6 dB relative to the maximum level measured in the fundamental emission.

3.2.3 Test Setup

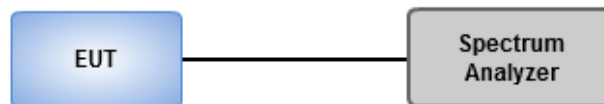

3.2.4 Test Result of Emission Bandwidth

Non-beamforming mode

Summary

Mode	Max-N dB (Hz)	Max-OBW (Hz)	ITU-Code	Min-N dB (Hz)	Min-OBW (Hz)
5.15-5.25GHz	-	-	-	-	-
802.11a_Nss1,(6Mbps)_4TX	21.594M	16.715M	16M7D1D	21.159M	16.57M
802.11ac VHT20_Nss1,(MCS0)_4TX	22.101M	17.873M	17M9D1D	21.377M	17.8M
802.11ac VHT40_Nss1,(MCS0)_4TX	40.29M	36.469M	36M5D1D	39.565M	36.179M
802.11ac VHT80_Nss1,(MCS0)_4TX	81.449M	74.964M	75M0D1D	80.58M	74.964M
5.25-5.35GHz	-	-	-	-	-
802.11a_Nss1,(6Mbps)_4TX	21.667M	16.787M	16M8D1D	21.159M	16.643M
802.11ac VHT20_Nss1,(MCS0)_4TX	21.812M	17.873M	17M9D1D	21.304M	17.8M
802.11ac VHT40_Nss1,(MCS0)_4TX	40.29M	36.469M	36M5D1D	39.565M	36.324M
802.11ac VHT80_Nss1,(MCS0)_4TX	82.029M	75.832M	75M8D1D	81.159M	75.543M
5.47-5.725GHz	-	-	-	-	-
802.11a_Nss1,(6Mbps)_4TX	21.594M	16.787M	16M8D1D	15.435M	13.329M
802.11ac VHT20_Nss1,(MCS0)_4TX	21.812M	17.873M	17M9D1D	15.609M	13.936M
802.11ac VHT40_Nss1,(MCS0)_4TX	43.043M	36.469M	36M5D1D	34.696M	33.025M
802.11ac VHT80_Nss1,(MCS0)_4TX	82.029M	75.832M	75M8D1D	75.217M	72.504M
5.725-5.85GHz	-	-	-	-	-
802.11a_Nss1,(6Mbps)_4TX	16.377M	17.438M	17M4D1D	3.13M	3.936M
802.11ac VHT20_Nss1,(MCS0)_4TX	17.609M	18.452M	18M5D1D	3.768M	4.284M
802.11ac VHT40_Nss1,(MCS0)_4TX	36.522M	41.245M	41M2D1D	3.13M	3.589M
802.11ac VHT80_Nss1,(MCS0)_4TX	76.522M	75.832M	75M8D1D	3.072M	3.821M

Max-N dB = Maximum 6dB down bandwidth for 5.725-5.85GHz band / Maximum 26dB down bandwidth for other band;

Max-OBW = Maximum 99% occupied bandwidth;

Min-N dB = Minimum 6dB down bandwidth for 5.725-5.85GHz band / Maximum 26dB down bandwidth for other band;

Min-OBW = Minimum 99% occupied bandwidth;

Result

Mode	Result	Limit (Hz)	Port 1-N dB (Hz)	Port 1-OBW (Hz)	Port 2-N dB (Hz)	Port 2-OBW (Hz)	Port 3-N dB (Hz)	Port 3-OBW (Hz)	Port 4-N dB (Hz)	Port 4-OBW (Hz)
802.11a_Nss1,(6Mbps)_4TX	-	-	-	-	-	-	-	-	-	-
5180MHz	Pass	Inf	21.449M	16.715M	21.377M	16.715M	21.159M	16.57M	21.304M	16.643M
5200MHz	Pass	Inf	21.594M	16.715M	21.304M	16.715M	21.304M	16.715M	21.304M	16.715M
5240MHz	Pass	Inf	21.377M	16.715M	21.304M	16.643M	21.377M	16.715M	21.232M	16.643M
5260MHz	Pass	Inf	21.667M	16.787M	21.667M	16.715M	21.377M	16.643M	21.232M	16.715M
5300MHz	Pass	Inf	21.377M	16.715M	21.377M	16.715M	21.159M	16.643M	21.159M	16.715M
5320MHz	Pass	Inf	21.522M	16.643M	21.522M	16.643M	21.377M	16.643M	21.232M	16.643M
5500MHz	Pass	Inf	21.449M	16.643M	21.232M	16.715M	21.377M	16.643M	21.304M	16.643M
5580MHz	Pass	Inf	21.377M	16.787M	21.304M	16.715M	21.304M	16.715M	21.304M	16.643M
5700MHz	Pass	Inf	21.594M	16.787M	21.304M	16.715M	21.159M	16.715M	21.377M	16.643M
5720MHz Straddle 5.47-5.725GHz	Pass	Inf	15.565M	13.372M	15.522M	13.415M	15.478M	13.329M	15.435M	13.372M
5720MHz Straddle 5.725-5.85GHz	Pass	500k	3.188M	4.11M	3.13M	4.168M	3.13M	4.11M	3.188M	3.936M
5745MHz	Pass	500k	16.304M	17.366M	16.304M	17.149M	16.304M	16.932M	16.304M	17.004M
5785MHz	Pass	500k	16.304M	17.438M	16.304M	17.221M	16.304M	17.004M	16.377M	16.932M
5825MHz	Pass	500k	16.377M	17.149M	16.304M	17.221M	16.377M	17.077M	16.304M	16.86M
802.11ac VHT20_Nss1,(MCS0)_4TX	-	-	-	-	-	-	-	-	-	-
5180MHz	Pass	Inf	22.101M	17.873M	21.377M	17.8M	21.667M	17.873M	21.377M	17.873M
5200MHz	Pass	Inf	21.884M	17.873M	21.667M	17.873M	21.449M	17.873M	21.594M	17.8M
5240MHz	Pass	Inf	21.594M	17.873M	21.667M	17.873M	21.594M	17.8M	21.667M	17.8M
5260MHz	Pass	Inf	21.667M	17.873M	21.449M	17.8M	21.449M	17.8M	21.449M	17.8M
5300MHz	Pass	Inf	21.594M	17.873M	21.377M	17.8M	21.667M	17.8M	21.522M	17.873M
5320MHz	Pass	Inf	21.812M	17.873M	21.304M	17.8M	21.377M	17.8M	21.812M	17.8M
5500MHz	Pass	Inf	21.667M	17.873M	21.449M	17.8M	21.377M	17.873M	21.594M	17.8M
5580MHz	Pass	Inf	21.739M	17.873M	21.304M	17.8M	21.377M	17.8M	21.377M	17.728M
5700MHz	Pass	Inf	21.812M	17.873M	21.594M	17.873M	21.304M	17.873M	21.522M	17.873M
5720MHz Straddle 5.47-5.725GHz	Pass	Inf	15.783M	13.936M	15.609M	13.98M	15.652M	13.936M	15.652M	13.98M
5720MHz Straddle 5.725-5.85GHz	Pass	500k	3.826M	4.284M	3.826M	4.342M	3.768M	4.342M	3.768M	4.342M
5745MHz	Pass	500k	17.609M	18.452M	17.609M	18.379M	17.609M	18.09M	17.609M	18.162M
5785MHz	Pass	500k	17.609M	18.452M	17.609M	18.234M	17.609M	18.234M	17.609M	18.017M
5825MHz	Pass	500k	17.609M	18.379M	17.609M	18.234M	17.609M	18.162M	17.609M	18.017M
802.11ac VHT40_Nss1,(MCS0)_4TX	-	-	-	-	-	-	-	-	-	-
5190MHz	Pass	Inf	39.855M	36.469M	39.565M	36.324M	39.71M	36.324M	39.855M	36.179M
5230MHz	Pass	Inf	40.29M	36.179M	39.855M	36.179M	39.855M	36.324M	39.565M	36.324M
5270MHz	Pass	Inf	40.29M	36.469M	39.565M	36.324M	39.565M	36.469M	39.565M	36.324M
5310MHz	Pass	Inf	39.855M	36.324M	39.855M	36.324M	39.71M	36.324M	39.71M	36.324M
5510MHz	Pass	Inf	40.435M	36.469M	39.855M	36.469M	39.71M	36.469M	39.565M	36.324M
5590MHz	Pass	Inf	43.043M	36.469M	39.565M	36.179M	39.71M	36.324M	39.855M	36.324M
5670MHz	Pass	Inf	40.145M	36.324M	39.42M	36.324M	39.855M	36.324M	39.71M	36.324M
5710MHz Straddle 5.47-5.725GHz	Pass	Inf	35.203M	33.126M	34.696M	33.126M	34.797M	33.025M	34.797M	33.025M

Mode	Result	Limit (Hz)	Port 1-N dB (Hz)	Port 1-OBW (Hz)	Port 2-N dB (Hz)	Port 2-OBW (Hz)	Port 3-N dB (Hz)	Port 3-OBW (Hz)	Port 4-N dB (Hz)	Port 4-OBW (Hz)
5710MHz Straddle 5.725-5.85GHz	Pass	500k	3.13M	3.647M	3.13M	3.589M	3.13M	3.647M	3.13M	3.589M
5755MHz	Pass	500k	36.232M	41.245M	36.522M	39.942M	36.377M	37.192M	36.232M	37.192M
5795MHz	Pass	500k	36.232M	39.653M	36.377M	39.074M	36.377M	37.337M	36.232M	37.048M
802.11ac VHT80_Nss1,(MCS0)_4TX	-	-	-	-	-	-	-	-	-	-
5210MHz	Pass	Inf	81.449M	74.964M	81.159M	74.964M	80.58M	74.964M	80.58M	74.964M
5290MHz	Pass	Inf	82.029M	75.543M	81.449M	75.543M	81.159M	75.832M	81.739M	75.832M
5530MHz	Pass	Inf	82.029M	75.832M	81.449M	75.832M	81.739M	75.832M	81.449M	75.832M
5610MHz	Pass	Inf	81.739M	75.543M	81.739M	75.832M	81.449M	75.832M	81.159M	75.832M
5690MHz Straddle 5.47-5.725GHz	Pass	Inf	75.87M	72.504M	75.435M	72.504M	75.435M	72.504M	75.217M	72.504M
5690MHz Straddle 5.725-5.85GHz	Pass	500k	3.072M	4.284M	3.13M	3.878M	3.13M	3.821M	3.13M	3.878M
5775MHz	Pass	500k	75.652M	75.832M	76.522M	75.832M	75.942M	75.832M	76.232M	75.832M

Port X-N dB = Port X 6dB down bandwidth for 5.725-5.85GHz band / 26dB down bandwidth for other band

Port X-OBW = Port X 99% occupied bandwidth;

802.11a_Nss1,(6Mbps)_4TX

EBW

5180MHz

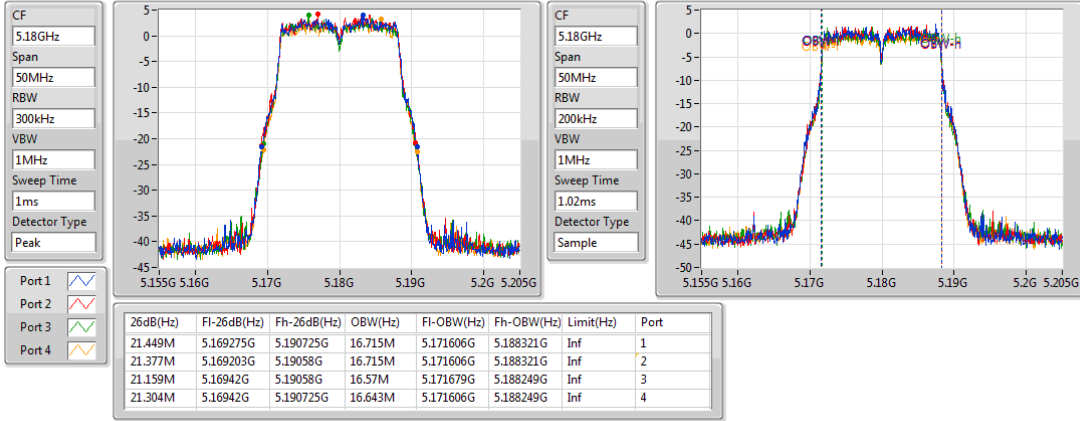

802.11a_Nss1,(6Mbps)_4TX

EBW

5200MHz

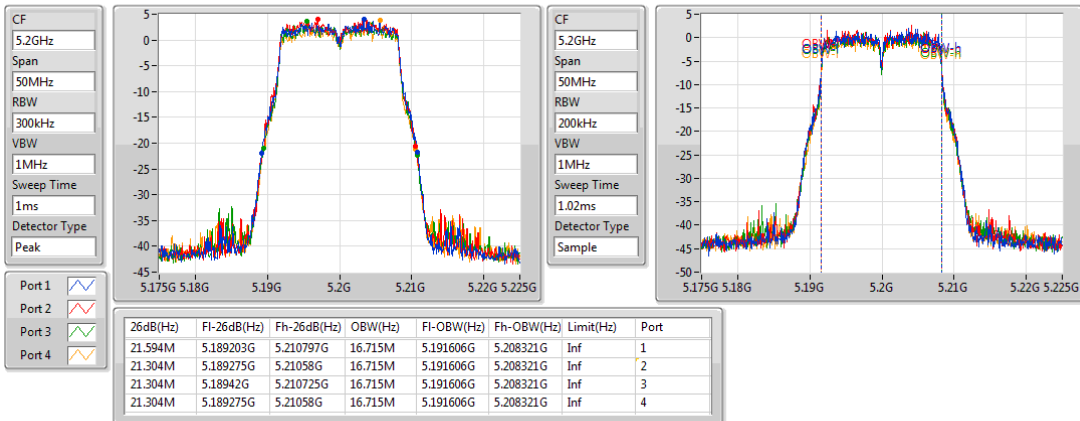

802.11a_Nss1,(6Mbps)_4TX

EBW

5240MHz

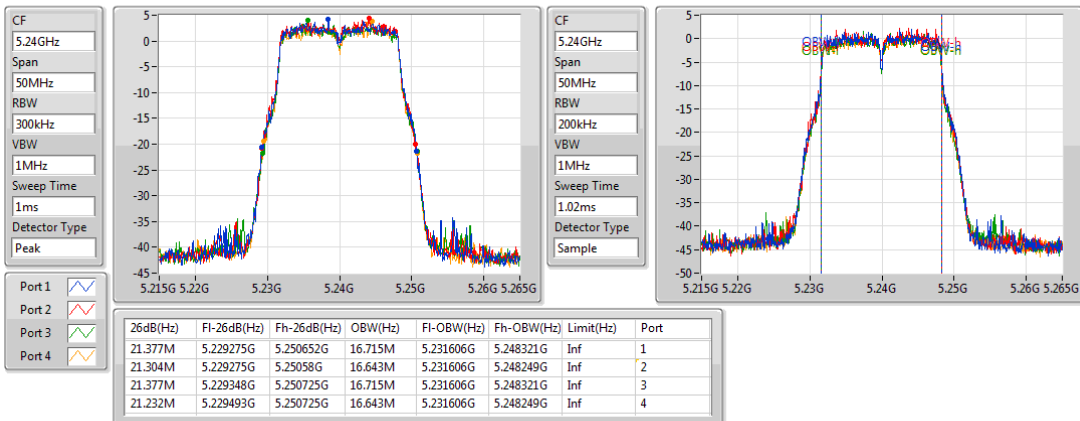

802.11a_Nss1,(6Mbps)_4TX

EBW

5260MHz

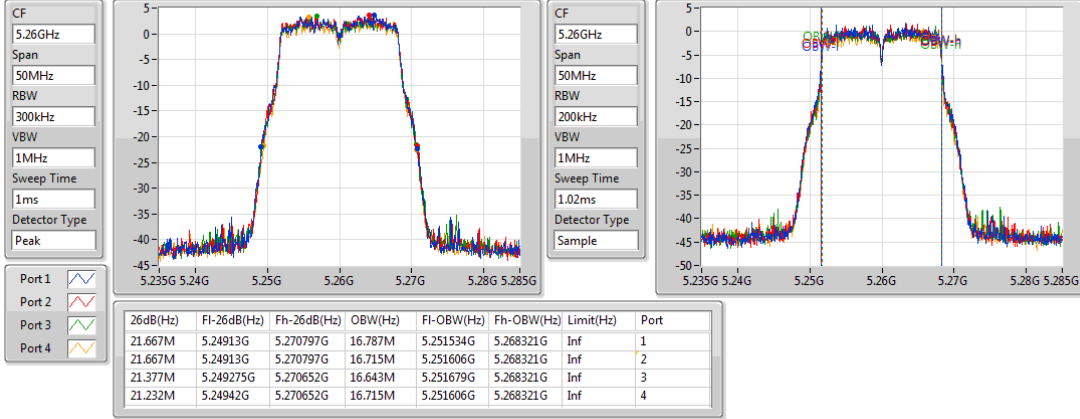

802.11a_Nss1,(6Mbps)_4TX

EBW

5300MHz

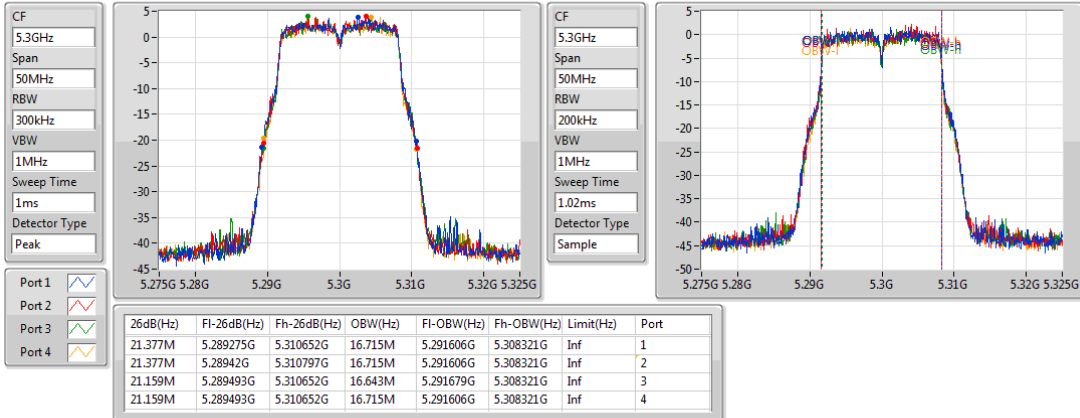

802.11a_Nss1,(6Mbps)_4TX

EBW

5320MHz

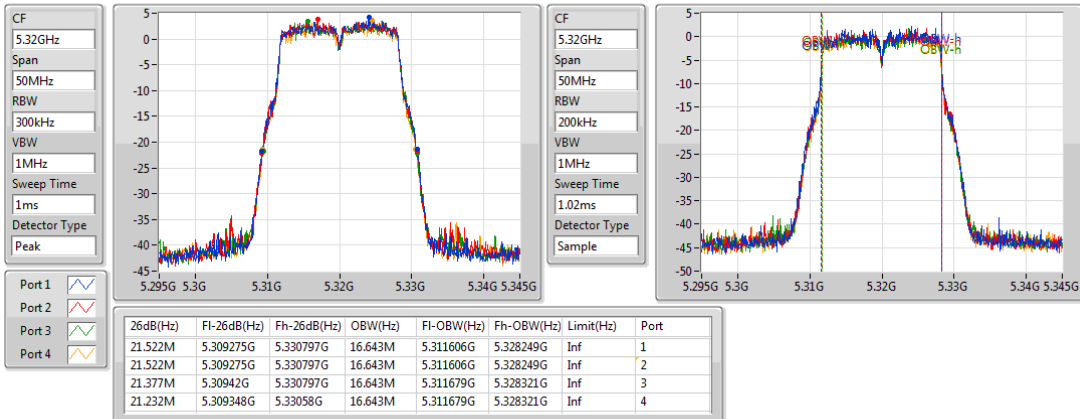

802.11a_Nss1,(6Mbps)_4TX

EBW

5500MHz

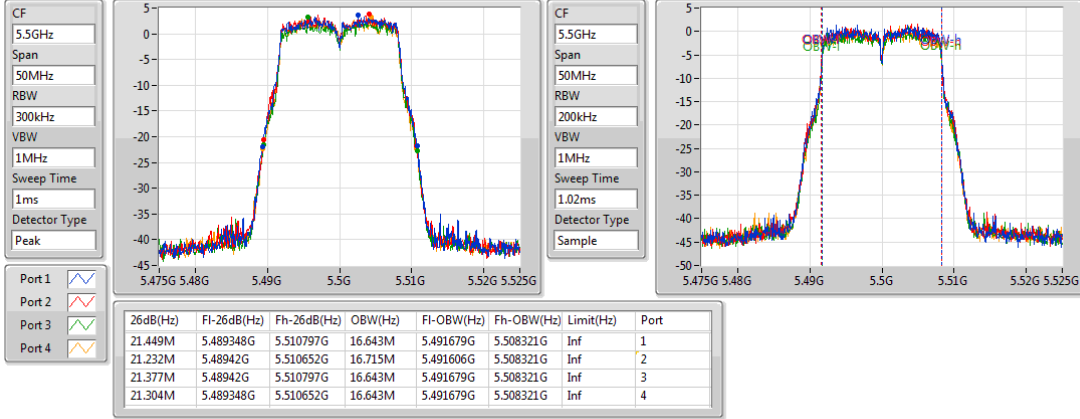

802.11a_Nss1,(6Mbps)_4TX

EBW

5580MHz

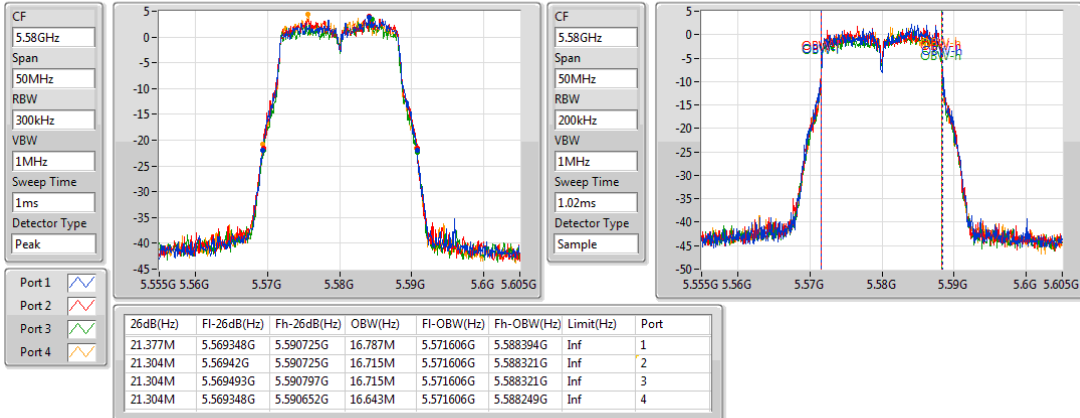

802.11a_Nss1,(6Mbps)_4TX

EBW

5700MHz

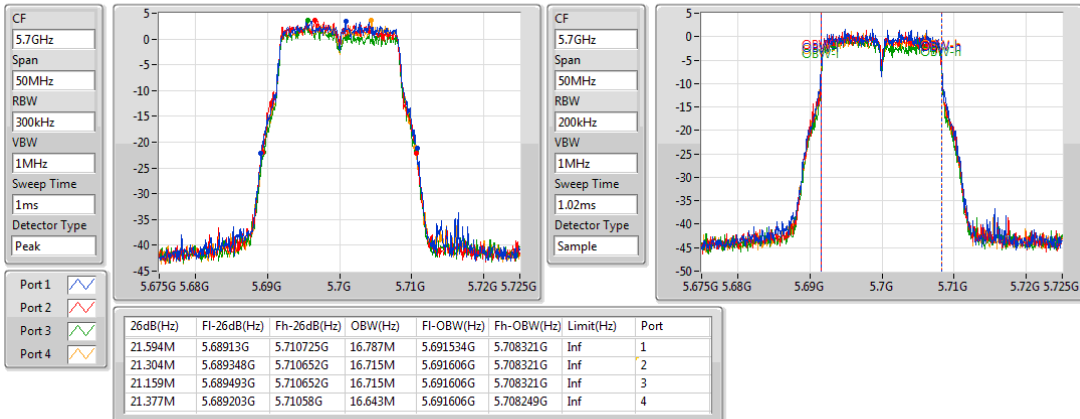

802.11a_Nss1,(6Mbps)_4TX

EBW

5720MHz Straddle 5.47-5.725GHz

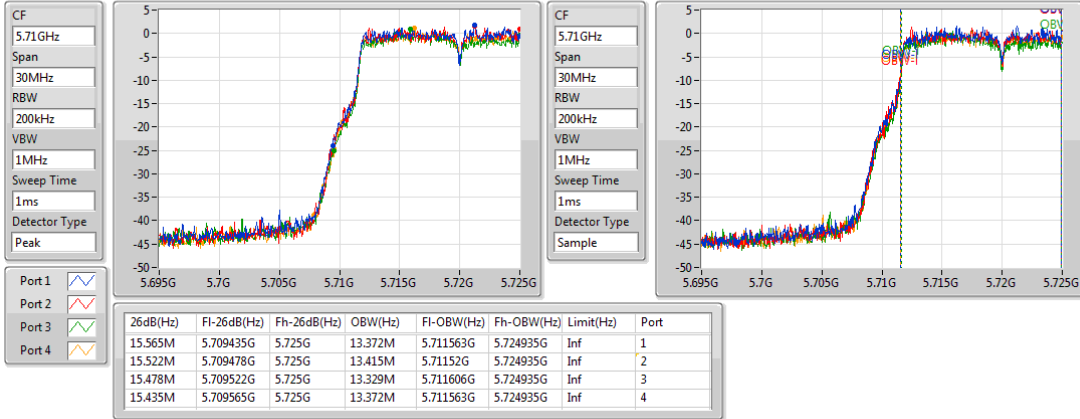

802.11a_Nss1,(6Mbps)_4TX

EBW

5720MHz Straddle 5.725-5.85GHz

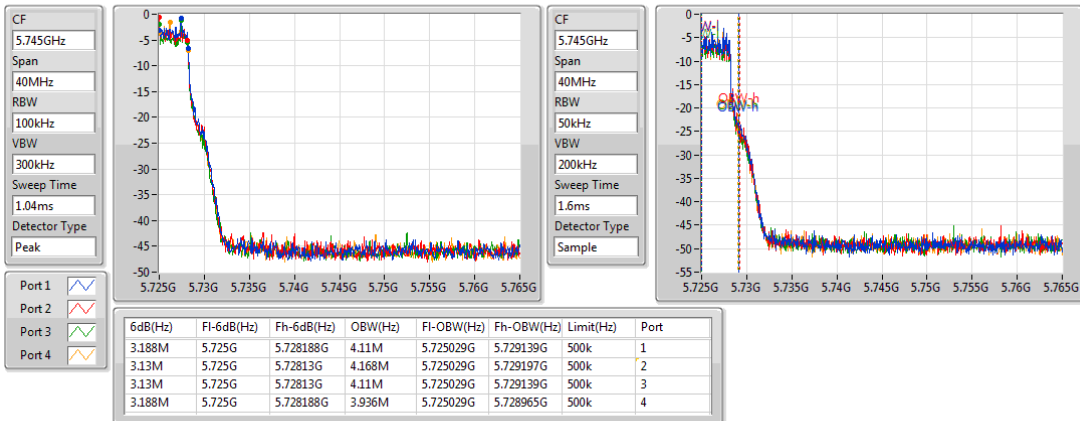

802.11a_Nss1,(6Mbps)_4TX

EBW

5745MHz

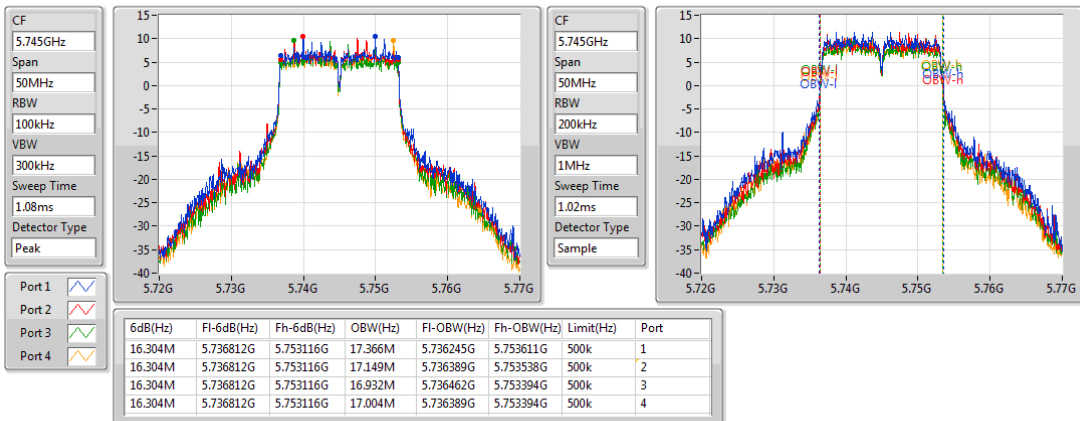

802.11a_Nss1,(6Mbps)_4TX

EBW

5785MHz

CF
5.785GHz
Span
50MHz
RBW
100kHz
VBW
300kHz
Sweep Time
1.08ms
Detector Type
Peak

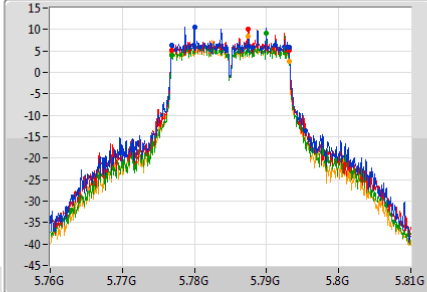

CF
5.785GHz
Span
50MHz
RBW
200kHz
VBW
1MHz
Sweep Time
1.02ms
Detector Type
Sample

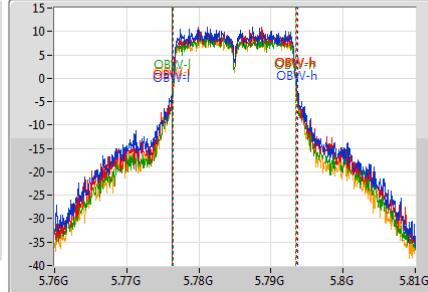

6dB(Hz)	Fl-6dB(Hz)	Fh-6dB(Hz)	OBW(Hz)	Fl-OBW(Hz)	Fh-OBW(Hz)	Limit(Hz)	Port
16.304M	5.776812G	5.793116G	17.438M	5.776245G	5.793683G	500k	1
16.304M	5.776812G	5.793116G	17.221M	5.776317G	5.793538G	500k	2
16.304M	5.776812G	5.793116G	17.004M	5.776462G	5.793466G	500k	3
16.377M	5.776812G	5.793188G	16.932M	5.776462G	5.793394G	500k	4

802.11a_Nss1,(6Mbps)_4TX

EBW

5825MHz

CF
5.825GHz
Span
50MHz
RBW
100kHz
VBW
300kHz
Sweep Time
1.08ms
Detector Type
Peak

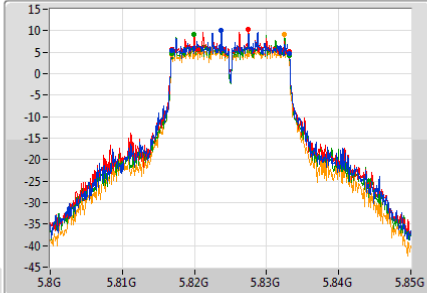

CF
5.825GHz
Span
50MHz
RBW
200kHz
VBW
1MHz
Sweep Time
1.02ms
Detector Type
Sample

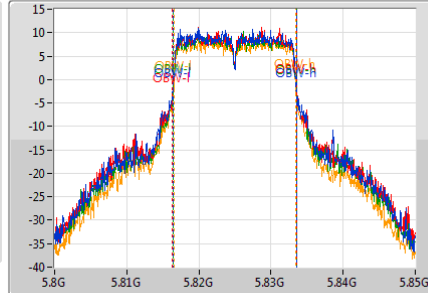

6dB(Hz)	Fl-6dB(Hz)	Fh-6dB(Hz)	OBW(Hz)	Fl-OBW(Hz)	Fh-OBW(Hz)	Limit(Hz)	Port
16.377M	5.816812G	5.833188G	17.149M	5.816389G	5.833538G	500k	1
16.304M	5.816812G	5.833116G	17.221M	5.816317G	5.833538G	500k	2
16.377M	5.816812G	5.833188G	17.077M	5.816462G	5.833538G	500k	3
16.304M	5.816812G	5.833116G	16.86M	5.816534G	5.833394G	500k	4

802.11ac VHT20_Nss1,(MCS0)_4TX

EBW

5180MHz

CF
5.18GHz
Span
50MHz
RBW
300kHz
VBW
1MHz
Sweep Time
1ms
Detector Type
Peak

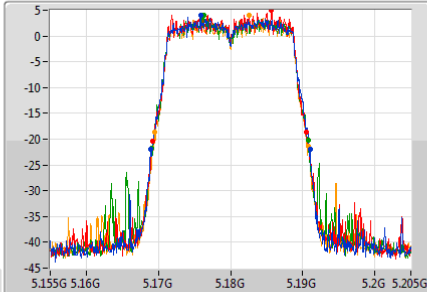

CF
5.18GHz
Span
50MHz
RBW
200kHz
VBW
1MHz
Sweep Time
1.02ms
Detector Type
Sample



26dB(Hz)	Fl-26dB(Hz)	Fh-26dB(Hz)	OBW(Hz)	Fl-OBW(Hz)	Fh-OBW(Hz)	Limit(Hz)	Port
22.101M	5.168913G	5.191014G	17.873M	5.171027G	5.1889G	Inf	1
21.377M	5.169203G	5.19058G	17.8M	5.1711G	5.1889G	Inf	2
21.667M	5.169058G	5.190725G	17.873M	5.171027G	5.1889G	Inf	3
21.377M	5.16942G	5.190797G	17.873M	5.171027G	5.1889G	Inf	4

802.11ac VHT20_Nss1,(MCS0)_4TX

EBW

5200MHz

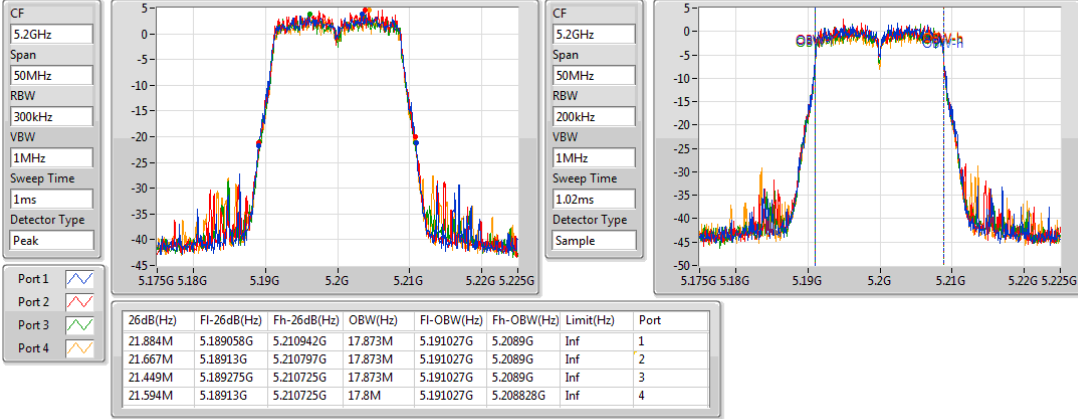

802.11ac VHT20_Nss1,(MCS0)_4TX

EBW

5240MHz

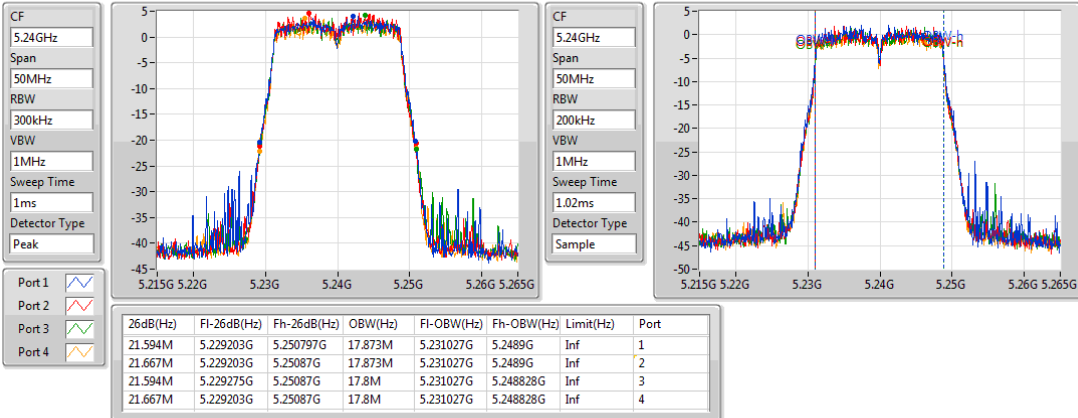

802.11ac VHT20_Nss1,(MCS0)_4TX

EBW

5260MHz

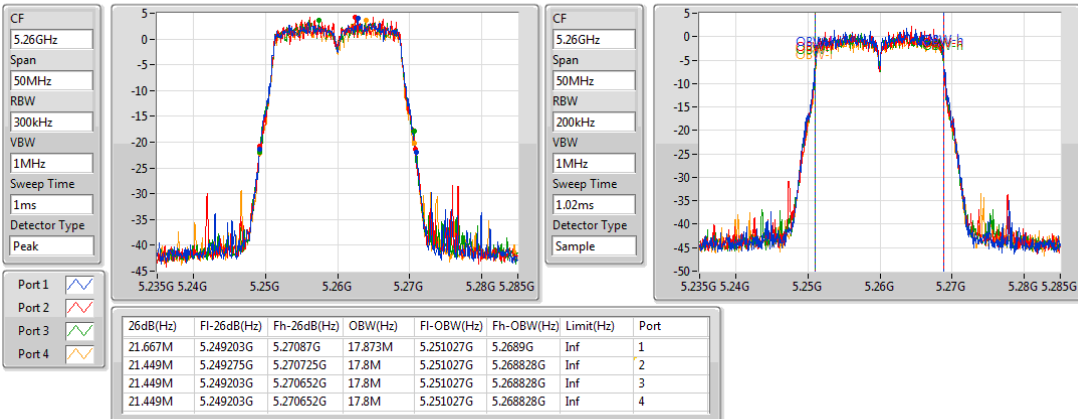

802.11ac VHT20_Nss1,(MCS0)_4TX

EBW

5300MHz

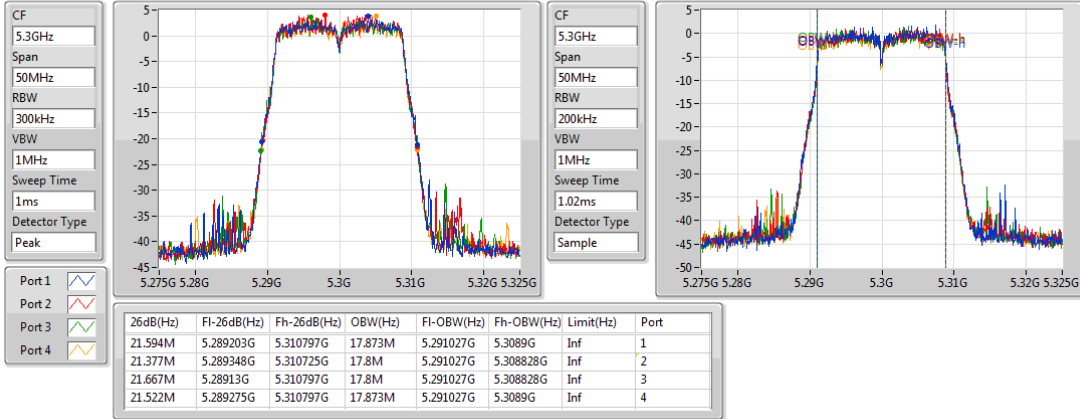

802.11ac VHT20_Nss1,(MCS0)_4TX

EBW

5320MHz

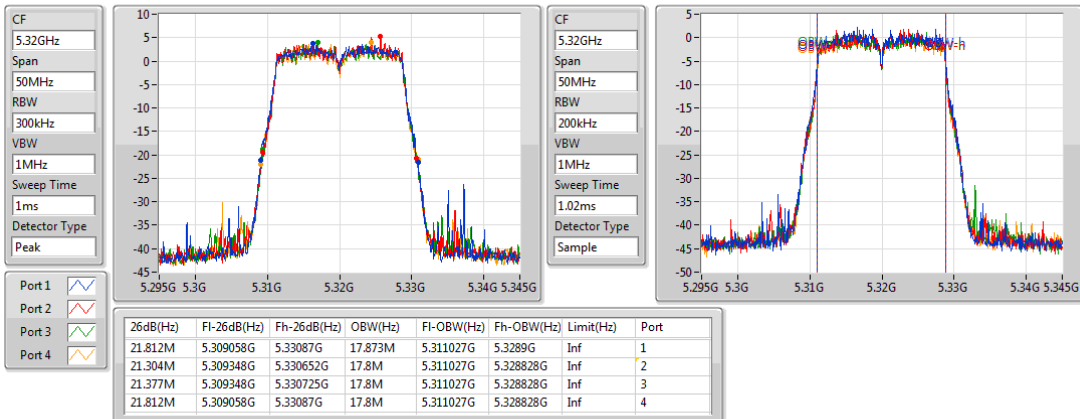

802.11ac VHT20_Nss1,(MCS0)_4TX

EBW

5500MHz

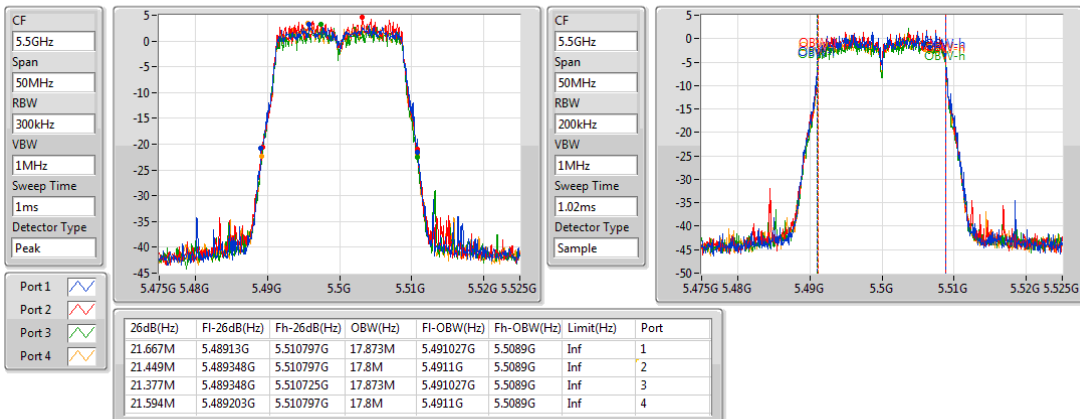

802.11ac VHT20_Nss1,(MCS0)_4TX

EBW

5580MHz

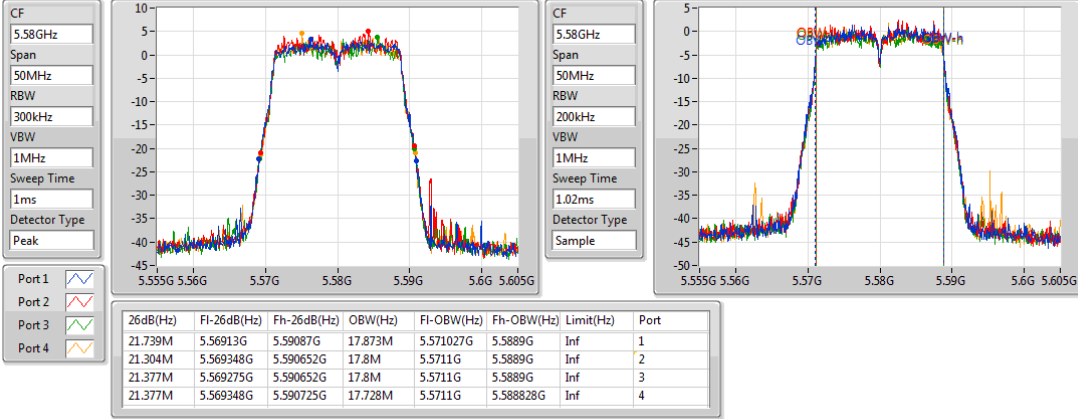

802.11ac VHT20_Nss1,(MCS0)_4TX

EBW

5700MHz

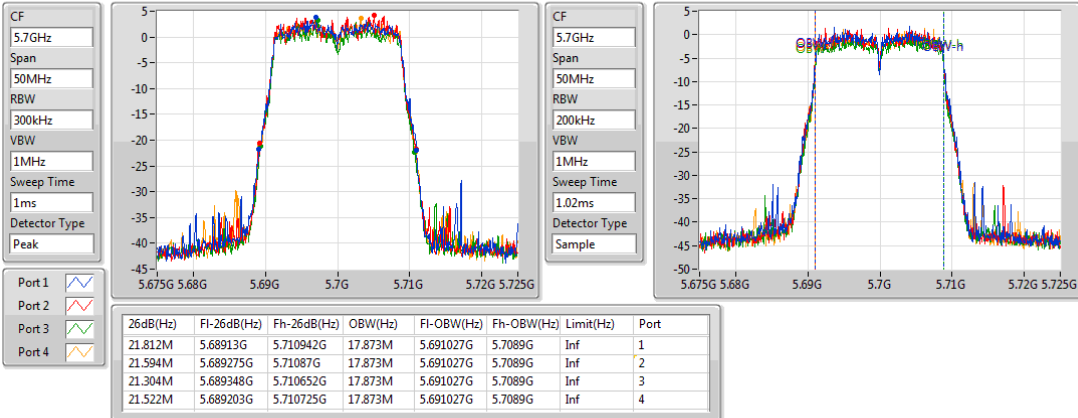

802.11ac VHT20_Nss1,(MCS0)_4TX

EBW

5720MHz Straddle 5.47-5.725GHz

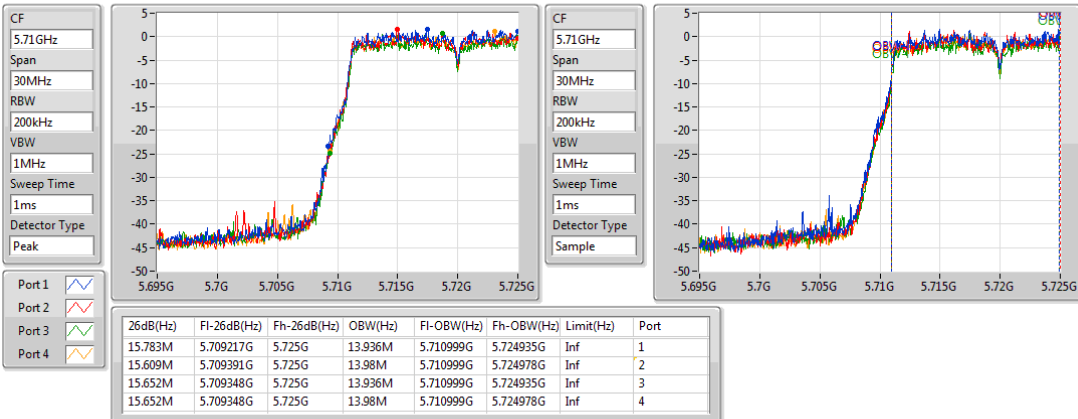

802.11ac VHT20_Nss1,(MCS0)_4TX

EBW

5720MHz Straddle 5.725-5.85GHz

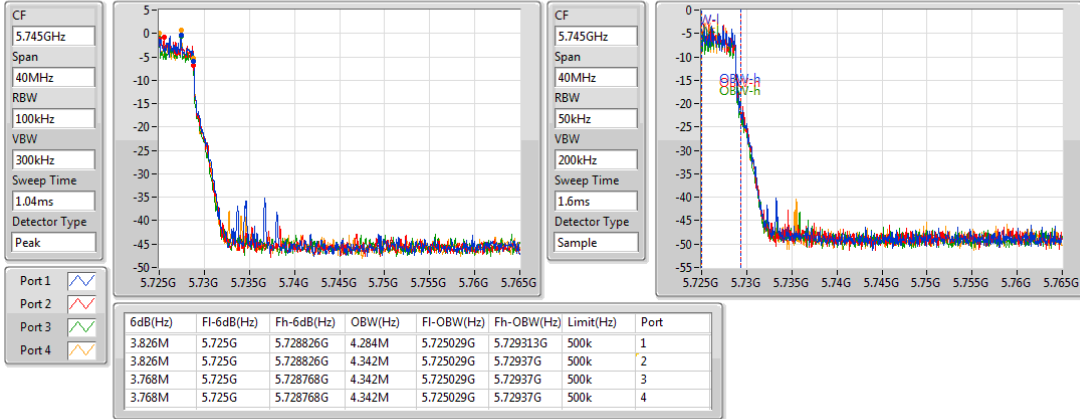

802.11ac VHT20_Nss1,(MCS0)_4TX

EBW

5745MHz

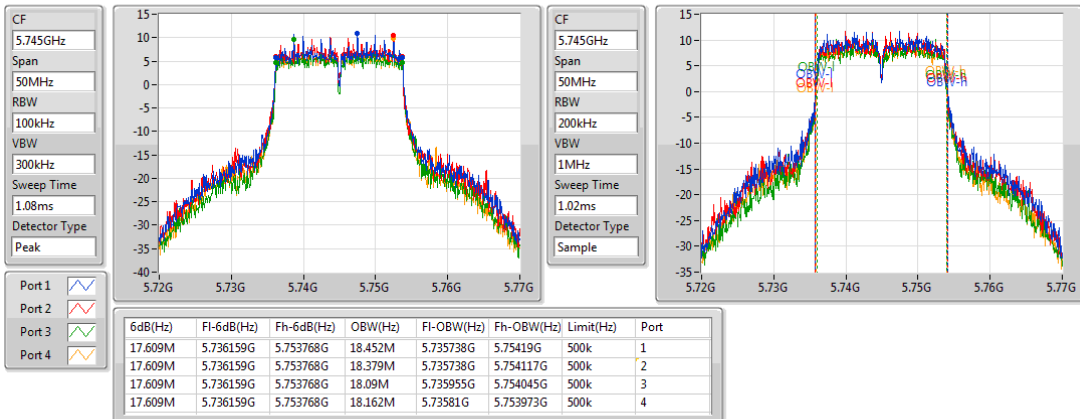

802.11ac VHT20_Nss1,(MCS0)_4TX

EBW

5785MHz

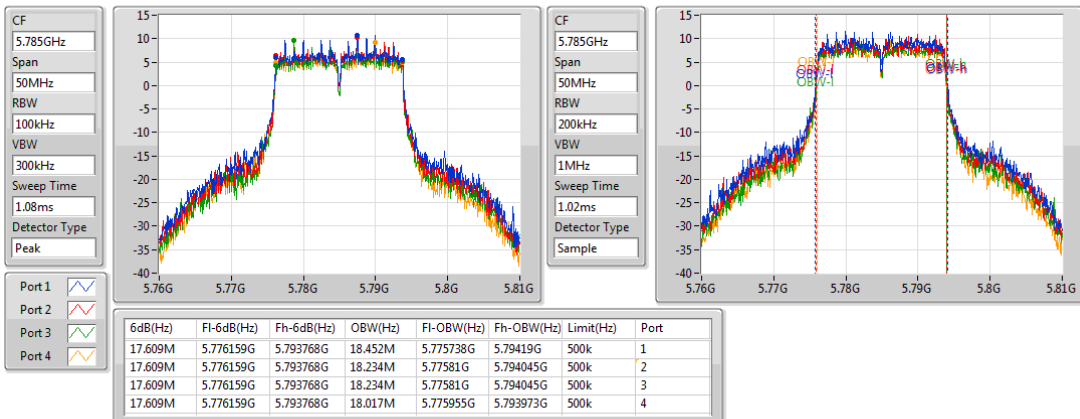

802.11ac VHT20_Nss1,(MCS0)_4TX

EBW

5825MHz

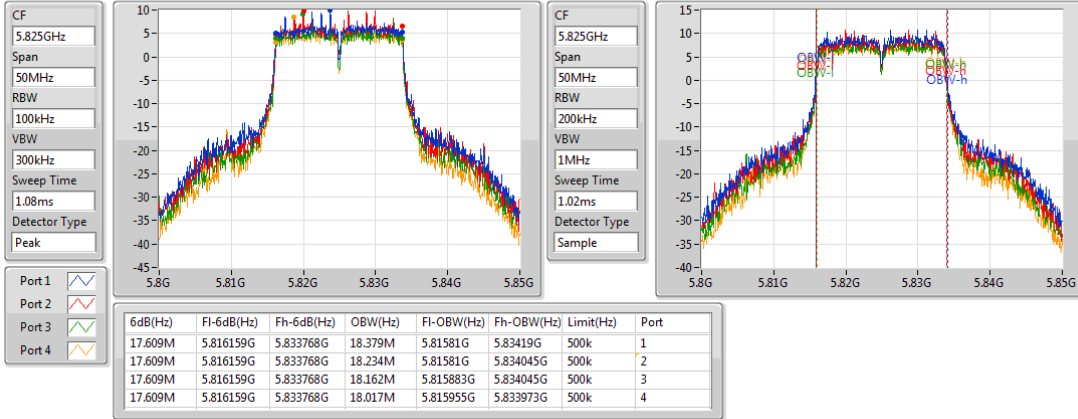

802.11ac VHT40_Nss1,(MCS0)_4TX

EBW

5190MHz

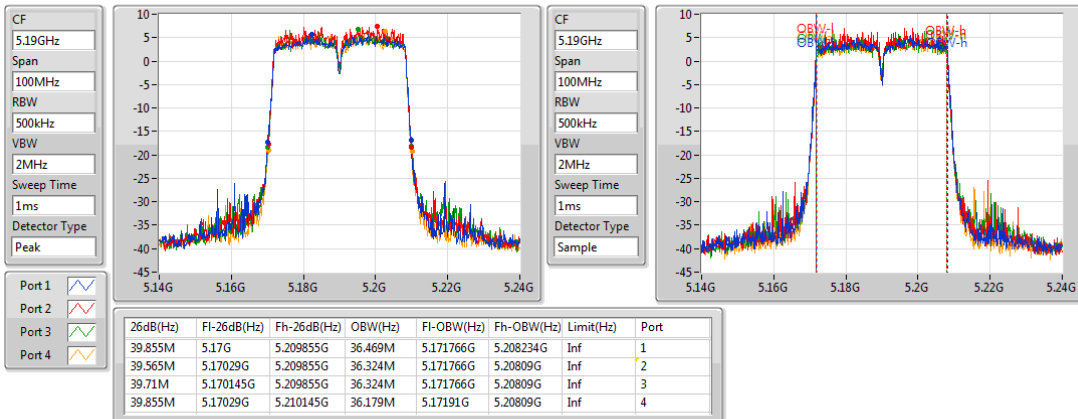

802.11ac VHT40_Nss1,(MCS0)_4TX

EBW

5230MHz

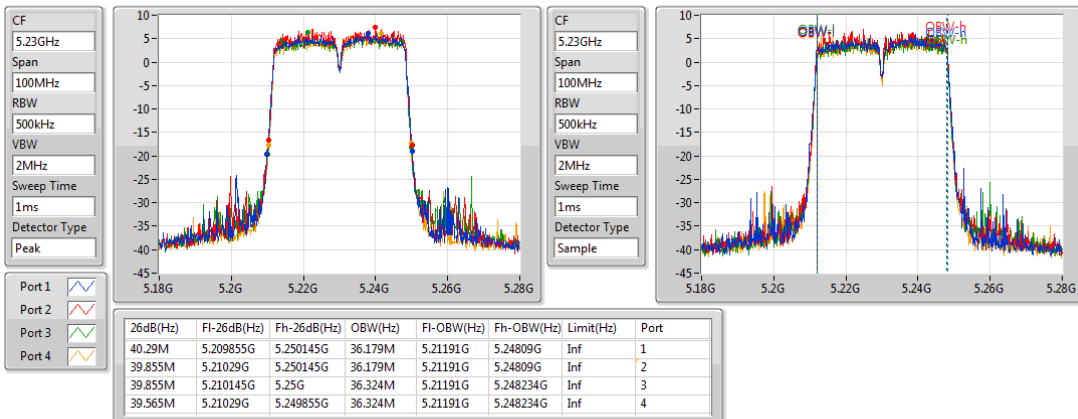

802.11ac VHT40_Nss1,(MCS0)_4TX

EBW

5270MHz

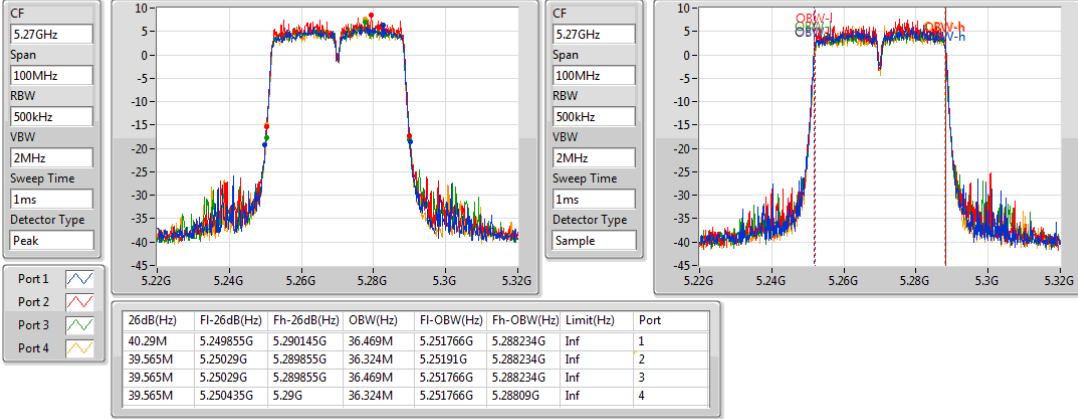

802.11ac VHT40_Nss1,(MCS0)_4TX

EBW

5310MHz

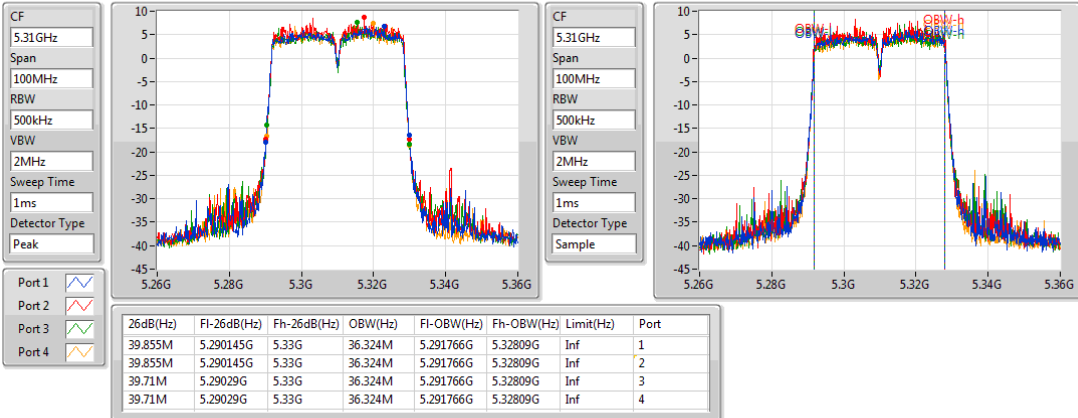

802.11ac VHT40_Nss1,(MCS0)_4TX

EBW

5510MHz

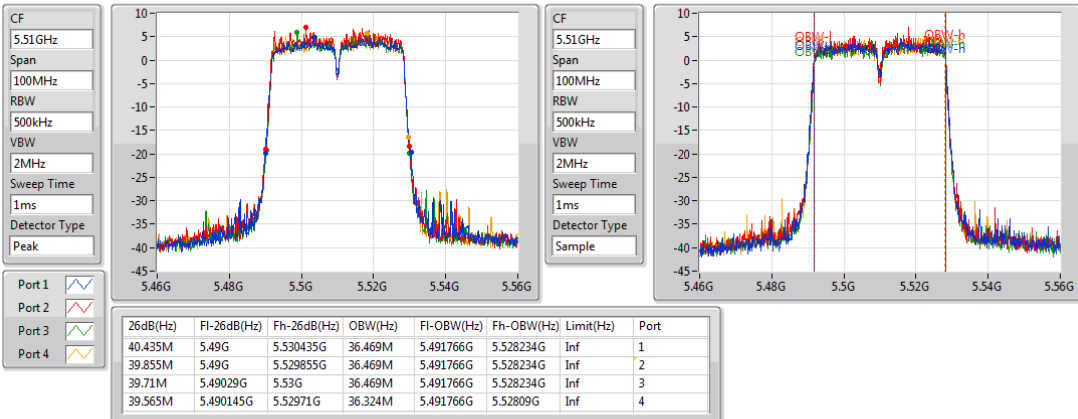

802.11ac VHT40_Nss1,(MCS0)_4TX

EBW

5590MHz

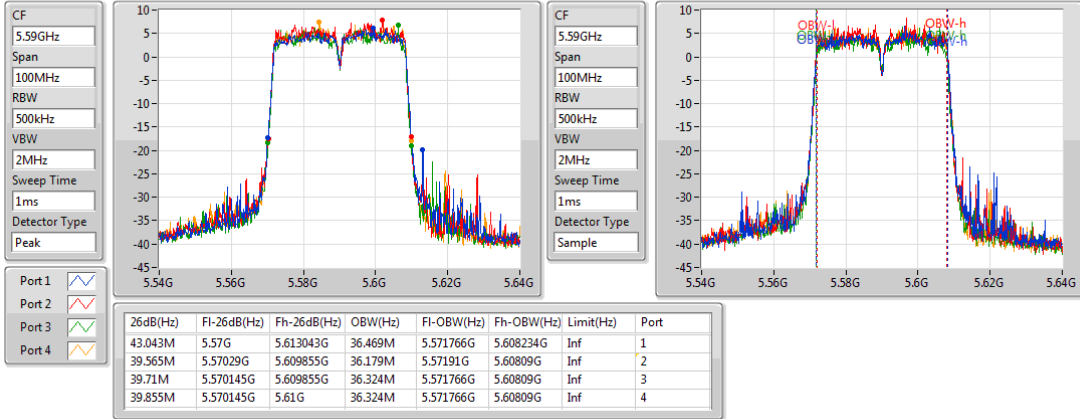

802.11ac VHT40_Nss1,(MCS0)_4TX

EBW

5670MHz

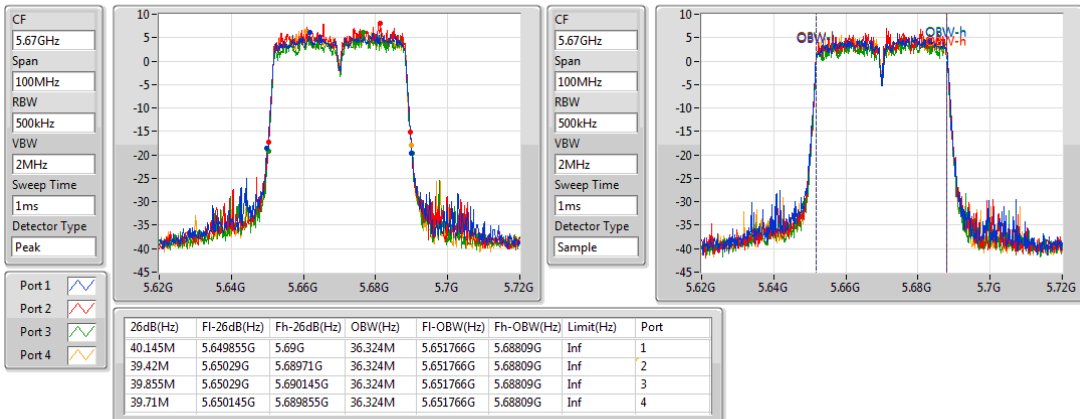

802.11ac VHT40_Nss1,(MCS0)_4TX

EBW

5710MHz Straddle 5.47-5.725GHz

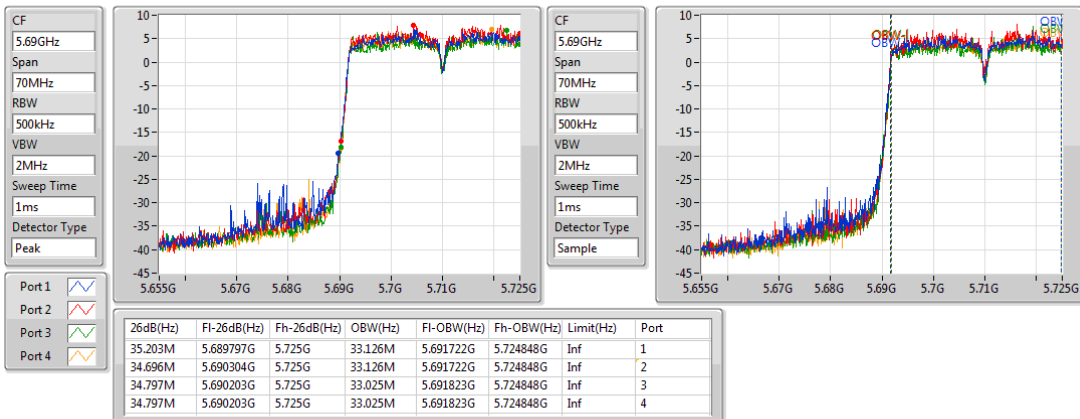

802.11ac VHT40_Nss1,(MCS0)_4TX

EBW

5710MHz Straddle 5.725-5.85GHz

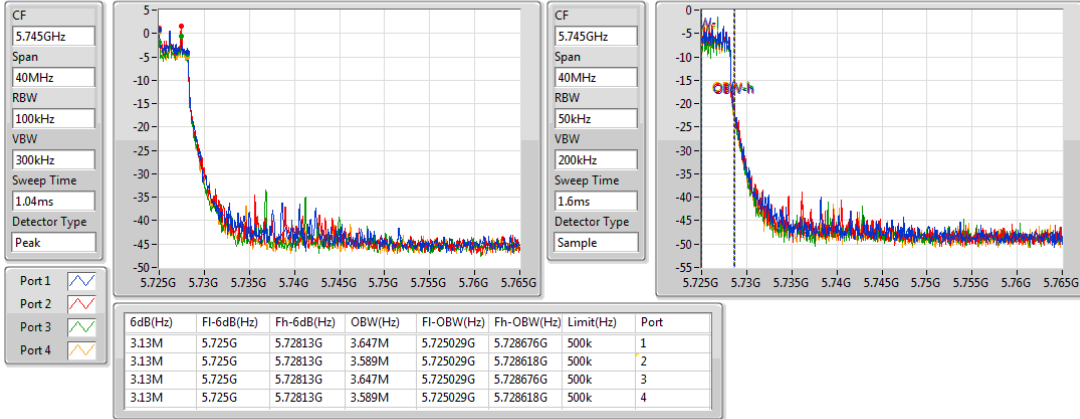

802.11ac VHT40_Nss1,(MCS0)_4TX

EBW

5755MHz

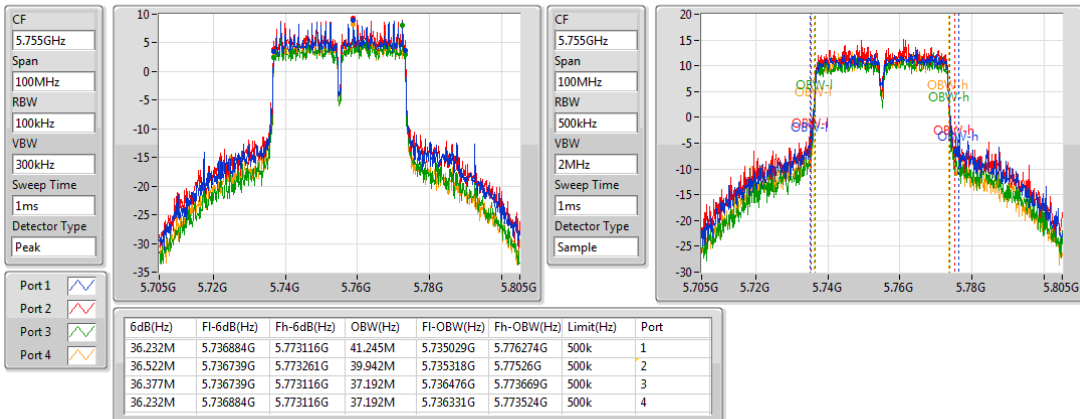

802.11ac VHT40_Nss1,(MCS0)_4TX

EBW

5795MHz

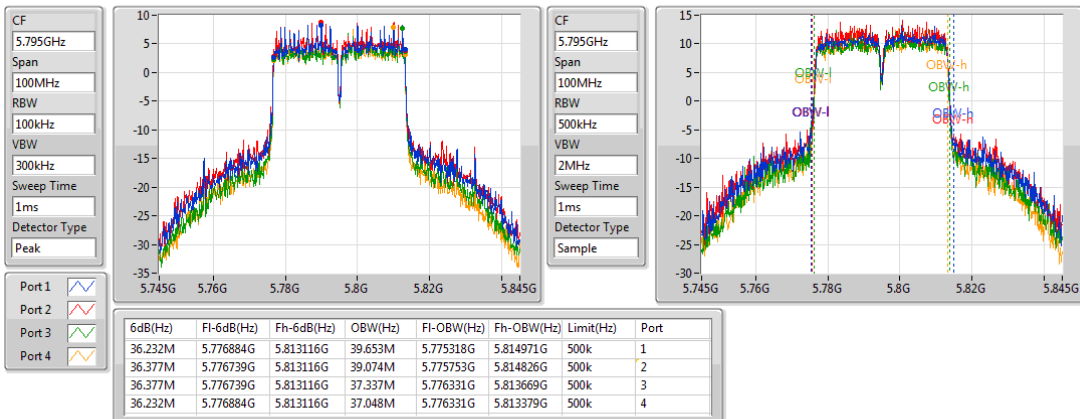

802.11ac VHT80_Nss1,(MCS0)_4TX

EBW

5210MHz

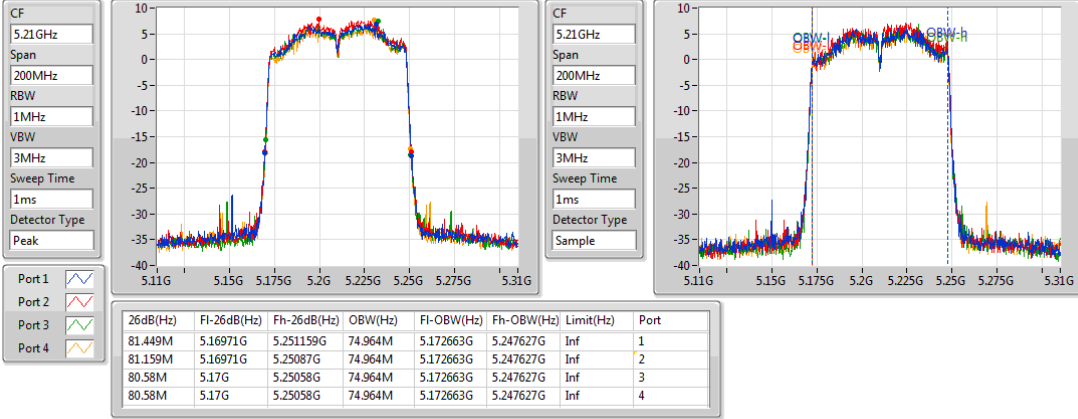

802.11ac VHT80_Nss1,(MCS0)_4TX

EBW

5290MHz

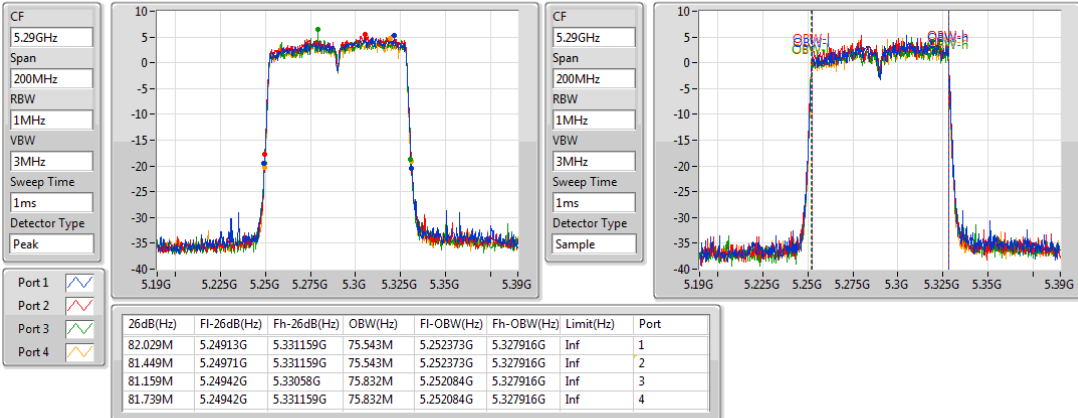

802.11ac VHT80_Nss1,(MCS0)_4TX

EBW

5530MHz

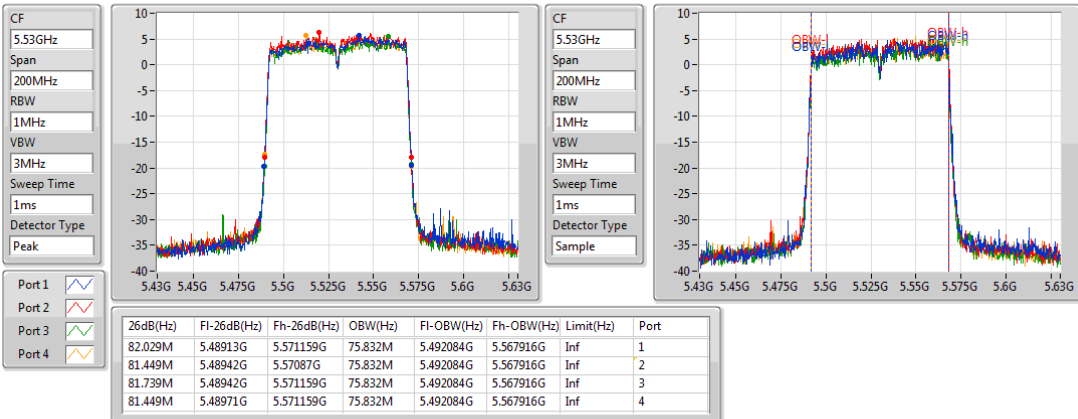

802.11ac VHT80_Nss1,(MCS0)_4TX

EBW

5610MHz

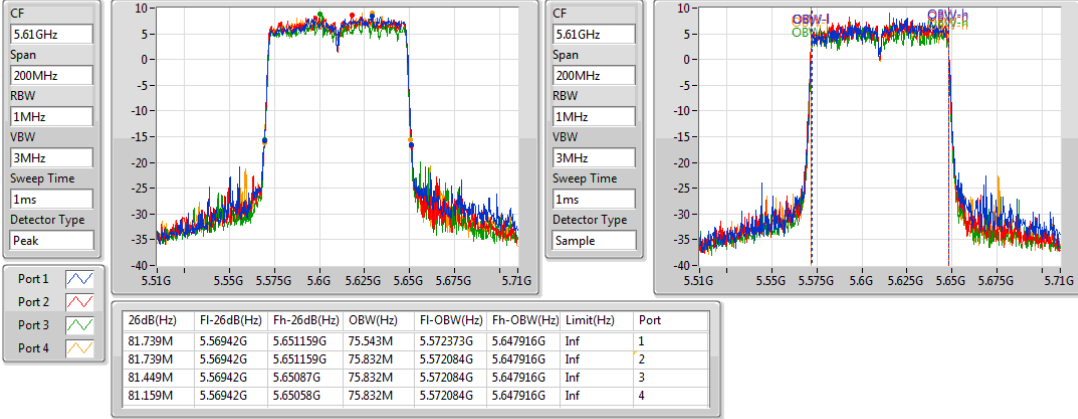

802.11ac VHT80_Nss1,(MCS0)_4TX

EBW

5690MHz Straddle 5.47-5.725GHz

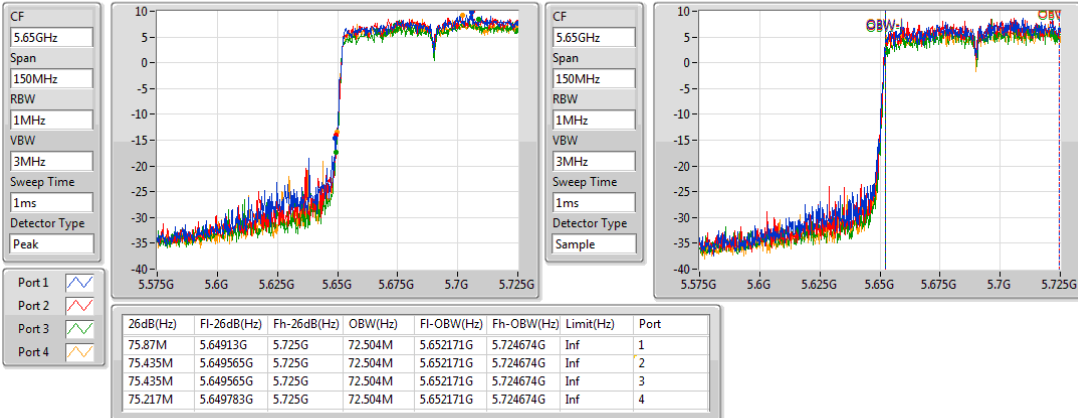

802.11ac VHT80_Nss1,(MCS0)_4TX

EBW

5690MHz Straddle 5.725-5.85GHz

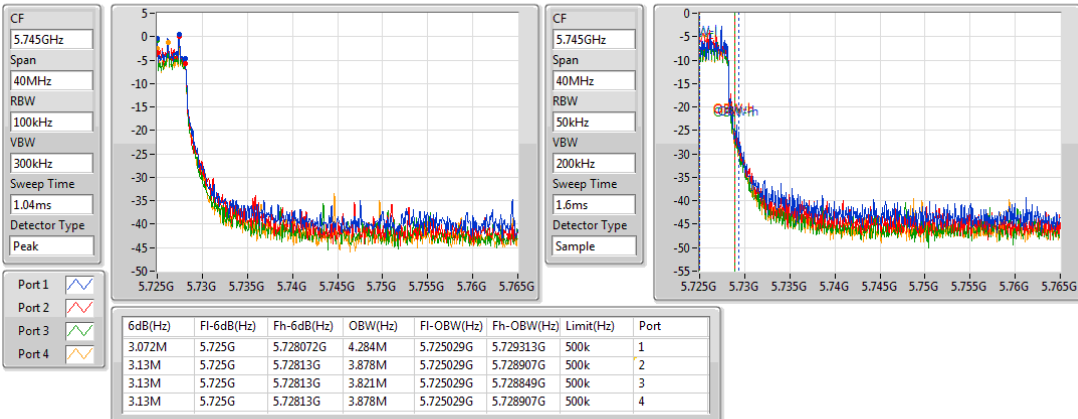

802.11ac VHT80_Nss1,(MCS0)_4TX

EBW

5775MHz

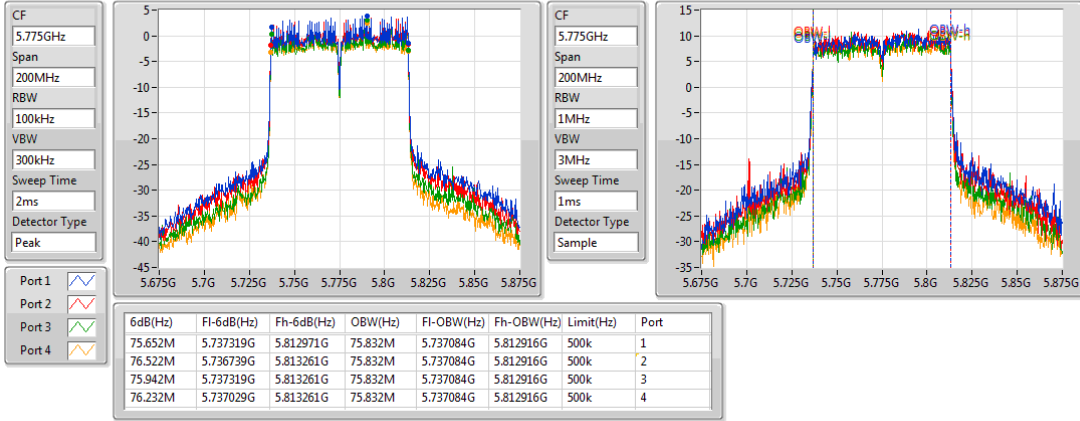

Beamforming mode

Summary

Mode	Max-N dB (Hz)	Max-OBW (Hz)	ITU-Code	Min-N dB (Hz)	Min-OBW (Hz)
5.15-5.25GHz	-	-	-	-	-
802.11ac VHT20-BF_Nss1,(MCS0)_4TX	21.957M	17.873M	17M9D1D	21.667M	17.728M
5.25-5.35GHz	-	-	-	-	-
802.11ac VHT20-BF_Nss1,(MCS0)_4TX	21.957M	17.873M	17M9D1D	21.667M	17.728M
5.47-5.725GHz	-	-	-	-	-
802.11ac VHT20-BF_Nss1,(MCS0)_4TX	21.957M	17.945M	17M9D1D	15.739M	13.98M
5.725-5.85GHz	-	-	-	-	-
802.11ac VHT20-BF_Nss1,(MCS0)_4TX	17.681M	18.017M	18MOD1D	3.71M	4.342M

Max-N dB = Maximum 6dB down bandwidth for 5.725-5.85GHz band / Maximum 26dB down bandwidth for other band;

Max-OBW = Maximum 99% occupied bandwidth;

Min-N dB = Minimum 6dB down bandwidth for 5.725-5.85GHz band / Maximum 26dB down bandwidth for other band;

Min-OBW = Minimum 99% occupied bandwidth;

Result

Mode	Result	Limit (Hz)	Port 1-N dB (Hz)	Port 1-OBW (Hz)	Port 2-N dB (Hz)	Port 2-OBW (Hz)	Port 3-N dB (Hz)	Port 3-OBW (Hz)	Port 4-N dB (Hz)	Port 4-OBW (Hz)
802.11ac VHT20-BF_Nss1,(MCS0)_4TX	-	-	-	-	-	-	-	-	-	-
5180MHz	Pass	Inf	21.667M	17.8M	21.884M	17.873M	21.957M	17.8M	21.884M	17.8M
5200MHz	Pass	Inf	21.957M	17.728M	21.812M	17.728M	21.812M	17.8M	21.884M	17.8M
5240MHz	Pass	Inf	21.812M	17.873M	21.667M	17.728M	21.884M	17.873M	21.884M	17.873M
5260MHz	Pass	Inf	21.812M	17.8M	21.812M	17.873M	21.957M	17.8M	21.667M	17.873M
5300MHz	Pass	Inf	21.739M	17.873M	21.739M	17.8M	21.812M	17.873M	21.957M	17.8M
5320MHz	Pass	Inf	21.667M	17.728M	21.667M	17.728M	21.739M	17.8M	21.667M	17.873M
5500MHz	Pass	Inf	21.812M	17.8M	21.667M	17.8M	21.667M	17.873M	21.957M	17.873M
5580MHz	Pass	Inf	21.884M	17.728M	21.884M	17.728M	21.739M	17.945M	21.594M	17.873M
5700MHz	Pass	Inf	21.812M	17.873M	21.667M	17.8M	21.667M	17.873M	21.739M	17.873M
5720MHz Straddle 5.47-5.725GHz	Pass	Inf	15.87M	14.023M	15.739M	13.98M	15.87M	13.98M	15.826M	13.98M
5720MHz Straddle 5.725-5.85GHz	Pass	500k	3.71M	4.342M	3.768M	4.399M	3.768M	4.342M	3.768M	4.342M
5745MHz	Pass	500k	17.681M	18.017M	17.609M	17.873M	17.609M	17.873M	17.609M	17.873M
5785MHz	Pass	500k	17.536M	17.873M	17.609M	17.945M	17.609M	17.945M	17.609M	17.873M
5825MHz	Pass	500k	17.319M	17.873M	17.609M	17.945M	17.609M	17.873M	17.681M	17.945M

Port X-N dB = Port X 6dB down bandwidth for 5.725-5.85GHz band / 26dB down bandwidth for other band

Port X-OBW = Port X 99% occupied bandwidth;

802.11ac VHT20-BF_Nss1,(MCS0)_4TX

EBW

5180MHz

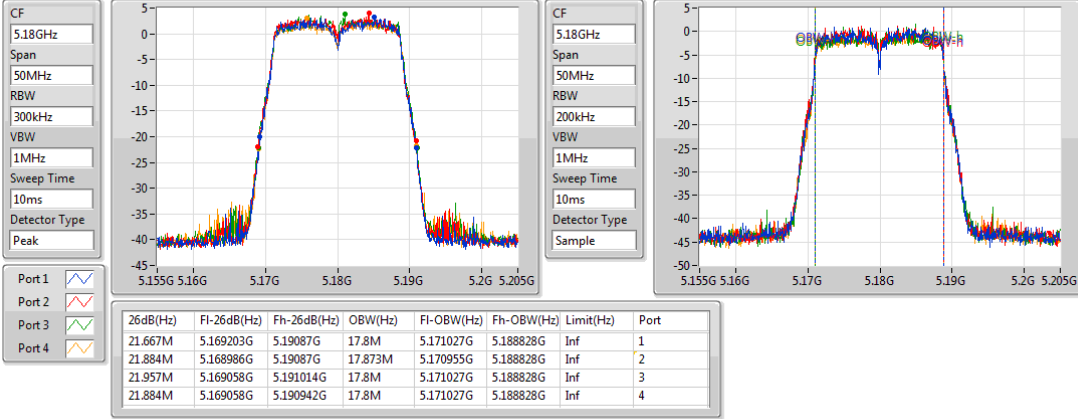

802.11ac VHT20-BF_Nss1,(MCS0)_4TX

EBW

5200MHz

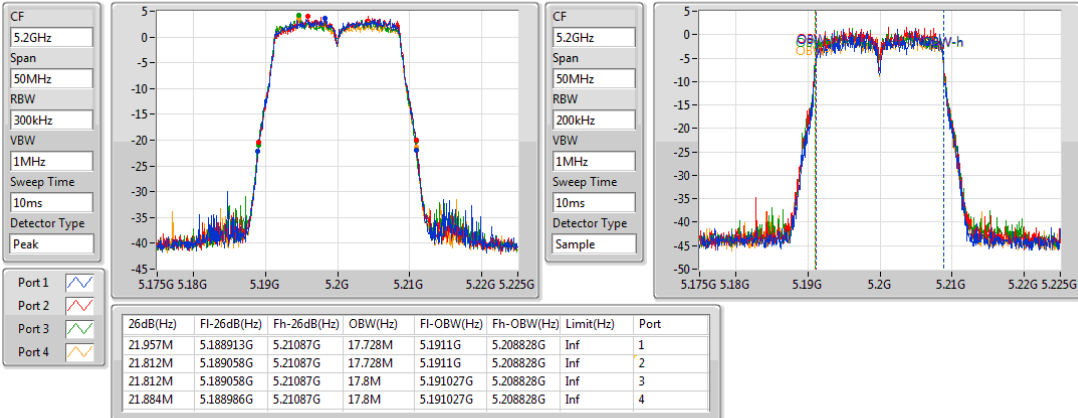

802.11ac VHT20-BF_Nss1,(MCS0)_4TX

EBW

5240MHz

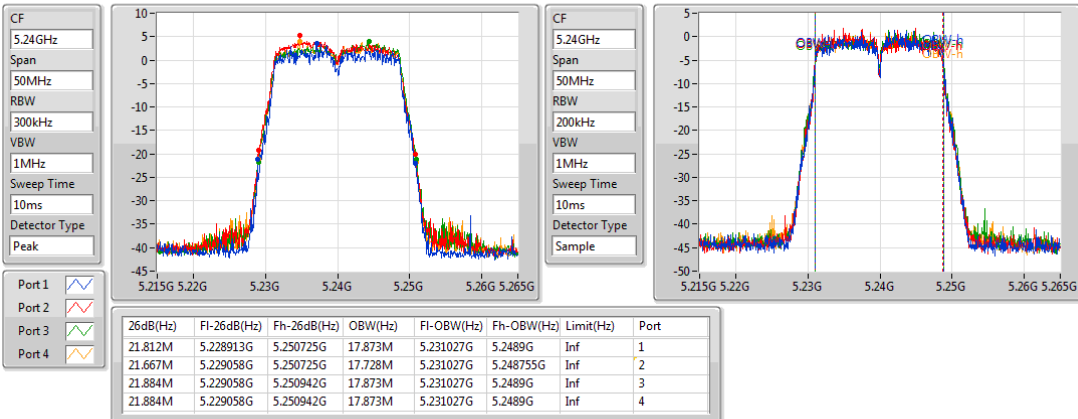

802.11ac VHT20-BF_Nss1,(MCS0)_4TX

EBW

5260MHz

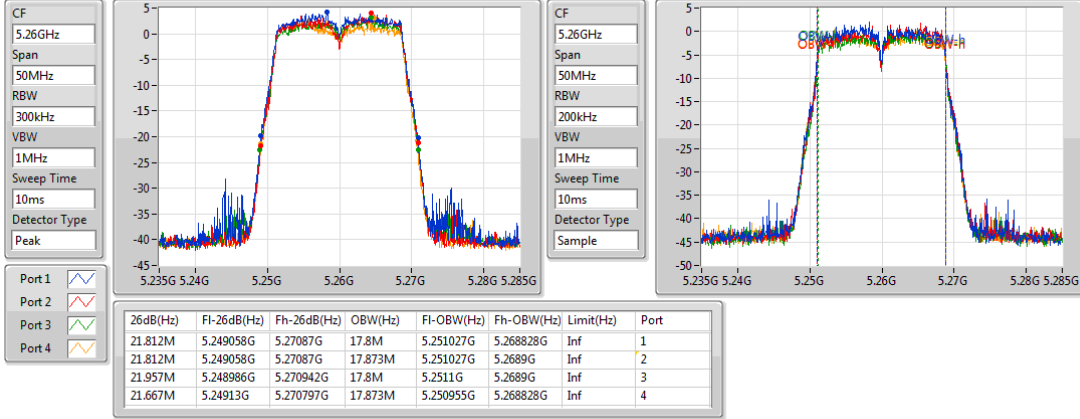

802.11ac VHT20-BF_Nss1,(MCS0)_4TX

EBW

5300MHz

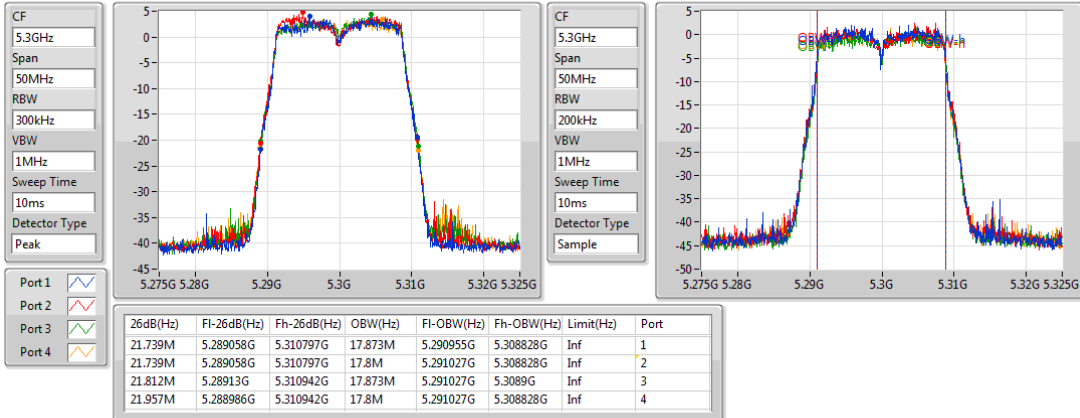

802.11ac VHT20-BF_Nss1,(MCS0)_4TX

EBW

5320MHz

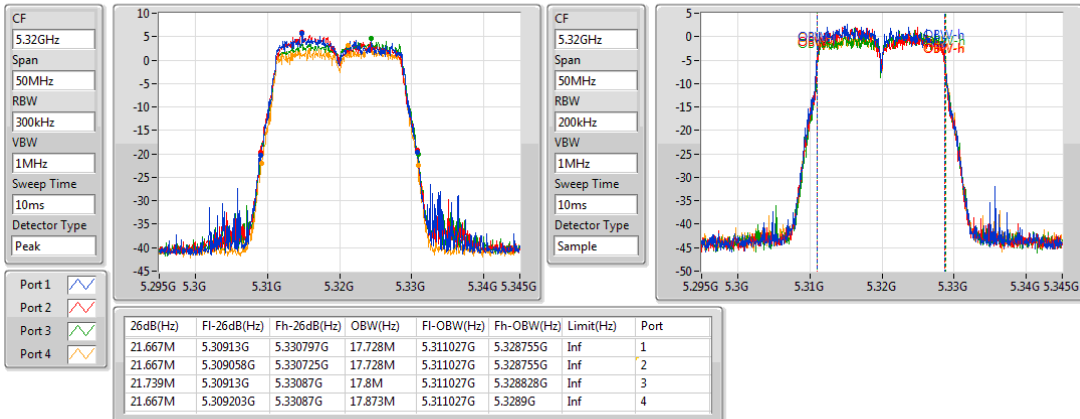

802.11ac VHT20-BF_Nss1,(MCS0)_4TX

EBW

5500MHz

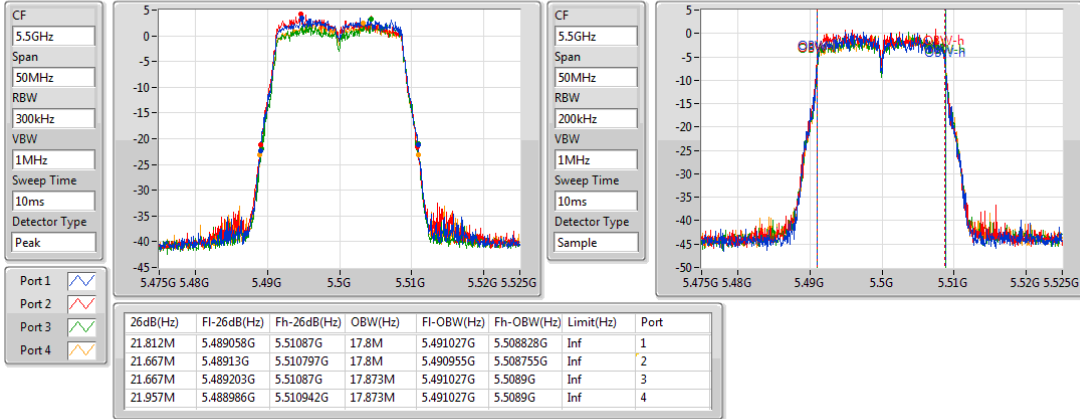

802.11ac VHT20-BF_Nss1,(MCS0)_4TX

EBW

5580MHz

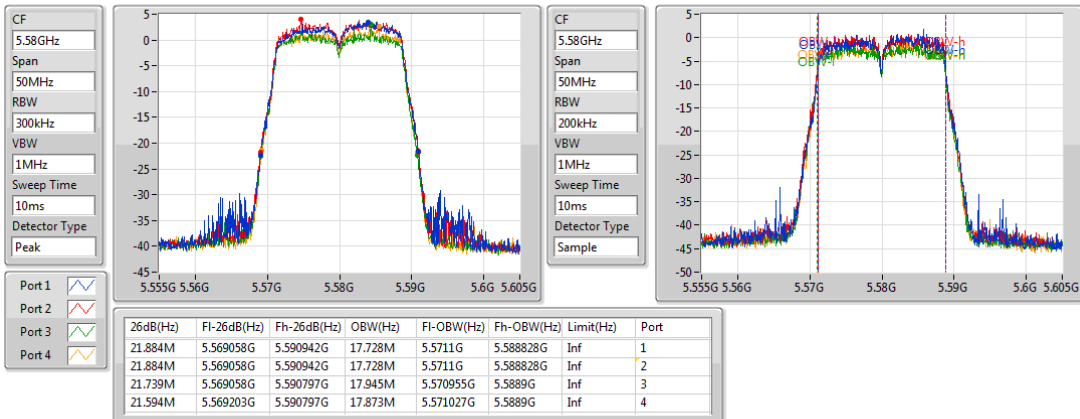

802.11ac VHT20-BF_Nss1,(MCS0)_4TX

EBW

5700MHz

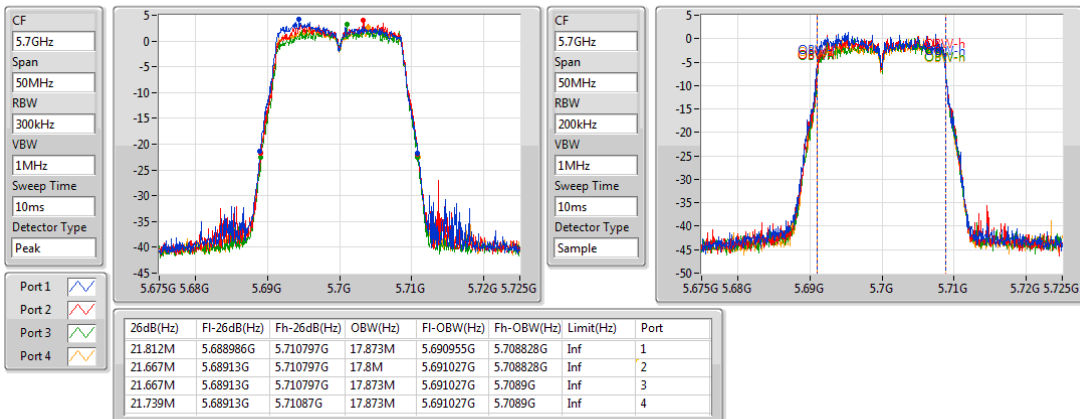

802.11ac VHT20-BF_Nss1,(MCS0)_4TX

EBW

5720MHz Straddle 5.47-5.725GHz

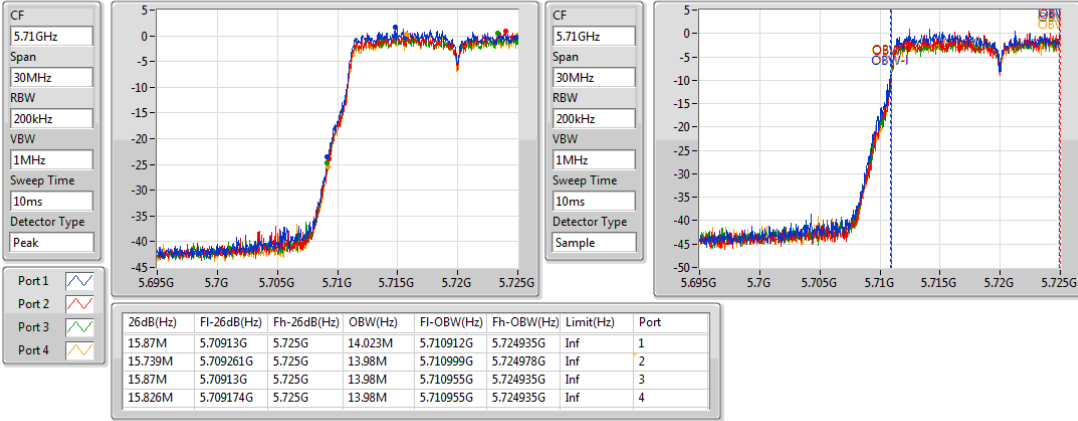

802.11ac VHT20-BF_Nss1,(MCS0)_4TX

EBW

5720MHz Straddle 5.725-5.85GHz

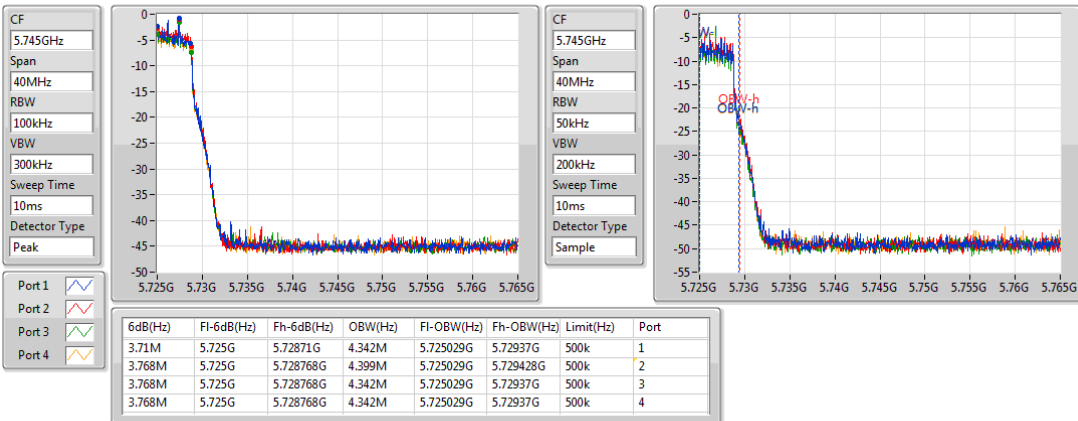

802.11ac VHT20-BF_Nss1,(MCS0)_4TX

EBW

5745MHz

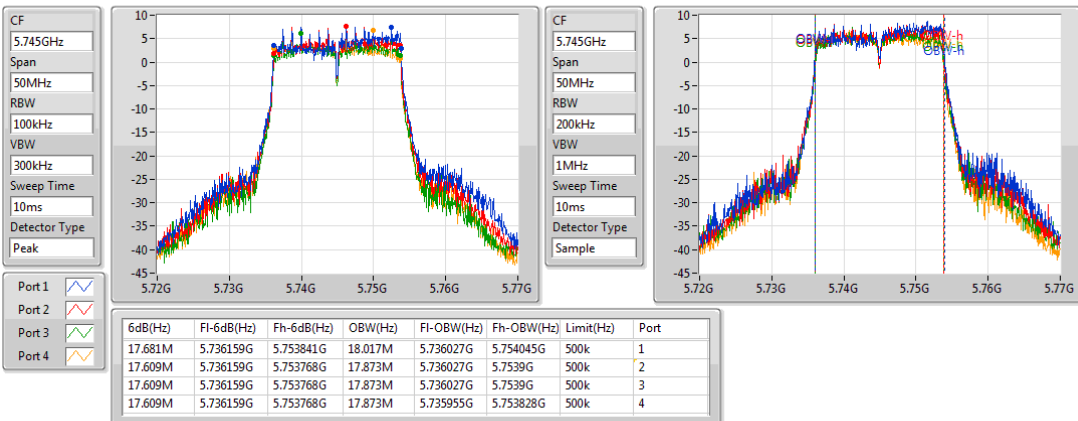

802.11ac VHT20-BF_Nss1,(MCS0)_4TX

EBW

5785MHz

CF
5.785GHz
Span
50MHz
RBW
100kHz
VBW
300kHz
Sweep Time
10ms
Detector Type
Peak

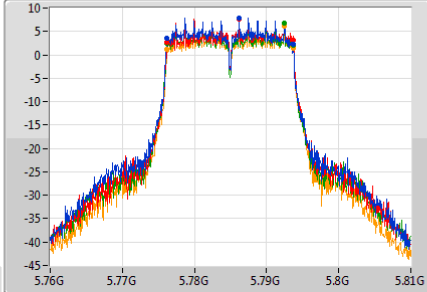

CF
5.785GHz
Span
50MHz
RBW
200kHz
VBW
1MHz
Sweep Time
10ms
Detector Type
Sample

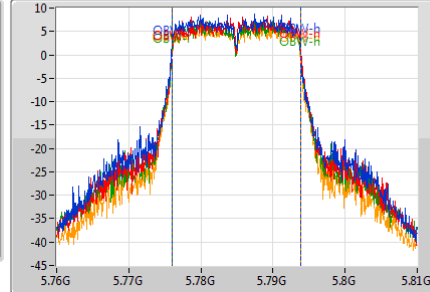

Port 1
Port 2
Port 3
Port 4

6dB(Hz)	Fl-6dB(Hz)	Fh-6dB(Hz)	OBW(Hz)	Fl-OBW(Hz)	Fh-OBW(Hz)	Limit(Hz)	Port
17.536M	5.776159G	5.793696G	17.873M	5.775955G	5.793828G	500k	1
17.609M	5.776159G	5.793768G	17.945M	5.775955G	5.7939G	500k	2
17.609M	5.776159G	5.793768G	17.945M	5.775955G	5.7939G	500k	3
17.609M	5.776159G	5.793768G	17.873M	5.775955G	5.793828G	500k	4

802.11ac VHT20-BF_Nss1,(MCS0)_4TX

EBW

5825MHz

CF
5.825GHz
Span
50MHz
RBW
100kHz
VBW
300kHz
Sweep Time
10ms
Detector Type
Peak

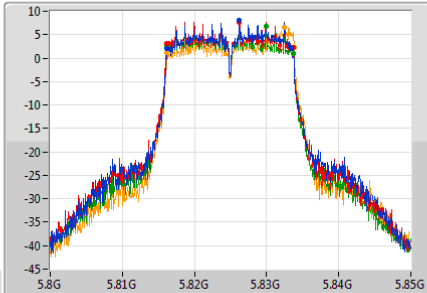

CF
5.825GHz
Span
50MHz
RBW
200kHz
VBW
1MHz
Sweep Time
10ms
Detector Type
Sample

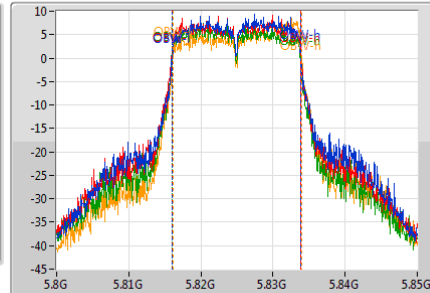

Port 1
Port 2
Port 3
Port 4

6dB(Hz)	Fl-6dB(Hz)	Fh-6dB(Hz)	OBW(Hz)	Fl-OBW(Hz)	Fh-OBW(Hz)	Limit(Hz)	Port
17.319M	5.816159G	5.833478G	17.873M	5.816027G	5.8339G	500k	1
17.609M	5.816159G	5.833768G	17.945M	5.815955G	5.8339G	500k	2
17.609M	5.816159G	5.833768G	17.873M	5.815955G	5.833828G	500k	3
17.681M	5.816159G	5.833841G	17.945M	5.8161G	5.834045G	500k	4

3.3 RF Output Power

3.3.1 Limit of RF Output Power

Frequency band 5150-5250 MHz		
Operating Mode		Limit
<input type="checkbox"/>	Outdoor access point	Conducted Power: 1 W The maximum e.i.r.p. at any elevation angle above 30 degrees as measured from the horizon must not exceed 125 mW (21 dBm)
<input type="checkbox"/>	Indoor access point	Conducted Power: 1 W
<input type="checkbox"/>	Fixed point-to-point access points	Conducted Power: 1 W
<input checked="" type="checkbox"/>	Client devices	Conducted Power: 250 mW

Frequency Band (MHz)		Limit
<input checked="" type="checkbox"/>	5250 ~ 5350	Conducted Power: 250mW or 11dBm+10 log B
<input checked="" type="checkbox"/>	5470 ~ 5725	Conducted Power: 250mW or 11dBm+10 log B
<input checked="" type="checkbox"/>	5725 ~ 5850	Conducted Power: 1 W

Note: "B" is the 26dB emission bandwidth in MHz.

3.3.2 Test Procedures

Method PM-G (Measurement using a gated RF average power meter)

Measurements is performed using a wideband gated RF power meter provided that the gate parameters are adjusted such that the power is measured only when the EUT is transmitting at its maximum power control level. Since the measurement is made only during the ON time of the transmitter, no duty cycle correction factor is required.

Spectrum analyzer (For channel that extends across the 5.725 GHz boundary)

1. Set RBW = 1MHz, VBW = 3MHz, Sweep time = Auto, Detector = RMS.
2. Trace average at least 100 traces in power averaging mode.
3. Compute power by integrating the spectrum across the 26 dB EBW.
4. Add $10 \log(1/X)$, X:duty cycle) if duty cycle is <98%).

3.3.3 Test Setup

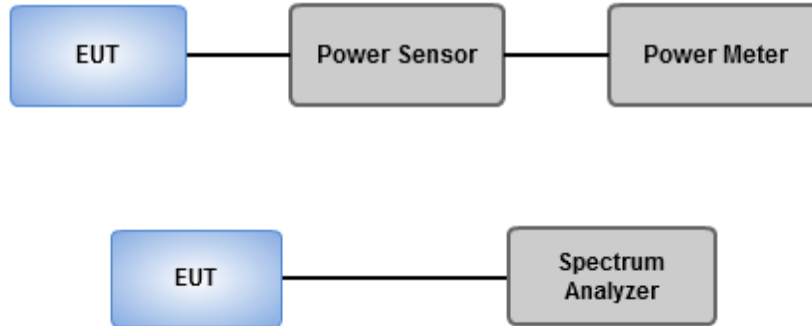

3.3.4 Test Result of Maximum Conducted Output Power

Non-beamforming mode

Summary

Mode	Total Power (dBm)	Total Power (W)	EIRP (dBm)	EIRP (W)
5.15-5.25GHz	-	-	-	-
802.11a_Nss1,(6Mbps)_4TX	18.88	0.07727	24.18	0.26182
802.11ac VHT20_Nss1,(MCS0)_4TX	18.97	0.07889	24.27	0.26730
802.11ac VHT40_Nss1,(MCS0)_4TX	21.66	0.14655	26.96	0.49659
802.11ac VHT80_Nss1,(MCS0)_4TX	21.23	0.13274	26.53	0.44978
5.25-5.35GHz	-	-	-	-
802.11a_Nss1,(6Mbps)_4TX	18.55	0.07161	24.55	0.28510
802.11ac VHT20_Nss1,(MCS0)_4TX	18.67	0.07362	24.67	0.29309
802.11ac VHT40_Nss1,(MCS0)_4TX	21.91	0.15524	27.91	0.61802
802.11ac VHT80_Nss1,(MCS0)_4TX	19.66	0.09247	25.66	0.36813
5.47-5.725GHz	-	-	-	-
802.11a_Nss1,(6Mbps)_4TX	18.48	0.07047	23.98	0.25003
802.11ac VHT20_Nss1,(MCS0)_4TX	18.52	0.07112	24.02	0.25235
802.11ac VHT40_Nss1,(MCS0)_4TX	21.78	0.15066	27.28	0.53456
802.11ac VHT80_Nss1,(MCS0)_4TX	23.12	0.20512	28.62	0.72778
5.725-5.85GHz	-	-	-	-
802.11a_Nss1,(6Mbps)_4TX	27.02	0.50350	32.52	1.78649
802.11ac VHT20_Nss1,(MCS0)_4TX	27.13	0.51642	32.63	1.83231
802.11ac VHT40_Nss1,(MCS0)_4TX	28.54	0.71450	34.04	2.53513
802.11ac VHT80_Nss1,(MCS0)_4TX	25.83	0.38282	31.33	1.35831

Result

Mode	Result	DG (dBi)	Port 1 (dBm)	Port 2 (dBm)	Port 3 (dBm)	Port 4 (dBm)	Total Power (dBm)	Power Limit (dBm)	EIRP (dBm)	EIRP Limit (dBm)
802.11a_Nss1,(6Mbps)_4TX	-	-	-	-	-	-	-	-	-	-
5180MHz	Pass	5.30	12.83	12.91	12.75	12.16	18.69	24.00	23.99	30.00
5200MHz	Pass	5.30	12.83	12.74	12.82	12.01	18.63	24.00	23.93	30.00
5240MHz	Pass	5.30	13.08	12.97	13.01	12.35	18.88	24.00	24.18	30.00
5260MHz	Pass	6.00	12.45	12.64	12.77	12.02	18.50	24.00	24.50	30.00
5300MHz	Pass	6.00	12.54	12.49	12.74	11.91	18.45	24.00	24.45	30.00
5320MHz	Pass	6.00	12.73	12.65	12.75	11.92	18.55	24.00	24.55	30.00
5500MHz	Pass	5.50	12.33	12.46	12.7	11.97	18.39	24.00	23.89	30.00
5580MHz	Pass	5.50	12.25	12.71	12.59	12.27	18.48	24.00	23.98	30.00
5700MHz	Pass	5.50	12.27	12.51	11.92	11.99	18.20	24.00	23.70	30.00
5720MHz Straddle 5.47-5.725GHz	Pass	5.50	11.66	11.51	10.62	11.03	17.24	22.89	22.74	28.89
5720MHz Straddle 5.725-5.85GHz	Pass	5.50	5.87	5.36	4.5	5.48	11.35	30.00	16.85	36.00
5745MHz	Pass	5.50	21.32	21.35	20.8	20.48	27.02	30.00	32.52	36.00
5785MHz	Pass	5.50	21.15	20.95	20.86	19.88	26.76	30.00	32.26	36.00
5825MHz	Pass	5.50	20.85	20.68	20.52	19.75	26.49	30.00	31.99	36.00
802.11ac VHT20_Nss1,(MCS0)_4TX	-	-	-	-	-	-	-	-	-	-
5180MHz	Pass	5.30	12.85	13.11	12.86	12.28	18.81	24.00	24.11	30.00
5200MHz	Pass	5.30	12.7	12.96	12.97	12.23	18.75	24.00	24.05	30.00
5240MHz	Pass	5.30	12.95	13.21	13.15	12.45	18.97	24.00	24.27	30.00
5260MHz	Pass	6.00	12.45	12.64	12.89	12.07	18.54	24.00	24.54	30.00
5300MHz	Pass	6.00	12.45	12.67	12.78	12.03	18.51	24.00	24.51	30.00
5320MHz	Pass	6.00	12.76	12.68	12.91	12.21	18.67	24.00	24.67	30.00
5500MHz	Pass	5.50	12.42	12.56	12.73	12.03	18.46	24.00	23.96	30.00
5580MHz	Pass	5.50	12.35	12.82	12.65	12.15	18.52	24.00	24.02	30.00
5700MHz	Pass	5.50	12.36	12.38	12.25	12.02	18.28	24.00	23.78	30.00
5720MHz Straddle 5.47-5.725GHz	Pass	5.50	11.6	11.3	10.49	10.97	17.13	22.93	22.63	28.93
5720MHz Straddle 5.725-5.85GHz	Pass	5.50	6.19	6.23	5.01	5.62	11.81	30.00	17.31	36.00
5745MHz	Pass	5.50	21.54	21.42	20.96	20.45	27.13	30.00	32.63	36.00
5785MHz	Pass	5.50	21.25	21.03	20.76	19.91	26.79	30.00	32.29	36.00
5825MHz	Pass	5.50	20.67	20.71	20.55	19.53	26.41	30.00	31.91	36.00
802.11ac VHT40_Nss1,(MCS0)_4TX	-	-	-	-	-	-	-	-	-	-
5190MHz	Pass	5.30	15.72	15.88	15.76	15.01	21.63	24.00	26.93	30.00
5230MHz	Pass	5.30	15.79	15.88	15.81	15.04	21.66	24.00	26.96	30.00
5270MHz	Pass	6.00	15.96	16.12	16.16	15.23	21.90	24.00	27.90	30.00
5310MHz	Pass	6.00	15.86	16.05	16.08	15.56	21.91	24.00	27.91	30.00
5510MHz	Pass	5.50	14.52	14.82	15.14	14.4	20.75	24.00	26.25	30.00
5590MHz	Pass	5.50	15.62	15.96	15.98	15.45	21.78	24.00	27.28	30.00
5670MHz	Pass	5.50	15.66	15.62	15.21	14.96	21.39	24.00	26.89	30.00
5710MHz Straddle 5.47-5.725GHz	Pass	5.50	15.74	15.58	14.5	14.85	21.22	24.00	26.72	30.00

Mode	Result	DG (dBi)	Port 1 (dBm)	Port 2 (dBm)	Port 3 (dBm)	Port 4 (dBm)	Total Power (dBm)	Power Limit (dBm)	EIRP (dBm)	EIRP Limit (dBm)
5710MHz Straddle 5.725-5.85GHz	Pass	5.50	5.77	5.72	4.62	4.66	11.25	30.00	16.75	36.00
5755MHz	Pass	5.50	22.85	22.95	22.35	21.85	28.54	30.00	34.04	36.00
5795MHz	Pass	5.50	22.62	22.55	22.36	21.4	28.28	30.00	33.78	36.00
802.11ac VHT80_Nss1,(MCS0)_4TX	-	-	-	-	-	-	-	-	-	-
5210MHz	Pass	5.30	15.18	15.65	15.43	14.51	21.23	24.00	26.53	30.00
5290MHz	Pass	6.00	13.81	13.92	13.75	13.01	19.66	24.00	25.66	30.00
5530MHz	Pass	5.50	14.33	14.69	14.6	13.9	20.41	24.00	25.91	30.00
5610MHz	Pass	5.50	17.35	17.16	17.01	16.82	23.11	24.00	28.61	30.00
5690MHz Straddle 5.47-5.725GHz	Pass	5.50	17.73	17.38	16.35	16.79	23.12	24.00	28.62	30.00
5690MHz Straddle 5.725-5.85GHz	Pass	5.50	4.67	4.58	3.6	3.52	10.15	30.00	15.65	36.00
5775MHz	Pass	5.50	20.21	20.16	19.75	19.03	25.83	30.00	31.33	36.00

DG = Directional Gain; **Port X** = Port X output power

802.11a_Nss1,(6Mbps)_4TX

AV Power

5720MHz Straddle 5.47-5.725GHz

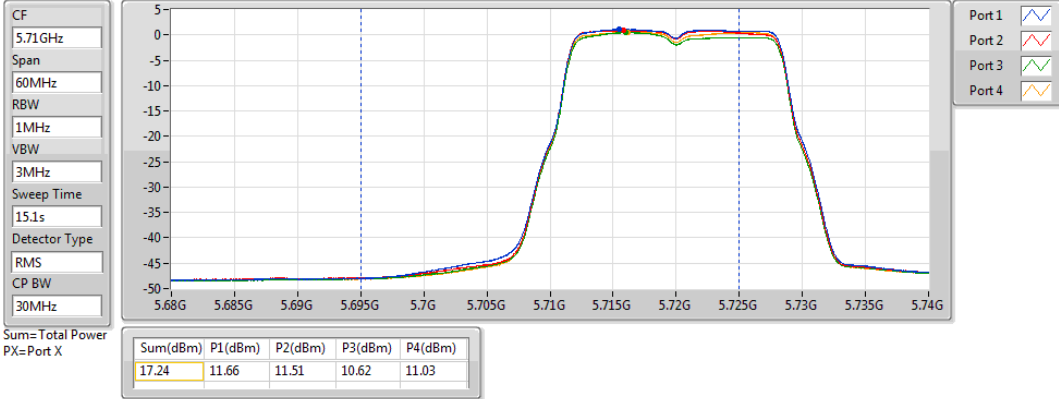

802.11a_Nss1,(6Mbps)_4TX

AV Power

5720MHz Straddle 5.725-5.85GHz

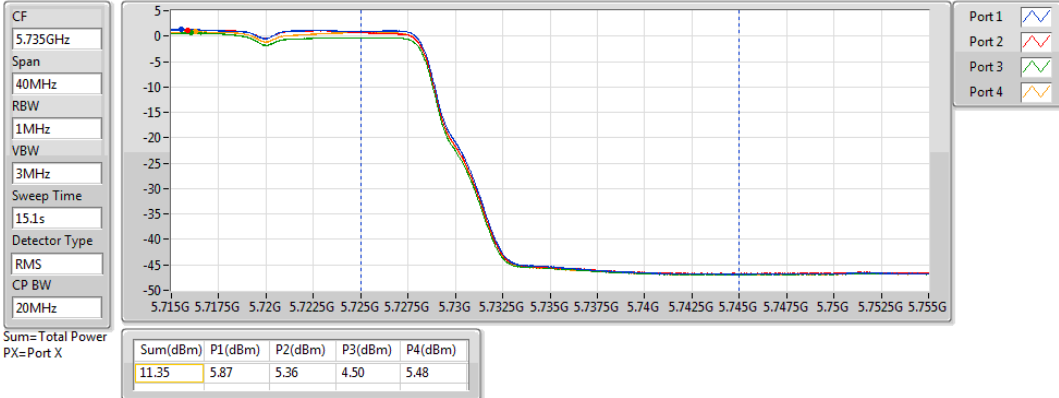

802.11ac VHT20_Nss1,(MCS0)_4TX

AV Power

5720MHz Straddle 5.47-5.725GHz

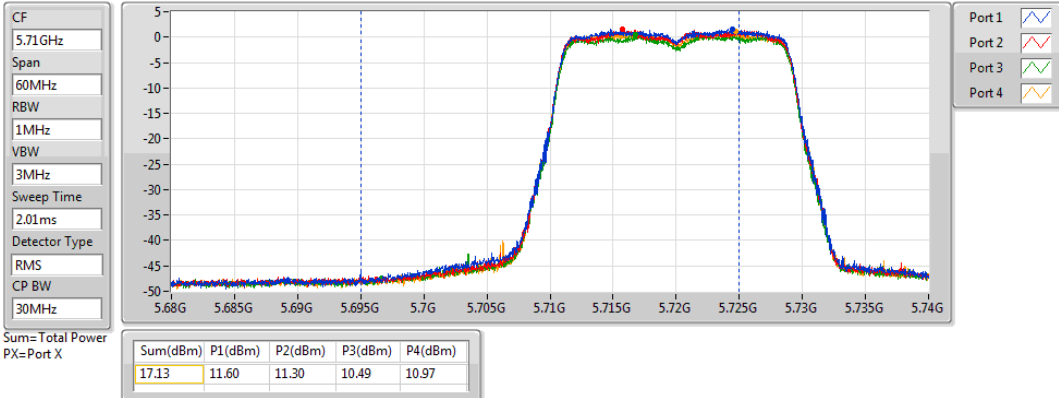

802.11ac VHT20_Nss1,(MCS0)_4TX

AV Power

5720MHz Straddle 5.725-5.85GHz

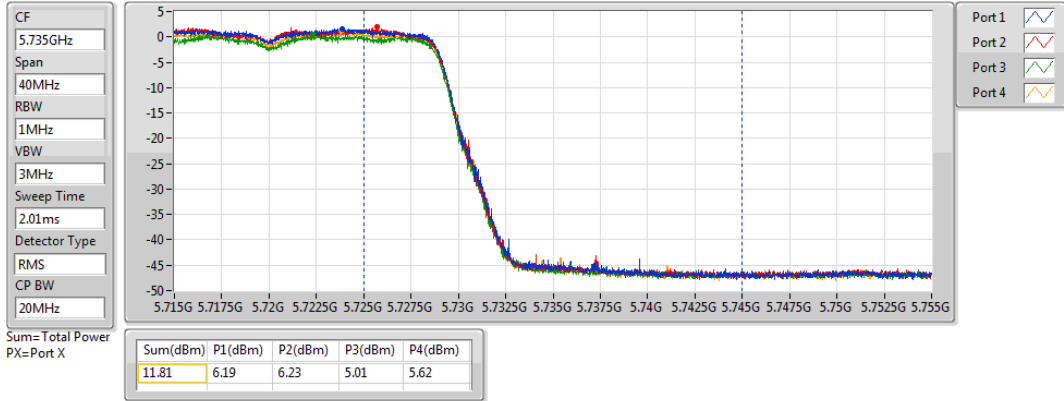

802.11ac VHT40_Nss1,(MCS0)_4TX

AV Power

5710MHz Straddle 5.47-5.725GHz

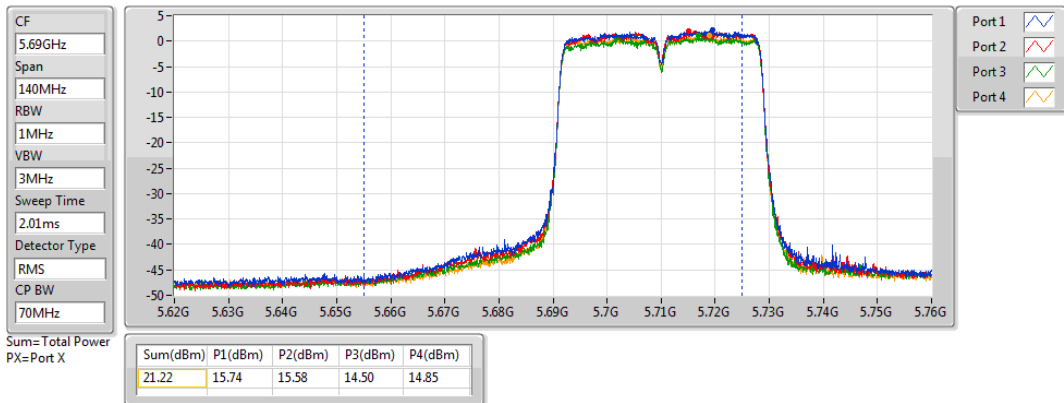

802.11ac VHT40_Nss1,(MCS0)_4TX

AV Power

5710MHz Straddle 5.725-5.85GHz

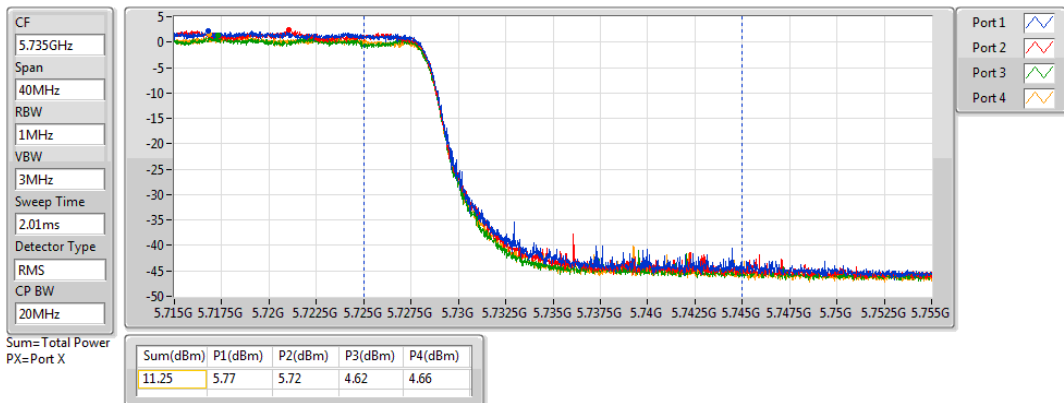

802.11ac VHT80_Nss1,(MCS0)_4TX

AV Power

5690MHz Straddle 5.47-5.725GHz

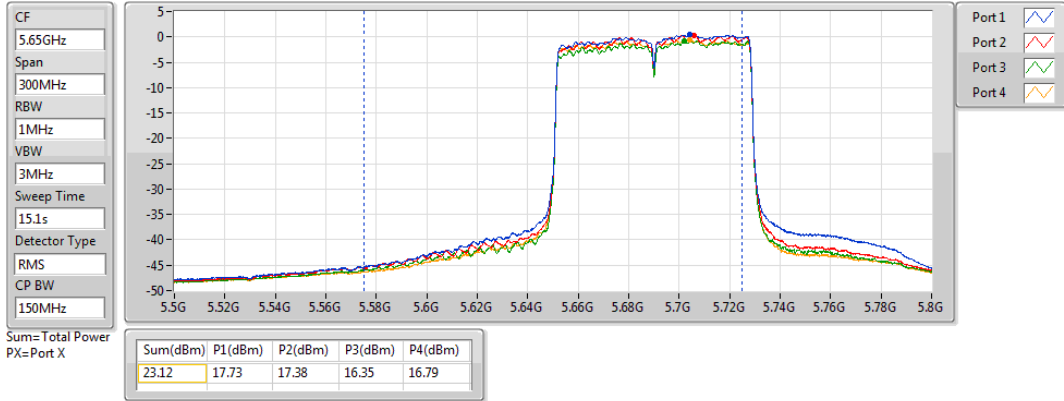

802.11ac VHT80_Nss1,(MCS0)_4TX

AV Power

5690MHz Straddle 5.725-5.85GHz

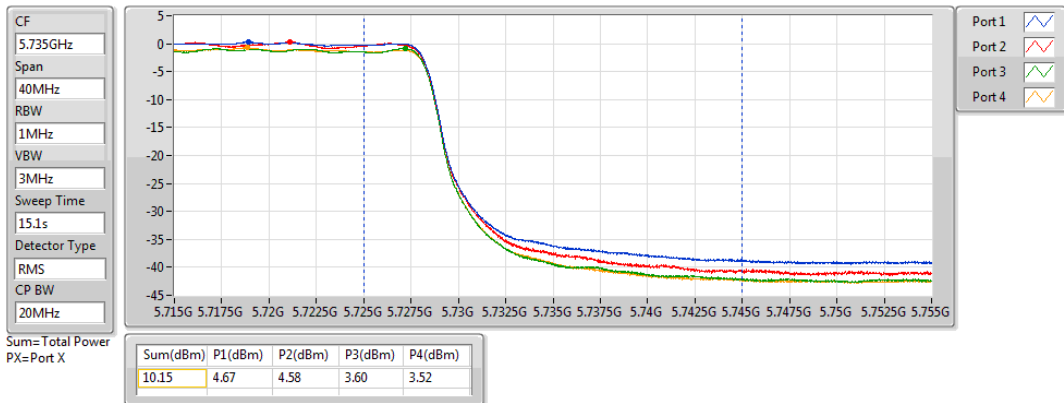

Beamforming mode

Summary

Mode	Total Power (dBm)	Total Power (W)	EIRP (dBm)	EIRP (W)
5.15-5.25GHz	-	-	-	-
802.11ac VHT20-BF_Nss1,(MCS0)_4TX	18.87	0.07709	29.60	0.91201
802.11ac VHT40-BF_Nss1,(MCS0)_4TX	15.64	0.03664	26.37	0.43351
802.11ac VHT80-BF_Nss1,(MCS0)_4TX	15.21	0.03319	25.94	0.39264
5.25-5.35GHz	-	-	-	-
802.11ac VHT20-BF_Nss1,(MCS0)_4TX	18.60	0.07244	29.50	0.89125
802.11ac VHT40-BF_Nss1,(MCS0)_4TX	15.89	0.03882	26.79	0.47753
802.11ac VHT80-BF_Nss1,(MCS0)_4TX	13.64	0.02312	24.54	0.28445
5.47-5.725GHz	-	-	-	-
802.11ac VHT20-BF_Nss1,(MCS0)_4TX	17.96	0.06252	29.02	0.79799
802.11ac VHT40-BF_Nss1,(MCS0)_4TX	15.76	0.03767	26.82	0.48084
802.11ac VHT80-BF_Nss1,(MCS0)_4TX	17.10	0.05129	28.16	0.65464
5.725-5.85GHz	-	-	-	-
802.11ac VHT20-BF_Nss1,(MCS0)_4TX	25.48	0.35318	35.68	3.69828
802.11ac VHT40-BF_Nss1,(MCS0)_4TX	22.52	0.17865	32.72	1.87068
802.11ac VHT80-BF_Nss1,(MCS0)_4TX	19.81	0.09572	30.01	1.00231

Result

Mode	Result	DG (dBi)	Port 1 (dBm)	Port 2 (dBm)	Port 3 (dBm)	Port 4 (dBm)	Total Power (dBm)	Power Limit (dBm)	EIRP (dBm)	EIRP Limit (dBm)
802.11ac VHT20-BF_Nss1,(MCS0)_4TX	-	-	-	-	-	-	-	-	-	-
5180MHz	Pass	10.73	12.77	13.14	12.89	12.07	18.76	19.27	29.49	30.00
5200MHz	Pass	10.73	12.75	12.94	13.03	12.31	18.79	19.27	29.52	30.00
5240MHz	Pass	10.73	12.91	13.06	13.01	12.37	18.87	19.27	29.60	30.00
5260MHz	Pass	10.90	12.42	12.74	12.8	11.97	18.52	19.10	29.42	30.00
5300MHz	Pass	10.90	12.63	12.46	12.72	11.85	18.45	19.10	29.35	30.00
5320MHz	Pass	10.90	12.53	12.87	12.75	12.14	18.60	19.10	29.50	30.00
5500MHz	Pass	11.06	12.24	11.42	11.93	11.3	17.76	18.94	28.82	30.00
5580MHz	Pass	11.06	11.96	11.22	12.31	11.47	17.78	18.94	28.84	30.00
5700MHz	Pass	11.06	12.17	12.33	11.24	11.92	17.96	18.94	29.02	30.00
5720MHz Straddle 5.47-5.725GHz	Pass	11.06	10.71	10.18	9.87	9.82	16.18	17.91	27.24	28.97
5720MHz Straddle 5.725-5.85GHz	Pass	10.20	5.09	5.69	4.6	4.57	11.03	25.80	21.23	36.00
5745MHz	Pass	10.20	19.24	19.52	18.79	18.85	25.13	25.80	35.33	36.00
5785MHz	Pass	10.20	19.65	19.84	19.24	18.91	25.45	25.80	35.65	36.00
5825MHz	Pass	10.20	19.64	19.82	19.43	18.9	25.48	25.80	35.68	36.00
802.11ac VHT40-BF_Nss1,(MCS0)_4TX	-	-	-	-	-	-	-	-	-	-
5190MHz	Pass	10.73	9.7	9.86	9.74	8.99	15.61	19.27	26.34	30.00
5230MHz	Pass	10.73	9.77	9.86	9.79	9.02	15.64	19.27	26.37	30.00
5270MHz	Pass	10.90	9.94	10.1	10.14	9.21	15.88	19.10	26.78	30.00
5310MHz	Pass	10.90	9.84	10.03	10.06	9.54	15.89	19.10	26.79	30.00
5510MHz	Pass	11.06	8.5	8.8	9.12	8.38	14.73	18.94	25.79	30.00
5590MHz	Pass	11.06	9.6	9.94	9.96	9.43	15.76	18.94	26.82	30.00
5670MHz	Pass	11.06	9.64	9.6	9.19	8.94	15.37	18.94	26.43	30.00
5710MHz Straddle 5.47-5.725GHz	Pass	11.06	9.72	9.56	8.48	8.83	15.20	18.94	26.26	30.00
5710MHz Straddle 5.725-5.85GHz	Pass	10.20	-0.25	-0.3	-1.4	-1.36	5.23	25.80	15.43	36.00
5755MHz	Pass	10.20	16.83	16.93	16.33	15.83	22.52	25.80	32.72	36.00
5795MHz	Pass	10.20	16.6	16.53	16.34	15.38	22.26	25.80	32.46	36.00
802.11ac VHT80-BF_Nss1,(MCS0)_4TX	-	-	-	-	-	-	-	-	-	-
5210MHz	Pass	10.73	9.16	9.63	9.41	8.49	15.21	19.27	25.94	30.00
5290MHz	Pass	10.90	7.79	7.9	7.73	6.99	13.64	19.10	24.54	30.00
5530MHz	Pass	11.06	8.31	8.67	8.58	7.88	14.39	18.94	25.45	30.00
5610MHz	Pass	11.06	11.33	11.14	10.99	10.8	17.09	18.94	28.15	30.00
5690MHz Straddle 5.47-5.725GHz	Pass	11.06	11.71	11.36	10.33	10.77	17.10	18.94	28.16	30.00
5690MHz Straddle 5.725-5.85GHz	Pass	10.20	-1.35	-1.44	-2.42	-2.5	4.13	25.80	14.33	36.00
5775MHz	Pass	10.20	14.19	14.14	13.73	13.01	19.81	25.80	30.01	36.00

DG = Directional Gain; Port X = Port X output power

Note:

5150-5250MHz: Directional gain = $10 * \log((10^{4.1/20} + 10^{4.9/20} + 10^{5.3/20} + 10^{4.5/20})^2 / 4)$ = 10.73 dBi > 6 dBi. Limit shall be reduced to 24 dBm – (10.73 dBi – 6 dBi) = 19.27 dBm.

5250-5350MHz: Directional gain = $10 * \log((10^{4.7/20} + 10^{4.2/20} + 10^{6/20} + 10^{4.5/20})^2 / 4)$ = 10.90 dBi > 6 dBi. Limit shall be reduced to 24 dBm – (10.90 dBi – 6 dBi) = 19.1 dBm.

5470-5725MHz: Directional gain = $10 * \log((10^{5.1/20} + 10^{5.3/20} + 10^{5.5/20} + 10^{4.2/20})^2 / 4)$ = 11.06 dBi > 6 dBi. Limit shall be reduced to 24 dBm – (11.06 dBi – 6 dBi) = 18.94 dBm.

5725-5850MHz: Directional gain = $10 * \log((10^{5.1/20} + 10^{5.5/20} + 10^{3/20} + 10^{2.8/20})^2 / 4)$ = 10.20 dBi > 6 dBi. Limit shall be reduced to 30 dBm – (10.20 dBi – 6 dBi) = 25.80 dBm.

802.11ac VHT20-BF_Nss1,(MCS0)_4TX

AV Power

5720MHz Straddle 5.47-5.725GHz

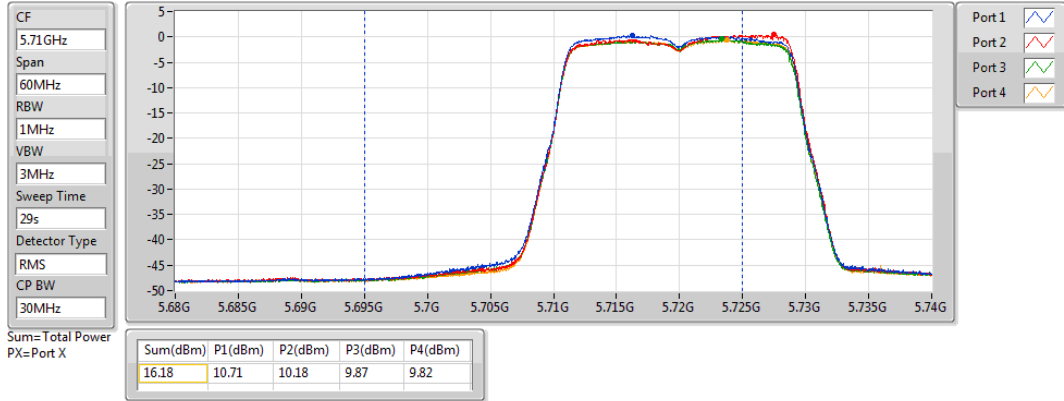

802.11ac VHT20-BF_Nss1,(MCS0)_4TX

AV Power

5720MHz Straddle 5.725-5.85GHz

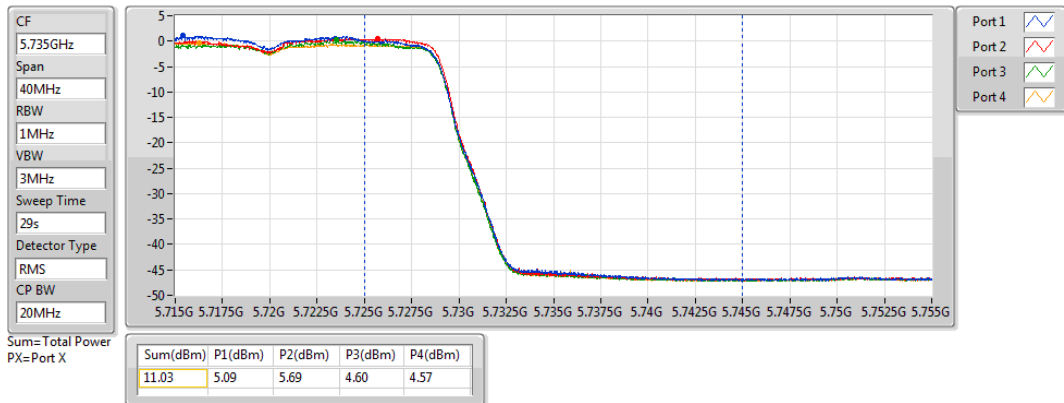

802.11ac VHT20-BF_Nss1,(MCS0)_4TX

AV Power

5720MHz Straddle 5.47-5.725GHz

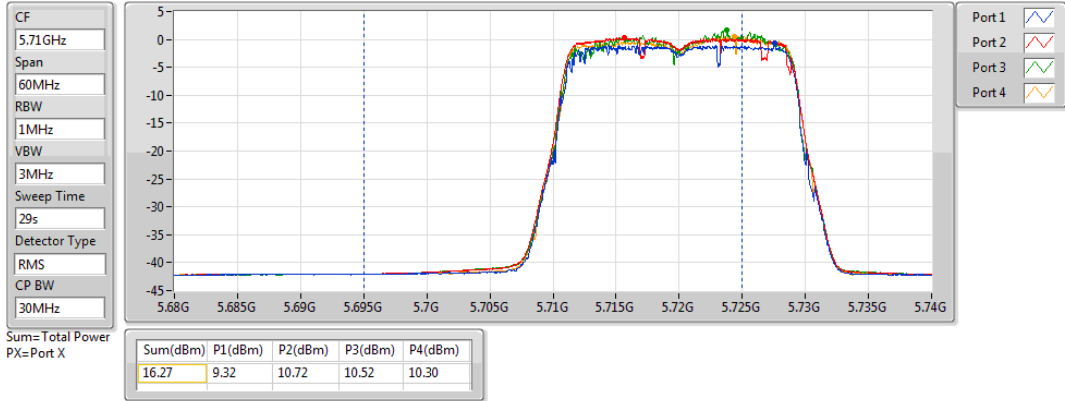

802.11ac VHT20-BF_Nss1,(MCS0)_4TX

AV Power

5720MHz Straddle 5.725-5.85GHz

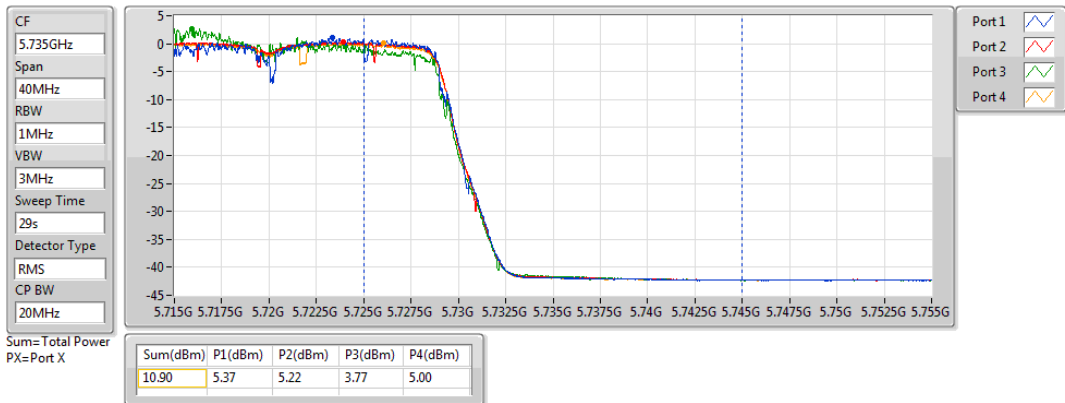

3.4 Peak Power Spectral Density

3.4.1 Limit of Peak Power Spectral Density

Frequency band 5150-5250 MHz		
Operating Mode		Limit
<input type="checkbox"/>	Outdoor access point	17 dBm / MHz
<input type="checkbox"/>	Indoor access point	17 dBm / MHz
<input type="checkbox"/>	Fixed point-to-point access points	17 dBm / MHz
<input checked="" type="checkbox"/>	Client devices	11 dBm / MHz

Frequency Band (MHz)		Limit
<input checked="" type="checkbox"/>	5250 ~ 5350	11 dBm / MHz
<input checked="" type="checkbox"/>	5470 ~ 5725	11 dBm / MHz
<input checked="" type="checkbox"/>	5725 ~ 5850	30 dBm /500 kHz

3.4.2 Test Procedures

For 5150 ~ 5250 MHz / 5250 ~ 5350 MHz / 5470 ~ 5725 MHz

Duty cycle \geq 98 %

1. Set RBW = 1 MHz, VBW = 3 MHz, Sweep time = auto, Detector = RMS.
2. Trace average 100 traces.
3. Use the peak marker function to determine the maximum amplitude level.

Duty cycle $<$ 98 %

1. Set RBW = 1 MHz, VBW = 3 MHz, Detector = RMS.
2. Set sweep time $\geq 10 * (\text{number of points in sweep}) * (\text{total on/off period of the transmitted signal})$.
3. Perform a single sweep.
4. Use the peak marker function to determine the maximum amplitude level.
5. Add $10 \log(1/x)$, where x is the duty cycle.

For 5725 ~ 5850 MHz

Duty cycle \geq 98 %

1. Set RBW = 500 kHz, VBW = 3 MHz, Sweep time = auto, Detector = RMS.
2. Trace average 100 traces.
3. Use the peak marker function to determine the maximum amplitude level.

Duty cycle $<$ 98 %

1. Set RBW = 500 kHz, VBW = 3 MHz, Detector = RMS.
2. Set sweep time $\geq 10 * (\text{number of points in sweep}) * (\text{total on/off period of the transmitted signal})$.
3. Perform a single sweep.
4. Use the peak marker function to determine the maximum amplitude level.
5. Add $10 \log(1/x)$, where x is the duty cycle.

3.4.3 Test Setup

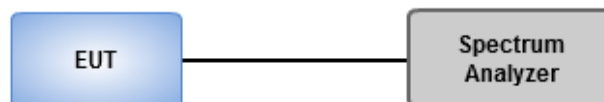

3.4.4 Test Result of Peak Power Spectral Density

Non-beamforming mode

Summary

Mode	PD (dBm/RBW)	EIRP PD (dBm/RBW)
5.15-5.25GHz	-	-
802.11a_Nss1,(6Mbps)_4TX	5.70	16.43
802.11ac VHT20_Nss1,(MCS0)_4TX	5.62	16.35
802.11ac VHT40_Nss1,(MCS0)_4TX	5.51	16.24
802.11ac VHT80_Nss1,(MCS0)_4TX	2.74	13.47
5.25-5.35GHz	-	-
802.11a_Nss1,(6Mbps)_4TX	5.59	16.49
802.11ac VHT20_Nss1,(MCS0)_4TX	5.37	16.27
802.11ac VHT40_Nss1,(MCS0)_4TX	5.82	16.72
802.11ac VHT80_Nss1,(MCS0)_4TX	0.37	11.27
5.47-5.725GHz	-	-
802.11a_Nss1,(6Mbps)_4TX	5.43	16.49
802.11ac VHT20_Nss1,(MCS0)_4TX	5.17	16.23
802.11ac VHT40_Nss1,(MCS0)_4TX	5.46	16.52
802.11ac VHT80_Nss1,(MCS0)_4TX	4.16	15.22
5.725-5.85GHz	-	-
802.11a_Nss1,(6Mbps)_4TX	12.90	23.10
802.11ac VHT20_Nss1,(MCS0)_4TX	13.03	23.23
802.11ac VHT40_Nss1,(MCS0)_4TX	11.00	21.20
802.11ac VHT80_Nss1,(MCS0)_4TX	5.20	15.40

RBW = 500kHz for 5.725-5.85GHz band / 1MHz for other band;

Result

Mode	Result	DG (dBi)	Port 1 (dBm/RBW)	Port 2 (dBm/RBW)	Port 3 (dBm/RBW)	Port 4 (dBm/RBW)	PD (dBm/RBW)	PD Limit (dBm/RBW)	EIRP PD (dBm/RBW)	EIRP PD Limit (dBm/RBW)
802.11a_Nss1,(6Mbps)_4TX	-	-	-	-	-	-	-	-	-	-
5180MHz	Pass	10.73	-0.31	-0.17	-0.80	-0.99	5.45	6.27	16.18	17.00
5200MHz	Pass	10.73	-0.34	-0.15	-0.75	-0.95	5.48	6.27	16.21	17.00
5240MHz	Pass	10.73	-0.10	0.03	-0.67	-0.59	5.70	6.27	16.43	17.00
5260MHz	Pass	10.90	-0.46	-0.34	-0.74	-1.00	5.39	6.10	16.29	17.00
5300MHz	Pass	10.90	-0.11	-0.13	-0.66	-0.82	5.59	6.10	16.49	17.00
5320MHz	Pass	10.90	-0.16	-0.26	-0.61	-0.72	5.59	6.10	16.49	17.00
5500MHz	Pass	11.06	-0.27	-0.37	-1.03	-1.04	5.34	5.94	16.40	17.00
5580MHz	Pass	11.06	0.06	-0.30	-0.87	-0.52	5.43	5.94	16.49	17.00
5700MHz	Pass	11.06	-0.60	-0.67	-1.19	-1.07	5.12	5.94	16.18	17.00
5720MHz Straddle 5.47-5.725GHz	Pass	11.06	-0.63	-0.73	-1.25	-1.21	5.06	5.94	16.12	17.00
5720MHz Straddle 5.725-5.85GHz	Pass	10.20	-2.48	-2.76	-3.87	-2.82	3.02	25.80	13.22	36.00
5745MHz	Pass	10.20	7.40	7.21	6.46	6.43	12.90	25.80	23.10	36.00
5785MHz	Pass	10.20	7.18	6.90	6.29	6.04	12.56	25.80	22.76	36.00
5825MHz	Pass	10.20	6.72	6.63	5.91	5.45	12.20	25.80	22.40	36.00
802.11ac VHT20_Nss1,(MCS0)_4TX	-	-	-	-	-	-	-	-	-	-
5180MHz	Pass	10.73	0.20	-0.01	-0.36	-0.83	5.39	6.27	16.12	17.00
5200MHz	Pass	10.73	-0.11	0.13	-0.45	-0.77	5.45	6.27	16.18	17.00
5240MHz	Pass	10.73	-0.03	0.12	-0.16	-0.57	5.62	6.27	16.35	17.00
5260MHz	Pass	10.90	-0.41	-0.12	-0.62	-1.04	5.16	6.10	16.06	17.00
5300MHz	Pass	10.90	-0.06	-0.26	-0.71	-0.87	5.29	6.10	16.19	17.00
5320MHz	Pass	10.90	0.02	-0.14	-0.46	-0.74	5.37	6.10	16.27	17.00
5500MHz	Pass	11.06	-0.56	-0.07	-1.07	-0.99	5.00	5.94	16.06	17.00
5580MHz	Pass	11.06	-0.31	0.13	-0.73	-0.68	5.17	5.94	16.23	17.00
5700MHz	Pass	11.06	-0.09	-0.06	-1.10	-0.76	5.11	5.94	16.17	17.00
5720MHz Straddle 5.47-5.725GHz	Pass	11.06	-0.34	0.00	-1.41	-0.95	4.96	5.94	16.02	17.00
5720MHz Straddle 5.725-5.85GHz	Pass	10.20	-2.00	-1.73	-2.78	-2.57	3.49	25.80	13.69	36.00
5745MHz	Pass	10.20	7.89	7.68	6.65	6.74	13.03	25.80	23.23	36.00
5785MHz	Pass	10.20	7.52	7.42	6.71	6.39	12.71	25.80	22.91	36.00
5825MHz	Pass	10.20	7.17	7.13	6.16	5.90	12.21	25.80	22.41	36.00
802.11ac VHT40_Nss1,(MCS0)_4TX	-	-	-	-	-	-	-	-	-	-
5190MHz	Pass	10.73	-0.19	0.05	-0.47	-0.84	5.48	6.27	16.21	17.00
5230MHz	Pass	10.73	0.03	-0.12	-0.61	-1.00	5.51	6.27	16.24	17.00
5270MHz	Pass	10.90	0.10	0.09	-0.02	-0.06	5.64	6.10	16.54	17.00
5310MHz	Pass	10.90	0.34	0.43	-0.33	-0.28	5.82	6.10	16.72	17.00
5510MHz	Pass	11.06	-1.20	-0.78	-1.94	-1.60	4.39	5.94	15.45	17.00
5590MHz	Pass	11.06	0.07	0.32	-0.46	-0.37	5.28	5.94	16.34	17.00
5670MHz	Pass	11.06	0.05	0.35	-1.24	-0.66	5.20	5.94	16.26	17.00
5710MHz Straddle 5.47-5.725GHz	Pass	11.06	0.19	0.44	-0.58	-0.48	5.46	5.94	16.52	17.00
5710MHz Straddle 5.725-5.85GHz	Pass	10.20	-1.81	-1.65	-2.73	-3.02	3.34	25.80	13.54	36.00

Mode	Result	DG (dBi)	Port 1 (dBm/RBW)	Port 2 (dBm/RBW)	Port 3 (dBm/RBW)	Port 4 (dBm/RBW)	PD (dBm/RBW)	PD Limit (dBm/RBW)	EIRP PD (dBm/RBW)	EIRP PD Limit (dBm/RBW)
5755MHz	Pass	10.20	5.63	6.21	4.80	4.54	11.00	25.80	21.20	36.00
5795MHz	Pass	10.20	5.28	5.62	4.70	4.28	10.60	25.80	20.80	36.00
802.11ac VHT80_Nss1,(MCS0)_4TX	-	-	-	-	-	-	-	-	-	-
5210MHz	Pass	10.73	-3.16	-2.72	-3.40	-3.92	2.74	6.27	13.47	17.00
5290MHz	Pass	10.90	-5.41	-5.34	-5.91	-5.99	0.37	6.10	11.27	17.00
5530MHz	Pass	11.06	-4.65	-4.16	-5.39	-5.12	1.10	5.94	12.16	17.00
5610MHz	Pass	11.06	-1.09	-1.63	-2.13	-2.17	3.79	5.94	14.85	17.00
5690MHz Straddle 5.47-5.725GHz	Pass	11.06	-1.15	-1.18	-2.26	-2.16	4.16	5.94	15.22	17.00
5690MHz Straddle 5.725-5.85GHz	Pass	10.20	-3.27	-3.13	-3.96	-4.40	2.25	25.80	12.45	36.00
5775MHz	Pass	10.20	-0.15	-0.28	-1.20	-1.50	5.20	25.80	15.40	36.00

DG = Directional Gain; **RBW** = 500kHz for 5.725-5.85GHz band / 1MHz for other band;

PD = trace bin-by-bin of each transmits port summing can be performed maximum power density; **Port X** = Port Xpower density;

Note:

5150-5250MHz: Directional gain = $10 * \log((10^{4.1/20} + 10^{4.9/20} + 10^{5.3/20} + 10^{4.5/20})^2 / 4)$ = 10.73 dBi > 6 dBi. Limit shall be reduced to 11 dBm – (10.73 dBi – 6 dBi) = 6.27 dBm.

5250-5350MHz: Directional gain = $10 * \log((10^{4.7/20} + 10^{4.2/20} + 10^{6/20} + 10^{4.5/20})^2 / 4)$ = 10.90 dBi > 6 dBi. Limit shall be reduced to 11 dBm – (10.90 dBi – 6 dBi) = 6.10 dBm.

5470-5725MHz: Directional gain = $10 * \log((10^{5.1/20} + 10^{5.3/20} + 10^{5.5/20} + 10^{4.2/20})^2 / 4)$ = 11.06 dBi > 6 dBi. Limit shall be reduced to 11 dBm – (11.06 dBi – 6 dBi) = 5.94 dBm.

5725-5850MHz: Directional gain = $10 * \log((10^{5.1/20} + 10^{5.5/20} + 10^{3/20} + 10^{2.8/20})^2 / 4)$ = 10.20 dBi > 6 dBi. Limit shall be reduced to 30 dBm – (10.20 dBi – 6 dBi) = 25.80 dBm.

802.11a_Nss1,(6Mbps)_4TX

PSD

5180MHz

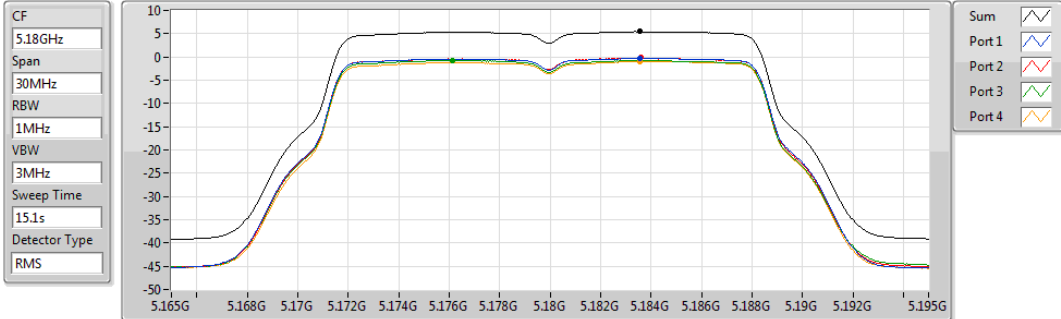

Sum	PD	Port 1	Port 2	Port 3	Port 4
(dBm/RBW)	(dBm/RBW)	(dBm/RBW)	(dBm/RBW)	(dBm/RBW)	(dBm/RBW)
5.45	5.45	-0.31	-0.17	-0.80	-0.99

802.11a_Nss1,(6Mbps)_4TX

PSD

5200MHz

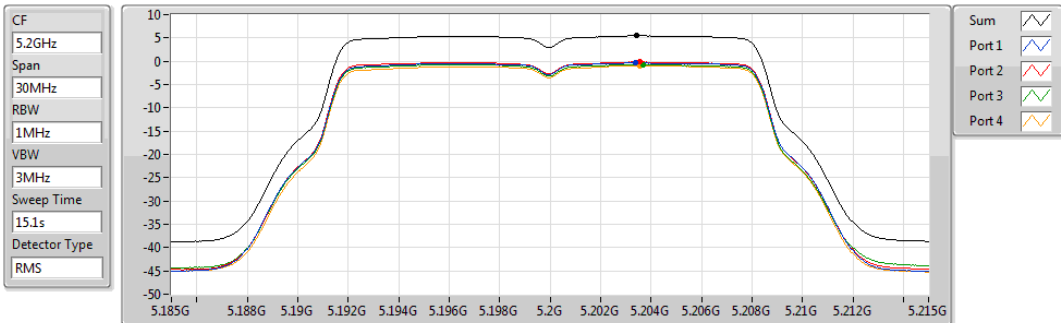

Sum	PD	Port 1	Port 2	Port 3	Port 4
(dBm/RBW)	(dBm/RBW)	(dBm/RBW)	(dBm/RBW)	(dBm/RBW)	(dBm/RBW)
5.48	5.48	-0.34	-0.15	-0.75	-0.95

802.11a_Nss1,(6Mbps)_4TX

PSD

5240MHz

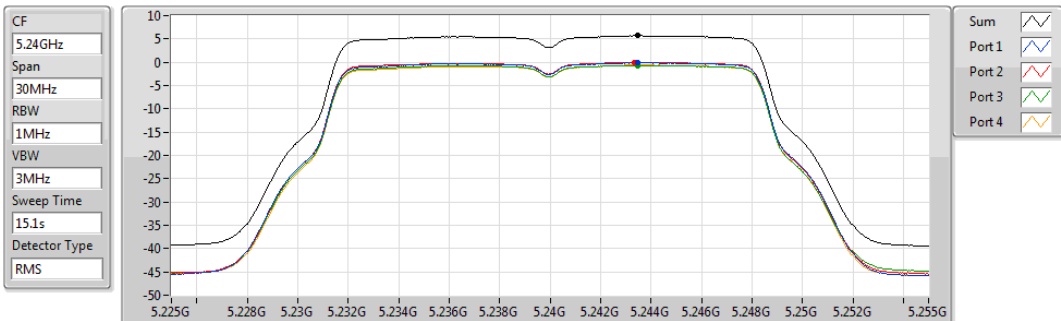

Sum	PD	Port 1	Port 2	Port 3	Port 4
(dBm/RBW)	(dBm/RBW)	(dBm/RBW)	(dBm/RBW)	(dBm/RBW)	(dBm/RBW)
5.70	5.70	-0.10	0.03	-0.67	-0.59

802.11a_Nss1,(6Mbps)_4TX

PSD

5260MHz

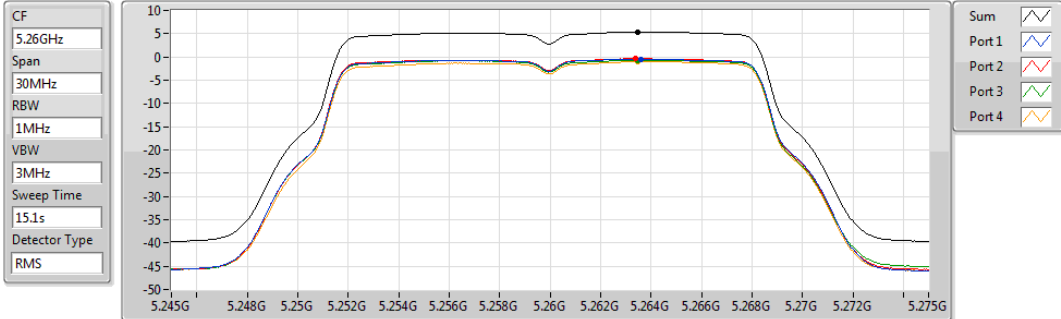

Sum	PD	Port 1	Port 2	Port 3	Port 4
(dBm/RBW)	(dBm/RBW)	(dBm/RBW)	(dBm/RBW)	(dBm/RBW)	(dBm/RBW)
5.39	5.39	-0.46	-0.34	-0.74	-1.00

802.11a_Nss1,(6Mbps)_4TX

PSD

5300MHz

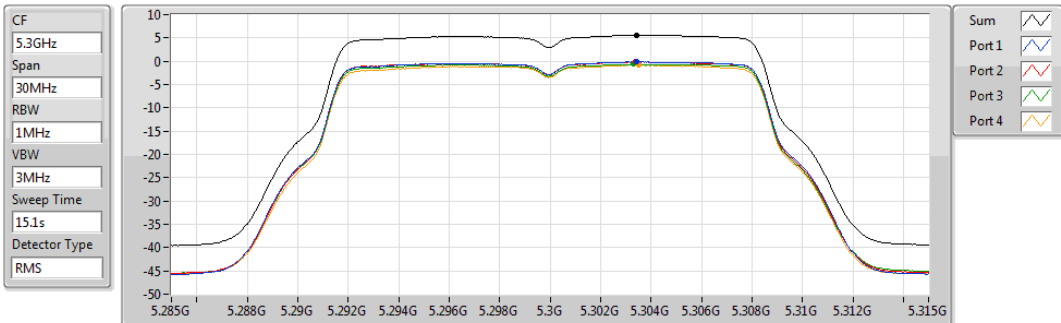

Sum	PD	Port 1	Port 2	Port 3	Port 4
(dBm/RBW)	(dBm/RBW)	(dBm/RBW)	(dBm/RBW)	(dBm/RBW)	(dBm/RBW)
5.59	5.59	-0.11	-0.13	-0.66	-0.82

802.11a_Nss1,(6Mbps)_4TX

PSD

5320MHz

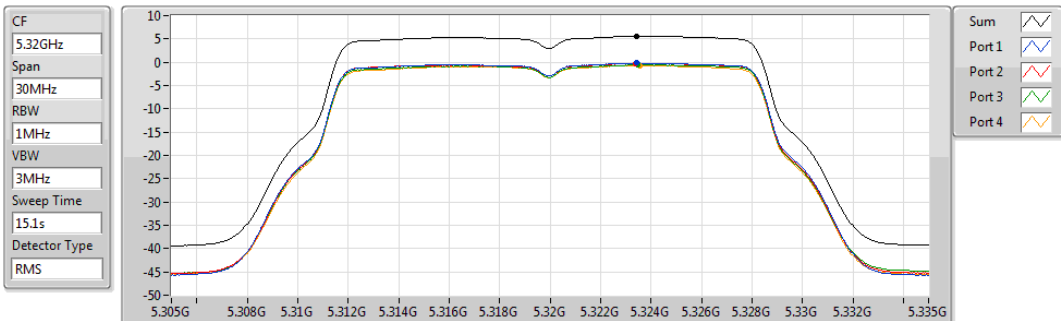

Sum	PD	Port 1	Port 2	Port 3	Port 4
(dBm/RBW)	(dBm/RBW)	(dBm/RBW)	(dBm/RBW)	(dBm/RBW)	(dBm/RBW)
5.59	5.59	-0.16	-0.26	-0.61	-0.72

802.11a_Nss1,(6Mbps)_4TX

PSD

5500MHz

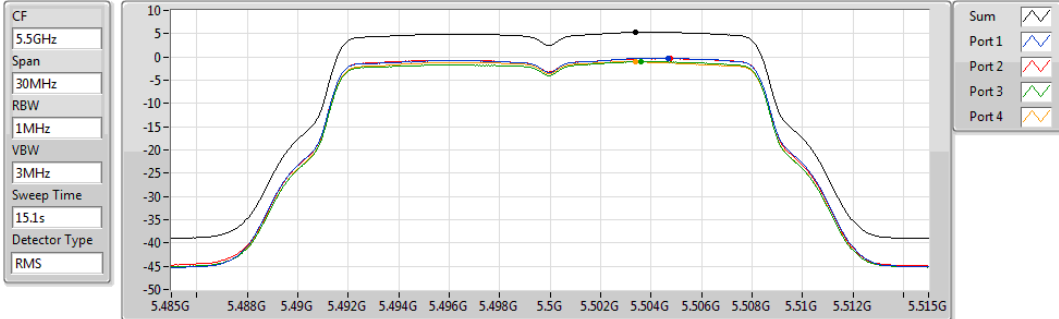

Sum	PD	Port 1	Port 2	Port 3	Port 4
(dBm/RBW)	(dBm/RBW)	(dBm/RBW)	(dBm/RBW)	(dBm/RBW)	(dBm/RBW)
5.34	5.34	-0.27	-0.37	-1.03	-1.04

802.11a_Nss1,(6Mbps)_4TX

PSD

5580MHz

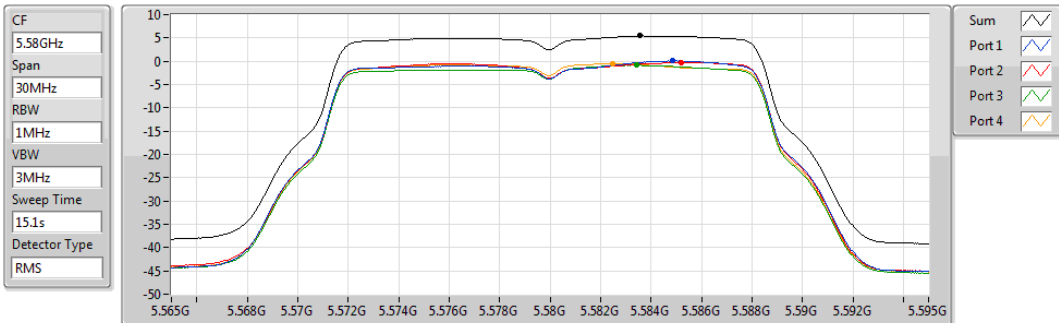

Sum	PD	Port 1	Port 2	Port 3	Port 4
(dBm/RBW)	(dBm/RBW)	(dBm/RBW)	(dBm/RBW)	(dBm/RBW)	(dBm/RBW)
5.43	5.43	0.06	-0.30	-0.87	-0.52

802.11a_Nss1,(6Mbps)_4TX

PSD

5700MHz

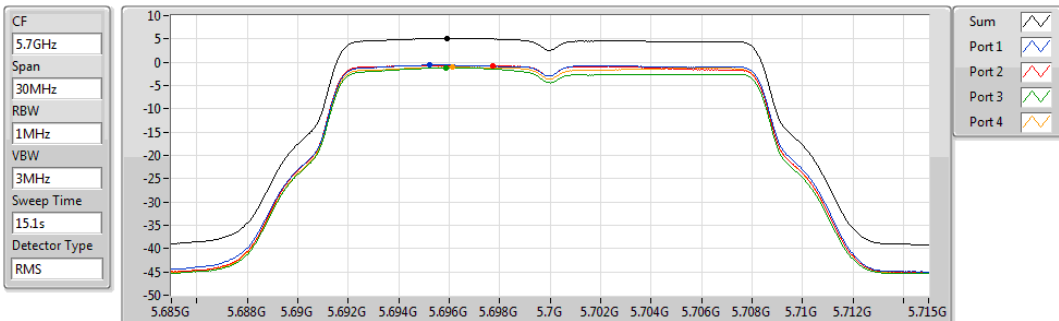

Sum	PD	Port 1	Port 2	Port 3	Port 4
(dBm/RBW)	(dBm/RBW)	(dBm/RBW)	(dBm/RBW)	(dBm/RBW)	(dBm/RBW)
5.12	5.12	-0.60	-0.67	-1.19	-1.07

802.11a_Nss1,(6Mbps)_4TX

PSD

5720MHz Straddle 5.47-5.725GHz

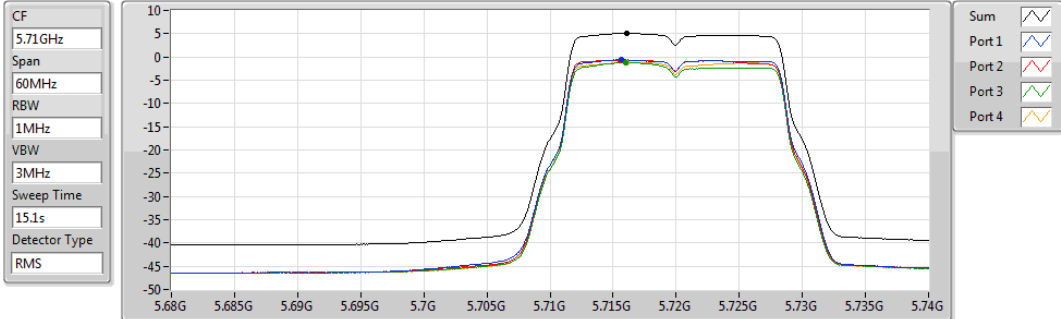

Sum	PD	Port 1	Port 2	Port 3	Port 4
(dBm/RBW)	(dBm/RBW)	(dBm/RBW)	(dBm/RBW)	(dBm/RBW)	(dBm/RBW)
5.06	5.06	-0.63	-0.73	-1.25	-1.21

802.11a_Nss1,(6Mbps)_4TX

PSD

5720MHz Straddle 5.725-5.85GHz

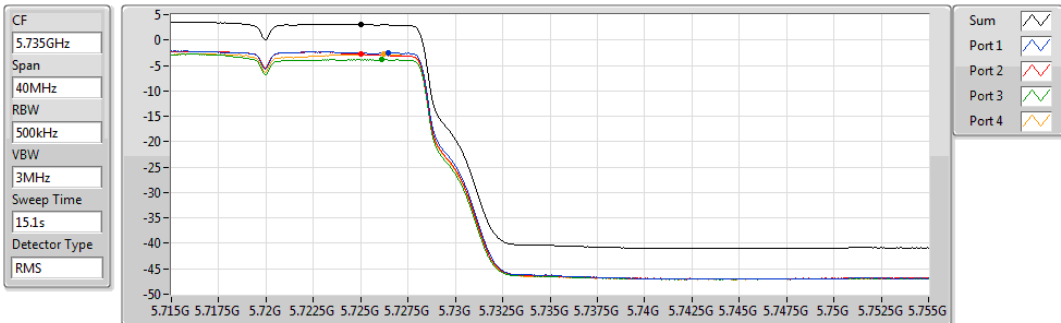

Sum	PD	Port 1	Port 2	Port 3	Port 4
(dBm/RBW)	(dBm/RBW)	(dBm/RBW)	(dBm/RBW)	(dBm/RBW)	(dBm/RBW)
3.02	3.02	-2.48	-2.76	-3.87	-2.82

802.11a_Nss1,(6Mbps)_4TX

PSD

5745MHz

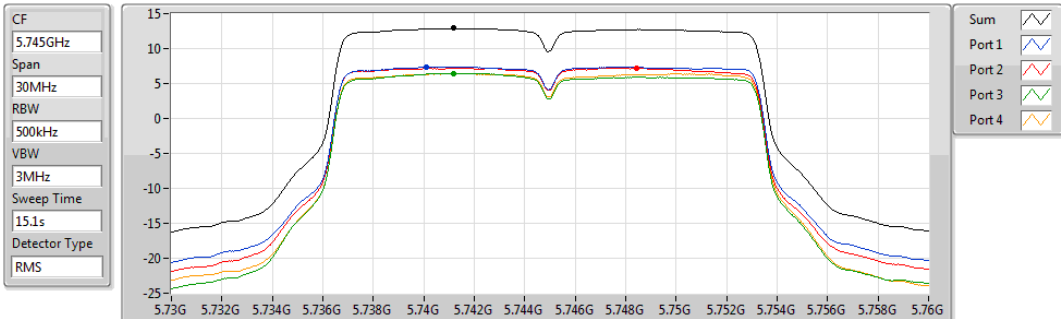

Sum	PD	Port 1	Port 2	Port 3	Port 4
(dBm/RBW)	(dBm/RBW)	(dBm/RBW)	(dBm/RBW)	(dBm/RBW)	(dBm/RBW)
12.90	12.90	7.40	7.21	6.46	6.43

802.11a_Nss1,(6Mbps)_4TX

PSD

5785MHz

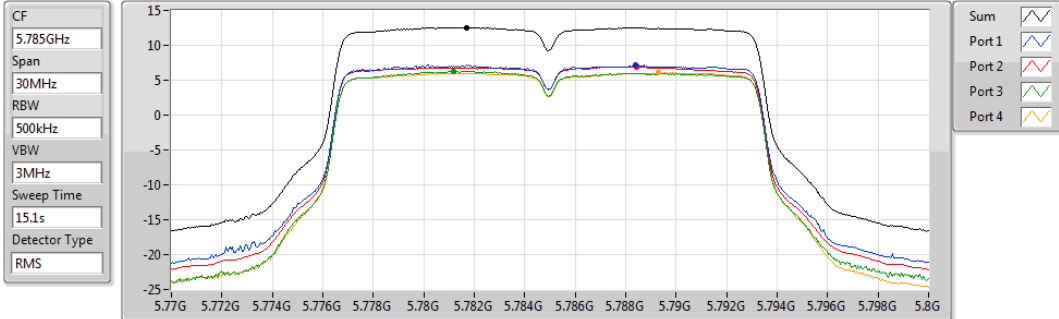

Sum	PD	Port 1	Port 2	Port 3	Port 4
(dBm/RBW)	(dBm/RBW)	(dBm/RBW)	(dBm/RBW)	(dBm/RBW)	(dBm/RBW)
12.56	12.56	7.18	6.90	6.29	6.04

802.11a_Nss1,(6Mbps)_4TX

PSD

5825MHz

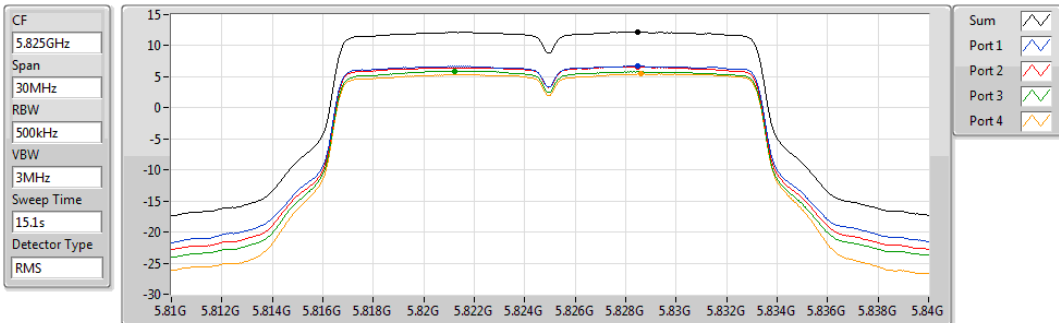

Sum	PD	Port 1	Port 2	Port 3	Port 4
(dBm/RBW)	(dBm/RBW)	(dBm/RBW)	(dBm/RBW)	(dBm/RBW)	(dBm/RBW)
12.20	12.20	6.72	6.63	5.91	5.45

802.11ac VHT20_Nss1,(MCS0)_4TX

PSD

5180MHz

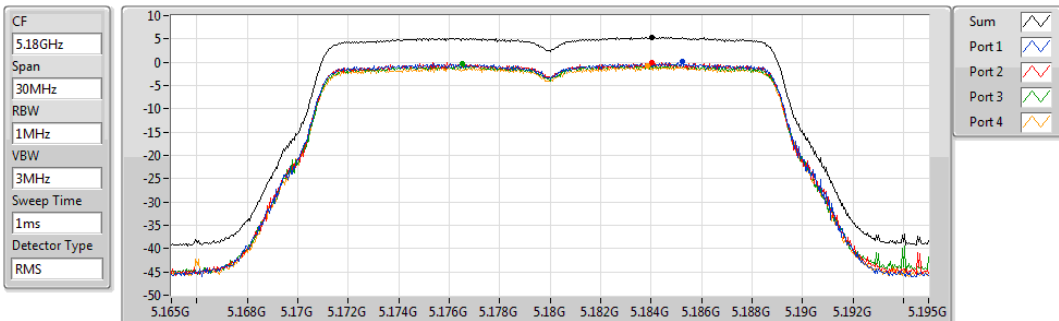

Sum	PD	Port 1	Port 2	Port 3	Port 4
(dBm/RBW)	(dBm/RBW)	(dBm/RBW)	(dBm/RBW)	(dBm/RBW)	(dBm/RBW)
5.39	5.39	0.20	-0.01	-0.36	-0.83

802.11ac VHT20_Nss1,(MCS0)_4TX

PSD

5200MHz

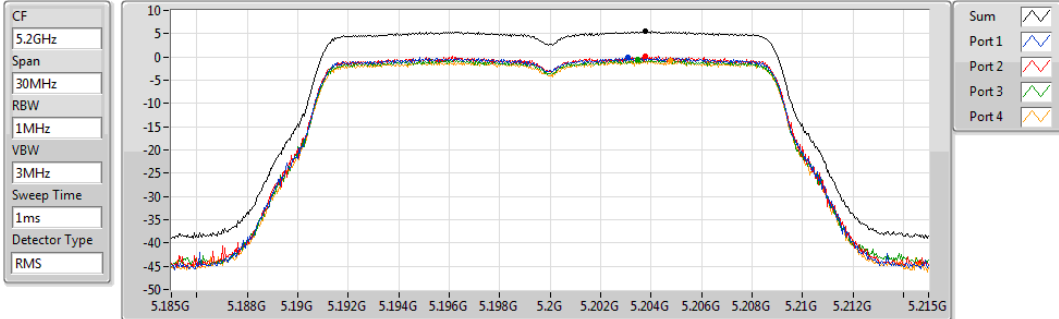

Sum	PD	Port 1	Port 2	Port 3	Port 4
(dBm/1MHz)	(dBm/1MHz)	(dBm/1MHz)	(dBm/1MHz)	(dBm/1MHz)	(dBm/1MHz)
5.45	5.45	-0.11	0.13	-0.45	-0.77

802.11ac VHT20_Nss1,(MCS0)_4TX

PSD

5240MHz

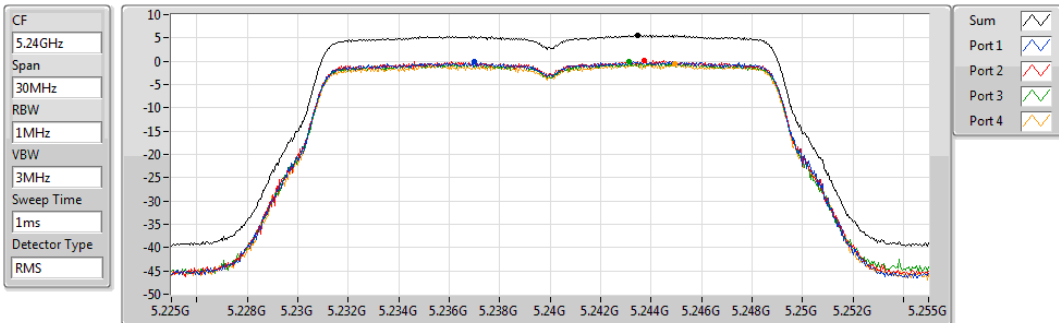

Sum	PD	Port 1	Port 2	Port 3	Port 4
(dBm/1MHz)	(dBm/1MHz)	(dBm/1MHz)	(dBm/1MHz)	(dBm/1MHz)	(dBm/1MHz)
5.62	5.62	-0.03	0.12	-0.16	-0.57

802.11ac VHT20_Nss1,(MCS0)_4TX

PSD

5260MHz

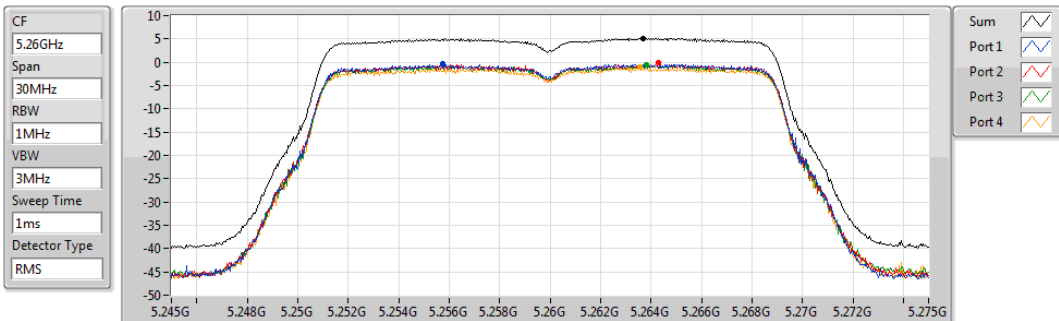

Sum	PD	Port 1	Port 2	Port 3	Port 4
(dBm/1MHz)	(dBm/1MHz)	(dBm/1MHz)	(dBm/1MHz)	(dBm/1MHz)	(dBm/1MHz)
5.16	5.16	-0.41	-0.12	-0.62	-1.04

802.11ac VHT20_Nss1,(MCS0)_4TX

PSD

5300MHz

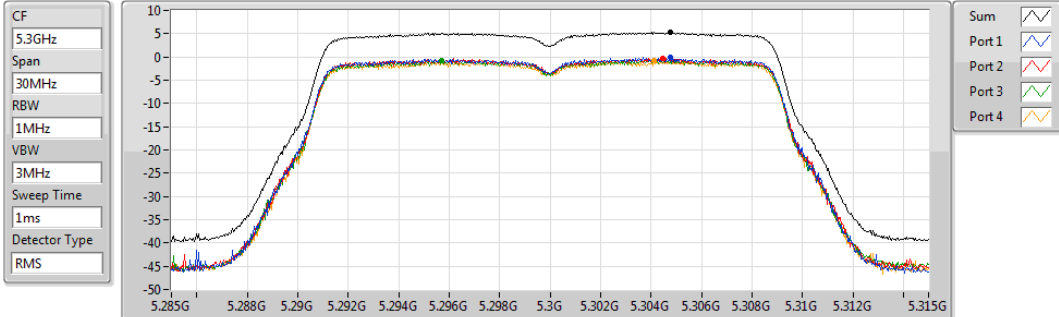

Sum	PD	Port 1	Port 2	Port 3	Port 4
(dBm/RBW)	(dBm/RBW)	(dBm/RBW)	(dBm/RBW)	(dBm/RBW)	(dBm/RBW)
5.29	5.29	-0.06	-0.26	-0.71	-0.87

802.11ac VHT20_Nss1,(MCS0)_4TX

PSD

5320MHz

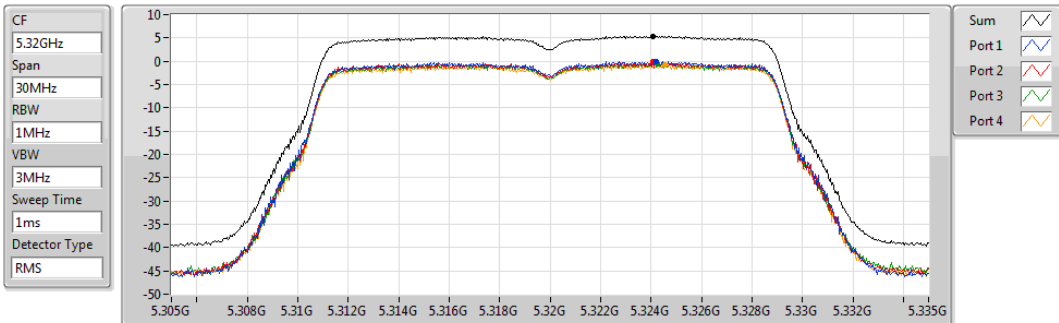

Sum	PD	Port 1	Port 2	Port 3	Port 4
(dBm/RBW)	(dBm/RBW)	(dBm/RBW)	(dBm/RBW)	(dBm/RBW)	(dBm/RBW)
5.37	5.37	0.02	-0.14	-0.46	-0.74

802.11ac VHT20_Nss1,(MCS0)_4TX

PSD

5500MHz

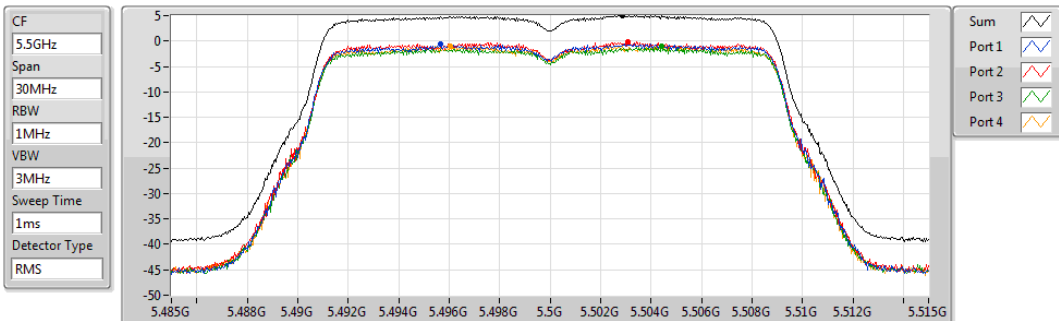

Sum	PD	Port 1	Port 2	Port 3	Port 4
(dBm/RBW)	(dBm/RBW)	(dBm/RBW)	(dBm/RBW)	(dBm/RBW)	(dBm/RBW)
5.00	5.00	-0.56	-0.07	-1.07	-0.99

802.11ac VHT20_Nss1,(MCS0)_4TX

PSD

5580MHz

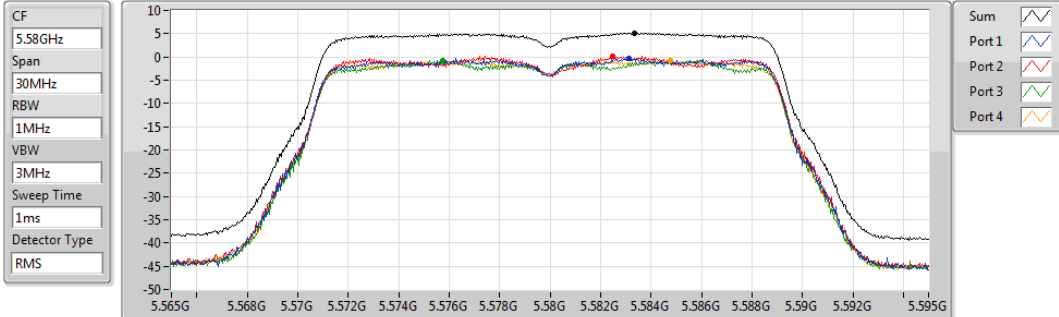

Sum	PD	Port 1	Port 2	Port 3	Port 4
(dBm/100kHz)	(dBm/100kHz)	(dBm/100kHz)	(dBm/100kHz)	(dBm/100kHz)	(dBm/100kHz)
5.17	5.17	-0.31	0.13	-0.73	-0.68

802.11ac VHT20_Nss1,(MCS0)_4TX

PSD

5700MHz

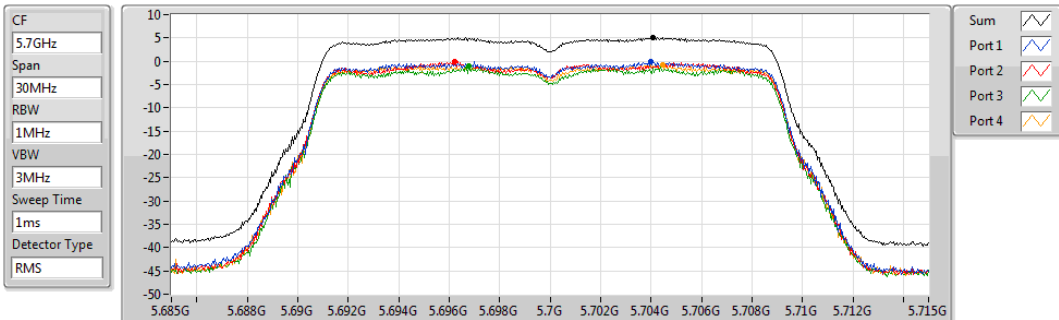

Sum	PD	Port 1	Port 2	Port 3	Port 4
(dBm/100kHz)	(dBm/100kHz)	(dBm/100kHz)	(dBm/100kHz)	(dBm/100kHz)	(dBm/100kHz)
5.11	5.11	-0.09	-0.06	-1.10	-0.76

802.11ac VHT20_Nss1,(MCS0)_4TX

PSD

5720MHz Straddle 5.47-5.725GHz

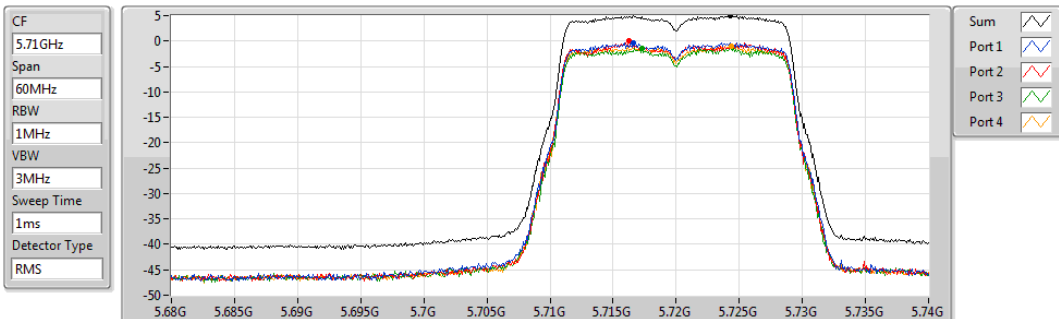

Sum	PD	Port 1	Port 2	Port 3	Port 4
(dBm/100kHz)	(dBm/100kHz)	(dBm/100kHz)	(dBm/100kHz)	(dBm/100kHz)	(dBm/100kHz)
4.96	4.96	-0.34	0.00	-1.41	-0.95

802.11ac VHT20_Nss1,(MCS0)_4TX

PSD

5720MHz Straddle 5.725-5.85GHz

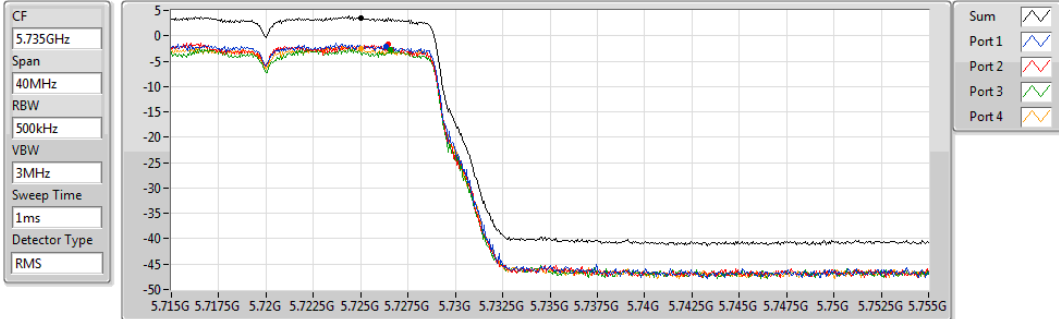

Sum	PD	Port 1	Port 2	Port 3	Port 4
(dBm/RBW)	(dBm/RBW)	(dBm/RBW)	(dBm/RBW)	(dBm/RBW)	(dBm/RBW)
3.49	3.49	-2.00	-1.73	-2.78	-2.57

802.11ac VHT20_Nss1,(MCS0)_4TX

PSD

5745MHz

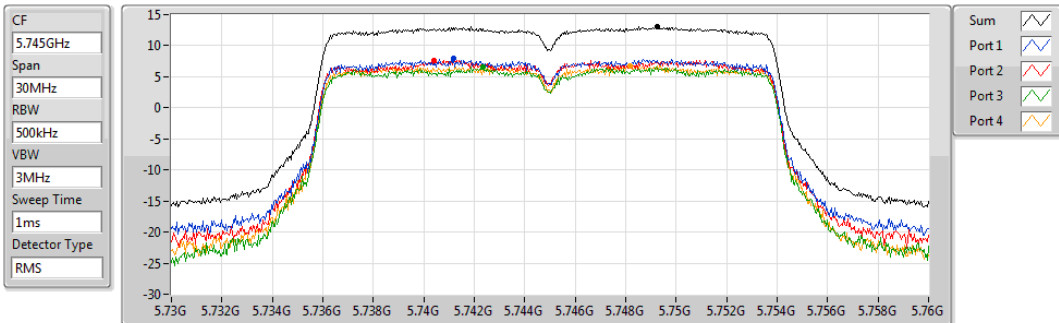

Sum	PD	Port 1	Port 2	Port 3	Port 4
(dBm/RBW)	(dBm/RBW)	(dBm/RBW)	(dBm/RBW)	(dBm/RBW)	(dBm/RBW)
13.03	13.03	7.89	7.68	6.65	6.74

802.11ac VHT20_Nss1,(MCS0)_4TX

PSD

5785MHz

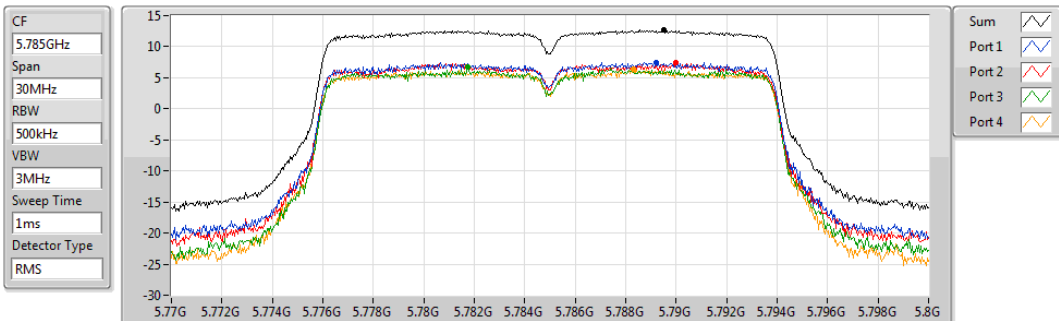

Sum	PD	Port 1	Port 2	Port 3	Port 4
(dBm/RBW)	(dBm/RBW)	(dBm/RBW)	(dBm/RBW)	(dBm/RBW)	(dBm/RBW)
12.71	12.71	7.52	7.42	6.71	6.39

802.11ac VHT20_Nss1,(MCS0)_4TX

PSD

5825MHz

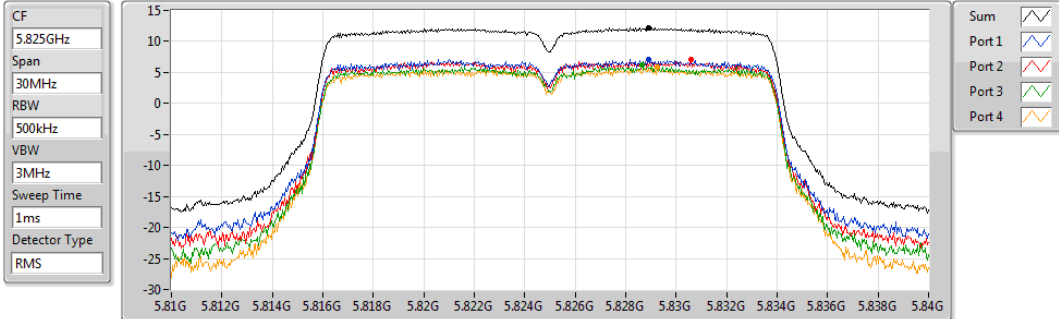

Sum	PD	Port 1	Port 2	Port 3	Port 4
(dBm/RBW)	(dBm/RBW)	(dBm/RBW)	(dBm/RBW)	(dBm/RBW)	(dBm/RBW)
12.21	12.21	7.17	7.13	6.16	5.90

802.11ac VHT40_Nss1,(MCS0)_4TX

PSD

5190MHz

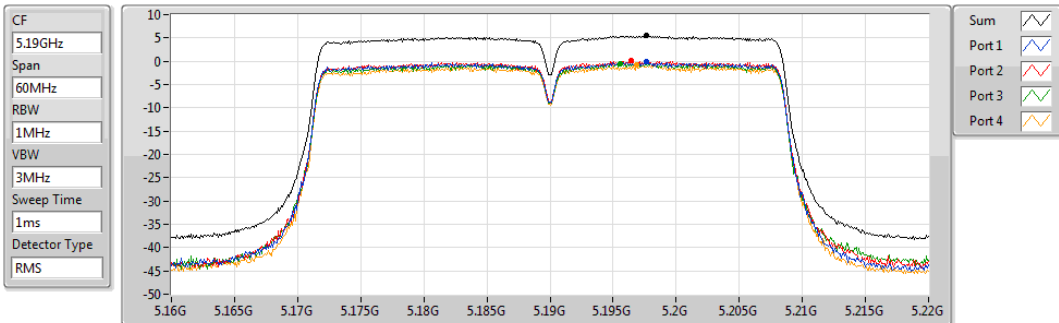

Sum	PD	Port 1	Port 2	Port 3	Port 4
(dBm/RBW)	(dBm/RBW)	(dBm/RBW)	(dBm/RBW)	(dBm/RBW)	(dBm/RBW)
5.48	5.48	-0.19	0.05	-0.47	-0.84

802.11ac VHT40_Nss1,(MCS0)_4TX

PSD

5230MHz

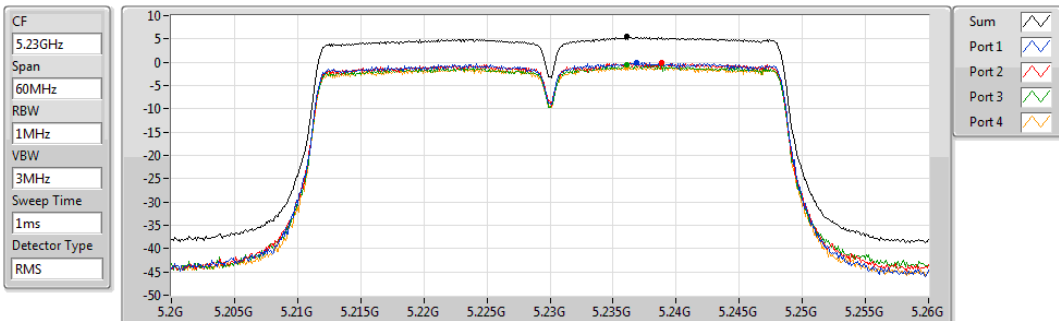

Sum	PD	Port 1	Port 2	Port 3	Port 4
(dBm/RBW)	(dBm/RBW)	(dBm/RBW)	(dBm/RBW)	(dBm/RBW)	(dBm/RBW)
5.51	5.51	0.03	-0.12	-0.61	-1.00

802.11ac VHT40_Nss1,(MCS0)_4TX

PSD

5270MHz

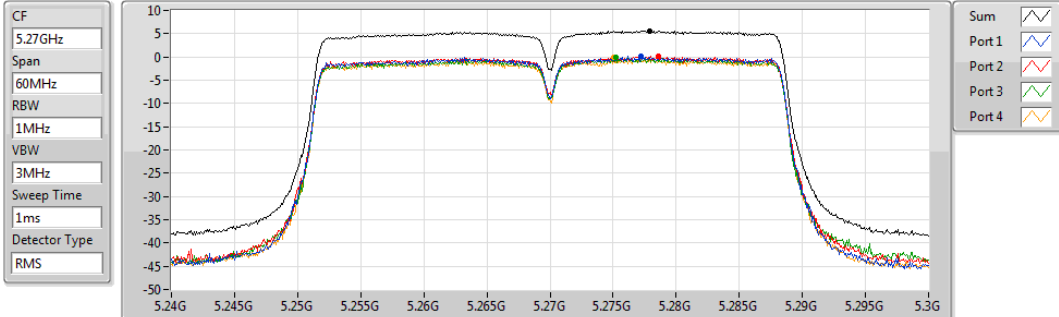

Sum	PD	Port 1	Port 2	Port 3	Port 4
(dBm/100kHz)	(dBm/100kHz)	(dBm/100kHz)	(dBm/100kHz)	(dBm/100kHz)	(dBm/100kHz)
5.64	5.64	0.10	0.09	-0.02	-0.06

802.11ac VHT40_Nss1,(MCS0)_4TX

PSD

5310MHz

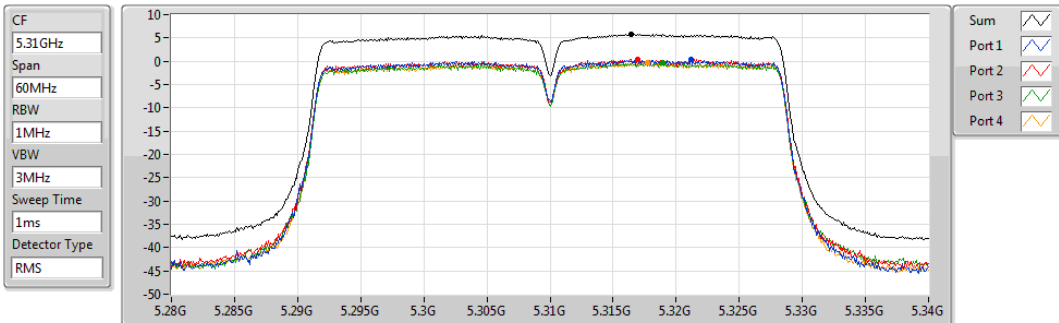

Sum	PD	Port 1	Port 2	Port 3	Port 4
(dBm/100kHz)	(dBm/100kHz)	(dBm/100kHz)	(dBm/100kHz)	(dBm/100kHz)	(dBm/100kHz)
5.82	5.82	0.34	0.43	-0.33	-0.28

802.11ac VHT40_Nss1,(MCS0)_4TX

PSD

5510MHz

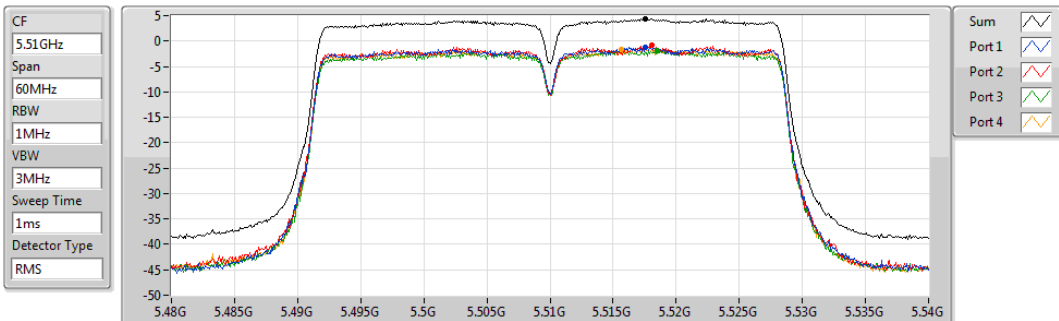

Sum	PD	Port 1	Port 2	Port 3	Port 4
(dBm/100kHz)	(dBm/100kHz)	(dBm/100kHz)	(dBm/100kHz)	(dBm/100kHz)	(dBm/100kHz)
4.39	4.39	-1.20	-0.78	-1.94	-1.60

802.11ac VHT40_Nss1,(MCS0)_4TX

PSD

5590MHz

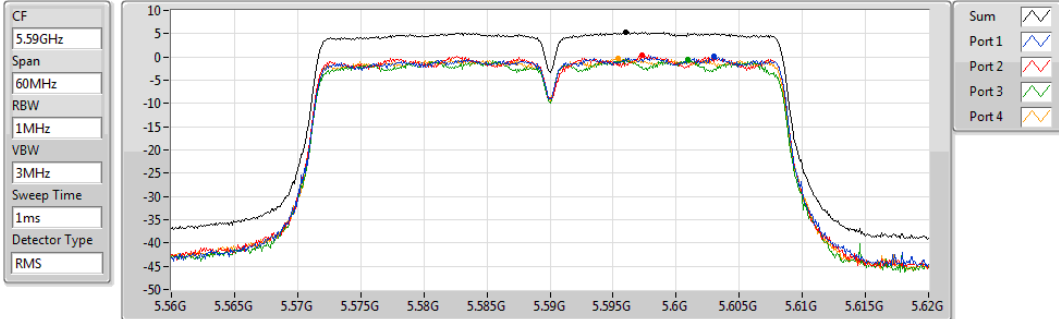

Sum	PD	Port 1	Port 2	Port 3	Port 4
(dBm/RBW)	(dBm/RBW)	(dBm/RBW)	(dBm/RBW)	(dBm/RBW)	(dBm/RBW)
5.28	5.28	0.07	0.32	-0.46	-0.37

802.11ac VHT40_Nss1,(MCS0)_4TX

PSD

5670MHz

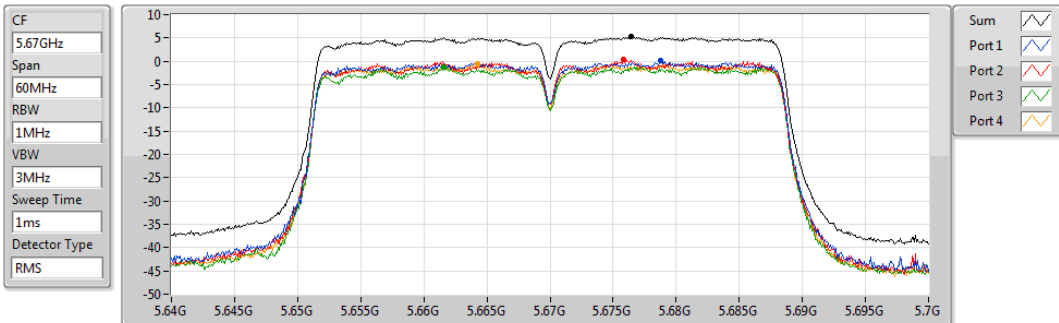

Sum	PD	Port 1	Port 2	Port 3	Port 4
(dBm/RBW)	(dBm/RBW)	(dBm/RBW)	(dBm/RBW)	(dBm/RBW)	(dBm/RBW)
5.20	5.20	0.05	0.35	-1.24	-0.66

802.11ac VHT40_Nss1,(MCS0)_4TX

PSD

5710MHz Straddle 5.47-5.725GHz

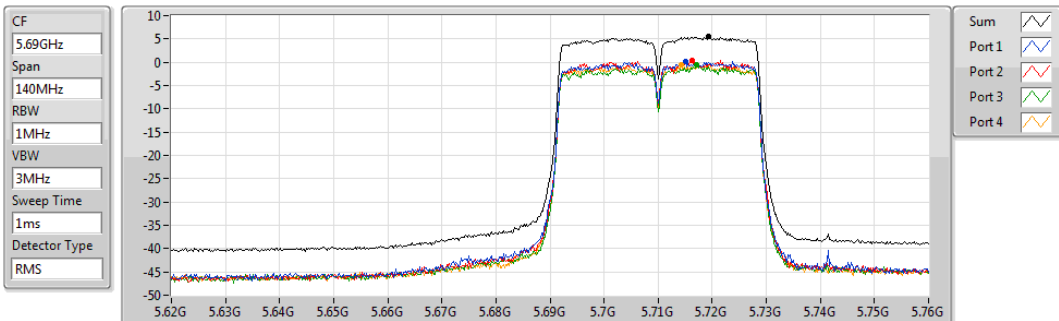

Sum	PD	Port 1	Port 2	Port 3	Port 4
(dBm/RBW)	(dBm/RBW)	(dBm/RBW)	(dBm/RBW)	(dBm/RBW)	(dBm/RBW)
5.46	5.46	0.19	0.44	-0.58	-0.48

802.11ac VHT40_Nss1,(MCS0)_4TX

PSD

5710MHz Straddle 5.725-5.85GHz

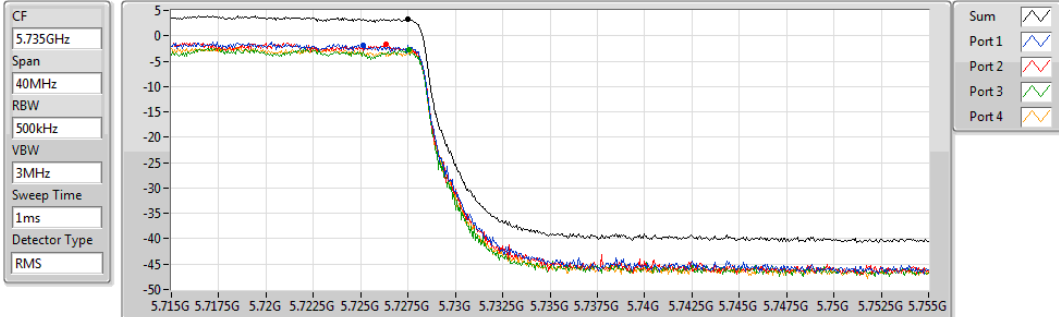

Sum	PD	Port 1	Port 2	Port 3	Port 4
(dBm/RBW)	(dBm/RBW)	(dBm/RBW)	(dBm/RBW)	(dBm/RBW)	(dBm/RBW)
3.34	3.34	-1.81	-1.65	-2.73	-3.02

802.11ac VHT40_Nss1,(MCS0)_4TX

PSD

5755MHz

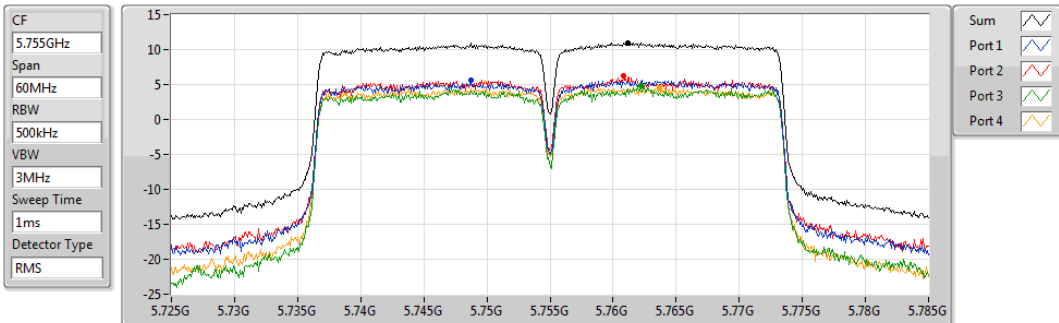

Sum	PD	Port 1	Port 2	Port 3	Port 4
(dBm/RBW)	(dBm/RBW)	(dBm/RBW)	(dBm/RBW)	(dBm/RBW)	(dBm/RBW)
11.00	11.00	5.63	6.21	4.80	4.54

802.11ac VHT40_Nss1,(MCS0)_4TX

PSD

5795MHz

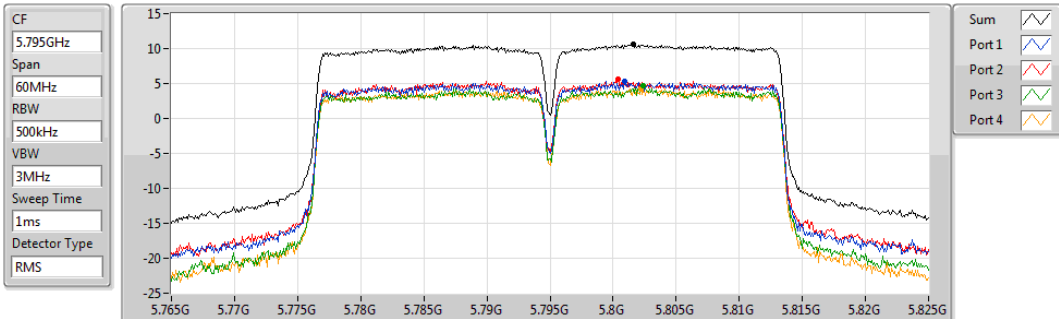

Sum	PD	Port 1	Port 2	Port 3	Port 4
(dBm/RBW)	(dBm/RBW)	(dBm/RBW)	(dBm/RBW)	(dBm/RBW)	(dBm/RBW)
10.60	10.60	5.28	5.62	4.70	4.28

802.11ac VHT80_Nss1,(MCS0)_4TX

PSD

5210MHz

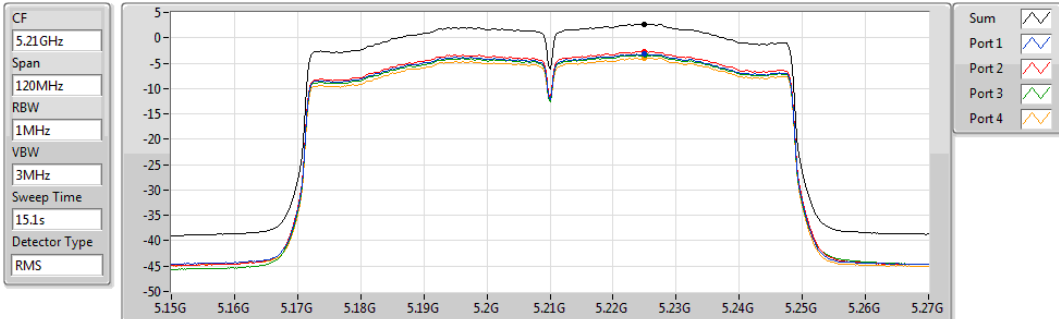

Sum	PD	Port 1	Port 2	Port 3	Port 4
(dBm/RBW)	(dBm/RBW)	(dBm/RBW)	(dBm/RBW)	(dBm/RBW)	(dBm/RBW)
2.74	2.74	-3.16	-2.72	-3.40	-3.92

802.11ac VHT80_Nss1,(MCS0)_4TX

PSD

5290MHz

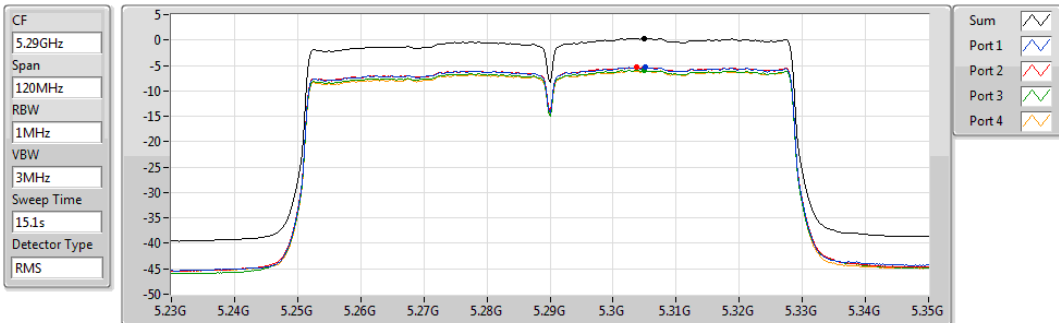

Sum	PD	Port 1	Port 2	Port 3	Port 4
(dBm/RBW)	(dBm/RBW)	(dBm/RBW)	(dBm/RBW)	(dBm/RBW)	(dBm/RBW)
0.37	0.37	-5.41	-5.34	-5.91	-5.99

802.11ac VHT80_Nss1,(MCS0)_4TX

PSD

5530MHz

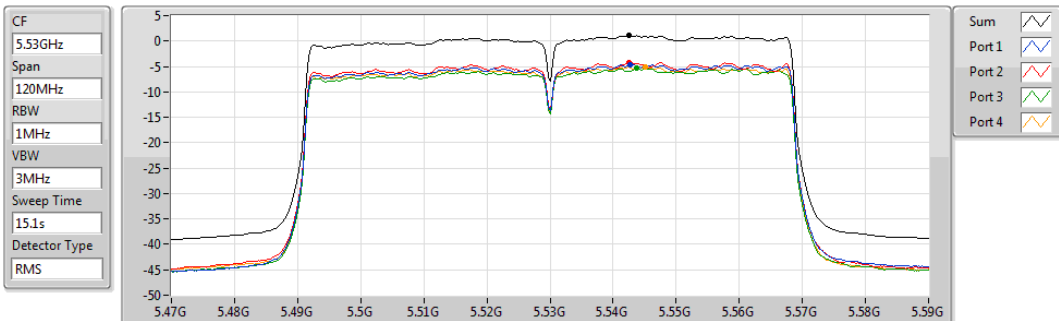

Sum	PD	Port 1	Port 2	Port 3	Port 4
(dBm/RBW)	(dBm/RBW)	(dBm/RBW)	(dBm/RBW)	(dBm/RBW)	(dBm/RBW)
1.10	1.10	-4.65	-4.16	-5.39	-5.12

802.11ac VHT80_Nss1,(MCS0)_4TX

PSD

5610MHz

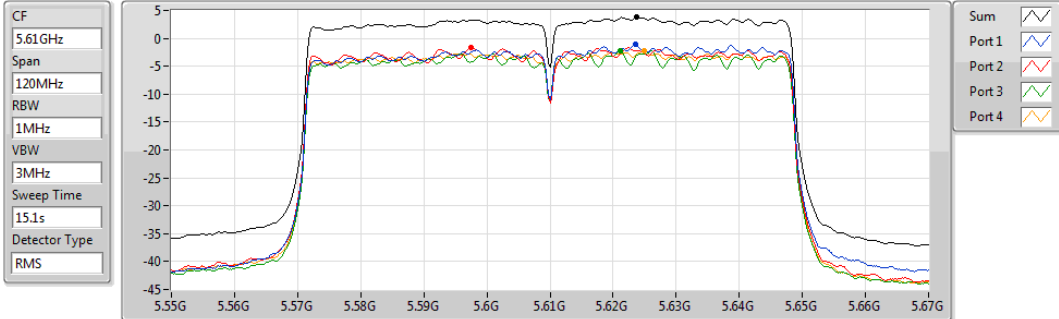

Sum	PD	Port 1	Port 2	Port 3	Port 4
(dBm/100kHz)	(dBm/100kHz)	(dBm/100kHz)	(dBm/100kHz)	(dBm/100kHz)	(dBm/100kHz)
3.79	3.79	-1.09	-1.63	-2.13	-2.17

802.11ac VHT80_Nss1,(MCS0)_4TX

PSD

5690MHz Straddle 5.47-5.725GHz

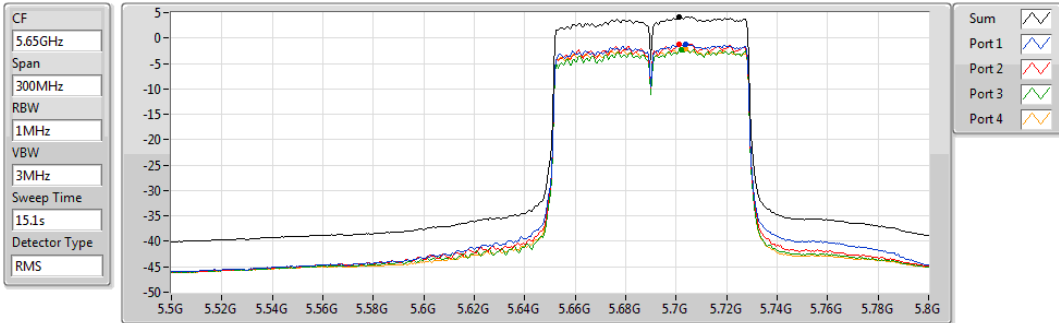

Sum	PD	Port 1	Port 2	Port 3	Port 4
(dBm/100kHz)	(dBm/100kHz)	(dBm/100kHz)	(dBm/100kHz)	(dBm/100kHz)	(dBm/100kHz)
4.16	4.16	-1.15	-1.18	-2.26	-2.16

802.11ac VHT80_Nss1,(MCS0)_4TX

PSD

5690MHz Straddle 5.725-5.85GHz

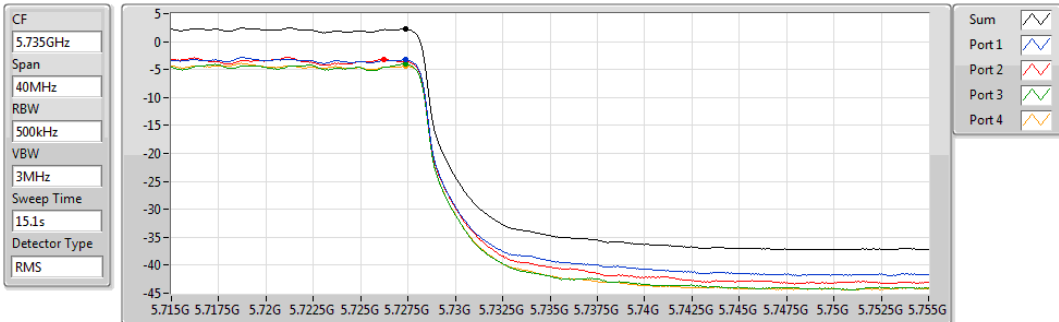

Sum	PD	Port 1	Port 2	Port 3	Port 4
(dBm/100kHz)	(dBm/100kHz)	(dBm/100kHz)	(dBm/100kHz)	(dBm/100kHz)	(dBm/100kHz)
2.25	2.25	-3.27	-3.13	-3.96	-4.40

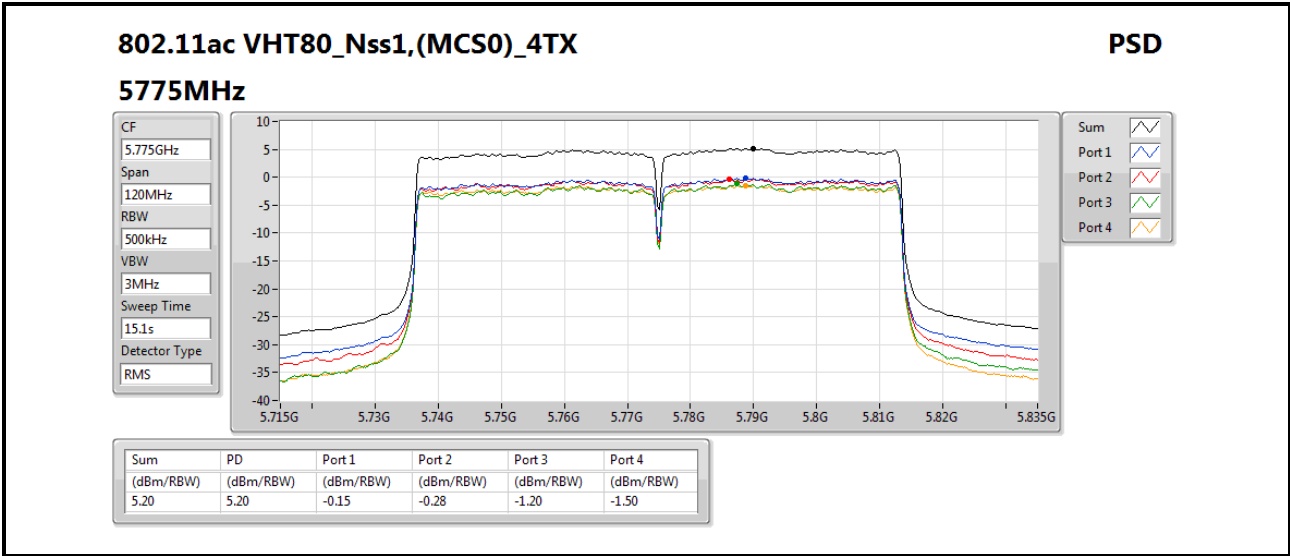

Beamforming mode

Summary

Mode	PD (dBm/RBW)	EIRP PD (dBm/RBW)
5.15-5.25GHz	-	-
802.11ac VHT20-BF_Nss1,(MCS0)_4TX	5.79	16.52
5.25-5.35GHz	-	-
802.11ac VHT20-BF_Nss1,(MCS0)_4TX	5.90	16.80
5.47-5.725GHz	-	-
802.11ac VHT20-BF_Nss1,(MCS0)_4TX	4.77	15.83
5.725-5.85GHz	-	-
802.11ac VHT20-BF_Nss1,(MCS0)_4TX	10.65	20.85

RBW = 500kHz for 5.725-5.85GHz band / 1MHz for other band;

Result

Mode	Result	DG (dBi)	Port 1 (dBm/RBW)	Port 2 (dBm/RBW)	Port 3 (dBm/RBW)	Port 4 (dBm/RBW)	PD (dBm/RBW)	PD Limit (dBm/RBW)	EIRP PD (dBm/RBW)	EIRP PD Limit (dBm/RBW)
802.11ac VHT20-BF_Nss1,(MCS0)_4TX	-	-	-	-	-	-	-	-	-	-
5180MHz	Pass	10.73	0.30	0.24	-0.63	-0.66	5.42	6.27	16.15	17.00
5200MHz	Pass	10.73	0.28	0.25	-0.62	-0.54	5.45	6.27	16.18	17.00
5240MHz	Pass	10.73	0.47	0.63	-0.42	-0.76	5.79	6.27	16.52	17.00
5260MHz	Pass	10.90	0.75	0.55	-0.31	-0.47	5.72	6.10	16.62	17.00
5300MHz	Pass	10.90	0.99	0.53	-0.42	-0.63	5.90	6.10	16.80	17.00
5320MHz	Pass	10.90	1.08	0.50	-0.49	-1.25	5.76	6.10	16.66	17.00
5500MHz	Pass	11.06	-0.80	0.02	-1.91	-2.29	4.59	5.94	15.65	17.00
5580MHz	Pass	11.06	-1.25	-0.94	-1.86	-1.86	4.38	5.94	15.44	17.00
5700MHz	Pass	11.06	-0.32	-0.65	-1.04	-1.43	4.77	5.94	15.83	17.00
5720MHz Straddle 5.47-5.725GHz	Pass	11.06	-0.77	-0.76	-1.97	-1.99	4.31	5.94	15.37	17.00
5720MHz Straddle 5.725-5.85GHz	Pass	10.20	-3.10	-2.75	-3.57	-3.95	2.52	25.80	12.72	36.00
5745MHz	Pass	10.20	5.71	4.99	4.10	4.28	10.34	25.80	20.54	36.00
5785MHz	Pass	10.20	5.78	5.54	4.01	5.13	10.63	25.80	20.83	36.00
5825MHz	Pass	10.20	6.17	5.21	4.82	4.20	10.65	25.80	20.85	36.00

DG = Directional Gain; **RBW** = 500kHz for 5.725-5.85GHz band / 1MHz for other band;

PD = trace bin-by-bin of each transmits port summing can be performed maximum power density; **Port X** = Port Xpower density;

Note:

5150-5250MHz: Directional gain = $10 * \log((10^{4.1/20} + 10^{4.9/20} + 10^{5.3/20} + 10^{4.5/20})^2 / 4)$ = 10.73 dBi > 6 dBi. Limit shall be reduced to 11 dBm – (10.73 dBi – 6 dBi) = 6.27

5250-5350MHz: Directional gain = $10 * \log((10^{4.7/20} + 10^{4.2/20} + 10^{6/20} + 10^{4.5/20})^2 / 4)$ = 10.90 dBi > 6 dBi. Limit shall be reduced to 11 dBm – (10.90 dBi – 6 dBi) = 6.10 dBm.

5470-5725MHz: Directional gain = $10 * \log((10^{5.1/20} + 10^{5.3/20} + 10^{5.5/20} + 10^{4.2/20})^2 / 4)$ = 11.06 dBi > 6 dBi. Limit shall be reduced to 11 dBm – (11.06 dBi – 6 dBi) = 5.94 dBm.

5725-5850MHz: Directional gain = $10 * \log((10^{5.1/20} + 10^{5.5/20} + 10^{3/20} + 10^{2.8/20})^2 / 4)$ = 10.20 dBi > 6 dBi. Limit shall be reduced to 30 dBm – (10.20 dBi – 6 dBi) = 25.80 dBm.

802.11ac VHT20-BF_Nss1,(MCS0)_4TX

PSD

5180MHz

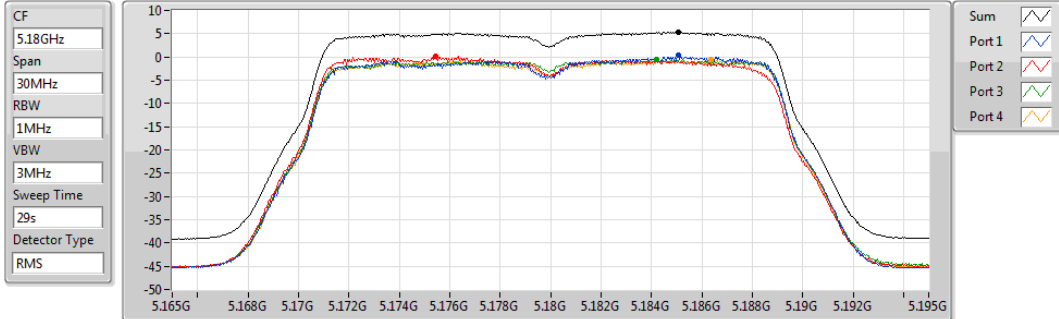

Sum	PD	Port 1	Port 2	Port 3	Port 4
(dBm/RBW)	(dBm/RBW)	(dBm/RBW)	(dBm/RBW)	(dBm/RBW)	(dBm/RBW)
5.42	5.42	0.30	0.24	-0.63	-0.66

802.11ac VHT20-BF_Nss1,(MCS0)_4TX

PSD

5200MHz

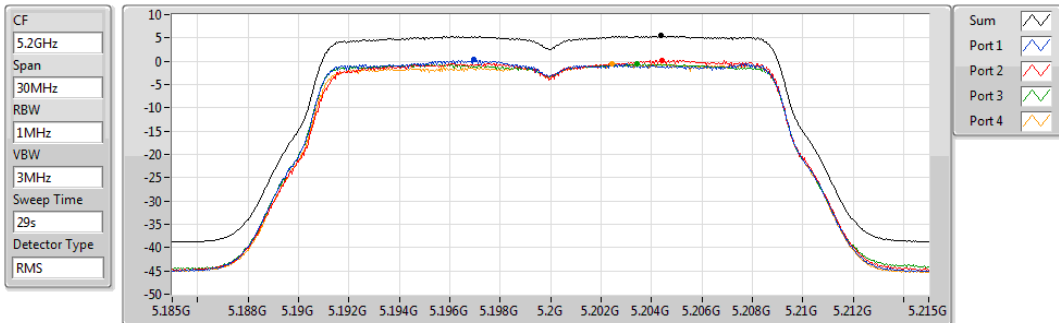

Sum	PD	Port 1	Port 2	Port 3	Port 4
(dBm/RBW)	(dBm/RBW)	(dBm/RBW)	(dBm/RBW)	(dBm/RBW)	(dBm/RBW)
5.45	5.45	0.28	0.25	-0.62	-0.54

802.11ac VHT20-BF_Nss1,(MCS0)_4TX

PSD

5240MHz

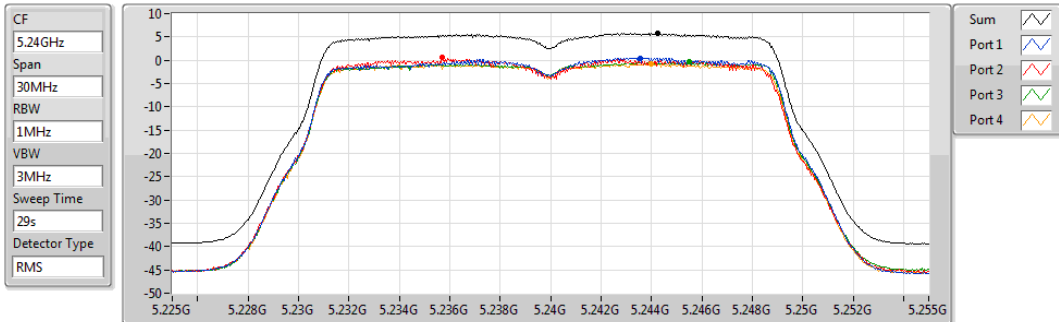

Sum	PD	Port 1	Port 2	Port 3	Port 4
(dBm/RBW)	(dBm/RBW)	(dBm/RBW)	(dBm/RBW)	(dBm/RBW)	(dBm/RBW)
5.79	5.79	0.47	0.63	-0.42	-0.76

802.11ac VHT20-BF_Nss1,(MCS0)_4TX

PSD

5260MHz

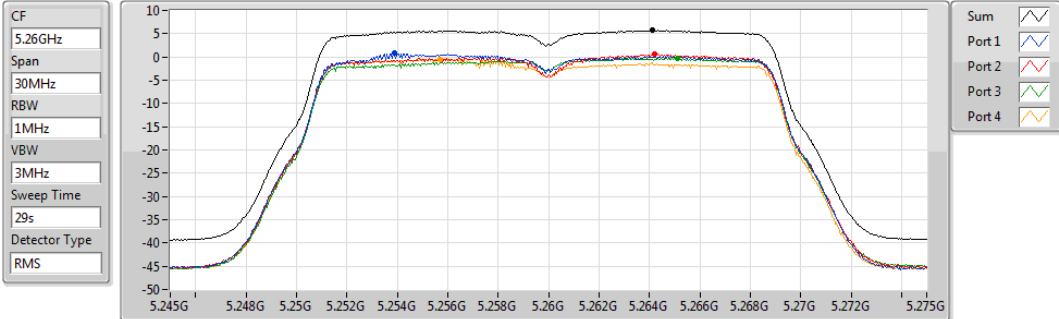

Sum	PD	Port 1	Port 2	Port 3	Port 4
(dBm/RBW)	(dBm/RBW)	(dBm/RBW)	(dBm/RBW)	(dBm/RBW)	(dBm/RBW)
5.72	5.72	0.75	0.55	-0.31	-0.47

802.11ac VHT20-BF_Nss1,(MCS0)_4TX

PSD

5300MHz

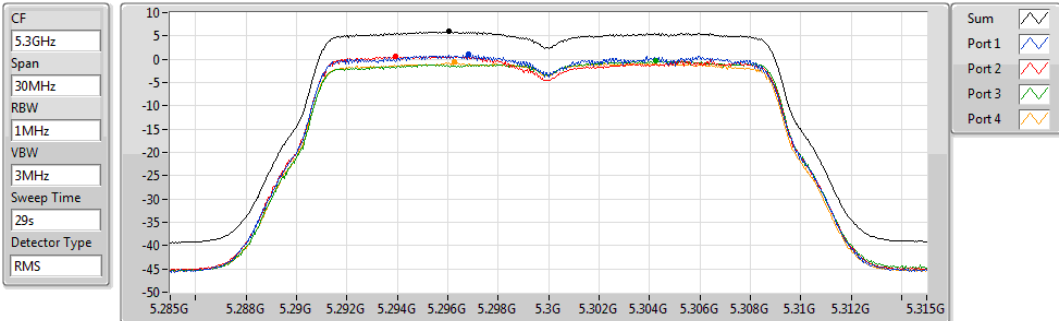

Sum	PD	Port 1	Port 2	Port 3	Port 4
(dBm/RBW)	(dBm/RBW)	(dBm/RBW)	(dBm/RBW)	(dBm/RBW)	(dBm/RBW)
5.90	5.90	0.99	0.53	-0.42	-0.63

802.11ac VHT20-BF_Nss1,(MCS0)_4TX

PSD

5320MHz

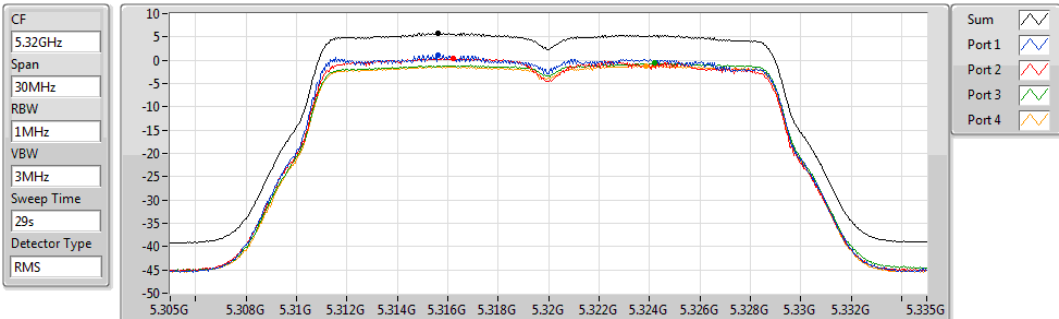

Sum	PD	Port 1	Port 2	Port 3	Port 4
(dBm/RBW)	(dBm/RBW)	(dBm/RBW)	(dBm/RBW)	(dBm/RBW)	(dBm/RBW)
5.76	5.76	1.08	0.50	-0.49	-1.25

802.11ac VHT20-BF_Nss1,(MCS0)_4TX

PSD

5500MHz

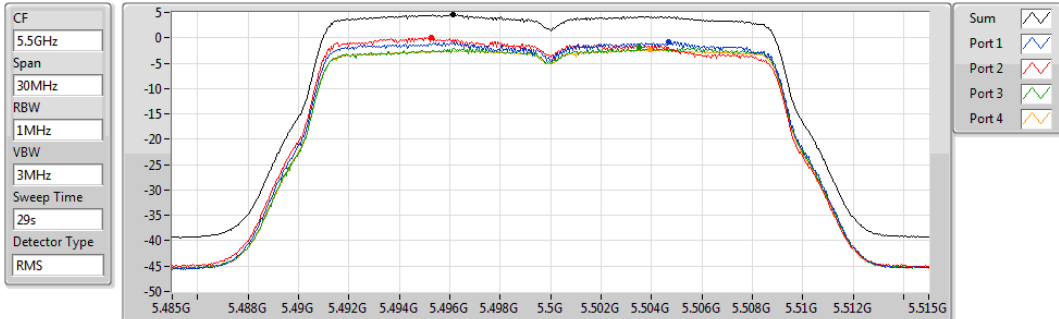

Sum	PD	Port 1	Port 2	Port 3	Port 4
(dBm/1MHz)	(dBm/1MHz)	(dBm/1MHz)	(dBm/1MHz)	(dBm/1MHz)	(dBm/1MHz)
4.59	4.59	-0.80	0.02	-1.91	-2.29

802.11ac VHT20-BF_Nss1,(MCS0)_4TX

PSD

5580MHz

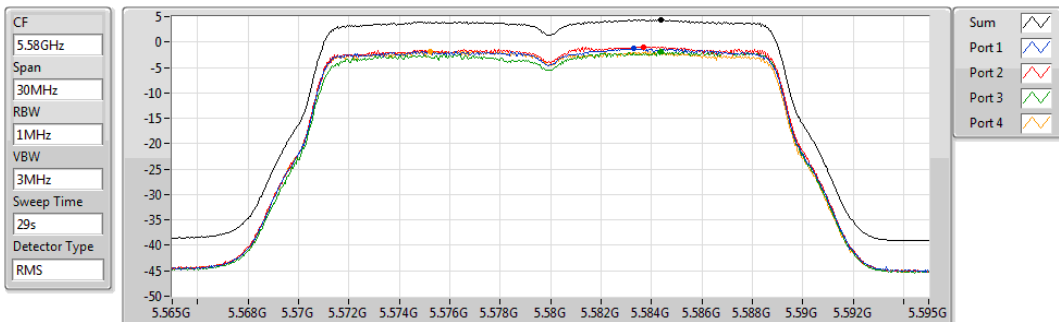

Sum	PD	Port 1	Port 2	Port 3	Port 4
(dBm/1MHz)	(dBm/1MHz)	(dBm/1MHz)	(dBm/1MHz)	(dBm/1MHz)	(dBm/1MHz)
4.38	4.38	-1.25	-0.94	-1.86	-1.86

802.11ac VHT20-BF_Nss1,(MCS0)_4TX

PSD

5700MHz

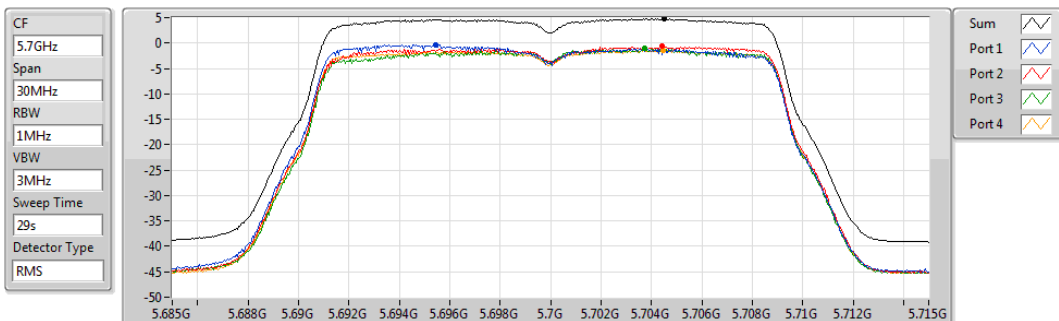

Sum	PD	Port 1	Port 2	Port 3	Port 4
(dBm/1MHz)	(dBm/1MHz)	(dBm/1MHz)	(dBm/1MHz)	(dBm/1MHz)	(dBm/1MHz)
4.77	4.77	-0.32	-0.65	-1.04	-1.43

802.11ac VHT20-BF_Nss1,(MCS0)_4TX

PSD

5720MHz Straddle 5.47-5.725GHz

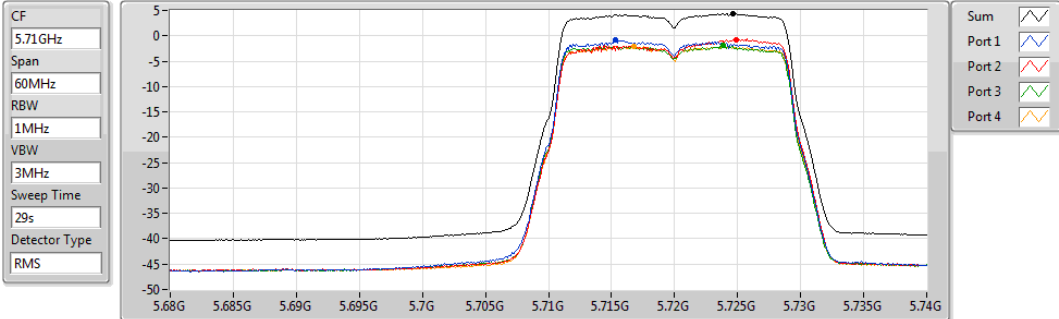

Sum	PD	Port 1	Port 2	Port 3	Port 4
(dBm/RBW)	(dBm/RBW)	(dBm/RBW)	(dBm/RBW)	(dBm/RBW)	(dBm/RBW)
4.31	4.31	-0.77	-0.76	-1.97	-1.99

802.11ac VHT20-BF_Nss1,(MCS0)_4TX

PSD

5720MHz Straddle 5.725-5.85GHz

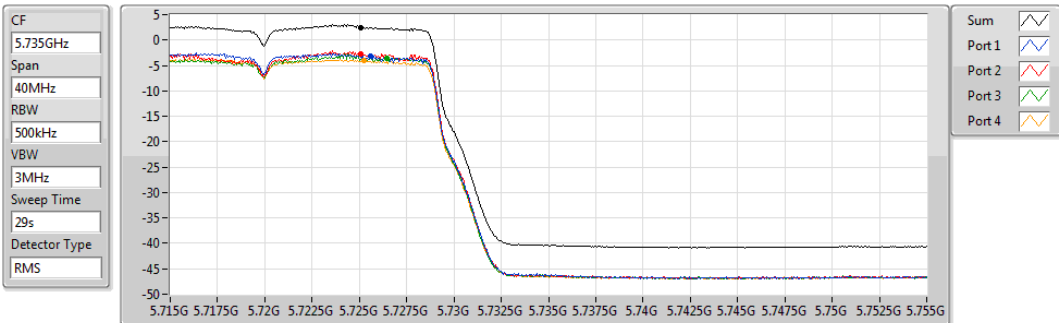

Sum	PD	Port 1	Port 2	Port 3	Port 4
(dBm/RBW)	(dBm/RBW)	(dBm/RBW)	(dBm/RBW)	(dBm/RBW)	(dBm/RBW)
2.52	2.52	-3.10	-2.75	-3.57	-3.95

802.11ac VHT20-BF_Nss1,(MCS0)_4TX

PSD

5745MHz

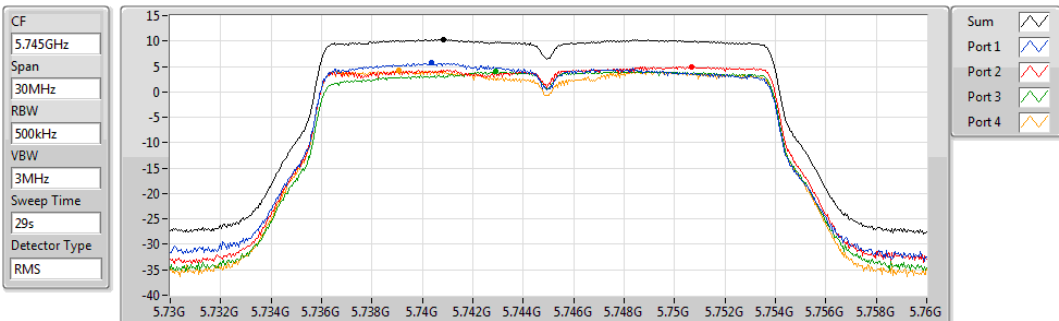

Sum	PD	Port 1	Port 2	Port 3	Port 4
(dBm/RBW)	(dBm/RBW)	(dBm/RBW)	(dBm/RBW)	(dBm/RBW)	(dBm/RBW)
10.34	10.34	5.71	4.99	4.10	4.28

802.11ac VHT20-BF_Nss1,(MCS0)_4TX

PSD

5785MHz

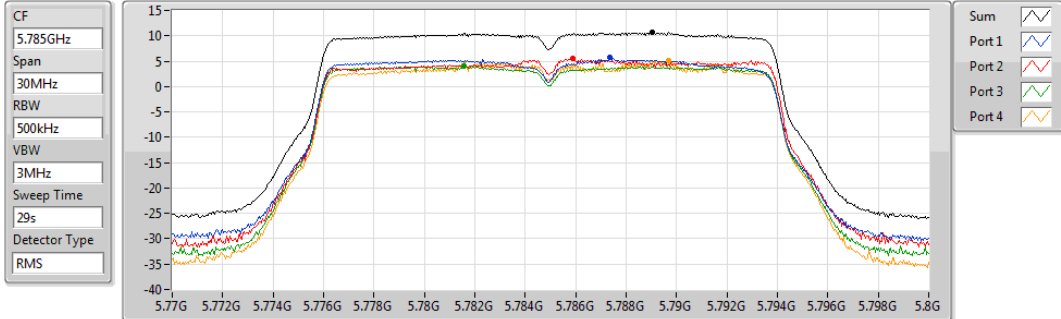

Sum	PD	Port 1	Port 2	Port 3	Port 4
(dBm/RBW)	(dBm/RBW)	(dBm/RBW)	(dBm/RBW)	(dBm/RBW)	(dBm/RBW)
10.63	10.63	5.78	5.54	4.01	5.13

802.11ac VHT20-BF_Nss1,(MCS0)_4TX

PSD

5825MHz

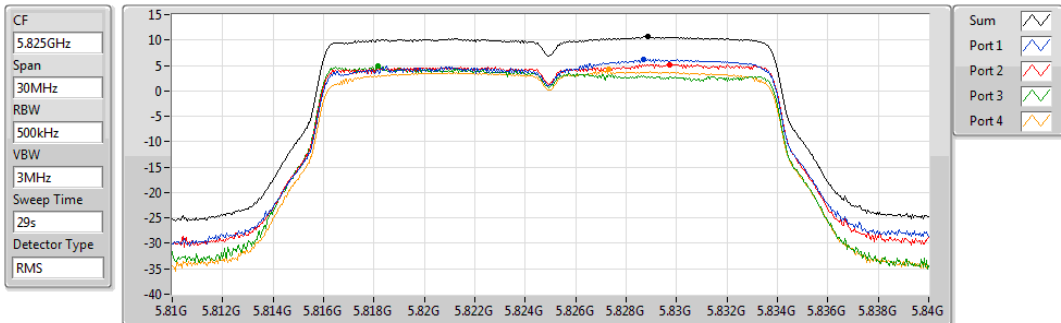

Sum	PD	Port 1	Port 2	Port 3	Port 4
(dBm/RBW)	(dBm/RBW)	(dBm/RBW)	(dBm/RBW)	(dBm/RBW)	(dBm/RBW)
10.65	10.65	6.17	5.21	4.82	4.20

3.5 Transmitter Radiated and Band Edge Emissions

3.5.1 Limit of Transmitter Radiated and Band Edge Emissions

Restricted Band Emissions Limit			
Frequency Range (MHz)	Field Strength (uV/m)	Field Strength (dBuV/m)	Measure Distance (m)
0.009~0.490	2400/F(kHz)	48.5 - 13.8	300
0.490~1.705	24000/F(kHz)	33.8 - 23	30
1.705~30.0	30	29	30
30~88	100	40	3
88~216	150	43.5	3
216~960	200	46	3
Above 960	500	54	3

Note 1:
Qusai-Peak value is measured for frequency below 1GHz except for 9–90 kHz, 110–490 kHz frequency band. Peak and average value are measured for frequency above 1GHz. The limit on average radio frequency emission is as above table. The limit on peak radio frequency emissions is 20 dB above the maximum permitted average emission limit

Note 2:
Measurements may be performed at a distance other than what is specified provided. When performing measurements at a distance other than that specified, the results shall be extrapolated to the specified distance using an extrapolation factor as below, Frequency at or above 30 MHz: 20 dB/decade Frequency below 30 MHz: 40 dB/decade.

Un-restricted band emissions above 1GHz Limit	
Operating Band	Limit
5.15 - 5.25 GHz	e.i.r.p. -27 dBm [68.2 dBuV/m@3m]
5.25 - 5.35 GHz	e.i.r.p. -27 dBm [68.2 dBuV/m@3m]
5.47 - 5.725 GHz	e.i.r.p. -27 dBm [68.2 dBuV/m@3m]
5.725 - 5.850 GHz	All emissions shall be limited to a level of -27 dBm/MHz at 75 MHz or more above or below the band edge increasing linearly to 10 dBm/MHz at 25 MHz above or below the band edge, and from 25 MHz above or below the band edge increasing linearly to a level of 15.6 dBm/MHz at 5 MHz above or below the band edge, and from 5 MHz above or below the band edge increasing linearly to a level of 27 dBm/MHz at the band edge.

Note 1: Measurements may be performed at a distance other than the limit distance provided they are not performed in the near field and the emissions to be measured can be detected by the measurement equipment. When performing measurements at a distance other than that specified, the results shall be extrapolated to the specified distance using an extrapolation factor of 20 dB/decade (inverse of linear distance for field-strength measurements, inverse of linear distance-squared for power-density measurements).

3.5.2 Test Procedures

1. Measurement is made at a semi-anechoic chamber that incorporates a turntable allowing a EUT rotation of 360°. A continuously-rotating, remotely-controlled turntable is installed at the test site to support the EUT and facilitate determination of the direction of maximum radiation for each EUT emission frequency. The EUT is placed at test table. For emissions testing at or below 1 GHz, the table height is 80 cm above the reference ground plane. For emission measurements above 1 GHz, the table height is 1.5 m
2. Measurement is made with the antenna positioned in both the horizontal and vertical planes of polarization. The measurement antenna is varied in height (1m ~ 4m) above the reference ground plane to obtain the maximum signal strength. Distance between EUT and antenna is 3 m.
3. This investigation is performed with the EUT rotated 360°, the antenna height scanned between 1 m and 4 m, and the antenna rotated to repeat the measurements for both the horizontal and vertical antenna polarizations.

Note:

1. 120kHz measurement bandwidth of test receiver and Quasi-peak detector is for radiated emission below 1GHz.
2. RBW=1MHz, VBW=3MHz and Peak detector is for peak measured value of radiated emission above 1GHz.
3. RBW=1MHz, VBW=1/T and Peak detector is for average measured value of radiated emission above 1GHz.

3.5.3 Test Setup

Radiated Emissions below 1 GHz

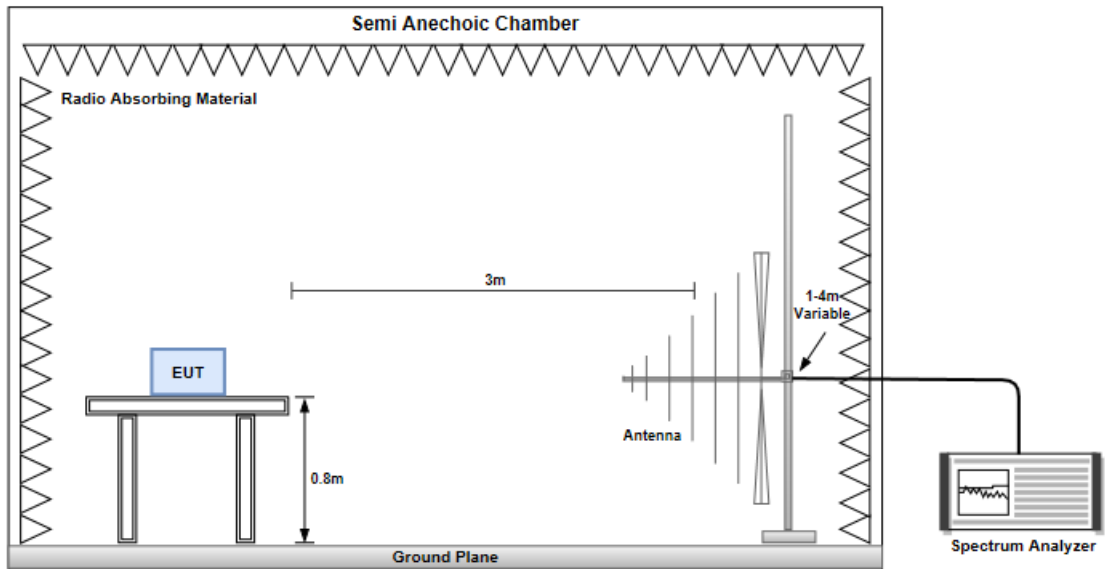

Radiated Emissions above 1 GHz

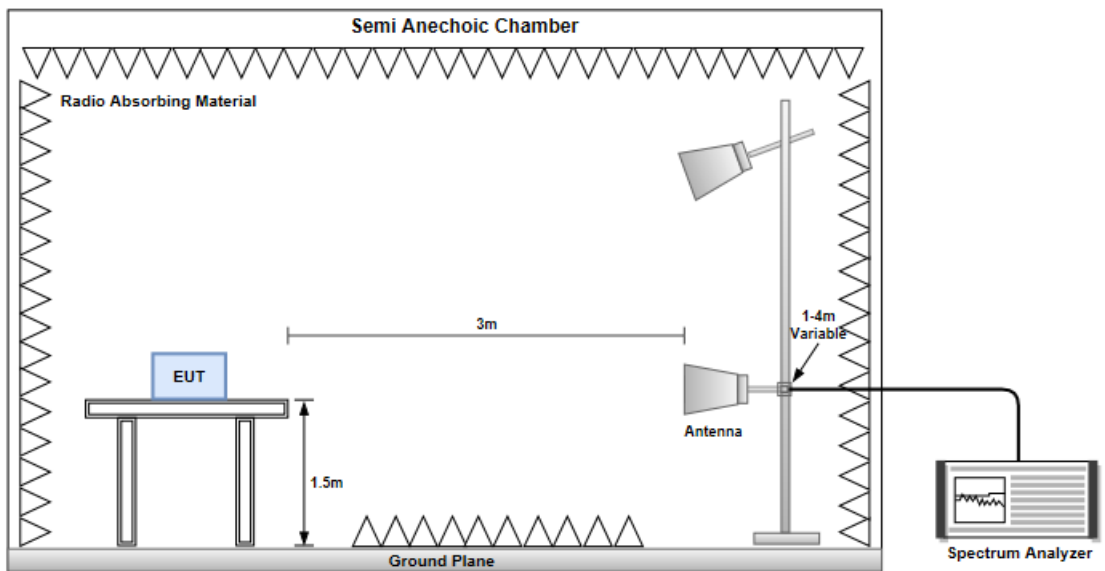

Non-beamforming mode

3.5.4 Transmitter Radiated Unwanted Emissions (Below 1GHz)

Modulation	VHT80	Test Freq. (MHz)	5690
Polarization	Horizontal		

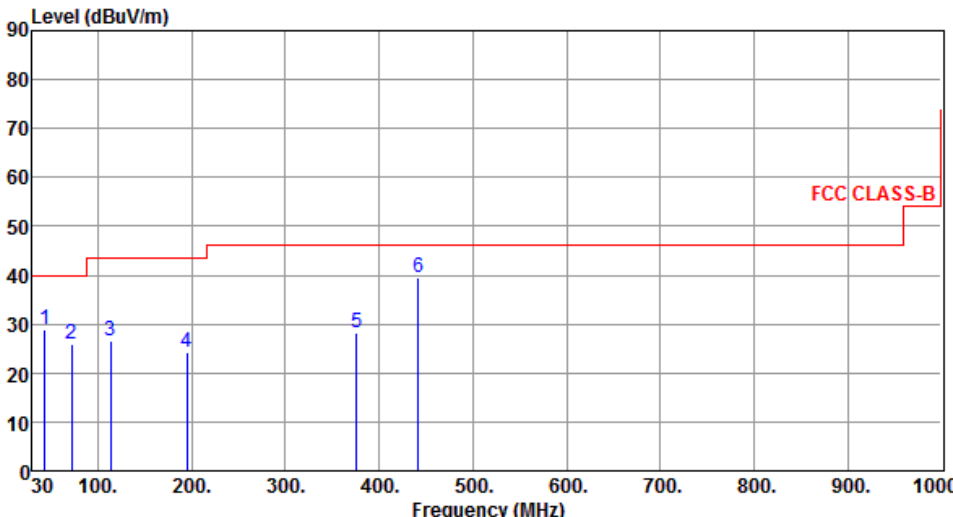

	Freq. MHz	Emission level dBUV/m	Limit dBUV/m	Margin dB	SA reading dBUV	Factor dB	Remark	ANT High cm	Turn Table deg
1	43.51	28.89	40.00	-11.11	37.81	-8.92	Peak	---	---
2	71.55	25.74	40.00	-14.26	36.70	-10.96	Peak	---	---
3	113.39	26.48	43.50	-17.02	38.28	-11.80	Peak	---	---
4	194.88	24.25	43.50	-19.25	36.10	-11.85	Peak	---	---
5	376.29	28.37	46.00	-17.63	34.76	-6.39	Peak	---	---
6	442.22	39.58	46.00	-6.42	44.00	-4.42	Peak	---	---

Note 1: Emission Level (dBUV/m) = SA Reading (dBUV/m) + Factor* (dB)
*Factor includes antenna factor , cable loss and amplifier gain
Note 2: Margin (dB) = Emission level (dBUV/m) – Limit (dBUV/m).
Note 3: All spurious emissions below 30MHz are more than 20 dB below the limit.

Modulation	VHT80	Test Freq. (MHz)	5690
Polarization	Vertical		

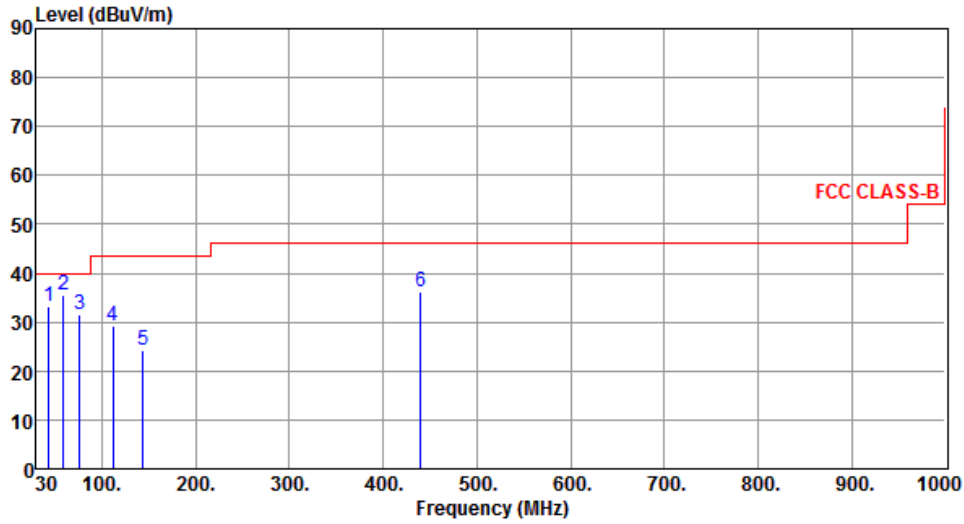

	Freq. MHz	Emission level dBuV/m	Limit dBuV/m	Margin dB	SA reading dBuV	Factor dB	Remark	ANT High cm	Turn Table deg
1	43.52	33.31	40.00	-6.69	42.23	-8.92	Peak	---	---
2	59.33	35.41	40.00	-4.59	44.67	-9.26	Peak	---	---
3	76.48	31.59	40.00	-8.41	44.07	-12.48	Peak	---	---
4	111.48	29.18	43.50	-14.32	41.22	-12.04	Peak	---	---
5	143.49	24.35	43.50	-19.15	33.34	-8.99	Peak	---	---
6	440.33	36.24	46.00	-9.76	40.70	-4.46	Peak	---	---

Note 1: Emission Level (dBuV/m) = SA Reading (dBuV/m) + Factor* (dB)

*Factor includes antenna factor , cable loss and amplifier gain

Note 2: Margin (dB) = Emission level (dBuV/m) – Limit (dBuV/m).

Note 3: All spurious emissions below 30MHz are more than 20 dB below the limit.

Modulation	VHT40	Test Freq. (MHz)	5755
Polarization	Horizontal		

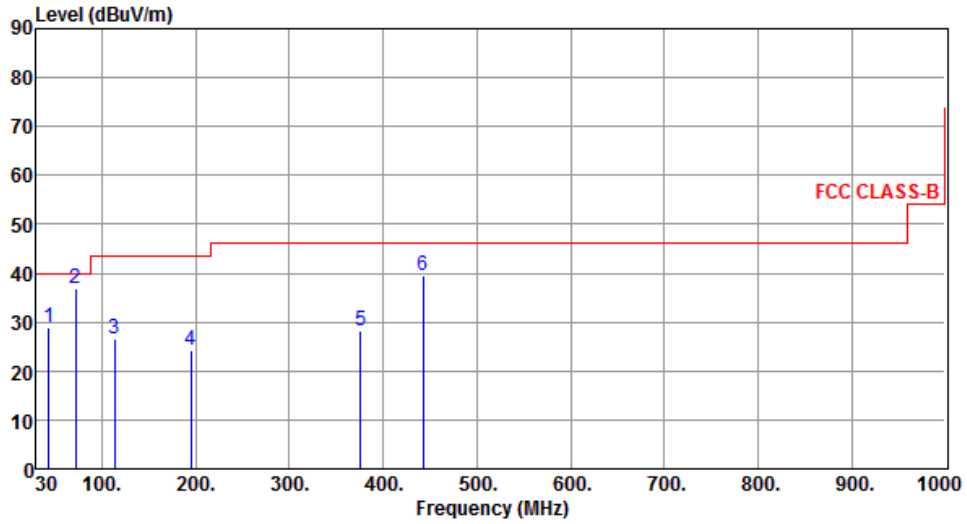

	Freq. MHz	Emission level dBuV/m	Limit dBuV/m	Margin dB	SA reading dBuV	Factor dB	Remark	ANT High cm	Turn Table deg
1	43.39	28.75	40.00	-11.25	37.67	-8.92	Peak	---	---
2	71.50	36.81	40.00	-3.19	47.77	-10.96	Peak	---	---
3	113.42	26.41	43.50	-17.09	38.21	-11.80	Peak	---	---
4	194.87	24.25	43.50	-19.25	36.10	-11.85	Peak	---	---
5	376.29	28.31	46.00	-17.69	34.70	-6.39	Peak	---	---
6	442.28	39.54	46.00	-6.46	43.95	-4.41	Peak	---	---

Note 1: Emission Level (dBuV/m) = SA Reading (dBuV/m) + Factor* (dB)

*Factor includes antenna factor , cable loss and amplifier gain

Note 2: Margin (dB) = Emission level (dBuV/m) – Limit (dBuV/m).

Note 3: All spurious emissions below 30MHz are more than 20 dB below the limit.

Modulation	VHT40	Test Freq. (MHz)	5755
Polarization	Vertical		

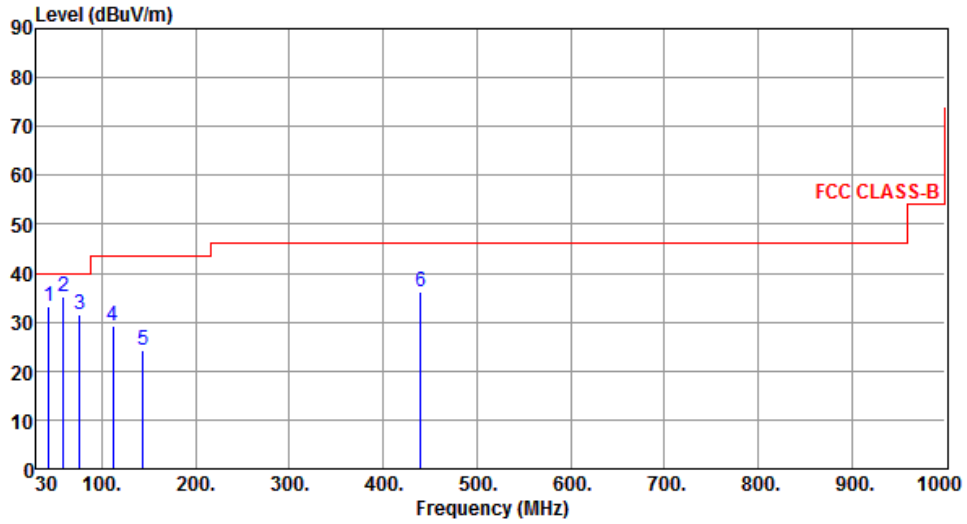

	Freq. MHz	Emission level dBuV/m	Limit dBuV/m	Margin dB	SA reading dBuV	Factor dB	Remark	ANT High cm	Turn Table deg
1	43.51	33.35	40.00	-6.65	42.27	-8.92	Peak	---	---
2	59.31	35.28	40.00	-4.72	44.54	-9.26	Peak	---	---
3	76.48	31.57	40.00	-8.43	44.05	-12.48	Peak	---	---
4	111.49	29.18	43.50	-14.32	41.22	-12.04	Peak	---	---
5	143.46	24.32	43.50	-19.18	33.31	-8.99	Peak	---	---
6	440.33	36.27	46.00	-9.73	40.73	-4.46	Peak	---	---

Note 1: Emission Level (dBuV/m) = SA Reading (dBuV/m) + Factor* (dB)

*Factor includes antenna factor , cable loss and amplifier gain

Note 2: Margin (dB) = Emission level (dBuV/m) – Limit (dBuV/m).

Note 3: All spurious emissions below 30MHz are more than 20 dB below the limit.

3.5.5 Transmitter Radiated Unwanted Emissions (Above 1GHz) for 11a

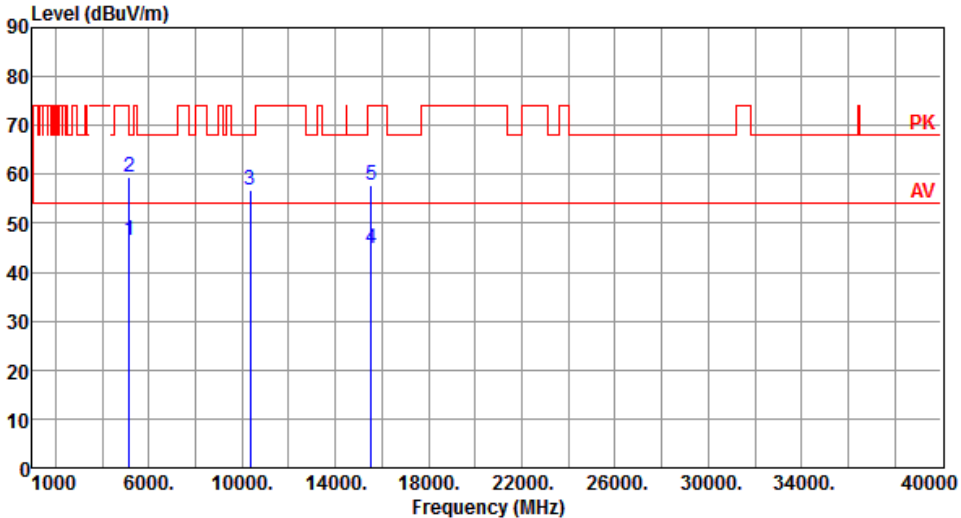
Modulation	11a	Test Freq. (MHz)	5180																																																																					
Polarization	Horizontal																																																																							
																																																																								
	<table border="1"> <thead> <tr> <th>Freq.</th> <th>Emission level</th> <th>Limit</th> <th>Margin</th> <th>SA reading</th> <th>Factor</th> <th>Remark</th> <th>ANT High</th> <th>Turn Table</th> </tr> <tr> <th>MHz</th> <th>dBuV/m</th> <th>dBuV/m</th> <th>dB</th> <th>dBuV</th> <th>dB</th> <th></th> <th>cm</th> <th>deg</th> </tr> </thead> <tbody> <tr> <td>1</td> <td>5150.00</td> <td>46.53</td> <td>54.00</td> <td>-7.47</td> <td>40.58</td> <td>5.95</td> <td>Average</td> <td>100</td> <td>54</td> </tr> <tr> <td>2</td> <td>5150.00</td> <td>59.49</td> <td>74.00</td> <td>-14.51</td> <td>53.54</td> <td>5.95</td> <td>Peak</td> <td>100</td> <td>54</td> </tr> <tr> <td>3</td> <td>10360.00</td> <td>56.72</td> <td>68.20</td> <td>-11.48</td> <td>41.62</td> <td>15.10</td> <td>Peak</td> <td>100</td> <td>80</td> </tr> <tr> <td>4</td> <td>15540.00</td> <td>44.89</td> <td>54.00</td> <td>-9.11</td> <td>29.24</td> <td>15.65</td> <td>Average</td> <td>100</td> <td>30</td> </tr> <tr> <td>5</td> <td>15540.00</td> <td>57.65</td> <td>74.00</td> <td>-16.35</td> <td>42.00</td> <td>15.65</td> <td>Peak</td> <td>100</td> <td>30</td> </tr> </tbody> </table>	Freq.	Emission level	Limit	Margin	SA reading	Factor	Remark	ANT High	Turn Table	MHz	dBuV/m	dBuV/m	dB	dBuV	dB		cm	deg	1	5150.00	46.53	54.00	-7.47	40.58	5.95	Average	100	54	2	5150.00	59.49	74.00	-14.51	53.54	5.95	Peak	100	54	3	10360.00	56.72	68.20	-11.48	41.62	15.10	Peak	100	80	4	15540.00	44.89	54.00	-9.11	29.24	15.65	Average	100	30	5	15540.00	57.65	74.00	-16.35	42.00	15.65	Peak	100	30			
Freq.	Emission level	Limit	Margin	SA reading	Factor	Remark	ANT High	Turn Table																																																																
MHz	dBuV/m	dBuV/m	dB	dBuV	dB		cm	deg																																																																
1	5150.00	46.53	54.00	-7.47	40.58	5.95	Average	100	54																																																															
2	5150.00	59.49	74.00	-14.51	53.54	5.95	Peak	100	54																																																															
3	10360.00	56.72	68.20	-11.48	41.62	15.10	Peak	100	80																																																															
4	15540.00	44.89	54.00	-9.11	29.24	15.65	Average	100	30																																																															
5	15540.00	57.65	74.00	-16.35	42.00	15.65	Peak	100	30																																																															
<p>Note 1: Emission Level (dBuV/m) = SA Reading (dBuV/m) + Factor* (dB) *Factor includes antenna factor , cable loss and amplifier gain Note 2: Margin (dB) = Emission level (dBuV/m) – Limit (dBuV/m).</p>																																																																								

Modulation	11a	Test Freq. (MHz)	5180
Polarization	Vertical		

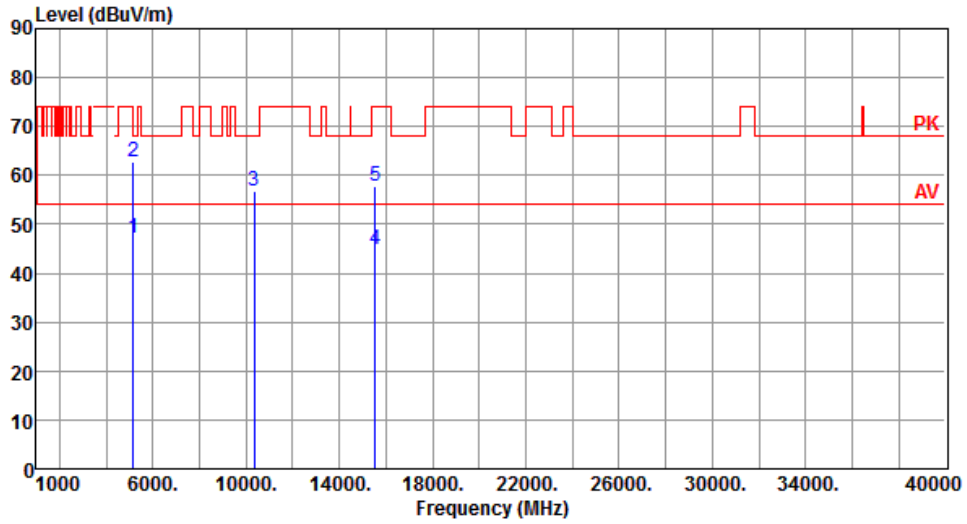

	Freq. MHz	Emission level dBuV/m	Limit dBuV/m	Margin dB	SA reading dBuV	Factor dB	Remark	ANT High cm	Turn Table deg
1	5150.00	47.26	54.00	-6.74	41.31	5.95	Average	100	75
2	5150.00	62.80	74.00	-11.20	56.85	5.95	Peak	100	75
3	10360.00	56.69	68.20	-11.51	41.59	15.10	Peak	100	20
4	15540.00	44.93	54.00	-9.07	29.28	15.65	Average	100	50
5	15540.00	57.94	74.00	-16.06	42.29	15.65	Peak	100	50

Note 1: Emission Level (dBuV/m) = SA Reading (dBuV/m) + Factor* (dB)

*Factor includes antenna factor , cable loss and amplifier gain

Note 2: Margin (dB) = Emission level (dBuV/m) – Limit (dBuV/m).

Modulation	11a	Test Freq. (MHz)	5200
Polarization	Horizontal		

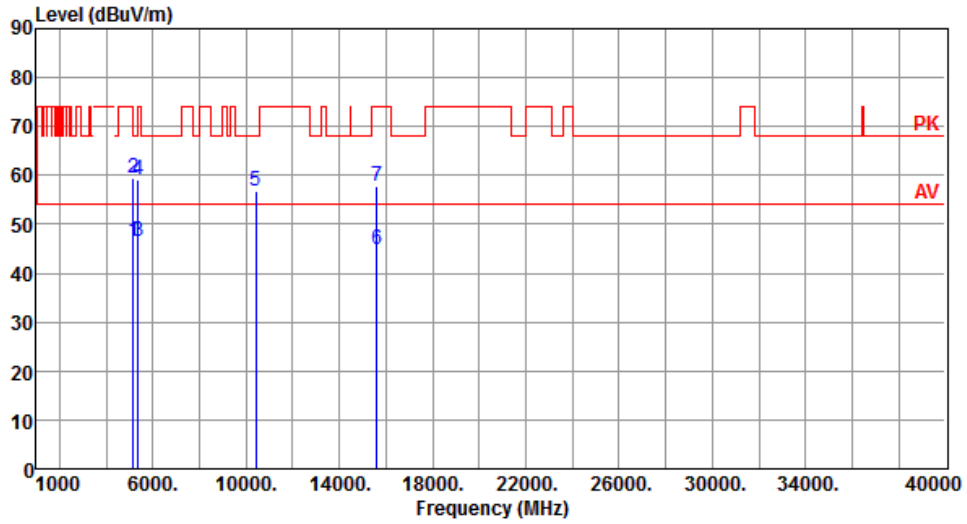

	Freq. MHz	Emission level dBuV/m	Limit dBuV/m	Margin dB	SA reading dBuV	Factor dB	Remark	ANT High cm	Turn Table deg
1	5150.00	46.33	54.00	-7.67	40.38	5.95	Average	100	55
2	5150.00	59.55	74.00	-14.45	53.60	5.95	Peak	100	55
3	5360.00	46.57	54.00	-7.43	41.12	5.45	Average	100	55
4	5360.00	59.24	74.00	-14.76	53.79	5.45	Peak	100	55
5	10400.00	56.68	68.20	-11.52	41.35	15.33	Peak	100	90
6	15600.00	44.85	54.00	-9.15	29.36	15.49	Average	100	70
7	15600.00	57.84	74.00	-16.16	42.35	15.49	Peak	100	70

Note 1: Emission Level (dBuV/m) = SA Reading (dBuV/m) + Factor* (dB)

*Factor includes antenna factor , cable loss and amplifier gain

Note 2: Margin (dB) = Emission level (dBuV/m) – Limit (dBuV/m).

Modulation	11a	Test Freq. (MHz)	5200
Polarization	Vertical		

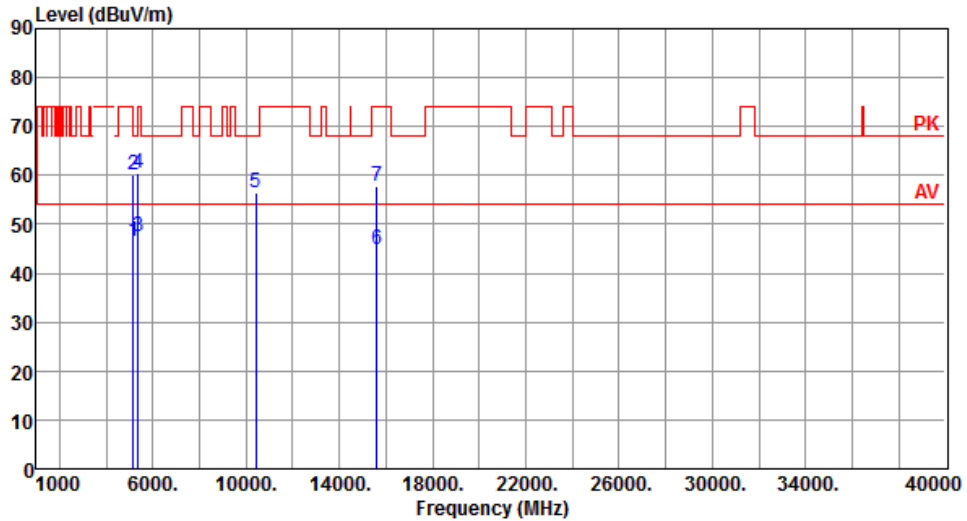

	Freq. MHz	Emission level dBuV/m	Limit dBuV/m	Margin dB	SA reading dBuV	Factor dB	Remark	ANT High cm	Turn Table deg
1	5150.00	46.58	54.00	-7.42	40.63	5.95	Average	100	77
2	5150.00	60.21	74.00	-13.79	54.26	5.95	Peak	100	77
3	5360.00	47.58	54.00	-6.42	42.13	5.45	Average	100	77
4	5360.00	60.57	74.00	-13.43	55.12	5.45	Peak	100	77
5	10400.00	56.59	68.20	-11.61	41.26	15.33	Peak	100	50
6	15600.00	44.94	54.00	-9.06	29.45	15.49	Average	100	30
7	15600.00	57.88	74.00	-16.12	42.39	15.49	Peak	100	30

Note 1: Emission Level (dBuV/m) = SA Reading (dBuV/m) + Factor* (dB)

*Factor includes antenna factor , cable loss and amplifier gain

Note 2: Margin (dB) = Emission level (dBuV/m) – Limit (dBuV/m).

Modulation	11a	Test Freq. (MHz)	5240
Polarization	Horizontal		

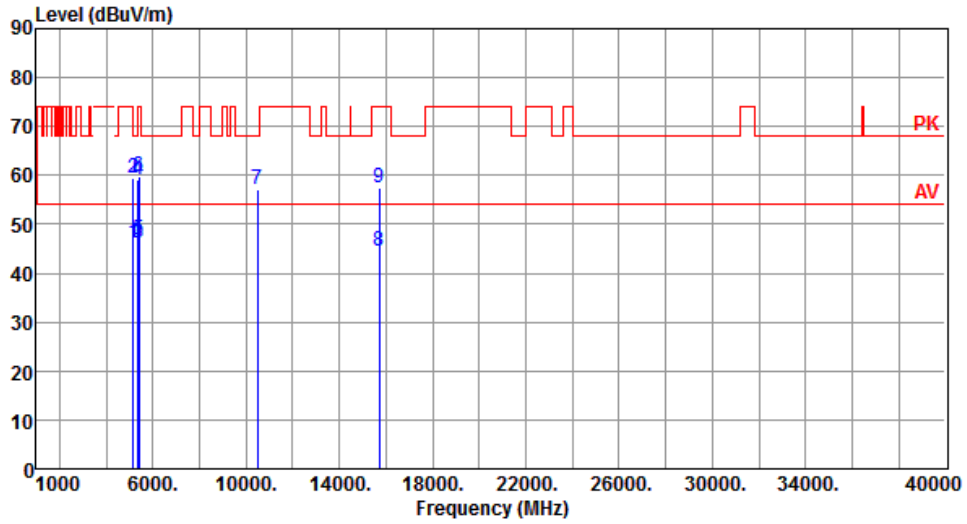

	Freq. MHz	Emission level dBuV/m	Limit dBuV/m	Margin dB	SA reading dBuV	Factor dB	Remark	ANT High cm	Turn Table deg
1	5150.00	46.21	54.00	-7.79	40.26	5.95	Average	100	53
2	5150.00	59.48	74.00	-14.52	53.53	5.95	Peak	100	53
3	5350.00	46.05	54.00	-7.95	40.65	5.40	Average	100	53
4	5350.00	59.25	74.00	-14.75	53.85	5.40	Peak	100	53
5	5400.00	46.76	54.00	-7.24	41.12	5.64	Average	100	53
6	5400.00	59.79	74.00	-14.21	54.15	5.64	Peak	100	53
7	10480.00	57.00	68.20	-11.20	41.69	15.31	Peak	100	50
8	15720.00	44.47	54.00	-9.53	29.24	15.23	Average	100	30
9	15720.00	57.59	74.00	-16.41	42.36	15.23	Peak	100	30

Note 1: Emission Level (dBuV/m) = SA Reading (dBuV/m) + Factor* (dB)

*Factor includes antenna factor , cable loss and amplifier gain

Note 2: Margin (dB) = Emission level (dBuV/m) – Limit (dBuV/m).

Modulation	11a	Test Freq. (MHz)	5240
Polarization	Vertical		

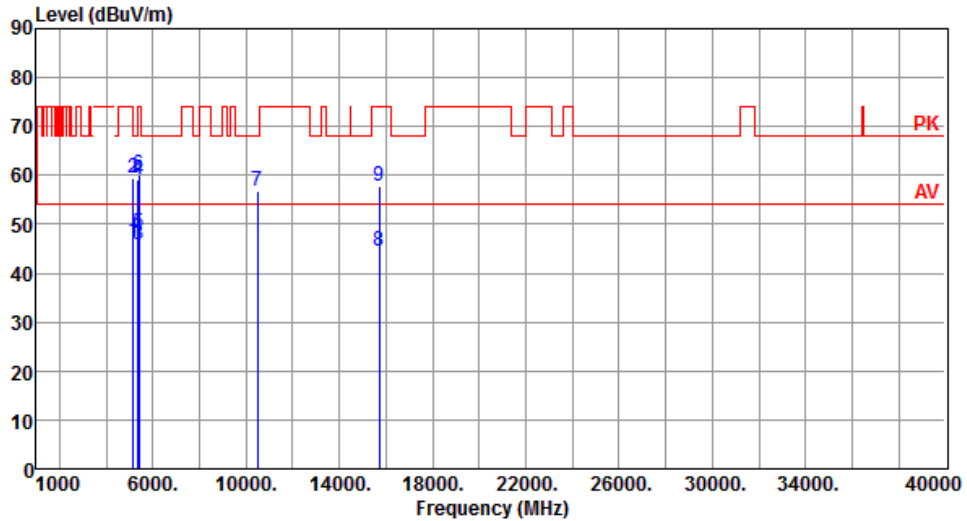

	Freq. MHz	Emission level dBuV/m	Limit dBuV/m	Margin dB	SA reading dBuV	Factor dB	Remark	ANT High cm	Turn Table deg
1	5150.00	46.34	54.00	-7.66	40.39	5.95	Average	105	74
2	5150.00	59.42	74.00	-14.58	53.47	5.95	Peak	105	74
3	5350.00	45.93	54.00	-8.07	40.53	5.40	Average	105	74
4	5350.00	58.96	74.00	-15.04	53.56	5.40	Peak	105	74
5	5400.00	48.10	54.00	-5.90	42.46	5.64	Average	105	74
6	5400.00	60.23	74.00	-13.77	54.59	5.64	Peak	105	74
7	10480.00	56.84	68.20	-11.36	41.53	15.31	Peak	100	20
8	15720.00	44.48	54.00	-9.52	29.25	15.23	Average	100	35
9	15720.00	57.84	74.00	-16.16	42.61	15.23	Peak	100	35

Note 1: Emission Level (dBuV/m) = SA Reading (dBuV/m) + Factor* (dB)

*Factor includes antenna factor , cable loss and amplifier gain

Note 2: Margin (dB) = Emission level (dBuV/m) – Limit (dBuV/m).

Modulation	11a	Test Freq. (MHz)	5260
Polarization	Horizontal		

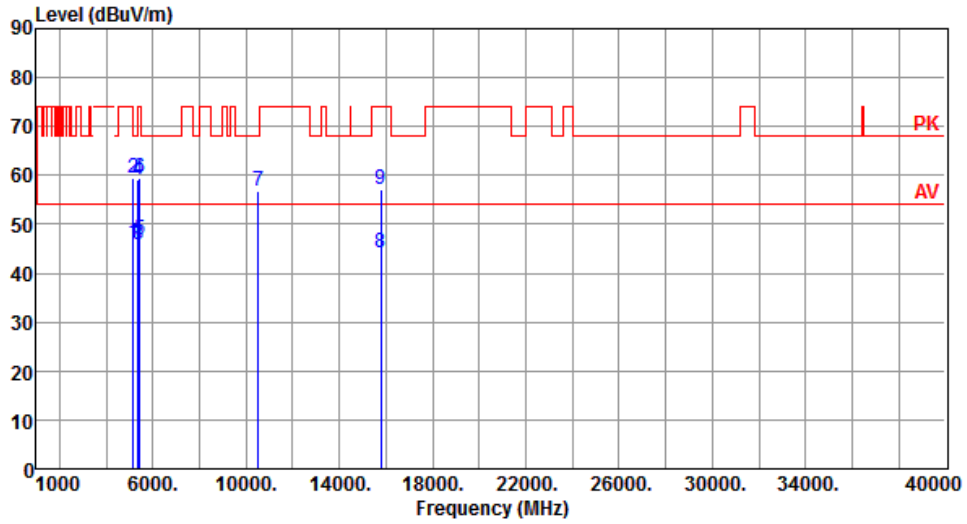

	Freq. MHz	Emission level dBuV/m	Limit dBuV/m	Margin dB	SA reading dBuV	Factor dB	Remark	ANT High cm	Turn Table deg
1	5150.00	46.21	54.00	-7.79	40.26	5.95	Average	100	52
2	5150.00	59.36	74.00	-14.64	53.41	5.95	Peak	100	52
3	5350.00	45.74	54.00	-8.26	40.34	5.40	Average	100	52
4	5350.00	59.01	74.00	-14.99	53.61	5.40	Peak	100	52
5	5420.00	46.85	54.00	-7.15	41.12	5.73	Average	100	52
6	5420.00	59.60	74.00	-14.40	53.87	5.73	Peak	100	52
7	10520.00	56.68	68.20	-11.52	41.35	15.33	Peak	100	90
8	15780.00	44.29	54.00	-9.71	29.34	14.95	Average	100	50
9	15780.00	57.26	74.00	-16.74	42.31	14.95	Peak	100	50

Note 1: Emission Level (dBuV/m) = SA Reading (dBuV/m) + Factor* (dB)

*Factor includes antenna factor , cable loss and amplifier gain

Note 2: Margin (dB) = Emission level (dBuV/m) – Limit (dBuV/m).

Modulation	11a	Test Freq. (MHz)	5260
Polarization	Vertical		

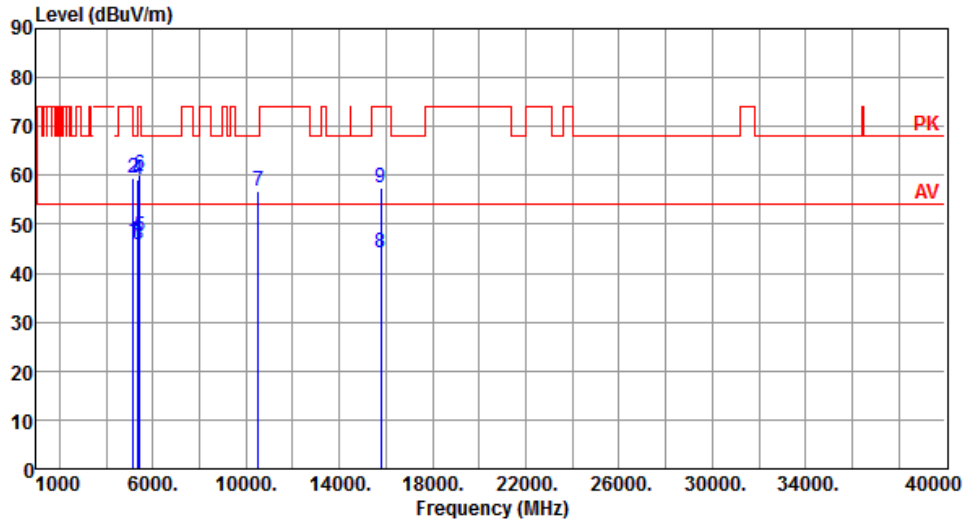

	Freq. MHz	Emission level dBuV/m	Limit dBuV/m	Margin dB	SA reading dBuV	Factor dB	Remark	ANT High cm	Turn Table deg
1	5150.00	46.63	54.00	-7.37	40.68	5.95	Average	100	85
2	5150.00	59.49	74.00	-14.51	53.54	5.95	Peak	100	85
3	5350.00	45.68	54.00	-8.32	40.28	5.40	Average	100	85
4	5350.00	59.03	74.00	-14.97	53.63	5.40	Peak	100	85
5	5420.00	47.36	54.00	-6.64	41.63	5.73	Average	100	85
6	5420.00	60.26	74.00	-13.74	54.53	5.73	Peak	100	85
7	10520.00	56.82	68.20	-11.38	41.49	15.33	Peak	100	20
8	15780.00	44.09	54.00	-9.91	29.14	14.95	Average	100	30
9	15780.00	57.48	74.00	-16.52	42.53	14.95	Peak	100	30

Note 1: Emission Level (dBuV/m) = SA Reading (dBuV/m) + Factor* (dB)

*Factor includes antenna factor , cable loss and amplifier gain

Note 2: Margin (dB) = Emission level (dBuV/m) – Limit (dBuV/m).

Modulation	11a	Test Freq. (MHz)	5300
Polarization	Horizontal		

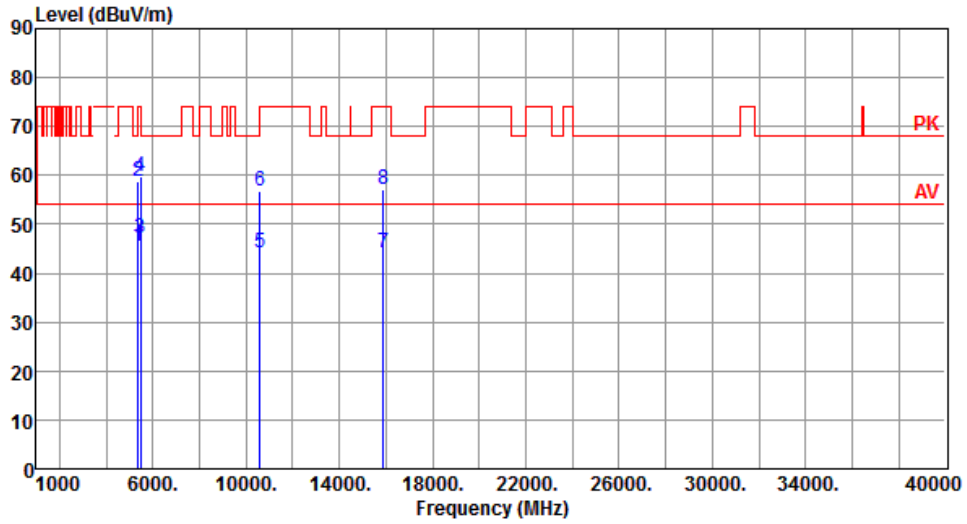

	Freq. MHz	Emission level dBuV/m	Limit dBuV/m	Margin dB	SA reading dBuV	Factor dB	Remark	ANT High cm	Turn Table deg
1	5350.00	45.61	54.00	-8.39	40.21	5.40	Average	102	54
2	5350.00	58.75	74.00	-15.25	53.35	5.40	Peak	102	54
3	5460.00	47.03	54.00	-6.97	41.11	5.92	Average	102	54
4	5460.00	59.77	74.00	-14.23	53.85	5.92	Peak	102	54
5	10600.00	44.05	54.00	-9.95	28.64	15.41	Average	100	100
6	10600.00	56.63	74.00	-17.37	41.22	15.41	Peak	100	100
7	15900.00	44.13	54.00	-9.87	29.24	14.89	Average	100	20
8	15900.00	57.28	74.00	-16.72	42.39	14.89	Peak	100	20

Note 1: Emission Level (dBuV/m) = SA Reading (dBuV/m) + Factor* (dB)

*Factor includes antenna factor , cable loss and amplifier gain

Note 2: Margin (dB) = Emission level (dBuV/m) – Limit (dBuV/m).

Modulation	11a	Test Freq. (MHz)	5300
Polarization	Vertical		

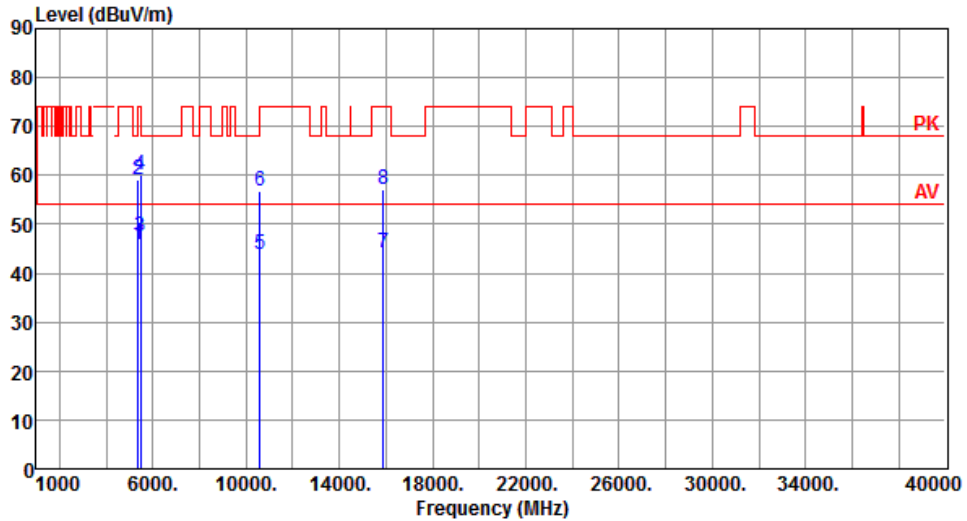

	Freq. MHz	Emission level dBuV/m	Limit dBuV/m	Margin dB	SA reading dBuV	Factor dB	Remark	ANT High cm	Turn Table deg
1	5350.00	45.92	54.00	-8.08	40.52	5.40	Average	100	85
2	5350.00	59.05	74.00	-14.95	53.65	5.40	Peak	100	85
3	5460.00	47.53	54.00	-6.47	41.61	5.92	Average	100	85
4	5460.00	60.17	74.00	-13.83	54.25	5.92	Peak	100	85
5	10600.00	43.97	54.00	-10.03	28.56	15.41	Average	100	50
6	10600.00	56.67	74.00	-17.33	41.26	15.41	Peak	100	50
7	15900.00	44.23	54.00	-9.77	29.34	14.89	Average	100	40
8	15900.00	57.23	74.00	-16.77	42.34	14.89	Peak	100	40

Note 1: Emission Level (dBuV/m) = SA Reading (dBuV/m) + Factor* (dB)

*Factor includes antenna factor , cable loss and amplifier gain

Note 2: Margin (dB) = Emission level (dBuV/m) – Limit (dBuV/m).

Modulation	11a	Test Freq. (MHz)	5320
Polarization	Horizontal		

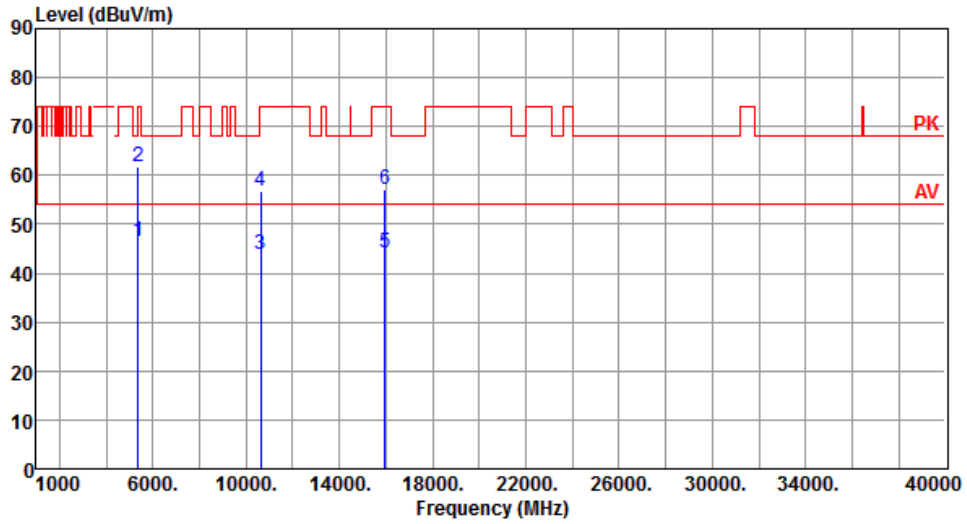

	Freq. MHz	Emission level dBuV/m	Limit dBuV/m	Margin dB	SA reading dBuV	Factor dB	Remark	ANT High cm	Turn Table deg
1	5350.00	46.61	54.00	-7.39	41.21	5.40	Average	103	51
2	5350.00	61.75	74.00	-12.25	56.35	5.40	Peak	103	51
3	10640.00	43.71	54.00	-10.29	28.35	15.36	Average	100	40
4	10640.00	56.86	74.00	-17.14	41.50	15.36	Peak	100	40
5	15960.00	44.32	54.00	-9.68	29.41	14.91	Average	100	30
6	15960.00	57.28	74.00	-16.72	42.37	14.91	Peak	100	30

Note 1: Emission Level (dBuV/m) = SA Reading (dBuV/m) + Factor* (dB)

*Factor includes antenna factor , cable loss and amplifier gain

Note 2: Margin (dB) = Emission level (dBuV/m) – Limit (dBuV/m).

Modulation	11a	Test Freq. (MHz)	5320
Polarization	Vertical		

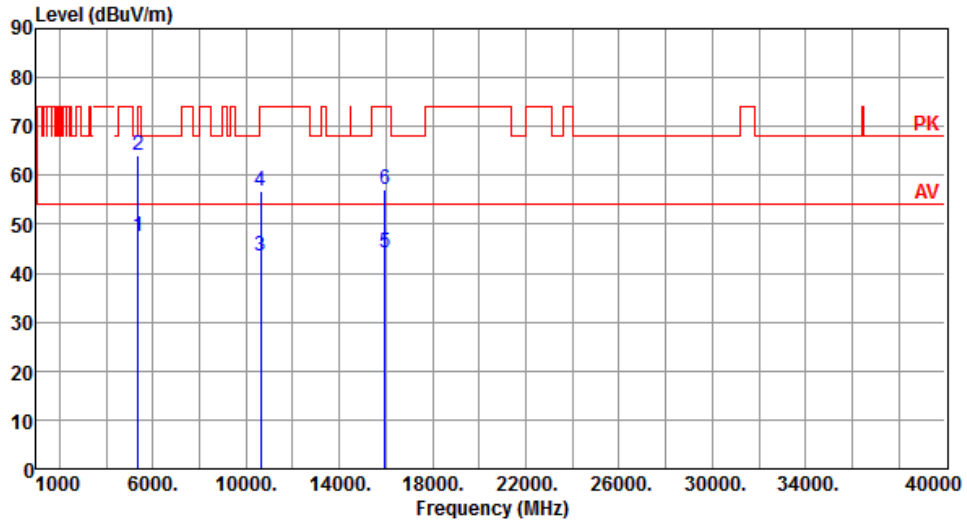

	Freq. MHz	Emission level dBuV/m	Limit dBuV/m	Margin dB	SA reading dBuV	Factor dB	Remark	ANT High cm	Turn Table deg
1	5350.00	47.64	54.00	-6.36	42.24	5.40	Average	100	84
2	5350.00	64.05	74.00	-9.95	58.65	5.40	Peak	100	84
3	10640.00	43.60	54.00	-10.40	28.24	15.36	Average	100	20
4	10640.00	56.64	74.00	-17.36	41.28	15.36	Peak	100	20
5	15960.00	44.28	54.00	-9.72	29.37	14.91	Average	100	30
6	15960.00	57.23	74.00	-16.77	42.32	14.91	Peak	100	30

Note 1: Emission Level (dBuV/m) = SA Reading (dBuV/m) + Factor* (dB)

*Factor includes antenna factor , cable loss and amplifier gain

Note 2: Margin (dB) = Emission level (dBuV/m) – Limit (dBuV/m).

Modulation	11a	Test Freq. (MHz)	5500
Polarization	Horizontal		

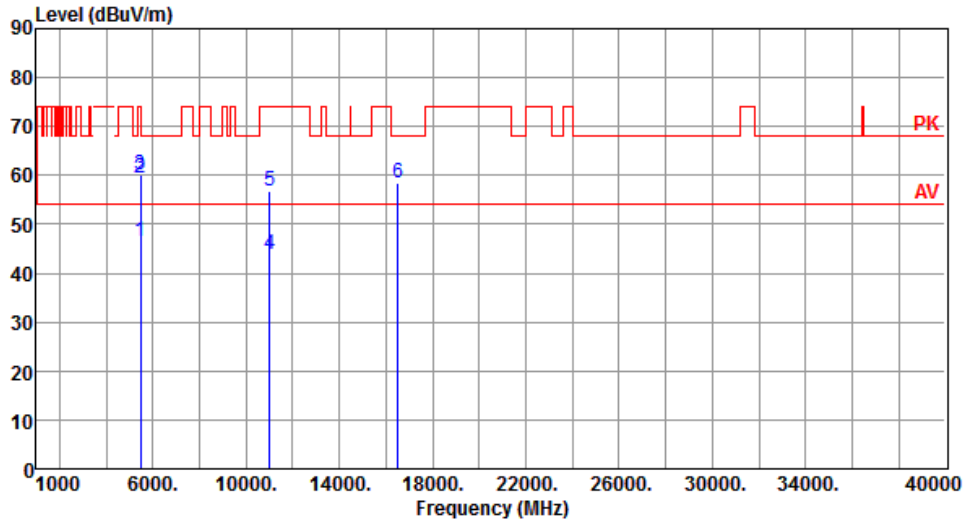

	Freq. MHz	Emission level dBuV/m	Limit dBuV/m	Margin dB	SA reading dBuV	Factor dB	Remark	ANT High cm	Turn Table deg
1	5460.00	46.47	54.00	-7.53	40.55	5.92	Average	100	74
2	5460.00	59.45	74.00	-14.55	53.53	5.92	Peak	100	74
3	5470.00	60.12	68.20	-8.08	54.16	5.96	Peak	100	74
4	11000.00	43.86	54.00	-10.14	28.28	15.58	Average	100	25
5	11000.00	56.79	74.00	-17.21	41.21	15.58	Peak	100	25
6	16500.00	58.37	68.20	-9.83	42.54	15.83	Peak	100	90

Note 1: Emission Level (dBuV/m) = SA Reading (dBuV/m) + Factor* (dB)

*Factor includes antenna factor , cable loss and amplifier gain

Note 2: Margin (dB) = Emission level (dBuV/m) – Limit (dBuV/m).

Modulation	11a	Test Freq. (MHz)	5500
Polarization	Vertical		

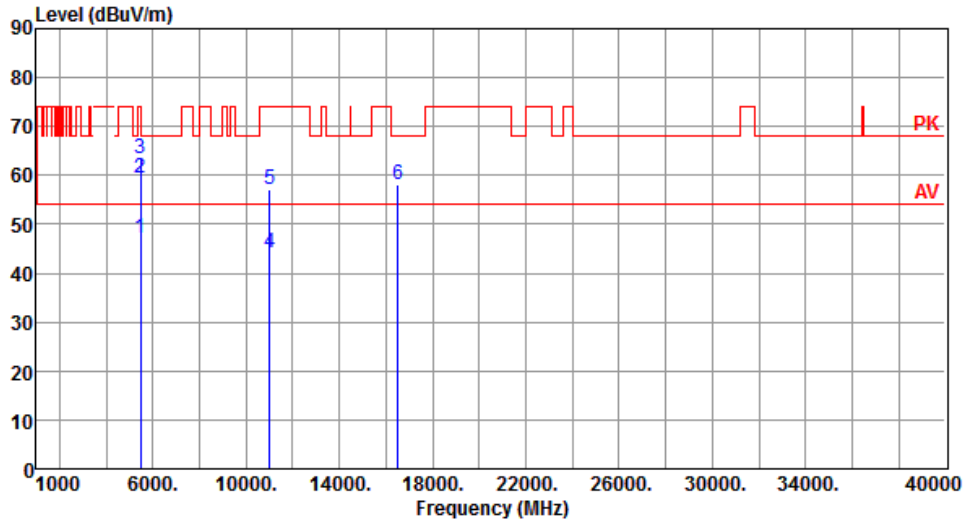

	Freq. MHz	Emission level dBuV/m	Limit dBuV/m	Margin dB	SA reading dBuV	Factor dB	Remark	ANT High cm	Turn Table deg
1	5460.00	47.24	54.00	-6.76	41.32	5.92	Average	102	84
2	5460.00	59.56	74.00	-14.44	53.64	5.92	Peak	102	84
3	5470.00	63.37	68.20	-4.83	57.41	5.96	Peak	102	84
4	11000.00	44.03	54.00	-9.97	28.45	15.58	Average	100	30
5	11000.00	57.21	74.00	-16.79	41.63	15.58	Peak	100	30
6	16500.00	58.17	68.20	-10.03	42.34	15.83	Peak	100	60

Note 1: Emission Level (dBuV/m) = SA Reading (dBuV/m) + Factor* (dB)

*Factor includes antenna factor , cable loss and amplifier gain

Note 2: Margin (dB) = Emission level (dBuV/m) – Limit (dBuV/m).

Modulation	11a	Test Freq. (MHz)	5580
Polarization	Horizontal		

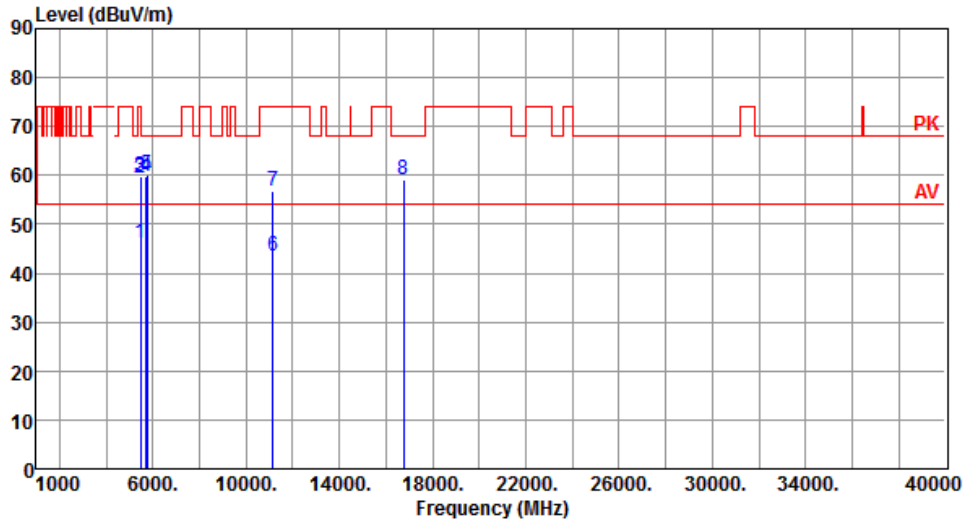

	Freq. MHz	Emission level dBuV/m	Limit dBuV/m	Margin dB	SA reading dBuV	Factor dB	Remark	ANT High cm	Turn Table deg
1	5460.00	46.17	54.00	-7.83	40.25	5.92	Average	100	53
2	5460.00	59.45	74.00	-14.55	53.53	5.92	Peak	100	53
3	5470.00	59.65	68.20	-8.55	53.69	5.96	Peak	100	53
4	5725.00	59.85	68.20	-8.35	53.56	6.29	Peak	100	53
5	5740.00	60.18	68.20	-8.02	53.86	6.32	Peak	100	53
6	11160.00	43.56	54.00	-10.44	28.30	15.26	Average	100	20
7	11160.00	56.79	74.00	-17.21	41.53	15.26	Peak	100	20
8	16740.00	59.11	68.20	-9.09	42.26	16.85	Peak	100	30

Note 1: Emission Level (dBuV/m) = SA Reading (dBuV/m) + Factor* (dB)

*Factor includes antenna factor , cable loss and amplifier gain

Note 2: Margin (dB) = Emission level (dBuV/m) – Limit (dBuV/m).

Modulation	11a	Test Freq. (MHz)	5580
Polarization	Vertical		

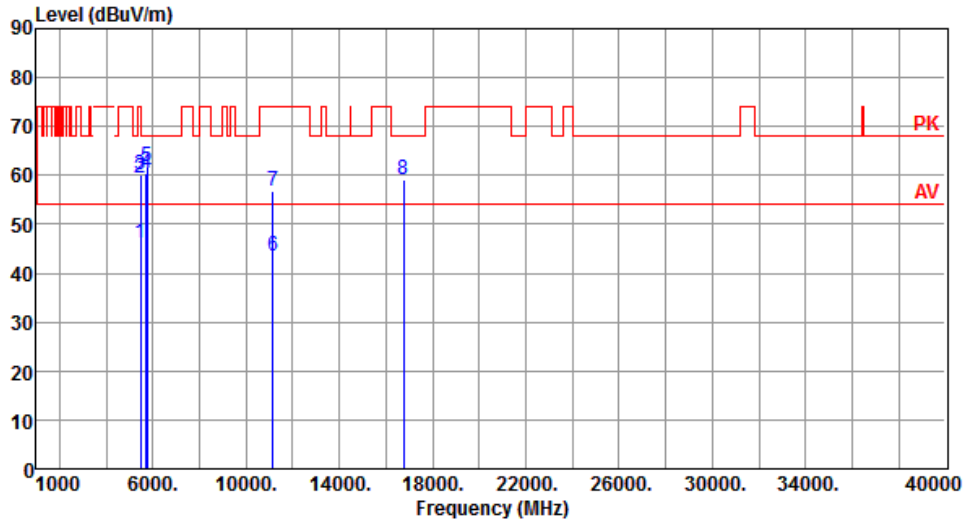

	Freq. MHz	Emission level dBuV/m	Limit dBuV/m	Margin dB	SA reading dBuV	Factor dB	Remark	ANT High cm	Turn Table deg
1	5460.00	46.30	54.00	-7.70	40.38	5.92	Average	100	88
2	5460.00	59.48	74.00	-14.52	53.56	5.92	Peak	100	88
3	5470.00	60.08	68.20	-8.12	54.12	5.96	Peak	100	88
4	5725.00	60.35	68.20	-7.85	54.06	6.29	Peak	100	88
5	5740.00	61.73	68.20	-6.47	55.41	6.32	Peak	100	88
6	11160.00	43.61	54.00	-10.39	28.35	15.26	Average	100	60
7	11160.00	56.68	74.00	-17.32	41.42	15.26	Peak	100	60
8	16740.00	59.27	68.20	-8.93	42.42	16.85	Peak	100	20

Note 1: Emission Level (dBuV/m) = SA Reading (dBuV/m) + Factor* (dB)

*Factor includes antenna factor , cable loss and amplifier gain

Note 2: Margin (dB) = Emission level (dBuV/m) – Limit (dBuV/m).

Modulation	11a	Test Freq. (MHz)	5700
Polarization	Horizontal		

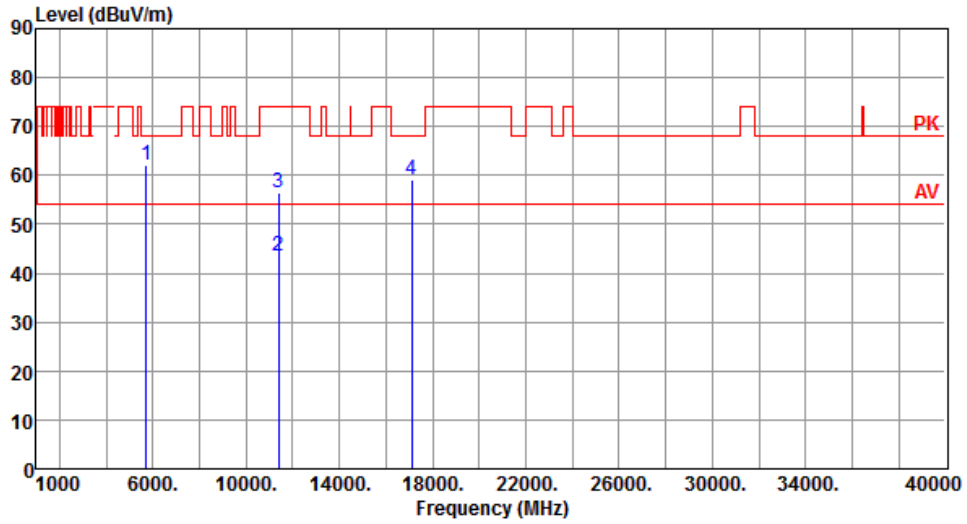

	Freq. MHz	Emission level dBuV/m	Limit dBuV/m	Margin dB	SA reading dBuV	Factor dB	Remark	ANT High cm	Turn Table deg
1	5725.00	62.04	68.20	-6.16	55.75	6.29	Peak	103	72
2	11400.00	43.65	54.00	-10.35	28.32	15.33	Average	100	80
3	11400.00	56.54	74.00	-17.46	41.21	15.33	Peak	100	80
4	17100.00	59.28	68.20	-8.92	42.39	16.89	Peak	100	50

Note 1: Emission Level (dBuV/m) = SA Reading (dBuV/m) + Factor* (dB)

*Factor includes antenna factor , cable loss and amplifier gain

Note 2: Margin (dB) = Emission level (dBuV/m) – Limit (dBuV/m).

Modulation	11a	Test Freq. (MHz)	5700
Polarization	Vertical		

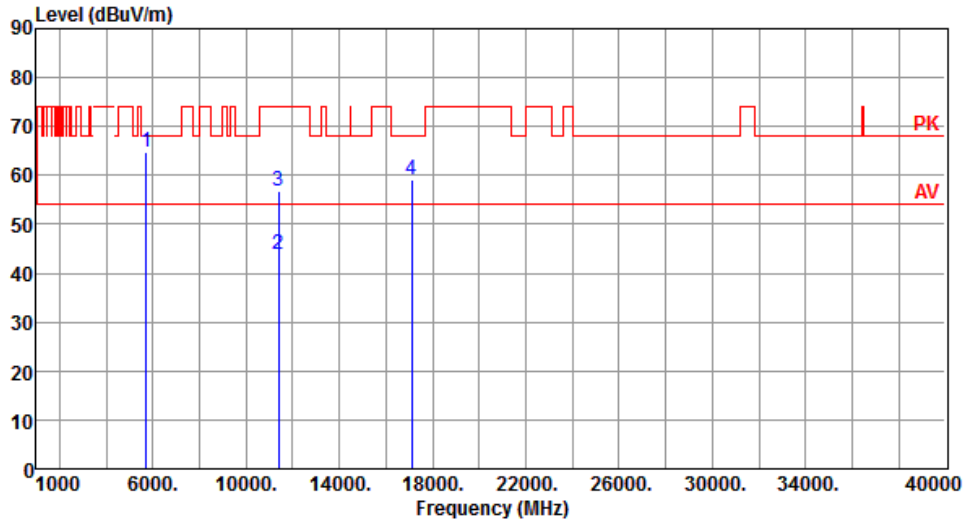

	Freq. MHz	Emission level dBuV/m	Limit dBuV/m	Margin dB	SA reading dBuV	Factor dB	Remark	ANT High cm	Turn Table deg
1	5725.00	64.64	68.20	-3.56	58.35	6.29	Peak	100	86
2	11400.00	43.87	54.00	-10.13	28.54	15.33	Average	100	30
3	11400.00	56.68	74.00	-17.32	41.35	15.33	Peak	100	30
4	17100.00	59.23	68.20	-8.97	42.34	16.89	Peak	100	60

Note 1: Emission Level (dBuV/m) = SA Reading (dBuV/m) + Factor* (dB)

*Factor includes antenna factor , cable loss and amplifier gain

Note 2: Margin (dB) = Emission level (dBuV/m) – Limit (dBuV/m).

Modulation	11a	Test Freq. (MHz)	5720
Polarization	Horizontal		

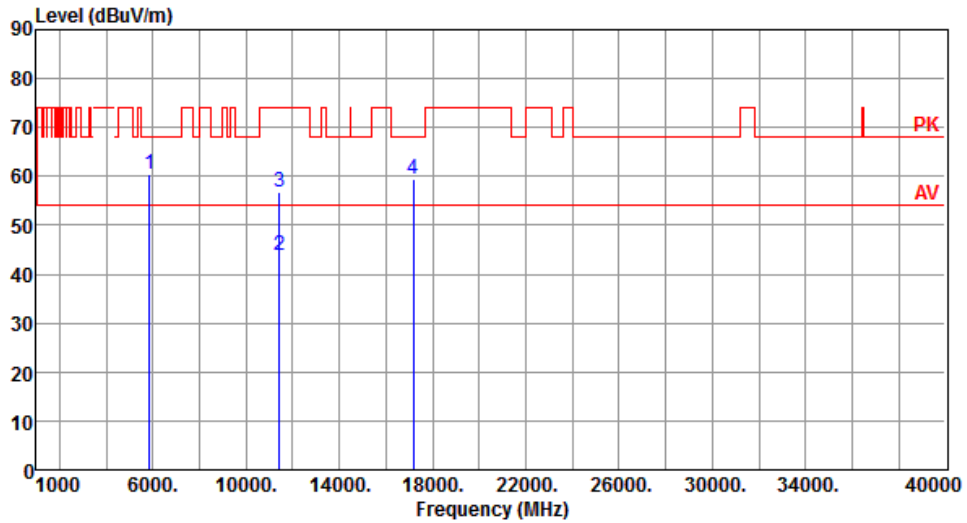

	Freq. MHz	Emission level dBuV/m	Limit dBuV/m	Margin dB	SA reading dBuV	Factor dB	Remark	ANT High cm	Turn Table deg
1	5850.00	60.54	68.20	-7.66	53.87	6.67	Peak	100	75
2	11440.00	43.72	54.00	-10.28	28.33	15.39	Average	100	30
3	11440.00	56.80	74.00	-17.20	41.41	15.39	Peak	100	30
4	17160.00	59.41	68.20	-8.79	42.56	16.85	Peak	100	90

Note 1: Emission Level (dBuV/m) = SA Reading (dBuV/m) + Factor* (dB)

*Factor includes antenna factor , cable loss and amplifier gain

Note 2: Margin (dB) = Emission level (dBuV/m) – Limit (dBuV/m).

Modulation	11a	Test Freq. (MHz)	5720
Polarization	Vertical		

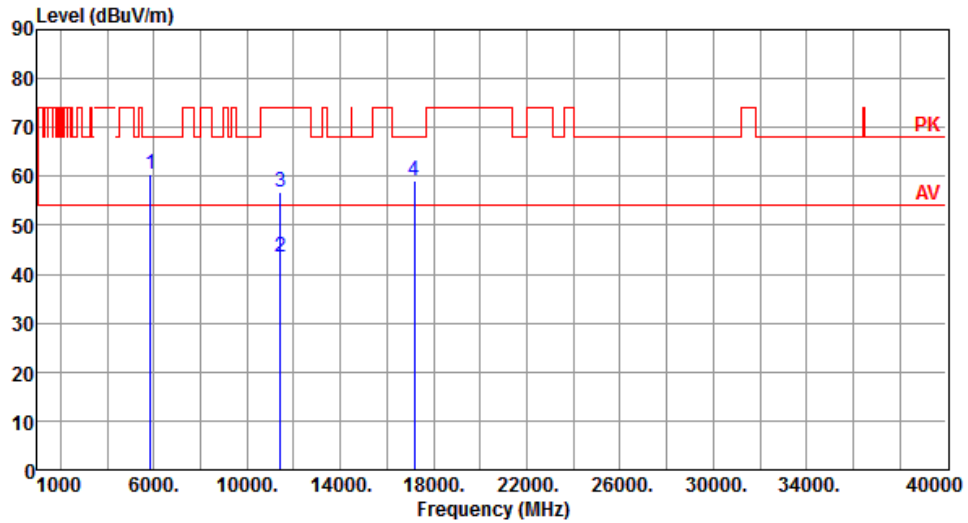

	Freq. MHz	Emission level dBuV/m	Limit dBuV/m	Margin dB	SA reading dBuV	Factor dB	Remark	ANT High cm	Turn Table deg
1	5850.00	60.41	68.20	-7.79	53.74	6.67	Peak	100	82
2	11440.00	43.60	54.00	-10.40	28.21	15.39	Average	100	50
3	11440.00	56.65	74.00	-17.35	41.26	15.39	Peak	100	50
4	17160.00	59.12	68.20	-9.08	42.27	16.85	Peak	100	30

Note 1: Emission Level (dBuV/m) = SA Reading (dBuV/m) + Factor* (dB)

*Factor includes antenna factor , cable loss and amplifier gain

Note 2: Margin (dB) = Emission level (dBuV/m) – Limit (dBuV/m).

Modulation	11a	Test Freq. (MHz)	5745
Polarization	Horizontal		

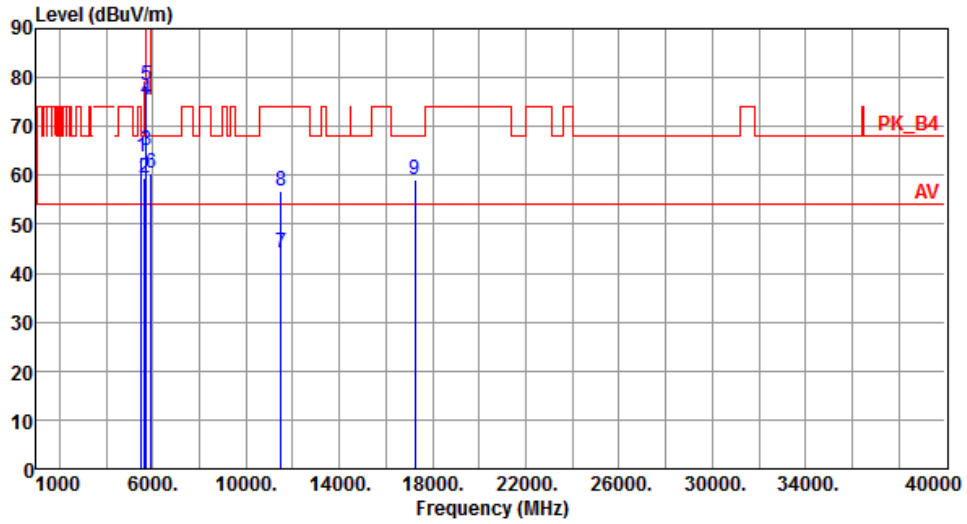

	Freq. MHz	Emission level dBuV/m	Limit dBuV/m	Margin dB	SA reading dBuV	Factor dB	Remark	ANT High cm	Turn Table deg
1	5505.00	63.77	68.20	-4.43	57.68	6.09	Peak	137	89
2	5650.00	59.61	68.20	-8.59	53.70	5.91	Peak	137	89
3	5700.00	64.98	105.20	-40.22	58.75	6.23	Peak	137	89
4	5720.00	75.23	110.80	-35.57	68.95	6.28	Peak	137	89
5	5725.00	78.49	122.20	-43.71	72.20	6.29	Peak	137	89
6	5925.00	60.51	68.20	-7.69	53.69	6.82	Peak	137	89
7	11490.00	44.11	54.00	-9.89	28.66	15.45	Average	100	50
8	11490.00	56.79	74.00	-17.21	41.34	15.45	Peak	100	50
9	17235.00	59.26	68.20	-8.94	42.28	16.98	Peak	100	20

Note 1: Emission Level (dBuV/m) = SA Reading (dBuV/m) + Factor* (dB)

*Factor includes antenna factor , cable loss and amplifier gain

Note 2: Margin (dB) = Emission level (dBuV/m) – Limit (dBuV/m).

Modulation	11a	Test Freq. (MHz)	5745
Polarization	Vertical		

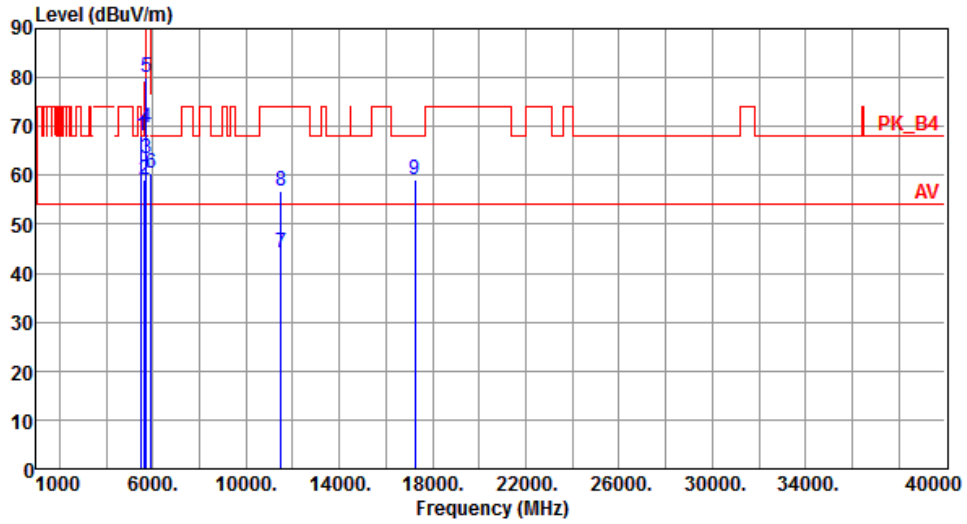

	Freq. MHz	Emission level dBuV/m	Limit dBuV/m	Margin dB	SA reading dBuV	Factor dB	Remark	ANT High cm	Turn Table deg
1	5505.00	67.93	68.20	-0.27	61.84	6.09	Peak	110	7
2	5650.00	59.07	68.20	-9.13	53.16	5.91	Peak	100	4
3	5700.00	63.46	105.20	-41.74	57.23	6.23	Peak	100	4
4	5720.00	69.69	110.80	-41.11	63.41	6.28	Peak	100	4
5	5725.00	79.98	122.20	-42.22	73.69	6.29	Peak	100	4
6	5925.00	60.47	68.20	-7.73	53.65	6.82	Peak	100	4
7	11490.00	44.22	54.00	-9.78	28.77	15.45	Average	100	30
8	11490.00	56.82	74.00	-17.18	41.37	15.45	Peak	100	30
9	17235.00	59.24	68.20	-8.96	42.26	16.98	Peak	100	25

Note 1: Emission Level (dBuV/m) = SA Reading (dBuV/m) + Factor* (dB)

*Factor includes antenna factor , cable loss and amplifier gain

Note 2: Margin (dB) = Emission level (dBuV/m) – Limit (dBuV/m).

Modulation	11a	Test Freq. (MHz)	5785
Polarization	Horizontal		

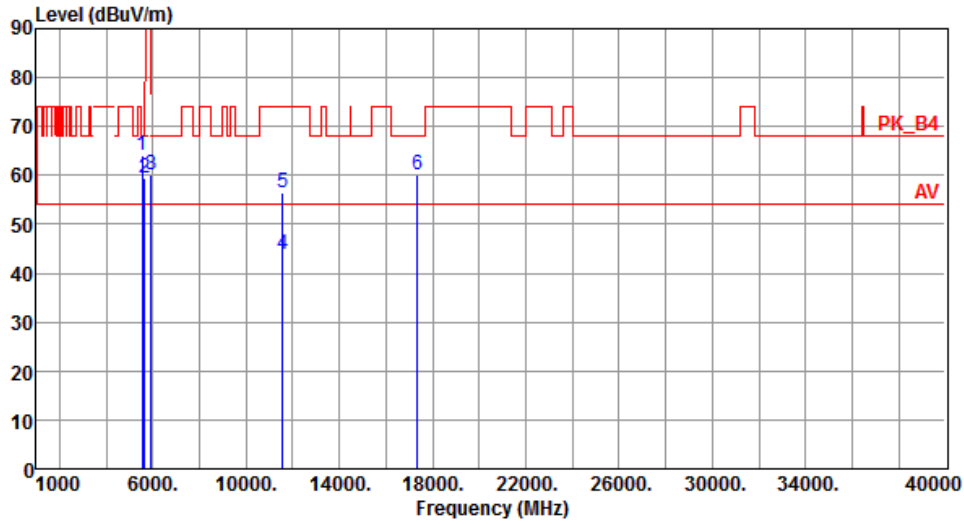

	Freq. MHz	Emission level dBuV/m	Limit dBuV/m	Margin dB	SA reading dBuV	Factor dB	Remark	ANT High cm	Turn Table deg
1	5545.00	63.96	68.20	-4.24	57.95	6.01	Peak	132	92
2	5650.00	59.36	68.20	-8.84	53.45	5.91	Peak	132	92
3	5925.00	60.14	68.20	-8.06	53.32	6.82	Peak	132	92
4	11570.00	43.75	54.00	-10.25	28.45	15.30	Average	100	40
5	11570.00	56.51	74.00	-17.49	41.21	15.30	Peak	100	40
6	17355.00	59.96	68.20	-8.24	42.35	17.61	Peak	100	90

Note 1: Emission Level (dBuV/m) = SA Reading (dBuV/m) + Factor* (dB)

*Factor includes antenna factor , cable loss and amplifier gain

Note 2: Margin (dB) = Emission level (dBuV/m) – Limit (dBuV/m).

Modulation	11a	Test Freq. (MHz)	5785
Polarization	Vertical		

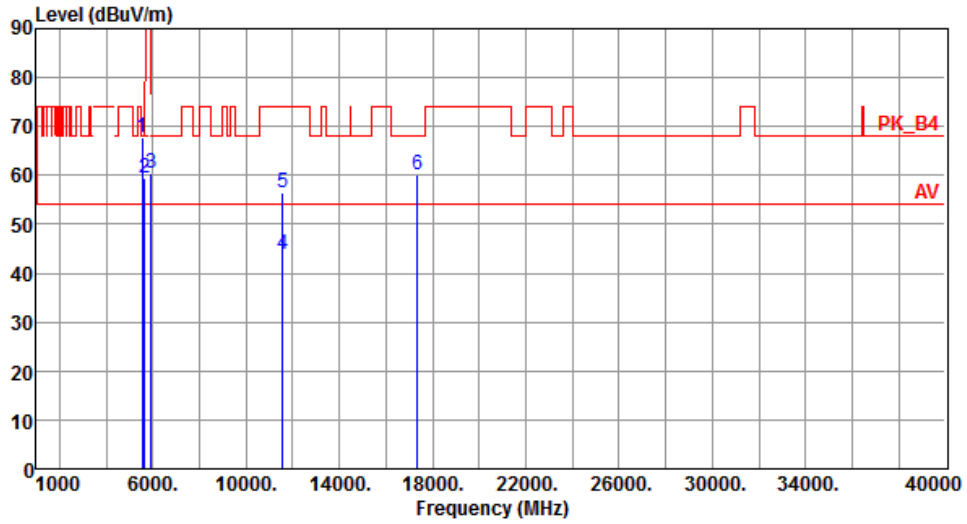

	Freq. MHz	Emission level dBuV/m	Limit dBuV/m	Margin dB	SA reading dBuV	Factor dB	Remark	ANT High cm	Turn Table deg
1	5545.00	67.87	68.20	-0.33	61.86	6.01	Peak	132	4
2	5650.00	59.36	68.20	-8.84	53.45	5.91	Peak	100	6
3	5925.00	60.44	68.20	-7.76	53.62	6.82	Peak	100	6
4	11570.00	43.94	54.00	-10.06	28.64	15.30	Average	100	30
5	11570.00	56.53	74.00	-17.47	41.23	15.30	Peak	100	30
6	17355.00	60.15	68.20	-8.05	42.54	17.61	Peak	100	25

Note 1: Emission Level (dBuV/m) = SA Reading (dBuV/m) + Factor* (dB)

*Factor includes antenna factor , cable loss and amplifier gain

Note 2: Margin (dB) = Emission level (dBuV/m) – Limit (dBuV/m).

Modulation	11a	Test Freq. (MHz)	5825
Polarization	Horizontal		

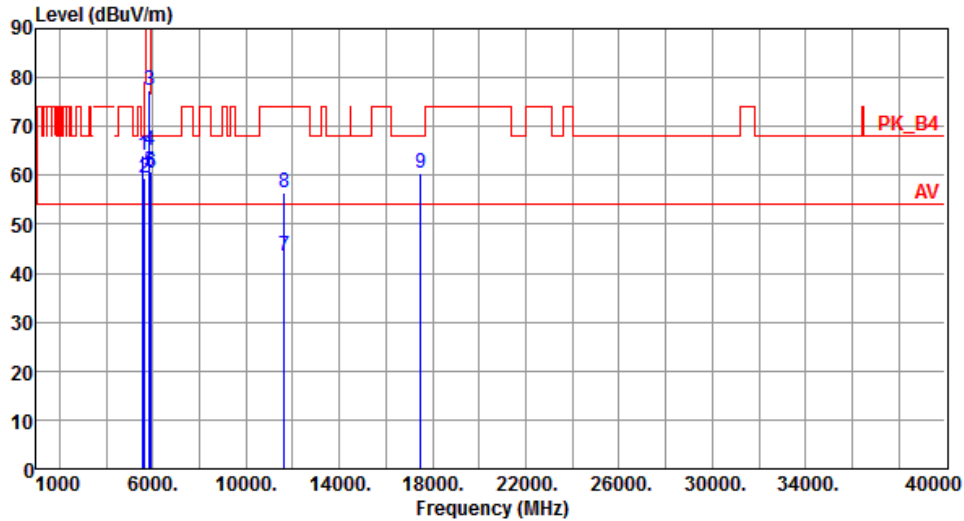

	Freq. MHz	Emission level dBuV/m	Limit dBuV/m	Margin dB	SA reading dBuV	Factor dB	Remark	ANT High cm	Turn Table deg
1	5585.00	63.95	68.20	-4.25	57.96	5.99	Peak	130	87
2	5650.00	59.56	68.20	-8.64	53.65	5.91	Peak	130	87
3	5850.00	77.29	122.20	-44.91	70.62	6.67	Peak	130	87
4	5855.00	65.00	110.80	-45.80	58.32	6.68	Peak	130	87
5	5875.00	60.84	105.20	-44.36	54.12	6.72	Peak	130	87
6	5925.00	60.35	68.20	-7.85	53.53	6.82	Peak	130	87
7	11650.00	43.43	54.00	-10.57	28.37	15.06	Average	100	30
8	11650.00	56.58	74.00	-17.42	41.52	15.06	Peak	100	30
9	17475.00	60.58	68.20	-7.62	42.35	18.23	Peak	100	25

Note 1: Emission Level (dBuV/m) = SA Reading (dBuV/m) + Factor* (dB)

*Factor includes antenna factor , cable loss and amplifier gain

Note 2: Margin (dB) = Emission level (dBuV/m) – Limit (dBuV/m).

Modulation	11a	Test Freq. (MHz)	5825
Polarization	Vertical		

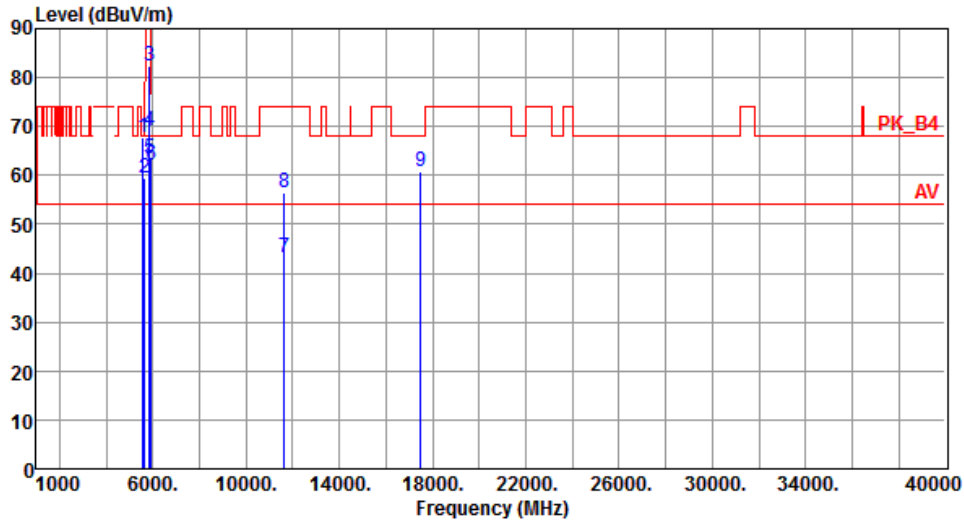

	Freq. MHz	Emission level dBuV/m	Limit dBuV/m	Margin dB	SA reading dBuV	Factor dB	Remark	ANT High cm	Turn Table deg
1	5585.00	67.84	68.20	-0.36	61.85	5.99	Peak	128	5
2	5650.00	59.53	68.20	-8.67	53.62	5.91	Peak	100	9
3	5850.00	82.32	122.20	-39.88	75.65	6.67	Peak	100	9
4	5855.00	69.03	110.80	-41.77	62.35	6.68	Peak	100	9
5	5875.00	63.37	105.20	-41.83	56.65	6.72	Peak	100	9
6	5925.00	61.94	68.20	-6.26	55.12	6.82	Peak	100	9
7	11650.00	43.29	54.00	-10.71	28.23	15.06	Average	100	30
8	11650.00	56.38	74.00	-17.62	41.32	15.06	Peak	100	30
9	17475.00	60.88	68.20	-7.32	42.65	18.23	Peak	100	30

Note 1: Emission Level (dBuV/m) = SA Reading (dBuV/m) + Factor* (dB)

*Factor includes antenna factor , cable loss and amplifier gain

Note 2: Margin (dB) = Emission level (dBuV/m) – Limit (dBuV/m).

3.5.6 Transmitter Radiated Unwanted Emissions (Above 1GHz) for VHT20

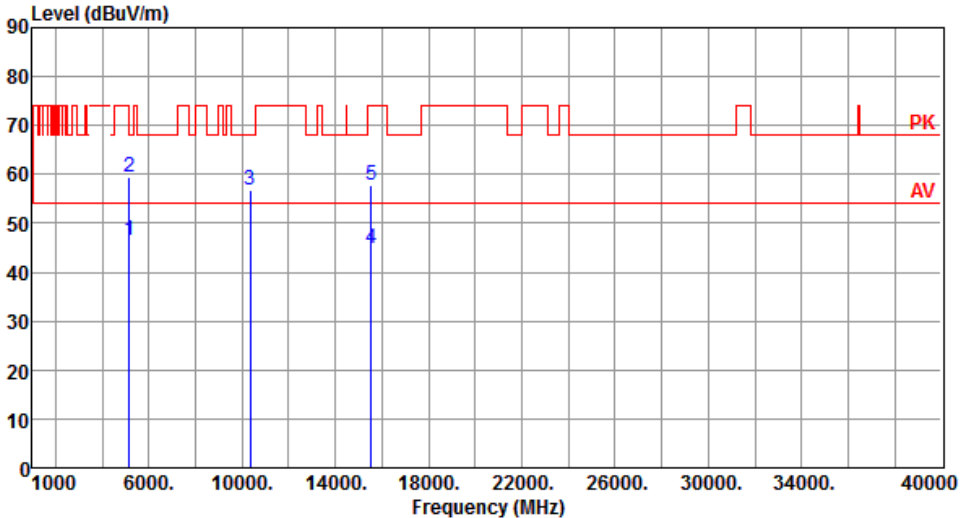
Modulation	VHT20	Test Freq. (MHz)	5180																																																																		
Polarization	Horizontal																																																																				
																																																																					
	<table border="1"> <thead> <tr> <th>Freq.</th> <th>Emission level</th> <th>Limit</th> <th>Margin</th> <th>SA reading</th> <th>Factor</th> <th>Remark</th> <th>ANT High</th> <th>Turn Table</th> </tr> <tr> <th>MHz</th> <th>dBuV/m</th> <th>dBuV/m</th> <th>dB</th> <th>dBuV</th> <th>dB</th> <th></th> <th>cm</th> <th>deg</th> </tr> </thead> <tbody> <tr> <td>1</td> <td>5150.00</td> <td>46.37</td> <td>54.00</td> <td>-7.63</td> <td>40.42</td> <td>5.95</td> <td>Average</td> <td>100</td> <td>54</td> </tr> <tr> <td>2</td> <td>5150.00</td> <td>59.57</td> <td>74.00</td> <td>-14.43</td> <td>53.62</td> <td>5.95</td> <td>Peak</td> <td>100</td> <td>54</td> </tr> <tr> <td>3</td> <td>10360.00</td> <td>56.69</td> <td>68.20</td> <td>-11.51</td> <td>41.59</td> <td>15.10</td> <td>Peak</td> <td>100</td> <td>70</td> </tr> <tr> <td>4</td> <td>15540.00</td> <td>44.91</td> <td>54.00</td> <td>-9.09</td> <td>29.26</td> <td>15.65</td> <td>Average</td> <td>100</td> <td>40</td> </tr> <tr> <td>5</td> <td>15540.00</td> <td>57.78</td> <td>74.00</td> <td>-16.22</td> <td>42.13</td> <td>15.65</td> <td>Peak</td> <td>100</td> <td>40</td> </tr> </tbody> </table>	Freq.	Emission level	Limit	Margin	SA reading	Factor	Remark	ANT High	Turn Table	MHz	dBuV/m	dBuV/m	dB	dBuV	dB		cm	deg	1	5150.00	46.37	54.00	-7.63	40.42	5.95	Average	100	54	2	5150.00	59.57	74.00	-14.43	53.62	5.95	Peak	100	54	3	10360.00	56.69	68.20	-11.51	41.59	15.10	Peak	100	70	4	15540.00	44.91	54.00	-9.09	29.26	15.65	Average	100	40	5	15540.00	57.78	74.00	-16.22	42.13	15.65	Peak	100	40
Freq.	Emission level	Limit	Margin	SA reading	Factor	Remark	ANT High	Turn Table																																																													
MHz	dBuV/m	dBuV/m	dB	dBuV	dB		cm	deg																																																													
1	5150.00	46.37	54.00	-7.63	40.42	5.95	Average	100	54																																																												
2	5150.00	59.57	74.00	-14.43	53.62	5.95	Peak	100	54																																																												
3	10360.00	56.69	68.20	-11.51	41.59	15.10	Peak	100	70																																																												
4	15540.00	44.91	54.00	-9.09	29.26	15.65	Average	100	40																																																												
5	15540.00	57.78	74.00	-16.22	42.13	15.65	Peak	100	40																																																												
<p>Note 1: Emission Level (dBuV/m) = SA Reading (dBuV/m) + Factor* (dB) *Factor includes antenna factor , cable loss and amplifier gain Note 2: Margin (dB) = Emission level (dBuV/m) – Limit (dBuV/m).</p>																																																																					

Modulation	VHT20	Test Freq. (MHz)	5180
Polarization	Vertical		

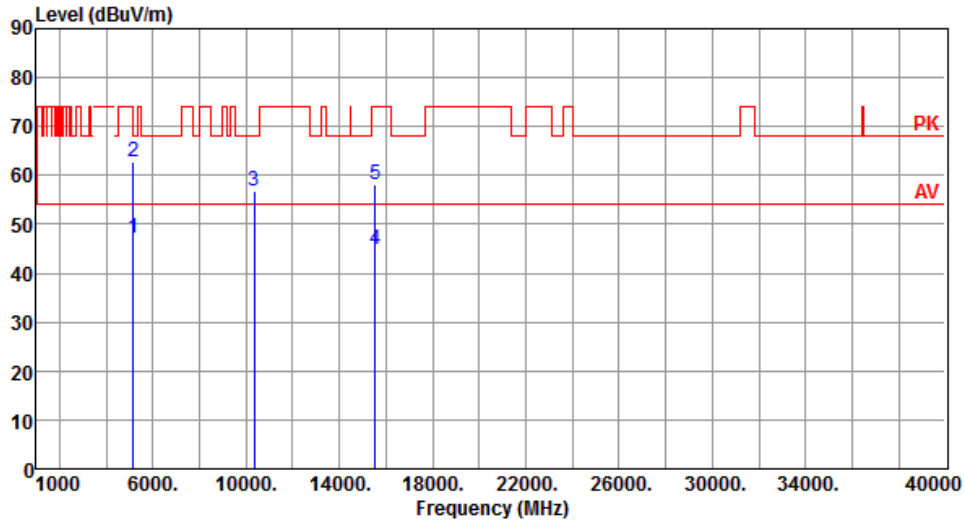

	Freq. MHz	Emission level dBuV/m	Limit dBuV/m	Margin dB	SA reading dBuV	Factor dB	Remark	ANT High cm	Turn Table deg
1	5150.00	47.20	54.00	-6.80	41.25	5.95	Average	100	76
2	5150.00	62.74	74.00	-11.26	56.79	5.95	Peak	100	76
3	10360.00	56.72	68.20	-11.48	41.62	15.10	Peak	100	30
4	15540.00	44.92	54.00	-9.08	29.27	15.65	Average	100	50
5	15540.00	57.96	74.00	-16.04	42.31	15.65	Peak	100	50

Note 1: Emission Level (dBuV/m) = SA Reading (dBuV/m) + Factor* (dB)

*Factor includes antenna factor , cable loss and amplifier gain

Note 2: Margin (dB) = Emission level (dBuV/m) – Limit (dBuV/m).

Modulation	VHT20	Test Freq. (MHz)	5200
Polarization	Horizontal		

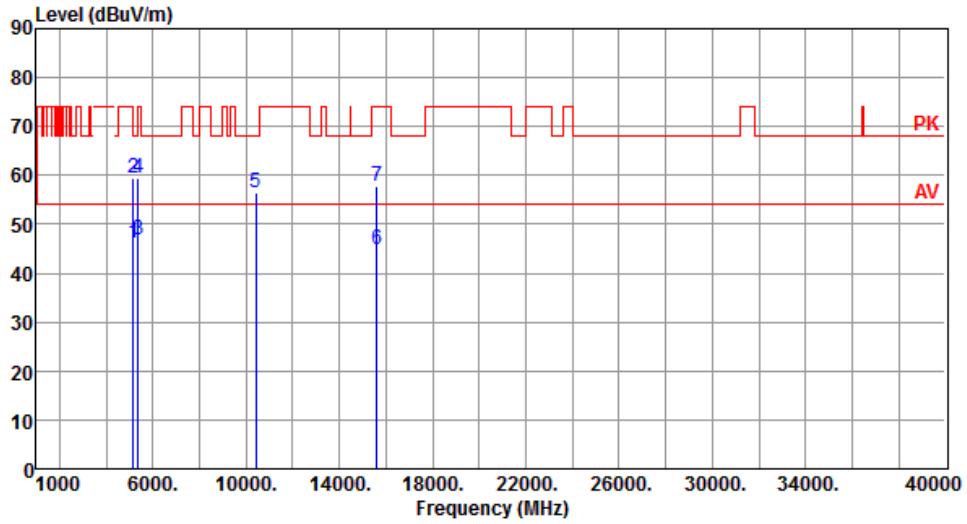

	Freq. MHz	Emission level dBuV/m	Limit dBuV/m	Margin dB	SA reading dBuV	Factor dB	Remark	ANT High cm	Turn Table deg
1	5150.00	46.20	54.00	-7.80	40.25	5.95	Average	100	58
2	5150.00	59.54	74.00	-14.46	53.59	5.95	Peak	100	58
3	5360.00	46.71	54.00	-7.29	41.26	5.45	Average	100	58
4	5360.00	59.32	74.00	-14.68	53.87	5.45	Peak	100	58
5	10400.00	56.62	68.20	-11.58	41.29	15.33	Peak	100	60
6	15600.00	44.78	54.00	-9.22	29.29	15.49	Average	100	70
7	15600.00	57.73	74.00	-16.27	42.24	15.49	Peak	100	70

Note 1: Emission Level (dBuV/m) = SA Reading (dBuV/m) + Factor* (dB)

*Factor includes antenna factor , cable loss and amplifier gain

Note 2: Margin (dB) = Emission level (dBuV/m) – Limit (dBuV/m).

Modulation	VHT20	Test Freq. (MHz)	5200
Polarization	Vertical		

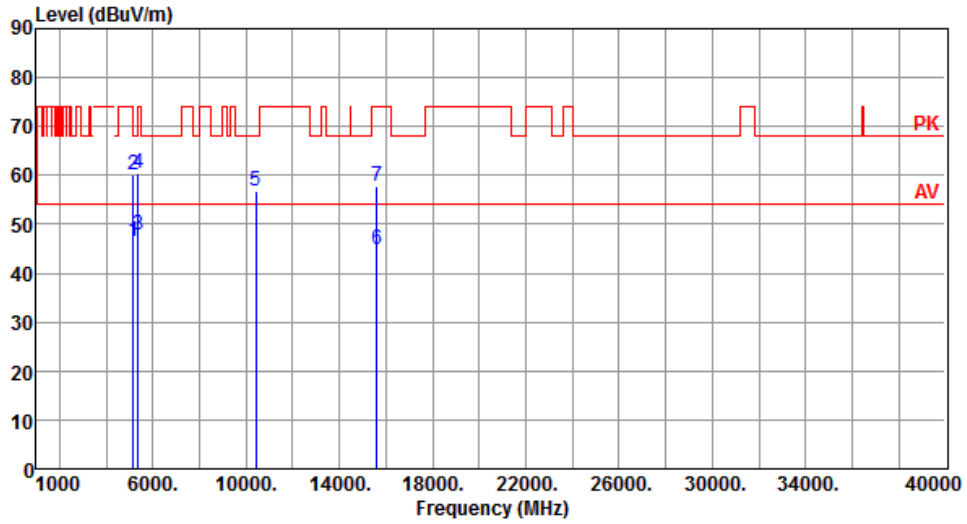

	Freq. MHz	Emission level dBuV/m	Limit dBuV/m	Margin dB	SA reading dBuV	Factor dB	Remark	ANT High cm	Turn Table deg
1	5150.00	46.50	54.00	-7.50	40.55	5.95	Average	100	77
2	5150.00	60.26	74.00	-13.74	54.31	5.95	Peak	100	77
3	5360.00	47.70	54.00	-6.30	42.25	5.45	Average	100	77
4	5360.00	60.51	74.00	-13.49	55.06	5.45	Peak	100	77
5	10400.00	56.71	68.20	-11.49	41.38	15.33	Peak	100	40
6	15600.00	44.83	54.00	-9.17	29.34	15.49	Average	100	25
7	15600.00	57.83	74.00	-16.17	42.34	15.49	Peak	100	25

Note 1: Emission Level (dBuV/m) = SA Reading (dBuV/m) + Factor* (dB)

*Factor includes antenna factor , cable loss and amplifier gain

Note 2: Margin (dB) = Emission level (dBuV/m) – Limit (dBuV/m).

Modulation	VHT20	Test Freq. (MHz)	5240
Polarization	Horizontal		

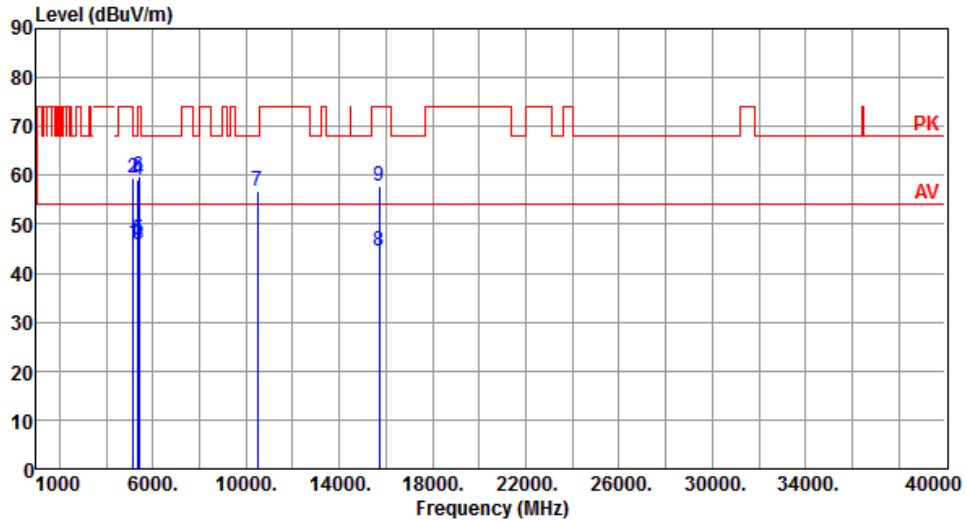

	Freq. MHz	Emission level dBuV/m	Limit dBuV/m	Margin dB	SA reading dBuV	Factor dB	Remark	ANT High cm	Turn Table deg
1	5150.00	46.26	54.00	-7.74	40.31	5.95	Average	100	54
2	5150.00	59.41	74.00	-14.59	53.46	5.95	Peak	100	54
3	5350.00	45.92	54.00	-8.08	40.52	5.40	Average	100	54
4	5350.00	59.14	74.00	-14.86	53.74	5.40	Peak	100	54
5	5400.00	46.90	54.00	-7.10	41.26	5.64	Average	100	56
6	5400.00	59.76	74.00	-14.24	54.12	5.64	Peak	100	56
7	10480.00	56.86	68.20	-11.34	41.55	15.31	Peak	100	50
8	15720.00	44.54	54.00	-9.46	29.31	15.23	Average	100	30
9	15720.00	57.77	74.00	-16.23	42.54	15.23	Peak	100	30

Note 1: Emission Level (dBuV/m) = SA Reading (dBuV/m) + Factor* (dB)

*Factor includes antenna factor , cable loss and amplifier gain

Note 2: Margin (dB) = Emission level (dBuV/m) – Limit (dBuV/m).

Modulation	VHT20	Test Freq. (MHz)	5240
Polarization	Vertical		

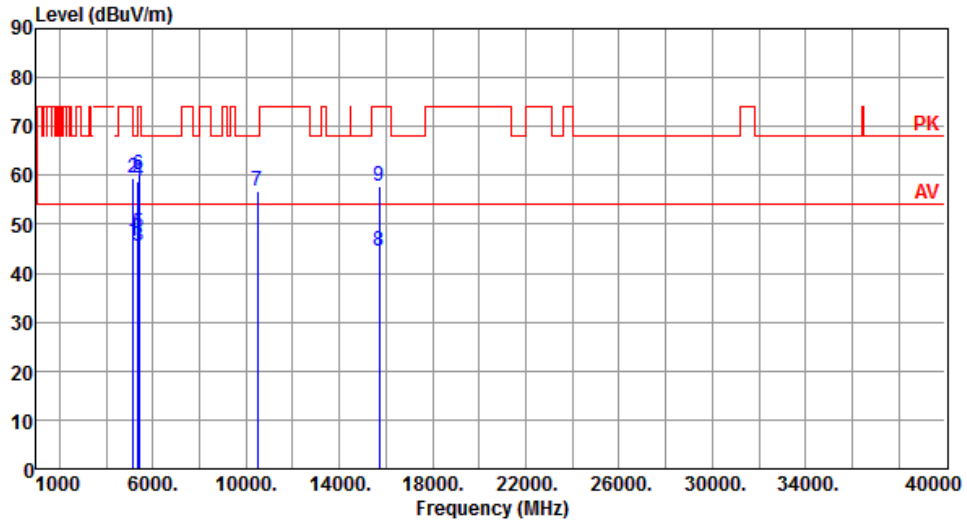

	Freq. MHz	Emission level dBuV/m	Limit dBuV/m	Margin dB	SA reading dBuV	Factor dB	Remark	ANT High cm	Turn Table deg
1	5150.00	46.37	54.00	-7.63	40.42	5.95	Average	100	74
2	5150.00	59.47	74.00	-14.53	53.52	5.95	Peak	100	74
3	5350.00	45.61	54.00	-8.39	40.21	5.40	Average	100	74
4	5350.00	58.94	74.00	-15.06	53.54	5.40	Peak	100	74
5	5400.00	48.02	54.00	-5.98	42.38	5.64	Average	100	74
6	5400.00	60.26	74.00	-13.74	54.62	5.64	Peak	100	74
7	10480.00	56.78	68.20	-11.42	41.47	15.31	Peak	100	20
8	15720.00	44.59	54.00	-9.41	29.36	15.23	Average	100	35
9	15720.00	57.78	74.00	-16.22	42.55	15.23	Peak	100	35

Note 1: Emission Level (dBuV/m) = SA Reading (dBuV/m) + Factor* (dB)

*Factor includes antenna factor , cable loss and amplifier gain

Note 2: Margin (dB) = Emission level (dBuV/m) – Limit (dBuV/m).

Modulation	VHT20	Test Freq. (MHz)	5260
Polarization	Horizontal		

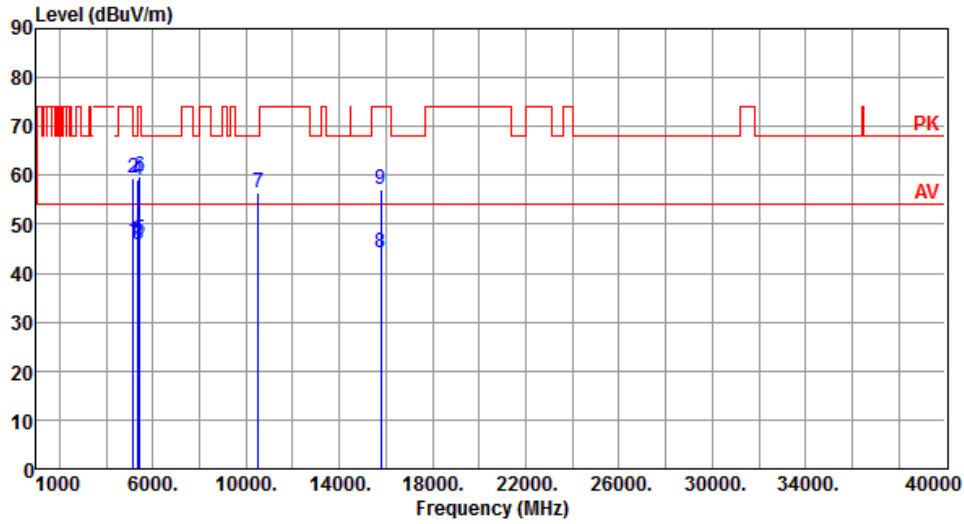

	Freq. MHz	Emission level dBuV/m	Limit dBuV/m	Margin dB	SA reading dBuV	Factor dB	Remark	ANT High cm	Turn Table deg
1	5150.00	46.33	54.00	-7.67	40.38	5.95	Average	100	55
2	5150.00	59.51	74.00	-14.49	53.56	5.95	Peak	100	55
3	5350.00	45.93	54.00	-8.07	40.53	5.40	Average	100	55
4	5350.00	58.95	74.00	-15.05	53.55	5.40	Peak	100	55
5	5420.00	46.91	54.00	-7.09	41.18	5.73	Average	100	55
6	5420.00	59.69	74.00	-14.31	53.96	5.73	Peak	100	55
7	10520.00	56.61	68.20	-11.59	41.28	15.33	Peak	100	70
8	15780.00	44.22	54.00	-9.78	29.27	14.95	Average	100	60
9	15780.00	57.10	74.00	-16.90	42.15	14.95	Peak	100	60

Note 1: Emission Level (dBuV/m) = SA Reading (dBuV/m) + Factor* (dB)

*Factor includes antenna factor , cable loss and amplifier gain

Note 2: Margin (dB) = Emission level (dBuV/m) – Limit (dBuV/m).

Modulation	VHT20	Test Freq. (MHz)	5260
Polarization	Vertical		

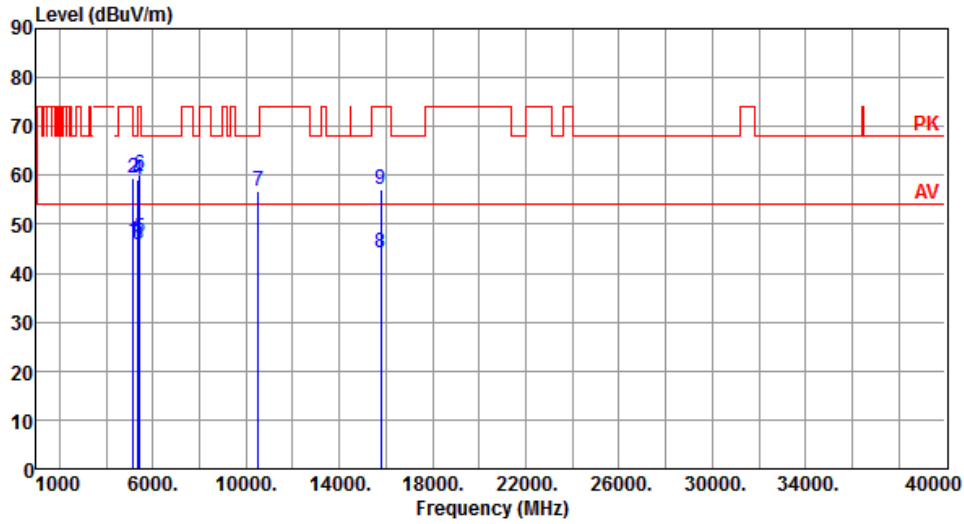

	Freq. MHz	Emission level dBuV/m	Limit dBuV/m	Margin dB	SA reading dBuV	Factor dB	Remark	ANT High cm	Turn Table deg
1	5150.00	46.54	54.00	-7.46	40.59	5.95	Average	100	86
2	5150.00	59.58	74.00	-14.42	53.63	5.95	Peak	100	86
3	5350.00	45.71	54.00	-8.29	40.31	5.40	Average	100	86
4	5350.00	58.97	74.00	-15.03	53.57	5.40	Peak	100	86
5	5420.00	47.30	54.00	-6.70	41.57	5.73	Average	100	86
6	5420.00	60.01	74.00	-13.99	54.28	5.73	Peak	100	86
7	10520.00	56.84	68.20	-11.36	41.51	15.33	Peak	100	40
8	15780.00	44.16	54.00	-9.84	29.21	14.95	Average	100	55
9	15780.00	57.27	74.00	-16.73	42.32	14.95	Peak	100	55

Note 1: Emission Level (dBuV/m) = SA Reading (dBuV/m) + Factor* (dB)

*Factor includes antenna factor , cable loss and amplifier gain

Note 2: Margin (dB) = Emission level (dBuV/m) – Limit (dBuV/m).

Modulation	VHT20	Test Freq. (MHz)	5300
Polarization	Horizontal		

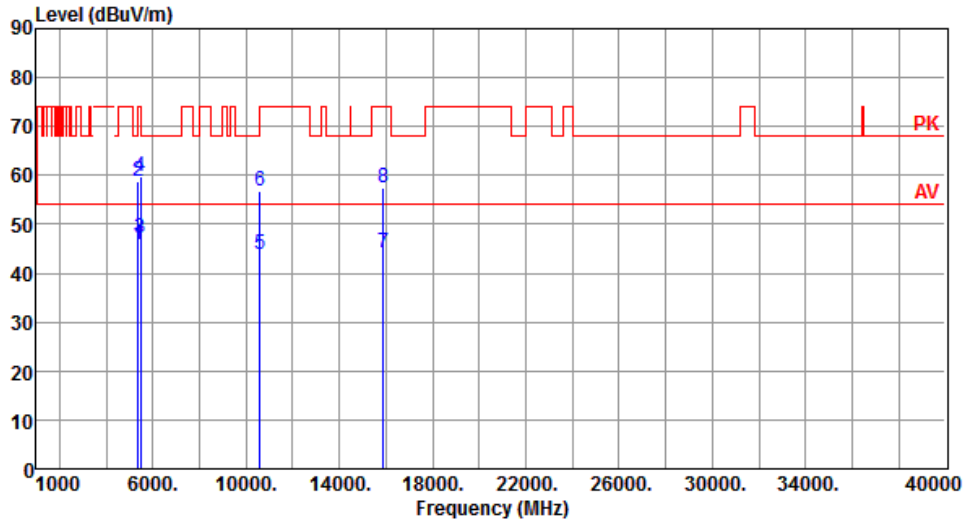

	Freq. MHz	Emission level dBuV/m	Limit dBuV/m	Margin dB	SA reading dBuV	Factor dB	Remark	ANT High cm	Turn Table deg
1	5350.00	45.75	54.00	-8.25	40.35	5.40	Average	102	59
2	5350.00	58.81	74.00	-15.19	53.41	5.40	Peak	102	59
3	5460.00	47.20	54.00	-6.80	41.28	5.92	Average	102	59
4	5460.00	59.65	74.00	-14.35	53.73	5.92	Peak	102	59
5	10600.00	43.94	54.00	-10.06	28.53	15.41	Average	100	100
6	10600.00	56.66	74.00	-17.34	41.25	15.41	Peak	100	100
7	15900.00	44.16	54.00	-9.84	29.27	14.89	Average	100	20
8	15900.00	57.30	74.00	-16.70	42.41	14.89	Peak	100	20

Note 1: Emission Level (dBuV/m) = SA Reading (dBuV/m) + Factor* (dB)

*Factor includes antenna factor , cable loss and amplifier gain

Note 2: Margin (dB) = Emission level (dBuV/m) – Limit (dBuV/m).

Modulation	VHT20	Test Freq. (MHz)	5300
Polarization	Vertical		

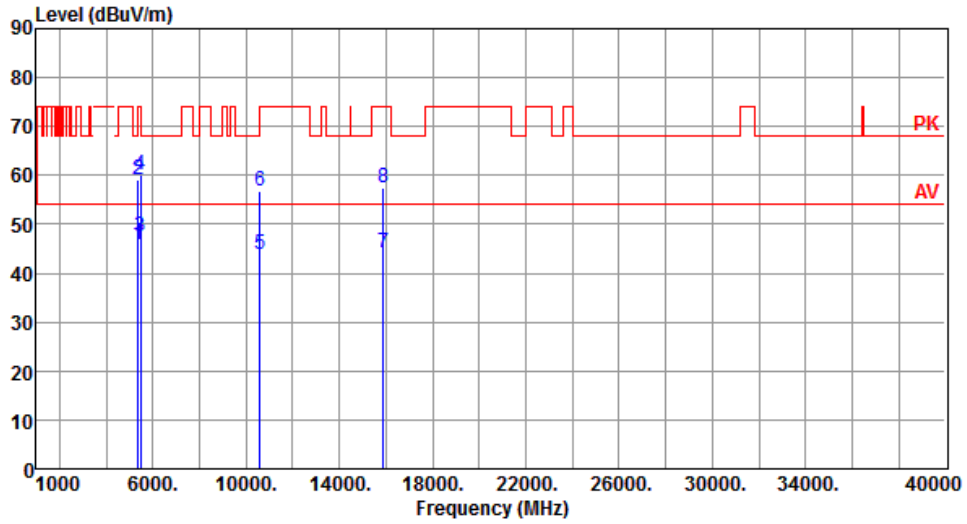

	Freq. MHz	Emission level dBuV/m	Limit dBuV/m	Margin dB	SA reading dBuV	Factor dB	Remark	ANT High cm	Turn Table deg
1	5350.00	45.96	54.00	-8.04	40.56	5.40	Average	100	82
2	5350.00	58.99	74.00	-15.01	53.59	5.40	Peak	100	82
3	5460.00	47.56	54.00	-6.44	41.64	5.92	Average	100	82
4	5460.00	60.08	74.00	-13.92	54.16	5.92	Peak	100	82
5	10600.00	43.87	54.00	-10.13	28.46	15.41	Average	100	90
6	10600.00	56.76	74.00	-17.24	41.35	15.41	Peak	100	90
7	15900.00	44.17	54.00	-9.83	29.28	14.89	Average	100	40
8	15900.00	57.40	74.00	-16.60	42.51	14.89	Peak	100	40

Note 1: Emission Level (dBuV/m) = SA Reading (dBuV/m) + Factor* (dB)

*Factor includes antenna factor , cable loss and amplifier gain

Note 2: Margin (dB) = Emission level (dBuV/m) – Limit (dBuV/m).

Modulation	VHT20	Test Freq. (MHz)	5320
Polarization	Horizontal		

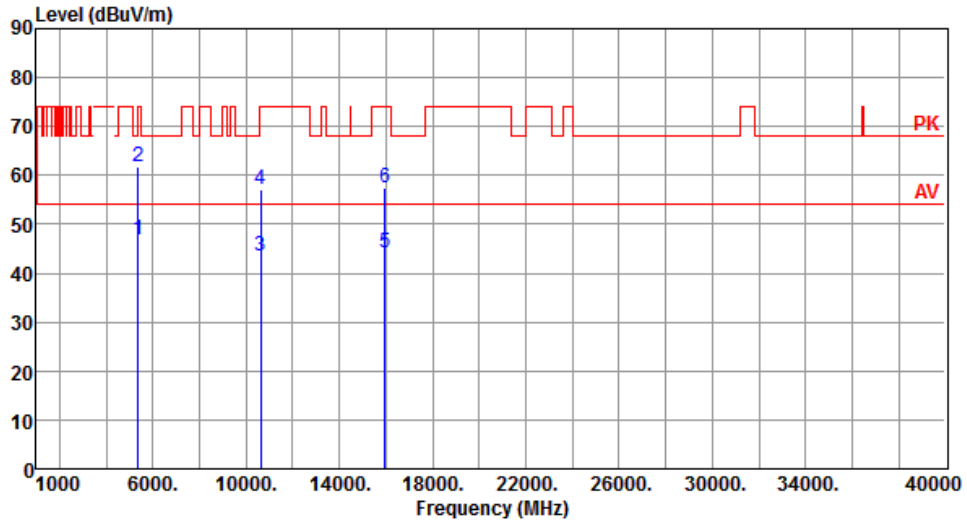

	Freq. MHz	Emission level dBuV/m	Limit dBuV/m	Margin dB	SA reading dBuV	Factor dB	Remark	ANT High cm	Turn Table deg
1	5350.00	46.71	54.00	-7.29	41.31	5.40	Average	103	53
2	5350.00	61.66	74.00	-12.34	56.26	5.40	Peak	103	53
3	10640.00	43.63	54.00	-10.37	28.27	15.36	Average	100	40
4	10640.00	56.99	74.00	-17.01	41.63	15.36	Peak	100	40
5	15960.00	44.27	54.00	-9.73	29.36	14.91	Average	100	30
6	15960.00	57.42	74.00	-16.58	42.51	14.91	Peak	100	30

Note 1: Emission Level (dBuV/m) = SA Reading (dBuV/m) + Factor* (dB)

*Factor includes antenna factor , cable loss and amplifier gain

Note 2: Margin (dB) = Emission level (dBuV/m) – Limit (dBuV/m).

Modulation	VHT20	Test Freq. (MHz)	5320
Polarization	Vertical		

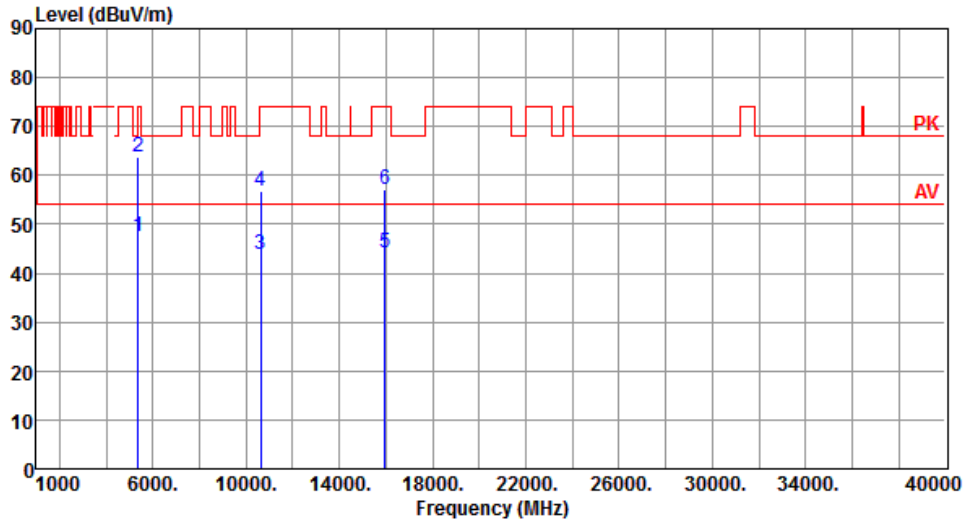

	Freq. MHz	Emission level dBuV/m	Limit dBuV/m	Margin dB	SA reading dBuV	Factor dB	Remark	ANT High cm	Turn Table deg
1	5350.00	47.58	54.00	-6.42	42.18	5.40	Average	100	84
2	5350.00	63.81	74.00	-10.19	58.41	5.40	Peak	100	84
3	10640.00	43.73	54.00	-10.27	28.37	15.36	Average	100	30
4	10640.00	56.77	74.00	-17.23	41.41	15.36	Peak	100	30
5	15960.00	44.16	54.00	-9.84	29.25	14.91	Average	100	60
6	15960.00	57.20	74.00	-16.80	42.29	14.91	Peak	100	60

Note 1: Emission Level (dBuV/m) = SA Reading (dBuV/m) + Factor* (dB)

*Factor includes antenna factor , cable loss and amplifier gain

Note 2: Margin (dB) = Emission level (dBuV/m) – Limit (dBuV/m).

Modulation	VHT20	Test Freq. (MHz)	5500
Polarization	Horizontal		

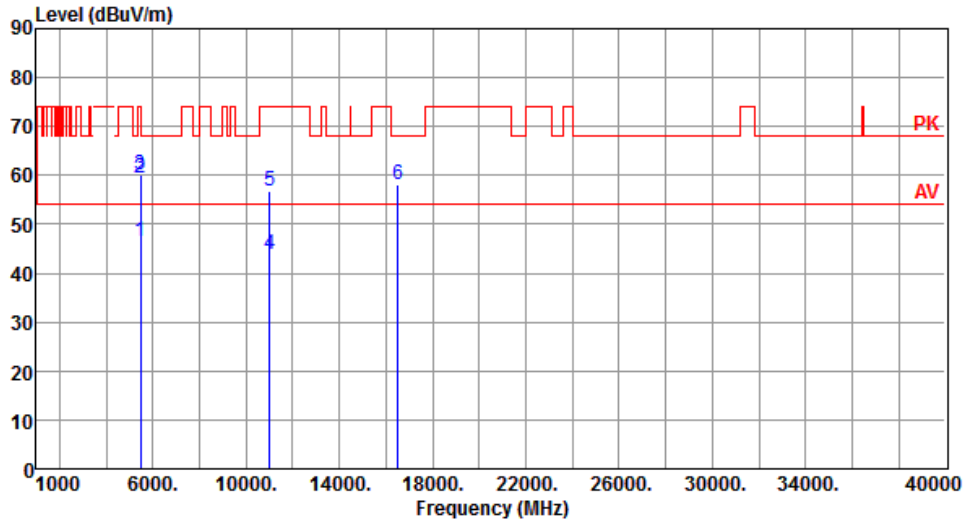

	Freq. MHz	Emission level dBuV/m	Limit dBuV/m	Margin dB	SA reading dBuV	Factor dB	Remark	ANT High cm	Turn Table deg
1	5460.00	46.53	54.00	-7.47	40.61	5.92	Average	100	72
2	5460.00	59.56	74.00	-14.44	53.64	5.92	Peak	100	72
3	5470.00	60.22	68.20	-7.98	54.26	5.96	Peak	100	72
4	11000.00	43.95	54.00	-10.05	28.37	15.58	Average	100	25
5	11000.00	56.93	74.00	-17.07	41.35	15.58	Peak	100	25
6	16500.00	58.17	68.20	-10.03	42.34	15.83	Peak	100	90

Note 1: Emission Level (dBuV/m) = SA Reading (dBuV/m) + Factor* (dB)

*Factor includes antenna factor , cable loss and amplifier gain

Note 2: Margin (dB) = Emission level (dBuV/m) – Limit (dBuV/m).

Modulation	VHT20	Test Freq. (MHz)	5500
Polarization	Vertical		

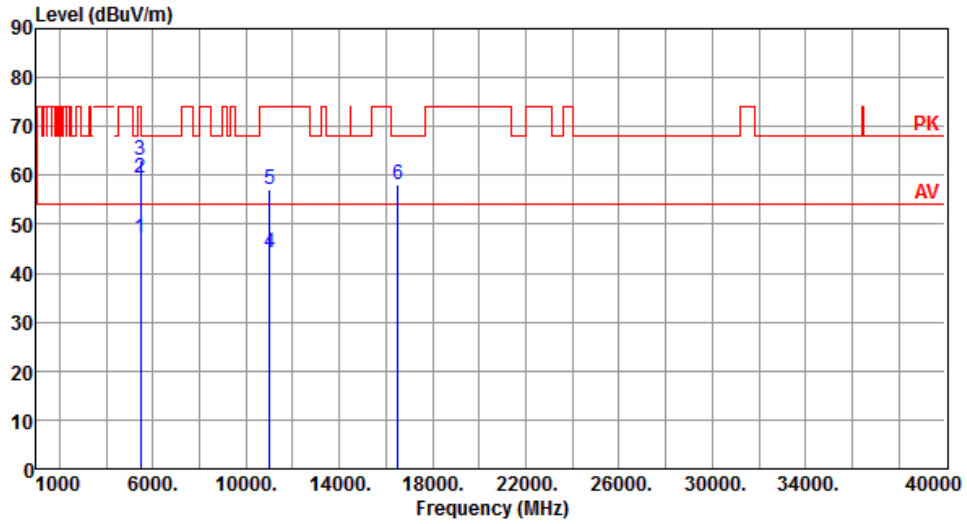

	Freq. MHz	Emission level dBuV/m	Limit dBuV/m	Margin dB	SA reading dBuV	Factor dB	Remark	ANT High cm	Turn Table deg
1	5460.00	47.19	54.00	-6.81	41.27	5.92	Average	103	84
2	5460.00	59.50	74.00	-14.50	53.58	5.92	Peak	103	84
3	5470.00	63.25	68.20	-4.95	57.29	5.96	Peak	103	84
4	11000.00	44.04	54.00	-9.96	28.46	15.58	Average	100	40
5	11000.00	57.11	74.00	-16.89	41.53	15.58	Peak	100	40
6	16500.00	58.04	68.20	-10.16	42.21	15.83	Peak	100	60

Note 1: Emission Level (dBuV/m) = SA Reading (dBuV/m) + Factor* (dB)

*Factor includes antenna factor , cable loss and amplifier gain

Note 2: Margin (dB) = Emission level (dBuV/m) – Limit (dBuV/m).

Modulation	VHT20	Test Freq. (MHz)	5580
Polarization	Horizontal		

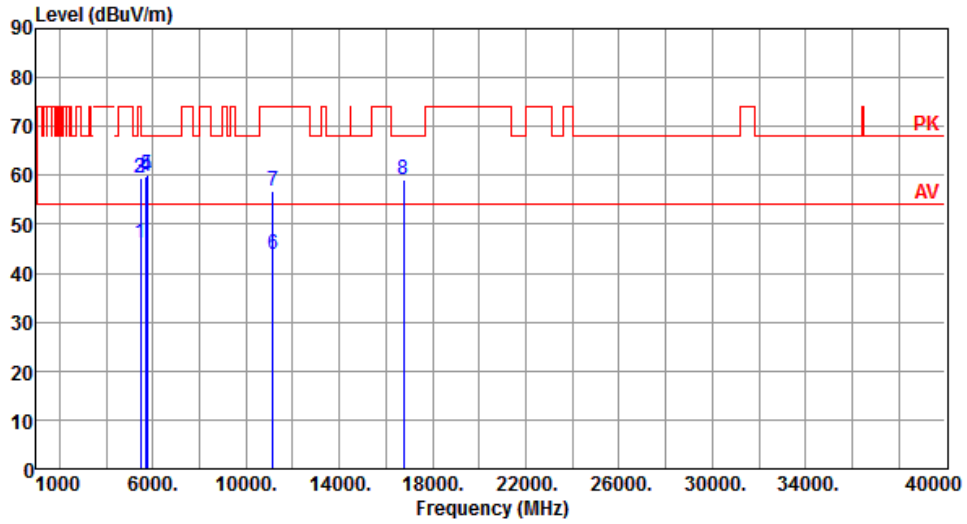

	Freq. MHz	Emission level dBuV/m	Limit dBuV/m	Margin dB	SA reading dBuV	Factor dB	Remark	ANT High cm	Turn Table deg
1	5460.00	46.22	54.00	-7.78	40.30	5.92	Average	100	53
2	5460.00	59.53	74.00	-14.47	53.61	5.92	Peak	100	53
3	5470.00	59.46	68.20	-8.74	53.50	5.96	Peak	100	53
4	5725.00	59.74	68.20	-8.46	53.45	6.29	Peak	100	53
5	5740.00	60.11	68.20	-8.09	53.79	6.32	Peak	100	53
6	11160.00	43.71	54.00	-10.29	28.45	15.26	Average	100	60
7	11160.00	56.88	74.00	-17.12	41.62	15.26	Peak	100	60
8	16740.00	59.16	68.20	-9.04	42.31	16.85	Peak	100	40

Note 1: Emission Level (dBuV/m) = SA Reading (dBuV/m) + Factor* (dB)

*Factor includes antenna factor , cable loss and amplifier gain

Note 2: Margin (dB) = Emission level (dBuV/m) – Limit (dBuV/m).

Modulation	VHT20	Test Freq. (MHz)	5580
Polarization	Vertical		

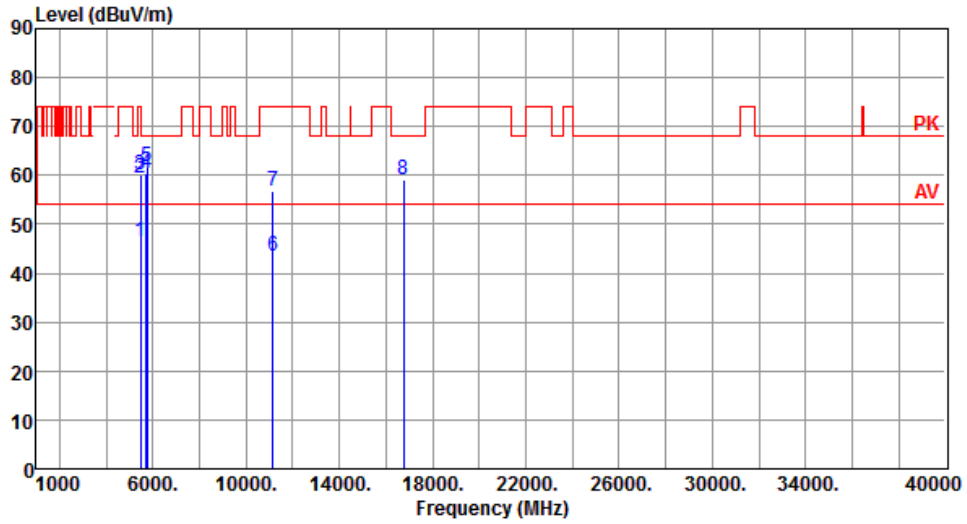

	Freq. MHz	Emission level dBuV/m	Limit dBuV/m	Margin dB	SA reading dBuV	Factor dB	Remark	ANT High cm	Turn Table deg
1	5460.00	46.33	54.00	-7.67	40.41	5.92	Average	100	85
2	5460.00	59.52	74.00	-14.48	53.60	5.92	Peak	100	85
3	5470.00	60.09	68.20	-8.11	54.13	5.96	Peak	100	85
4	5725.00	60.41	68.20	-7.79	54.12	6.29	Peak	100	85
5	5740.00	61.65	68.20	-6.55	55.33	6.32	Peak	100	85
6	11160.00	43.53	54.00	-10.47	28.27	15.26	Average	100	60
7	11160.00	56.65	74.00	-17.35	41.39	15.26	Peak	100	60
8	16740.00	59.18	68.20	-9.02	42.33	16.85	Peak	100	20

Note 1: Emission Level (dBuV/m) = SA Reading (dBuV/m) + Factor* (dB)

*Factor includes antenna factor , cable loss and amplifier gain

Note 2: Margin (dB) = Emission level (dBuV/m) – Limit (dBuV/m).

Modulation	VHT20	Test Freq. (MHz)	5700
Polarization	Horizontal		

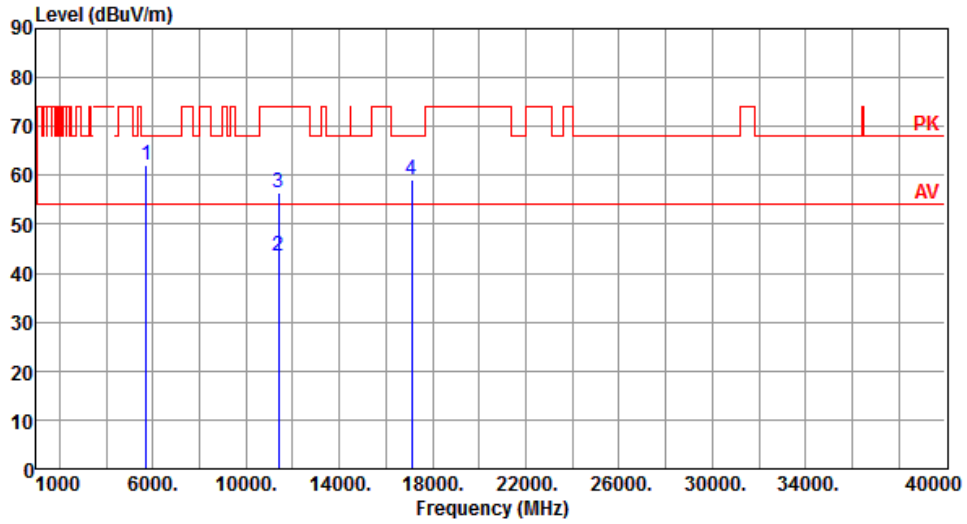

	Freq. MHz	Emission level dBuV/m	Limit dBuV/m	Margin dB	SA reading dBuV	Factor dB	Remark	ANT High cm	Turn Table deg
1	5725.00	61.98	68.20	-6.22	55.69	6.29	Peak	105	72
2	11400.00	43.59	54.00	-10.41	28.26	15.33	Average	100	80
3	11400.00	56.52	74.00	-17.48	41.19	15.33	Peak	100	80
4	17100.00	59.26	68.20	-8.94	42.37	16.89	Peak	100	50

Note 1: Emission Level (dBuV/m) = SA Reading (dBuV/m) + Factor* (dB)

*Factor includes antenna factor , cable loss and amplifier gain

Note 2: Margin (dB) = Emission level (dBuV/m) – Limit (dBuV/m).

Modulation	VHT20	Test Freq. (MHz)	5700
Polarization	Vertical		

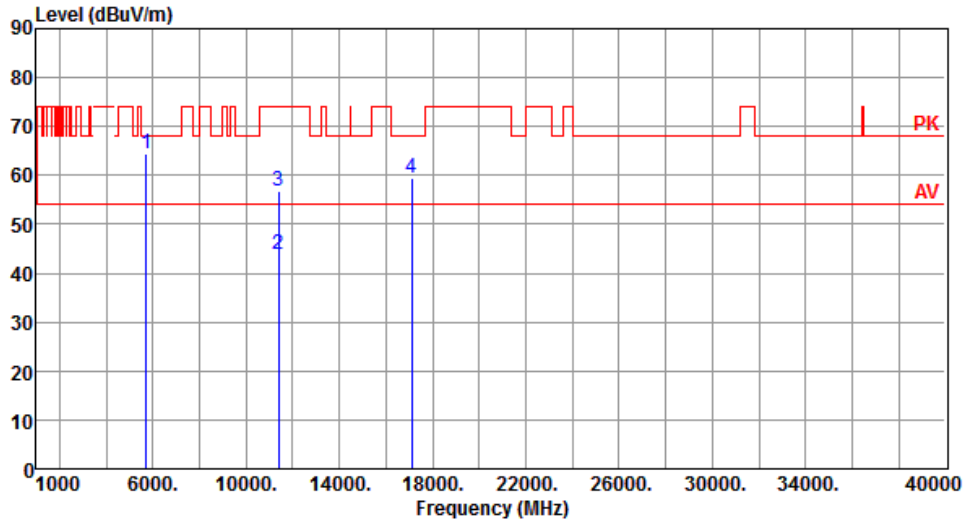

	Freq. MHz	Emission level dBuV/m	Limit dBuV/m	Margin dB	SA reading dBuV	Factor dB	Remark	ANT High cm	Turn Table deg
1	5725.00	64.41	68.20	-3.79	58.12	6.29	Peak	100	84
2	11400.00	43.94	54.00	-10.06	28.61	15.33	Average	100	60
3	11400.00	56.70	74.00	-17.30	41.37	15.33	Peak	100	60
4	17100.00	59.30	68.20	-8.90	42.41	16.89	Peak	100	100

Note 1: Emission Level (dBuV/m) = SA Reading (dBuV/m) + Factor* (dB)

*Factor includes antenna factor , cable loss and amplifier gain

Note 2: Margin (dB) = Emission level (dBuV/m) – Limit (dBuV/m).

Modulation	VHT20	Test Freq. (MHz)	5720
Polarization	Horizontal		

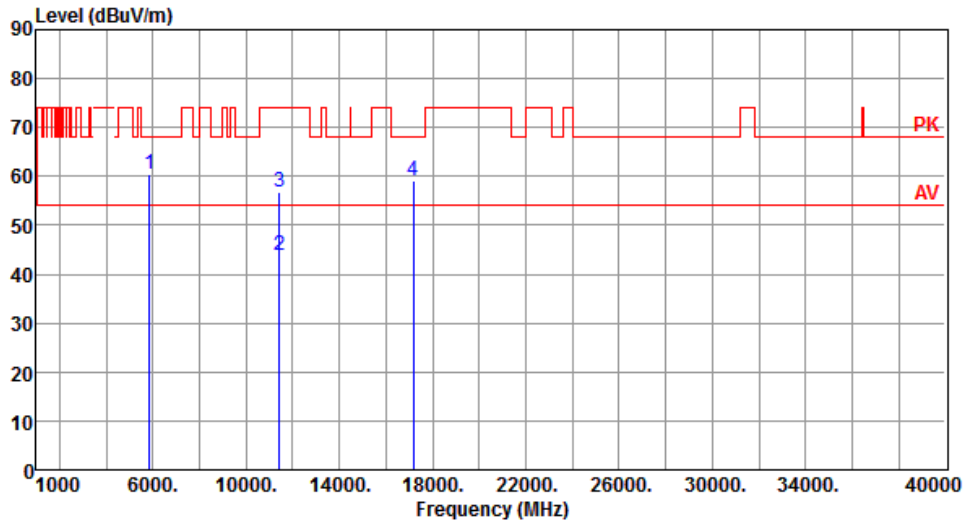

	Freq. MHz	Emission level dBuV/m	Limit dBuV/m	Margin dB	SA reading dBuV	Factor dB	Remark	ANT High cm	Turn Table deg
1	5850.00	60.53	68.20	-7.67	53.86	6.67	Peak	100	74
2	11440.00	43.84	54.00	-10.16	28.45	15.39	Average	100	30
3	11440.00	56.75	74.00	-17.25	41.36	15.39	Peak	100	30
4	17160.00	59.16	68.20	-9.04	42.31	16.85	Peak	100	90

Note 1: Emission Level (dBuV/m) = SA Reading (dBuV/m) + Factor* (dB)

*Factor includes antenna factor , cable loss and amplifier gain

Note 2: Margin (dB) = Emission level (dBuV/m) – Limit (dBuV/m).

Modulation	VHT20	Test Freq. (MHz)	5720
Polarization	Vertical		

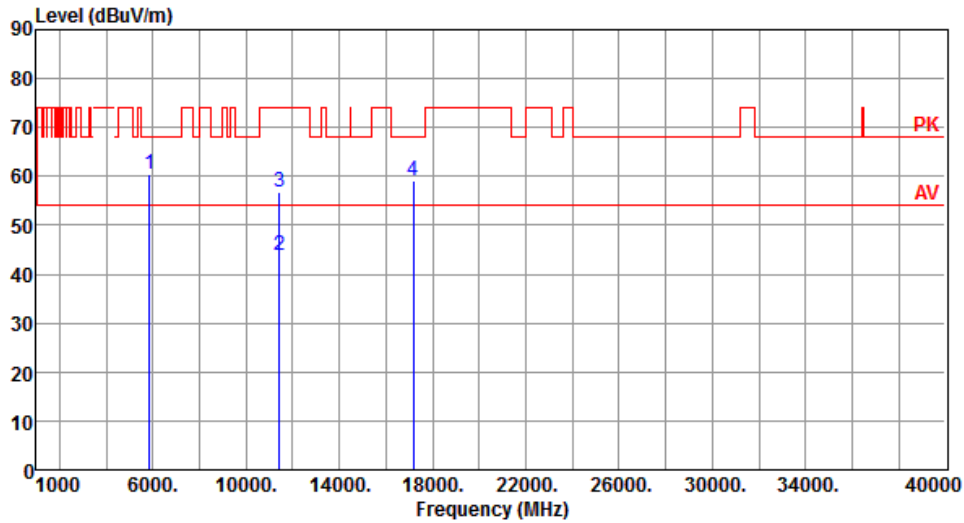

	Freq. MHz	Emission level dBuV/m	Limit dBuV/m	Margin dB	SA reading dBuV	Factor dB	Remark	ANT High cm	Turn Table deg
1	5850.00	60.32	68.20	-7.88	53.65	6.67	Peak	100	84
2	11440.00	43.85	54.00	-10.15	28.46	15.39	Average	100	30
3	11440.00	56.71	74.00	-17.29	41.32	15.39	Peak	100	30
4	17160.00	59.20	68.20	-9.00	42.35	16.85	Peak	100	30

Note 1: Emission Level (dBuV/m) = SA Reading (dBuV/m) + Factor* (dB)

*Factor includes antenna factor , cable loss and amplifier gain

Note 2: Margin (dB) = Emission level (dBuV/m) – Limit (dBuV/m).

Modulation	VHT20	Test Freq. (MHz)	5745
Polarization	Horizontal		

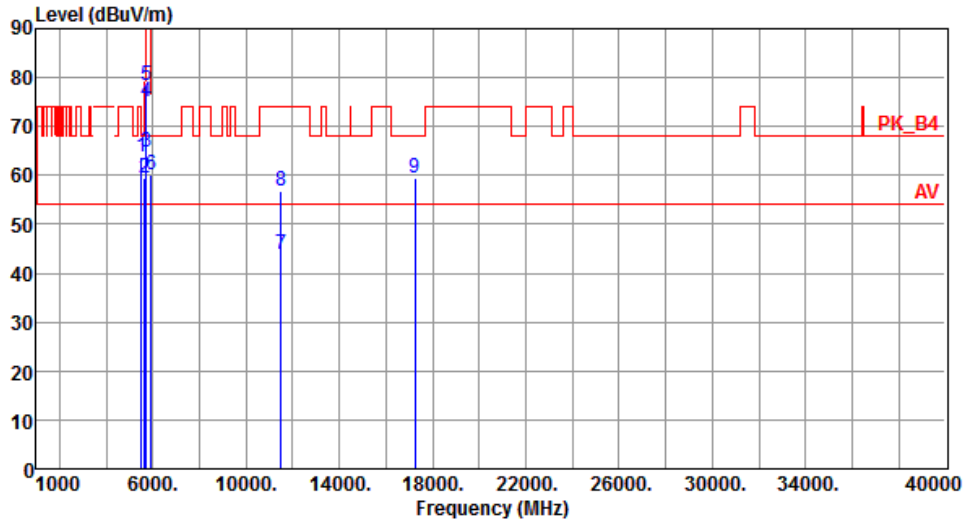

	Freq. MHz	Emission level dBuV/m	Limit dBuV/m	Margin dB	SA reading dBuV	Factor dB	Remark	ANT High cm	Turn Table deg
1	5505.00	63.64	68.20	-4.56	57.55	6.09	Peak	134	88
2	5650.00	59.50	68.20	-8.70	53.59	5.91	Peak	134	88
3	5700.00	64.85	105.20	-40.35	58.62	6.23	Peak	134	88
4	5720.00	74.92	110.80	-35.88	68.64	6.28	Peak	134	88
5	5725.00	78.44	122.20	-43.76	72.15	6.29	Peak	134	88
6	5925.00	60.27	68.20	-7.93	53.45	6.82	Peak	134	88
7	11490.00	43.81	54.00	-10.19	28.36	15.45	Average	100	30
8	11490.00	56.73	74.00	-17.27	41.28	15.45	Peak	100	30
9	17235.00	59.29	68.20	-8.91	42.31	16.98	Peak	100	50

Note 1: Emission Level (dBuV/m) = SA Reading (dBuV/m) + Factor* (dB)

*Factor includes antenna factor , cable loss and amplifier gain

Note 2: Margin (dB) = Emission level (dBuV/m) – Limit (dBuV/m).

Modulation	VHT20	Test Freq. (MHz)	5745
Polarization	Vertical		

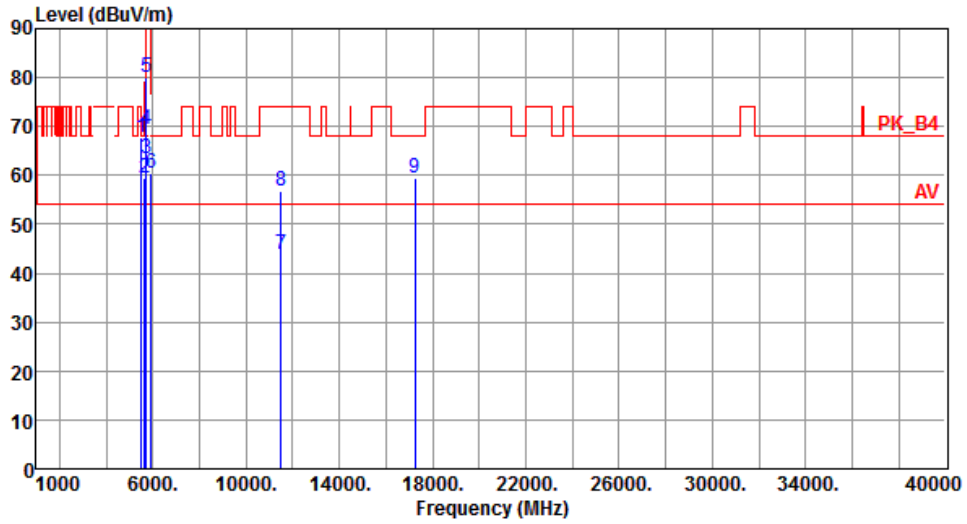

	Freq. MHz	Emission level dBuV/m	Limit dBuV/m	Margin dB	SA reading dBuV	Factor dB	Remark	ANT High cm	Turn Table deg
1	5505.00	67.75	68.20	-0.45	61.66	6.09	Peak	113	7
2	5650.00	59.56	68.20	-8.64	53.65	5.91	Peak	100	5
3	5700.00	63.48	105.20	-41.72	57.25	6.23	Peak	100	5
4	5720.00	69.51	110.80	-41.29	63.23	6.28	Peak	100	5
5	5725.00	79.94	122.20	-42.26	73.65	6.29	Peak	100	5
6	5925.00	60.38	68.20	-7.82	53.56	6.82	Peak	100	5
7	11490.00	44.00	54.00	-10.00	28.55	15.45	Average	100	40
8	11490.00	56.67	74.00	-17.33	41.22	15.45	Peak	100	40
9	17235.00	59.33	68.20	-8.87	42.35	16.98	Peak	100	60

Note 1: Emission Level (dBuV/m) = SA Reading (dBuV/m) + Factor* (dB)

*Factor includes antenna factor , cable loss and amplifier gain

Note 2: Margin (dB) = Emission level (dBuV/m) – Limit (dBuV/m).

Modulation	VHT20	Test Freq. (MHz)	5785
Polarization	Horizontal		

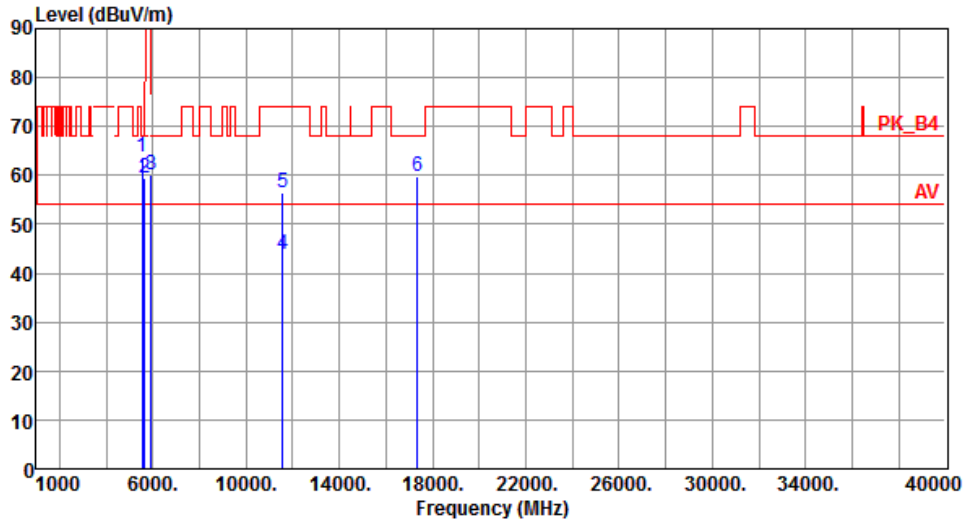

	Freq. MHz	Emission level dBuV/m	Limit dBuV/m	Margin dB	SA reading dBuV	Factor dB	Remark	ANT High cm	Turn Table deg
1	5545.00	63.88	68.20	-4.32	57.87	6.01	Peak	133	88
2	5650.00	59.59	68.20	-8.61	53.68	5.91	Peak	133	88
3	5925.00	60.23	68.20	-7.97	53.41	6.82	Peak	133	88
4	11570.00	43.67	54.00	-10.33	28.37	15.30	Average	100	50
5	11570.00	56.59	74.00	-17.41	41.29	15.30	Peak	100	50
6	17355.00	59.92	68.20	-8.28	42.31	17.61	Peak	100	60

Note 1: Emission Level (dBuV/m) = SA Reading (dBuV/m) + Factor* (dB)

*Factor includes antenna factor , cable loss and amplifier gain

Note 2: Margin (dB) = Emission level (dBuV/m) – Limit (dBuV/m).

Modulation	VHT20	Test Freq. (MHz)	5785
Polarization	Vertical		

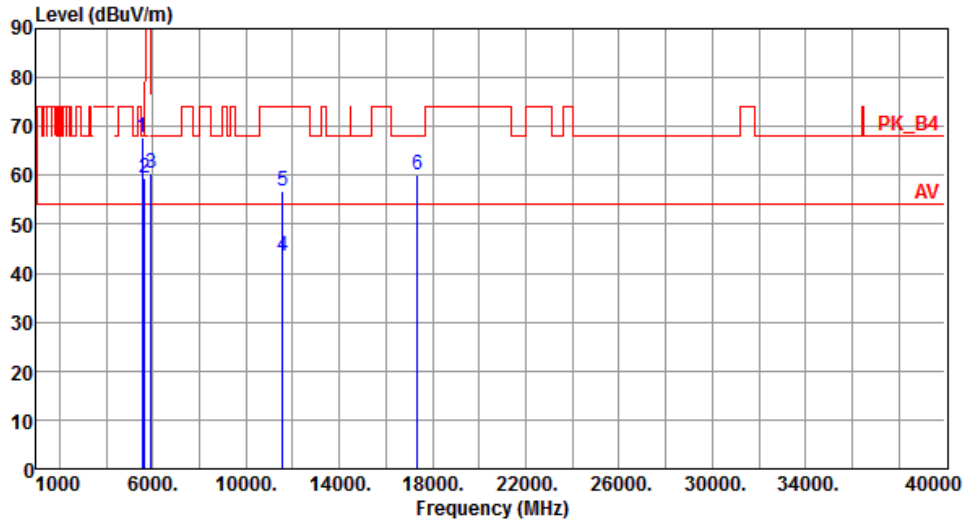

	Freq. MHz	Emission level dBuV/m	Limit dBuV/m	Margin dB	SA reading dBuV	Factor dB	Remark	ANT High cm	Turn Table deg
1	5545.00	67.82	68.20	-0.38	61.81	6.01	Peak	112	8
2	5650.00	59.54	68.20	-8.66	53.63	5.91	Peak	100	5
3	5925.00	60.29	68.20	-7.91	53.47	6.82	Peak	100	5
4	11570.00	43.54	54.00	-10.46	28.24	15.30	Average	100	30
5	11570.00	56.77	74.00	-17.23	41.47	15.30	Peak	100	30
6	17355.00	60.08	68.20	-8.12	42.47	17.61	Peak	100	55

Note 1: Emission Level (dBuV/m) = SA Reading (dBuV/m) + Factor* (dB)

*Factor includes antenna factor , cable loss and amplifier gain

Note 2: Margin (dB) = Emission level (dBuV/m) – Limit (dBuV/m).

Modulation	VHT20	Test Freq. (MHz)	5825
Polarization	Horizontal		

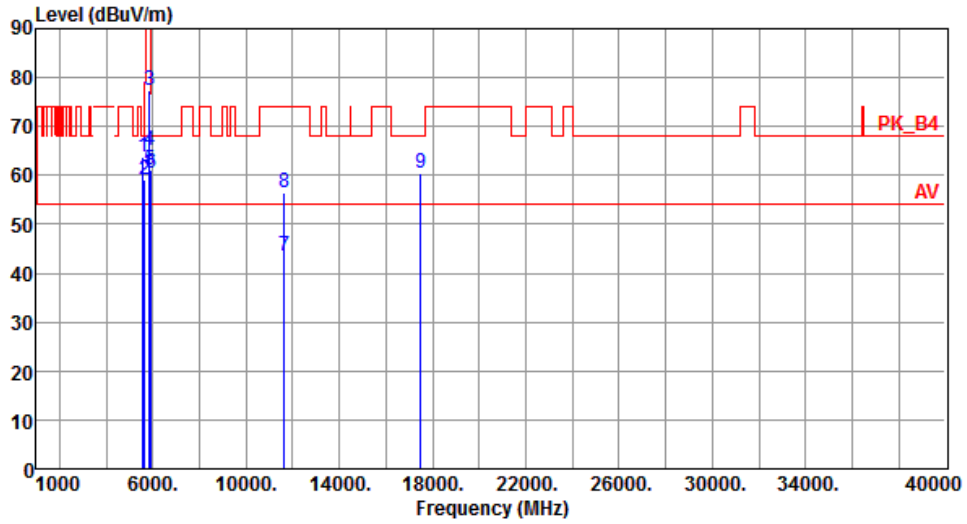

	Freq. MHz	Emission level dBuV/m	Limit dBuV/m	Margin dB	SA reading dBuV	Factor dB	Remark	ANT High cm	Turn Table deg
1	5585.00	63.82	68.20	-4.38	57.83	5.99	Peak	129	86
2	5650.00	59.15	68.20	-9.05	53.24	5.91	Peak	129	86
3	5850.00	77.23	122.20	-44.97	70.56	6.67	Peak	129	86
4	5855.00	64.97	110.80	-45.83	58.29	6.68	Peak	129	86
5	5875.00	60.98	105.20	-44.22	54.26	6.72	Peak	129	86
6	5925.00	60.39	68.20	-7.81	53.57	6.82	Peak	129	86
7	11650.00	43.48	54.00	-10.52	28.42	15.06	Average	100	30
8	11650.00	56.37	74.00	-17.63	41.31	15.06	Peak	100	30
9	17475.00	60.52	68.20	-7.68	42.29	18.23	Peak	100	25

Note 1: Emission Level (dBuV/m) = SA Reading (dBuV/m) + Factor* (dB)

*Factor includes antenna factor , cable loss and amplifier gain

Note 2: Margin (dB) = Emission level (dBuV/m) – Limit (dBuV/m).

Modulation	VHT20	Test Freq. (MHz)	5825
Polarization	Vertical		

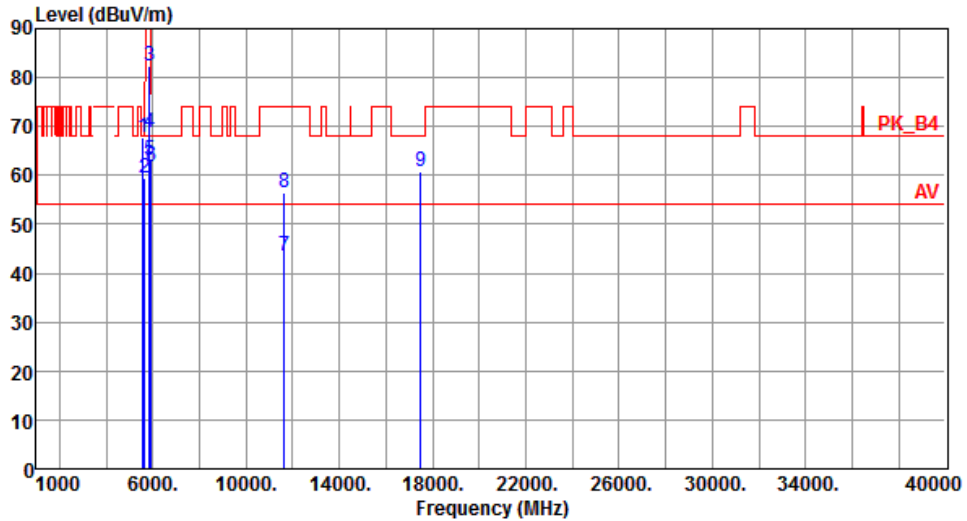

	Freq. MHz	Emission level dBuV/m	Limit dBuV/m	Margin dB	SA reading dBuV	Factor dB	Remark	ANT High cm	Turn Table deg
1	5585.00	67.71	68.20	-0.49	61.72	5.99	Peak	115	9
2	5650.00	59.49	68.20	-8.71	53.58	5.91	Peak	105	7
3	5850.00	82.26	122.20	-39.94	75.59	6.67	Peak	105	7
4	5855.00	68.82	110.80	-41.98	62.14	6.68	Peak	105	7
5	5875.00	63.21	105.20	-41.99	56.49	6.72	Peak	105	7
6	5925.00	61.88	68.20	-6.32	55.06	6.82	Peak	105	7
7	11650.00	43.48	54.00	-10.52	28.42	15.06	Average	100	20
8	11650.00	56.44	74.00	-17.56	41.38	15.06	Peak	100	20
9	17475.00	60.81	68.20	-7.39	42.58	18.23	Peak	100	90

Note 1: Emission Level (dBuV/m) = SA Reading (dBuV/m) + Factor* (dB)

*Factor includes antenna factor , cable loss and amplifier gain

Note 2: Margin (dB) = Emission level (dBuV/m) – Limit (dBuV/m).

3.5.7 Transmitter Radiated Unwanted Emissions (Above 1GHz) for VHT40

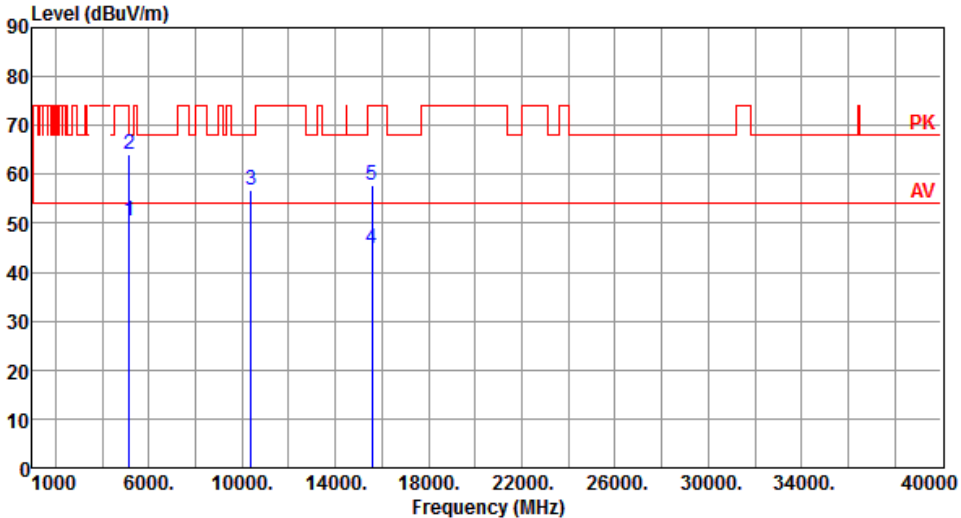
Modulation	VHT40	Test Freq. (MHz)	5190																																																																		
Polarization	Horizontal																																																																				
																																																																					
	<table border="1"> <thead> <tr> <th>Freq.</th> <th>Emission level</th> <th>Limit</th> <th>Margin</th> <th>SA reading</th> <th>Factor</th> <th>Remark</th> <th>ANT High</th> <th>Turn Table</th> </tr> <tr> <th>MHz</th> <th>dBuV/m</th> <th>dBuV/m</th> <th>dB</th> <th>dBuV</th> <th>dB</th> <th></th> <th>cm</th> <th>deg</th> </tr> </thead> <tbody> <tr> <td>1</td> <td>5150.00</td> <td>50.36</td> <td>54.00</td> <td>-3.64</td> <td>44.41</td> <td>5.95</td> <td>Average</td> <td>100</td> <td>55</td> </tr> <tr> <td>2</td> <td>5150.00</td> <td>63.97</td> <td>74.00</td> <td>-10.03</td> <td>58.02</td> <td>5.95</td> <td>Peak</td> <td>100</td> <td>55</td> </tr> <tr> <td>3</td> <td>10380.00</td> <td>56.77</td> <td>68.20</td> <td>-11.43</td> <td>41.55</td> <td>15.22</td> <td>Peak</td> <td>100</td> <td>30</td> </tr> <tr> <td>4</td> <td>15570.00</td> <td>44.81</td> <td>54.00</td> <td>-9.19</td> <td>29.24</td> <td>15.57</td> <td>Average</td> <td>100</td> <td>25</td> </tr> <tr> <td>5</td> <td>15570.00</td> <td>57.80</td> <td>74.00</td> <td>-16.20</td> <td>42.23</td> <td>15.57</td> <td>Peak</td> <td>100</td> <td>25</td> </tr> </tbody> </table>	Freq.	Emission level	Limit	Margin	SA reading	Factor	Remark	ANT High	Turn Table	MHz	dBuV/m	dBuV/m	dB	dBuV	dB		cm	deg	1	5150.00	50.36	54.00	-3.64	44.41	5.95	Average	100	55	2	5150.00	63.97	74.00	-10.03	58.02	5.95	Peak	100	55	3	10380.00	56.77	68.20	-11.43	41.55	15.22	Peak	100	30	4	15570.00	44.81	54.00	-9.19	29.24	15.57	Average	100	25	5	15570.00	57.80	74.00	-16.20	42.23	15.57	Peak	100	25
Freq.	Emission level	Limit	Margin	SA reading	Factor	Remark	ANT High	Turn Table																																																													
MHz	dBuV/m	dBuV/m	dB	dBuV	dB		cm	deg																																																													
1	5150.00	50.36	54.00	-3.64	44.41	5.95	Average	100	55																																																												
2	5150.00	63.97	74.00	-10.03	58.02	5.95	Peak	100	55																																																												
3	10380.00	56.77	68.20	-11.43	41.55	15.22	Peak	100	30																																																												
4	15570.00	44.81	54.00	-9.19	29.24	15.57	Average	100	25																																																												
5	15570.00	57.80	74.00	-16.20	42.23	15.57	Peak	100	25																																																												
<p>Note 1: Emission Level (dBuV/m) = SA Reading (dBuV/m) + Factor* (dB) *Factor includes antenna factor , cable loss and amplifier gain Note 2: Margin (dB) = Emission level (dBuV/m) – Limit (dBuV/m).</p>																																																																					

Modulation	VHT40	Test Freq. (MHz)	5190
Polarization	Vertical		

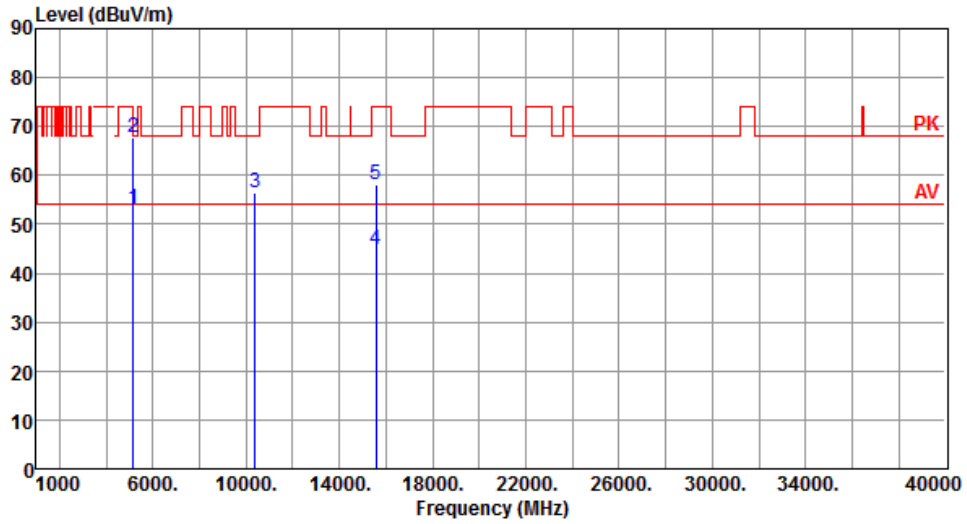

	Freq. MHz	Emission level dBuV/m	Limit dBuV/m	Margin dB	SA reading dBuV	Factor dB	Remark	ANT High cm	Turn Table deg
1	5150.00	53.07	54.00	-0.93	47.12	5.95	Average	100	76
2	5150.00	67.63	74.00	-6.37	61.68	5.95	Peak	100	76
3	10380.00	56.57	68.20	-11.63	41.35	15.22	Peak	100	25
4	15570.00	44.80	54.00	-9.20	29.23	15.57	Average	100	30
5	15570.00	58.11	74.00	-15.89	42.54	15.57	Peak	100	30

Note 1: Emission Level (dBuV/m) = SA Reading (dBuV/m) + Factor* (dB)

*Factor includes antenna factor , cable loss and amplifier gain

Note 2: Margin (dB) = Emission level (dBuV/m) – Limit (dBuV/m).

Modulation	VHT40	Test Freq. (MHz)	5230
Polarization	Horizontal		

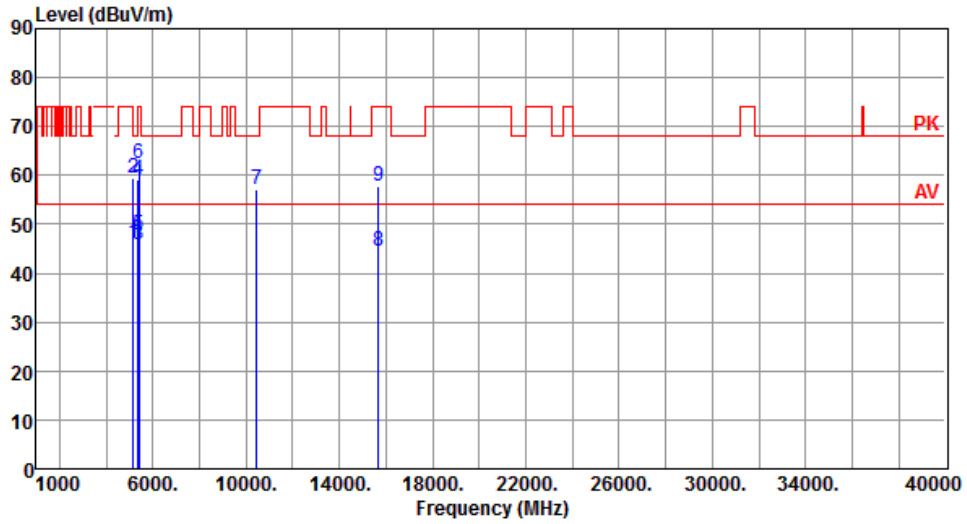

	Freq. MHz	Emission level dBuV/m	Limit dBuV/m	Margin dB	SA reading dBuV	Factor dB	Remark	ANT High cm	Turn Table deg
1	5150.00	46.31	54.00	-7.69	40.36	5.95	Average	100	54
2	5150.00	59.37	74.00	-14.63	53.42	5.95	Peak	100	54
3	5350.00	45.92	54.00	-8.08	40.52	5.40	Average	100	54
4	5350.00	59.05	74.00	-14.95	53.65	5.40	Peak	100	54
5	5390.00	47.94	54.00	-6.06	42.35	5.59	Average	100	102
6	5390.00	62.34	74.00	-11.66	56.75	5.59	Peak	100	102
7	10460.00	57.00	68.20	-11.20	41.68	15.32	Peak	100	80
8	15690.00	44.46	54.00	-9.54	29.11	15.35	Average	100	70
9	15690.00	57.75	74.00	-16.25	42.40	15.35	Peak	100	70

Note 1: Emission Level (dBuV/m) = SA Reading (dBuV/m) + Factor* (dB)

*Factor includes antenna factor , cable loss and amplifier gain

Note 2: Margin (dB) = Emission level (dBuV/m) – Limit (dBuV/m).

Modulation	VHT40	Test Freq. (MHz)	5230
Polarization	Vertical		

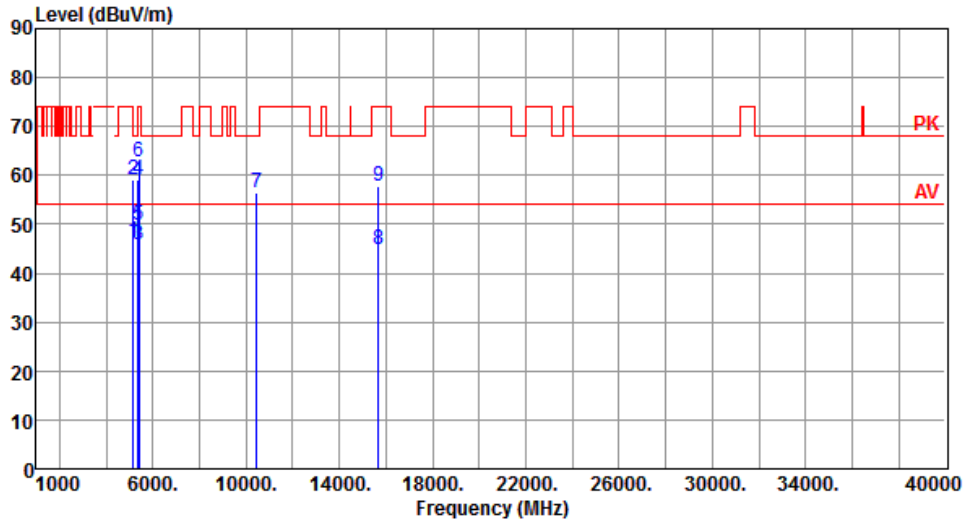

	Freq. MHz	Emission level dBuV/m	Limit dBuV/m	Margin dB	SA reading dBuV	Factor dB	Remark	ANT High cm	Turn Table deg
1	5150.00	46.57	54.00	-7.43	40.62	5.95	Average	100	75
2	5150.00	59.20	74.00	-14.80	53.25	5.95	Peak	100	75
3	5350.00	45.93	54.00	-8.07	40.53	5.40	Average	100	75
4	5350.00	58.99	74.00	-15.01	53.59	5.40	Peak	100	75
5	5390.00	49.84	54.00	-4.16	44.25	5.59	Average	100	75
6	5390.00	62.77	74.00	-11.23	57.18	5.59	Peak	100	75
7	10460.00	56.57	68.20	-11.63	41.25	15.32	Peak	100	50
8	15690.00	44.79	54.00	-9.21	29.44	15.35	Average	100	30
9	15690.00	57.68	74.00	-16.32	42.33	15.35	Peak	100	30

Note 1: Emission Level (dBuV/m) = SA Reading (dBuV/m) + Factor* (dB)

*Factor includes antenna factor , cable loss and amplifier gain

Note 2: Margin (dB) = Emission level (dBuV/m) – Limit (dBuV/m).

Modulation	VHT40	Test Freq. (MHz)	5270
Polarization	Horizontal		

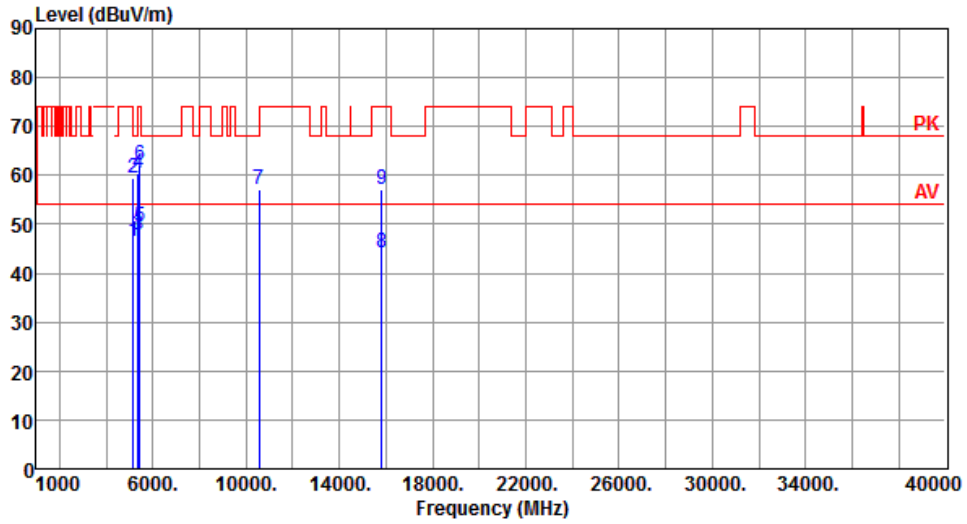

	Freq. MHz	Emission level dBuV/m	Limit dBuV/m	Margin dB	SA reading dBuV	Factor dB	Remark	ANT High cm	Turn Table deg
1	5150.00	46.40	54.00	-7.60	40.45	5.95	Average	100	85
2	5150.00	59.47	74.00	-14.53	53.52	5.95	Peak	100	85
3	5350.00	47.94	54.00	-6.06	42.54	5.40	Average	100	85
4	5350.00	60.36	74.00	-13.64	54.96	5.40	Peak	100	85
5	5430.00	49.53	54.00	-4.47	43.76	5.77	Average	100	85
6	5430.00	62.13	74.00	-11.87	56.36	5.77	Peak	100	85
7	10540.00	56.98	68.20	-11.22	41.63	15.35	Peak	100	70
8	15810.00	44.20	54.00	-9.80	29.35	14.85	Average	100	20
9	15810.00	57.03	74.00	-16.97	42.18	14.85	Peak	100	20

Note 1: Emission Level (dBuV/m) = SA Reading (dBuV/m) + Factor* (dB)

*Factor includes antenna factor , cable loss and amplifier gain

Note 2: Margin (dB) = Emission level (dBuV/m) – Limit (dBuV/m).

Modulation	VHT40	Test Freq. (MHz)	5270
Polarization	Vertical		

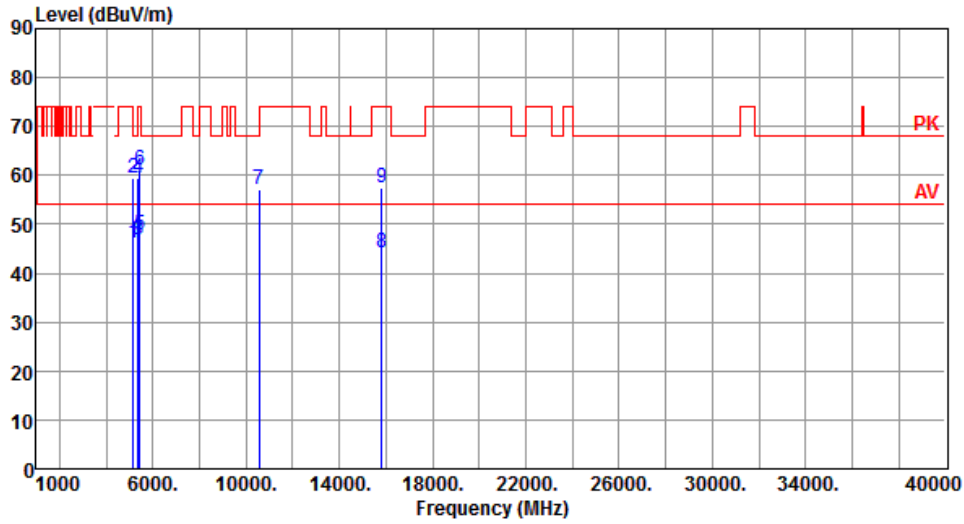

	Freq. MHz	Emission level dBuV/m	Limit dBuV/m	Margin dB	SA reading dBuV	Factor dB	Remark	ANT High cm	Turn Table deg
1	5150.00	46.23	54.00	-7.77	40.28	5.95	Average	100	57
2	5150.00	59.49	74.00	-14.51	53.54	5.95	Peak	100	57
3	5350.00	46.85	54.00	-7.15	41.45	5.40	Average	100	57
4	5350.00	59.52	74.00	-14.48	54.12	5.40	Peak	100	57
5	5430.00	47.83	54.00	-6.17	42.06	5.77	Average	100	113
6	5430.00	61.21	74.00	-12.79	55.44	5.77	Peak	100	113
7	10540.00	57.04	68.20	-11.16	41.69	15.35	Peak	100	20
8	15810.00	44.27	54.00	-9.73	29.42	14.85	Average	100	30
9	15810.00	57.39	74.00	-16.61	42.54	14.85	Peak	100	30

Note 1: Emission Level (dBuV/m) = SA Reading (dBuV/m) + Factor* (dB)

*Factor includes antenna factor , cable loss and amplifier gain

Note 2: Margin (dB) = Emission level (dBuV/m) – Limit (dBuV/m).

Modulation	VHT40	Test Freq. (MHz)	5310
Polarization	Horizontal		

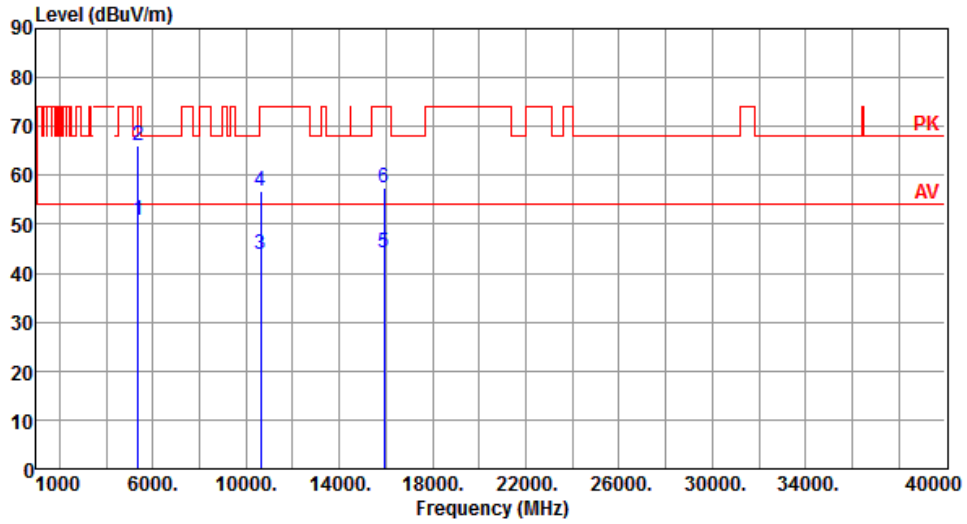

	Freq. MHz	Emission level dBuV/m	Limit dBuV/m	Margin dB	SA reading dBuV	Factor dB	Remark	ANT High cm	Turn Table deg
1	5350.00	50.76	54.00	-3.24	45.36	5.40	Average	100	56
2	5350.00	65.98	74.00	-8.02	60.58	5.40	Peak	100	56
3	10620.00	43.74	54.00	-10.26	28.35	15.39	Average	100	30
4	10620.00	56.63	74.00	-17.37	41.24	15.39	Peak	100	30
5	15930.00	44.27	54.00	-9.73	29.37	14.90	Average	100	60
6	15930.00	57.44	74.00	-16.56	42.54	14.90	Peak	100	60

Note 1: Emission Level (dBuV/m) = SA Reading (dBuV/m) + Factor* (dB)

*Factor includes antenna factor , cable loss and amplifier gain

Note 2: Margin (dB) = Emission level (dBuV/m) – Limit (dBuV/m).

Modulation	VHT40	Test Freq. (MHz)	5310
Polarization	Vertical		

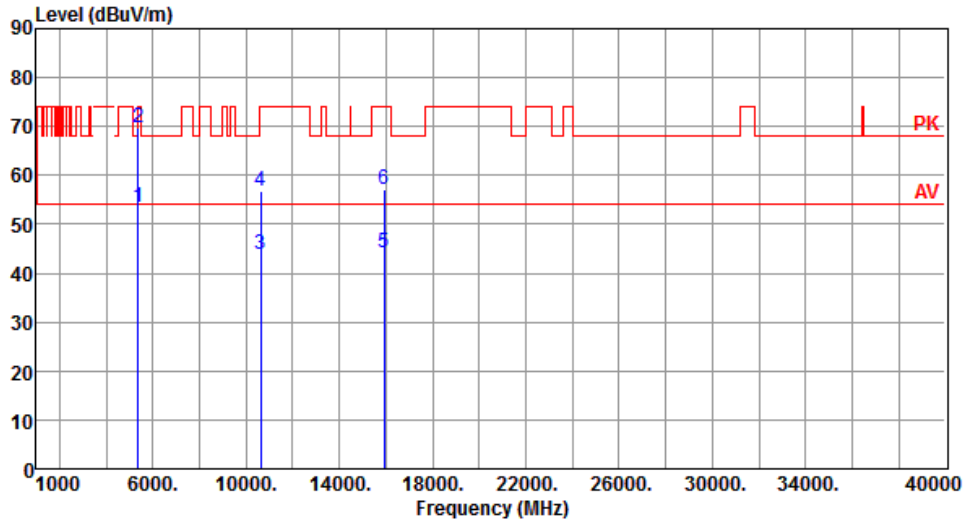

	Freq. MHz	Emission level dBuV/m	Limit dBuV/m	Margin dB	SA reading dBuV	Factor dB	Remark	ANT High cm	Turn Table deg
1	5350.00	53.45	54.00	-0.55	48.05	5.40	Average	100	87
2	5350.00	69.58	74.00	-4.42	64.18	5.40	Peak	100	87
3	10620.00	43.83	54.00	-10.17	28.44	15.39	Average	100	70
4	10620.00	56.64	74.00	-17.36	41.25	15.39	Peak	100	70
5	15930.00	44.15	54.00	-9.85	29.25	14.90	Average	100	100
6	15930.00	57.28	74.00	-16.72	42.38	14.90	Peak	100	100

Note 1: Emission Level (dBuV/m) = SA Reading (dBuV/m) + Factor* (dB)

*Factor includes antenna factor , cable loss and amplifier gain

Note 2: Margin (dB) = Emission level (dBuV/m) – Limit (dBuV/m).

Modulation	VHT40	Test Freq. (MHz)	5510
Polarization	Horizontal		

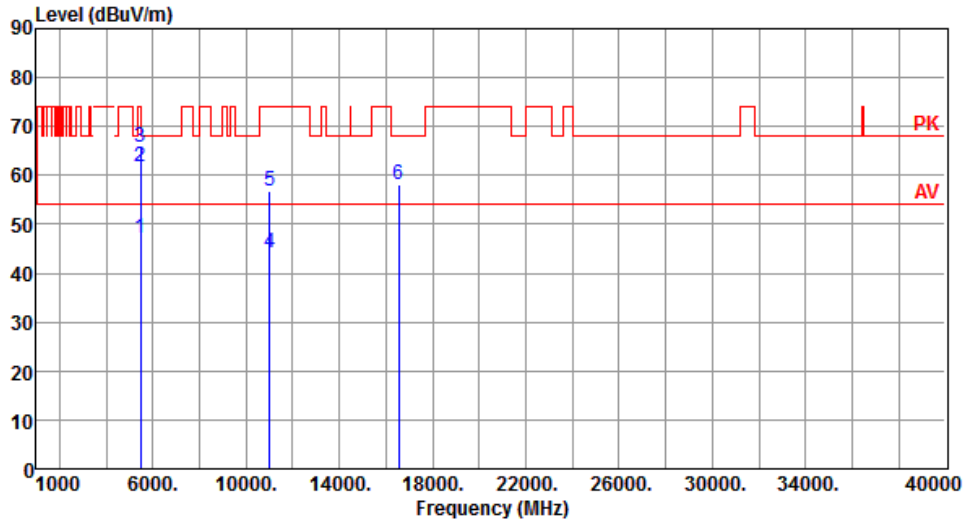

	Freq. MHz	Emission level dBuV/m	Limit dBuV/m	Margin dB	SA reading dBuV	Factor dB	Remark	ANT High cm	Turn Table deg
1	5460.00	47.21	54.00	-6.79	41.29	5.92	Average	100	81
2	5460.00	61.72	74.00	-12.28	55.80	5.92	Peak	100	81
3	5470.00	65.72	68.20	-2.48	59.76	5.96	Peak	100	81
4	11020.00	44.09	54.00	-9.91	28.54	15.55	Average	100	50
5	11020.00	56.80	74.00	-17.20	41.25	15.55	Peak	100	50
6	16530.00	58.12	68.20	-10.08	42.21	15.91	Peak	100	30

Note 1: Emission Level (dBuV/m) = SA Reading (dBuV/m) + Factor* (dB)

*Factor includes antenna factor , cable loss and amplifier gain

Note 2: Margin (dB) = Emission level (dBuV/m) – Limit (dBuV/m).

Modulation	VHT40	Test Freq. (MHz)	5510
Polarization	Vertical		

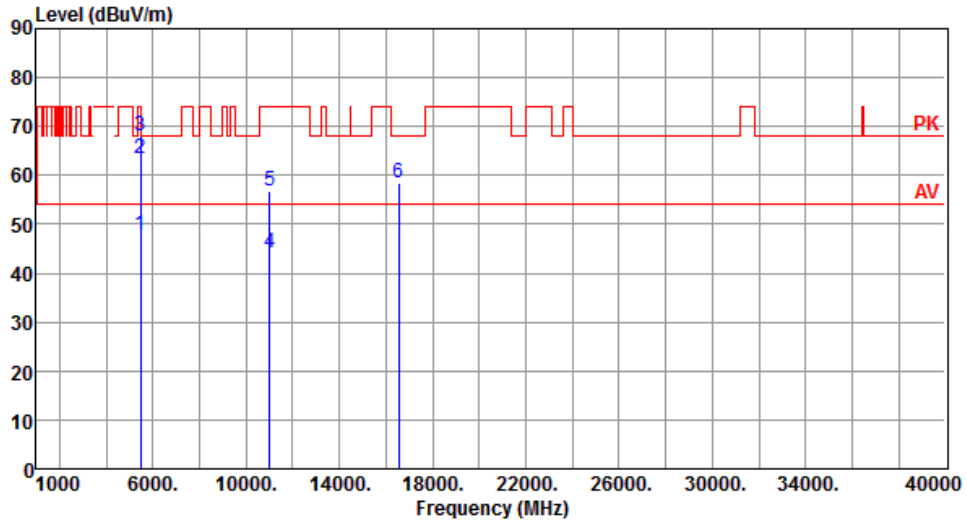

	Freq. MHz	Emission level dBuV/m	Limit dBuV/m	Margin dB	SA reading dBuV	Factor dB	Remark	ANT High cm	Turn Table deg
1	5460.00	47.96	54.00	-6.04	42.04	5.92	Average	100	347
2	5460.00	63.36	74.00	-10.64	57.44	5.92	Peak	100	347
3	5470.00	67.92	68.20	-0.28	61.96	5.96	Peak	100	347
4	11020.00	44.18	54.00	-9.82	28.63	15.55	Average	100	70
5	11020.00	56.88	74.00	-17.12	41.33	15.55	Peak	100	70
6	16530.00	58.45	68.20	-9.75	42.54	15.91	Peak	100	80

Note 1: Emission Level (dBuV/m) = SA Reading (dBuV/m) + Factor* (dB)

*Factor includes antenna factor , cable loss and amplifier gain

Note 2: Margin (dB) = Emission level (dBuV/m) – Limit (dBuV/m).

Modulation	VHT40	Test Freq. (MHz)	5590
Polarization	Horizontal		

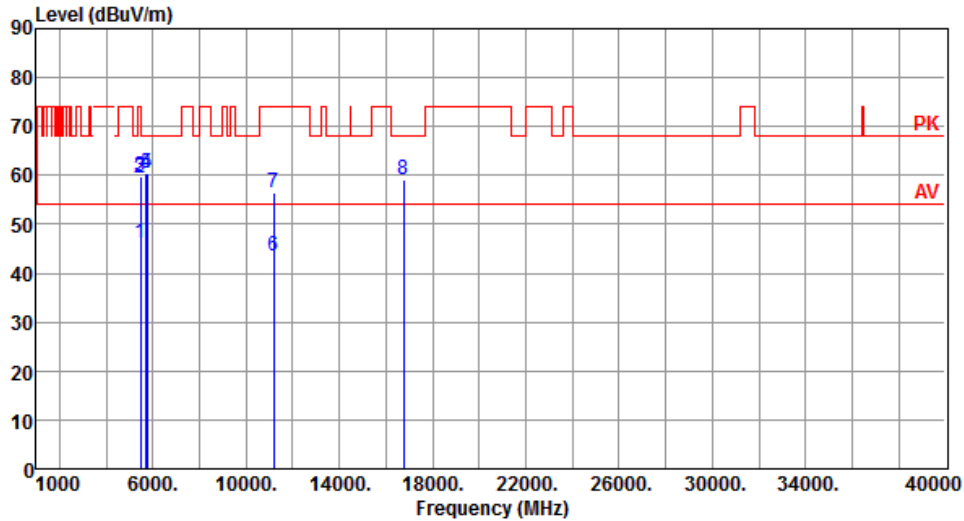

	Freq. MHz	Emission level dBuV/m	Limit dBuV/m	Margin dB	SA reading dBuV	Factor dB	Remark	ANT High cm	Turn Table deg
1	5460.00	46.18	54.00	-7.82	40.26	5.92	Average	100	79
2	5460.00	59.54	74.00	-14.46	53.62	5.92	Peak	100	79
3	5470.00	59.81	68.20	-8.39	53.85	5.96	Peak	100	79
4	5725.00	60.34	68.20	-7.86	54.05	6.29	Peak	100	79
5	5750.00	60.51	68.20	-7.69	54.17	6.34	Peak	100	79
6	11180.00	43.55	54.00	-10.45	28.34	15.21	Average	100	90
7	11180.00	56.45	74.00	-17.55	41.24	15.21	Peak	100	90
8	16770.00	59.24	68.20	-8.96	42.41	16.83	Peak	100	50

Note 1: Emission Level (dBuV/m) = SA Reading (dBuV/m) + Factor* (dB)

*Factor includes antenna factor , cable loss and amplifier gain

Note 2: Margin (dB) = Emission level (dBuV/m) – Limit (dBuV/m).

Modulation	VHT40	Test Freq. (MHz)	5590
Polarization	Vertical		

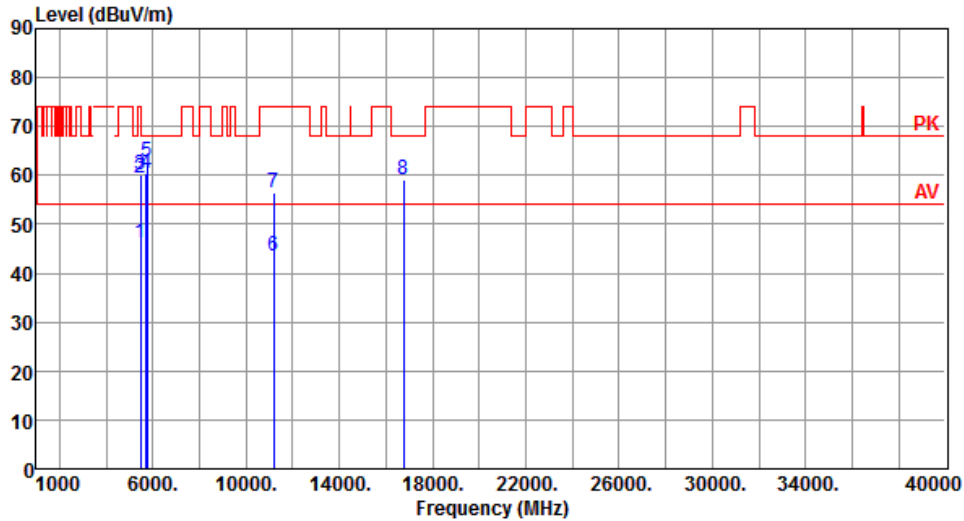

	Freq. MHz	Emission level dBuV/m	Limit dBuV/m	Margin dB	SA reading dBuV	Factor dB	Remark	ANT High cm	Turn Table deg
1	5460.00	46.17	54.00	-7.83	40.25	5.92	Average	100	82
2	5460.00	59.43	74.00	-14.57	53.51	5.92	Peak	100	82
3	5470.00	59.99	68.20	-8.21	54.03	5.96	Peak	100	82
4	5725.00	60.55	68.20	-7.65	54.26	6.29	Peak	100	82
5	5750.00	62.67	68.20	-5.53	56.33	6.34	Peak	100	82
6	11180.00	43.57	54.00	-10.43	28.36	15.21	Average	100	30
7	11180.00	56.49	74.00	-17.51	41.28	15.21	Peak	100	30
8	16770.00	59.26	68.20	-8.94	42.43	16.83	Peak	100	90

Note 1: Emission Level (dBuV/m) = SA Reading (dBuV/m) + Factor* (dB)

*Factor includes antenna factor , cable loss and amplifier gain

Note 2: Margin (dB) = Emission level (dBuV/m) – Limit (dBuV/m).

Modulation	VHT40	Test Freq. (MHz)	5670
Polarization	Horizontal		

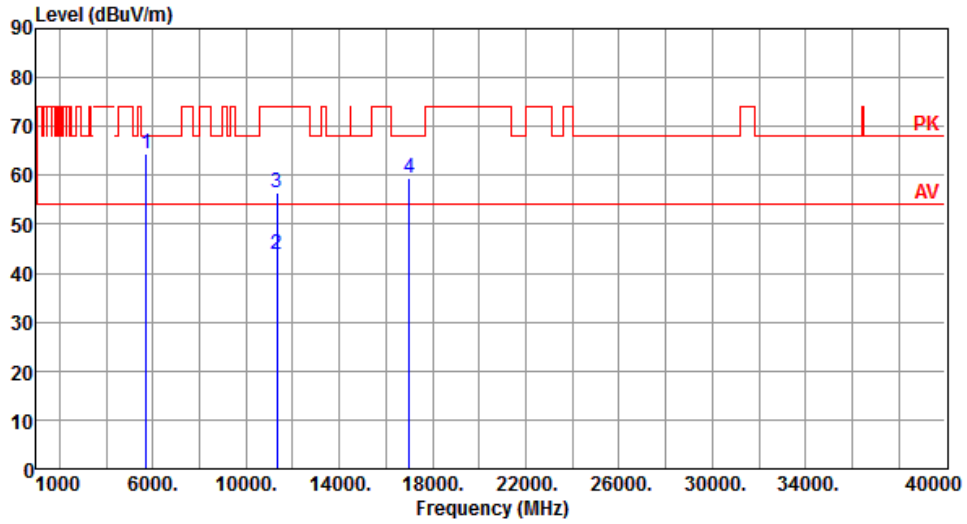

	Freq. MHz	Emission level dBuV/m	Limit dBuV/m	Margin dB	SA reading dBuV	Factor dB	Remark	ANT High cm	Turn Table deg
1	5725.00	64.41	68.20	-3.79	58.12	6.29	Peak	100	80
2	11340.00	43.73	54.00	-10.27	28.42	15.31	Average	100	30
3	11340.00	56.58	74.00	-17.42	41.27	15.31	Peak	100	30
4	17010.00	59.45	68.20	-8.75	42.33	17.12	Peak	100	10

Note 1: Emission Level (dBuV/m) = SA Reading (dBuV/m) + Factor* (dB)

*Factor includes antenna factor , cable loss and amplifier gain

Note 2: Margin (dB) = Emission level (dBuV/m) – Limit (dBuV/m).

Modulation	VHT40	Test Freq. (MHz)	5670
Polarization	Vertical		

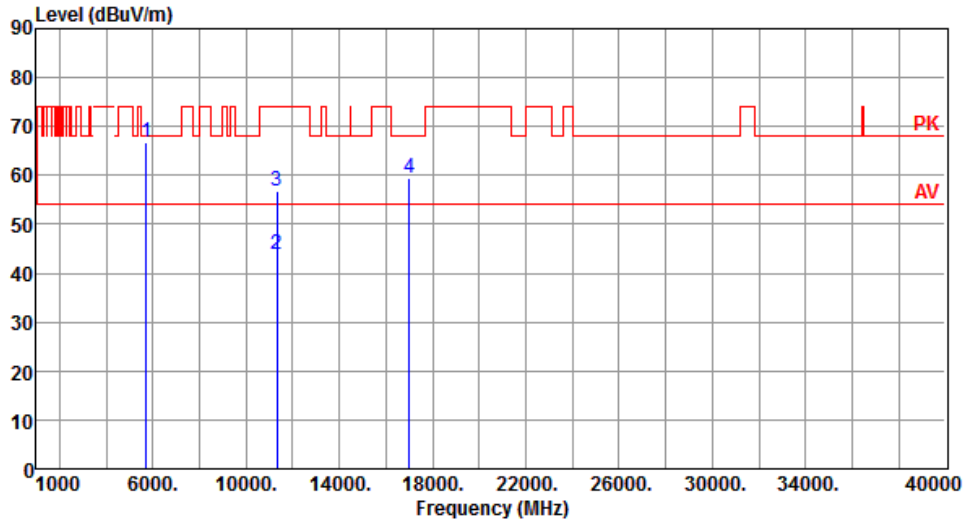

	Freq. MHz	Emission level dBuV/m	Limit dBuV/m	Margin dB	SA reading dBuV	Factor dB	Remark	ANT High cm	Turn Table deg
1	5725.00	66.62	68.20	-1.58	60.33	6.29	Peak	100	85
2	11340.00	43.88	54.00	-10.12	28.57	15.31	Average	100	70
3	11340.00	56.67	74.00	-17.33	41.36	15.31	Peak	100	70
4	17010.00	59.36	68.20	-8.84	42.24	17.12	Peak	100	20

Note 1: Emission Level (dBuV/m) = SA Reading (dBuV/m) + Factor* (dB)

*Factor includes antenna factor , cable loss and amplifier gain

Note 2: Margin (dB) = Emission level (dBuV/m) – Limit (dBuV/m).

Modulation	VHT40	Test Freq. (MHz)	5710
Polarization	Horizontal		

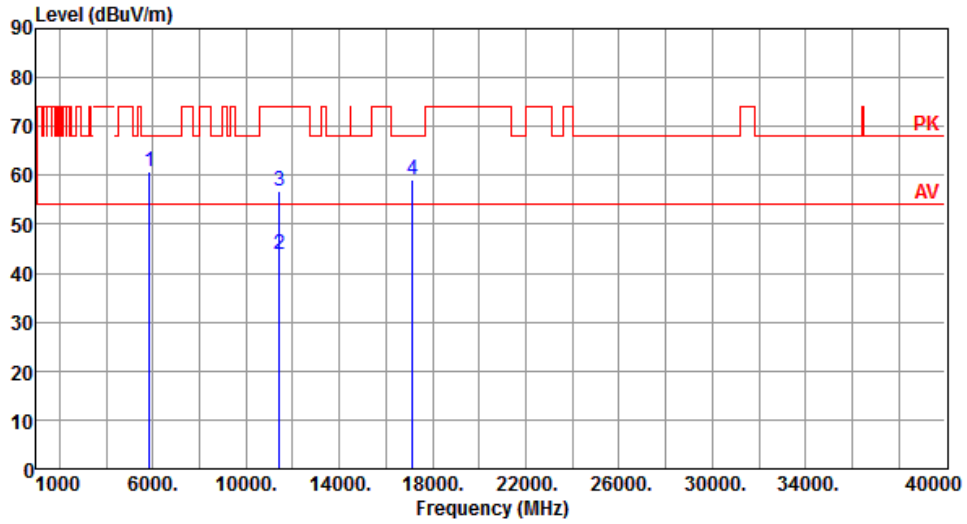

	Freq. MHz	Emission level dBuV/m	Limit dBuV/m	Margin dB	SA reading dBuV	Factor dB	Remark	ANT High cm	Turn Table deg
1	5850.00	60.63	68.20	-7.57	53.96	6.67	Peak	100	75
2	11420.00	43.78	54.00	-10.22	28.42	15.36	Average	100	20
3	11420.00	56.67	74.00	-17.33	41.31	15.36	Peak	100	20
4	17130.00	59.28	68.20	-8.92	42.41	16.87	Peak	100	80

Note 1: Emission Level (dBuV/m) = SA Reading (dBuV/m) + Factor* (dB)

*Factor includes antenna factor , cable loss and amplifier gain

Note 2: Margin (dB) = Emission level (dBuV/m) – Limit (dBuV/m).

Modulation	VHT40	Test Freq. (MHz)	5710
Polarization	Vertical		

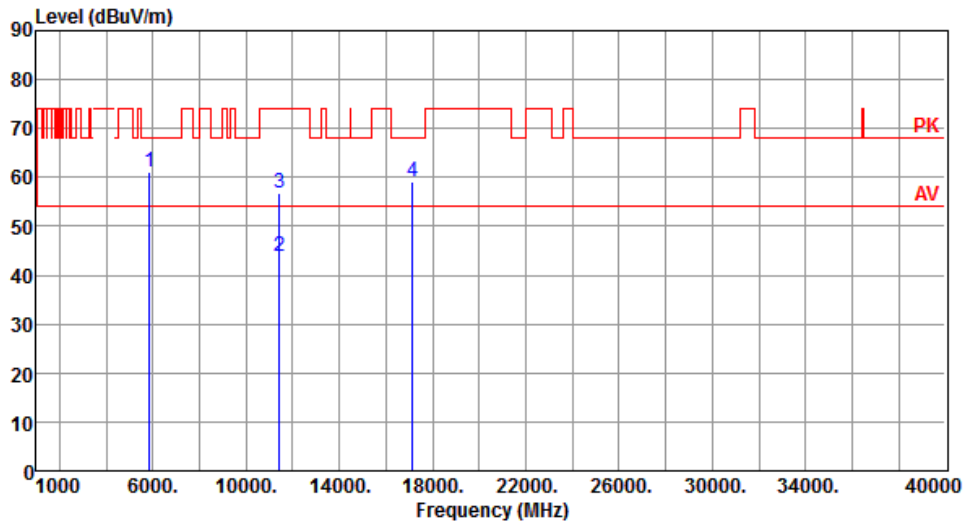

	Freq. MHz	Emission level dBuV/m	Limit dBuV/m	Margin dB	SA reading dBuV	Factor dB	Remark	ANT High cm	Turn Table deg
1	5850.00	60.98	68.20	-7.22	54.31	6.67	Peak	100	86
2	11420.00	43.79	54.00	-10.21	28.43	15.36	Average	100	30
3	11420.00	56.72	74.00	-17.28	41.36	15.36	Peak	100	30
4	17130.00	59.26	68.20	-8.94	42.39	16.87	Peak	100	40

Note 1: Emission Level (dBuV/m) = SA Reading (dBuV/m) + Factor* (dB)

*Factor includes antenna factor , cable loss and amplifier gain

Note 2: Margin (dB) = Emission level (dBuV/m) – Limit (dBuV/m).

Modulation	VHT40	Test Freq. (MHz)	5755
Polarization	Horizontal		

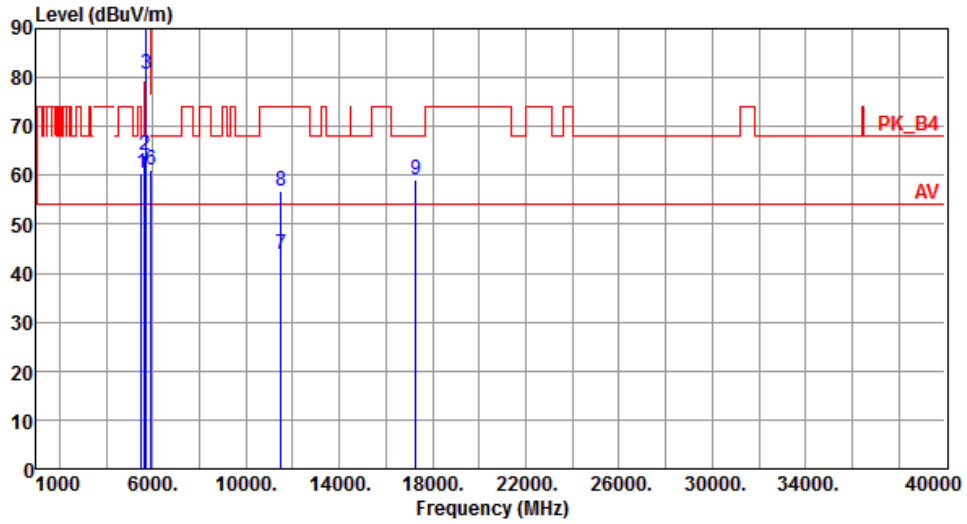

	Freq. MHz	Emission level dBuV/m	Limit dBuV/m	Margin dB	SA reading dBuV	Factor dB	Remark	ANT High cm	Turn Table deg
1	5515.00	60.37	68.20	-7.83	54.31	6.06	Peak	135	90
2	5650.00	64.03	68.20	-4.17	58.12	5.91	Peak	135	90
3	5700.00	80.79	105.20	-24.41	74.56	6.23	Peak	135	90
4	5720.00	91.58	110.80	-19.22	85.30	6.28	Peak	135	90
5	5725.00	91.98	122.20	-30.22	85.69	6.29	Peak	135	90
6	5925.00	60.94	68.20	-7.26	54.12	6.82	Peak	135	90
7	11510.00	43.79	54.00	-10.21	28.34	15.45	Average	100	40
8	11510.00	56.81	74.00	-17.19	41.36	15.45	Peak	100	40
9	17265.00	59.26	68.20	-8.94	42.15	17.11	Peak	100	55

Note 1: Emission Level (dBuV/m) = SA Reading (dBuV/m) + Factor* (dB)

*Factor includes antenna factor , cable loss and amplifier gain

Note 2: Margin (dB) = Emission level (dBuV/m) – Limit (dBuV/m).

Modulation	VHT40	Test Freq. (MHz)	5755
Polarization	Vertical		

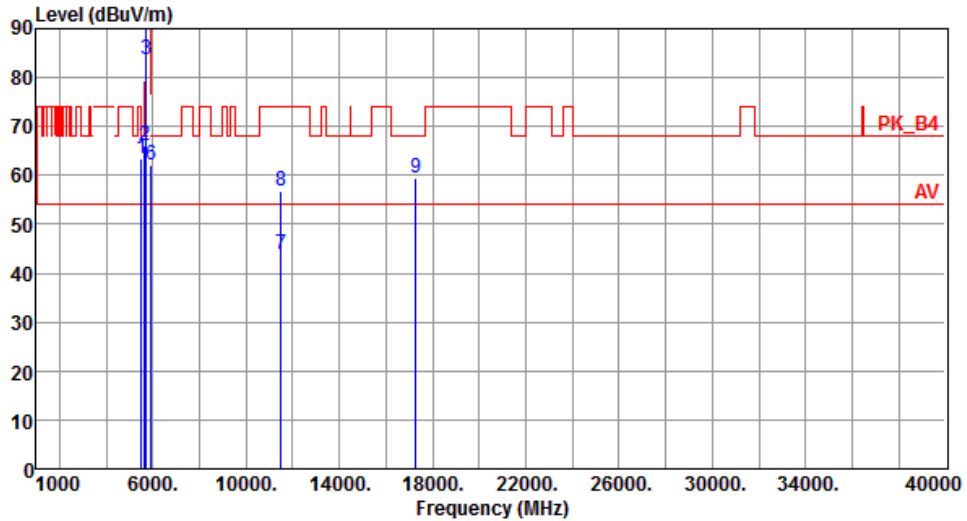

	Freq. MHz	Emission level dBuV/m	Limit dBuV/m	Margin dB	SA reading dBuV	Factor dB	Remark	ANT High cm	Turn Table deg
1	5515.00	63.48	68.20	-4.72	57.42	6.06	Peak	100	6
2	5650.00	66.22	68.20	-1.98	60.31	5.91	Peak	100	5
3	5700.00	83.85	105.20	-21.35	77.62	6.23	Peak	100	5
4	5720.00	95.39	110.80	-15.41	89.11	6.28	Peak	100	5
5	5725.00	95.74	122.20	-26.46	89.45	6.29	Peak	100	5
6	5925.00	62.13	68.20	-6.07	55.31	6.82	Peak	100	5
7	11510.00	43.93	54.00	-10.07	28.48	15.45	Average	100	30
8	11510.00	56.74	74.00	-17.26	41.29	15.45	Peak	100	30
9	17265.00	59.42	68.20	-8.78	42.31	17.11	Peak	100	60

Note 1: Emission Level (dBuV/m) = SA Reading (dBuV/m) + Factor* (dB)

*Factor includes antenna factor , cable loss and amplifier gain

Note 2: Margin (dB) = Emission level (dBuV/m) – Limit (dBuV/m).

Modulation	VHT40	Test Freq. (MHz)	5795
Polarization	Horizontal		

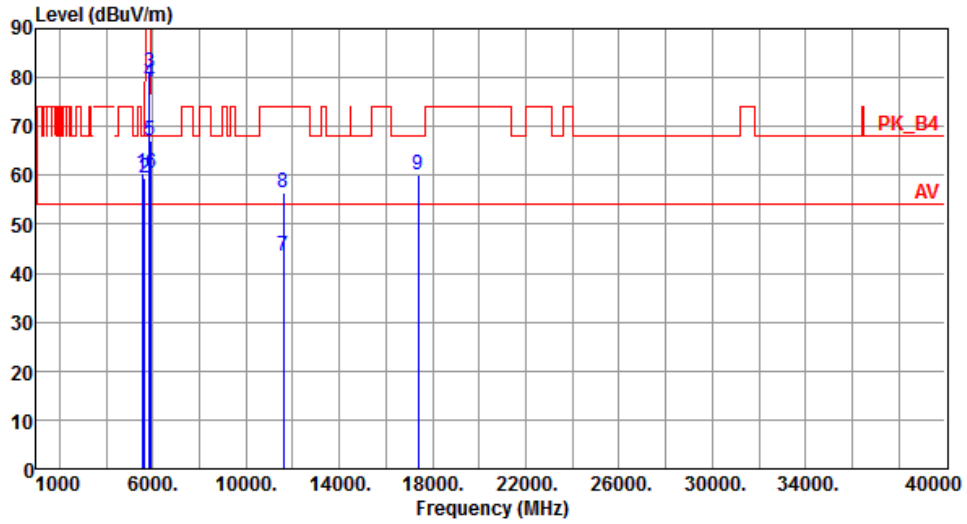

	Freq. MHz	Emission level dBuV/m	Limit dBuV/m	Margin dB	SA reading dBuV	Factor dB	Remark	ANT High cm	Turn Table deg
1	5555.00	60.30	68.20	-7.90	54.31	5.99	Peak	135	85
2	5650.00	59.49	68.20	-8.71	53.58	5.91	Peak	135	85
3	5850.00	80.93	122.20	-41.27	74.26	6.67	Peak	135	85
4	5855.00	79.13	110.80	-31.67	72.45	6.68	Peak	135	85
5	5875.00	67.07	105.20	-38.13	60.35	6.72	Peak	135	85
6	5925.00	60.30	68.20	-7.90	53.48	6.82	Peak	135	85
7	11590.00	43.59	54.00	-10.41	28.33	15.26	Average	100	50
8	11590.00	56.51	74.00	-17.49	41.25	15.26	Peak	100	50
9	17385.00	60.19	68.20	-8.01	42.38	17.81	Peak	100	60

Note 1: Emission Level (dBuV/m) = SA Reading (dBuV/m) + Factor* (dB)

*Factor includes antenna factor , cable loss and amplifier gain

Note 2: Margin (dB) = Emission level (dBuV/m) – Limit (dBuV/m).

Modulation	VHT40	Test Freq. (MHz)	5795
Polarization	Vertical		

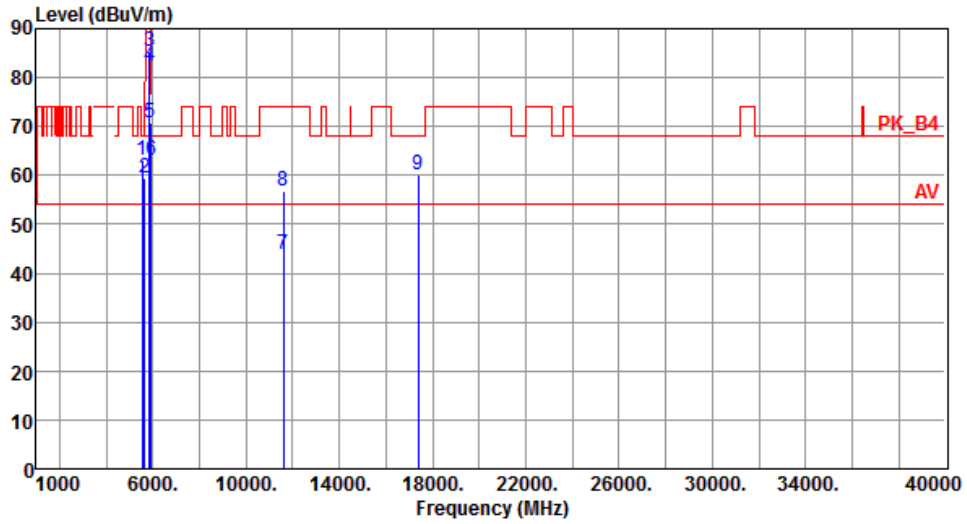

	Freq. MHz	Emission level dBuV/m	Limit dBuV/m	Margin dB	SA reading dBuV	Factor dB	Remark	ANT High cm	Turn Table deg
1	5555.00	63.13	68.20	-5.07	57.14	5.99	Peak	100	10
2	5650.00	59.50	68.20	-8.70	53.59	5.91	Peak	100	9
3	5850.00	85.32	122.20	-36.88	78.65	6.67	Peak	100	9
4	5855.00	82.53	110.80	-28.27	75.85	6.68	Peak	100	9
5	5875.00	70.84	105.20	-34.36	64.12	6.72	Peak	100	9
6	5925.00	63.00	68.20	-5.20	56.18	6.82	Peak	100	9
7	11590.00	43.73	54.00	-10.27	28.47	15.26	Average	100	20
8	11590.00	56.78	74.00	-17.22	41.52	15.26	Peak	100	20
9	17385.00	60.19	68.20	-8.01	42.38	17.81	Peak	100	30

Note 1: Emission Level (dBuV/m) = SA Reading (dBuV/m) + Factor* (dB)

*Factor includes antenna factor , cable loss and amplifier gain

Note 2: Margin (dB) = Emission level (dBuV/m) – Limit (dBuV/m).

3.5.8 Transmitter Radiated Unwanted Emissions (Above 1GHz) for VHT80

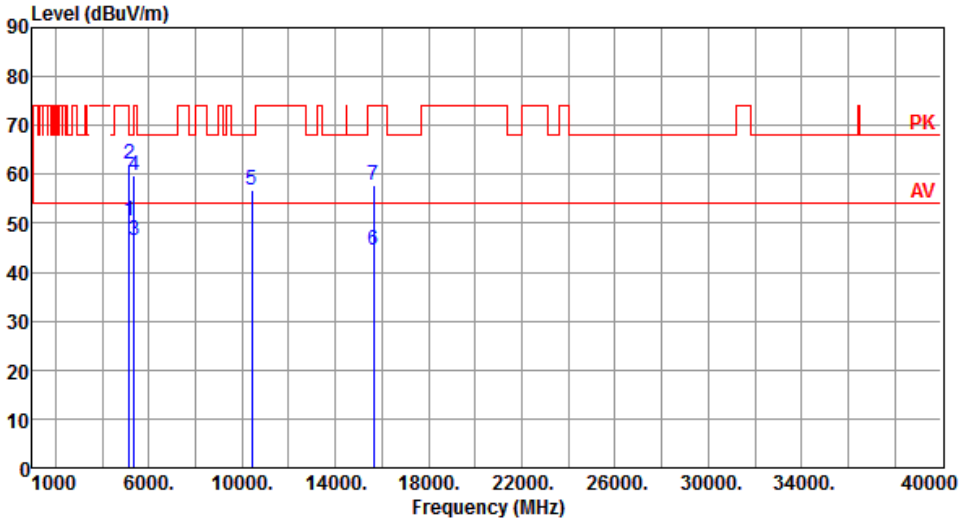
Modulation	VHT80	Test Freq. (MHz)	5210																																																																																									
Polarization	Horizontal																																																																																											
																																																																																												
	<table border="1"> <thead> <tr> <th>Freq.</th> <th>Emission level</th> <th>Limit</th> <th>Margin</th> <th>SA reading</th> <th>Factor</th> <th>Remark</th> <th>ANT High</th> <th>Turn Table</th> </tr> <tr> <th>MHz</th> <th>dBuV/m</th> <th>dBuV/m</th> <th>dB</th> <th>dBuV</th> <th>dB</th> <th></th> <th>cm</th> <th>deg</th> </tr> </thead> <tbody> <tr> <td>1</td> <td>5150.00</td> <td>50.36</td> <td>54.00</td> <td>-3.64</td> <td>44.41</td> <td>5.95</td> <td>Average</td> <td>100</td> <td>56</td> </tr> <tr> <td>2</td> <td>5150.00</td> <td>62.16</td> <td>74.00</td> <td>-11.84</td> <td>56.21</td> <td>5.95</td> <td>Peak</td> <td>100</td> <td>56</td> </tr> <tr> <td>3</td> <td>5350.00</td> <td>46.66</td> <td>54.00</td> <td>-7.34</td> <td>41.26</td> <td>5.40</td> <td>Average</td> <td>100</td> <td>56</td> </tr> <tr> <td>4</td> <td>5350.00</td> <td>59.71</td> <td>74.00</td> <td>-14.29</td> <td>54.31</td> <td>5.40</td> <td>Peak</td> <td>100</td> <td>56</td> </tr> <tr> <td>5</td> <td>10420.00</td> <td>56.66</td> <td>68.20</td> <td>-11.54</td> <td>41.34</td> <td>15.32</td> <td>Peak</td> <td>100</td> <td>40</td> </tr> <tr> <td>6</td> <td>15630.00</td> <td>44.62</td> <td>54.00</td> <td>-9.38</td> <td>29.18</td> <td>15.44</td> <td>Average</td> <td>100</td> <td>25</td> </tr> <tr> <td>7</td> <td>15630.00</td> <td>57.91</td> <td>74.00</td> <td>-16.09</td> <td>42.47</td> <td>15.44</td> <td>Peak</td> <td>100</td> <td>25</td> </tr> </tbody> </table>	Freq.	Emission level	Limit	Margin	SA reading	Factor	Remark	ANT High	Turn Table	MHz	dBuV/m	dBuV/m	dB	dBuV	dB		cm	deg	1	5150.00	50.36	54.00	-3.64	44.41	5.95	Average	100	56	2	5150.00	62.16	74.00	-11.84	56.21	5.95	Peak	100	56	3	5350.00	46.66	54.00	-7.34	41.26	5.40	Average	100	56	4	5350.00	59.71	74.00	-14.29	54.31	5.40	Peak	100	56	5	10420.00	56.66	68.20	-11.54	41.34	15.32	Peak	100	40	6	15630.00	44.62	54.00	-9.38	29.18	15.44	Average	100	25	7	15630.00	57.91	74.00	-16.09	42.47	15.44	Peak	100	25			
Freq.	Emission level	Limit	Margin	SA reading	Factor	Remark	ANT High	Turn Table																																																																																				
MHz	dBuV/m	dBuV/m	dB	dBuV	dB		cm	deg																																																																																				
1	5150.00	50.36	54.00	-3.64	44.41	5.95	Average	100	56																																																																																			
2	5150.00	62.16	74.00	-11.84	56.21	5.95	Peak	100	56																																																																																			
3	5350.00	46.66	54.00	-7.34	41.26	5.40	Average	100	56																																																																																			
4	5350.00	59.71	74.00	-14.29	54.31	5.40	Peak	100	56																																																																																			
5	10420.00	56.66	68.20	-11.54	41.34	15.32	Peak	100	40																																																																																			
6	15630.00	44.62	54.00	-9.38	29.18	15.44	Average	100	25																																																																																			
7	15630.00	57.91	74.00	-16.09	42.47	15.44	Peak	100	25																																																																																			
<p>Note 1: Emission Level (dBuV/m) = SA Reading (dBuV/m) + Factor* (dB) *Factor includes antenna factor , cable loss and amplifier gain Note 2: Margin (dB) = Emission level (dBuV/m) – Limit (dBuV/m).</p>																																																																																												

Modulation	VHT80	Test Freq. (MHz)	5210
Polarization	Vertical		

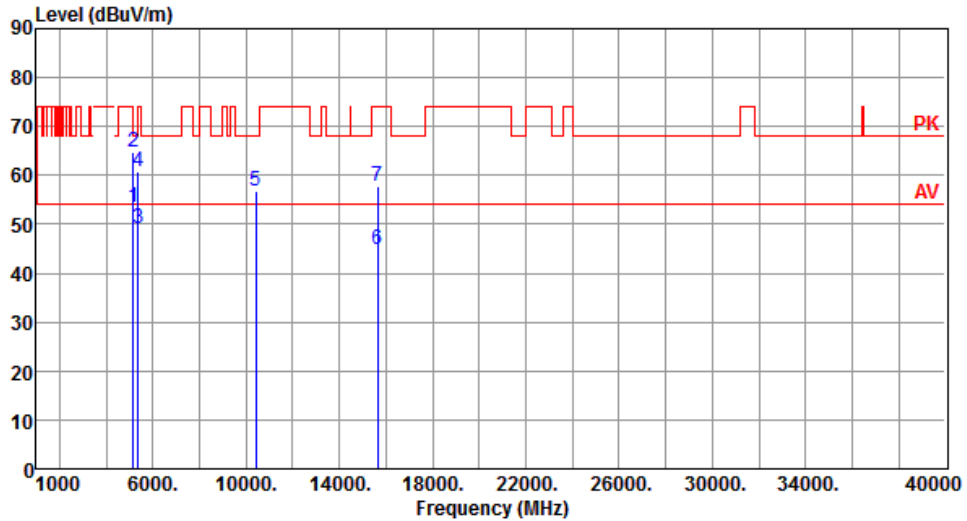

	Freq. MHz	Emission level dBuV/m	Limit dBuV/m	Margin dB	SA reading dBuV	Factor dB	Remark	ANT High cm	Turn Table deg
1	5150.00	53.59	54.00	-0.41	47.64	5.95	Average	100	79
2	5150.00	64.85	74.00	-9.15	58.90	5.95	Peak	100	79
3	5350.00	49.08	54.00	-4.92	43.68	5.40	Average	100	73
4	5350.00	60.87	74.00	-13.13	55.47	5.40	Peak	100	73
5	10420.00	56.69	68.20	-11.51	41.37	15.32	Peak	100	20
6	15630.00	44.68	54.00	-9.32	29.24	15.44	Average	100	30
7	15630.00	57.83	74.00	-16.17	42.39	15.44	Peak	100	30

Note 1: Emission Level (dBuV/m) = SA Reading (dBuV/m) + Factor* (dB)

*Factor includes antenna factor , cable loss and amplifier gain

Note 2: Margin (dB) = Emission level (dBuV/m) – Limit (dBuV/m).

Modulation	VHT80	Test Freq. (MHz)	5290
Polarization	Horizontal		

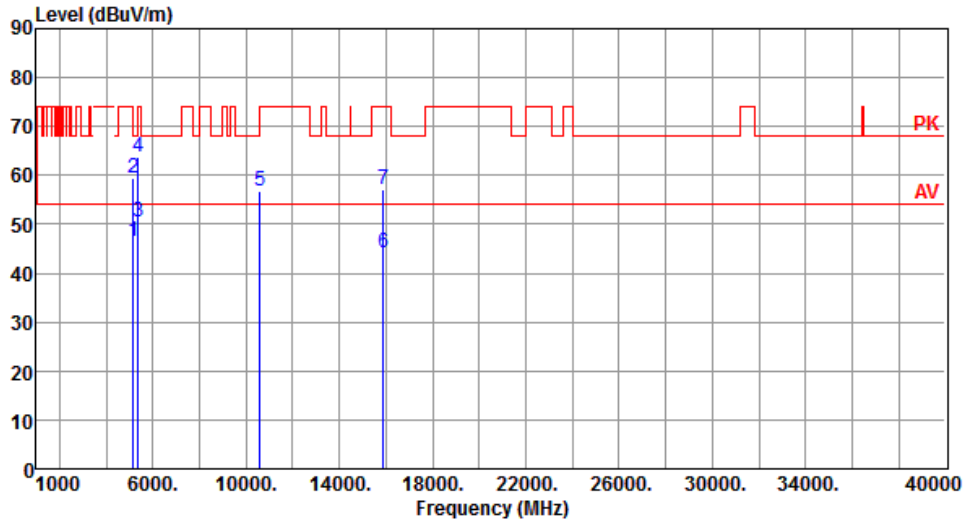

	Freq. MHz	Emission level dBuV/m	Limit dBuV/m	Margin dB	SA reading dBuV	Factor dB	Remark	ANT High cm	Turn Table deg
1	5150.00	46.51	54.00	-7.49	40.56	5.95	Average	100	54
2	5150.00	59.31	74.00	-14.69	53.36	5.95	Peak	100	54
3	5350.00	50.61	54.00	-3.39	45.21	5.40	Average	100	54
4	5350.00	63.76	74.00	-10.24	58.36	5.40	Peak	100	54
5	10580.00	56.75	68.20	-11.45	41.37	15.38	Peak	100	70
6	15870.00	44.12	54.00	-9.88	29.24	14.88	Average	100	40
7	15870.00	57.19	74.00	-16.81	42.31	14.88	Peak	100	40

Note 1: Emission Level (dBuV/m) = SA Reading (dBuV/m) + Factor* (dB)

*Factor includes antenna factor , cable loss and amplifier gain

Note 2: Margin (dB) = Emission level (dBuV/m) – Limit (dBuV/m).

Modulation	VHT80	Test Freq. (MHz)	5290
Polarization	Vertical		

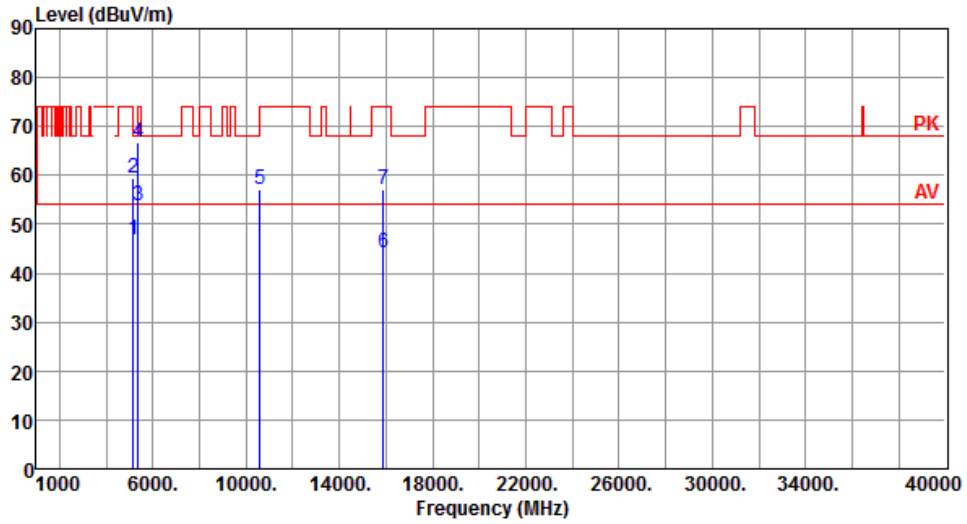

	Freq. MHz	Emission level dBuV/m	Limit dBuV/m	Margin dB	SA reading dBuV	Factor dB	Remark	ANT High cm	Turn Table deg
1	5150.00	46.89	54.00	-7.11	40.94	5.95	Average	100	87
2	5150.00	59.44	74.00	-14.56	53.49	5.95	Peak	100	87
3	5350.00	53.75	54.00	-0.25	48.35	5.40	Average	100	87
4	5350.00	66.85	74.00	-7.15	61.45	5.40	Peak	100	87
5	10580.00	57.01	68.20	-11.19	41.63	15.38	Peak	100	80
6	15870.00	44.24	54.00	-9.76	29.36	14.88	Average	100	50
7	15870.00	57.15	74.00	-16.85	42.27	14.88	Peak	100	50

Note 1: Emission Level (dBuV/m) = SA Reading (dBuV/m) + Factor* (dB)

*Factor includes antenna factor , cable loss and amplifier gain

Note 2: Margin (dB) = Emission level (dBuV/m) – Limit (dBuV/m).

Modulation	VHT80	Test Freq. (MHz)	5530
Polarization	Horizontal		

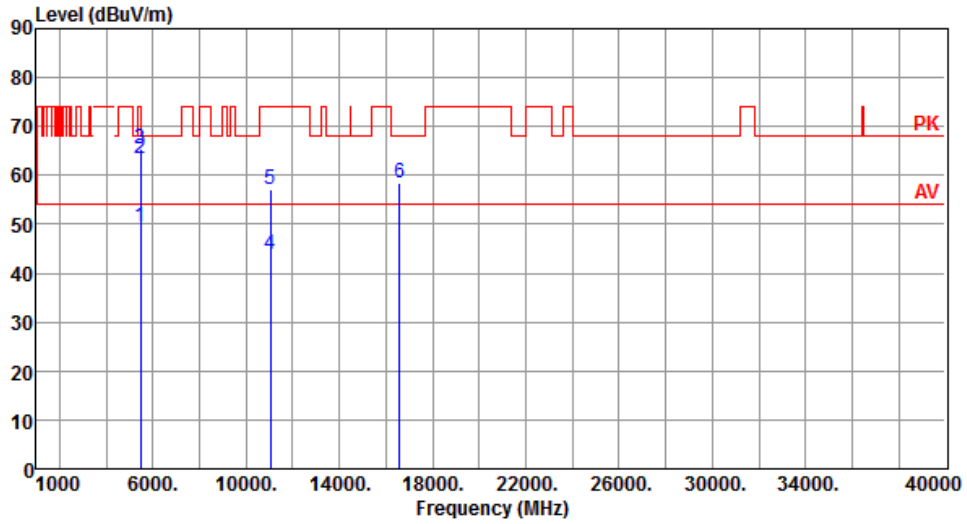

	Freq. MHz	Emission level dBuV/m	Limit dBuV/m	Margin dB	SA reading dBuV	Factor dB	Remark	ANT High cm	Turn Table deg
1	5460.00	49.49	54.00	-4.51	43.57	5.92	Average	100	75
2	5460.00	63.54	74.00	-10.46	57.62	5.92	Peak	100	75
3	5470.00	65.41	68.20	-2.79	59.45	5.96	Peak	100	75
4	11060.00	43.93	54.00	-10.07	28.45	15.48	Average	100	50
5	11060.00	57.17	74.00	-16.83	41.69	15.48	Peak	100	50
6	16590.00	58.51	68.20	-9.69	42.44	16.07	Peak	100	20

Note 1: Emission Level (dBuV/m) = SA Reading (dBuV/m) + Factor* (dB)

*Factor includes antenna factor , cable loss and amplifier gain

Note 2: Margin (dB) = Emission level (dBuV/m) – Limit (dBuV/m).

Modulation	VHT80	Test Freq. (MHz)	5530
Polarization	Vertical		

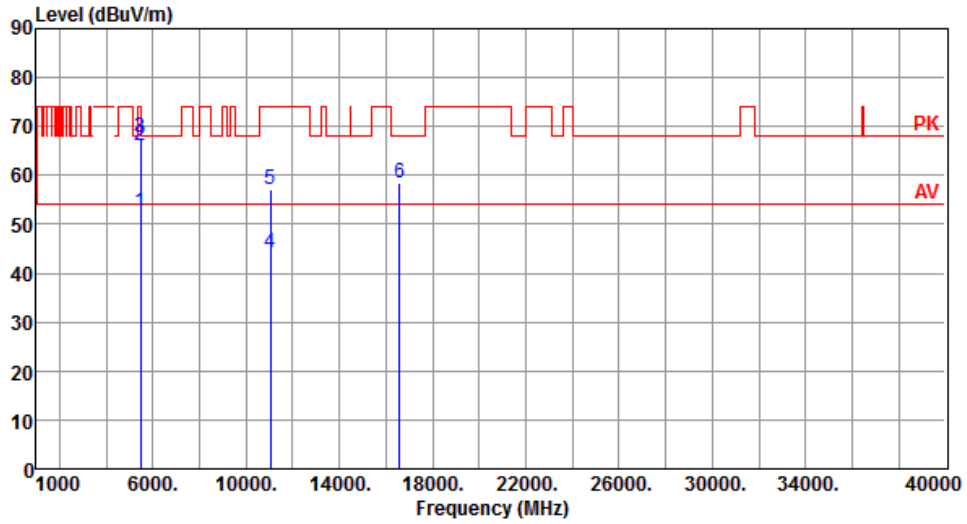

	Freq. MHz	Emission level dBuV/m	Limit dBuV/m	Margin dB	SA reading dBuV	Factor dB	Remark	ANT High cm	Turn Table deg
1	5460.00	52.33	54.00	-1.67	46.41	5.92	Average	100	85
2	5460.00	66.16	74.00	-7.84	60.24	5.92	Peak	100	85
3	5470.00	67.81	68.20	-0.39	61.85	5.96	Peak	100	85
4	11060.00	44.11	54.00	-9.89	28.63	15.48	Average	100	30
5	11060.00	57.02	74.00	-16.98	41.54	15.48	Peak	100	30
6	16590.00	58.44	68.20	-9.76	42.37	16.07	Peak	100	60

Note 1: Emission Level (dBuV/m) = SA Reading (dBuV/m) + Factor* (dB)

*Factor includes antenna factor , cable loss and amplifier gain

Note 2: Margin (dB) = Emission level (dBuV/m) – Limit (dBuV/m).

Modulation	VHT80	Test Freq. (MHz)	5610
Polarization	Horizontal		

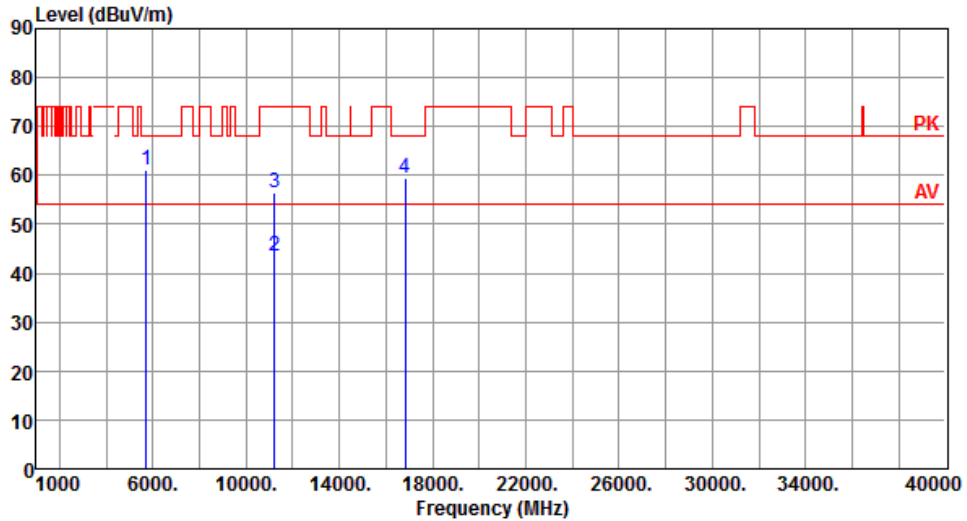

	Freq. MHz	Emission level dBuV/m	Limit dBuV/m	Margin dB	SA reading dBuV	Factor dB	Remark	ANT High cm	Turn Table deg
1	5725.00	61.15	68.20	-7.05	54.86	6.29	Peak	100	79
2	11220.00	43.61	54.00	-10.39	28.43	15.18	Average	100	50
3	11220.00	56.49	74.00	-17.51	41.31	15.18	Peak	100	50
4	16830.00	59.29	68.20	-8.91	42.51	16.78	Peak	100	90

Note 1: Emission Level (dBuV/m) = SA Reading (dBuV/m) + Factor* (dB)

*Factor includes antenna factor , cable loss and amplifier gain

Note 2: Margin (dB) = Emission level (dBuV/m) – Limit (dBuV/m).

Modulation	VHT80	Test Freq. (MHz)	5610
Polarization	Vertical		

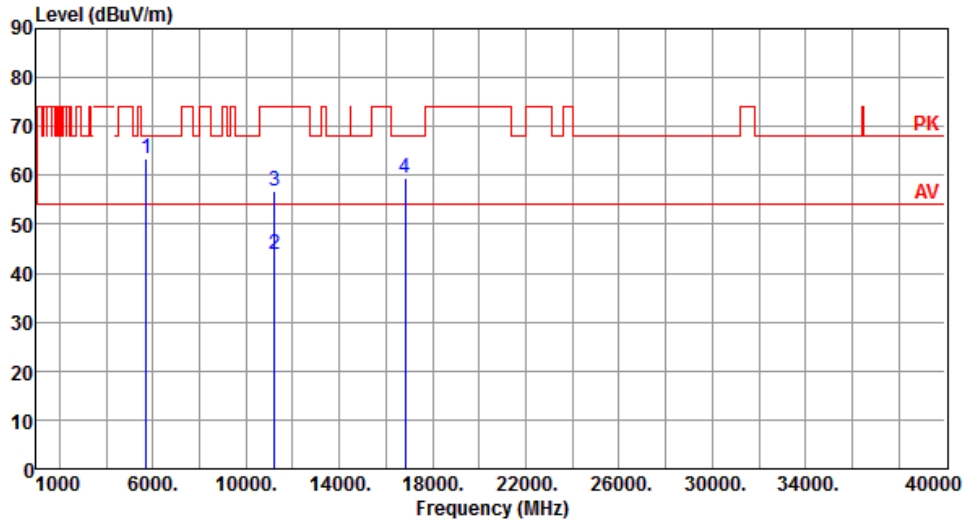

	Freq. MHz	Emission level dBuV/m	Limit dBuV/m	Margin dB	SA reading dBuV	Factor dB	Remark	ANT High cm	Turn Table deg
1	5725.00	63.41	68.20	-4.79	57.12	6.29	Peak	100	86
2	11220.00	43.71	54.00	-10.29	28.53	15.18	Average	100	25
3	11220.00	56.81	74.00	-17.19	41.63	15.18	Peak	100	25
4	16830.00	59.31	68.20	-8.89	42.53	16.78	Peak	100	30

Note 1: Emission Level (dBuV/m) = SA Reading (dBuV/m) + Factor* (dB)

*Factor includes antenna factor , cable loss and amplifier gain

Note 2: Margin (dB) = Emission level (dBuV/m) – Limit (dBuV/m).

Modulation	VHT80	Test Freq. (MHz)	5690
Polarization	Horizontal		

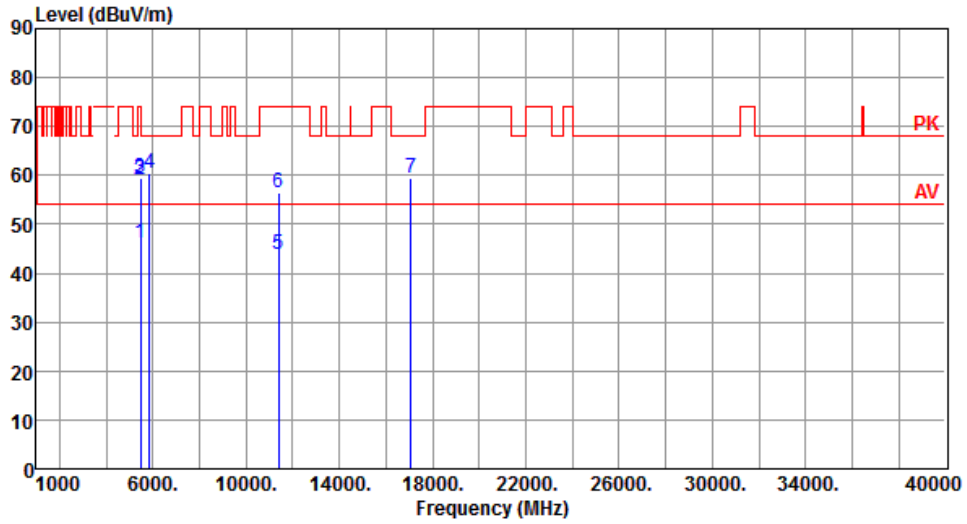

	Freq. MHz	Emission level dBuV/m	Limit dBuV/m	Margin dB	SA reading dBuV	Factor dB	Remark	ANT High cm	Turn Table deg
1	5460.00	46.19	54.00	-7.81	40.27	5.92	Average	100	73
2	5460.00	59.15	74.00	-14.85	53.23	5.92	Peak	100	73
3	5470.00	59.59	68.20	-8.61	53.63	5.96	Peak	100	73
4	5850.00	60.30	68.20	-7.90	53.63	6.67	Peak	100	73
5	11380.00	43.78	54.00	-10.22	28.46	15.32	Average	100	50
6	11380.00	56.61	74.00	-17.39	41.29	15.32	Peak	100	50
7	17070.00	59.35	68.20	-8.85	42.39	16.96	Peak	100	50

Note 1: Emission Level (dBuV/m) = SA Reading (dBuV/m) + Factor* (dB)

*Factor includes antenna factor , cable loss and amplifier gain

Note 2: Margin (dB) = Emission level (dBuV/m) – Limit (dBuV/m).

Modulation	VHT80	Test Freq. (MHz)	5690
Polarization	Vertical		

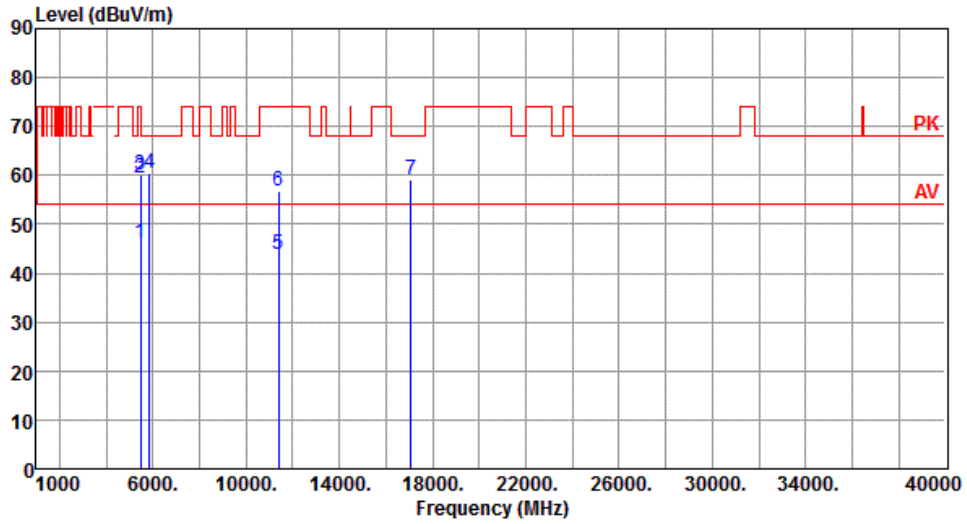

	Freq. MHz	Emission level dBuV/m	Limit dBuV/m	Margin dB	SA reading dBuV	Factor dB	Remark	ANT High cm	Turn Table deg
1	5460.00	46.30	54.00	-7.70	40.38	5.92	Average	100	87
2	5460.00	59.49	74.00	-14.51	53.57	5.92	Peak	100	87
3	5470.00	60.08	68.20	-8.12	54.12	5.96	Peak	100	87
4	5850.00	60.32	68.20	-7.88	53.65	6.67	Peak	100	87
5	11380.00	43.74	54.00	-10.26	28.42	15.32	Average	100	30
6	11380.00	56.67	74.00	-17.33	41.35	15.32	Peak	100	30
7	17070.00	59.23	68.20	-8.97	42.27	16.96	Peak	100	90

Note 1: Emission Level (dBuV/m) = SA Reading (dBuV/m) + Factor* (dB)

*Factor includes antenna factor , cable loss and amplifier gain

Note 2: Margin (dB) = Emission level (dBuV/m) – Limit (dBuV/m).

Modulation	VHT80	Test Freq. (MHz)	5775
Polarization	Horizontal		

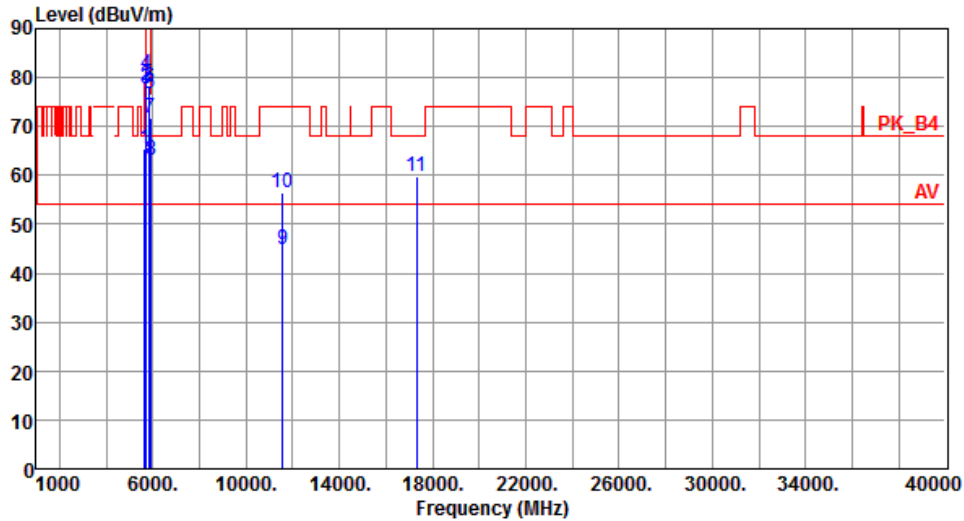

	Freq. MHz	Emission level dBuV/m	Limit dBuV/m	Margin dB	SA reading dBuV	Factor dB	Remark	ANT High cm	Turn Table deg
1	5650.00	65.33	68.20	-2.87	59.42	5.91	Peak	100	90
2	5700.00	78.54	105.20	-26.66	72.31	6.23	Peak	100	90
3	5720.00	77.63	110.80	-33.17	71.35	6.28	Peak	100	90
4	5725.00	80.58	122.20	-41.62	74.29	6.29	Peak	100	90
5	5850.00	76.80	122.20	-45.40	70.13	6.67	Peak	100	90
6	5855.00	77.97	110.80	-32.83	71.29	6.68	Peak	100	90
7	5875.00	71.74	105.20	-33.46	65.02	6.72	Peak	100	90
8	5925.00	63.01	68.20	-5.19	56.19	6.82	Peak	100	90
9	11550.00	44.68	54.00	-9.32	29.33	15.35	Average	100	80
10	11550.00	56.60	74.00	-17.40	41.25	15.35	Peak	100	80
11	17325.00	59.73	68.20	-8.47	42.31	17.42	Peak	100	60

Note 1: Emission Level (dBuV/m) = SA Reading (dBuV/m) + Factor* (dB)

*Factor includes antenna factor , cable loss and amplifier gain

Note 2: Margin (dB) = Emission level (dBuV/m) – Limit (dBuV/m).

Modulation	VHT80	Test Freq. (MHz)	5775
Polarization	Vertical		

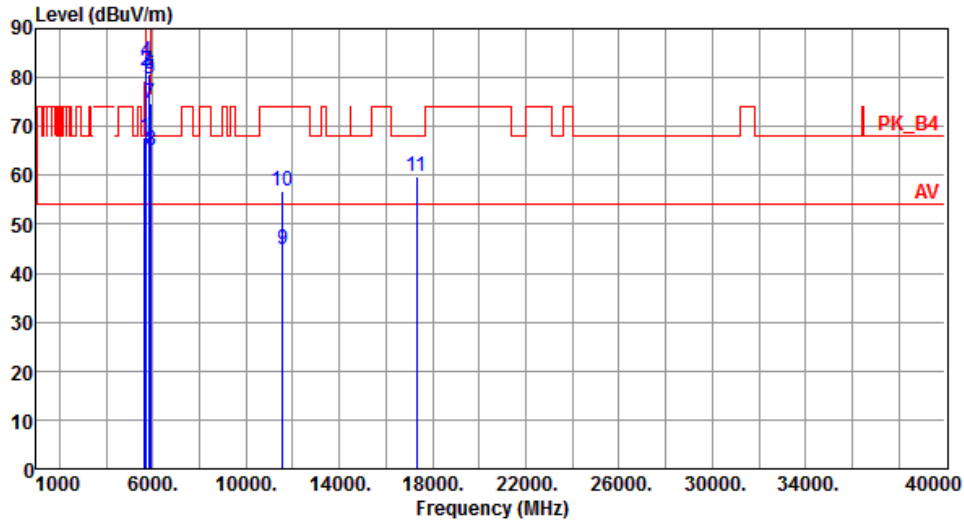

	Freq. MHz	Emission level dBuV/m	Limit dBuV/m	Margin dB	SA reading dBuV	Factor dB	Remark	ANT High cm	Turn Table deg
1	5650.00	67.66	68.20	-0.54	61.75	5.91	Peak	100	75
2	5700.00	81.52	105.20	-23.68	75.29	6.23	Peak	100	75
3	5720.00	81.27	110.80	-29.53	74.99	6.28	Peak	100	75
4	5725.00	83.42	122.20	-38.78	77.13	6.29	Peak	100	75
5	5850.00	79.84	122.20	-42.36	73.17	6.67	Peak	100	75
6	5855.00	80.72	110.80	-30.08	74.04	6.68	Peak	100	75
7	5875.00	74.79	105.20	-30.41	68.07	6.72	Peak	100	75
8	5925.00	65.02	68.20	-3.18	58.20	6.82	Peak	100	75
9	11550.00	44.77	54.00	-9.23	29.42	15.35	Average	100	30
10	11550.00	56.70	74.00	-17.30	41.35	15.35	Peak	100	30
11	17325.00	59.76	68.20	-8.44	42.34	17.42	Peak	100	50

Note 1: Emission Level (dBuV/m) = SA Reading (dBuV/m) + Factor* (dB)

*Factor includes antenna factor , cable loss and amplifier gain

Note 2: Margin (dB) = Emission level (dBuV/m) – Limit (dBuV/m).

Beamforming mode

3.5.9 Transmitter Radiated Unwanted Emissions (Below 1GHz)

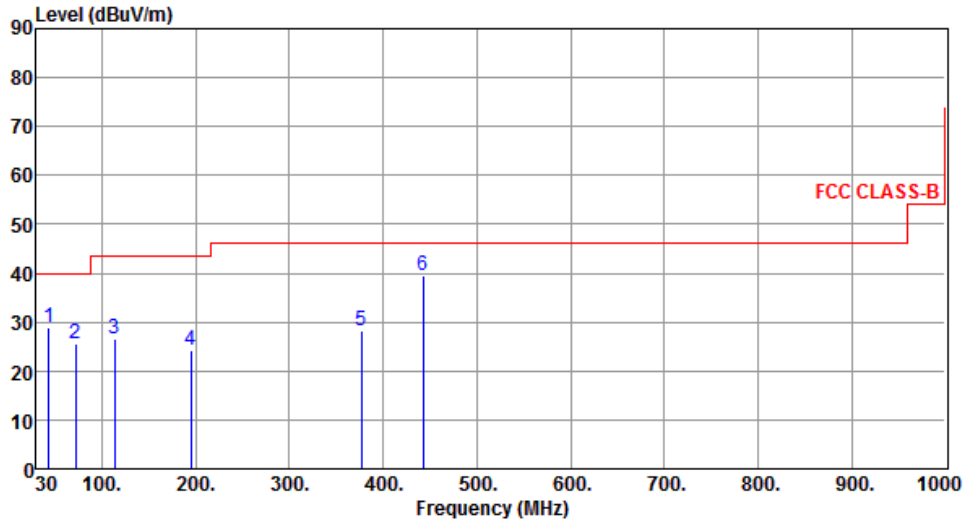
Modulation	VHT20	Test Freq. (MHz)	5240																																																															
Polarization	Horizontal																																																																	
 <p>The graph plots Level (dBuV/m) on the y-axis (0 to 90) against Frequency (MHz) on the x-axis (30 to 1000). A red step function represents the FCC CLASS-B limit, starting at 40 dBuV/m from 30 MHz to 100 MHz, rising to 45 dBuV/m from 100 MHz to 200 MHz, and then to 55 dBuV/m from 200 MHz to 1000 MHz. Six blue vertical lines represent measured peaks, labeled 1 through 6, with their frequencies and levels indicated in the table below.</p>																																																																		
	<table border="1"> <thead> <tr> <th>Freq. MHz</th> <th>Emission level dBuV/m</th> <th>Limit dBuV/m</th> <th>Margin dB</th> <th>SA reading dBuV</th> <th>Factor dB</th> <th>Remark</th> <th>ANT High cm</th> <th>Turn Table deg</th> </tr> </thead> <tbody> <tr> <td>1</td> <td>43.58</td> <td>40.00</td> <td>-11.25</td> <td>37.67</td> <td>-8.92</td> <td>Peak</td> <td>---</td> <td>---</td> </tr> <tr> <td>2</td> <td>71.59</td> <td>40.00</td> <td>-14.39</td> <td>36.58</td> <td>-10.97</td> <td>Peak</td> <td>---</td> <td>---</td> </tr> <tr> <td>3</td> <td>113.38</td> <td>43.50</td> <td>-16.92</td> <td>38.38</td> <td>-11.80</td> <td>Peak</td> <td>---</td> <td>---</td> </tr> <tr> <td>4</td> <td>194.75</td> <td>43.50</td> <td>-19.22</td> <td>36.11</td> <td>-11.83</td> <td>Peak</td> <td>---</td> <td>---</td> </tr> <tr> <td>5</td> <td>376.41</td> <td>46.00</td> <td>-17.71</td> <td>34.68</td> <td>-6.39</td> <td>Peak</td> <td>---</td> <td>---</td> </tr> <tr> <td>6</td> <td>442.31</td> <td>46.00</td> <td>-6.34</td> <td>44.07</td> <td>-4.41</td> <td>Peak</td> <td>---</td> <td>---</td> </tr> </tbody> </table>	Freq. MHz	Emission level dBuV/m	Limit dBuV/m	Margin dB	SA reading dBuV	Factor dB	Remark	ANT High cm	Turn Table deg	1	43.58	40.00	-11.25	37.67	-8.92	Peak	---	---	2	71.59	40.00	-14.39	36.58	-10.97	Peak	---	---	3	113.38	43.50	-16.92	38.38	-11.80	Peak	---	---	4	194.75	43.50	-19.22	36.11	-11.83	Peak	---	---	5	376.41	46.00	-17.71	34.68	-6.39	Peak	---	---	6	442.31	46.00	-6.34	44.07	-4.41	Peak	---	---		
Freq. MHz	Emission level dBuV/m	Limit dBuV/m	Margin dB	SA reading dBuV	Factor dB	Remark	ANT High cm	Turn Table deg																																																										
1	43.58	40.00	-11.25	37.67	-8.92	Peak	---	---																																																										
2	71.59	40.00	-14.39	36.58	-10.97	Peak	---	---																																																										
3	113.38	43.50	-16.92	38.38	-11.80	Peak	---	---																																																										
4	194.75	43.50	-19.22	36.11	-11.83	Peak	---	---																																																										
5	376.41	46.00	-17.71	34.68	-6.39	Peak	---	---																																																										
6	442.31	46.00	-6.34	44.07	-4.41	Peak	---	---																																																										
<p>Note 1: Emission Level (dBuV/m) = SA Reading (dBuV/m) + Factor* (dB) *Factor includes antenna factor , cable loss and amplifier gain Note 2: Margin (dB) = Emission level (dBuV/m) – Limit (dBuV/m). Note 3: All spurious emissions below 30MHz are more than 20 dB below the limit.</p>																																																																		

Modulation	VHT20	Test Freq. (MHz)	5240
Polarization	Vertical		

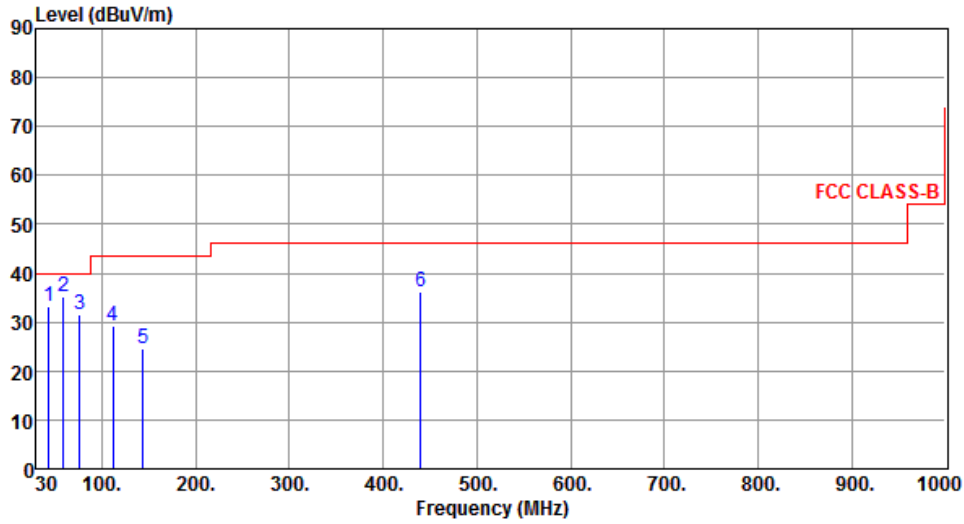

	Freq. MHz	Emission level dBuV/m	Limit dBuV/m	Margin dB	SA reading dBuV	Factor dB	Remark	ANT High cm	Turn Table deg
1	43.62	33.31	40.00	-6.69	42.23	-8.92	Peak	---	---
2	59.33	35.17	40.00	-4.83	44.43	-9.26	Peak	---	---
3	76.42	31.45	40.00	-8.55	43.91	-12.46	Peak	---	---
4	111.59	29.35	43.50	-14.15	41.37	-12.02	Peak	---	---
5	143.52	24.46	43.50	-19.04	33.45	-8.99	Peak	---	---
6	440.33	36.31	46.00	-9.69	40.77	-4.46	Peak	---	---

Note 1: Emission Level (dBuV/m) = SA Reading (dBuV/m) + Factor* (dB)

*Factor includes antenna factor , cable loss and amplifier gain

Note 2: Margin (dB) = Emission level (dBuV/m) – Limit (dBuV/m).

Note 3: All spurious emissions below 30MHz are more than 20 dB below the limit.

Modulation	VHT20	Test Freq. (MHz)	5785
Polarization	Horizontal		

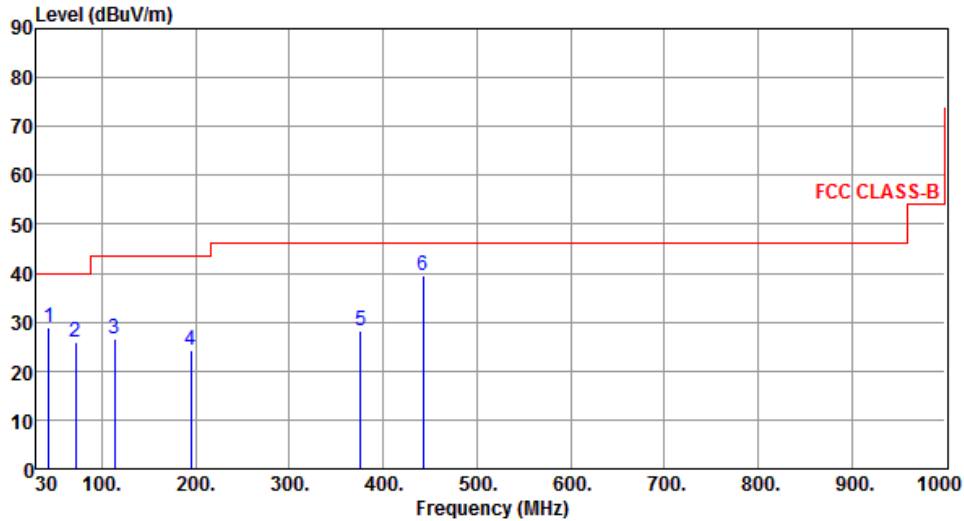

	Freq. MHz	Emission level dBuV/m	Limit dBuV/m	Margin dB	SA reading dBuV	Factor dB	Remark	ANT High cm	Turn Table deg
1	43.65	28.99	40.00	-11.01	37.91	-8.92	Peak	---	---
2	71.71	25.74	40.00	-14.26	36.72	-10.98	Peak	---	---
3	113.33	26.59	43.50	-16.91	38.40	-11.81	Peak	---	---
4	194.83	24.19	43.50	-19.31	36.03	-11.84	Peak	---	---
5	376.29	28.15	46.00	-17.85	34.54	-6.39	Peak	---	---
6	442.31	39.42	46.00	-6.58	43.83	-4.41	Peak	---	---

Note 1: Emission Level (dBuV/m) = SA Reading (dBuV/m) + Factor* (dB)

*Factor includes antenna factor , cable loss and amplifier gain

Note 2: Margin (dB) = Emission level (dBuV/m) – Limit (dBuV/m).

Note 3: All spurious emissions below 30MHz are more than 20 dB below the limit.

Modulation	VHT40	Test Freq. (MHz)	5785
Polarization	Vertical		

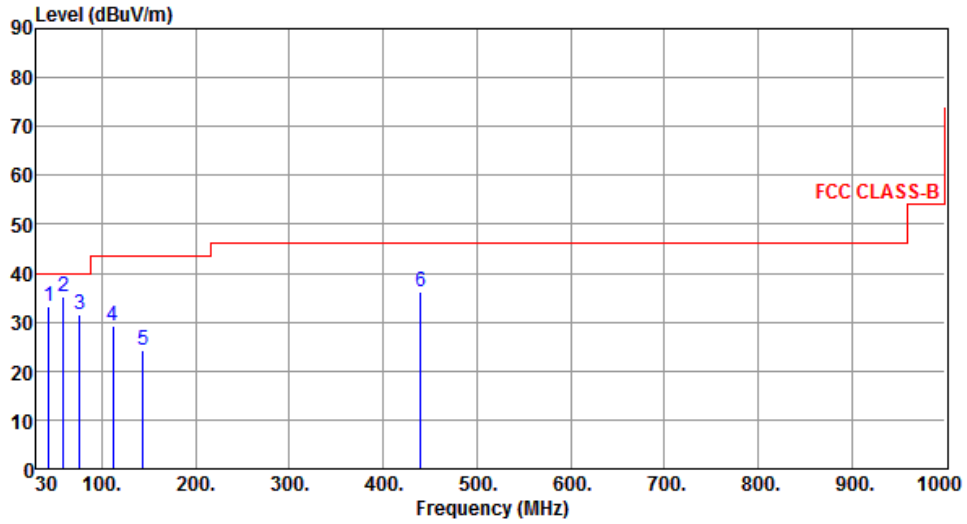

	Freq. MHz	Emission level dBuV/m	Limit dBuV/m	Margin dB	SA reading dBuV	Factor dB	Remark	ANT High cm	Turn Table deg
1	43.49	33.25	40.00	-6.75	42.17	-8.92	Peak	---	---
2	59.21	35.31	40.00	-4.69	44.58	-9.27	Peak	---	---
3	76.49	31.58	40.00	-8.42	44.07	-12.49	Peak	---	---
4	111.52	29.24	43.50	-14.26	41.28	-12.04	Peak	---	---
5	143.51	24.27	43.50	-19.23	33.26	-8.99	Peak	---	---
6	440.22	36.15	46.00	-9.85	40.62	-4.47	Peak	---	---

Note 1: Emission Level (dBuV/m) = SA Reading (dBuV/m) + Factor* (dB)

*Factor includes antenna factor , cable loss and amplifier gain

Note 2: Margin (dB) = Emission level (dBuV/m) – Limit (dBuV/m).

Note 3: All spurious emissions below 30MHz are more than 20 dB below the limit.

3.5.10 Transmitter Radiated Unwanted Emissions (Above 1GHz) for VHT20

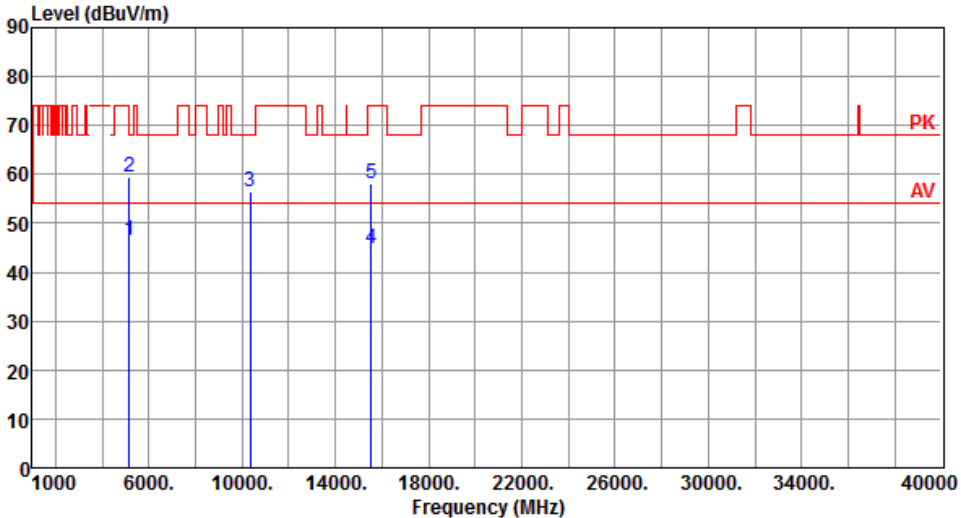
Modulation	VHT20	Test Freq. (MHz)	5180																																																																									
Polarization	Horizontal																																																																											
																																																																												
	<table border="1"> <thead> <tr> <th>Freq.</th> <th>Emission level</th> <th>Limit</th> <th>Margin</th> <th>SA reading</th> <th>Factor</th> <th>Remark</th> <th>ANT High</th> <th>Turn Table</th> </tr> <tr> <th>MHz</th> <th>dBuV/m</th> <th>dBuV/m</th> <th>dB</th> <th>dBuV</th> <th>dB</th> <th></th> <th>cm</th> <th>deg</th> </tr> </thead> <tbody> <tr> <td>1</td> <td>5150.00</td> <td>46.51</td> <td>54.00</td> <td>-7.49</td> <td>40.56</td> <td>5.95</td> <td>Average</td> <td>100</td> <td>120</td> </tr> <tr> <td>2</td> <td>5150.00</td> <td>59.54</td> <td>74.00</td> <td>-14.46</td> <td>53.59</td> <td>5.95</td> <td>Peak</td> <td>100</td> <td>120</td> </tr> <tr> <td>3</td> <td>10360.00</td> <td>56.39</td> <td>68.20</td> <td>-11.81</td> <td>41.29</td> <td>15.10</td> <td>Peak</td> <td>100</td> <td>100</td> </tr> <tr> <td>4</td> <td>15540.00</td> <td>44.78</td> <td>54.00</td> <td>-9.22</td> <td>29.13</td> <td>15.65</td> <td>Average</td> <td>100</td> <td>20</td> </tr> <tr> <td>5</td> <td>15540.00</td> <td>58.00</td> <td>74.00</td> <td>-16.00</td> <td>42.35</td> <td>15.65</td> <td>Peak</td> <td>100</td> <td>20</td> </tr> </tbody> </table>	Freq.	Emission level	Limit	Margin	SA reading	Factor	Remark	ANT High	Turn Table	MHz	dBuV/m	dBuV/m	dB	dBuV	dB		cm	deg	1	5150.00	46.51	54.00	-7.49	40.56	5.95	Average	100	120	2	5150.00	59.54	74.00	-14.46	53.59	5.95	Peak	100	120	3	10360.00	56.39	68.20	-11.81	41.29	15.10	Peak	100	100	4	15540.00	44.78	54.00	-9.22	29.13	15.65	Average	100	20	5	15540.00	58.00	74.00	-16.00	42.35	15.65	Peak	100	20							
Freq.	Emission level	Limit	Margin	SA reading	Factor	Remark	ANT High	Turn Table																																																																				
MHz	dBuV/m	dBuV/m	dB	dBuV	dB		cm	deg																																																																				
1	5150.00	46.51	54.00	-7.49	40.56	5.95	Average	100	120																																																																			
2	5150.00	59.54	74.00	-14.46	53.59	5.95	Peak	100	120																																																																			
3	10360.00	56.39	68.20	-11.81	41.29	15.10	Peak	100	100																																																																			
4	15540.00	44.78	54.00	-9.22	29.13	15.65	Average	100	20																																																																			
5	15540.00	58.00	74.00	-16.00	42.35	15.65	Peak	100	20																																																																			
<p>Note 1: Emission Level (dBuV/m) = SA Reading (dBuV/m) + Factor* (dB) *Factor includes antenna factor , cable loss and amplifier gain Note 2: Margin (dB) = Emission level (dBuV/m) – Limit (dBuV/m).</p>																																																																												

Modulation	VHT20	Test Freq. (MHz)	5180
Polarization	Vertical		

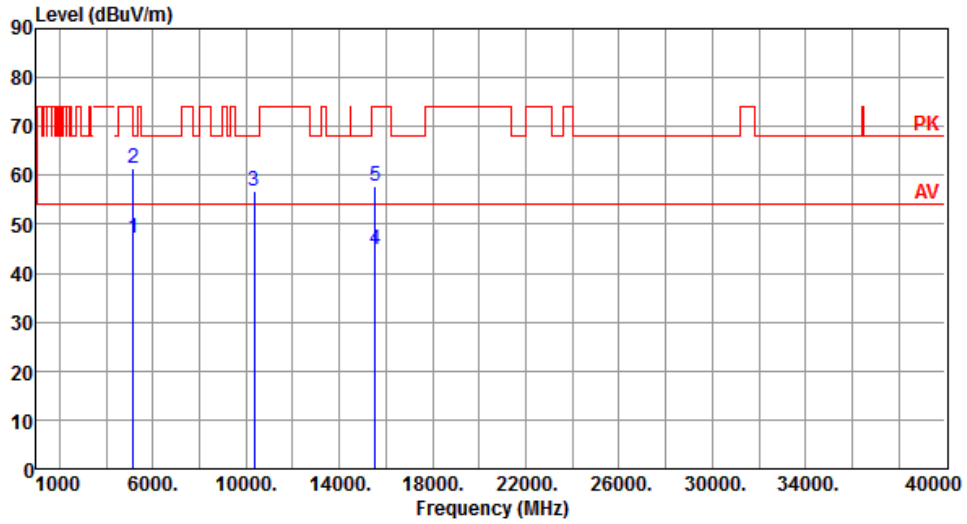

	Freq. MHz	Emission level dBuV/m	Limit dBuV/m	Margin dB	SA reading dBuV	Factor dB	Remark	ANT High cm	Turn Table deg
1	5150.00	47.05	54.00	-6.95	41.10	5.95	Average	100	86
2	5150.00	61.60	74.00	-12.40	55.65	5.95	Peak	100	86
3	10360.00	56.66	68.20	-11.54	41.56	15.10	Peak	100	60
4	15540.00	44.77	54.00	-9.23	29.12	15.65	Average	100	90
5	15540.00	57.90	74.00	-16.10	42.25	15.65	Peak	100	90

Note 1: Emission Level (dBuV/m) = SA Reading (dBuV/m) + Factor* (dB)

*Factor includes antenna factor , cable loss and amplifier gain

Note 2: Margin (dB) = Emission level (dBuV/m) – Limit (dBuV/m).

Modulation	VHT20	Test Freq. (MHz)	5200
Polarization	Horizontal		

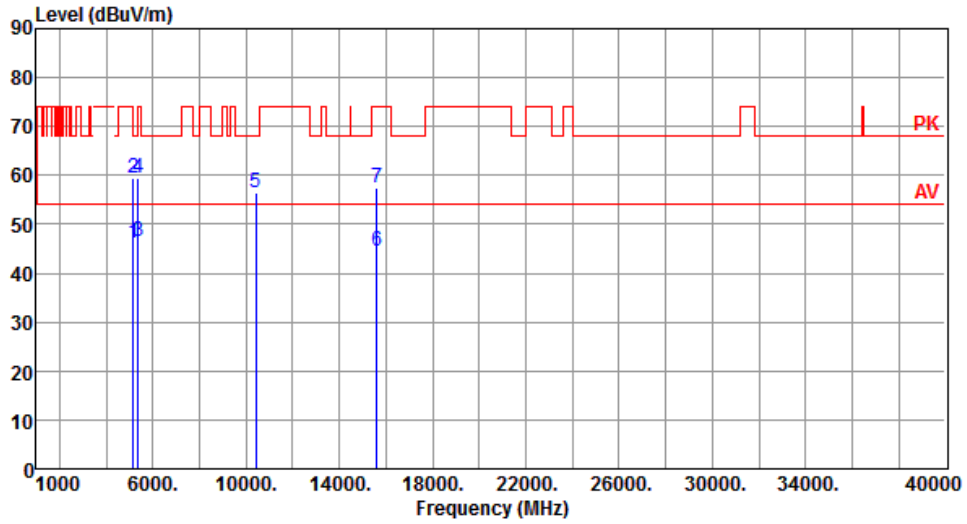

	Freq. MHz	Emission level dBuV/m	Limit dBuV/m	Margin dB	SA reading dBuV	Factor dB	Remark	ANT High cm	Turn Table deg
1	5150.00	46.21	54.00	-7.79	40.26	5.95	Average	100	119
2	5150.00	59.40	74.00	-14.60	53.45	5.95	Peak	100	119
3	5360.00	46.57	54.00	-7.43	41.12	5.45	Average	100	119
4	5360.00	59.57	74.00	-14.43	54.12	5.45	Peak	100	119
5	10400.00	56.59	68.20	-11.61	41.26	15.33	Peak	100	30
6	15600.00	44.63	54.00	-9.37	29.14	15.49	Average	100	25
7	15600.00	57.61	74.00	-16.39	42.12	15.49	Peak	100	25

Note 1: Emission Level (dBuV/m) = SA Reading (dBuV/m) + Factor* (dB)

*Factor includes antenna factor , cable loss and amplifier gain

Note 2: Margin (dB) = Emission level (dBuV/m) – Limit (dBuV/m).

Modulation	VHT20	Test Freq. (MHz)	5200
Polarization	Vertical		

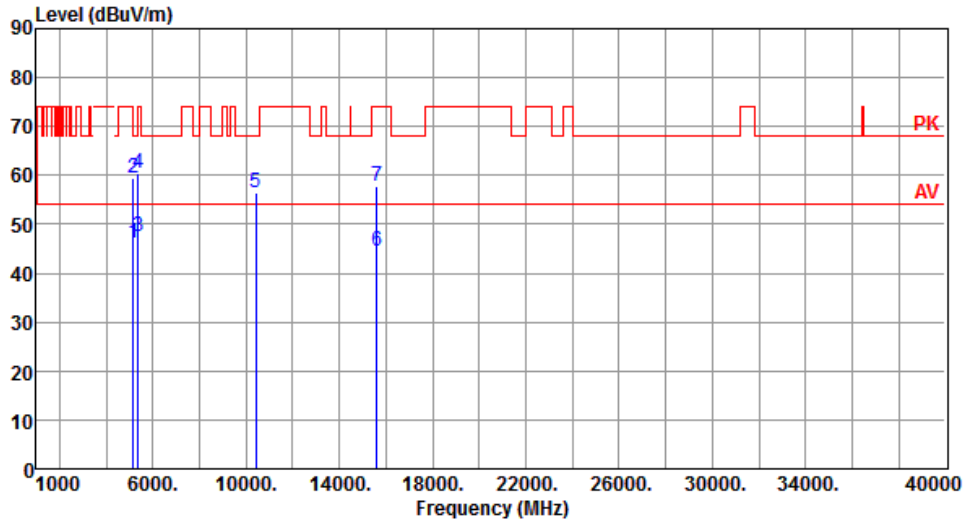

	Freq. MHz	Emission level dBuV/m	Limit dBuV/m	Margin dB	SA reading dBuV	Factor dB	Remark	ANT High cm	Turn Table deg
1	5150.00	46.21	54.00	-7.79	40.26	5.95	Average	100	88
2	5150.00	59.53	74.00	-14.47	53.58	5.95	Peak	100	88
3	5360.00	47.58	54.00	-6.42	42.13	5.45	Average	100	88
4	5360.00	60.57	74.00	-13.43	55.12	5.45	Peak	100	88
5	10400.00	56.56	68.20	-11.64	41.23	15.33	Peak	100	50
6	15600.00	44.65	54.00	-9.35	29.16	15.49	Average	100	70
7	15600.00	57.75	74.00	-16.25	42.26	15.49	Peak	100	70

Note 1: Emission Level (dBuV/m) = SA Reading (dBuV/m) + Factor* (dB)

*Factor includes antenna factor , cable loss and amplifier gain

Note 2: Margin (dB) = Emission level (dBuV/m) – Limit (dBuV/m).

Modulation	VHT20	Test Freq. (MHz)	5240
Polarization	Horizontal		

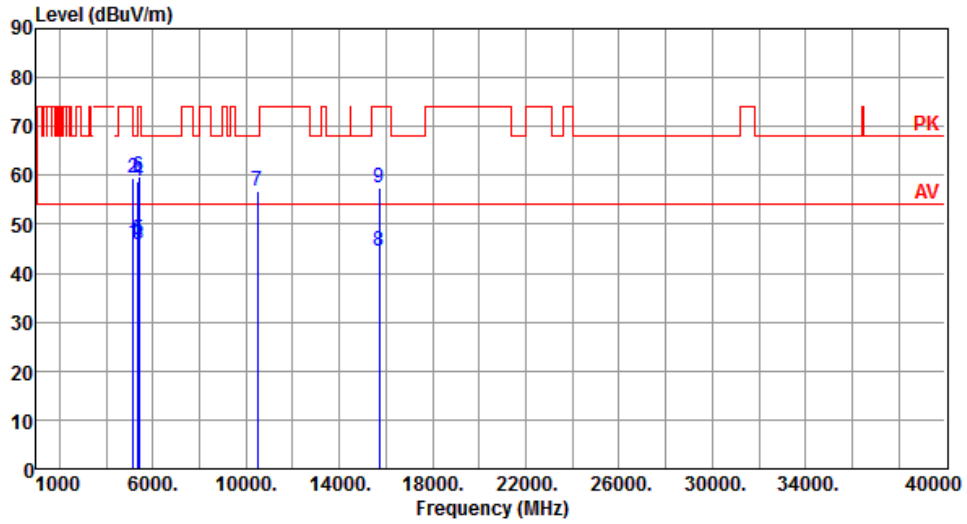

	Freq. MHz	Emission level dBuV/m	Limit dBuV/m	Margin dB	SA reading dBuV	Factor dB	Remark	ANT High cm	Turn Table deg
1	5150.00	46.21	54.00	-7.79	40.26	5.95	Average	100	118
2	5150.00	59.50	74.00	-14.50	53.55	5.95	Peak	100	118
3	5350.00	45.67	54.00	-8.33	40.27	5.40	Average	100	118
4	5350.00	58.85	74.00	-15.15	53.45	5.40	Peak	100	118
5	5400.00	46.95	54.00	-7.05	41.31	5.64	Average	100	118
6	5400.00	59.93	74.00	-14.07	54.29	5.64	Peak	100	118
7	10480.00	56.84	68.20	-11.36	41.53	15.31	Peak	100	90
8	15720.00	44.47	54.00	-9.53	29.24	15.23	Average	100	70
9	15720.00	57.47	74.00	-16.53	42.24	15.23	Peak	100	70

Note 1: Emission Level (dBuV/m) = SA Reading (dBuV/m) + Factor* (dB)

*Factor includes antenna factor , cable loss and amplifier gain

Note 2: Margin (dB) = Emission level (dBuV/m) – Limit (dBuV/m).

Modulation	VHT20	Test Freq. (MHz)	5240
Polarization	Vertical		

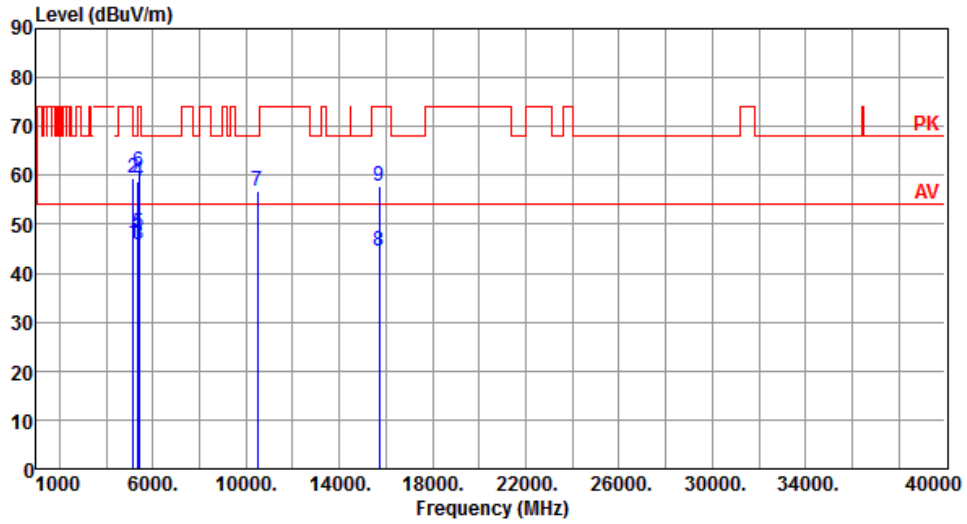

	Freq. MHz	Emission level dBuV/m	Limit dBuV/m	Margin dB	SA reading dBuV	Factor dB	Remark	ANT High cm	Turn Table deg
1	5150.00	46.19	54.00	-7.81	40.24	5.95	Average	100	86
2	5150.00	59.42	74.00	-14.58	53.47	5.95	Peak	100	86
3	5350.00	45.79	54.00	-8.21	40.39	5.40	Average	100	86
4	5350.00	58.86	74.00	-15.14	53.46	5.40	Peak	100	86
5	5400.00	48.03	54.00	-5.97	42.39	5.64	Average	100	86
6	5400.00	60.90	74.00	-13.10	55.26	5.64	Peak	100	86
7	10480.00	56.87	68.20	-11.33	41.56	15.31	Peak	100	50
8	15720.00	44.51	54.00	-9.49	29.28	15.23	Average	100	30
9	15720.00	57.69	74.00	-16.31	42.46	15.23	Peak	100	30

Note 1: Emission Level (dBuV/m) = SA Reading (dBuV/m) + Factor* (dB)

*Factor includes antenna factor , cable loss and amplifier gain

Note 2: Margin (dB) = Emission level (dBuV/m) – Limit (dBuV/m).

Modulation	VHT20	Test Freq. (MHz)	5260
Polarization	Horizontal		

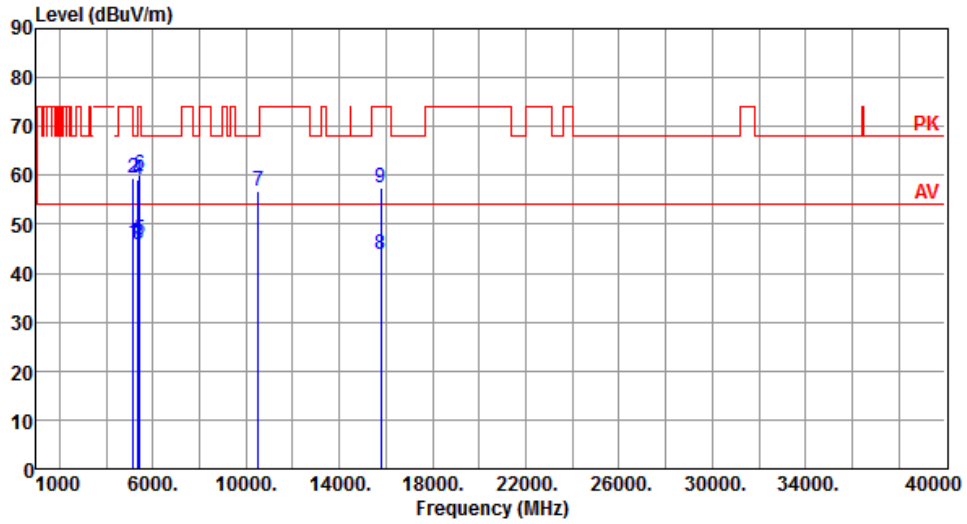

	Freq. MHz	Emission level dBuV/m	Limit dBuV/m	Margin dB	SA reading dBuV	Factor dB	Remark	ANT High cm	Turn Table deg
1	5150.00	46.32	54.00	-7.68	40.37	5.95	Average	100	117
2	5150.00	59.37	74.00	-14.63	53.42	5.95	Peak	100	117
3	5350.00	45.68	54.00	-8.32	40.28	5.40	Average	100	117
4	5350.00	59.09	74.00	-14.91	53.69	5.40	Peak	100	117
5	5420.00	46.96	54.00	-7.04	41.23	5.73	Average	100	117
6	5420.00	60.01	74.00	-13.99	54.28	5.73	Peak	100	117
7	10520.00	56.68	68.20	-11.52	41.35	15.33	Peak	100	80
8	15780.00	44.00	54.00	-10.00	29.05	14.95	Average	100	60
9	15780.00	57.31	74.00	-16.69	42.36	14.95	Peak	100	60

Note 1: Emission Level (dBuV/m) = SA Reading (dBuV/m) + Factor* (dB)

*Factor includes antenna factor , cable loss and amplifier gain

Note 2: Margin (dB) = Emission level (dBuV/m) – Limit (dBuV/m).

Modulation	VHT20	Test Freq. (MHz)	5260
Polarization	Vertical		

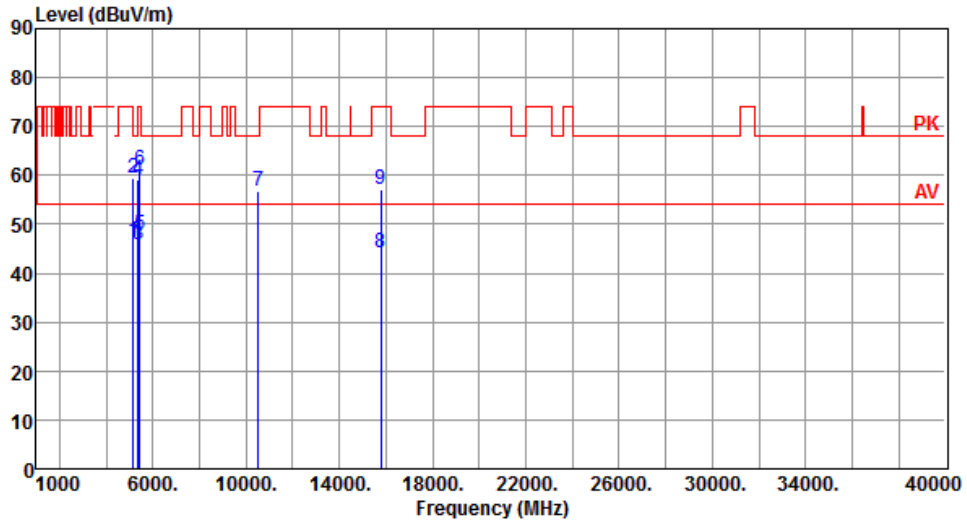

	Freq. MHz	Emission level dBuV/m	Limit dBuV/m	Margin dB	SA reading dBuV	Factor dB	Remark	ANT High cm	Turn Table deg
1	5150.00	46.33	54.00	-7.67	40.38	5.95	Average	100	87
2	5150.00	59.42	74.00	-14.58	53.47	5.95	Peak	100	87
3	5350.00	45.82	54.00	-8.18	40.42	5.40	Average	100	87
4	5350.00	59.09	74.00	-14.91	53.69	5.40	Peak	100	87
5	5420.00	47.85	54.00	-6.15	42.12	5.73	Average	100	87
6	5420.00	61.02	74.00	-12.98	55.29	5.73	Peak	100	87
7	10520.00	56.69	68.20	-11.51	41.36	15.33	Peak	100	30
8	15780.00	44.10	54.00	-9.90	29.15	14.95	Average	100	60
9	15780.00	57.22	74.00	-16.78	42.27	14.95	Peak	100	60

Note 1: Emission Level (dBuV/m) = SA Reading (dBuV/m) + Factor* (dB)

*Factor includes antenna factor , cable loss and amplifier gain

Note 2: Margin (dB) = Emission level (dBuV/m) – Limit (dBuV/m).

Modulation	VHT20	Test Freq. (MHz)	5300
Polarization	Horizontal		

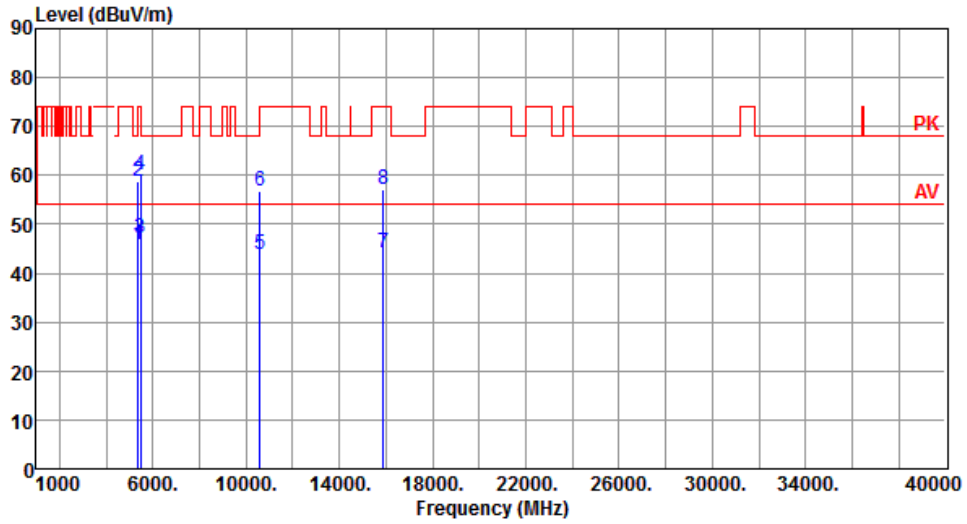

	Freq. MHz	Emission level dBuV/m	Limit dBuV/m	Margin dB	SA reading dBuV	Factor dB	Remark	ANT High cm	Turn Table deg
1	5350.00	45.68	54.00	-8.32	40.28	5.40	Average	100	116
2	5350.00	58.82	74.00	-15.18	53.42	5.40	Peak	100	116
3	5460.00	47.14	54.00	-6.86	41.22	5.92	Average	100	116
4	5460.00	60.07	74.00	-13.93	54.15	5.92	Peak	100	116
5	10600.00	43.69	54.00	-10.31	28.28	15.41	Average	100	20
6	10600.00	56.66	74.00	-17.34	41.25	15.41	Peak	100	20
7	15900.00	44.07	54.00	-9.93	29.18	14.89	Average	100	35
8	15900.00	57.12	74.00	-16.88	42.23	14.89	Peak	100	35

Note 1: Emission Level (dBuV/m) = SA Reading (dBuV/m) + Factor* (dB)

*Factor includes antenna factor , cable loss and amplifier gain

Note 2: Margin (dB) = Emission level (dBuV/m) – Limit (dBuV/m).

Modulation	VHT20	Test Freq. (MHz)	5300
Polarization	Vertical		

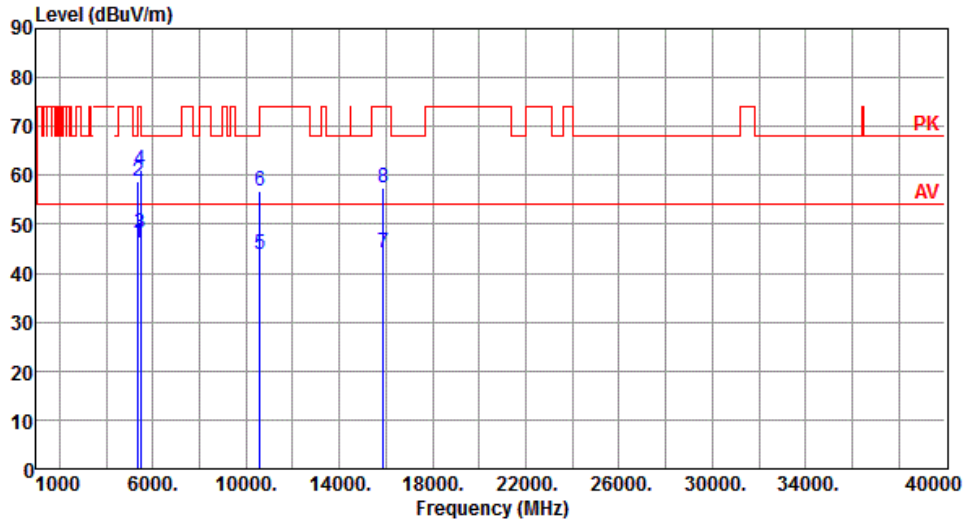

	Freq. MHz	Emission level dBuV/m	Limit dBuV/m	Margin dB	SA reading dBuV	Factor dB	Remark	ANT High cm	Turn Table deg
1	5350.00	46.09	54.00	-7.91	40.69	5.40	Average	100	84
2	5350.00	58.86	74.00	-15.14	53.46	5.40	Peak	100	84
3	5460.00	48.04	54.00	-5.96	42.12	5.92	Average	100	84
4	5460.00	61.07	74.00	-12.93	55.15	5.92	Peak	100	84
5	10600.00	43.74	54.00	-10.26	28.33	15.41	Average	100	50
6	10600.00	56.66	74.00	-17.34	41.25	15.41	Peak	100	50
7	15900.00	44.02	54.00	-9.98	29.13	14.89	Average	100	70
8	15900.00	57.38	74.00	-16.62	42.49	14.89	Peak	100	70

Note 1: Emission Level (dBuV/m) = SA Reading (dBuV/m) + Factor* (dB)

*Factor includes antenna factor , cable loss and amplifier gain

Note 2: Margin (dB) = Emission level (dBuV/m) – Limit (dBuV/m).

Modulation	VHT20	Test Freq. (MHz)	5320
Polarization	Horizontal		

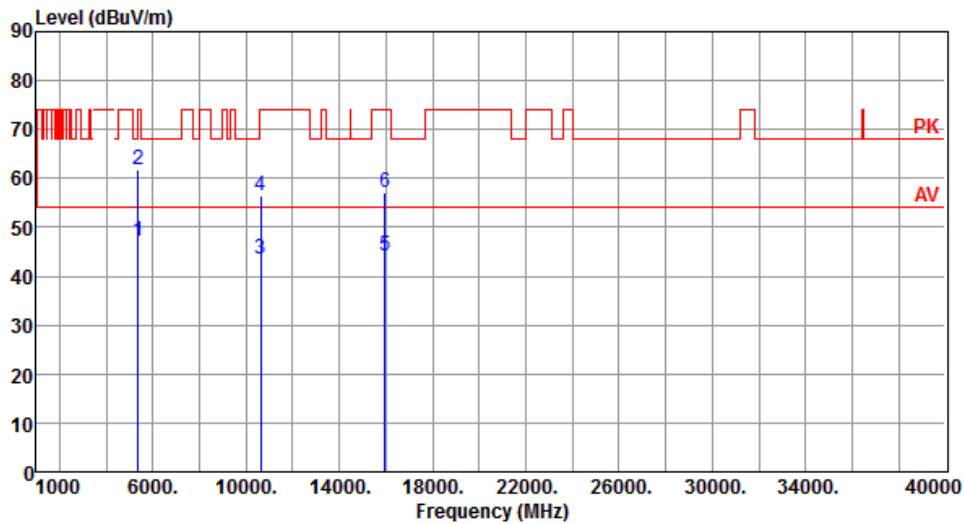

	Freq. MHz	Emission level dBuV/m	Limit dBuV/m	Margin dB	SA reading dBuV	Factor dB	Remark	ANT High cm	Turn Table deg
1	5350.00	47.05	54.00	-6.95	41.65	5.40	Average	100	121
2	5350.00	61.67	74.00	-12.33	56.27	5.40	Peak	100	121
3	10640.00	43.58	54.00	-10.42	28.22	15.36	Average	100	70
4	10640.00	56.60	74.00	-17.40	41.24	15.36	Peak	100	70
5	15960.00	44.02	54.00	-9.98	29.11	14.91	Average	100	30
6	15960.00	57.22	74.00	-16.78	42.31	14.91	Peak	100	30

Note 1: Emission Level (dBuV/m) = SA Reading (dBuV/m) + Factor* (dB)

*Factor includes antenna factor , cable loss and amplifier gain

Note 2: Margin (dB) = Emission level (dBuV/m) – Limit (dBuV/m).

Modulation	VHT20	Test Freq. (MHz)	5320
Polarization	Vertical		

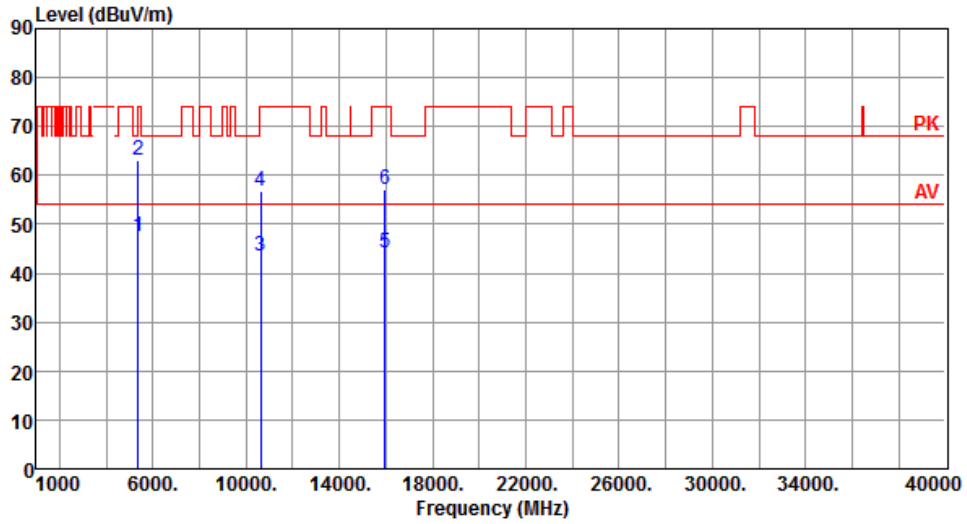

	Freq. MHz	Emission level dBuV/m	Limit dBuV/m	Margin dB	SA reading dBuV	Factor dB	Remark	ANT High cm	Turn Table deg
1	5350.00	47.65	54.00	-6.35	42.25	5.40	Average	100	88
2	5350.00	63.09	74.00	-10.91	57.69	5.40	Peak	100	88
3	10640.00	43.63	54.00	-10.37	28.27	15.36	Average	100	60
4	10640.00	56.74	74.00	-17.26	41.38	15.36	Peak	100	60
5	15960.00	44.08	54.00	-9.92	29.17	14.91	Average	100	200
6	15960.00	57.27	74.00	-16.73	42.36	14.91	Peak	100	200

Note 1: Emission Level (dBuV/m) = SA Reading (dBuV/m) + Factor* (dB)

*Factor includes antenna factor , cable loss and amplifier gain

Note 2: Margin (dB) = Emission level (dBuV/m) – Limit (dBuV/m).

Modulation	VHT20	Test Freq. (MHz)	5500
Polarization	Horizontal		

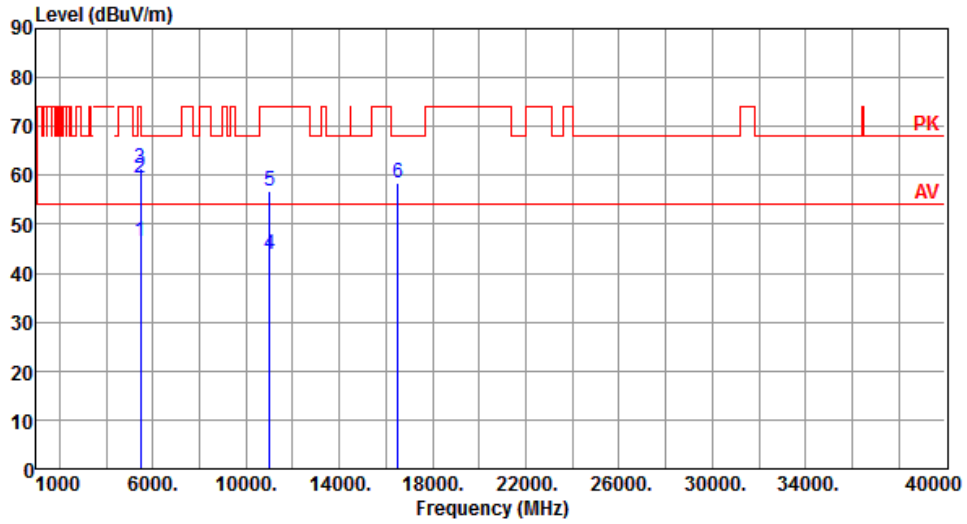

	Freq. MHz	Emission level dBuV/m	Limit dBuV/m	Margin dB	SA reading dBuV	Factor dB	Remark	ANT High cm	Turn Table deg
1	5460.00	46.47	54.00	-7.53	40.55	5.92	Average	315	107
2	5460.00	59.53	74.00	-14.47	53.61	5.92	Peak	315	107
3	5470.00	61.37	68.20	-6.83	55.41	5.96	Peak	315	107
4	11000.00	43.92	54.00	-10.08	28.34	15.58	Average	100	90
5	11000.00	56.86	74.00	-17.14	41.28	15.58	Peak	100	90
6	16500.00	58.29	68.20	-9.91	42.46	15.83	Peak	100	55

Note 1: Emission Level (dBuV/m) = SA Reading (dBuV/m) + Factor* (dB)

*Factor includes antenna factor , cable loss and amplifier gain

Note 2: Margin (dB) = Emission level (dBuV/m) – Limit (dBuV/m).

Modulation	VHT20	Test Freq. (MHz)	5500
Polarization	Vertical		

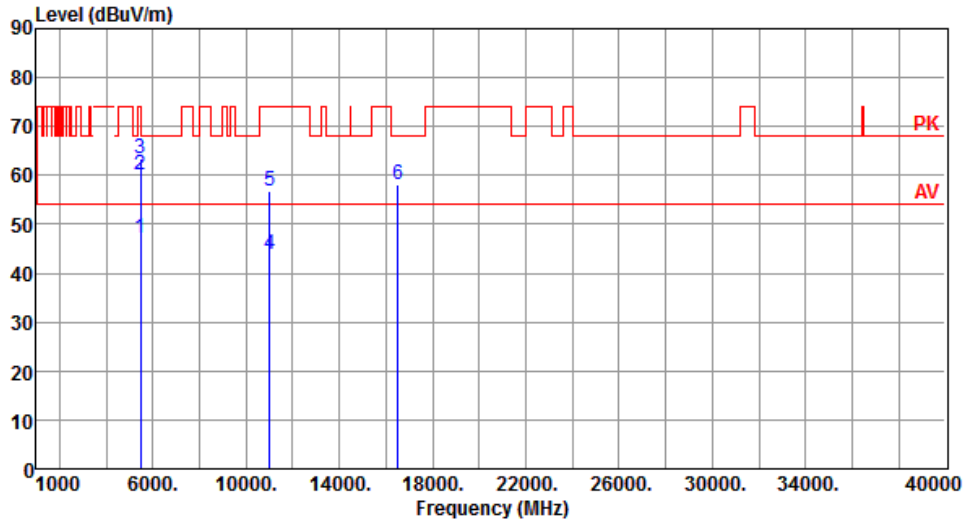

	Freq. MHz	Emission level dBuV/m	Limit dBuV/m	Margin dB	SA reading dBuV	Factor dB	Remark	ANT High cm	Turn Table deg
1	5460.00	47.14	54.00	-6.86	41.22	5.92	Average	100	117
2	5460.00	60.07	74.00	-13.93	54.15	5.92	Peak	100	117
3	5470.00	63.27	68.20	-4.93	57.31	5.96	Peak	100	117
4	11000.00	43.90	54.00	-10.10	28.32	15.58	Average	100	20
5	11000.00	56.84	74.00	-17.16	41.26	15.58	Peak	100	20
6	16500.00	58.16	68.20	-10.04	42.33	15.83	Peak	100	50

Note 1: Emission Level (dBuV/m) = SA Reading (dBuV/m) + Factor* (dB)

*Factor includes antenna factor , cable loss and amplifier gain

Note 2: Margin (dB) = Emission level (dBuV/m) – Limit (dBuV/m).

Modulation	VHT20	Test Freq. (MHz)	5580
Polarization	Horizontal		

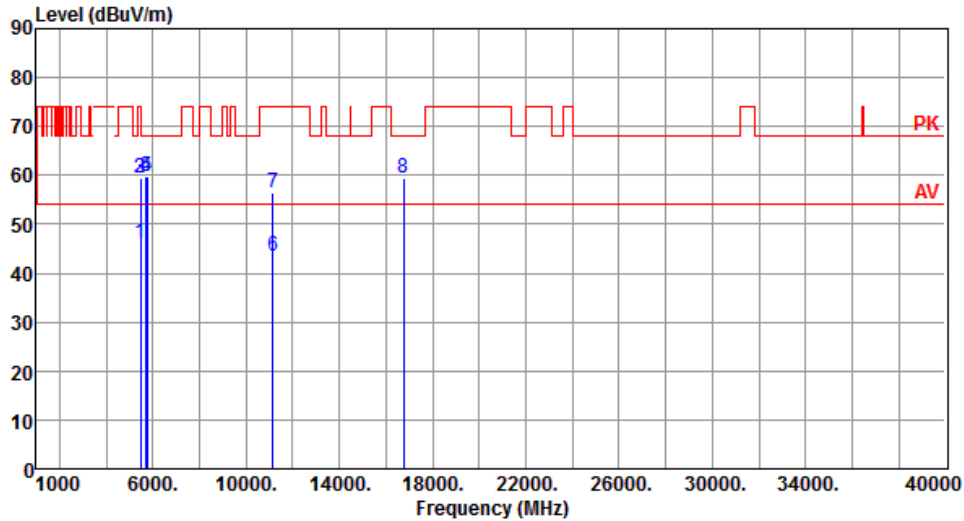

	Freq. MHz	Emission level dBuV/m	Limit dBuV/m	Margin dB	SA reading dBuV	Factor dB	Remark	ANT High cm	Turn Table deg
1	5460.00	46.19	54.00	-7.81	40.27	5.92	Average	320	107
2	5460.00	59.38	74.00	-14.62	53.46	5.92	Peak	320	107
3	5470.00	59.37	68.20	-8.83	53.41	5.96	Peak	320	107
4	5725.00	59.85	68.20	-8.35	53.56	6.29	Peak	320	107
5	5740.00	59.88	68.20	-8.32	53.56	6.32	Peak	320	107
6	11160.00	43.58	54.00	-10.42	28.32	15.26	Average	100	100
7	11160.00	56.48	74.00	-17.52	41.22	15.26	Peak	100	100
8	16740.00	59.42	68.20	-8.78	42.57	16.85	Peak	100	50

Note 1: Emission Level (dBuV/m) = SA Reading (dBuV/m) + Factor* (dB)

*Factor includes antenna factor , cable loss and amplifier gain

Note 2: Margin (dB) = Emission level (dBuV/m) – Limit (dBuV/m).

Modulation	VHT20	Test Freq. (MHz)	5580
Polarization	Vertical		

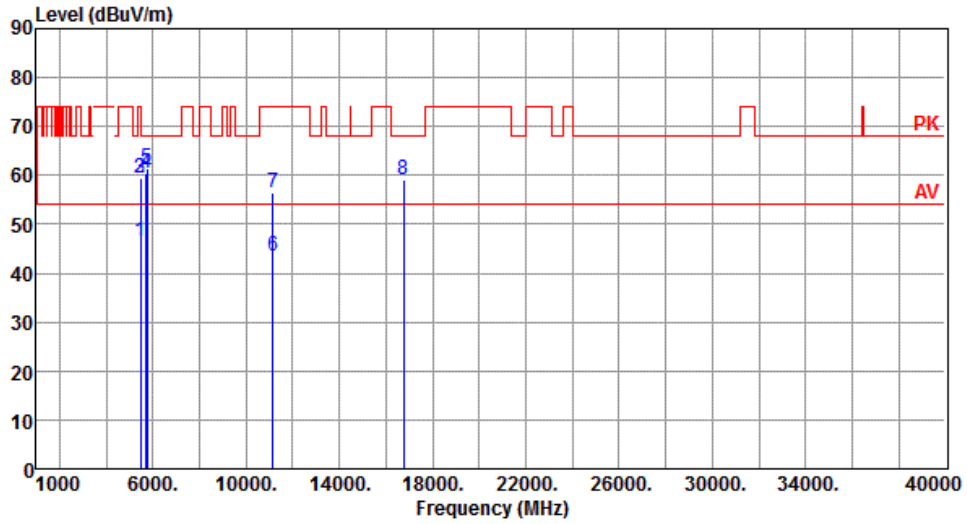

	Freq. MHz	Emission level dBuV/m	Limit dBuV/m	Margin dB	SA reading dBuV	Factor dB	Remark	ANT High cm	Turn Table deg
1	5460.00	46.49	54.00	-7.51	40.57	5.92	Average	100	111
2	5460.00	59.47	74.00	-14.53	53.55	5.92	Peak	100	111
3	5470.00	59.51	68.20	-8.69	53.55	5.96	Peak	100	111
4	5725.00	60.32	68.20	-7.88	54.03	6.29	Peak	100	111
5	5740.00	61.53	68.20	-6.67	55.21	6.32	Peak	100	111
6	11160.00	43.60	54.00	-10.40	28.34	15.26	Average	100	25
7	11160.00	56.52	74.00	-17.48	41.26	15.26	Peak	100	25
8	16740.00	59.12	68.20	-9.08	42.27	16.85	Peak	100	60

Note 1: Emission Level (dBuV/m) = SA Reading (dBuV/m) + Factor* (dB)

*Factor includes antenna factor , cable loss and amplifier gain

Note 2: Margin (dB) = Emission level (dBuV/m) – Limit (dBuV/m).

Modulation	VHT20	Test Freq. (MHz)	5700
Polarization	Horizontal		

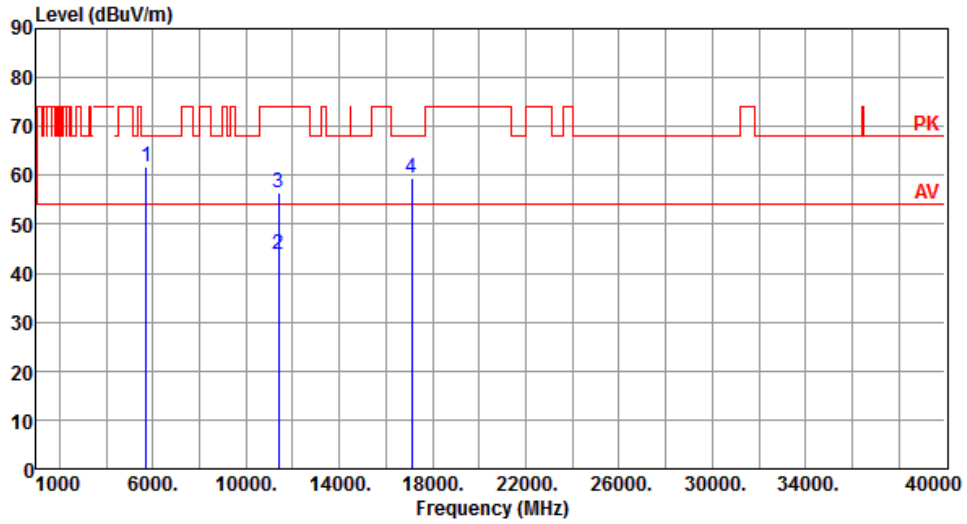

	Freq. MHz	Emission level dBuV/m	Limit dBuV/m	Margin dB	SA reading dBuV	Factor dB	Remark	ANT High cm	Turn Table deg
1	5725.00	61.68	68.20	-6.52	55.39	6.29	Peak	315	104
2	11400.00	43.75	54.00	-10.25	28.42	15.33	Average	100	30
3	11400.00	56.54	74.00	-17.46	41.21	15.33	Peak	100	30
4	17100.00	59.40	68.20	-8.80	42.51	16.89	Peak	100	90

Note 1: Emission Level (dBuV/m) = SA Reading (dBuV/m) + Factor* (dB)

*Factor includes antenna factor , cable loss and amplifier gain

Note 2: Margin (dB) = Emission level (dBuV/m) – Limit (dBuV/m).

Modulation	VHT20	Test Freq. (MHz)	5700
Polarization	Vertical		

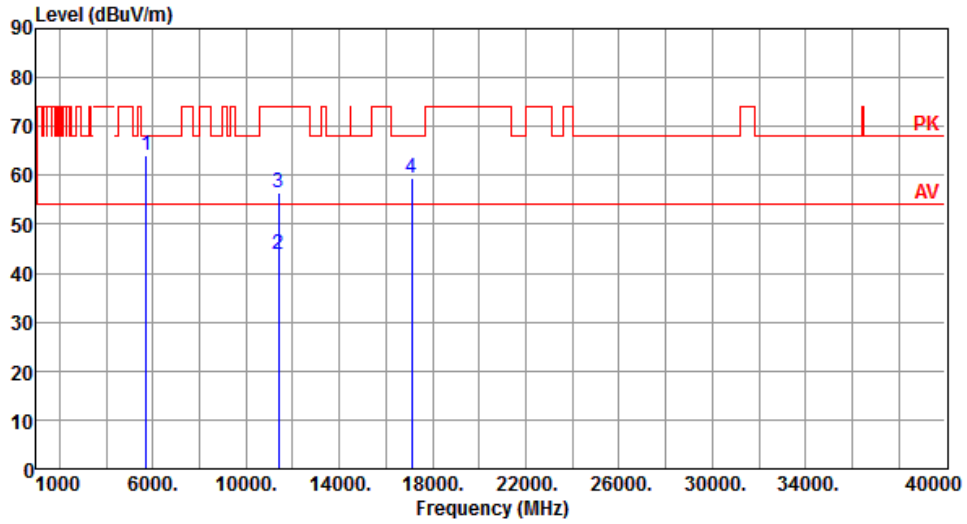

	Freq. MHz	Emission level dBuV/m	Limit dBuV/m	Margin dB	SA reading dBuV	Factor dB	Remark	ANT High cm	Turn Table deg
1	5725.00	63.98	68.20	-4.22	57.69	6.29	Peak	100	115
2	11400.00	43.88	54.00	-10.12	28.55	15.33	Average	100	30
3	11400.00	56.59	74.00	-17.41	41.26	15.33	Peak	100	30
4	17100.00	59.42	68.20	-8.78	42.53	16.89	Peak	100	50

Note 1: Emission Level (dBuV/m) = SA Reading (dBuV/m) + Factor* (dB)

*Factor includes antenna factor , cable loss and amplifier gain

Note 2: Margin (dB) = Emission level (dBuV/m) – Limit (dBuV/m).

Modulation	VHT20	Test Freq. (MHz)	5720
Polarization	Horizontal		

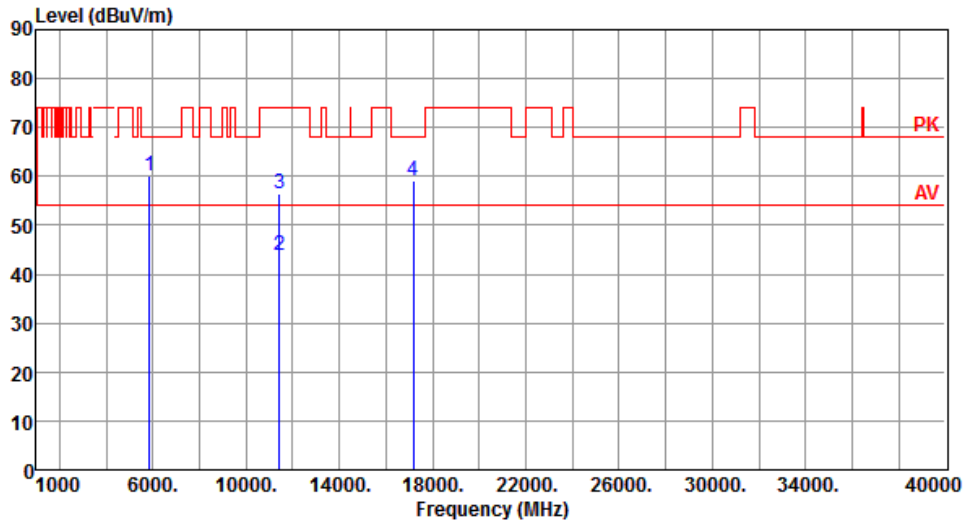

	Freq. MHz	Emission level dBuV/m	Limit dBuV/m	Margin dB	SA reading dBuV	Factor dB	Remark	ANT High cm	Turn Table deg
1	5850.00	60.24	68.20	-7.96	53.57	6.67	Peak	316	109
2	11440.00	43.76	54.00	-10.24	28.37	15.39	Average	100	60
3	11440.00	56.62	74.00	-17.38	41.23	15.39	Peak	100	60
4	17160.00	59.19	68.20	-9.01	42.34	16.85	Peak	100	55

Note 1: Emission Level (dBuV/m) = SA Reading (dBuV/m) + Factor* (dB)

*Factor includes antenna factor , cable loss and amplifier gain

Note 2: Margin (dB) = Emission level (dBuV/m) – Limit (dBuV/m).

Modulation	VHT20	Test Freq. (MHz)	5720
Polarization	Vertical		

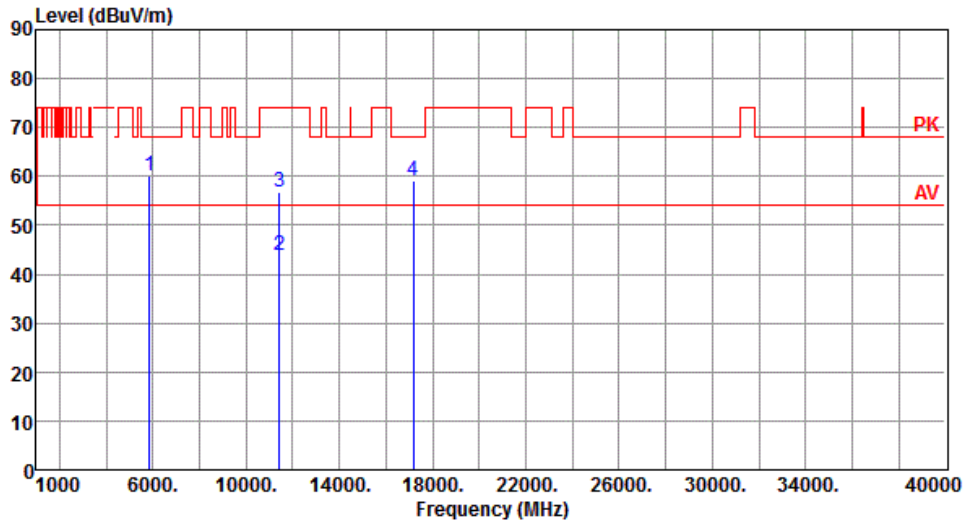

	Freq. MHz	Emission level dBuV/m	Limit dBuV/m	Margin dB	SA reading dBuV	Factor dB	Remark	ANT High cm	Turn Table deg
1	5850.00	60.26	68.20	-7.94	53.59	6.67	Peak	100	117
2	11440.00	43.73	54.00	-10.27	28.34	15.39	Average	100	20
3	11440.00	56.68	74.00	-17.32	41.29	15.39	Peak	100	20
4	17160.00	59.26	68.20	-8.94	42.41	16.85	Peak	100	35

Note 1: Emission Level (dBuV/m) = SA Reading (dBuV/m) + Factor* (dB)

*Factor includes antenna factor , cable loss and amplifier gain

Note 2: Margin (dB) = Emission level (dBuV/m) – Limit (dBuV/m).

Modulation	VHT20	Test Freq. (MHz)	5745
Polarization	Horizontal		

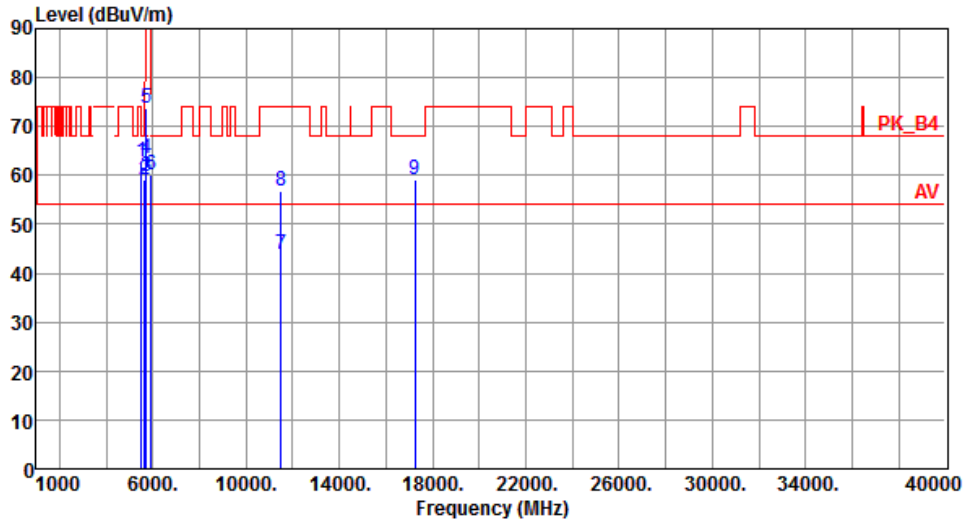

	Freq. MHz	Emission level dBuV/m	Limit dBuV/m	Margin dB	SA reading dBuV	Factor dB	Remark	ANT High cm	Turn Table deg
1	5505.00	62.62	68.20	-5.58	56.53	6.09	Peak	322	105
2	5650.00	59.15	68.20	-9.05	53.24	5.91	Peak	322	105
3	5700.00	59.79	105.20	-45.41	53.56	6.23	Peak	322	105
4	5720.00	63.53	110.80	-47.27	57.25	6.28	Peak	322	105
5	5725.00	73.74	122.20	-48.46	67.45	6.29	Peak	322	105
6	5925.00	60.27	68.20	-7.93	53.45	6.82	Peak	322	105
7	11490.00	43.80	54.00	-10.20	28.35	15.45	Average	100	50
8	11490.00	56.80	74.00	-17.20	41.35	15.45	Peak	100	50
9	17235.00	59.27	68.20	-8.93	42.29	16.98	Peak	100	60

Note 1: Emission Level (dBuV/m) = SA Reading (dBuV/m) + Factor* (dB)

*Factor includes antenna factor , cable loss and amplifier gain

Note 2: Margin (dB) = Emission level (dBuV/m) – Limit (dBuV/m).

Modulation	VHT20	Test Freq. (MHz)	5745
Polarization	Vertical		

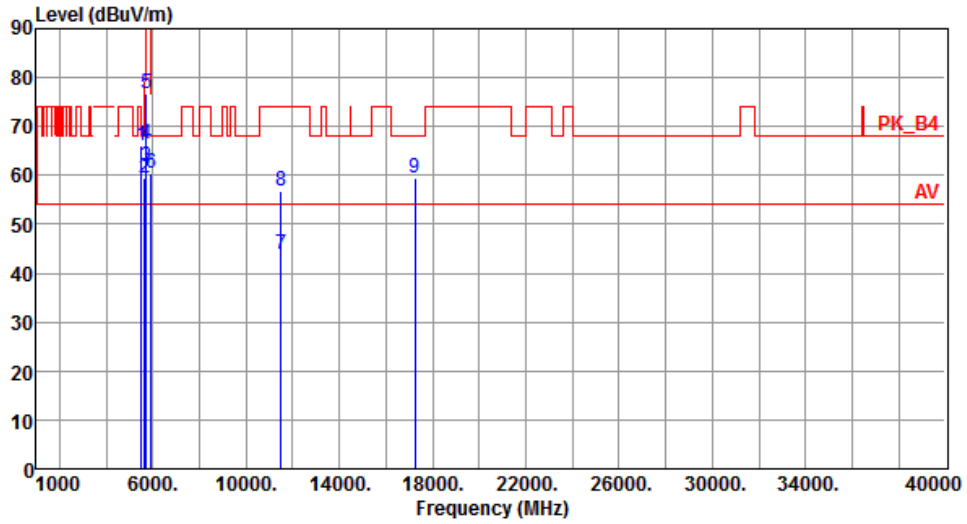

	Freq. MHz	Emission level dBuV/m	Limit dBuV/m	Margin dB	SA reading dBuV	Factor dB	Remark	ANT High cm	Turn Table deg
1	5505.00	65.93	68.20	-2.27	59.84	6.09	Peak	100	116
2	5650.00	59.36	68.20	-8.84	53.45	5.91	Peak	100	116
3	5700.00	61.69	105.20	-43.51	55.46	6.23	Peak	100	116
4	5720.00	66.39	110.80	-44.41	60.11	6.28	Peak	100	116
5	5725.00	76.75	122.20	-45.45	70.46	6.29	Peak	100	116
6	5925.00	60.36	68.20	-7.84	53.54	6.82	Peak	100	116
7	11490.00	43.92	54.00	-10.08	28.47	15.45	Average	100	80
8	11490.00	56.72	74.00	-17.28	41.27	15.45	Peak	100	80
9	17235.00	59.33	68.20	-8.87	42.35	16.98	Peak	100	50

Note 1: Emission Level (dBuV/m) = SA Reading (dBuV/m) + Factor* (dB)

*Factor includes antenna factor , cable loss and amplifier gain

Note 2: Margin (dB) = Emission level (dBuV/m) – Limit (dBuV/m).

Modulation	VHT20	Test Freq. (MHz)	5785
Polarization	Horizontal		

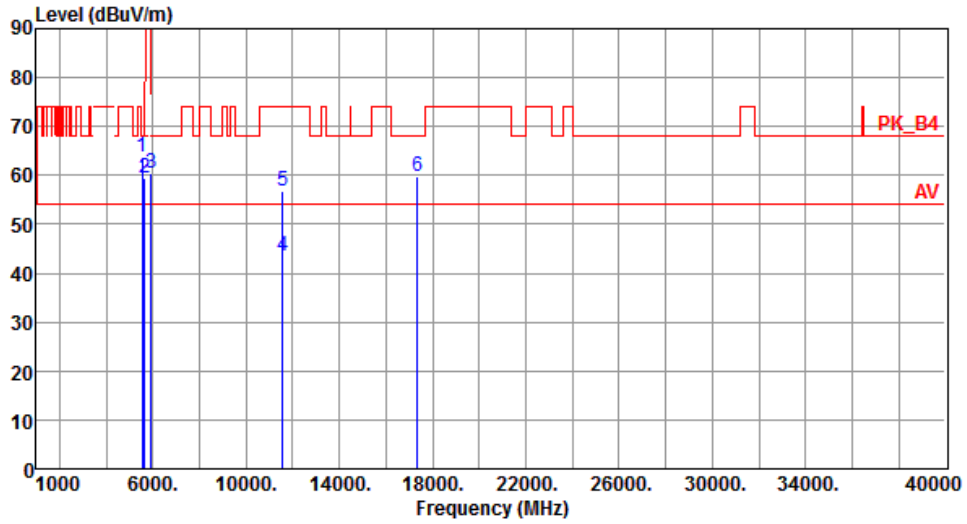

	Freq. MHz	Emission level dBuV/m	Limit dBuV/m	Margin dB	SA reading dBuV	Factor dB	Remark	ANT High cm	Turn Table deg
1	5545.00	63.69	68.20	-4.51	57.68	6.01	Peak	318	105
2	5650.00	59.37	68.20	-8.83	53.46	5.91	Peak	318	105
3	5925.00	60.35	68.20	-7.85	53.53	6.82	Peak	318	105
4	11570.00	43.54	54.00	-10.46	28.24	15.30	Average	100	20
5	11570.00	56.63	74.00	-17.37	41.33	15.30	Peak	100	20
6	17355.00	59.92	68.20	-8.28	42.31	17.61	Peak	100	55

Note 1: Emission Level (dBuV/m) = SA Reading (dBuV/m) + Factor* (dB)

*Factor includes antenna factor , cable loss and amplifier gain

Note 2: Margin (dB) = Emission level (dBuV/m) – Limit (dBuV/m).

Modulation	VHT20	Test Freq. (MHz)	5785
Polarization	Vertical		

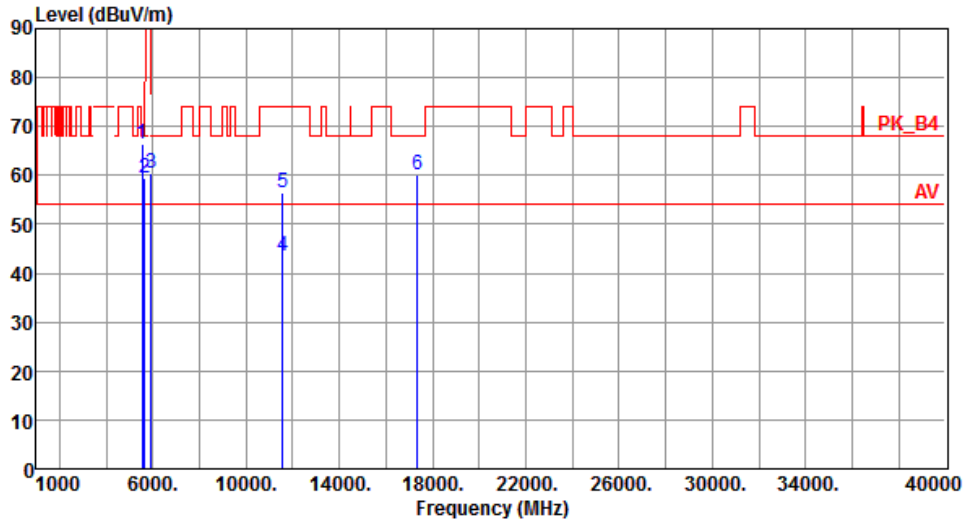

	Freq. MHz	Emission level dBuV/m	Limit dBuV/m	Margin dB	SA reading dBuV	Factor dB	Remark	ANT High cm	Turn Table deg
1	5545.00	66.56	68.20	-1.64	60.55	6.01	Peak	100	115
2	5650.00	59.47	68.20	-8.73	53.56	5.91	Peak	100	115
3	5925.00	60.47	68.20	-7.73	53.65	6.82	Peak	100	115
4	11570.00	43.66	54.00	-10.34	28.36	15.30	Average	100	40
5	11570.00	56.57	74.00	-17.43	41.27	15.30	Peak	100	40
6	17355.00	60.14	68.20	-8.06	42.53	17.61	Peak	100	60

Note 1: Emission Level (dBuV/m) = SA Reading (dBuV/m) + Factor* (dB)

*Factor includes antenna factor , cable loss and amplifier gain

Note 2: Margin (dB) = Emission level (dBuV/m) – Limit (dBuV/m).

Modulation	VHT20	Test Freq. (MHz)	5825
Polarization	Horizontal		

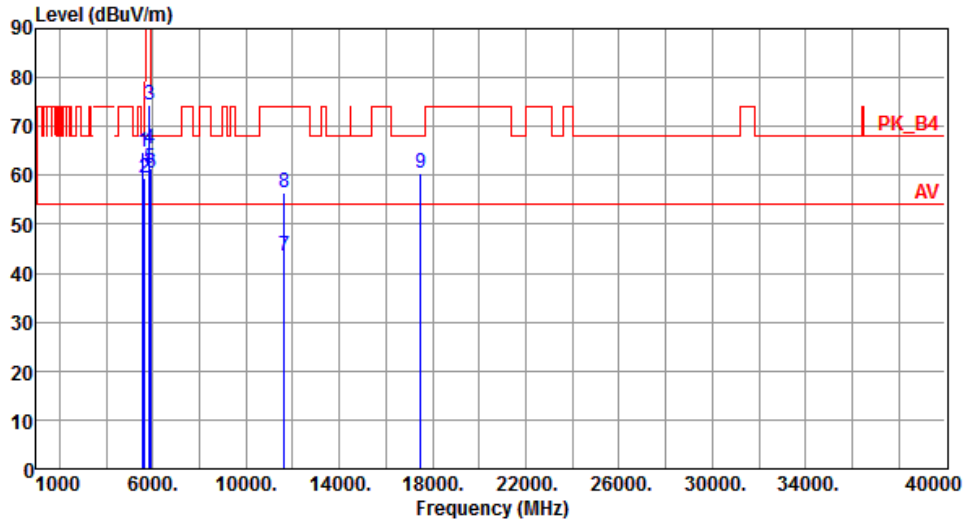

	Freq. MHz	Emission level dBuV/m	Limit dBuV/m	Margin dB	SA reading dBuV	Factor dB	Remark	ANT High cm	Turn Table deg
1	5585.00	64.76	68.20	-3.44	58.77	5.99	Peak	321	102
2	5650.00	59.40	68.20	-8.80	53.49	5.91	Peak	321	102
3	5850.00	74.33	122.20	-47.87	67.66	6.67	Peak	321	102
4	5855.00	65.27	110.80	-45.53	58.59	6.68	Peak	321	102
5	5875.00	61.38	105.20	-43.82	54.66	6.72	Peak	321	102
6	5925.00	60.35	68.20	-7.85	53.53	6.82	Peak	321	102
7	11650.00	43.37	54.00	-10.63	28.31	15.06	Average	100	30
8	11650.00	56.32	74.00	-17.68	41.26	15.06	Peak	100	30
9	17475.00	60.55	68.20	-7.65	42.32	18.23	Peak	100	50

Note 1: Emission Level (dBuV/m) = SA Reading (dBuV/m) + Factor* (dB)

*Factor includes antenna factor , cable loss and amplifier gain

Note 2: Margin (dB) = Emission level (dBuV/m) – Limit (dBuV/m).

Modulation	VHT20	Test Freq. (MHz)	5825
Polarization	Vertical		

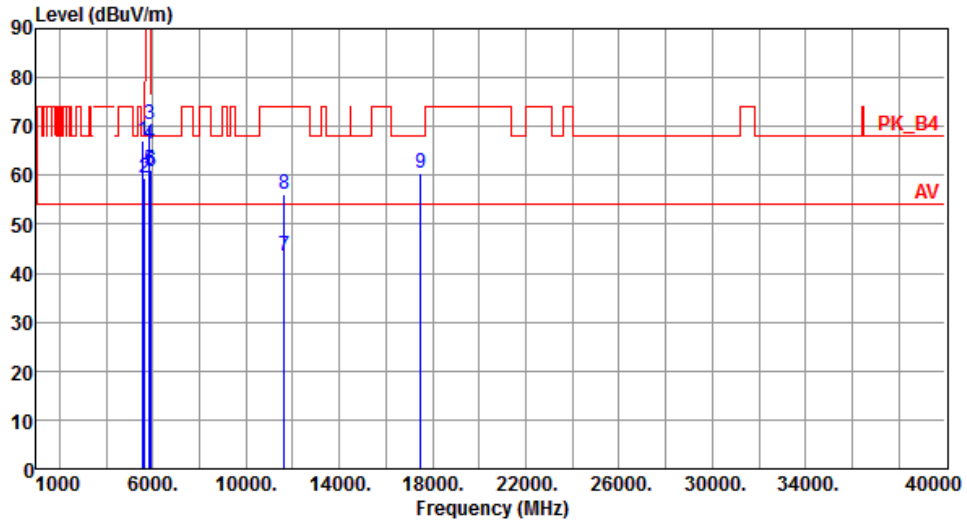

	Freq. MHz	Emission level dBuV/m	Limit dBuV/m	Margin dB	SA reading dBuV	Factor dB	Remark	ANT High cm	Turn Table deg
1	5585.00	67.21	68.20	-0.99	61.22	5.99	Peak	100	114
2	5650.00	59.43	68.20	-8.77	53.52	5.91	Peak	100	114
3	5850.00	70.40	122.20	-51.80	63.73	6.67	Peak	100	114
4	5855.00	66.55	110.80	-44.25	59.87	6.68	Peak	100	114
5	5875.00	61.12	105.20	-44.08	54.40	6.72	Peak	100	114
6	5925.00	60.80	68.20	-7.40	53.98	6.82	Peak	100	114
7	11650.00	43.45	54.00	-10.55	28.39	15.06	Average	100	50
8	11650.00	56.27	74.00	-17.73	41.21	15.06	Peak	100	50
9	17475.00	60.58	68.20	-7.62	42.35	18.23	Peak	100	90

Note 1: Emission Level (dBuV/m) = SA Reading (dBuV/m) + Factor* (dB)

*Factor includes antenna factor , cable loss and amplifier gain

Note 2: Margin (dB) = Emission level (dBuV/m) – Limit (dBuV/m).

3.6 Frequency Stability

3.6.1 Limit of Frequency Stability

Manufacturers of U-NII devices are responsible for ensuring frequency stability such that an emission is maintained within the band of operation under all conditions of normal operation as specified in the user's manual.

3.6.2 Test Procedures

1. The EUT is installed in an environment test chamber with external power source.
2. Set the chamber to operate at 20 centigrade and external power source to output at nominal voltage of EUT.
3. A sufficient stabilization period at each temperature is used prior to each frequency measurement.
4. When temperature is stabled, measure the frequency stability.
5. The test shall be performed under normal and extreme condition for temperature and voltage.

3.6.3 Test Setup

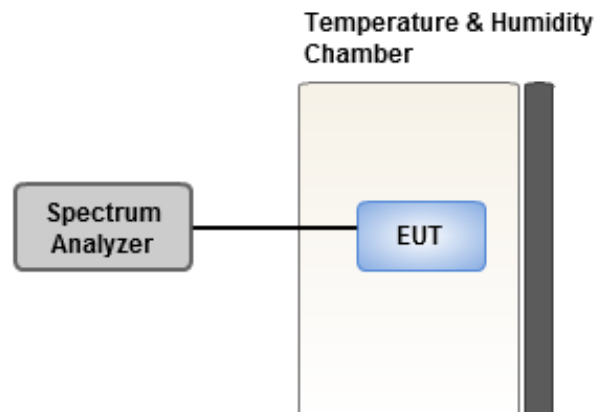

3.6.4 Test Result of Frequency Stability

Frequency: 5300 MHz	Frequency Drift (ppm)			
Temperature (°C)	0 minute	2 minutes	5 minutes	10 minutes
T20°CVmax	-3.35	-2.99	-2.86	-3.13
T20°CVmin	-3.87	-4.23	-3.25	-3.25
T50CVnom	17.05	17.48	17.74	17.46
T40°CVnom	15.58	15.74	15.62	16.06
T30°CVnom	10.97	11.42	11.54	11.81
T20°CVnom	16.05	15.84	16.20	15.71
T10°CVnom	6.98	7.33	7.05	6.94
T0°CVnom	8.83	9.18	9.45	9.20
T-10°CVnom	5.08	5.21	5.94	5.44
T-20°CVnom	6.48	6.43	6.48	6.69
T-30°CVnom	5.36	5.98	6.20	5.91
Vnom [Vac]: 120		Vmax [Vac]: 138		Vmin [Vac]: 102
Tnom [°C]: 20		Tmax [°C]: 50		Tmin [°C]: -30

Frequency: 5785 MHz	Frequency Drift (ppm)			
Temperature (°C)	0 minute	2 minutes	5 minutes	10 minutes
T20°CVmax	-3.67	-3.65	-3.35	-3.21
T20°CVmin	-2.63	-2.81	-2.27	-2.81
T50CVnom	15.65	15.93	16.01	15.39
T40°CVnom	14.11	14.20	13.73	14.29
T30°CVnom	9.47	9.85	9.25	9.84
T20°CVnom	-2.67	-2.95	-2.96	-2.73
T10°CVnom	6.43	6.48	6.62	6.82
T0°CVnom	7.39	7.72	7.09	7.85
T-10°CVnom	4.96	5.48	4.64	5.10
T-20°CVnom	5.79	5.59	6.50	5.83
T-30°CVnom	4.80	4.58	5.02	5.36
Vnom [Vac]: 120		Vmax [Vac]: 138		Vmin [Vac]: 102
Tnom [°C]: 20		Tmax [°C]: 50		Tmin [°C]: -30

4 Test laboratory information

Established in 2012, ICC provides foremost EMC & RF Testing and advisory consultation services by our skilled engineers and technicians. Our services employ a wide variety of advanced edge test equipment and one of the widest certification extents in the business.

International Certification Corp (EMC and Wireless Communication Laboratory), it is our definitive objective is to institute long term, trust-based associations with our clients. The expectation we set up with our clients is based on outstanding service, practical expertise and devotion to a certified value structure. Our passion is to grant our clients with best EMC / RF services by oriented knowledgeable and accommodating staff.

Our Test sites are located at Linkou District and Kwei Shan District. Location map can be found on our website <http://www.icertifi.com.tw>.

Linkou

Tel: 886-2-2601-1640

No. 30-2, Ding Fwu Tsuen, Lin
Kou District, New Taipei City,
Taiwan, R.O.C.

Kwei Shan

Tel: 886-3-271-8666

No. 3-1, Lane 6, Wen San 3rd St.,
Kwei Shan District, Tao Yuan City
333, Taiwan, R.O.C.

Kwei Shan Site II

Tel: 886-3-271-8640

No. 14-1, Lane 19, Wen San 3rd
St., Kwei Shan District, Tao Yuan
City 333, Taiwan, R.O.C.

If you have any suggestion, please feel free to contact us as below information.

Tel: 886-3-271-8666

Fax: 886-3-318-0155

Email: ICC_Service@icertifi.com.tw

==END==