

FCC Test Report

FCC ID : ACQ-MG3OTA
Equipment : Set Top Box
Model No. : MG3-OTA-H, MG3-OTA-L
Brand Name : TiVo
Applicant : ARRIS
Address : 101 Tournament Drive, Horsham
Pennsylvania, United States, 19044
Standard : 47 CFR FCC Part 15.247
Received Date : May 20, 2019
Tested Date : May 27 ~ Jun. 03, 2019

We, International Certification Corp., would like to declare that the tested sample has been evaluated and in compliance with the requirement of the above standards. The test results contained in this report refer exclusively to the product. It may be duplicated completely for legal use with the approval of the applicant. It shall not be reproduced except in full without the written approval of our laboratory.

Reviewed by:

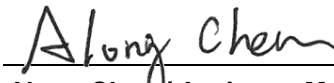

Along Chen / Assistant Manager

Approved by:



Gary Chang / Manager



Table of Contents

1	GENERAL DESCRIPTION	5
1.1	Information.....	5
1.2	Local Support Equipment List	8
1.3	Test Setup Chart	8
1.4	Test Equipment List and Calibration Data.....	9
1.5	Test Standards	10
1.6	Deviation from Test Standard and Measurement Procedure.....	10
1.7	Measurement Uncertainty	10
2	TEST CONFIGURATION	11
2.1	Testing Condition	11
2.2	The Worst Test Modes and Channel Details	11
3	TRANSMITTER TEST RESULTS.....	12
3.1	Conducted Emissions.....	12
3.2	6dB and Occupied Bandwidth	15
3.3	RF Output Power.....	18
3.4	Power Spectral Density	20
3.5	Emissions in Restricted Frequency Bands.....	23
3.6	Emissions in non-restricted Frequency Bands.....	33
4	TEST LABORATORY INFORMATION	35

Release Record

Report No.	Version	Description	Issued Date
FR932003-02AE	Rev. 01	Initial issue	Jun. 14, 2019

Summary of Test Results

FCC Rules	Test Items	Measured	Result
15.207	AC Power Line Conducted Emissions	[dBuV]: 0.165MHz 46.82 (Margin -8.39dB) - AV	Pass
15.247(d) 15.209	Radiated Emissions	[dBuV/m at 3m]: 59.31MHz 35.15 (Margin -4.85dB) - PK	Pass
15.247(b)(3)	Maximum Output Power	Power [dBm]: 1.82	Pass
15.247(a)(2)	6dB Bandwidth	Meet the requirement of limit	Pass
15.247(e)	Power Spectral Density	Meet the requirement of limit	Pass
15.203	Antenna Requirement	Meet the requirement of limit	Pass

Declaration of Conformity:

The test results with all measurement uncertainty excluded are presented in accordance with the regulation limits or requirements declared by manufacturers.

Comments and Explanations:

The declared of product specification for EUT presented in the report are provided by the manufacturer, and the manufacturer takes all the responsibilities for the accuracy of product specification.

1 General Description

1.1 Information

1.1.1 Product Details

The following models are provided to this EUT.

Model Name	Difference
MG3-OTA-H	ATSC tuner*4, 2TB HDD
MG3-OTA-L	ATSC tuner*2, 500GB HDD

★ The above models had been covered during the pretest and found that model **MG3-OTA-H** was the worst one and selected for final test and only its data was recorded in this report.

1.1.2 Specification of the Equipment under Test (EUT)

RF General Information				
Frequency Range (MHz)	Bluetooth Mode	Ch. Freq. (MHz)	Channel Number	Data Rate
2400-2483.5	V4.2 LE	2402-2480	0-39 [40]	1 Mbps

Note 1: Bluetooth LE (Low energy) uses GFSK modulation.

1.1.3 Antenna Details

Ant. No.	Type	Connector	Gain (dBi)	Remarks
1	Printing	N/A	3.6	---

1.1.4 Power Supply Type of Equipment under Test (EUT)

Power Supply Type	12Vdc from adapter
-------------------	--------------------

1.1.5 Accessories

Accessories		
No.	Equipment	Description
1	Adapter	Brand: TiVo Manufacturer: LITE-ON INC Model: PB-1300-3AR5 Power Rating: I/P: 100-120Vac, 1.0A, 60Hz O/P: 12Vdc, 2.5A Power Line: 1.8m non-shielded without core
2	Adapter	Brand: TiVo Manufacturer: NETBIT ELECTRONICS LTD. Model: NBS36E120250VU Power Rating: I/P: 100-120Vac, 60Hz, 0.8A O/P: 12.0Vdc, 2.5A Power Line: 1.8m non-shielded without core
3	HDMI cable	1.8m shielded without core
4	HDD	Brand: SEAGATE Model: ST2000VT000 Product: Video 2.5 HDD
5	HDD	Brand: SEAGATE Model: ST500VT003 Product: Video 2.5 HDD
6	Remote Control	Brand: REMOTESOLUTION CO.,LTD Model: SBOM_03031_000
7	AA Battery for Remote Control	1.5Vdc *2

1.1.6 Channel List

Frequency band (MHz)				2400~2483.5			
Channel	Frequency (MHz)	Channel	Frequency (MHz)	Channel	Frequency (MHz)	Channel	Frequency (MHz)
37	2402	9	2422	18	2442	28	2462
0	2404	10	2424	19	2444	29	2464
1	2406	38	2426	20	2446	30	2466
2	2408	11	2428	21	2448	31	2468
3	2410	12	2430	22	2450	32	2470
4	2412	13	2432	23	2452	33	2472
5	2414	14	2434	24	2454	34	2474
6	2416	15	2436	25	2456	35	2476
7	2418	16	2438	26	2458	36	2478
8	2420	17	2440	27	2460	39	2480

1.1.7 Test Tool and Duty Cycle

Test Tool	Putty, V0.6	
Duty Cycle and Duty Factor	Duty Cycle (%)	Duty Factor (dB)
	64.52	1.90

1.1.8 Power Index of Test Tool

Modulation Mode	Test Frequency (MHz)		
	2402	2440	2480
GFSK/1Mbps	Default	Default	Default

1.2 Local Support Equipment List

Support Equipment List					
No.	Equipment	Brand	Model	FCC ID	Remarks
1	Notebook	DELL	Latitude E6440	DoC	---
2	TV	CHIMEI	TL-24LF500D	---	---
3	USB Flash	Kingston	DTSE9	---	---
4	USB Flash	Kingston	DTSE9	---	---

1.3 Test Setup Chart

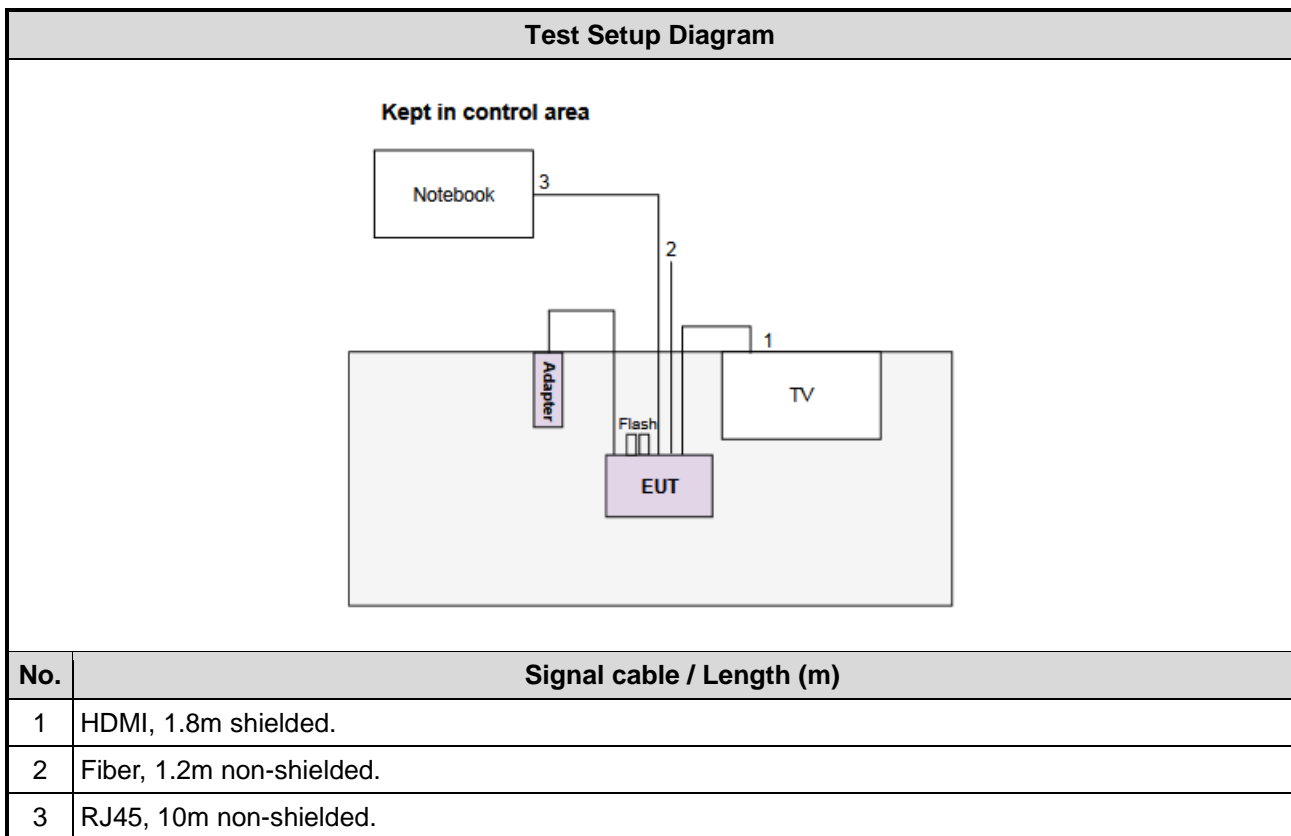

1.4 Test Equipment List and Calibration Data

Test Item	Conducted Emission				
Test Site	Conduction room 1 / (CO01-WS)				
Instrument	Manufacturer	Model No.	Serial No.	Calibration Date	Calibration Until
Receiver	R&S	ESR3	101657	Jan. 08, 2019	Jan. 07, 2020
LISN	SCHWARZBECK	Schwarzbeck 8127	8127-667	Nov. 05, 2018	Nov. 04, 2019
LISN (Support Unit)	SCHWARZBECK	Schwarzbeck 8127	8127-666	Nov. 29, 2018	Nov. 28, 2019
RF Cable-CON	Woken	CFD200-NL	CFD200-NL-001	Oct. 23, 2018	Oct. 23, 2019
50 ohm terminal (Support Unit)	NA	50	02	Apr. 19, 2019	Apr. 18, 2020
Measurement Software	AUDIX	e3	6.120210k	NA	NA

Note: Calibration Interval of instruments listed above is one year.

Test Item	Radiated Emission				
Test Site	966 chamber 3 / (03CH03-WS)				
Instrument	Manufacturer	Model No.	Serial No.	Calibration Date	Calibration Until
Spectrum Analyzer	R&S	FSV40	101499	Jan. 07, 2019	Jan. 06, 2020
Receiver	R&S	ESR3	101658	Dec. 11, 2018	Dec. 10, 2019
Bilog Antenna	SCHWARZBECK	VULB9168	VULB9168-685	Apr. 17, 2019	Apr. 16, 2020
Horn Antenna 1G-18G	SCHWARZBECK	BBHA 9120 D	BBHA 9120 D 1206	Jan. 07, 2019	Jan. 06, 2020
Horn Antenna 18G-40G	SCHWARZBECK	BBHA 9170	BBHA 9170517	Nov. 15, 2018	Nov. 14, 2019
Loop Antenna	R&S	HFH2-Z2	100330	Nov. 09, 2018	Nov. 08, 2019
Loop Antenna Cable	KOAX KABEL	101354-BW	101354-BW	Oct. 08, 2018	Oct. 07, 2019
Preamplifier	EMC	EMC02325	980187	Aug. 24, 2018	Aug. 23, 2019
Preamplifier	Agilent	83017A	MY53270014	Aug. 09, 2018	Aug. 08, 2019
Preamplifier	EMC	EMC184045B	980192	Aug. 09, 2018	Aug. 08, 2019
RF cable-3M	HUBER+SUHNER	SUCOFLEX104	MY22620/4	Oct. 01, 2018	Sep. 30, 2019
RF cable-8M	EMC	EMC104-SM-SM-80 00	181107	Oct. 01, 2018	Sep. 30, 2019
RF cable-1M	HUBER+SUHNER	SUCOFLEX104	MY22624/4	Oct. 01, 2018	Sep. 30, 2019
LF cable-0.8M	EMC	EMC8D-NM-NM-800	EMC8D-NM-NM-800 -001	Oct. 01, 2018	Sep. 30, 2019
LF cable-3M	EMC	EMC8D-NM-NM-300 0	131103	Oct. 01, 2018	Sep. 30, 2019
LF cable-13M	EMC	EMC8D-NM-NM-130 00	131104	Oct. 01, 2018	Sep. 30, 2019
Measurement Software	AUDIX	e3	6.120210g	NA	NA

Note: Calibration Interval of instruments listed above is one year.

Test Item	RF Conducted				
Test Site	(TH01-WS)				
Instrument	Manufacturer	Model No.	Serial No.	Calibration Date	Calibration Until
Spectrum Analyzer	R&S	FSV40	101063	Apr. 17, 2019	Apr. 16, 2020
Power Meter	Anritsu	ML2495A	1241002	Oct. 09, 2018	Oct. 08, 2019
Power Sensor	Anritsu	MA2411B	1207366	Oct. 09, 2018	Oct. 08, 2019
AC POWER SOURCE	APC	AFC-500W	F312060012	Nov. 29, 2018	Nov. 28, 2019
Measurement Software	SENSE-15247_FS	SENSE-15247_FS	V5.10.1	NA	NA
Note: Calibration Interval of instruments listed above is one year.					

1.5 Test Standards

According to the specification of EUT, the EUT must comply with following standards and KDB documents.

47 CFR FCC Part 15.247

ANSI C63.10-2013

FCC KDB 558074 D01 15.247 Meas Guidance v05r02

1.6 Deviation from Test Standard and Measurement Procedure

None

1.7 Measurement Uncertainty

ISO/IEC 17025 requires that an estimate of the measurement uncertainties associated with the emissions test results be included in the report. The measurement uncertainties given below are based on a 95% confidence level (based on a coverage factor (k=2))

Measurement Uncertainty	
Parameters	Uncertainty
Bandwidth	±34.130 Hz
Conducted power	±0.808 dB
Power density	±0.583 dB
Conducted emission	±2.715 dB
AC conducted emission	±2.92 dB
Radiated emission ≤ 1GHz	±3.96 dB
Radiated emission > 1GHz	±4.51 dB

2 Test Configuration

2.1 Testing Condition

Test Item	Test Site	Ambient Condition	Tested By
AC Conduction	CO01-WS	24°C / 65%	Alex Tsai
Radiated Emissions	03CH03-WS	24°C / 63-68%	Roger Lu
RF Conducted	TH01-WS	22°C / 66%	Aska Huang

- FCC Designation No.: TW0009
- FCC site registration No.: 207696
- ISED#: 10807A
- CAB identifier: TW2732

2.2 The Worst Test Modes and Channel Details

Test item	Mode	Test Frequency (MHz)	Data Rate	Test Configuration
AC Power Line Conducted Emissions Radiated Emissions \leq 1GHz	BT LE	2402	1Mbps	---
Maximum Output Power 6dB bandwidth Power spectral density Radiated Emissions > 1GHz	BT LE	2402, 2440, 2480	1Mbps	---

NOTE: Two adapters (LITE-ON & NETBIT) had been covered during the pretest and found that **NETBIT** adapter was the worst case for radiated emission test and **LITE-ON** adapter was the worst case for conducted emission test.

3 Transmitter Test Results

3.1 Conducted Emissions

3.1.1 Limit of Conducted Emissions

Conducted Emissions Limit		
Frequency Emission (MHz)	Quasi-Peak	Average
0.15-0.5	66 - 56 *	56 - 46 *
0.5-5	56	46
5-30	60	50

Note 1: * Decreases with the logarithm of the frequency.

3.1.2 Test Procedures

1. The device is placed on a test table, raised 80 cm above the reference ground plane. The vertical conducting plane is located 40 cm to the rear of the device.
2. The device is connected to line impedance stabilization network (LISN) and other accessories are connected to other LISN. Measured levels of AC power line conducted emission are across the 50 Ω LISN port.
3. AC conducted emission measurements is made over frequency range from 150 kHz to 30 MHz.
4. This measurement was performed with AC 120V/60Hz

3.1.3 Test Setup

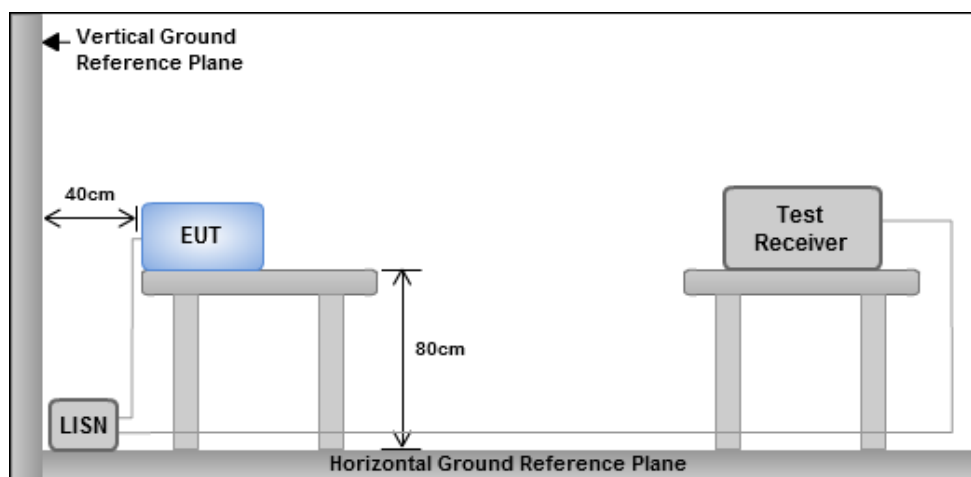

Note: 1. Support units were connected to second LISN.

2. Both of LISNs (AMN) are 80 cm from EUT and at least 80 cm from other units and other metal planes

3.1.4 Test Result of Conducted Emissions

Modulation Mode	GFSK	Test Freq. (MHz)	2402
Power Phase	Line		

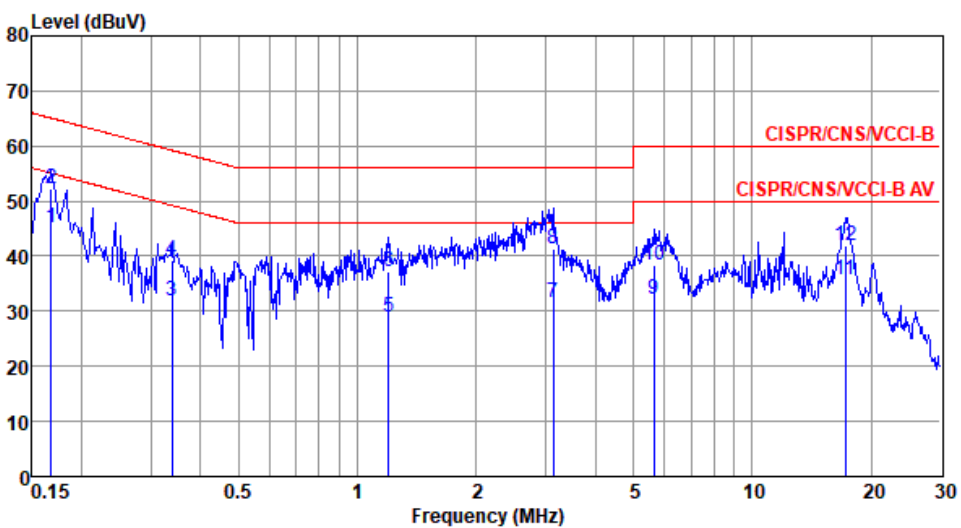

	Freq MHz	Level dBuV	Limit Line dBuV	Over Limit dB	Read Level dBuV	LISN factor dB	cable loss dB	Remark
1*	0.168	45.06	55.08	-10.02	35.32	9.53	0.06	Average
2	0.168	52.33	65.08	-12.75	42.59	9.53	0.06	QP
3	0.339	31.91	49.22	-17.31	22.03	9.56	0.08	Average
4	0.339	39.25	59.22	-19.97	29.37	9.56	0.08	QP
5	1.197	28.82	46.00	-17.18	18.78	9.60	0.12	Average
6	1.197	37.23	56.00	-18.77	27.19	9.60	0.12	QP
7	3.140	31.53	46.00	-14.47	21.31	9.61	0.24	Average
8	3.140	41.19	56.00	-14.81	30.97	9.61	0.24	QP
9	5.623	32.19	50.00	-17.81	21.84	9.62	0.34	Average
10	5.623	38.26	60.00	-21.74	27.91	9.62	0.34	QP
11	17.199	35.67	50.00	-14.33	24.90	9.66	0.58	Average
12	17.199	41.82	60.00	-18.18	31.05	9.66	0.58	QP

Note 1: Level (dBuV) = Read Level (dBuV) + LISN Factor (dB) + Cable Loss (dB).
 Note 2: Over Limit (dB) = Level (dBuV) – Limit Line (dBuV).

Modulation Mode	GFSK	Test Freq. (MHz)	2402
Power Phase	Neutral		

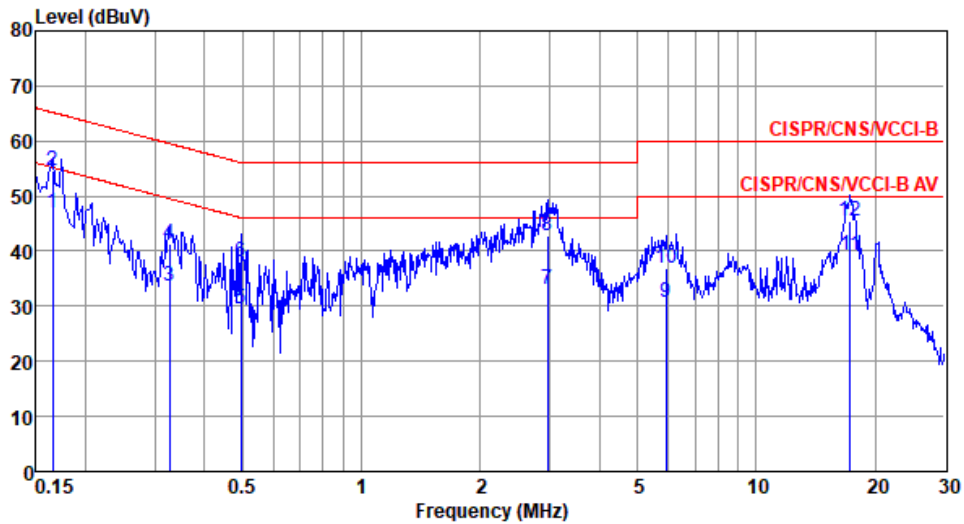

	Freq MHz	Level dBuV	Limit Line dBuV	Over Limit dB	Read Level dBuV	LISN factor dB	cable loss dB	Remark
1*	0.165	46.82	55.21	-8.39	37.07	9.57	0.06	Average
2	0.165	54.64	65.21	-10.57	44.89	9.57	0.06	QP
3	0.327	33.71	49.53	-15.82	23.90	9.60	0.08	Average
4	0.327	41.41	59.53	-18.12	31.60	9.60	0.08	QP
5	0.494	29.64	46.10	-16.46	19.79	9.62	0.08	Average
6	0.494	38.21	56.10	-17.89	28.36	9.62	0.08	QP
7	2.962	33.15	46.00	-12.85	23.00	9.66	0.23	Average
8	2.962	42.77	56.00	-13.23	32.62	9.66	0.23	QP
9	5.898	30.80	50.00	-19.20	20.49	9.68	0.35	Average
10	5.898	36.85	60.00	-23.15	26.54	9.68	0.35	QP
11	17.291	39.28	50.00	-10.72	28.52	9.79	0.58	Average
12	17.291	45.35	60.00	-14.65	34.59	9.79	0.58	QP

Note 1: Level (dBuV) = Read Level (dBuV) + LISN Factor (dB) + Cable Loss (dB).
 Note 2: Over Limit (dB) = Level (dBuV) – Limit Line (dBuV).

3.2 6dB and Occupied Bandwidth

3.2.1 Limit of 6dB Bandwidth

The minimum 6dB bandwidth shall be at least 500 kHz.

3.2.2 Test Procedures

6dB Bandwidth

1. Set resolution bandwidth (RBW) = 100 kHz, Video bandwidth = 300 kHz.
2. Detector = Peak, Trace mode = max hold.
3. Sweep = auto couple, Allow the trace to stabilize.
4. Measure the maximum width of the emission that is constrained by the frequencies associated with the two outermost amplitude points (upper and lower) that are attenuated by 6dB relative to the maximum level measured in the fundamental emission.

Occupied Bandwidth

1. Set resolution bandwidth (RBW) = 1% ~ 5 % of OBW, Video bandwidth = 3 x RBW
2. Detector = Sample, Trace mode = max hold.
3. Sweep = auto couple, Allow the trace to stabilize.
4. Use the OBW measurement function of spectrum analyzer to measure the occupied bandwidth.

3.2.3 Test Setup

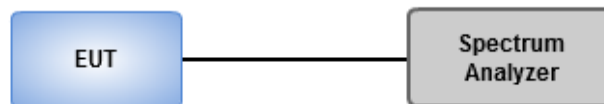

3.2.4 Test Result of 6dB and Occupied Bandwidth

Summary

Mode	Max-N dB (Hz)	Max-OBW (Hz)	ITU-Code	Min-N dB (Hz)	Min-OBW (Hz)
2.4-2.4835GHz	-	-	-	-	-
BT-LE(1Mbps)	750k	1.114M	1M11F1D	742.754k	1.107M

Max-N dB = Maximum 6dB down bandwidth; **Max-OBW** = Maximum 99% occupied bandwidth;
Min-N dB = Minimum 6dB down bandwidth; **Min-OBW** = Minimum 99% occupied bandwidth;

Result

Mode	Result	Limit (Hz)	Port 1-N dB (Hz)	Port 1-OBW (Hz)
BT-LE(1Mbps)	-	-	-	-
2402MHz	Pass	500k	750k	1.107M
2440MHz	Pass	500k	742.754k	1.107M
2480MHz	Pass	500k	742.754k	1.114M

Port X-N dB = Port X 6dB down bandwidth; **Port X-OBW** = Port X 99% occupied bandwidth;

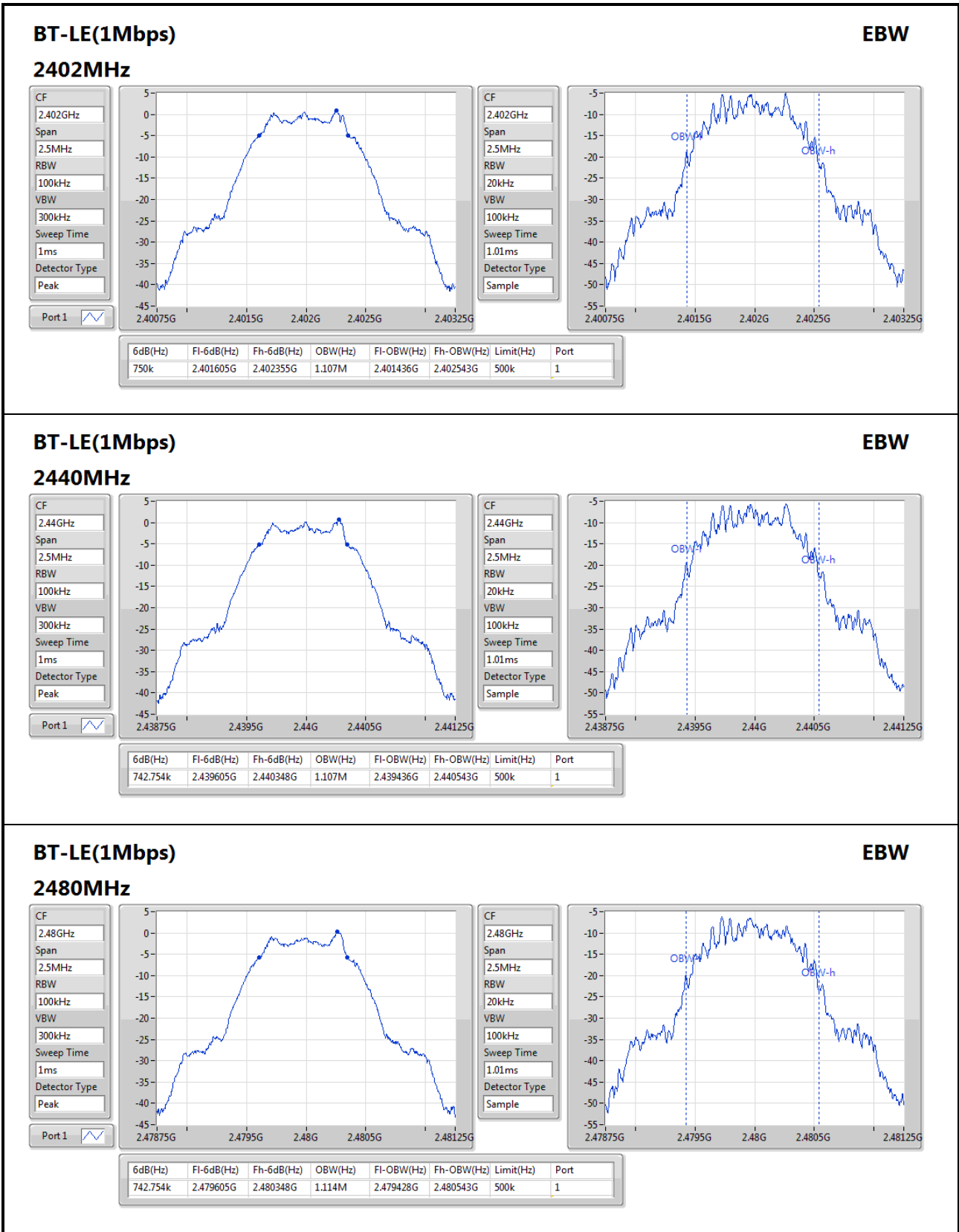

3.3 RF Output Power

3.3.1 Limit of RF Output Power

Conducted power shall not exceed 1Watt.

Antenna gain $\leq 6\text{dBi}$, no any corresponding reduction is in output power limit.

3.3.2 Test Procedures

A broadband RF power meter is used for output power measurement. The video bandwidth of power meter is greater than DTS bandwidth of EUT. If duty cycle of test signal is not 100 %, trigger and gating function of power meter will be enabled to capture transmission burst for measuring output power.

3.3.3 Test Setup

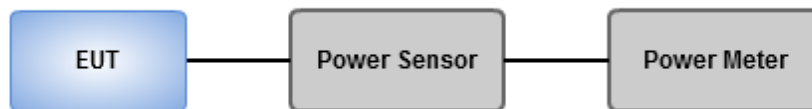

3.3.4 Test Result of Maximum Output Power

Summary of Peak Conducted Output Power

Mode	Power (dBm)	Power (W)
2.4-2.4835GHz	-	-
BT-LE(1Mbps)	1.82	0.00152

Result

Mode	Result	Gain (dBi)	Power (dBm)	Power Limit (dBm)
BT-LE(1Mbps)	-	-	-	-
2402MHz	Pass	3.60	1.82	30.00
2440MHz	Pass	3.60	1.30	30.00
2480MHz	Pass	3.60	0.82	30.00

Summary of Conducted (Average) Output Power

Mode	Power (dBm)	Power (W)
2.4-2.4835GHz	-	-
BT-LE(1Mbps)	1.69	0.00148

Result

Mode	Result	Gain (dBi)	Power (dBm)	Power Limit (dBm)
BT-LE(1Mbps)	-	-	-	-
2402MHz	Pass	3.60	1.69	-
2440MHz	Pass	3.60	1.16	-
2480MHz	Pass	3.60	0.66	-

Note: Average power is for reference only.

3.4 Power Spectral Density

3.4.1 Limit of Power Spectral Density

Power spectral density shall not be greater than 8 dBm in any 3 kHz band.

3.4.2 Test Procedures

1. Set the RBW = 3 kHz, VBW = 10 kHz.
2. Detector = Peak, Sweep time = auto couple.
3. Trace mode = max hold, allow trace to fully stabilize.
4. Use the peak marker function to determine the maximum amplitude level.

3.4.3 Test Setup

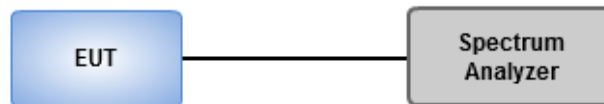

3.4.4 Test Result of Power Spectral Density

Summary

Mode	PD (dBm/RBW)
2.4-2.4835GHz	-
BT-LE(1Mbps)	-12.60

Result

Mode	Result	Gain (dBi)	PD (dBm/RBW)	PD Limit (dBm/RBW)
BT-LE(1Mbps)	-	-	-	-
2402MHz	Pass	3.60	-12.60	8.00
2440MHz	Pass	3.60	-13.06	8.00
2480MHz	Pass	3.60	-13.71	8.00

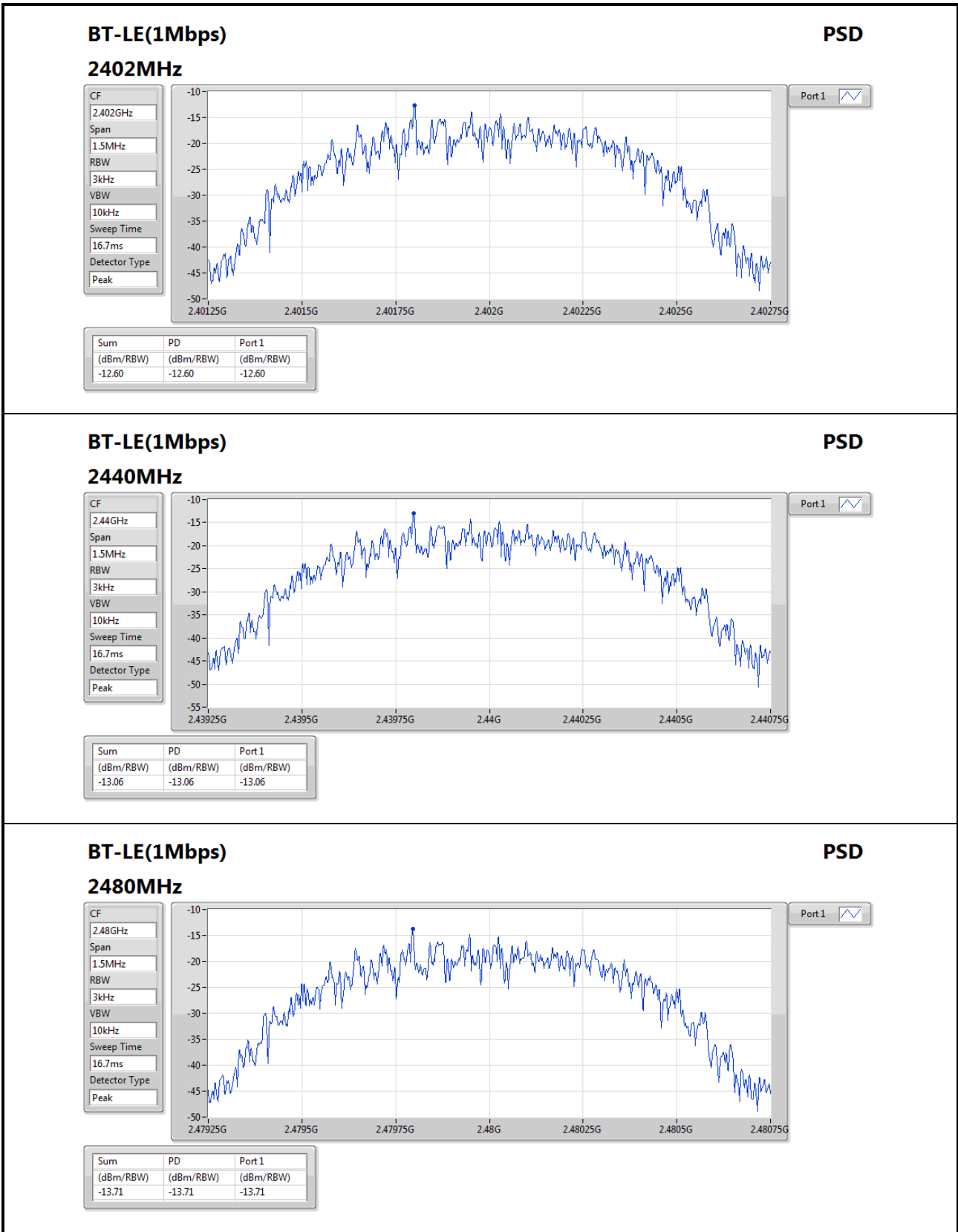

3.5 Emissions in Restricted Frequency Bands

3.5.1 Limit of Emissions in Restricted Frequency Bands

Restricted Band Emissions Limit			
Frequency Range (MHz)	Field Strength (uV/m)	Field Strength (dBuV/m)	Measure Distance (m)
0.009~0.490	2400/F(kHz)	48.5 - 13.8	300
0.490~1.705	24000/F(kHz)	33.8 - 23	30
1.705~30.0	30	29	30
30~88	100	40	3
88~216	150	43.5	3
216~960	200	46	3
Above 960	500	54	3

Note 1:
Quasi-Peak value is measured for frequency below 1GHz except for 9–90 kHz, 110–490 kHz frequency band. Peak and average value are measured for frequency above 1GHz. The limit on average radio frequency emission is as above table. The limit on peak radio frequency emissions is 20 dB above the maximum permitted average emission limit

Note 2:
Measurements may be performed at a distance other than what is specified provided. When performing measurements at a distance other than that specified, the results shall be extrapolated to the specified distance using an extrapolation factor as below, Frequency at or above 30 MHz: 20 dB/decade Frequency below 30 MHz: 40 dB/decade.

3.5.2 Test Procedures

1. Measurement is made at a semi-anechoic chamber that incorporates a turntable allowing a EUT rotation of 360°. A continuously-rotating, remotely-controlled turntable is installed at the test site to support the EUT and facilitate determination of the direction of maximum radiation for each EUT emission frequency. The EUT is placed at test table. For emissions testing at or below 1 GHz, the table height is 80 cm above the reference ground plane. For emission measurements above 1 GHz, the table height is 1.5 m
2. Measurement is made with the antenna positioned in both the horizontal and vertical planes of polarization. The measurement antenna is varied in height (1m ~ 4m) above the reference ground plane to obtain the maximum signal strength. Distance between EUT and antenna is 3 m.
3. This investigation is performed with the EUT rotated 360°, the antenna height scanned between 1 m and 4 m, and the antenna rotated to repeat the measurements for both the horizontal and vertical antenna polarizations.

Note:

1. 120kHz measurement bandwidth of test receiver and Quasi-peak detector is for radiated emission below 1GHz.
2. RBW=1MHz, VBW=3MHz and Peak detector is for peak measured value of radiated emission above 1GHz.
3. RBW=1MHz, VBW=1/T and Peak detector is for average measured value of radiated emission above 1GHz.

3.5.3 Test Setup

Radiated Emissions below 1 GHz

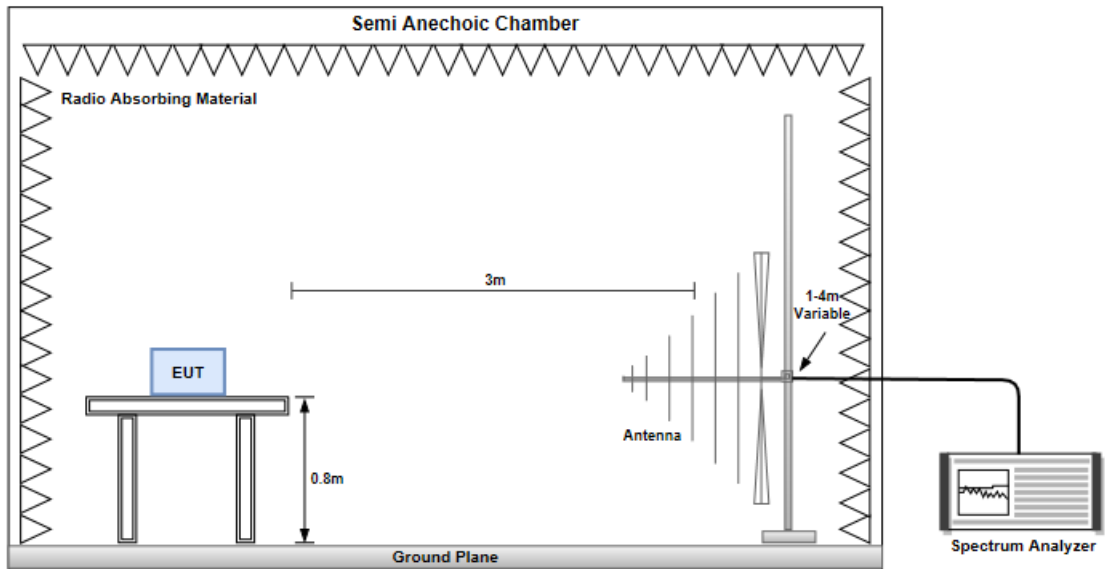

Radiated Emissions above 1 GHz

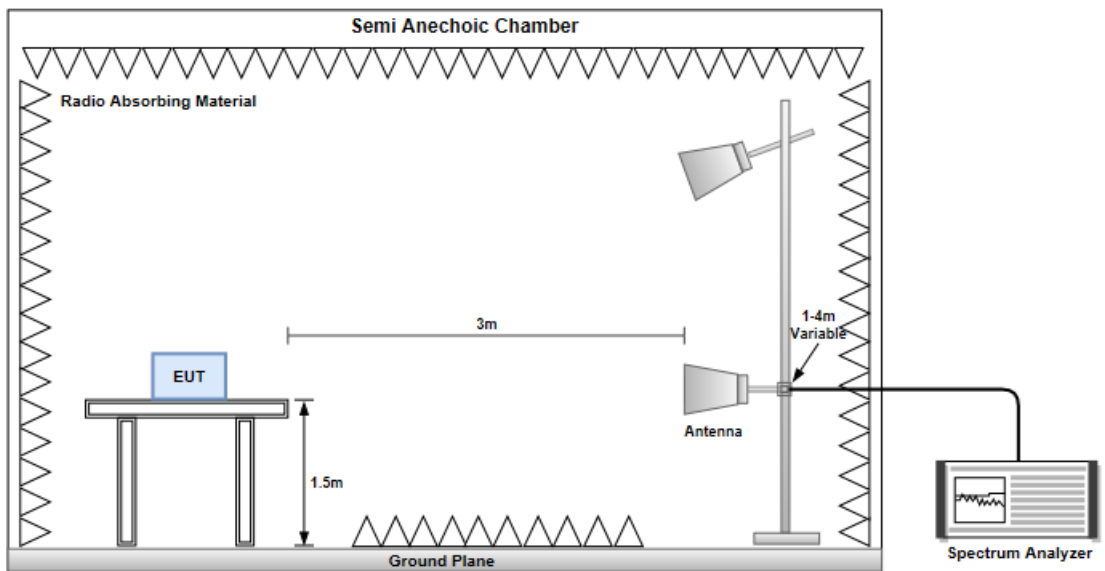

3.5.4 Transmitter Radiated Unwanted Emissions (Below 1GHz)

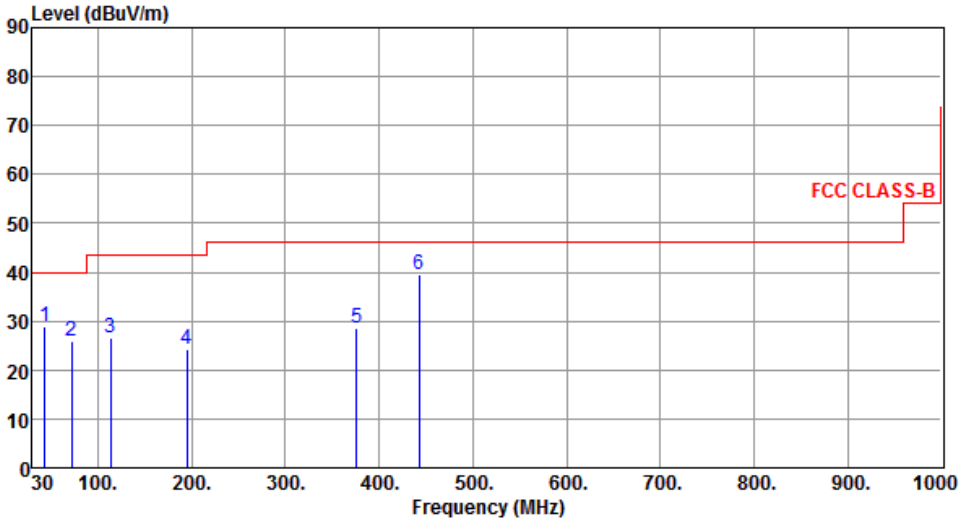
Modulation	GFSK	Test Freq. (MHz)	2440						
Polarization	Horizontal								
									
	Freq.	Emission level	Limit	Margin	SA reading	Factor	Remark	ANT High cm	Turn Table deg
	MHz	dBuV/m	dBuV/m	dB	dBuV	dB			
1	43.51	28.77	40.00	-11.23	37.69	-8.92	Peak	---	---
2	71.69	25.76	40.00	-14.24	36.74	-10.98	Peak	---	---
3	113.42	26.49	43.50	-17.01	38.29	-11.80	Peak	---	---
4	194.90	24.35	43.50	-19.15	36.20	-11.85	Peak	---	---
5	376.29	28.41	46.00	-17.59	34.80	-6.39	Peak	---	---
6	442.29	39.57	46.00	-6.43	43.98	-4.41	Peak	---	---
<p>Note 1: Emission Level (dBuV/m) = SA Reading (dBuV/m) + Factor* (dB) *Factor includes antenna factor , cable loss and amplifier gain Note 2: Margin (dB) = Emission level (dBuV/m) – Limit (dBuV/m). Note 3: All spurious emissions below 30MHz are more than 20 dB below the limit.</p>									

Modulation	GFSK	Test Freq. (MHz)	2440
Polarization	Vertical		

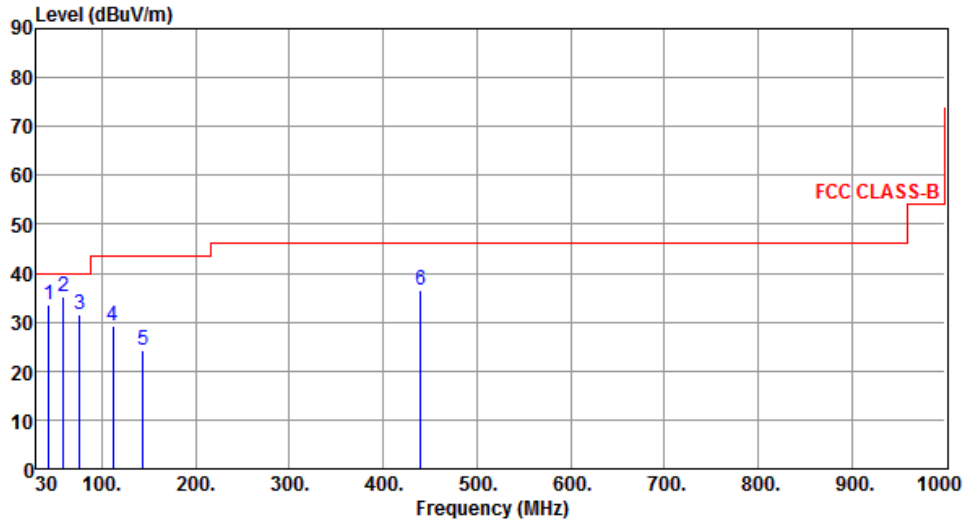

	Freq. MHz	Emission level dBuV/m	Limit dBuV/m	Margin dB	SA reading dBuV	Factor dB	Remark	ANT High cm	Turn Table deg
1	43.55	33.45	40.00	-6.55	42.37	-8.92	Peak	---	---
2	59.31	35.15	40.00	-4.85	44.41	-9.26	Peak	---	---
3	76.48	31.53	40.00	-8.47	44.01	-12.48	Peak	---	---
4	111.48	29.14	43.50	-14.36	41.18	-12.04	Peak	---	---
5	143.48	24.36	43.50	-19.14	33.35	-8.99	Peak	---	---
6	440.21	36.42	46.00	-9.58	40.89	-4.47	Peak	---	---

Note 1: Emission Level (dBuV/m) = SA Reading (dBuV/m) + Factor* (dB)

*Factor includes antenna factor , cable loss and amplifier gain

Note 2: Margin (dB) = Emission level (dBuV/m) – Limit (dBuV/m).

Note 3: All spurious emissions below 30MHz are more than 20 dB below the limit.

3.5.5 Transmitter Radiated Unwanted Emissions (Above 1GHz) for GFSK

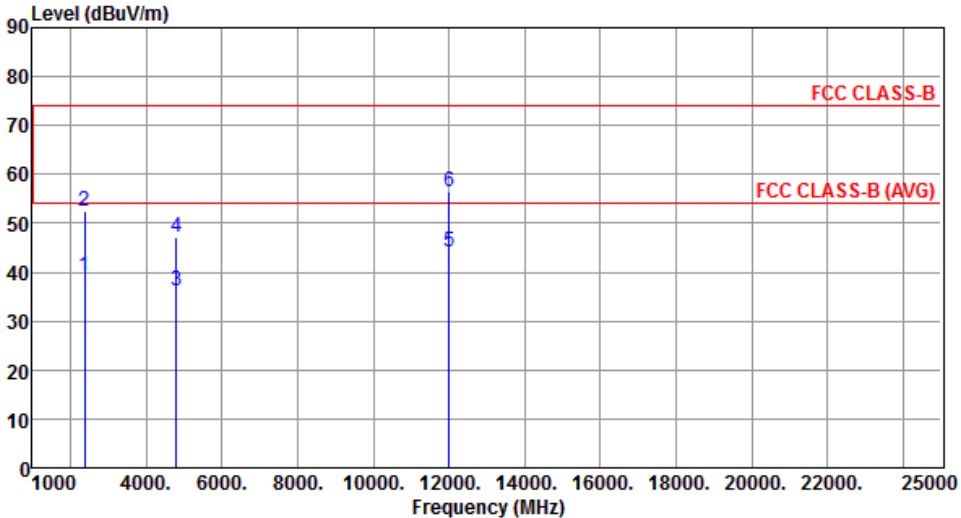
Modulation	GFSK	Test Freq. (MHz)	2402						
Polarization	Horizontal								
									
	Freq.	Emission level	Limit	Margin	SA reading	Factor	Remark	ANT High	Turn Table
	MHz	dBuV/m	dBuV/m	dB	dBuV	dB		cm	deg
1	2390.00	39.30	54.00	-14.70	40.26	-0.96	Average	202	318
2	2390.00	52.34	74.00	-21.66	53.30	-0.96	Peak	202	318
3	4804.00	36.07	54.00	-17.93	31.27	4.80	Average	100	69
4	4804.00	47.16	74.00	-26.84	42.36	4.80	Peak	100	69
5	12010.00	44.04	54.00	-9.96	29.24	14.80	Average	100	40
6	12010.00	56.38	74.00	-17.62	41.58	14.80	Peak	100	40
<p>Note 1: Emission Level (dBuV/m) = SA Reading (dBuV/m) + Factor* (dB) *Factor includes antenna factor , cable loss and amplifier gain Note 2: Margin (dB) = Emission level (dBuV/m) – Limit (dBuV/m).</p>									

Modulation	GFSK	Test Freq. (MHz)	2402
Polarization	Vertical		

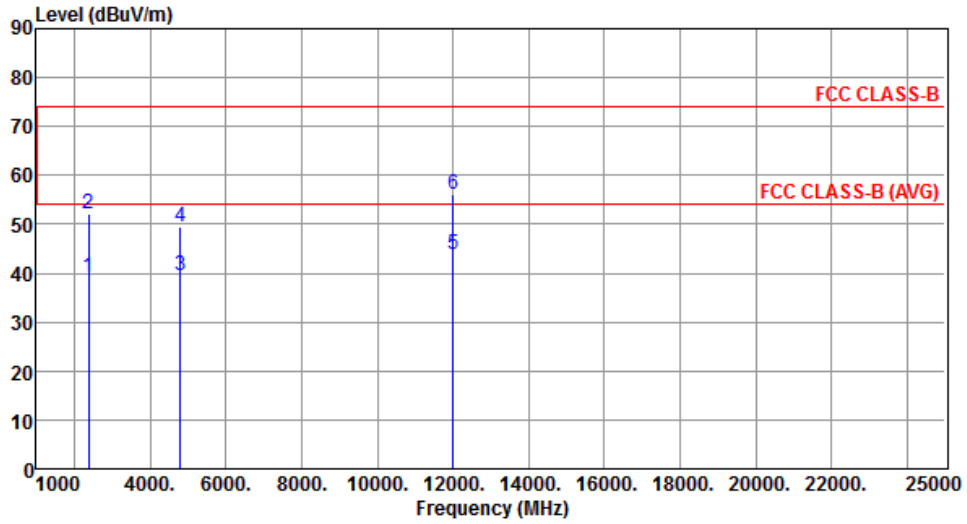

	Freq. MHz	Emission level dBuV/m	Limit dBuV/m	Margin dB	SA reading dBuV	Factor dB	Remark	ANT High cm	Turn Table deg
1	2390.00	39.17	54.00	-14.83	40.13	-0.96	Average	305	265
2	2390.00	52.30	74.00	-21.70	53.26	-0.96	Peak	305	265
3	4804.00	39.37	54.00	-14.63	34.57	4.80	Average	302	110
4	4804.00	49.50	74.00	-24.50	44.70	4.80	Peak	302	110
5	12010.00	43.95	54.00	-10.05	29.15	14.80	Average	100	30
6	12010.00	56.09	74.00	-17.91	41.29	14.80	Peak	100	30

Note 1: Emission Level (dBuV/m) = SA Reading (dBuV/m) + Factor* (dB)

*Factor includes antenna factor , cable loss and amplifier gain

Note 2: Margin (dB) = Emission level (dBuV/m) – Limit (dBuV/m).

Modulation	GFSK	Test Freq. (MHz)	2440
Polarization	Horizontal		

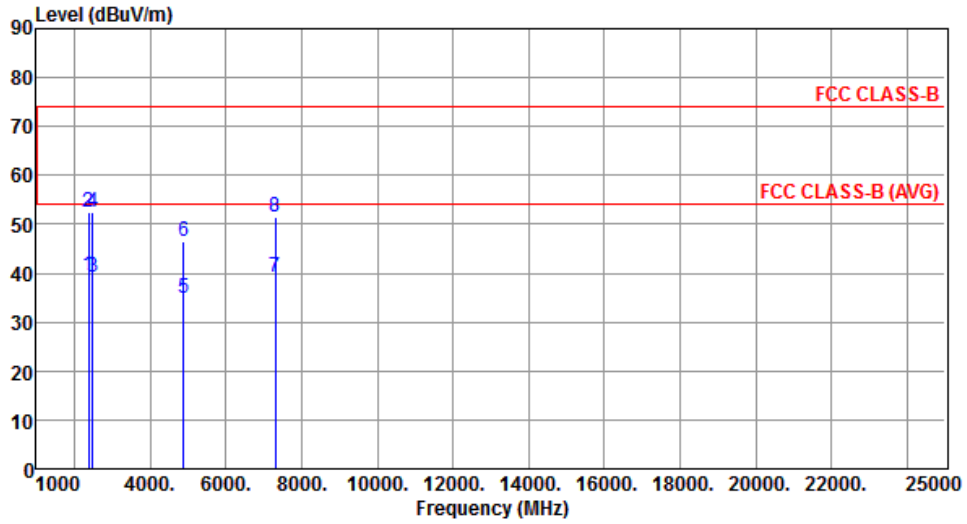

	Freq. MHz	Emission level dBuV/m	Limit dBuV/m	Margin dB	SA reading dBuV	Factor dB	Remark	ANT High cm	Turn Table deg
1	2390.00	39.60	54.00	-14.40	40.56	-0.96	Average	195	314
2	2390.00	52.58	74.00	-21.42	53.54	-0.96	Peak	195	314
3	2483.50	39.25	54.00	-14.75	40.37	-1.12	Average	195	314
4	2483.50	52.51	74.00	-21.49	53.63	-1.12	Peak	195	314
5	4880.00	34.94	54.00	-19.06	30.03	4.91	Average	100	71
6	4880.00	46.62	74.00	-27.38	41.71	4.91	Peak	100	71
7	7320.00	39.16	54.00	-14.84	28.84	10.32	Average	100	10
8	7320.00	51.44	74.00	-22.56	41.12	10.32	Peak	100	10

Note 1: Emission Level (dBuV/m) = SA Reading (dBuV/m) + Factor* (dB)

*Factor includes antenna factor , cable loss and amplifier gain

Note 2: Margin (dB) = Emission level (dBuV/m) – Limit (dBuV/m).

Modulation	GFSK	Test Freq. (MHz)	2440
Polarization	Vertical		

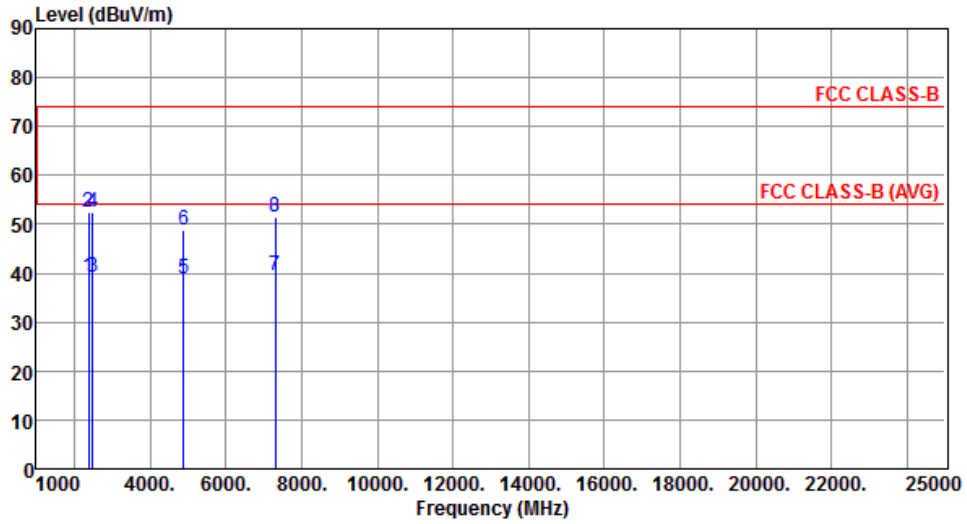

	Freq. MHz	Emission level dBuV/m	Limit dBuV/m	Margin dB	SA reading dBuV	Factor dB	Remark	ANT High cm	Turn Table deg
1	2390.00	39.30	54.00	-14.70	40.26	-0.96	Average	311	264
2	2390.00	52.49	74.00	-21.51	53.45	-0.96	Peak	311	264
3	2483.50	39.23	54.00	-14.77	40.35	-1.12	Average	311	264
4	2483.50	52.50	74.00	-21.50	53.62	-1.12	Peak	311	264
5	4880.00	38.79	54.00	-15.21	33.88	4.91	Average	300	100
6	4880.00	48.81	74.00	-25.19	43.90	4.91	Peak	300	100
7	7320.00	39.36	54.00	-14.64	29.04	10.32	Average	100	30
8	7320.00	51.58	74.00	-22.42	41.26	10.32	Peak	100	30

Note 1: Emission Level (dBuV/m) = SA Reading (dBuV/m) + Factor* (dB)

*Factor includes antenna factor , cable loss and amplifier gain

Note 2: Margin (dB) = Emission level (dBuV/m) – Limit (dBuV/m).

Modulation	GFSK	Test Freq. (MHz)	2480
Polarization	Horizontal		

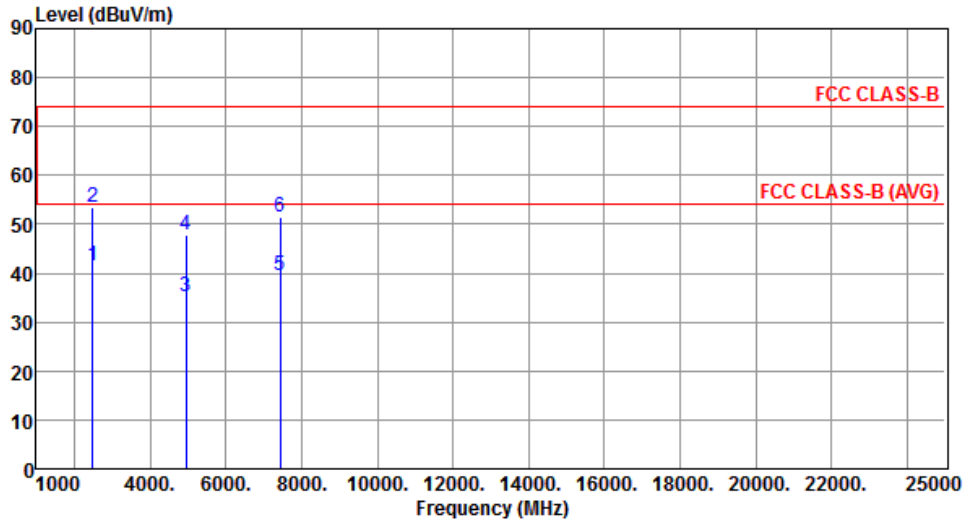

	Freq. MHz	Emission level dBuV/m	Limit dBuV/m	Margin dB	SA reading dBuV	Factor dB	Remark	ANT High cm	Turn Table deg
1	2483.50	41.40	54.00	-12.60	42.52	-1.12	Average	195	313
2	2483.50	53.57	74.00	-20.43	54.69	-1.12	Peak	195	313
3	4960.00	35.30	54.00	-18.70	30.11	5.19	Average	100	68
4	4960.00	47.81	74.00	-26.19	42.62	5.19	Peak	100	68
5	7440.00	39.38	54.00	-14.62	29.03	10.35	Average	100	50
6	7440.00	51.63	74.00	-22.37	41.28	10.35	Peak	100	50

Note 1: Emission Level (dBuV/m) = SA Reading (dBuV/m) + Factor* (dB)

*Factor includes antenna factor , cable loss and amplifier gain

Note 2: Margin (dB) = Emission level (dBuV/m) – Limit (dBuV/m).

Modulation	GFSK	Test Freq. (MHz)	2480
Polarization	Vertical		

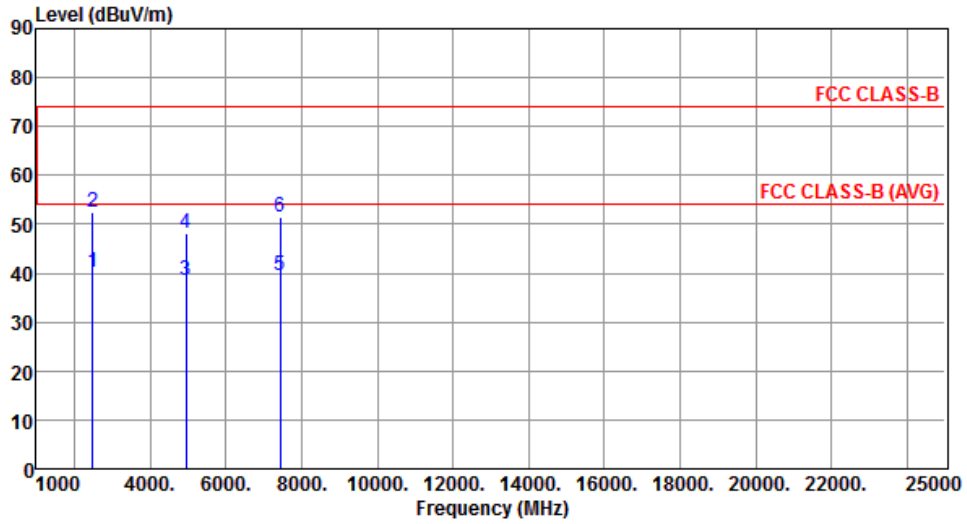

	Freq. MHz	Emission level dBuV/m	Limit dBuV/m	Margin dB	SA reading dBuV	Factor dB	Remark	ANT High cm	Turn Table deg
1	2483.50	40.14	54.00	-13.86	41.26	-1.12	Average	305	269
2	2483.50	52.42	74.00	-21.58	53.54	-1.12	Peak	305	269
3	4960.00	38.53	54.00	-15.47	33.34	5.19	Average	295	103
4	4960.00	48.04	74.00	-25.96	42.85	5.19	Peak	295	103
5	7440.00	39.36	54.00	-14.64	29.01	10.35	Average	100	30
6	7440.00	51.62	74.00	-22.38	41.27	10.35	Peak	100	30

Note 1: Emission Level (dBuV/m) = SA Reading (dBuV/m) + Factor* (dB)

*Factor includes antenna factor , cable loss and amplifier gain

Note 2: Margin (dB) = Emission level (dBuV/m) – Limit (dBuV/m).

3.6 Emissions in non-restricted Frequency Bands

3.6.1 Emissions in non-restricted frequency bands limit

Peak power in any 100 kHz bandwidth outside of the authorized frequency band shall be attenuated by at least 20 dB relative to the maximum in-band peak PSD level in 100 kHz.

3.6.2 Test Procedures

Reference level measurement

1. Set RBW=100kHz, VBW = 300kHz , Detector = Peak, Sweep time = Auto
2. Trace = max hold , Allow Trace to fully stabilize
3. Use the peak marker function to determine the maximum PSD level

Emission level measurement

1. Set RBW=100kHz, VBW = 300kHz , Detector = Peak, Sweep time = Auto
2. Trace = max hold , Allow Trace to fully stabilize
3. Scan Frequency range is up to 25GHz
4. Use the peak marker function to determine the maximum amplitude level

3.6.3 Test Setup

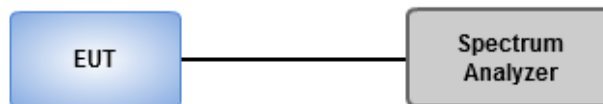

3.6.4 Test Result of Emissions in non-restricted Frequency Bands

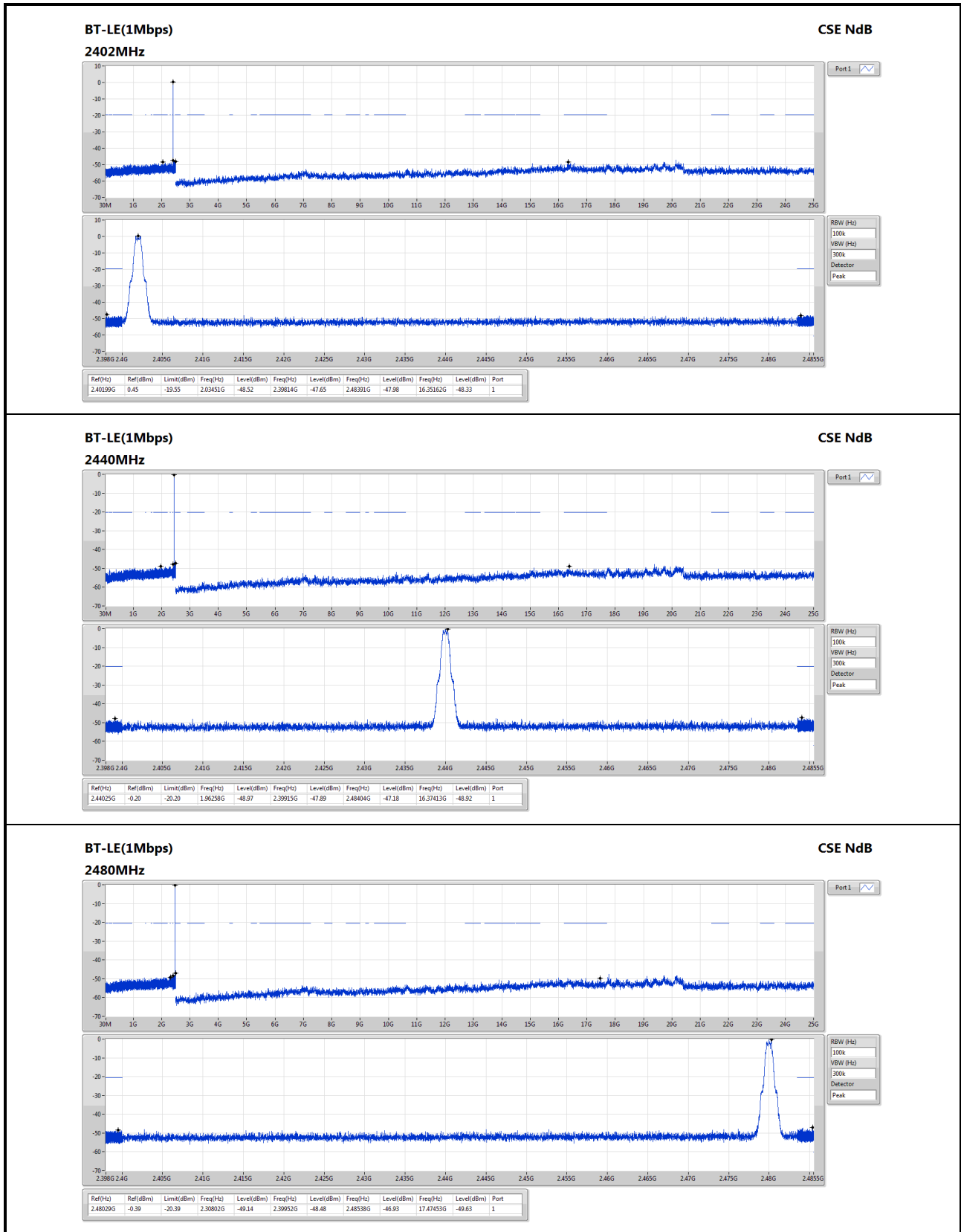

4 Test laboratory information

Established in 2012, ICC provides foremost EMC & RF Testing and advisory consultation services by our skilled engineers and technicians. Our services employ a wide variety of advanced edge test equipment and one of the widest certification extents in the business.

International Certification Corp (EMC and Wireless Communication Laboratory), it is our definitive objective is to institute long term, trust-based associations with our clients. The expectation we set up with our clients is based on outstanding service, practical expertise and devotion to a certified value structure. Our passion is to grant our clients with best EMC / RF services by oriented knowledgeable and accommodating staff.

Our Test sites are located at Linkou District and Kwei Shan District. Location map can be found on our website <http://www.icertifi.com.tw>.

Linkou

Tel: 886-2-2601-1640

No. 30-2, Ding Fwu Tsuen, Lin
Kou District, New Taipei City,
Taiwan, R.O.C.

Kwei Shan

Tel: 886-3-271-8666

No. 3-1, Lane 6, Wen San 3rd St.,
Kwei Shan District, Tao Yuan City
333, Taiwan, R.O.C.

Kwei Shan Site II

Tel: 886-3-271-8640

No. 14-1, Lane 19, Wen San 3rd
St., Kwei Shan District, Tao Yuan
City 333, Taiwan, R.O.C.

If you have any suggestion, please feel free to contact us as below information.

Tel: 886-3-271-8666

Fax: 886-3-318-0155

Email: ICC_Service@icertifi.com.tw

==END==