

# FCC Test Report

**FCC ID** : ACQ-MG3  
**Equipment** : Set Top Box  
**Model No.** : MG3  
**Brand Name** : ARRIS  
**Applicant** : ARRIS  
**Address** : 101 Tournament Drive, Horsham  
Pennsylvania, United States, 19044  
**Standard** : 47 CFR FCC Part 15.247  
**Received Date** : Mar. 20, 2019  
**Tested Date** : Jul. 10 ~ Jul. 23, 2019

We, International Certification Corp., would like to declare that the tested sample has been evaluated and in compliance with the requirement of the above standards. The test results contained in this report refer exclusively to the product. It may be duplicated completely for legal use with the approval of the applicant. It shall not be reproduced except in full without the written approval of our laboratory.

Reviewed by:

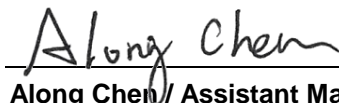

Along Chen / Assistant Manager

Approved by:



Gary Chang / Manager



---

## Table of Contents

<b>1</b>	<b>GENERAL DESCRIPTION .....</b>	<b>5</b>
1.1	Information.....	5
1.2	Local Support Equipment List .....	7
1.3	Test Setup Chart .....	7
1.4	The Equipment List .....	8
1.5	Test Standards .....	9
1.6	Deviation from Test Standard and Measurement Procedure.....	9
1.7	Measurement Uncertainty .....	9
<b>2</b>	<b>TEST CONFIGURATION .....</b>	<b>10</b>
2.1	Testing Condition .....	10
2.2	The Worst Test Modes and Channel Details .....	10
<b>3</b>	<b>TRANSMITTER TEST RESULTS.....</b>	<b>11</b>
3.1	Conducted Emissions.....	11
3.2	6dB and Occupied Bandwidth .....	14
3.3	RF Output Power.....	17
3.4	Power Spectral Density .....	19
3.5	Unwanted Emissions into Restricted Frequency Bands .....	22
3.6	Emissions in Non-Restricted Frequency Bands.....	32
<b>4</b>	<b>TEST LABORATORY INFORMATION .....</b>	<b>34</b>

---

## Release Record

Report No.	Version	Description	Issued Date
FR932003-03-1	Rev. 01	Initial issue	Sep. 04, 2019
FR932003-03-1	Rev. 02	Corrected the HDD information on P5.	Nov. 05, 2019

## Summary of Test Results

FCC Rules	Test Items	Measured	Result
15.207	Conducted Emissions	[dBuV]: 0.159MHz 56.47 (Margin -9.05dB) - QP	Pass
15.247(d) 15.209	Radiated Emissions	[dBuV/m at 3m]: 7275.00MHz 53.80 (Margin -0.20dB) - AV	Pass
15.247(b)(3)	Maximum Output Power	Max Power [dBm]: 4.09	Pass
15.247(a)(2)	6dB Bandwidth	Meet the requirement of limit	Pass
15.247(e)	Power Spectral Density	Meet the requirement of limit	Pass
15.203	Antenna Requirement	Meet the requirement of limit	Pass

### Declaration of Conformity:

The test results with all measurement uncertainty excluded are presented in accordance with the regulation limits or requirements declared by manufacturers.

### Comments and Explanations:

The declared of product specification for EUT presented in the report are provided by the manufacturer, and the manufacturer takes all the responsibilities for the accuracy of product specification.

# 1 General Description

## 1.1 Information

### 1.1.1 Specification of the Equipment under Test (EUT)

RF General Information				
Frequency Range (MHz)	Mode	Ch. Frequency (MHz)	Channel Number	Data Rate
2425~2475	RF4CE	2425~2475	15-25 [3]	250kbps

Note 1: RF4CE uses DSSS-O-QPSK modulation.

### 1.1.2 Antenna Details

Ant. No.	Type	Connector	Gain (dBi)	Remarks
1	Printing	No	3.36	---

### 1.1.3 Power Supply Type of Equipment under Test (EUT)

Power Supply Type	12Vdc from adapter
-------------------	--------------------

### 1.1.4 Accessories

Accessories		
No.	Equipment	Description
1	Adapter	Brand: TiVo Manufacturer: LITE-ON INC Model: PB-1300-3AR5 Power Rating: I/P: 100-120Vac, 1.0A, 60Hz O/P: 12Vdc, 2.5A Power Line: 1.8m non-shielded without core
2	Adapter	Brand: TiVo Manufacturer: NETBIT ELECTRONICS LTD. Model: NBS36E120250VU Power Rating: I/P: 100-120Vac, 60Hz, 0.8A O/P: 12.0Vdc, 2.5A Power Line: 1.8m non-shielded without core
3	HDMI cable	1.8m shielded without core
4	HDD	Brand: SEAGATE Model: ST1000VT001 Product: Video 2.5 HDD
5	M-CARD	Brand: ARRIS

### 1.1.5 Channel List

Channel No.	Frequency (MHz)
15	2425
20	2450
25	2475

### 1.1.6 Test Tool and Duty Cycle

<b>Test Tool</b>	Putty, V 0.60.0.0	
<b>Duty Cycle and Duty Factor</b>	<b>Duty Cycle (%)</b>	<b>Duty Factor (dB)</b>
	100.00	0.00

### 1.1.7 Power Index of Test Tool

Modulation Mode	Test Frequency (MHz)	Power Index
DSSS	2425	4
DSSS	2450	3
DSSS	2475	3

## 1.2 Local Support Equipment List

Support Equipment List					
No.	Equipment	Brand	Model	FCC ID	Remarks
1	Notebook	DELL	Latitude E6440	DoC	---
2	TV	CHIMEI	TL-24LF500D	---	---
3	USB Flash	Kingston	DTSE9	---	---
4	USB Flash	Kingston	DTSE9	---	---

## 1.3 Test Setup Chart

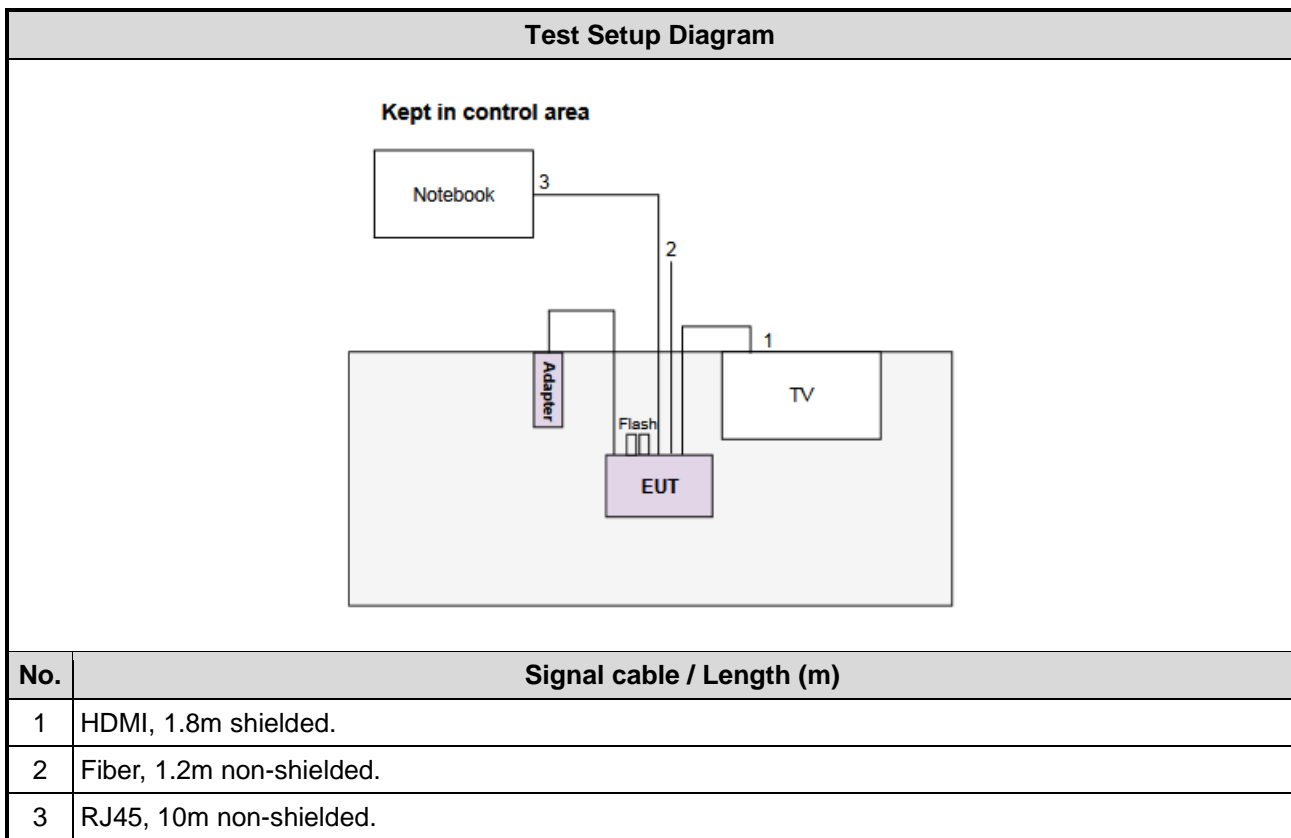

## 1.4 The Equipment List

Test Item	Conducted Emission				
Test Site	Conduction room 1 / (CO01-WS)				
Instrument	Manufacturer	Model No.	Serial No.	Calibration Date	Calibration Until
Receiver	R&S	ESR3	101657	Jan. 08, 2019	Jan. 07, 2020
LISN	R&S	ENV216	101579	Mar. 08, 2019	Mar. 07, 2020
RF Cable-CON	Woken	CFD200-NL	CFD200-NL-001	Oct. 23, 2018	Oct. 22, 2019
Measurement Software	AUDIX	e3	6.120210k	NA	NA

Note: Calibration Interval of instruments listed above is one year.

Test Item	Radiated Emission				
Test Site	966 chamber 3 / (03CH03-WS)				
Instrument	Manufacturer	Model No.	Serial No.	Calibration Date	Calibration Until
Spectrum Analyzer	R&S	FSV40	101499	Jan. 07, 2019	Jan. 06, 2020
Receiver	R&S	ESR3	101658	Dec. 11, 2018	Dec. 10, 2019
Bilog Antenna	SCHWARZBECK	VULB9168	VULB9168-685	Apr. 17, 2019	Apr. 16, 2020
Horn Antenna 1G-18G	SCHWARZBECK	BBHA 9120 D	BBHA 9120 D 1206	Jan. 07, 2019	Jan. 06, 2020
Horn Antenna 18G-40G	SCHWARZBECK	BBHA 9170	BBHA 9170517	Nov. 15, 2018	Nov. 14, 2019
Loop Antenna	R&S	HFH2-Z2	100330	Nov. 09, 2018	Nov. 08, 2019
Loop Antenna Cable	KOAX KABEL	101354-BW	101354-BW	Oct. 08, 2018	Oct. 07, 2019
Preamplifier	EMC	EMC02325	980187	Aug. 24, 2018	Aug. 23, 2019
Preamplifier	Agilent	83017A	MY53270014	Aug. 09, 2018	Aug. 08, 2019
Preamplifier	EMC	EMC184045B	980192	Aug. 09, 2018	Aug. 08, 2019
RF cable-3M	HUBER+SUHNER	SUCOFLEX104	MY22620/4	Oct. 01, 2018	Sep. 30, 2019
RF cable-8M	EMC	EMC104-SM-SM-8000	181107	Oct. 01, 2018	Sep. 30, 2019
RF cable-1M	HUBER+SUHNER	SUCOFLEX104	MY22624/4	Oct. 01, 2018	Sep. 30, 2019
LF cable-0.8M	EMC	EMC8D-NM-NM-800	EMC8D-NM-NM-800-001	Oct. 01, 2018	Sep. 30, 2019
LF cable-3M	EMC	EMC8D-NM-NM-3000	131103	Oct. 01, 2018	Sep. 30, 2019
LF cable-13M	EMC	EMC8D-NM-NM-13000	131104	Oct. 01, 2018	Sep. 30, 2019
Measurement Software	AUDIX	e3	6.120210g	NA	NA

Note: Calibration Interval of instruments listed above is one year.



<b>Test Item</b>	RF Conducted				
<b>Test Site</b>	(TH01-WS)				
<b>Instrument</b>	<b>Manufacturer</b>	<b>Model No.</b>	<b>Serial No.</b>	<b>Calibration Date</b>	<b>Calibration Until</b>
Spectrum Analyzer	R&S	FSV40	101063	Apr. 17, 2019	Apr. 16, 2020
Power Meter	Anritsu	ML2495A	1241002	Oct. 09, 2018	Oct. 08, 2019
Power Sensor	Anritsu	MA2411B	1207366	Oct. 09, 2018	Oct. 08, 2019
AC POWER SOURCE	APC	AFC-500W	F312060012	Nov. 29, 2018	Nov. 28, 2019
Measurement Software	Sporton	Sporton_1	1.3.30	NA	NA
Note: Calibration Interval of instruments listed above is one year.					

## 1.5 Test Standards

According to the specification of EUT, the EUT must comply with following standards and KDB documents.

47 CFR FCC Part 15.247

ANSI C63.10-2013

FCC KDB 558074 D01 15.247 Meas Guidance v05r02

## 1.6 Deviation from Test Standard and Measurement Procedure

None

## 1.7 Measurement Uncertainty

ISO/IEC 17025 requires that an estimate of the measurement uncertainties associated with the emissions test results be included in the report. The measurement uncertainties given below are based on a 95% confidence level (based on a coverage factor (k=2))

Measurement Uncertainty	
Parameters	Uncertainty
Bandwidth	±34.130 Hz
Conducted power	±0.808 dB
Power density	±0.583 dB
Conducted emission	±2.715 dB
AC conducted emission	±2.92 dB
Radiated emission ≤ 1GHz	±3.96 dB
Radiated emission > 1GHz	±4.51 dB

## 2 Test Configuration

### 2.1 Testing Condition

Test Item	Test Site	Ambient Condition	Tested By
AC Conduction	CO01-WS	24°C / 61%	Alex Tsai
Radiated Emissions	03CH03-WS	25°C / 62%	Roger Lu
RF Conducted	TH01-WS	23°C / 64%	Brad Wu

- FCC Designation No.: TW0009
- FCC site registration No.: 207696
- ISED#: 10807A
- CAB identifier: TW2732

### 2.2 The Worst Test Modes and Channel Details

Test item	Modulation Mode	Test Frequency (MHz)	Data Rate	Test Configuration
Conducted Emissions	DSSS	2425	250kbps	---
Radiated Emissions ≤1GHz	DSSS	2425	250kbps	---
Radiated Emissions >1GHz Maximum Output Power 6dB bandwidth Power spectral density	DSSS	2425 / 2450 / 2475	250kbps	---

**NOTE:** Two adapters (LITE-ON & NETBIT) had been covered during the pretest and found that **NETBIT** adapter was the worst case for radiated emission test and **LITE-ON** adapter was the worst case for conducted emission test.

## 3 Transmitter Test Results

### 3.1 Conducted Emissions

#### 3.1.1 Limit of Conducted Emissions

Conducted Emissions Limit		
Frequency Emission (MHz)	Quasi-Peak	Average
0.15-0.5	66 - 56 *	56 - 46 *
0.5-5	56	46
5-30	60	50

Note 1: \* Decreases with the logarithm of the frequency.

#### 3.1.2 Test Procedures

1. The device is placed on a test table, raised 80 cm above the reference ground plane. The vertical conducting plane is located 40 cm to the rear of the device.
2. The device is connected to line impedance stabilization network (LISN) and other accessories are connected to other LISN. Measured levels of AC power line conducted emission are across the 50  $\Omega$  LISN port.
3. AC conducted emission measurements is made over frequency range from 150 kHz to 30 MHz.
4. This measurement was performed with AC 120V / 60Hz.

#### 3.1.3 Test Setup



- Note: 1. Support units were connected to second LISN.  
2. Both of LISNs (AMN) are 80 cm from EUT and at least 80 cm from other units and other metal planes

### 3.1.4 Test Result of Conducted Emissions

<b>Modulation</b>	DSSS	<b>Test Freq. (MHz)</b>	2425
<b>Power Phase</b>	Line		

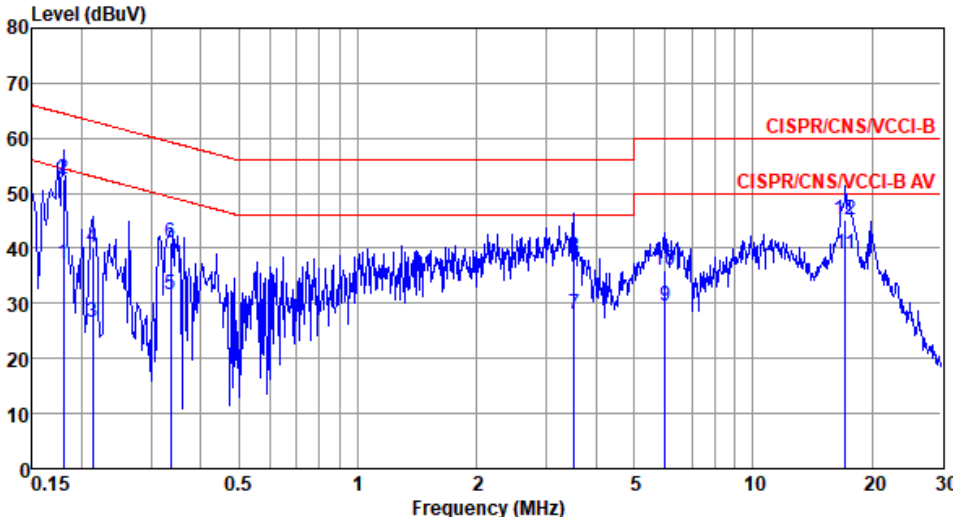

The graph displays the conducted emission levels in dBuV across a frequency range from 0.15 MHz to 30 MHz. Two red lines represent the CISPR/CNS/VCCI-B limit (upper) and the CISPR/CNS/VCCI-B AV limit (lower). The blue line shows the measured emission level, which generally stays below the limits, with some peaks near 0.15 MHz and 17.109 MHz.

	Freq	Level	Limit	Over	Read	LISN	cable	Remark
	MHz	dBuV	Line	Limit	Level	factor	loss	
			dBuV	dB	dBuV	dB	dB	
1	0.180	37.19	54.50	-17.31	27.43	9.54	0.06	Average
2	0.180	52.67	64.50	-11.83	42.91	9.54	0.06	QP
3	0.213	26.49	53.10	-26.61	16.68	9.54	0.07	Average
4	0.213	40.10	63.10	-23.00	30.29	9.54	0.07	QP
5	0.336	31.66	49.31	-17.65	21.78	9.56	0.08	Average
6	0.336	40.94	59.31	-18.37	31.06	9.56	0.08	QP
7	3.528	28.00	46.00	-18.00	17.75	9.61	0.26	Average
8	3.528	38.33	56.00	-17.67	28.08	9.61	0.26	QP
9	5.993	29.41	50.00	-20.59	19.04	9.63	0.35	Average
10	5.993	36.01	60.00	-23.99	25.64	9.63	0.35	QP
11*	17.109	39.04	50.00	-10.96	28.27	9.66	0.58	Average
12	17.109	45.24	60.00	-14.76	34.47	9.66	0.58	QP

Note 1: Level (dBuV) = Read Level (dBuV) + LISN Factor (dB) + Cable Loss (dB).  
 Note 2: Over Limit (dB) = Level (dBuV) – Limit Line (dBuV).

<b>Modulation</b>	DSSS	<b>Test Freq. (MHz)</b>	2425
<b>Power Phase</b>	Neutral		

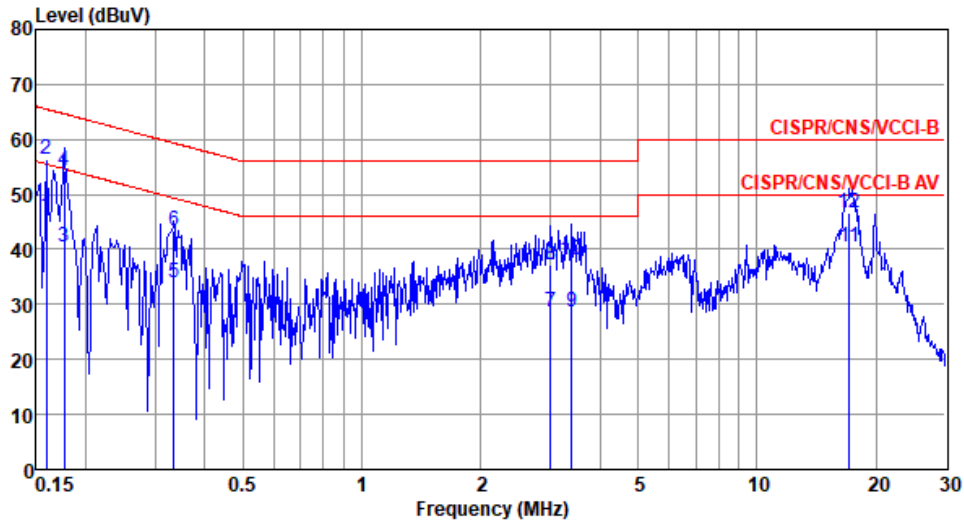

	Freq MHz	Level dBuV	Limit Line dBuV	Over Limit dB	Read Level dBuV	LISN factor dB	cable loss dB	Remark
1	0.159	46.10	55.52	-9.42	36.36	9.57	0.05	Average
2*	0.159	56.47	65.52	-9.05	46.73	9.57	0.05	QP
3	0.177	40.54	54.64	-14.10	30.77	9.58	0.06	Average
4	0.177	54.34	64.64	-10.30	44.57	9.58	0.06	QP
5	0.334	34.08	49.35	-15.27	24.27	9.60	0.08	Average
6	0.334	43.41	59.35	-15.94	33.60	9.60	0.08	QP
7	3.009	28.66	46.00	-17.34	18.51	9.66	0.23	Average
8	3.009	37.10	56.00	-18.90	26.95	9.66	0.23	QP
9	3.399	28.67	46.00	-17.33	18.50	9.66	0.25	Average
10	3.399	38.08	56.00	-17.92	27.91	9.66	0.25	QP
11	17.109	40.58	50.00	-9.42	29.82	9.79	0.58	Average
12	17.109	46.73	60.00	-13.27	35.97	9.79	0.58	QP

Note 1: Level (dBuV) = Read Level (dBuV) + LISN Factor (dB) + Cable Loss (dB).  
 2: Over Limit (dB) = Level (dBuV) – Limit Line (dBuV).

## 3.2 6dB and Occupied Bandwidth

### 3.2.1 Limit of 6dB Bandwidth

The minimum 6dB bandwidth shall be at least 500 kHz.

### 3.2.2 Test Procedures

#### 6dB Bandwidth

1. Set resolution bandwidth (RBW) = 100 kHz, Video bandwidth = 300 kHz.
2. Detector = Peak, Trace mode = max hold.
3. Sweep = auto couple, Allow the trace to stabilize.
4. Measure the maximum width of the emission that is constrained by the frequencies associated with the two outermost amplitude points (upper and lower) that are attenuated by 6dB relative to the maximum level measured in the fundamental emission.

#### Occupied Bandwidth

1. Set resolution bandwidth (RBW) = 1 MHz, Video bandwidth = 3 MHz.
2. Detector = Sample, Trace mode = max hold.
3. Sweep = auto couple, Allow the trace to stabilize.
4. Use the OBW measurement function of spectrum analyzer to measure the occupied bandwidth.

### 3.2.3 Test Setup

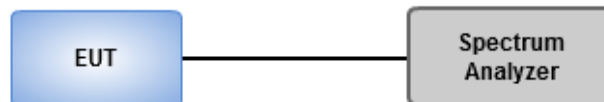

### 3.2.4 Test Result of 6dB and Occupied Bandwidth

#### Summary

Mode	Max-N dB (Hz)	Max-OBW (Hz)	ITU-Code	Min-N dB (Hz)	Min-OBW (Hz)
2.4-2.4835GHz	-	-	-	-	-
RF4CE	1.612M	2.368M	2M37G1D	1.594M	2.342M

**Max-N dB** = Maximum 6dB down bandwidth; **Max-OBW** = Maximum 99% occupied bandwidth;  
**Min-N dB** = Minimum 6dB down bandwidth; **Min-OBW** = Minimum 99% occupied bandwidth;

#### Result

Mode	Result	Limit (Hz)	Port 1-N dB (Hz)	Port 1-OBW (Hz)
RF4CE	-	-	-	-
2425MHz	Pass	500k	1.594M	2.368M
2450MHz	Pass	500k	1.612M	2.342M
2475MHz	Pass	500k	1.594M	2.363M

**Port X-N dB** = Port X 6dB down bandwidth; **Port X-OBW** = Port X 99% occupied bandwidth;

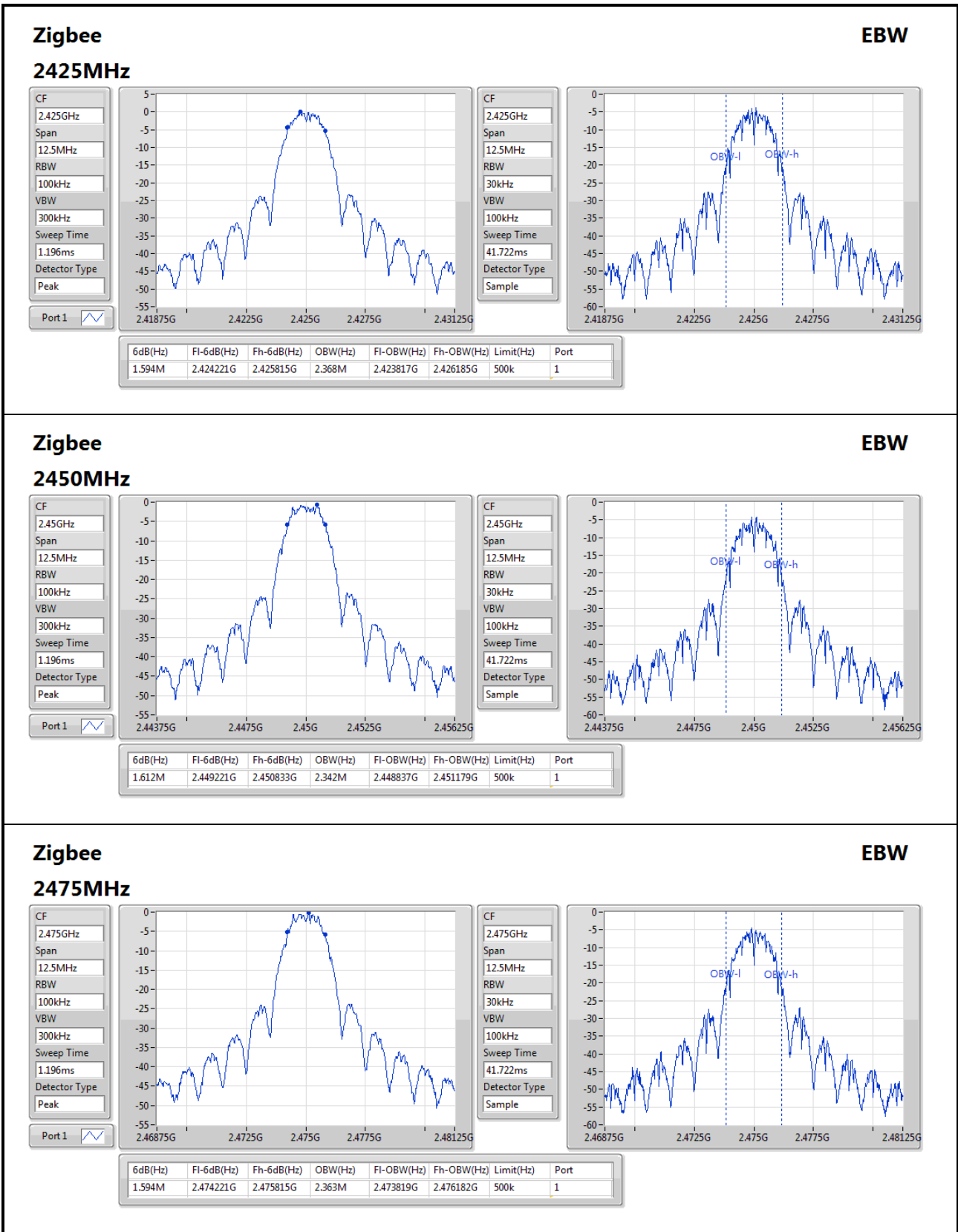



### 3.3 RF Output Power

#### 3.3.1 Limit of RF Output Power

Conducted power shall not exceed 1Watt.

Antenna gain  $\leq 6\text{dBi}$ , no any corresponding reduction is in output power limit.

#### 3.3.2 Test Procedures

A broadband RF power meter is used for output power measurement. The video bandwidth of power meter is greater than DTS bandwidth of EUT. If duty cycle of test signal is not 100 %, trigger and gating function of power meter will be enabled to capture transmission burst for measuring output power.

#### 3.3.3 Test Setup

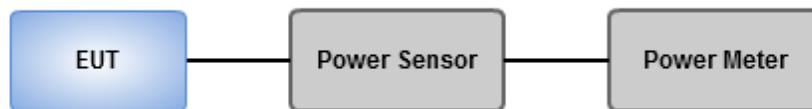

### 3.3.4 Test Result of Maximum Output Power

#### Summary of Peak Power

Mode	Total Power (dBm)	Total Power (W)
2.4-2.4835GHz	-	-
RF4CE	4.09	0.00256

#### Result

Mode	Result	DG (dBi)	Port 1 (dBm)	Total Power (dBm)	Power Limit (dBm)
RF4CE	-	-	-	-	-
2425MHz	Pass	3.36	4.09	4.09	30.00
2450MHz	Pass	3.36	3.55	3.55	30.00
2475MHz	Pass	3.36	3.80	3.80	30.00

DG = Directional Gain; Port X = Port X output power

#### Summary of Average Power

Mode	Total Power (dBm)	Total Power (W)
2.4-2.4835GHz	-	-
RF4CE	3.99	0.00251

#### Result

Mode	Result	DG (dBi)	Port 1 (dBm)	Total Power (dBm)	Power Limit (dBm)
RF4CE	-	-	-	-	-
2425MHz	Pass	3.36	3.99	3.99	-
2450MHz	Pass	3.36	3.43	3.43	-
2475MHz	Pass	3.36	3.69	3.69	-

DG = Directional Gain; Port X = Port X output power

Note : Conducted average output power is for reference only

## 3.4 Power Spectral Density

### 3.4.1 Limit of Power Spectral Density

Power spectral density shall not be greater than 8 dBm in any 3 kHz band.

### 3.4.2 Test Procedures

1. Set the RBW = 3 kHz, VBW = 10 kHz.
2. Detector = Peak, Sweep time = auto couple.
3. Trace mode = max hold, allow trace to fully stabilize.
4. Use the peak marker function to determine the maximum amplitude level.

### 3.4.3 Test Setup

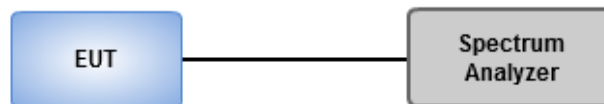

### 3.4.4 Test Result of Power Spectral Density

#### Summary

Mode	PD (dBm/RBW)
2.4-2.4835GHz	-
RF4CE	-11.01

#### Result

Mode	Result	DG (dBi)	Port 1 (dBm/RBW)	PD (dBm/RBW)	PD Limit (dBm/RBW)
RF4CE	-	-	-	-	-
2425MHz	Pass	3.36	-11.01	-11.01	8.00
2450MHz	Pass	3.36	-11.94	-11.94	8.00
2475MHz	Pass	3.36	-11.75	-11.75	8.00

DG = Directional Gain;

PD = trace bin-by-bin of each transmits port summing can be performed maximum power density; **Port X** = Port X power density;

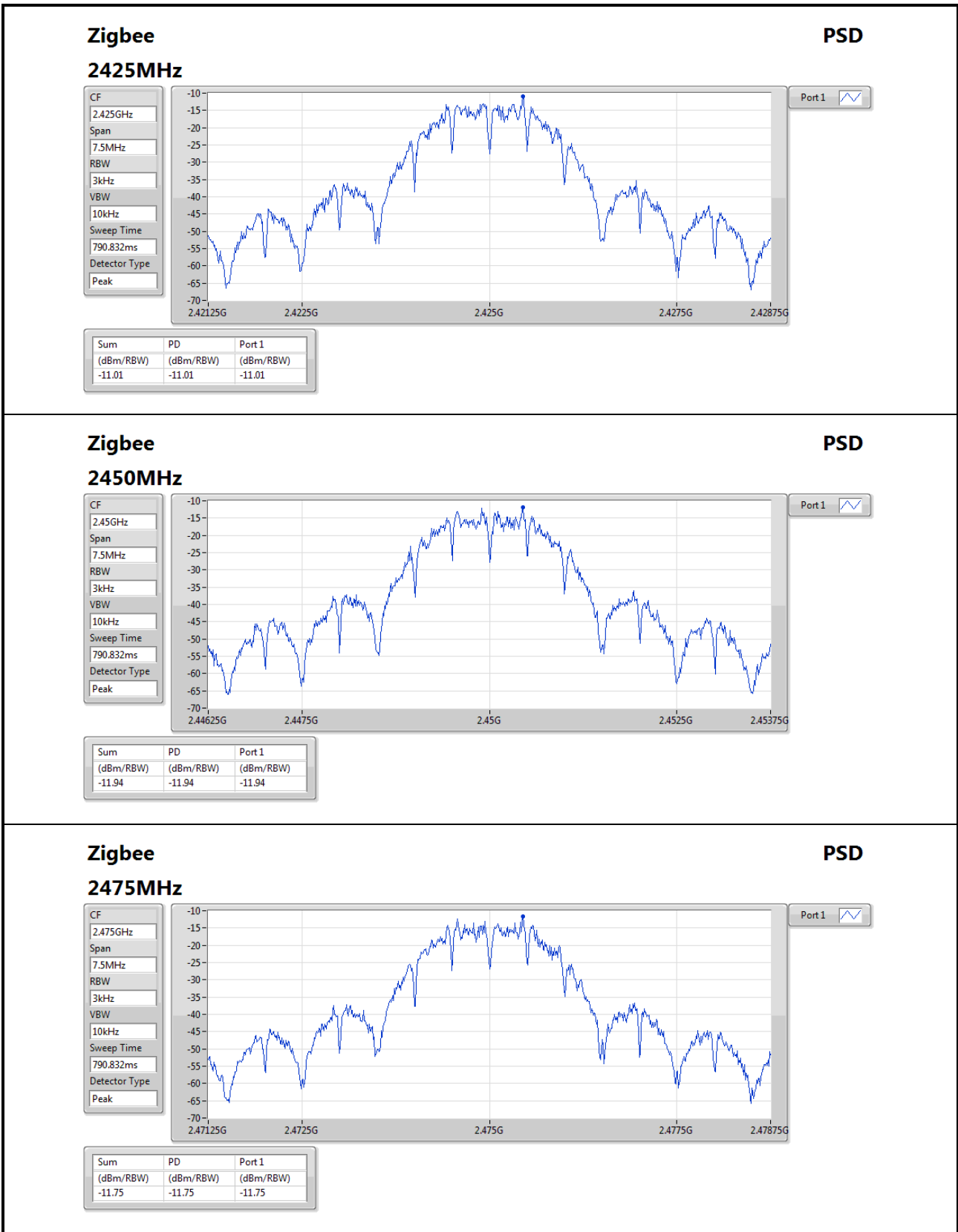

## 3.5 Unwanted Emissions into Restricted Frequency Bands

### 3.5.1 Limit of Unwanted Emissions into Restricted Frequency Bands

Restricted Band Emissions Limit			
Frequency Range (MHz)	Field Strength (uV/m)	Field Strength (dBuV/m)	Measure Distance (m)
0.009~0.490	2400/F(kHz)	48.5 - 13.8	300
0.490~1.705	24000/F(kHz)	33.8 - 23	30
1.705~30.0	30	29	30
30~88	100	40	3
88~216	150	43.5	3
216~960	200	46	3
Above 960	500	54	3

**Note 1:**  
Quasi-Peak value is measured for frequency below 1GHz except for 9–90 kHz, 110–490 kHz frequency band. Peak and average value are measured for frequency above 1GHz. The limit on average radio frequency emission is as above table. The limit on peak radio frequency emissions is 20 dB above the maximum permitted average emission limit

**Note 2:**  
Measurements may be performed at a distance other than what is specified provided. When performing measurements at a distance other than that specified, the results shall be extrapolated to the specified distance using an extrapolation factor as below, Frequency at or above 30 MHz: 20 dB/decade Frequency below 30 MHz: 40 dB/decade.

### 3.5.2 Test Procedures

1. Measurement is made at a semi-anechoic chamber that incorporates a turntable allowing a EUT rotation of 360°. A continuously-rotating, remotely-controlled turntable is installed at the test site to support the EUT and facilitate determination of the direction of maximum radiation for each EUT emission frequency. The EUT is placed at test table. For emissions testing at or below 1 GHz, the table height is 80 cm above the reference ground plane. For emission measurements above 1 GHz, the table height is 1.5 m
2. Measurement is made with the antenna positioned in both the horizontal and vertical planes of polarization. The measurement antenna is varied in height (1m ~ 4m) above the reference ground plane to obtain the maximum signal strength. Distance between EUT and antenna is 3 m.
3. This investigation is performed with the EUT rotated 360°, the antenna height scanned between 1 m and 4 m, and the antenna rotated to repeat the measurements for both the horizontal and vertical antenna polarizations.

**Note:**

1. 120kHz measurement bandwidth of test receiver and Quasi-peak detector is for radiated emission below 1GHz.
2. RBW=1MHz, VBW=3MHz and Peak detector is for peak measured value of radiated emission above 1GHz.
3. RBW=1MHz, VBW=1/T and Peak detector is for average measured value of radiated emission above 1GHz.

### 3.5.3 Test Setup

#### Radiated Emissions below 1 GHz

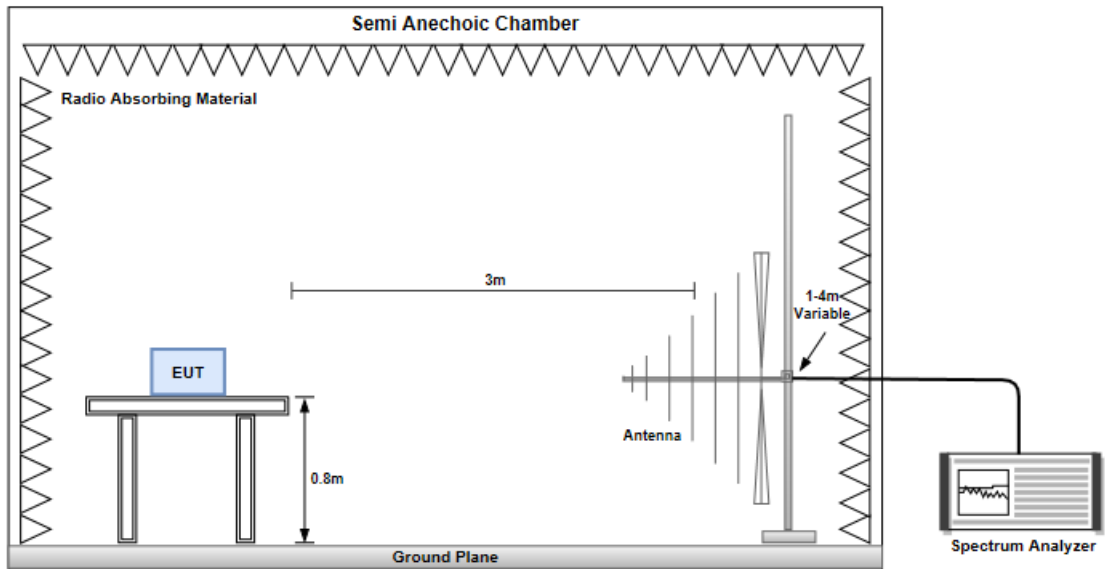

#### Radiated Emissions above 1 GHz

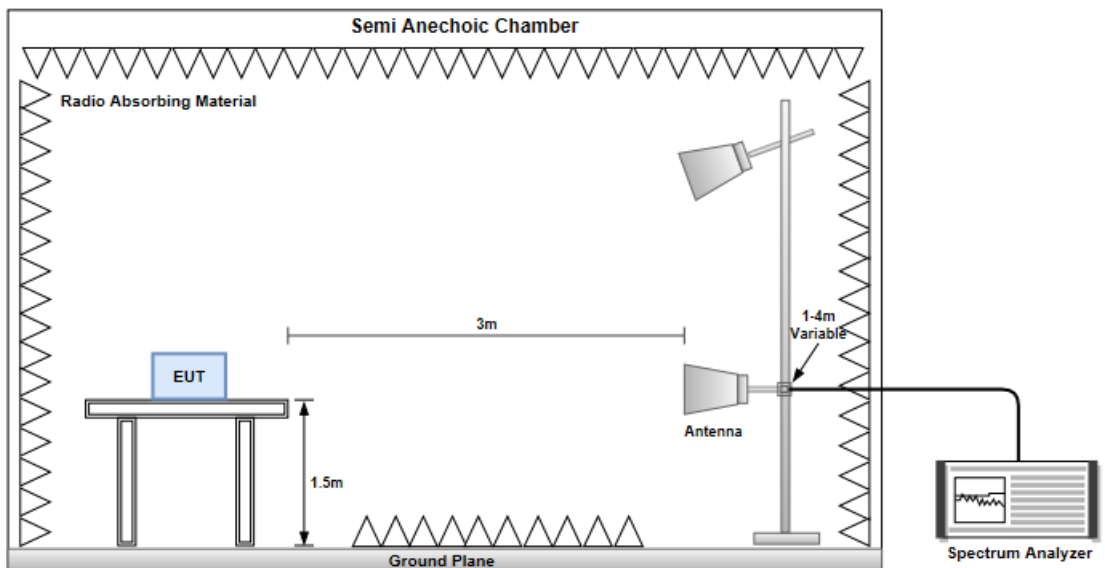

### 3.5.4 Transmitter Radiated Unwanted Emissions (Below 1GHz)

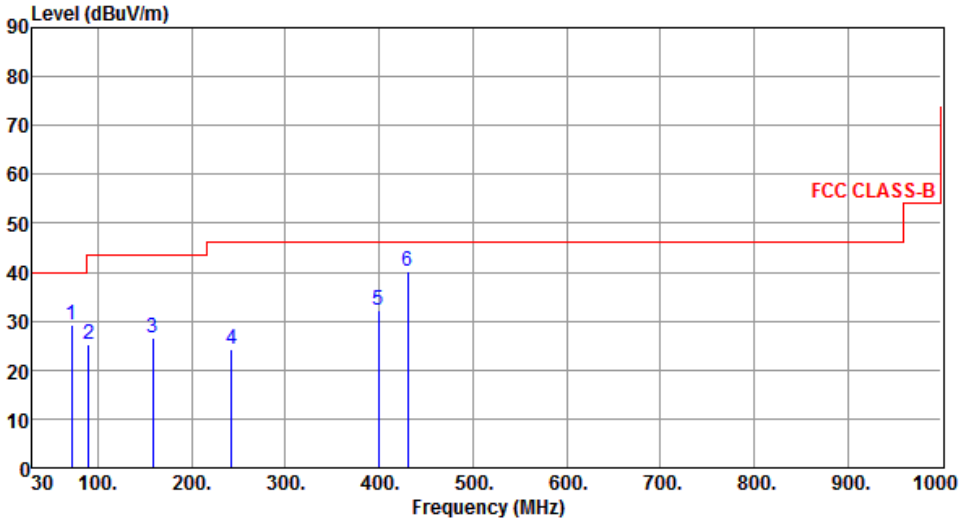
Modulation	GFSK	Test Freq. (MHz)	2425						
Polarization	Horizontal								
									
	Freq.	Emission level	Limit	Margin	SA reading	Factor	Remark	ANT High	Turn Table
	MHz	dBuV/m	dBuV/m	dB	dBuV	dB		cm	deg
1	71.69	29.31	40.00	-10.69	40.29	-10.98	Peak	---	---
2	90.26	25.23	43.50	-18.27	40.01	-14.78	Peak	---	---
3	158.12	26.55	43.50	-16.95	35.25	-8.70	Peak	---	---
4	242.51	24.12	46.00	-21.88	34.42	-10.30	Peak	---	---
5	399.62	32.12	46.00	-13.88	37.94	-5.82	Peak	---	---
6	430.61	40.21	46.00	-5.79	45.09	-4.88	Peak	---	---
<p>Note 1: Emission Level (dBuV/m) = SA Reading (dBuV/m) + Factor* (dB)            *Factor includes antenna factor , cable loss and amplifier gain            Note 2: Margin (dB) = Emission level (dBuV/m) – Limit (dBuV/m).            Note 3: All spurious emissions below 30MHz are more than 20 dB below the limit.</p>									



<b>Modulation</b>	GFSK	<b>Test Freq. (MHz)</b>	2425
<b>Polarization</b>	Vertical		

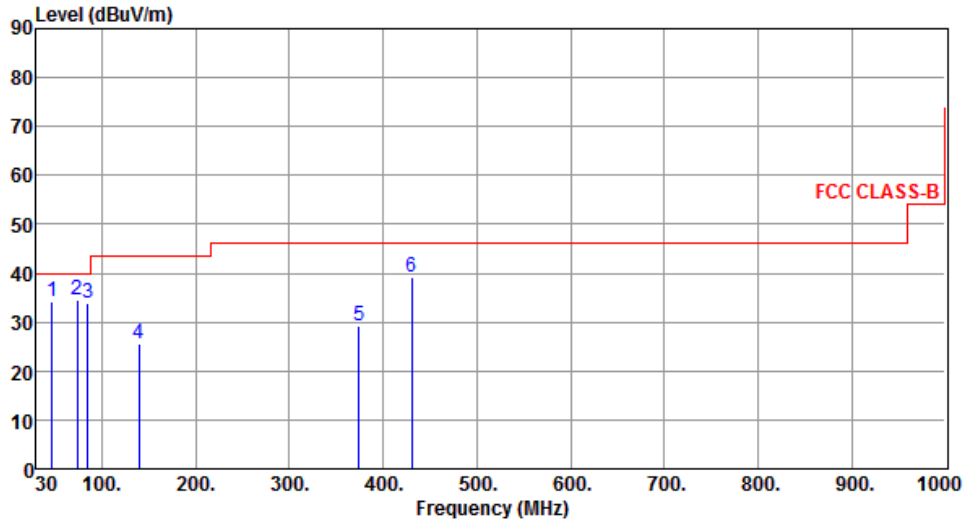

	Freq. MHz	Emission level dBuV/m	Limit dBuV/m	Margin dB	SA reading dBuV	Factor dB	Remark	ANT High cm	Turn Table deg
1	46.52	34.19	40.00	-5.81	42.84	-8.65	Peak	---	---
2	73.59	34.62	40.00	-5.38	46.38	-11.76	Peak	---	---
3	85.31	33.85	40.00	-6.15	48.30	-14.45	Peak	---	---
4	139.59	25.48	43.50	-18.02	34.82	-9.34	Peak	---	---
5	374.52	29.29	46.00	-16.71	35.73	-6.44	Peak	---	---
6	430.61	39.31	46.00	-6.69	44.19	-4.88	Peak	---	---

Note 1: Emission Level (dBuV/m) = SA Reading (dBuV/m) + Factor\* (dB)

\*Factor includes antenna factor , cable loss and amplifier gain

Note 2: Margin (dB) = Emission level (dBuV/m) – Limit (dBuV/m).

Note 3: All spurious emissions below 30MHz are more than 20 dB below the limit.

### 3.5.5 Transmitter Radiated Unwanted Emissions (Above 1GHz) for GFSK

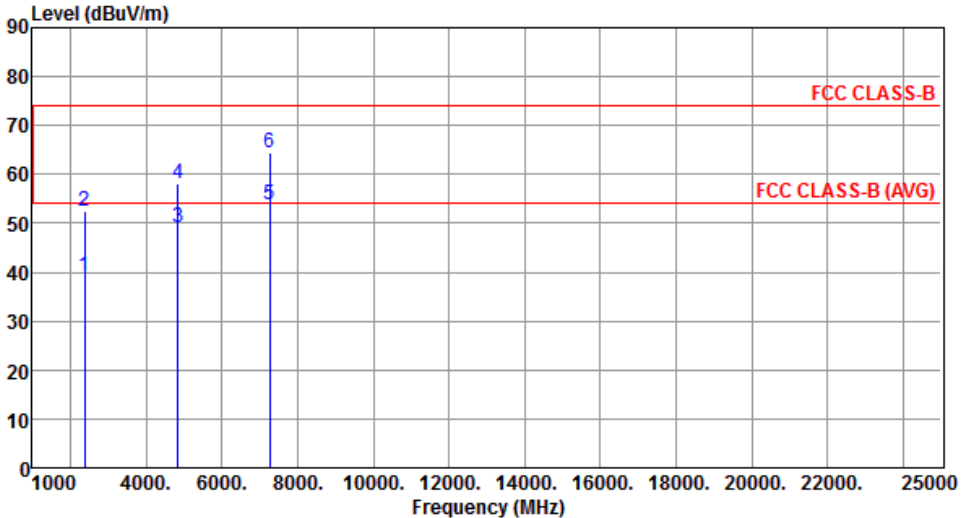
Modulation	GFSK	Test Freq. (MHz)	2425						
Polarization	Horizontal								
									
	Freq.	Emission level	Limit	Margin	SA reading	Factor	Remark	ANT High	Turn Table
	MHz	dBuV/m	dBuV/m	dB	dBuV	dB		cm	deg
	1	2390.00	39.30	54.00	-14.70	40.26	-0.96	Average	115 244
	2	2390.00	52.50	74.00	-21.50	53.46	-0.96	Peak	115 244
	3	4850.00	49.10	54.00	-4.90	44.16	4.94	Average	100 256
	4	4850.00	58.08	74.00	-15.92	53.14	4.94	Peak	100 256
	5	7275.00	53.80	54.00	-0.20	43.41	10.39	Average	100 261
	6	7275.00	64.39	74.00	-9.61	54.00	10.39	Peak	100 261
<p>Note 1: Emission Level (dBuV/m) = SA Reading (dBuV/m) + Factor* (dB)            *Factor includes antenna factor , cable loss and amplifier gain            Note 2: Margin (dB) = Emission level (dBuV/m) – Limit (dBuV/m).</p>									

<b>Modulation</b>	GFSK	<b>Test Freq. (MHz)</b>	2425
<b>Polarization</b>	Vertical		

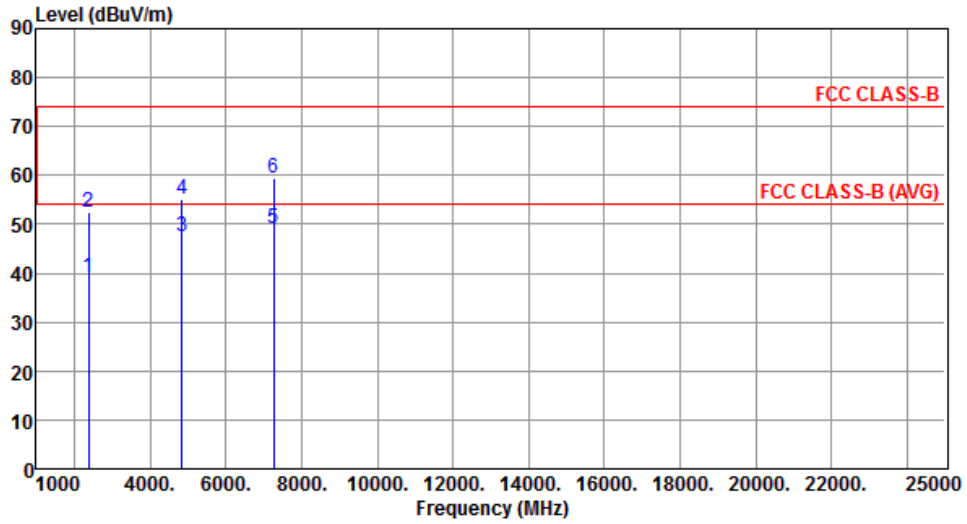

	Freq. MHz	Emission level dBuV/m	Limit dBuV/m	Margin dB	SA reading dBuV	Factor dB	Remark	ANT High cm	Turn Table deg
1	2390.00	39.35	54.00	-14.65	40.31	-0.96	Average	100	105
2	2390.00	52.55	74.00	-21.45	53.51	-0.96	Peak	100	105
3	4850.00	47.42	54.00	-6.58	42.48	4.94	Average	100	213
4	4850.00	55.20	74.00	-18.80	50.26	4.94	Peak	100	213
5	7275.00	49.01	54.00	-4.99	38.62	10.39	Average	100	116
6	7275.00	59.51	74.00	-14.49	49.12	10.39	Peak	100	116

Note 1: Emission Level (dBuV/m) = SA Reading (dBuV/m) + Factor\* (dB)

\*Factor includes antenna factor , cable loss and amplifier gain

Note 2: Margin (dB) = Emission level (dBuV/m) – Limit (dBuV/m).

<b>Modulation</b>	GFSK	<b>Test Freq. (MHz)</b>	2450
<b>Polarization</b>	Horizontal		

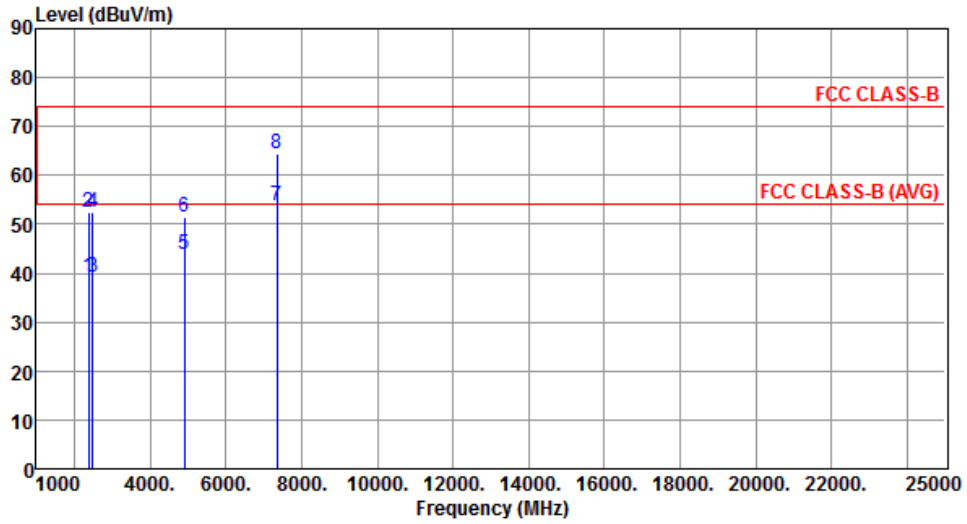

	Freq. MHz	Emission level dBuV/m	Limit dBuV/m	Margin dB	SA reading dBuV	Factor dB	Remark	ANT High cm	Turn Table deg
1	2390.00	39.30	54.00	-14.70	40.26	-0.96	Average	105	244
2	2390.00	52.58	74.00	-21.42	53.54	-0.96	Peak	105	244
3	2483.50	39.15	54.00	-14.85	40.27	-1.12	Average	105	244
4	2483.50	52.56	74.00	-21.44	53.68	-1.12	Peak	105	244
5	4900.00	43.84	54.00	-10.16	38.95	4.89	Average	100	250
6	4900.00	51.58	74.00	-22.42	46.69	4.89	Peak	100	250
7	7350.00	53.75	54.00	-0.25	43.50	10.25	Average	116	265
8	7350.00	64.26	74.00	-9.74	54.01	10.25	Peak	116	265

Note 1: Emission Level (dBuV/m) = SA Reading (dBuV/m) + Factor\* (dB)

\*Factor includes antenna factor , cable loss and amplifier gain

Note 2: Margin (dB) = Emission level (dBuV/m) – Limit (dBuV/m).

<b>Modulation</b>	GFSK	<b>Test Freq. (MHz)</b>	2450
<b>Polarization</b>	Vertical		

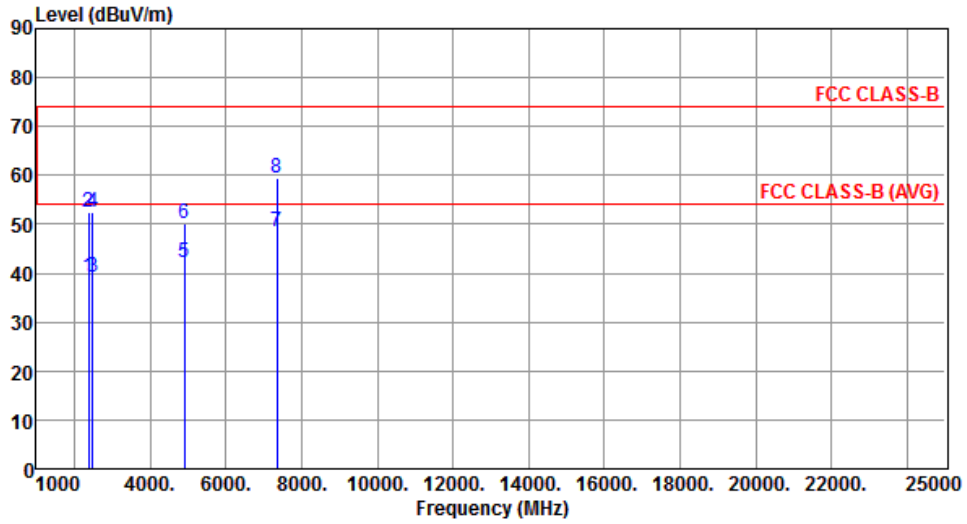

	Freq. MHz	Emission level dBuV/m	Limit dBuV/m	Margin dB	SA reading dBuV	Factor dB	Remark	ANT High cm	Turn Table deg
1	2390.00	39.35	54.00	-14.65	40.31	-0.96	Average	100	109
2	2390.00	52.46	74.00	-21.54	53.42	-0.96	Peak	100	109
3	2483.50	39.09	54.00	-14.91	40.21	-1.12	Average	100	109
4	2483.50	52.33	74.00	-21.67	53.45	-1.12	Peak	100	109
5	4900.00	42.21	54.00	-11.79	37.32	4.89	Average	100	215
6	4900.00	50.30	74.00	-23.70	45.41	4.89	Peak	100	215
7	7350.00	48.65	54.00	-5.35	38.40	10.25	Average	100	113
8	7350.00	59.40	74.00	-14.60	49.15	10.25	Peak	100	113

Note 1: Emission Level (dBuV/m) = SA Reading (dBuV/m) + Factor\* (dB)

\*Factor includes antenna factor , cable loss and amplifier gain

Note 2: Margin (dB) = Emission level (dBuV/m) – Limit (dBuV/m).

<b>Modulation</b>	GFSK	<b>Test Freq. (MHz)</b>	2475
<b>Polarization</b>	Horizontal		

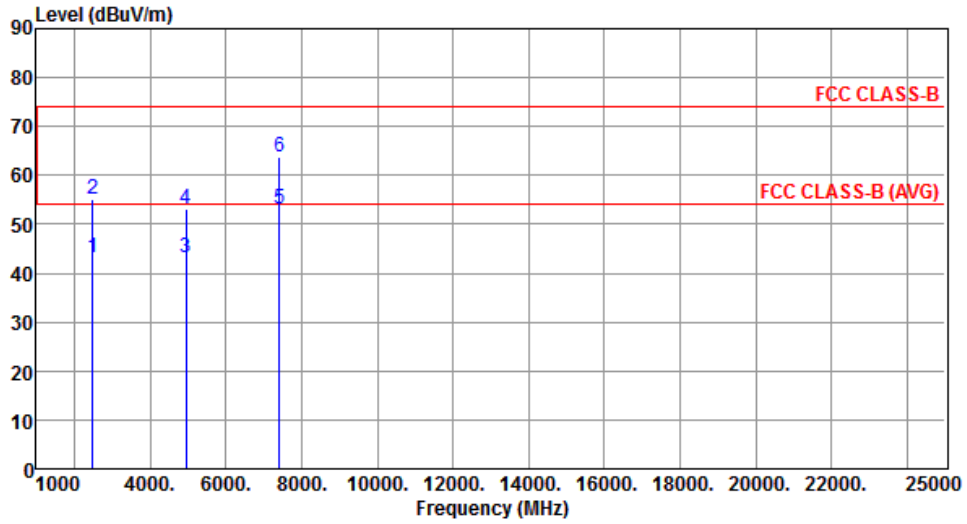

	Freq. MHz	Emission level dBuV/m	Limit dBuV/m	Margin dB	SA reading dBuV	Factor dB	Remark	ANT High cm	Turn Table deg
1	2483.50	43.01	54.00	-10.99	44.13	-1.12	Average	105	238
2	2483.50	55.04	74.00	-18.96	56.16	-1.12	Peak	105	238
3	4950.00	43.29	54.00	-10.71	38.15	5.14	Average	100	254
4	4950.00	53.07	74.00	-20.93	47.93	5.14	Peak	100	254
5	7425.00	53.21	54.00	-0.79	42.95	10.26	Average	100	260
6	7425.00	63.79	74.00	-10.21	53.53	10.26	Peak	100	260

Note 1: Emission Level (dBuV/m) = SA Reading (dBuV/m) + Factor\* (dB)

\*Factor includes antenna factor , cable loss and amplifier gain

Note 2: Margin (dB) = Emission level (dBuV/m) – Limit (dBuV/m).

<b>Modulation</b>	GFSK	<b>Test Freq. (MHz)</b>	2475
<b>Polarization</b>	Vertical		

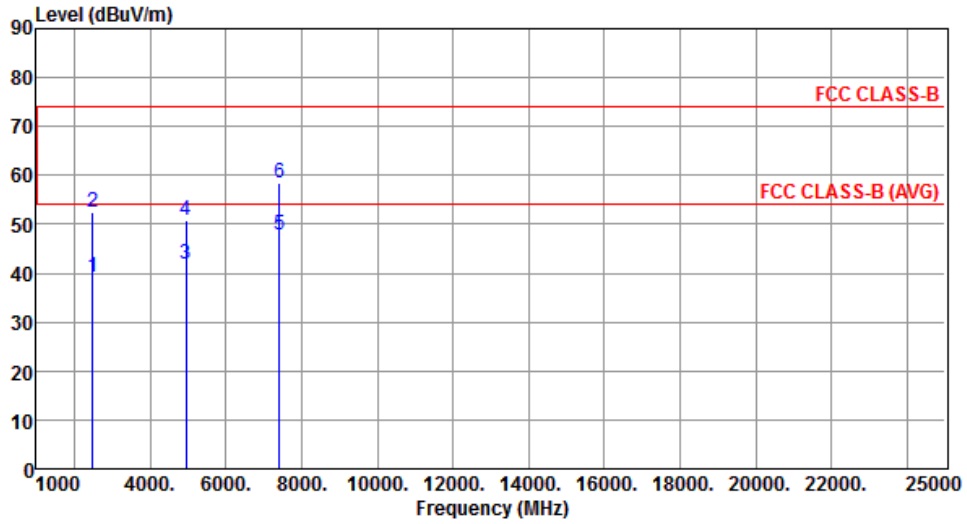

	Freq. MHz	Emission level dBuV/m	Limit dBuV/m	Margin dB	SA reading dBuV	Factor dB	Remark	ANT High cm	Turn Table deg
1	2483.50	39.14	54.00	-14.86	40.26	-1.12	Average	100	102
2	2483.50	52.37	74.00	-21.63	53.49	-1.12	Peak	100	102
3	4950.00	41.79	54.00	-12.21	36.65	5.14	Average	100	214
4	4950.00	50.70	74.00	-23.30	45.56	5.14	Peak	100	214
5	7425.00	47.93	54.00	-6.07	37.67	10.26	Average	100	115
6	7425.00	58.52	74.00	-15.48	48.26	10.26	Peak	100	115

Note 1: Emission Level (dBuV/m) = SA Reading (dBuV/m) + Factor\* (dB)

\*Factor includes antenna factor , cable loss and amplifier gain

Note 2: Margin (dB) = Emission level (dBuV/m) – Limit (dBuV/m).

## 3.6 Emissions in Non-Restricted Frequency Bands

### 3.6.1 Emissions in Non-Restricted Frequency Bands Limit

Peak power in any 100 kHz bandwidth outside of the authorized frequency band shall be attenuated by at least 20 dB relative to the maximum in-band peak PSD level in 100 kHz el in 100 kHz.

### 3.6.2 Test Procedures

#### Reference level measurement

1. Set RBW=100 kHz, VBW = 300 kHz , Detector = Peak, Sweep time = Auto.
2. Trace = max hold, Allow Trace to fully stabilize.
3. Use the peak marker function to determine the maximum PSD level.

#### Emission level measurement

1. Set RBW=100 kHz, VBW = 300 kHz , Detector = Peak, Sweep time = Auto.
2. Trace = max hold, Allow Trace to fully stabilize.
3. Scan Frequency range is up to 25GHz.
4. Use the peak marker function to determine the maximum amplitude level.

### 3.6.3 Test Setup

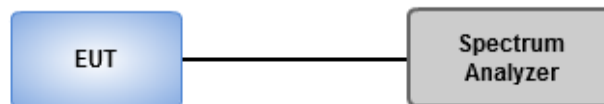



### 3.6.4 Unwanted Emissions into Non-Restricted Frequency Bands

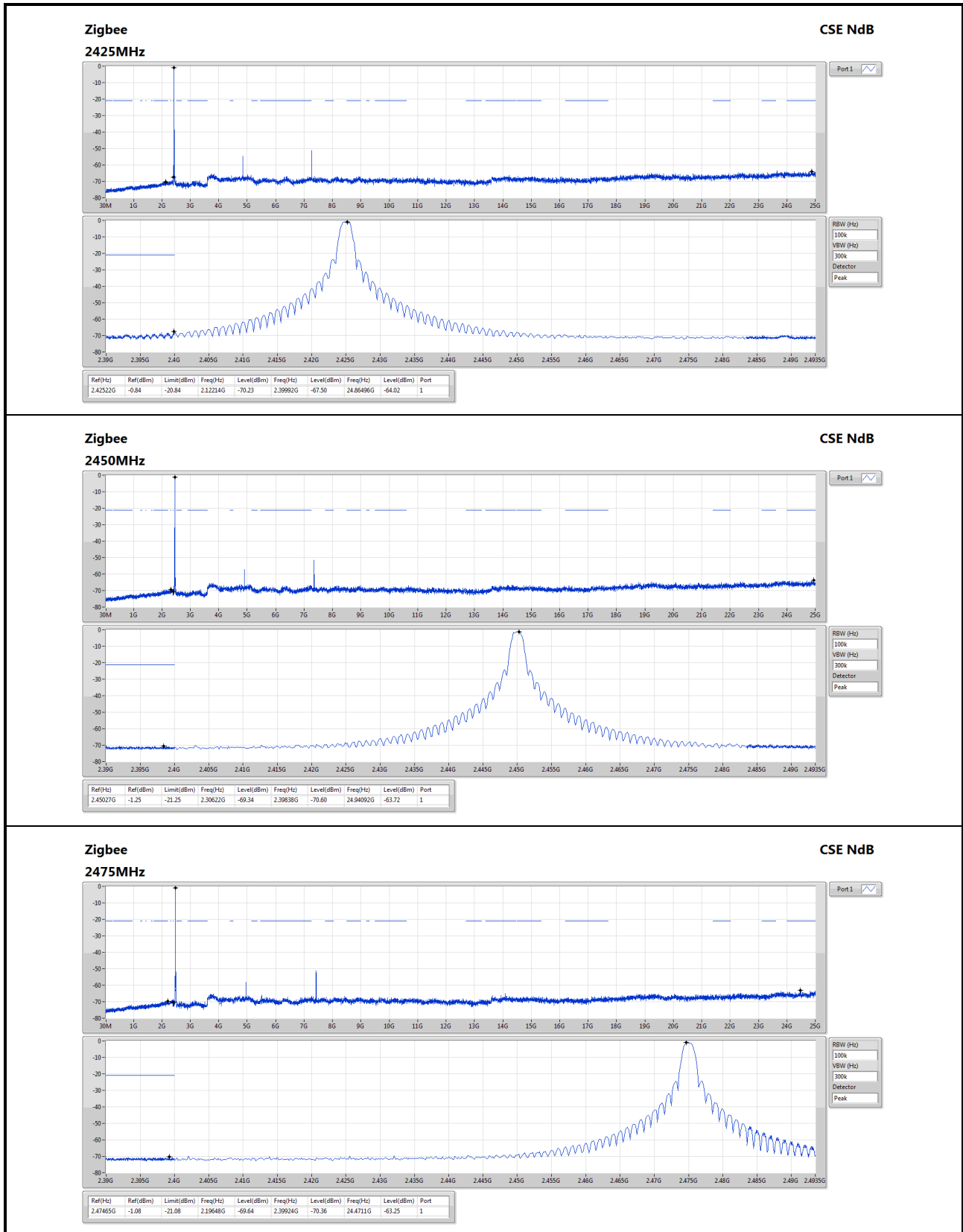

## 4 Test laboratory information

Established in 2012, ICC provides foremost EMC & RF Testing and advisory consultation services by our skilled engineers and technicians. Our services employ a wide variety of advanced edge test equipment and one of the widest certification extents in the business.

International Certification Corp (EMC and Wireless Communication Laboratory), it is our definitive objective is to institute long term, trust-based associations with our clients. The expectation we set up with our clients is based on outstanding service, practical expertise and devotion to a certified value structure. Our passion is to grant our clients with best EMC / RF services by oriented knowledgeable and accommodating staff.

Our Test sites are located at Linkou District and Kwei Shan District. Location map can be found on our website <http://www.icertifi.com.tw>.

### **Linkou**

Tel: 886-2-2601-1640

No. 30-2, Ding Fwu Tsuen, Lin  
Kou District, New Taipei City,  
Taiwan, R.O.C.

### **Kwei Shan**

Tel: 886-3-271-8666

No. 3-1, Lane 6, Wen San 3rd St.,  
Kwei Shan District, Tao Yuan City  
333, Taiwan, R.O.C.

### **Kwei Shan Site II**

Tel: 886-3-271-8640

No. 14-1, Lane 19, Wen San 3rd  
St., Kwei Shan District, Tao Yuan  
City 333, Taiwan, R.O.C.

If you have any suggestion, please feel free to contact us as below information.

Tel: 886-3-271-8666

Fax: 886-3-318-0155

Email: ICC\_Service@icertifi.com.tw

==END==