

# FCC Test Report

**FCC ID** : ACQ-MG3R  
**Equipment** : Set Top Box  
**Model No.** : MG3-R  
**Brand Name** : TiVo  
**Applicant** : ARRIS  
**Address** : 101 Tournament Drive, Horsham  
Pennsylvania, United States, 19044  
**Standard** : 47 CFR FCC Part 15.247  
**Received Date** : Mar. 20, 2019  
**Tested Date** : Apr. 23 ~ May 28, 2019

We, International Certification Corp., would like to declare that the tested sample has been evaluated and in compliance with the requirement of the above standards. The test results contained in this report refer exclusively to the product. It may be duplicated completely for legal use with the approval of the applicant. It shall not be reproduced except in full without the written approval of our laboratory.

Reviewed by:

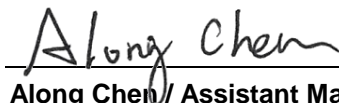

Along Chen / Assistant Manager

Approved by:



Gary Chang / Manager



---

## Table of Contents

<b>1</b>	<b>GENERAL DESCRIPTION .....</b>	<b>5</b>
1.1	Information.....	5
1.2	Local Support Equipment List .....	8
1.3	Test Setup Chart .....	9
1.4	The Equipment List .....	11
1.5	Test Standards .....	12
1.6	Deviation from Test Standard and Measurement Procedure.....	12
1.7	Measurement Uncertainty .....	12
<b>2</b>	<b>TEST CONFIGURATION .....</b>	<b>13</b>
2.1	Testing Condition .....	13
2.2	The Worst Test Modes and Channel Details .....	13
<b>3</b>	<b>TRANSMITTER TEST RESULTS.....</b>	<b>14</b>
3.1	Conducted Emissions.....	14
3.2	6dB and Occupied Bandwidth .....	19
3.3	RF Output Power.....	27
3.4	Power Spectral Density .....	30
3.5	Unwanted Emissions into Restricted Frequency Bands .....	38
3.6	Emissions in Non-Restricted Frequency Bands.....	74
<b>4</b>	<b>TEST LABORATORY INFORMATION .....</b>	<b>80</b>

---

## Release Record

Report No.	Version	Description	Issued Date
FR932003AC	Rev. 01	Initial issue	Jun. 10, 2019

## Summary of Test Results

FCC Rules	Test Items	Measured	Result
15.207	Conducted Emissions	[dBuV]: 0.159MHz 49.61 (Margin -5.91dB) - AV	Pass
15.247(d) 15.209	Radiated Emissions	[dBuV/m at 3m]: 2487.00MHz 53.86 (Margin -0.14dB) - AV	Pass
15.247(b)(3)	Maximum Output Power	Max Power [dBm]: <b>Non-beamforming mode</b> 29.87 <b>Beamforming mode</b> 25.70	Pass
15.247(a)(2)	6dB Bandwidth	Meet the requirement of limit	Pass
15.247(e)	Power Spectral Density	Meet the requirement of limit	Pass
15.203	Antenna Requirement	Meet the requirement of limit	Pass

### Declaration of Conformity:

The test results with all measurement uncertainty excluded are presented in accordance with the regulation limits or requirements declared by manufacturers.

### Comments and Explanations:

The declared of product specification for EUT presented in the report are provided by the manufacturer, and the manufacturer takes all the responsibilities for the accuracy of product specification.

# 1 General Description

## 1.1 Information

### 1.1.1 Specification of the Equipment under Test (EUT)

RF General Information					
Frequency Range (MHz)	IEEE Std. 802.11	Ch. Freq. (MHz)	Channel Number	Transmit Chains (N <sub>TX</sub> )	Data Rate / MCS
2400-2483.5	b	2412-2462	1-11 [11]	4	1-11 Mbps
2400-2483.5	g	2412-2462	1-11 [11]	4	6-54 Mbps
2400-2483.5	n (HT20)	2412-2462	1-11 [11]	4	MCS 0-31
2400-2483.5	n (HT40)	2422-2452	3-9 [7]	4	MCS 0-31
2400-2483.5	ac (VHT20)	2412-2462	1-11 [11]	4	MCS 0-9
2400-2483.5	ac (VHT40)	2422-2452	3-9 [7]	4	MCS 0-9

Note 1: RF output power specifies that Maximum Conducted (Average) Output Power.  
 Note 2: 802.11b uses a combination of DSSS-DBPSK, DQPSK, CCK modulation.  
 Note 3: 802.11g/n/ac uses a combination of OFDM-BPSK, QPSK, 16QAM, 64QAM, 256QAM modulation..  
 Note 4: 802.11ac supports beamforming function.

### 1.1.2 Antenna Details

Ant. No.	Model	Type	Connector	Operating Frequencies (MHz) / Antenna Gain (dBi)				
				2400~2483.5	5150~5250	5250~5350	5470~5725	5725~5850
1	M2420ARVS U_G115U	PIFA	UFL	3.2	4.1	4.7	5.1	5.1
2	M2420ARHS U_G55U	PIFA	UFL	3	4.9	4.2	5.3	5.5
3	M2420SDAR VSU_G120U	PIFA	UFL	2.5	5.3	6	5.5	3
4	M2420SDAR VSU_G270U	PIFA	UFL	2.8	4.5	4.5	4.2	2.8

### 1.1.3 Power Supply Type of Equipment under Test (EUT)

<b>Power Supply Type</b>	12Vdc from adapter
--------------------------	--------------------

### 1.1.4 Accessories

Accessories		
No.	Equipment	Description
1	Adapter	Brand: TiVo Manufacturer: LITE-ON INC Model: PB-1300-3AR5 Power Rating: I/P: 100-120Vac, 1.0A, 60Hz O/P: 12Vdc, 2.5A Power Line: 1.8m non-shielded without core
2	Adapter	Brand: TiVo Manufacturer: NETBIT ELECTRONICS LTD. Model: NBS36E120250VU Power Rating: I/P: 100-120Vac, 60Hz, 0.8A O/P: 12.0Vdc, 2.5A Power Line: 1.8m non-shielded without core
3	HDMI cable	1.8m shielded without core
4	HDD	Brand: SEAGATE Model: ST2000VT000 Product: Video 2.5 HDD
5	Remote Control	Brand: REMOTESOLUTION CO.,LTD Model: SBOM_03031_000
6	AA Battery for Remote Control	1.5Vdc *2

### 1.1.5 Channel List

Frequency band (MHz)		2400~2483.5	
802.11 b / g / n HT20 / ac VHT20		802.11n HT40 / ac VHT40	
Channel	Frequency(MHz)	Channel	Frequency(MHz)
1	2412	3	2422
2	2417	4	2427
3	2422	5	2432
4	2427	6	2437
5	2432	7	2442
6	2437	8	2447
7	2442	9	2452
8	2447	---	---
9	2452	---	---
10	2457	---	---
11	2462	---	---

### 1.1.6 Test Tool and Duty Cycle

Test Tool	Mtool, V3.1.0.3				
Duty Cycle and Duty Factor	Mode	Non-beamforming		Beamforming	
		Duty cycle (%)	Duty factor (dB)	Duty cycle (%)	Duty factor (dB)
	11b	96.69%	0.15	---	---
	11g	95.67%	0.19	---	---
	VHT20	99.26%	0.03	97.15%	0.13
VHT40	99.11%	0.04	---	---	

### 1.1.7 Power Index of Test Tool

Modulation Mode	Test Frequency (MHz)	Power Index	
		Non-beamforming	Beamforming
11b	2412	80	---
11b	2437	92	---
11b	2462	92	---
11g	2412	72	---
11g	2437	80	---
11g	2462	74	---
VHT20	2412	70	70
VHT20	2437	76	76
VHT20	2462	72	72
VHT40	2422	54	30
VHT40	2437	68	44
VHT40	2452	58	34

## 1.2 Local Support Equipment List

### *Non-beamforming mode*

Support Equipment List					
No.	Equipment	Brand	Model	FCC ID	Remarks
1	Notebook	DELL	Latitude E6440	DoC	---
2	TV	CHIMEI	TL-24LF500D	---	---
3	USB Flash	Kingston	DTSE9	---	---
4	USB Flash	Kingston	DTSE9	---	---

### *Beamforming mode*

Support Equipment List					
No.	Equipment	Brand	Model	FCC ID	Remarks
1	Notebook	DELL	Latitude E6440	DoC	---
2	TV	CHIMEI	TL-24LF500D	---	---
3	USB Flash	Kingston	DTSE9	---	---
4	USB Flash	Kingston	DTSE9	---	---
5	Notebook	DELL	Latitude E5470	DoC	---
6	BF Client	TiVo	MG3-R	---	Provided by applicant.



## 1.3 Test Setup Chart

### *Non-beamforming mode*

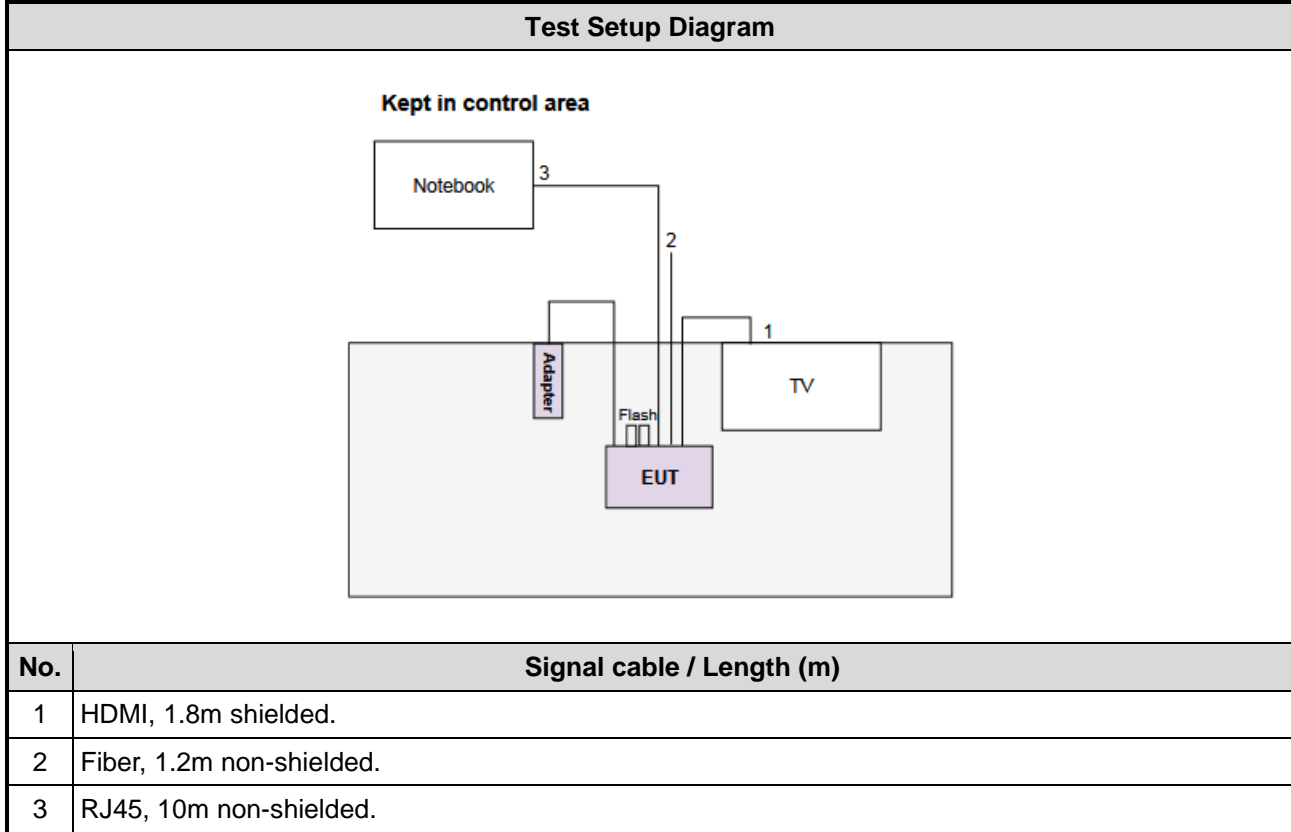

**Beamforming mode**

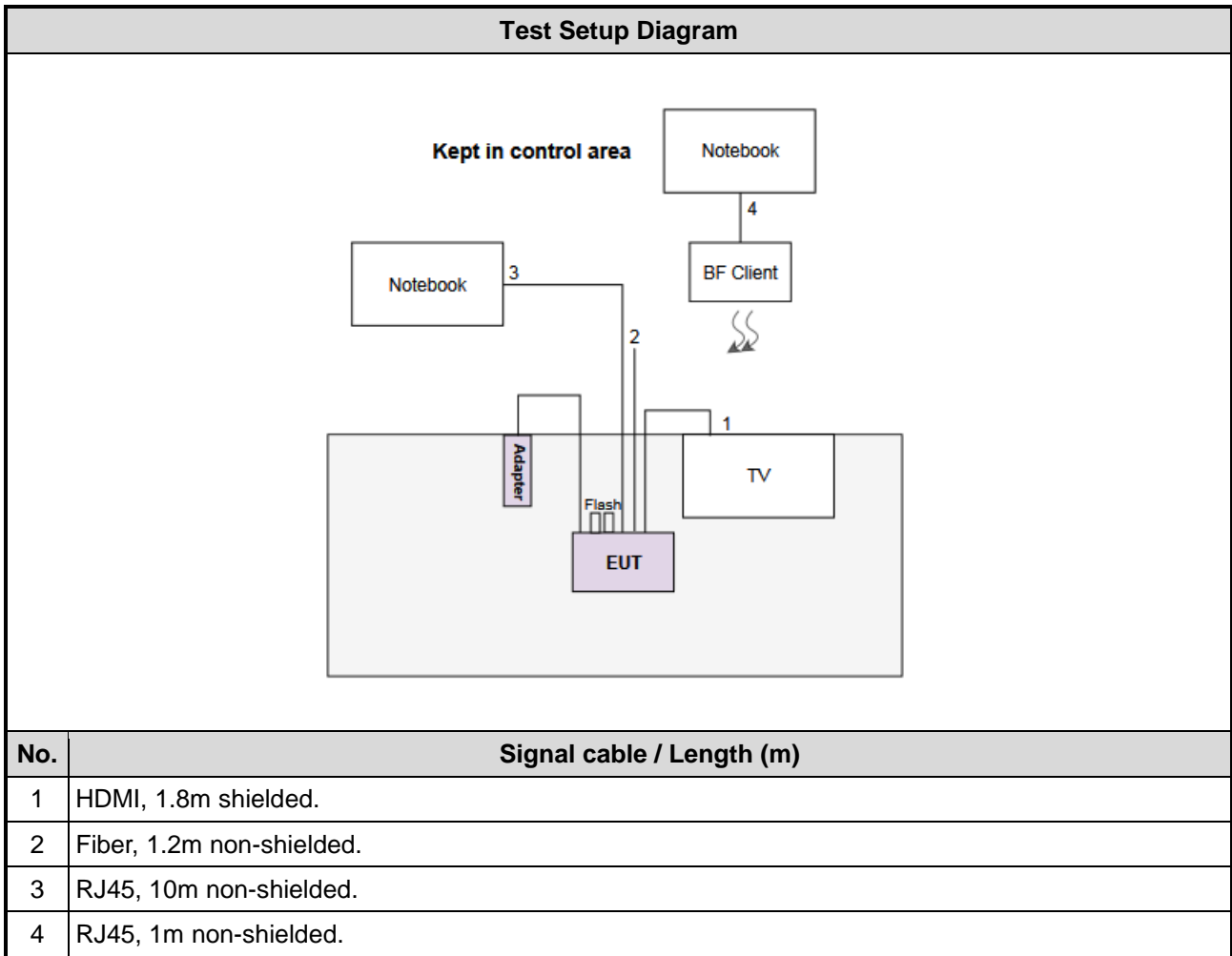

## 1.4 The Equipment List

Test Item	Conducted Emission				
Test Site	Conduction room 1 / (CO01-WS)				
Instrument	Manufacturer	Model No.	Serial No.	Calibration Date	Calibration Until
Receiver	R&S	ESR3	101657	Jan. 08, 2019	Jan. 07, 2020
LISN	SCHWARZBECK	Schwarzbeck 8127	8127-667	Nov. 05, 2018	Nov. 04, 2019
LISN (Support Unit)	SCHWARZBECK	Schwarzbeck 8127	8127-666	Nov. 29, 2018	Nov. 28, 2019
RF Cable-CON	Woken	CFD200-NL	CFD200-NL-001	Oct. 23, 2018	Oct. 23, 2019
50 ohm terminal (Support Unit)	NA	50	02	Apr. 19, 2019	Apr. 18, 2020
Measurement Software	AUDIX	e3	6.120210k	NA	NA

Note: Calibration Interval of instruments listed above is one year.

Test Item	Radiated Emission				
Test Site	966 chamber 3 / (03CH03-WS)				
Instrument	Manufacturer	Model No.	Serial No.	Calibration Date	Calibration Until
Spectrum Analyzer	R&S	FSV40	101499	Jan. 07, 2019	Jan. 06, 2020
Receiver	R&S	ESR3	101658	Dec. 11, 2018	Dec. 10, 2019
Bilog Antenna	SCHWARZBECK	VULB9168	VULB9168-685	Apr. 17, 2019	Apr. 16, 2020
Horn Antenna 1G-18G	SCHWARZBECK	BBHA 9120 D	BBHA 9120 D 1206	Jan. 07, 2019	Jan. 06, 2020
Horn Antenna 18G-40G	SCHWARZBECK	BBHA 9170	BBHA 9170517	Nov. 15, 2018	Nov. 14, 2019
Loop Antenna	R&S	HFH2-Z2	100330	Nov. 09, 2018	Nov. 08, 2019
Loop Antenna Cable	KOAX KABEL	101354-BW	101354-BW	Oct. 08, 2018	Oct. 07, 2019
Preamplifier	EMC	EMC02325	980187	Aug. 24, 2018	Aug. 23, 2019
Preamplifier	Agilent	83017A	MY53270014	Aug. 09, 2018	Aug. 08, 2019
Preamplifier	EMC	EMC184045B	980192	Aug. 09, 2018	Aug. 08, 2019
RF cable-3M	HUBER+SUHNER	SUCOFLEX104	MY22620/4	Oct. 01, 2018	Sep. 30, 2019
RF cable-8M	EMC	EMC104-SM-SM-80 00	181107	Oct. 01, 2018	Sep. 30, 2019
RF cable-1M	HUBER+SUHNER	SUCOFLEX104	MY22624/4	Oct. 01, 2018	Sep. 30, 2019
LF cable-0.8M	EMC	EMC8D-NM-NM-800	EMC8D-NM-NM-800 -001	Oct. 01, 2018	Sep. 30, 2019
LF cable-3M	EMC	EMC8D-NM-NM-300 0	131103	Oct. 01, 2018	Sep. 30, 2019
LF cable-13M	EMC	EMC8D-NM-NM-130 00	131104	Oct. 01, 2018	Sep. 30, 2019
Measurement Software	SENSE-15247_DTS	V5.9	--	NA	NA

Note: Calibration Interval of instruments listed above is one year.

<b>Test Item</b>	RF Conducted				
<b>Test Site</b>	(TH01-WS)				
<b>Instrument</b>	<b>Manufacturer</b>	<b>Model No.</b>	<b>Serial No.</b>	<b>Calibration Date</b>	<b>Calibration Until</b>
Spectrum Analyzer	R&S	FSV40	101063	Apr. 17, 2019	Apr. 16, 2020
Power Meter	Anritsu	ML2495A	1241002	Oct. 09, 2018	Oct. 08, 2019
Power Sensor	Anritsu	MA2411B	1207366	Oct. 09, 2018	Oct. 08, 2019
AC POWER SOURCE	APC	AFC-500W	F312060012	Nov. 29, 2018	Nov. 28, 2019
Measurement Software	Sporton	Sporton_1	1.3.30	NA	NA
Note: Calibration Interval of instruments listed above is one year.					

## 1.5 Test Standards

According to the specification of EUT, the EUT must comply with following standards and KDB documents.

47 CFR FCC Part 15.247

ANSI C63.10-2013

FCC KDB 558074 D01 15.247 Meas Guidance v05r02

FCC KDB 662911 D01 Multiple Transmitter Output v02r01

## 1.6 Deviation from Test Standard and Measurement Procedure

None

## 1.7 Measurement Uncertainty

ISO/IEC 17025 requires that an estimate of the measurement uncertainties associated with the emissions test results be included in the report. The measurement uncertainties given below are based on a 95% confidence level (based on a coverage factor ( $k=2$ ))

Measurement Uncertainty	
Parameters	Uncertainty
Bandwidth	$\pm 34.130$ Hz
Conducted power	$\pm 0.808$ dB
Power density	$\pm 0.583$ dB
Conducted emission	$\pm 2.715$ dB
AC conducted emission	$\pm 2.92$ dB
Radiated emission $\leq 1$ GHz	$\pm 3.96$ dB
Radiated emission $> 1$ GHz	$\pm 4.51$ dB

## 2 Test Configuration

### 2.1 Testing Condition

Test Item	Test Site	Ambient Condition	Tested By
AC Conduction	CO01-WS	24°C / 65%	Alex Tsai
Radiated Emissions	03CH03-WS	24-25°C / 62%	Roger Lu
RF Conducted	TH01-WS	22°C / 66%	Aska Huang

- FCC Designation No.: TW0009
- FCC site registration No.: 207696
- ISED#: 10807A
- CAB identifier: TW2732

### 2.2 The Worst Test Modes and Channel Details

#### Non-beamforming mode

Test item	Modulation Mode	Test Frequency (MHz)	Data Rate (Mbps) / MCS	Test Configuration
Conducted Emissions	11b	2437	1 Mbps	---
Radiated Emissions ≤1GHz	11b	2437	1 Mbps	---
Maximum Output Power	11b	2412 / 2437 / 2462	1 Mbps	---
Radiated Emissions >1GHz	11g	2412 / 2437 / 2462	6 Mbps	
6dB bandwidth	VHT20	2412 / 2437 / 2462	MCS 0	
Power spectral density	VHT40	2422 / 2437 / 2452	MCS 0	

**NOTE:** Two adapters (LITE-ON & NETBIT) had been covered during the pretest and found that **NETBIT** adapter was the worst case for radiated emission test and **LITE-ON** adapter was the worst case for conducted emission test.

#### Beamforming mode

Test item	Modulation Mode	Test Frequency (MHz)	Data Rate (Mbps) / MCS	Test Configuration
Conducted Emissions	VHT20	2437	MCS 0	---
Radiated Emissions ≤1GHz	VHT20	2437	MCS 0	---
Maximum Output Power	VHT20 VHT40	2412 / 2437 / 2462 2422 / 2437 / 2452	MCS 0 MCS 0	---
Radiated Emissions >1GHz	VHT20	2412 / 2437 / 2462	MCS 0	---
6dB bandwidth	VHT20	2412 / 2437 / 2462	MCS 0	---
Power spectral density	VHT20	2412 / 2437 / 2462	MCS 0	---

**NOTE:**

1. Two adapters (LITE-ON & NETBIT) had been covered during the pretest and found that **NETBIT** adapter was the worst case for radiated emission test and **LITE-ON** adapter was the worst case for conducted emission test.
2. VHT40 mode of beamforming mode is not tested for other items since the output power is lower 6.02 dB than VHT40 mode of non-beamforming mode.

## 3 Transmitter Test Results

### 3.1 Conducted Emissions

#### 3.1.1 Limit of Conducted Emissions

Conducted Emissions Limit		
Frequency Emission (MHz)	Quasi-Peak	Average
0.15-0.5	66 - 56 *	56 - 46 *
0.5-5	56	46
5-30	60	50

Note 1: \* Decreases with the logarithm of the frequency.

#### 3.1.2 Test Procedures

1. The device is placed on a test table, raised 80 cm above the reference ground plane. The vertical conducting plane is located 40 cm to the rear of the device.
2. The device is connected to line impedance stabilization network (LISN) and other accessories are connected to other LISN. Measured levels of AC power line conducted emission are across the 50  $\Omega$  LISN port.
3. AC conducted emission measurements is made over frequency range from 150 kHz to 30 MHz.
4. This measurement was performed with AC 120V / 60Hz.

#### 3.1.3 Test Setup

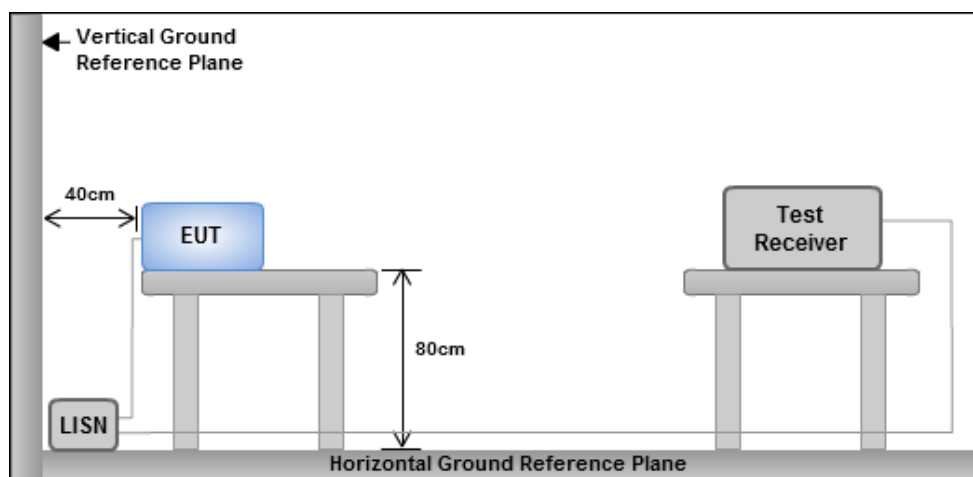

- Note: 1. Support units were connected to second LISN.  
 2. Both of LISNs (AMN) are 80 cm from EUT and at least 80 cm from other units and other metal planes

### 3.1.4 Test Result of Conducted Emissions

#### Non-beamforming mode

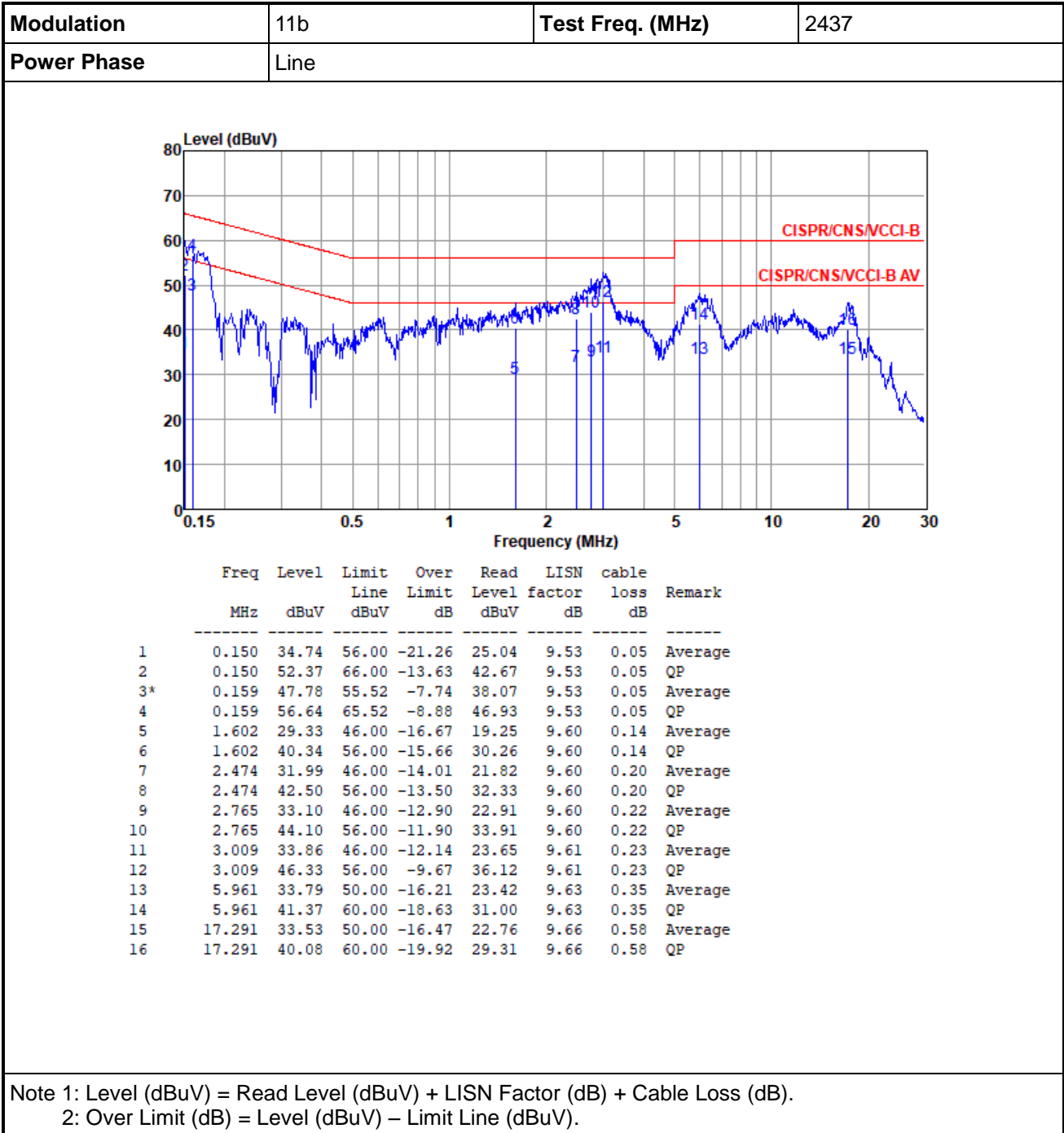

<b>Modulation</b>	11b	<b>Test Freq. (MHz)</b>	2437
<b>Power Phase</b>	Neutral		

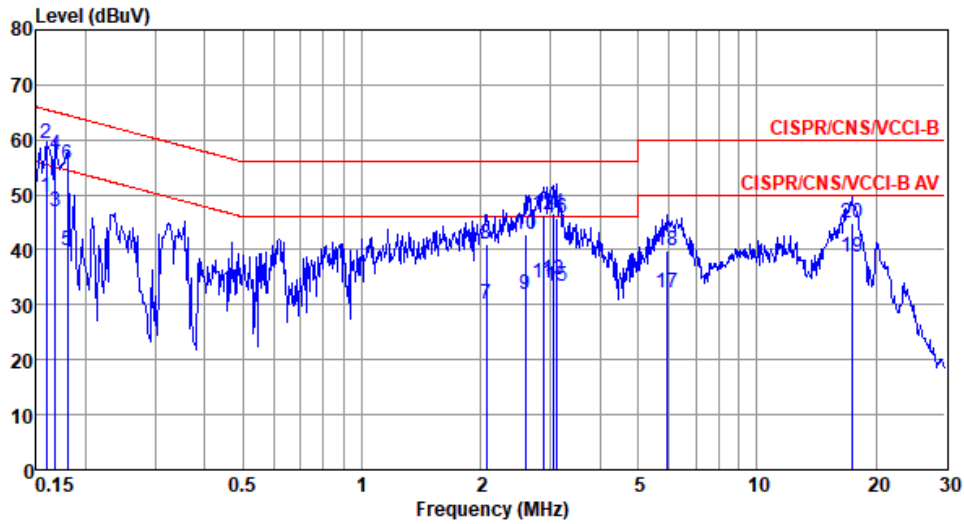

	Freq MHz	Level dBuV	Limit Line dBuV	Over Limit dB	Read Level dBuV	LISN factor dB	cable loss dB	Remark
1*	0.159	49.61	55.52	-5.91	39.87	9.57	0.05	Average
2	0.159	59.26	65.52	-6.26	49.52	9.57	0.05	QP
3	0.168	47.07	55.08	-8.01	37.32	9.57	0.06	Average
4	0.168	57.25	65.08	-7.83	47.50	9.57	0.06	QP
5	0.180	39.86	54.50	-14.64	30.09	9.58	0.06	Average
6	0.180	55.50	64.50	-9.00	45.73	9.58	0.06	QP
7	2.066	30.05	46.00	-15.95	19.98	9.65	0.17	Average
8	2.066	41.06	56.00	-14.94	30.99	9.65	0.17	QP
9	2.594	31.90	46.00	-14.10	21.80	9.65	0.20	Average
10	2.594	42.84	56.00	-13.16	32.74	9.65	0.20	QP
11	2.884	34.07	46.00	-11.93	23.93	9.66	0.22	Average
12	2.884	46.21	56.00	-9.79	36.07	9.66	0.22	QP
13	3.041	34.51	46.00	-11.49	24.36	9.66	0.23	Average
14	3.041	46.69	56.00	-9.31	36.54	9.66	0.23	QP
15	3.123	33.23	46.00	-12.77	23.07	9.66	0.24	Average
16	3.123	45.71	56.00	-10.29	35.55	9.66	0.24	QP
17	5.898	32.23	50.00	-17.77	21.92	9.68	0.35	Average
18	5.898	39.77	60.00	-20.23	29.46	9.68	0.35	QP
19	17.383	38.66	50.00	-11.34	27.89	9.79	0.58	Average
20	17.383	44.94	60.00	-15.06	34.17	9.79	0.58	QP

Note 1: Level (dBuV) = Read Level (dBuV) + LISN Factor (dB) + Cable Loss (dB).  
 Note 2: Over Limit (dB) = Level (dBuV) – Limit Line (dBuV).



### Beamforming mode

<b>Modulation</b>	VHT20	<b>Test Freq. (MHz)</b>	2437
<b>Power Phase</b>	Line		

  

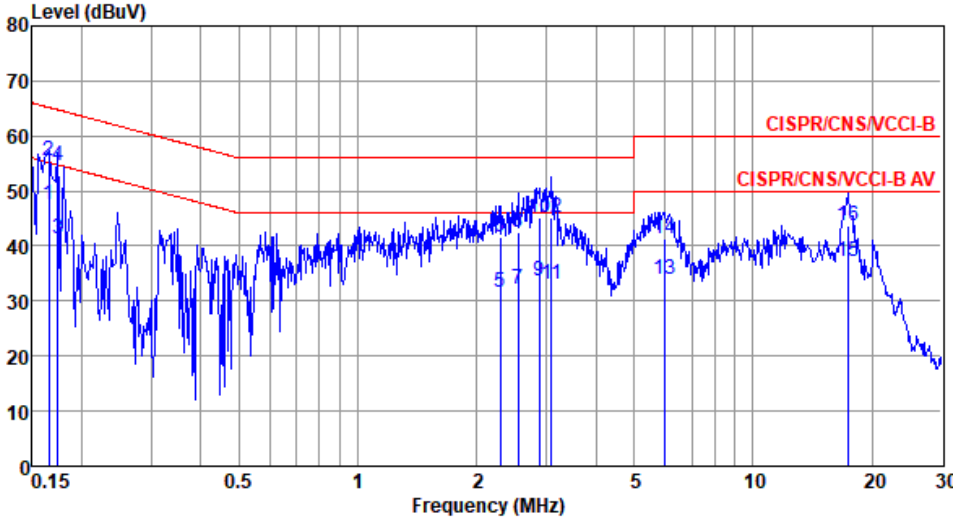

	Freq MHz	Level dBuV	Limit Line dBuV	Over Limit dB	Read Level dBuV	LISN factor dB	cable loss dB	Remark
1*	0.165	47.44	55.21	-7.77	37.71	9.53	0.06	Average
2	0.165	55.61	65.21	-9.60	45.88	9.53	0.06	QP
3	0.174	41.32	54.77	-13.45	31.56	9.54	0.06	Average
4	0.174	54.56	64.77	-10.21	44.80	9.54	0.06	QP
5	2.297	31.64	46.00	-14.36	21.50	9.60	0.18	Average
6	2.297	41.52	56.00	-14.48	31.38	9.60	0.18	QP
7	2.540	32.09	46.00	-13.91	21.92	9.60	0.20	Average
8	2.540	42.56	56.00	-13.44	32.39	9.60	0.20	QP
9	2.884	33.78	46.00	-12.22	23.58	9.61	0.22	Average
10	2.884	45.21	56.00	-10.79	35.01	9.61	0.22	QP
11	3.090	33.15	46.00	-12.85	22.93	9.61	0.24	Average
12	3.090	45.20	56.00	-10.80	34.98	9.61	0.24	QP
13	5.961	33.89	50.00	-16.11	23.52	9.63	0.35	Average
14	5.961	41.47	60.00	-18.53	31.10	9.63	0.35	QP
15	17.383	37.30	50.00	-12.70	26.52	9.66	0.58	Average
16	17.383	43.59	60.00	-16.41	32.81	9.66	0.58	QP

Note 1: Level (dBuV) = Read Level (dBuV) + LISN Factor (dB) + Cable Loss (dB).  
 Note 2: Over Limit (dB) = Level (dBuV) – Limit Line (dBuV).

<b>Modulation</b>	VHT20	<b>Test Freq. (MHz)</b>	2437
<b>Power Phase</b>	Neutral		

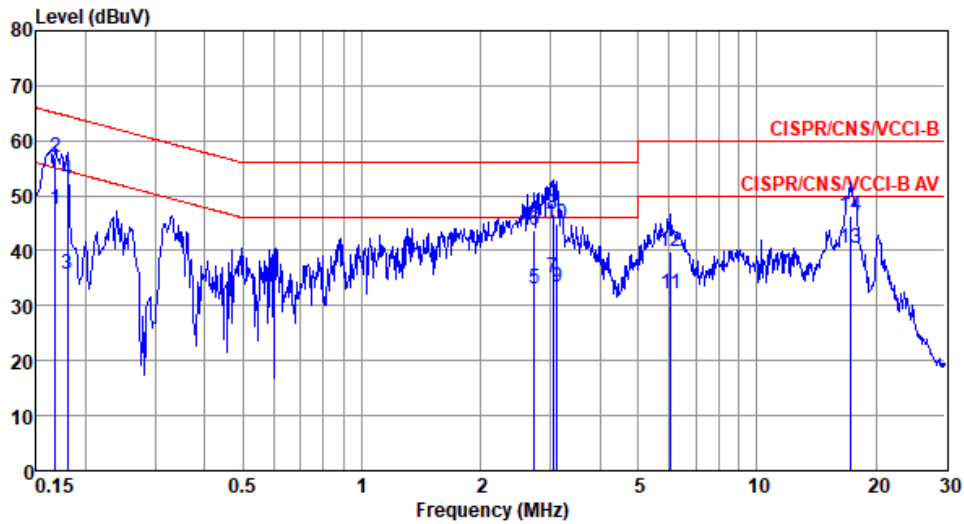

	Freq	Level	Limit	Over	Read	LISN	cable	Remark
	MHz	dBuV	Line	Limit	Level	factor	loss	
			dBuV	dB	dBuV	dB	dB	
1*	0.168	47.51	55.08	-7.57	37.76	9.57	0.06	Average
2	0.168	57.07	65.08	-8.01	47.32	9.57	0.06	QP
3	0.180	35.72	54.50	-18.78	25.95	9.58	0.06	Average
4	0.180	52.88	64.50	-11.62	43.11	9.58	0.06	QP
5	2.736	32.97	46.00	-13.03	22.86	9.65	0.21	Average
6	2.736	43.71	56.00	-12.29	33.60	9.65	0.21	QP
7	3.041	35.03	46.00	-10.97	24.88	9.66	0.23	Average
8	3.041	46.58	56.00	-9.42	36.43	9.66	0.23	QP
9	3.123	33.48	46.00	-12.52	23.32	9.66	0.24	Average
10	3.123	44.88	56.00	-11.12	34.72	9.66	0.24	QP
11	6.056	32.17	50.00	-17.83	21.86	9.68	0.35	Average
12	6.056	39.83	60.00	-20.17	29.52	9.68	0.35	QP
13	17.199	40.45	50.00	-9.55	29.69	9.79	0.58	Average
14	17.199	46.49	60.00	-13.51	35.73	9.79	0.58	QP

Note 1: Level (dBuV) = Read Level (dBuV) + LISN Factor (dB) + Cable Loss (dB).  
 Note 2: Over Limit (dB) = Level (dBuV) – Limit Line (dBuV).

## 3.2 6dB and Occupied Bandwidth

### 3.2.1 Limit of 6dB Bandwidth

The minimum 6dB bandwidth shall be at least 500 kHz.

### 3.2.2 Test Procedures

#### 6dB Bandwidth

1. Set resolution bandwidth (RBW) = 100 kHz, Video bandwidth = 300 kHz.
2. Detector = Peak, Trace mode = max hold.
3. Sweep = auto couple, Allow the trace to stabilize.
4. Measure the maximum width of the emission that is constrained by the frequencies associated with the two outermost amplitude points (upper and lower) that are attenuated by 6dB relative to the maximum level measured in the fundamental emission.

#### Occupied Bandwidth

1. Set resolution bandwidth (RBW) = 1% ~ 5 % of OBW, Video bandwidth = 3 x RBW
2. Detector = Sample, Trace mode = max hold.
3. Sweep = auto couple, Allow the trace to stabilize.
4. Use the OBW measurement function of spectrum analyzer to measure the occupied bandwidth.

### 3.2.3 Test Setup

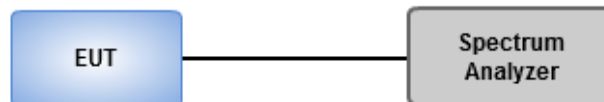

### 3.2.4 Test Result of 6dB and Occupied Bandwidth

#### Non-beamforming mode

##### Summary

Mode	Max-N dB (Hz)	Max-OBW (Hz)	ITU-Code	Min-N dB (Hz)	Min-OBW (Hz)
2.4-2.4835GHz	-	-	-	-	-
802.11b_Nss1,(1Mbps)_4TX	8.551M	10.42M	10M4G1D	7.029M	10.203M
802.11g_Nss1,(6Mbps)_4TX	16.304M	16.425M	16M4D1D	13.188M	16.281M
802.11ac VHT20_Nss1,(MCS0)_4TX	17.536M	17.656M	17M7D1D	13.986M	17.511M
802.11ac VHT40_Nss1,(MCS0)_4TX	36.377M	36.469M	36M5D1D	35.942M	36.179M

**Max-N dB** = Maximum 6dB down bandwidth; **Max-OBW** = Maximum 99% occupied bandwidth;  
**Min-N dB** = Minimum 6dB down bandwidth; **Min-OBW** = Minimum 99% occupied bandwidth;

##### Result

Mode	Result	Limit (Hz)	Port 1-N dB (Hz)	Port 1-OBW (Hz)	Port 2-N dB (Hz)	Port 2-OBW (Hz)	Port 3-N dB (Hz)	Port 3-OBW (Hz)	Port 4-N dB (Hz)	Port 4-OBW (Hz)
802.11b_Nss1,(1Mbps)_4TX	-	-	-	-	-	-	-	-	-	-
2412MHz	Pass	500k	7.101M	10.203M	7.536M	10.203M	8.043M	10.203M	8.043M	10.203M
2437MHz	Pass	500k	8.043M	10.347M	7.029M	10.347M	8.043M	10.347M	8.043M	10.347M
2462MHz	Pass	500k	8.116M	10.347M	8.551M	10.275M	7.536M	10.42M	8.116M	10.42M
802.11g_Nss1,(6Mbps)_4TX	-	-	-	-	-	-	-	-	-	-
2412MHz	Pass	500k	14.13M	16.353M	13.841M	16.353M	16.014M	16.353M	15.435M	16.353M
2437MHz	Pass	500k	14.058M	16.425M	15.725M	16.353M	16.014M	16.353M	15.072M	16.353M
2462MHz	Pass	500k	15.072M	16.425M	13.696M	16.425M	16.304M	16.353M	13.188M	16.281M
802.11ac VHT20_Nss1,(MCS0)_4TX	-	-	-	-	-	-	-	-	-	-
2412MHz	Pass	500k	13.986M	17.656M	16.014M	17.511M	14.42M	17.511M	15M	17.511M
2437MHz	Pass	500k	17.029M	17.583M	17.174M	17.511M	17.536M	17.583M	16.377M	17.583M
2462MHz	Pass	500k	14.855M	17.656M	16.304M	17.583M	16.304M	17.583M	15.725M	17.583M
802.11ac VHT40_Nss1,(MCS0)_4TX	-	-	-	-	-	-	-	-	-	-
2422MHz	Pass	500k	35.942M	36.469M	36.377M	36.179M	36.377M	36.179M	36.377M	36.469M
2437MHz	Pass	500k	36.377M	36.324M	36.377M	36.179M	36.377M	36.179M	36.087M	36.324M
2452MHz	Pass	500k	36.377M	36.324M	36.377M	36.324M	36.377M	36.324M	36.377M	36.324M

**Port X-N dB** = Port X 6dB down bandwidth; **Port X-OBW** = Port X 99% occupied bandwidth;

### 802.11b\_Nss1,(1Mbps)\_4TX

EBW

2412MHz

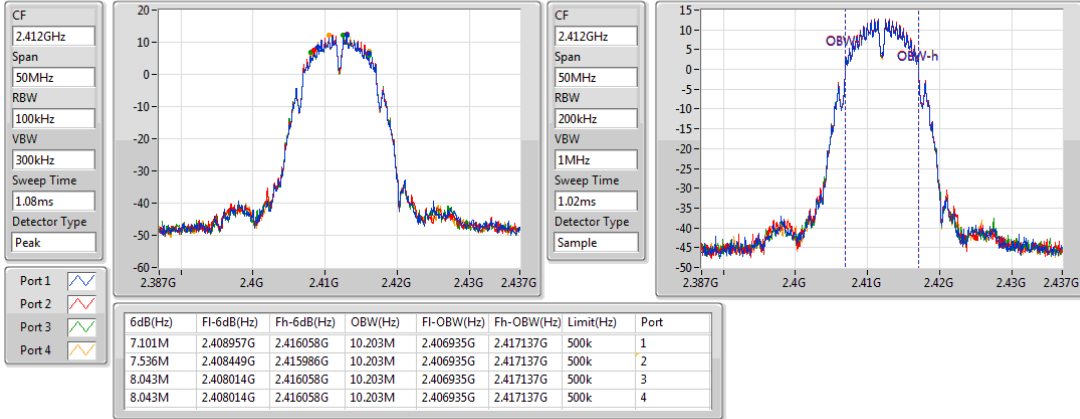

### 802.11b\_Nss1,(1Mbps)\_4TX

EBW

2437MHz

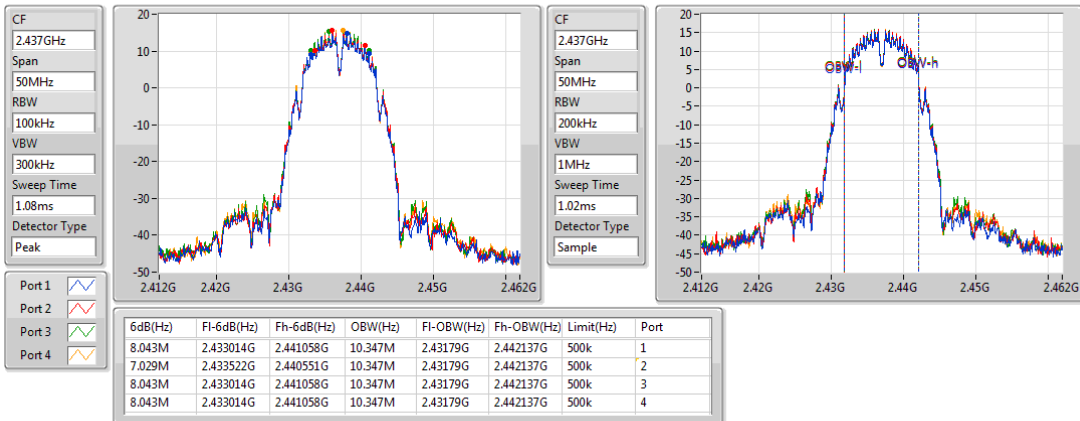

### 802.11b\_Nss1,(1Mbps)\_4TX

EBW

2462MHz

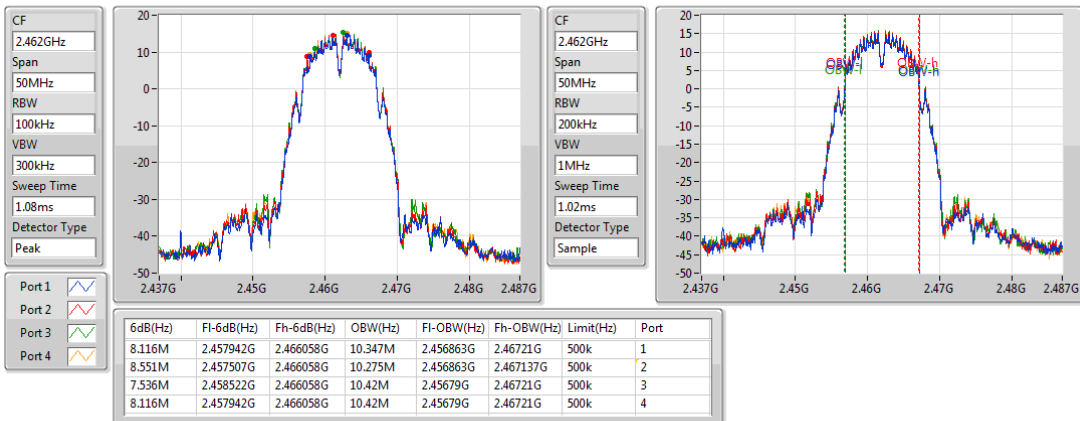

### 802.11g\_Nss1,(6Mbps)\_4TX

EBW

#### 2412MHz

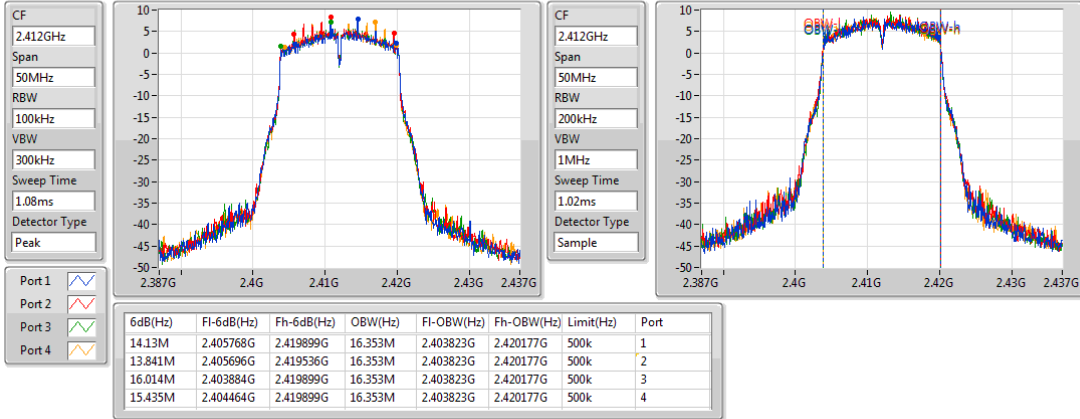

### 802.11g\_Nss1,(6Mbps)\_4TX

EBW

#### 2437MHz

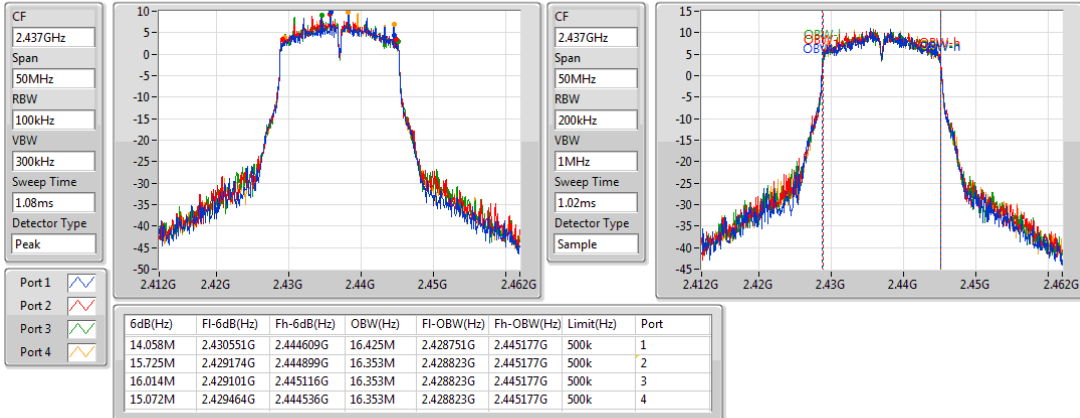

### 802.11g\_Nss1,(6Mbps)\_4TX

EBW

#### 2462MHz

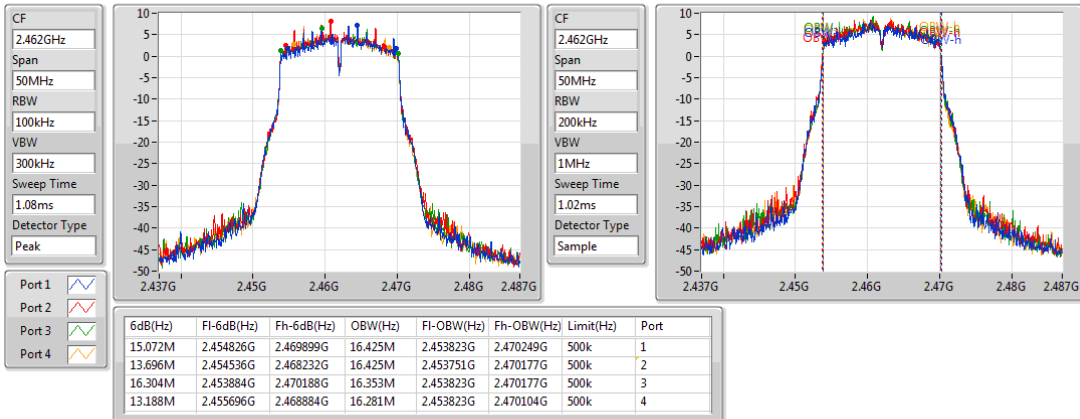

### 802.11ac VHT20\_Nss1,(MCS0)\_4TX

EBW

#### 2412MHz

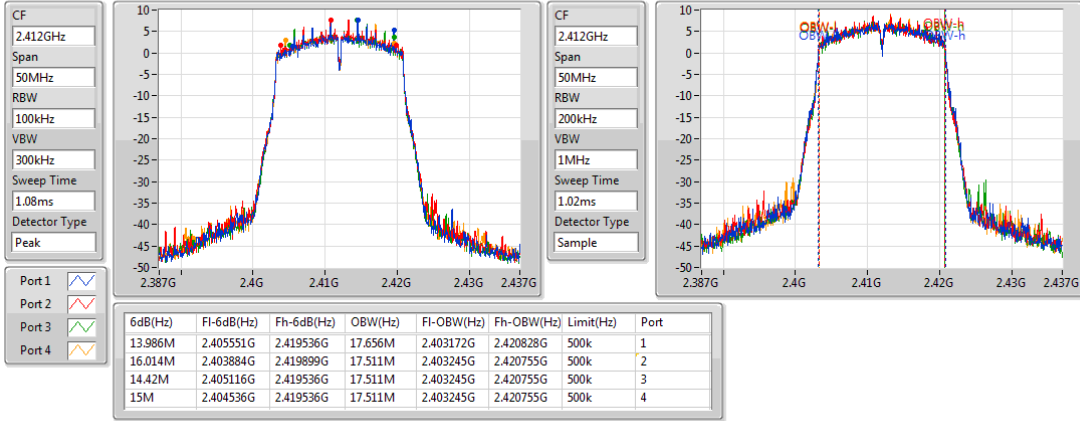

### 802.11ac VHT20\_Nss1,(MCS0)\_4TX

EBW

#### 2437MHz

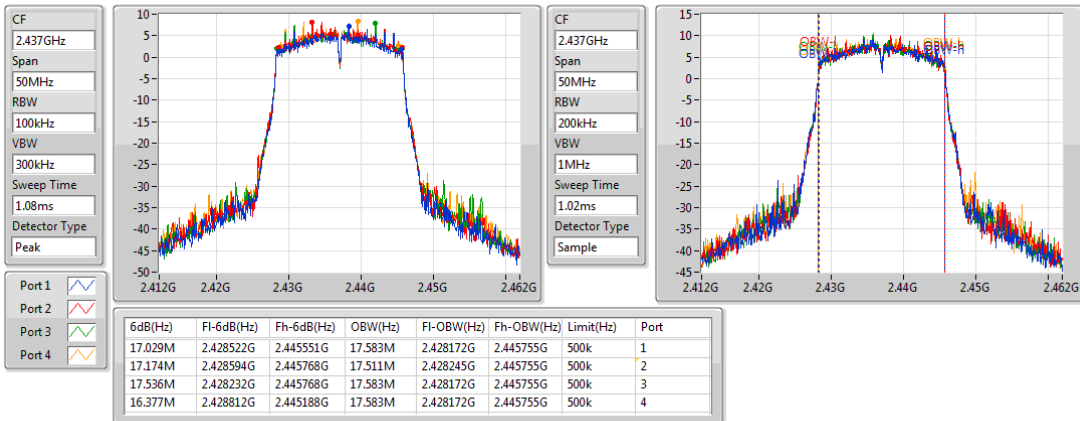

### 802.11ac VHT20\_Nss1,(MCS0)\_4TX

EBW

#### 2462MHz

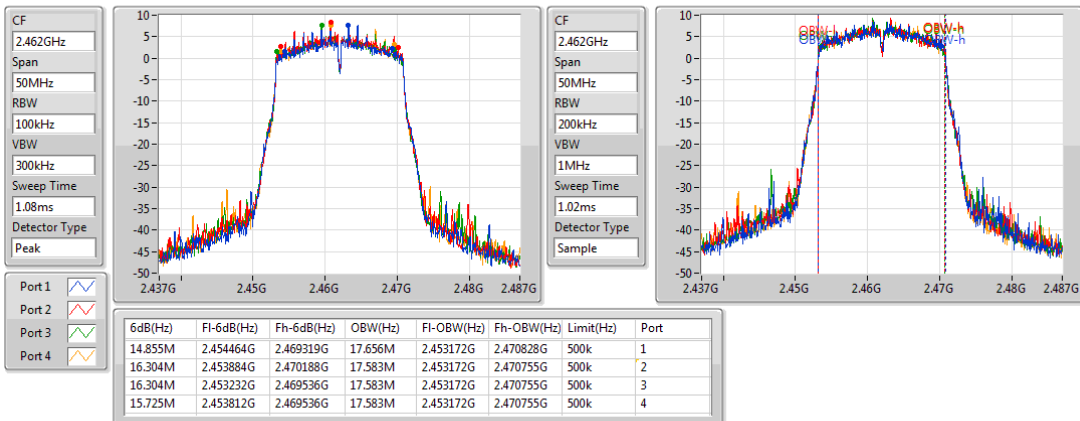

### 802.11ac VHT40\_Nss1,(MCS0)\_4TX

EBW

2422MHz

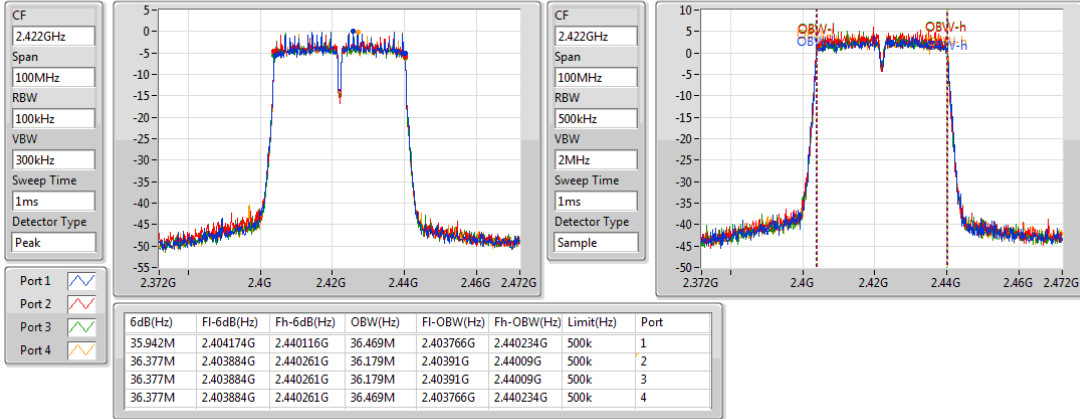

### 802.11ac VHT40\_Nss1,(MCS0)\_4TX

EBW

2437MHz

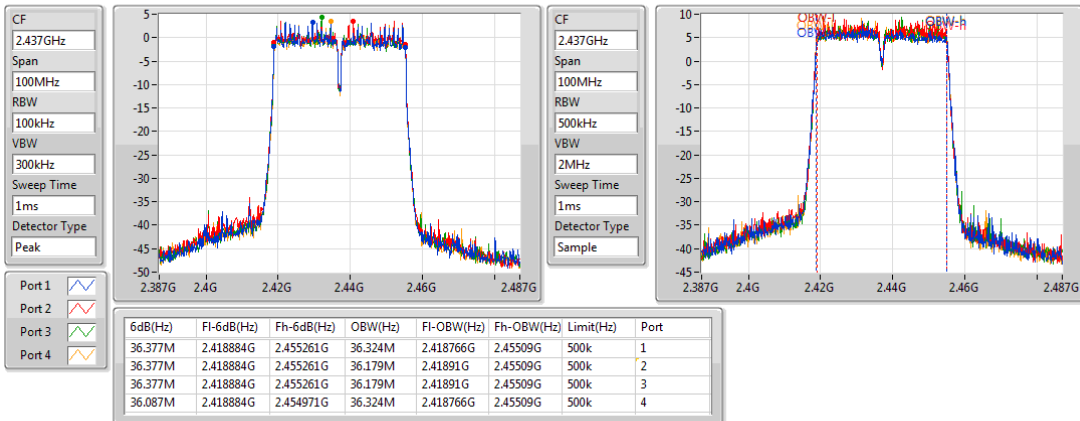

### 802.11ac VHT40\_Nss1,(MCS0)\_4TX

EBW

2452MHz

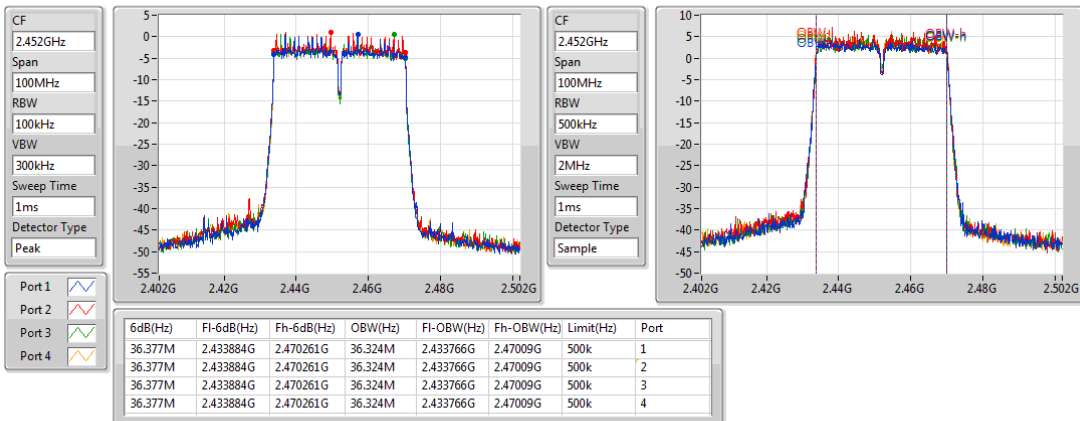



## Beamforming mode

### Summary

Mode	Max-N dB (Hz)	Max-OBW (Hz)	ITU-Code	Min-N dB (Hz)	Min-OBW (Hz)
2.4-2.4835GHz	-	-	-	-	-
802.11ac VHT20-BF_Nss1,(MCS0)_4TX	15.942M	17.583M	17M6D1D	10.145M	17.366M

**Max-N dB** = Maximum 6dB down bandwidth; **Max-OBW** = Maximum 99% occupied bandwidth;  
**Min-N dB** = Minimum 6dB down bandwidth; **Min-OBW** = Minimum 99% occupied bandwidth;

### Result

Mode	Result	Limit (Hz)	Port 1-N dB (Hz)	Port 1-OBW (Hz)	Port 2-N dB (Hz)	Port 2-OBW (Hz)	Port 3-N dB (Hz)	Port 3-OBW (Hz)	Port 4-N dB (Hz)	Port 4-OBW (Hz)
802.11ac VHT20-BF_Nss1,(MCS0)_4TX	-	-	-	-	-	-	-	-	-	-
2412MHz	Pass	500k	15.507M	17.583M	15.072M	17.511M	11.377M	17.511M	13.841M	17.511M
2437MHz	Pass	500k	10.145M	17.583M	13.696M	17.366M	10.725M	17.366M	15.072M	17.511M
2462MHz	Pass	500k	15.942M	17.583M	10.652M	17.511M	15.072M	17.511M	12.101M	17.511M

**Port X-N dB** = Port X 6dB down bandwidth; **Port X-OBW** = Port X 99% occupied bandwidth;

### 802.11ac VHT20-BF\_Nss1,(MCS0)\_4TX

EBW

#### 2412MHz

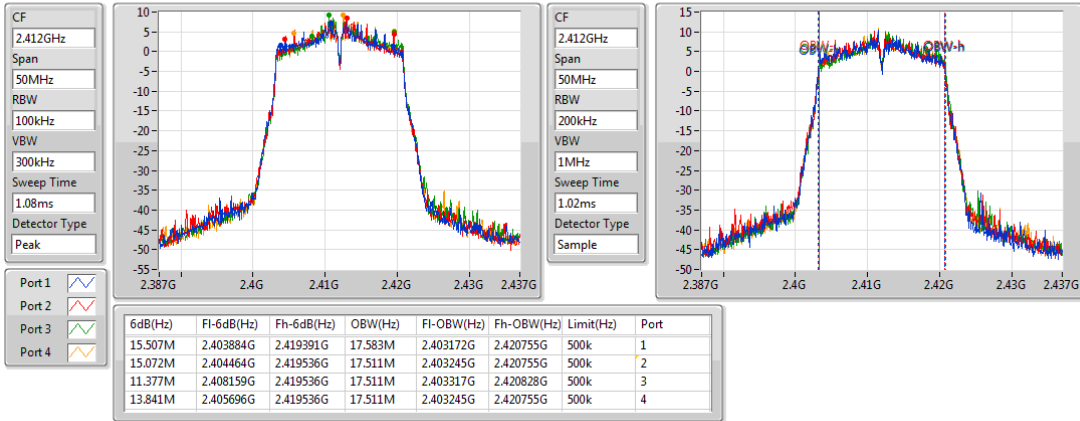

### 802.11ac VHT20-BF\_Nss1,(MCS0)\_4TX

EBW

#### 2437MHz

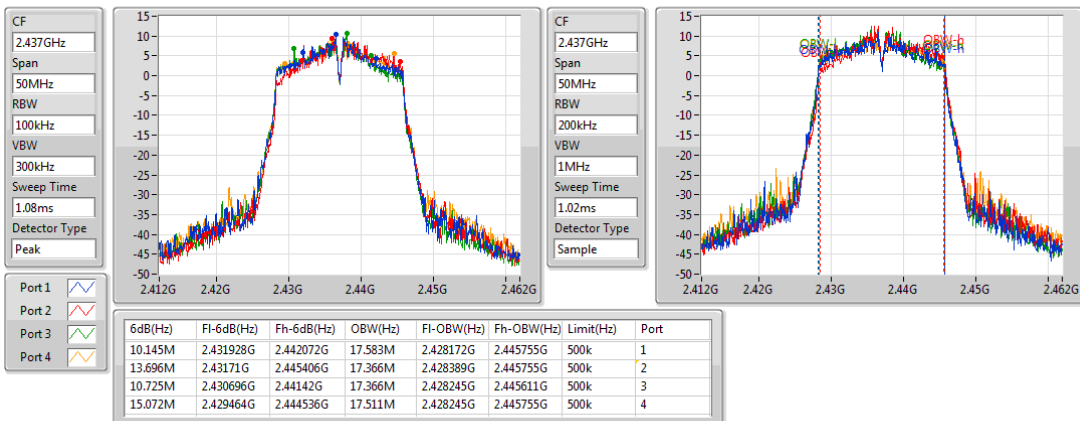

### 802.11ac VHT20-BF\_Nss1,(MCS0)\_4TX

EBW

#### 2462MHz

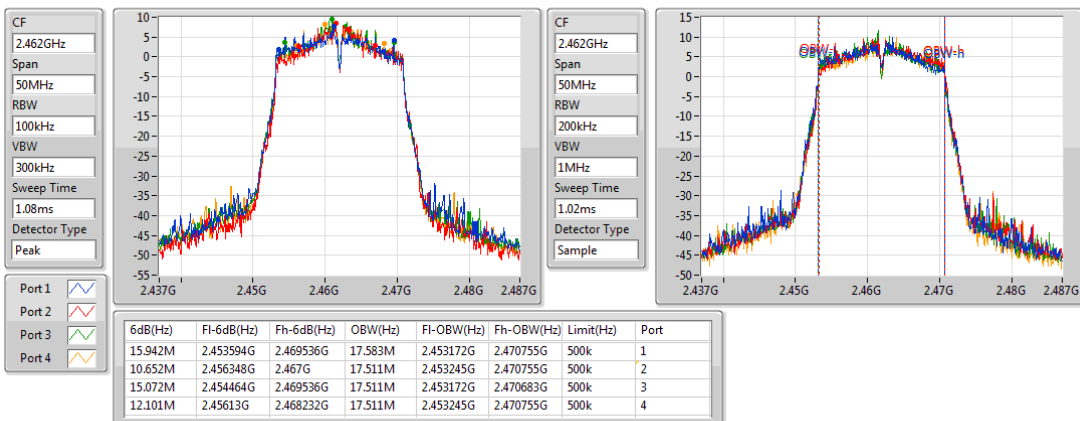

### 3.3 RF Output Power

#### 3.3.1 Limit of RF Output Power

Conducted power shall not exceed 1Watt.

Antenna gain  $\leq 6\text{dBi}$ , no any corresponding reduction is in output power limit.

Antenna gain  $> 6\text{dBi}$

Non Fixed, point to point operations.

The conducted output power from the intentional radiator shall be reduced by the amount in dB that the directional gain of the antenna exceeds 6 dB

Fixed, point to point operations

Systems operating in the 2400–2483.5 MHz band that are used exclusively for fixed, point-to-point Operations, maximum peak output power of the intentional radiator is reduced by 1 dB for every 3 dB that the directional gain of the antenna exceeds 6 dBi.

#### 3.3.2 Test Procedures

A broadband RF power meter is used for output power measurement. The video bandwidth of power meter is greater than DTS bandwidth of EUT. If duty cycle of test signal is not 100 %, trigger and gating function of power meter will be enabled to capture transmission burst for measuring output power.

#### 3.3.3 Test Setup

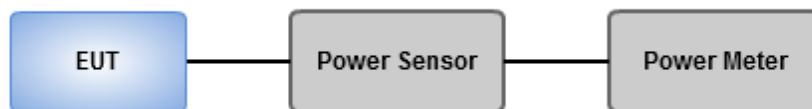

### 3.3.4 Test Result of Maximum Output Power

#### Non-beamforming mode

#### Summary of Conducted (Average) Output Power

Mode	Total Power (dBm)	Total Power (W)
2.4-2.4835GHz	-	-
802.11b_Nss1,(1Mbps)_4TX	29.87	0.97051
802.11g_Nss1,(6Mbps)_4TX	26.89	0.48865
802.11ac VHT20_Nss1,(MCS0)_4TX	25.76	0.37670
802.11ac VHT40_Nss1,(MCS0)_4TX	23.60	0.22909

#### Result

Mode	Result	DG (dBi)	Port 1 (dBm)	Port 2 (dBm)	Port 3 (dBm)	Port 4 (dBm)	Total Power (dBm)	Power Limit (dBm)	EIRP (dBm)	EIRP Limit (dBm)
802.11b_Nss1,(1Mbps)_4TX	-	-	-	-	-	-	-	-	-	-
2412MHz	Pass	3.20	20.95	21.22	21.16	20.89	27.08	30.00	30.28	36.00
2437MHz	Pass	3.20	23.77	24.02	23.85	23.75	29.87	30.00	33.07	36.00
2462MHz	Pass	3.20	23.47	23.81	23.76	23.64	29.69	30.00	32.89	36.00
802.11g_Nss1,(6Mbps)_4TX	-	-	-	-	-	-	-	-	-	-
2412MHz	Pass	3.20	18.92	19.05	18.82	18.88	24.94	30.00	28.14	36.00
2437MHz	Pass	3.20	20.74	20.88	20.95	20.91	26.89	30.00	30.09	36.00
2462MHz	Pass	3.20	18.92	19.33	19.37	19.33	25.26	30.00	28.46	36.00
802.11ac VHT20_Nss1,(MCS0)_4TX	-	-	-	-	-	-	-	-	-	-
2412MHz	Pass	3.20	18.23	18.37	18.38	18.15	24.30	30.00	27.50	36.00
2437MHz	Pass	3.20	19.66	19.85	19.77	19.68	25.76	30.00	28.96	36.00
2462MHz	Pass	3.20	18.44	18.73	18.67	18.54	24.62	30.00	27.82	36.00
802.11ac VHT40_Nss1,(MCS0)_4TX	-	-	-	-	-	-	-	-	-	-
2422MHz	Pass	3.20	14.02	14.11	14.15	13.88	20.06	30.00	23.26	36.00
2437MHz	Pass	3.20	17.46	17.68	17.64	17.54	23.60	30.00	26.80	36.00
2452MHz	Pass	3.20	14.89	15.10	14.84	14.81	20.93	30.00	24.13	36.00

DG = Directional Gain; Port X = Port X output power

## Beamforming mode

### Summary

Mode	Total Power (dBm)	Total Power (W)
2.4-2.4835GHz	-	-
802.11ac VHT20-BF_Nss1,(MCS0)_4TX	25.70	0.37154
802.11ac VHT40-BF_Nss1,(MCS0)_4TX	17.58	0.05728

### Result

Mode	Result	DG (dBi)	Port 1 (dBm)	Port 2 (dBm)	Port 3 (dBm)	Port 4 (dBm)	Total Power (dBm)	Power Limit (dBm)	EIRP (dBm)	EIRP Limit (dBm)
802.11ac VHT20-BF_Nss1,(MCS0)_4TX	-	-	-	-	-	-	-	-	-	-
2412MHz	Pass	8.90	18.25	18.35	18.34	18.11	24.28	27.10	33.18	36.00
2437MHz	Pass	8.90	19.62	19.81	19.72	19.55	25.70	27.10	34.60	36.00
2462MHz	Pass	8.90	18.36	18.66	18.61	18.49	24.55	27.10	33.45	36.00
802.11ac VHT40-BF_Nss1,(MCS0)_4TX	-	-	-	-	-	-	-	-	-	-
2422MHz	Pass	8.90	8.00	8.09	8.13	7.86	14.04	27.10	22.94	36.00
2437MHz	Pass	8.90	11.44	11.66	11.62	11.52	17.58	27.10	26.48	36.00
2452MHz	Pass	8.90	8.87	9.08	8.82	8.79	14.91	27.10	23.81	36.00

DG = Directional Gain; Port X = Port X output power

#### Note:

Directional gain =  $10 * \log((10^{3.2/20} + 10^{3/20} + 10^{2.5/20} + 10^{2.8/20})^2 / 4) = 8.90 \text{ dBi} > 6 \text{ dBi}$ . Limit shall be reduced to  $30 \text{ dBm} - (8.90 \text{ dBi} - 6 \text{ dBi}) = 27.10 \text{ dBm}$ .

## 3.4 Power Spectral Density

### 3.4.1 Limit of Power Spectral Density

Power spectral density shall not be greater than 8 dBm in any 3 kHz band.

### 3.4.2 Test Procedures

#### Peak PSD

1. Set the RBW = 3 kHz, VBW = 10 kHz.
2. Detector = Peak, Sweep time = auto couple.
3. Trace mode = max hold, allow trace to fully stabilize.
4. Use the peak marker function to determine the maximum amplitude level.

#### Average PSD, duty cycle $\geq$ 98%

1. Set the RBW = 30 kHz, VBW = 100 kHz.
2. Detector = RMS, Sweep time = auto couple.
3. Sweep time = auto couple.
4. Employ trace averaging (RMS) mode over a minimum of 100 traces.
5. Use the peak marker function to determine the maximum amplitude level.

#### Average PSD, duty cycle $<$ 98%

1. Set the RBW = 30 kHz, VBW = 100 kHz. Detector = RMS.
2. Set the sweep time to:  $\geq 10$  (number of measurement points in sweep) x (total on/off period of the transmitted signal).
3. Perform the measurement over a single sweep.
4. Use the peak marker function to determine the maximum amplitude level.
5. Add  $10 \log (1/x)$ , where x is the duty cycle.

### 3.4.3 Test Setup

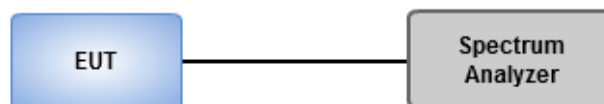

### 3.4.4 Test Result of Power Spectral Density

#### Non-beamforming mode

##### Summary

Mode	PD (dBm/RBW)
2.4-2.4835GHz	-
802.11b_Nss1,(1Mbps)_4TX	3.52
802.11g_Nss1,(6Mbps)_4TX	3.12
802.11ac VHT20_Nss1,(MCS0)_4TX	1.43
802.11ac VHT40_Nss1,(MCS0)_4TX	-4.37

##### Result

Mode	Result	DG (dBi)	Port 1 (dBm/RBW)	Port 2 (dBm/RBW)	Port 3 (dBm/RBW)	Port 4 (dBm/RBW)	PD (dBm/RBW)	PD Limit (dBm/RBW)
802.11b_Nss1,(1Mbps)_4TX	-	-	-	-	-	-	-	-
2412MHz	Pass	8.90	-5.04	-5.08	-4.60	-4.59	0.76	5.10
2437MHz	Pass	8.90	-2.30	-2.10	-1.61	-1.96	3.26	5.10
2462MHz	Pass	8.90	-2.40	-1.97	-2.02	-1.89	3.52	5.10
802.11g_Nss1,(6Mbps)_4TX	-	-	-	-	-	-	-	-
2412MHz	Pass	8.90	-4.92	-4.43	-4.59	-4.52	1.41	5.10
2437MHz	Pass	8.90	-3.32	-2.62	-2.71	-2.83	3.12	5.10
2462MHz	Pass	8.90	-5.31	-4.74	-4.89	-5.14	1.01	5.10
802.11ac VHT20_Nss1,(MCS0)_4TX	-	-	-	-	-	-	-	-
2412MHz	Pass	8.90	-5.77	-5.25	-5.49	-5.44	-0.10	5.10
2437MHz	Pass	8.90	-4.18	-4.10	-3.86	-3.82	1.43	5.10
2462MHz	Pass	8.90	-5.60	-4.64	-4.74	-5.13	0.38	5.10
802.11ac VHT40_Nss1,(MCS0)_4TX	-	-	-	-	-	-	-	-
2422MHz	Pass	8.90	-13.42	-12.98	-12.14	-12.77	-7.46	5.10
2437MHz	Pass	8.90	-9.75	-9.01	-9.67	-9.87	-4.37	5.10
2452MHz	Pass	8.90	-12.59	-12.16	-12.71	-12.59	-6.87	5.10

DG = Directional Gain;

PD = trace bin-by-bin of each transmits port summing can be performed maximum power density; **Port X** = Port X power density;

##### Note:

Directional gain =  $10 * \log((10^{3.2/20} + 10^{3/20} + 10^{2.5/20} + 10^{2.8/20})^2 / 4) = 8.90 \text{ dBi} > 6 \text{ dBi}$ . Limit shall be reduced to  $8\text{dBm} - (8.90 \text{ dBi} - 6 \text{ dBi}) = 5.1 \text{ dBm}$ .

### 802.11b\_Nss1,(1Mbps)\_4TX

PSD

2412MHz

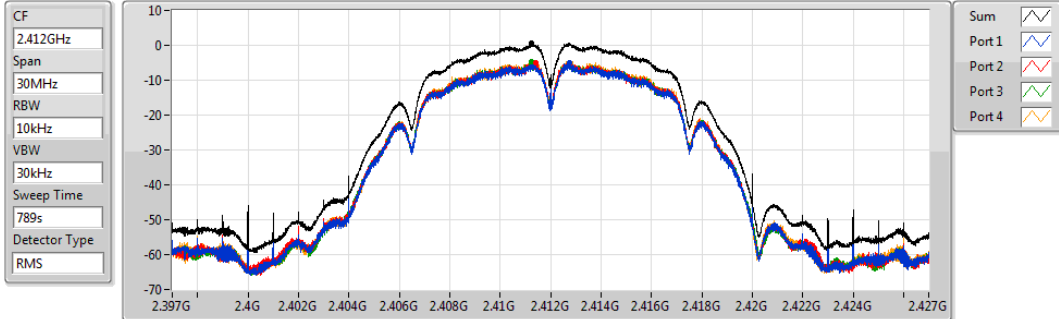

Sum	PD	Port 1	Port 2	Port 3	Port 4
(dBm/10kHz)	(dBm/10kHz)	(dBm/10kHz)	(dBm/10kHz)	(dBm/10kHz)	(dBm/10kHz)
0.76	0.76	-5.04	-5.08	-4.60	-4.59

### 802.11b\_Nss1,(1Mbps)\_4TX

PSD

2437MHz

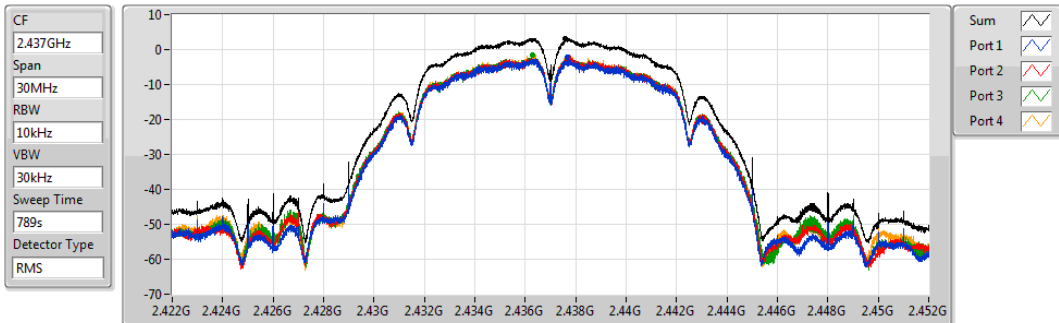

Sum	PD	Port 1	Port 2	Port 3	Port 4
(dBm/10kHz)	(dBm/10kHz)	(dBm/10kHz)	(dBm/10kHz)	(dBm/10kHz)	(dBm/10kHz)
3.26	3.26	-2.30	-2.10	-1.61	-1.96

### 802.11b\_Nss1,(1Mbps)\_4TX

PSD

2462MHz

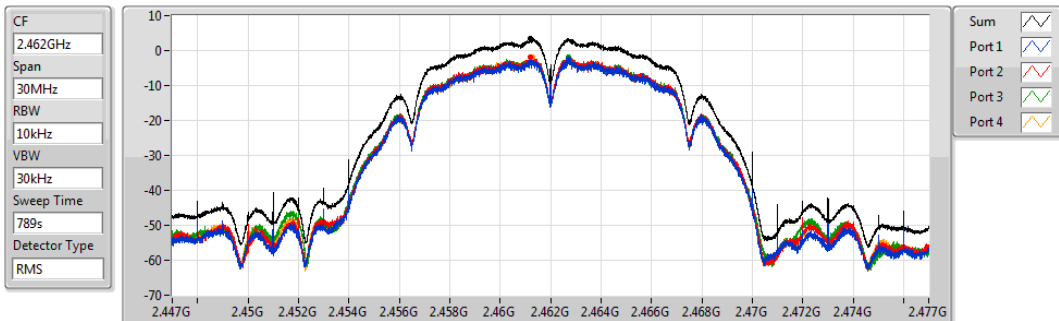

Sum	PD	Port 1	Port 2	Port 3	Port 4
(dBm/10kHz)	(dBm/10kHz)	(dBm/10kHz)	(dBm/10kHz)	(dBm/10kHz)	(dBm/10kHz)
3.52	3.52	-2.40	-1.97	-2.02	-1.89



### 802.11g\_Nss1,(6Mbps)\_4TX

PSD

2412MHz

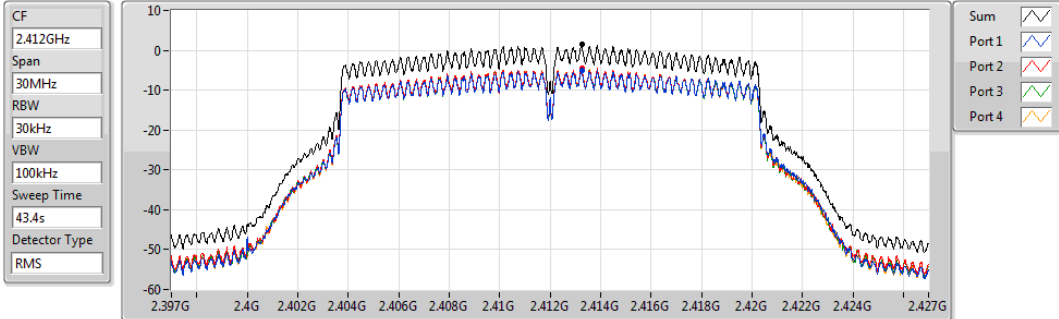

Sum	PD	Port 1	Port 2	Port 3	Port 4
(dBm/RBW)	(dBm/RBW)	(dBm/RBW)	(dBm/RBW)	(dBm/RBW)	(dBm/RBW)
1.41	1.41	-4.92	-4.43	-4.59	-4.52

### 802.11g\_Nss1,(6Mbps)\_4TX

PSD

2437MHz

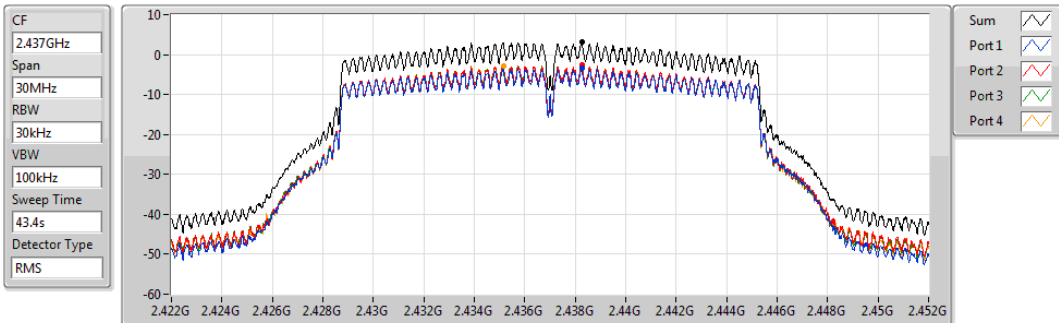

Sum	PD	Port 1	Port 2	Port 3	Port 4
(dBm/RBW)	(dBm/RBW)	(dBm/RBW)	(dBm/RBW)	(dBm/RBW)	(dBm/RBW)
3.12	3.12	-3.32	-2.62	-2.71	-2.83

### 802.11g\_Nss1,(6Mbps)\_4TX

PSD

2462MHz

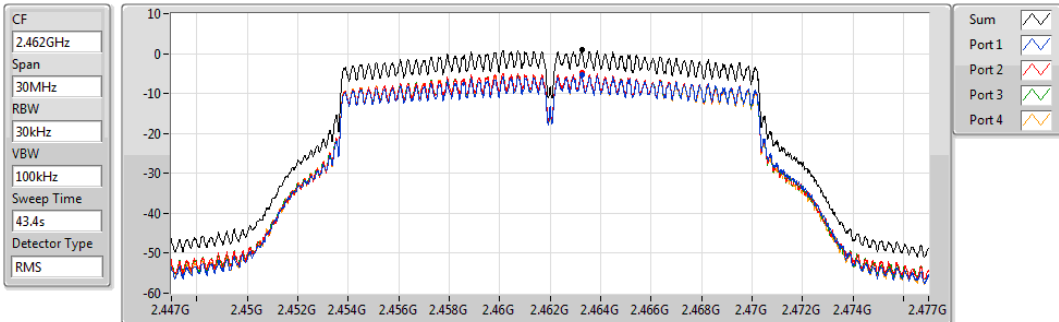

Sum	PD	Port 1	Port 2	Port 3	Port 4
(dBm/RBW)	(dBm/RBW)	(dBm/RBW)	(dBm/RBW)	(dBm/RBW)	(dBm/RBW)
1.01	1.01	-5.31	-4.74	-4.89	-5.14

### 802.11ac VHT20\_Nss1,(MCS0)\_4TX

PSD

2412MHz

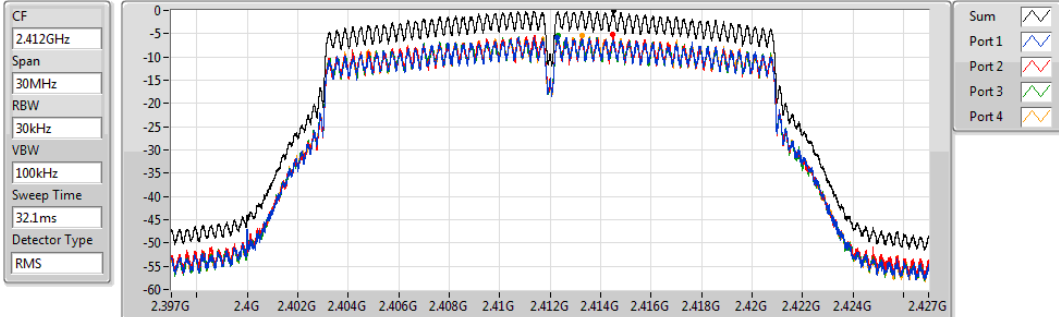

Sum	PD	Port 1	Port 2	Port 3	Port 4
(dBm/RBW)	(dBm/RBW)	(dBm/RBW)	(dBm/RBW)	(dBm/RBW)	(dBm/RBW)
-0.10	-0.10	-5.77	-5.25	-5.49	-5.44

### 802.11ac VHT20\_Nss1,(MCS0)\_4TX

PSD

2437MHz

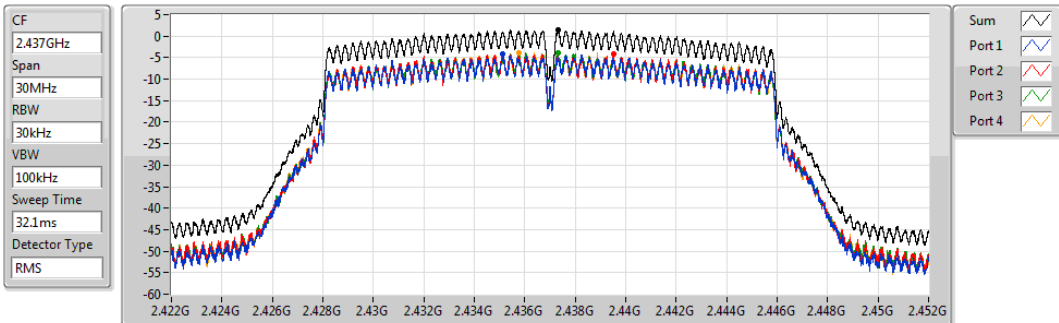

Sum	PD	Port 1	Port 2	Port 3	Port 4
(dBm/RBW)	(dBm/RBW)	(dBm/RBW)	(dBm/RBW)	(dBm/RBW)	(dBm/RBW)
1.43	1.43	-4.18	-4.10	-3.86	-3.82

### 802.11ac VHT20\_Nss1,(MCS0)\_4TX

PSD

2462MHz

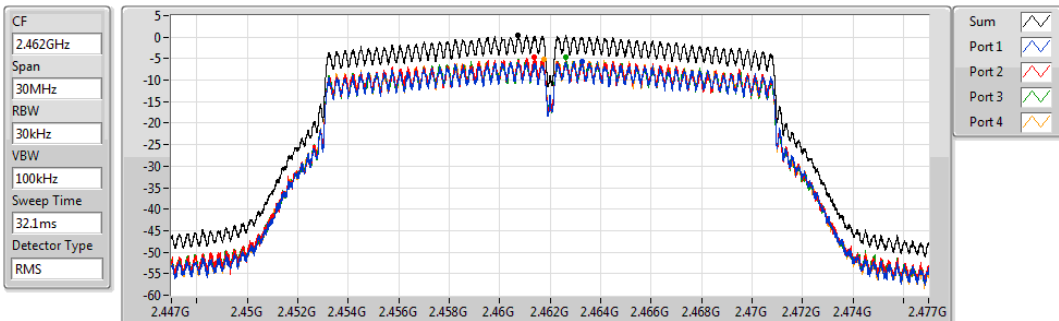

Sum	PD	Port 1	Port 2	Port 3	Port 4
(dBm/RBW)	(dBm/RBW)	(dBm/RBW)	(dBm/RBW)	(dBm/RBW)	(dBm/RBW)
0.38	0.38	-5.60	-4.64	-4.74	-5.13

### 802.11ac VHT40\_Nss1,(MCS0)\_4TX

PSD

2422MHz

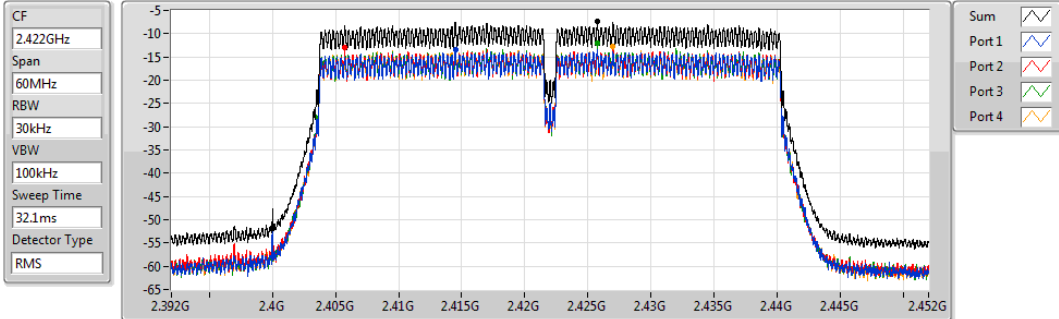

Sum	PD	Port 1	Port 2	Port 3	Port 4
(dBm/RBW)	(dBm/RBW)	(dBm/RBW)	(dBm/RBW)	(dBm/RBW)	(dBm/RBW)
-7.46	-7.46	-13.42	-12.98	-12.14	-12.77

### 802.11ac VHT40\_Nss1,(MCS0)\_4TX

PSD

2437MHz

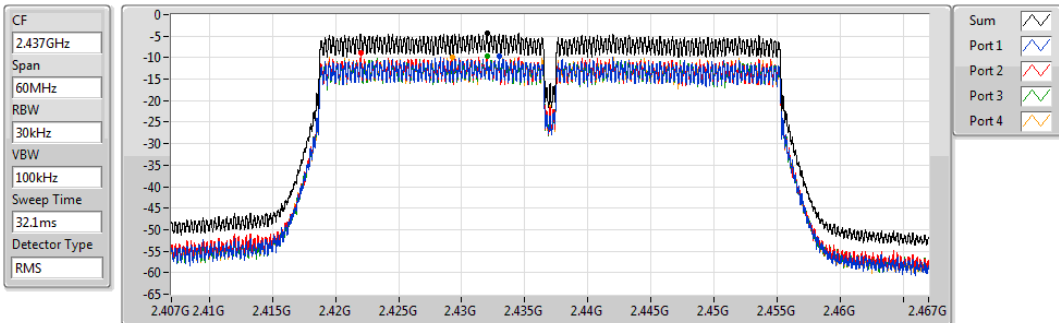

Sum	PD	Port 1	Port 2	Port 3	Port 4
(dBm/RBW)	(dBm/RBW)	(dBm/RBW)	(dBm/RBW)	(dBm/RBW)	(dBm/RBW)
-4.37	-4.37	-9.75	-9.01	-9.67	-9.87

### 802.11ac VHT40\_Nss1,(MCS0)\_4TX

PSD

2452MHz

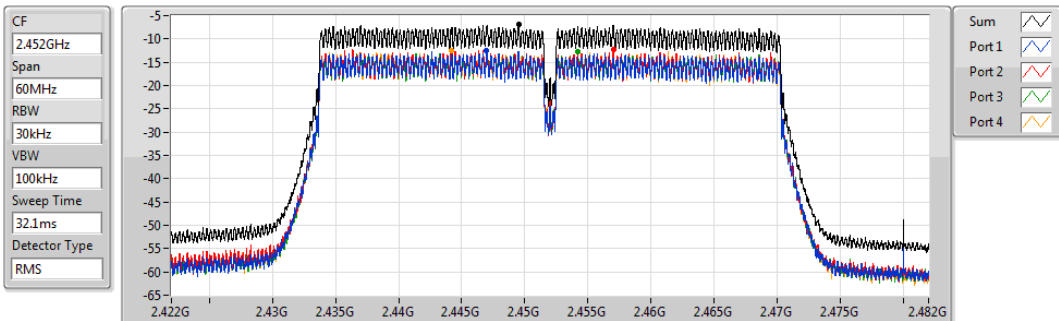

Sum	PD	Port 1	Port 2	Port 3	Port 4
(dBm/RBW)	(dBm/RBW)	(dBm/RBW)	(dBm/RBW)	(dBm/RBW)	(dBm/RBW)
-6.87	-6.87	-12.59	-12.16	-12.71	-12.59

## Beamforming mode

### Summary

Mode	PD (dBm/RBW)
2.4-2.4835GHz	-
802.11ac VHT20-BF_Nss1,(MCS0)_4TX	3.93

RBW=3kHz.

### Result

Mode	Result	DG (dBi)	Port 1 (dBm/RBW)	Port 2 (dBm/RBW)	Port 3 (dBm/RBW)	Port 4 (dBm/RBW)	PD (dBm/RBW)	PD Limit (dBm/RBW)
802.11ac VHT20-BF_Nss1,(MCS0)_4TX	-	-	-	-	-	-	-	-
2412MHz	Pass	8.90	-2.36	-2.23	-2.40	-1.58	2.19	5.10
2437MHz	Pass	8.90	-0.76	-0.90	-0.98	-0.24	3.93	5.10
2462MHz	Pass	8.90	-2.00	-1.83	-1.86	-2.06	2.71	5.10

**DG** = Directional Gain;

**PD** = trace bin-by-bin of each transmits port summing can be performed maximum power density; **Port X** = Port X power density;

**Note:** Directional gain =  $10 * \log((10^{3.2/20} + 10^{3/20} + 10^{2.5/20} + 10^{2.8/20})^2 / 4) = 8.90 \text{ dBi} > 6 \text{ dBi}$ . Limit shall be reduced to 8 dBm – (8.90 dBi – 6 dBi) = 5.10 dBm.

### 802.11ac VHT20-BF\_Nss1,(MCS0)\_4TX

PSD

2412MHz

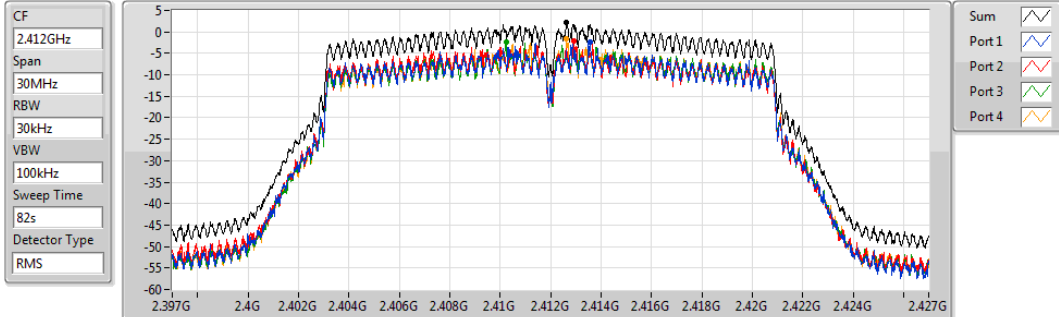

Sum	PD	Port 1	Port 2	Port 3	Port 4
(dBm/RBW)	(dBm/RBW)	(dBm/RBW)	(dBm/RBW)	(dBm/RBW)	(dBm/RBW)
2.19	2.19	-2.36	-2.23	-2.40	-1.58

### 802.11ac VHT20-BF\_Nss1,(MCS0)\_4TX

PSD

2437MHz

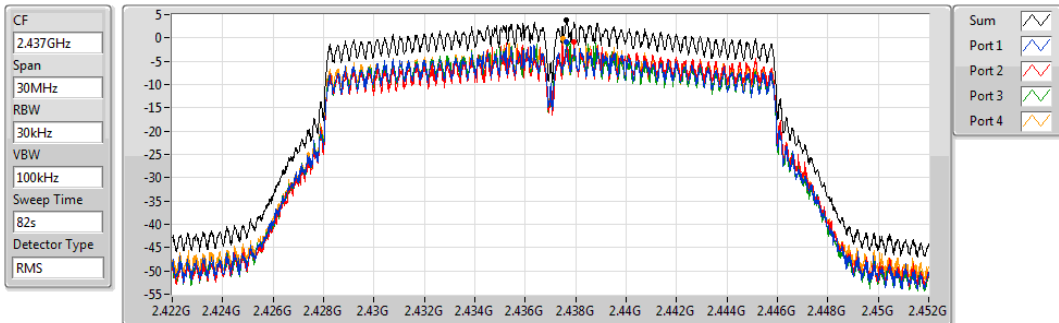

Sum	PD	Port 1	Port 2	Port 3	Port 4
(dBm/RBW)	(dBm/RBW)	(dBm/RBW)	(dBm/RBW)	(dBm/RBW)	(dBm/RBW)
3.93	3.93	-0.76	-0.90	-0.98	-0.24

### 802.11ac VHT20-BF\_Nss1,(MCS0)\_4TX

PSD

2462MHz

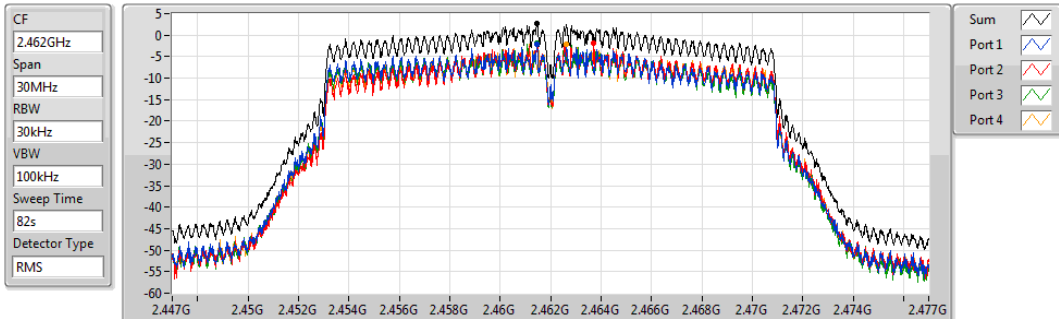

Sum	PD	Port 1	Port 2	Port 3	Port 4
(dBm/RBW)	(dBm/RBW)	(dBm/RBW)	(dBm/RBW)	(dBm/RBW)	(dBm/RBW)
2.71	2.71	-2.00	-1.83	-1.86	-2.06

## 3.5 Unwanted Emissions into Restricted Frequency Bands

### 3.5.1 Limit of Unwanted Emissions into Restricted Frequency Bands

Restricted Band Emissions Limit			
Frequency Range (MHz)	Field Strength (uV/m)	Field Strength (dBuV/m)	Measure Distance (m)
0.009~0.490	2400/F(kHz)	48.5 - 13.8	300
0.490~1.705	24000/F(kHz)	33.8 - 23	30
1.705~30.0	30	29	30
30~88	100	40	3
88~216	150	43.5	3
216~960	200	46	3
Above 960	500	54	3

**Note 1:**  
Quasi-Peak value is measured for frequency below 1GHz except for 9–90 kHz, 110–490 kHz frequency band. Peak and average value are measured for frequency above 1GHz. The limit on average radio frequency emission is as above table. The limit on peak radio frequency emissions is 20 dB above the maximum permitted average emission limit

**Note 2:**  
Measurements may be performed at a distance other than what is specified provided. When performing measurements at a distance other than that specified, the results shall be extrapolated to the specified distance using an extrapolation factor as below, Frequency at or above 30 MHz: 20 dB/decade Frequency below 30 MHz: 40 dB/decade.

### 3.5.2 Test Procedures

1. Measurement is made at a semi-anechoic chamber that incorporates a turntable allowing a EUT rotation of 360°. A continuously-rotating, remotely-controlled turntable is installed at the test site to support the EUT and facilitate determination of the direction of maximum radiation for each EUT emission frequency. The EUT is placed at test table. For emissions testing at or below 1 GHz, the table height is 80 cm above the reference ground plane. For emission measurements above 1 GHz, the table height is 1.5 m
2. Measurement is made with the antenna positioned in both the horizontal and vertical planes of polarization. The measurement antenna is varied in height (1m ~ 4m) above the reference ground plane to obtain the maximum signal strength. Distance between EUT and antenna is 3 m.
3. This investigation is performed with the EUT rotated 360°, the antenna height scanned between 1 m and 4 m, and the antenna rotated to repeat the measurements for both the horizontal and vertical antenna polarizations.

**Note:**

1. 120kHz measurement bandwidth of test receiver and Quasi-peak detector is for radiated emission below 1GHz.
2. RBW=1MHz, VBW=3MHz and Peak detector is for peak measured value of radiated emission above 1GHz.
3. RBW=1MHz, VBW=1/T and Peak detector is for average measured value of radiated emission above 1GHz.

### 3.5.3 Test Setup

#### Radiated Emissions below 1 GHz

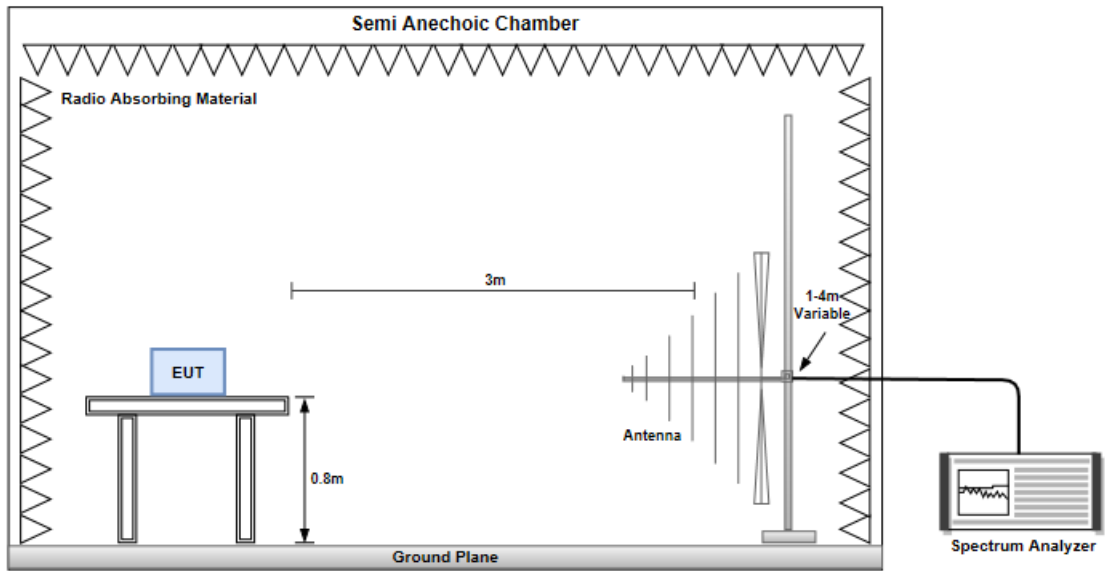

#### Radiated Emissions above 1 GHz

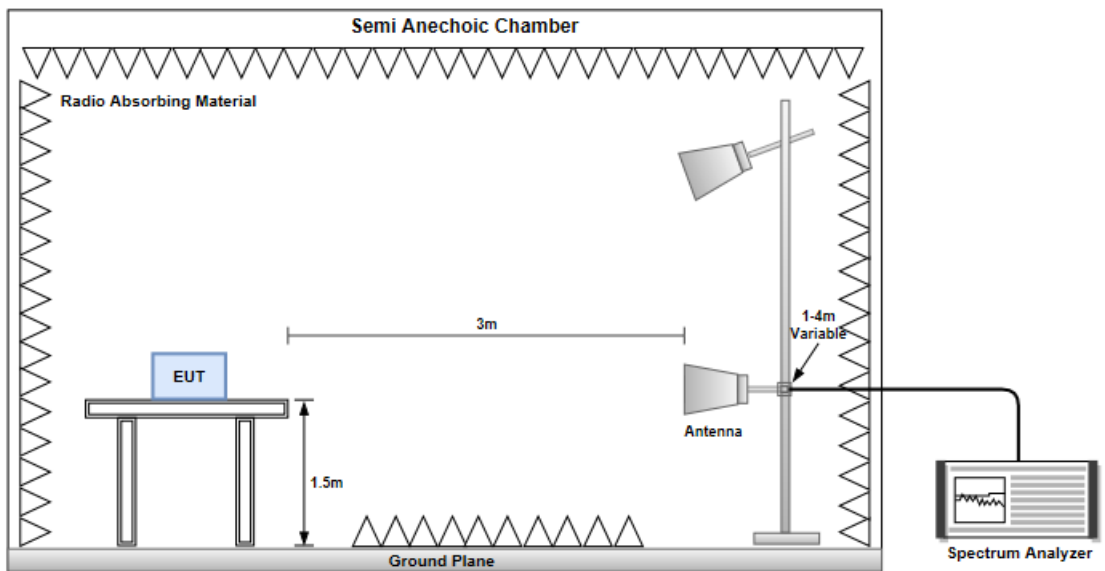

**Non-beamforming mode**

**3.5.4 Transmitter Radiated Unwanted Emissions (Below 1GHz)**

<b>Modulation</b>	11b	<b>Test Freq. (MHz)</b>	2437
<b>Polarization</b>	Horizontal		

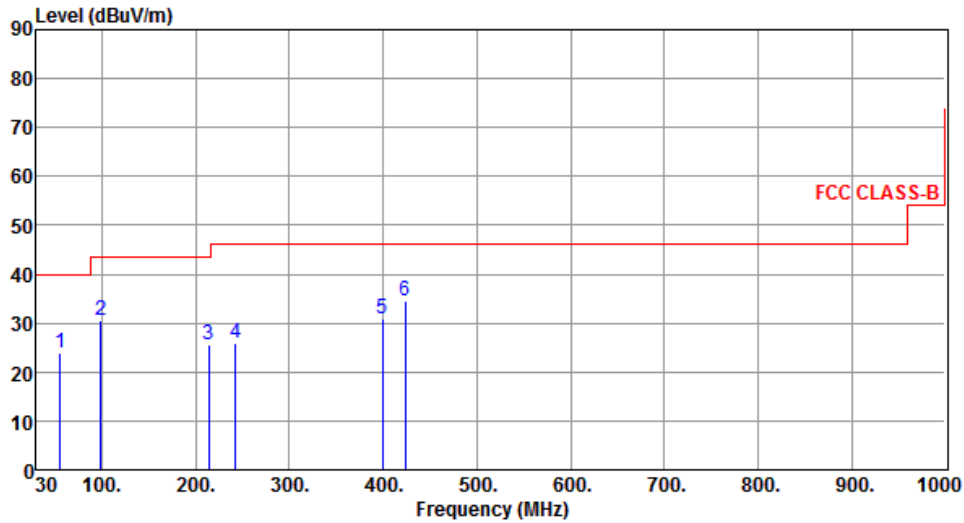

	Freq. MHz	Emission level dBuV/m	Limit dBuV/m	Margin dB	SA reading dBuV	Factor dB	Remark	ANT High cm	Turn Table deg
1	55.22	23.79	40.00	-16.21	32.85	-9.06	Peak	---	---
2	98.87	30.42	43.50	-13.08	44.29	-13.87	Peak	---	---
3	214.30	25.63	43.50	-17.87	37.81	-12.18	Peak	---	---
4	242.43	25.90	46.00	-20.10	36.20	-10.30	Peak	---	---
5	399.57	30.84	46.00	-15.16	36.66	-5.82	Peak	---	---
6	423.82	34.65	46.00	-11.35	39.80	-5.15	Peak	---	---

Note 1: Emission Level (dBuV/m) = SA Reading (dBuV/m) + Factor\* (dB)

\*Factor includes antenna factor , cable loss and amplifier gain

Note 2: Margin (dB) = Emission level (dBuV/m) – Limit (dBuV/m).

Note 3: All spurious emissions below 30MHz are more than 20 dB below the limit.



<b>Modulation</b>	11b	<b>Test Freq. (MHz)</b>	2437
<b>Polarization</b>	Vertical		

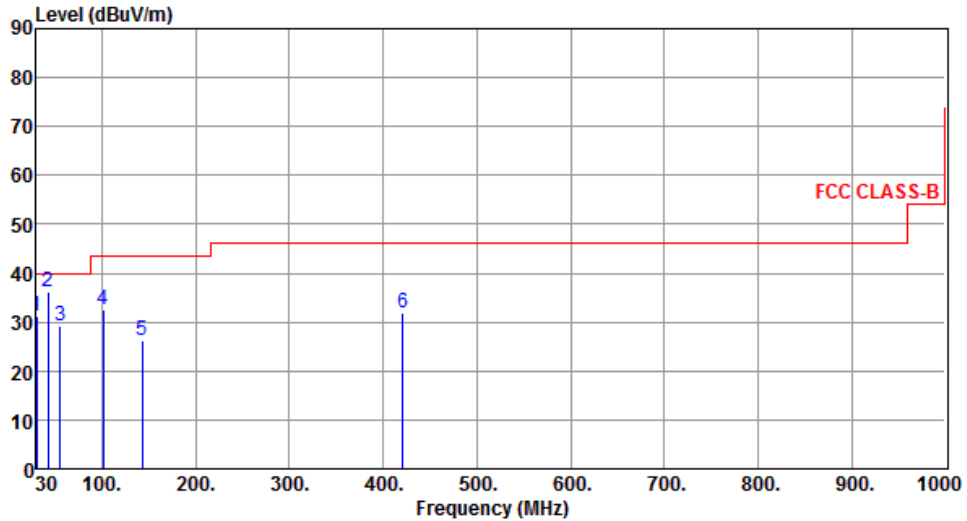

	Freq. MHz	Emission level dBuV/m	Limit dBuV/m	Margin dB	SA reading dBuV	Factor dB	Remark	ANT High cm	Turn Table deg
1	30.00	31.16	40.00	-8.84	41.32	-10.16	Peak	---	---
2	42.61	36.25	40.00	-3.75	45.23	-8.98	Peak	---	---
3	55.22	29.37	40.00	-10.63	38.43	-9.06	Peak	---	---
4	101.78	32.66	43.50	-10.84	46.06	-13.40	Peak	---	---
5	142.52	26.14	43.50	-17.36	35.23	-9.09	Peak	---	---
6	420.91	32.00	46.00	-14.00	37.22	-5.22	Peak	---	---

Note 1: Emission Level (dBuV/m) = SA Reading (dBuV/m) + Factor\* (dB)

\*Factor includes antenna factor , cable loss and amplifier gain

Note 2: Margin (dB) = Emission level (dBuV/m) – Limit (dBuV/m).

Note 3: All spurious emissions below 30MHz are more than 20 dB below the limit.

### 3.5.5 Transmitter Radiated Unwanted Emissions (Above 1GHz) for 11b

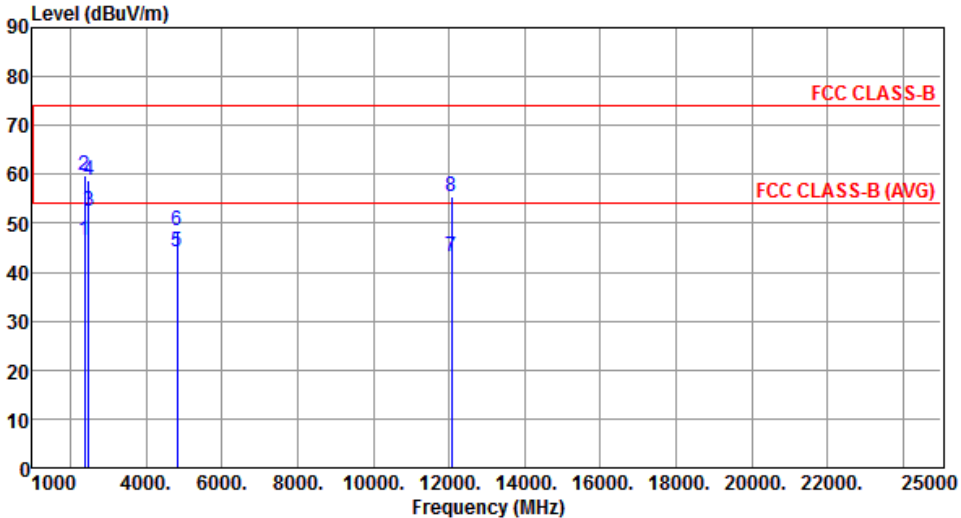
Modulation	11b	Test Freq. (MHz)	2412						
Polarization	Horizontal								
									
	Freq.	Emission level	Limit	Margin	SA reading	Factor	Remark	ANT High	Turn Table
	MHz	dBUV/m	dBUV/m	dB	dBUV	dB		cm	deg
1	2390.00	46.58	54.00	-7.42	47.54	-0.96	Average	100	118
2	2390.00	59.63	74.00	-14.37	60.59	-0.96	Peak	100	118
3	2487.00	52.59	54.00	-1.41	53.72	-1.13	Average	146	78
4	2487.00	58.73	74.00	-15.27	59.86	-1.13	Peak	146	78
5	4824.00	44.31	54.00	-9.69	39.44	4.87	Average	100	336
6	4824.00	48.45	74.00	-25.55	43.58	4.87	Peak	100	336
7	12060.00	43.33	54.00	-10.67	28.41	14.92	Average	100	20
8	12060.00	55.61	74.00	-18.39	40.69	14.92	Peak	100	20

Note 1: Emission Level (dBUV/m) = SA Reading (dBUV/m) + Factor\* (dB)  
\*Factor includes antenna factor , cable loss and amplifier gain  
Note 2: Margin (dB) = Emission level (dBUV/m) – Limit (dBUV/m).

<b>Modulation</b>	11b	<b>Test Freq. (MHz)</b>	2412
<b>Polarization</b>	Vertical		

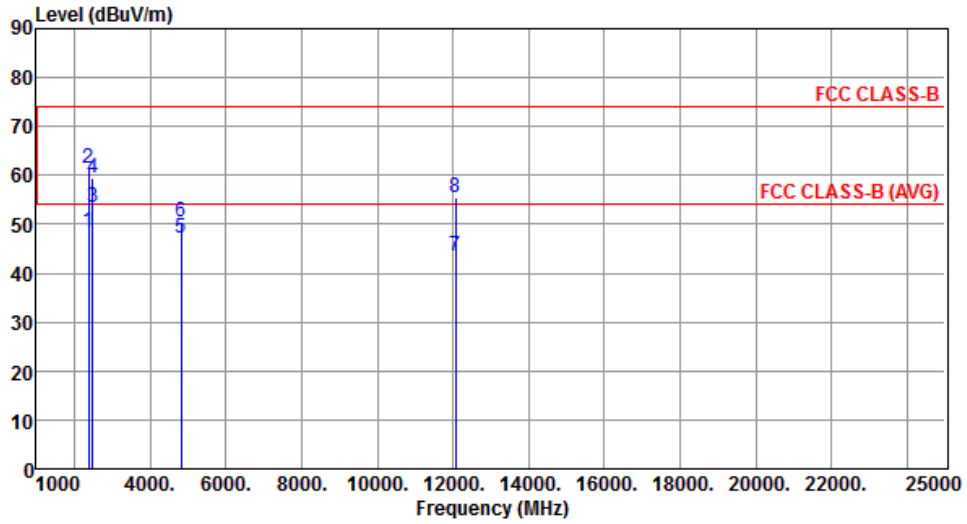

	Freq. MHz	Emission level dBuV/m	Limit dBuV/m	Margin dB	SA reading dBuV	Factor dB	Remark	ANT High cm	Turn Table deg
1	2390.00	48.63	54.00	-5.37	49.59	-0.96	Average	160	265
2	2390.00	61.55	74.00	-12.45	62.51	-0.96	Peak	160	265
3	2487.00	53.56	54.00	-0.44	54.69	-1.13	Average	131	299
4	2487.00	59.42	74.00	-14.58	60.55	-1.13	Peak	131	299
5	4824.00	47.07	54.00	-6.93	42.20	4.87	Average	100	169
6	4824.00	50.55	74.00	-23.45	45.68	4.87	Peak	100	169
7	12060.00	43.37	54.00	-10.63	28.45	14.92	Average	100	30
8	12060.00	55.50	74.00	-18.50	40.58	14.92	Peak	100	30

Note 1: Emission Level (dBuV/m) = SA Reading (dBuV/m) + Factor\* (dB)

\*Factor includes antenna factor , cable loss and amplifier gain

Note 2: Margin (dB) = Emission level (dBuV/m) – Limit (dBuV/m).

<b>Modulation</b>	11b	<b>Test Freq. (MHz)</b>	2437
<b>Polarization</b>	Horizontal		

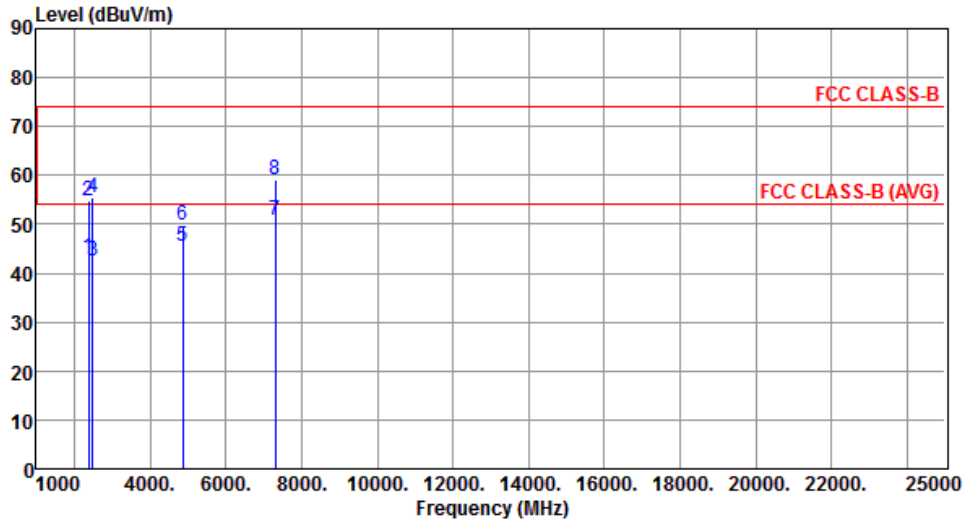

	Freq. MHz	Emission level dBuV/m	Limit dBuV/m	Margin dB	SA reading dBuV	Factor dB	Remark	ANT High cm	Turn Table deg
1	2390.00	43.30	54.00	-10.70	44.26	-0.96	Average	100	118
2	2390.00	54.89	74.00	-19.11	55.85	-0.96	Peak	100	118
3	2483.50	42.57	54.00	-11.43	43.69	-1.12	Average	100	118
4	2483.50	55.46	74.00	-18.54	56.58	-1.12	Peak	100	118
5	4874.00	45.40	54.00	-8.60	40.49	4.91	Average	103	344
6	4874.00	49.85	74.00	-24.15	44.94	4.91	Peak	103	344
7	7311.00	50.71	54.00	-3.29	40.36	10.35	Average	109	1
8	7311.00	59.12	74.00	-14.88	48.77	10.35	Peak	109	1

Note 1: Emission Level (dBuV/m) = SA Reading (dBuV/m) + Factor\* (dB)

\*Factor includes antenna factor , cable loss and amplifier gain

Note 2: Margin (dB) = Emission level (dBuV/m) – Limit (dBuV/m).

<b>Modulation</b>	11b	<b>Test Freq. (MHz)</b>	2437
<b>Polarization</b>	Vertical		

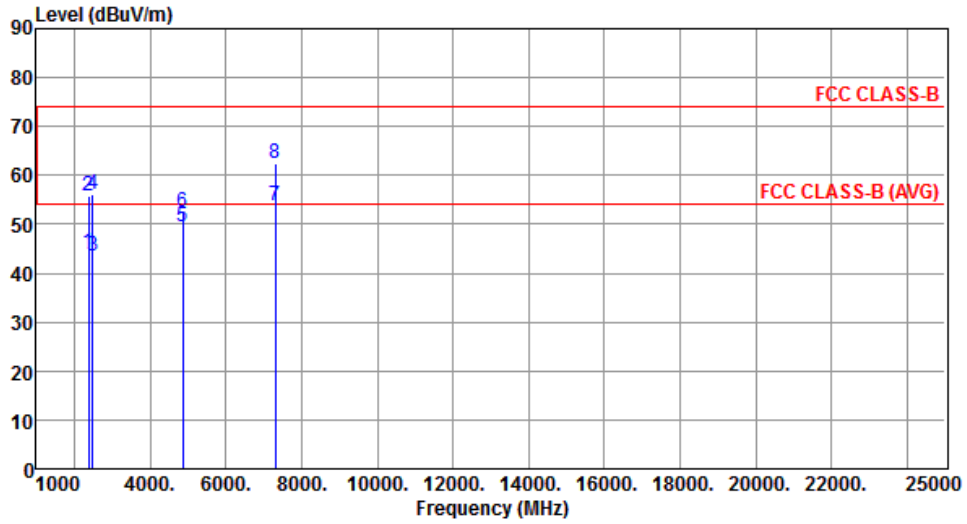

	Freq. MHz	Emission level dBuV/m	Limit dBuV/m	Margin dB	SA reading dBuV	Factor dB	Remark	ANT High cm	Turn Table deg
1	2390.00	44.18	54.00	-9.82	45.14	-0.96	Average	122	234
2	2390.00	55.94	74.00	-18.06	56.90	-0.96	Peak	122	234
3	2483.50	43.45	54.00	-10.55	44.57	-1.12	Average	122	234
4	2483.50	56.14	74.00	-17.86	57.26	-1.12	Peak	122	234
5	4874.00	49.41	54.00	-4.59	44.50	4.91	Average	101	191
6	4874.00	52.55	74.00	-21.45	47.64	4.91	Peak	101	191
7	7311.00	53.73	54.00	-0.27	43.38	10.35	Average	116	138
8	7311.00	62.30	74.00	-11.70	51.95	10.35	Peak	116	138

Note 1: Emission Level (dBuV/m) = SA Reading (dBuV/m) + Factor\* (dB)

\*Factor includes antenna factor , cable loss and amplifier gain

Note 2: Margin (dB) = Emission level (dBuV/m) – Limit (dBuV/m).

<b>Modulation</b>	11b	<b>Test Freq. (MHz)</b>	2462
<b>Polarization</b>	Horizontal		

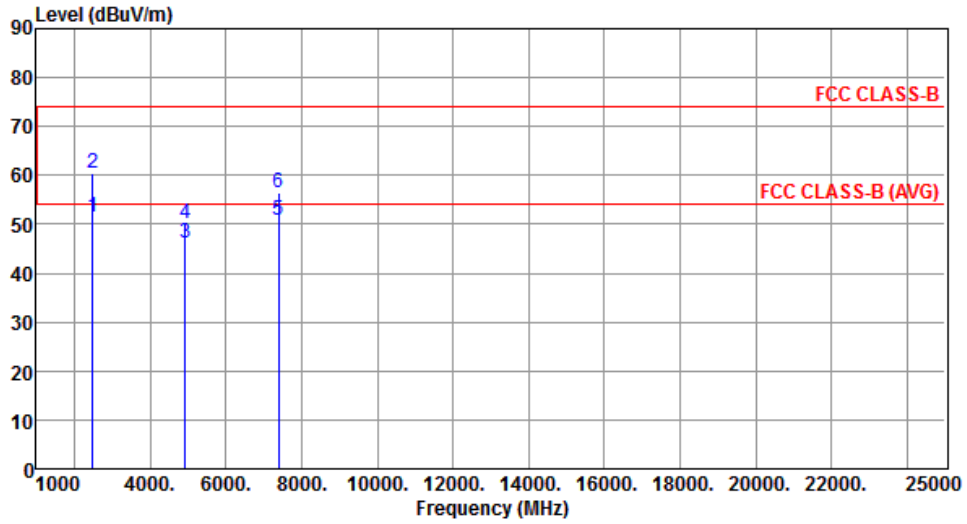

	Freq. MHz	Emission level dBuV/m	Limit dBuV/m	Margin dB	SA reading dBuV	Factor dB	Remark	ANT High cm	Turn Table deg
1	2483.50	51.33	54.00	-2.67	52.45	-1.12	Average	100	119
2	2483.50	60.43	74.00	-13.57	61.55	-1.12	Peak	100	119
3	4924.00	46.27	54.00	-7.73	41.26	5.01	Average	105	346
4	4924.00	50.27	74.00	-23.73	45.26	5.01	Peak	105	346
5	7386.00	50.70	54.00	-3.30	40.55	10.15	Average	105	5
6	7386.00	56.36	74.00	-17.64	46.21	10.15	Peak	105	5

Note 1: Emission Level (dBuV/m) = SA Reading (dBuV/m) + Factor\* (dB)

\*Factor includes antenna factor , cable loss and amplifier gain

Note 2: Margin (dB) = Emission level (dBuV/m) – Limit (dBuV/m).

<b>Modulation</b>	11b	<b>Test Freq. (MHz)</b>	2462
<b>Polarization</b>	Vertical		

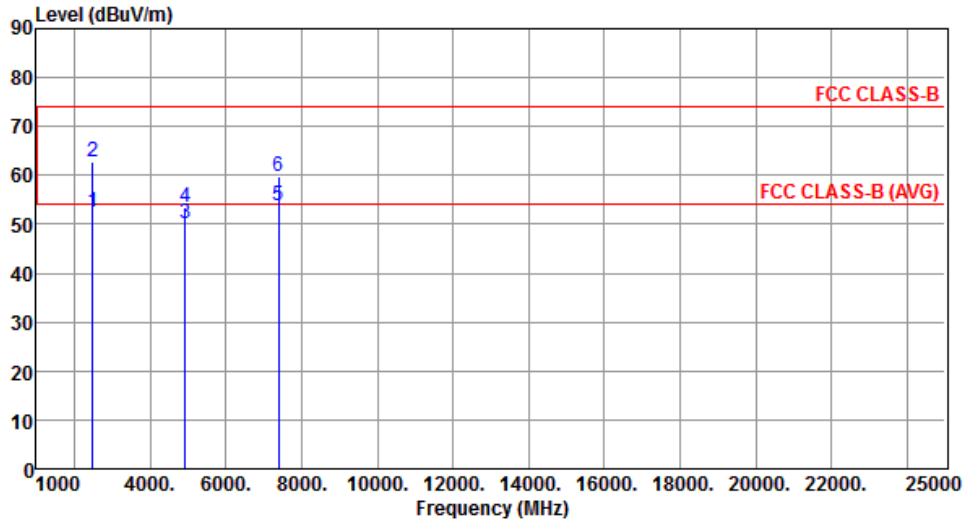

	Freq. MHz	Emission level dBuV/m	Limit dBuV/m	Margin dB	SA reading dBuV	Factor dB	Remark	ANT High cm	Turn Table deg
1	2483.50	52.48	54.00	-1.52	53.60	-1.12	Average	118	235
2	2483.50	62.74	74.00	-11.26	63.86	-1.12	Peak	118	235
3	4924.00	50.03	54.00	-3.97	45.02	5.01	Average	100	190
4	4924.00	53.55	74.00	-20.45	48.54	5.01	Peak	100	190
5	7386.00	53.82	54.00	-0.18	43.67	10.15	Average	117	138
6	7386.00	59.93	74.00	-14.07	49.78	10.15	Peak	117	138

Note 1: Emission Level (dBuV/m) = SA Reading (dBuV/m) + Factor\* (dB)

\*Factor includes antenna factor , cable loss and amplifier gain

Note 2: Margin (dB) = Emission level (dBuV/m) – Limit (dBuV/m).

### 3.5.6 Transmitter Radiated Unwanted Emissions (Above 1GHz) for 11g

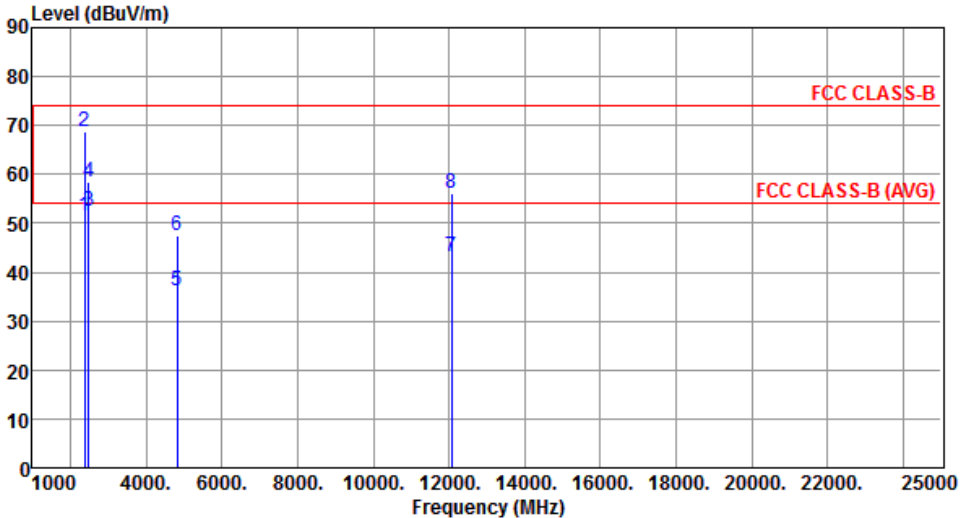
Modulation	11g	Test Freq. (MHz)	2412						
Polarization	Horizontal								
									
	Freq.	Emission level	Limit	Margin	SA reading	Factor	Remark	ANT High	Turn Table
	MHz	dBUV/m	dBUV/m	dB	dBUV	dB		cm	deg
1	2390.00	51.35	54.00	-2.65	52.31	-0.96	Average	100	125
2	2390.00	68.89	74.00	-5.11	69.85	-0.96	Peak	100	125
3	2487.00	52.54	54.00	-1.46	53.67	-1.13	Average	100	117
4	2487.00	58.46	74.00	-15.54	59.59	-1.13	Peak	100	117
5	4824.00	36.13	54.00	-17.87	31.26	4.87	Average	100	165
6	4824.00	47.44	74.00	-26.56	42.57	4.87	Peak	100	165
7	12060.00	43.18	54.00	-10.82	28.26	14.92	Average	100	90
8	12060.00	56.24	74.00	-17.76	41.32	14.92	Peak	100	90
<p>Note 1: Emission Level (dBUV/m) = SA Reading (dBUV/m) + Factor* (dB)            *Factor includes antenna factor , cable loss and amplifier gain            Note 2: Margin (dB) = Emission level (dBUV/m) – Limit (dBUV/m).</p>									



<b>Modulation</b>	11g	<b>Test Freq. (MHz)</b>	2412
<b>Polarization</b>	Vertical		

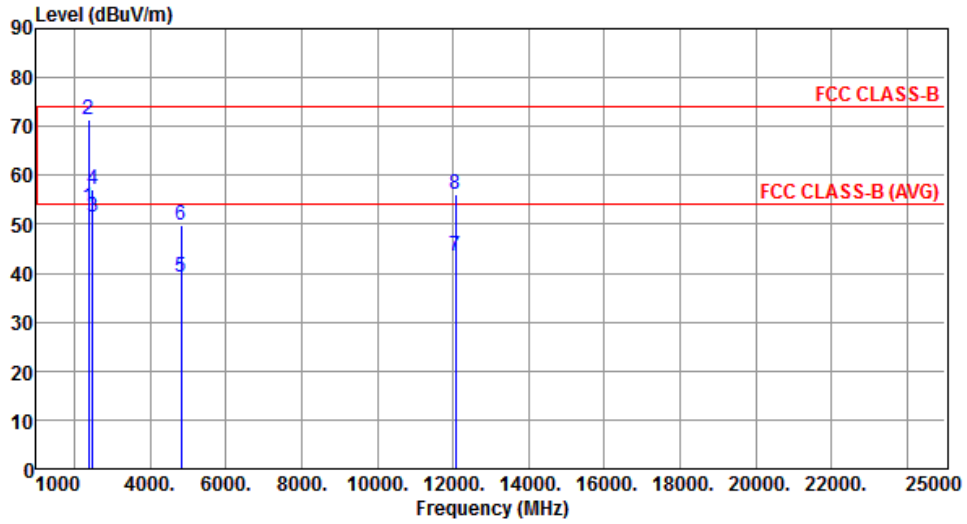

	Freq. MHz	Emission level dBuV/m	Limit dBuV/m	Margin dB	SA reading dBuV	Factor dB	Remark	ANT High cm	Turn Table deg
1	2390.00	53.51	54.00	-0.49	54.47	-0.96	Average	235	3
2	2390.00	71.26	74.00	-2.74	72.22	-0.96	Peak	235	3
3	2487.00	51.42	54.00	-2.58	52.55	-1.13	Average	140	70
4	2487.00	57.11	74.00	-16.89	58.24	-1.13	Peak	140	70
5	4824.00	39.17	54.00	-14.83	34.30	4.87	Average	100	170
6	4824.00	49.71	74.00	-24.29	44.84	4.87	Peak	100	170
7	12060.00	43.57	54.00	-10.43	28.65	14.92	Average	100	30
8	12060.00	56.19	74.00	-17.81	41.27	14.92	Peak	100	30

Note 1: Emission Level (dBuV/m) = SA Reading (dBuV/m) + Factor\* (dB)

\*Factor includes antenna factor , cable loss and amplifier gain

Note 2: Margin (dB) = Emission level (dBuV/m) – Limit (dBuV/m).

<b>Modulation</b>	11g	<b>Test Freq. (MHz)</b>	2437
<b>Polarization</b>	Horizontal		

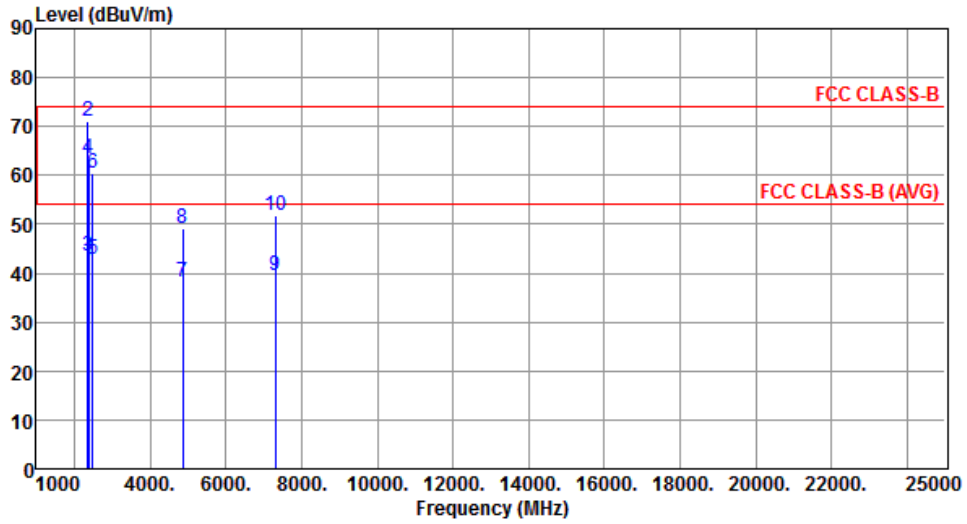

	Freq. MHz	Emission level dBuV/m	Limit dBuV/m	Margin dB	SA reading dBuV	Factor dB	Remark	ANT High cm	Turn Table deg
1	2360.00	42.43	54.00	-11.57	43.31	-0.88	Average	158	90
2	2360.00	71.05	74.00	-2.95	71.93	-0.88	Peak	158	90
3	2390.00	43.60	54.00	-10.40	44.56	-0.96	Average	158	90
4	2390.00	63.49	74.00	-10.51	64.45	-0.96	Peak	158	90
5	2483.50	42.72	54.00	-11.28	43.84	-1.12	Average	158	90
6	2483.50	60.30	74.00	-13.70	61.42	-1.12	Peak	158	90
7	4874.00	38.03	54.00	-15.97	33.12	4.91	Average	100	339
8	4874.00	49.26	74.00	-24.74	44.35	4.91	Peak	100	339
9	7311.00	39.61	54.00	-14.39	29.26	10.35	Average	105	5
10	7311.00	51.93	74.00	-22.07	41.58	10.35	Peak	105	5

Note 1: Emission Level (dBuV/m) = SA Reading (dBuV/m) + Factor\* (dB)

\*Factor includes antenna factor , cable loss and amplifier gain

Note 2: Margin (dB) = Emission level (dBuV/m) – Limit (dBuV/m).

<b>Modulation</b>	11g	<b>Test Freq. (MHz)</b>	2437
<b>Polarization</b>	Vertical		

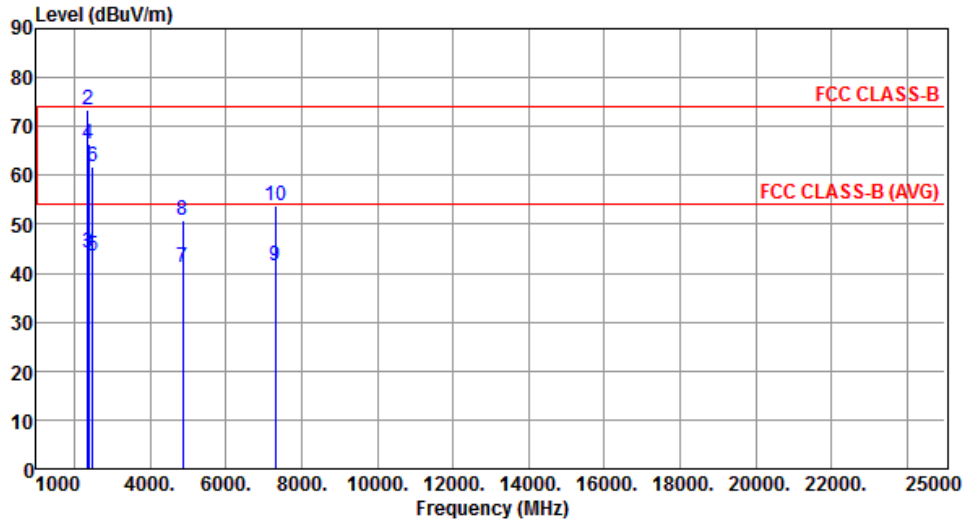

	Freq. MHz	Emission level dBuV/m	Limit dBuV/m	Margin dB	SA reading dBuV	Factor dB	Remark	ANT High cm	Turn Table deg
1	2360.00	43.63	54.00	-10.37	44.51	-0.88	Average	117	335
2	2360.00	73.55	74.00	-0.45	74.43	-0.88	Peak	117	335
3	2390.00	44.06	54.00	-9.94	45.02	-0.96	Average	117	234
4	2390.00	66.49	74.00	-7.51	67.45	-0.96	Peak	117	234
5	2483.50	43.39	54.00	-10.61	44.51	-1.12	Average	117	295
6	2483.50	61.64	74.00	-12.36	62.76	-1.12	Peak	117	295
7	4874.00	41.13	54.00	-12.87	36.22	4.91	Average	100	168
8	4874.00	50.76	74.00	-23.24	45.85	4.91	Peak	100	168
9	7311.00	41.61	54.00	-12.39	31.26	10.35	Average	100	116
10	7311.00	53.93	74.00	-20.07	43.58	10.35	Peak	100	116

Note 1: Emission Level (dBuV/m) = SA Reading (dBuV/m) + Factor\* (dB)

\*Factor includes antenna factor , cable loss and amplifier gain

Note 2: Margin (dB) = Emission level (dBuV/m) – Limit (dBuV/m).

<b>Modulation</b>	11g	<b>Test Freq. (MHz)</b>	2462
<b>Polarization</b>	Horizontal		

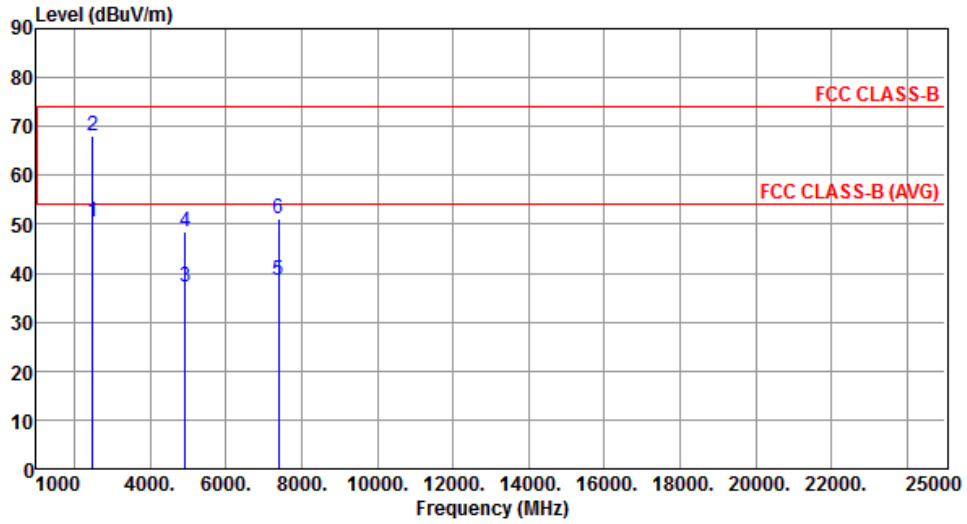

	Freq. MHz	Emission level dBuV/m	Limit dBuV/m	Margin dB	SA reading dBuV	Factor dB	Remark	ANT High cm	Turn Table deg
1	2483.50	50.53	54.00	-3.47	51.65	-1.12	Average	100	126
2	2483.50	67.93	74.00	-6.07	69.05	-1.12	Peak	100	126
3	4924.00	37.13	54.00	-16.87	32.12	5.01	Average	100	345
4	4924.00	48.59	74.00	-25.41	43.58	5.01	Peak	100	345
5	7386.00	38.60	54.00	-15.40	28.45	10.15	Average	100	50
6	7386.00	51.20	74.00	-22.80	41.05	10.15	Peak	100	50

Note 1: Emission Level (dBuV/m) = SA Reading (dBuV/m) + Factor\* (dB)

\*Factor includes antenna factor , cable loss and amplifier gain

Note 2: Margin (dB) = Emission level (dBuV/m) – Limit (dBuV/m).

<b>Modulation</b>	11g	<b>Test Freq. (MHz)</b>	2462
<b>Polarization</b>	Vertical		

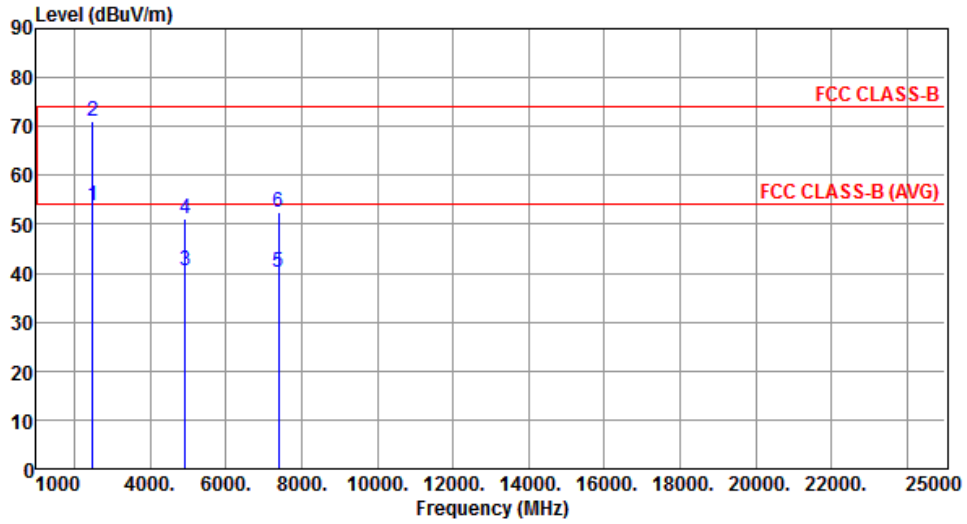

	Freq. MHz	Emission level dBuV/m	Limit dBuV/m	Margin dB	SA reading dBuV	Factor dB	Remark	ANT High cm	Turn Table deg
1	2483.50	53.65	54.00	-0.35	54.77	-1.12	Average	235	352
2	2483.50	70.96	74.00	-3.04	72.08	-1.12	Peak	235	352
3	4924.00	40.46	54.00	-13.54	35.45	5.01	Average	100	171
4	4924.00	51.24	74.00	-22.76	46.23	5.01	Peak	100	171
5	7386.00	40.33	54.00	-13.67	30.18	10.15	Average	100	116
6	7386.00	52.51	74.00	-21.49	42.36	10.15	Peak	100	116

Note 1: Emission Level (dBuV/m) = SA Reading (dBuV/m) + Factor\* (dB)

\*Factor includes antenna factor , cable loss and amplifier gain

Note 2: Margin (dB) = Emission level (dBuV/m) – Limit (dBuV/m).

### 3.5.7 Transmitter Radiated Unwanted Emissions (Above 1GHz) for VHT20

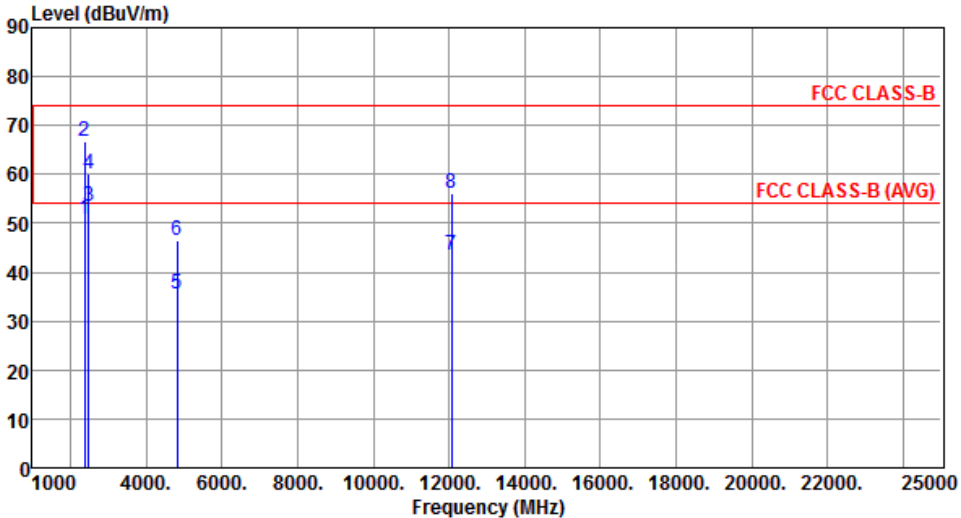
Modulation	VHT20	Test Freq. (MHz)	2412						
Polarization	Horizontal								
									
	Freq.	Emission level	Limit	Margin	SA reading	Factor	Remark	ANT High	Turn Table
	MHz	dBuV/m	dBuV/m	dB	dBuV	dB		cm	deg
1	2390.00	50.73	54.00	-3.27	51.69	-0.96	Average	100	115
2	2390.00	66.60	74.00	-7.40	67.56	-0.96	Peak	100	115
3	2487.00	53.56	54.00	-0.44	54.69	-1.13	Average	120	78
4	2487.00	60.14	74.00	-13.86	61.27	-1.13	Peak	120	78
5	4824.00	35.39	54.00	-18.61	30.52	4.87	Average	100	336
6	4824.00	46.44	74.00	-27.56	41.57	4.87	Peak	100	336
7	12060.00	43.46	54.00	-10.54	28.54	14.92	Average	100	60
8	12060.00	56.13	74.00	-17.87	41.21	14.92	Peak	100	60

Note 1: Emission Level (dBuV/m) = SA Reading (dBuV/m) + Factor\* (dB)  
\*Factor includes antenna factor , cable loss and amplifier gain  
Note 2: Margin (dB) = Emission level (dBuV/m) – Limit (dBuV/m).

<b>Modulation</b>	VHT20	<b>Test Freq. (MHz)</b>	2412
<b>Polarization</b>	Vertical		

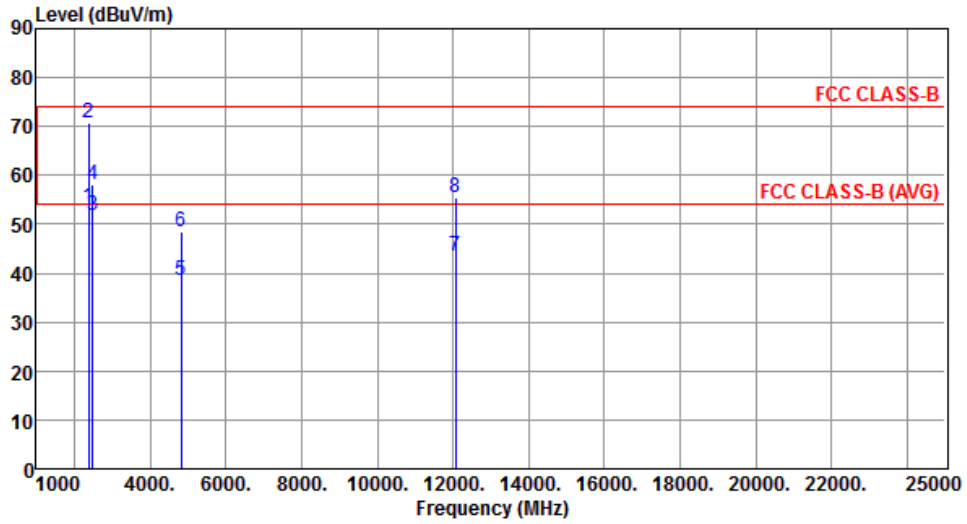

	Freq. MHz	Emission level dBuV/m	Limit dBuV/m	Margin dB	SA reading dBuV	Factor dB	Remark	ANT High cm	Turn Table deg
1	2390.00	53.50	54.00	-0.50	54.46	-0.96	Average	100	291
2	2390.00	70.87	74.00	-3.13	71.83	-0.96	Peak	100	291
3	2487.00	51.71	54.00	-2.29	52.84	-1.13	Average	126	278
4	2487.00	58.12	74.00	-15.88	59.25	-1.13	Peak	126	278
5	4824.00	38.55	54.00	-15.45	33.68	4.87	Average	100	165
6	4824.00	48.44	74.00	-25.56	43.57	4.87	Peak	100	165
7	12060.00	43.39	54.00	-10.61	28.47	14.92	Average	100	30
8	12060.00	55.51	74.00	-18.49	40.59	14.92	Peak	100	30

Note 1: Emission Level (dBuV/m) = SA Reading (dBuV/m) + Factor\* (dB)

\*Factor includes antenna factor , cable loss and amplifier gain

Note 2: Margin (dB) = Emission level (dBuV/m) – Limit (dBuV/m).

<b>Modulation</b>	VHT20	<b>Test Freq. (MHz)</b>	2437
<b>Polarization</b>	Horizontal		

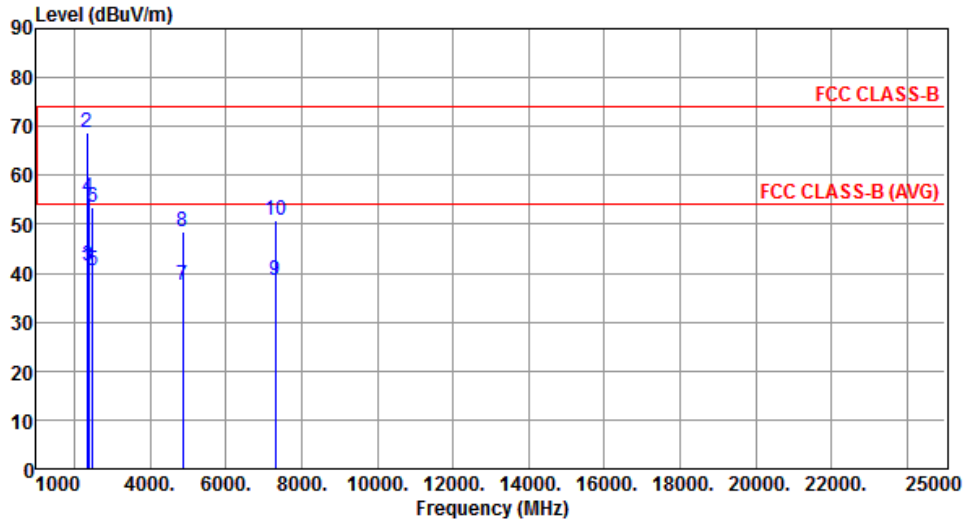

	Freq. MHz	Emission level dBuV/m	Limit dBuV/m	Margin dB	SA reading dBuV	Factor dB	Remark	ANT High cm	Turn Table deg
1	2340.00	41.22	54.00	-12.78	42.05	-0.83	Average	155	85
2	2340.00	68.75	74.00	-5.25	69.58	-0.83	Peak	155	85
3	2390.00	41.57	54.00	-12.43	42.53	-0.96	Average	110	117
4	2390.00	55.50	74.00	-18.50	56.46	-0.96	Peak	110	117
5	2483.50	40.57	54.00	-13.43	41.69	-1.12	Average	110	117
6	2483.50	53.56	74.00	-20.44	54.68	-1.12	Peak	110	117
7	4874.00	37.37	54.00	-16.63	32.46	4.91	Average	100	338
8	4874.00	48.50	74.00	-25.50	43.59	4.91	Peak	100	338
9	7311.00	38.56	54.00	-15.44	28.21	10.35	Average	100	30
10	7311.00	50.98	74.00	-23.02	40.63	10.35	Peak	100	30

Note 1: Emission Level (dBuV/m) = SA Reading (dBuV/m) + Factor\* (dB)

\*Factor includes antenna factor , cable loss and amplifier gain

Note 2: Margin (dB) = Emission level (dBuV/m) – Limit (dBuV/m).



<b>Modulation</b>	VHT20	<b>Test Freq. (MHz)</b>	2437
<b>Polarization</b>	Vertical		

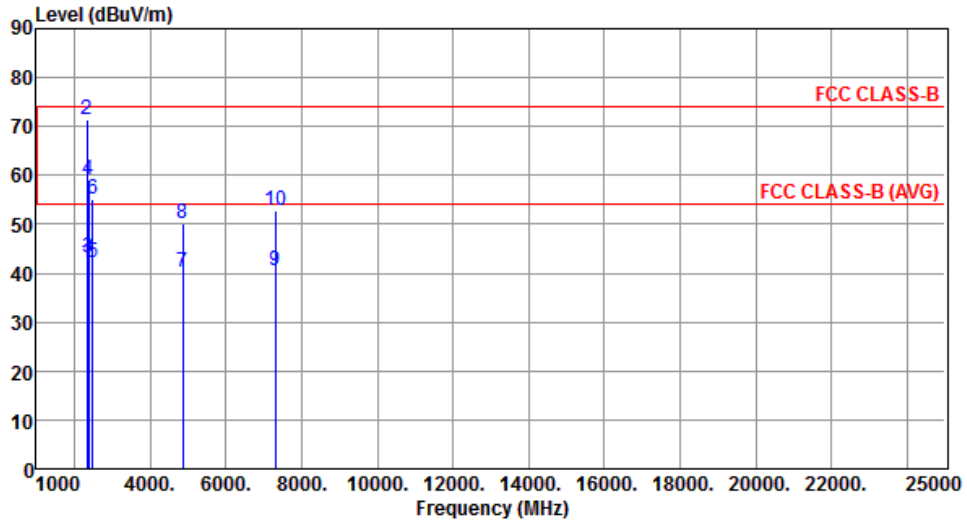

	Freq. MHz	Emission level dBuV/m	Limit dBuV/m	Margin dB	SA reading dBuV	Factor dB	Remark	ANT High cm	Turn Table deg
1	2340.00	42.29	54.00	-11.71	43.12	-0.83	Average	156	300
2	2340.00	71.26	74.00	-2.74	72.09	-0.83	Peak	156	300
3	2390.00	43.29	54.00	-10.71	44.25	-0.96	Average	215	15
4	2390.00	59.16	74.00	-14.84	60.12	-0.96	Peak	215	15
5	2483.50	42.26	54.00	-11.74	43.38	-1.12	Average	215	15
6	2483.50	55.14	74.00	-18.86	56.26	-1.12	Peak	215	15
7	4874.00	40.22	54.00	-13.78	35.31	4.91	Average	100	171
8	4874.00	50.29	74.00	-23.71	45.38	4.91	Peak	100	171
9	7311.00	40.40	54.00	-13.60	30.05	10.35	Average	100	116
10	7311.00	52.89	74.00	-21.11	42.54	10.35	Peak	100	116

Note 1: Emission Level (dBuV/m) = SA Reading (dBuV/m) + Factor\* (dB)

\*Factor includes antenna factor , cable loss and amplifier gain

Note 2: Margin (dB) = Emission level (dBuV/m) – Limit (dBuV/m).

<b>Modulation</b>	VHT20	<b>Test Freq. (MHz)</b>	2462
<b>Polarization</b>	Horizontal		

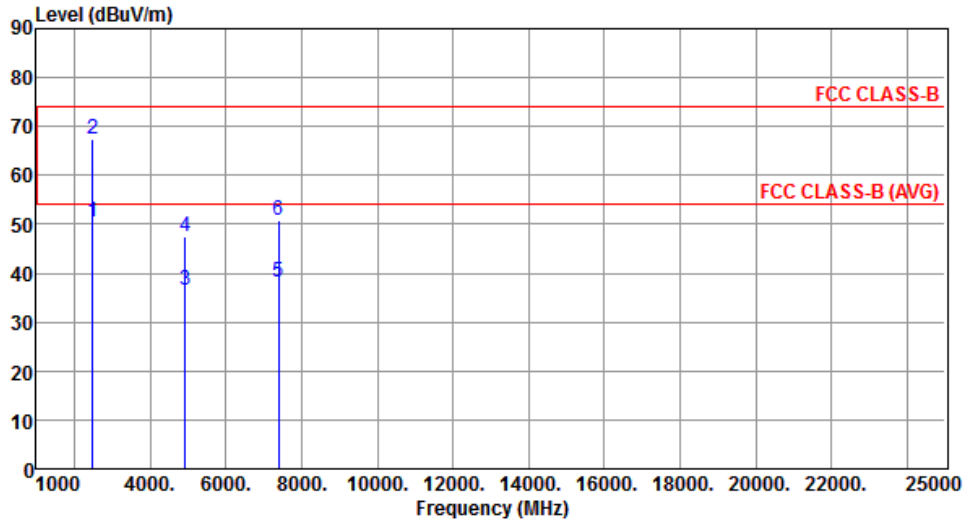

	Freq. MHz	Emission level dBuV/m	Limit dBuV/m	Margin dB	SA reading dBuV	Factor dB	Remark	ANT High cm	Turn Table deg
1	2483.50	50.56	54.00	-3.44	51.68	-1.12	Average	100	124
2	2483.50	67.57	74.00	-6.43	68.69	-1.12	Peak	100	124
3	4924.00	36.43	54.00	-17.57	31.42	5.01	Average	100	342
4	4924.00	47.57	74.00	-26.43	42.56	5.01	Peak	100	342
5	7386.00	38.29	54.00	-15.71	28.14	10.15	Average	100	30
6	7386.00	50.74	74.00	-23.26	40.59	10.15	Peak	100	30

Note 1: Emission Level (dBuV/m) = SA Reading (dBuV/m) + Factor\* (dB)

\*Factor includes antenna factor , cable loss and amplifier gain

Note 2: Margin (dB) = Emission level (dBuV/m) – Limit (dBuV/m).

<b>Modulation</b>	VHT20	<b>Test Freq. (MHz)</b>	2462
<b>Polarization</b>	Vertical		

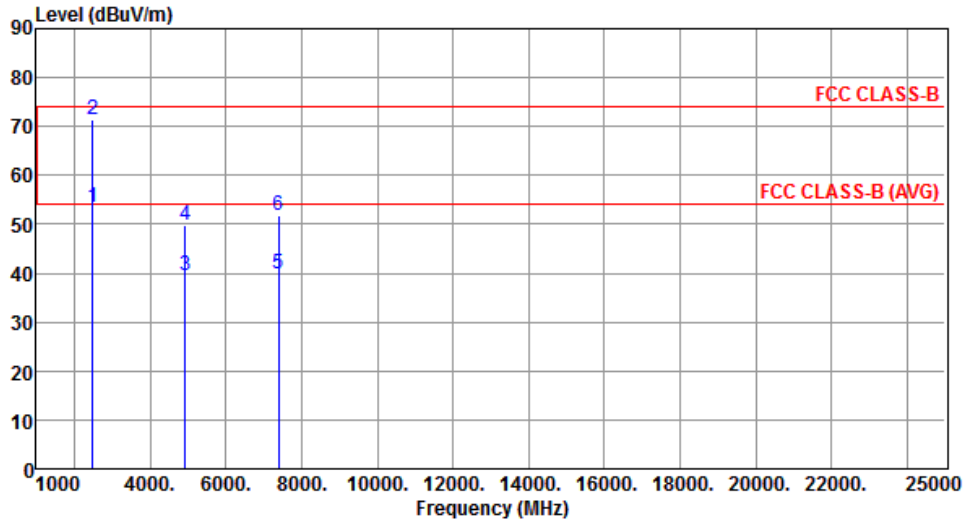

	Freq. MHz	Emission level dBuV/m	Limit dBuV/m	Margin dB	SA reading dBuV	Factor dB	Remark	ANT High cm	Turn Table deg
1	2483.50	53.55	54.00	-0.45	54.67	-1.12	Average	100	292
2	2483.50	71.37	74.00	-2.63	72.49	-1.12	Peak	100	292
3	4924.00	39.57	54.00	-14.43	34.56	5.01	Average	100	166
4	4924.00	49.69	74.00	-24.31	44.68	5.01	Peak	100	166
5	7386.00	39.73	54.00	-14.27	29.58	10.15	Average	100	119
6	7386.00	51.84	74.00	-22.16	41.69	10.15	Peak	100	119

Note 1: Emission Level (dBuV/m) = SA Reading (dBuV/m) + Factor\* (dB)

\*Factor includes antenna factor , cable loss and amplifier gain

Note 2: Margin (dB) = Emission level (dBuV/m) – Limit (dBuV/m).

### 3.5.8 Transmitter Radiated Unwanted Emissions (Above 1GHz) for VHT40

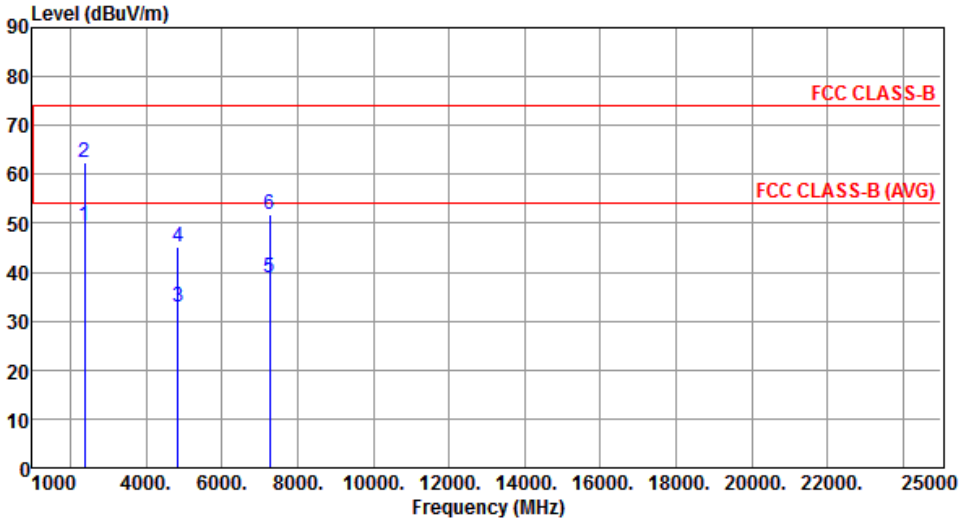
Modulation	VHT40	Test Freq. (MHz)	2422						
Polarization	Horizontal								
									
	Freq.	Emission level	Limit	Margin	SA reading	Factor	Remark	ANT High	Turn Table
	MHz	dBuV/m	dBuV/m	dB	dBuV	dB		cm	deg
1	2390.00	49.57	54.00	-4.43	50.53	-0.96	Average	100	117
2	2390.00	62.36	74.00	-11.64	63.32	-0.96	Peak	100	117
3	4844.00	33.04	54.00	-20.96	28.11	4.93	Average	100	30
4	4844.00	45.31	74.00	-28.69	40.38	4.93	Peak	100	30
5	7266.00	38.85	54.00	-15.15	28.45	10.40	Average	100	60
6	7266.00	51.65	74.00	-22.35	41.25	10.40	Peak	100	60
<p>Note 1: Emission Level (dBuV/m) = SA Reading (dBuV/m) + Factor* (dB)            *Factor includes antenna factor , cable loss and amplifier gain            Note 2: Margin (dB) = Emission level (dBuV/m) – Limit (dBuV/m).</p>									

<b>Modulation</b>	VHT40	<b>Test Freq. (MHz)</b>	2422
<b>Polarization</b>	Vertical		

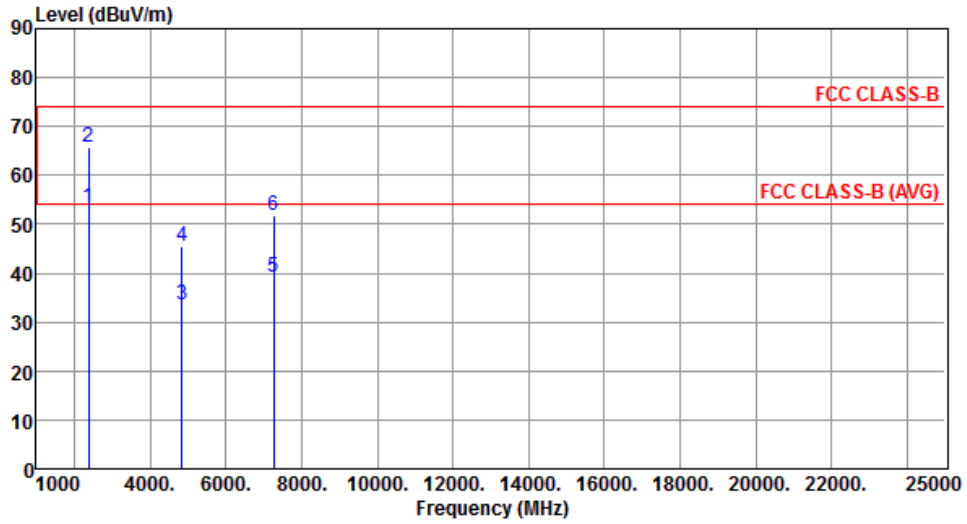

	Freq. MHz	Emission level dBuV/m	Limit dBuV/m	Margin dB	SA reading dBuV	Factor dB	Remark	ANT High cm	Turn Table deg
1	2390.00	53.53	54.00	-0.47	54.49	-0.96	Average	133	279
2	2390.00	65.63	74.00	-8.37	66.59	-0.96	Peak	133	279
3	4844.00	33.38	54.00	-20.62	28.45	4.93	Average	100	90
4	4844.00	45.39	74.00	-28.61	40.46	4.93	Peak	100	90
5	7266.00	39.09	54.00	-14.91	28.69	10.40	Average	100	50
6	7266.00	51.65	74.00	-22.35	41.25	10.40	Peak	100	50

Note 1: Emission Level (dBuV/m) = SA Reading (dBuV/m) + Factor\* (dB)

\*Factor includes antenna factor , cable loss and amplifier gain

Note 2: Margin (dB) = Emission level (dBuV/m) – Limit (dBuV/m).

<b>Modulation</b>	VHT40	<b>Test Freq. (MHz)</b>	2437
<b>Polarization</b>	Horizontal		

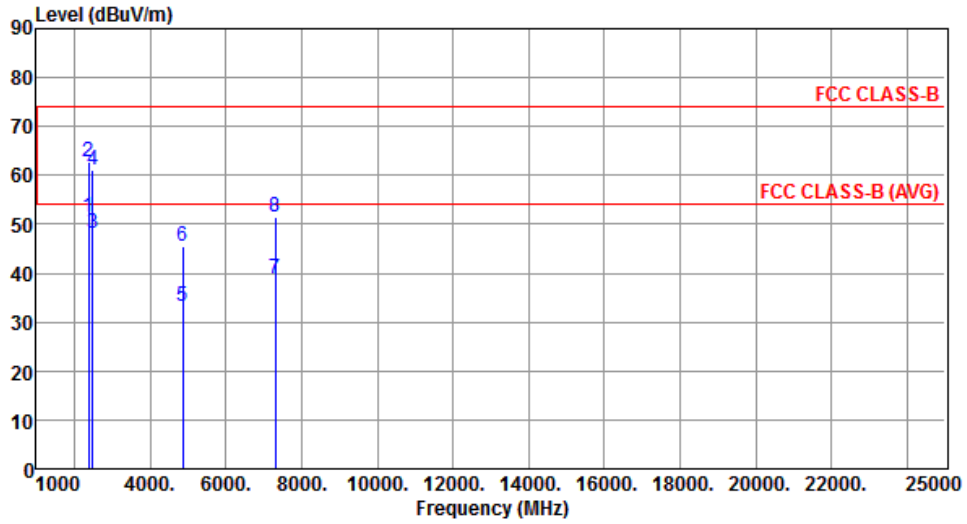

	Freq. MHz	Emission level dBuV/m	Limit dBuV/m	Margin dB	SA reading dBuV	Factor dB	Remark	ANT High cm	Turn Table deg
1	2390.00	51.39	54.00	-2.61	52.35	-0.96	Average	100	121
2	2390.00	62.63	74.00	-11.37	63.59	-0.96	Peak	100	121
3	2483.50	48.14	54.00	-5.86	49.26	-1.12	Average	100	121
4	2483.50	61.15	74.00	-12.85	62.27	-1.12	Peak	100	121
5	4874.00	33.22	54.00	-20.78	28.31	4.91	Average	100	25
6	4874.00	45.43	74.00	-28.57	40.52	4.91	Peak	100	25
7	7311.00	38.89	54.00	-15.11	28.54	10.35	Average	100	60
8	7311.00	51.38	74.00	-22.62	41.03	10.35	Peak	100	60

Note 1: Emission Level (dBuV/m) = SA Reading (dBuV/m) + Factor\* (dB)

\*Factor includes antenna factor , cable loss and amplifier gain

Note 2: Margin (dB) = Emission level (dBuV/m) – Limit (dBuV/m).

<b>Modulation</b>	VHT40	<b>Test Freq. (MHz)</b>	2437
<b>Polarization</b>	Vertical		

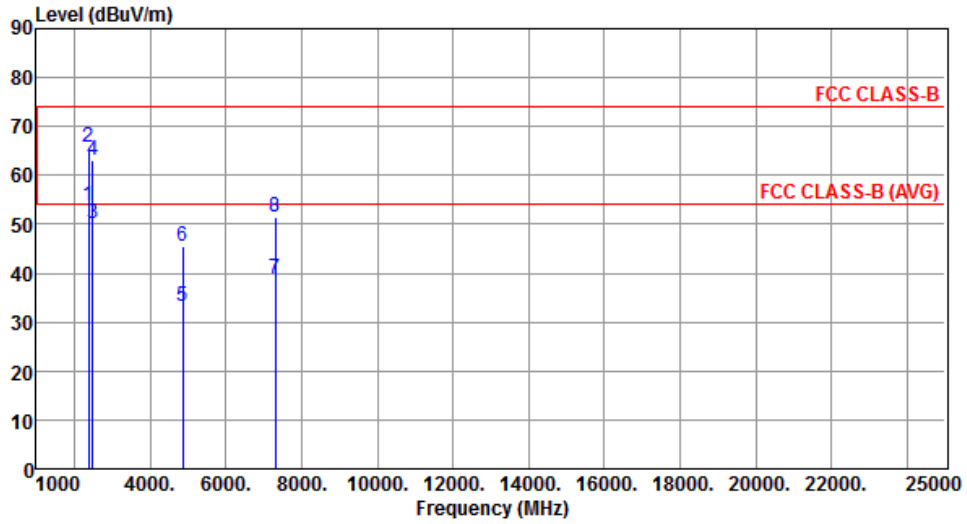

	Freq. MHz	Emission level dBuV/m	Limit dBuV/m	Margin dB	SA reading dBuV	Factor dB	Remark	ANT High cm	Turn Table deg
1	2390.00	53.67	54.00	-0.33	54.63	-0.96	Average	131	274
2	2390.00	65.92	74.00	-8.08	66.88	-0.96	Peak	131	274
3	2483.50	50.23	54.00	-3.77	51.35	-1.12	Average	131	274
4	2483.50	63.24	74.00	-10.76	64.36	-1.12	Peak	131	274
5	4874.00	33.16	54.00	-20.84	28.25	4.91	Average	100	30
6	4874.00	45.59	74.00	-28.41	40.68	4.91	Peak	100	30
7	7311.00	38.81	54.00	-15.19	28.46	10.35	Average	100	50
8	7311.00	51.56	74.00	-22.44	41.21	10.35	Peak	100	50

Note 1: Emission Level (dBuV/m) = SA Reading (dBuV/m) + Factor\* (dB)

\*Factor includes antenna factor , cable loss and amplifier gain

Note 2: Margin (dB) = Emission level (dBuV/m) – Limit (dBuV/m).

<b>Modulation</b>	VHT40	<b>Test Freq. (MHz)</b>	2452
<b>Polarization</b>	Horizontal		

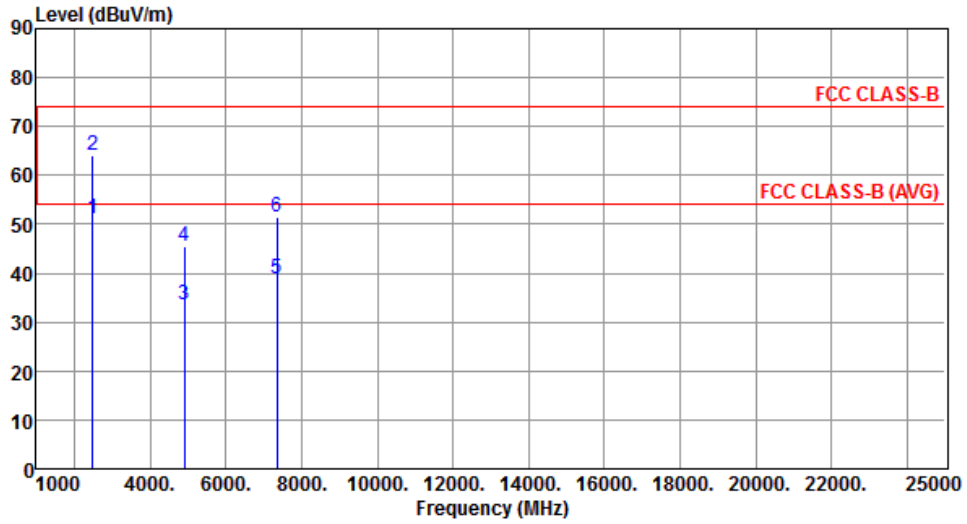

	Freq. MHz	Emission level dBuV/m	Limit dBuV/m	Margin dB	SA reading dBuV	Factor dB	Remark	ANT High cm	Turn Table deg
1	2483.50	51.12	54.00	-2.88	52.24	-1.12	Average	100	119
2	2483.50	64.24	74.00	-9.76	65.36	-1.12	Peak	100	119
3	4904.00	33.48	54.00	-20.52	28.57	4.91	Average	100	90
4	4904.00	45.60	74.00	-28.40	40.69	4.91	Peak	100	90
5	7356.00	38.80	54.00	-15.20	28.57	10.23	Average	100	55
6	7356.00	51.49	74.00	-22.51	41.26	10.23	Peak	100	55

Note 1: Emission Level (dBuV/m) = SA Reading (dBuV/m) + Factor\* (dB)

\*Factor includes antenna factor , cable loss and amplifier gain

Note 2: Margin (dB) = Emission level (dBuV/m) – Limit (dBuV/m).



<b>Modulation</b>	VHT40	<b>Test Freq. (MHz)</b>	2452
<b>Polarization</b>	Vertical		

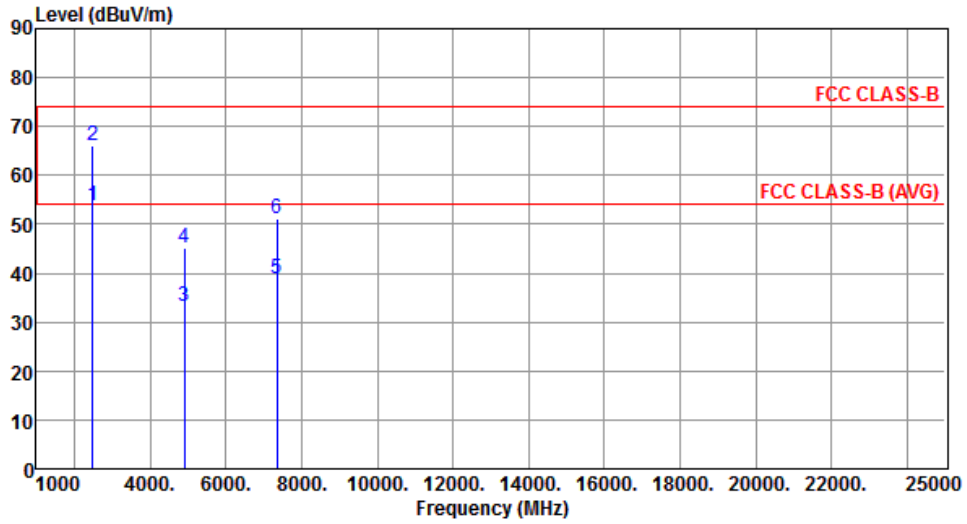

	Freq. MHz	Emission level dBuV/m	Limit dBuV/m	Margin dB	SA reading dBuV	Factor dB	Remark	ANT High cm	Turn Table deg
1	2483.50	53.72	54.00	-0.28	54.84	-1.12	Average	131	281
2	2483.50	66.00	74.00	-8.00	67.12	-1.12	Peak	131	281
3	4904.00	33.37	54.00	-20.63	28.46	4.91	Average	100	50
4	4904.00	45.26	74.00	-28.74	40.35	4.91	Peak	100	50
5	7356.00	38.92	54.00	-15.08	28.69	10.23	Average	100	60
6	7356.00	51.26	74.00	-22.74	41.03	10.23	Peak	100	60

Note 1: Emission Level (dBuV/m) = SA Reading (dBuV/m) + Factor\* (dB)

\*Factor includes antenna factor , cable loss and amplifier gain

Note 2: Margin (dB) = Emission level (dBuV/m) – Limit (dBuV/m).

### Beamforming mode

### 3.5.9 Transmitter Radiated Unwanted Emissions (Below 1GHz)

Modulation	VHT20	Test Freq. (MHz)	2437
Polarization	Horizontal		

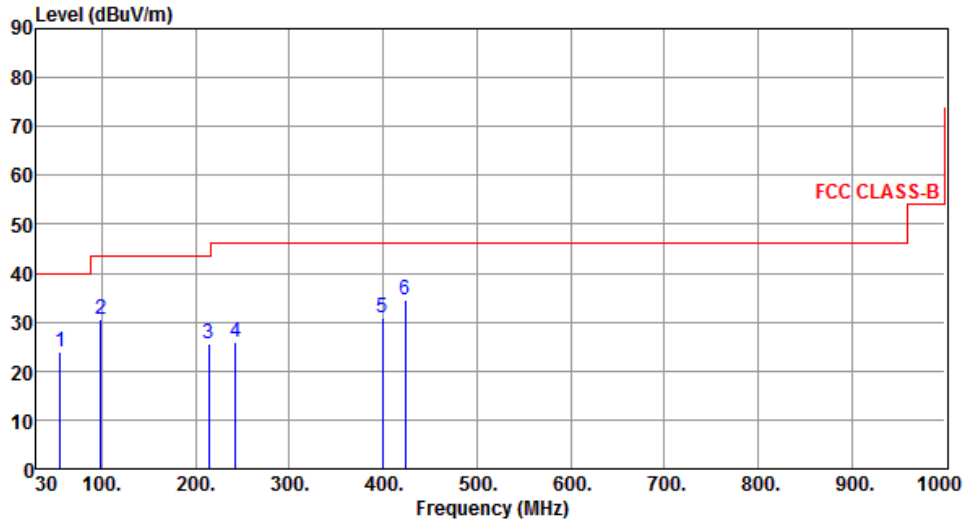

	Freq. MHz	Emission level dBuV/m	Limit dBuV/m	Margin dB	SA reading dBuV	Factor dB	Remark	ANT High cm	Turn Table deg
1	55.31	23.85	40.00	-16.15	32.90	-9.05	Peak	---	---
2	98.86	30.59	43.50	-12.91	44.46	-13.87	Peak	---	---
3	214.28	25.65	43.50	-17.85	37.83	-12.18	Peak	---	---
4	242.38	25.76	46.00	-20.24	36.06	-10.30	Peak	---	---
5	399.61	30.78	46.00	-15.22	36.60	-5.82	Peak	---	---
6	423.77	34.55	46.00	-11.45	39.70	-5.15	Peak	---	---

Note 1: Emission Level (dBuV/m) = SA Reading (dBuV/m) + Factor\* (dB)

\*Factor includes antenna factor, cable loss and amplifier gain

Note 2: Margin (dB) = Emission level (dBuV/m) – Limit (dBuV/m).

Note 3: All spurious emissions below 30MHz are more than 20 dB below the limit.

<b>Modulation</b>	VHT20	<b>Test Freq. (MHz)</b>	2437
<b>Polarization</b>	Vertical		

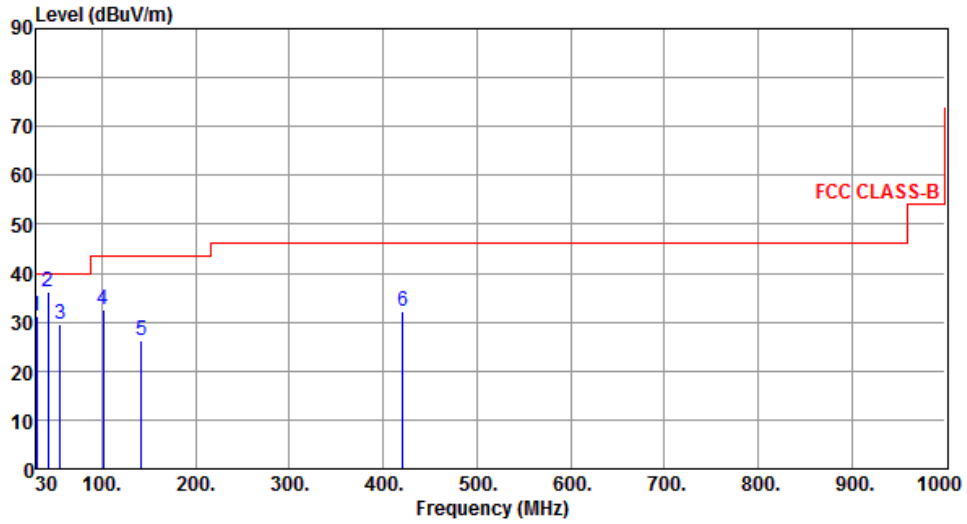

	Freq. MHz	Emission level dBuV/m	Limit dBuV/m	Margin dB	SA reading dBuV	Factor dB	Remark	ANT High cm	Turn Table deg
1	30.12	31.22	40.00	-8.78	41.37	-10.15	Peak	---	---
2	42.59	36.21	40.00	-3.79	45.19	-8.98	Peak	---	---
3	55.22	29.42	40.00	-10.58	38.48	-9.06	Peak	---	---
4	101.69	32.55	43.50	-10.95	45.96	-13.41	Peak	---	---
5	142.49	26.21	43.50	-17.29	35.30	-9.09	Peak	---	---
6	420.99	32.15	46.00	-13.85	37.37	-5.22	Peak	---	---

Note 1: Emission Level (dBuV/m) = SA Reading (dBuV/m) + Factor\* (dB)

\*Factor includes antenna factor , cable loss and amplifier gain

Note 2: Margin (dB) = Emission level (dBuV/m) – Limit (dBuV/m).

Note 3: All spurious emissions below 30MHz are more than 20 dB below the limit.

### 3.5.10 Transmitter Radiated Unwanted Emissions (Above 1GHz) for VHT20

Modulation	VHT20	Test Freq. (MHz)	2412						
Polarization	Horizontal								
Freq.	Emission level	Limit	Margin	SA reading	Factor	Remark	ANT High	Turn Table	
MHz	dBUV/m	dBUV/m	dB	dBuV	dB		cm	deg	
1	2390.00	52.00	54.00	-2.00	52.96	-0.96	Average	100	103
2	2390.00	70.49	74.00	-3.51	71.45	-0.96	Peak	100	103
3	2487.00	53.86	54.00	-0.14	54.99	-1.13	Average	169	84
4	2487.00	59.54	74.00	-14.46	60.67	-1.13	Peak	169	84
5	4824.00	33.17	54.00	-20.83	28.30	4.87	Average	100	240
6	4824.00	46.12	74.00	-27.88	41.25	4.87	Peak	100	240
7	12060.00	43.38	54.00	-10.62	28.46	14.92	Average	100	50
8	12060.00	56.18	74.00	-17.82	41.26	14.92	Peak	100	50

Note 1: Emission Level (dBUV/m) = SA Reading (dBUV/m) + Factor\* (dB)  
\*Factor includes antenna factor , cable loss and amplifier gain  
Note 2: Margin (dB) = Emission level (dBUV/m) – Limit (dBUV/m).

<b>Modulation</b>	VHT20	<b>Test Freq. (MHz)</b>	2412
<b>Polarization</b>	Vertical		

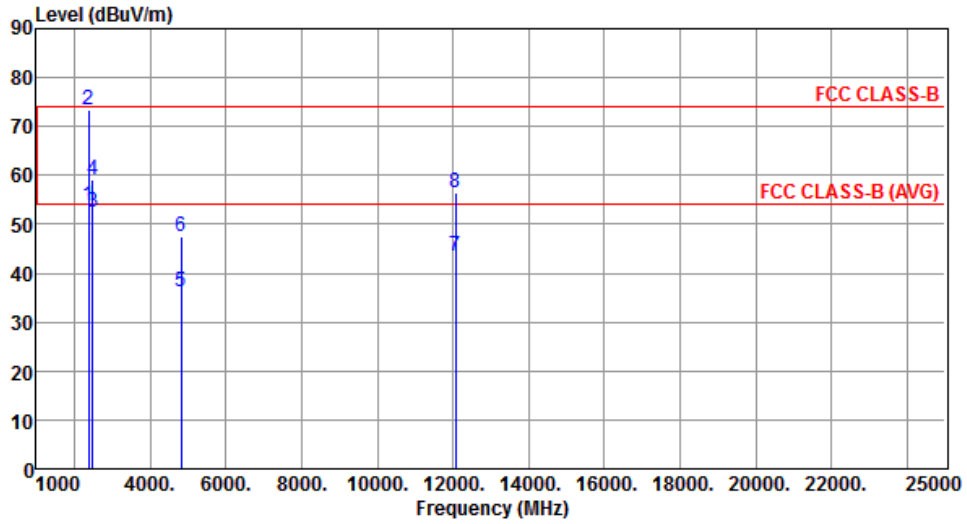

	Freq. MHz	Emission level dBuV/m	Limit dBuV/m	Margin dB	SA reading dBuV	Factor dB	Remark	ANT High cm	Turn Table deg
1	2390.00	53.79	54.00	-0.21	54.75	-0.96	Average	228	262
2	2390.00	73.39	74.00	-0.61	74.35	-0.96	Peak	228	262
3	2487.00	52.37	54.00	-1.63	53.50	-1.13	Average	162	284
4	2487.00	59.08	74.00	-14.92	60.21	-1.13	Peak	162	284
5	4824.00	36.12	54.00	-17.88	31.25	4.87	Average	100	226
6	4824.00	47.55	74.00	-26.45	42.68	4.87	Peak	100	226
7	12060.00	43.61	54.00	-10.39	28.69	14.92	Average	100	60
8	12060.00	56.60	74.00	-17.40	41.68	14.92	Peak	100	60

Note 1: Emission Level (dBuV/m) = SA Reading (dBuV/m) + Factor\* (dB)

\*Factor includes antenna factor , cable loss and amplifier gain

Note 2: Margin (dB) = Emission level (dBuV/m) – Limit (dBuV/m).

<b>Modulation</b>	VHT20	<b>Test Freq. (MHz)</b>	2437
<b>Polarization</b>	Horizontal		

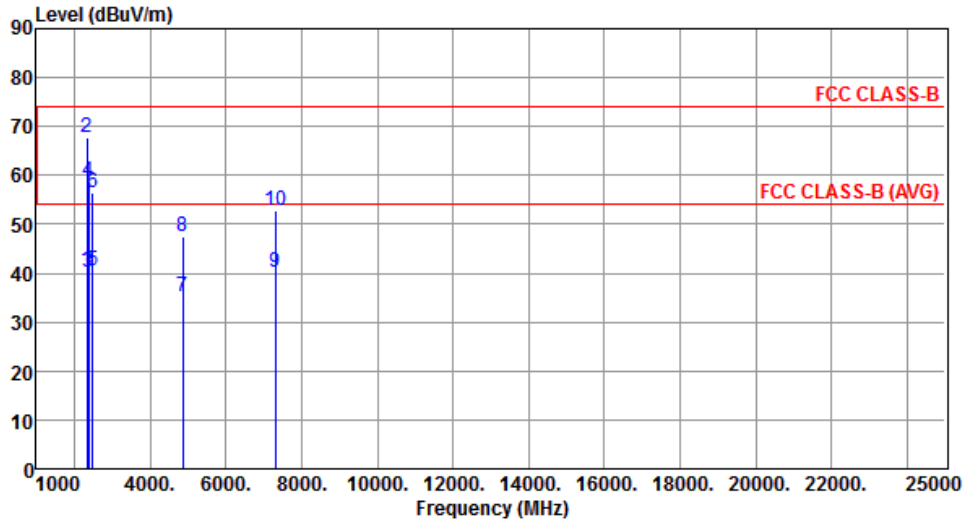

	Freq. MHz	Emission level dBuV/m	Limit dBuV/m	Margin dB	SA reading dBuV	Factor dB	Remark	ANT High cm	Turn Table deg
1	2340.00	40.52	54.00	-13.48	41.35	-0.83	Average	105	105
2	2340.00	67.62	74.00	-6.38	68.45	-0.83	Peak	105	105
3	2390.00	40.29	54.00	-13.71	41.25	-0.96	Average	105	105
4	2390.00	58.89	74.00	-15.11	59.85	-0.96	Peak	105	105
5	2483.50	40.53	54.00	-13.47	41.65	-1.12	Average	105	105
6	2483.50	56.57	74.00	-17.43	57.69	-1.12	Peak	105	105
7	4874.00	35.18	54.00	-18.82	30.27	4.91	Average	100	251
8	4874.00	47.65	74.00	-26.35	42.74	4.91	Peak	100	251
9	7311.00	40.22	54.00	-13.78	29.87	10.35	Average	100	252
10	7311.00	52.80	74.00	-21.20	42.45	10.35	Peak	100	252

Note 1: Emission Level (dBuV/m) = SA Reading (dBuV/m) + Factor\* (dB)

\*Factor includes antenna factor , cable loss and amplifier gain

Note 2: Margin (dB) = Emission level (dBuV/m) – Limit (dBuV/m).

<b>Modulation</b>	VHT20	<b>Test Freq. (MHz)</b>	2437
<b>Polarization</b>	Vertical		

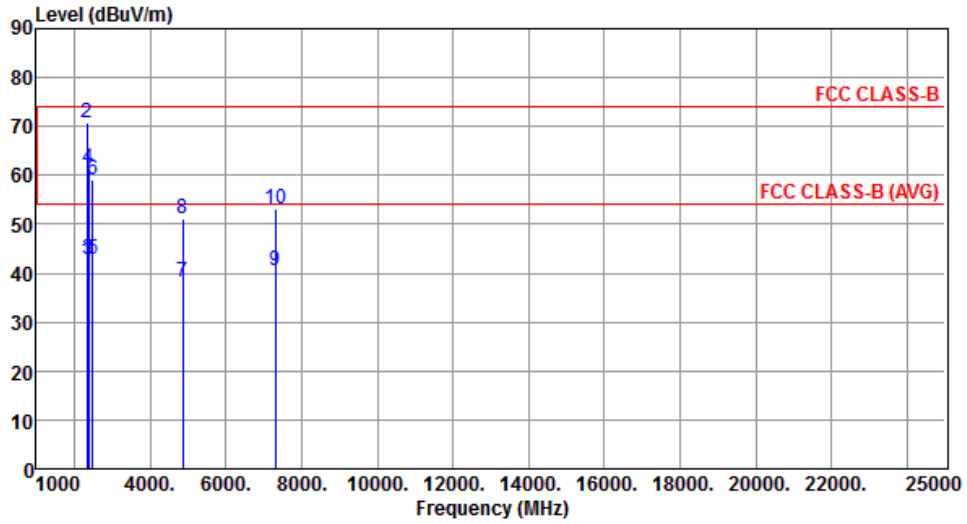

	Freq. MHz	Emission level dBuV/m	Limit dBuV/m	Margin dB	SA reading dBuV	Factor dB	Remark	ANT High cm	Turn Table deg
1	2340.00	42.42	54.00	-11.58	43.25	-0.83	Average	213	277
2	2340.00	70.61	74.00	-3.39	71.44	-0.83	Peak	213	277
3	2390.00	42.71	54.00	-11.29	43.67	-0.96	Average	213	277
4	2390.00	61.36	74.00	-12.64	62.32	-0.96	Peak	213	277
5	2483.50	42.82	54.00	-11.18	43.94	-1.12	Average	213	277
6	2483.50	59.04	74.00	-14.96	60.16	-1.12	Peak	213	277
7	4874.00	38.03	54.00	-15.97	33.12	4.91	Average	100	222
8	4874.00	51.19	74.00	-22.81	46.28	4.91	Peak	100	222
9	7311.00	40.39	54.00	-13.61	30.04	10.35	Average	100	308
10	7311.00	53.17	74.00	-20.83	42.82	10.35	Peak	100	308

Note 1: Emission Level (dBuV/m) = SA Reading (dBuV/m) + Factor\* (dB)

\*Factor includes antenna factor , cable loss and amplifier gain

Note 2: Margin (dB) = Emission level (dBuV/m) – Limit (dBuV/m).

<b>Modulation</b>	VHT20	<b>Test Freq. (MHz)</b>	2462
<b>Polarization</b>	Horizontal		

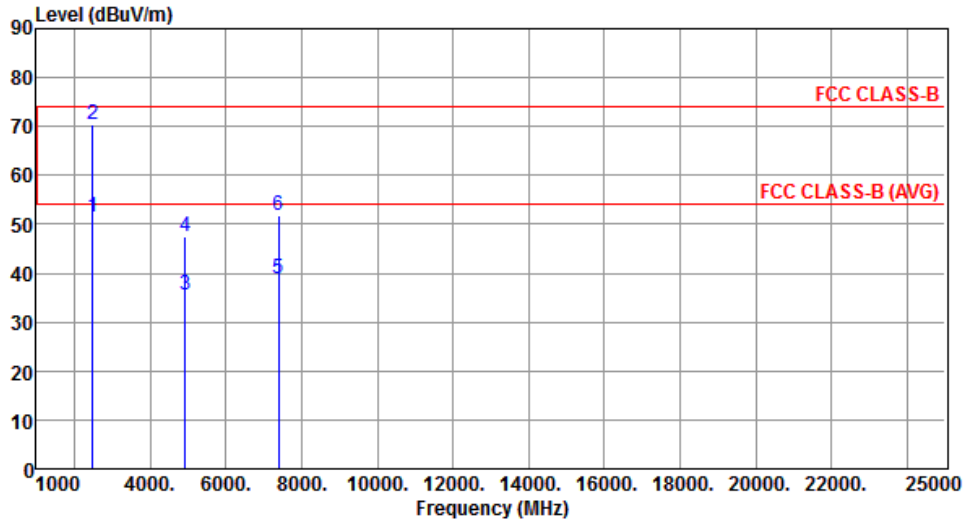

	Freq. MHz	Emission level dBuV/m	Limit dBuV/m	Margin dB	SA reading dBuV	Factor dB	Remark	ANT High cm	Turn Table deg
1	2483.50	51.52	54.00	-2.48	52.64	-1.12	Average	100	110
2	2483.50	70.57	74.00	-3.43	71.69	-1.12	Peak	100	110
3	4924.00	35.57	54.00	-18.43	30.56	5.01	Average	100	253
4	4924.00	47.60	74.00	-26.40	42.59	5.01	Peak	100	253
5	7386.00	38.80	54.00	-15.20	28.65	10.15	Average	100	25
6	7386.00	51.71	74.00	-22.29	41.56	10.15	Peak	100	25

Note 1: Emission Level (dBuV/m) = SA Reading (dBuV/m) + Factor\* (dB)

\*Factor includes antenna factor , cable loss and amplifier gain

Note 2: Margin (dB) = Emission level (dBuV/m) – Limit (dBuV/m).



<b>Modulation</b>	VHT20	<b>Test Freq. (MHz)</b>	2462
<b>Polarization</b>	Vertical		

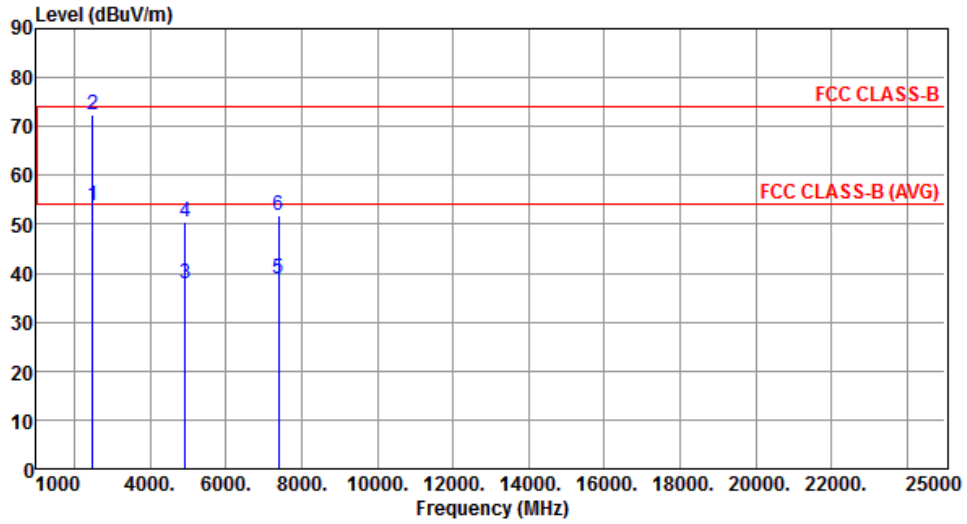

	Freq. MHz	Emission level dBuV/m	Limit dBuV/m	Margin dB	SA reading dBuV	Factor dB	Remark	ANT High cm	Turn Table deg
1	2483.50	53.77	54.00	-0.23	54.89	-1.12	Average	162	280
2	2483.50	72.39	74.00	-1.61	73.51	-1.12	Peak	162	280
3	4924.00	37.87	54.00	-16.13	32.86	5.01	Average	100	226
4	4924.00	50.32	74.00	-23.68	45.31	5.01	Peak	100	226
5	7386.00	39.01	54.00	-14.99	28.86	10.15	Average	100	315
6	7386.00	51.84	74.00	-22.16	41.69	10.15	Peak	100	315

Note 1: Emission Level (dBuV/m) = SA Reading (dBuV/m) + Factor\* (dB)

\*Factor includes antenna factor , cable loss and amplifier gain

Note 2: Margin (dB) = Emission level (dBuV/m) – Limit (dBuV/m).

## 3.6 Emissions in Non-Restricted Frequency Bands

### 3.6.1 Emissions in Non-Restricted Frequency Bands Limit

Peak power in any 100 kHz bandwidth outside of the authorized frequency band shall be attenuated by at least 30 dB relative to the maximum in-band peak PSD level in 100 kHz.

### 3.6.2 Test Procedures

#### Reference level measurement

1. Set RBW=100kHz, VBW = 300kHz , Detector = Peak, Sweep time = Auto
2. Trace = max hold , Allow Trace to fully stabilize
3. Use the peak marker function to determine the maximum PSD level

#### Emission level measurement

1. Set RBW=100kHz, VBW = 300kHz , Detector = Peak, Sweep time = Auto
2. Trace = max hold , Allow Trace to fully stabilize
3. Scan Frequency range is up to 25GHz
4. Use the peak marker function to determine the maximum amplitude level

### 3.6.3 Test Setup

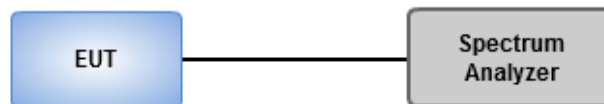

## Non-beamforming mode

### 3.6.4 Unwanted Emissions into Non-Restricted Frequency Bands

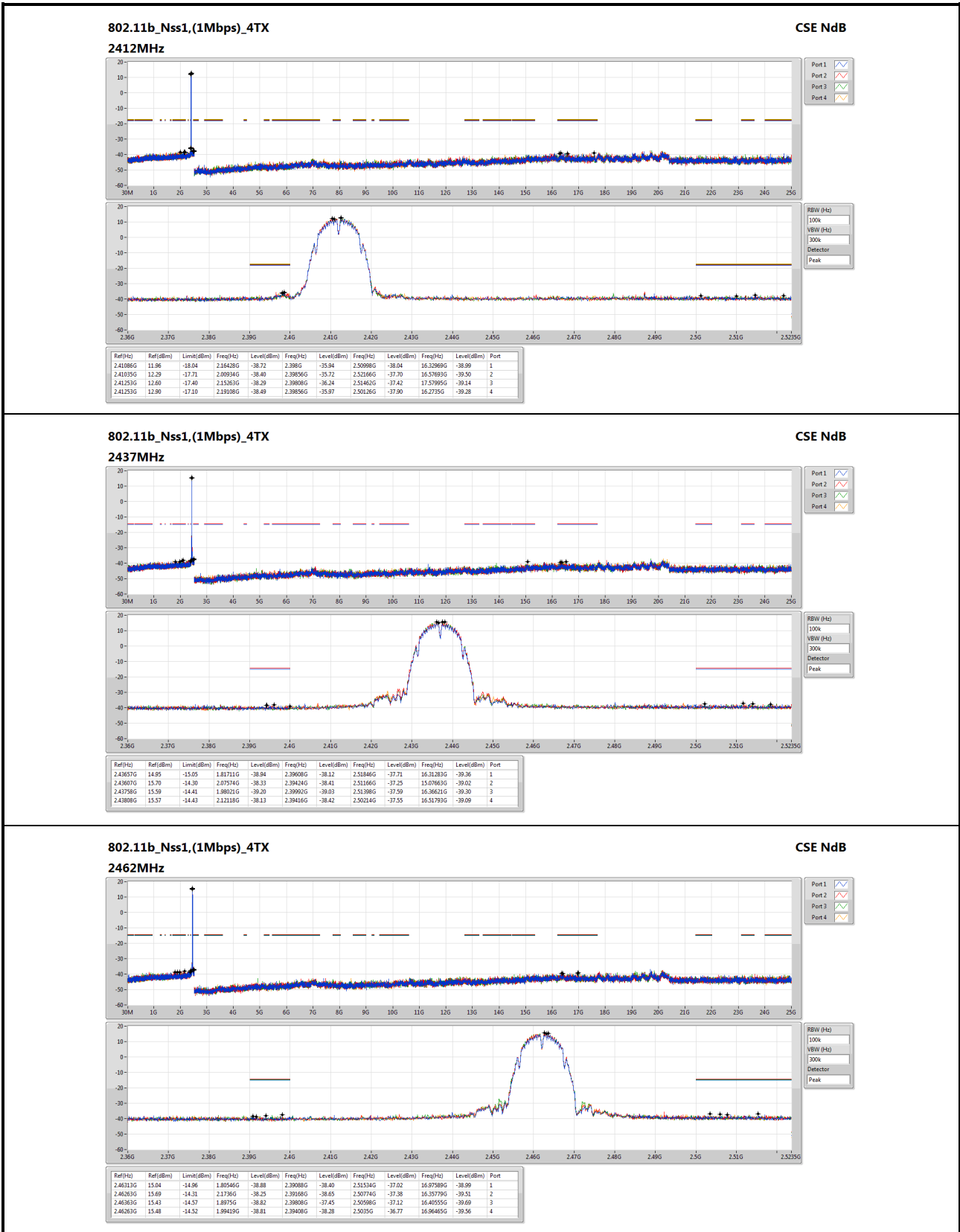
**802.11b\_Nss1,(1Mbps)\_4TX**
**CSE NdB**

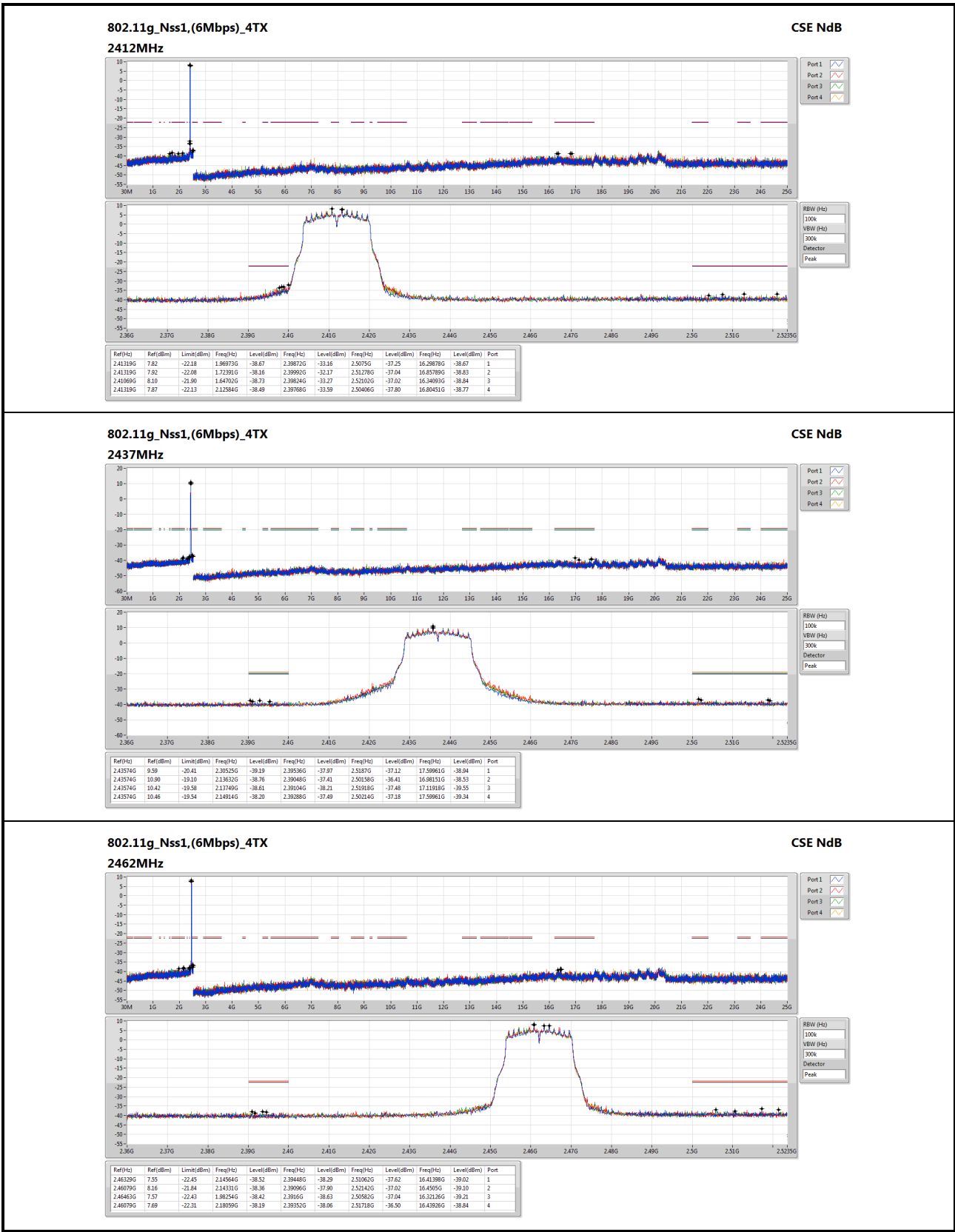

**802.11ac VHT20\_Nss1,(MCS0)\_4TX**  
**2412MHz**

CSE NdB

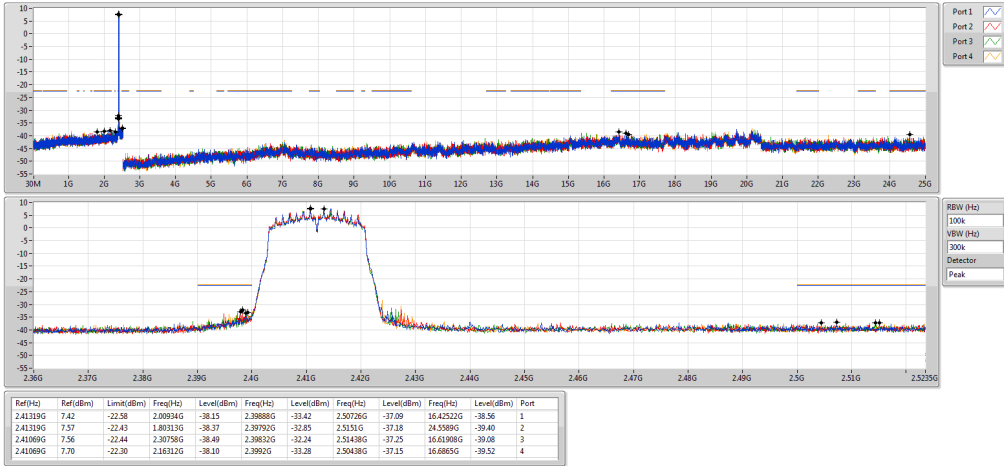

**802.11ac VHT20\_Nss1,(MCS0)\_4TX**  
**2437MHz**

CSE NdB

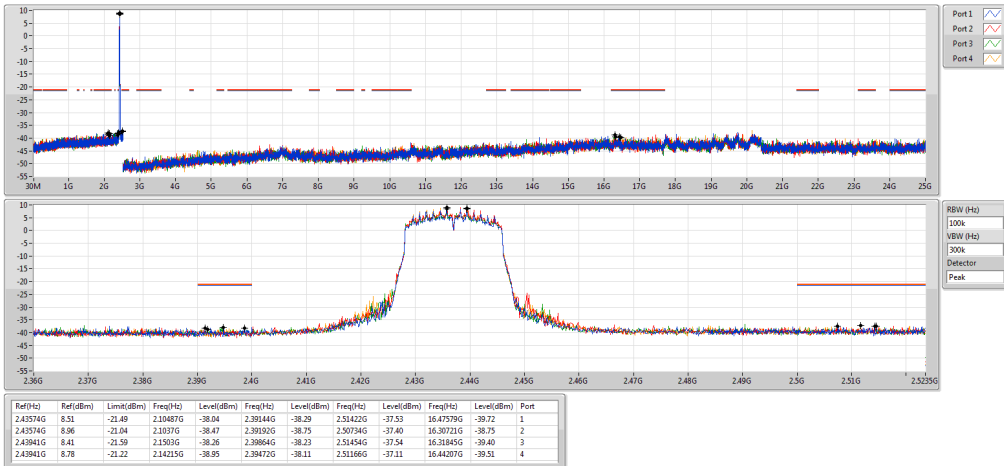

**802.11ac VHT20\_Nss1,(MCS0)\_4TX**  
**2462MHz**

CSE NdB

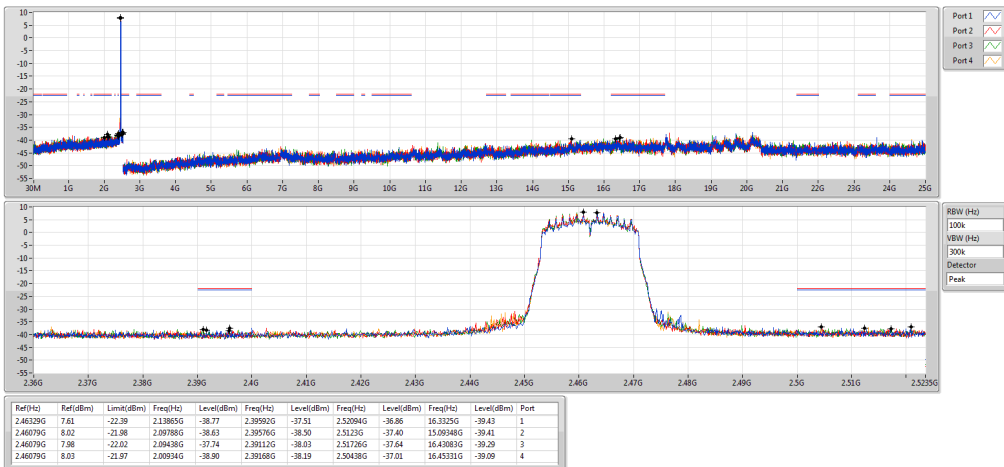

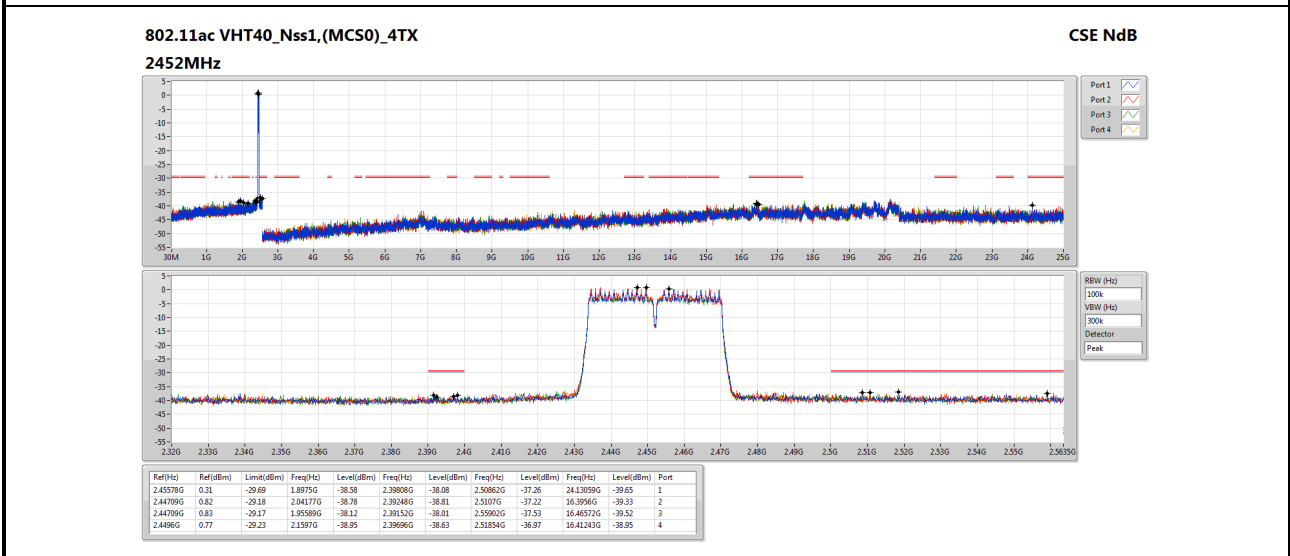
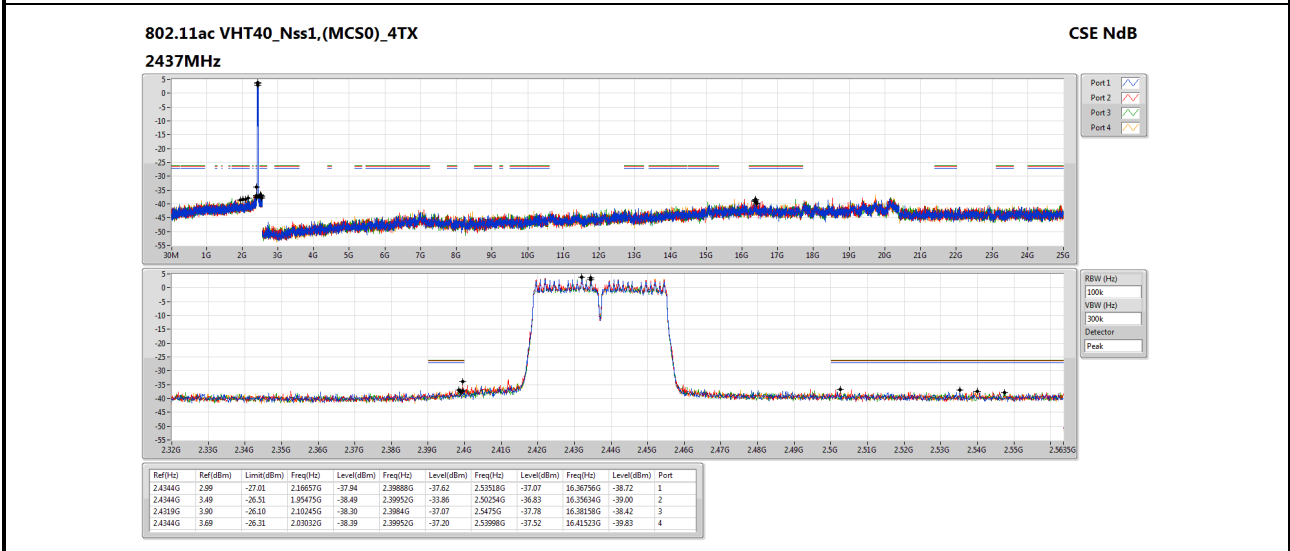
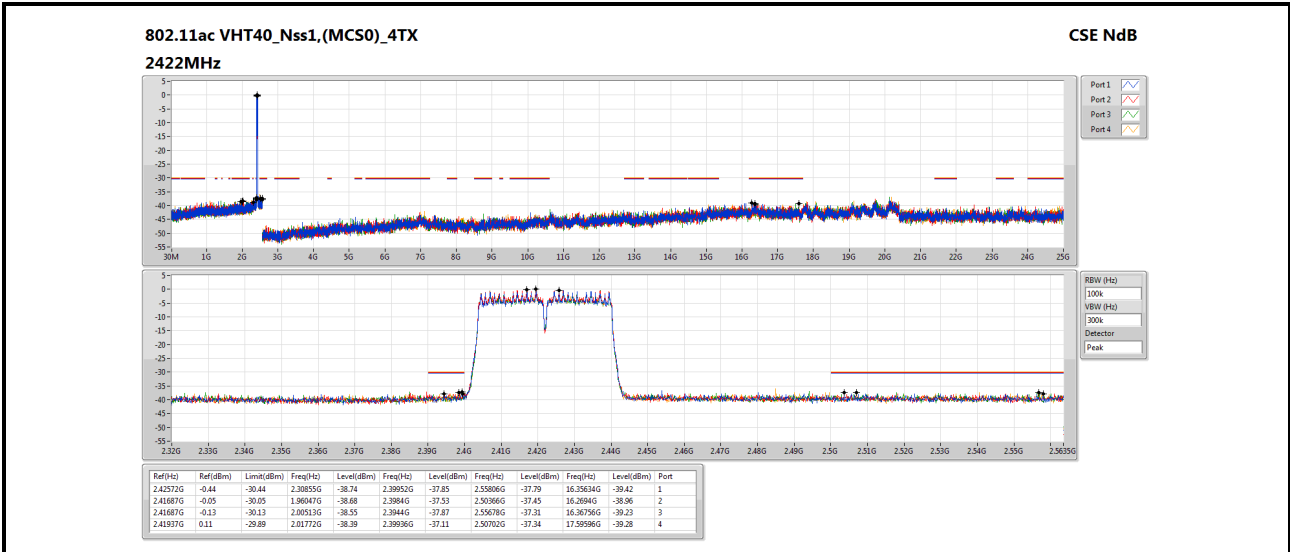

## Beamforming mode

### 3.6.5 Unwanted Emissions into Non-Restricted Frequency Bands

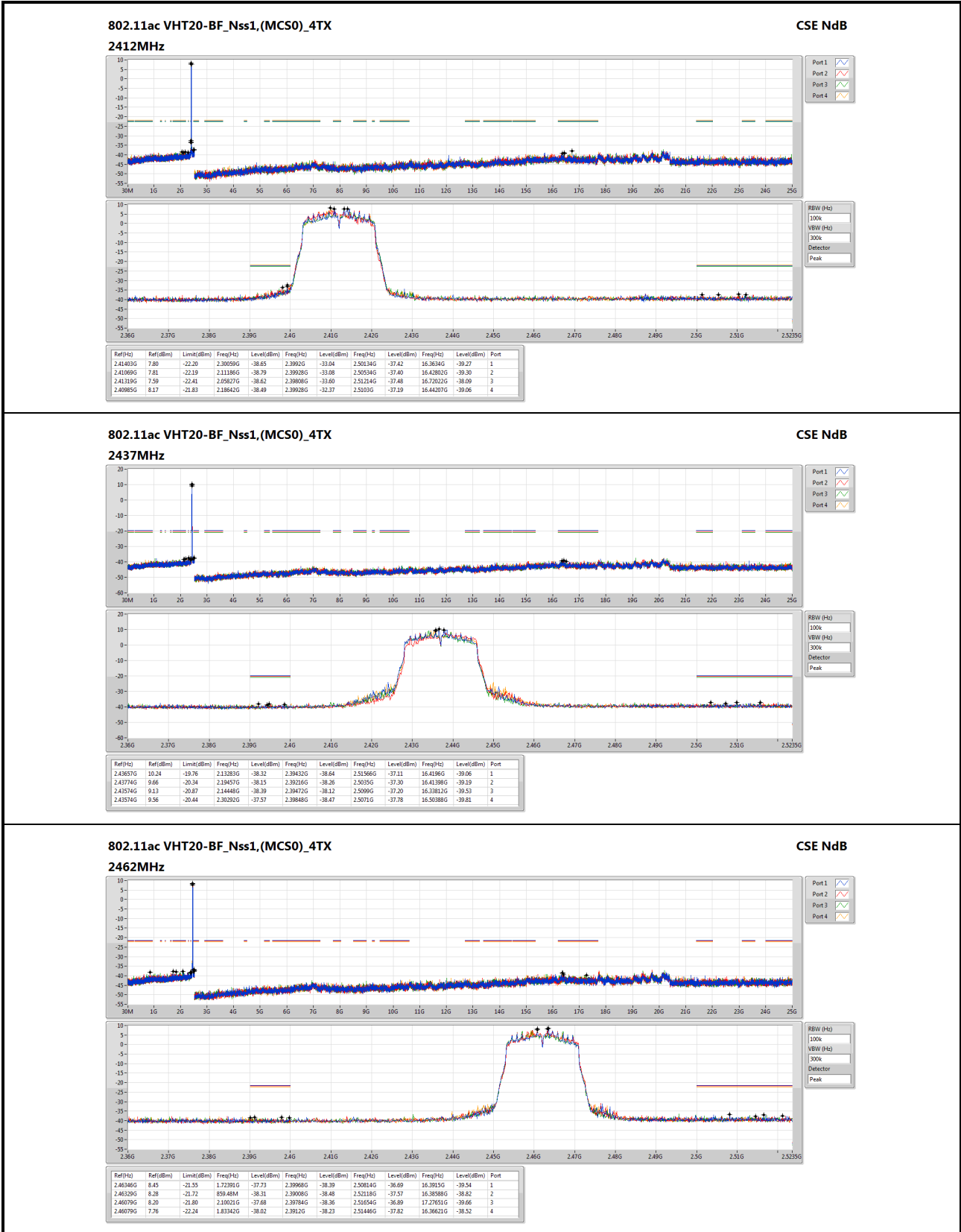

## 4 Test laboratory information

Established in 2012, ICC provides foremost EMC & RF Testing and advisory consultation services by our skilled engineers and technicians. Our services employ a wide variety of advanced edge test equipment and one of the widest certification extents in the business.

International Certification Corp (EMC and Wireless Communication Laboratory), it is our definitive objective is to institute long term, trust-based associations with our clients. The expectation we set up with our clients is based on outstanding service, practical expertise and devotion to a certified value structure. Our passion is to grant our clients with best EMC / RF services by oriented knowledgeable and accommodating staff.

Our Test sites are located at Linkou District and Kwei Shan District. Location map can be found on our website <http://www.icertifi.com.tw>.

### **Linkou**

Tel: 886-2-2601-1640

No. 30-2, Ding Fwu Tsuen, Lin  
Kou District, New Taipei City,  
Taiwan, R.O.C.

### **Kwei Shan**

Tel: 886-3-271-8666

No. 3-1, Lane 6, Wen San 3rd St.,  
Kwei Shan District, Tao Yuan City  
333, Taiwan, R.O.C.

### **Kwei Shan Site II**

Tel: 886-3-271-8640

No. 14-1, Lane 19, Wen San 3rd  
St., Kwei Shan District, Tao Yuan  
City 333, Taiwan, R.O.C.

If you have any suggestion, please feel free to contact us as below information.

Tel: 886-3-271-8666

Fax: 886-3-318-0155

Email: ICC\_Service@icertifi.com.tw

==END==