



**Nemko Test Report:** 2015 285795 FCC15407

**Applicant:** ARRIS Technology, Inc.  
6450 Sequence Dr.  
San Diego, CA 92121

**Equipment under Test:  
(E.U.T.)** IP810

**In Accordance With:** **FCC Part 15, Subpart E, 15.407**  
UNLICENSED NATIONAL INFORMATION  
INFRASTRUCTURE DEVICES

**Tested By:** Nemko USA, Inc.  
2210 Faraday Ave. Ste 150  
Carlsbad, CA 92008  
USA

**TESTED BY:**  **DATE:** 09 June 2015  
\_\_\_\_\_  
David Light, Wireless Engineer

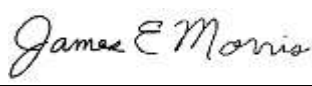
**APPROVED BY:**  **DATE:** 31 August 2015  
\_\_\_\_\_  
Jim Morris, EMC Manager

**Number of Pages: 77**

**Table of Contents**

<b>SECTION 1.</b>	<b>SUMMARY OF TEST RESULTS</b>	<b>3</b>
<b>SECTION 2.</b>	<b>EQUIPMENT UNDER TEST (E.U.T.)</b>	<b>5</b>
<b>SECTION 3.</b>	<b>EMISSION BANDWIDTH</b>	<b>6</b>
<b>SECTION 4.</b>	<b>OUTPUT POWER AND SPECTRAL DENSITY</b>	<b>25</b>
<b>SECTION 5</b>	<b>UNDESIRABLE EMISSIONS</b>	<b>50</b>
<b>SECTION 6.</b>	<b>UNWANTED EMISSIONS BELOW 1 GHZ</b>	<b>62</b>
<b>SECTION 7.</b>	<b>POWERLINE CONDUCTED EMISSIONS</b>	<b>64</b>
<b>SECTION 8.</b>	<b>TEST EQUIPMENT LIST</b>	<b>67</b>
<b>ANNEX A - TEST DETAILS</b>		<b>68</b>
<b>ANNEX B - TEST DIAGRAMS</b>		<b>75</b>

**Section 1. Summary of Test Results**

Manufacturer: ARRIS Technology, Inc.

Model No.: IP810

Serial No.: None

General: **All measurements are traceable to national standards.**

These tests were conducted on a sample of the equipment for the purpose of demonstrating compliance with Part 15, Subpart E, Paragraph 15.407 for Unlicensed National Information Infrastructure Devices. Radiated tests were conducted in accordance with ANSI C63.10-2013. Radiated emissions are made on an open area test site. A description of the test facility is on file with the FCC.

KDB 905462 D07 v01 "OVERVIEW OF REVISED RULES FOR U-NII DEVICES" was used to as test guidance.

- |                                     |                            |                                     |                     |
|-------------------------------------|----------------------------|-------------------------------------|---------------------|
| <input checked="" type="checkbox"/> | New Submission             | <input checked="" type="checkbox"/> | Production Unit     |
| <input type="checkbox"/>            | Class II Permissive Change | <input type="checkbox"/>            | Pre-Production Unit |

THIS TEST REPORT RELATES ONLY TO THE ITEM(S) TESTED.

THE FOLLOWING DEVIATIONS FROM, ADDITIONS TO, OR EXCLUSIONS FROM THE TEST SPECIFICATIONS HAVE BEEN MADE.

See "Summary of Test Data".



NVLAP Lab Code 200116-0

*This report must not be used to claim product certification, approval, or endorsement by NVLAP, NIST, or any agency of the Federal Government. Nemko USA, Inc. is a NVLAP accredited laboratory.*

Nemko USA Inc. authorizes the above named company to reproduce this report provided it is reproduced in its entirety and for use by the company's employees only.

Any use which a third party makes of this report, or any reliance on or decisions to be made based on it, are the responsibility of such third parties. Nemko USA Inc. accepts no responsibility for damages, if any, suffered by any third party as a result of decisions made or actions based on this report. This report applies only to the items tested.

**Summary of Test Data**

<b>NAME OF TEST</b>	<b>PARA. NO.</b>	<b>RESULT</b>
Powerline Conducted Emissions	15.207(a)	Complies
Output Power	15.407(a)(1)(2)(3)	Complies
Peak Power Spectral Density	15.407 (a)(1)(2)(3)	Complies
Emission Bandwidth	15.403	Complies
Undesirable Emissions	15.407(b)	Complies
Unwanted Emissions Below 1000 MHz	15.209	Complies
UNII TPC and DFS Compliance	15.407 (h)	N/A*

\*Not operating in 5.25-5.35GHz band and 5.47-5.725GHz band.

**Footnotes:**

## **Section 2. Equipment under Test (E.U.T.)**

### **General Equipment Information**

**Frequency Band (MHz):** 5.15 to 5.25 GHz  
5.725 to 5.85 GHz

**Operating Frequency of Test Sample:** 5.18 to 5.24 GHz  
5.745 to 5.825GHz

**User Frequency Adjustment:** Software controlled

**HW1:** IP810 PPR5-A124 (Conductive measurement)

**HW2:** IP810 PPR5-B283 (radiated emission and power line emission measurement)

**Power Supply:** LiteON, model # PA-1180-2AR1, Arris part # 558124-005, input: 100-240V 50-60Hz, output: 12V

**Antenna:** Airgain N5X20SC 65 mm (max gain 5 dBi based on test data)

**Section 3. Emission Bandwidth**

NAME OF TEST: Emission Bandwidth	PARA. NO.: 15.407
TESTED BY: David Light	DATE: 21 May 2015

**Test Results:** Complies.

**Measurement Data:** See attached plots

**Test Conditions:** 35 %RH  
22 °C

**Measurement Uncertainty:** +/-1x10<sup>-7</sup> ppm

**Test Equipment Used:** 1036

**Test Data – 99% Emission Bandwidth**

802.11a  
 99% Bandwidth  
 Low Channel – UNII 1

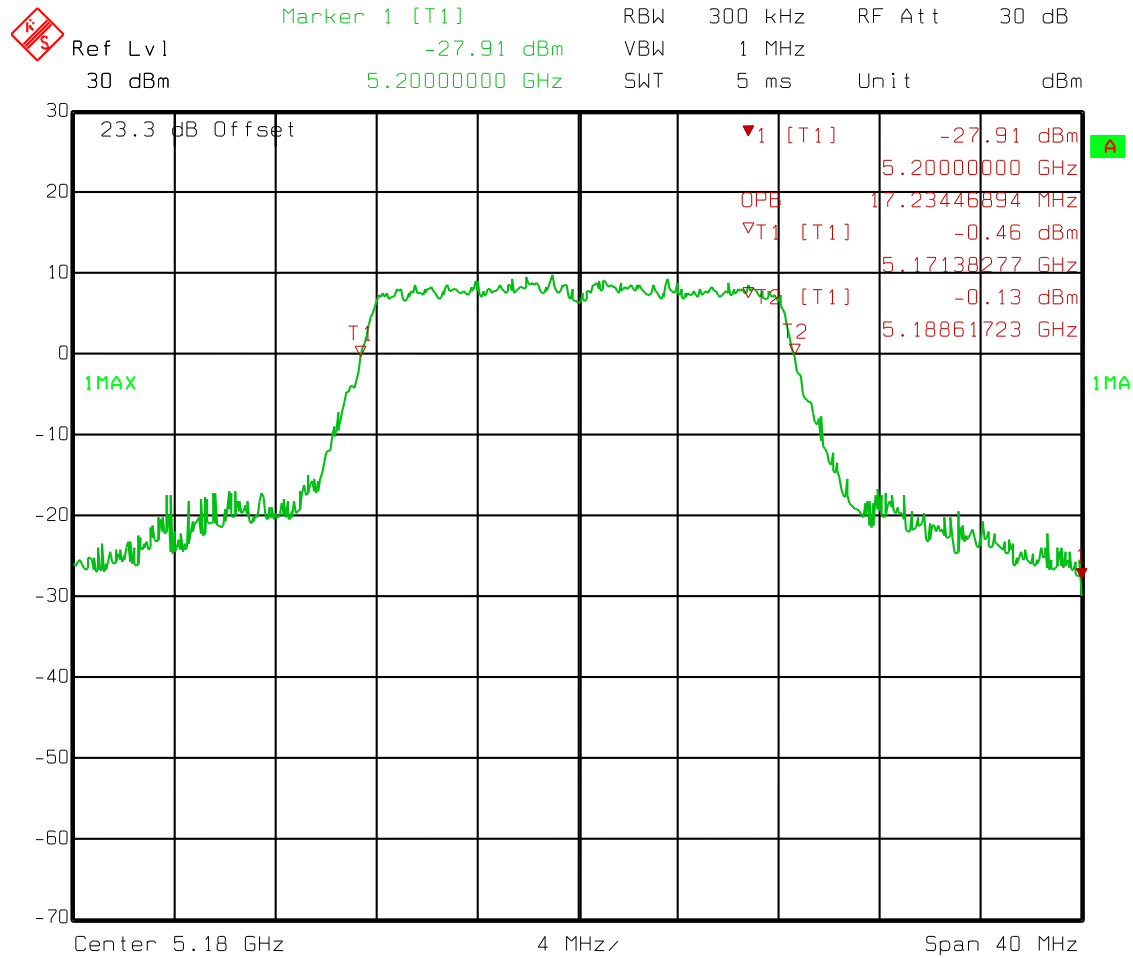

Date: 21.MAY 2015 09:54:46

**Test Data – 99% Emission Bandwidth**

802.11a  
 99% Bandwidth  
 Mid Channel – UNII 1

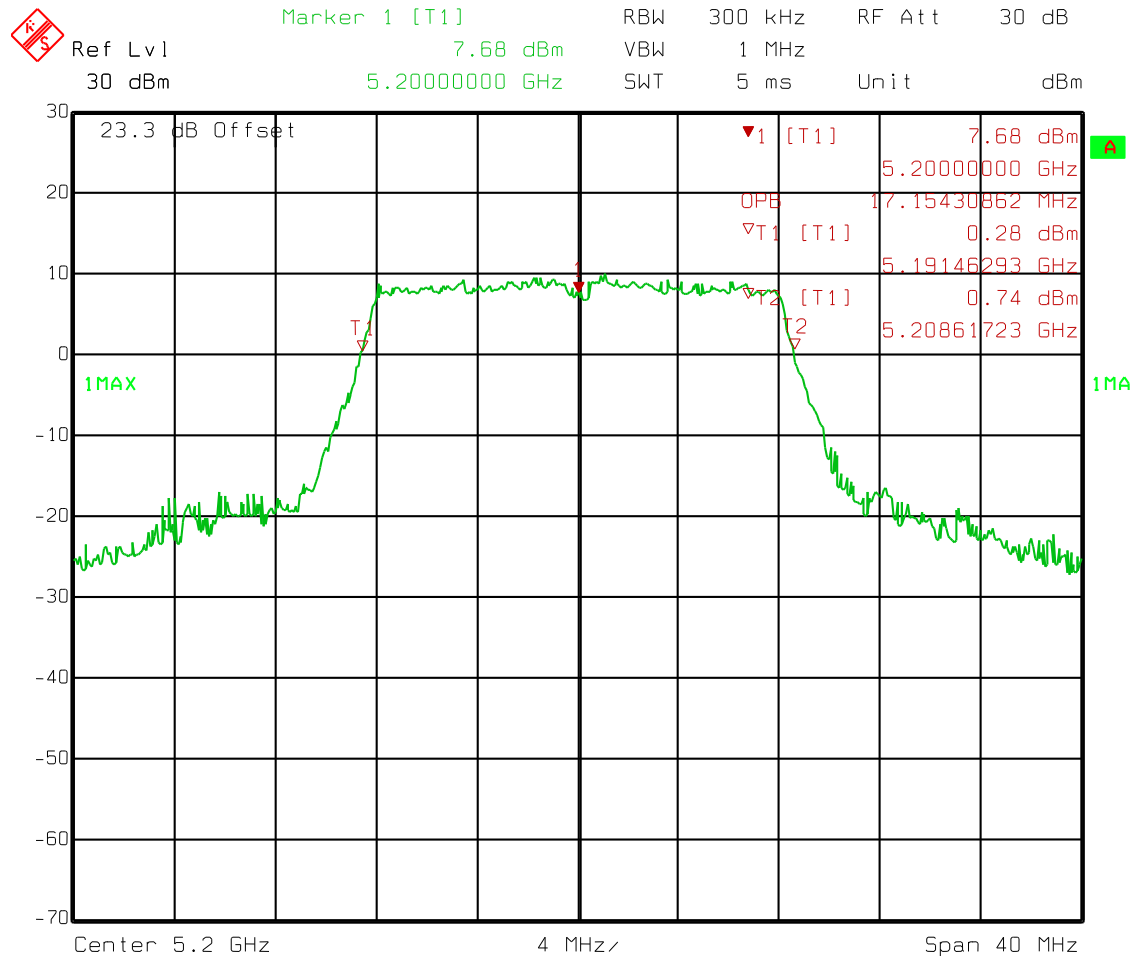

Date: 21.MAY 2015 09:53:36



Test Data – 99% Emission Bandwidth

802.11a  
 99% Bandwidth  
 High Channel – UNII 1

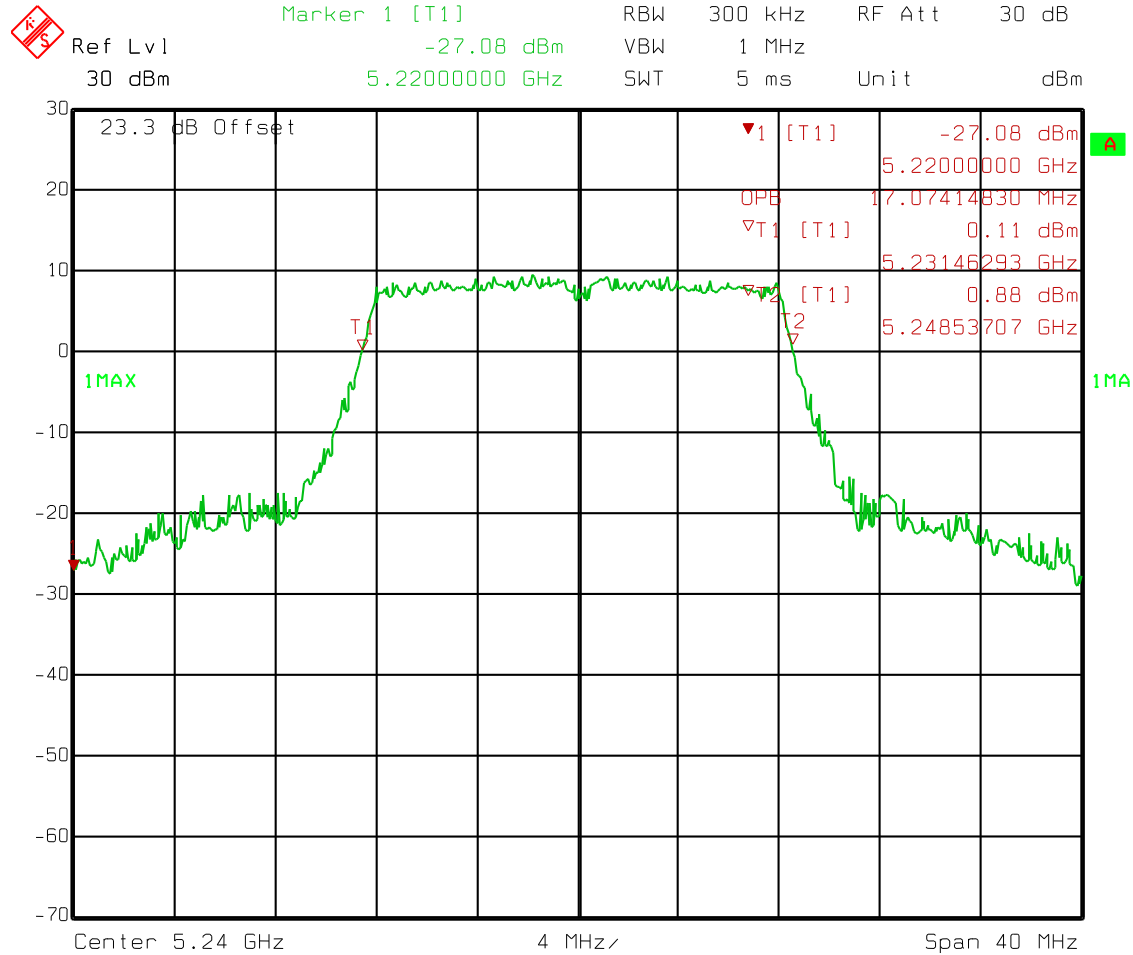

Date: 21.MAY 2015 09:55:41

Test Data – 99% Emission Bandwidth

802.11a  
 99% Bandwidth  
 Low Channel – UNII 3

	Marker 1 [T1]	RBW	300 kHz	RF Att	30 dB
	Ref Lvl	-27.18 dBm	VBW	1 MHz	
	30 dBm	5.72500000 GHz	SWT	5 ms	Unit dBm

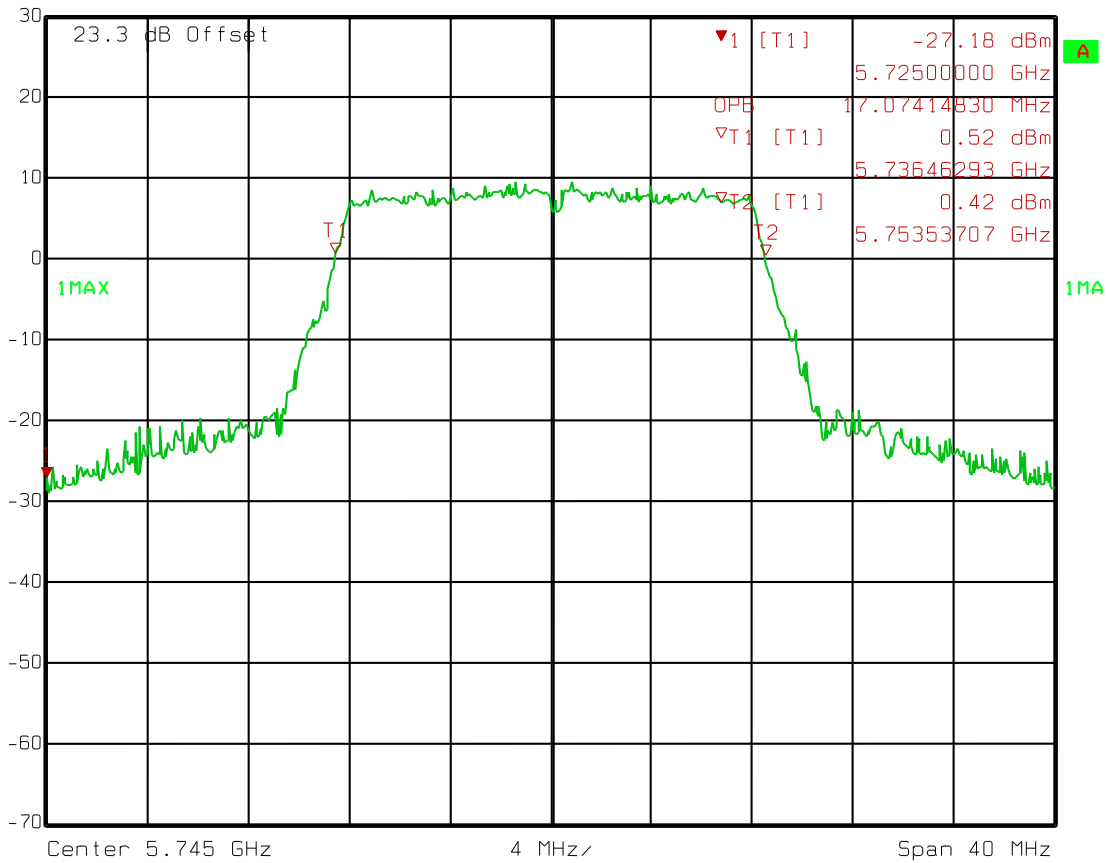

Date: 21.MAY 2015 11:05:32

Test Data – 99% Emission Bandwidth

802.11a  
 99% Bandwidth  
 Mid Channel – UNII 3

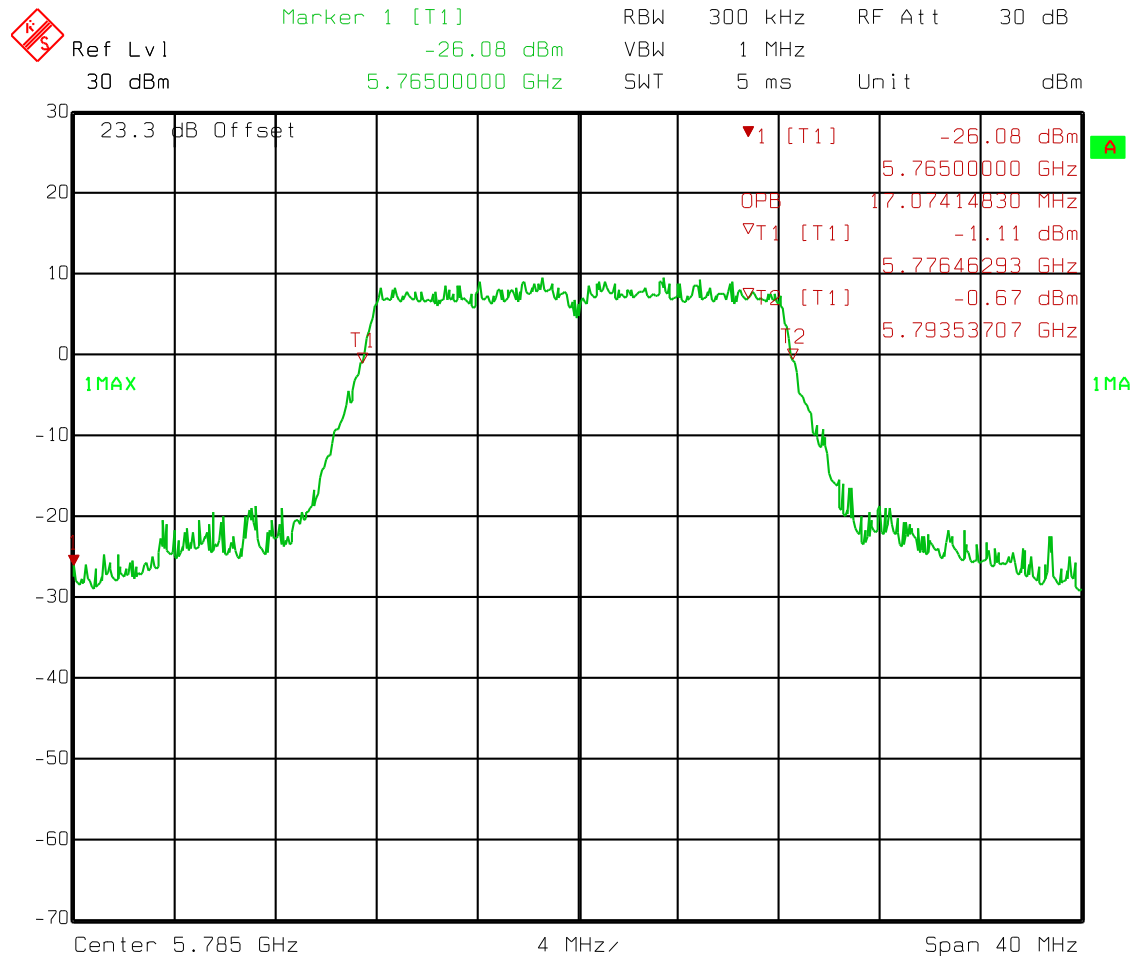

Date: 21.MAY 2015 11:06:17

**Test Data – 99% Emission Bandwidth**

802.11a  
 99% Bandwidth  
 High Channel – UNII 3

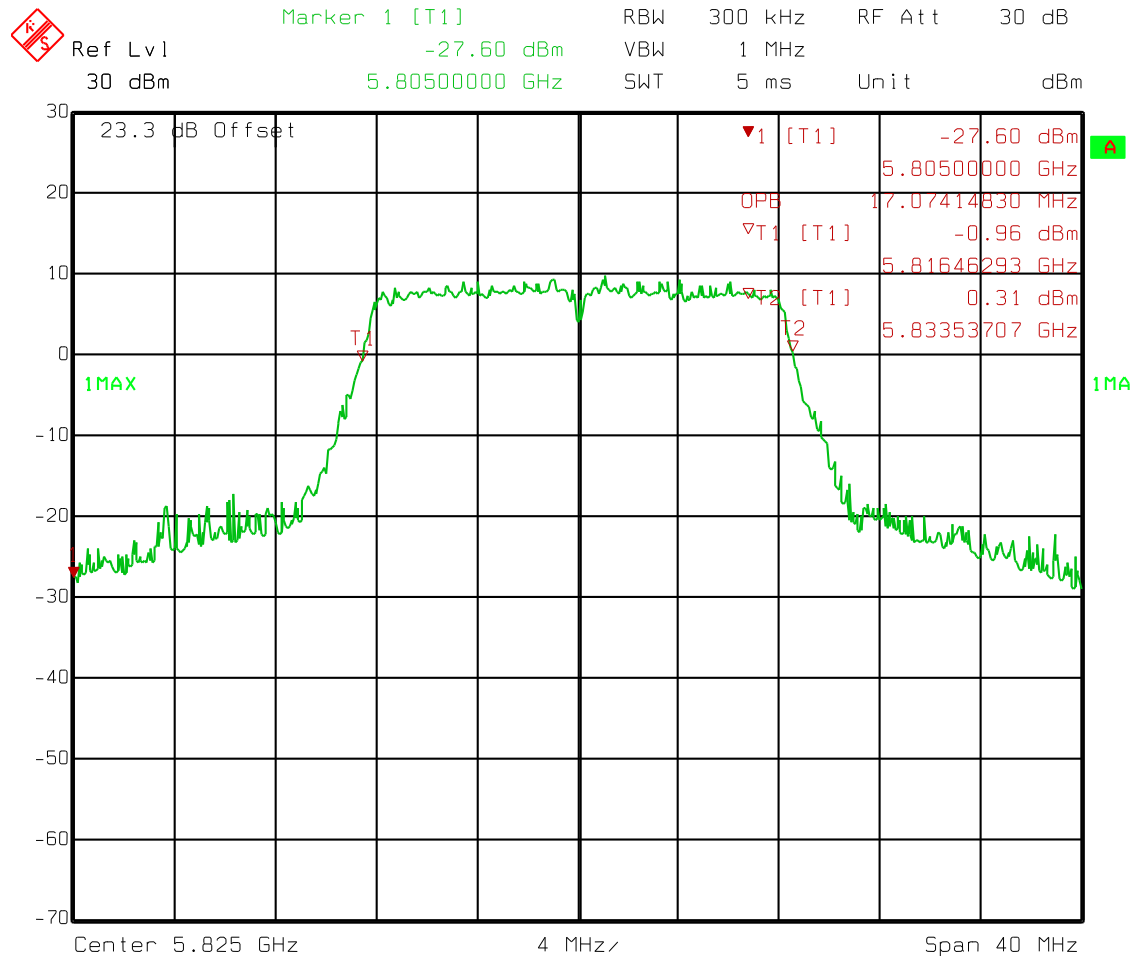

Date: 21.MAY 2015 11:07:10

**Test Data – 99% Emission Bandwidth**

802.11n 20 MHz  
 99% Bandwidth  
 Low Channel – UNII 1

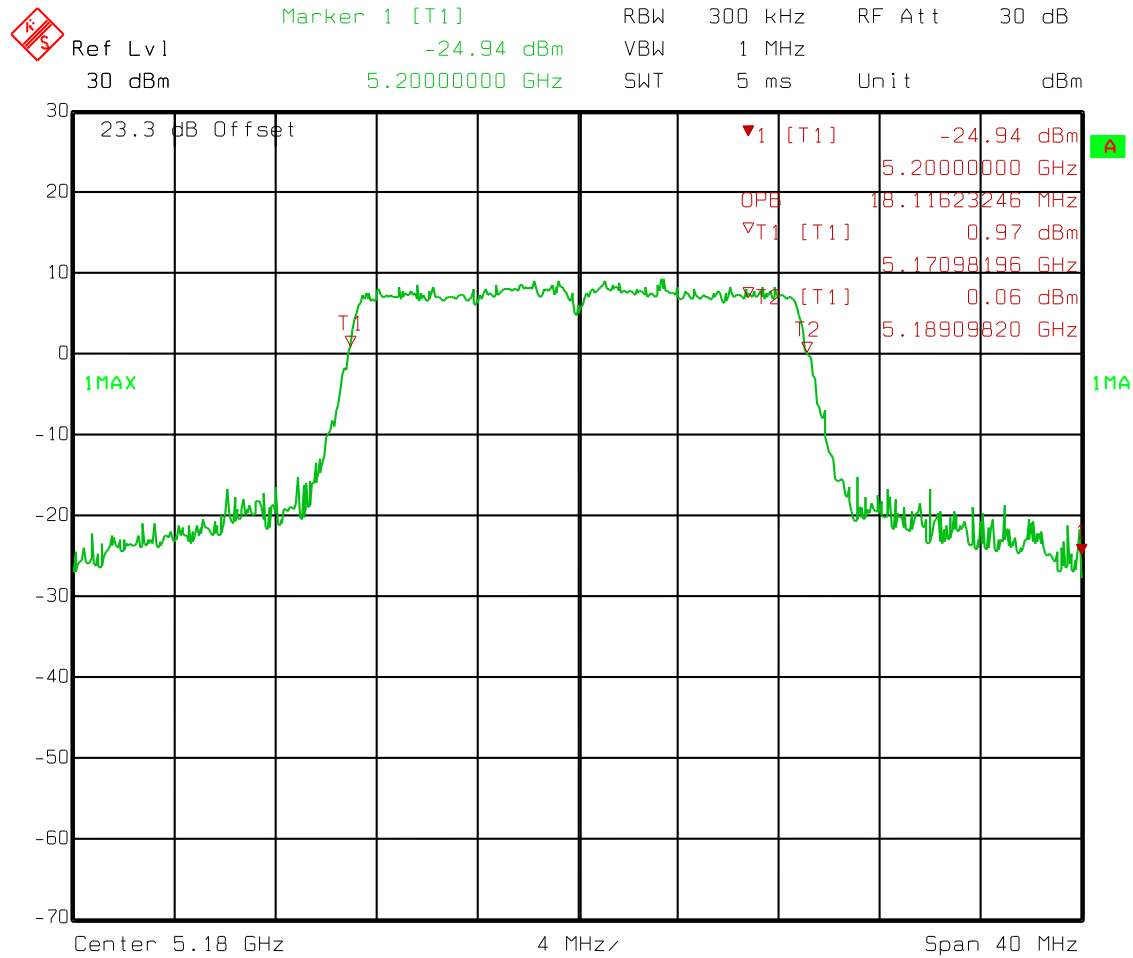

Date: 21.MAY 2015 11:08:16

**Test Data – 99% Emission Bandwidth**

802.11n 20 MHz  
 99% Bandwidth  
 Mid Channel – UNII 1

	Marker 1 [T1]	RBW	300 kHz	RF Att	30 dB
	Ref Lvl	-25.67 dBm	VBW	1 MHz	
	30 dBm	5.20000000 GHz	SWT	5 ms	Unit dBm

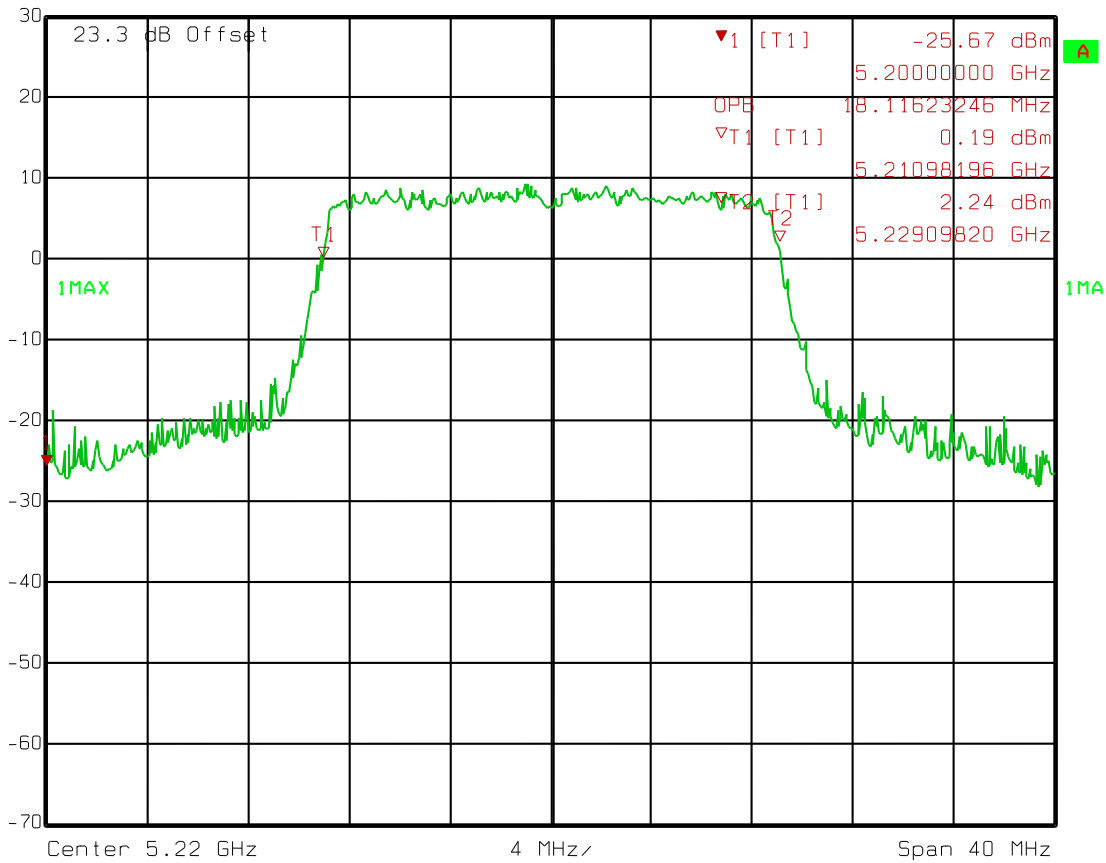

Date: 21.MAY 2015 11:09:00

**Test Data – 99% Emission Bandwidth**

802.11n 20 MHz  
 99% Bandwidth  
 High Channel – UNII 1

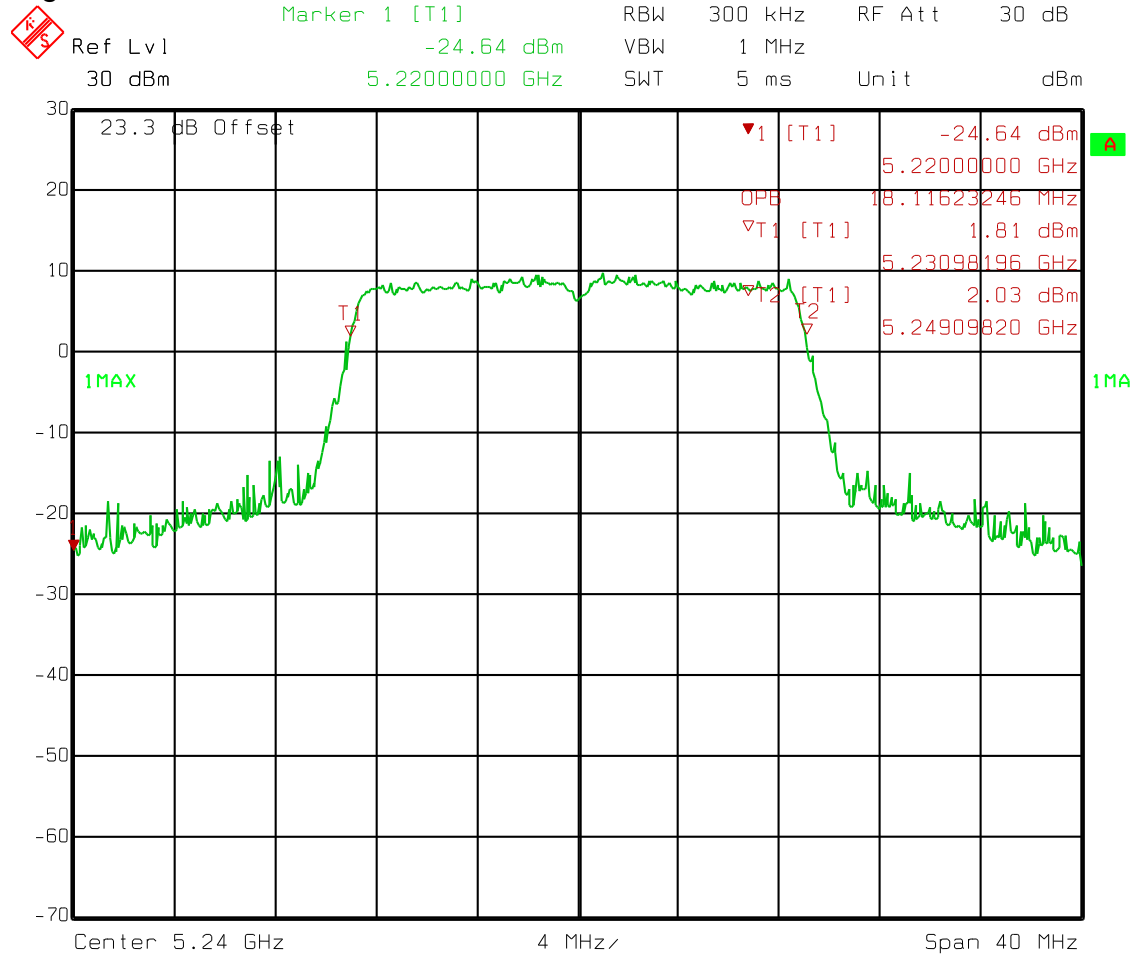

Date: 21.MAY 2015 11:09:52

Test Data – 99% Emission Bandwidth

802.11n 20 MHz  
 99% Bandwidth  
 Low Channel – UNII 3

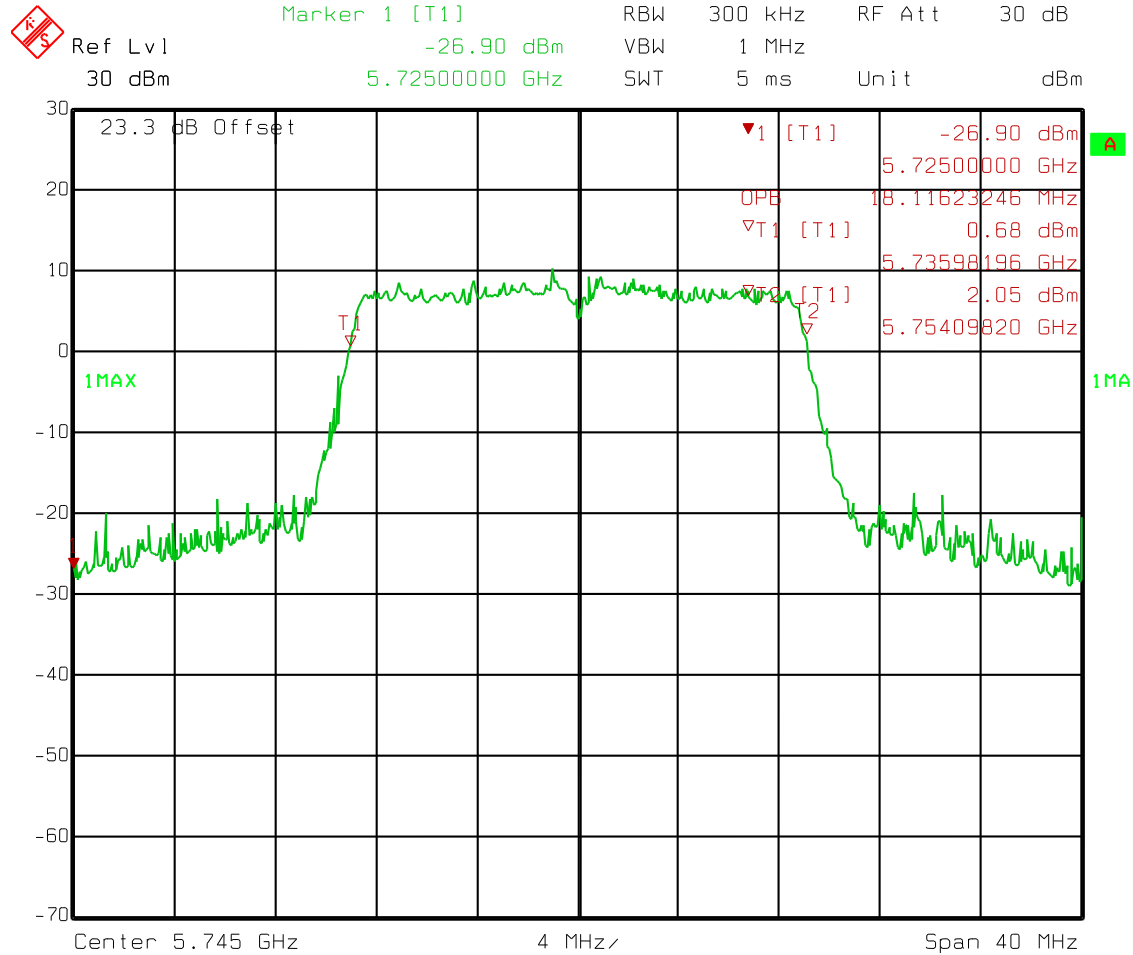

Date: 21.MAY 2015 11:15:15



**Test Data – 99% Emission Bandwidth**

802.11n 20 MHz  
 99% Bandwidth  
 Mid Channel – UNII 3

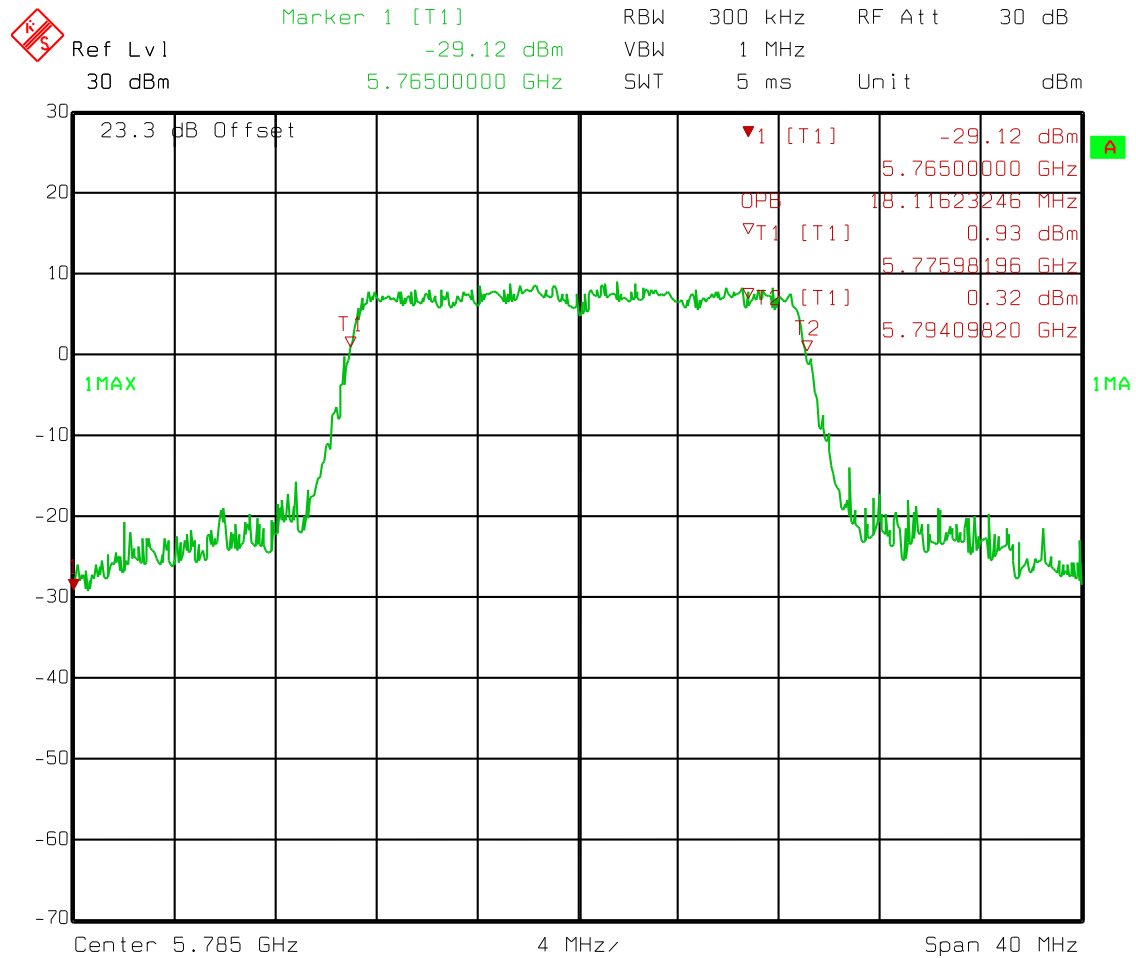

Date: 21.MAY 2015 11:15:59

Test Data – 99% Emission Bandwidth

802.11n 20 MHz  
 99% Bandwidth  
 High Channel – UNII 3

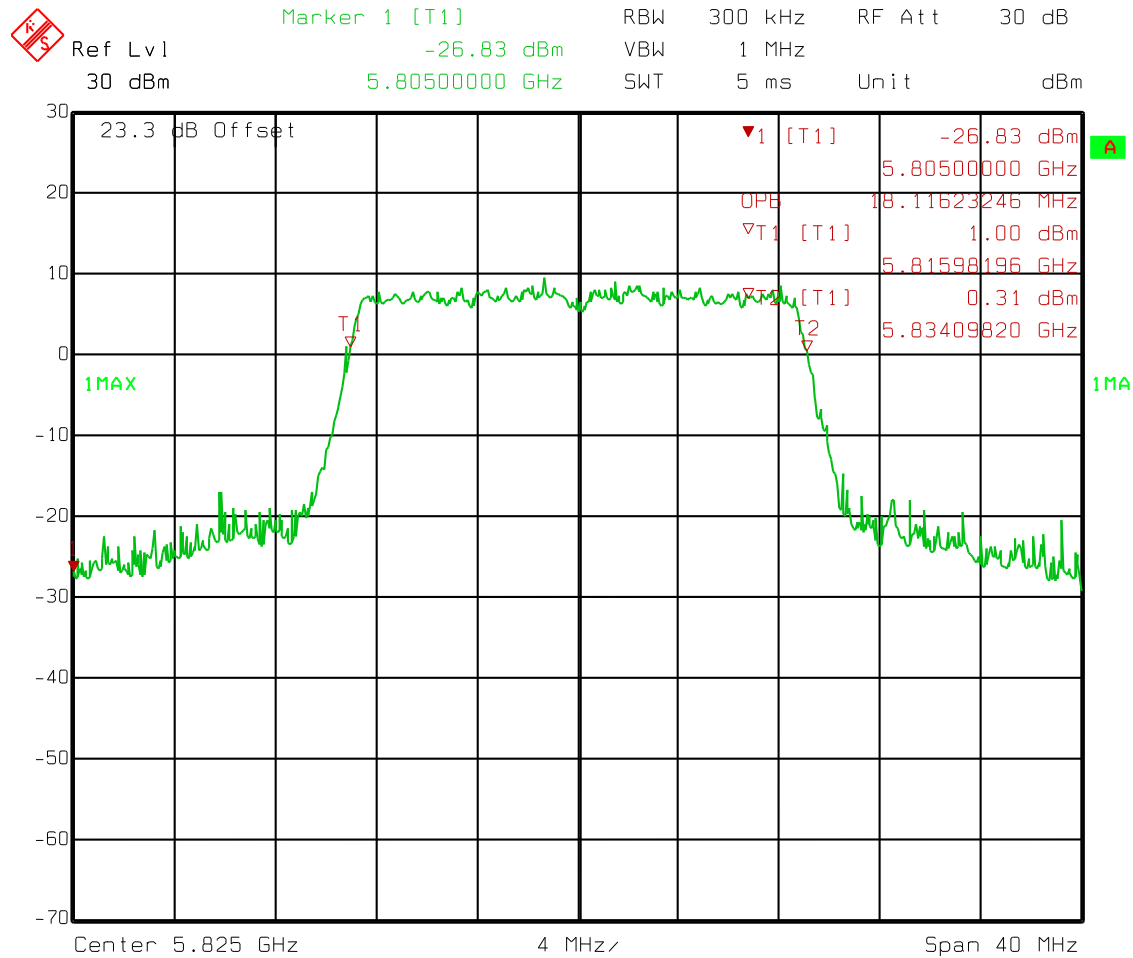

Date: 21.MAY 2015 11:16:39

**Test Data – 99% Emission Bandwidth**

802.11n 40 MHz  
 99% Bandwidth  
 Low Channel – UNII 1

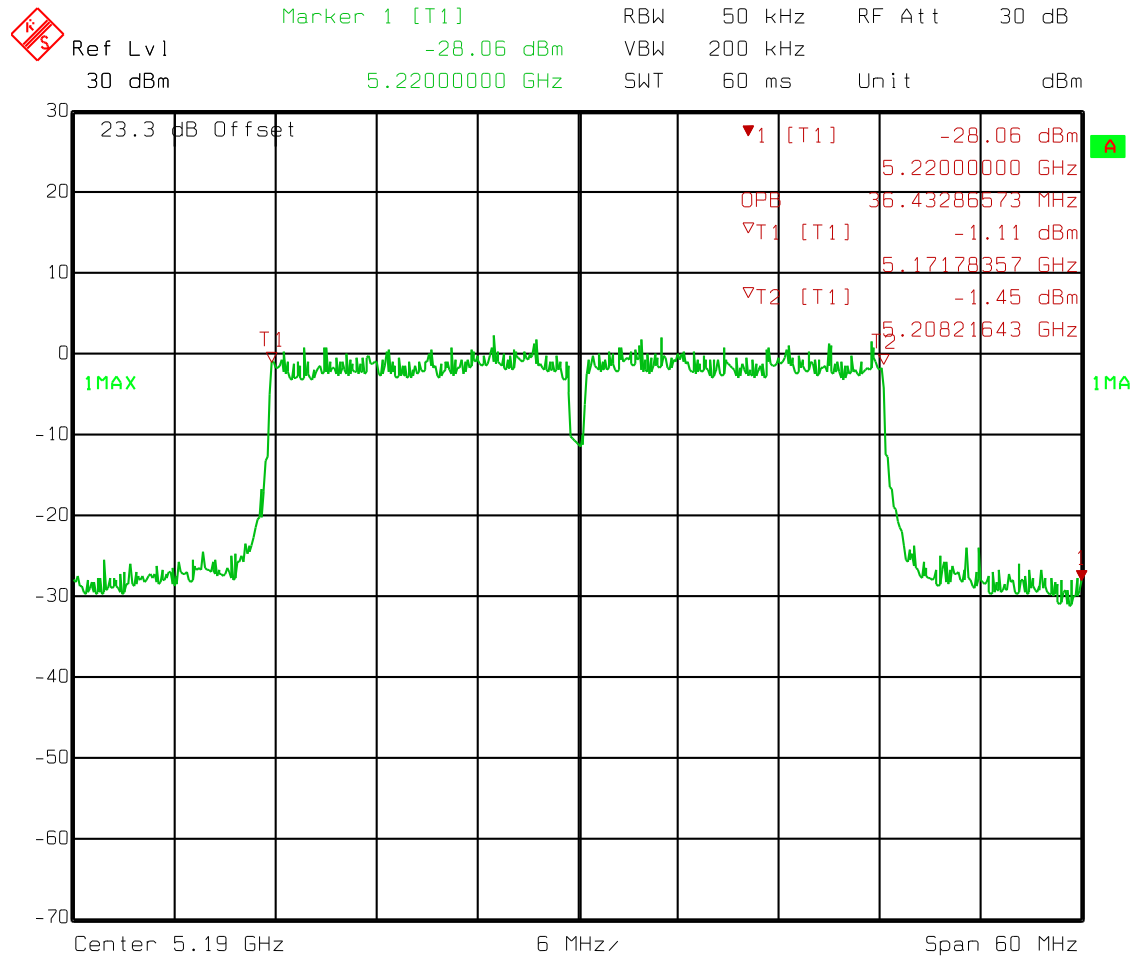

Date: 21.MAY 2015 11:36:49

**Test Data – 99% Emission Bandwidth**

802.11n 40 MHz  
 99% Bandwidth  
 High Channel – UNII 1

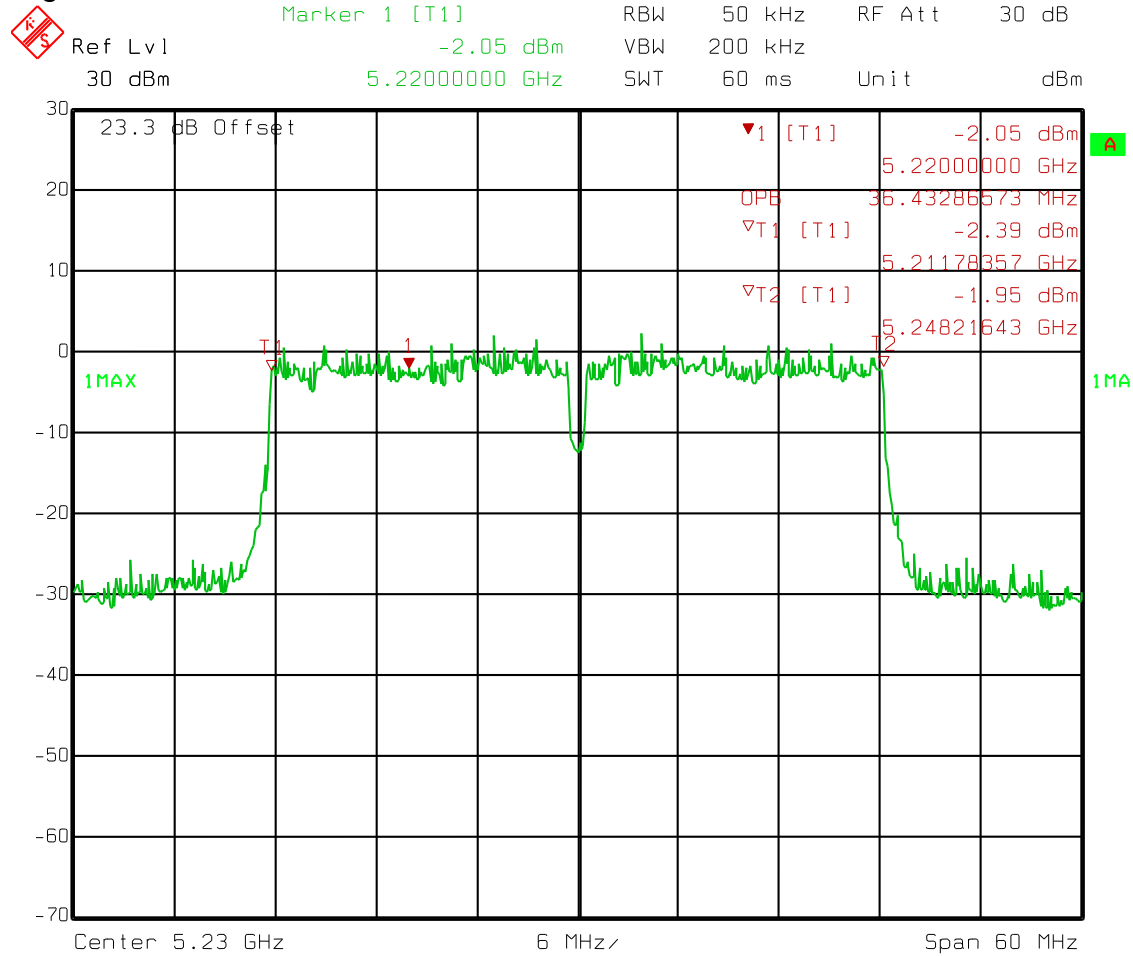

Date: 21.MAY 2015 11:37:45

**Test Data – 99% Emission Bandwidth**

802.11n 40 MHz  
 99% Bandwidth  
 Low Channel – UNII 3

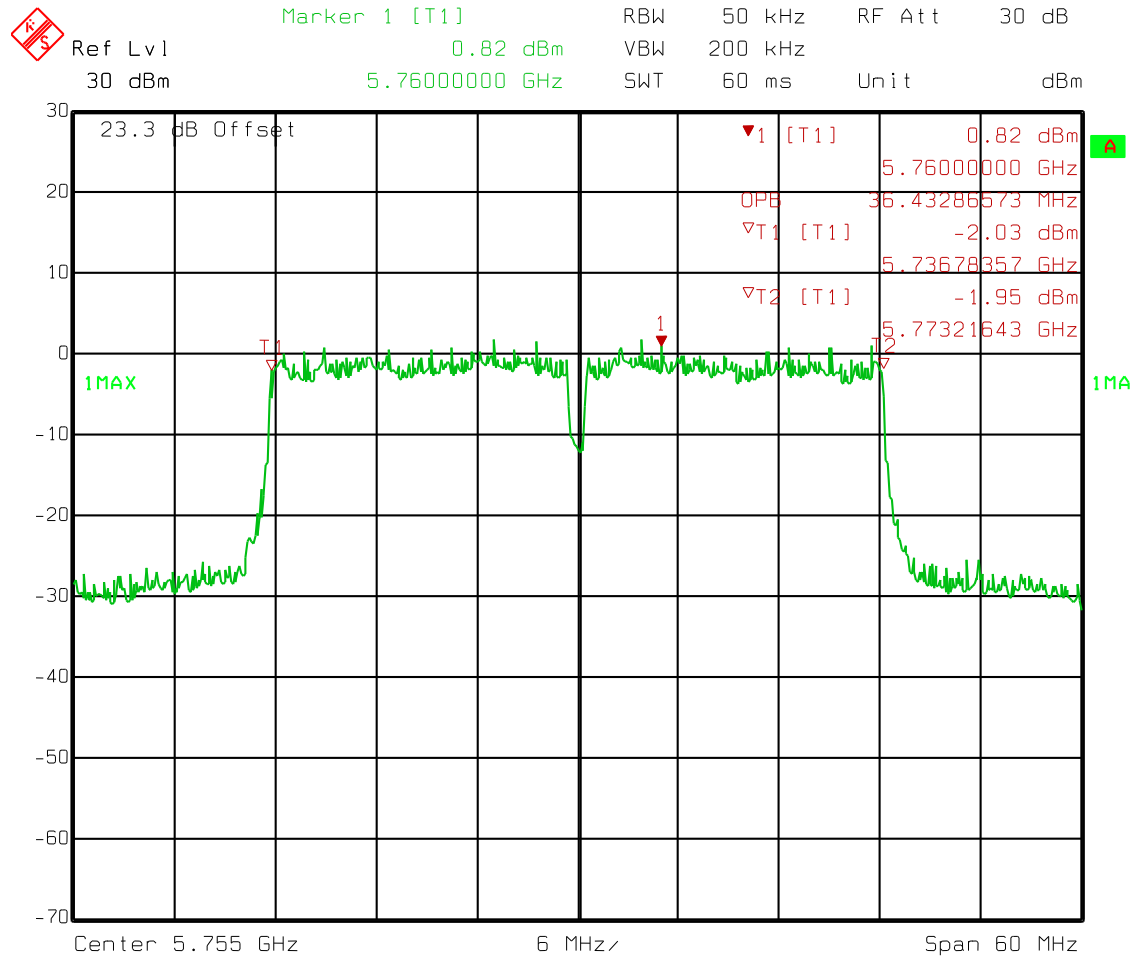

Date: 21.MAY 2015 11:43:11

**Test Data – 99% Emission Bandwidth**

802.11n 40 MHz  
 99% Bandwidth  
 High Channel – UNII 3

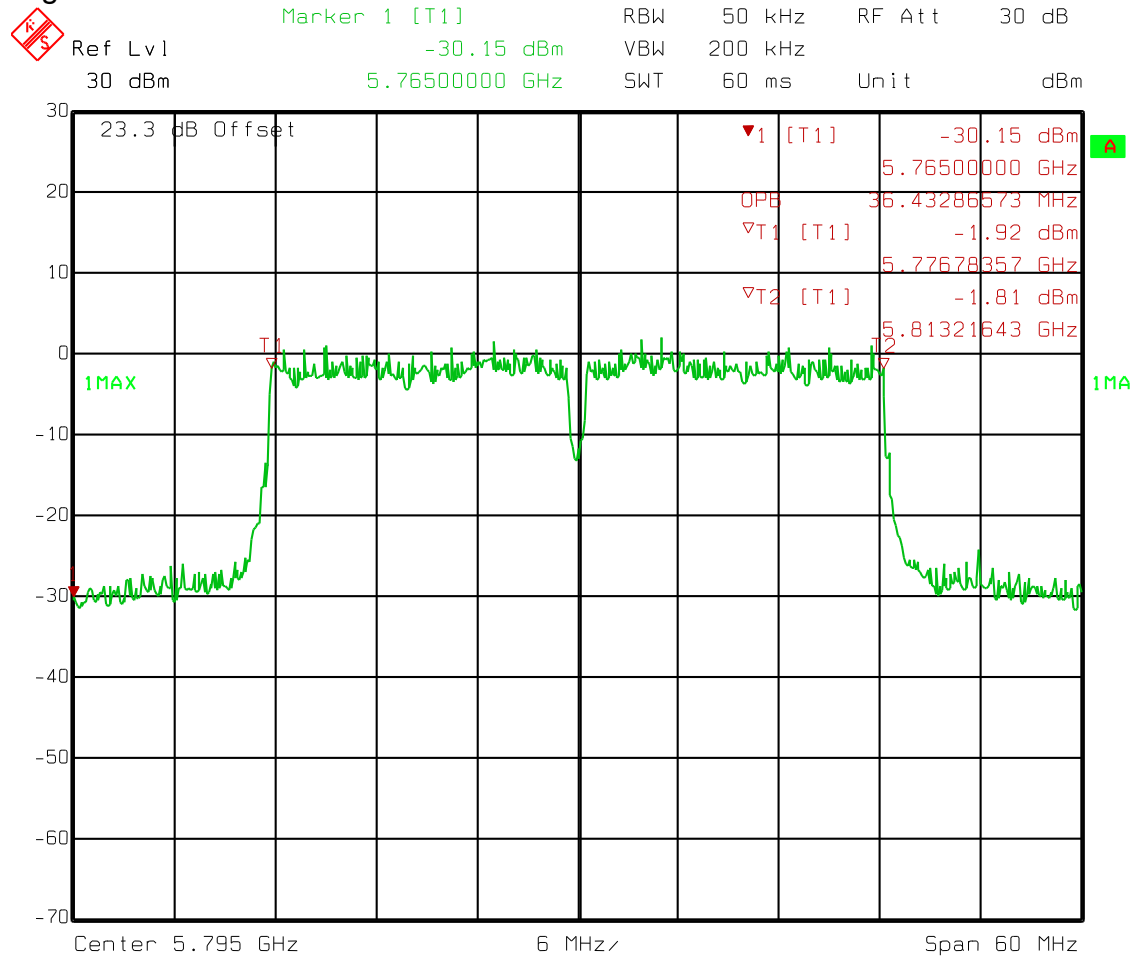

Date: 21.MAY 2015 11:44:03

Test Data – 99% Emission Bandwidth

802.11ac  
 99% Bandwidth  
 UNII 1

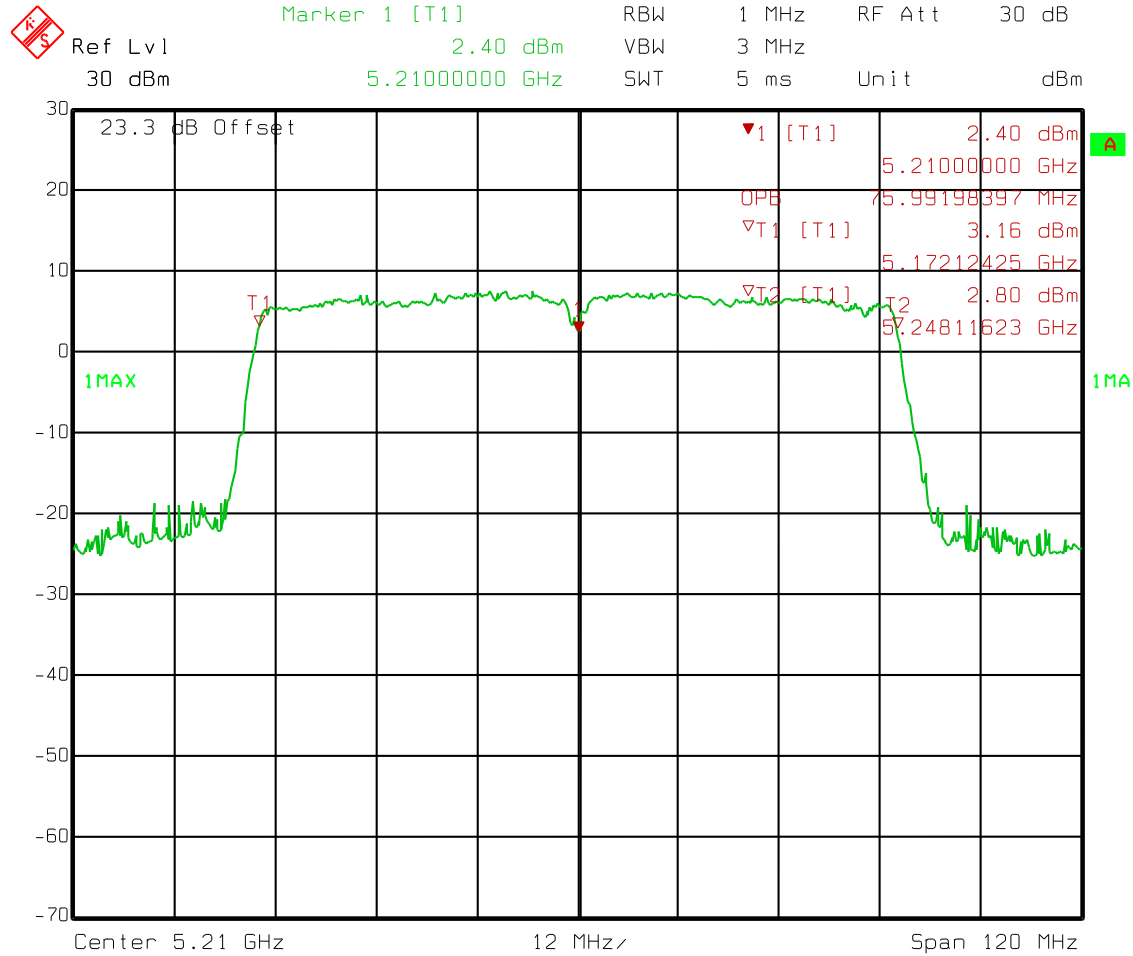

Date: 21.MAY 2015 11:30:29

Test Data – 99% Emission Bandwidth

802.11ac  
 99% Bandwidth  
 UNII 3

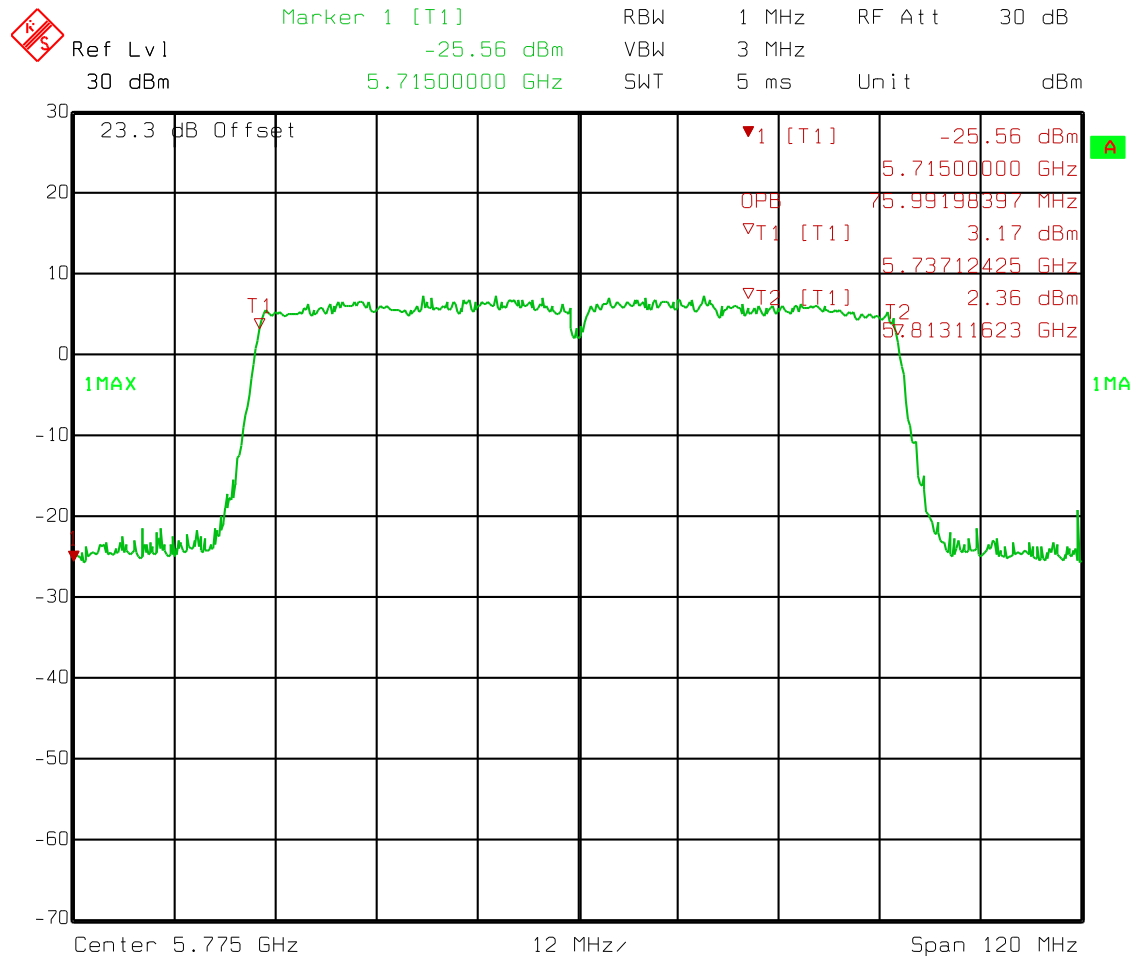

Date: 21.MAY 2015 11:34:33



**Section 4. Output Power and Spectral Density**

NAME OF TEST: Output Power and Spectral Density	PARA. NO.: 15.407(a)
TESTED BY: David Light	DATE: 22 May 2014

**Test Results:** Complies.

**Measurement Data:** Refer to attached data

**Note:** 9.8 dB is added to calculate EIRP from the attached plots.  
Antenna Gain = 5 dBi  
Correction for 3x3 MIMO =  $10 \log (N_{ANT}) = 4.8 \text{ dB}$

**Test Conditions:** 35 %RH  
22 °C

**Measurement Uncertainty:** +/-1.7 dB

**Test Equipment Used:** 1036

- This device was tested at +/- 15% input power per 15.31(e), with no variation in output power.
- For battery powered equipment, the device was tested with a fresh battery per 15.31(e).
- The device was tested on three channels per 15.31(l).
- This test was performed radiated.

**Test Data – Output Power**

Frequency (MHz)	Mode 802.11 a/n20/n40/ac	Ant Gain (dBi)	MIMO Correction (dB)	Output Power (dBm)	Corrected Power (dBm)	Power Limit (dBm)	EIRP (dBm)	EIRP Limit (dBm)
5180	a	5	4.8	10.5	15.3	21	20.3	27
5220	a	5	4.8	10.5	15.3	21	20.3	27
5240	a	5	4.8	10.5	15.3	21	20.3	27
5745	a	5	4.8	10.1	14.9	30	19.9	36
5785	a	5	4.8	10	14.8	30	19.8	36
5825	a	5	4.8	10.1	14.9	30	19.9	36
5180	n20	5	4.8	10.2	15	21	20	27
5220	n20	5	4.8	10.3	15.1	21	20.1	27
5240	n20	5	4.8	10.3	15.1	21	20.1	27
5745	n20	5	4.8	10	14.8	30	19.8	36
5785	n20	5	4.8	9.8	14.6	30	19.6	36
5825	n20	5	4.8	10	14.8	30	19.8	36
5190	n40	5	4.8	9.8	14.6	21	19.6	27
5230	n40	5	4.8	9.9	14.7	24	19.7	30
5670	n40	5	4.8	9.7	14.5	24	19.5	30
5755	n40	5	4.8	9.8	14.6	30	19.6	36
5795	n40	5	4.8	9.9	14.7	30	19.7	36
5210	ac	5	4.8	9.6	14.4	21	19.4	27
5775	ac	5	4.8	9.3	14.1	30	19.1	36

Highest MPE Calculation 802.11a



**Prediction of MPE limit at a given distance**

Equation from page 18 of OET Bulletin 65, Edition 97-01

$$S = \frac{PG}{4\pi R^2}$$

where: S = power density  
 P = power input to the antenna  
 G = power gain of the antenna in the direction of interest relative to isotropic radiator  
 R = distance to the center of radiation of the antenna

Maximum peak output power at antenna input terminal:	<u>15.3</u>	(dBm)	*
Maximum peak output power at antenna input terminal:	<u>33.9</u>	(mW)	
Antenna gain(maximum):	<u>5</u>	(dBi)	*
Maximum antenna gain:	<u>3.16</u>	(numeric)	
Time Averaging:	<u>100</u>	(%)	*
Prediction distance:	<u>1300</u>	(cm)	*
Prediction frequency:	<u>5240</u>	(MHz)	*
FCC MPE limit for uncontrolled exposure at prediction frequency:	<u>1.000</u>	(mW/cm <sup>2</sup> )	
IC MPE limit for uncontrolled exposure at prediction frequency:	<u>28.89</u>	(W/m <sup>2</sup> )	
Power density at prediction frequency:	<u>0.000005</u>	(mW/cm <sup>2</sup> )	
This equates to:	<u>0.000050</u>	(W/m <sup>2</sup> )	

**Highest MPE Calculation 802.11n (20)**



**Prediction of MPE limit at a given distance**

Equation from page 18 of OET Bulletin 65, Edition 97-01

$$S = \frac{PG}{4\pi R^2}$$

where: S = power density  
 P = power input to the antenna  
 G = power gain of the antenna in the direction of interest relative to isotropic radiator  
 R = distance to the center of radiation of the antenna

Maximum peak output power at antenna input terminal:	<u>15.1</u>	(dBm)	*
Maximum peak output power at antenna input terminal:	<u>32.4</u>	(mW)	
Antenna gain(maximum):	<u>5</u>	(dBi)	*
Maximum antenna gain:	<u>3.16</u>	(numeric)	
Time Averaging:	<u>100</u>	(%)	*
Prediction distance:	<u>1300</u>	(cm)	*
Prediction frequency:	<u>5240</u>	(MHz)	*
FCC MPE limit for uncontrolled exposure at prediction frequency:	<u>1.000</u>	(mW/cm <sup>2</sup> )	
IC MPE limit for uncontrolled exposure at prediction frequency:	<u>28.89</u>	(W/m <sup>2</sup> )	
Power density at prediction frequency:	<u>0.000005</u>	(mW/cm <sup>2</sup> )	
This equates to:	<u>0.000048</u>	(W/m <sup>2</sup> )	

**Highest MPE Calculation 802.11n (40)**



**Prediction of MPE limit at a given distance**

Equation from page 18 of OET Bulletin 65, Edition 97-01

$$S = \frac{PG}{4\pi R^2}$$

where: S = power density  
 P = power input to the antenna  
 G = power gain of the antenna in the direction of interest relative to isotropic radiator  
 R = distance to the center of radiation of the antenna

Maximum peak output power at antenna input terminal:	<u>14.7</u> (dBm)	*
Maximum peak output power at antenna input terminal:	<u>29.5</u> (mW)	
Antenna gain(maximum):	<u>5</u> (dBi)	*
Maximum antenna gain:	<u>3.16</u> (numeric)	
Time Averaging:	<u>100</u> (%)	*
Prediction distance:	<u>1300</u> (cm)	*
Prediction frequency:	<u>5795</u> (MHz)	*
FCC MPE limit for uncontrolled exposure at prediction frequency:	<u>1.000</u> (mW/cm <sup>2</sup> )	
IC MPE limit for uncontrolled exposure at prediction frequency:	<u>30.95</u> (W/m <sup>2</sup> )	
Power density at prediction frequency:	<u>0.000004</u> (mW/cm <sup>2</sup> )	
This equates to:	<u>0.000044</u> (W/m <sup>2</sup> )	

**Highest MPE Calculation 802.11ac**



**Prediction of MPE limit at a given distance**

Equation from page 18 of OET Bulletin 65, Edition 97-01

$$S = \frac{PG}{4\pi R^2}$$

where: S = power density  
 P = power input to the antenna  
 G = power gain of the antenna in the direction of interest relative to isotropic radiator  
 R = distance to the center of radiation of the antenna

Maximum peak output power at antenna input terminal:	<u>14.4</u>	(dBm)	*
Maximum peak output power at antenna input terminal:	<u>27.5</u>	(mW)	
Antenna gain(maximum):	<u>5</u>	(dBi)	*
Maximum antenna gain:	<u>3.16</u>	(numeric)	
Time Averaging:	<u>100</u>	(%)	*
Prediction distance:	<u>1300</u>	(cm)	*
Prediction frequency:	<u>5210</u>	(MHz)	*
FCC MPE limit for uncontrolled exposure at prediction frequency:	<u>1.000</u>	(mW/cm <sup>2</sup> )	
IC MPE limit for uncontrolled exposure at prediction frequency:	<u>28.78</u>	(W/m <sup>2</sup> )	
Power density at prediction frequency:	<u>0.000004</u>	(mW/cm <sup>2</sup> )	
This equates to:	<u>0.000041</u>	(W/m <sup>2</sup> )	

**Test Data –Spectral Density**

Frequency (MHz)	Mode 802.11 a/n20/n40/ac	MIMO Correction (dB)	Spectral Density (dBm)	Corrected Density (dBm)	Limit (dBm)
5180	a	4.8	-0.1	4.7	11
5220	a	4.8	0.1	4.9	11
5240	a	4.8	0	4.8	11
5745	a	4.8	-0.5	4.3	30
5785	a	4.8	-0.7	4.1	30
5825	a	4.8	-0.5	4.3	30
5180	n20	4.8	-0.8	4	11
5220	n20	4.8	-0.7	4.1	11
5240	n20	4.8	-0.7	4.1	11
5745	n20	4.8	-1	3.8	30
5785	n20	4.8	-1.3	3.5	30
5825	n20	4.8	-1.1	3.7	30
5190	n40	4.8	-3.9	0.9	11
5230	n40	4.8	-3.8	1	11
5755	n40	4.8	-3.8	1	30
5795	n40	4.8	-3.9	0.9	30
5210	ac	4.8	-6.8	-2	11
5775	ac	4.8	-7.2	-2.4	30

**Test Data – Peak Power and Density**

802.11a  
 Power and Density  
 Low Channel – UNII 1

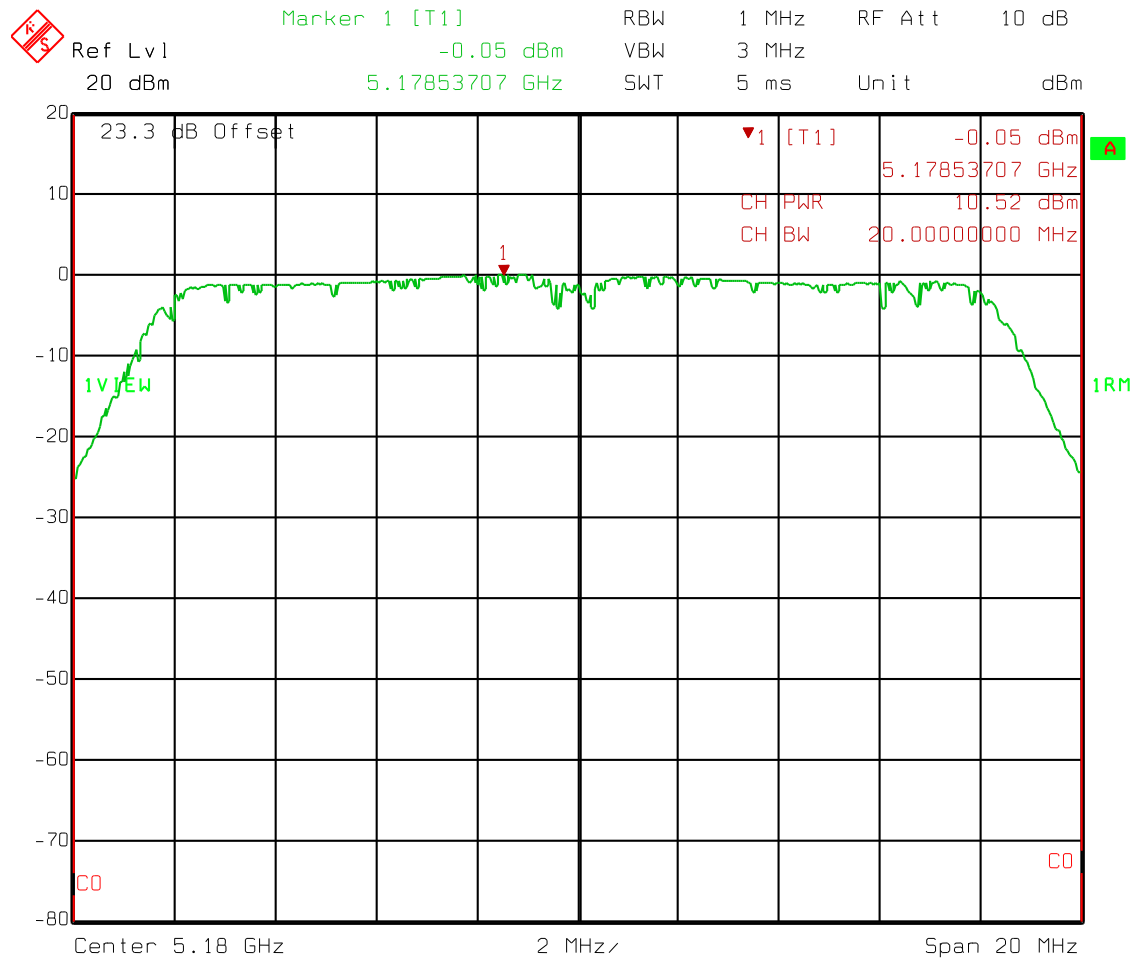

Date: 22.MAY 2015 07:24:25



Test Data – Peak Power and Density

802.11a  
Power and Density  
Mid Channel – UNII 1

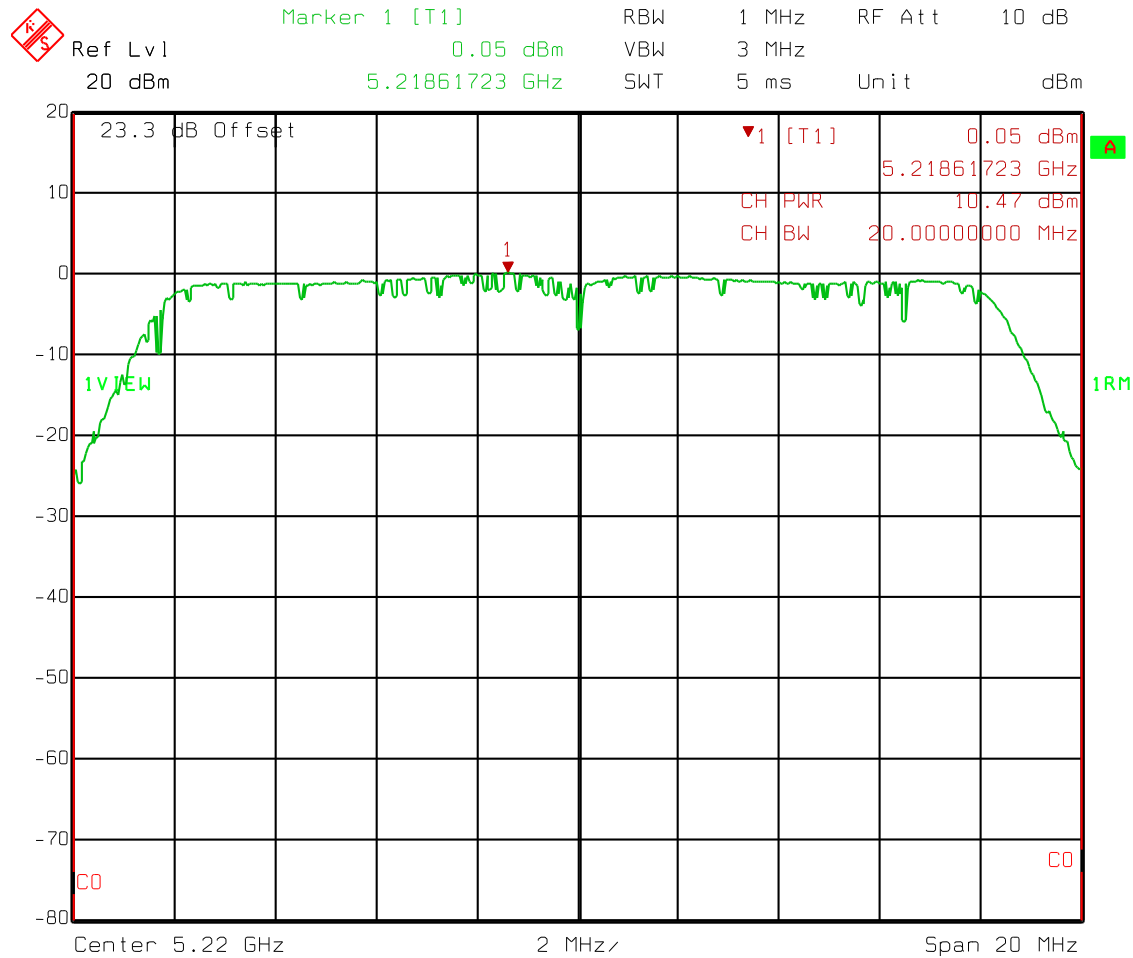

Date: 22.MAY 2015 07:25:52

Test Data – Peak Power and Density

802.11a  
Power and Density  
High Channel – UNII 1

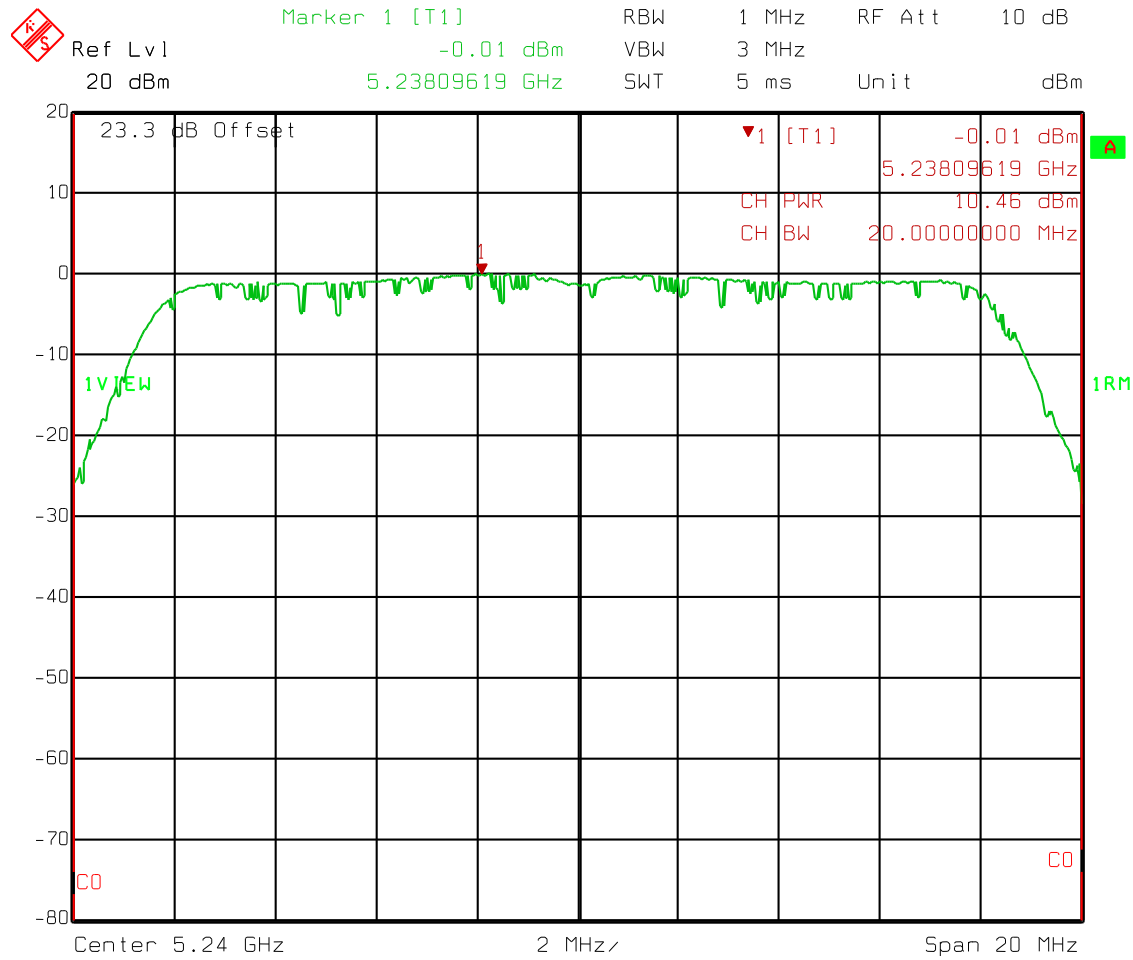

Date: 22.MAY 2015 07:26:42

Test Data – Peak Power and Density

802.11a  
Power and Density  
Low Channel – UNII 3

 Ref Lvl 20 dBm  
Marker 1 [T1] -0.53 dBm  
5.74377756 GHz  
RBW 1 MHz RF Att 10 dB  
VBW 3 MHz  
SWT 5 ms Unit dBm

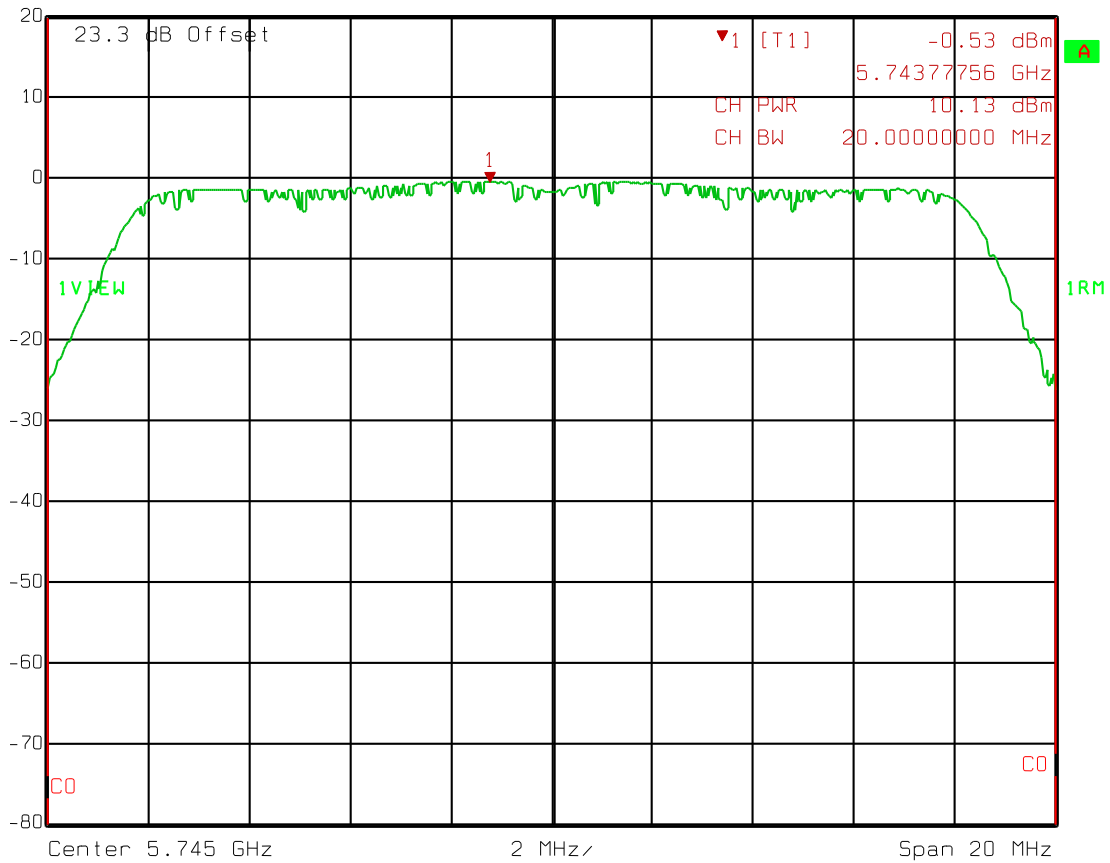

Date: 22.MAY 2015 07:32:39

Test Data – Peak Power and Density

802.11a  
Power and Density  
Mid Channel – UNII 3

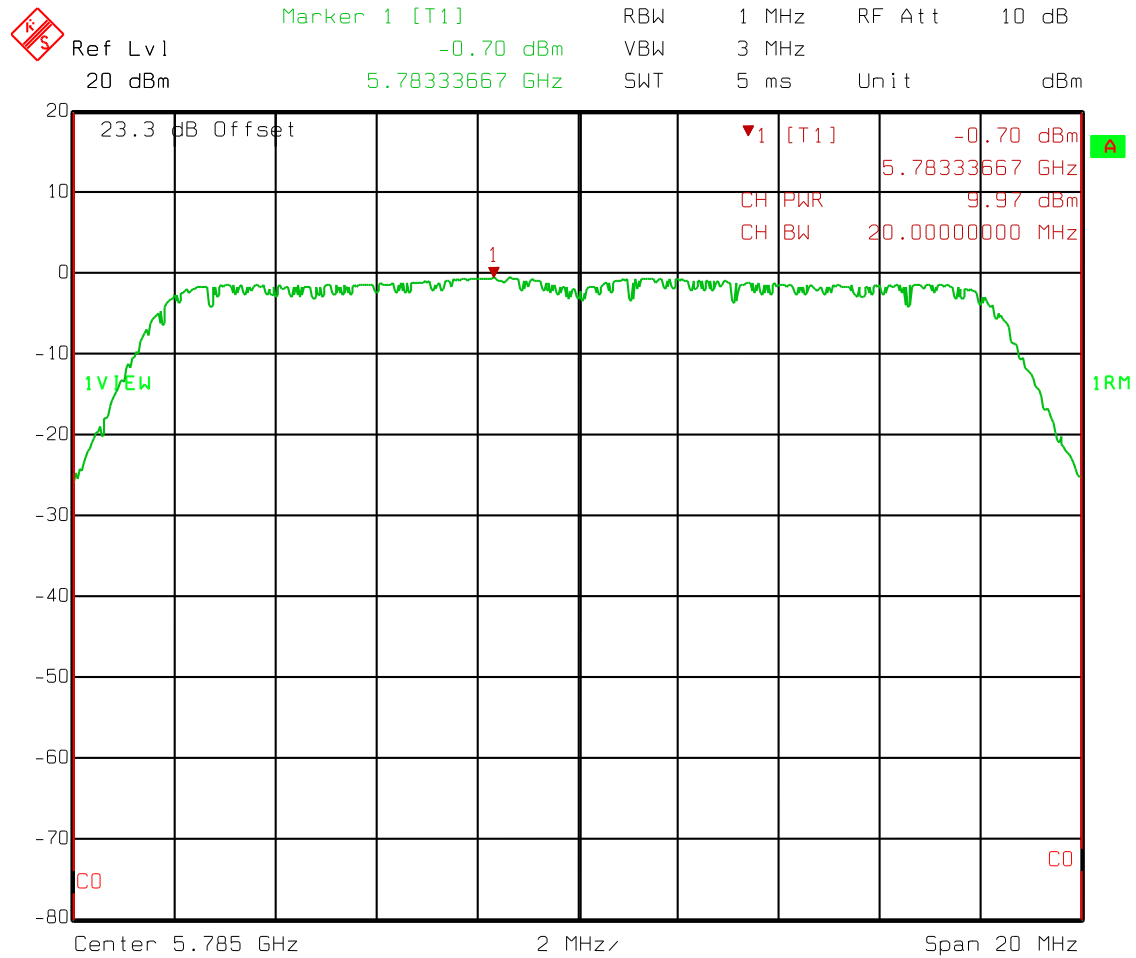

Date: 22.MAY 2015 07:33:06

Test Data – Peak Power and Density

802.11a  
 Power and Density  
 High Channel – UNII 3

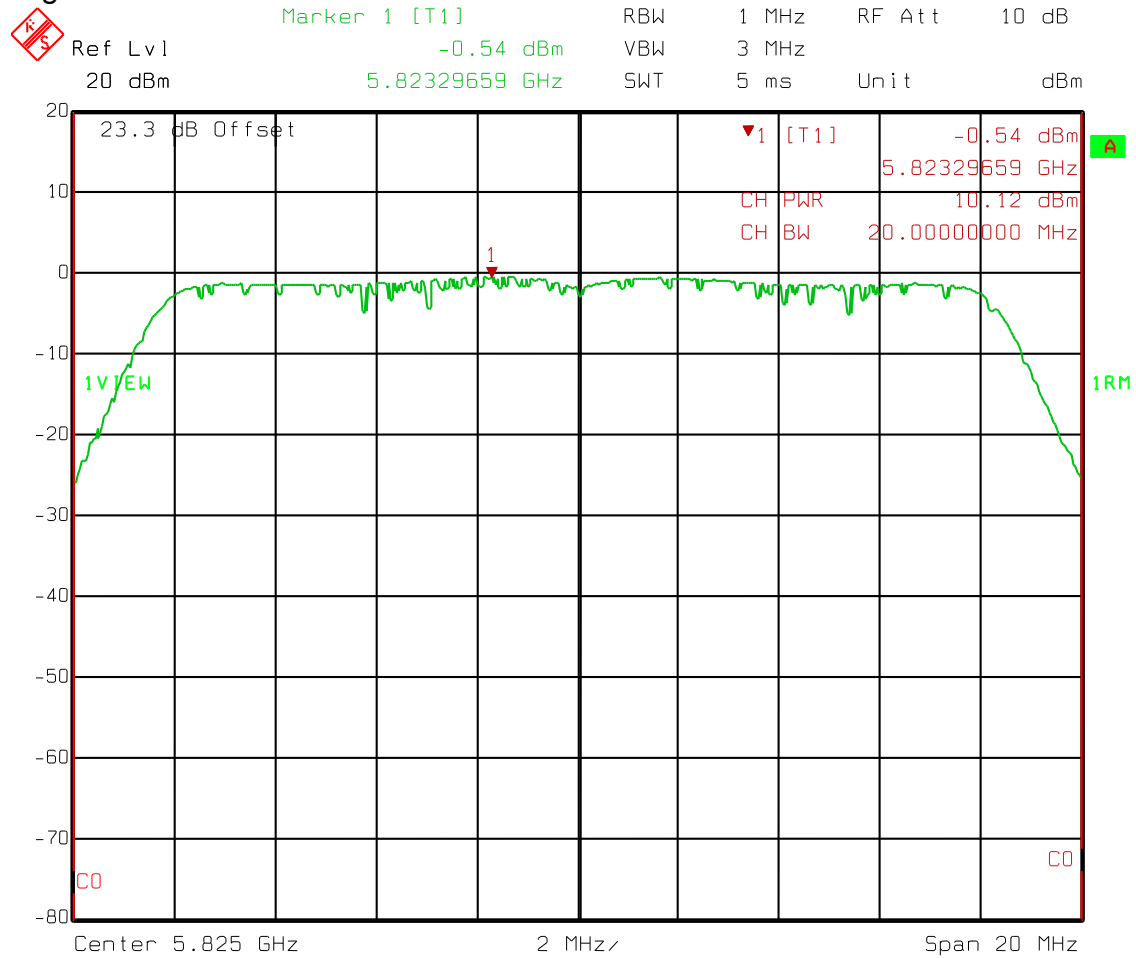

Date: 22.MAY 2015 07:33:51

**Test Data – Peak Power and Density**

802.11n 20 MHz  
 Power and Density  
 Low Channel – UNII 1

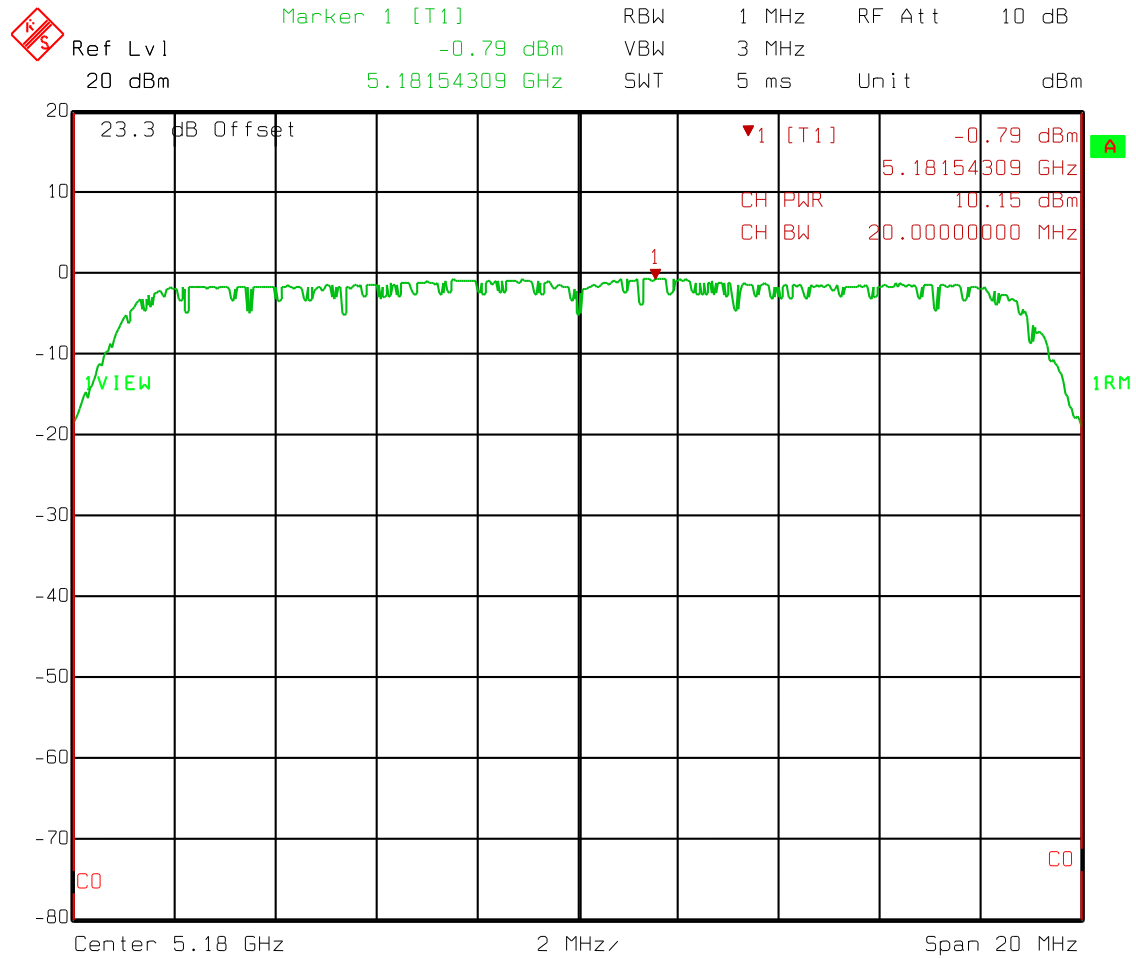

Date: 22.MAY 2015 07:36:29

**Test Data – Peak Power and Density**

802.11n 20 MHz  
 Power and Density  
 Mid Channel – UNII 1

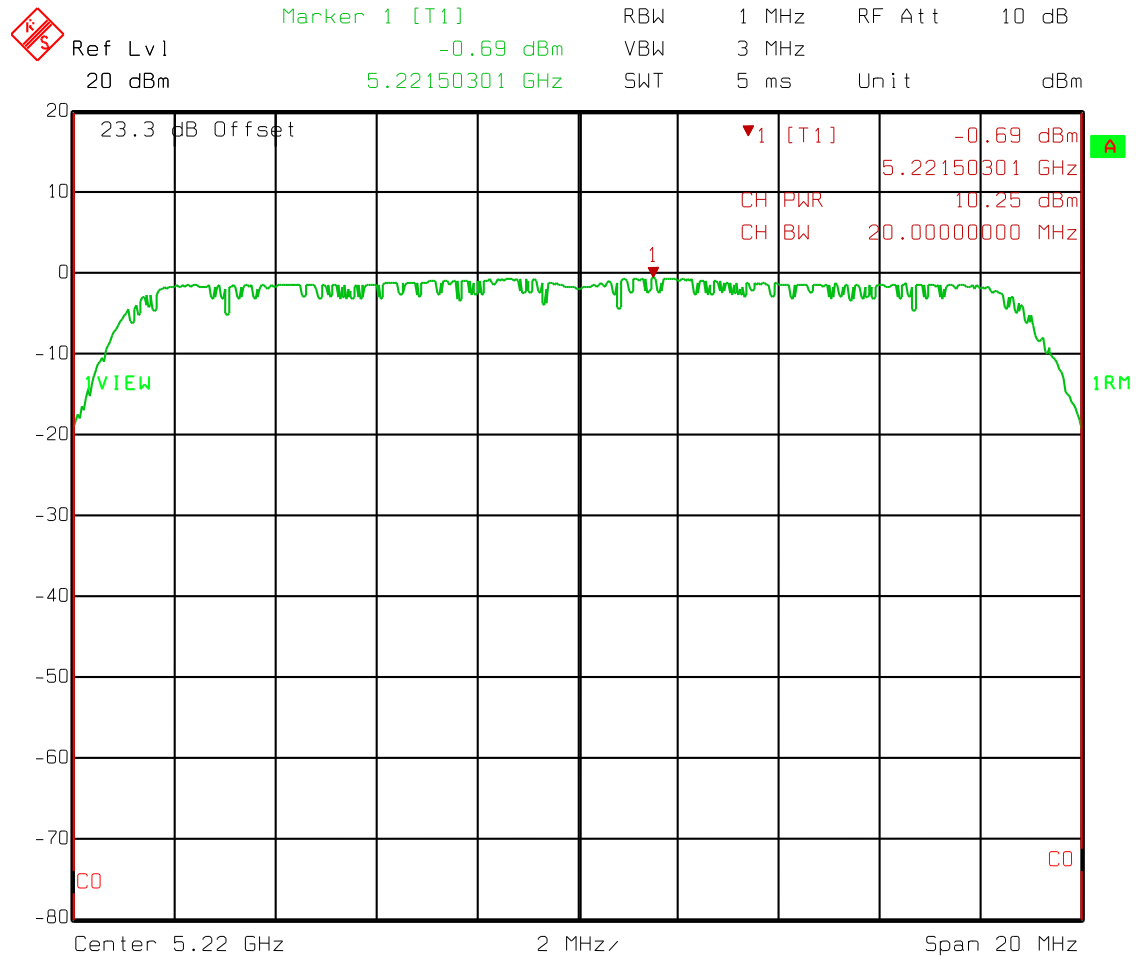

Date: 22.MAY 2015 07:37:11

Test Data – Peak Power and Density

802.11n 20 MHz  
Power and Density  
High Channel – UNII 1

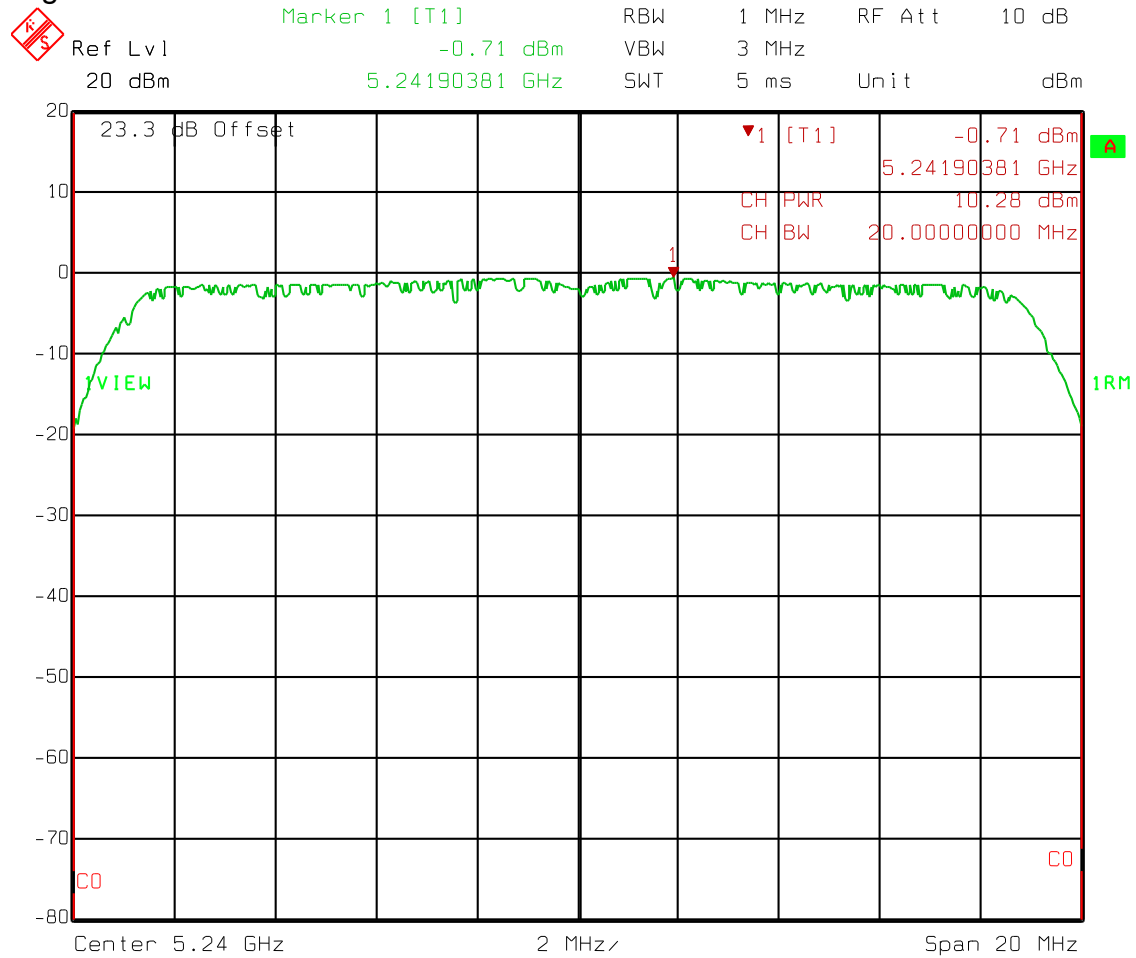

Date: 22.MAY 2015 07:37:51



Test Data – Peak Power and Density

802.11n 20 MHz  
Power and Density  
Low Channel – UNII 3

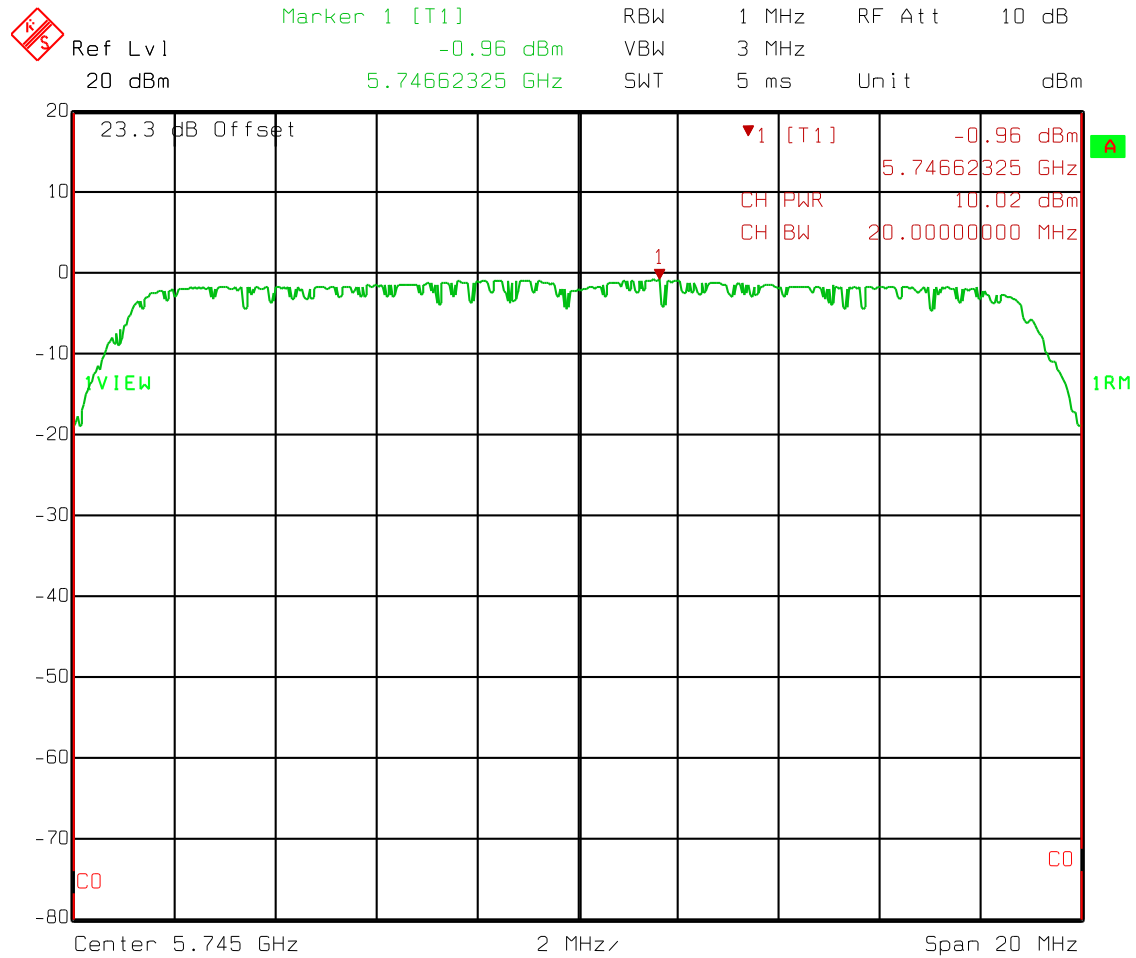

Date: 22.MAY 2015 07:43:09

Test Data – Peak Power and Density

802.11n 20 MHz  
Power and Density  
Mid Channel – UNII 3

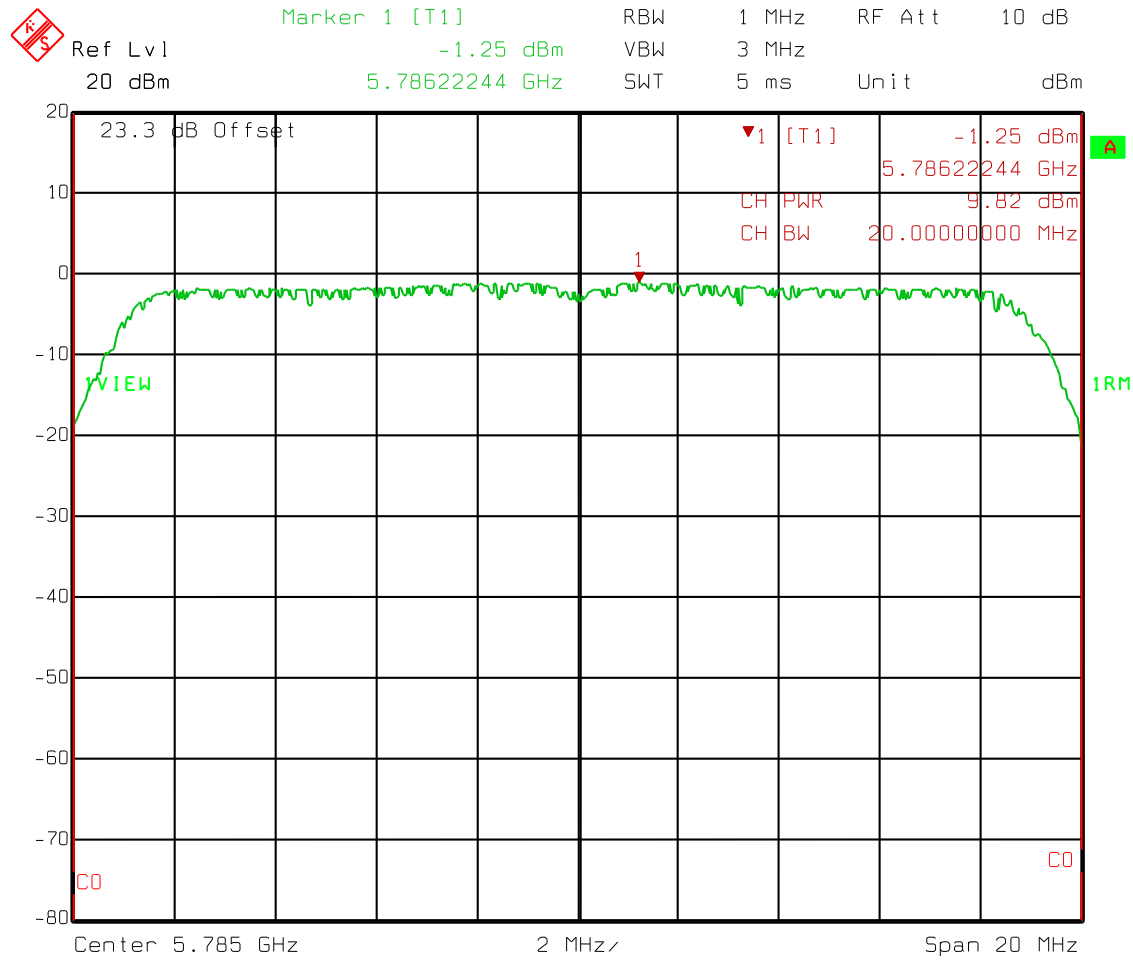

Date: 22.MAY 2015 07:43:55

Test Data – Peak Power and Density

802.11n 20 MHz  
Power and Density  
High Channel – UNII 3

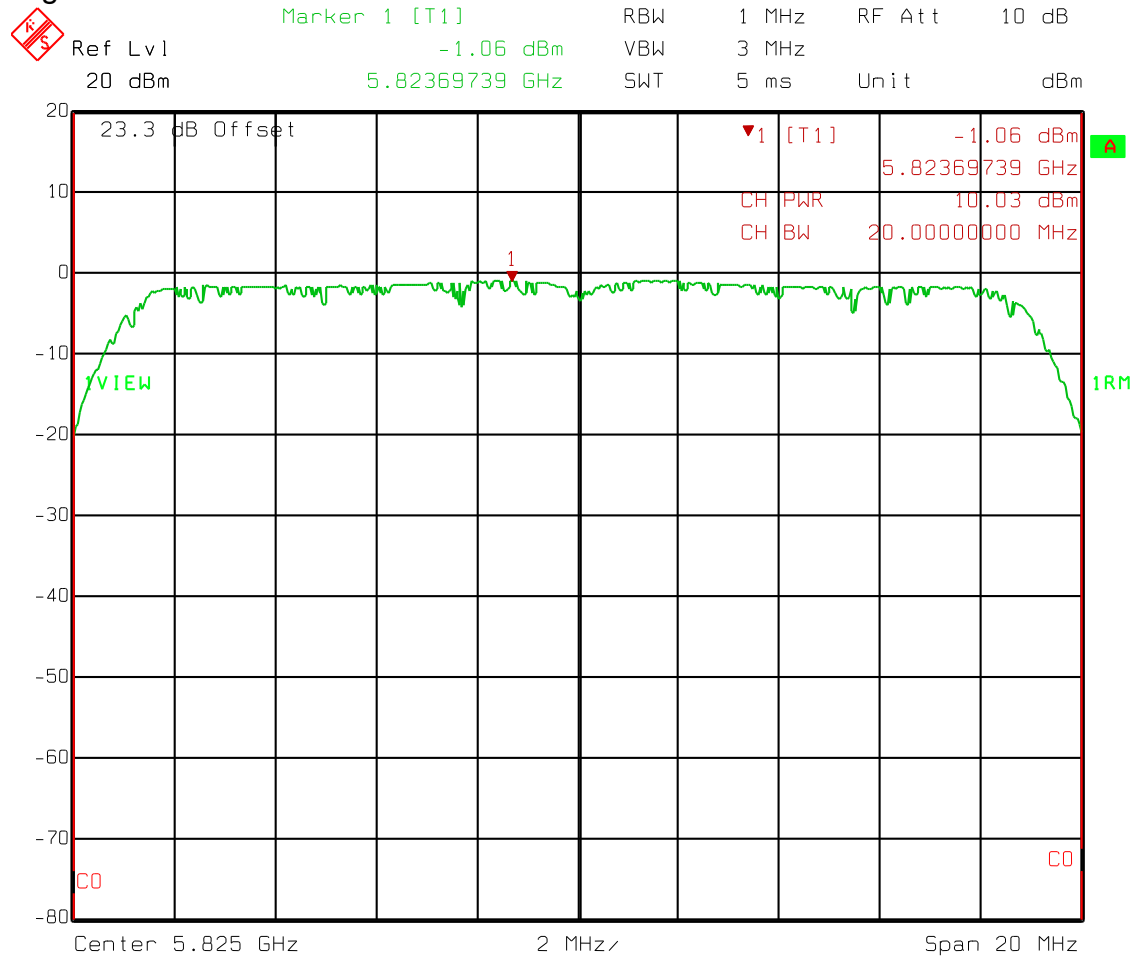

Date: 22.MAY 2015 07:44:41

Test Data – Peak Power and Density

802.11n 40 MHz  
Power and Density  
Low Channel – UNII 1

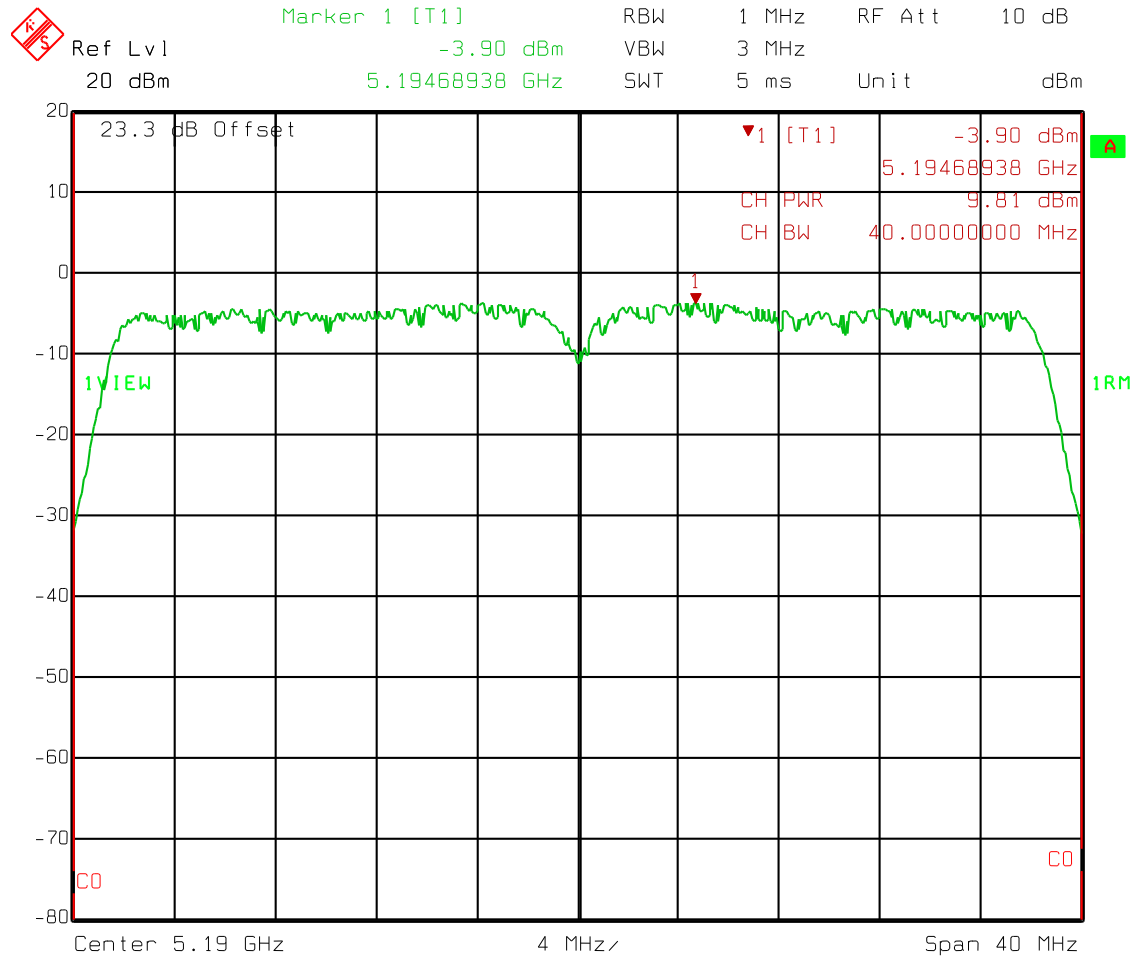

Date: 22.MAY 2015 07:45:48

Test Data – Peak Power and Density

802.11n 40 MHz  
Power and Density  
High Channel – UNII 1

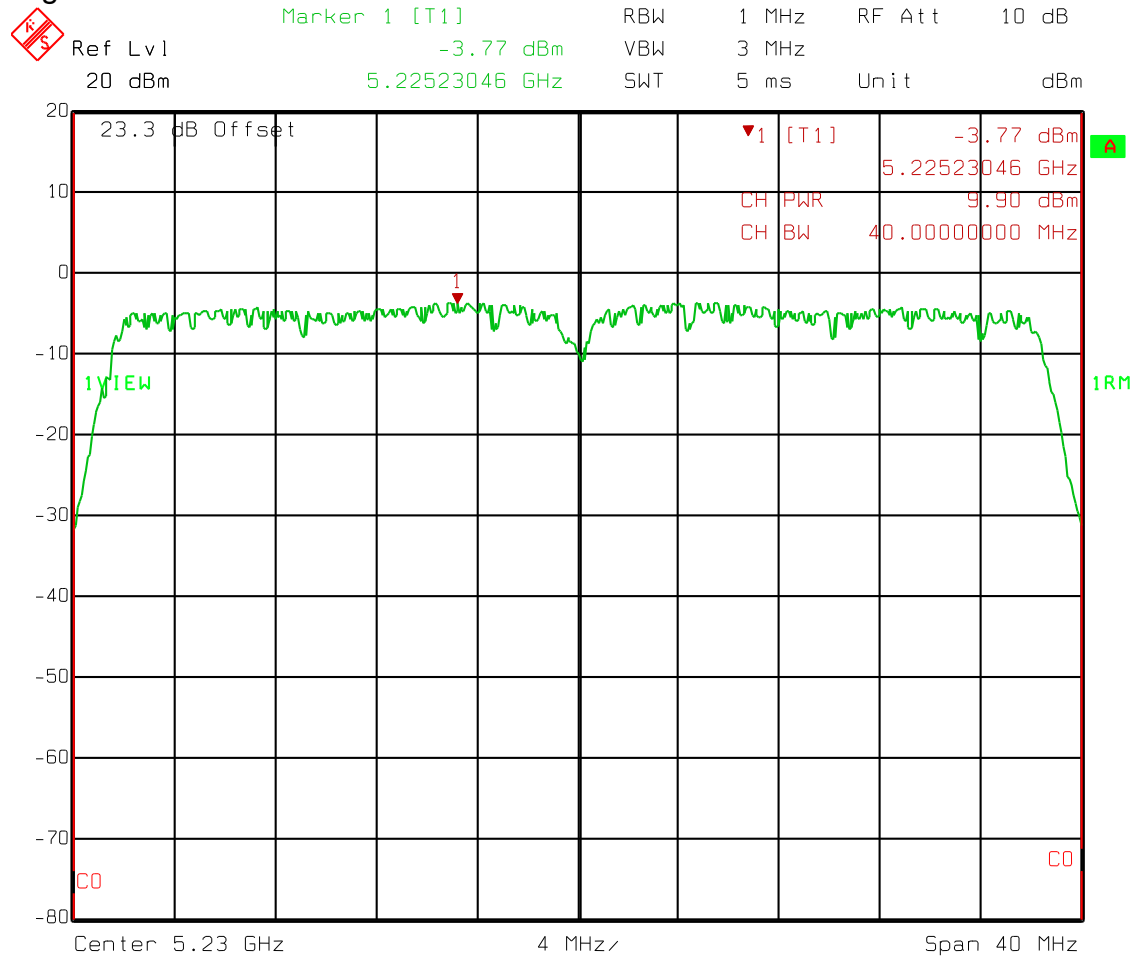

Date: 22.MAY 2015 07:46:39

Test Data – Peak Power and Density

802.11n 40 MHz  
 Power and Density  
 Low Channel – UNII 3

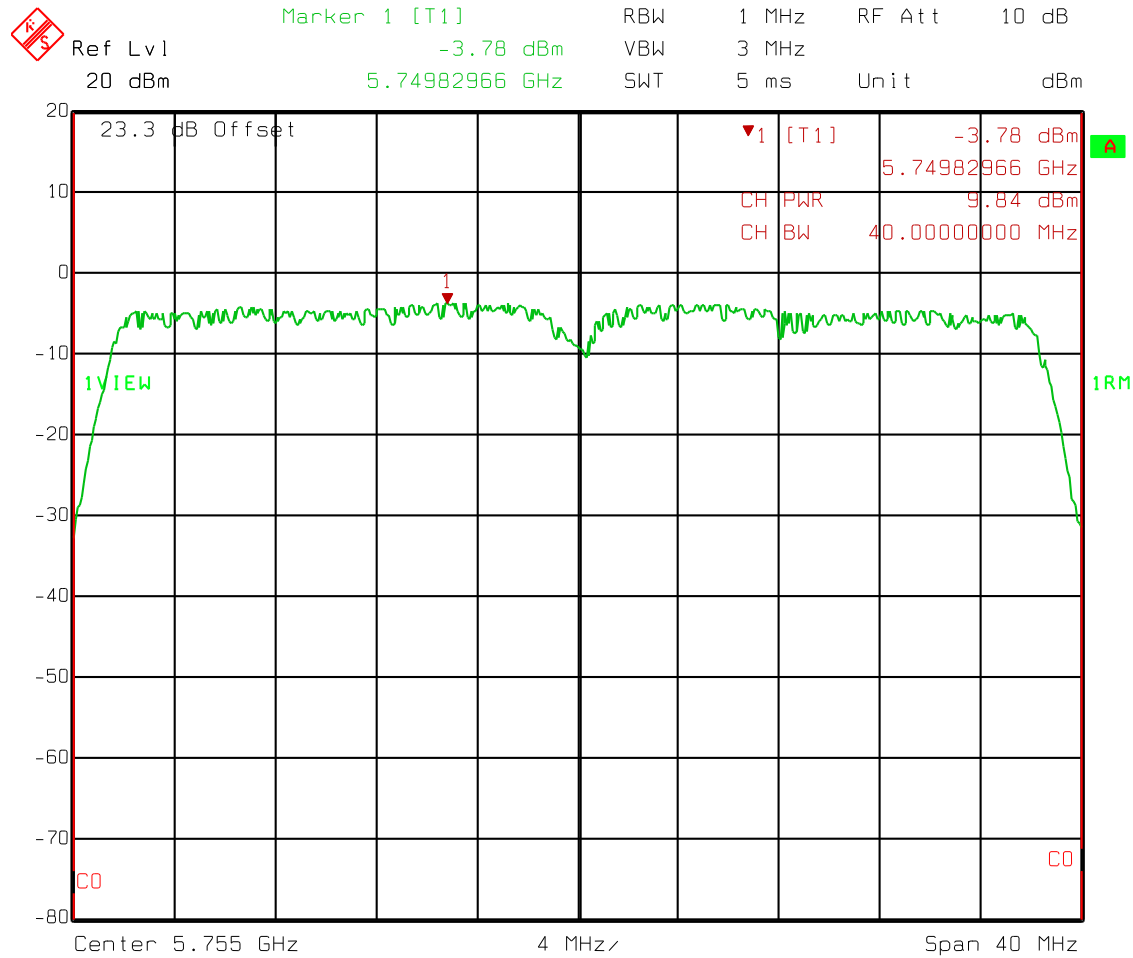

Date: 22.MAY 2015 07:52:24

Test Data – Peak Power and Density

802.11n 40 MHz  
Power and Density  
High Channel – UNII 3

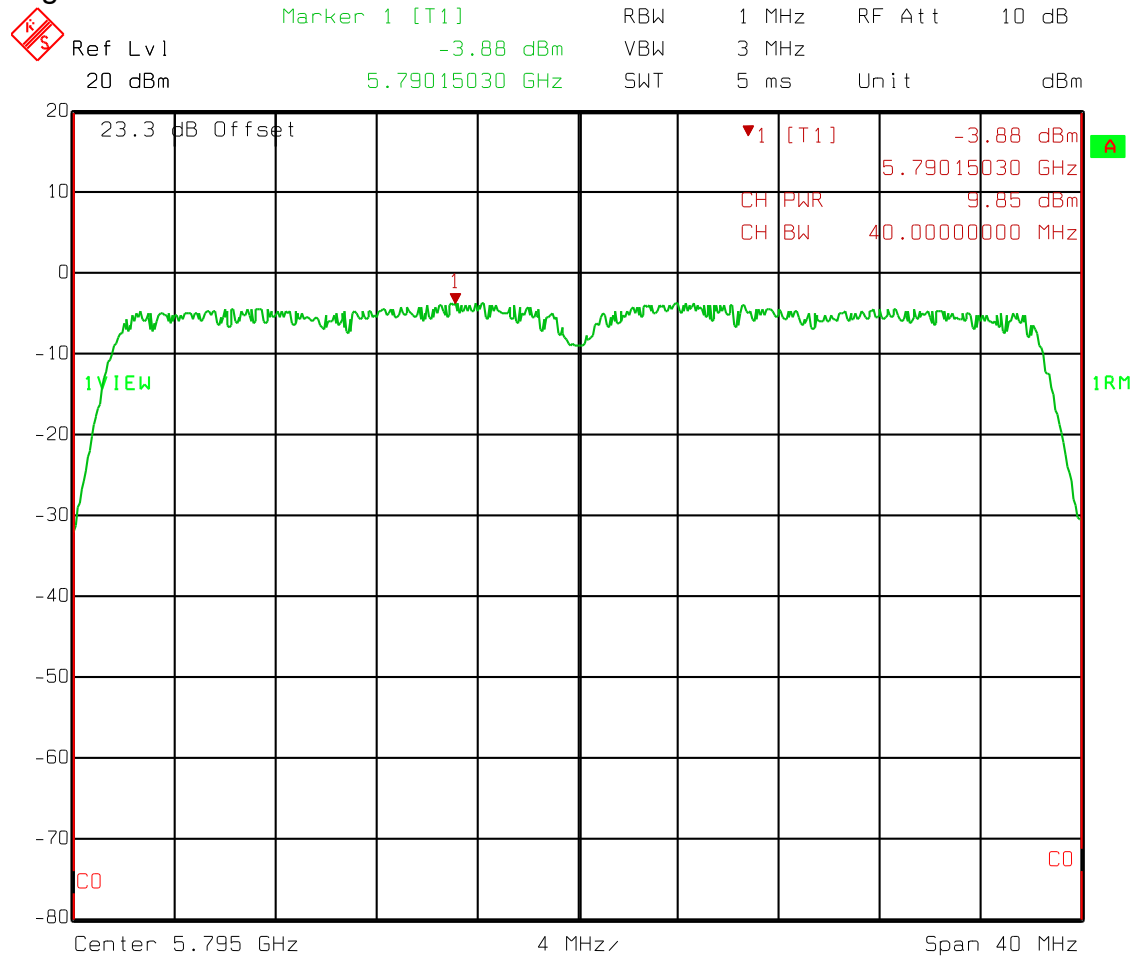

Date: 22.MAY 2015 07:53:05

Test Data – Peak Power and Density

802.11ac  
Power and Density  
UNII 1

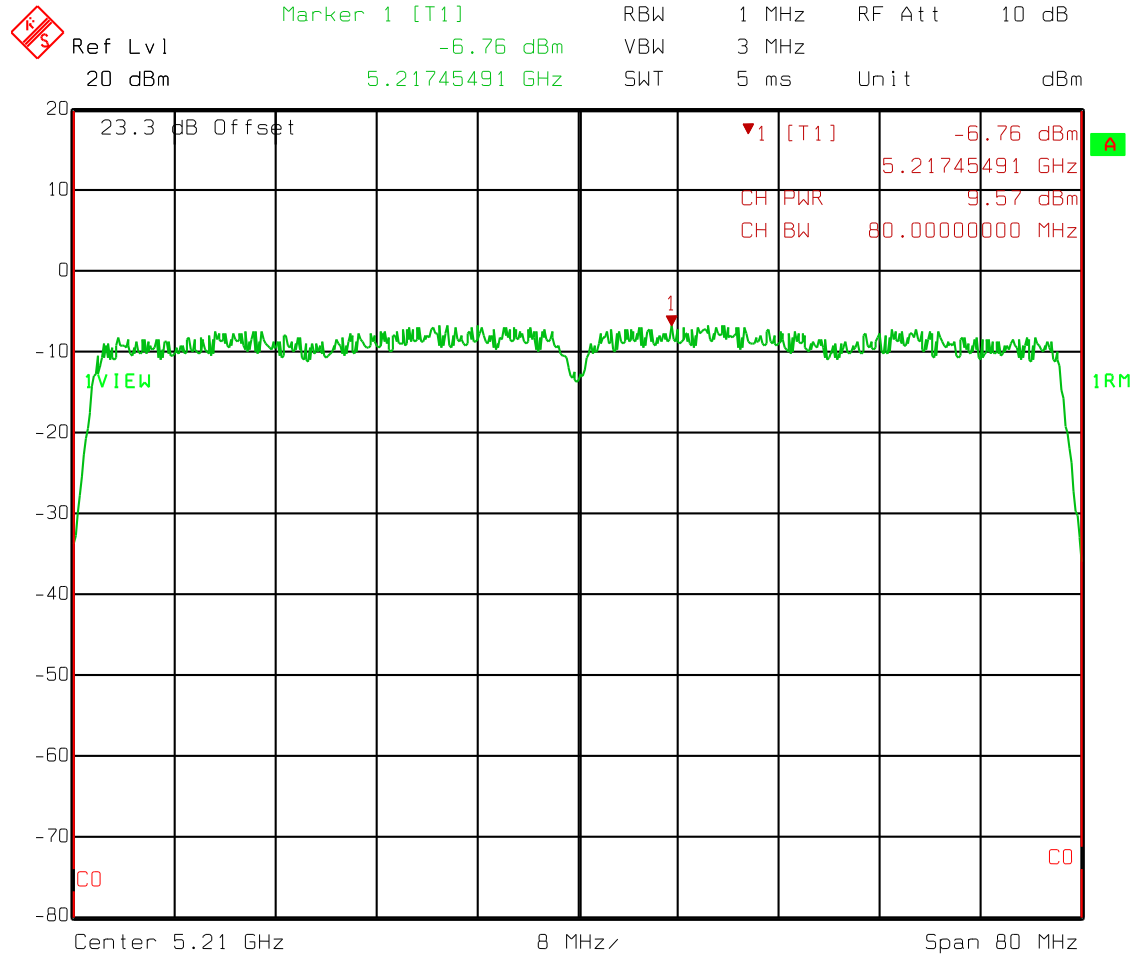

Date: 22.MAY 2015 07:54:07



**Test Data – Peak Power and Density**

802.11ac  
 Power and Density  
 UNII 3

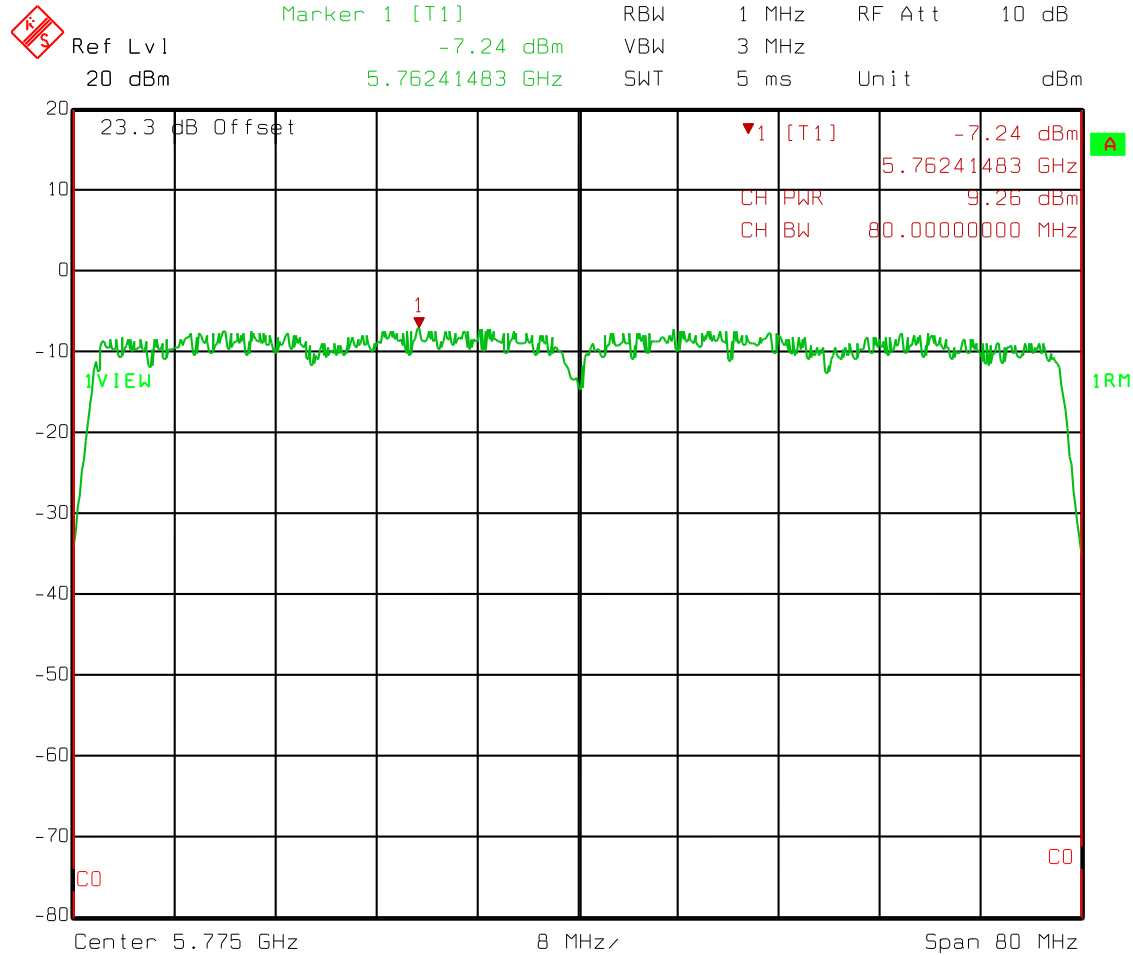

Date: 22.MAY 2015 07:58:53

**Section 5 Undesirable Emissions**

NAME OF TEST: Undesirable Emissions	PARA. NO.: 15.407(b))
TESTED BY:	DATE:

**Test Results:** Complies.

**Measurement Data:** There were no emissions below the noise floor which was at least 20 dB below the specification limit. Band edge data is presented below. The spectrum was searched from 30 MHz to 40 GHz

**Test Conditions:** 35 %RH  
22 °C

**Measurement Uncertainty:** +/-1.7 dB

**Test Equipment Used:** 1036

Test Data – Undesirable Emissions –  
Band Edges

802.11a  
Lower Band Edge  
Low Channel – UNII 1

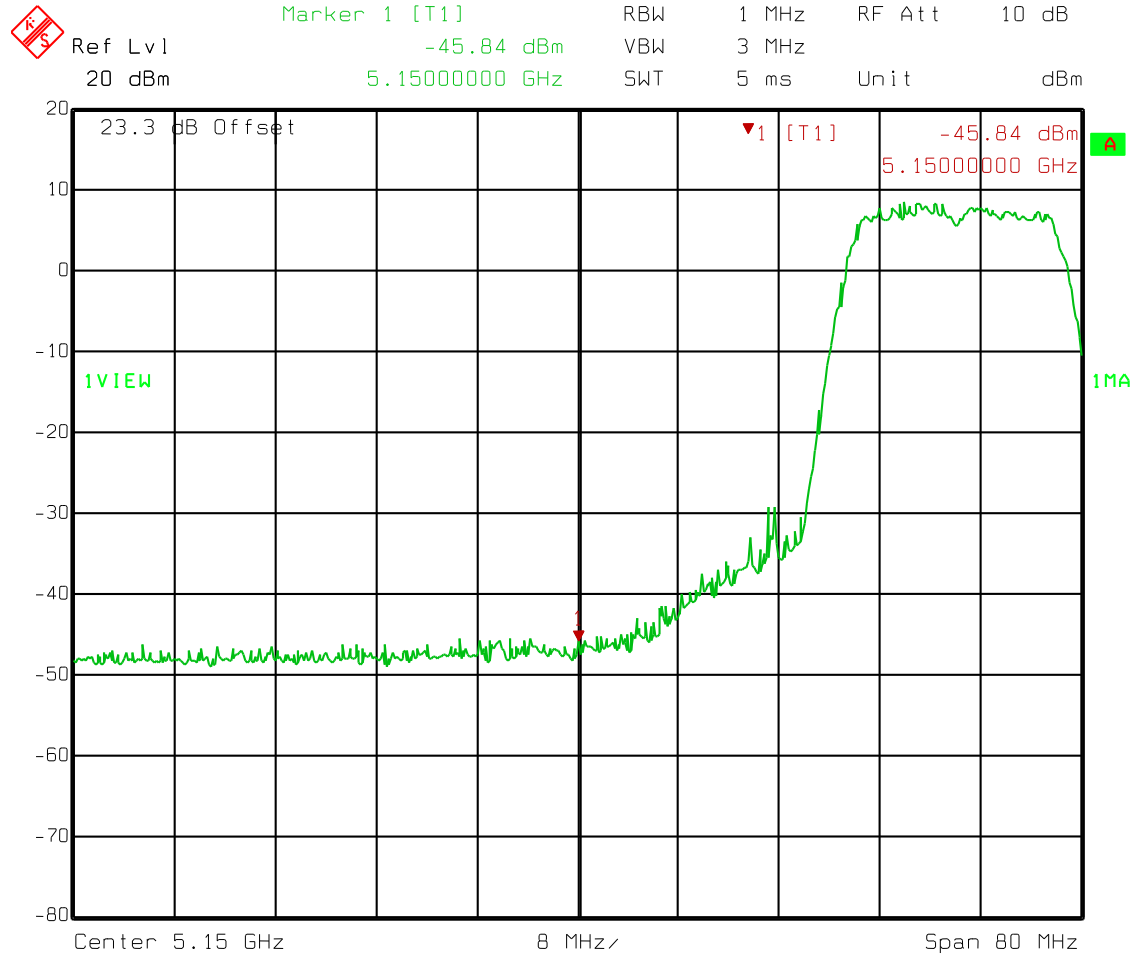

Date: 22.MAY 2015 08:13:31

Test Data – Undesirable Emissions –  
Band Edges

802.11a  
Lower Band Edge  
Low Channel – UNII 3

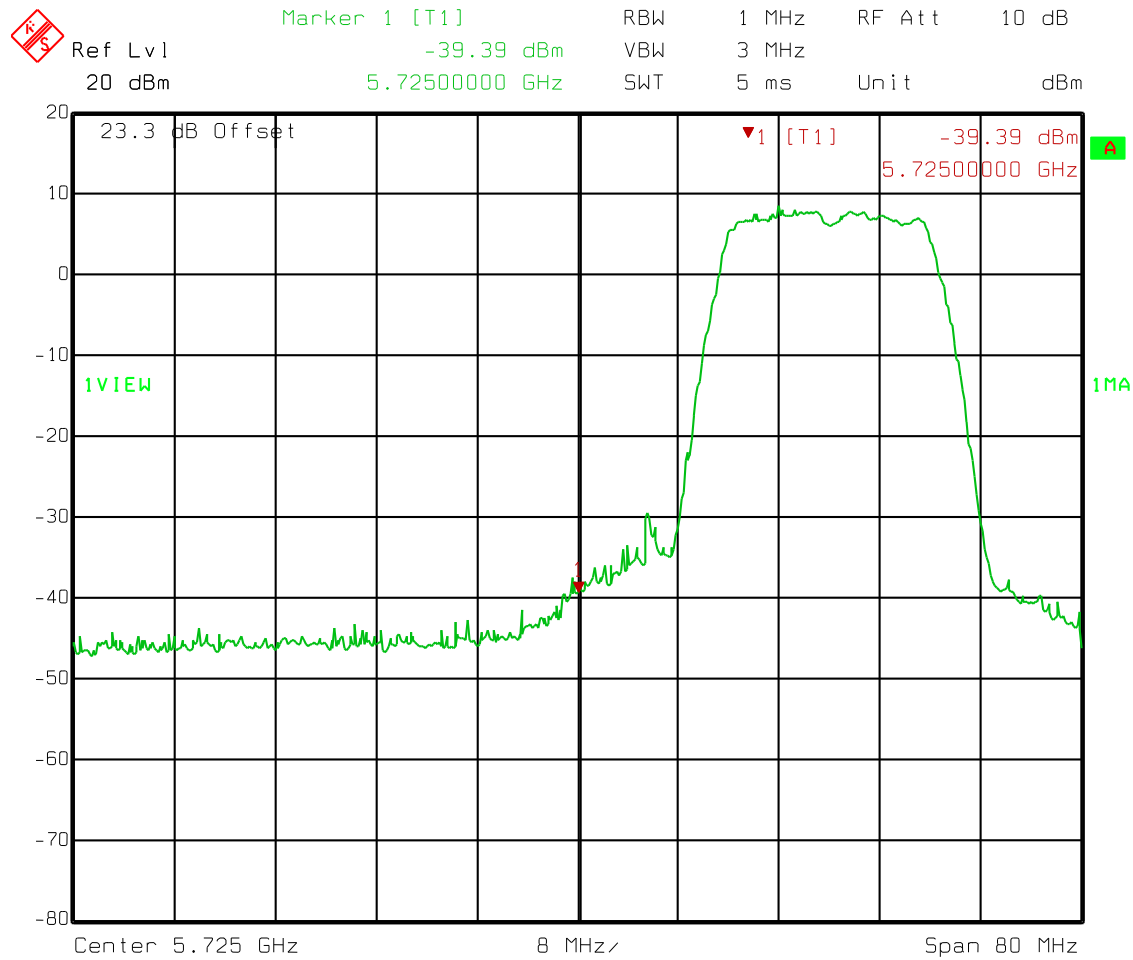

Date: 22.MAY 2015 08:22:00

Test Data – Undesirable Emissions –  
Band Edges

802.11a  
Upper Band Edge  
Upper Channel – UNII 3

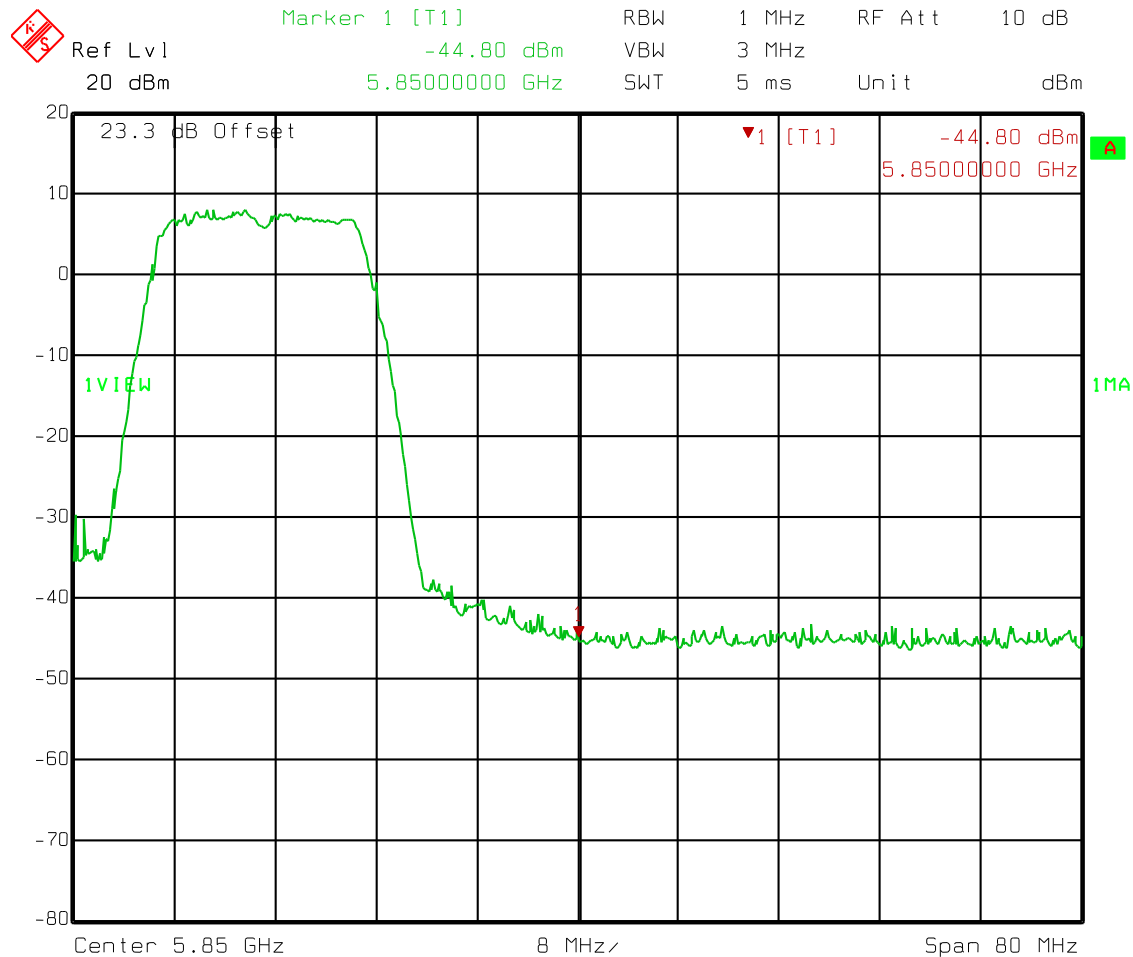

Date: 22.MAY 2015 08:23:08

**Test Data – Undesirable Emissions –**

Band Edges

802.11n 20 MHz

Lower Band Edge

Low Channel – UNII 1

	Marker 1 [T1]	RBW	1 MHz	RF Att	10 dB
	Ref Lvl	-46.68 dBm	VBW	3 MHz	
	20 dBm	5.1500000 GHz	SWT	5 ms	Unit dBm

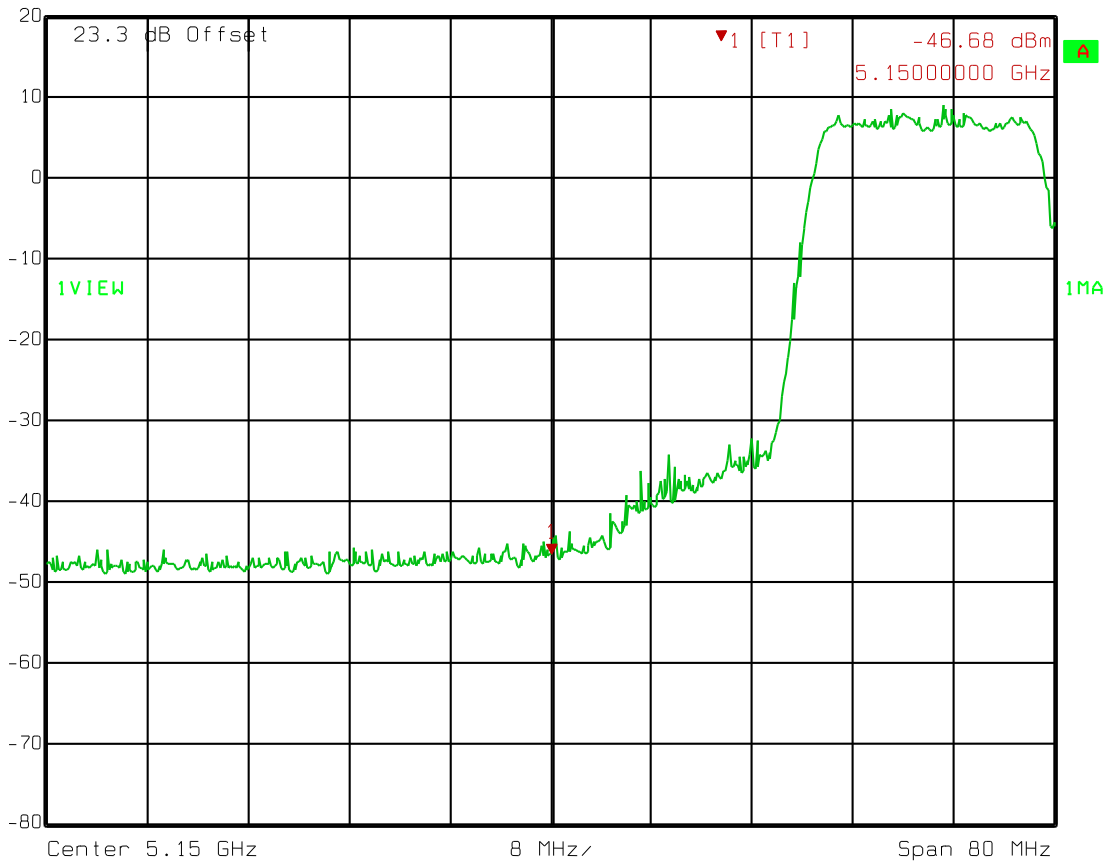

Date: 22.MAY 2015 08:25:37

Test Data – Undesirable Emissions –  
Band Edges

802.11n 20 MHz  
Lower Band Edge  
Low Channel – UNII 3

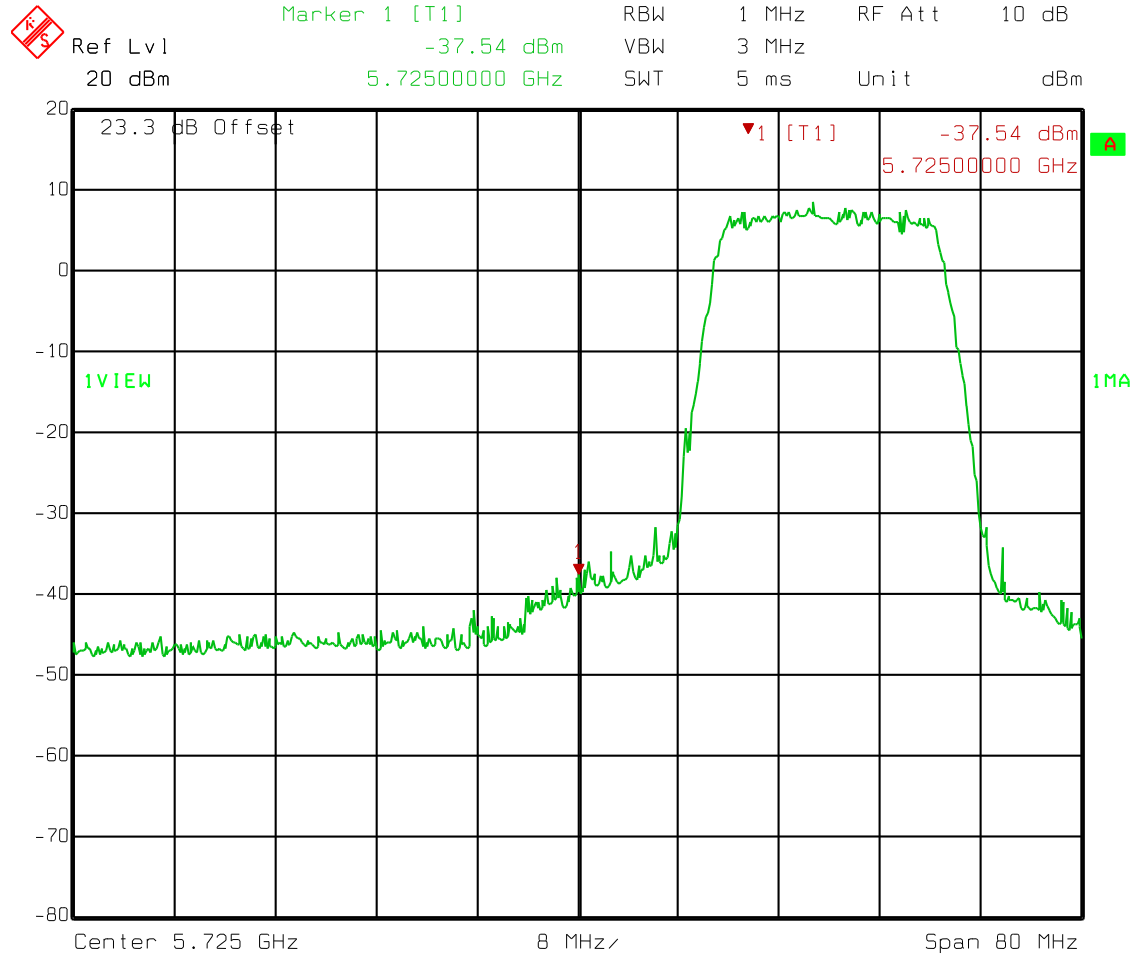

Date: 22.MAY 2015 08:29:03

Test Data – Undesirable Emissions –  
Band Edges

802.11n 20 MHz  
Upper Band Edge  
Upper Channel – UNII 3

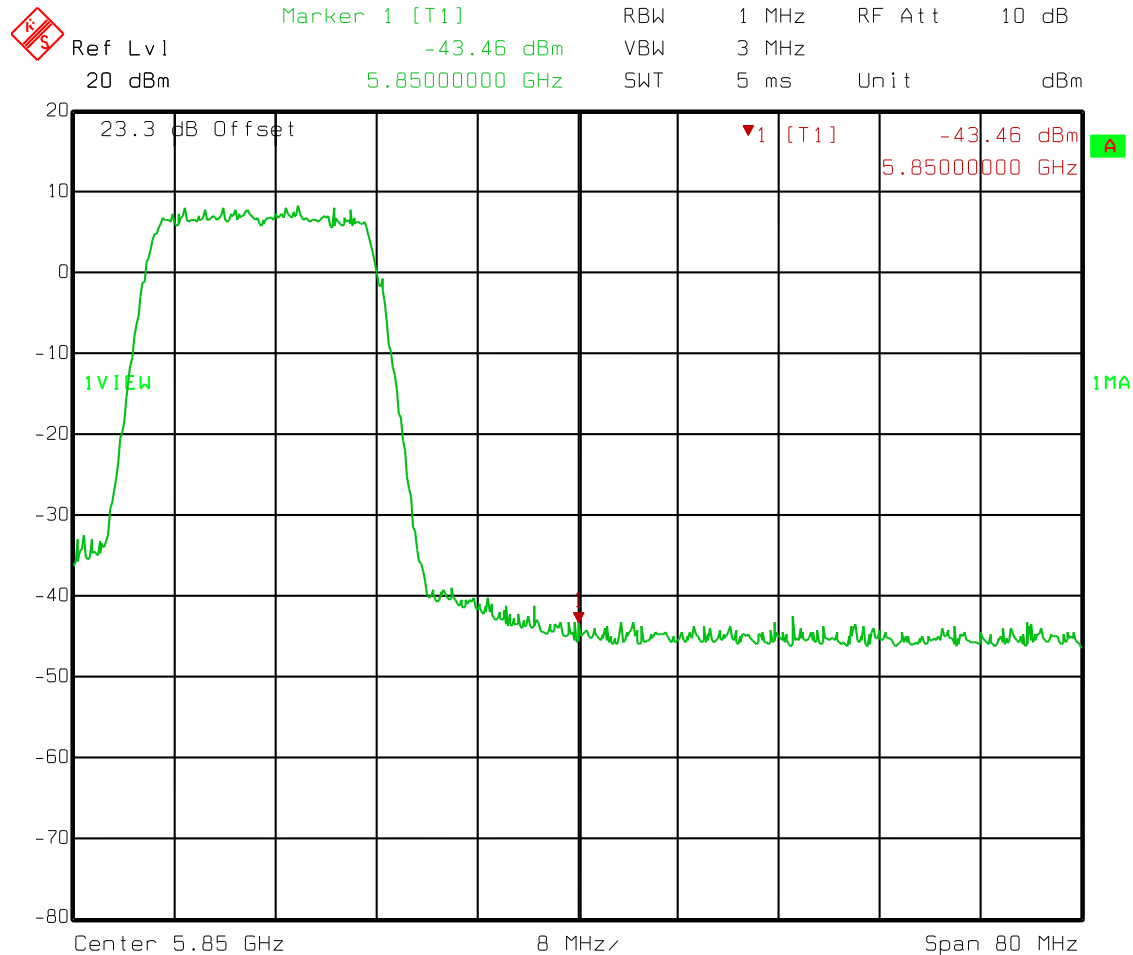

Date: 22.MAY 2015 08:30:01



Test Data – Undesirable Emissions –  
Band Edges

802.11n 40 MHz  
Lower Band Edge  
Low Channel – UNII 1

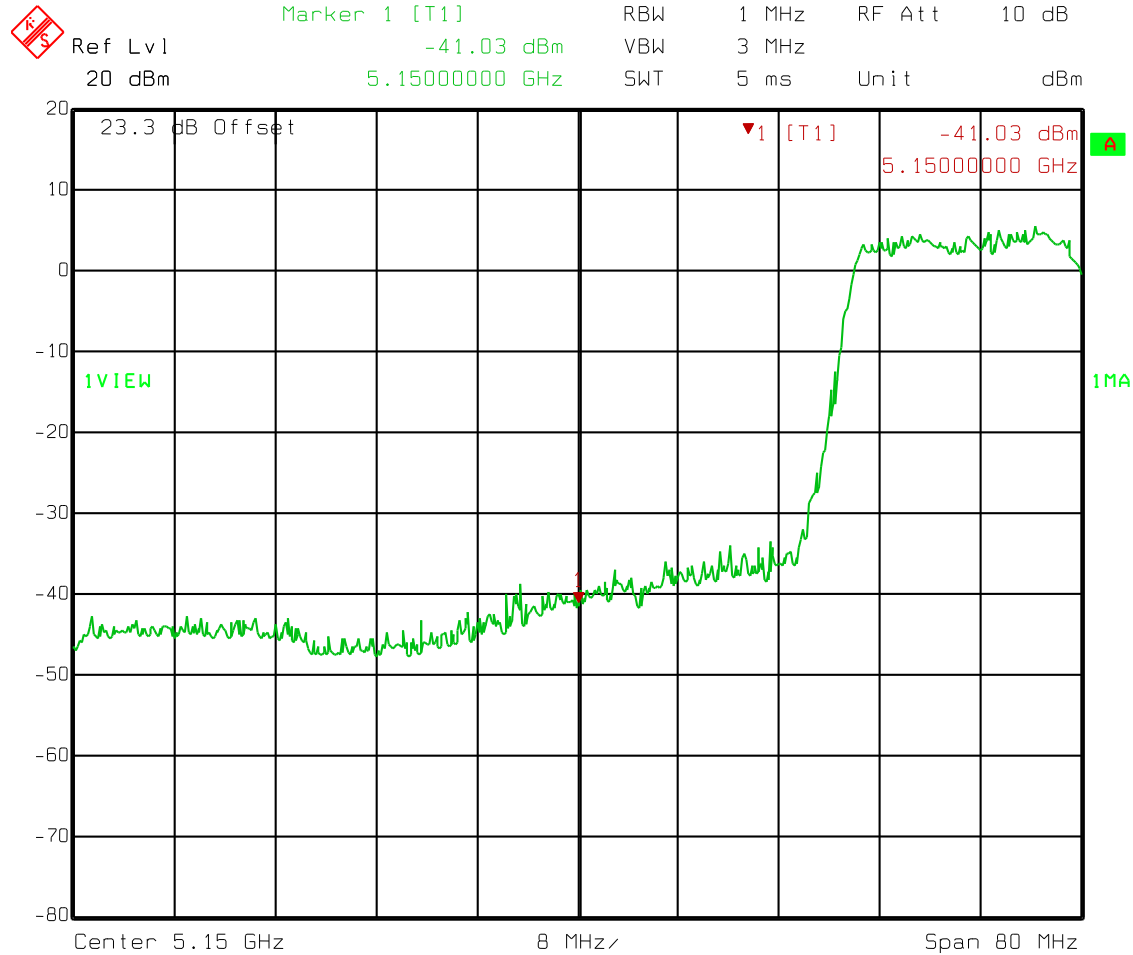

Date: 22.MAY 2015 08:41:22

Test Data – Undesirable Emissions –  
Band Edges

802.11n 40 MHz  
Lower Band Edge  
Low Channel – UNII 3

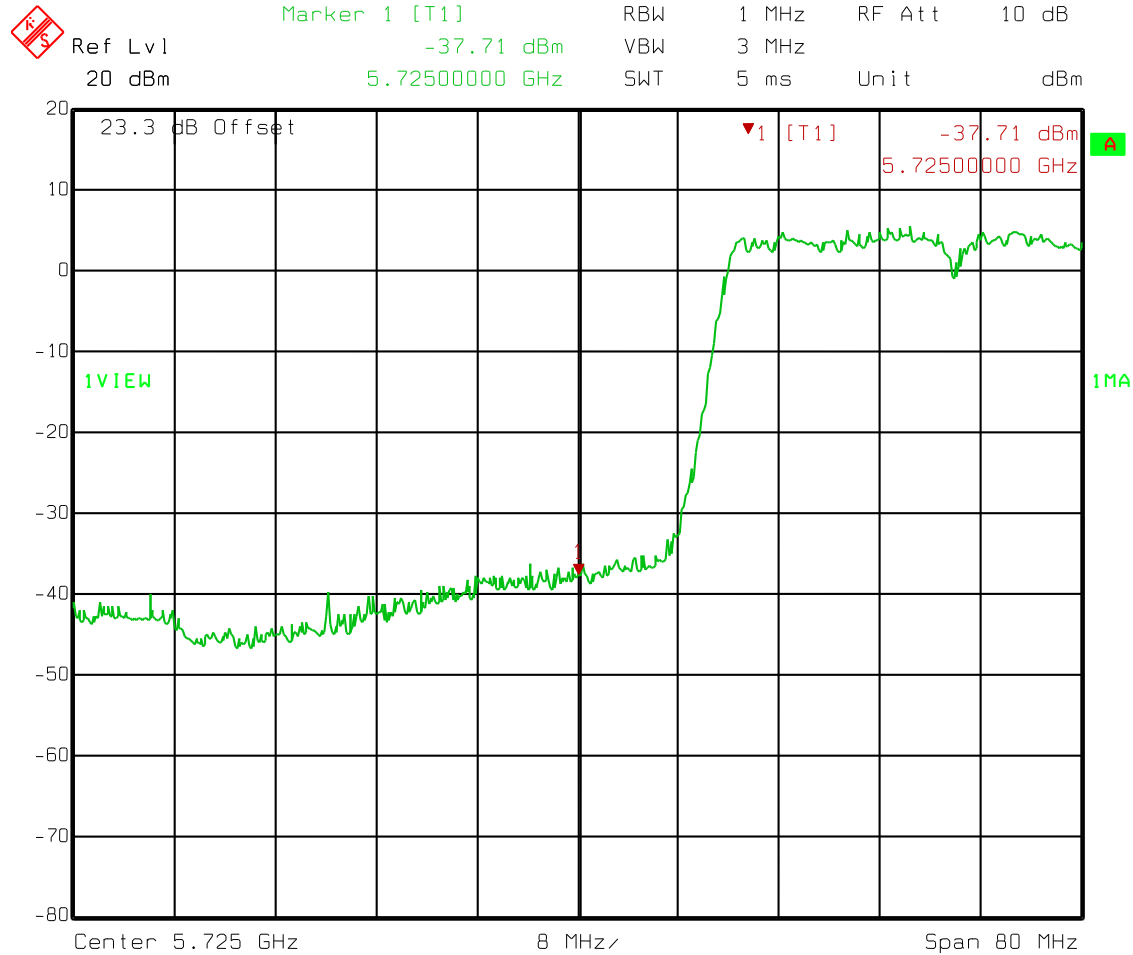

Date: 22.MAY 2015 08:45:34

Test Data – Undesirable Emissions –  
Band Edges

802.11n 40 MHz  
Upper Band Edge  
Upper Channel – UNII 3

 Marker 1 [T1] RBW 1 MHz RF Att 10 dB  
Ref Lvl -44.34 dBm VBW 3 MHz  
20 dBm 5.85000000 GHz SWT 5 ms Unit dBm

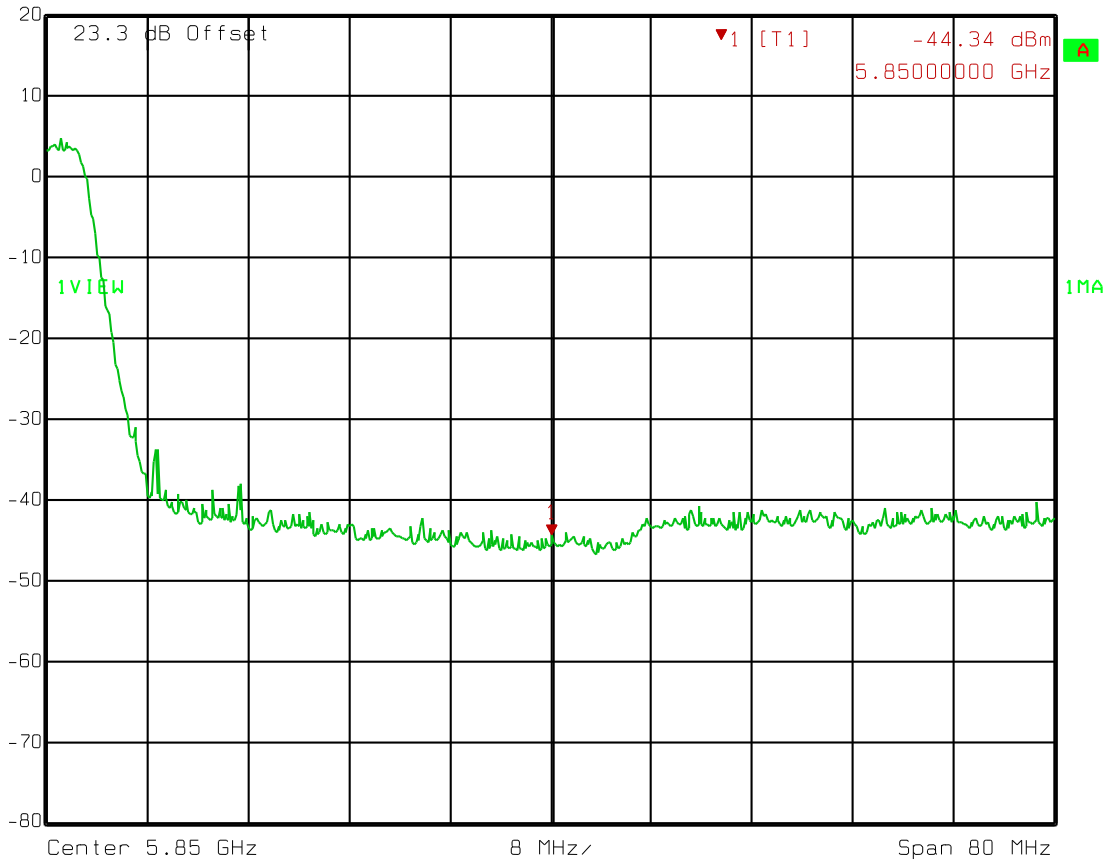

Date: 22.MAY 2015 08:46:29

Test Data – Undesirable Emissions –  
Band Edges

802.11ac  
Lower Band Edge  
Low Channel – UNII 1

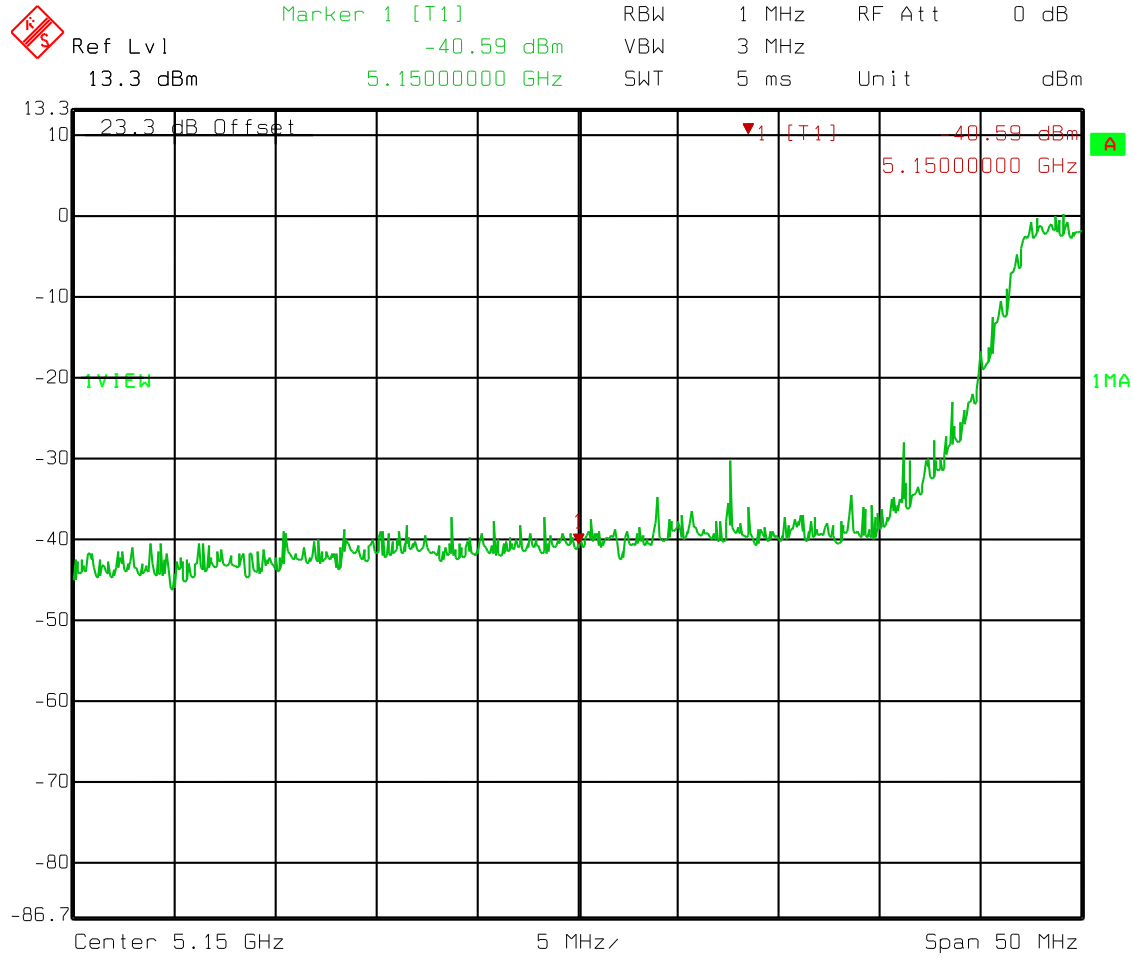

Date: 22.MAY 2015 08:49:49

Test Data – Undesirable Emissions –  
Band Edges

802.11ac  
Lower and Lower Band Edges  
Low Channel – UNII 3

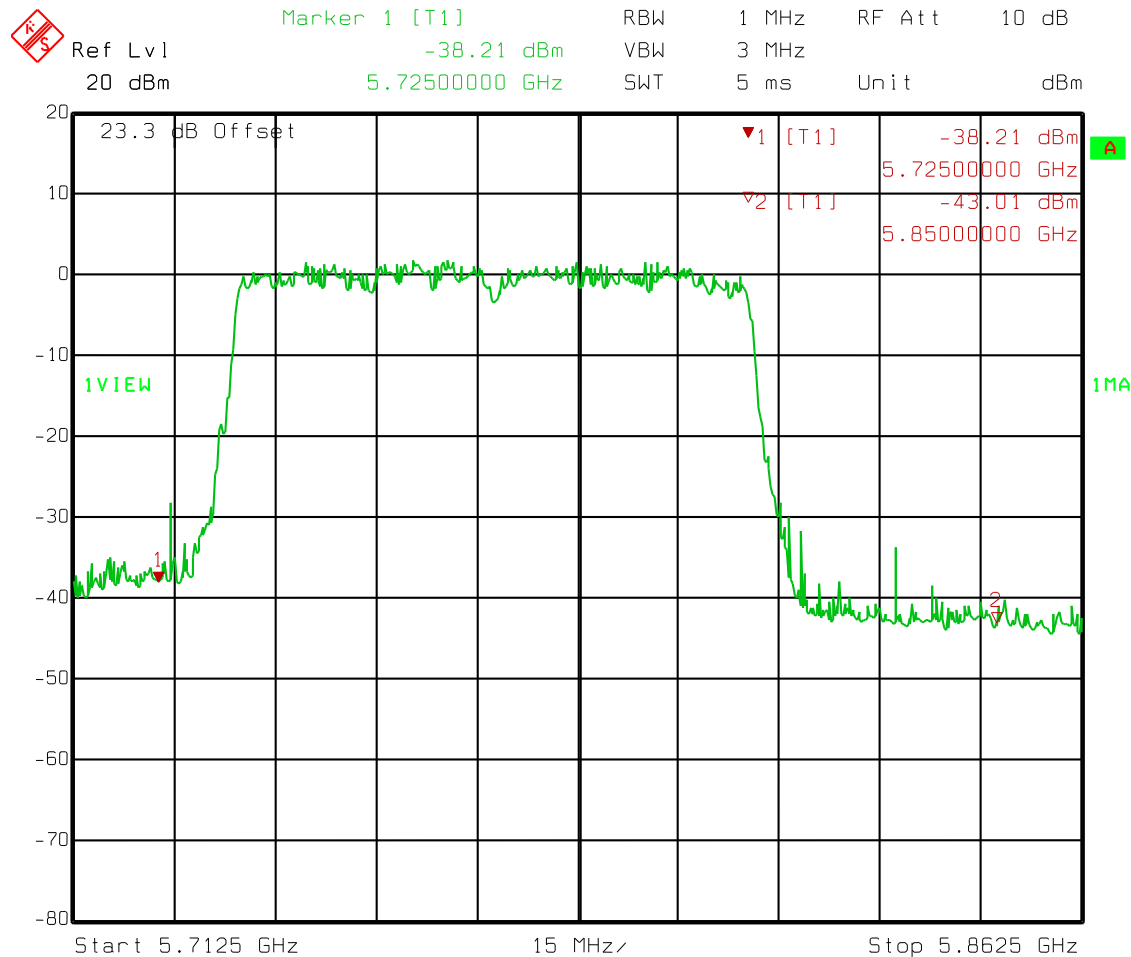

Date: 22.MAY 2015 08:54:39

**Section 6. Unwanted Emissions Below 1 GHz**

NAME OF TEST: Unwanted Emissions Below 1 GHz	PARA. NO.: 15.407(b)(6)
TESTED BY: David Light	DATE: 26 May 2015

**Test Results:** Complies.

**Measurement Data:** See attached table.

**Test Conditions:** 35 %RH  
22 °C

**Measurement Uncertainty:** +/-1.7 dB

**Test Equipment Used:**

ESIB26	837491/0002	Rohde & Schwarz	Receiver, EMI
SAS-540	736	A.H. Systems Inc	Biconical Antenna
3147	9606-1246	EMCO	Antenna, LPA

Notes:

RBW=VBW=100 kHz

Test Data - Unwanted Emissions Below 1 GHz

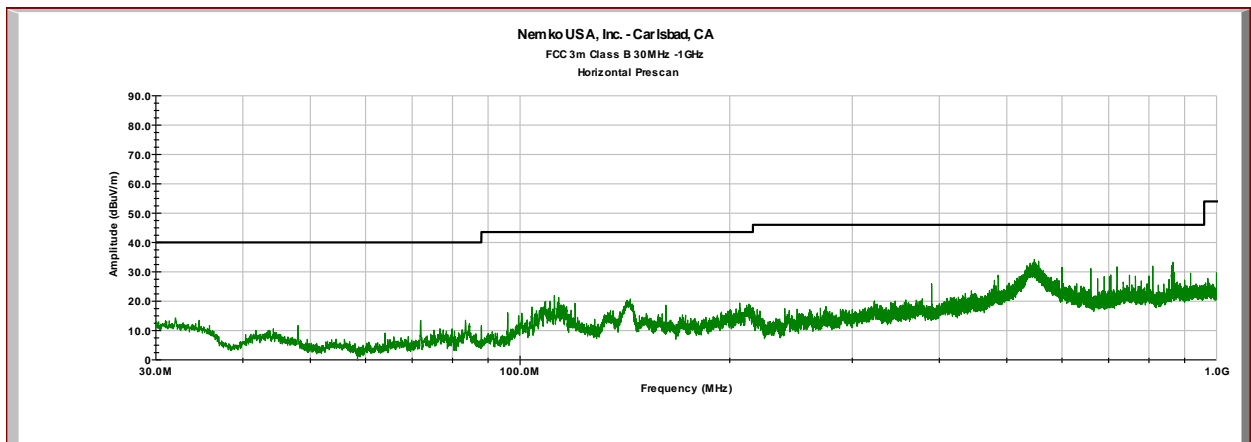
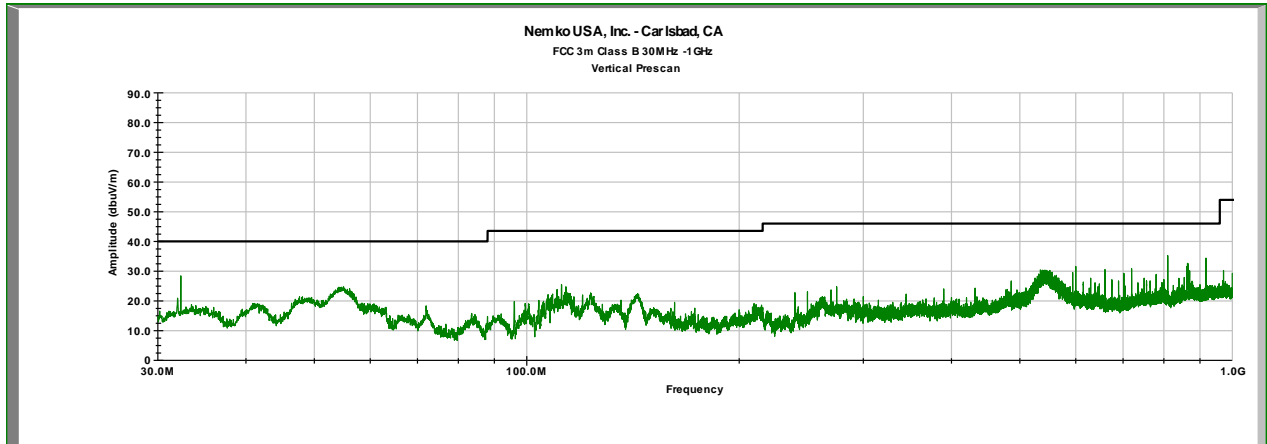

**Section 7. Powerline Conducted Emissions**

NAME OF TEST: Powerline Conducted Emissions	PARA. NO.: 15.207(a)
TESTED BY: David Light	DATE: 22 May 2015

**Test Results:** Complies.

**Measurement Data:** See attached plots.

**Measurement Uncertainty:** +/- 1.7 dB

**Test Equipment Used:**

FSP7	839337/0022	Rohde & Schwarz	Spectrum Analyzer
ENV216	101045	Rohde & Schwarz	LISN



Test Data – Powerline Conducted Emissions

LINE 1

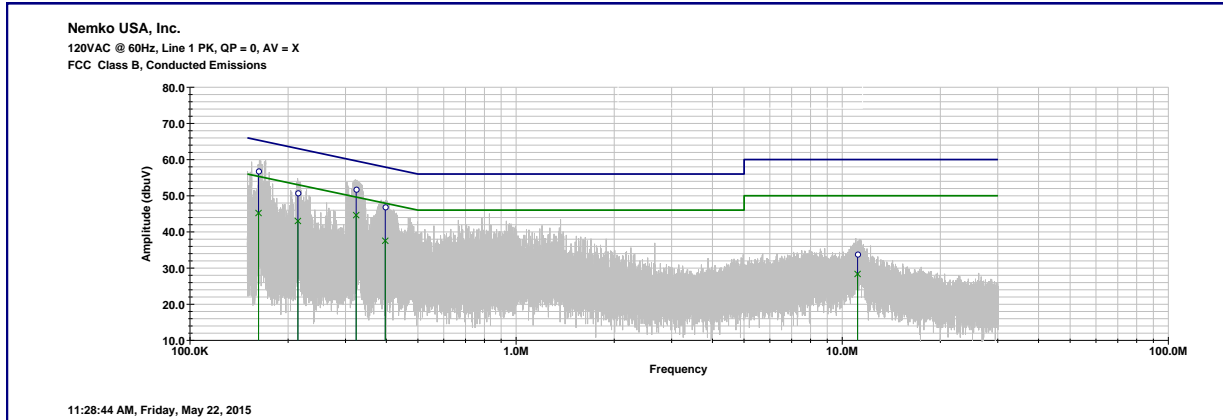

Frequency kHz	QP Rdng (dBuV)	Avg Rdng (dBuV)	QP Limit (dBuV)	Avg Limit (dBuV)	QP Margin (dB)	Avg Limit (dB)
162.237	56.8	45.2	65.7	55.3	8.9	10.1
214.333	50.8	43	64.2	53	13.4	10
323.332	51.8	44.6	61	49.6	9.2	5
396.89	46.9	37.6	58.9	47.9	12	10.3
11140.3	33.8	28.4	60	50	26.2	21.6

**Test Data – Powerline Conducted Emissions**

Neutral

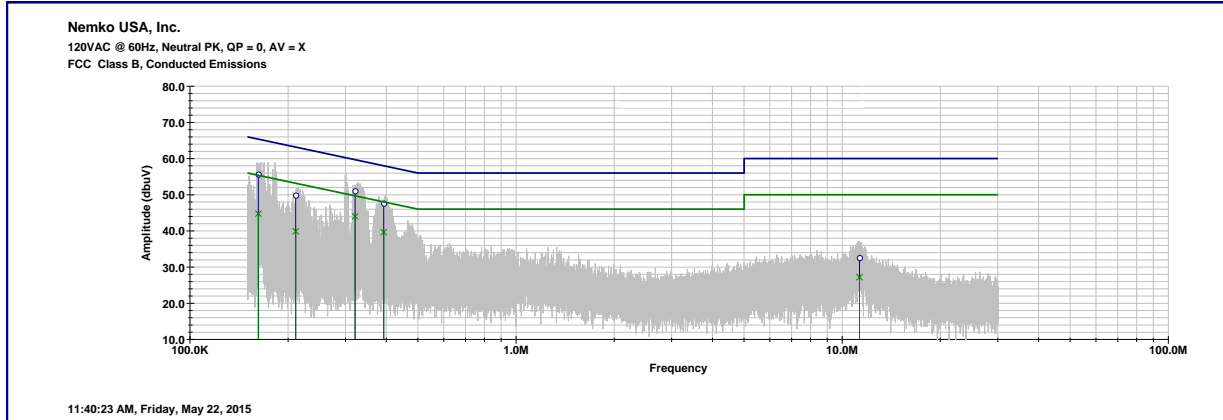

Frequency kHz	QP Rdng (dBuV)	Avg Rdng (dBuV)	QP Limit (dBuV)	Avg Limit (dBuV)	QP Margin	Avg Limit (dB)
162.05	55.7	44.8	65.7	55.4	10	10.6
210.886	49.9	39.9	64.3	53.2	14.4	13.3
320.888	51	44	61.1	49.7	10.1	5.7
392.755	47.6	39.6	59.1	48	11.5	8.4
11293.5	32.6	27.2	60	50	27.4	22.8

**Section 8. Test Equipment List**

Model	Serial	Manufacturer	Description	Due Cal
FSEK 30	830846/006	Rohde & Schwarz	Spectrum Analyzer	2015-07-15
ESIB26	837491/0002	Rohde & Schwarz	Receiver, EMI	2015-11-04
FSP7	839337/0022	Rohde & Schwarz	Spectrum Analyzer	2015-11-03
SAS-540	736	A.H. Systems Inc	Biconical Antenna	2015-12-16
3147	9606-1246	EMCO	Antenna, LPA	2016-03-09
SAS-571	688	AH Systems	DRG Horn	2016-11-25
ENV216	101045	Rohde & Schwarz	LISN	2016-05-15

Controlling Equipment: HW: HP8510w laptop, SW: Broadcom MTools 2.0.1.7

**Nemko USA, Inc.**

FCC PART 15, SUBPART E  
Unlicensed National Information  
Infrastructure Devices

*EQUIPMENT:* IP810

Test Report No.: 2015 285795 FCC15407

---

## **ANNEX A - TEST DETAILS**

NAME OF TEST: Powerline Conducted Emissions	PARA. NO.: 15.207(a)
---	----------------------

**Minimum Standard:** §15.207 Conducted limits.

(a) Except as shown in paragraphs (b) and (c) of this section, for an intentional radiator that is designed to be connected to the public utility (AC) power line, the radio frequency voltage that is conducted back onto the AC power line on any frequency or frequencies, within the band 150 kHz to 30 MHz, shall not exceed the limits in the following table, as measured using a 50 mH/50 ohms line impedance stabilization network (LISN). Compliance with the provisions of this paragraph shall be based on the measurement of the radio frequency voltage between each power line and ground at the power terminal. The lower limit applies at the boundary between the frequency ranges.

Frequency of Conducted Emission (MHz)	Limit (dBmV)	
	Quasi-peak	Average
0.15-0.5	66 to 56*	56 to 46*
0.5-5	56	46
5-30	60	50

\* Decreases with the logarithm of the frequency.

(b) The limit shown in paragraph (a) of this section shall not apply to carrier current systems operating as intentional radiators on frequencies below 30 MHz. In lieu thereof, these carrier current systems shall be subject to the following standards:

(1) For carrier current systems containing their fundamental emission within the frequency band 535-1705 kHz and intended to be received using a standard AM broadcast receiver: no limit on conducted emissions.

(2) For all other carrier current systems: 1000 mV within the frequency band 535-1705 kHz, as measured using a 50 mH/50 ohms LISN.

(3) Carrier current systems operating below 30 MHz are also subject to the radiated emission limits as provided in §15.205 and §§15.209, 15.221, 15.223, 15.225 or 15.227, as appropriate.

(c) Measurements to demonstrate compliance with the conducted limits are not required for devices which only employ battery power for operation and which do not operate from the AC power lines or contain provisions for operation while connected to the AC power lines. Devices that include, or make provision for, the use of battery chargers which permit operating while charging, AC adaptors or battery eliminators or that connect to the AC power lines indirectly, obtaining their power through another device which is connected to the AC power lines, shall be tested to demonstrate compliance with the conducted limits.

NAME OF TEST: Output Power and Spectral Density	PARA. NO.: 15.407
---	-------------------

**Minimum Standard:**

Power limits:

(1) For the band 5.15-5.25 GHz.

(i) For an outdoor access point operating in the band 5.15-5.25 GHz, the maximum conducted output power over the frequency band of operation shall not exceed 1 W provided the maximum antenna gain does not exceed 6 dBi. In addition, the maximum power spectral density shall not exceed 17 dBm in any 1 megahertz band. If transmitting antennas of directional gain greater than 6 dBi are used, both the maximum conducted output power and the maximum power spectral density shall be reduced by the amount in dB that the directional gain of the antenna exceeds 6 dBi. The maximum e.i.r.p. at any elevation angle above 30 degrees as measured from the horizon must not exceed 125 mW (21 dBm).

(ii) For an indoor access point operating in the band 5.15-5.25 GHz, the maximum conducted output power over the frequency band of operation shall not exceed 1 W provided the maximum antenna gain does not exceed 6 dBi. In addition, the maximum power spectral density shall not exceed 17 dBm in any 1 megahertz band. If transmitting antennas of directional gain greater than 6 dBi are used, both the maximum conducted output power and the maximum power spectral density shall be reduced by the amount in dB that the directional gain of the antenna exceeds 6 dBi.

(iii) For fixed point-to-point access points operating in the band 5.15-5.25 GHz, the maximum conducted output power over the frequency band of operation shall not exceed 1 W. In addition, the maximum power spectral density shall not exceed 17 dBm in any 1 megahertz band. Fixed point-to-point U-NII devices may employ antennas with directional gain up to 23 dBi without any corresponding reduction in the maximum conducted output power or maximum power spectral density. For fixed point-to-point transmitters that employ a directional antenna gain greater than 23 dBi, a 1 dB reduction in maximum conducted output power and maximum power spectral density is required for each 1 dB of antenna gain in excess of 23 dBi. Fixed, point-to-point operations exclude the use of point-to-multipoint systems, omnidirectional applications, and multiple collocated transmitters transmitting the same information. The operator of the U-NII device, or if the

equipment is professionally installed, the installer, is responsible for ensuring that systems employing high gain directional antennas are used exclusively for fixed, point-to-point operations.

(iv) For mobile and portable client devices in the 5.15-5.25 GHz band, the maximum conducted output power over the frequency band of operation shall not exceed 250 mW provided the maximum antenna gain does not exceed 6 dBi. In addition, the maximum power spectral density shall not exceed 11 dBm in any 1 megahertz band. If transmitting antennas of directional gain greater than 6 dBi are used, both the maximum conducted output power and the maximum power spectral density shall be reduced by the amount in dB that the directional gain of the antenna exceeds 6 dBi.

(2) For the band 5.725-5.85 GHz, the maximum conducted output power over the frequency band of operation shall not exceed 1 W. In addition, the maximum power spectral density shall not exceed 30 dBm in any 500-kHz band. If transmitting antennas of directional gain greater than 6 dBi are used, both the maximum conducted output power and the maximum power spectral density shall be reduced by the amount in dB that the directional gain of the antenna exceeds 6 dBi. However, fixed point-to-point U-NII devices operating in this band may employ transmitting antennas with directional gain greater than 6 dBi without any corresponding reduction in transmitter conducted power. Fixed, point-to-point operations exclude the use of point-to-multipoint systems, omnidirectional applications, and multiple collocated transmitters transmitting the same information. The operator of the U-NII device, or if the equipment is professionally installed, the installer, is responsible for ensuring that systems employing high gain directional antennas are used exclusively for fixed, point-to-point operations.

Note to paragraph (a)(3): The Commission strongly recommends that parties employing U-NII devices to provide critical communications services should determine if there are any nearby Government radar systems that could affect their operation.

(3) The maximum conducted output power must be measured over any interval of continuous transmission using instrumentation calibrated in terms of an rms-equivalent voltage.

(4) The maximum power spectral density is measured as a conducted emission by direct connection of a calibrated test instrument to the equipment under test. If the device cannot be connected directly, alternative techniques acceptable to the

Commission may be used. Measurements in the 5.725-5.85 GHz band are made over a reference bandwidth of 500 kHz or the 26 dB emission bandwidth of the device, whichever is less. Measurements in the 5.15-5.25 GHz, 5.25-5.35 GHz, and the 5.47-5.725 GHz bands are made over a bandwidth of 1 MHz or the 26 dB emission bandwidth of the device, whichever is less. A narrower resolution bandwidth can be used, provided that the measured power is integrated over the full reference bandwidth.



**Maximum Power Spectral Density (PSD)**

The rules requires “maximum power spectral density” measurements where the intent is to measure the maximum value of the time average of the power spectral density measured during a period of continuous transmission.

1. Create an average power spectrum for the EUT operating mode being tested by following the instructions in section II.E.2. for measuring maximum conducted output power using a spectrum analyzer or EMI receiver: select the appropriate test method (SA-1, SA-2, SA-3, or alternatives to each) and apply it up to, but not including, the step labeled, “Compute power...”. (This procedure is required even if the maximum conducted output power measurement was performed using a power meter, method PM.)

2. Use the peak search function on the instrument to find the peak of the spectrum and record its value.

3. Make the following adjustments to the peak value of the spectrum, if applicable:

a) If Method SA-2 or SA-2 Alternative was used, add  $10 \log(1/x)$ , where  $x$  is the duty cycle, to the peak of the spectrum.

b) If Method SA-3 Alternative was used and the linear mode was used in step II.E.2.g)(viii), add 1 dB to the final result to compensate for the difference between linear averaging and power averaging.

4. The result is the Maximum PSD over 1 MHz reference bandwidth.

789033 D02 General UNII Test Procedures New Rules v01

Page 10

5. For devices operating in the bands 5.15-5.25 GHz, 5.25-5.35 GHz, and 5.47-5.725 GHz, the above procedures make use of 1 MHz RBW to satisfy directly the 1 MHz reference bandwidth specified in § 15.407(a)(5). For devices operating in the band 5.725-5.85 GHz, the rules specify a measurement bandwidth of 500 kHz. Many spectrum analyzers do not have 500 kHz RBW, thus a narrower RBW may need to be used. The rules permit the use of a RBWs less than 1 MHz, or 500 kHz, “provided that the measured power is integrated over the full reference bandwidth” to show the total power over the specified measurement bandwidth (i.e., 1 MHz, or 500 kHz). If measurements are performed using a reduced resolution bandwidth (< 1 MHz, or < 500 kHz) and integrated over 1 MHz, or 500 KHz bandwidth, the following adjustments to the procedures apply:

a) Set  $RBW \geq 1/T$ , where  $T$  is defined in section II.B.I.a).

b) Set  $VBW \geq 3 RBW$ .

c) If measurement bandwidth of Maximum PSD is specified in 500 kHz, add  $10 \log(500 \text{ kHz} / RBW)$  to the measured result, whereas  $RBW (< 500 \text{ KHz})$  is the reduced resolution bandwidth of the spectrum analyzer set during measurement.

d) If measurement bandwidth of Maximum PSD is specified in 1 MHz, add  $10 \log(1 \text{ MHz} / RBW)$  to the measured result, whereas  $RBW (< 1 \text{ MHz})$  is the reduced resolution bandwidth of spectrum analyzer set during measurement.

e) Care must be taken to ensure that the measurements are performed during a period of continuous transmission or are corrected upward for duty cycle.

Note: As a practical matter, it is recommended to use reduced RBW of 100 KHz for the sections 5.c) and 5.d) above, since  $RBW=100 \text{ KHz}$  is available on nearly all spectrum analyzers.

NAME OF TEST: Emission Bandwidth

PARA. NO.: 15.407

### **99 Percent Occupied Bandwidth**

The 99-percent occupied bandwidth is the frequency bandwidth such that, below its lower and above its upper frequency limits, the mean powers are each equal to 0.5 % of the total mean power of the given emission. Measurement of the 99-percent occupied bandwidth is required only as a condition for using the optional band-edge measurement techniques described in section II.G.3.d). Measurements of 99-percent occupied bandwidth may also optionally be used in lieu of the EBW to

789033 D02 General UNII Test Procedures New Rules v01

Page 4

Define the minimum frequency range over which the spectrum is integrated when measuring maximum conducted output power as described in section II.E. However, the EBW must be measured to determine bandwidth dependent limits on maximum conducted output power in accordance with 15.407(a). The following procedure shall be used for measuring (99 %) power bandwidth:

1. Set center frequency to the nominal EUT channel center frequency.
2. Set span = 1.5 times to 5.0 times the OBW.
3. Set RBW = 1 % to 5 % of the OBW
4. Set VBW  $\geq 3 \cdot$  RBW
5. Video averaging is not permitted. Where practical, a sample detection and single sweep mode shall be used. Otherwise, peak detection and max hold mode (until the trace stabilizes) shall be used.
6. Use the 99 % power bandwidth function of the instrument (if available).
7. If the instrument does not have a 99 % power bandwidth function, the trace data points are recovered and directly summed in power units. The recovered amplitude data points, beginning at the lowest frequency, are placed in a running sum until 0.5 % of the total is reached; that frequency is recorded as the lower frequency. The process is repeated until 99.5 % of the total is reached; that frequency is recorded as the upper frequency. The 99% occupied bandwidth is the difference between these two frequencies.

**Nemko USA, Inc.**

FCC PART 15, SUBPART E  
Unlicensed National Information  
Infrastructure Devices

*EQUIPMENT:* IP810

Test Report No.: 2015 285795 FCC15407

---

## **ANNEX B - TEST DIAGRAMS**

**Test Site For Radiated Emissions**

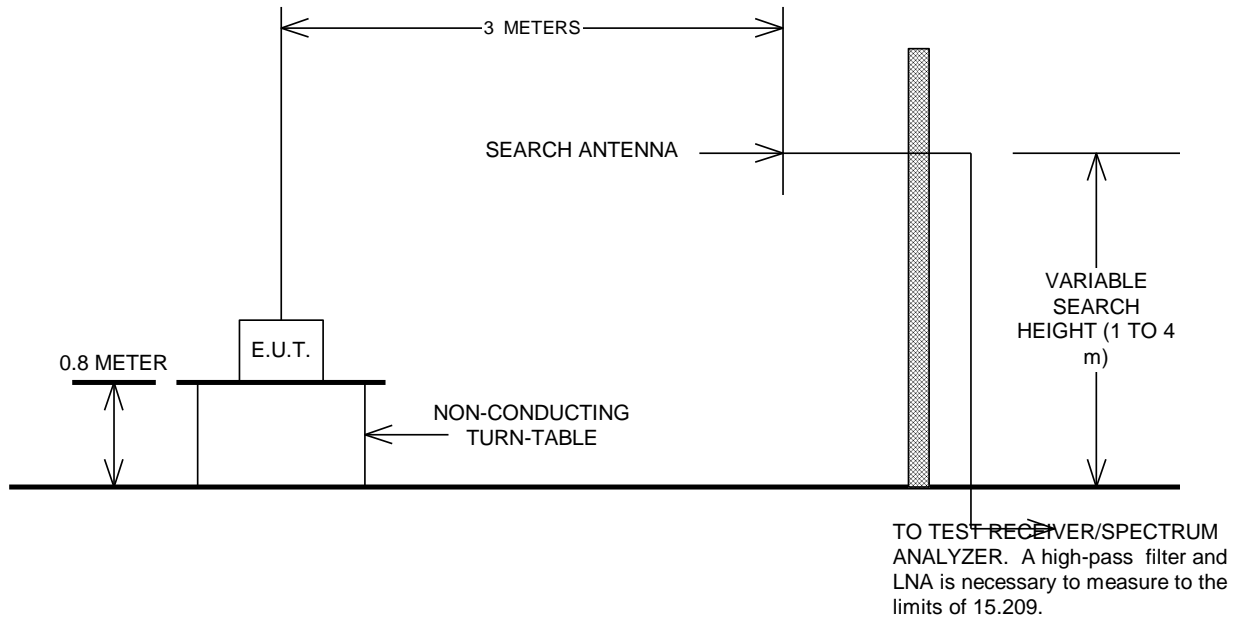

**Conducted Emissions**

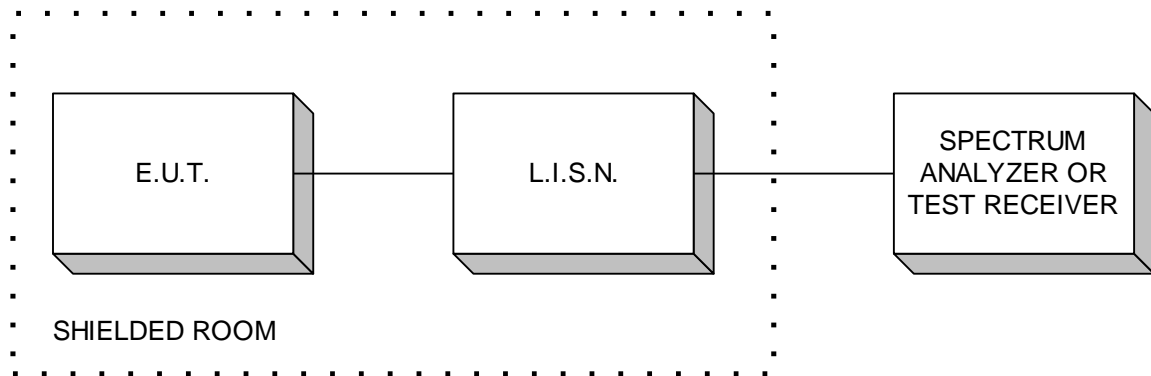

**Peak Power At Antenna Terminals**

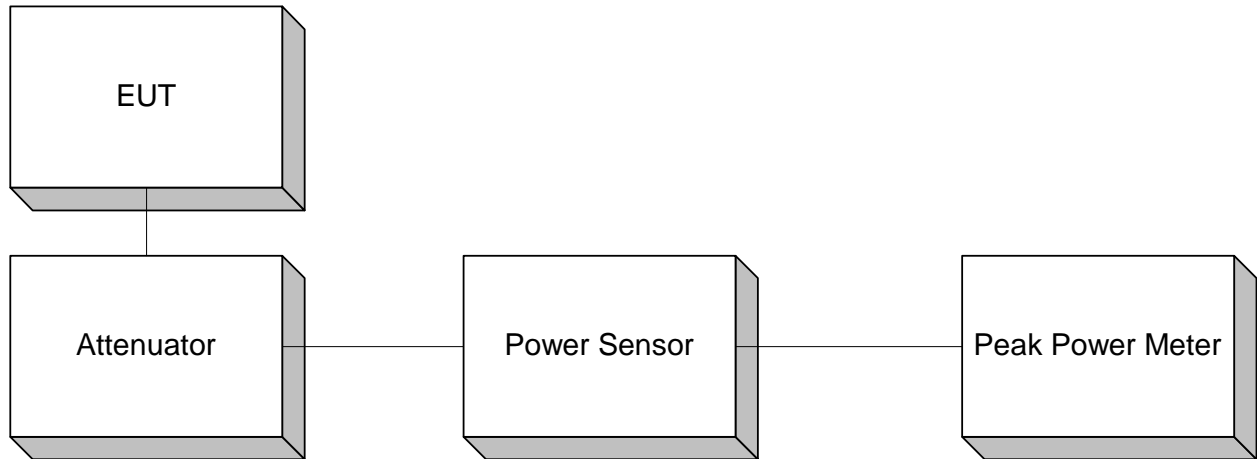

Note: A spectrum analyzer may be substituted for Peak Power Meter given that the measurement bandwidth is sufficient to capture the 60 dB bandwidth of the transmitter.

**Minimum 6 dB Bandwidth  
Peak Power Spectral Density  
Spurious Emissions (conducted)**

