

Block Diagram

FCC ID: ACLAPBP21

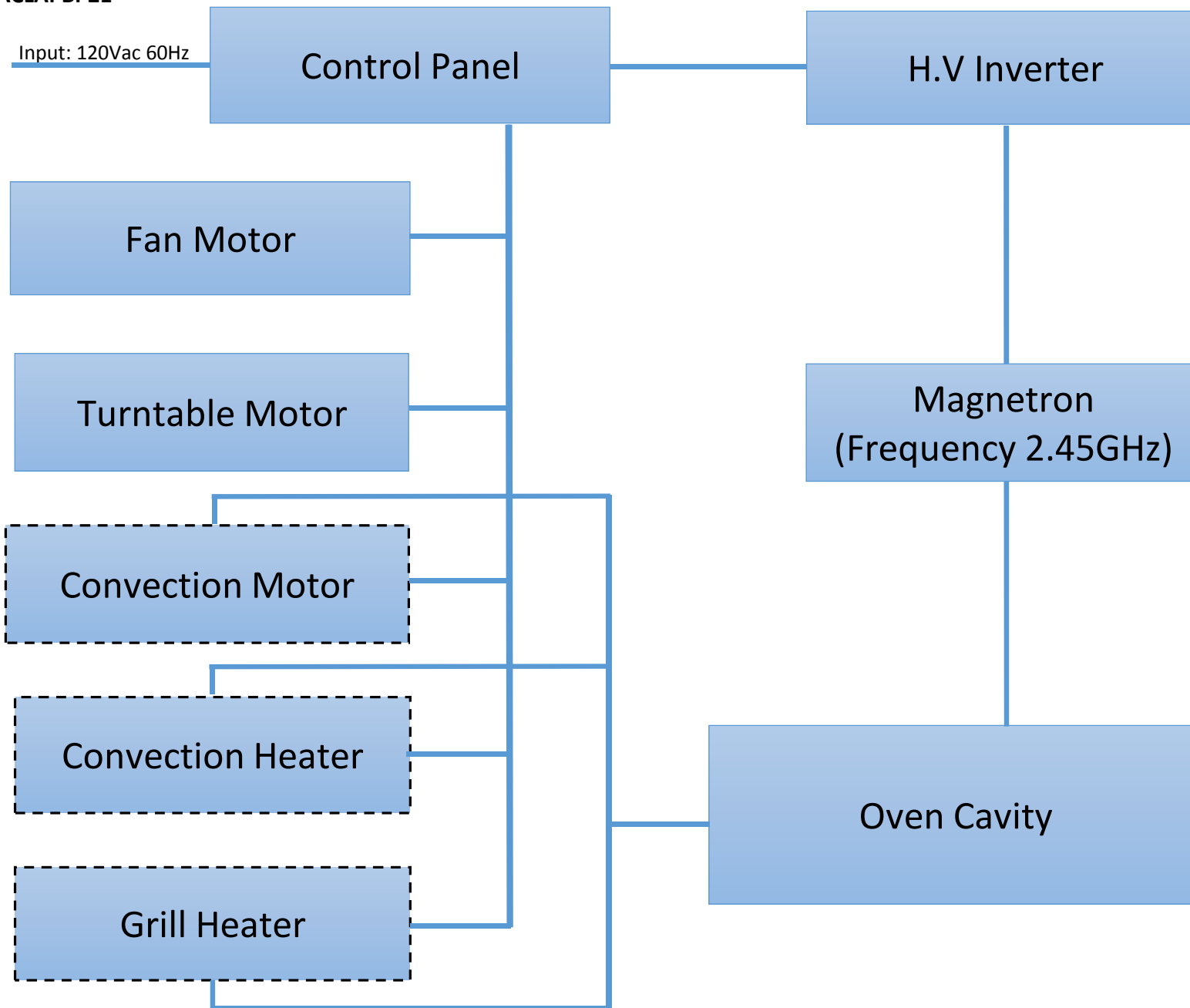

Note Components outlined with a dotted line are optional and may not be provided in this model family.