



FCC RADIO TEST REPORT

FCC ID : ACJFZN1E
Equipment : Tablet Computer
Brand Name : Panasonic
Model Name : FZ-N1KB
Marketing Name : FZ-N1
Applicant : Panasonic Corporation of North America
Two Riverfront Plaza, 9th Floor, Newark, NJ
07102-5490
Manufacturer : Panasonic Mobile Communications Co., Ltd.
600 Saedo-cho, Tsuzuki-ku, Yokohama City
224-8539, Japan
Standard : 47 CFR Part 2, 22(H), 24(E)

The product was received on Apr. 22, 2020 and testing was started from May 05, 2020 and completed on May 07, 2020. We, SPORTON INTERNATIONAL INC. EMC & Wireless Communications Laboratory, would like to declare that the tested sample has been evaluated in accordance with the test procedures given in ANSI / TIA-603-E and has been in compliance with the applicable technical standards.

The report must not be used by the client to claim product certification, approval, or endorsement by TAF or any agency of government.

The test results in this report apply exclusively to the tested model / sample. Without written approval of SPORTON INTERNATIONAL INC. EMC & Wireless Communications Laboratory, the test report shall not be reproduced except in full.

Louis Wu

Approved by: Louis Wu

SPORTON INTERNATIONAL INC. EMC & Wireless Communications Laboratory

No. 52, Huaya 1st Rd., Guishan Dist., Taoyuan City, Taiwan (R.O.C.)



Table of Contents

| | |
|--|-----------|
| History of this test report..... | 3 |
| Summary of Test Result..... | 4 |
| 1 General Description | 5 |
| 1.1 Product Feature of Equipment Under Test | 5 |
| 1.2 Modification of EUT | 5 |
| 1.3 Testing Location | 6 |
| 1.4 Applicable Standards | 6 |
| 2 Test Configuration of Equipment Under Test | 7 |
| 2.1 Test Mode..... | 7 |
| 2.2 Connection Diagram of Test System | 7 |
| 2.3 Support Unit used in test configuration | 8 |
| 2.4 Measurement Results Explanation Example | 8 |
| 2.5 Frequency List of Low/Middle/High Channels..... | 8 |
| 3 Conducted Test Result | 9 |
| 3.1 Measuring Instruments..... | 9 |
| 3.2 Conducted Output Power and ERP/EIRP | 10 |
| 3.3 Peak-to-Average Ratio | 11 |
| 3.4 99% Occupied Bandwidth and 26dB Bandwidth Measurement..... | 12 |
| 3.5 Conducted Band Edge | 13 |
| 3.6 Conducted Spurious Emission | 14 |
| 3.7 Frequency Stability..... | 15 |
| 4 Radiated Test Items | 16 |
| 4.1 Measuring Instruments..... | 16 |
| 4.2 Test Setup | 16 |
| 4.3 Test Result of Radiated Test..... | 17 |
| 4.4 Field Strength of Spurious Radiation Measurement | 18 |
| 5 List of Measuring Equipment..... | 19 |
| 6 Uncertainty of Evaluation | 21 |
| Appendix A. Test Results of Conducted Test | |
| Appendix B. Test Results of ERP/EIRP and Radiated Test | |
| Appendix C. Test Setup Photographs | |



History of this test report

| Report No. | Version | Description | Issued Date |
|------------|---------|--------------------------------|---------------|
| FG042038A | 01 | Initial issue of report | May 19, 2020 |
| FG042038A | 02 | Adding Accessories Information | Jun. 04, 2020 |
| | | | |
| | | | |
| | | | |
| | | | |
| | | | |
| | | | |
| | | | |
| | | | |
| | | | |
| | | | |
| | | | |
| | | | |
| | | | |
| | | | |
| | | | |
| | | | |
| | | | |
| | | | |



Summary of Test Result

| Report Clause | Ref Std. Clause | Test Items | Result (PASS/FAIL) | Remark |
|---------------|---------------------------------------|---|--------------------|--------------------------------------|
| 3.2 | §2.1046 | Conducted Output Power | Pass | - |
| | §22.913 (a)(2) | Effective Radiated Power (WCDMA Band V) | | |
| | §24.232 (c) | Equivalent Isotropic Radiated Power (WCDMA Band II) | | |
| 3.3 | §24.232 (d) | Peak-to-Average Ratio | Pass | |
| 3.4 | §2.1049 §22.917 (b) §24.238 (b) | Occupied Bandwidth (WCDMA Band V) (WCDMA Band II) | Pass | - |
| 3.5 | §2.1051 §22.917 (a) §24.238 (a) | Band Edge Measurement (WCDMA Band V) (WCDMA Band II) | Pass | - |
| 3.6 | §2.1051 §22.917 (a) §24.238 (a) | Conducted Emission (WCDMA Band V) (WCDMA Band II) | Pass | - |
| 3.7 | §2.1055 §22.355 §24.235 | Frequency Stability Temperature & Voltage | Pass | - |
| 4.4 | §2.1053 §22.917 (a) §24.238 (a) | Field Strength of Spurious Radiation (WCDMA Band V) (WCDMA Band II) | Pass | Under limit 34.69 dB at 7414.000 MHz |

Declaration of Conformity:

The test results with all measurement uncertainty excluded are presented in accordance with the regulation limits or requirements declared by manufacturers.

Comments and Explanations:

The declared of product specification for EUT presented in the report are provided by the manufacturer, and the manufacturer takes all the responsibilities for the accuracy of product specification.

Reviewed by: Wii Chang

Report Producer: Lucy Wu



1 General Description

1.1 Product Feature of Equipment Under Test

WCDMA/LTE, Bluetooth, Wi-Fi 2.4GHz 802.11b/g/n/ac, Wi-Fi 5GHz 802.11a/n/ac, NFC, and GNSS.

| Product Specification subjective to this standard | |
|---|--|
| Antenna Type | WWAN: Fixed Internal Antenna WLAN: Monopole Antenna Bluetooth: Monopole Antenna GPS / Glonass : Monopole Antenna NFC: Loop Antenna |

| Accessories Information | | |
|-------------------------|------------|---------------|
| Cradle | Brand Name | Panasonic |
| | Model Name | FZ-VEBN111A |
| AC Adapter 1 | Brand Name | Panasonic |
| | Model Name | CF-AA6413A |
| AC Adapter 2 | Brand Name | Panasonic |
| | Model Name | FZ-AAE184EM |
| USB Cable 1 | Brand Name | Panasonic |
| | Model Name | K2KYYYYY00221 |
| USB Cable 2 | Brand Name | N/A |
| | Model Name | SPA-US15 |
| Battery | Brand Name | Panasonic |
| | Model Name | FZ-VZSUN110U |

1.2 Modification of EUT

No modifications are made to the EUT during all test items.



1.3 Testing Location

| | |
|---------------------------|---|
| Test Site | SPORTON INTERNATIONAL INC. EMC & Wireless Communications Laboratory |
| Test Site Location | No.52, Huaya 1st Rd., Guishan Dist., Taoyuan City, Taiwan (R.O.C.) TEL: +886-3-327-3456 FAX: +886-3-328-4978 |
| Test Site No. | Sporton Site No. |
| | TH03-HY |
| Test Engineer | Louis Chung |
| Temperature | 21~24°C |
| Relative Humidity | 51~55% |

Note: The test site complies with ANSI C63.4 2014 requirement.

| | |
|---------------------------|---|
| Test Site | SPORTON INTERNATIONAL INC. EMC & Wireless Communications Laboratory |
| Test Site Location | No.58, Aly. 75, Ln. 564, Wenhua 3rd, Rd., Guishan Dist., Taoyuan City, Taiwan (R.O.C.) TEL: +886-3-327-0868 FAX: +886-3-327-0855 |
| Test Site No. | Sporton Site No. |
| | 03CH13-HY |
| Test Engineer | Daniel Lee, Jacky Hung and Wilson Wu |
| Temperature | 20~25°C |
| Relative Humidity | 50~60% |

Note: The test site complies with ANSI C63.4 2014 requirement.

FCC Designation No.: TW1190 and TW0007

1.4 Applicable Standards

According to the specifications of the manufacturer, the EUT must comply with the requirements of the following standards:

- ♦ ANSI C63.26-2015
- ♦ ANSI / TIA-603-E
- ♦ 47 CFR Part 2, 22(H), 24(E)
- ♦ FCC KDB 971168 D01 Power Meas. License Digital Systems v03r01
- ♦ FCC KDB 412172 D01 Determining ERP and EIRP v01r01
- ♦ FCC KDB 414788 D01 Radiated Test Site v01r01

Remark:

1. All test items were verified and recorded according to the standards and without any deviation during the test.
2. This EUT has also been tested and complied with the requirements of FCC Part 15, Subpart B, recorded in a separate test report.
3. The TAF code is not including all the FCC KDB listed without accreditation.

2 Test Configuration of Equipment Under Test

2.1 Test Mode

Antenna port conducted and radiated test items were performed according to KDB 971168 D01 Power Meas. License Digital Systems v03r01 with maximum output power.

For radiated measurement, pre-scanned in three orthogonal panels, X, Y, Z. The worst cases (Y plane) were recorded in this report.

Radiated emissions were investigated as following frequency range:

1. 30 MHz to 9000 MHz for WCDMA Band V
2. 30 MHz to 19100 MHz for WCDMA Band II

All modes and data rates and positions were investigated.

Test modes are chosen to be reported as the worst case configuration below:

| Test Modes | | |
|---------------|---------------------|---------------------|
| Band | Radiated TCs | Conducted TCs |
| WCDMA Band V | ■ RMC 12.2Kbps Link | ■ RMC 12.2Kbps Link |
| WCDMA Band II | ■ RMC 12.2Kbps Link | ■ RMC 12.2Kbps Link |

Remark: All the radiated test cases were performed with Adapter 2 and USB Cable 1.

2.2 Connection Diagram of Test System

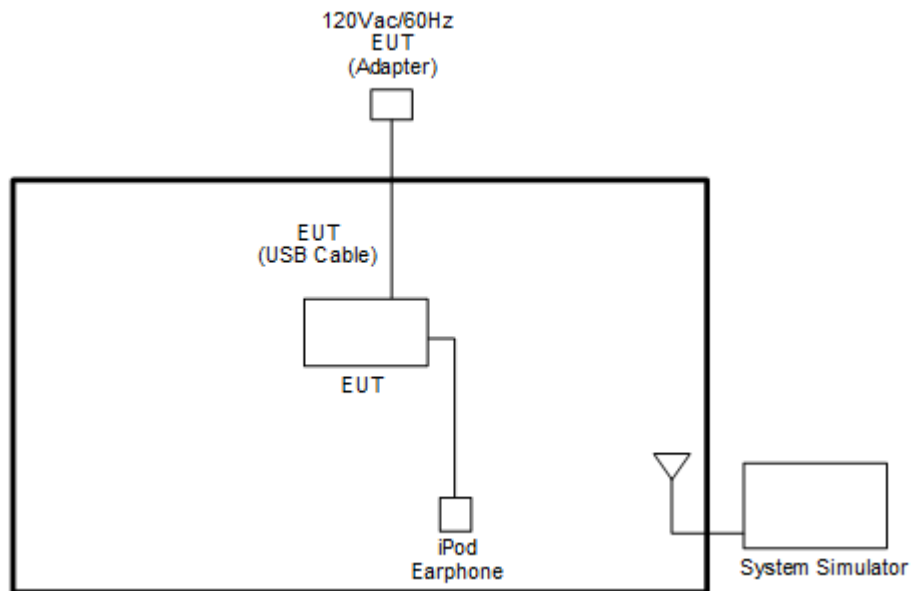



2.3 Support Unit used in test configuration

| Item | Equipment | Trade Name | Model No. | FCC ID | Data Cable | Power Cord |
|------|------------------|------------|-----------|--------------|-------------------|-------------------|
| 1. | System Simulator | Anritsu | MT8820C | N/A | N/A | Unshielded, 1.8 m |
| 2. | iPod Earphone | Apple | N/A | Verification | Unshielded, 1.0 m | N/A |

2.4 Measurement Results Explanation Example

For all conducted test items:

The offset level is set in the spectrum analyzer to compensate the RF cable loss and attenuator factor between RF conducted output port and spectrum analyzer. With the offset compensation, the spectrum analyzer reading level will be exactly the RF output level.

The spectrum analyzer offset is derived from RF cable loss and attenuator factor.

$$\text{Offset} = \text{RF cable loss} + \text{attenuator factor}.$$

The following shows an offset computation example with RF cable loss 4.2 dB and a 10dB attenuator.

Example:

$$\begin{aligned} \text{Offset(dB)} &= \text{RF cable loss(dB)} + \text{attenuator factor(dB)}. \\ &= 4.2 + 10 = 14.2 \text{ (dB)} \end{aligned}$$

2.5 Frequency List of Low/Middle/High Channels

| Frequency List | | | | |
|------------------|------------------------|--------|--------|---------|
| Band | Channel/Frequency(MHz) | Lowest | Middle | Highest |
| WCDMA Band V | Channel | 4132 | 4182 | 4233 |
| | Frequency | 826.4 | 836.4 | 846.6 |
| WCDMA Band II | Channel | 9262 | 9400 | 9538 |
| | Frequency | 1852.4 | 1880.0 | 1907.6 |

3 Conducted Test Result

3.1 Measuring Instruments

See list of measuring instruments of this test report.

3.1.1 Test Setup

3.1.2 Conducted Output Power

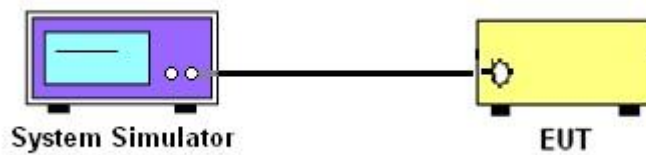

3.1.3 Peak-to-Average Ratio, Occupied Bandwidth, Conducted Band-Edge and Conducted Spurious Emission

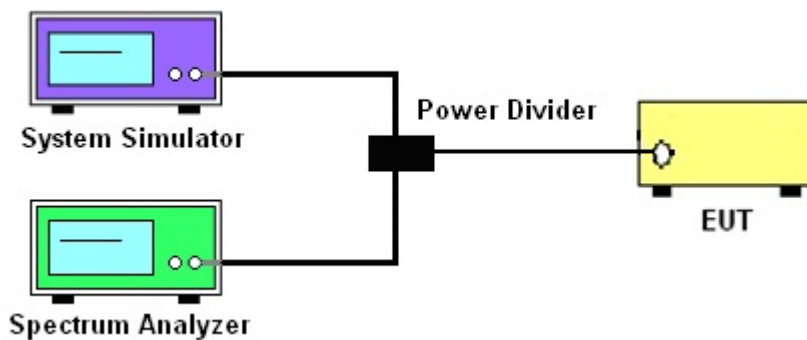

3.1.4 Frequency Stability

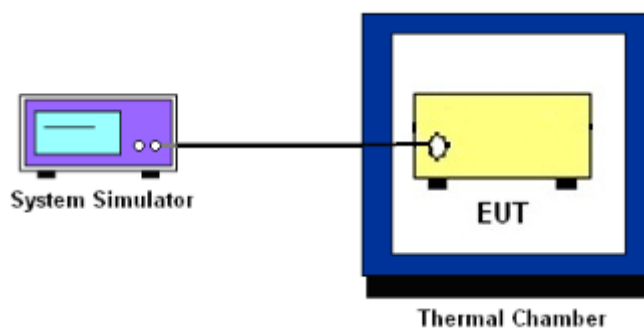

3.1.5 Test Result of Conducted Test

Please refer to Appendix A.



3.2 Conducted Output Power and ERP/EIRP

3.2.1 Description of the Conducted Output Power and ERP/EIRP

A system simulator was used to establish communication with the EUT. Its parameters were set to enforce EUT transmitting at the maximum power. The measured power in the radio frequency on the transmitter output terminals shall be reported.

The ERP of mobile transmitters must not exceed 7 Watts for WCDMA Band V

The EIRP of mobile transmitters must not exceed 2 Watts for WCDMA Band II

According to KDB 412172 D01 Power Approach,

$EIRP = P_T + G_T - L_C$, $ERP = EIRP - 2.15$, where

P_T = transmitter output power in dBm

G_T = gain of the transmitting antenna in dBi

L_C = signal attenuation in the connecting cable between the transmitter and antenna in dB

3.2.2 Test Procedures

1. The transmitter output port was connected to the system simulator.
2. Set EUT at maximum power through system simulator.
3. Select lowest, middle, and highest channels for each band and different modulation.
4. Measure the maximum burst average power for GSM and maximum average power for other modulation signal.



3.3 Peak-to-Average Ratio

3.3.1 Description of the PAR Measurement

The peak-to-average ratio (PAR) of the transmission may not exceed 13 dB.

3.3.2 Test Procedures

The testing follows ANSI C63.26-2015 Section 5.2.6

1. The EUT was connected to spectrum analyzer and system simulator via a power divider.
2. Set EUT to transmit at maximum output power.
3. When the duty cycle is less than 98%, then signal gating will be implemented on the spectrum analyzer by triggering from the system simulator.
4. Set the CCDF (Complementary Cumulative Distribution Function) option of the spectrum analyzer.
5. Record the maximum PAPR level associated with a probability of 0.1%.



3.4 99% Occupied Bandwidth and 26dB Bandwidth Measurement

3.4.1 Description of 99% Occupied Bandwidth and 26dB Bandwidth Measurement

The occupied bandwidth is the width of a frequency band such that, below the lower and above the upper frequency limits, the mean powers emitted are each equal to a specified percentage 0.5% of the total mean transmitted power.

The 26 dB emission bandwidth is defined as the frequency range between two points, one above and one below the carrier frequency, at which the spectral density of the emission is attenuated 26 dB below the maximum in-band spectral density of the modulated signal. Spectral density (power per unit bandwidth) is to be measured with a detector of resolution bandwidth equal to approximately 1.0% of the emission bandwidth.

3.4.2 Test Procedures

The testing follows ANSI C63.26-2015 Section 5.4.3 (26dB) and Section 5.4.4 (99OB)

1. The EUT was connected to spectrum analyzer and system simulator via a power divider.
2. The spectrum analyzer center frequency is set to the nominal EUT channel center frequency. The span range for the spectrum analyzer shall be between two and five times the anticipated OBW.
3. The nominal resolution bandwidth (RBW) shall be in the range of 1 to 5 % of the anticipated OBW, and the VBW shall be at least 3 times the RBW.
4. Set the detection mode to peak, and the trace mode to max hold.
5. Determine the reference value: Set the EUT to transmit a modulated signal. Allow the trace to stabilize. Set the spectrum analyzer marker to the highest level of the displayed trace.
(this is the reference value)
6. Determine the “-26 dB down amplitude” as equal to (Reference Value – X).
7. Place two markers, one at the lowest and the other at the highest frequency of the envelope of the spectral display such that each marker is at or slightly below the “-X dB down amplitude” determined in step 6. If a marker is below this “-X dB down amplitude” value it shall be placed as close as possible to this value. The OBW is the positive frequency difference between the two markers.
8. Use the 99 % power bandwidth function of the spectrum analyzer and report the measured bandwidth.



3.5 Conducted Band Edge

3.5.1 Description of Conducted Band Edge Measurement

The power of any emission outside of the authorized operating frequency ranges must be lower than the transmitter power (P) by a factor of at least $43 + 10 \log (P)$ dB.

3.5.2 Test Procedures

The testing follows FCC KDB 971168 D01 v03r01 Section 6.1.

1. The EUT was connected to the spectrum analyzer and system simulator via a power divider.
2. The RF output of EUT was connected to the spectrum analyzer by an RF cable and attenuator. The path loss was compensated to the results for each measurement.
3. The band edges of low and high channels for the highest RF powers were measured.
4. The RF fundamental frequency should be excluded against the limit line in the operating frequency band.
5. The limit line is derived from $43 + 10\log(P)$ dB below the transmitter power P(Watts)



3.6 Conducted Spurious Emission

3.6.1 Description of Conducted Spurious Emission Measurement

The power of any emission outside of the authorized operating frequency ranges must be lower than the transmitter power (P) by a factor of at least $43 + 10 \log (P)$ dB.

It is measured by means of a calibrated spectrum analyzer and scanned from 30 MHz up to a frequency including its 10th harmonic.

3.6.2 Test Procedures

The testing follows FCC KDB 971168 D01 v03r01 Section 6.1.

1. The EUT was connected to the spectrum analyzer and system simulator via a power divider.
2. The RF output of EUT was connected to the spectrum analyzer by an RF cable and attenuator.
The path loss was compensated to the results for each measurement.
3. The middle channel for the highest RF power within the transmitting frequency was measured.
4. The conducted spurious emission for the whole frequency range was taken.
5. The RF fundamental frequency should be excluded against the limit line in the operating frequency band.
6. The limit line is derived from $43 + 10\log(P)$ dB below the transmitter power P(Watts)



3.7 Frequency Stability

3.7.1 Description of Frequency Stability Measurement

22.355

The frequency stability shall be measured by variation of ambient temperature and variation of primary supply voltage to ensure that the fundamental emission stays within the authorized frequency block. The frequency stability of the transmitter shall be maintained within $\pm 0.00025\%$ ($\pm 2.5\text{ppm}$) of the center frequency.

24.235

The frequency stability shall be sufficient to ensure that the fundamental emission stays within the authorized frequency block.

3.7.2 Test Procedures for Temperature Variation

The testing follows FCC KDB 971168 D01 v03r01 Section 9.0.

1. The EUT was set up in the thermal chamber and connected with the system simulator.
2. With power OFF, the temperature was decreased to -30°C and the EUT was stabilized before testing. Power was applied and the maximum change in frequency was recorded within one minute.
3. With power OFF, the temperature was raised in 10°C steps up to 50°C . The EUT was stabilized at each step for at least half an hour. Power was applied and the maximum frequency change was recorded within one minute.

3.7.3 Test Procedures for Voltage Variation

The testing follows FCC KDB 971168 D01 v03r01 Section 9.0.

1. The EUT was placed in a temperature chamber at $20\pm 5^{\circ}\text{C}$ and connected with the system simulator.
2. The power supply voltage to the EUT was varied from 85% to 115% of the nominal value measured at the input to the EUT.
3. The variation in frequency was measured for the worst case.

4 Radiated Test Items

4.1 Measuring Instruments

See list of measuring instruments of this test report.

4.2 Test Setup

For radiated emissions below 30MHz

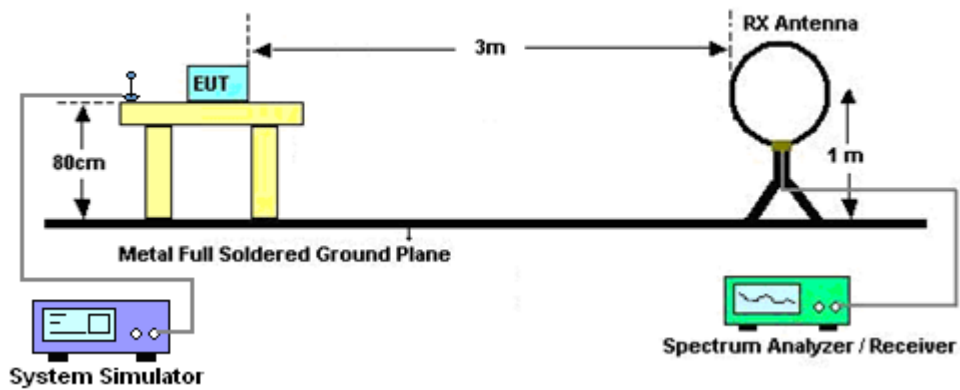

For radiated test from 30MHz to 1GHz

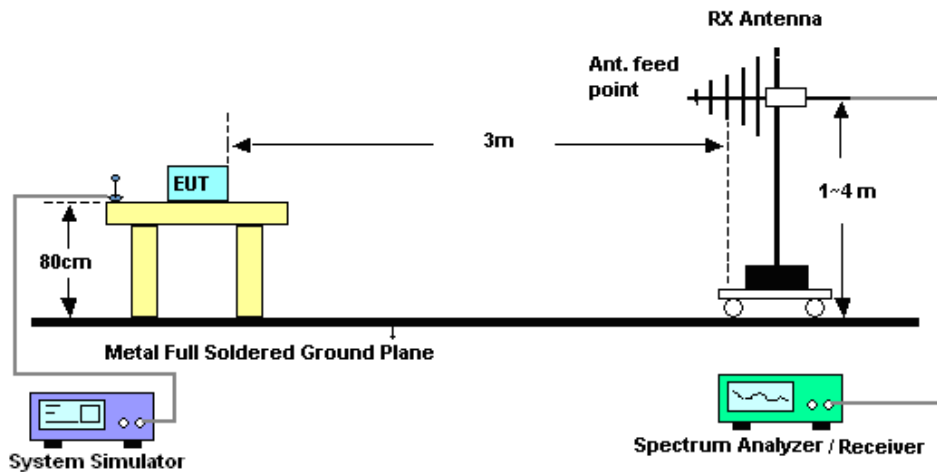

For radiated test above 1GHz

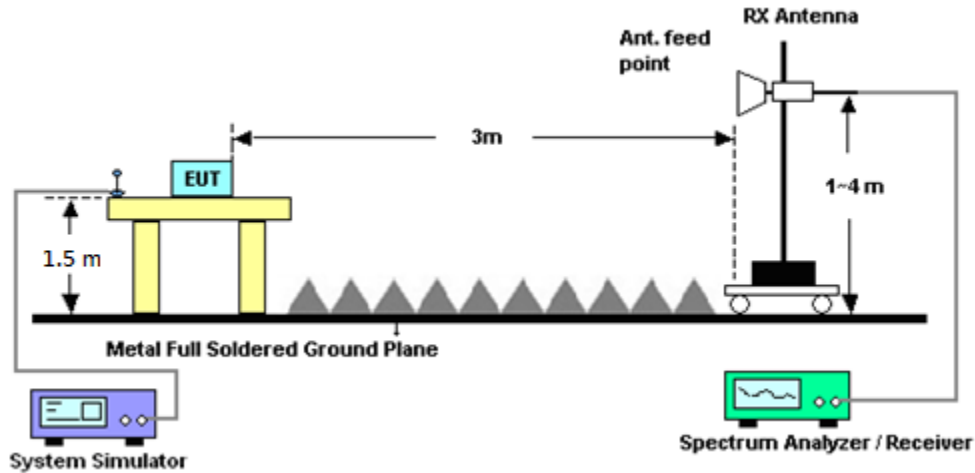

4.3 Test Result of Radiated Test

Please refer to Appendix B.

Note:

The low frequency, which started from 9 kHz to 30MHz, was pre-scanned and the result which was 20dB lower than the limit line was not reported.

There is a comparison data of both open-field test site and alternative test site - semi-Anechoic chamber according to 414788 D01 Radiated Test Site v01r01, and the result came out very similar.



4.4 Field Strength of Spurious Radiation Measurement

4.4.1 Description of Field Strength of Spurious Radiated Measurement

The power of any emission outside of the authorized operating frequency ranges must be attenuated below the transmitter power (P) by a factor of at least $43 + 10 \log (P)$ dB. The spectrum is scanned from 30 MHz up to a frequency including its 10th harmonic.

4.4.2 Test Procedures

The testing follows FCC KDB 971168 D01 v03r01 Section 7 and ANSI / TIA-603-E Section 2.2.12.

1. The EUT was placed on a rotatable wooden table 0.8 meters for frequency below 1GHz and 1.5 meter for frequency above 1GHz above the ground.
2. The EUT was set 3 meters from the receiving antenna, which was mounted on the antenna tower.
3. The table was rotated 360 degrees to determine the position of the highest spurious emission.
4. The height of the receiving antenna is varied between one meter and four meters to search for the maximum spurious emission for both horizontal and vertical polarizations.
5. Make the measurement with the spectrum analyzer's RBW = 1MHz, VBW = 3MHz, taking record of maximum spurious emission.
6. A horn antenna was substituted in place of the EUT and was driven by a signal generator.
7. Tune the output power of signal generator to the same emission level with EUT maximum spurious emission.
8. Taking the record of output power at antenna port.
9. Repeat step 7 to step 8 for another polarization.
10. $EIRP (dBm) = S.G. Power - Tx Cable Loss + Tx Antenna Gain$
11. $ERP (dBm) = EIRP - 2.15$
12. The RF fundamental frequency should be excluded against the limit line in the operating frequency band.
13. The limit line is derived from $43 + 10\log(P)$ dB below the transmitter power P(Watts)



5 List of Measuring Equipment

| Instrument | Manufacturer | Model No. | Serial No. | Characteristics | Calibration Date | Test Date | Due Date | Remark |
|---------------------------|-------------------|---------------------------------|------------|---------------------------------|------------------|-------------------------------|---------------|-----------------------|
| Hygrometer | Testo | 608-H1 | 34893241 | N/A | Mar. 26, 2020 | May 07, 2020 | Mar. 25, 2021 | Conducted (TH03-HY) |
| Spectrum Analyzer | Rohde & Schwarz | FSP30 | 101329 | 9kHz~30GHz | Sep. 04, 2019 | May 07, 2020 | Sep. 03, 2020 | Conducted (TH03-HY) |
| Temperature Chamber | ESPEC | SU-641 | 92013721 | -30°C ~70°C | Nov. 26, 2019 | May 07, 2020 | Nov. 25, 2020 | Conducted (TH03-HY) |
| Programmable Power Supply | GW Instek | PSS-2005 | EL890001 | 1V~20V 0.5A~4A | Oct. 09, 2019 | May 07, 2020 | Oct. 08, 2020 | Conducted (TH03-HY) |
| Base Station (Measure) | Rohde & Schwarz | CMU200 | 117995 | GSM / GPRS / WCDMA / CDMA | Aug. 23, 2019 | May 07, 2020 | Aug. 22, 2020 | Conducted (TH03-HY) |
| Power Divider | Warison | WCOU-0.4-26.5S-20 | #A | N/A | Nov. 06, 2019 | May 07, 2020 | Nov. 05, 2020 | Conducted (TH03-HY) |
| Amplifier | Sonoma-Instrument | 310 N | 187282 | 9KHz~1GHz | Dec. 17, 2019 | May 05, 2020~ May 06, 2020 | Dec. 16, 2020 | Radiation (03CH13-HY) |
| Bilog Antenna | TESEQ | CBL 6111D&00800 N1D01N-06 | 40103&07 | 30MHz to 1GHz | Apr. 29, 2020 | May 05, 2020~ May 06, 2020 | Apr. 28, 2021 | Radiation (03CH13-HY) |
| Bilog Antenna | TESEQ | CBL 6111D&00800 N1D01N-06 | 41912 & 07 | 30MHz to 1GHz | Apr. 29, 2020 | May 05, 2020~ May 06, 2020 | Apr. 28, 2021 | Radiation (03CH13-HY) |
| Horn Antenna | SCHWARZBECK | BBHA 9120 D | 9120D-1241 | 1GHz ~ 18GHz | Jul. 02, 2019 | May 05, 2020~ May 06, 2020 | Jul. 01, 2020 | Radiation (03CH13-HY) |
| Horn Antenna | SCHWARZBECK | BBHA 9120 D | 9120D-1212 | 1GHz ~ 18GHz | May 14, 2019 | May 05, 2020~ May 06, 2020 | May 13, 2020 | Radiation (03CH13-HY) |
| Preamplifier | MITEQ | AMF-7D-0010 1800-30-10P | 1590074 | 1GHz~18GHz | May 20, 2019 | May 05, 2020~ May 06, 2020 | May 19, 2020 | Radiation (03CH13-HY) |
| Preamplifier | Keysight | 83017A | MY53270147 | 1GHz~26.5GHz | Oct. 28, 2019 | May 05, 2020~ May 06, 2020 | Oct. 27, 2010 | Radiation (03CH13-HY) |
| Signal Generator | Rohde & Schwarz | SMF100A | 101107 | 100kHz~40GHz | Aug. 27, 2019 | May 05, 2020~ May 06, 2020 | Aug. 26, 2020 | Radiation (03CH13-HY) |
| Spectrum Analyzer | Keysight | N9010A | MY55370526 | 10Hz~44GHz | Mar. 20, 2020 | May 05, 2020~ May 06, 2020 | Mar. 19, 2021 | Radiation (03CH13-HY) |
| Controller | EMEC | EM1000 | N/A | Control Turn table & Ant Mast | N/A | May 05, 2020~ May 06, 2020 | N/A | Radiation (03CH13-HY) |
| Antenna Mast | EMEC | AM-BS-4500-B | N/A | 1m~4m | N/A | May 05, 2020~ May 06, 2020 | N/A | Radiation (03CH13-HY) |
| Turn Table | EMEC | TT2000 | N/A | 0~360 Degree | N/A | May 05, 2020~ May 06, 2020 | N/A | Radiation (03CH13-HY) |
| Software | Audix | E3 6.2009-8-24 | RK-000992 | N/A | N/A | May 05, 2020~ May 06, 2020 | N/A | Radiation (03CH13-HY) |
| Preamplifier | EMEC | EM18G40G | 060715 | 18GHz ~ 40GHz | Dec. 13, 2019 | May 05, 2020~ May 06, 2020 | Dec. 12, 2020 | Radiation (03CH13-HY) |



| Instrument | Manufacturer | Model No. | Serial No. | Characteristics | Calibration Date | Test Date | Due Date | Remark |
|----------------------|----------------|-------------------------------------|-----------------|----------------------------|------------------|-------------------------------|---------------|--------------------------|
| RF Cable | HUBER + SUHNER | SUCOFLEX 126E | 0030/126E | 30M-18G | Feb. 12, 2020 | May 05, 2020~ May 06, 2020 | Feb. 21, 2021 | Radiation (03CH13-HY) |
| RF Cable | HUBER + SUHNER | SUCOFLEX 104 | 804793/4 | 30M-18G | Feb. 12, 2020 | May 05, 2020~ May 06, 2020 | Feb. 21, 2021 | Radiation (03CH13-HY) |
| RF Cable | HUBER + SUHNER | SUCOFLEX 102 | 505134/2 | 30M~40GHz | Feb. 25, 2020 | May 05, 2020~ May 06, 2020 | Feb. 24, 2021 | Radiation (03CH13-HY) |
| SHF-EHF Horn Antenna | SCHWARZBECK | BBHA 9170 | BBHA917058 4 | 18GHz- 40GHz | Dec. 10, 2019 | May 05, 2020~ May 06, 2020 | Dec. 09, 2020 | Radiation (03CH13-HY) |
| SHF-EHF Horn Antenna | SCHWARZBECK | BBHA 9170 | BBHA917057 6 | 18GHz~40GHz | May 14, 2019 | May 05, 2020~ May 06, 2020 | May 13, 2020 | Radiation (03CH13-HY) |
| Filter | Wainwright | WHKX12-2700 -3000-18000-6 0SS | SN2 | 3GHz High Pass Filter | Jul. 14, 2019 | May 05, 2020~ May 06, 2020 | Jul. 13, 2020 | Radiation (03CH13-HY) |
| Filter | Wainwright | WHKX12-1080 -1200-15000-6 0SS | SN3 | 1.2GHz High Pass Filter | Jul. 03, 2019 | May 05, 2020~ May 06, 2020 | Jul. 02, 2020 | Radiation (03CH13-HY) |
| Hygrometer | TECPEL | DTM-303B | TP157151 | N/A | Jun. 17, 2019 | May 05, 2020~ May 06, 2020 | Jun. 16, 2020 | Radiation (03CH13-HY) |



6 Uncertainty of Evaluation

Uncertainty of Radiated Emission Measurement (30 MHz ~ 1000 MHz)

| | |
|---|------|
| Measuring Uncertainty for a Level of Confidence of 95% ($U = 2Uc(y)$) | 3.21 |
|---|------|

Uncertainty of Radiated Emission Measurement (1 GHz ~ 18 GHz)

| | |
|---|------|
| Measuring Uncertainty for a Level of Confidence of 95% ($U = 2Uc(y)$) | 3.24 |
|---|------|

Uncertainty of Radiated Emission Measurement (18 GHz ~ 40 GHz)

| | |
|---|------|
| Measuring Uncertainty for a Level of Confidence of 95% ($U = 2Uc(y)$) | 3.99 |
|---|------|



Appendix A. Test Results of Conducted Test

Conducted Output Power(Average power)

| Conducted Power (*Unit: dBm) | | | | | | |
|------------------------------|--------------|--------------|-------|---------------|--------------|--------|
| Band | WCDMA Band V | | | WCDMA Band II | | |
| Channel | 4132 | 4182 | 4233 | 9262 | 9400 | 9538 |
| Frequency | 826.4 | 836.4 | 846.6 | 1852.4 | 1880 | 1907.6 |
| RMC 12.2K | 23.66 | 23.81 | 23.27 | 23.60 | 23.62 | 23.43 |
| HSDPA Subtest-1 | 22.65 | 22.78 | 22.27 | 22.57 | 22.60 | 22.43 |
| HSDPA Subtest-2 | 22.64 | 22.77 | 22.28 | 22.57 | 22.59 | 22.44 |
| HSDPA Subtest-3 | 22.14 | 22.27 | 21.77 | 22.07 | 22.09 | 21.94 |
| HSDPA Subtest-4 | 22.14 | 22.28 | 21.77 | 22.07 | 22.08 | 21.93 |
| HSUPA Subtest-1 | 22.66 | 22.79 | 22.29 | 22.57 | 22.59 | 22.43 |
| HSUPA Subtest-2 | 20.66 | 20.79 | 20.28 | 20.57 | 20.58 | 20.44 |
| HSUPA Subtest-3 | 21.66 | 21.78 | 21.28 | 21.58 | 21.59 | 21.43 |
| HSUPA Subtest-4 | 20.66 | 20.78 | 20.28 | 20.57 | 20.58 | 20.44 |
| HSUPA Subtest-5 | 22.65 | 22.78 | 22.28 | 22.57 | 22.59 | 22.42 |





A2. WCDMA

Peak-to-Average Ratio

| Mode | WCDMA Band V | WCDMA Band II | Limit: 13dB |
|------------|--------------|---------------|-------------|
| Mod. | RMC 12.2Kbps | RMC 12.2Kbps | Result |
| Lowest CH | 3.20 | 3.12 | PASS |
| Middle CH | 3.16 | 2.96 | |
| Highest CH | 3.20 | 3.12 | |

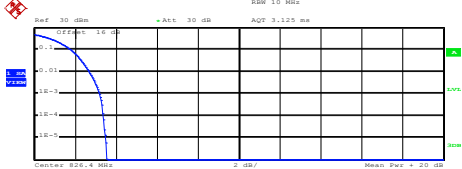
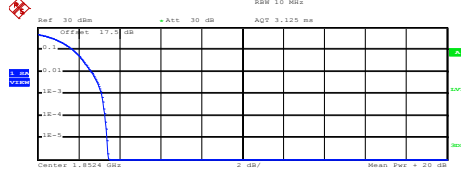

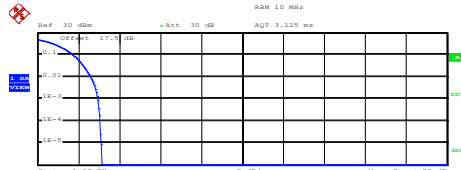
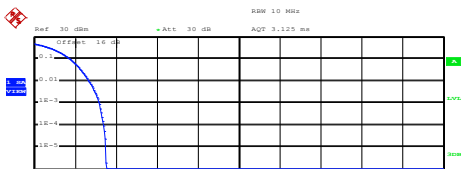
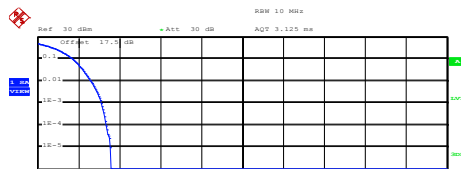
| WCDMA Band V (RMC 12.2Kbps) | WCDMA Band II (RMC 12.2Kbps) | | | | | | | | | | | | | | | | |
|--|------------------------------|---------|-----|---------|------|---------|-------|---------|--|------|---------|-----|---------|------|---------|-------|---------|
| <p style="text-align: center;">Lowest Channel</p>  <p>Center: 826.4 MHz 2 dB/ Mean Pwr: +20 dB</p> <p>Complementary Cumulative Distribution Function (100000 samples) Trace 1 Mean: 22.88 dBm Peak: 26.44 dBm Crest: 3.56 dB</p> <table border="1"> <tr><td>10 %</td><td>1.80 dB</td></tr> <tr><td>1 %</td><td>2.68 dB</td></tr> <tr><td>.1 %</td><td>3.20 dB</td></tr> <tr><td>.01 %</td><td>3.40 dB</td></tr> </table> <p>Date: 7.MAY.2020 10:35:07</p> | 10 % | 1.80 dB | 1 % | 2.68 dB | .1 % | 3.20 dB | .01 % | 3.40 dB | <p style="text-align: center;">Lowest Channel</p>  <p>Center: 1.8524 GHz 2 dB/ Mean Pwr: +20 dB</p> <p>Complementary Cumulative Distribution Function (100000 samples) Trace 1 Mean: 22.00 dBm Peak: 25.45 dBm Crest: 3.45 dB</p> <table border="1"> <tr><td>10 %</td><td>1.72 dB</td></tr> <tr><td>1 %</td><td>2.64 dB</td></tr> <tr><td>.1 %</td><td>3.12 dB</td></tr> <tr><td>.01 %</td><td>3.28 dB</td></tr> </table> <p>Date: 7.MAY.2020 10:18:17</p> | 10 % | 1.72 dB | 1 % | 2.64 dB | .1 % | 3.12 dB | .01 % | 3.28 dB |
| 10 % | 1.80 dB | | | | | | | | | | | | | | | | |
| 1 % | 2.68 dB | | | | | | | | | | | | | | | | |
| .1 % | 3.20 dB | | | | | | | | | | | | | | | | |
| .01 % | 3.40 dB | | | | | | | | | | | | | | | | |
| 10 % | 1.72 dB | | | | | | | | | | | | | | | | |
| 1 % | 2.64 dB | | | | | | | | | | | | | | | | |
| .1 % | 3.12 dB | | | | | | | | | | | | | | | | |
| .01 % | 3.28 dB | | | | | | | | | | | | | | | | |
| <p style="text-align: center;">Middle Channel</p>  <p>Center: 826.4 MHz 2 dB/ Mean Pwr: +20 dB</p> <p>Complementary Cumulative Distribution Function (100000 samples) Trace 1 Mean: 22.82 dBm Peak: 26.37 dBm Crest: 3.55 dB</p> <table border="1"> <tr><td>10 %</td><td>1.72 dB</td></tr> <tr><td>1 %</td><td>2.64 dB</td></tr> <tr><td>.1 %</td><td>3.16 dB</td></tr> <tr><td>.01 %</td><td>3.40 dB</td></tr> </table> <p>Date: 7.MAY.2020 10:35:24</p> | 10 % | 1.72 dB | 1 % | 2.64 dB | .1 % | 3.16 dB | .01 % | 3.40 dB | <p style="text-align: center;">Middle Channel</p>  <p>Center: 1.858 GHz 2 dB/ Mean Pwr: +20 dB</p> <p>Complementary Cumulative Distribution Function (100000 samples) Trace 1 Mean: 21.61 dBm Peak: 24.75 dBm Crest: 3.14 dB</p> <table border="1"> <tr><td>10 %</td><td>1.72 dB</td></tr> <tr><td>1 %</td><td>2.60 dB</td></tr> <tr><td>.1 %</td><td>2.96 dB</td></tr> <tr><td>.01 %</td><td>3.08 dB</td></tr> </table> <p>Date: 7.MAY.2020 10:18:30</p> | 10 % | 1.72 dB | 1 % | 2.60 dB | .1 % | 2.96 dB | .01 % | 3.08 dB |
| 10 % | 1.72 dB | | | | | | | | | | | | | | | | |
| 1 % | 2.64 dB | | | | | | | | | | | | | | | | |
| .1 % | 3.16 dB | | | | | | | | | | | | | | | | |
| .01 % | 3.40 dB | | | | | | | | | | | | | | | | |
| 10 % | 1.72 dB | | | | | | | | | | | | | | | | |
| 1 % | 2.60 dB | | | | | | | | | | | | | | | | |
| .1 % | 2.96 dB | | | | | | | | | | | | | | | | |
| .01 % | 3.08 dB | | | | | | | | | | | | | | | | |
| <p style="text-align: center;">Highest Channel</p>  <p>Center: 826.6 MHz 2 dB/ Mean Pwr: +20 dB</p> <p>Complementary Cumulative Distribution Function (100000 samples) Trace 1 Mean: 22.29 dBm Peak: 25.80 dBm Crest: 3.52 dB</p> <table border="1"> <tr><td>10 %</td><td>1.76 dB</td></tr> <tr><td>1 %</td><td>2.68 dB</td></tr> <tr><td>.1 %</td><td>3.20 dB</td></tr> <tr><td>.01 %</td><td>3.40 dB</td></tr> </table> <p>Date: 7.MAY.2020 10:35:34</p> | 10 % | 1.76 dB | 1 % | 2.68 dB | .1 % | 3.20 dB | .01 % | 3.40 dB | <p style="text-align: center;">Highest Channel</p>  <p>Center: 1.9076 GHz 2 dB/ Mean Pwr: +20 dB</p> <p>Complementary Cumulative Distribution Function (100000 samples) Trace 1 Mean: 21.73 dBm Peak: 25.31 dBm Crest: 3.58 dB</p> <table border="1"> <tr><td>10 %</td><td>1.72 dB</td></tr> <tr><td>1 %</td><td>2.60 dB</td></tr> <tr><td>.1 %</td><td>3.12 dB</td></tr> <tr><td>.01 %</td><td>3.36 dB</td></tr> </table> <p>Date: 7.MAY.2020 10:18:42</p> | 10 % | 1.72 dB | 1 % | 2.60 dB | .1 % | 3.12 dB | .01 % | 3.36 dB |
| 10 % | 1.76 dB | | | | | | | | | | | | | | | | |
| 1 % | 2.68 dB | | | | | | | | | | | | | | | | |
| .1 % | 3.20 dB | | | | | | | | | | | | | | | | |
| .01 % | 3.40 dB | | | | | | | | | | | | | | | | |
| 10 % | 1.72 dB | | | | | | | | | | | | | | | | |
| 1 % | 2.60 dB | | | | | | | | | | | | | | | | |
| .1 % | 3.12 dB | | | | | | | | | | | | | | | | |
| .01 % | 3.36 dB | | | | | | | | | | | | | | | | |



26dB Bandwidth

| Mode | WCDMA Band V 26dB BW(MHz) | WCDMA Band II 26dB BW(MHz) |
|-------------------|--------------------------------------|---------------------------------------|
| Mod. | RMC 12.2Kbps | RMC 12.2Kbps |
| Lowest CH | 4.70 | 4.71 |
| Middle CH | 4.71 | 4.72 |
| Highest CH | 4.72 | 4.71 |



WCDMA Band V (RMC 12.2Kbps)

WCDMA Band II (RMC 12.2Kbps)

Lowest Channel

Lowest Channel

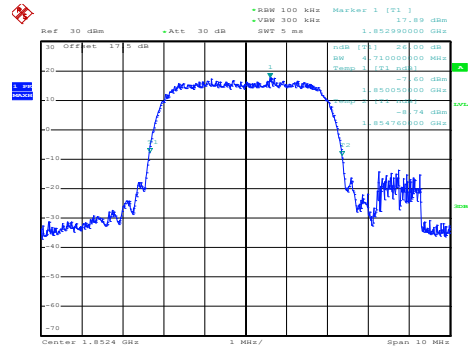
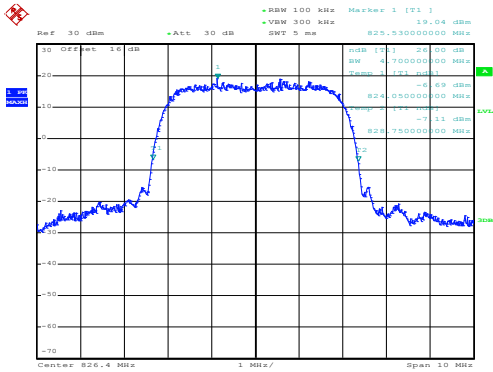

Date: 7.MAY.2020 10:31:06

Date: 7.MAY.2020 10:14:09

Middle Channel

Middle Channel

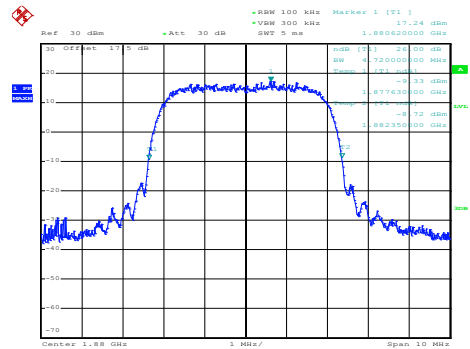
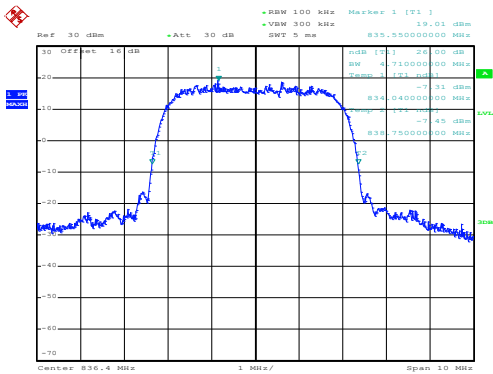

Date: 7.MAY.2020 10:31:50

Date: 7.MAY.2020 10:14:43

Highest Channel

Highest Channel

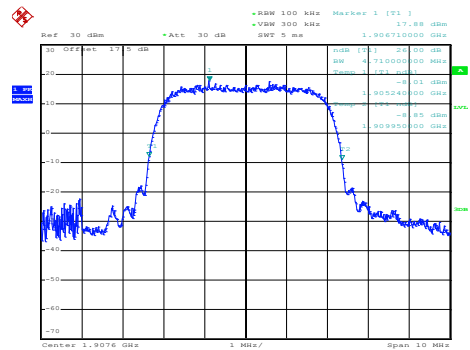
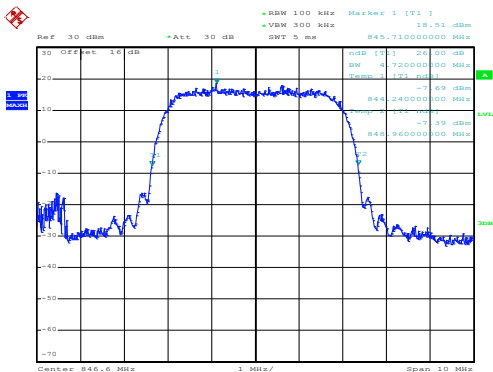

Date: 7.MAY.2020 10:32:27

Date: 7.MAY.2020 10:15:16



Occupied Bandwidth

| Mode | WCDMA Band V 99% OBW(MHz) | WCDMA Band II 99% OBW(MHz) |
|-------------------|--------------------------------------|---------------------------------------|
| Mod. | RMC 12.2Kbps | RMC 12.2Kbps |
| Lowest CH | 4.15 | 4.14 |
| Middle CH | 4.15 | 4.13 |
| Highest CH | 4.14 | 4.13 |



| WCDMA Band V (RMC 12.2Kbps) | WCDMA Band II (RMC 12.2Kbps) |
|---|--|
| <p style="text-align: center;">Lowest Channel</p> <p>Ref: 30 dBm, Att: 30 dB, RBW: 100 kHz, VSW: 300 kHz, SWF: 5 ms, Marker 1: 18.07 dBm, Center: 826.4 MHz, Span: 10 MHz.</p> <p>Date: 7.MAY.2020 10:36:16</p> | <p style="text-align: center;">Lowest Channel</p> <p>Ref: 30 dBm, Att: 30 dB, RBW: 100 kHz, VSW: 300 kHz, SWF: 5 ms, Marker 1: 18.13 dBm, Center: 1.8524 GHz, Span: 10 MHz.</p> <p>Date: 7.MAY.2020 10:19:16</p> |
| <p style="text-align: center;">Middle Channel</p> <p>Ref: 30 dBm, Att: 30 dB, RBW: 100 kHz, VSW: 300 kHz, SWF: 5 ms, Marker 1: 18.03 dBm, Center: 836.4 MHz, Span: 10 MHz.</p> <p>Date: 7.MAY.2020 10:36:54</p> | <p style="text-align: center;">Middle Channel</p> <p>Ref: 30 dBm, Att: 30 dB, RBW: 100 kHz, VSW: 300 kHz, SWF: 5 ms, Marker 1: 17.74 dBm, Center: 1.88 GHz, Span: 10 MHz.</p> <p>Date: 7.MAY.2020 10:19:50</p> |
| <p style="text-align: center;">Highest Channel</p> <p>Ref: 30 dBm, Att: 30 dB, RBW: 100 kHz, VSW: 300 kHz, SWF: 5 ms, Marker 1: 18.78 dBm, Center: 846.6 MHz, Span: 10 MHz.</p> <p>Date: 7.MAY.2020 10:37:45</p> | <p style="text-align: center;">Highest Channel</p> <p>Ref: 30 dBm, Att: 30 dB, RBW: 100 kHz, VSW: 300 kHz, SWF: 5 ms, Marker 1: 17.45 dBm, Center: 1.9076 GHz, Span: 10 MHz.</p> <p>Date: 7.MAY.2020 10:20:24</p> |



Conducted Band Edge

WCDMA Band V (RMC 12.2Kbps)

Lowest Band Edge

Highest Band Edge

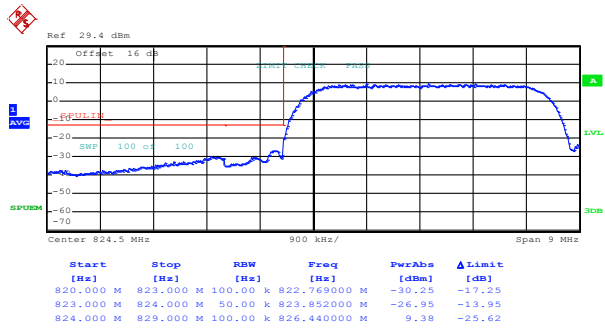

Date: 7.MAY.2020 10:40:34

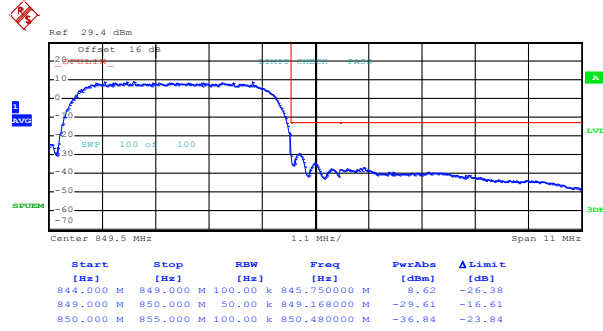

Date: 7.MAY.2020 10:43:25

WCDMA Band II (RMC 12.2Kbps)

Lowest Band Edge

Highest Band Edge

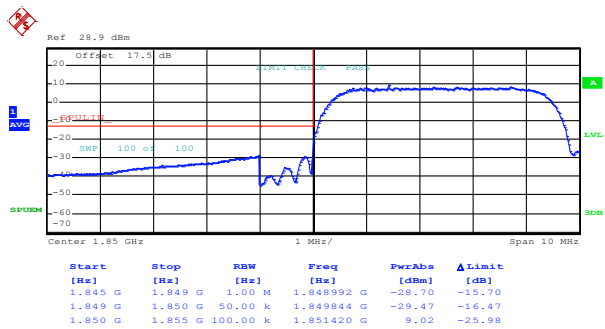

Date: 7.MAY.2020 10:23:18

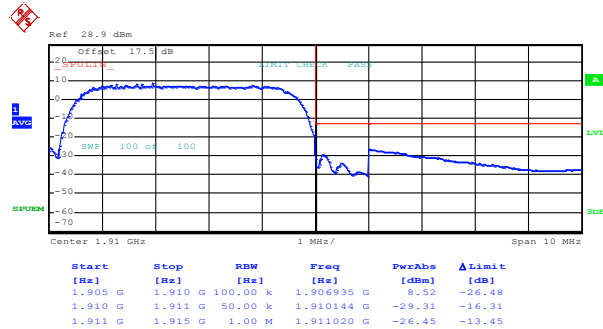

Date: 7.MAY.2020 10:29:32

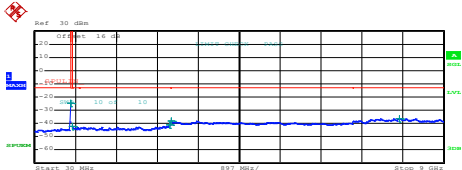
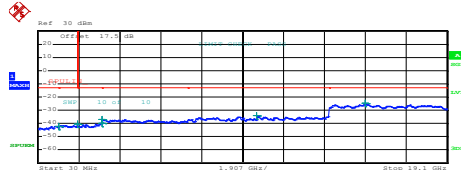
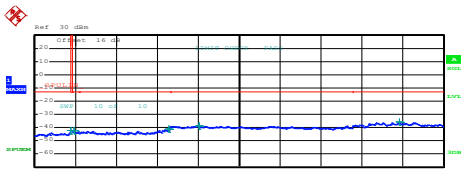
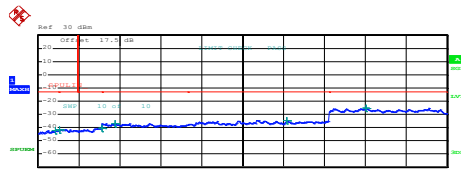
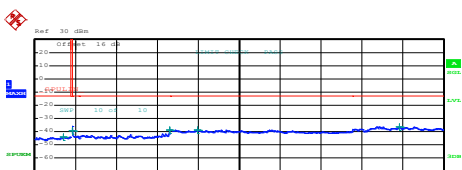
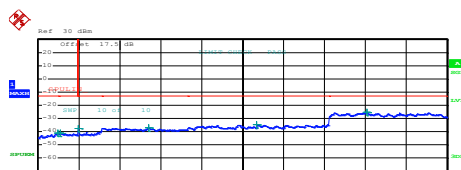

Conducted Spurious Emission

| WCDMA Band V (RMC 12.2Kbps) | WCDMA Band II (RMC 12.2Kbps) | | | | | | | | | | | | | | | | | | | | | | | | | | | | | | | | | | | | | | | | | | | | | | | | | | | | | | | | | | | | | | | | | | | | | | | | | | | | | | |
|---|------------------------------|-----------|--------------|--------------|--------------|-------------|----------|-----------|---------|--------------|--------|--------|-----------|---------|---------|--------------|--------|--------|---------|---------|---------|------------|--------|--------|---------|---------|---------|------------|--------|--------|---------|---------|---------|------------|--------|--------|--|------------|-----------|----------|-----------|--------------|-------------|----------|---------|---------|--------------|--------|--------|---------|---------|---------|------------|--------|--------|---------|---------|---------|------------|--------|--------|---------|---------|---------|------------|--------|--------|---------|----------|---------|-------------|--------|--------|----------|----------|---------|-------------|--------|--------|
| Lowest Channel | Lowest Channel | | | | | | | | | | | | | | | | | | | | | | | | | | | | | | | | | | | | | | | | | | | | | | | | | | | | | | | | | | | | | | | | | | | | | | | | | | | | | | |
|  <table border="1" data-bbox="239 660 654 739"> <thead> <tr> <th>Start [Hz]</th> <th>Stop [Hz]</th> <th>RBW [Hz]</th> <th>Freq [Hz]</th> <th>PerAbs [dBm]</th> <th>ΔLimit [dB]</th> </tr> </thead> <tbody> <tr> <td>30,000 M</td> <td>820,000 M</td> <td>1,000 M</td> <td>818,407500 M</td> <td>-24.83</td> <td>-11.83</td> </tr> <tr> <td>855,000 M</td> <td>1,000 G</td> <td>1,000 M</td> <td>862,702500 M</td> <td>-41.95</td> <td>-28.95</td> </tr> <tr> <td>1,000 G</td> <td>3,000 G</td> <td>1,000 M</td> <td>2,900000 G</td> <td>-42.24</td> <td>-28.24</td> </tr> <tr> <td>3,000 G</td> <td>7,000 G</td> <td>1,000 M</td> <td>3,000000 G</td> <td>-38.16</td> <td>-25.16</td> </tr> <tr> <td>7,000 G</td> <td>9,000 G</td> <td>1,000 M</td> <td>8,029000 G</td> <td>-36.36</td> <td>-23.36</td> </tr> </tbody> </table> <p>Date: 7.MAY.2020 10:44:57</p> | Start [Hz] | Stop [Hz] | RBW [Hz] | Freq [Hz] | PerAbs [dBm] | ΔLimit [dB] | 30,000 M | 820,000 M | 1,000 M | 818,407500 M | -24.83 | -11.83 | 855,000 M | 1,000 G | 1,000 M | 862,702500 M | -41.95 | -28.95 | 1,000 G | 3,000 G | 1,000 M | 2,900000 G | -42.24 | -28.24 | 3,000 G | 7,000 G | 1,000 M | 3,000000 G | -38.16 | -25.16 | 7,000 G | 9,000 G | 1,000 M | 8,029000 G | -36.36 | -23.36 |  <table border="1" data-bbox="885 660 1300 739"> <thead> <tr> <th>Start [Hz]</th> <th>Stop [Hz]</th> <th>RBW [Hz]</th> <th>Freq [Hz]</th> <th>PerAbs [dBm]</th> <th>ΔLimit [dB]</th> </tr> </thead> <tbody> <tr> <td>30,000 M</td> <td>3,000 G</td> <td>1,000 M</td> <td>992,725000 M</td> <td>-42.07</td> <td>-29.07</td> </tr> <tr> <td>1,000 G</td> <td>1,845 G</td> <td>1,000 M</td> <td>1,843500 G</td> <td>-40.71</td> <td>-27.71</td> </tr> <tr> <td>1,915 G</td> <td>3,000 G</td> <td>1,000 M</td> <td>2,998879 G</td> <td>-39.61</td> <td>-26.61</td> </tr> <tr> <td>3,000 G</td> <td>7,000 G</td> <td>1,000 M</td> <td>3,011000 G</td> <td>-37.03</td> <td>-24.03</td> </tr> <tr> <td>7,000 G</td> <td>13,600 G</td> <td>1,000 M</td> <td>10,216675 G</td> <td>-34.06</td> <td>-21.06</td> </tr> <tr> <td>13,600 G</td> <td>19,100 G</td> <td>1,000 M</td> <td>15,362500 G</td> <td>-24.77</td> <td>-11.77</td> </tr> </tbody> </table> <p>Date: 7.MAY.2020 10:16:14</p> | Start [Hz] | Stop [Hz] | RBW [Hz] | Freq [Hz] | PerAbs [dBm] | ΔLimit [dB] | 30,000 M | 3,000 G | 1,000 M | 992,725000 M | -42.07 | -29.07 | 1,000 G | 1,845 G | 1,000 M | 1,843500 G | -40.71 | -27.71 | 1,915 G | 3,000 G | 1,000 M | 2,998879 G | -39.61 | -26.61 | 3,000 G | 7,000 G | 1,000 M | 3,011000 G | -37.03 | -24.03 | 7,000 G | 13,600 G | 1,000 M | 10,216675 G | -34.06 | -21.06 | 13,600 G | 19,100 G | 1,000 M | 15,362500 G | -24.77 | -11.77 |
| Start [Hz] | Stop [Hz] | RBW [Hz] | Freq [Hz] | PerAbs [dBm] | ΔLimit [dB] | | | | | | | | | | | | | | | | | | | | | | | | | | | | | | | | | | | | | | | | | | | | | | | | | | | | | | | | | | | | | | | | | | | | | | | | | | |
| 30,000 M | 820,000 M | 1,000 M | 818,407500 M | -24.83 | -11.83 | | | | | | | | | | | | | | | | | | | | | | | | | | | | | | | | | | | | | | | | | | | | | | | | | | | | | | | | | | | | | | | | | | | | | | | | | | |
| 855,000 M | 1,000 G | 1,000 M | 862,702500 M | -41.95 | -28.95 | | | | | | | | | | | | | | | | | | | | | | | | | | | | | | | | | | | | | | | | | | | | | | | | | | | | | | | | | | | | | | | | | | | | | | | | | | |
| 1,000 G | 3,000 G | 1,000 M | 2,900000 G | -42.24 | -28.24 | | | | | | | | | | | | | | | | | | | | | | | | | | | | | | | | | | | | | | | | | | | | | | | | | | | | | | | | | | | | | | | | | | | | | | | | | | |
| 3,000 G | 7,000 G | 1,000 M | 3,000000 G | -38.16 | -25.16 | | | | | | | | | | | | | | | | | | | | | | | | | | | | | | | | | | | | | | | | | | | | | | | | | | | | | | | | | | | | | | | | | | | | | | | | | | |
| 7,000 G | 9,000 G | 1,000 M | 8,029000 G | -36.36 | -23.36 | | | | | | | | | | | | | | | | | | | | | | | | | | | | | | | | | | | | | | | | | | | | | | | | | | | | | | | | | | | | | | | | | | | | | | | | | | |
| Start [Hz] | Stop [Hz] | RBW [Hz] | Freq [Hz] | PerAbs [dBm] | ΔLimit [dB] | | | | | | | | | | | | | | | | | | | | | | | | | | | | | | | | | | | | | | | | | | | | | | | | | | | | | | | | | | | | | | | | | | | | | | | | | | |
| 30,000 M | 3,000 G | 1,000 M | 992,725000 M | -42.07 | -29.07 | | | | | | | | | | | | | | | | | | | | | | | | | | | | | | | | | | | | | | | | | | | | | | | | | | | | | | | | | | | | | | | | | | | | | | | | | | |
| 1,000 G | 1,845 G | 1,000 M | 1,843500 G | -40.71 | -27.71 | | | | | | | | | | | | | | | | | | | | | | | | | | | | | | | | | | | | | | | | | | | | | | | | | | | | | | | | | | | | | | | | | | | | | | | | | | |
| 1,915 G | 3,000 G | 1,000 M | 2,998879 G | -39.61 | -26.61 | | | | | | | | | | | | | | | | | | | | | | | | | | | | | | | | | | | | | | | | | | | | | | | | | | | | | | | | | | | | | | | | | | | | | | | | | | |
| 3,000 G | 7,000 G | 1,000 M | 3,011000 G | -37.03 | -24.03 | | | | | | | | | | | | | | | | | | | | | | | | | | | | | | | | | | | | | | | | | | | | | | | | | | | | | | | | | | | | | | | | | | | | | | | | | | |
| 7,000 G | 13,600 G | 1,000 M | 10,216675 G | -34.06 | -21.06 | | | | | | | | | | | | | | | | | | | | | | | | | | | | | | | | | | | | | | | | | | | | | | | | | | | | | | | | | | | | | | | | | | | | | | | | | | |
| 13,600 G | 19,100 G | 1,000 M | 15,362500 G | -24.77 | -11.77 | | | | | | | | | | | | | | | | | | | | | | | | | | | | | | | | | | | | | | | | | | | | | | | | | | | | | | | | | | | | | | | | | | | | | | | | | | |
| Middle Channel | Middle Channel | | | | | | | | | | | | | | | | | | | | | | | | | | | | | | | | | | | | | | | | | | | | | | | | | | | | | | | | | | | | | | | | | | | | | | | | | | | | | | |
|  <table border="1" data-bbox="239 1176 654 1254"> <thead> <tr> <th>Start [Hz]</th> <th>Stop [Hz]</th> <th>RBW [Hz]</th> <th>Freq [Hz]</th> <th>PerAbs [dBm]</th> <th>ΔLimit [dB]</th> </tr> </thead> <tbody> <tr> <td>30,000 M</td> <td>820,000 M</td> <td>1,000 M</td> <td>818,417500 M</td> <td>-42.15</td> <td>-29.15</td> </tr> <tr> <td>855,000 M</td> <td>1,000 G</td> <td>1,000 M</td> <td>871,108750 M</td> <td>-42.26</td> <td>-29.26</td> </tr> <tr> <td>1,000 G</td> <td>3,000 G</td> <td>1,000 M</td> <td>2,981000 G</td> <td>-41.34</td> <td>-28.34</td> </tr> <tr> <td>3,000 G</td> <td>7,000 G</td> <td>1,000 M</td> <td>3,000000 G</td> <td>-38.03</td> <td>-25.03</td> </tr> <tr> <td>7,000 G</td> <td>9,000 G</td> <td>1,000 M</td> <td>8,037500 G</td> <td>-36.06</td> <td>-23.06</td> </tr> </tbody> </table> <p>Date: 7.MAY.2020 10:45:48</p> | Start [Hz] | Stop [Hz] | RBW [Hz] | Freq [Hz] | PerAbs [dBm] | ΔLimit [dB] | 30,000 M | 820,000 M | 1,000 M | 818,417500 M | -42.15 | -29.15 | 855,000 M | 1,000 G | 1,000 M | 871,108750 M | -42.26 | -29.26 | 1,000 G | 3,000 G | 1,000 M | 2,981000 G | -41.34 | -28.34 | 3,000 G | 7,000 G | 1,000 M | 3,000000 G | -38.03 | -25.03 | 7,000 G | 9,000 G | 1,000 M | 8,037500 G | -36.06 | -23.06 |  <table border="1" data-bbox="885 1176 1300 1254"> <thead> <tr> <th>Start [Hz]</th> <th>Stop [Hz]</th> <th>RBW [Hz]</th> <th>Freq [Hz]</th> <th>PerAbs [dBm]</th> <th>ΔLimit [dB]</th> </tr> </thead> <tbody> <tr> <td>30,000 M</td> <td>3,000 G</td> <td>1,000 M</td> <td>827,097500 M</td> <td>-42.00</td> <td>-29.00</td> </tr> <tr> <td>1,000 G</td> <td>3,845 G</td> <td>1,000 M</td> <td>3,029300 G</td> <td>-43.45</td> <td>-29.45</td> </tr> <tr> <td>1,915 G</td> <td>3,000 G</td> <td>1,000 M</td> <td>2,995389 G</td> <td>-40.43</td> <td>-27.43</td> </tr> <tr> <td>3,000 G</td> <td>7,000 G</td> <td>1,000 M</td> <td>3,002000 G</td> <td>-34.86</td> <td>-23.86</td> </tr> <tr> <td>7,000 G</td> <td>13,600 G</td> <td>1,000 M</td> <td>11,607625 G</td> <td>-34.46</td> <td>-21.46</td> </tr> <tr> <td>13,600 G</td> <td>19,100 G</td> <td>1,000 M</td> <td>15,338000 G</td> <td>-25.28</td> <td>-12.28</td> </tr> </tbody> </table> <p>Date: 7.MAY.2020 10:17:07</p> | Start [Hz] | Stop [Hz] | RBW [Hz] | Freq [Hz] | PerAbs [dBm] | ΔLimit [dB] | 30,000 M | 3,000 G | 1,000 M | 827,097500 M | -42.00 | -29.00 | 1,000 G | 3,845 G | 1,000 M | 3,029300 G | -43.45 | -29.45 | 1,915 G | 3,000 G | 1,000 M | 2,995389 G | -40.43 | -27.43 | 3,000 G | 7,000 G | 1,000 M | 3,002000 G | -34.86 | -23.86 | 7,000 G | 13,600 G | 1,000 M | 11,607625 G | -34.46 | -21.46 | 13,600 G | 19,100 G | 1,000 M | 15,338000 G | -25.28 | -12.28 |
| Start [Hz] | Stop [Hz] | RBW [Hz] | Freq [Hz] | PerAbs [dBm] | ΔLimit [dB] | | | | | | | | | | | | | | | | | | | | | | | | | | | | | | | | | | | | | | | | | | | | | | | | | | | | | | | | | | | | | | | | | | | | | | | | | | |
| 30,000 M | 820,000 M | 1,000 M | 818,417500 M | -42.15 | -29.15 | | | | | | | | | | | | | | | | | | | | | | | | | | | | | | | | | | | | | | | | | | | | | | | | | | | | | | | | | | | | | | | | | | | | | | | | | | |
| 855,000 M | 1,000 G | 1,000 M | 871,108750 M | -42.26 | -29.26 | | | | | | | | | | | | | | | | | | | | | | | | | | | | | | | | | | | | | | | | | | | | | | | | | | | | | | | | | | | | | | | | | | | | | | | | | | |
| 1,000 G | 3,000 G | 1,000 M | 2,981000 G | -41.34 | -28.34 | | | | | | | | | | | | | | | | | | | | | | | | | | | | | | | | | | | | | | | | | | | | | | | | | | | | | | | | | | | | | | | | | | | | | | | | | | |
| 3,000 G | 7,000 G | 1,000 M | 3,000000 G | -38.03 | -25.03 | | | | | | | | | | | | | | | | | | | | | | | | | | | | | | | | | | | | | | | | | | | | | | | | | | | | | | | | | | | | | | | | | | | | | | | | | | |
| 7,000 G | 9,000 G | 1,000 M | 8,037500 G | -36.06 | -23.06 | | | | | | | | | | | | | | | | | | | | | | | | | | | | | | | | | | | | | | | | | | | | | | | | | | | | | | | | | | | | | | | | | | | | | | | | | | |
| Start [Hz] | Stop [Hz] | RBW [Hz] | Freq [Hz] | PerAbs [dBm] | ΔLimit [dB] | | | | | | | | | | | | | | | | | | | | | | | | | | | | | | | | | | | | | | | | | | | | | | | | | | | | | | | | | | | | | | | | | | | | | | | | | | |
| 30,000 M | 3,000 G | 1,000 M | 827,097500 M | -42.00 | -29.00 | | | | | | | | | | | | | | | | | | | | | | | | | | | | | | | | | | | | | | | | | | | | | | | | | | | | | | | | | | | | | | | | | | | | | | | | | | |
| 1,000 G | 3,845 G | 1,000 M | 3,029300 G | -43.45 | -29.45 | | | | | | | | | | | | | | | | | | | | | | | | | | | | | | | | | | | | | | | | | | | | | | | | | | | | | | | | | | | | | | | | | | | | | | | | | | |
| 1,915 G | 3,000 G | 1,000 M | 2,995389 G | -40.43 | -27.43 | | | | | | | | | | | | | | | | | | | | | | | | | | | | | | | | | | | | | | | | | | | | | | | | | | | | | | | | | | | | | | | | | | | | | | | | | | |
| 3,000 G | 7,000 G | 1,000 M | 3,002000 G | -34.86 | -23.86 | | | | | | | | | | | | | | | | | | | | | | | | | | | | | | | | | | | | | | | | | | | | | | | | | | | | | | | | | | | | | | | | | | | | | | | | | | |
| 7,000 G | 13,600 G | 1,000 M | 11,607625 G | -34.46 | -21.46 | | | | | | | | | | | | | | | | | | | | | | | | | | | | | | | | | | | | | | | | | | | | | | | | | | | | | | | | | | | | | | | | | | | | | | | | | | |
| 13,600 G | 19,100 G | 1,000 M | 15,338000 G | -25.28 | -12.28 | | | | | | | | | | | | | | | | | | | | | | | | | | | | | | | | | | | | | | | | | | | | | | | | | | | | | | | | | | | | | | | | | | | | | | | | | | |
| Highest Channel | Highest Channel | | | | | | | | | | | | | | | | | | | | | | | | | | | | | | | | | | | | | | | | | | | | | | | | | | | | | | | | | | | | | | | | | | | | | | | | | | | | | | |
|  <table border="1" data-bbox="239 1691 654 1769"> <thead> <tr> <th>Start [Hz]</th> <th>Stop [Hz]</th> <th>RBW [Hz]</th> <th>Freq [Hz]</th> <th>PerAbs [dBm]</th> <th>ΔLimit [dB]</th> </tr> </thead> <tbody> <tr> <td>30,000 M</td> <td>820,000 M</td> <td>1,000 M</td> <td>850,187500 M</td> <td>-42.72</td> <td>-29.72</td> </tr> <tr> <td>855,000 M</td> <td>1,000 G</td> <td>1,000 M</td> <td>855,108750 M</td> <td>-39.24</td> <td>-26.24</td> </tr> <tr> <td>1,000 G</td> <td>3,000 G</td> <td>1,000 M</td> <td>2,988000 G</td> <td>-38.76</td> <td>-25.76</td> </tr> <tr> <td>3,000 G</td> <td>7,000 G</td> <td>1,000 M</td> <td>3,000000 G</td> <td>-38.68</td> <td>-25.68</td> </tr> <tr> <td>7,000 G</td> <td>9,000 G</td> <td>1,000 M</td> <td>8,030000 G</td> <td>-36.18</td> <td>-23.18</td> </tr> </tbody> </table> <p>Date: 7.MAY.2020 10:46:38</p> | Start [Hz] | Stop [Hz] | RBW [Hz] | Freq [Hz] | PerAbs [dBm] | ΔLimit [dB] | 30,000 M | 820,000 M | 1,000 M | 850,187500 M | -42.72 | -29.72 | 855,000 M | 1,000 G | 1,000 M | 855,108750 M | -39.24 | -26.24 | 1,000 G | 3,000 G | 1,000 M | 2,988000 G | -38.76 | -25.76 | 3,000 G | 7,000 G | 1,000 M | 3,000000 G | -38.68 | -25.68 | 7,000 G | 9,000 G | 1,000 M | 8,030000 G | -36.18 | -23.18 |  <table border="1" data-bbox="885 1691 1300 1769"> <thead> <tr> <th>Start [Hz]</th> <th>Stop [Hz]</th> <th>RBW [Hz]</th> <th>Freq [Hz]</th> <th>PerAbs [dBm]</th> <th>ΔLimit [dB]</th> </tr> </thead> <tbody> <tr> <td>30,000 M</td> <td>3,000 G</td> <td>1,000 M</td> <td>856,107500 M</td> <td>-40.80</td> <td>-27.80</td> </tr> <tr> <td>1,000 G</td> <td>1,845 G</td> <td>1,000 M</td> <td>1,070769 G</td> <td>-41.22</td> <td>-28.22</td> </tr> <tr> <td>1,915 G</td> <td>3,000 G</td> <td>1,000 M</td> <td>1,993071 G</td> <td>-37.60</td> <td>-24.60</td> </tr> <tr> <td>3,000 G</td> <td>7,000 G</td> <td>1,000 M</td> <td>5,182000 G</td> <td>-37.06</td> <td>-24.06</td> </tr> <tr> <td>7,000 G</td> <td>13,600 G</td> <td>1,000 M</td> <td>10,216675 G</td> <td>-34.73</td> <td>-21.73</td> </tr> <tr> <td>13,600 G</td> <td>19,100 G</td> <td>1,000 M</td> <td>15,362500 G</td> <td>-25.32</td> <td>-12.32</td> </tr> </tbody> </table> <p>Date: 7.MAY.2020 10:17:59</p> | Start [Hz] | Stop [Hz] | RBW [Hz] | Freq [Hz] | PerAbs [dBm] | ΔLimit [dB] | 30,000 M | 3,000 G | 1,000 M | 856,107500 M | -40.80 | -27.80 | 1,000 G | 1,845 G | 1,000 M | 1,070769 G | -41.22 | -28.22 | 1,915 G | 3,000 G | 1,000 M | 1,993071 G | -37.60 | -24.60 | 3,000 G | 7,000 G | 1,000 M | 5,182000 G | -37.06 | -24.06 | 7,000 G | 13,600 G | 1,000 M | 10,216675 G | -34.73 | -21.73 | 13,600 G | 19,100 G | 1,000 M | 15,362500 G | -25.32 | -12.32 |
| Start [Hz] | Stop [Hz] | RBW [Hz] | Freq [Hz] | PerAbs [dBm] | ΔLimit [dB] | | | | | | | | | | | | | | | | | | | | | | | | | | | | | | | | | | | | | | | | | | | | | | | | | | | | | | | | | | | | | | | | | | | | | | | | | | |
| 30,000 M | 820,000 M | 1,000 M | 850,187500 M | -42.72 | -29.72 | | | | | | | | | | | | | | | | | | | | | | | | | | | | | | | | | | | | | | | | | | | | | | | | | | | | | | | | | | | | | | | | | | | | | | | | | | |
| 855,000 M | 1,000 G | 1,000 M | 855,108750 M | -39.24 | -26.24 | | | | | | | | | | | | | | | | | | | | | | | | | | | | | | | | | | | | | | | | | | | | | | | | | | | | | | | | | | | | | | | | | | | | | | | | | | |
| 1,000 G | 3,000 G | 1,000 M | 2,988000 G | -38.76 | -25.76 | | | | | | | | | | | | | | | | | | | | | | | | | | | | | | | | | | | | | | | | | | | | | | | | | | | | | | | | | | | | | | | | | | | | | | | | | | |
| 3,000 G | 7,000 G | 1,000 M | 3,000000 G | -38.68 | -25.68 | | | | | | | | | | | | | | | | | | | | | | | | | | | | | | | | | | | | | | | | | | | | | | | | | | | | | | | | | | | | | | | | | | | | | | | | | | |
| 7,000 G | 9,000 G | 1,000 M | 8,030000 G | -36.18 | -23.18 | | | | | | | | | | | | | | | | | | | | | | | | | | | | | | | | | | | | | | | | | | | | | | | | | | | | | | | | | | | | | | | | | | | | | | | | | | |
| Start [Hz] | Stop [Hz] | RBW [Hz] | Freq [Hz] | PerAbs [dBm] | ΔLimit [dB] | | | | | | | | | | | | | | | | | | | | | | | | | | | | | | | | | | | | | | | | | | | | | | | | | | | | | | | | | | | | | | | | | | | | | | | | | | |
| 30,000 M | 3,000 G | 1,000 M | 856,107500 M | -40.80 | -27.80 | | | | | | | | | | | | | | | | | | | | | | | | | | | | | | | | | | | | | | | | | | | | | | | | | | | | | | | | | | | | | | | | | | | | | | | | | | |
| 1,000 G | 1,845 G | 1,000 M | 1,070769 G | -41.22 | -28.22 | | | | | | | | | | | | | | | | | | | | | | | | | | | | | | | | | | | | | | | | | | | | | | | | | | | | | | | | | | | | | | | | | | | | | | | | | | |
| 1,915 G | 3,000 G | 1,000 M | 1,993071 G | -37.60 | -24.60 | | | | | | | | | | | | | | | | | | | | | | | | | | | | | | | | | | | | | | | | | | | | | | | | | | | | | | | | | | | | | | | | | | | | | | | | | | |
| 3,000 G | 7,000 G | 1,000 M | 5,182000 G | -37.06 | -24.06 | | | | | | | | | | | | | | | | | | | | | | | | | | | | | | | | | | | | | | | | | | | | | | | | | | | | | | | | | | | | | | | | | | | | | | | | | | |
| 7,000 G | 13,600 G | 1,000 M | 10,216675 G | -34.73 | -21.73 | | | | | | | | | | | | | | | | | | | | | | | | | | | | | | | | | | | | | | | | | | | | | | | | | | | | | | | | | | | | | | | | | | | | | | | | | | |
| 13,600 G | 19,100 G | 1,000 M | 15,362500 G | -25.32 | -12.32 | | | | | | | | | | | | | | | | | | | | | | | | | | | | | | | | | | | | | | | | | | | | | | | | | | | | | | | | | | | | | | | | | | | | | | | | | | |



Frequency Stability

| Test Conditions | Middle Channel | WCDMA Band V (RMC 12.2Kbps) | Limit 2.5ppm |
|------------------|-------------------|--------------------------------|-----------------|
| Temperature (°C) | Voltage (Volt) | Deviation (ppm) | Result |
| 50 | Normal Voltage | 0.0012 | PASS |
| 40 | Normal Voltage | 0.0012 | |
| 30 | Normal Voltage | 0.0000 | |
| 20(Ref.) | Normal Voltage | 0.0000 | |
| 10 | Normal Voltage | 0.0132 | |
| 0 | Normal Voltage | 0.0179 | |
| -10 | Normal Voltage | 0.0179 | |
| -20 | Normal Voltage | 0.0167 | |
| -30 | Normal Voltage | 0.0000 | |
| 20 | Maximum Voltage | 0.0012 | |
| 20 | Normal Voltage | 0.0000 | |
| 20 | Battery End Point | 0.0000 | |

| Test Conditions | Middle Channel | WCDMA Band II (RMC 12.2Kbps) | Limit Note 2. |
|------------------|-------------------|---------------------------------|------------------|
| Temperature (°C) | Voltage (Volt) | Deviation (ppm) | Result |
| 50 | Normal Voltage | 0.0032 | PASS |
| 40 | Normal Voltage | 0.0064 | |
| 30 | Normal Voltage | 0.0005 | |
| 20(Ref.) | Normal Voltage | 0.0000 | |
| 10 | Normal Voltage | 0.0021 | |
| 0 | Normal Voltage | 0.0027 | |
| -10 | Normal Voltage | 0.0032 | |
| -20 | Normal Voltage | 0.0032 | |
| -30 | Normal Voltage | 0.0005 | |
| 20 | Maximum Voltage | 0.0005 | |
| 20 | Normal Voltage | 0.0000 | |
| 20 | Battery End Point | 0.0005 | |

Note:

1. Normal Voltage = 3.8V. ; Battery End Point (BEP) = 3.4 V. ; Maximum Voltage =4.2 V
2. The frequency fundamental emissions stay within the authorized frequency block.



Appendix B. Test Results of ERP/EIRP and Radiated Test

ERP/EIRP

| Channel | Mode | Conducted | | ERP | |
|---------|------------------|-------------|---------------|----------|--------|
| | | Power (dBm) | Power (Watts) | ERP(dBm) | ERP(W) |
| Lowest | WCDMA Band V | 23.66 | 0.2323 | 21.51 | 0.1416 |
| Middle | RMC 12.2Kbps | 23.81 | 0.2404 | 21.66 | 0.1466 |
| Highest | (GT - LC = 0 dB) | 23.27 | 0.2123 | 21.12 | 0.1294 |
| Limit | ERP < 7W | Result | | PASS | |

| Channel | Mode | Conducted | | EIRP | |
|---------|--------------------|-------------|---------------|-----------|---------|
| | | Power (dBm) | Power (Watts) | EIRP(dBm) | EIRP(W) |
| Lowest | WCDMA Band II | 23.60 | 0.2291 | 25.10 | 0.3236 |
| Middle | RMC 12.2Kbps | 23.62 | 0.2301 | 25.12 | 0.3251 |
| Highest | (GT - LC = 1.5 dB) | 23.43 | 0.2203 | 24.93 | 0.3112 |
| Limit | EIRP < 2W | Result | | PASS | |



Radiated Spurious Emission

WCDMA 850

| WCDMA 850 | | | | | | | | | |
|-----------|-------------------|-------------|---------------|-------------------|-------------------|--------------------|----------------------|-----------------------|--------------------|
| Channel | Frequency (MHz) | ERP (dBm) | Limit (dBm) | Over Limit (dB) | SPA Reading (dBm) | S.G. Power (dBm) | TX Cable loss (dB) | TX Antenna Gain (dBi) | Polarization (H/V) |
| Lowest | 1652 | -62.04 | -13 | -49.04 | -75.03 | -67.44 | 1.23 | 8.78 | H |
| | 2479 | -58.91 | -13 | -45.91 | -75.72 | -65.81 | 1.44 | 10.48 | H |
| | 3305 | -57.84 | -13 | -44.84 | -76.38 | -65.79 | 1.71 | 11.82 | H |
| | | | | | | | | | H |
| | 1652 | -62.35 | -13 | -49.35 | -75.21 | -67.75 | 1.23 | 8.78 | V |
| | 2479 | -58.80 | -13 | -45.80 | -75.88 | -65.70 | 1.44 | 10.48 | V |
| | 3305 | -57.09 | -13 | -44.09 | -76.05 | -65.04 | 1.71 | 11.82 | V |
| | | | | | | | | | V |
| Middle | 1672 | -62.01 | -13 | -49.01 | -75.03 | -67.48 | 1.24 | 8.85 | H |
| | 2509 | -58.68 | -13 | -45.68 | -75.45 | -65.60 | 1.44 | 10.51 | H |
| | 3345 | -56.72 | -13 | -43.72 | -75.01 | -64.76 | 1.74 | 11.94 | H |
| | | | | | | | | | H |
| | 1672 | -61.87 | -13 | -48.87 | -74.78 | -67.34 | 1.24 | 8.85 | V |
| | 2509 | -58.33 | -13 | -45.33 | -75.29 | -65.25 | 1.44 | 10.51 | V |
| | 3345 | -56.62 | -13 | -43.62 | -75.44 | -64.66 | 1.74 | 11.94 | V |
| | | | | | | | | | V |
| Highest | 1693 | -61.52 | -13 | -48.52 | -74.57 | -67.06 | 1.24 | 8.93 | H |
| | 2539 | -58.70 | -13 | -45.70 | -75.51 | -65.64 | 1.44 | 10.53 | H |
| | 3386 | -58.03 | -13 | -45.03 | -76.07 | -66.16 | 1.78 | 12.06 | H |
| | | | | | | | | | H |
| | 1693 | -61.35 | -13 | -48.35 | -74.32 | -66.89 | 1.24 | 8.93 | V |
| | 2539 | -58.44 | -13 | -45.44 | -75.47 | -65.38 | 1.44 | 10.53 | V |
| | 3386 | -57.39 | -13 | -44.39 | -76.07 | -65.52 | 1.78 | 12.06 | V |
| | | | | | | | | | V |

Remark: Spurious emissions within 30-1000MHz were found more than 20dB below limit line.



WCDMA 1900

| WCDMA 1900 | | | | | | | | | |
|------------|-------------------|--------------|---------------|-------------------|-------------------|--------------------|----------------------|-----------------------|--------------------|
| Channel | Frequency (MHz) | EIRP (dBm) | Limit (dBm) | Over Limit (dB) | SPA Reading (dBm) | S.G. Power (dBm) | TX Cable loss (dB) | TX Antenna Gain (dBi) | Polarization (H/V) |
| Lowest | 3707 | -50.08 | -13 | -37.08 | -70.63 | -60.38 | 1.98 | 12.28 | H |
| | 5562 | -49.16 | -13 | -36.16 | -72.72 | -59.31 | 2.14 | 12.29 | H |
| | 7414 | -47.69 | -13 | -34.69 | -75.77 | -55.68 | 2.17 | 10.15 | H |
| | | | | | | | | | H |
| | 3707 | -49.45 | -13 | -36.45 | -70.53 | -59.75 | 1.98 | 12.28 | V |
| | 5562 | -50.56 | -13 | -37.56 | -74.74 | -60.71 | 2.14 | 12.29 | V |
| | 7414 | -47.85 | -13 | -34.85 | -75.88 | -55.84 | 2.17 | 10.15 | V |
| | | | | | | | | | V |
| Middle | 3760 | -53.58 | -13 | -40.58 | -74.27 | -63.82 | 2.01 | 12.24 | H |
| | 5640 | -52.02 | -13 | -39.02 | -75.68 | -62.29 | 2.12 | 12.40 | H |
| | 7520 | -48.06 | -13 | -35.06 | -75.86 | -56.02 | 2.11 | 10.07 | H |
| | | | | | | | | | H |
| | 3760 | -54.44 | -13 | -41.44 | -75.62 | -64.68 | 2.01 | 12.24 | V |
| | 5640 | -52.14 | -13 | -39.14 | -76.43 | -62.41 | 2.12 | 12.40 | V |
| | 7520 | -48.12 | -13 | -35.12 | -75.81 | -56.08 | 2.11 | 10.07 | V |
| | | | | | | | | | V |
| Highest | 3812 | -53.19 | -13 | -40.19 | -73.98 | -63.37 | 2.03 | 12.21 | H |
| | 5716 | -50.66 | -13 | -37.66 | -74.68 | -61.06 | 2.11 | 12.50 | H |
| | 7624 | -48.31 | -13 | -35.31 | -75.61 | -56.64 | 2.11 | 10.45 | H |
| | | | | | | | | | H |
| | 3812 | -53.60 | -13 | -40.60 | -74.87 | -63.78 | 2.03 | 12.21 | V |
| | 5716 | -51.83 | -13 | -38.83 | -76.41 | -62.23 | 2.11 | 12.50 | V |
| | 7624 | -48.22 | -13 | -35.22 | -75.56 | -56.55 | 2.11 | 10.45 | V |
| | | | | | | | | | V |

Remark: Spurious emissions within 30-1000MHz were found more than 20dB below limit line.