



FCC RADIO TEST REPORT

FCC ID : ACJFZN1E
Equipment : Tablet Computer
Brand Name : Panasonic
Model Name : FZ-N1KB
Marketing Name : FZ-N1
Applicant : Panasonic Corporation of North America
Two Riverfront Plaza, 9th Floor, Newark, NJ
07102-5490
Manufacturer : Panasonic Mobile Communications Co., Ltd.
600 Saedo-cho, Tsuzuki-ku, Yokohama City
224-8539, Japan
Standard : FCC Part 15 Subpart E §15.407

The product was received on Apr. 22, 2020 and testing was started from Apr. 24, 2020 and completed on May 29, 2020. We, SPORTON INTERNATIONAL INC., EMC & Wireless Communications Laboratory, would like to declare that the tested sample has been evaluated in accordance with the test procedures and has been in compliance with the applicable technical standards.

The report must not be used by the client to claim product certification, approval, or endorsement by TAF or any agency of government.

The test results in this report apply exclusively to the tested model / sample. Without written approval of SPORTON INTERNATIONAL INC. EMC & Wireless Communications Laboratory, the test report shall not be reproduced except in full.

Louis Wu

Approved by: Louis Wu

SPORTON INTERNATIONAL INC. EMC & Wireless Communications Laboratory

No. 52, Huaya 1st Rd., Guishan Dist., Taoyuan City, Taiwan (R.O.C.)



Table of Contents

History of this test report.....	3
Summary of Test Result.....	4
1 General Description	5
1.1 Product Feature of Equipment Under Test.....	5
1.2 Modification of EUT	5
1.3 Testing Location	6
1.4 Applicable Standards.....	6
2 Test Configuration of Equipment Under Test	7
2.1 Carrier Frequency and Channel	7
2.2 Test Mode.....	8
2.3 Connection Diagram of Test System.....	10
2.4 Support Unit used in test configuration and system	11
2.5 EUT Operation Test Setup	11
2.6 Measurement Results Explanation Example.....	11
3 Test Result	12
3.1 26dB & 99% Occupied Bandwidth Measurement	12
3.2 Maximum Conducted Output Power Measurement	14
3.3 Power Spectral Density Measurement	15
3.4 Unwanted Emissions Measurement.....	17
3.5 AC Conducted Emission Measurement.....	22
3.6 Automatically Discontinue Transmission	24
3.7 Antenna Requirements.....	25
4 List of Measuring Equipment.....	26
5 Uncertainty of Evaluation	28
Appendix A. Conducted Test Results	
Appendix B. AC Conducted Emission Test Result	
Appendix C. Radiated Spurious Emission	
Appendix D. Radiated Spurious Emission Plots	
Appendix E. Duty Cycle Plots	
Appendix F. Setup Photographs	



Summary of Test Result

Report Clause	Ref Std. Clause	Test Items	Result (PASS/FAIL)	Remark
3.1	15.403(i)	26dB Bandwidth	Pass	-
3.1	2.1049	99% Occupied Bandwidth	Reporting only	-
3.2	15.407(a)	Maximum Conducted Output Power	Pass	-
3.3	15.407(a)	Power Spectral Density	Pass	-
3.4	15.407(b)	Unwanted Emissions	Pass	Under limit 1.77 dB at 5350.320 MHz
3.5	15.207	AC Conducted Emission	Pass	Under limit 17.85 dB at 0.501 MHz
3.6	15.407(c)	Automatically Discontinue Transmission	Pass	-
3.7	15.203 15.407(a)	Antenna Requirement	Pass	-

Declaration of Conformity:

The test results with all measurement uncertainty excluded are presented in accordance with the regulation limits or requirements declared by manufacturers.

Comments and Explanations:

The declared of product specification for EUT presented in the report are provided by the manufacturer, and the manufacturer takes all the responsibilities for the accuracy of product specification.

Reviewed by: Wii Chang

Report Producer: Yimin Ho



1 General Description

1.1 Product Feature of Equipment Under Test

WCDMA/LTE, Bluetooth, Wi-Fi 2.4GHz 802.11b/g/n/ac, Wi-Fi 5GHz 802.11a/n/ac, NFC, and GNSS.

Product Specification subjective to this standard	
Antenna Type	WWAN: Fixed Internal Antenna WLAN: Monopole Antenna Bluetooth: Monopole Antenna GPS / Glonass: Monopole Antenna NFC: Loop Antenna

Accessories Information		
Cradle	Brand Name	Panasonic
	Model Name	FZ-VEBN111A
AC Adapter 1	Brand Name	Panasonic
	Model Name	CF-AA6413A
AC Adapter 2	Brand Name	Panasonic
	Model Name	FZ-AAE184EM
USB Cable 1	Brand Name	Panasonic
	Model Name	K2KYYYYY00221
USB Cable 2	Brand Name	N/A
	Model Name	SPA-US15
Battery	Brand Name	Panasonic
	Model Name	FZ-VZSUN110U

1.2 Modification of EUT

No modifications are made to the EUT during all test items.



1.3 Testing Location

Test Site	SPORTON INTERNATIONAL INC. EMC & Wireless Communications Laboratory	
Test Site Location	No.52, Huaya 1st Rd., Guishan Dist., Taoyuan City, Taiwan (R.O.C.) TEL: +886-3-327-3456 FAX: +886-3-328-4978	
Test Site No.	Sporton Site No.	
	TH05-HY	CO05-HY

Note: The test site complies with ANSI C63.4 2014 requirement.

Test Site	SPORTON INTERNATIONAL INC. EMC & Wireless Communications Laboratory	
Test Site Location	No.58, Aly. 75, Ln. 564, Wenhua 3rd, Rd., Guishan Dist., Taoyuan City, Taiwan (R.O.C.) TEL: +886-3-327-0868 FAX: +886-3-327-0855	
Test Site No.	Sporton Site No.	
	03CH15-HY	

Note: The test site complies with ANSI C63.4 2014 requirement.

FCC designation No.: TW1190 and TW0007

1.4 Applicable Standards

According to the specifications of the manufacturer, the EUT must comply with the requirements of the following standards:

- ♦ FCC Part 15 Subpart E
- ♦ FCC KDB 789033 D02 General UNII Test Procedures New Rules v02r01.
- ♦ FCC KDB 414788 D01 Radiated Test Site v01r01.
- ♦ ANSI C63.10-2013

Remark:

1. All test items were verified and recorded according to the standards and without any deviation during the test.
2. This EUT has also been tested and complied with the requirements of FCC Part 15, Subpart B, recorded in a separate test report.
3. The TAF code is not including all the FCC KDB listed without accreditation.



2 Test Configuration of Equipment Under Test

- a. The EUT has been associated with peripherals and configuration operated in a manner tended to maximize its emission characteristics in a typical application. Frequency range investigated: conduction emission (150 kHz to 30 MHz), radiation emission (9 kHz to the 10th harmonic of the highest fundamental frequency or to 40 GHz, whichever is lower). For radiated measurement, pre-scanned in three orthogonal panels, X, Y, Z. The worst cases (Y plane) were recorded in this report.
- b. AC power line Conducted Emission was tested under maximum output power.

2.1 Carrier Frequency and Channel

Frequency Band	Channel	Freq. (MHz)	Channel	Freq. (MHz)
5150-5250 MHz Band 1 (U-NII-1)	36	5180	44	5220
	38*	5190	46*	5230
	40	5200	48	5240
	42 [#]	5210		

Frequency Band	Channel	Freq. (MHz)	Channel	Freq. (MHz)
5250-5350 MHz Band 2 (U-NII-2A)	52	5260	60	5300
	54*	5270	62*	5310
	56	5280	64	5320
	58 [#]	5290		

Frequency Band	Channel	Freq. (MHz)	Channel	Freq. (MHz)
5470-5725 MHz Band 3 (U-NII-2C)	100	5500	112	5560
	102*	5510	116	5580
	104	5520	132	5660
	106 [#]	5530	134*	5670
	108	5540	136	5680
	110*	5550	140	5700

Frequency Band	Channel	Freq. (MHz)	Channel	Freq. (MHz)
TDWR Channel	118*	5590	124	5620
	120	5600	126*	5630
	122 [#]	5610	128	5640

Note:

1. The above Frequency and Channel in "*" were 802.11n HT40 and 802.11ac VHT40.
2. The above Frequency and Channel in "[#]" were 802.11ac VHT80.



2.2 Test Mode

Final test modes are considering the modulation and worse data rates as below table.

Modulation	Data Rate
802.11a	6 Mbps
802.11n HT20	MCS0
802.11n HT40	MCS0
802.11ac VHT20 (Covered by HT20)	MCS0
802.11ac VHT40 (Covered by HT40)	MCS0
802.11ac VHT80	MCS0

Test Cases	
AC Conducted Emission	Mode 1 : WCDMA Band V Idle + Bluetooth Link + WLAN (5GHz) Link + Camera (Front) + Earphone + Battery + USB Cable 1 (Charging from AC Adapter 2)
Remark: For Radiated Test Cases, the tests were performed with AC Adapter 2 and USB Cable 1.	



Ch. #		Band I : 5150-5250 MHz	Band II : 5250-5350 MHz	Band III : 5470-5725MHz
		802.11a	802.11a	802.11a
L	Low	36	52	100
M	Middle	44	60	116
H	High	48	64	140

Ch. #		Band I : 5150-5250 MHz	Band II : 5250-5350 MHz	Band III : 5470-5725MHz
		802.11n HT20	802.11n HT20	802.11n HT20
L	Low	36	52	100
M	Middle	44	60	116
H	High	48	64	140

Ch. #		Band I : 5150-5250 MHz	Band II : 5250-5350 MHz	Band III : 5470-5725MHz
		802.11n HT40	802.11n HT40	802.11n HT40
L	Low	38	54	102
M	Middle	-	-	110
H	High	46	62	134

Ch. #		Band I : 5150-5250 MHz	Band II : 5250-5350 MHz	Band III : 5470-5725MHz
		802.11ac VHT80	802.11ac VHT80	802.11ac VHT80
L	Low	-	-	106
M	Middle	42	58	122
H	High	-	-	-

Remark: For radiation spurious emission, the final modulation and the worst data rate was reference the max RF conducted power.

2.3 Connection Diagram of Test System

<WLAN Tx>

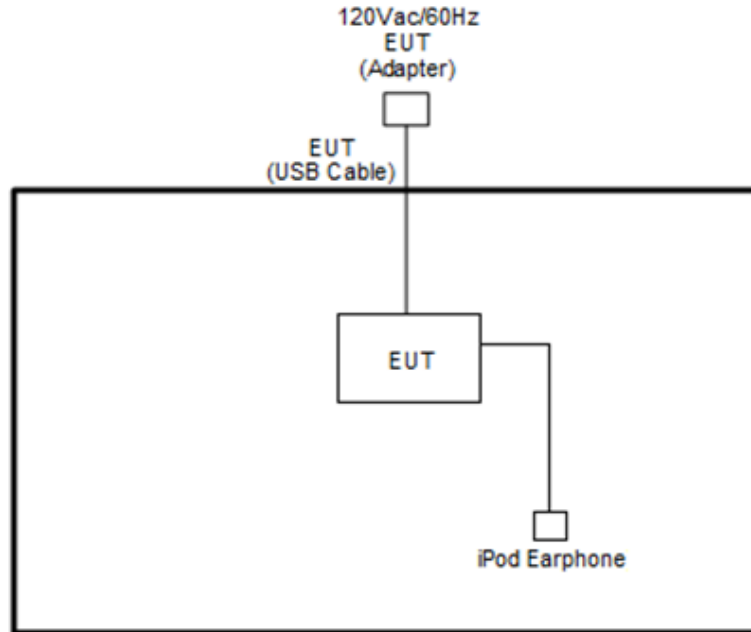

<AC Conducted Emission Mode>

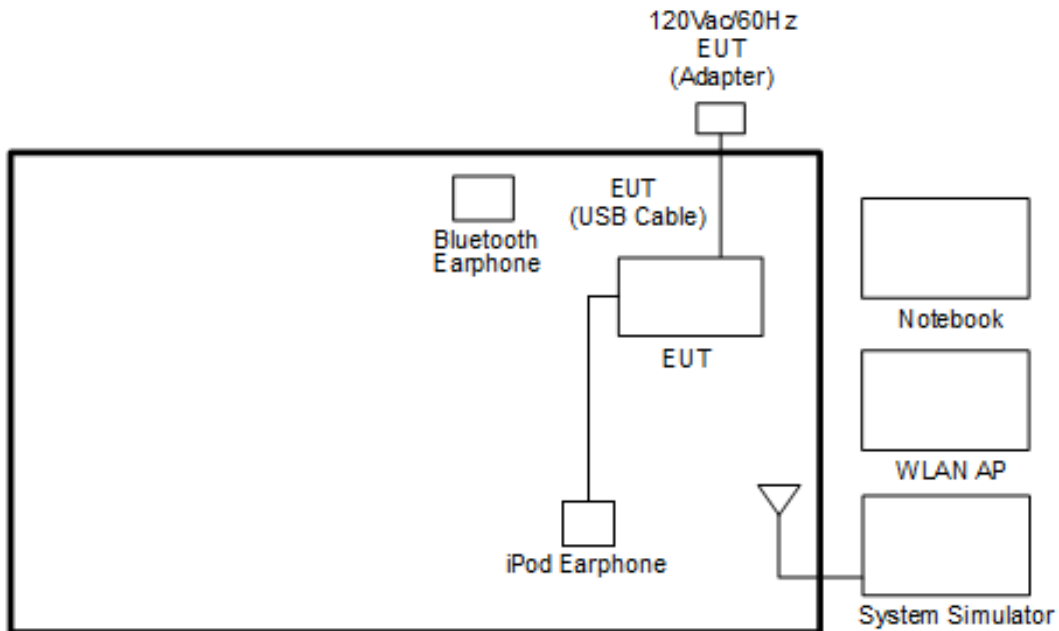



2.4 Support Unit used in test configuration and system

Item	Equipment	Trade Name	Model Name	FCC ID	Data Cable	Power Cord
1.	System Simulator	Anritsu	MT8820C	N/A	N/A	Unshielded, 1.8 m
2.	System Simulator	R&S	CMW 500	N/A	N/A	Unshielded, 1.8 m
3.	Notebook	DELL	Latitude E3340	FCC DoC	N/A	AC I/P: Unshielded, 1.2 m DC O/P: Shielded, 1.8 m
4.	Bluetooth Earphone	Sony Ericsson	MW600	PY7DDA-2029	N/A	N/A
5.	WLAN AP	ASUS	RT-AC66U	MSQ-RTAC66U	N/A	Unshielded, 1.8 m
6.	SD Card	SanDisk	MicroSD HC	FCC DoC	N/A	N/A
7.	iPod Earphone	Apple	N/A	Verification	Unshielded, 1.0m	N/A

2.5 EUT Operation Test Setup

The RF test items, utility "QRCT v3.0.298.0" was installed in Notebook which was programmed in order to make the EUT get into the engineering modes to provide channel selection, power level, data rate and the application type and for continuous transmitting signals.

2.6 Measurement Results Explanation Example

For all conducted test items:

The offset level is set in the spectrum analyzer to compensate the RF cable loss and attenuator factor between EUT conducted output port and spectrum analyzer. With the offset compensation, the spectrum analyzer reading level is exactly the EUT RF output level.

Example :

The spectrum analyzer offset is derived from RF cable loss and attenuator factor.

Offset = RF cable loss + attenuator factor.

Following shows an offset computation example with cable loss 4.2 dB and 10dB attenuator.

$$\begin{aligned} \text{Offset(dB)} &= \text{RF cable loss(dB)} + \text{attenuator factor(dB)}. \\ &= 4.2 + 10 = 14.2 \text{ (dB)} \end{aligned}$$

3 Test Result

3.1 26dB & 99% Occupied Bandwidth Measurement

3.1.1 Description of 26dB & 99% Occupied Bandwidth

This section is for reporting purpose only.

There is no restriction limits for bandwidth.

3.1.2 Measuring Instruments

See list of measuring equipment of this test report.

3.1.3 Test Procedures

1. The testing follows FCC KDB 789033 D02 General UNII Test Procedures New Rules v02r01. Section C) Emission bandwidth
2. Set RBW = approximately 1% of the emission bandwidth.
3. Set the VBW > RBW.
4. Detector = Peak.
5. Trace mode = max hold
6. Measure the maximum width of the emission that is 26 dB down from the peak of the emission. Compare this with the RBW setting of the analyzer. Readjust RBW and repeat measurement as needed until the RBW/EBW ratio is approximately 1%.
7. For 99% Bandwidth Measurement, the spectrum analyzer's resolution bandwidth (RBW) is set 1-5% of the emission bandwidth and set the Video bandwidth (VBW) $\geq 3 * RBW$.
8. Measure and record the results in the test report.

3.1.4 Test Setup

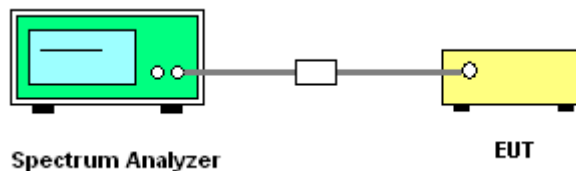

3.1.5 Test Result of 26dB & 99% Occupied Bandwidth

Please refer to Appendix A.

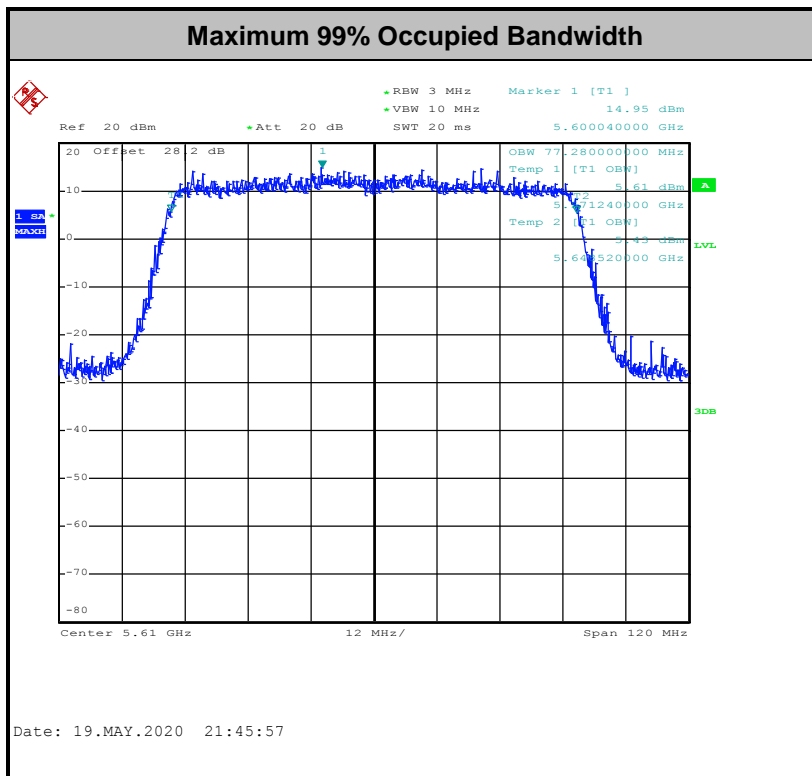
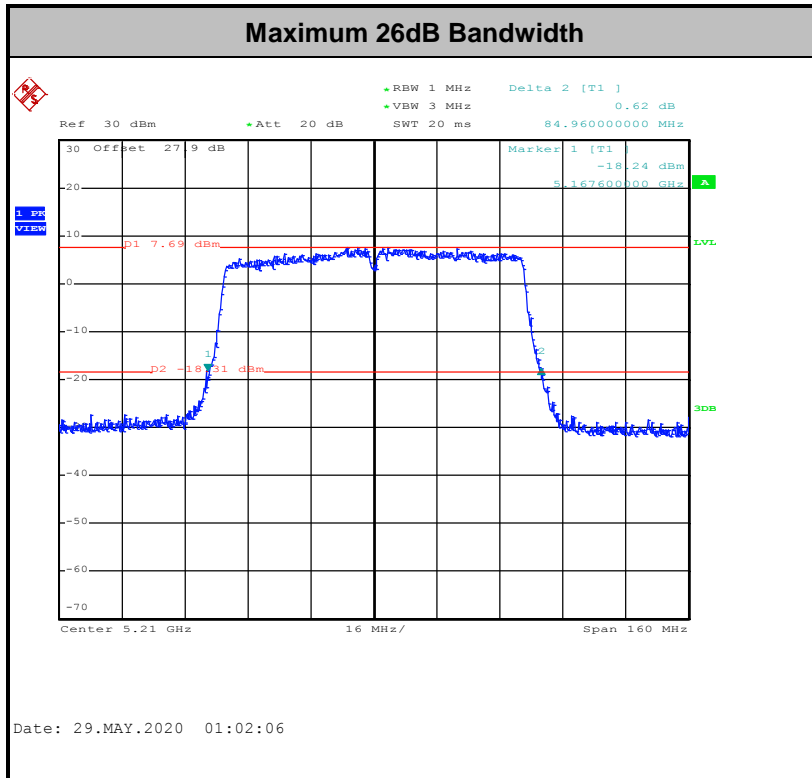

Note: The occupied channel bandwidth is maintained within the band of operation for all of the modulations.

3.2 Maximum Conducted Output Power Measurement

3.2.1 Limit of Maximum Conducted Output Power

<FCC 14-30 CFR 15.407>

For the 5.15–5.25 GHz bands:

- For mobile and portable client devices in the 5.15–5.25 GHz band, the maximum conducted output power over the frequency band of operation shall not exceed 250 mW. For an indoor access point operating in the band 5.15-5.25 GHz, the maximum conducted output power over the frequency band of operation shall not exceed 1 W.

For the 5.25–5.725 GHz bands:

- The maximum conducted output power over the frequency bands of operation shall not exceed the lesser of 250 mW or $11 \text{ dBm} + 10 \log B$, where B is the 26 dB emission bandwidth in megahertz.

If transmitting antennas of directional gain greater than 6 dBi are used, the peak output power shall be reduced by the amount in dB that the directional gain of the antenna exceeds 6 dBi.

Note that U-NII-2 band, devices with a maximum e.i.r.p. greater than 500 mW shall implement TPC in order to have the capability to operate at least 6 dB below the maximum permitted e.i.r.p. of 1 W.

3.2.2 Measuring Instruments

See list of measuring equipment of this test report.

3.2.3 Test Procedures

The testing follows Method PM-G of FCC KDB 789033 D02 General UNII Test Procedures New Rules v02r01.

Method PM-G (Measurement using an RF average power meter):

1. Measurement is performed using a wideband RF power meter.
2. The EUT is configured to transmit at its maximum power control level.
3. Measure the average power of the transmitter
4. Since the measurement is made only during the ON time of the transmitter, no duty cycle correction factor is required.

3.2.4 Test Setup

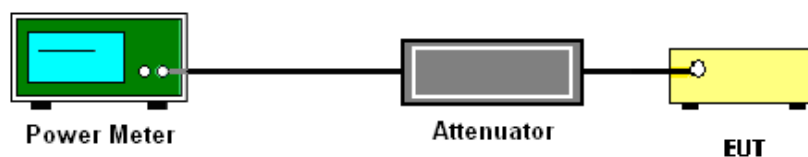

3.2.5 Test Result of Maximum Conducted Output Power

Please refer to Appendix A.



3.3 Power Spectral Density Measurement

3.3.1 Limit of Power Spectral Density

<FCC 14-30 CFR 15.407>

For the 5.15–5.25 GHz bands:

For mobile and portable client devices in the 5.15–5.25 GHz band, the maximum power spectral density shall not exceed 11 dBm in any 1.0 MHz band. For an indoor access point operating in the band 5.15-5.25 GHz, the maximum power spectral density shall not exceed 17 dBm in any 1.0 MHz band.

For the 5.25–5.725 GHz bands:

The maximum power spectral density shall not exceed 11 dBm in any 1.0 MHz band.

If transmitting antennas of directional gain greater than 6 dBi are used, the peak output power shall be reduced by the amount in dB that the directional gain of the antenna exceeds 6 dBi.

3.3.2 Measuring Instruments

See list of measuring equipment of this test report.

3.3.3 Test Procedures

The testing follows FCC KDB 789033 D02 General UNII Test Procedures New Rules v02r01. Section F) Maximum power spectral density.

Method SA-3

(power averaging (rms) detection with max hold):

- Set span to encompass the entire emission bandwidth (EBW) of the signal.
 - Set RBW = 1 MHz.
 - Set VBW \geq 3 MHz
 - Number of points in sweep \geq 2 Span / RBW.
 - Sweep time \leq (number of points in sweep) \times T, when duty cycle is less than 98 percent where T is the minimum transmission duration over which the transmitter is on and is transmitting at its maximum power control level for the tested mode of operation.
 - Detector = power averaging (rms).
 - Trace mode = max hold.
 - Allow max hold to run for at least 60 seconds, or longer as needed to allow the trace to stabilize.
1. The RF output of EUT was connected to the spectrum analyzer by a low loss cable.
 2. Each plot has already offset with cable loss, and attenuator loss. Measure the PPSD and record it.



3.4 Unwanted Emissions Measurement

This section is to measure unwanted emissions through radiated measurement for band edge spurious emissions and out of band emissions measurement.

3.4.1 Limit of Unwanted Emissions

- (1) For transmitters operating in the 5150-5250 MHz band: all emissions outside of the 5150-5350 MHz band shall not exceed an EIRP of -27dBm/MHz.

For transmitters operating in the 5250-5350 MHz band: all emissions outside of the 5150-5350 MHz band shall not exceed an EIRP of -27 dBm/MHz. Devices operating in the 5250-5350 MHz band that generate emissions in the 5150-5250 MHz band must meet all applicable technical requirements for operation in the 5150-5250 MHz band (including indoor use) or alternatively meet an out-of-band emission EIRP limit of -27 dBm/MHz in the 5150-5250 MHz band.

For transmitters operating in the 5470-5600 MHz and 5650-5725MHz band: all emissions outside of the 5470-5600 MHz and 5650-5725MHz band shall not exceed an EIRP of -27 dBm/MHz.

- (2) Unwanted spurious emissions fallen in restricted bands shall comply with the general field strength limits as below table:

Frequency (MHz)	Field Strength (microvolts/meter)	Measurement Distance (meters)
0.009 – 0.490	2400/F(kHz)	300
0.490 – 1.705	24000/F(kHz)	30
1.705 – 30.0	30	30
30 – 88	100	3
88 – 216	150	3
216 - 960	200	3
Above 960	500	3

Note: The following formula is used to convert the EIRP to field strength.

$$E = \frac{1000000\sqrt{30P}}{3} \text{ } \mu\text{V/m, where P is the eirp (Watts)}$$



EIRP (dBm)	Field Strength at 3m (dBμV/m)
- 27	68.3

(3) KDB789033 D02 v02r01 G)2)c)

- (i) Sections 15.407(b)(1-3) specifies the unwanted emissions limit for the U-NII-1 and U-NII-2 bands. As specified, emissions above 1000 MHz that are outside of the restricted bands are subject to a peak emission limit of -27 dBm/MHz.
- (ii) Section 15.407(b)(4) specifies the unwanted emissions limit for the U-NII-3 band. A band emissions mask is specified in Section 15.407(b)(4)(i). The emission limits are based on the use of a peak detector.

3.4.2 Measuring Instruments

See list of measuring equipment of this test report.

3.4.3 Test Procedures

1. The testing follows FCC KDB 789033 D02 General UNII Test Procedures New Rules v02r01. Section G) Unwanted emissions measurement.

(1) Procedure for Unwanted Emissions Measurements Below 1000MHz

- RBW = 120 kHz
- VBW = 300 kHz
- Detector = Peak
- Trace mode = max hold

(2) Procedure for Peak Unwanted Emissions Measurements Above 1000 MHz

- RBW = 1 MHz
- VBW ≥ 3 MHz
- Detector = Peak
- Sweep time = auto
- Trace mode = max hold

(3) Procedures for Average Unwanted Emissions Measurements Above 1000MHz

- RBW = 1 MHz
- VBW = 10 Hz, when duty cycle is no less than 98 percent.
- VBW ≥ 1/T, when duty cycle is less than 98 percent where T is the minimum transmission duration over which the transmitter is on and is transmitting at its maximum power control level for the tested mode of operation.

2. The EUT was placed on a turntable with 0.8 meter for frequency below 1GHz and 1.5 meter for frequency above 1GHz respectively above ground.
3. The EUT was set 3 meters from the interference receiving antenna which was mounted on the top of a variable height antenna tower.
4. The antenna is a broadband antenna and its height is adjusted between one meter and four meters above ground to find the maximum value of the field strength for both horizontal polarization and vertical polarization of the antenna.
5. For each suspected emission, the EUT was arranged to its worst case and then adjust the antenna tower (from 1 m to 4 m) and turntable (from 0 degree to 360 degrees) to find the maximum reading.
6. For testing below 1GHz, if the emission level of the EUT in peak mode was 3 dB lower than the limit specified, then peak values of EUT will be reported, otherwise, the emissions will be repeated one by one using the CISPR quasi-peak method and reported.
7. For testing above 1GHz, the emission level of the EUT in peak mode was 20dB lower than average limit (that means the emission level in average mode also complies with the limit in average mode), then peak values of EUT will be reported, otherwise, the emissions will be measured in average mode again and reported.

3.4.4 Test Setup

For radiated emissions below 30MHz

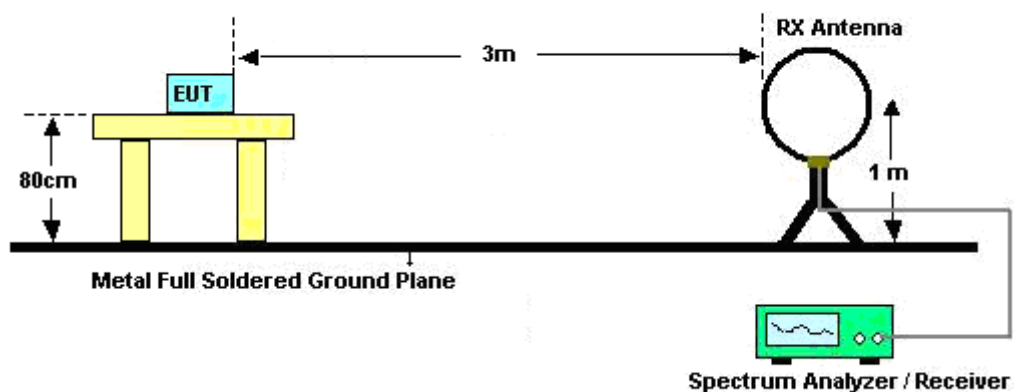

For radiated emissions from 30MHz to 1GHz

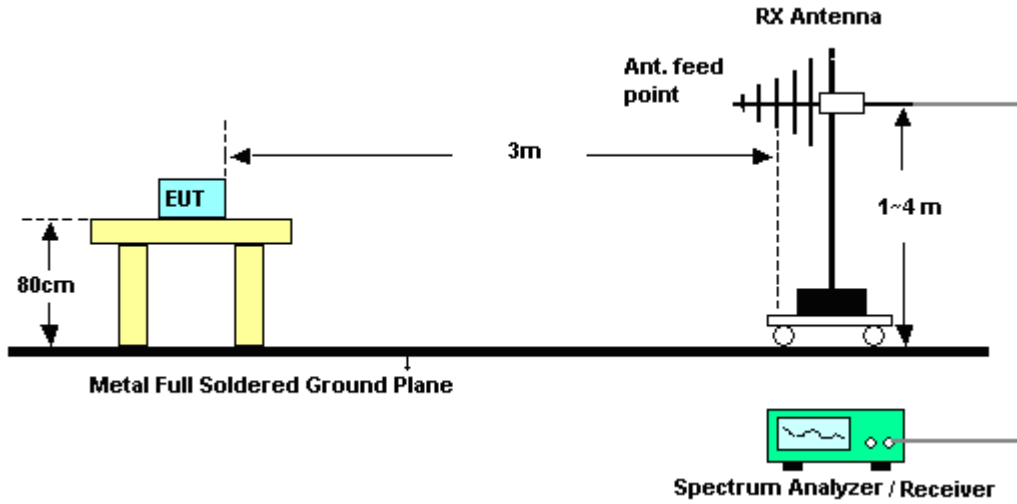

For radiated emissions above 1GHz

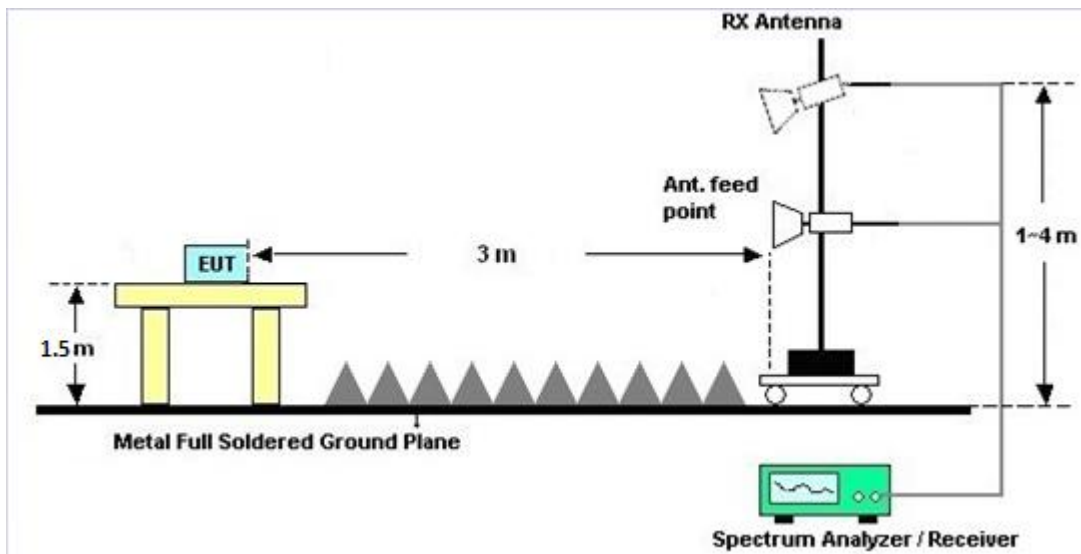



3.4.5 Test Results of Radiated Spurious Emissions (9 kHz ~ 30 MHz)

The low frequency, which started from 9 kHz to 30MHz, was pre-scanned and the result which was 20dB lower than the limit line was not reported.

There is a comparison data of both open-field test site and alternative test site - semi-Anechoic chamber according to 414788 D01 Radiated Test Site v01r01, and the result came out very similar.

3.4.6 Test Result of Radiated Spurious at Band Edges

Please refer to Appendix C and D.

3.4.7 Duty Cycle

Please refer to Appendix E.

3.4.8 Test Result of Radiated Spurious Emissions (30MHz ~ 10th Harmonic)

Please refer to Appendix C and D.



3.5 AC Conducted Emission Measurement

3.5.1 Limit of AC Conducted Emission

For equipment that is designed to be connected to the public utility (AC) power line, the radio frequency voltage that is conducted back onto the AC power line on any frequency or frequencies within the band 150 kHz to 30 MHz shall not exceed the limits in the following table.

Frequency of emission (MHz)	Conducted limit (dBµV)	
	Quasi-peak	Average
0.15-0.5	66 to 56*	56 to 46*
0.5-5	56	46
5-30	60	50

*Decreases with the logarithm of the frequency.

3.5.2 Measuring Instruments

See list of measuring equipment of this test report.

3.5.3 Test Procedures

1. The EUT was placed 0.4 meter from the conducting wall of the shielding room was kept at least 80 centimeters from any other grounded conducting surface.
2. Connect EUT to the power mains through a line impedance stabilization network (LISN).
3. All the support units are connecting to the other LISN.
4. The LISN provides 50 ohm coupling impedance for the measuring instrument.
5. The FCC states that a 50 ohm, 50 microhenry LISN should be used.
6. Both sides of AC line were checked for maximum conducted interference.
7. The frequency range from 150 kHz to 30 MHz was searched.
8. Set the test-receiver system to Peak Detect Function and specified bandwidth with Maximum Hold Mode.

3.5.4 Test Setup

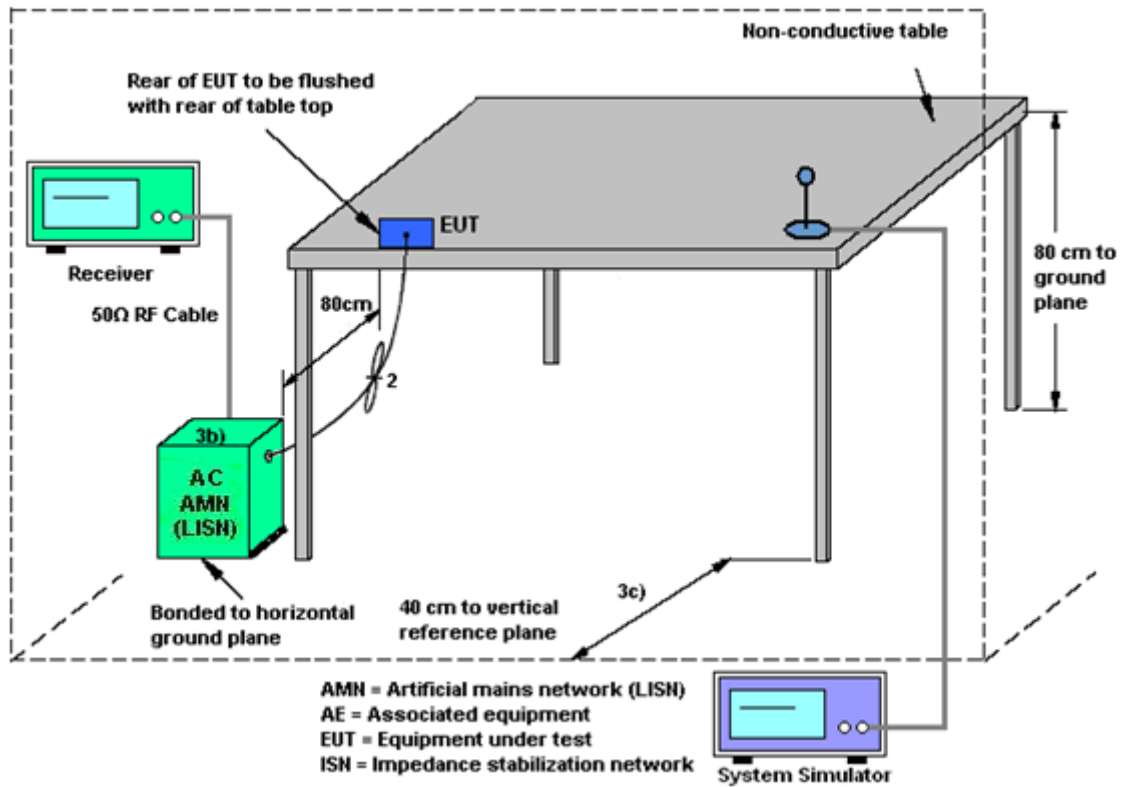

3.5.5 Test Result of AC Conducted Emission

Please refer to Appendix B.



3.6 Automatically Discontinue Transmission

3.6.1 Limit of Automatically Discontinue Transmission

The device shall automatically discontinue transmission in case of either absence of information to transmit or operational failure. These provisions are not intended to preclude the transmission of control or signaling information or the use of repetitive codes used by certain digital technologies to complete frame or burst intervals. Applicants shall include in their application for equipment authorization to describe how this requirement is met.

3.6.2 Measuring Instruments

See list of measuring equipment of this test report.

3.6.3 Test Result of Automatically Discontinue Transmission

While the EUT is not transmitting any information, the EUT can automatically discontinue transmission and become standby mode for power saving. The EUT can detect the controlling signal of ACK message transmitting from remote device and verify whether it shall resend or discontinue transmission.



3.7 Antenna Requirements

3.7.1 Standard Applicable

If transmitting antenna directional gain is greater than 6 dBi, both the peak transmit power and the peak power spectral density shall be reduced by the amount in dB that the directional gain of the antenna exceeds 6 dBi.

3.7.2 Antenna Anti-Replacement Construction

An embedded-in antenna design is used.

3.7.3 Antenna Gain

The antenna peak gain of EUT is less than 6 dBi. Therefore, it is not necessary to reduce maximum peak output power limit.



4 List of Measuring Equipment

Instrument	Manufacturer	Model No.	Serial No.	Characteristics	Calibration Date	Test Date	Due Date	Remark
Loop Antenna	Rohde & Schwarz	HFH2-Z2	100488	9 kHz~30 MHz	Jan. 09, 2020	May 01, 2020~ May 28, 2020	Jan. 08, 2021	Radiation (03CH15-HY)
Bilog Antenna	TESEQ	CBL6111D&0 0800N1D01N- 06	41912&05	30MHz to 1GHz	Feb. 09, 2020	May 01, 2020~ May 28, 2020	Feb. 08, 2021	Radiation (03CH15-HY)
Horn Antenna	SCHWARZBE CK	BBHA 9120 D	9120D-211 4	1-18GHz	Jul. 31, 2019	May 01, 2020~ May 28, 2020	Jul. 30, 2020	Radiation (03CH15-HY)
SHF-EHF Horn Antenna	SCHWARZBE CK	BBHA 9170	BBHA9170 584	18GHz- 40GHz	Dec. 10, 2019	May 01, 2020~ May 28, 2020	Dec. 09, 2020	Radiation (03CH15-HY)
Amplifier	SONOMA	310N	363440	9kHz~1GHz	Dec. 27, 2019	May 01, 2020~ May 28, 2020	Dec. 26, 2020	Radiation (03CH15-HY)
Preamplifier	Jet-Power	JPA0118-55-3 03	171000180 0055007	1GHz~18GHz	Mar. 31, 2020	May 01, 2020~ May 28, 2020	Mar. 30, 2021	Radiation (03CH15-HY)
Preamplifier	Keysight	83017A	MY532701 95	1GHz~26.5GHz	Aug. 23, 2019	May 01, 2020~ May 28, 2020	Aug. 22, 2020	Radiation (03CH15-HY)
Preamplifier	EMEC	EM18G40G	060715	18GHz ~ 40GHz	Dec. 13, 2019	May 01, 2020~ May 28, 2020	Dec. 12, 2020	Radiation (03CH15-HY)
EMI Test Receiver	Keysight	N9038A (MXE)	MY541300 85	20MHz~8.4GHz	Nov. 01, 2019	May 01, 2020~ May 28, 2020	Oct. 31, 2020	Radiation (03CH15-HY)
EMI Test Receiver	Rohde & Schwarz	ESU26	100390	20Hz~26.5GHz	Feb. 25, 2020	May 01, 2020~ May 28, 2020	Feb. 24, 2021	Radiation (03CH15-HY)
Antenna Mast	ChainTek	MBS-520-1	N/A	1m~4m	N/A	May 01, 2020~ May 28, 2020	N/A	Radiation (03CH15-HY)
Turn Table	ChainTek	T-200-S-1	N/A	0~360 Degree	N/A	May 01, 2020~ May 28, 2020	N/A	Radiation (03CH15-HY)
Software	Audix	E3 6.2009-8-24 (k5)	RK-00045 1	N/A	N/A	May 01, 2020~ May 28, 2020	N/A	Radiation (03CH15-HY)
RF Cable	HUBER + SUHNER	SUCOFLEX 104	MY36980/ 4	30M-18G	Apr. 14, 2020	May 01, 2020~ May 28, 2020	Apr. 13, 2021	Radiation (03CH15-HY)
RF Cable	HUBER + SUHNER	SUCOFLEX 104	MY9838/4 PE	30M-18G	Apr. 14, 2020	May 01, 2020~ May 28, 2020	Apr. 13, 2021	Radiation (03CH15-HY)
RF Cable	HUBER + SUHNER	SUCOFLEX 104	MY802430 /4	30M~18GHz	Apr. 14, 2020	May 01, 2020~ May 28, 2020	Apr. 13, 2021	Radiation (03CH15-HY)
RF Cable	HUBER + SUHNER	SUCOFLEX 102	505134/2	30MHz-40GHz	Feb. 25, 2020	May 01, 2020~ May 28, 2020	Feb. 24, 2021	Radiation (03CH15-HY)
RF Cable	HUBER + SUHNER	SUCOFLEX 102	800740/2	30MHz-40GHz	Feb. 25, 2020	May 01, 2020~ May 28, 2020	Feb. 24, 2021	Radiation (03CH15-HY)
Filter	Wainwright	WLK4-1000-1 530-8000-40S S	SN4	1.53G Low Pass	Jul. 04, 2019	May 01, 2020~ May 28, 2020	Jul. 03, 2020	Radiation (03CH15-HY)
Filter	Wainwright	WHKX8-5872. 5-6750-18000 -40ST	SN6	6.75GHz High Pass Filter	Jul. 02, 2019	May 01, 2020~ May 28, 2020	Jul. 01, 2020	Radiation (03CH15-HY)



Instrument	Manufacturer	Model No.	Serial No.	Characteristics	Calibration Date	Test Date	Due Date	Remark
Hygrometer	Testo	608-H2	41410069	N/A	Jun. 17, 2019	Apr. 24, 2020~ May 29, 2020	Jun. 16, 2020	Conducted (TH05-HY)
Power Sensor	DARE	RPR3006W	16I00054S NO10	10MHz~6GHz	Dec. 23, 2019	Apr. 24, 2020~ May 29, 2020	Dec. 22, 2020	Conducted (TH05-HY)
Spectrum Analyzer	Rohde & Schwarz	FSP40	100055	9kHz-40GHz	Aug. 14, 2019	Apr. 24, 2020~ May 29, 2020	Aug. 13, 2020	Conducted (TH05-HY)
Switch Box & RF Cable	Burgeon	ETF-058	EC130048 4	N/A	Aug. 22, 2019	Apr. 24, 2020~ May 29, 2020	Aug. 21, 2020	Conducted (TH05-HY)
AC Power Source	ChainTek	APC-1000W	N/A	N/A	N/A	Apr. 28, 2020	N/A	Conduction (CO05-HY)
EMI Test Receiver	Rohde & Schwarz	ESR3	102388	9kHz~3.6GHz	Nov. 15, 2019	Apr. 28, 2020	Nov. 14, 2020	Conduction (CO05-HY)
Hygrometer	Testo	608-H1	34913912	N/A	Nov. 07, 2019	Apr. 28, 2020	Nov. 06, 2020	Conduction (CO05-HY)
LISN	Rohde & Schwarz	ENV216	100080	9kHz~30MHz	Nov. 20, 2019	Apr. 28, 2020	Nov. 19, 2020	Conduction (CO05-HY)
Software	Rohde & Schwarz	EMC32 V10.30	N/A	N/A	N/A	Apr. 28, 2020	N/A	Conduction (CO05-HY)
LF Cable	HUBER + SUHNER	RG-214/U	LF01	N/A	Jan. 02, 2020	Apr. 28, 2020	Jan. 01, 2021	Conduction (CO05-HY)
Pulse Limiter	Rohde & Schwarz	ESH3-Z2	100851	N/A	Jan. 02, 2020	Apr. 28, 2020	Jan. 01, 2021	Conduction (CO05-HY)



5 Uncertainty of Evaluation

Uncertainty of Conducted Emission Measurement (150kHz ~ 30MHz)

Measuring Uncertainty for a Level of Confidence of 95% ($U = 2Uc(y)$)	2.3
---	-----

Uncertainty of Radiated Emission Measurement (30 MHz ~ 1000 MHz)

Measuring Uncertainty for a Level of Confidence of 95% ($U = 2Uc(y)$)	5.0
---	-----

Uncertainty of Radiated Emission Measurement (1000 MHz ~ 18000 MHz)

Measuring Uncertainty for a Level of Confidence of 95% ($U = 2Uc(y)$)	5.4
---	-----

Uncertainty of Radiated Emission Measurement (18000 MHz ~ 40000 MHz)

Measuring Uncertainty for a Level of Confidence of 95% ($U = 2Uc(y)$)	5.0
---	-----

Appendix A. Test Result of Conducted Test Items

Test Engineer:	Eason Huang/junyu	Temperature:	21~25	°C
Test Date:	2020/4/24~2020/5/19	Relative Humidity:	51~54	%

TEST RESULTS DATA
26dB and 99% OBW

Band I single antenna													
Mod.	Data Rate	NTX	CH.	Freq. (MHz)	99% Bandwidth (MHz)		26 dB Bandwidth (MHz)		IC 99% Bandwidth Power Limit (dBm)		IC 99% Bandwidth EIRP Limit (dBm)		Note
					Ant 1	Ant 2	Ant 1	Ant 2	Ant 1	Ant 2	Ant 1	Ant 2	
11a	6Mbps	1	36	5180	16.75	-	24.75	-	-	-	22.24	-	
11a	6Mbps	1	44	5220	16.80	-	25.00	-	-	-	22.25	-	
11a	6Mbps	1	48	5240	16.75	-	24.00	-	-	-	22.24	-	
HT20	MCS0	1	36	5180	17.95	-	24.65	-	-	-	22.54	-	
HT20	MCS0	1	44	5220	17.95	-	25.85	-	-	-	22.54	-	
HT20	MCS0	1	48	5240	17.95	-	25.20	-	-	-	22.54	-	
HT40	MCS0	1	38	5190	36.60	-	42.48	-	-	-	23.01	-	
HT40	MCS0	1	46	5230	36.60	-	42.48	-	-	-	23.01	-	
VHT80	MCS0	1	42	5210	76.92	-	84.96	-	-	-	23.01	-	

TEST RESULTS DATA
Average Power Table

FCC Band I single antenna												
Mod.	Data Rate	NTX	CH.	Freq. (MHz)	Average Conducted Power (dBm)			FCC Conducted Power Limit (dBm)		DG (dBi)		Pass/Fail
					Ant 1	Ant 2	SUM	Ant 1	Ant 2	Ant 1	Ant 2	
11a	6Mbps	1	36	5180	17.10	-		24.00	-	2.00	-	Pass
11a	6Mbps	1	44	5220	16.80	-		24.00	-	2.00	-	Pass
11a	6Mbps	1	48	5240	17.20	-		24.00	-	2.00	-	Pass
HT20	MCS0	1	36	5180	17.10	-		24.00	-	2.00	-	Pass
HT20	MCS0	1	44	5220	17.10	-		24.00	-	2.00	-	Pass
HT20	MCS0	1	48	5240	17.30	-		24.00	-	2.00	-	Pass
HT40	MCS0	1	38	5190	15.70	-		24.00	-	2.00	-	Pass
HT40	MCS0	1	46	5230	17.20	-		24.00	-	2.00	-	Pass
VHT20	MCS0	1	36	5180	17.00	-		24.00	-	2.00	-	Pass
VHT20	MCS0	1	44	5220	17.00	-		24.00	-	2.00	-	Pass
VHT20	MCS0	1	48	5240	17.20	-		24.00	-	2.00	-	Pass
VHT40	MCS0	1	38	5190	15.60	-		24.00	-	2.00	-	Pass
VHT40	MCS0	1	46	5230	17.10	-		24.00	-	2.00	-	Pass
VHT80	MCS0	1	42	5210	15.60	-		24.00	-	2.00	-	Pass

TEST RESULTS DATA
Power Spectral Density

FCC Band I single antenna												
Mod.	Data Rate	NTX	CH.	Freq. (MHz)	Average Power Density (dBm/MHz)			Average PSD Limit (dBm/MHz)		DG (dBi)		Pass /Fail
					Ant 1	Ant 2	SUM	Ant 1	Ant 2	Ant 1	Ant 2	
11a	6Mbps	1	36	5180	7.79	-		11.00	-	2.00	-	Pass
11a	6Mbps	1	44	5220	7.67	-		11.00	-	2.00	-	Pass
11a	6Mbps	1	48	5240	7.90	-		11.00	-	2.00	-	Pass
HT20	MCS0	1	36	5180	7.66	-		11.00	-	2.00	-	Pass
HT20	MCS0	1	44	5220	7.85	-		11.00	-	2.00	-	Pass
HT20	MCS0	1	48	5240	7.97	-		11.00	-	2.00	-	Pass
HT40	MCS0	1	38	5190	2.49	-		11.00	-	2.00	-	Pass
HT40	MCS0	1	46	5230	5.23	-		11.00	-	2.00	-	Pass
VHT80	MCS0	1	42	5210	0.32	-		11.00	-	2.00	-	Pass

TEST RESULTS DATA
26dB and 99% OBW

Band II single antenna															
Mod.	Data Rate	NTX	CH.	Freq. (MHz)	99% Bandwidth (MHz)		26 dB Bandwidth (MHz)		IC 99% Bandwidth Power Limit (dBm)		IC 99% Bandwidth EIRP Limit (dBm)		FCC 26dB Bandwidth Power Limit (dBm)		Note
					Ant 1	Ant 2	Ant 1	Ant 2	Ant 1	Ant 2	Ant 1	Ant 2	Ant 1	Ant 2	
11a	6Mbps	1	52	5260	16.75	-	24.50	-	23.24	-	29.24	-	23.98	-	
11a	6Mbps	1	60	5300	16.75	-	24.10	-	23.24	-	29.24	-	23.98	-	
11a	6Mbps	1	64	5320	16.80	-	23.65	-	23.25	-	29.25	-	23.98	-	
HT20	MCS0	1	52	5260	17.90	-	25.45	-	23.53	-	29.53	-	23.98	-	
HT20	MCS0	1	60	5300	17.90	-	24.75	-	23.53	-	29.53	-	23.98	-	
HT20	MCS0	1	64	5320	17.95	-	24.90	-	23.54	-	29.54	-	23.98	-	
HT40	MCS0	1	54	5270	36.70	-	42.30	-	23.98	-	30.00	-	23.98	-	
HT40	MCS0	1	62	5310	36.60	-	42.30	-	23.98	-	30.00	-	23.98	-	
VHT80	MCS0	1	58	5290	76.92	-	83.84	-	23.98	-	30.00	-	23.98	-	

TEST RESULTS DATA
Average Power Table

FCC Band II single antenna													
Mod.	Data Rate	NTX	CH.	Freq. (MHz)	Average Conducted Power (dBm)			FCC Conducted Power Limit (dBm)		DG (dBi)		EIRP Power Limit (dBm)	Pass/Fail
					Ant 1	Ant 2	SUM	Ant 1	Ant 2	Ant 1	Ant 2		
11a	6Mbps	1	52	5260	18.20	-		23.98	-	2.00	-	26.99	Pass
11a	6Mbps	1	60	5300	18.30	-		23.98	-	2.00	-	26.99	Pass
11a	6Mbps	1	64	5320	18.30	-		23.98	-	2.00	-	26.99	Pass
HT20	MCS0	1	52	5260	18.20	-		23.98	-	2.00	-	26.99	Pass
HT20	MCS0	1	60	5300	18.20	-		23.98	-	2.00	-	26.99	Pass
HT20	MCS0	1	64	5320	18.20	-		23.98	-	2.00	-	26.99	Pass
HT40	MCS0	1	54	5270	17.40	-		23.98	-	2.00	-	26.99	Pass
HT40	MCS0	1	62	5310	17.40	-		23.98	-	2.00	-	26.99	Pass
VHT20	MCS0	1	52	5260	18.10	-		23.98	-	2.00	-	26.99	Pass
VHT20	MCS0	1	60	5300	18.10	-		23.98	-	2.00	-	26.99	Pass
VHT20	MCS0	1	64	5320	18.10	-		23.98	-	2.00	-	26.99	Pass
VHT40	MCS0	1	54	5270	17.30	-		23.98	-	2.00	-	26.99	Pass
VHT40	MCS0	1	62	5310	17.30	-		23.98	-	2.00	-	26.99	Pass
VHT80	MCS0	1	58	5290	17.40	-		23.98	-	2.00	-	26.99	Pass

TEST RESULTS DATA
Power Spectral Density

Band II single antenna													
Mod.	Data Rate	N _{TX}	CH.	Freq. (MHz)	Average Power Density (dBm/MHz)			Average PSD Limit (dBm/MHz)		DG (dBi)			Pass /Fail
					Ant 1	Ant 2	SUM	Ant 1	Ant 2	Ant 1	Ant 2		
11a	6Mbps	1	52	5260	9.74	-		11.00	-	2.00	-		Pass
11a	6Mbps	1	60	5300	10.26	-		11.00	-	2.00	-		Pass
11a	6Mbps	1	64	5320	10.51	-		11.00	-	2.00	-		Pass
HT20	MCS0	1	52	5260	10.07	-		11.00	-	2.00	-		Pass
HT20	MCS0	1	60	5300	10.09	-		11.00	-	2.00	-		Pass
HT20	MCS0	1	64	5320	10.06	-		11.00	-	2.00	-		Pass
HT40	MCS0	1	54	5270	5.53	-		11.00	-	2.00	-		Pass
HT40	MCS0	1	62	5310	5.78	-		11.00	-	2.00	-		Pass
VHT80	MCS0	1	58	5290	2.33	-		11.00	-	2.00	-		Pass

TEST RESULTS DATA
26dB and 99% OBW

Band III single antenna																
Mod.	Data Rate	NTX	CH.	Freq. (MHz)	99% Bandwidth In U-NII 2C (MHz)		26 dB Bandwidth In U-NII 2C (MHz)		IC 99% Bandwidth Power Limit (dBm)		IC 99% Bandwidth EIRP Limit (dBm)		FCC 26dB Bandwidth Power Limit (dBm)		6 dB Bandwidth for Straddle Channel (MHz)	
					Ant 1	Ant 2	Ant 1	Ant 2	Ant 1	Ant 2	Ant 1	Ant 2	Ant 1	Ant 2	Ant 1	Ant 2
11a	6Mbps	1	100	5500	16.75	-	24.35	-	23.24	-	29.24	-	23.98	-	----	----
11a	6Mbps	1	116	5580	16.75	-	24.30	-	23.24	-	29.24	-	23.98	-	----	----
11a	6Mbps	1	140	5700	16.80	-	24.75	-	23.25	-	29.25	-	23.98	-	----	----
HT20	MCS0	1	100	5500	17.90	-	24.45	-	23.53	-	29.53	-	23.98	-	----	----
HT20	MCS0	1	116	5580	17.90	-	24.95	-	23.53	-	29.53	-	23.98	-	----	----
HT20	MCS0	1	140	5700	17.95	-	25.55	-	23.54	-	29.54	-	23.98	-	----	----
HT40	MCS0	1	102	5510	36.50	-	41.76	-	23.98	-	30.00	-	23.98	-	----	----
HT40	MCS0	1	110	5550	36.70	-	42.12	-	23.98	-	30.00	-	23.98	-	----	----
HT40	MCS0	1	134	5670	36.80	-	42.48	-	23.98	-	30.00	-	23.98	-	----	----
VHT80	MCS0	1	106	5530	77.16	-	83.52	-	23.98	-	30.00	-	23.98	-	----	----
VHT80	MCS0	1	122	5610	77.28	-	82.88	-	23.98	-	30.00	-	23.98	-	----	----

TEST RESULTS DATA
Average Power Table

FCC Band III single antenna													
Mod.	Data Rate	NTX	CH.	Freq. (MHz)	Average Conducted Power (dBm)			FCC Conducted Power Limit (dBm)		DG (dBi)		EIRP Power Limit (dBm)	Pass/Fail
					Ant 1	Ant 2	SUM	Ant 1	Ant 2	Ant 1	Ant 2		
11a	6Mbps	1	100	5500	18.40	-		23.98	-	2.00	-	26.99	Pass
11a	6Mbps	1	116	5580	18.40	-		23.98	-	2.00	-	26.99	Pass
11a	6Mbps	1	140	5700	18.40	-		23.98	-	2.00	-	26.99	Pass
HT20	MCS0	1	100	5500	18.30	-		23.98	-	2.00	-	26.99	Pass
HT20	MCS0	1	116	5580	18.40	-		23.98	-	2.00	-	26.99	Pass
HT20	MCS0	1	140	5700	18.30	-		23.98	-	2.00	-	26.99	Pass
HT40	MCS0	1	102	5510	17.20	-		23.98	-	2.00	-	26.99	Pass
HT40	MCS0	1	110	5550	17.20	-		23.98	-	2.00	-	26.99	Pass
HT40	MCS0	1	134	5670	17.20	-		23.98	-	2.00	-	26.99	Pass
VHT20	MCS0	1	100	5500	18.20	-		23.98	-	2.00	-	26.99	Pass
VHT20	MCS0	1	116	5580	18.30	-		23.98	-	2.00	-	26.99	Pass
VHT20	MCS0	1	140	5700	18.20	-		23.98	-	2.00	-	26.99	Pass
VHT40	MCS0	1	102	5510	17.10	-		23.98	-	2.00	-	26.99	Pass
VHT40	MCS0	1	110	5550	17.10	-		23.98	-	2.00	-	26.99	Pass
VHT40	MCS0	1	134	5670	17.10	-		23.98	-	2.00	-	26.99	Pass
VHT80	MCS0	1	106	5530	17.20	-		23.98	-	2.00	-	26.99	Pass
VHT80	MCS0	1	122	5610	17.20	-		23.98	-	2.00	-	26.99	Pass

TEST RESULTS DATA
Power Spectral Density

Band III single antenna													
Mod.	Data Rate	NTX	CH.	Freq. (MHz)	Average Power Density (dBm/MHz)			Average PSD Limit (dBm/MHz)		DG (dBi)			Pass /Fail
					Ant 1	Ant 2	SUM	Ant 1	Ant 2	Ant 1	Ant 2		
11a	6Mbps	1	100	5500	10.04	-		11.00	-	2.00	-		Pass
11a	6Mbps	1	116	5580	10.62	-		11.00	-	2.00	-		Pass
11a	6Mbps	1	140	5700	10.04	-		11.00	-	2.00	-		Pass
HT20	MCS0	1	100	5500	10.27	-		11.00	-	2.00	-		Pass
HT20	MCS0	1	116	5580	10.60	-		11.00	-	2.00	-		Pass
HT20	MCS0	1	140	5700	10.36	-		11.00	-	2.00	-		Pass
HT40	MCS0	1	102	5510	5.44	-		11.00	-	2.00	-		Pass
HT40	MCS0	1	110	5550	5.59	-		11.00	-	2.00	-		Pass
HT40	MCS0	1	134	5670	5.28	-		11.00	-	2.00	-		Pass
VHT80	MCS0	1	106	5530	2.93	-		11.00	-	2.00	-		Pass
VHT80	MCS0	1	122	5610	2.98	-		11.00	-	2.00	-		Pass



Appendix B. AC Conducted Emission Test Results

Test Engineer :	Tom Lee	Temperature :	21~23°C
		Relative Humidity :	40~43%

EUT Information

Report NO : 042038
 Test Mode : Mode 1
 Test Voltage : 120Vac/60Hz
 Phase : Line

Full Spectrum

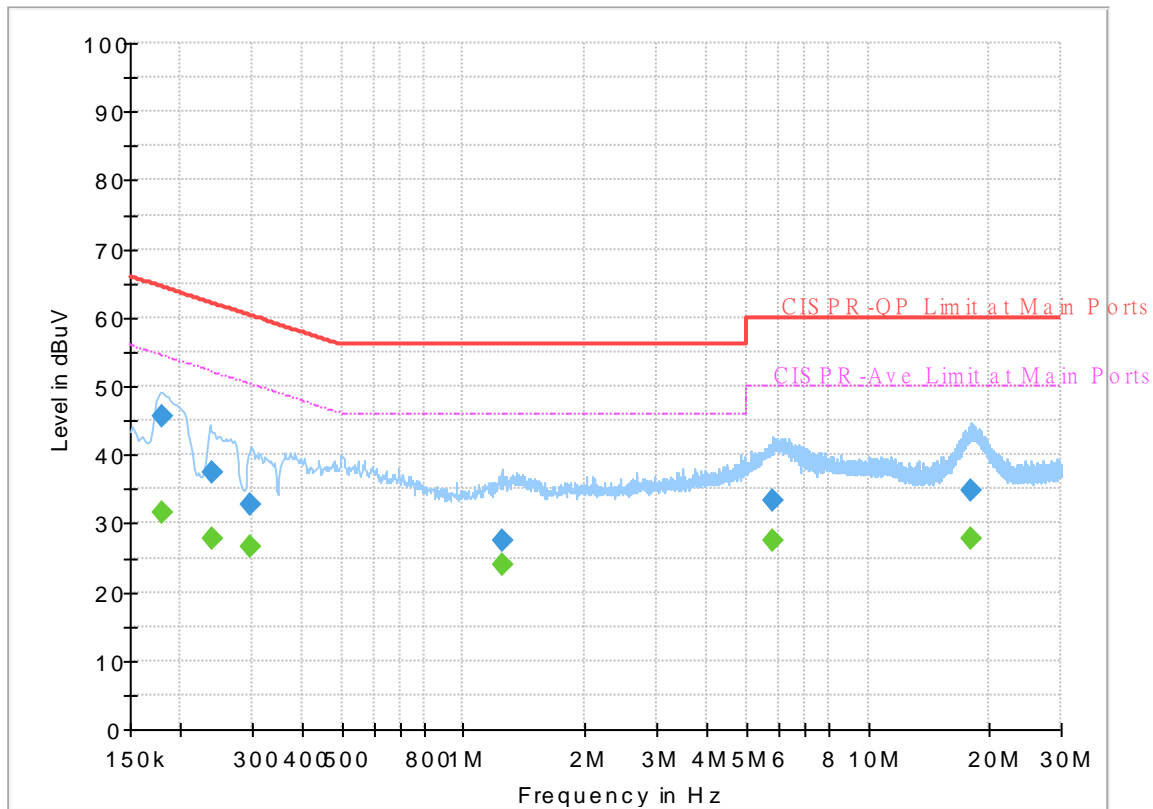

Final_Result

Frequency (MHz)	QuasiPeak (dBuV)	CAverage (dBuV)	Limit (dBuV)	Margin (dB)	Line	Filter	Corr. (dB)
0.179340	---	31.65	54.52	22.87	L1	OFF	19.6
0.179340	45.49	---	64.52	19.03	L1	OFF	19.6
0.240000	---	27.92	52.10	24.18	L1	OFF	19.6
0.240000	37.48	---	62.10	24.62	L1	OFF	19.6
0.297330	---	26.55	50.32	23.77	L1	OFF	19.6
0.297330	32.87	---	60.32	27.45	L1	OFF	19.6
1.242330	---	23.91	46.00	22.09	L1	OFF	19.6
1.242330	27.46	---	56.00	28.54	L1	OFF	19.6
5.829000	---	27.39	50.00	22.61	L1	OFF	19.9
5.829000	33.36	---	60.00	26.64	L1	OFF	19.9
18.054870	---	27.79	50.00	22.21	L1	OFF	20.3
18.054870	34.86	---	60.00	25.14	L1	OFF	20.3

EUT Information

Report NO : 042038
 Test Mode : Mode 1
 Test Voltage : 120Vac/60Hz
 Phase : Neutral

Full Spectrum

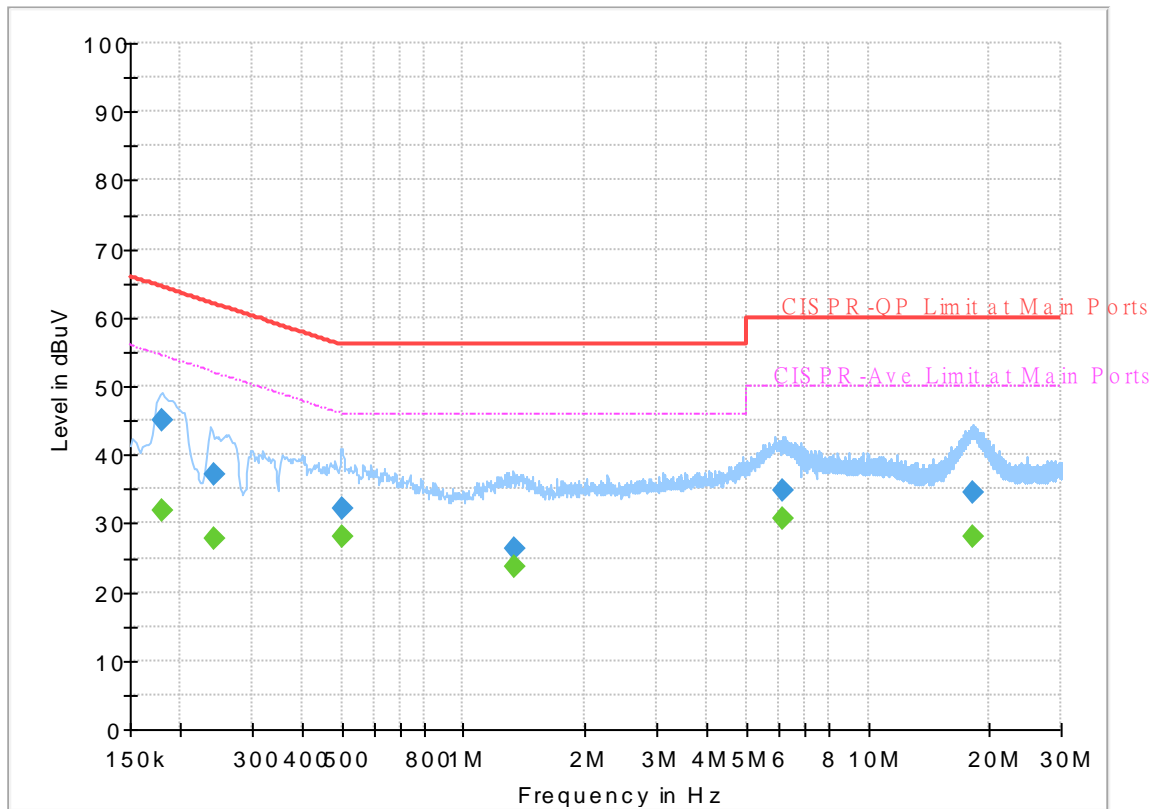

Final_Result

Frequency (MHz)	QuasiPeak (dBuV)	CAverage (dBuV)	Limit (dBuV)	Margin (dB)	Line	Filter	Corr. (dB)
0.180150	45.08	---	64.48	19.40	N	OFF	19.6
0.180150	---	31.83	54.48	22.65	N	OFF	19.6
0.242250	37.08	---	62.02	24.94	N	OFF	19.6
0.242250	---	27.71	52.02	24.31	N	OFF	19.6
0.500550	32.10	---	56.00	23.90	N	OFF	19.6
0.500550	---	28.15	46.00	17.85	N	OFF	19.6
1.333500	26.25	---	56.00	29.75	N	OFF	19.6
1.333500	---	23.56	46.00	22.44	N	OFF	19.6
6.144000	34.74	---	60.00	25.26	N	OFF	19.9
6.144000	---	30.56	50.00	19.44	N	OFF	19.9
18.183750	34.54	---	60.00	25.46	N	OFF	20.3
18.183750	---	28.08	50.00	21.92	N	OFF	20.3



Appendix C. Radiated Spurious Emission

Test Engineer :	Leo Lee, Mancy Chou and Bigshow Wang	Temperature :	22.1~23.1°C
		Relative Humidity :	55~60%

Band 1 - 5150~5250MHz

WIFI 802.11a (Band Edge @ 3m)

WIFI	Note	Frequency	Level	Over	Limit	Read	Antenna	Path	Preamp	Ant	Table	Peak	Pol.	
Ant.				Limit	Line	Level	Factor	Loss	Factor	Pos	Pos	Avg.		
1		(MHz)	(dBμV/m)	(dB)	(dBμV/m)	(dBμV)	(dB/m)	(dB)	(dB)	(cm)	(deg)	(P/A)	(H/V)	
802.11a CH 36 5180MHz		5143.52	52.13	-21.87	74	39.99	32.09	10.48	30.43	210	291	P	H	
		5148.46	42.64	-11.36	54	30.48	32.1	10.49	30.43	210	291	A	H	
	*	5180	102.33	-	-	90.3	31.92	10.54	30.43	210	291	P	H	
	*	5180	94.82	-	-	82.79	31.92	10.54	30.43	210	291	A	H	
													H	
														H
			5132.86	54.48	-19.52	74	42.37	32.07	10.47	30.43	151	2	P	V
			5150	44.35	-9.65	54	32.19	32.1	10.49	30.43	151	2	A	V
	*		5180	110.29	-	-	98.26	31.92	10.54	30.43	151	2	P	V
	*		5180	102.67	-	-	90.64	31.92	10.54	30.43	151	2	A	V
														V
														V
802.11a CH 44 5220MHz		5133.9	52.48	-21.52	74	40.37	32.07	10.47	30.43	202	42	P	H	
		5135.46	42.42	-11.58	54	30.31	32.07	10.47	30.43	202	42	A	H	
	*	5220	102.53	-	-	90.7	31.68	10.58	30.43	202	42	P	H	
	*	5220	94.74	-	-	82.91	31.68	10.58	30.43	202	42	A	H	
			5390.56	51.95	-22.05	74	40.08	31.64	10.66	30.43	202	42	P	H
			5449.08	42.21	-11.79	54	30.22	31.7	10.72	30.43	202	42	A	H
			5149.76	53.33	-20.67	74	41.17	32.1	10.49	30.43	148	9	P	V
			5147.94	43.56	-10.44	54	31.4	32.1	10.49	30.43	148	9	A	V
	*		5220	110.01	-	-	98.18	31.68	10.58	30.43	148	9	P	V
	*		5220	102.39	-	-	90.56	31.68	10.58	30.43	148	9	A	V
			5437.32	52.85	-21.15	74	40.87	31.7	10.71	30.43	148	9	P	V
			5402.32	42.44	-11.56	54	30.51	31.7	10.66	30.43	148	9	A	V



802.11a CH 48 5240MHz		5033.02	52.09	-21.91	74	40.37	31.83	10.32	30.43	200	38	P	H
		5102.7	42.4	-11.6	54	30.4	32.01	10.42	30.43	200	38	A	H
	*	5240	101.7	-	-	89.98	31.56	10.59	30.43	200	38	P	H
	*	5240	94.11	-	-	82.39	31.56	10.59	30.43	200	38	A	H
		5418.56	52.66	-21.34	74	40.71	31.7	10.68	30.43	200	38	P	H
		5423.32	42.32	-11.68	54	30.36	31.7	10.69	30.43	200	38	A	H
		5116.48	53.27	-20.73	74	41.22	32.03	10.45	30.43	156	17	P	V
		5144.56	43.03	-10.97	54	30.88	32.09	10.49	30.43	156	17	A	V
	*	5240	108.48	-	-	96.76	31.56	10.59	30.43	156	17	P	V
	*	5240	102.64	-	-	90.92	31.56	10.59	30.43	156	17	A	V
		5410.16	52.11	-21.89	74	40.17	31.7	10.67	30.43	156	17	P	V
		5418.56	42.47	-11.53	54	30.52	31.7	10.68	30.43	156	17	A	V
Remark	1. No other spurious found. 2. All results are PASS against Peak and Average limit line.												



Band 1 5150~5250MHz

WIFI 802.11a (Harmonic @ 3m)

WIFI Ant. 1	Note	Frequency (MHz)	Level (dBμV/m)	Over Limit (dB)	Limit Line (dBμV/m)	Read Level (dBμV)	Antenna Factor (dB/m)	Path Loss (dB)	Preamp Factor (dB)	Ant Pos (cm)	Table Pos (deg)	Peak Avg. (P/A)	Pol. (H/V)
802.11a CH 36 5180MHz		10360	51.02	-17.18	68.2	57.25	39.9	14.26	60.39	100	0	P	H
		15540	48.94	-25.06	74	54.92	38	17.29	61.27	100	0	P	H
													H
													H
		10360	51.92	-16.28	68.2	58.15	39.9	14.26	60.39	100	0	P	V
		15540	48.29	-25.71	74	54.27	38	17.29	61.27	100	0	P	V
													V
													V
802.11a CH 44 5220MHz		10440	50.93	-17.27	68.2	57.11	40.1	14.3	60.58	100	0	P	H
		15660	48.62	-25.38	74	54.66	37.58	17.39	61.01	100	0	P	H
													H
													H
		10440	51.2	-17	68.2	57.38	40.1	14.3	60.58	100	0	P	V
		15660	48.49	-25.51	74	54.53	37.58	17.39	61.01	100	0	P	V
													V
													V
802.11a CH 48 5240MHz		10480	51.22	-16.98	68.2	57.49	40.1	14.31	60.68	100	0	P	H
		15720	48.65	-25.35	74	54.65	37.46	17.42	60.88	100	0	P	H
													H
													H
		10480	51.1	-17.1	68.2	57.37	40.1	14.31	60.68	100	0	P	V
		15720	49.16	-24.84	74	55.16	37.46	17.42	60.88	100	0	P	V
													V
													V
Remark	1. No other spurious found. 2. All results are PASS against Peak and Average limit line.												



Band 1 5150~5250MHz

WIFI 802.11n HT20 (Band Edge @ 3m)

WIFI Ant. 1	Note	Frequency (MHz)	Level (dBμV/m)	Over Limit (dB)	Limit Line (dBμV/m)	Read Level (dBμV)	Antenna Factor (dB/m)	Path Loss (dB)	Preamp Factor (dB)	Ant Pos (cm)	Table Pos (deg)	Peak Avg. (P/A)	Pol. (H/V)	
802.11n HT20 CH 36 5180MHz		5148.46	54.01	-19.99	74	41.85	32.1	10.49	30.43	210	291	P	H	
		5149.5	42.86	-11.14	54	30.7	32.1	10.49	30.43	210	291	A	H	
	*	5180	102.9	-	-	90.87	31.92	10.54	30.43	210	291	P	H	
	*	5180	93.95	-	-	81.92	31.92	10.54	30.43	210	291	A	H	
													H	
													H	
			5143	60.29	-13.71	74	48.15	32.09	10.48	30.43	151	18	P	V
			5149.76	45.34	-8.66	54	33.18	32.1	10.49	30.43	151	18	A	V
		*	5180	111.39	-	-	99.36	31.92	10.54	30.43	151	18	P	V
		*	5180	102.04	-	-	90.01	31.92	10.54	30.43	151	18	A	V
													V	
													V	
802.11n HT20 CH 44 5220MHz		5119.6	52.51	-21.49	74	40.45	32.04	10.45	30.43	193	37	P	H	
		5135.98	42.43	-11.57	54	30.32	32.07	10.47	30.43	193	37	A	H	
		* 5220	102.98	-	-	91.15	31.68	10.58	30.43	193	37	P	H	
		* 5220	94.13	-	-	82.3	31.68	10.58	30.43	193	37	A	H	
			5412.4	52.39	-21.61	74	40.44	31.7	10.68	30.43	193	37	P	H
			5458.04	42.34	-11.66	54	30.29	31.75	10.73	30.43	193	37	A	H
			5147.68	54.34	-19.66	74	42.18	32.1	10.49	30.43	142	17	P	V
			5150	44.05	-9.95	54	31.89	32.1	10.49	30.43	142	17	A	V
		*	5220	111.24	-	-	99.41	31.68	10.58	30.43	142	17	P	V
		*	5220	102.2	-	-	90.37	31.68	10.58	30.43	142	17	A	V
		5411.28	52.58	-21.42	74	40.64	31.7	10.67	30.43	142	17	P	V	
		5449.64	42.54	-11.46	54	30.55	31.7	10.72	30.43	142	17	A	V	



802.11n HT20 CH 48 5240MHz		5087.36	52.58	-21.42	74	40.64	31.97	10.4	30.43	199	40	P	H
		5148.98	42.46	-11.54	54	30.3	32.1	10.49	30.43	199	40	A	H
	*	5240	102.56	-	-	90.84	31.56	10.59	30.43	199	40	P	H
	*	5240	94.32	-	-	82.6	31.56	10.59	30.43	199	40	A	H
		5401.48	51.94	-22.06	74	40.01	31.7	10.66	30.43	199	40	P	H
		5457.48	42.2	-11.8	54	30.16	31.74	10.73	30.43	199	40	A	H
		5143.78	53.08	-20.92	74	40.93	32.09	10.49	30.43	157	18	P	V
		5147.68	43	-11	54	30.84	32.1	10.49	30.43	157	18	A	V
	*	5240	111.13	-	-	99.41	31.56	10.59	30.43	157	18	P	V
	*	5240	102.14	-	-	90.42	31.56	10.59	30.43	157	18	A	V
		5458.32	52.2	-21.8	74	40.15	31.75	10.73	30.43	157	18	P	V
		5425.28	42.52	-11.48	54	30.56	31.7	10.69	30.43	157	18	A	V
Remark	1. No other spurious found. 2. All results are PASS against Peak and Average limit line.												



Band 1 5150~5250MHz

WIFI 802.11n HT20 (Harmonic @ 3m)

WIFI Ant. 1	Note	Frequency (MHz)	Level (dBμV/m)	Over Limit (dB)	Limit Line (dBμV/m)	Read Level (dBμV)	Antenna Factor (dB/m)	Path Loss (dB)	Preamp Factor (dB)	Ant Pos (cm)	Table Pos (deg)	Peak Avg. (P/A)	Pol. (H/V)
802.11n HT20 CH 36 5180MHz		10360	49.42	-18.78	68.2	55.65	39.9	14.26	60.39	100	0	P	H
		15540	47.03	-26.97	74	53.01	38	17.29	61.27	100	0	P	H
													H
													H
		10360	49.2	-19	68.2	55.43	39.9	14.26	60.39	100	0	P	V
		15540	46.91	-27.09	74	52.89	38	17.29	61.27	100	0	P	V
													V
802.11n HT20 CH 44 5220MHz		10440	49.48	-18.72	68.2	55.66	40.1	14.3	60.58	100	0	P	H
		15660	47.06	-26.94	74	53.1	37.58	17.39	61.01	100	0	P	H
													H
													H
		10440	49.73	-18.47	68.2	55.91	40.1	14.3	60.58	100	0	P	V
		15660	48.12	-25.88	74	54.16	37.58	17.39	61.01	100	0	P	V
													V
802.11n HT20 CH 48 5240MHz		10480	51.1	-17.1	68.2	57.37	40.1	14.31	60.68	100	0	P	H
		15720	47.58	-26.42	74	53.58	37.46	17.42	60.88	100	0	P	H
													H
													H
		10480	49.96	-18.24	68.2	56.23	40.1	14.31	60.68	100	0	P	V
		15720	48.04	-25.96	74	54.04	37.46	17.42	60.88	100	0	P	V
													V
Remark	1. No other spurious found.												
	2. All results are PASS against Peak and Average limit line.												



Band 1 5150~5250MHz

WIFI 802.11n HT40 (Band Edge @ 3m)

WIFI Ant. 1	Note	Frequency (MHz)	Level (dBμV/m)	Over Limit (dB)	Limit Line (dBμV/m)	Read Level (dBμV)	Antenna Factor (dB/m)	Path Loss (dB)	Preamp Factor (dB)	Ant Pos (cm)	Table Pos (deg)	Peak Avg. (P/A)	Pol. (H/V)
802.11n HT40 CH 38 5190MHz		5150	54.66	-19.34	74	42.5	32.1	10.49	30.43	100	7	P	H
		5150	46.4	-7.6	54	34.24	32.1	10.49	30.43	100	7	A	H
	*	5190	97.91	-	-	85.93	31.86	10.55	30.43	100	7	P	H
	*	5190	90.11	-	-	78.13	31.86	10.55	30.43	100	7	A	H
		5446	52.23	-21.77	74	40.24	31.7	10.72	30.43	100	7	P	H
		5409.6	42.94	-11.06	54	31	31.7	10.67	30.43	100	7	A	H
		5147.94	59.4	-14.6	74	47.24	32.1	10.49	30.43	266	46	P	V
		5149.5	51.45	-2.55	54	39.29	32.1	10.49	30.43	266	46	A	V
	*	5190	103.99	-	-	92.01	31.86	10.55	30.43	266	46	P	V
	*	5190	96.56	-	-	84.58	31.86	10.55	30.43	266	46	A	V
		5423.6	52.7	-21.3	74	40.74	31.7	10.69	30.43	266	46	P	V
		5434.52	43.06	-10.94	54	31.09	31.7	10.7	30.43	266	46	A	V
802.11n HT40 CH 46 5230MHz		5147.42	52.22	-21.78	74	40.07	32.09	10.49	30.43	397	294	P	H
		5116.48	43.35	-10.65	54	31.3	32.03	10.45	30.43	397	294	A	H
	*	5230	98.73	-	-	86.96	31.62	10.58	30.43	397	294	P	H
	*	5230	90.58	-	-	78.81	31.62	10.58	30.43	397	294	A	H
		5440.12	52.13	-21.87	74	40.15	31.7	10.71	30.43	397	294	P	H
		5442.64	43.12	-10.88	54	31.14	31.7	10.71	30.43	397	294	A	H
		5149.24	52.83	-21.17	74	40.67	32.1	10.49	30.43	240	46	P	V
		5149.24	44.03	-9.97	54	31.87	32.1	10.49	30.43	240	46	A	V
	*	5230	106.43	-	-	94.66	31.62	10.58	30.43	240	46	P	V
	*	5230	97.9	-	-	86.13	31.62	10.58	30.43	240	46	A	V
	5436.76	53.04	-20.96	74	41.07	31.7	10.7	30.43	240	46	P	V	
	5414.64	43.43	-10.57	54	31.48	31.7	10.68	30.43	240	46	A	V	
Remark	1. No other spurious found. 2. All results are PASS against Peak and Average limit line.												



Band 1 5150~5250MHz

WIFI 802.11n HT40 (Harmonic @ 3m)

WIFI Ant. 1	Note	Frequency (MHz)	Level (dBμV/m)	Over Limit (dB)	Limit Line (dBμV/m)	Read Level (dBμV)	Antenna Factor (dB/m)	Path Loss (dB)	Preamp Factor (dB)	Ant Pos (cm)	Table Pos (deg)	Peak Avg. (P/A)	Pol. (H/V)
802.11n HT40 CH 38 5190MHz		10380	49.74	-18.46	68.2	55.9	40	14.27	60.43	100	0	P	H
		15570	47.04	-26.96	74	53.07	37.85	17.32	61.2	100	0	P	H
													H
													H
		10380	49.29	-18.91	68.2	55.45	40	14.27	60.43	100	0	P	V
		15570	47.44	-26.56	74	53.47	37.85	17.32	61.2	100	0	P	V
													V
													V
802.11n HT40 CH 46 5230MHz		10460	49.47	-18.73	68.2	55.7	40.1	14.3	60.63	100	0	P	H
		15690	47.92	-26.08	74	53.94	37.52	17.41	60.95	100	0	P	H
													H
													H
		10460	50.21	-17.99	68.2	56.44	40.1	14.3	60.63	100	0	P	V
		15690	48.03	-25.97	74	54.05	37.52	17.41	60.95	100	0	P	V
													V
													V
Remark	1. No other spurious found. 2. All results are PASS against Peak and Average limit line.												



Band 1 5150~5250MHz

WIFI 802.11ac VHT80 (Band Edge @ 3m)

WIFI Ant. 1	Note	Frequency (MHz)	Level (dBμV/m)	Over Limit (dB)	Limit Line (dBμV/m)	Read Level (dBμV)	Antenna Factor (dB/m)	Path Loss (dB)	Preamp Factor (dB)	Ant Pos (cm)	Table Pos (deg)	Peak Avg. (P/A)	Pol. (H/V)
802.11ac VHT80 CH 42 5210MHz		5146.9	54.14	-19.86	74	41.99	32.09	10.49	30.43	100	2	P	H
		5150	45.53	-8.47	54	33.37	32.1	10.49	30.43	100	2	A	H
	*	5210	93.27	-	-	81.39	31.74	10.57	30.43	100	2	P	H
	*	5210	85.51	-	-	73.63	31.74	10.57	30.43	100	2	A	H
		5437.6	51.27	-22.73	74	39.29	31.7	10.71	30.43	100	2	P	H
		5440.4	42.66	-11.34	54	30.68	31.7	10.71	30.43	100	2	A	H
		5146.12	60.34	-13.66	74	48.19	32.09	10.49	30.43	269	37	P	V
		5147.68	51.98	-2.02	54	39.82	32.1	10.49	30.43	269	37	A	V
	*	5210	100.45	-	-	88.57	31.74	10.57	30.43	269	37	P	V
	*	5210	93.1	-	-	81.22	31.74	10.57	30.43	269	37	A	V
		5397.84	51.48	-22.52	74	39.56	31.69	10.66	30.43	269	37	P	V
	5417.44	43.01	-10.99	54	31.06	31.7	10.68	30.43	269	37	A	V	
Remark	1. No other spurious found. 2. All results are PASS against Peak and Average limit line.												



Band 1 5150~5250MHz

WIFI 802.11ac VHT80 (Harmonic @ 3m)

WIFI Ant. 1	Note	Frequency (MHz)	Level (dBμV/m)	Over Limit (dB)	Limit Line (dBμV/m)	Read Level (dBμV)	Antenna Factor (dB/m)	Path Loss (dB)	Preamp Factor (dB)	Ant Pos (cm)	Table Pos (deg)	Peak Avg. (P/A)	Pol. (H/V)	
802.11ac VHT80 CH 42 5210MHz		10420	50.03	-18.17	68.2	56.18	40.1	14.28	60.53	100	0	P	H	
		15630	47.52	-26.48	74	53.59	37.64	17.36	61.07	100	0	P	H	
													H	
													H	
			10420	50.48	-17.72	68.2	56.63	40.1	14.28	60.53	100	0	P	V
			15630	49.05	-24.95	74	55.12	37.64	17.36	61.07	100	0	P	V
														V
													V	
Remark	1. No other spurious found. 2. All results are PASS against Peak and Average limit line.													



Band 2 - 5250~5350MHz

WIFI 802.11a (Band Edge @ 3m)

WIFI	Note	Frequency	Level	Over	Limit	Read	Antenna	Path	Preamp	Ant	Table	Peak	Pol.
Ant.				Limit	Line	Level	Factor	Loss	Factor	Pos	Pos	Avg.	
1		(MHz)	(dBμV/m)	(dB)	(dBμV/m)	(dBμV)	(dB/m)	(dB)	(dB)	(cm)	(deg)	(P/A)	(H/V)
802.11a CH 52 5260MHz		5114.92	51.19	-22.81	74	39.15	32.03	10.44	30.43	100	8	P	H
		5146.88	42.04	-11.96	54	29.89	32.09	10.49	30.43	100	8	A	H
	*	5260	101.78	-	-	90.13	31.48	10.6	30.43	100	8	P	H
	*	5260	94.33	-	-	82.68	31.48	10.6	30.43	100	8	A	H
		5424.72	51.42	-22.58	74	39.46	31.7	10.69	30.43	100	8	P	H
		5419.2	41.79	-12.21	54	29.84	31.7	10.68	30.43	100	8	A	H
		5114.24	50.84	-23.16	74	38.8	32.03	10.44	30.43	195	41	P	V
		5104.38	42.32	-11.68	54	30.31	32.01	10.43	30.43	195	41	A	V
	*	5260	110.09	-	-	98.44	31.48	10.6	30.43	195	41	P	V
	*	5260	102.52	-	-	90.87	31.48	10.6	30.43	195	41	A	V
		5402.16	51.87	-22.13	74	39.94	31.7	10.66	30.43	195	41	P	V
		5355.12	42.32	-11.68	54	30.68	31.43	10.64	30.43	195	41	A	V
802.11a CH 60 5300MHz		5143.14	51.2	-22.8	74	39.06	32.09	10.48	30.43	100	5	P	H
		5110.5	42.03	-11.97	54	30	32.02	10.44	30.43	100	5	A	H
	*	5300	101.66	-	-	90.08	31.4	10.61	30.43	100	5	P	H
	*	5300	94.26	-	-	82.68	31.4	10.61	30.43	100	5	A	H
		5393.52	51.61	-22.39	74	39.72	31.66	10.66	30.43	100	5	P	H
		5362.08	42.34	-11.66	54	30.66	31.47	10.64	30.43	100	5	A	H
		5088.74	51.54	-22.46	74	39.59	31.98	10.4	30.43	186	43	P	V
		5140.76	42.15	-11.85	54	30.02	32.08	10.48	30.43	186	43	A	V
	*	5300	109.16	-	-	97.58	31.4	10.61	30.43	186	43	P	V
	*	5300	101.67	-	-	90.09	31.4	10.61	30.43	186	43	A	V
		5354.4	54.11	-19.89	74	42.47	31.43	10.64	30.43	186	43	P	V
		5357.04	44.68	-9.32	54	33.03	31.44	10.64	30.43	186	43	A	V



802.11a CH 64 5320MHz	*	5320	102.1	-	-	90.51	31.4	10.62	30.43	120	6	P	H
	*	5320	94.34	-	-	82.75	31.4	10.62	30.43	120	6	A	H
		5426.24	51.39	-22.61	74	39.43	31.7	10.69	30.43	120	6	P	H
		5364.8	41.98	-12.02	54	30.28	31.49	10.64	30.43	120	6	A	H
												P	H
												A	H
	*	5320	109.05	-	-	97.46	31.4	10.62	30.43	182	41	P	V
	*	5320	101.57	-	-	89.98	31.4	10.62	30.43	182	41	A	V
		5353.76	53.86	-20.14	74	42.23	31.42	10.64	30.43	182	41	P	V
		5350.88	44.13	-9.87	54	32.51	31.41	10.64	30.43	182	41	A	V
												P	V
												A	V
Remark	1. No other spurious found. 2. All results are PASS against Peak and Average limit line.												



Band 2 5250~5350MHz

WIFI 802.11a (Harmonic @ 3m)

WIFI Ant. 1	Note	Frequency (MHz)	Level (dBμV/m)	Over Limit (dB)	Limit Line (dBμV/m)	Read Level (dBμV)	Antenna Factor (dB/m)	Path Loss (dB)	Preamp Factor (dB)	Ant Pos (cm)	Table Pos (deg)	Peak Avg. (P/A)	Pol. (H/V)
802.11a CH 52 5260MHz		10520	49.59	-18.61	68.2	55.92	40.12	14.3	60.75	100	0	P	H
		15780	48.36	-25.64	74	54.33	37.34	17.45	60.76	100	0	P	H
													H
													H
		10520	49.67	-18.53	68.2	56	40.12	14.3	60.75	100	0	P	V
		15780	48.43	-25.57	74	54.4	37.34	17.45	60.76	100	0	P	V
													V
													V
802.11a CH 60 5300MHz		10600	49.58	-24.42	74	55.92	40.2	14.28	60.82	100	0	P	H
		15900	47.41	-26.59	74	53.59	36.8	17.52	60.5	100	0	P	H
													H
													H
		10600	49.54	-24.46	74	55.88	40.2	14.28	60.82	100	0	P	V
		15900	46.93	-27.07	74	53.11	36.8	17.52	60.5	100	0	P	V
													V
													V
802.11a CH 64 5320MHz		10640	49.32	-24.68	74	55.75	40.16	14.26	60.85	100	0	P	H
		15960	47.88	-26.12	74	53.88	36.92	17.45	60.37	100	0	P	H
													H
													H
		10640	49.89	-24.11	74	56.32	40.16	14.26	60.85	100	0	P	V
		15960	48.21	-25.79	74	54.21	36.92	17.45	60.37	100	0	P	V
													V
													V
Remark	1. No other spurious found. 2. All results are PASS against Peak and Average limit line.												



Band 2 5250~5350MHz

WIFI 802.11n HT20 (Band Edge @ 3m)

WIFI Ant. 1	Note	Frequency (MHz)	Level (dBμV/m)	Over Limit (dB)	Limit Line (dBμV/m)	Read Level (dBμV)	Antenna Factor (dB/m)	Path Loss (dB)	Preamp Factor (dB)	Ant Pos (cm)	Table Pos (deg)	Peak Avg. (P/A)	Pol. (H/V)
802.11n HT20 CH 52 5260MHz		5149.94	51.01	-22.99	74	38.85	32.1	10.49	30.43	100	8	P	H
		5136.34	42.09	-11.91	54	29.98	32.07	10.47	30.43	100	8	A	H
	*	5260	102.91	-	-	91.26	31.48	10.6	30.43	100	8	P	H
	*	5260	94.11	-	-	82.46	31.48	10.6	30.43	100	8	A	H
		5390.88	51.74	-22.26	74	39.86	31.65	10.66	30.43	100	8	P	H
		5453.04	41.96	-12.04	54	29.95	31.72	10.72	30.43	100	8	A	H
		5078.88	52.24	-21.76	74	40.32	31.96	10.39	30.43	198	42	P	V
		5145.18	42.23	-11.77	54	30.08	32.09	10.49	30.43	198	42	A	V
	*	5260	111.03	-	-	99.38	31.48	10.6	30.43	198	42	P	V
	*	5260	102	-	-	90.35	31.48	10.6	30.43	198	42	A	V
		5426.16	52.68	-21.32	74	40.72	31.7	10.69	30.43	198	42	P	V
		5354.88	42.43	-11.57	54	30.79	31.43	10.64	30.43	198	42	A	V
802.11n HT20 CH 60 5300MHz		5107.78	52.03	-21.97	74	40.01	32.02	10.43	30.43	116	4	P	H
		5137.36	42.02	-11.98	54	29.9	32.07	10.48	30.43	116	4	A	H
	*	5300	103.3	-	-	91.72	31.4	10.61	30.43	116	4	P	H
	*	5300	94.29	-	-	82.71	31.4	10.61	30.43	116	4	A	H
		5351.28	51.36	-22.64	74	39.74	31.41	10.64	30.43	116	4	P	H
		5350.32	42.47	-11.53	54	30.86	31.4	10.64	30.43	116	4	A	H
		5124.78	53.41	-20.59	74	41.33	32.05	10.46	30.43	171	42	P	V
		5115.94	42.18	-11.82	54	30.14	32.03	10.44	30.43	171	42	A	V
	*	5300	110.7	-	-	99.12	31.4	10.61	30.43	171	42	P	V
	*	5300	101.4	-	-	89.82	31.4	10.61	30.43	171	42	A	V
	5353.44	59.46	-14.54	74	47.83	31.42	10.64	30.43	171	42	P	V	
	5352	45.14	-8.86	54	33.52	31.41	10.64	30.43	171	42	A	V	



802.11n HT20 CH 64 5320MHz	*	5320	102.03	-	-	90.44	31.4	10.62	30.43	100	5	P	H
	*	5320	92.74	-	-	81.15	31.4	10.62	30.43	100	5	A	H
		5352.64	53.85	-20.15	74	42.22	31.42	10.64	30.43	100	5	P	H
		5367.04	42.31	-11.69	54	30.59	31.5	10.65	30.43	100	5	A	H
													H
													H
	*	5320	110.39	-	-	98.8	31.4	10.62	30.43	184	41	P	V
	*	5320	101.27	-	-	89.68	31.4	10.62	30.43	184	41	A	V
		5351.36	60.17	-13.83	74	48.55	31.41	10.64	30.43	184	41	P	V
		5359.2	44.61	-9.39	54	32.94	31.46	10.64	30.43	184	41	A	V
													V
													V
Remark	1. No other spurious found. 2. All results are PASS against Peak and Average limit line.												



Band 2 5250~5350MHz

WIFI 802.11n HT20 (Harmonic @ 3m)

WIFI Ant. 1	Note	Frequency (MHz)	Level (dBμV/m)	Over Limit (dB)	Limit Line (dBμV/m)	Read Level (dBμV)	Antenna Factor (dB/m)	Path Loss (dB)	Preamp Factor (dB)	Ant Pos (cm)	Table Pos (deg)	Peak Avg. (P/A)	Pol. (H/V)
802.11n HT20 CH 52 5260MHz		10520	49.19	-19.01	68.2	55.52	40.12	14.3	60.75	100	0	P	H
		15780	47.79	-26.21	74	53.76	37.34	17.45	60.76	100	0	P	H
													H
													H
		10520	49.93	-18.27	68.2	56.26	40.12	14.3	60.75	100	0	P	V
		15780	48.07	-25.93	74	54.04	37.34	17.45	60.76	100	0	P	V
													V
													V
802.11n HT20 CH 60 5300MHz		10600	49.88	-24.12	74	56.22	40.2	14.28	60.82	100	0	P	H
		15900	47.73	-26.27	74	53.91	36.8	17.52	60.5	100	0	P	H
													H
													H
		10600	49.5	-24.5	74	55.84	40.2	14.28	60.82	100	0	P	V
		15900	47.03	-26.97	74	53.21	36.8	17.52	60.5	100	0	P	V
													V
													V
802.11n HT20 CH 64 5320MHz		10640	49.35	-24.65	74	55.78	40.16	14.26	60.85	100	0	P	H
		15960	47.59	-26.41	74	53.59	36.92	17.45	60.37	100	0	P	H
													H
													H
		10640	49.98	-24.02	74	56.41	40.16	14.26	60.85	100	0	P	V
		15960	47.1	-26.9	74	53.1	36.92	17.45	60.37	100	0	P	V
													V
													V
Remark	1. No other spurious found. 2. All results are PASS against Peak and Average limit line.												



Band 2 5250~5350MHz

WIFI 802.11n HT40 (Band Edge @ 3m)

WIFI Ant. 1	Note	Frequency (MHz)	Level (dBμV/m)	Over Limit (dB)	Limit Line (dBμV/m)	Read Level (dBμV)	Antenna Factor (dB/m)	Path Loss (dB)	Preamp Factor (dB)	Ant Pos (cm)	Table Pos (deg)	Peak Avg. (P/A)	Pol. (H/V)	
802.11n HT40 CH 54 5270MHz		5096.22	51.15	-22.85	74	39.17	31.99	10.42	30.43	106	4	P	H	
		5117.64	43.05	-10.95	54	30.99	32.04	10.45	30.43	106	4	A	H	
	*	5270	98.76	-	-	87.13	31.46	10.6	30.43	106	4	P	H	
	*	5270	90.8	-	-	79.17	31.46	10.6	30.43	106	4	A	H	
		5382.24	52.01	-21.99	74	40.2	31.59	10.65	30.43	106	4	P	H	
		5432.64	42.71	-11.29	54	30.74	31.7	10.7	30.43	106	4	A	H	
		5138.04	50.88	-23.12	74	38.75	32.08	10.48	30.43	199	40	P	V	
		5105.06	42.87	-11.13	54	30.86	32.01	10.43	30.43	199	40	A	V	
	*	5270	106.3	-	-	94.67	31.46	10.6	30.43	199	40	P	V	
	*	5270	98.29	-	-	86.66	31.46	10.6	30.43	199	40	A	V	
		5352.48	54.05	-19.95	74	42.43	31.41	10.64	30.43	199	40	P	V	
		5352	43.96	-10.04	54	32.34	31.41	10.64	30.43	199	40	A	V	
	802.11n HT40 CH 62 5310MHz		5126.82	52.01	-21.99	74	39.93	32.05	10.46	30.43	112	7	P	H
			5084.66	42.83	-11.17	54	30.89	31.97	10.4	30.43	112	7	A	H
*		5310	99.08	-	-	87.49	31.4	10.62	30.43	112	7	P	H	
*		5310	90.8	-	-	79.21	31.4	10.62	30.43	112	7	A	H	
		5359.68	56.36	-17.64	74	44.69	31.46	10.64	30.43	112	7	P	H	
		5350.08	45.46	-8.54	54	33.85	31.4	10.64	30.43	112	7	A	H	
		5069.02	52.69	-21.31	74	40.8	31.94	10.38	30.43	185	43	P	V	
		5109.82	43.03	-10.97	54	31	32.02	10.44	30.43	185	43	A	V	
*		5310	106.06	-	-	94.47	31.4	10.62	30.43	185	43	P	V	
*		5310	98.03	-	-	86.44	31.4	10.62	30.43	185	43	A	V	
	5353.44	61.08	-12.92	74	49.45	31.42	10.64	30.43	185	43	P	V		
	5350.08	50.11	-3.89	54	38.5	31.4	10.64	30.43	185	43	A	V		
Remark	1. No other spurious found. 2. All results are PASS against Peak and Average limit line.													



Band 2 5250~5350MHz

WIFI 802.11n HT40 (Harmonic @ 3m)

WIFI Ant. 1	Note	Frequency (MHz)	Level (dBμV/m)	Over Limit (dB)	Limit Line (dBμV/m)	Read Level (dBμV)	Antenna Factor (dB/m)	Path Loss (dB)	Preamp Factor (dB)	Ant Pos (cm)	Table Pos (deg)	Peak Avg. (P/A)	Pol. (H/V)
802.11n HT40 CH 54 5270MHz		10540	49.87	-18.33	68.2	56.19	40.14	14.3	60.76	100	0	P	H
		15810	47.47	-26.53	74	53.44	37.25	17.47	60.69	100	0	P	H
													H
													H
		10540	49.83	-18.37	68.2	56.15	40.14	14.3	60.76	100	0	P	V
		15810	48.25	-25.75	74	54.22	37.25	17.47	60.69	100	0	P	V
													V
													V
802.11n HT40 CH 62 5310MHz		10620	49.86	-24.14	74	56.24	40.18	14.27	60.83	100	0	P	H
		15930	47.53	-26.47	74	53.62	36.86	17.49	60.44	100	0	P	H
													H
													H
		10620	49.72	-24.28	74	56.1	40.18	14.27	60.83	100	0	P	V
		15930	46.82	-27.18	74	52.91	36.86	17.49	60.44	100	0	P	V
													V
													V
Remark	1. No other spurious found. 2. All results are PASS against Peak and Average limit line.												



Band 2 5250~5350MHz

WIFI 802.11ac VHT80 (Band Edge @ 3m)

WIFI Ant. 1	Note	Frequency (MHz)	Level (dBμV/m)	Over Limit (dB)	Limit Line (dBμV/m)	Read Level (dBμV)	Antenna Factor (dB/m)	Path Loss (dB)	Preamp Factor (dB)	Ant Pos (cm)	Table Pos (deg)	Peak Avg. (P/A)	Pol. (H/V)
802.11ac VHT80 CH 58 5290MHz		5057.12	51.99	-22.01	74	40.15	31.91	10.36	30.43	295	15	P	H
		5101.66	42.94	-11.06	54	30.95	32	10.42	30.43	295	15	A	H
	*	5290	94.53	-	-	82.93	31.42	10.61	30.43	295	15	P	H
	*	5290	87.06	-	-	75.46	31.42	10.61	30.43	295	15	A	H
		5352.48	52.45	-21.55	74	40.83	31.41	10.64	30.43	295	15	P	H
		5350.08	45.53	-8.47	54	33.92	31.4	10.64	30.43	295	15	A	H
		5141.44	52.34	-21.66	74	40.21	32.08	10.48	30.43	194	4	P	V
		5145.52	43.2	-10.8	54	31.05	32.09	10.49	30.43	194	4	A	V
	*	5290	102.96	-	-	91.36	31.42	10.61	30.43	194	4	P	V
	*	5290	94.9	-	-	83.3	31.42	10.61	30.43	194	4	A	V
		5352.48	60.89	-13.11	74	49.27	31.41	10.64	30.43	194	4	P	V
	5350.32	52.23	-1.77	54	40.62	31.4	10.64	30.43	194	4	A	V	
Remark	1. No other spurious found. 2. All results are PASS against Peak and Average limit line.												



Band 2 5250~5350MHz

WIFI 802.11ac VHT80 (Harmonic @ 3m)

WIFI Ant. 1	Note	Frequency (MHz)	Level (dBμV/m)	Over Limit (dB)	Limit Line (dBμV/m)	Read Level (dBμV)	Antenna Factor (dB/m)	Path Loss (dB)	Preamp Factor (dB)	Ant Pos (cm)	Table Pos (deg)	Peak Avg. (P/A)	Pol. (H/V)	
802.11ac VHT80 CH 58 5290MHz		10580	48.9	-19.3	68.2	55.53	40.18	14.29	61.1	100	0	P	H	
		15870	46.5	-27.5	74	53.16	36.95	17.51	61.12	100	0	P	H	
													H	
													H	
			10580	50.18	-18.02	68.2	56.81	40.18	14.29	61.1	100	0	P	V
			15870	46.81	-27.19	74	53.47	36.95	17.51	61.12	100	0	P	V
														V
													V	
Remark	1. No other spurious found. 2. All results are PASS against Peak and Average limit line.													



Band 3 - 5470~5725MHz

WIFI 802.11a (Band Edge @ 3m)

WIFI	Note	Frequency	Level	Over	Limit	Read	Antenna	Path	Preamp	Ant	Table	Peak	Pol.	
Ant.				Limit	Line	Level	Factor	Loss	Factor	Pos	Pos	Avg.		
1		(MHz)	(dBμV/m)	(dB)	(dBμV/m)	(dBμV)	(dB/m)	(dB)	(dB)	(cm)	(deg)	(P/A)	(H/V)	
802.11a CH 100 5500MHz		5460	53.34	-20.66	74	41.28	31.76	10.73	30.43	300	34	P	H	
		5469.84	54.99	-13.21	68.2	42.86	31.82	10.74	30.43	300	34	P	H	
		5459.6	42.67	-11.33	54	30.61	31.76	10.73	30.43	300	34	A	H	
	*	5500	104.01	-	-	91.66	32	10.78	30.43	300	34	P	H	
	*	5500	96.5	-	-	84.15	32	10.78	30.43	300	34	A	H	
														H
			5459.12	58.33	-15.67	74	46.28	31.75	10.73	30.43	199	38	P	V
			5470	58.15	-10.05	68.2	46.02	31.82	10.74	30.43	199	38	P	V
			5459.76	43.85	-10.15	54	31.79	31.76	10.73	30.43	199	38	A	V
	*		5500	108.39	-	-	96.04	32	10.78	30.43	199	38	P	V
	*		5500	100.87	-	-	88.52	32	10.78	30.43	199	38	A	V
														V
802.11a CH 116 5580MHz		5438.56	52.65	-21.35	74	40.67	31.7	10.71	30.43	281	31	P	H	
		5463.76	51.98	-16.22	68.2	39.89	31.78	10.74	30.43	281	31	P	H	
		5457.76	42.18	-11.82	54	30.13	31.75	10.73	30.43	281	31	A	H	
	*	5580	104.35	-	-	92.1	31.86	10.87	30.48	281	31	P	H	
	*	5580	96.95	-	-	84.7	31.86	10.87	30.48	281	31	A	H	
			5750.195	50.81	-17.39	68.2	38.54	32	10.86	30.59	281	31	P	H
			5422	52.2	-21.8	74	40.24	31.7	10.69	30.43	180	40	P	V
			5467.6	50.96	-17.24	68.2	38.84	31.81	10.74	30.43	180	40	P	V
			5451.28	42.5	-11.5	54	30.5	31.71	10.72	30.43	180	40	A	V
	*		5580	108.19	-	-	95.94	31.86	10.87	30.48	180	40	P	V
	*		5580	100.92	-	-	88.67	31.86	10.87	30.48	180	40	A	V
			5752.4	50.46	-17.74	68.2	38.18	32.01	10.86	30.59	180	40	P	V



802.11a CH 140 5700MHz	*	5700	103.35	-	-	91.03	32	10.87	30.55	281	31	P	H
	*	5700	95.89	-	-	83.57	32	10.87	30.55	281	31	A	H
		5730.84	58.8	-9.4	68.2	46.5	32	10.87	30.57	281	31	P	H
													H
													H
													H
	*	5700	108.31	-	-	95.99	32	10.87	30.55	187	45	P	V
	*	5700	100.86	-	-	88.54	32	10.87	30.55	187	45	A	V
		5727.24	62.94	-5.26	68.2	50.64	32	10.87	30.57	187	45	P	V
													V
													V
													V
Remark	1. No other spurious found. 2. All results are PASS against Peak and Average limit line.												



Band 3 - 5470~5725MHz

WIFI 802.11a (Harmonic @ 3m)

WIFI Ant. 1	Note	Frequency (MHz)	Level (dBµV/m)	Over Limit (dB)	Limit Line (dBµV/m)	Read Level (dBµV)	Antenna Factor (dB/m)	Path Loss (dB)	Preamp Factor (dB)	Ant Pos (cm)	Table Pos (deg)	Peak Avg. (P/A)	Pol. (H/V)
802.11a CH 100 5500MHz		11000	49.57	-24.43	74	55.85	40.6	14.22	61.1	100	0	P	H
		16500	49.27	-18.93	68.2	52.09	38.8	17.78	59.4	100	0	P	H
													H
													H
		11000	49.41	-24.59	74	55.69	40.6	14.22	61.1	100	0	P	V
		16500	48.96	-19.24	68.2	51.78	38.8	17.78	59.4	100	0	P	V
													V
													V
802.11a CH 116 5580MHz		11160	49.47	-24.53	74	55.79	40.22	14.5	61.04	100	0	P	H
		16740	49.18	-19.02	68.2	50.26	39.98	18.2	59.26	100	0	P	H
													H
													H
		11160	49.7	-24.3	74	56.02	40.22	14.5	61.04	100	0	P	V
		16740	49.12	-19.08	68.2	50.2	39.98	18.2	59.26	100	0	P	V
													V
													V
802.11a CH 140 5700MHz		11400	49.14	-24.86	74	54.91	40.3	14.87	60.94	100	0	P	H
		17100	50.62	-17.58	68.2	50.29	40.8	18.51	58.98	100	0	P	H
													H
													H
		11400	49.96	-24.04	74	55.73	40.3	14.87	60.94	100	0	P	V
		17100	50.42	-17.78	68.2	50.09	40.8	18.51	58.98	100	0	P	V
													V
													V
Remark	1. No other spurious found. 2. All results are PASS against Peak and Average limit line.												



Band 3 - 5470~5725MHz

WIFI 802.11n HT20 (Band Edge @ 3m)

WIFI Ant. 1	Note	Frequency (MHz)	Level (dBμV/m)	Over Limit (dB)	Limit Line (dBμV/m)	Read Level (dBμV)	Antenna Factor (dB/m)	Path Loss (dB)	Preamp Factor (dB)	Ant Pos (cm)	Table Pos (deg)	Peak Avg. (P/A)	Pol. (H/V)	
802.11n HT20 CH 100 5500MHz		5459.44	56.48	-17.52	74	44.42	31.76	10.73	30.43	303	30	P	H	
		5463.28	55.86	-12.34	68.2	43.77	31.78	10.74	30.43	303	30	P	H	
		5459.44	43.19	-10.81	54	31.13	31.76	10.73	30.43	303	30	A	H	
	*	5500	104.97	-	-	92.62	32	10.78	30.43	303	30	P	H	
	*	5500	96.11	-	-	83.76	32	10.78	30.43	303	30	A	H	
														H
			5459.6	61.29	-12.71	74	49.23	31.76	10.73	30.43	206	36	P	V
			5465.2	61.56	-6.64	68.2	49.46	31.79	10.74	30.43	206	36	P	V
			5454	45.88	-8.12	54	33.87	31.72	10.72	30.43	206	36	A	V
	*		5500	109.9	-	-	97.55	32	10.78	30.43	206	36	P	V
	*		5500	100.8	-	-	88.45	32	10.78	30.43	206	36	A	V
														V
802.11n HT20 CH 116 5580MHz		5428	52.19	-21.81	74	40.23	31.7	10.69	30.43	292	35	P	H	
		5465.2	51.75	-16.45	68.2	39.65	31.79	10.74	30.43	292	35	P	H	
		5459.68	42.24	-11.76	54	30.18	31.76	10.73	30.43	292	35	A	H	
	*	5580	105.81	-	-	93.56	31.86	10.87	30.48	292	35	P	H	
	*	5580	96.61	-	-	84.36	31.86	10.87	30.48	292	35	A	H	
			5755.865	52.11	-16.09	68.2	39.82	32.02	10.86	30.59	292	35	P	H
			5458.24	52.69	-21.31	74	40.64	31.75	10.73	30.43	193	38	P	V
			5465.2	51.92	-16.28	68.2	39.82	31.79	10.74	30.43	193	38	P	V
			5444.56	42.56	-11.44	54	30.58	31.7	10.71	30.43	193	38	A	V
	*		5580	109.68	-	-	97.43	31.86	10.87	30.48	193	38	P	V
	*		5580	100.34	-	-	88.09	31.86	10.87	30.48	193	38	A	V
			5734.13	52.54	-15.66	68.2	40.25	32	10.87	30.58	193	38	P	V



802.11n HT20 CH 140 5700MHz	*	5700	104.61	-	-	92.29	32	10.87	30.55	296	30	P	H
	*	5700	95.44	-	-	83.12	32	10.87	30.55	296	30	A	H
		5725.96	58.06	-10.14	68.2	45.76	32	10.87	30.57	296	30	P	H
													H
													H
													H
	*	5700	109.22	-	-	96.9	32	10.87	30.55	172	44	P	V
	*	5700	100.54	-	-	88.22	32	10.87	30.55	172	44	A	V
		5739.96	65.19	-3.01	68.2	52.91	32	10.86	30.58	172	44	P	V
													V
													V
													V
Remark	1. No other spurious found. 2. All results are PASS against Peak and Average limit line.												



Band 3 - 5470~5725MHz

WIFI 802.11n HT20 (Harmonic @ 3m)

WIFI Ant. 1	Note	Frequency (MHz)	Level (dBμV/m)	Over Limit (dB)	Limit Line (dBμV/m)	Read Level (dBμV)	Antenna Factor (dB/m)	Path Loss (dB)	Preamp Factor (dB)	Ant Pos (cm)	Table Pos (deg)	Peak Avg. (P/A)	Pol. (H/V)
802.11n HT20 CH 100 5500MHz		11000	49.96	-24.04	74	56.24	40.6	14.22	61.1	100	0	P	H
		16500	48.98	-19.22	68.2	51.8	38.8	17.78	59.4	100	0	P	H
													H
													H
		11000	49.58	-24.42	74	55.86	40.6	14.22	61.1	100	0	P	V
		16500	47.15	-21.05	68.2	49.97	38.8	17.78	59.4	100	0	P	V
													V
802.11n HT20 CH 116 5580MHz		11160	49.9	-24.1	74	56.22	40.22	14.5	61.04	100	0	P	H
		16740	50.3	-17.9	68.2	51.38	39.98	18.2	59.26	100	0	P	H
													H
													H
		11160	49.67	-24.33	74	55.99	40.22	14.5	61.04	100	0	P	V
		16740	49.23	-18.97	68.2	50.31	39.98	18.2	59.26	100	0	P	V
													V
802.11n HT20 CH 140 5700MHz		11400	49.99	-24.01	74	55.76	40.3	14.87	60.94	100	0	P	H
		17100	50.97	-17.23	68.2	50.64	40.8	18.51	58.98	100	0	P	H
													H
													H
		11400	49.55	-24.45	74	55.32	40.3	14.87	60.94	100	0	P	V
		17100	50.64	-17.56	68.2	50.31	40.8	18.51	58.98	100	0	P	V
													V
Remark	1. No other spurious found.												
	2. All results are PASS against Peak and Average limit line.												



Band 3 - 5470~5725MHz

WIFI 802.11n HT40 (Band Edge @ 3m)

WIFI Ant. 1	Note	Frequency (MHz)	Level (dBμV/m)	Over Limit (dB)	Limit Line (dBμV/m)	Read Level (dBμV)	Antenna Factor (dB/m)	Path Loss (dB)	Preamp Factor (dB)	Ant Pos (cm)	Table Pos (deg)	Peak Avg. (P/A)	Pol. (H/V)
802.11n HT40 CH 102 5510MHz		5450.71	54.87	-19.13	74	42.88	31.7	10.72	30.43	302	30	P	H
		5469.61	55.28	-12.92	68.2	43.15	31.82	10.74	30.43	302	30	P	H
		5456.65	43.66	-10.34	54	31.62	31.74	10.73	30.43	302	30	A	H
	*	5510	99.69	-	-	87.38	31.96	10.79	30.44	302	30	P	H
	*	5510	91.7	-	-	79.39	31.96	10.79	30.44	302	30	A	H
		5741.375	52.14	-16.06	68.2	39.86	32	10.86	30.58	302	30	P	H
		5452.87	58.74	-15.26	74	46.73	31.72	10.72	30.43	212	41	P	V
		5468.53	60.39	-7.81	68.2	48.27	31.81	10.74	30.43	212	41	P	V
		5459.89	45.75	-8.25	54	33.69	31.76	10.73	30.43	212	41	A	V
	*	5510	104.47	-	-	92.16	31.96	10.79	30.44	212	41	P	V
	*	5510	96.36	-	-	84.05	31.96	10.79	30.44	212	41	A	V
		5736.335	51.91	-16.29	68.2	39.62	32	10.87	30.58	212	41	P	V
802.11n HT40 CH 110 5550MHz		5388.07	51.89	-22.11	74	40.03	31.63	10.66	30.43	297	30	P	H
		5466.91	51.71	-16.49	68.2	39.6	31.8	10.74	30.43	297	30	P	H
		5454.49	42.98	-11.02	54	30.95	31.73	10.73	30.43	297	30	A	H
	*	5550	99.86	-	-	87.68	31.8	10.84	30.46	297	30	P	H
	*	5550	91.93	-	-	79.75	31.8	10.84	30.46	297	30	A	H
		5761.85	51.5	-16.7	68.2	39.18	32.05	10.86	30.59	297	30	P	H
		5407.24	52.26	-21.74	74	40.32	31.7	10.67	30.43	196	40	P	V
		5465.29	54.52	-13.68	68.2	42.42	31.79	10.74	30.43	196	40	P	V
		5458.27	43.58	-10.42	54	31.53	31.75	10.73	30.43	196	40	A	V
	*	5550	104.55	-	-	92.37	31.8	10.84	30.46	196	40	P	V
	*	5550	96.24	-	-	84.06	31.8	10.84	30.46	196	40	A	V
		5756.18	52.41	-15.79	68.2	40.12	32.02	10.86	30.59	196	40	P	V



802.11n HT40 CH 134 5670MHz		5387.74	51.73	-22.27	74	39.87	31.63	10.66	30.43	283	33	P	H
		5467.29	50.97	-17.23	68.2	38.86	31.8	10.74	30.43	283	33	P	H
		5428.44	42.88	-11.12	54	30.92	31.7	10.69	30.43	283	33	A	H
	*	5670	99.48	-	-	87.26	31.88	10.88	30.54	283	33	P	H
	*	5670	91.45	-	-	79.23	31.88	10.88	30.54	283	33	A	H
		5732.8	54.4	-13.8	68.2	42.1	32	10.87	30.57	283	33	P	H
		5450.64	52.28	-21.72	74	40.29	31.7	10.72	30.43	173	41	P	V
		5462.48	51.47	-16.73	68.2	39.4	31.77	10.73	30.43	173	41	P	V
		5426.22	42.99	-11.01	54	31.03	31.7	10.69	30.43	173	41	A	V
	*	5670	103.44	-	-	91.22	31.88	10.88	30.54	173	41	P	V
	*	5670	95.3	-	-	83.08	31.88	10.88	30.54	173	41	A	V
		5725	60.19	-8.01	68.2	47.89	32	10.87	30.57	173	41	P	V
Remark	1. No other spurious found. 2. All results are PASS against Peak and Average limit line.												



Band 3 - 5470~5725MHz

WIFI 802.11n HT40 (Harmonic @ 3m)

WIFI Ant. 1	Note	Frequency (MHz)	Level (dBμV/m)	Over Limit (dB)	Limit Line (dBμV/m)	Read Level (dBμV)	Antenna Factor (dB/m)	Path Loss (dB)	Preamp Factor (dB)	Ant Pos (cm)	Table Pos (deg)	Peak Avg. (P/A)	Pol. (H/V)	
802.11n HT40 CH 102 5510MHz		11020	47.91	-26.09	74	54.19	40.56	14.25	61.09	100	0	P	H	
		16530	47.39	-20.81	68.2	50.11	38.83	17.83	59.38	100	0	P	H	
													H	
													H	
			11020	48.38	-25.62	74	54.66	40.56	14.25	61.09	100	0	P	V
			16530	46.34	-21.86	68.2	49.06	38.83	17.83	59.38	100	0	P	V
														V
802.11n HT40 CH 110 5550MHz		11100	47.98	-26.02	74	54.31	40.4	14.33	61.06	100	0	P	H	
		16650	47.58	-20.62	68.2	49.51	39.3	18.08	59.31	100	0	P	H	
													H	
													H	
			11100	47.36	-26.64	74	53.69	40.4	14.33	61.06	100	0	P	V
			16650	47.25	-20.95	68.2	49.18	39.3	18.08	59.31	100	0	P	V
														V
802.11n HT40 CH 134 5670MHz		11340	46.8	-27.2	74	52.7	40.18	14.88	60.96	100	0	P	H	
		17010	48.69	-19.51	68.2	48.73	40.62	18.43	59.09	100	0	P	H	
													H	
													H	
			11340	47.27	-26.73	74	53.17	40.18	14.88	60.96	100	0	P	V
			17010	48.8	-19.4	68.2	48.84	40.62	18.43	59.09	100	0	P	V
														V
Remark	1. No other spurious found.													
	2. All results are PASS against Peak and Average limit line.													



Band 3 - 5470~5725MHz

WIFI 802.11ac VHT80 (Band Edge @ 3m)

WIFI Ant. 1	Note	Frequency (MHz)	Level (dBμV/m)	Over Limit (dB)	Limit Line (dBμV/m)	Read Level (dBμV)	Antenna Factor (dB/m)	Path Loss (dB)	Preamp Factor (dB)	Ant Pos (cm)	Table Pos (deg)	Peak Avg. (P/A)	Pol. (H/V)
802.11ac VHT80 CH 106 5530MHz		5459.62	53.28	-20.72	74	41.22	31.76	10.73	30.43	297	30	P	H
		5468.26	54.89	-13.31	68.2	42.77	31.81	10.74	30.43	297	30	P	H
		5459.89	44.38	-9.62	54	32.32	31.76	10.73	30.43	297	30	A	H
	*	5530	97.13	-	-	84.89	31.88	10.81	30.45	297	30	P	H
	*	5530	88.66	-	-	76.42	31.88	10.81	30.45	297	30	A	H
		5729.72	51.42	-16.78	68.2	39.12	32	10.87	30.57	297	30	P	H
		5456.92	58.79	-15.21	74	46.75	31.74	10.73	30.43	194	41	P	V
		5468.53	60.23	-7.97	68.2	48.11	31.81	10.74	30.43	194	41	P	V
		5459.08	46.52	-7.48	54	34.47	31.75	10.73	30.43	194	41	A	V
	*	5530	101.17	-	-	88.93	31.88	10.81	30.45	194	41	P	V
	*	5530	93.06	-	-	80.82	31.88	10.81	30.45	194	41	A	V
802.11ac VHT80 CH 122 5610MHz		5741.69	52.87	-15.33	68.2	40.59	32	10.86	30.58	194	41	P	V
		5459.35	51.92	-22.08	74	39.86	31.76	10.73	30.43	290	30	P	H
		5465.56	51	-17.2	68.2	38.9	31.79	10.74	30.43	290	30	P	H
		5417.5	42.84	-11.16	54	30.89	31.7	10.68	30.43	290	30	A	H
	*	5610	97.79	-	-	85.52	31.88	10.89	30.5	290	30	P	H
	*	5610	89.81	-	-	77.54	31.88	10.89	30.5	290	30	A	H
		5758.7	51.48	-16.72	68.2	39.18	32.03	10.86	30.59	290	30	P	H
		5451.52	52.25	-21.75	74	40.25	31.71	10.72	30.43	181	42	P	V
		5465.02	52.18	-16.02	68.2	40.08	31.79	10.74	30.43	181	42	P	V
		5399.68	43.15	-10.85	54	31.22	31.7	10.66	30.43	181	42	A	V
	*	5610	101.4	-	-	89.13	31.88	10.89	30.5	181	42	P	V
*	5610	93.12	-	-	80.85	31.88	10.89	30.5	181	42	A	V	
	5727.515	52.43	-15.77	68.2	40.13	32	10.87	30.57	181	42	P	V	
Remark	1. No other spurious found. 2. All results are PASS against Peak and Average limit line.												



Band 3 5470~5725MHz

WIFI 802.11ac VHT80 (Harmonic @ 3m)

WIFI Ant. 1	Note	Frequency (MHz)	Level (dBμV/m)	Over Limit (dB)	Limit Line (dBμV/m)	Read Level (dBμV)	Antenna Factor (dB/m)	Path Loss (dB)	Preamp Factor (dB)	Ant Pos (cm)	Table Pos (deg)	Peak Avg. (P/A)	Pol. (H/V)
802.11ac VHT80 CH 106 5530MHz		11060	48.24	-25.76	74	54.55	40.48	14.29	61.08	100	0	P	H
		16590	47.74	-20.46	68.2	50.25	38.89	17.95	59.35	100	0	P	H
													H
													H
		11060	48.39	-25.61	74	54.7	40.48	14.29	61.08	100	0	P	V
		16590	47.37	-20.83	68.2	49.88	38.89	17.95	59.35	100	0	P	V
													V
802.11ac VHT80 CH 122 5610MHz		11220	46.75	-27.25	74	52.99	40.1	14.67	61.01	100	0	P	H
		16830	48.6	-19.6	68.2	49.2	40.34	18.26	59.2	100	0	P	H
													H
													H
		11220	47.05	-26.95	74	53.29	40.1	14.67	61.01	100	0	P	V
		16830	48.91	-19.29	68.2	49.51	40.34	18.26	59.2	100	0	P	V
													V
Remark	1. No other spurious found.												
	2. All results are PASS against Peak and Average limit line.												



Emission below 1GHz

WIFI 802.11 ac80 (LF @ 3m)

WIFI	Note	Frequency	Level	Over	Limit	Read	Antenna	Path	Preamp	Ant	Table	Peak	Pol.	
Ant.				Limit	Line	Level	Factor	Loss	Factor	Pos	Pos	Avg.		
1		(MHz)	(dBμV/m)	(dB)	(dBμV/m)	(dBμV)	(dB/m)	(dB)	(dB)	(cm)	(deg)	(P/A)	(H/V)	
802.11 Ac80 LF		31.94	20.05	-19.95	40	29.87	21.84	0.67	32.33	-	-	P	H	
		198.78	28.49	-15.01	43.5	43.81	15.1	1.96	32.38	-	-	P	H	
		303.54	27.22	-18.78	46	38.22	19.13	2.38	32.51	-	-	P	H	
		558.65	26.71	-19.29	46	30.05	25.72	3.29	32.35	-	-	P	H	
		746.83	34.69	-11.31	46	35.68	27.66	3.81	32.46	100	0	P	H	
		891.36	34.22	-11.78	46	33.39	28.51	4.25	31.93	-	-	P	H	
														H
														H
														H
														H
														H
														H
														H
			37.76	28.9	-11.1	40	40	20.51	0.73	32.34	100	0	P	V
			83.35	25.04	-14.96	40	42.31	13.97	1.21	32.45	-	-	P	V
			196.84	21.73	-21.77	43.5	37.07	15.09	1.95	32.38	-	-	P	V
			411.21	24.23	-21.77	46	31.48	22.25	2.74	32.24	-	-	P	V
			566.41	27.19	-18.81	46	30.41	25.88	3.3	32.4	-	-	P	V
			893.3	34.08	-11.92	46	33.21	28.55	4.26	31.94	-	-	P	V
														V
													V	
													V	
													V	
													V	
													V	
Remark	1. No other spurious found. 2. All results are PASS against limit line.													



Note symbol

*	Fundamental Frequency which can be ignored. However, the level of any unwanted emissions shall not exceed the level of the fundamental frequency.
!	Test result is over limit line.
P/A	Peak or Average
H/V	Horizontal or Vertical



A calculation example for radiated spurious emission is shown as below:

WIFI	Note	Frequency	Level	Over	Limit	Read	Antenna	Path	Preamp	Ant	Table	Peak	Pol.
Ant.				Limit	Line	Level	Factor	Loss	Factor	Pos	Pos	Avg.	
1		(MHz)	(dBμV/m)	(dB)	(dBμV/m)	(dBμV)	(dB/m)	(dB)	(dB)	(cm)	(deg)	(P/A)	(H/V)
802.11b		2390	55.45	-18.55	74	54.51	32.22	4.58	35.86	103	308	P	H
CH 01		2390	43.54	-10.46	54	42.6	32.22	4.58	35.86	103	308	A	H
2412MHz													

1. Path Loss(dB) = Cable loss(dB) + Filter loss(dB) + Attenuator loss(dB)
2. Level(dBμV/m) = Antenna Factor(dB/m) + Path Loss(dB) + Read Level(dBμV) - Preamp Factor(dB)
3. Over Limit(dB) = Level(dBμV/m) – Limit Line(dBμV/m)

For Peak Limit @ 2390MHz:

1. Level(dBμV/m)
= Antenna Factor(dB/m) + Path Loss(dB) + Read Level(dBμV) - Preamp Factor(dB)
= 32.22(dB/m) + 4.58(dB) + 54.51(dBμV) – 35.86 (dB)
= 55.45 (dBμV/m)
2. Over Limit(dB)
= Level(dBμV/m) – Limit Line(dBμV/m)
= 55.45(dBμV/m) – 74(dBμV/m)
= -18.55(dB)

For Average Limit @ 2390MHz:

1. Level(dBμV/m)
= Antenna Factor(dB/m) + Path Loss(dB) + Read Level(dBμV) - Preamp Factor(dB)
= 32.22(dB/m) + 4.58(dB) + 42.6(dBμV) – 35.86 (dB)
= 43.54 (dBμV/m)
2. Over Limit(dB) = Level(dBμV/m) – Limit Line(dBμV/m)
= 43.54(dBμV/m) – 54(dBμV/m)
= -10.46(dB)

Both peak and average measured complies with the limit line, so test result is “PASS”.



Appendix D. Radiated Spurious Emission Plots

Test Engineer :	Leo Lee, Mancy Chou and Bigshow Wang	Temperature :	22.1~23.1°C
		Relative Humidity :	55~60%

Note symbol

-L	Low channel location
-R	High channel location

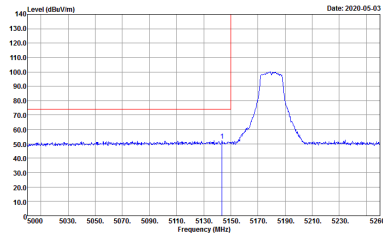
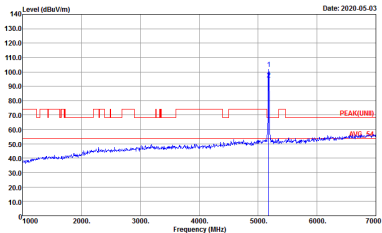
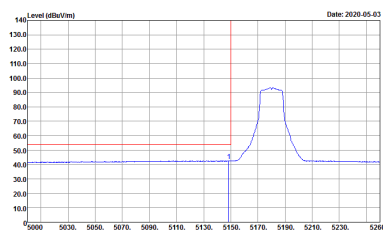

Band 1 - 5150~5250MHz
WIFI 802.11a (Band Edge @ 3m)

WIFI	Band 1 5150~5250MHz Band Edge @ 3m	
ANT	802.11a CH36 5180MHz	
1	Horizontal	Fundamental
Peak	 <p>Site : 03CH15-HY Condition : PEAK_BE_74 3m 91200_15_1620 HORIZONTAL Detector : Peak Project : 042038</p>	 <p>Site : 03CH15-HY Condition : PEAK(LINE) 3m 91200_15_1620 HORIZONTAL Detector : Peak Project : 042038</p>
Avg.	 <p>Site : 03CH15-HY Condition : AV6_BE_54 3m 91200_15_1620 HORIZONTAL Detector : Peak Project : 042038</p>	Left blank

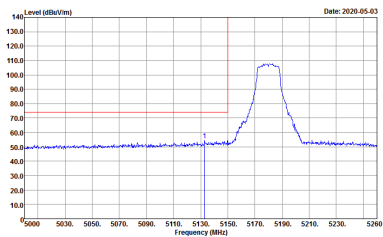
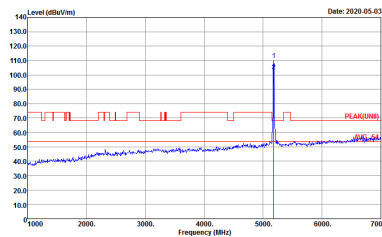
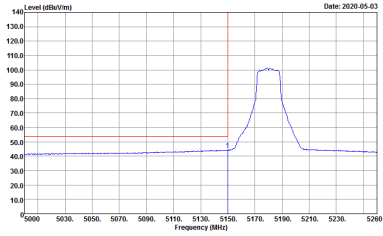

WIFI	Band 1 5150~5250MHz Band Edge @ 3m	
ANT	802.11a CH36 5180MHz	
1	Vertical	Fundamental
<p>Peak</p>	 <p>Site : 03CH15-HY Condition : PEAK_BE_74 3m 91200_15_1620 VERTICAL Detector : Peak Project : 042038</p>	 <p>Site : 03CH15-HY Condition : PEAK(LINII) 3m 91200_15_1620 VERTICAL Detector : Peak Project : 042038</p>
<p>Avg.</p>	 <p>Site : 03CH15-HY Condition : AVG_BE_54 3m 91200_15_1620 VERTICAL Detector : Peak Project : 042038</p>	<p>Left blank</p>

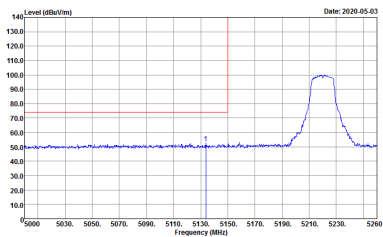
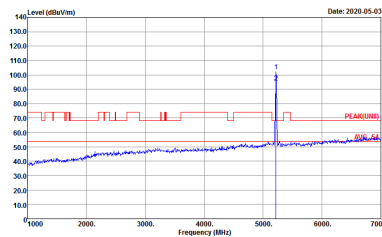
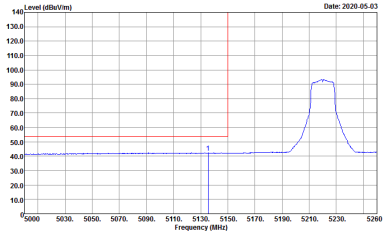

WIFI	Band 1 5150~5250MHz Band Edge @ 3m	
ANT	802.11a CH44 5220MHz - L	
1	Horizontal	Fundamental
Peak	 <p>Site : 03CH15-HY Condition : PEAK_BE_74 3m 91200_15_1620 HORIZONTAL Detector : Peak Project : 042038</p>	 <p>Site : 03CH15-HY Condition : PEAKUNII 3m 91200_15_1620 HORIZONTAL Detector : Peak Project : 042038</p>
Avg.	 <p>Site : 03CH15-HY Condition : AVG_BE_54 3m 91200_15_1620 HORIZONTAL Detector : Peak Project : 042038</p>	Left blank

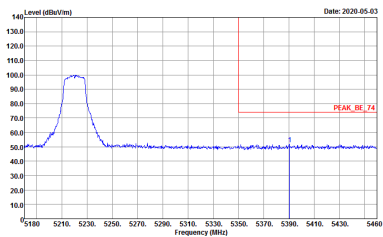
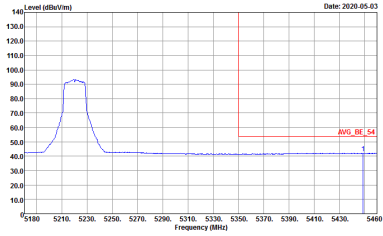

WIFI	Band 1 5150~5250MHz Band Edge @ 3m	
ANT	802.11a CH44 5220MHz - R	
1	Horizontal	Fundamental
Peak	 <p> Site : 03CH15-HY Condition : PEAK_BE_74 3m 91200_15_1620 HORIZONTAL Detector : Peak Project : 042038 </p>	Left blank
Avg.	 <p> Site : 03CH15-HY Condition : AVG_BE_54 3m 91200_15_1620 HORIZONTAL Detector : Peak Project : 042038 </p>	Left blank

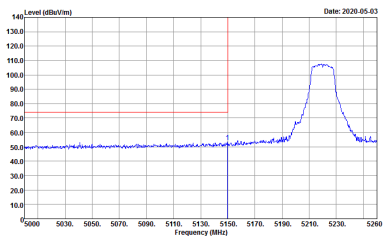
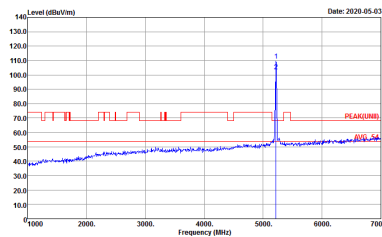
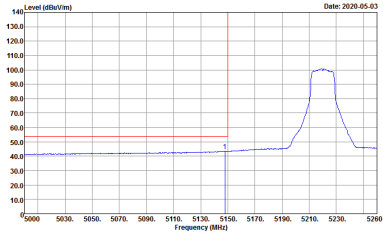

WIFI	Band 1 5150~5250MHz Band Edge @ 3m	
ANT	802.11a CH44 5220MHz - L	
1	Vertical	Fundamental
Peak	 <p>Site : 03CH15-HY Condition : PEAK_BE_74 3m 9120D_15_1620 VERTICAL Detector : Peak Project : 042038</p>	 <p>Site : 03CH15-HY Condition : PEAK(LINII) 3m 9120D_15_1620 VERTICAL Detector : Peak Project : 042038</p>
Avg.	 <p>Site : 03CH15-HY Condition : AVG_BE_54 3m 9120D_15_1620 VERTICAL Detector : Peak Project : 042038</p>	Left blank

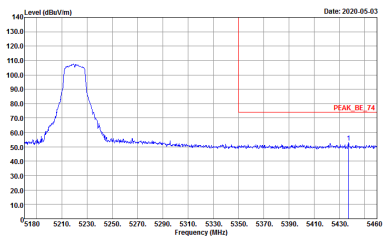
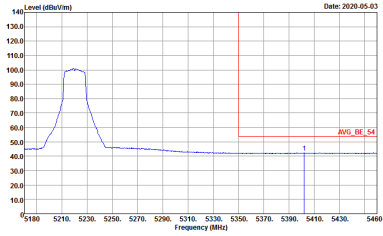

WIFI	Band 1 5150~5250MHz Band Edge @ 3m	
ANT	802.11a CH44 5220MHz - R	
1	Vertical	Fundamental
<p>Peak</p>	 <p>Site : 03CH15-HY Condition : PEAK_BE_74 3m 9120D_15_1620 VERTICAL Detector : Peak Project : 042038</p>	<p>Left blank</p>
<p>Avg.</p>	 <p>Site : 03CH15-HY Condition : AVG_BE_54 3m 9120D_15_1620 VERTICAL Detector : Peak Project : 042038</p>	<p>Left blank</p>

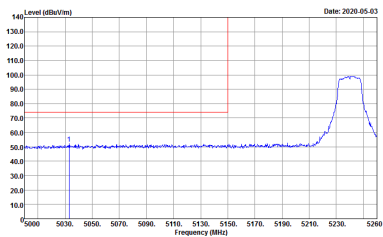
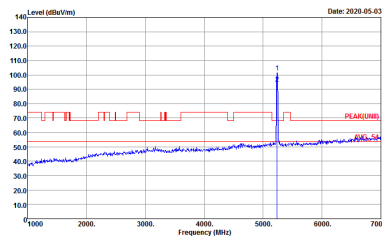
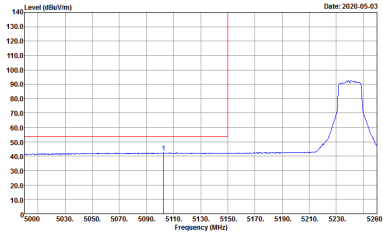

WIFI	Band 1 5150~5250MHz Band Edge @ 3m	
ANT	802.11a CH48 5240MHz - L	
1	Horizontal	Fundamental
Peak	 <p>Site : 03CH15-HY Condition : PEAK_BE_74 3m 91200_15_1620 HORIZONTAL Detector : Peak Project : 042038</p>	 <p>Site : 03CH15-HY Condition : PEAKUNII 3m 91200_15_1620 HORIZONTAL Detector : Peak Project : 042038</p>
Avg.	 <p>Site : 03CH15-HY Condition : AVG_BE_54 3m 91200_15_1620 HORIZONTAL Detector : Peak Project : 042038</p>	Left blank

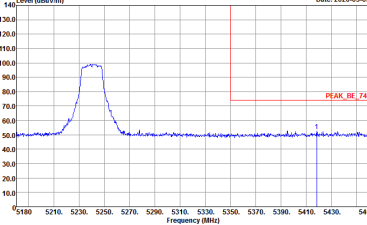
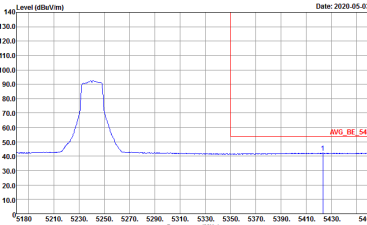

WIFI	Band 1 5150~5250MHz Band Edge @ 3m	
ANT	802.11a CH48 5240MHz - R	
1	Horizontal	Fundamental
<p>Peak</p>	 <p>Site : 03CH15-HY Condition : PEAK_BE_74 3m 9120D_15_1620 HORIZONTAL Detector : Peak Project : 042038</p>	<p>Left blank</p>
<p>Avg.</p>	 <p>Site : 03CH15-HY Condition : AVG_BE_54 3m 9120D_15_1620 HORIZONTAL Detector : Peak Project : 042038</p>	<p>Left blank</p>

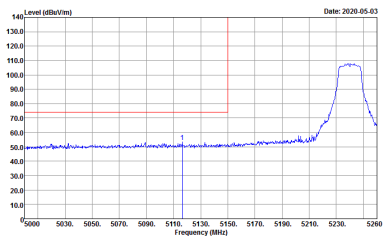
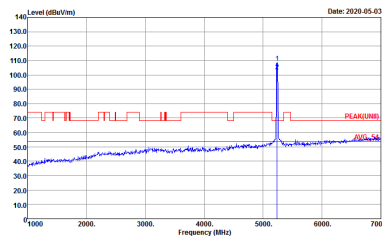
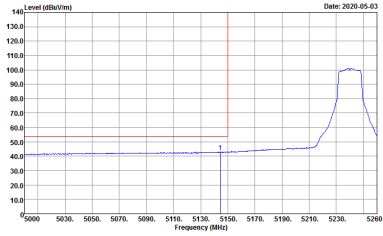

WIFI	Band 1 5150~5250MHz Band Edge @ 3m	
ANT	802.11a CH48 5240MHz - L	
1	Vertical	Fundamental
Peak	 <p>Site : 03CH15-HY Condition : PEAK_BE_74 3m 91200_15_1620 VERTICAL Detector : Peak Project : 042038</p>	 <p>Site : 03CH15-HY Condition : PEAK(UNII) 3m 91200_15_1620 VERTICAL Detector : Peak Project : 042038</p>
Avg.	 <p>Site : 03CH15-HY Condition : AVG_BE_54 3m 91200_15_1620 VERTICAL Detector : Peak Project : 042038</p>	Left blank

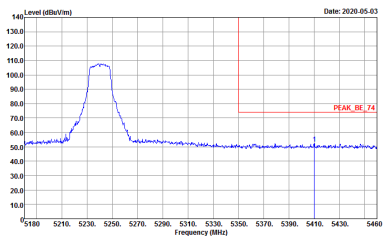
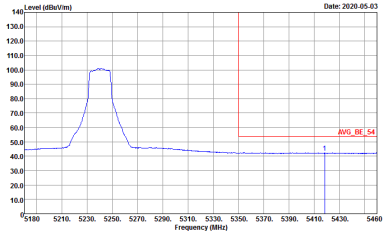

WIFI	Band 1 5150~5250MHz Band Edge @ 3m	
ANT	802.11a CH48 5240MHz - R	
1	Vertical	Fundamental
<p>Peak</p>	 <p>Site : 03CH15-HY Condition : PEAK_BE_74 3m 91200_15_1620 VERTICAL Detector : Peak Project : 042038</p>	<p>Left blank</p>
<p>Avg.</p>	 <p>Site : 03CH15-HY Condition : AVG_BE_54 3m 91200_15_1620 VERTICAL Detector : Peak Project : 042038</p>	<p>Left blank</p>

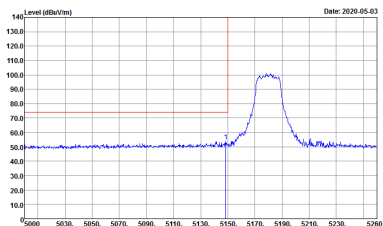
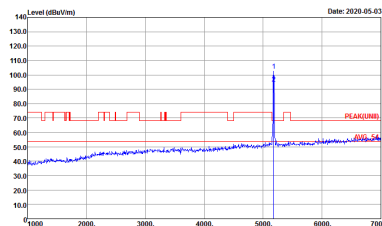
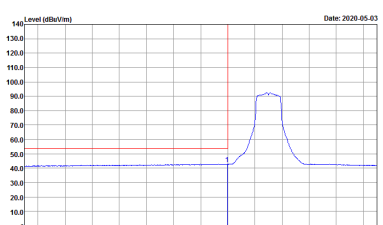

Band 1 5150~5250MHz
WIFI 802.11n HT20 (Band Edge @ 3m)

WIFI	Band 1 5150~5250MHz Band Edge @ 3m	
ANT	802.11n HT20 CH36 5180MHz	
1	Horizontal	Fundamental
<p align="center">Peak</p>	 <p>Site : 03CH15-1Y Condition : PEAK_BE_74 3m 91200_15_1620 HORIZONTAL RBW:1000.000KHz VBW:3000.000KHz SWT:Auto Detector : Peak Project : 042038</p>	 <p>Site : 03CH15-1Y Condition : PEAK(UNIT) 3m 91200_15_1620 HORIZONTAL RBW:1000.000KHz VBW:3000.000KHz SWT:Auto Detector : Peak Project : 042038</p>
<p align="center">Avg.</p>	 <p>Site : 03CH15-1Y Condition : AVG_BE_54 3m 91200_15_1620 HORIZONTAL RBW:1000.000KHz VBW:1.000KHz SWT:Auto Detector : Peak Project : 042038</p>	<p align="center">Left blank</p>

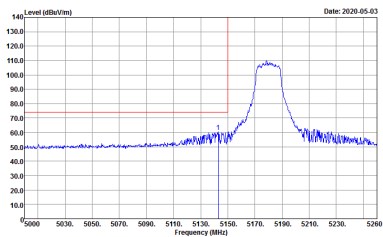
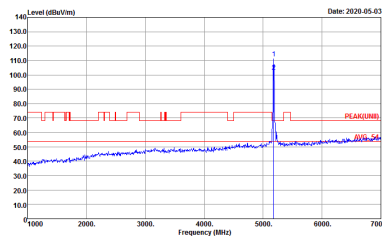
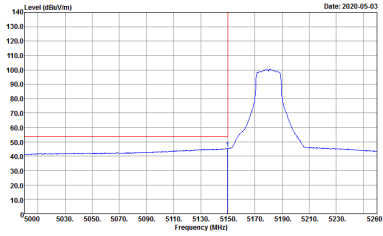

WIFI	Band 1 5150~5250MHz Band Edge @ 3m	
ANT	802.11n HT20 CH36 5180MHz	
1	Vertical	Fundamental
Peak	 <p>Site : 03CH15-HY Condition : PEAK_BE_74 3m 9120D_15_1620 VERTICAL Detector : Peak Project : 042038</p>	 <p>Site : 03CH15-HY Condition : PEAK(LINII) 3m 9120D_15_1620 VERTICAL Detector : Peak Project : 042038</p>
Avg.	 <p>Site : 03CH15-HY Condition : AVG_BE_54 3m 9120D_15_1620 VERTICAL Detector : Peak Project : 042038</p>	Left blank



WIFI	Band 1 5150~5250MHz Band Edge @ 3m	
ANT	802.11n HT20 CH44 5220MHz - L	
1	Horizontal	Fundamental
Peak	<p>Site : 03CH15-HY Condition : PEAK_BE_74 3m 91200_15_1620 HORIZONTAL Detector : Peak Project : 042038</p>	<p>Site : 03CH15-HY Condition : PEAK(LINII) 3m 91200_15_1620 HORIZONTAL Detector : Peak Project : 042038</p>
Avg.	<p>Site : 03CH15-HY Condition : AVG_BE_54 3m 91200_15_1620 HORIZONTAL Detector : Peak Project : 042038</p>	Left blank

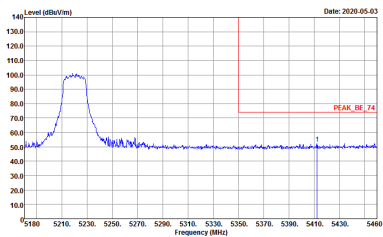
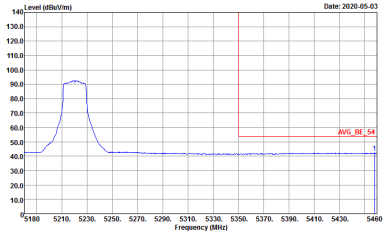

WIFI	Band 1 5150~5250MHz Band Edge @ 3m	
ANT	802.11n HT20 CH44 5220MHz - R	
1	Horizontal	Fundamental
Peak	 <p>Site : 03CH15-HY Condition : PEAK_BE_74 3m 9120D_15_1620 HORIZONTAL Detector : Peak Project : 042038</p>	Left blank
Avg.	 <p>Site : 03CH15-HY Condition : AVG_BE_54 3m 9120D_15_1620 HORIZONTAL Detector : Peak Project : 042038</p>	Left blank

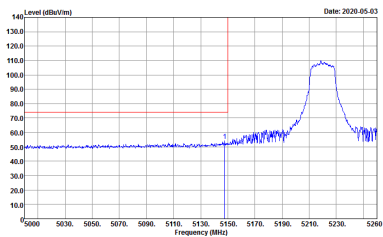
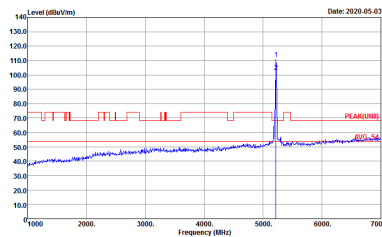
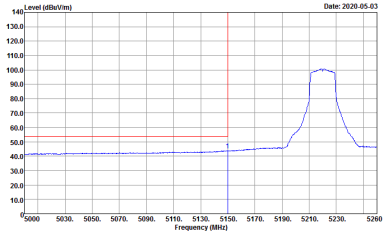

WIFI	Band 1 5150~5250MHz Band Edge @ 3m	
ANT	802.11n HT20 CH44 5220MHz - L	
1	Vertical	Fundamental
Peak	 <p>Site : 03CH15-HY Condition : PEAK_BE_74 3m 91200_15_1620 VERTICAL Detector : Peak Project : 042038</p>	 <p>Site : 03CH15-HY Condition : PEAK(UNII) 3m 91200_15_1620 VERTICAL Detector : Peak Project : 042038</p>
Avg.	 <p>Site : 03CH15-HY Condition : AVG_BE_54 3m 91200_15_1620 VERTICAL Detector : Peak Project : 042038</p>	Left blank

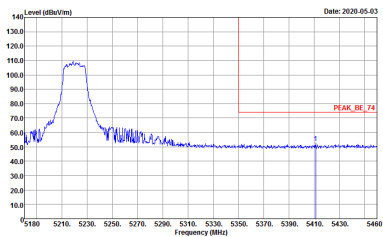
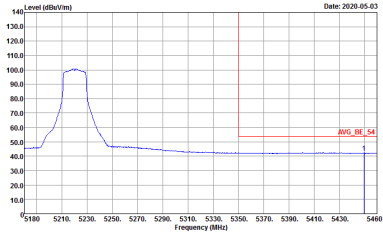

WIFI	Band 1 5150~5250MHz Band Edge @ 3m	
ANT	802.11n HT20 CH44 5220MHz - R	
1	Vertical	Fundamental
Peak	 <p>Site : 03CH15-HY Condition : PEAK_BE_74 3m 9120D_15_1620 VERTICAL Detector : Peak Project : 042038</p>	Left blank
Avg.	 <p>Site : 03CH15-HY Condition : AVG_BE_54 3m 9120D_15_1620 VERTICAL Detector : Peak Project : 042038</p>	Left blank

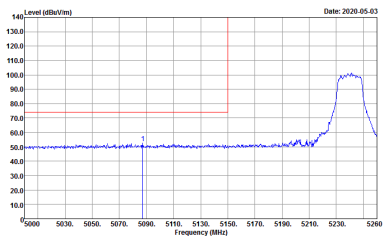
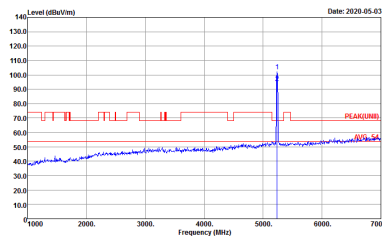
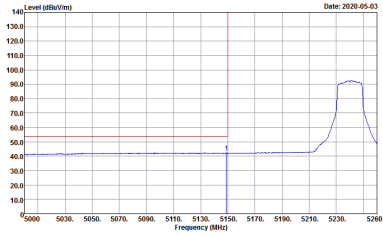

WIFI	Band 1 5150~5250MHz Band Edge @ 3m	
ANT	802.11n HT20 CH48 5240MHz - L	
1	Horizontal	Fundamental
Peak	 <p>Date: 2020-05-03</p> <p>Site : 03CH15-HY Condition : PEAK_BE_74 3m 91200_15_1620 HORIZONTAL RBW:1000.000KHz VBW:3000.000KHz SWT:Auto Detector : Peak Project : 042038</p>	 <p>Date: 2020-05-03</p> <p>Site : 03CH15-HY Condition : PEAK(UNII) 3m 91200_15_1620 HORIZONTAL RBW:1000.000KHz VBW:3000.000KHz SWT:Auto Detector : Peak Project : 042038</p>
Avg.	 <p>Date: 2020-05-03</p> <p>Site : 03CH15-HY Condition : AVG_BE_54 3m 91200_15_1620 HORIZONTAL RBW:1000.000KHz VBW:1000KHz SWT:Auto Detector : Peak Project : 042038</p>	Left blank

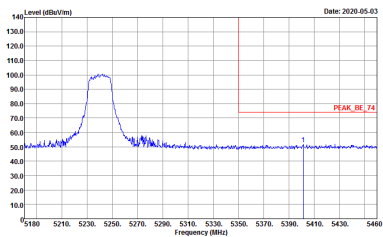
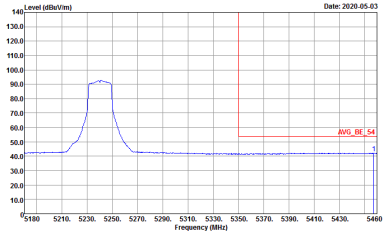

WIFI	Band 1 5150~5250MHz Band Edge @ 3m	
ANT	802.11n HT20 CH48 5240MHz - R	
1	Horizontal	Fundamental
Peak	 <p>Site : 03CH15-HY Condition : PEAK_BE_74 3m 91200_15_1620 HORIZONTAL Detector : Peak Project : 042038</p>	Left blank
Avg.	 <p>Site : 03CH15-HY Condition : AVG_BE_54 3m 91200_15_1620 HORIZONTAL Detector : Peak Project : 042038</p>	Left blank

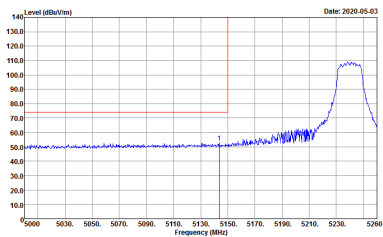
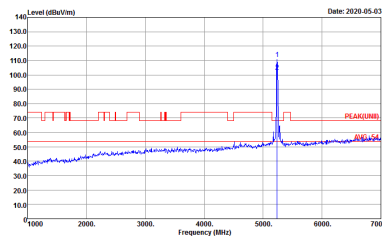
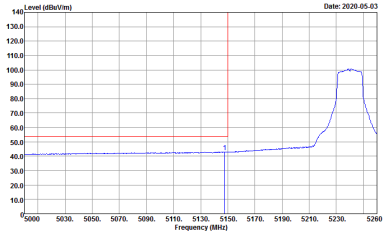

WIFI	Band 1 5150~5250MHz Band Edge @ 3m	
ANT	802.11n HT20 CH48 5240MHz - L	
1	Vertical	Fundamental
Peak	 <p>Site : 03CH15-HY Condition : PEAK_BE_74 3m 91200_15_1620 VERTICAL Detector : Peak Project : 042038</p>	 <p>Site : 03CH15-HY Condition : PEAK(UNII) 3m 91200_15_1620 VERTICAL Detector : Peak Project : 042038</p>
Avg.	 <p>Site : 03CH15-HY Condition : AVG_BE_54 3m 91200_15_1620 VERTICAL Detector : Peak Project : 042038</p>	Left blank

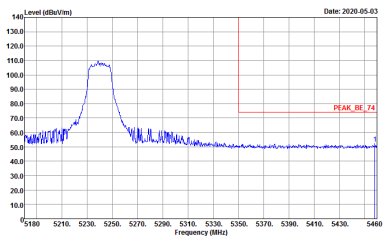
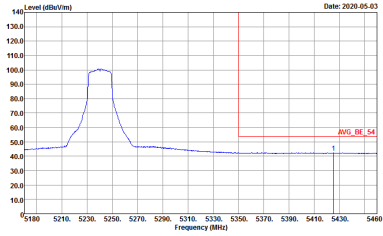

WIFI	Band 1 5150~5250MHz Band Edge @ 3m	
ANT	802.11n HT20 CH48 5240MHz - R	
1	Vertical	Fundamental
Peak	 <p>Site : 03CH15-HY Condition : PEAK_BE_74 3m 91200_15_1620 VERTICAL Detector : Peak Project : 042038</p>	Left blank
Avg.	 <p>Site : 03CH15-HY Condition : AVG_BE_54 3m 91200_15_1620 VERTICAL Detector : Peak Project : 042038</p>	Left blank



Band 1 5150~5250MHz
WIFI 802.11n HT40 (Band Edge @ 3m)

WIFI	Band 1 5150~5250MHz Band Edge @ 3m	
ANT	802.11n HT40 CH38 5190MHz - L	
1	Horizontal	Fundamental
<p align="center">Peak</p>	<p>Site : 03CH15-HY Condition : PEAK_BE_74 3m 91200_15_1620 HORIZONTAL RBW:1000.000KHz VBW:3000.000KHz SWT:Auto Detector : Peak Project : 042038 Setting : 15.5</p>	<p>Site : 03CH15-HY Condition : PEAK(UNIT) 3m 91200_15_1620 HORIZONTAL RBW:1000.000KHz VBW:3000.000KHz SWT:Auto Detector : Peak Project : 042038 Setting : 15.5</p>
<p align="center">Avg.</p>	<p>Site : 03CH15-HY Condition : AVG_BE_54 3m 91200_15_1620 HORIZONTAL RBW:1000.000KHz VBW:3.000KHz SWT:Auto Detector : Peak Project : 042038 Setting : 15.5</p>	<p align="center">Left blank</p>

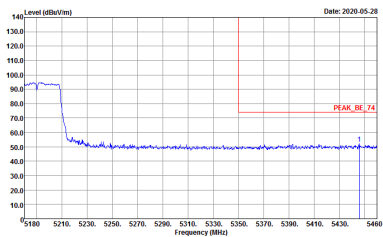
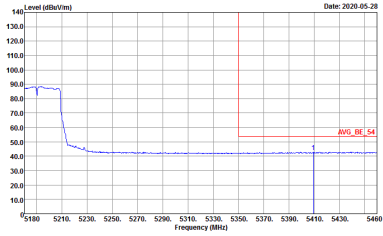

WIFI	Band 1 5150~5250MHz Band Edge @ 3m	
ANT	802.11n HT40 CH38 5190MHz - R	
1	Horizontal	Fundamental
<p>Peak</p>	 <p>Site : 03CH15-HY Condition : PEAK_BE_74 3m 91200_15_1620 HORIZONTAL Detector : Peak Project : 042038 Setting : 15.5</p>	<p>Left blank</p>
<p>Avg.</p>	 <p>Site : 03CH15-HY Condition : AVG_BE_54 3m 91200_15_1620 HORIZONTAL Detector : Peak Project : 042038 Setting : 15.5</p>	<p>Left blank</p>

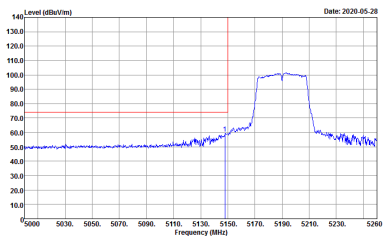
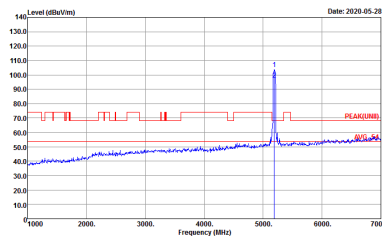
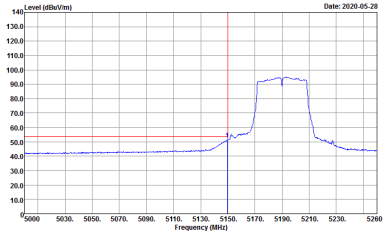

WIFI	Band 1 5150~5250MHz Band Edge @ 3m	
ANT	802.11n HT40 CH38 5190MHz - L	
1	Vertical	Fundamental
Peak	 <p>Date: 2020-05-28</p> <p>Site : 03CH15-HY Condition : PEAK_BE_74 3m 91200_15_1620 VERTICAL Detector : Peak Project : 042038 Setting : 15.5</p>	 <p>Date: 2020-05-28</p> <p>Site : 03CH15-HY Condition : PEAK(LINII) 3m 91200_15_1620 VERTICAL Detector : Peak Project : 042038 Setting : 15.5</p>
Avg.	 <p>Date: 2020-05-28</p> <p>Site : 03CH15-HY Condition : AVG_BE_54 3m 91200_15_1620 VERTICAL Detector : Peak Project : 042038 Setting : 15.5</p>	Left blank

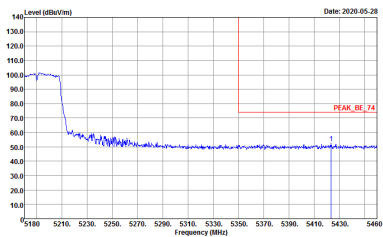
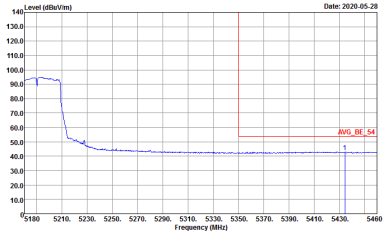

WIFI	Band 1 5150~5250MHz Band Edge @ 3m	
ANT	802.11n HT40 CH38 5190MHz - R	
1	Vertical	Fundamental
<p>Peak</p>	 <p>Site : 03CH15-HY Condition : PEAK_BE_74 3m 91200_15_1620 VERTICAL Detector : Peak Project : 042038 Setting : 15.5</p>	<p>Left blank</p>
<p>Avg.</p>	 <p>Site : 03CH15-HY Condition : AVG_BE_54 3m 91200_15_1620 VERTICAL Detector : Peak Project : 042038 Setting : 15.5</p>	<p>Left blank</p>

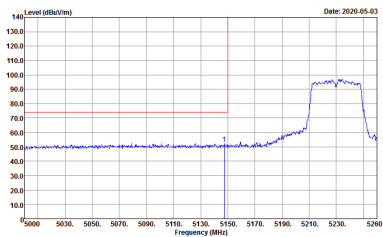
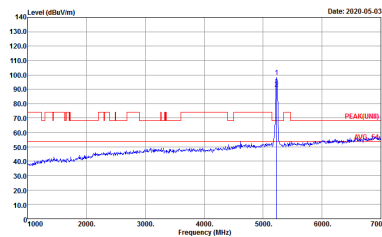
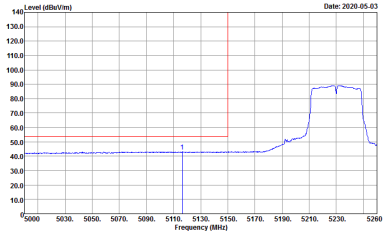

WIFI	Band 1 5150~5250MHz Band Edge @ 3m	
ANT	802.11n HT40 CH46 5230MHz - L	
1	Horizontal	Fundamental
Peak	 <p>Date: 2020-05-03</p> <p>Site : 03CH15-HY Condition : PEAK_BE_74 3m 91200_15_1620 HORIZONTAL RBW:1000.000kHz VBW:3000.000kHz SWT:Auto Detector : Peak Project : 042038</p>	 <p>Date: 2020-05-03</p> <p>Site : 03CH15-HY Condition : PEAK(UNII) 3m 91200_15_1620 HORIZONTAL RBW:1000.000kHz VBW:3000.000kHz SWT:Auto Detector : Peak Project : 042038</p>
Avg.	 <p>Date: 2020-05-03</p> <p>Site : 03CH15-HY Condition : AVG_BE_54 3m 91200_15_1620 HORIZONTAL RBW:1000.000kHz VBW:3.000kHz SWT:Auto Detector : Peak Project : 042038</p>	Left blank

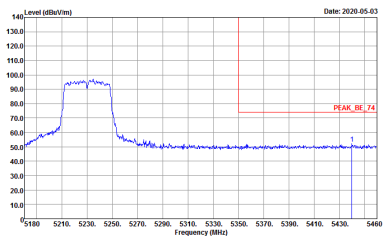
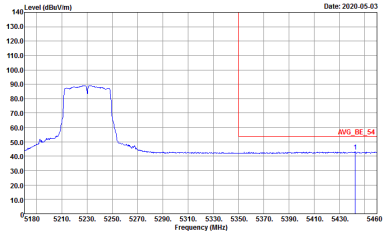

WIFI	Band 1 5150~5250MHz Band Edge @ 3m	
ANT	802.11n HT40 CH46 5230MHz - R	
1	Horizontal	Fundamental
<p>Peak</p>	 <p>Site : 03CH15-HY Condition : PEAK_BE_74 3m 91200_15_1620 HORIZONTAL Detector : Peak Project : 042038</p>	<p>Left blank</p>
<p>Avg.</p>	 <p>Site : 03CH15-HY Condition : AVG_BE_54 3m 91200_15_1620 HORIZONTAL Detector : Peak Project : 042038</p>	<p>Left blank</p>

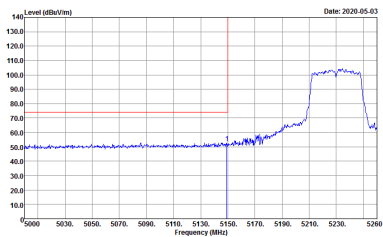
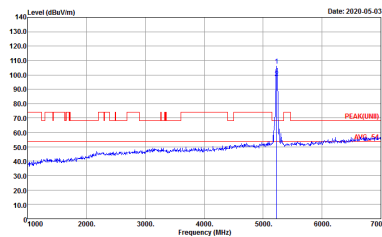
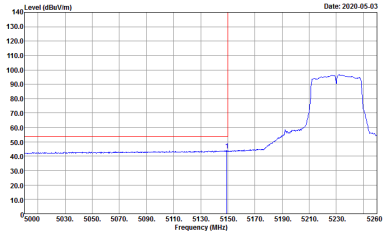

WIFI	Band 1 5150~5250MHz Band Edge @ 3m	
ANT	802.11n HT40 CH46 5230MHz - L	
1	Vertical	Fundamental
Peak	 <p>Site : 03CH15-HY Condition : PEAK_BE_74 3m 91200_15_1620 VERTICAL Detector : Peak Project : 042038</p>	 <p>Site : 03CH15-HY Condition : PEAK(LINII) 3m 91200_15_1620 VERTICAL Detector : Peak Project : 042038</p>
Avg.	 <p>Site : 03CH15-HY Condition : AVG_BE_54 3m 91200_15_1620 VERTICAL Detector : Peak Project : 042038</p>	Left blank

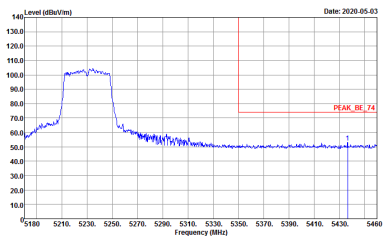
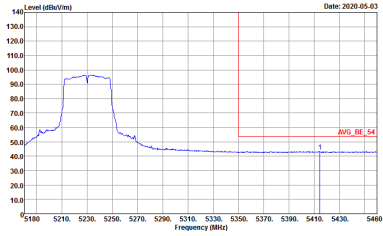

WIFI	Band 1 5150~5250MHz Band Edge @ 3m	
ANT	802.11n HT40 CH46 5230MHz - R	
1	Vertical	Fundamental
Peak	 <p>Site : 03CH15-HY Condition : PEAK_BE_74 3m 91200_15_1620 VERTICAL RBW:1000.000KHz VBW:3000.000KHz SWT:Auto Detector : Peak Project : 042038</p>	Left blank
Avg.	 <p>Site : 03CH15-HY Condition : AVG_BE_54 3m 91200_15_1620 VERTICAL RBW:1000.000KHz VBW:3.000KHz SWT:Auto Detector : Peak Project : 042038</p>	Left blank

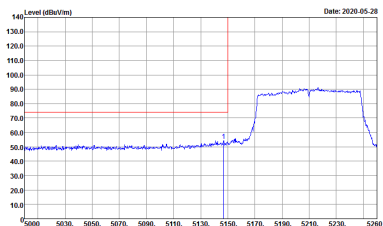
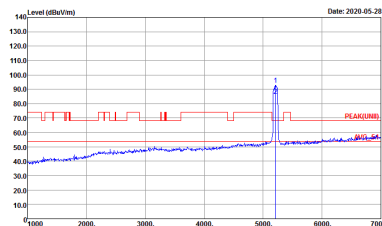
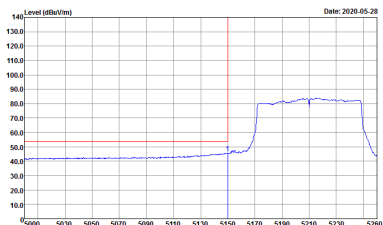

Band 1 5150~5250MHz
WIFI 802.11ac VHT80 (Band Edge @ 3m)

WIFI	Band 1 5150~5250MHz Band Edge @ 3m	
ANT	802.11ac VHT80 CH42 5210MHz - L	
1	Horizontal	Fundamental
<p>Peak</p>	 <p>Site : 03CH15-HY Condition : PEAK_BE_74 3m 91200_15_1620 HORIZONTAL RBW:1000.000KHz VBW:3000.000KHz SWT:Auto Detector : Peak Project : 042038 Setting : 15</p>	 <p>Site : 03CH15-HY Condition : PEAK(UNIT) 3m 91200_15_1620 HORIZONTAL RBW:1000.000KHz VBW:3000.000KHz SWT:Auto Detector : Peak Project : 042038 Setting : 15</p>
<p>Avg.</p>	 <p>Site : 03CH15-HY Condition : AVG_BE_54 3m 91200_15_1620 HORIZONTAL RBW:1000.000KHz VBW:3000.000KHz SWT:Auto Detector : Peak Project : 042038 Setting : 15</p>	<p>Left blank</p>

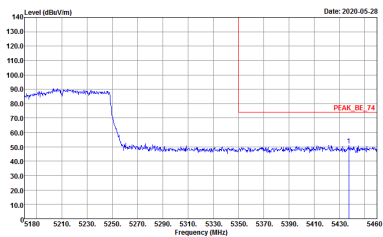
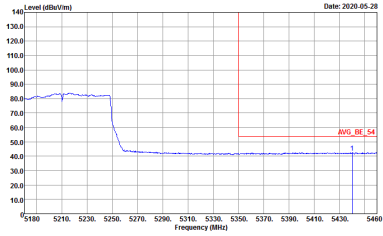

WIFI	Band 1 5150~5250MHz Band Edge @ 3m	
ANT	802.11ac VHT80 CH42 5210MHz - R	
1	Horizontal	Fundamental
Peak	 <p>Date: 2020-05-28</p> <p>Site : 03CH15-HY Condition : PEAK_BE_74 3m 91200_15_1620 HORIZONTAL Detector : Peak Project : 042038 Setting : 15</p>	Left blank
Avg.	 <p>Date: 2020-05-28</p> <p>Site : 03CH15-HY Condition : AVG_BE_54 3m 91200_15_1620 HORIZONTAL Detector : Peak Project : 042038 Setting : 15</p>	Left blank

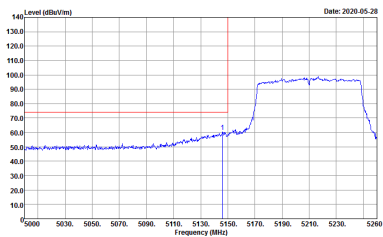
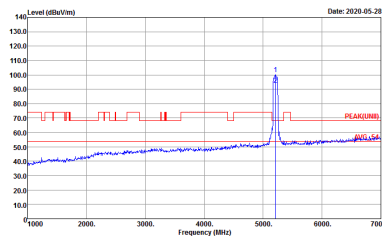
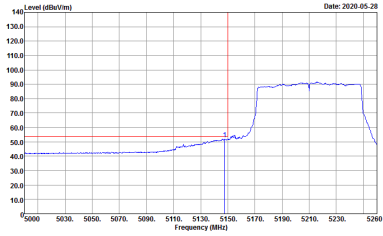

WIFI	Band 1 5150~5250MHz Band Edge @ 3m	
ANT	802.11ac VHT80 CH42 5210MHz - L	
1	Vertical	Fundamental
<p>Peak</p>	 <p>Date: 2020-05-28</p> <p>Site : 03CH15-HY Condition : PEAK_BE_74 3m 91200_15_1620 VERTICAL Detector : Peak Project : 042038 Setting : 15</p>	 <p>Date: 2020-05-28</p> <p>Site : 03CH15-HY Condition : PEAK(LINII) 3m 91200_15_1620 VERTICAL Detector : Peak Project : 042038 Setting : 15</p>
<p>Avg.</p>	 <p>Date: 2020-05-28</p> <p>Site : 03CH15-HY Condition : AVG_BE_54 3m 91200_15_1620 VERTICAL Detector : Peak Project : 042038 Setting : 15</p>	<p>Left blank</p>

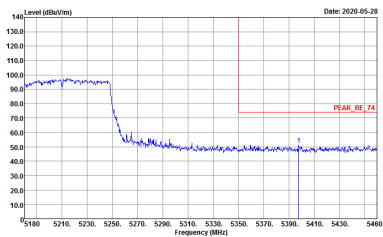
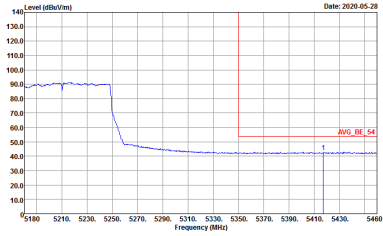

WIFI	Band 1 5150~5250MHz Band Edge @ 3m	
ANT	802.11ac VHT80 CH42 5210MHz - R	
1	Vertical	Fundamental
<p>Peak</p>	 <p>Site : 03CH15-HY Condition : PEAK_BE_74 3m 91200_15_1620 VERTICAL Detector : Peak Project : 042038 Setting : 15</p>	<p>Left blank</p>
<p>Avg.</p>	 <p>Site : 03CH15-HY Condition : AVG_BE_54 3m 91200_15_1620 VERTICAL Detector : Peak Project : 042038 Setting : 15</p>	<p>Left blank</p>



Band 1 - 5150~5250MHz

WIFI 802.11a (Harmonic @ 3m)

WIFI	Band 1 5150~5250MHz Harmonic @ 3m	
ANT	802.11a CH36 5180MHz	
1	Horizontal	Vertical
<p>Peak</p> <p>Avg.</p>	<p>Site : 03CH15-HY Condition : PEAR(LINE1) 3m 91200_15_1620 HORIZONTAL Detector : Peak Project : 042038</p>	<p>Site : 03CH15-HY Condition : PEAR(LINE1) 3m 91200_15_1620 VERTICAL Detector : Peak Project : 042038</p>

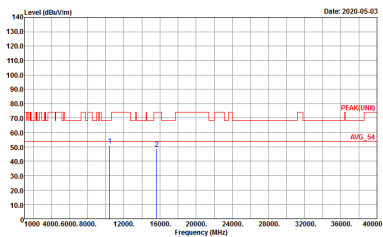
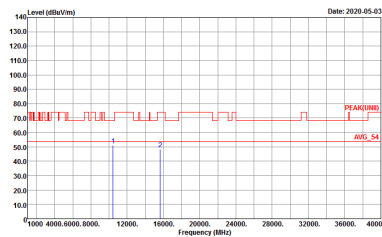

WIFI	Band 1 5150~5250MHz Harmonic @ 3m	
ANT	802.11a CH44 5220MHz	
1	Horizontal	Vertical
<p>Peak</p> <p>Avg.</p>	 <p>Site : 03CH15-11Y Condition : PEAK(LINEI) 3m 9120D_15_1620 HORIZONTAL Detector : Peak Project : 042038</p>	 <p>Site : 03CH15-11Y Condition : PEAK(LINEI) 3m 9120D_15_1620 VERTICAL Detector : Peak Project : 042038</p>



WIFI	Band 1 5150~5250MHz Harmonic @ 3m	
ANT	802.11a CH48 5240MHz	
1	Horizontal	Vertical
Peak Avg.	<p>Site : 03CH15-11Y Condition : PEAK(LINE1) 3m 9120D_15_1620 HORIZONTAL Detector : Peak Project : 042038</p>	<p>Site : 03CH15-11Y Condition : PEAK(LINE1) 3m 9120D_15_1620 VERTICAL Detector : Peak Project : 042038</p>



**Band 1 5150~5250MHz
WIFI 802.11n HT20 (Harmonic @ 3m)**

WIFI	Band 1 5150~5250MHz Harmonic @ 3m	
ANT	802.11n HT20 CH36 5180MHz	
1	Horizontal	Vertical
Peak Avg.	<p>Site : 03CH15-FY Condition : PEAK(LINII) 3m 91200_15_1620 HORIZONTAL Detector : Peak Project : 042038</p>	<p>Site : 03CH15-FY Condition : PEAK(LINII) 3m 91200_15_1620 VERTICAL Detector : Peak Project : 042038</p>

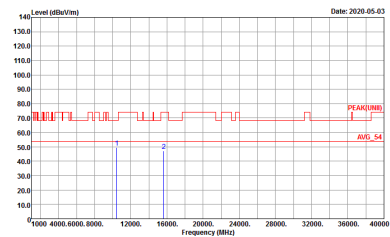
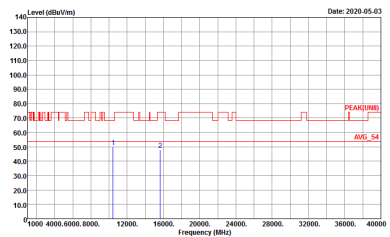

WIFI	Band 1 5150~5250MHz Harmonic @ 3m	
ANT	802.11n HT20 CH44 5220MHz	
1	Horizontal	Vertical
<p>Peak</p> <p>Avg.</p>	 <p>Site : 03CH15-11Y Condition : PEAK(LINE1) 3m 9120D_15_1620 HORIZONTAL Detector : Peak Project : 042038</p>	 <p>Site : 03CH15-11Y Condition : PEAK(LINE1) 3m 9120D_15_1620 VERTICAL Detector : Peak Project : 042038</p>

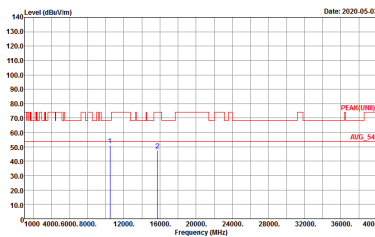
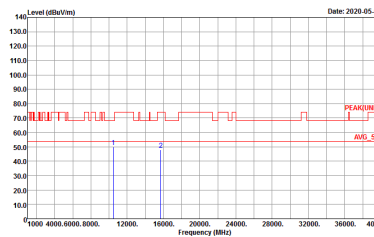

WIFI	Band 1 5150~5250MHz Harmonic @ 3m	
ANT	802.11n HT20 CH48 5240MHz	
1	Horizontal	Vertical
<p>Peak</p> <p>Avg.</p>	 <p>Site : 03CH15-11Y Condition : PEAK(LINE1) 3m 9120D_15_1620 HORIZONTAL Detector : Peak Project : 042038</p>	 <p>Site : 03CH15-11Y Condition : PEAK(LINE1) 3m 9120D_15_1620 VERTICAL Detector : Peak Project : 042038</p>



Band 1 5150~5250MHz
WIFI 802.11n HT40 (Harmonic @ 3m)

WIFI	Band 1 5150~5250MHz Harmonic @ 3m	
ANT	802.11n HT40 CH38 5190MHz	
1	Horizontal	Vertical
<p>Peak</p> <p>Avg.</p>	<p>Site : 03CH15-HY Condition : PEAK(LINII) 3m 91200_15_1620 HORIZONTAL Detector : Peak Project : 042038</p>	<p>Site : 03CH15-HY Condition : PEAK(LINII) 3m 91200_15_1620 VERTICAL Detector : Peak Project : 042038</p>



WIFI	Band 1 5150~5250MHz Harmonic @ 3m	
ANT	802.11n HT40 CH46 5230MHz	
1	Horizontal	Vertical
Peak Avg.	<p>Site : 03CH15-11Y Condition : PEAK(LINE1) 3m 9120D_15_1620 HORIZONTAL Detector : Peak Project : 042038</p>	<p>Site : 03CH15-11Y Condition : PEAK(LINE1) 3m 9120D_15_1620 VERTICAL Detector : Peak Project : 042038</p>



**Band 1 5150~5250MHz
WIFI 802.11ac VHT80 (Harmonic @ 3m)**

WIFI	Band 1 5150~5250MHz Harmonic @ 3m	
ANT	802.11ac VHT80 CH42 5210MHz	
1	Horizontal	Vertical
<p>Peak</p> <p>Avg.</p>	<p>Site : 03CH15-HY Condition : PEAK(LIMIT) 3m 91200_15_1620 HORIZONTAL Detector : Peak Project : 042038</p>	<p>Site : 03CH15-HY Condition : PEAK(LIMIT) 3m 91200_15_1620 VERTICAL Detector : Peak Project : 042038</p>



Band 2 - 5250~5350MHz
WIFI 802.11a (Band Edge @ 3m)

WIFI	Band 2 5250~5350MHz Band Edge @ 3m	
ANT	802.11a CH52 5260MHz - L	
1	Horizontal	Fundamental
Peak	<p>Site : 03CH15-HY Condition : PEAK_BE_74 3m 91200_15_1620 HORIZONTAL RBW:1000.000KHz VBW:3000.000KHz SWT:Auto Detector : Peak Project : 042038</p>	<p>Site : 03CH15-HY Condition : PEAK(LINE) 3m 91200_15_1620 HORIZONTAL RBW:1000.000KHz VBW:3000.000KHz SWT:Auto Detector : Peak Project : 042038</p>
Avg.	<p>Site : 03CH15-HY Condition : AV6_BE_54 3m 91200_15_1620 HORIZONTAL RBW:1000.000KHz VBW:1000KHz SWT:Auto Detector : Peak Project : 042038</p>	Left blank

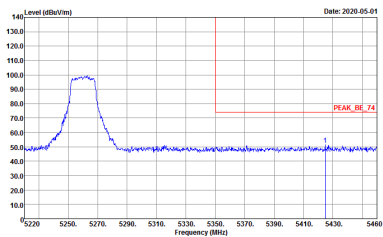
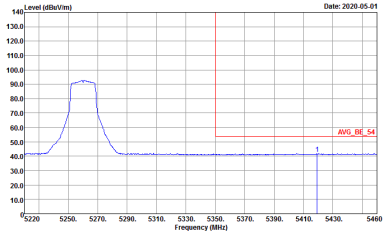

WIFI	Band 2 5250~5350MHz Band Edge @ 3m	
ANT	802.11a CH52 5260MHz - R	
1	Horizontal	Fundamental
<p>Peak</p>	 <p>Site : 03CH15-HY Condition : PEAK_BE_74 3m 9120D_15_1620 HORIZONTAL Detector : Peak Project : 042038</p>	<p>Left blank</p>
<p>Avg.</p>	 <p>Site : 03CH15-HY Condition : AVG_BE_54 3m 9120D_15_1620 HORIZONTAL Detector : Peak Project : 042038</p>	<p>Left blank</p>

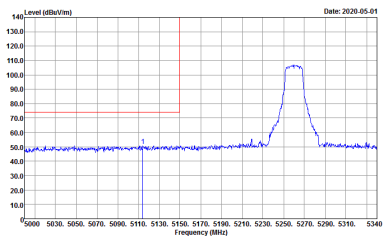
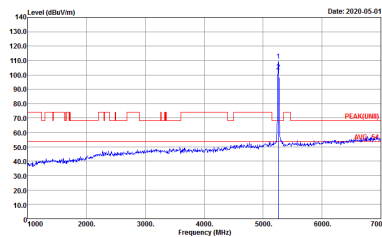
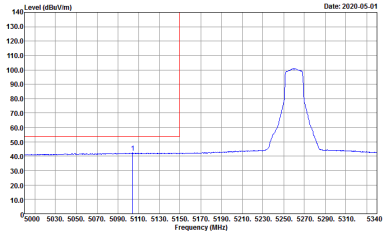

WIFI	Band 2 5250~5350MHz Band Edge @ 3m	
ANT	802.11a CH52 5260MHz - L	
1	Vertical	Fundamental
Peak	 <p>Site : 03CH15-HY Condition : PEAK_BE_74 3m 9120D_15_1620 VERTICAL Detector : Peak Project : 042038</p>	 <p>Site : 03CH15-HY Condition : PEAK(UNII) 3m 9120D_15_1620 VERTICAL Detector : Peak Project : 042038</p>
Avg.	 <p>Site : 03CH15-HY Condition : AVG_BE_54 3m 9120D_15_1620 VERTICAL Detector : Peak Project : 042038</p>	Left blank

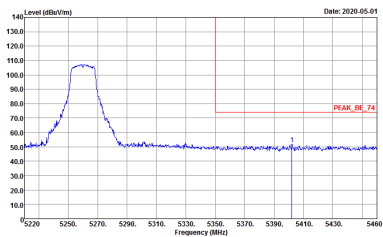
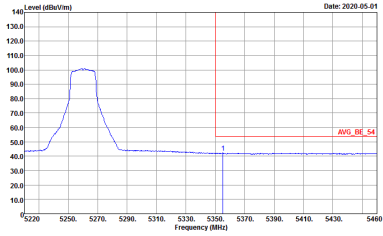

WIFI	Band 2 5250~5350MHz Band Edge @ 3m	
ANT	802.11a CH52 5260MHz - R	
1	Vertical	Fundamental
<p>Peak</p>	 <p>Site : 03CH15-HY Condition : PEAK_BE_74 3m 9120D_15_1620 VERTICAL Detector : Peak Project : 042038</p>	<p>Left blank</p>
<p>Avg.</p>	 <p>Site : 03CH15-HY Condition : AVG_BE_54 3m 9120D_15_1620 VERTICAL Detector : Peak Project : 042038</p>	<p>Left blank</p>

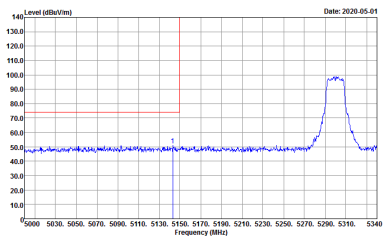
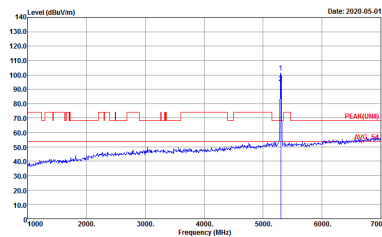

WIFI	Band 2 5250~5350MHz Band Edge @ 3m	
ANT	802.11a CH60 5300MHz - L	
1	Horizontal	Fundamental
Peak	 <p>Site : 03CH15-HY Condition : PEAK_BE_74 3m 91200_15_1620 HORIZONTAL Detector : Peak Project : 042038</p>	 <p>Site : 03CH15-HY Condition : PEAK(UNII) 3m 91200_15_1620 HORIZONTAL Detector : Peak Project : 042038</p>
Avg.	 <p>Site : 03CH15-HY Condition : AVG_BE_54 3m 91200_15_1620 HORIZONTAL Detector : Peak Project : 042038</p>	Left blank

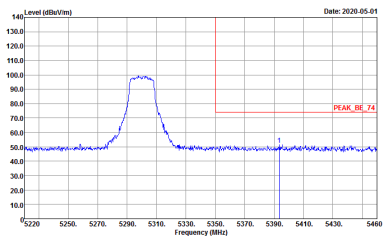
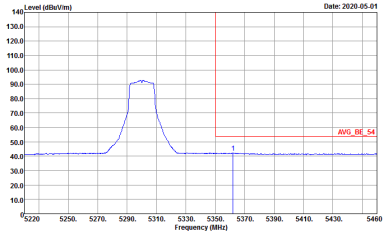

WIFI	Band 2 5250~5350MHz Band Edge @ 3m	
ANT	802.11a CH60 5300MHz - R	
1	Horizontal	Fundamental
<p>Peak</p>	 <p>Site : 03CH15-HY Condition : PEAK_BE_74 3m 91200_15_1620 HORIZONTAL Detector : Peak Project : 042038</p>	<p>Left blank</p>
<p>Avg.</p>	 <p>Site : 03CH15-HY Condition : AVG_BE_54 3m 91200_15_1620 HORIZONTAL Detector : Peak Project : 042038</p>	<p>Left blank</p>

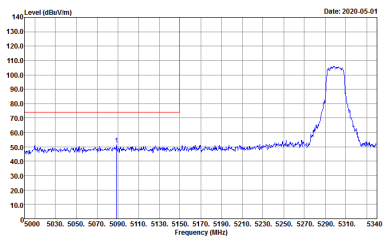
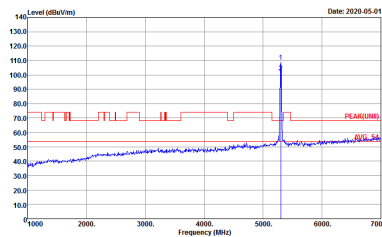
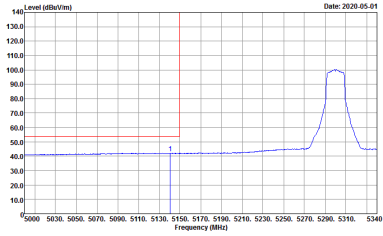

WIFI	Band 2 5250~5350MHz Band Edge @ 3m	
ANT	802.11a CH60 5300MHz - L	
1	Vertical	Fundamental
Peak	 <p>Site : 03CH15-HY Condition : PEAK_BE_74 3m 91200_15_1620 VERTICAL Detector : Peak Project : 042038</p>	 <p>Site : 03CH15-HY Condition : PEAK(LINII) 3m 91200_15_1620 VERTICAL Detector : Peak Project : 042038</p>
Avg.	 <p>Site : 03CH15-HY Condition : AVG_BE_54 3m 91200_15_1620 VERTICAL Detector : Peak Project : 042038</p>	Left blank

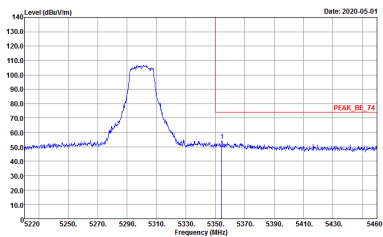
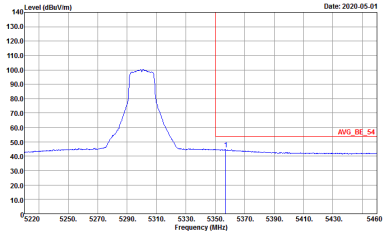

WIFI	Band 2 5250~5350MHz Band Edge @ 3m	
ANT	802.11a CH60 5300MHz - R	
1	Vertical	Fundamental
<p>Peak</p>	 <p>Site : 03CH15-HY Condition : PEAK_BE_74 3m 9120D_15_1620 VERTICAL Detector : Peak Project : 042038</p>	<p>Left blank</p>
<p>Avg.</p>	 <p>Site : 03CH15-HY Condition : AVG_BE_54 3m 9120D_15_1620 VERTICAL Detector : Peak Project : 042038</p>	<p>Left blank</p>

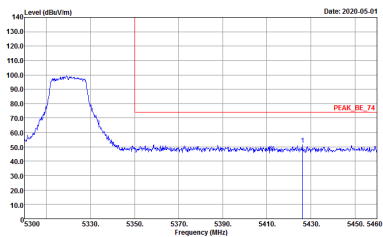
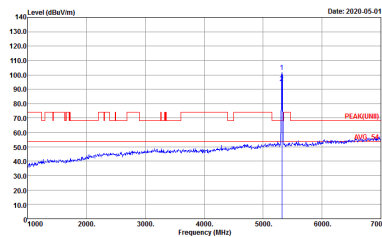
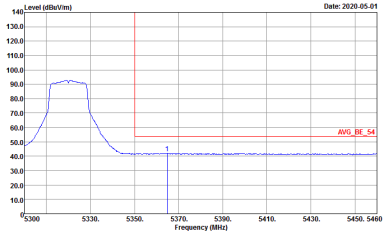

WIFI	Band 2 5250~5350MHz Band Edge @ 3m	
ANT	802.11a CH64 5320MHz	
1	Horizontal	Fundamental
Peak	 <p>Site : 03CH15-HY Condition : PEAK_BE_74 3m 91200_15_1620 HORIZONTAL : RBW:1000.000KHz VBW:3000.000KHz SWT:Auto Detector : Peak Project : 042038</p>	 <p>Site : 03CH15-HY Condition : PEAK(LIMB) 3m 91200_15_1620 HORIZONTAL : RBW:1000.000KHz VBW:3000.000KHz SWT:Auto Detector : Peak Project : 042038</p>
Avg.	 <p>Site : 03CH15-HY Condition : AVG_BE_54 3m 91200_15_1620 HORIZONTAL : RBW:1000.000KHz VBW:1000KHz SWT:Auto Detector : Peak Project : 042038</p>	Left blank

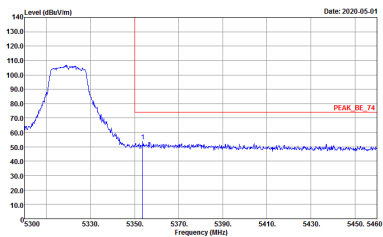
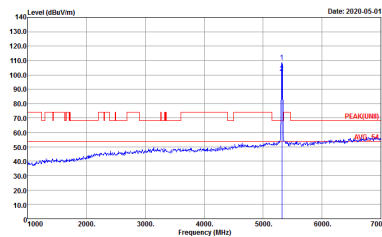
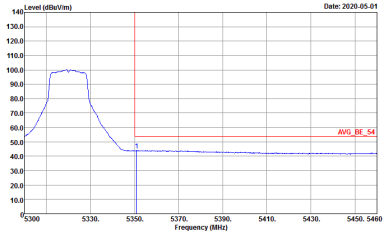

WIFI	Band 2 5250~5350MHz Band Edge @ 3m	
ANT	802.11a CH64 5320MHz	
1	Vertical	Fundamental
<p>Peak</p>	 <p>Site : 03CH15-HY Condition : PEAK_BE_74 3m 91200_15_1620 VERTICAL Detector : Peak Project : 042038</p>	 <p>Site : 03CH15-HY Condition : PEAK(LINB) 3m 91200_15_1620 VERTICAL Detector : Peak Project : 042038</p>
<p>Avg.</p>	 <p>Site : 03CH15-HY Condition : AVG_BE_54 3m 91200_15_1620 VERTICAL Detector : Peak Project : 042038</p>	<p>Left blank</p>



Band 2 5250~5350MHz
WIFI 802.11n HT20 (Band Edge @ 3m)

WIFI	Band 2 5250~5350MHz Band Edge @ 3m	
ANT	802.11n HT20 CH52 5260MHz - L	
1	Horizontal	Fundamental
Peak	<p>Site : 03CH15-HY Condition : PEAK_BE_74 3m 91200_15_1620 HORIZONTAL RBW:1000.000KHz VBW:3000.000KHz SWT:Auto Detector : Peak Project : 042038</p>	<p>Site : 03CH15-HY Condition : PEAK(UNIT) 3m 91200_15_1620 HORIZONTAL RBW:1000.000KHz VBW:3000.000KHz SWT:Auto Detector : Peak Project : 042038</p>
Avg.	<p>Site : 03CH15-HY Condition : AVG_BE_54 3m 91200_15_1620 HORIZONTAL RBW:1000.000KHz VBW:1.000KHz SWT:Auto Detector : Peak Project : 042038</p>	Left blank

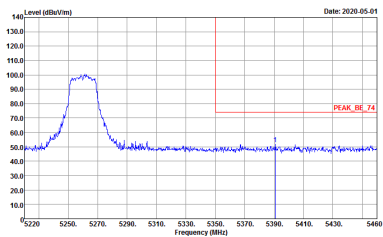
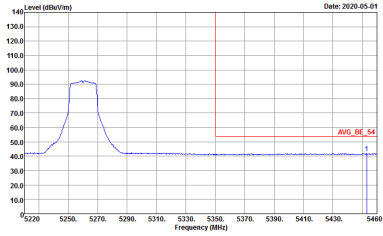

WIFI	Band 2 5250~5350MHz Band Edge @ 3m	
ANT	802.11n HT20 CH52 5260MHz - R	
1	Horizontal	Fundamental
<p>Peak</p>	 <p>Site : 03CH15-HY Condition : PEAK_BE_74 3m 9120D_15_1620 HORIZONTAL Detector : Peak Project : 042038</p>	<p>Left blank</p>
<p>Avg.</p>	 <p>Site : 03CH15-HY Condition : AVG_BE_54 3m 9120D_15_1620 HORIZONTAL Detector : Peak Project : 042038</p>	<p>Left blank</p>



WIFI	Band 2 5250~5350MHz Band Edge @ 3m	
ANT	802.11n HT20 CH52 5260MHz - L	
1	Vertical	Fundamental
Peak	<p>Site : 03CH15-HY Condition : PEAK_BE_74 3m 9120D_15_1620 VERTICAL Detector : RBW:1000.000KHz VBW:3000.000KHz SWT:Auto Project : Peak : -042038</p>	<p>Site : 03CH15-HY Condition : PEAK(LINII) 3m 9120D_15_1620 VERTICAL Detector : RBW:1000.000KHz VBW:3000.000KHz SWT:Auto Project : Peak : -042038</p>
Avg.	<p>Site : 03CH15-HY Condition : AVG_BE_54 3m 9120D_15_1620 VERTICAL Detector : RBW:1000.000KHz VBW:1000KHz SWT:Auto Project : Peak : -042038</p>	Left blank

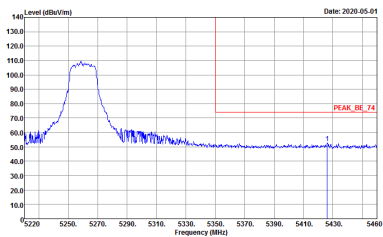
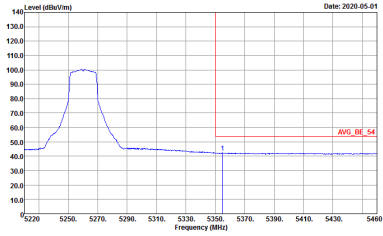

WIFI	Band 2 5250~5350MHz Band Edge @ 3m	
ANT	802.11n HT20 CH52 5260MHz - R	
1	Vertical	Fundamental
Peak	 <p>Site : 03CH15-HY Condition : PEAK_BE_74 3m 9120D_15_1620 VERTICAL Detector : Peak Project : 042038</p>	Left blank
Avg.	 <p>Site : 03CH15-HY Condition : AVG_BE_54 3m 9120D_15_1620 VERTICAL Detector : Peak Project : 042038</p>	Left blank

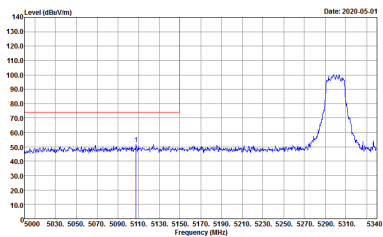
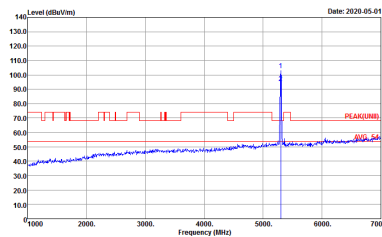
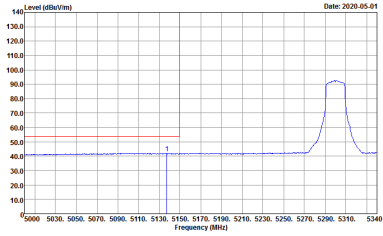

WIFI	Band 2 5250~5350MHz Band Edge @ 3m	
ANT	802.11n HT20 CH60 5300MHz - L	
1	Horizontal	Fundamental
Peak	 <p>Site : 03CH15-HY Condition : PEAK_BE_74 3m 91200_15_1620 HORIZONTAL Detector : Peak Project : 042038</p>	 <p>Site : 03CH15-HY Condition : PEAKUNII 3m 91200_15_1620 HORIZONTAL Detector : Peak Project : 042038</p>
Avg.	 <p>Site : 03CH15-HY Condition : AVG_BE_54 3m 91200_15_1620 HORIZONTAL Detector : Peak Project : 042038</p>	Left blank

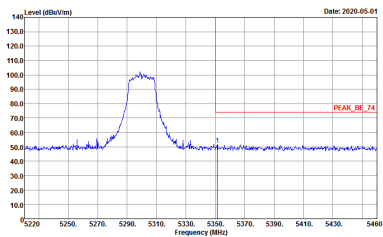
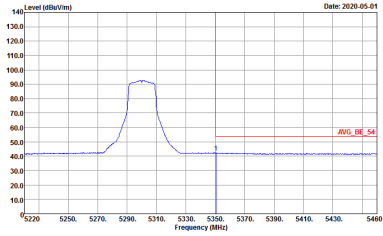

WIFI	Band 2 5250~5350MHz Band Edge @ 3m	
ANT	802.11n HT20 CH60 5300MHz - R	
1	Horizontal	Vertical
<p>Peak</p>	 <p>Site : 03CH15-HY Condition : PEAK_BE_74 3m 91200_15_1620 HORIZONTAL Detector : Peak Project : 042038</p>	<p>Left blank</p>
<p>Avg.</p>	 <p>Site : 03CH15-HY Condition : AVG_BE_54 3m 91200_15_1620 HORIZONTAL Detector : Peak Project : 042038</p>	<p>Left blank</p>



WIFI	Band 2 5250~5350MHz Band Edge @ 3m	
ANT	802.11n HT20 CH60 5300MHz - L	
1	Vertical	Fundamental
Peak	<p>Site : 03CH15-HY Condition : PEAK_BE_74 3m 91200_15_1620 VERTICAL Detector : Peak Project : 042038</p>	<p>Site : 03CH15-HY Condition : PEAK(UNII) 3m 91200_15_1620 VERTICAL Detector : Peak Project : 042038</p>
Avg.	<p>Site : 03CH15-HY Condition : AVG_BE_54 3m 91200_15_1620 VERTICAL Detector : Peak Project : 042038</p>	Left blank

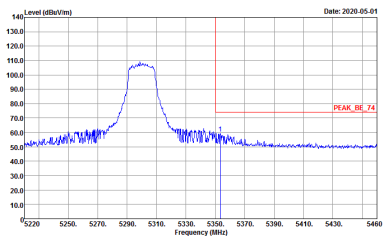
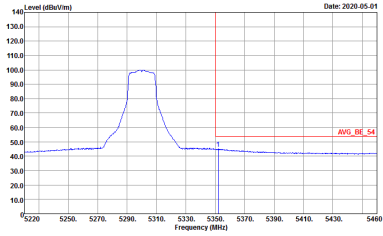

WIFI	Band 2 5250~5350MHz Band Edge @ 3m	
ANT	802.11n HT20 CH60 5300MHz - R	
1	Vertical	Fundamental
Peak	 <p>Site : 03CH15-HY Condition : PEAK_BE_74 3m 91200_15_1620 VERTICAL RBW:1000.000KHz, VBW:3000.000KHz, SWT:Auto Detector : Peak Project : 042038</p>	Left blank
Avg.	 <p>Site : 03CH15-HY Condition : AVG_BE_54 3m 91200_15_1620 VERTICAL RBW:1000.000KHz, VBW:1000KHz, SWT:Auto Detector : Peak Project : 042038</p>	Left blank

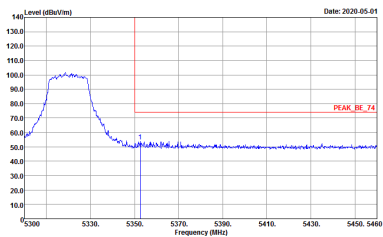
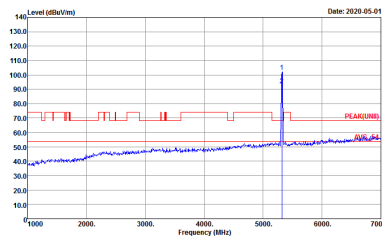
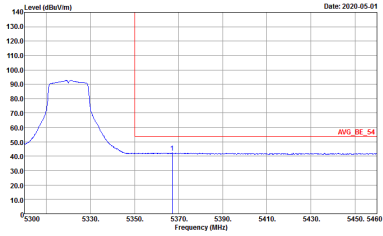

WIFI	Band 2 5250~5350MHz Band Edge @ 3m	
ANT	802.11n HT20 CH64 5320MHz	
1	Horizontal	Fundamental
Peak	 <p>Date: 2020-05-01</p> <p>Site : 03CH15-HY Condition : PEAK_BE_74 3m 91200_15_1620 HORIZONTAL RBW:1000.000KHz VBW:3000.000KHz SWT:Auto Detector : Peak Project : 042038</p>	 <p>Date: 2020-05-01</p> <p>Site : 03CH15-HY Condition : PEAK(LINII) 3m 91200_15_1620 HORIZONTAL RBW:1000.000KHz VBW:3000.000KHz SWT:Auto Detector : Peak Project : 042038</p>
Avg.	 <p>Date: 2020-05-01</p> <p>Site : 03CH15-HY Condition : AVG_BE_54 3m 91200_15_1620 HORIZONTAL RBW:1000.000KHz VBW:1000KHz SWT:Auto Detector : Peak Project : 042038</p>	Left blank

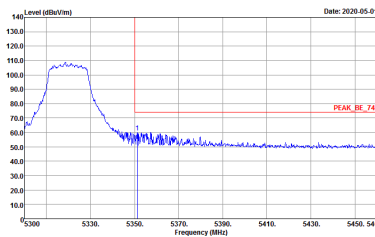
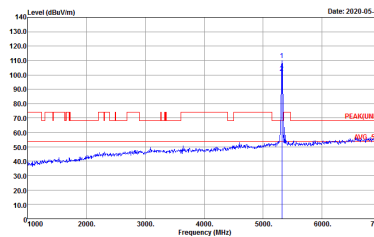
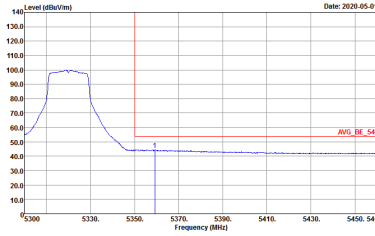

WIFI	Band 2 5250~5350MHz Band Edge @ 3m	
ANT	802.11n HT20 CH64 5320MHz	
1	Vertical	Fundamental
Peak	 <p>Site : 03CH15-HY Condition : PEAK_BE_74 3m 91200_15_1620 VERTICAL Detector : Peak Project : 042038</p>	 <p>Site : 03CH15-HY Condition : PEAK(LINII) 3m 91200_15_1620 VERTICAL Detector : Peak Project : 042038</p>
Avg.	 <p>Site : 03CH15-HY Condition : AVG_BE_54 3m 91200_15_1620 VERTICAL Detector : Peak Project : 042038</p>	Left blank



Band 2 5250~5350MHz
WIFI 802.11n HT40 (Band Edge @ 3m)

WIFI	Band 2 5250~5350MHz Band Edge @ 3m	
ANT	802.11n HT40 CH54 5270MHz - L	
1	Horizontal	Fundamental
Peak	<p>Site : 03CH15-HY Condition : PEAK_BE_74 3m 91200_15_1620 HORIZONTAL RBW:1000.000KHz VBW:3000.000KHz SWT:Auto Detector : Peak Project : 042038</p>	<p>Site : 03CH15-HY Condition : PEAK(UNIT) 3m 91200_15_1620 HORIZONTAL RBW:1000.000KHz VBW:3000.000KHz SWT:Auto Detector : Peak Project : 042038</p>
Avg.	<p>Site : 03CH15-HY Condition : AVG_BE_54 3m 91200_15_1620 HORIZONTAL RBW:1000.000KHz VBW:3.000KHz SWT:Auto Detector : Peak Project : 042038</p>	Left blank



WIFI	Band 2 5250~5350MHz Band Edge @ 3m	
ANT	802.11n HT40 CH54 5270MHz - R	
1	Horizontal	Fundamental
<p>Peak</p>		<p>Left blank</p>
<p>Avg.</p>		<p>Left blank</p>

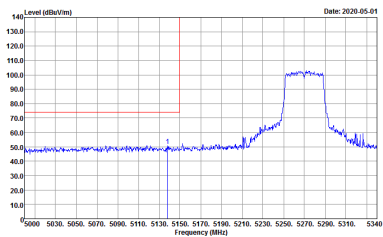
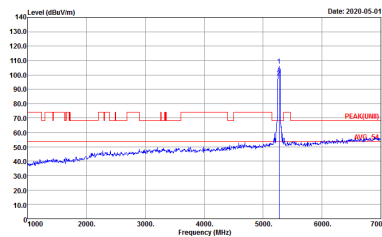
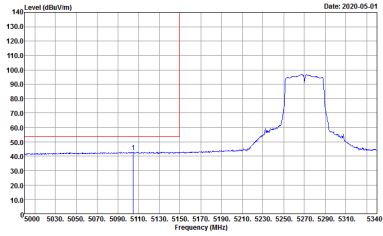

WIFI	Band 2 5250~5350MHz Band Edge @ 3m	
ANT	802.11n HT40 CH54 5270MHz - L	
1	Vertical	Vertical
<p>Peak</p>	 <p>Site : 03CH15-HY Condition : PEAK_BE_74 3m 9120D_15_1620 VERTICAL Detector : Peak Project : 042038</p>	 <p>Site : 03CH15-HY Condition : PEAK(LINII) 3m 9120D_15_1620 VERTICAL Detector : Peak Project : 042038</p>
<p>Avg.</p>	 <p>Site : 03CH15-HY Condition : AVG_BE_54 3m 9120D_15_1620 VERTICAL Detector : Peak Project : 042038</p>	<p>Left blank</p>

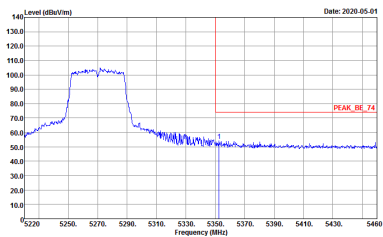
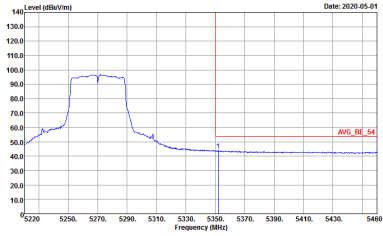

WIFI	Band 2 5250~5350MHz Band Edge @ 3m	
ANT	802.11n HT40 CH54 5270MHz - R	
1	Vertical	Vertical
<p>Peak</p>	 <p>Site : 03CH15-HY Condition : PEAK_BE_74 3m 91200_15_1620 VERTICAL Detector : Peak Project : 042038</p>	<p>Left blank</p>
<p>Avg.</p>	 <p>Site : 03CH15-HY Condition : AVG_BE_54 3m 91200_15_1620 VERTICAL Detector : Peak Project : 042038</p>	<p>Left blank</p>

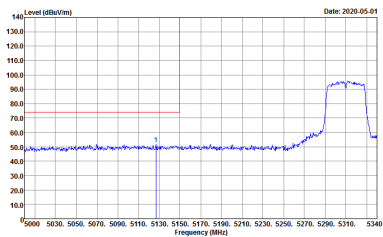
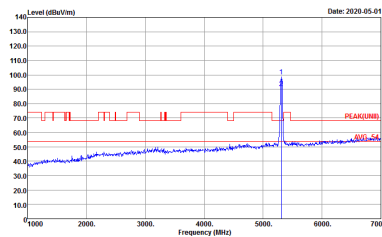
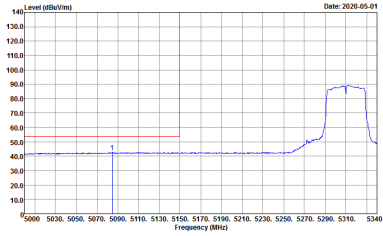

WIFI	Band 2 5250~5350MHz Band Edge @ 3m	
ANT	802.11n HT40 CH62 5310MHz - L	
1	Horizontal	Fundamental
Peak	 <p>Site : 03CH15-HY Condition : PEAK_BE_74 3m 91200_15_1620 HORIZONTAL Detector : Peak Project : 042038</p>	 <p>Site : 03CH15-HY Condition : PEAK(LINII) 3m 91200_15_1620 HORIZONTAL Detector : Peak Project : 042038</p>
Avg.	 <p>Site : 03CH15-HY Condition : AVG_BE_54 3m 91200_15_1620 HORIZONTAL Detector : Peak Project : 042038</p>	Left blank

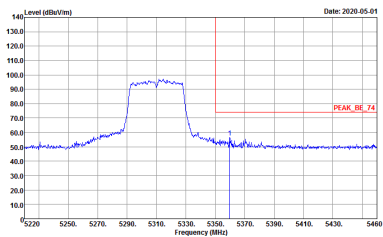
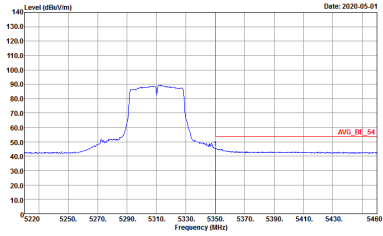

WIFI	Band 2 5250~5350MHz Band Edge @ 3m	
ANT	802.11n HT40 CH62 5310MHz - R	
1	Horizontal	Fundamental
Peak	 <p>Site : 03CH15-HY Condition : PEAK_BE_74 3m 91200_15_1620 HORIZONTAL Detector : Peak Project : 042038</p>	Left blank
Avg.	 <p>Site : 03CH15-HY Condition : AVG_BE_54 3m 91200_15_1620 HORIZONTAL Detector : Peak Project : 042038</p>	Left blank



WIFI	Band 2 5250~5350MHz Band Edge @ 3m	
ANT	802.11n HT40 CH62 5310MHz - L	
1	Vertical	Fundamental
Peak	<p>Site : 03CH15-HY Condition : PEAK_BE_74 3m 91200_15_1620 VERTICAL Detector : Peak Project : 042038</p>	<p>Site : 03CH15-HY Condition : PEAK(UNII) 3m 91200_15_1620 VERTICAL Detector : Peak Project : 042038</p>
Avg.	<p>Site : 03CH15-HY Condition : AVG_BE_54 3m 91200_15_1620 VERTICAL Detector : Peak Project : 042038</p>	Left blank

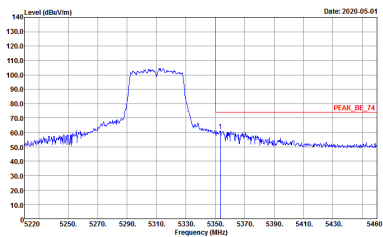
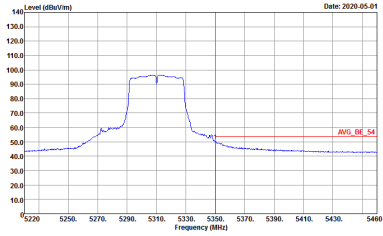

WIFI	Band 2 5250~5350MHz Band Edge @ 3m	
ANT	802.11n HT40 CH62 5310MHz - R	
1	Vertical	Fundamental
<p>Peak</p>	 <p>Site : 03CH15-HY Condition : PEAK_BE_74 3m 9120D_15_1620 VERTICAL Detector : Peak Project : 042038</p>	<p>Left blank</p>
<p>Avg.</p>	 <p>Site : 03CH15-HY Condition : AVG_BE_54 3m 9120D_15_1620 VERTICAL Detector : Peak Project : 042038</p>	<p>Left blank</p>

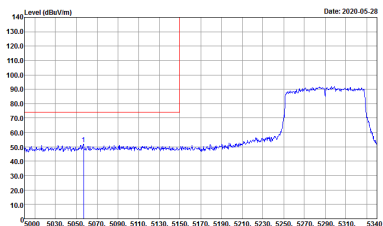
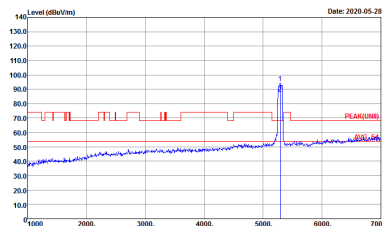
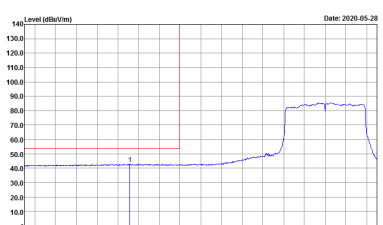

Band 2 5250~5350MHz
WIFI 802.11ac VHT80 (Band Edge @ 3m)

WIFI	Band 2 5250~5350MHz Band Edge @ 3m	
ANT	802.11ac VHT80 CH58 5290MHz - L	
1	Horizontal	Fundamental
Peak	 <p>Site : 03CH15-HY Condition : PEAK_BE_74 3m 91200_15_1620 HORIZONTAL RBW:1000.000KHz VBW:3000.000KHz SWT:Auto Detector : Peak Project : 042038</p>	 <p>Site : 03CH15-HY Condition : PEAK(UNIT) 3m 91200_15_1620 HORIZONTAL RBW:1000.000KHz VBW:3000.000KHz SWT:Auto Detector : Peak Project : 042038</p>
Avg.	 <p>Site : 03CH15-HY Condition : AVG_BE_54 3m 91200_15_1620 HORIZONTAL RBW:1000.000KHz VBW:3.000KHz SWT:Auto Detector : Peak Project : 042038</p>	Left blank

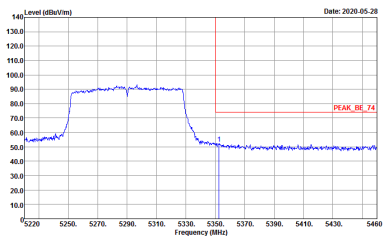

WIFI	Band 2 5250~5350MHz Band Edge @ 3m	
ANT	802.11ac VHT80 CH58 5290MHz - R	
1	Horizontal	Fundamental
<p>Peak</p>	 <p>Site : 03CH15-HY Condition : PEAK_BE_74 3m 91200_15_1620 HORIZONTAL Detector : Peak Project : 042038</p>	<p>Left blank</p>
<p>Avg.</p>	 <p>Site : 03CH15-HY Condition : AVG_BE_54 3m 91200_15_1620 HORIZONTAL Detector : Peak Project : 042038</p>	<p>Left blank</p>



WIFI	Band 2 5250~5350MHz Band Edge @ 3m	
ANT	802.11ac VHT80 CH58 5290MHz - L	
1	Vertical	Fundamental
Peak	<p>Site : 03CH15-HY Condition : PEAK_BE_74 3m 91200_15_1620 VERTICAL Detector : Peak Project : 042038</p>	<p>Site : 03CH15-HY Condition : PEAK(LINII) 3m 91200_15_1620 VERTICAL Detector : Peak Project : 042038</p>
Avg.	<p>Site : 03CH15-HY Condition : AVG_BE_54 3m 91200_15_1620 VERTICAL Detector : Peak Project : 042038</p>	Left blank

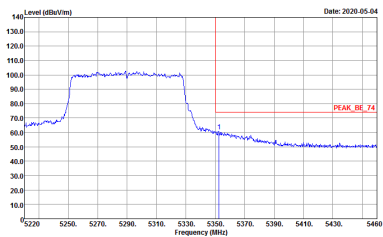
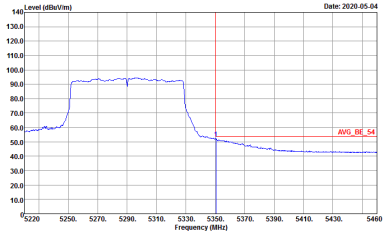

WIFI	Band 2 5250~5350MHz Band Edge @ 3m	
ANT	802.11ac VHT80 CH58 5290MHz - R	
1	Vertical	Fundamental
<p>Peak</p>	 <p>Site : 03CH15-HY Condition : PEAK_BE_74 3m 91200_15_1620 VERTICAL Detector : Peak Project : 042038</p>	<p>Left blank</p>
<p>Avg.</p>	 <p>Site : 03CH15-HY Condition : AVG_BE_54 3m 91200_15_1620 VERTICAL Detector : Peak Project : 042038</p>	<p>Left blank</p>



Band 2 - 5250~5350MHz

WIFI 802.11a (Harmonic @ 3m)

WIFI	Band 2 5250~5350MHz Harmonic @ 3m	
ANT	802.11a CH52 5260MHz	
1	Horizontal	Vertical
<p>Peak</p> <p>Avg.</p>	<p>Site : 03CH15-HY Condition : PEAR(LINE1) 3m 91200_15_1620 HORIZONTAL Detector : Peak Project : 042038</p>	<p>Site : 03CH15-HY Condition : PEAR(LINE1) 3m 91200_15_1620 VERTICAL Detector : Peak Project : 042038</p>

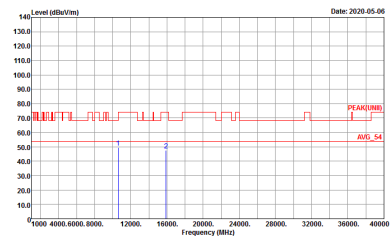
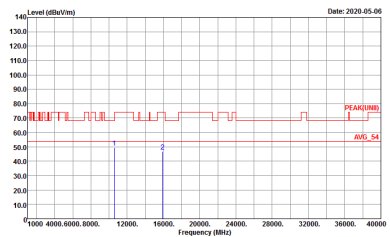

WIFI	Band 2 5250~5350MHz Harmonic @ 3m	
ANT	802.11a CH60 5300MHz	
1	Horizontal	Vertical
<p>Peak</p> <p>Avg.</p>	 <p>Site : 03CH15-11Y Condition : PEAK(LINE1) 3m 91200_15_1620 HORIZONTAL Detector : Peak Project : 042038</p>	 <p>Site : 03CH15-11Y Condition : PEAK(LINE1) 3m 91200_15_1620 VERTICAL Detector : Peak Project : 042038</p>

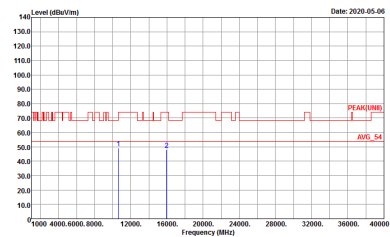
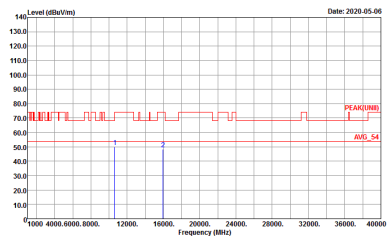

WIFI	Band 2 5250~5350MHz Harmonic @ 3m	
ANT	802.11a CH64 5320MHz	
1	Horizontal	Vertical
<p>Peak</p> <p>Avg.</p>	 <p>Site : 03CH15-11Y Condition : PEAK(LINE1) 3m 91200_15_1620 HORIZONTAL Detector : Peak Project : 042038</p>	 <p>Site : 03CH15-11Y Condition : PEAK(LINE1) 3m 91200_15_1620 VERTICAL Detector : Peak Project : 042038</p>



Band 2 5250~5350MHz
WIFI 802.11n HT20 (Harmonic @ 3m)

WIFI	Band 2 5250~5350MHz Harmonic @ 3m	
ANT	802.11n HT20 CH52 5260MHz	
1	Horizontal	Vertical
Peak Avg.	<p>Site : 03CH15-HY Condition : PEAK(LINII) 3m 91200_15_1620 HORIZONTAL Detector : Peak Project : 042038</p>	<p>Site : 03CH15-HY Condition : PEAK(LINII) 3m 91200_15_1620 VERTICAL Detector : Peak Project : 042038</p>



WIFI	Band 2 5250~5350MHz Harmonic @ 3m	
ANT	802.11n HT20 CH60 5300MHz	
1	Horizontal	Vertical
Peak Avg.	<p>Site : 03CH15-11Y Condition : PEAK(LINE1) 3m 91200_15_1620 HORIZONTAL Detector : Peak Project : 042038</p>	<p>Site : 03CH15-11Y Condition : PEAK(LINE1) 3m 91200_15_1620 VERTICAL Detector : Peak Project : 042038</p>

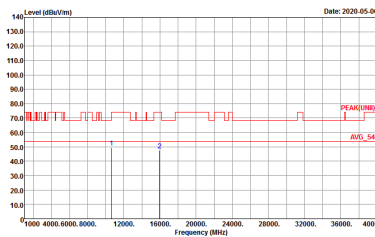
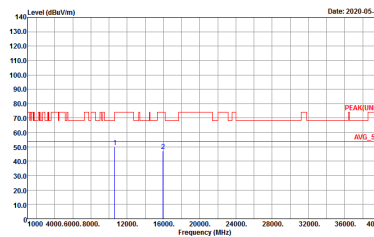

WIFI	Band 2 5250~5350MHz Harmonic @ 3m	
ANT	802.11n HT20 CH64 5320MHz	
1	Horizontal	Vertical
<p>Peak</p> <p>Avg.</p>	 <p>Site : 03CH15-11Y Condition : PEAK(LINE1) 3m 9120D_15_1620 HORIZONTAL Detector : Peak Project : 042038</p>	 <p>Site : 03CH15-11Y Condition : PEAK(LINE1) 3m 9120D_15_1620 VERTICAL Detector : Peak Project : 042038</p>



Band 2 5250~5350MHz
WIFI 802.11n HT40 (Harmonic @ 3m)

WIFI	Band 2 5250~5350MHz Harmonic @ 3m	
ANT	802.11n HT40 CH54 5270MHz	
1	Horizontal	Vertical
Peak Avg.	<p>Site : 03CH15-HY Condition : PEAK(LINII) 3m 91200_15_1620 HORIZONTAL Detector : Peak Project : 042038</p>	<p>Site : 03CH15-HY Condition : PEAK(LINII) 3m 91200_15_1620 VERTICAL Detector : Peak Project : 042038</p>



WIFI	Band 2 5250~5350MHz Harmonic @ 3m	
ANT	802.11n HT40 CH62 5310MHz	
1	Horizontal	Vertical
Peak Avg.	<p>Site : 03CH15-11Y Condition : PEAK(LINE1) 3m 91200_15_1620 HORIZONTAL Detector : Peak Project : 042038</p>	<p>Site : 03CH15-11Y Condition : PEAK(LINE1) 3m 91200_15_1620 VERTICAL Detector : Peak Project : 042038</p>



**Band 2 5250~5350MHz
WIFI 802.11ac VHT80 (Harmonic @ 3m)**

WIFI	Band 2 5250~5350MHz Harmonic @ 3m	
ANT	802.11ac VHT80 CH58 5290MHz	
1	Horizontal	Vertical
Peak Avg.	<p>Site : 03CH15-HY Condition : PEAK(LINII) 3m 91200_15_1620 HORIZONTAL Detector : Peak Project : 042038</p>	<p>Site : 03CH15-HY Condition : PEAK(LINII) 3m 91200_15_1620 VERTICAL Detector : Peak Project : 042038</p>



Band 3 - 5470~5725MHz
WIFI 802.11a (Band Edge @ 3m)

WIFI	Band 3 5470~5725MHz Band Edge @ 3m	
ANT	802.11a CH100 5500MHz	
1	Horizontal	Fundamental
Peak	<p>Site : 03CH15-HY Condition : PEAK_BE(UNIT)_B3 3m 91200_15_1620 HORIZONTAL Detector : Peak Project : 042038</p>	<p>Site : 03CH15-HY Condition : PEAK(UNIT) 3m 91200_15_1620 HORIZONTAL Detector : Peak Project : 042038</p>
Avg.	<p>Site : 03CH15-HY Condition : AV6_BE(UNIT)_B3 3m 91200_15_1620 HORIZONTAL Detector : Peak Project : 042038</p>	Left blank

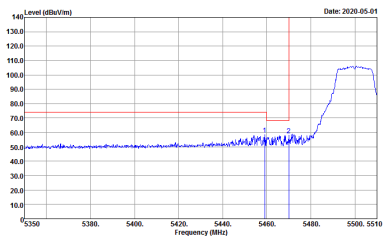
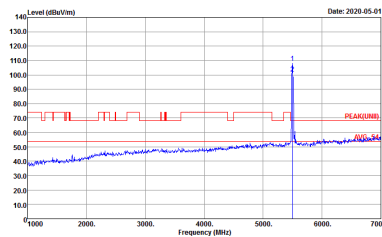
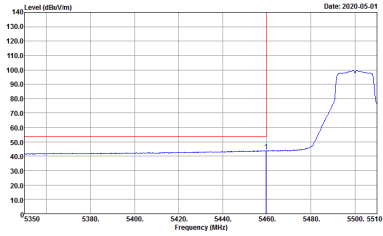

WIFI	Band 3 5470~5725MHz Band Edge @ 3m	
ANT	802.11a CH100 5500MHz	
1	Vertical	Fundamental
<p>Peak</p>	 <p>Site : 03CH15-HY Condition : PEAK_BE(UNIT), B3 3m 91200_15_1620 VERTICAL Detector : Peak Project : 042038</p>	 <p>Site : 03CH15-HY Condition : PEAK(UNIT) 3m 91200_15_1620 VERTICAL Detector : Peak Project : 042038</p>
<p>Avg.</p>	 <p>Site : 03CH15-HY Condition : AVG_BE(UNIT), B3 3m 91200_15_1620 VERTICAL Detector : Peak Project : 042038</p>	<p>Left blank</p>

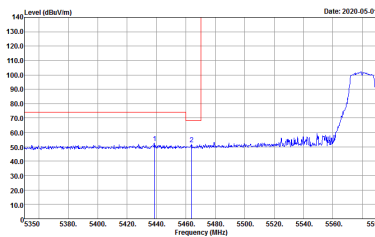
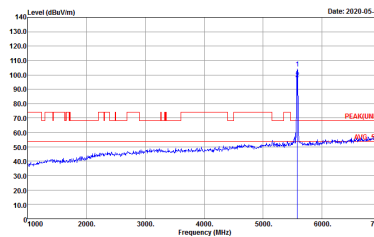
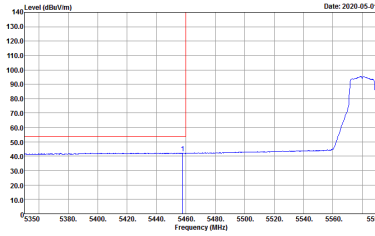

WIFI	Band 3 5470~5725MHz Band Edge @ 3m	
ANT	802.11a CH116 5580MHz - L	
1	Horizontal	Fundamental
Peak	 <p>Date: 2020-05-01</p> <p>Site : 03CH15-HY Condition : PEAK_BE(UNIT), B3 3m 91200_15_1620 HORIZONTAL RBW:1000.000KHz VBW:3000.000KHz SWT:Auto Detector : Peak Project : 042038</p>	 <p>Date: 2020-05-01</p> <p>Site : 03CH15-HY Condition : PEAK(UNIT) 3m 91200_15_1620 HORIZONTAL RBW:1000.000KHz VBW:3000.000KHz SWT:Auto Detector : Peak Project : 042038</p>
Avg.	 <p>Date: 2020-05-01</p> <p>Site : 03CH15-HY Condition : AVG_BE(UNIT), B3 3m 91200_15_1620 HORIZONTAL RBW:1000.000KHz VBW:1000KHz SWT:Auto Detector : Peak Project : 042038</p>	Left blank



WIFI	Band 3 5470~5725MHz Band Edge @ 3m	
ANT	802.11a CH116 5580MHz - R	
1	Horizontal	Fundamental
Peak	<p>Site : D8CH15-4/F Condition : PEAK_BE([UNIT]), B3 3m 91200_15_1620 HORIZONTAL Detector : Peak Project : 042038</p>	Left blank



WIFI	Band 3 5470~5725MHz Band Edge @ 3m	
ANT	802.11a CH116 5580MHz - L	
1	Vertical	Fundamental
Peak	<p>Site : 03CH15-HY Condition : PEAK_BE(UNIT), B3 3m 91200_15_1620 VERTICAL Detector : Peak Project : 042038</p>	<p>Site : 03CH15-HY Condition : PEAK(UNIT) 3m 91200_15_1620 VERTICAL Detector : Peak Project : 042038</p>
Avg.	<p>Site : 03CH15-HY Condition : AVG_BE(UNIT), B3 3m 91200_15_1620 VERTICAL Detector : Peak Project : 042038</p>	Left blank



WIFI	Band 3 5470~5725MHz Band Edge @ 3m	
ANT	802.11a CH116 5580MHz - R	
1	Vertical	Fundamental
Peak	<p>Site : D8CH15-414 Condition : PEAK_BE([UNIT]), B3 3m 91200_15_1620 VERTICAL Detector : Peak Project : 042038 Date: 2020-05-01</p>	Left blank

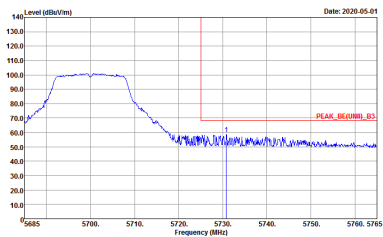
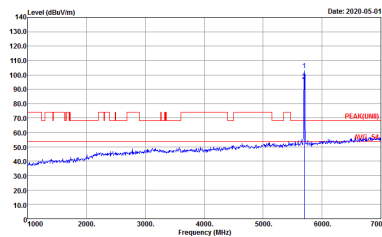

WIFI	Band 3 5470~5725MHz Band Edge @ 3m	
ANT	802.11a CH140 5700MHz	
1	Horizontal	Fundamental
Peak	 <p>Site : 03CH15-14V Condition : PEAK_BE[UNII], B3 3m 91200_15_1620 HORIZONTAL Detector : Peak Project : 042038</p>	 <p>Site : 03CH15-14V Condition : PEAK[UNII] 3m 91200_15_1620 HORIZONTAL Detector : Peak Project : 042038</p>



WIFI	Band 3 5470~5725MHz Band Edge @ 3m	
ANT	802.11a CH140 5700MHz	
1	Vertical	Fundamental
Peak	<p>Site : 03CH15-111 Condition : PEAK_BE(UNIT1)_B3 3m 91200_15_1620 VERTICAL Detector : Peak Project : 042038</p>	<p>Site : 03CH15-111 Condition : PEAK(UNIT1)_3m 91200_15_1620 VERTICAL Detector : Peak Project : 042038</p>

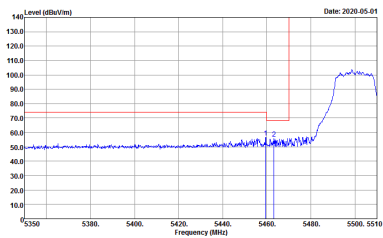
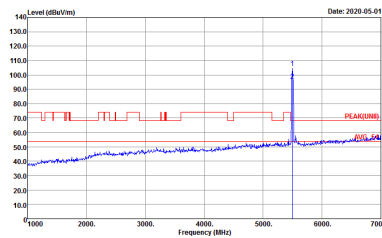
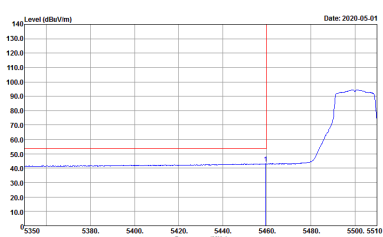

**Band 3 5470~5725MHz
WIFI 802.11n HT20 (Band Edge @ 3m)**

WIFI	Band 3 5470~5725MHz Band Edge @ 3m	
ANT	802.11n HT20 CH100 5500MHz	
1	Horizontal	Fundamental
Peak	 <p>Site : 03CH15-HY Condition : PEAK_BE(UNIT1)_B3 3m 91200_15_1620 HORIZONTAL Detector : Peak Project : 042038</p>	 <p>Site : 03CH15-HY Condition : PEAK(UNIT1) 3m 91200_15_1620 HORIZONTAL Detector : Peak Project : 042038</p>
Avg.	 <p>Site : 03CH15-HY Condition : AVG_BE(UNIT1)_B3 3m 91200_15_1620 HORIZONTAL Detector : Peak Project : 042038</p>	Left blank

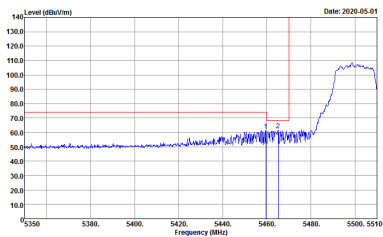
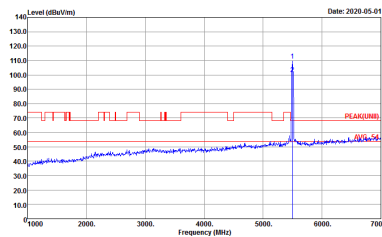
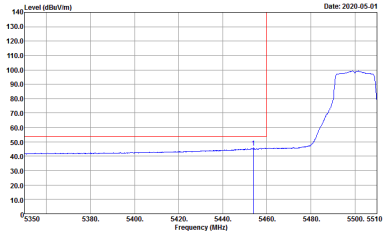

WIFI	Band 3 5470~5725MHz Band Edge @ 3m	
ANT	802.11n HT20 CH100 5500MHz	
1	Vertical	Fundamental
<p>Peak</p>	 <p>Site : 03CH15-HY Condition : PEAK_BE(UNIT), B3 3m 91200_15_1620 VERTICAL Detector : Peak Project : 042038</p>	 <p>Site : 03CH15-HY Condition : PEAK(UNIT) 3m 91200_15_1620 VERTICAL Detector : Peak Project : 042038</p>
<p>Avg.</p>	 <p>Site : 03CH15-HY Condition : AVG_BE(UNIT), B3 3m 91200_15_1620 VERTICAL Detector : Peak Project : 042038</p>	<p>Left blank</p>

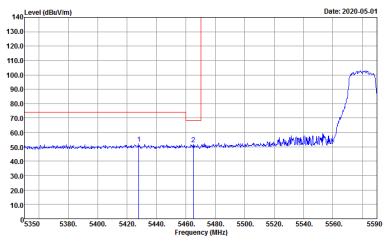
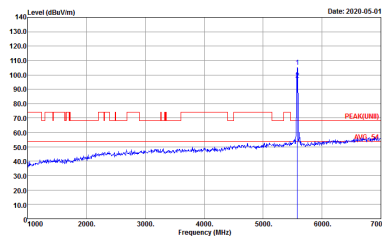
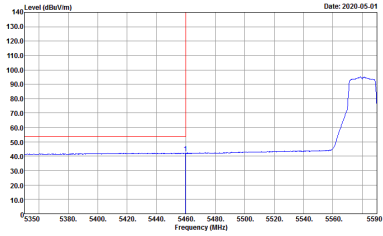

WIFI	Band 3 5470~5725MHz Band Edge @ 3m	
ANT	802.11n HT20 CH116 5580MHz - L	
1	Horizontal	Fundamental
Peak	 <p>Site : 03CH15-HY Condition : PEAK_BE(UNIT), B3 3m 91200_15_1620 HORIZONTAL Detector : Peak Project : 042038</p>	 <p>Site : 03CH15-HY Condition : PEAK(UNIT) 3m 91200_15_1620 HORIZONTAL Detector : Peak Project : 042038</p>
Avg.	 <p>Site : 03CH15-HY Condition : AVG_BE(UNIT), B3 3m 91200_15_1620 HORIZONTAL Detector : Peak Project : 042038</p>	Left blank



WIFI	Band 3 5470~5725MHz Band Edge @ 3m	
ANT	802.11n HT20 CH116 5580MHz - R	
1	Horizontal	Fundamental
Peak	<p>Site : D3CH15-4/F Condition : PEAK_BE[UNII], B3 3m 91200_15_1620 HORIZONTAL Detector : Peak Project : 042038</p>	Left blank



WIFI	Band 3 5470~5725MHz Band Edge @ 3m	
ANT	802.11n HT20 CH116 5580MHz - L	
1	Vertical	Fundamental
Peak	<p>Site : 03CH15-HY Condition : PEAK_BE(UNIT1)_B3 3m 91200_15_1620 VERTICAL Detector : Peak Project : 042038</p>	<p>Site : 03CH15-HY Condition : PEAK(UNIT1)_3m 91200_15_1620 VERTICAL Detector : Peak Project : 042038</p>
Avg.	<p>Site : 03CH15-HY Condition : AVG_BE(UNIT1)_B3 3m 91200_15_1620 VERTICAL Detector : Peak Project : 042038</p>	Left blank



WIFI	Band 3 5470~5725MHz Band Edge @ 3m	
ANT	802.11n HT20 CH116 5580MHz - R	
1	Vertical	Fundamental
Peak	<p>Site : D3CH15-414 Condition : PEAK_BE([UNIT]), B3 3m 91200_15_1620 VERTICAL Detector : Peak Project : 042038</p>	Left blank

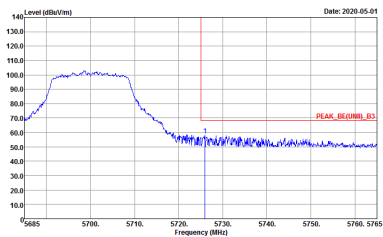
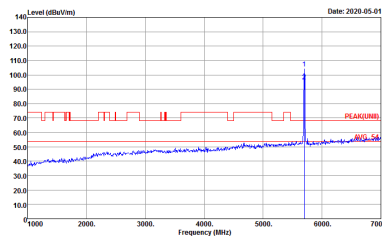

WIFI	Band 3 5470~5725MHz Band Edge @ 3m	
ANT	802.11n HT20 CH140 5700MHz	
1	Horizontal	Fundamental
Peak	 <p>Site : 03CH15-11V Condition : PEAK_BE[UNII], B3 3m 91200_15_1620 HORIZONTAL Detector : Peak Project : 042038</p>	 <p>Site : 03CH15-11V Condition : PEAK[UNII] 3m 91200_15_1620 HORIZONTAL Detector : Peak Project : 042038</p>



WIFI	Band 3 5470~5725MHz Band Edge @ 3m	
ANT	802.11n HT20 CH140 5700MHz	
1	Vertical	Fundamental
Peak.	<p>Site : 03CH15-11V Condition : PEAK_BE[UNII], B3 3m 91200_15_1620 VERTICAL Detector : RBW:1000.000KHz VBW:3000.000KHz SWT:Auto Project : 042038</p>	<p>Site : 03CH15-11V Condition : PEAK[UNII] 3m 91200_15_1620 VERTICAL Detector : RBW:1000.000KHz VBW:3000.000KHz SWT:Auto Project : 042038</p>

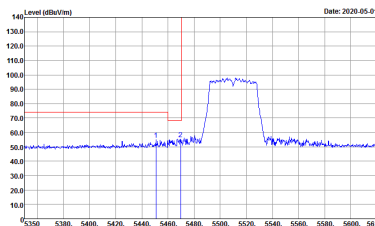
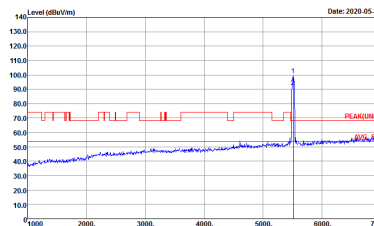
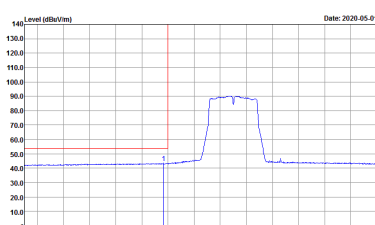

**Band 3 5470~5725MHz
WIFI 802.11n HT40 (Band Edge @ 3m)**

WIFI	Band 3 5470~5725MHz Band Edge @ 3m	
ANT	802.11n HT40 CH102 5510MHz - L	
1	Horizontal	Fundamental
<p>Peak</p>	 <p>Site : 03CH15-1FY Condition : PEAK_BE(UNIT1)_B3 3m 91200_15_1620 HORIZONTAL Detector : Peak Project : 042038</p>	 <p>Site : 03CH15-1FY Condition : PEAK(UNIT1) 3m 91200_15_1620 HORIZONTAL Detector : Peak Project : 042038</p>
<p>Avg.</p>	 <p>Site : 03CH15-1FY Condition : AVG_BE(UNIT1)_B3 3m 91200_15_1620 HORIZONTAL Detector : Peak Project : 042038</p>	<p>Left blank</p>



WIFI	Band 3 5470~5725MHz Band Edge @ 3m	
ANT	802.11n HT40 CH102 5510MHz - R	
1	Horizontal	Fundamental
Peak	<p>Site : D3CH15-4/F Condition : PEAK_BE([UNIT]), B3 3m 91200_15_1620 HORIZONTAL Detector : Peak Project : 042038</p>	Left blank

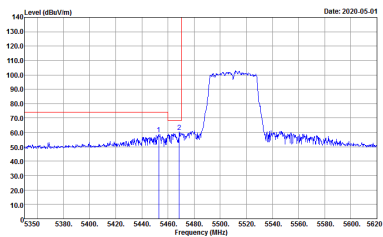
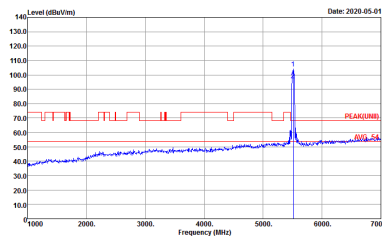
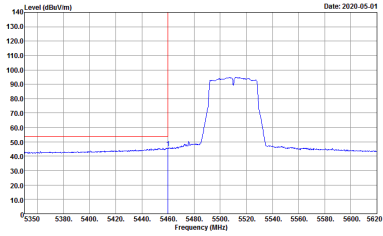

WIFI	Band 3 5470~5725MHz Band Edge @ 3m	
ANT	802.11n HT40 CH102 5510MHz - L	
1	Vertical	Fundamental
Peak	 <p>Site : 03CH15-HY Condition : PEAK_BE(UNIT), B3 3m 91200_15_1620 VERTICAL Detector : Peak Project : 042038</p>	 <p>Site : 03CH15-HY Condition : PEAK(UNIT) 3m 91200_15_1620 VERTICAL Detector : Peak Project : 042038</p>
Avg.	 <p>Site : 03CH15-HY Condition : AVG_BE(UNIT), B3 3m 91200_15_1620 VERTICAL Detector : Peak Project : 042038</p>	Left blank



WIFI	Band 3 5470~5725MHz Band Edge @ 3m	
ANT	802.11n HT40 CH102 5510MHz - R	
1	Vertical	Fundamental
Peak	<p>Site : D3CH15-4/F Condition : PEAK_BE([UNIT]), B3 3m 91200_15_1620 VERTICAL Detector : Peak Project : 042038</p>	Left blank

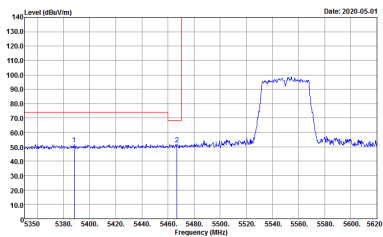

WIFI	Band 3 5470~5725MHz Band Edge @ 3m	
ANT	802.11n HT40 CH110 5550MHz - L	
1	Horizontal	Fundamental
Peak	 <p>Date: 2020-05-01</p> <p>Site : 03CH15-HY Condition : PEAK_BE(UNIT), B3 3m 91200_15_1620 HORIZONTAL Detector : RBW:1000.000KHz VBW:3000.000KHz SWT:Auto Project : Peak Project : -042038</p>	 <p>Date: 2020-05-01</p> <p>Site : 03CH15-HY Condition : PEAK(UNIT) 3m 91200_15_1620 HORIZONTAL Detector : RBW:1000.000KHz VBW:3000.000KHz SWT:Auto Project : Peak Project : -042038</p>
Avg.	 <p>Date: 2020-05-01</p> <p>Site : 03CH15-HY Condition : AVG_BE(UNIT), B3 3m 91200_15_1620 HORIZONTAL Detector : RBW:1000.000KHz VBW:3000.000KHz SWT:Auto Project : Peak Project : -042038</p>	Left blank



WIFI	Band 3 5470~5725MHz Band Edge @ 3m	
ANT	802.11n HT40 CH110 5550MHz - R	
1	Horizontal	Fundamental
Peak	<p>Site : D3CH15-4/F Condition : PEAK_BE([UNIT]), B3 3m 91200_15_1620 HORIZONTAL Detector : Peak Project : 042038</p>	Left blank

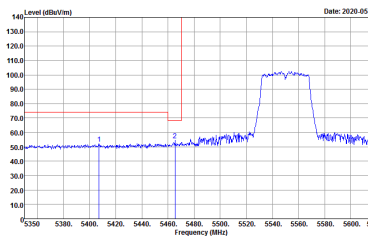
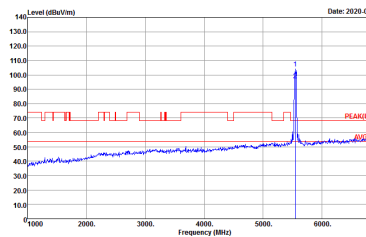
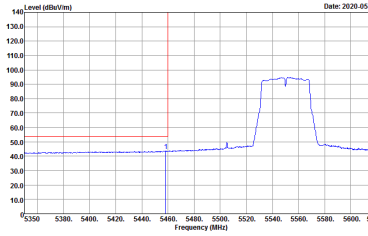

WIFI	Band 3 5470~5725MHz Band Edge @ 3m	
ANT	802.11n HT40 CH110 5550MHz - L	
1	Vertical	Fundamental
Peak	 <p>Site : 03CH15-HY Condition : PEAK_BE(UNIT), B3 3m 91200_15_1620 VERTICAL Detector : Peak Project : 042038</p>	 <p>Site : 03CH15-HY Condition : PEAK(UNIT) 3m 91200_15_1620 VERTICAL Detector : Peak Project : 042038</p>
Avg.	 <p>Site : 03CH15-HY Condition : AVG_BE(UNIT), B3 3m 91200_15_1620 VERTICAL Detector : Peak Project : 042038</p>	Left blank



WIFI	Band 3 5470~5725MHz Band Edge @ 3m	
ANT	802.11n HT40 CH110 5550MHz - R	
1	Vertical	Fundamental
Peak	<p>Site : D3CH15-414 Condition : PEAK_BE[UNIT], B3 3m 91200_15_1620 VERTICAL Detector : Peak Project : 042038</p>	Left blank

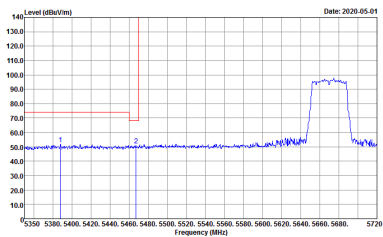
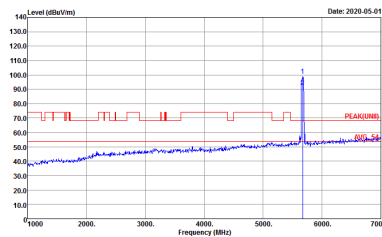

WIFI	Band 3 5470~5725MHz Band Edge @ 3m	
ANT	802.11n HT40 CH134 5670MHz - L	
1	Horizontal	Fundamental
Peak	 <p>Date: 2020-05-01</p> <p>Site : 03CH15-HY Condition : PEAK_BE(UNIT), B3 3m 91200_15_1620 HORIZONTAL Detector : RBW:1000.000KHz VBW:3000.000KHz SWT:Auto Project : Peak : 042038</p>	 <p>Date: 2020-05-01</p> <p>Site : 03CH15-HY Condition : PEAK(UNIT) 3m 91200_15_1620 HORIZONTAL Detector : RBW:1000.000KHz VBW:3000.000KHz SWT:Auto Project : Peak : 042038</p>
Avg.	 <p>Date: 2020-05-01</p> <p>Site : 03CH15-HY Condition : AVG_BE(UNIT), B3 3m 91200_15_1620 HORIZONTAL Detector : RBW:1000.000KHz VBW:3000.000KHz SWT:Auto Project : Peak : 042038</p>	Left blank



WIFI	Band 3 5470~5725MHz Band Edge @ 3m	
ANT	802.11n HT40 CH134 5670MHz - R	
1	Horizontal	Fundamental
Peak	<p>Site : D3CH15-4/F Condition : PEAK_BE([UNIT], B3 3m 91200_15_1620 HORIZONTAL RBW:1000.000KHz, VBW:3000.000KHz, SWT:Auto Detector : Peak Project : 042038</p>	Left blank



WIFI	Band 3 5470~5725MHz Band Edge @ 3m	
ANT	802.11n HT40 CH134 5670MHz - L	
1	Vertical	Fundamental
Peak	<p>Site : 03CH15-HY Condition : PEAK_BE(UNIT), B3 3m 91200_15_1620 VERTICAL Detector : RBW:1000.000KHz VBW:3000.000KHz SWT:Auto Project : Peak Project : -042038</p>	<p>Site : 03CH15-HY Condition : PEAK(UNIT) 3m 91200_15_1620 VERTICAL Detector : RBW:1000.000KHz VBW:3000.000KHz SWT:Auto Project : Peak Project : -042038</p>
Avg.	<p>Site : 03CH15-HY Condition : AVG_BE(UNIT), B3 3m 91200_15_1620 VERTICAL Detector : RBW:1000.000KHz VBW:3000.000KHz SWT:Auto Project : Peak Project : -042038</p>	Left blank



WIFI	Band 3 5470~5725MHz Band Edge @ 3m	
ANT	802.11n HT40 CH134 5670MHz - R	
1	Vertical	Fundamental
Peak	<p>Site : D3CH15-4/F Condition : PEAK_BE[UNII], B3 3m 91200_15_1620 VERTICAL Detector : Peak Project : 042038</p>	Left blank

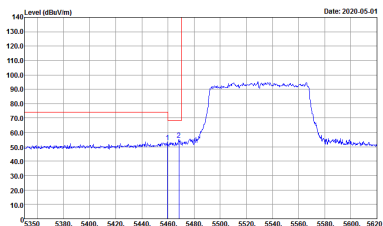
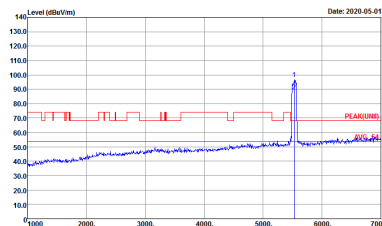
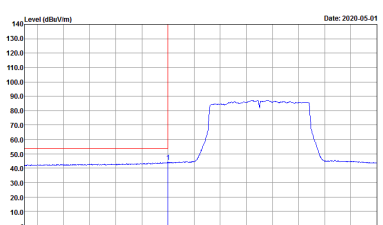

Band 3 5470~5725MHz
WIFI 802.11ac VHT80 (Band Edge @ 3m)

WIFI	Band 3 5470~5725MHz Band Edge @ 3m	
ANT	802.11ac VHT80 CH106 5530MHz - L	
1	Horizontal	Fundamental
Peak	 <p>Site : 03CH15-HY Condition : PEAK_BE(UNIT1)_B3 3m 91200_15_1620 HORIZONTAL Detector : Peak Project : 042038</p>	 <p>Site : 03CH15-HY Condition : PEAK(UNIT1) 3m 91200_15_1620 HORIZONTAL Detector : Peak Project : 042038</p>
Avg.	 <p>Site : 03CH15-HY Condition : AVG_BE(UNIT1)_B3 3m 91200_15_1620 HORIZONTAL Detector : Peak Project : 042038</p>	Left blank



WIFI	Band 3 5470~5725MHz Band Edge @ 3m	
ANT	802.11ac VHT80 CH106 5530MHz - R	
1	Horizontal	Fundamental
Peak	<p>Site : D3CH15-4/F Condition : PEAK_BE([UNIT], B3 3m 91200_15_1620 HORIZONTAL Detector : Peak Project : 042038</p>	Left blank

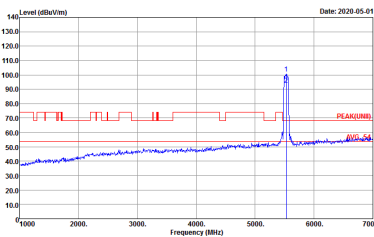

WIFI	Band 3 5470~5725MHz Band Edge @ 3m	
ANT	802.11ac VHT80 CH106 5530MHz - L	
1	Vertical	Fundamental
Peak	 <p>Date: 2020-05-01</p> <p>Site : 03CH15-HY Condition : PEAK_BE(UNIT1)_B3 3m 91200_15_1620 VERTICAL RBW:1000.000KHz VBW:3000.000KHz SWT:Auto Detector : Peak Project : 042038</p>	 <p>Date: 2020-05-01</p> <p>Site : 03CH15-HY Condition : PEAK(UNIT1)_3m 91200_15_1620 VERTICAL RBW:1000.000KHz VBW:3000.000KHz SWT:Auto Detector : Peak Project : 042038</p>
Avg.	 <p>Date: 2020-05-01</p> <p>Site : 03CH15-HY Condition : AVG_BE(UNIT1)_B3 3m 91200_15_1620 VERTICAL RBW:1000.000KHz VBW:3000.000KHz SWT:Auto Detector : Peak Project : 042038</p>	Left blank



WIFI	Band 3 5470~5725MHz Band Edge @ 3m	
ANT	802.11ac VHT80 CH106 5530MHz - R	
1	Vertical	Fundamental
Peak	<p>Site : D3CH15-4/F Condition : PEAK_BE([UNIT]), B3 3m 91200_15_1620 VERTICAL Detector : Peak Project : 042038</p>	Left blank

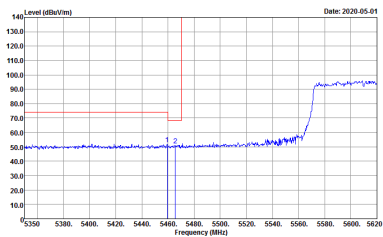
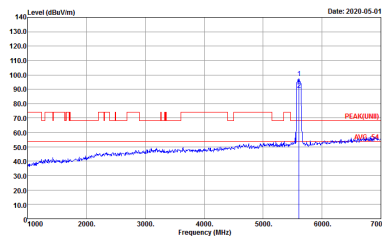

WIFI	Band 3 5470~5725MHz Band Edge @ 3m	
ANT	802.11ac VHT80 CH122 5610MHz - L	
1	Horizontal	Fundamental
Peak	 <p>Date: 2020-05-01</p> <p>Site : 03CH15-HY Condition : PEAK_BE(UNIT), B3 3m 91200_15_1620 HORIZONTAL Detector : Peak Project : 042038</p>	 <p>Date: 2020-05-01</p> <p>Site : 03CH15-HY Condition : PEAK(UNIT) 3m 91200_15_1620 HORIZONTAL Detector : Peak Project : 042038</p>
Avg.	 <p>Date: 2020-05-01</p> <p>Site : 03CH15-HY Condition : AVG_BE(UNIT), B3 3m 91200_15_1620 HORIZONTAL Detector : Peak Project : 042038</p>	Left blank



WIFI	Band 3 5470~5725MHz Band Edge @ 3m	
ANT	802.11ac VHT80 CH122 5610MHz - R	
1	Horizontal	Fundamental
Peak	<p>Site : D3CH15-4/F Condition : PEAK_BE([UNIT]), B3 3m 91200_15_1620 HORIZONTAL Detector : Peak Project : 042038</p>	Left blank

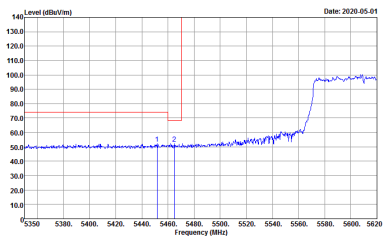
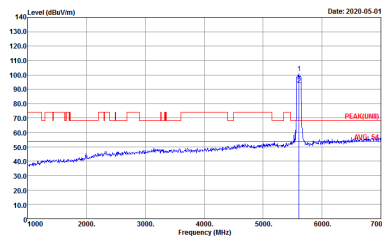
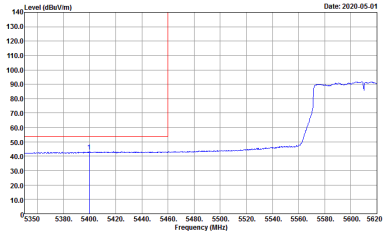

WIFI	Band 3 5470~5725MHz Band Edge @ 3m	
ANT	802.11ac VHT80 CH122 5610MHz - L	
1	Vertical	Fundamental
Peak	 <p>Date: 2020-05-01</p> <p>Site : 03CH15-HY Condition : PEAK_BE(UNIT), B3 3m 91200_15_1620 VERTICAL RBW:1000.000KHz VBW:3000.000KHz SWT:Auto Detector : Peak Project : 042038</p>	 <p>Date: 2020-05-01</p> <p>Site : 03CH15-HY Condition : PEAK(UNIT) 3m 91200_15_1620 VERTICAL RBW:1000.000KHz VBW:3000.000KHz SWT:Auto Detector : Peak Project : 042038</p>
Avg.	 <p>Date: 2020-05-01</p> <p>Site : 03CH15-HY Condition : AVG_BE(UNIT), B3 3m 91200_15_1620 VERTICAL RBW:1000.000KHz VBW:3000.000KHz SWT:Auto Detector : Peak Project : 042038</p>	Left blank



WIFI	Band 3 5470~5725MHz Band Edge @ 3m	
ANT	802.11ac VHT80 CH122 5610MHz - R	
1	Vertical	Fundamental
Peak	<p>Site : D3CH15-414 Condition : PEAK_RE([UNIT]), B3 3m 91200_15_1620 VERTICAL Detector : Peak Project : 042038</p>	Left blank



Band 3 - 5470~5725MHz
WIFI 802.11a (Harmonic @ 3m)

WIFI	Band 3 5470~5725MHz Harmonic @ 3m	
ANT	802.11a CH100 5500MHz	
1	Horizontal	Vertical
Peak Avg.	<p>Site : 03CH15-HY Condition : PEAR(LINET) 3m 91200_15_1620 HORIZONTAL Detector : Peak Project : 042038</p>	<p>Site : 03CH15-HY Condition : PEAR(LINET) 3m 91200_15_1620 VERTICAL Detector : Peak Project : 042038</p>



WIFI	Band 3 5470~5725MHz Harmonic @ 3m	
ANT	802.11a CH116 5580MHz	
1	Horizontal	Vertical
Peak Avg.	<p>Site : 03CH15-11Y Condition : PEAK(LINEI) 3m 9120D_15_1620 HORIZONTAL Detector : Peak Project : 042038</p>	<p>Site : 03CH15-11Y Condition : PEAK(LINEI) 3m 9120D_15_1620 VERTICAL Detector : Peak Project : 042038</p>

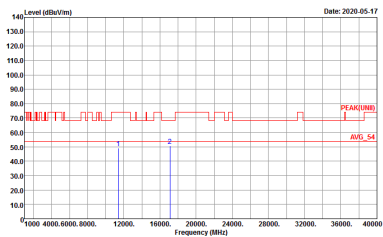
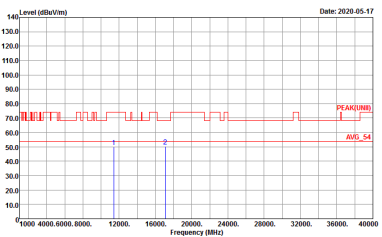

WIFI	Band 3 5470~5725MHz Harmonic @ 3m	
ANT	802.11a CH140 5700MHz	
1	Horizontal	Vertical
<p>Peak</p> <p>Avg.</p>	 <p>Site : 03CH15-11Y Condition : PEAK(LINEI) 3m 9120D_15_1620 HORIZONTAL Detector : Peak Project : 042038</p>	 <p>Site : 03CH15-11Y Condition : PEAK(LINEI) 3m 9120D_15_1620 VERTICAL Detector : Peak Project : 042038</p>



Band 3 5470~5725MHz
WIFI 802.11n HT20 (Harmonic @ 3m)

WIFI	Band 3 5470~5725MHz Harmonic @ 3m	
ANT	802.11n HT20 CH100 5500MHz	
1	Horizontal	Vertical
Peak Avg.	<p>Site : 03CH15-HY Condition : PEAK(LINII) 3m 91200_15_1620 HORIZONTAL Detector : Peak Project : 042038</p>	<p>Site : 03CH15-HY Condition : PEAK(LINII) 3m 91200_15_1620 VERTICAL Detector : Peak Project : 042038</p>



WIFI	Band 3 5470~5725MHz Harmonic @ 3m	
ANT	802.11n HT20 CH116 5580MHz	
1	Horizontal	Vertical
Peak Avg.	<p>Site : 03CH15-11Y Condition : PEAK(LINE1) 3m 9120D_15_1620 HORIZONTAL Detector : Peak Project : 042038</p>	<p>Site : 03CH15-11Y Condition : PEAK(LINE1) 3m 9120D_15_1620 VERTICAL Detector : Peak Project : 042038</p>



WIFI	Band 3 5470~5725MHz Harmonic @ 3m	
ANT	802.11n HT20 CH140 5700MHz	
1	Horizontal	Vertical
Peak Avg.	<p>Site : 03CH15-11Y Condition : PEAK(LINE1) 3m 9120D_15_1620 HORIZONTAL Detector : Peak Project : 042038</p>	<p>Site : 03CH15-11Y Condition : PEAK(LINE1) 3m 9120D_15_1620 VERTICAL Detector : Peak Project : 042038</p>



Band 3 5470~5725MHz
WIFI 802.11n HT40 (Harmonic @ 3m)

WIFI	Band 3 5470~5725MHz Harmonic @ 3m	
ANT	802.11n HT40 CH102 5510MHz	
1	Horizontal	Vertical
Peak Avg.	<p>Site : 03CH15-HY Condition : PEAK(LNII) 3m 91200_15_1620 HORIZONTAL Detector : Peak Project : 042038</p>	<p>Site : 03CH15-HY Condition : PEAK(LNII) 3m 91200_15_1620 VERTICAL Detector : Peak Project : 042038</p>



WIFI	Band 3 5470~5725MHz Harmonic @ 3m	
ANT	802.11n HT40 CH110 5550MHz	
1	Horizontal	Vertical
Peak Avg.	<p>Site : 03CH15-11Y Condition : PEAK(LINEI) 3m 9120D_15_1620 HORIZONTAL Detector : Peak Project : 042038</p>	<p>Site : 03CH15-11Y Condition : PEAK(LINEI) 3m 9120D_15_1620 VERTICAL Detector : Peak Project : 042038</p>



WIFI	Band 3 5470~5725MHz Harmonic @ 3m	
ANT	802.11n HT40 CH134 5670MHz	
1	Horizontal	Vertical
Peak Avg.	<p>Site : 03CH15-11Y Condition : PEAK(LINE1) 3m 9120D_15_1620 HORIZONTAL Detector : Peak Project : 042038</p>	<p>Site : 03CH15-11Y Condition : PEAK(LINE1) 3m 9120D_15_1620 VERTICAL Detector : Peak Project : 042038</p>



**Band 3 5470~5725MHz
WIFI 802.11ac VHT80 (Harmonic @ 3m)**

WIFI	Band 3 5470~5725MHz Harmonic @ 3m	
ANT	802.11ac VHT80 CH106 5530MHz	
1	Horizontal	Vertical
Peak Avg.	<p>Site : 03CH15-HY Condition : PEAK(LNII) 3m 91200_15_1620 HORIZONTAL Detector : Peak Project : 042038</p>	<p>Site : 03CH15-HY Condition : PEAK(LNII) 3m 91200_15_1620 VERTICAL Detector : Peak Project : 042038</p>



WIFI	Band 3 5470~5725MHz Harmonic @ 3m	
ANT	802.11ac VHT80 CH122 5610MHz	
1	Horizontal	Vertical
Peak Avg.	<p>Site : 03CH15-11Y Condition : PEAK(LINE1) 3m 9120D_15_1620 HORIZONTAL Detector : Peak Project : 042038</p>	<p>Site : 03CH15-11Y Condition : PEAK(LINE1) 3m 9120D_15_1620 VERTICAL Detector : Peak Project : 042038</p>



Emission below 1GHz
5GHz WIFI 802.11n HT20 (LF)

WIFI	5GHz WIFI	
ANT	802.11n HT20 LF	
1	Horizontal	Vertical
QP / Peak	<p>Site : 03CH15-HY Condition : QP 3m B1LOG_15_41912 HORIZONTAL Detector : Peak Project : 042038</p>	<p>Site : 03CH15-HY Condition : QP 3m B1LOG_15_41912 VERTICAL Detector : Peak Project : 042038</p>



Appendix E. Duty Cycle Plots

Band	Duty Cycle(%)	T(us)	1/T(kHz)	VBW Setting	Duty Factor(dB)
802.11a	94.72	2065	0.48	1kHz	0.24
5GHz 802.11n HT20	94.62	1935	0.52	1kHz	0.24
5GHz 802.11n HT40	90.80	948	1.05	3kHz	0.42
5GHz 802.11ac VHT80	88.53	733	1.36	3kHz	0.53



802.11a

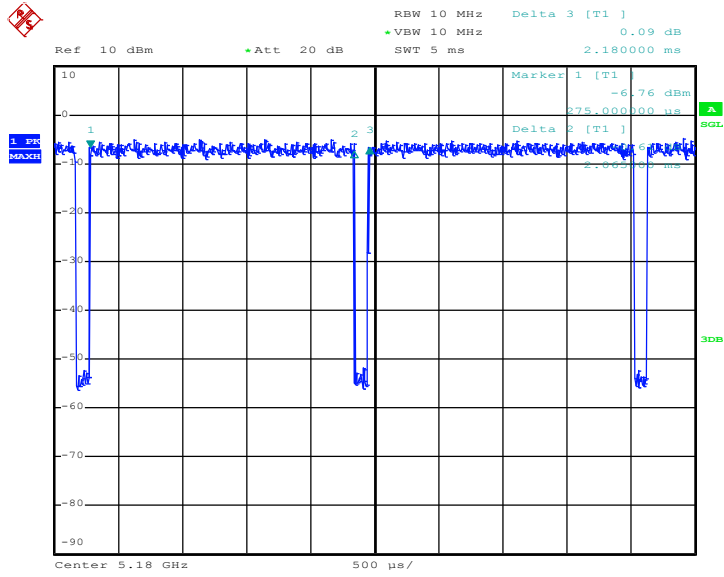

Date: 24.APR.2020 15:46:30

802.11n HT20

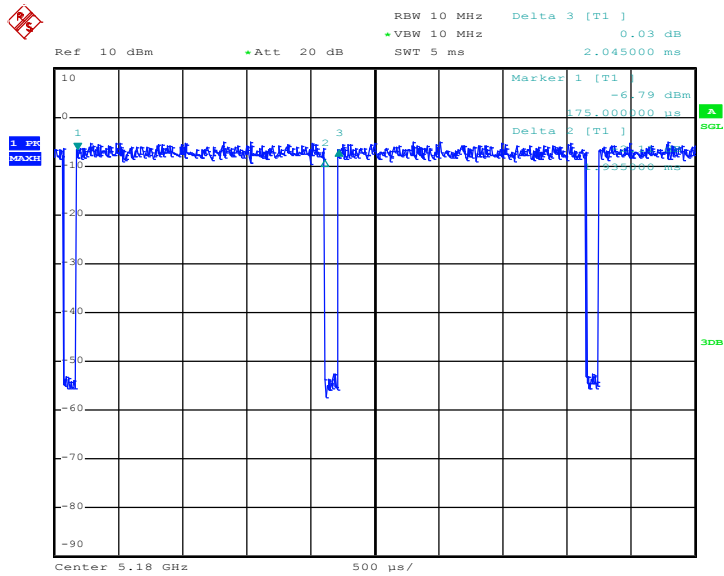

Date: 24.APR.2020 15:48:23



802.11n HT40

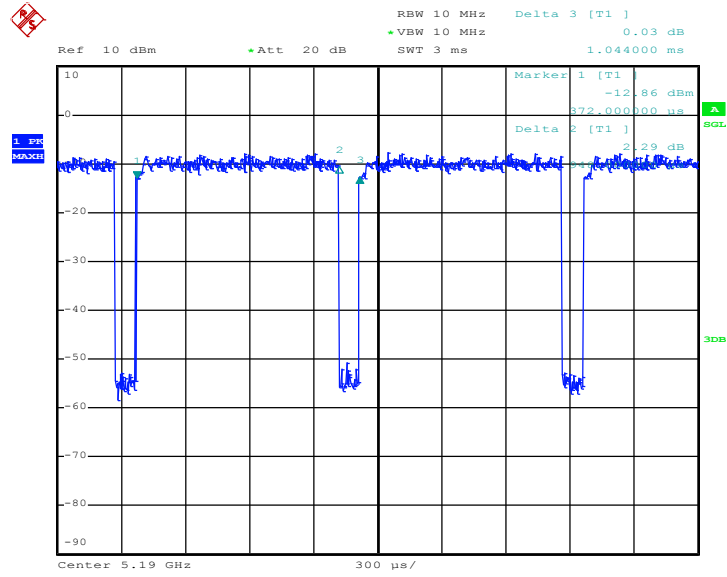

Date: 24.APR.2020 15:52:56

802.11ac VHT80

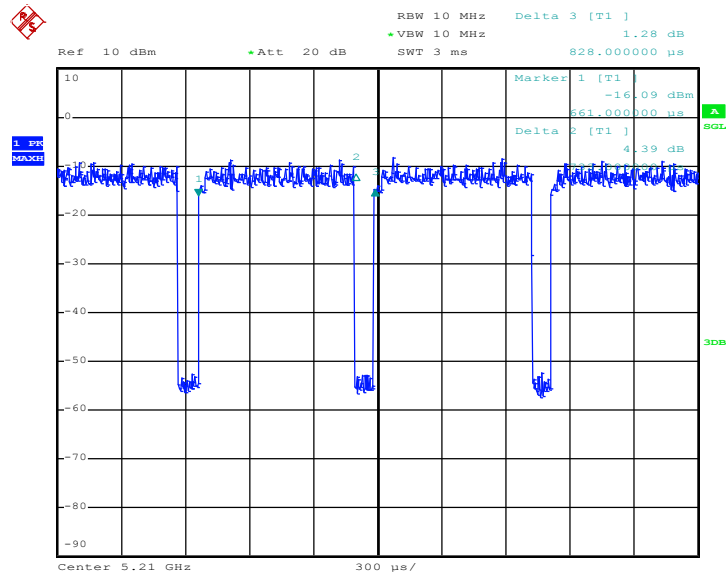

Date: 24.APR.2020 15:57:37