

**Calibration Laboratory of
Schmid & Partner
Engineering AG**
Zeughausstrasse 43, 8004 Zurich, Switzerland



S Schweizerischer Kalibrierdienst
C Service suisse d'étalonnage
S Servizio svizzero di taratura
Swiss Calibration Service

Accredited by the Swiss Accreditation Service (SAS)
The Swiss Accreditation Service is one of the signatories to the EA
Multilateral Agreement for the recognition of calibration certificates

Accreditation No.: **SCS 0108**

Client **PC Test**

Certificate No: **ES3-3287_Sep17**

CALIBRATION CERTIFICATE

Object **ES3DV3 - SN:3287**

Calibration procedure(s) **QA CAL-01.v9, QA CAL-23.v5, QA CAL-25.v6
Calibration procedure for dosimetric E-field probes**

Calibration date: **September 18, 2017**

*SCV
10/03/2017*

This calibration certificate documents the traceability to national standards, which realize the physical units of measurements (SI).
The measurements and the uncertainties with confidence probability are given on the following pages and are part of the certificate.

All calibrations have been conducted in the closed laboratory facility: environment temperature (22 ± 3)°C and humidity < 70%.

Calibration Equipment used (M&TE critical for calibration)

Primary Standards	ID	Cal Date (Certificate No.)	Scheduled Calibration
Power meter NRP	SN: 104778	04-Apr-17 (No. 217-02521/02522)	Apr-18
Power sensor NRP-Z91	SN: 103244	04-Apr-17 (No. 217-02521)	Apr-18
Power sensor NRP-Z91	SN: 103245	04-Apr-17 (No. 217-02525)	Apr-18
Reference 20 dB Attenuator	SN: S5277 (20x)	07-Apr-17 (No. 217-02528)	Apr-18
Reference Probe ES3DV2	SN: 3013	31-Dec-16 (No. ES3-3013_Dec16)	Dec-17
DAE4	SN: 660	7-Dec-16 (No. DAE4-660_Dec16)	Dec-17
Secondary Standards	ID	Check Date (in house)	Scheduled Check
Power meter E4419B	SN: GB41293874	06-Apr-16 (in house check Jun-16)	In house check: Jun-18
Power sensor E4412A	SN: MY41498087	06-Apr-16 (in house check Jun-16)	In house check: Jun-18
Power sensor E4412A	SN: 000110210	06-Apr-16 (in house check Jun-16)	In house check: Jun-18
RF generator HP 8648C	SN: US3642U01700	04-Aug-99 (in house check Jun-16)	In house check: Jun-18
Network Analyzer HP 8753E	SN: US37390585	18-Oct-01 (in house check Oct-16)	In house check: Oct-17

Calibrated by:	Name Leif Klysner	Function Laboratory Technician	Signature
Approved by:	Name Katja Pokovic	Function Technical Manager	Signature

Issued: September 19, 2017

This calibration certificate shall not be reproduced except in full without written approval of the laboratory.



Accredited by the Swiss Accreditation Service (SAS)

Accreditation No.: **SCS 0108**

The Swiss Accreditation Service is one of the signatories to the EA
Multilateral Agreement for the recognition of calibration certificates

Glossary:

TSL	tissue simulating liquid
NORM _{x,y,z}	sensitivity in free space
ConvF	sensitivity in TSL / NORM _{x,y,z}
DCP	diode compression point
CF	crest factor (1/duty_cycle) of the RF signal
A, B, C, D	modulation dependent linearization parameters
Polarization φ	φ rotation around probe axis
Polarization ϑ	ϑ rotation around an axis that is in the plane normal to probe axis (at measurement center), i.e., $\vartheta = 0$ is normal to probe axis
Connector Angle	information used in DASY system to align probe sensor X to the robot coordinate system

Calibration is Performed According to the Following Standards:

- a) IEEE Std 1528-2013, "IEEE Recommended Practice for Determining the Peak Spatial-Averaged Specific Absorption Rate (SAR) in the Human Head from Wireless Communications Devices: Measurement Techniques", June 2013
- b) IEC 62209-1, "Measurement procedure for the assessment of Specific Absorption Rate (SAR) from hand-held and body-mounted devices used next to the ear (frequency range of 300 MHz to 6 GHz)", July 2016
- c) IEC 62209-2, "Procedure to determine the Specific Absorption Rate (SAR) for wireless communication devices used in close proximity to the human body (frequency range of 30 MHz to 6 GHz)", March 2010
- d) KDB 865664, "SAR Measurement Requirements for 100 MHz to 6 GHz"

Methods Applied and Interpretation of Parameters:

- **NORM_{x,y,z}**: Assessed for E-field polarization $\vartheta = 0$ ($f \leq 900$ MHz in TEM-cell; $f > 1800$ MHz: R22 waveguide). NORM_{x,y,z} are only intermediate values, i.e., the uncertainties of NORM_{x,y,z} does not affect the E²-field uncertainty inside TSL (see below ConvF).
- **NORM(f)_{x,y,z} = NORM_{x,y,z} * frequency_response** (see Frequency Response Chart). This linearization is implemented in DASY4 software versions later than 4.2. The uncertainty of the frequency response is included in the stated uncertainty of ConvF.
- **DCP_{x,y,z}**: DCP are numerical linearization parameters assessed based on the data of power sweep with CW signal (no uncertainty required). DCP does not depend on frequency nor media.
- **PAR**: PAR is the Peak to Average Ratio that is not calibrated but determined based on the signal characteristics
- **A_{x,y,z}; B_{x,y,z}; C_{x,y,z}; D_{x,y,z}; VR_{x,y,z}; A, B, C, D** are numerical linearization parameters assessed based on the data of power sweep for specific modulation signal. The parameters do not depend on frequency nor media. VR is the maximum calibration range expressed in RMS voltage across the diode.
- **ConvF and Boundary Effect Parameters**: Assessed in flat phantom using E-field (or Temperature Transfer Standard for $f \leq 800$ MHz) and inside waveguide using analytical field distributions based on power measurements for $f > 800$ MHz. The same setups are used for assessment of the parameters applied for boundary compensation (alpha, depth) of which typical uncertainty values are given. These parameters are used in DASY4 software to improve probe accuracy close to the boundary. The sensitivity in TSL corresponds to NORM_{x,y,z} * ConvF whereby the uncertainty corresponds to that given for ConvF. A frequency dependent ConvF is used in DASY version 4.4 and higher which allows extending the validity from ± 50 MHz to ± 100 MHz.
- **Spherical isotropy (3D deviation from isotropy)**: in a field of low gradients realized using a flat phantom exposed by a patch antenna.
- **Sensor Offset**: The sensor offset corresponds to the offset of virtual measurement center from the probe tip (on probe axis). No tolerance required.
- **Connector Angle**: The angle is assessed using the information gained by determining the NORM_x (no uncertainty required).

Probe ES3DV3

SN:3287

Manufactured: June 7, 2010
Calibrated: September 18, 2017

Calibrated for DASY/EASY Systems
(Note: non-compatible with DASY2 system!)

DASY/EASY - Parameters of Probe: ES3DV3 - SN:3287

Basic Calibration Parameters

	Sensor X	Sensor Y	Sensor Z	Unc (k=2)
Norm ($\mu\text{V}/(\text{V}/\text{m})^2$) ^A	0.87	0.98	1.00	$\pm 10.1\%$
DCP (mV) ^B	107.7	103.1	105.0	

Modulation Calibration Parameters

UID	Communication System Name		A dB	B dB $\sqrt{\mu\text{V}}$	C	D dB	VR mV	Unc ^E (k=2)
0	CW	X	0.0	0.0	1.0	0.00	191.5	$\pm 3.3\%$
		Y	0.0	0.0	1.0		198.9	
		Z	0.0	0.0	1.0		180.8	

Note: For details on UID parameters see Appendix.

Sensor Model Parameters

	C1 fF	C2 fF	α V^{-1}	T1 $\text{ms}\cdot\text{V}^{-2}$	T2 $\text{ms}\cdot\text{V}^{-1}$	T3 ms	T4 V^{-2}	T5 V^{-1}	T6
X	54.28	378.7	33.99	28.46	2.430	5.072	1.313	0.408	1.009
Y	59.16	422.2	35.13	29.85	3.583	5.094	0.041	0.732	1.008
Z	43.70	307.8	34.40	28.00	2.236	5.100	1.282	0.347	1.010

The reported uncertainty of measurement is stated as the standard uncertainty of measurement multiplied by the coverage factor $k=2$, which for a normal distribution corresponds to a coverage probability of approximately 95%.

^A The uncertainties of Norm X,Y,Z do not affect the E^2 -field uncertainty inside TSL (see Pages 5 and 6).

^B Numerical linearization parameter: uncertainty not required.

^E Uncertainty is determined using the max. deviation from linear response applying rectangular distribution and is expressed for the square of the field value.

DASY/EASY - Parameters of Probe: ES3DV3 - SN:3287

Calibration Parameter Determined in Head Tissue Simulating Media

f (MHz) ^C	Relative Permittivity ^F	Conductivity (S/m) ^F	ConvF X	ConvF Y	ConvF Z	Alpha ^G	Depth ^G (mm)	Unc (k=2)
750	41.9	0.89	7.00	7.00	7.00	0.26	1.80	± 12.0 %
835	41.5	0.90	6.70	6.70	6.70	0.56	1.23	± 12.0 %
1750	40.1	1.37	5.57	5.57	5.57	0.53	1.28	± 12.0 %
1900	40.0	1.40	5.34	5.34	5.34	0.41	1.52	± 12.0 %
2300	39.5	1.67	4.94	4.94	4.94	0.42	1.57	± 12.0 %
2450	39.2	1.80	4.64	4.64	4.64	0.55	1.39	± 12.0 %
2600	39.0	1.96	4.44	4.44	4.44	0.58	1.43	± 12.0 %

^C Frequency validity above 300 MHz of ± 100 MHz only applies for DASY v4.4 and higher (see Page 2), else it is restricted to ± 50 MHz. The uncertainty is the RSS of the ConvF uncertainty at calibration frequency and the uncertainty for the indicated frequency band. Frequency validity below 300 MHz is ± 10, 25, 40, 50 and 70 MHz for ConvF assessments at 30, 64, 128, 150 and 220 MHz respectively. Above 5 GHz frequency validity can be extended to ± 110 MHz.

^F At frequencies below 3 GHz, the validity of tissue parameters (ϵ and σ) can be relaxed to ± 10% if liquid compensation formula is applied to measured SAR values. At frequencies above 3 GHz, the validity of tissue parameters (ϵ and σ) is restricted to ± 5%. The uncertainty is the RSS of the ConvF uncertainty for indicated target tissue parameters.

^G Alpha/Depth are determined during calibration. SPEAG warrants that the remaining deviation due to the boundary effect after compensation is always less than ± 1% for frequencies below 3 GHz and below ± 2% for frequencies between 3-6 GHz at any distance larger than half the probe tip diameter from the boundary.

DASY/EASY - Parameters of Probe: ES3DV3 - SN:3287

Calibration Parameter Determined in Body Tissue Simulating Media

f (MHz) ^C	Relative Permittivity ^F	Conductivity (S/m) ^F	ConvF X	ConvF Y	ConvF Z	Alpha ^G	Depth ^G (mm)	Unc (k=2)
750	55.5	0.96	6.71	6.71	6.71	0.45	1.38	± 12.0 %
835	55.2	0.97	6.56	6.56	6.56	0.80	1.05	± 12.0 %
1750	53.4	1.49	5.19	5.19	5.19	0.37	1.73	± 12.0 %
1900	53.3	1.52	5.00	5.00	5.00	0.47	1.51	± 12.0 %
2300	52.9	1.81	4.66	4.66	4.66	0.59	1.36	± 12.0 %
2450	52.7	1.95	4.47	4.47	4.47	0.55	1.20	± 12.0 %
2600	52.5	2.16	4.28	4.28	4.28	0.50	1.20	± 12.0 %

^C Frequency validity above 300 MHz of ± 100 MHz only applies for DASY v4.4 and higher (see Page 2), else it is restricted to ± 50 MHz. The uncertainty is the RSS of the ConvF uncertainty at calibration frequency and the uncertainty for the indicated frequency band. Frequency validity below 300 MHz is ± 10, 25, 40, 50 and 70 MHz for ConvF assessments at 30, 64, 128, 150 and 220 MHz respectively. Above 5 GHz frequency validity can be extended to ± 110 MHz.

^F At frequencies below 3 GHz, the validity of tissue parameters (ϵ and σ) can be relaxed to ± 10% if liquid compensation formula is applied to measured SAR values. At frequencies above 3 GHz, the validity of tissue parameters (ϵ and σ) is restricted to ± 5%. The uncertainty is the RSS of the ConvF uncertainty for indicated target tissue parameters.

^G Alpha/Depth are determined during calibration. SPEAG warrants that the remaining deviation due to the boundary effect after compensation is always less than ± 1% for frequencies below 3 GHz and below ± 2% for frequencies between 3-6 GHz at any distance larger than half the probe tip diameter from the boundary.

Frequency Response of E-Field

(TEM-Cell:ifi110 EXX, Waveguide: R22)

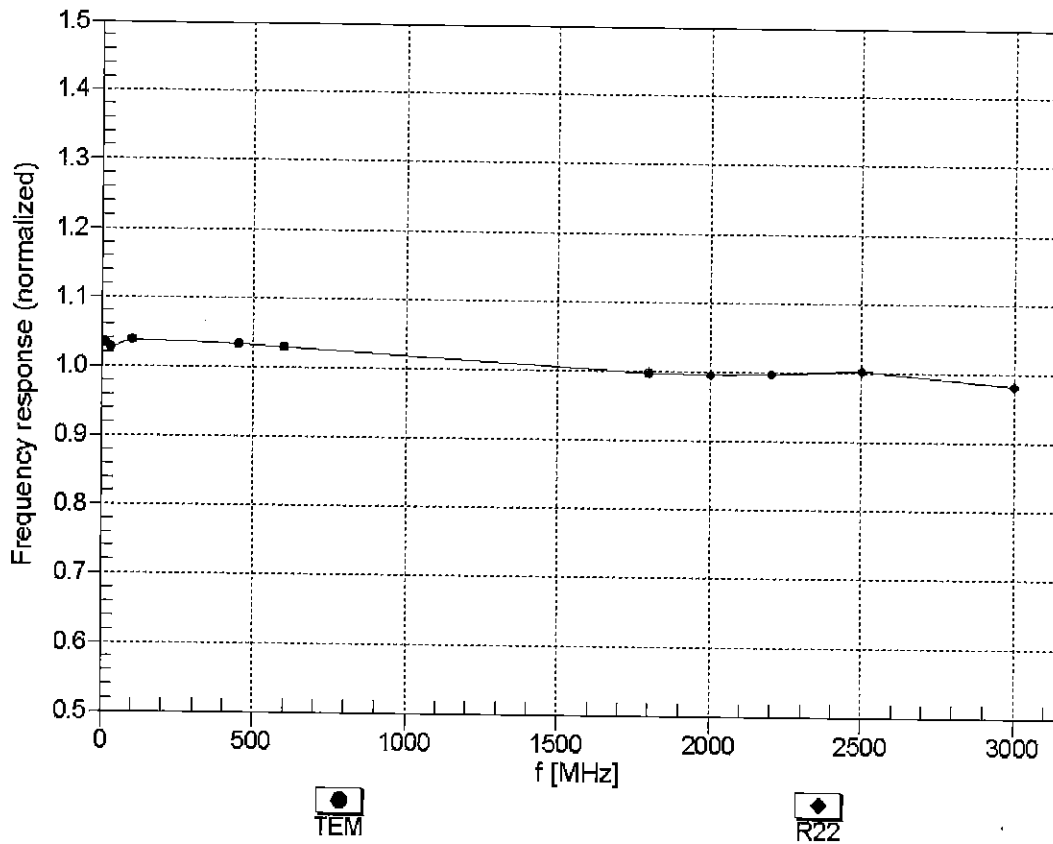

Uncertainty of Frequency Response of E-field: $\pm 6.3\%$ (k=2)

Receiving Pattern (ϕ), $\theta = 0^\circ$

f=600 MHz, TEM

f=1800 MHz, R22

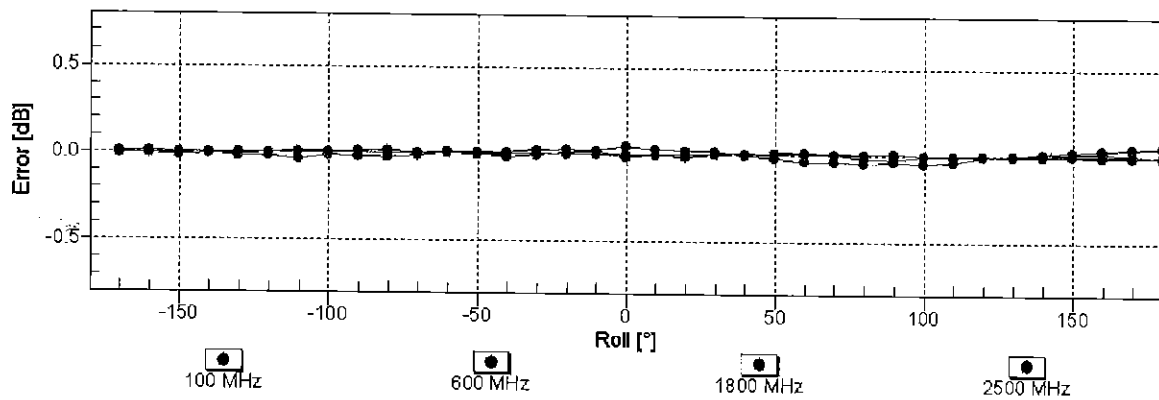
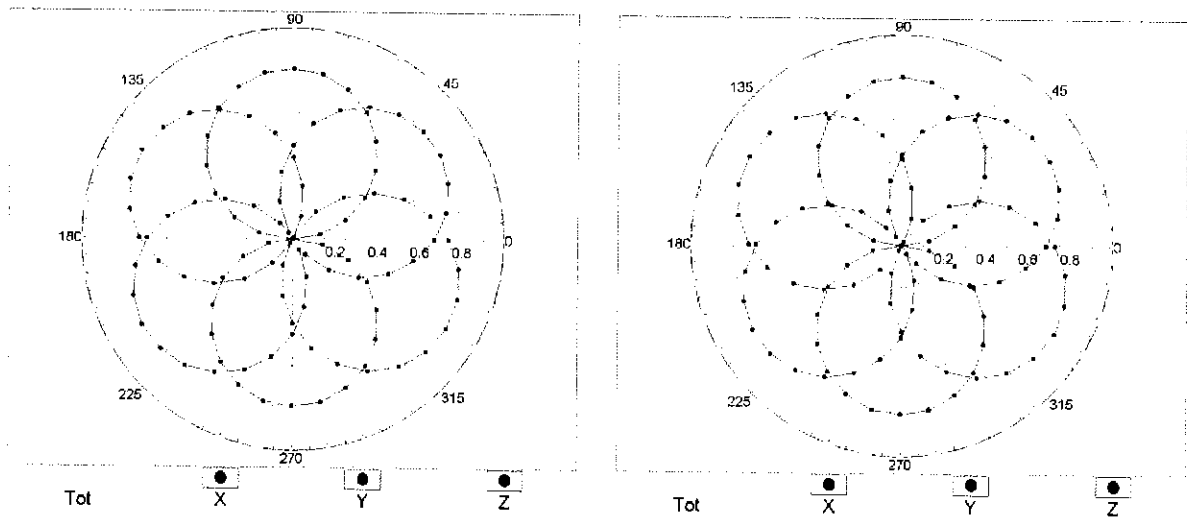

Uncertainty of Axial Isotropy Assessment: $\pm 0.5\%$ (k=2)

Dynamic Range $f(SAR_{head})$ (TEM cell , $f_{eval}= 1900$ MHz)

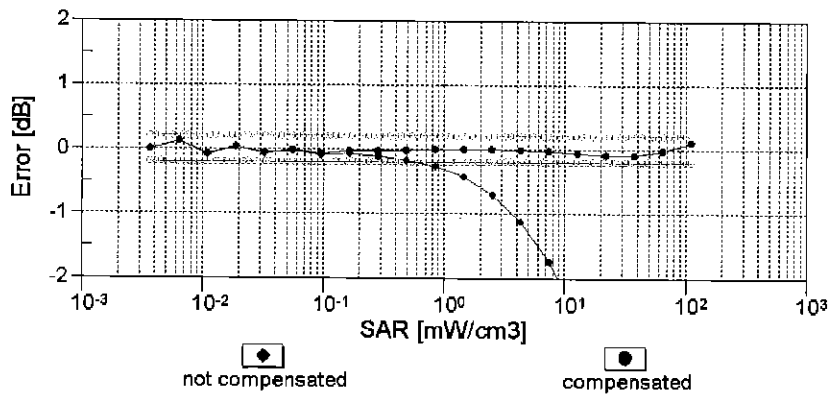
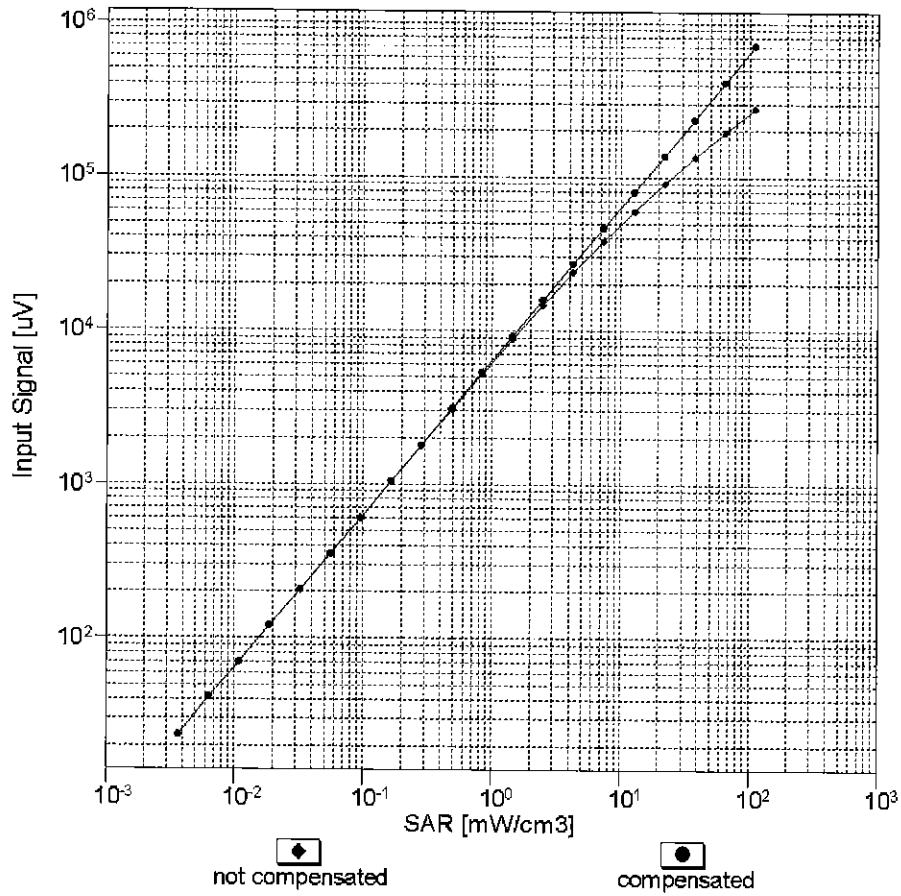

Uncertainty of Linearity Assessment: $\pm 0.6\%$ (k=2)

Conversion Factor Assessment

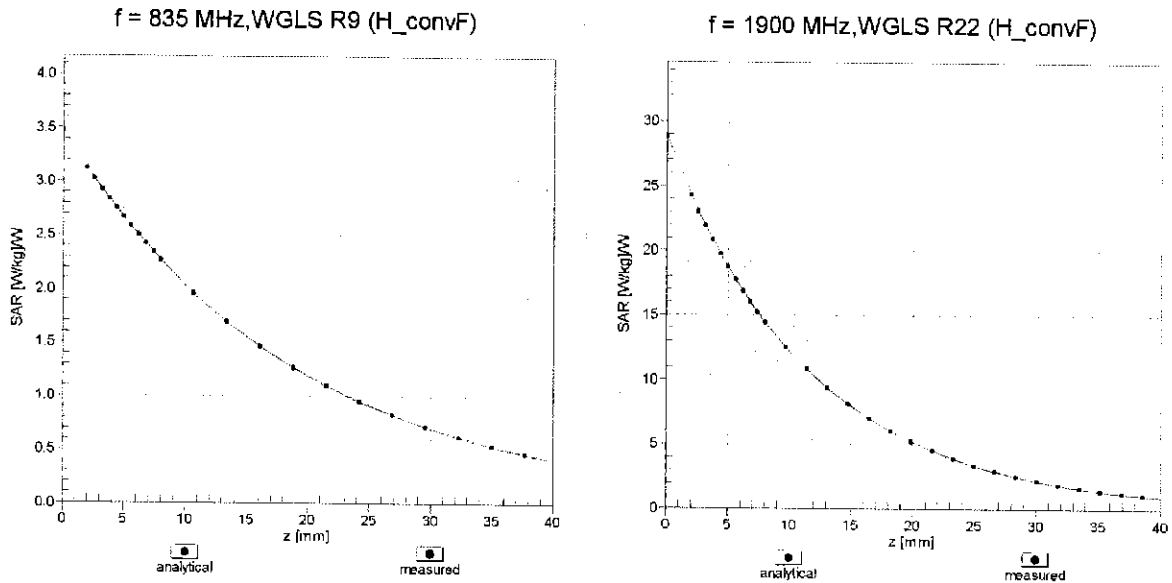

Deviation from Isotropy in Liquid Error (ϕ, ϑ), f = 900 MHz

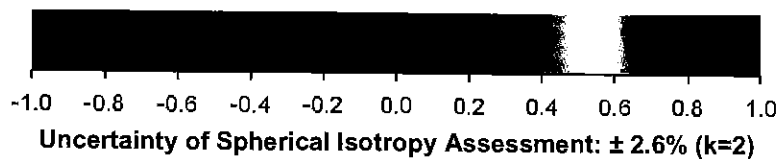
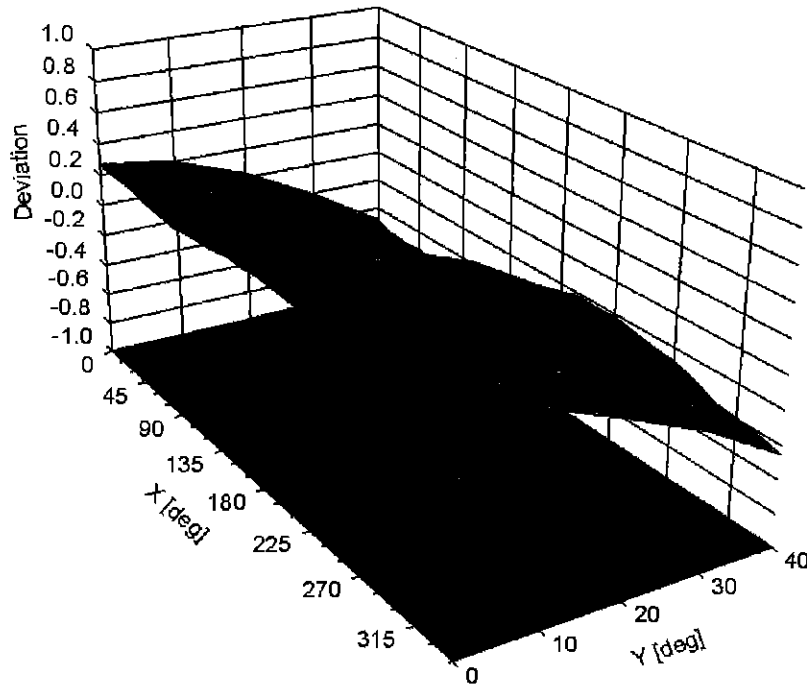

DASY/EASY - Parameters of Probe: ES3DV3 - SN:3287

Other Probe Parameters

Sensor Arrangement	Triangular
Connector Angle (°)	89.6
Mechanical Surface Detection Mode	enabled
Optical Surface Detection Mode	disabled
Probe Overall Length	337 mm
Probe Body Diameter	10 mm
Tip Length	10 mm
Tip Diameter	4 mm
Probe Tip to Sensor X Calibration Point	2 mm
Probe Tip to Sensor Y Calibration Point	2 mm
Probe Tip to Sensor Z Calibration Point	2 mm
Recommended Measurement Distance from Surface	3 mm

Appendix: Modulation Calibration Parameters

UID	Communication System Name		A dB	B dB $\sqrt{\mu V}$	C	D dB	VR mV	Max Unc ^E (k=2)
0	CW	X	0.00	0.00	1.00	0.00	191.5	$\pm 3.3\%$
		Y	0.00	0.00	1.00		198.9	
		Z	0.00	0.00	1.00		180.8	
10010- CAA	SAR Validation (Square, 100ms, 10ms)	X	10.31	82.54	19.92	10.00	25.0	$\pm 9.6\%$
		Y	9.70	81.57	20.65		25.0	
		Z	13.02	86.61	21.44		25.0	
10011- CAB	UMTS-FDD (WCDMA)	X	1.65	76.64	20.39	0.00	150.0	$\pm 9.6\%$
		Y	1.11	68.31	15.89		150.0	
		Z	1.20	70.53	17.08		150.0	
10012- CAB	IEEE 802.11b WiFi 2.4 GHz (DSSS, 1 Mbps)	X	1.42	67.62	17.77	0.41	150.0	$\pm 9.6\%$
		Y	1.35	65.44	16.09		150.0	
		Z	1.35	66.18	16.60		150.0	
10013- CAB	IEEE 802.11g WiFi 2.4 GHz (DSSS-OFDM, 6 Mbps)	X	5.13	67.63	17.69	1.46	150.0	$\pm 9.6\%$
		Y	5.21	67.37	17.49		150.0	
		Z	5.05	67.67	17.63		150.0	
10021- DAC	GSM-FDD (TDMA, GMSK)	X	36.11	104.66	28.70	9.39	50.0	$\pm 9.6\%$
		Y	17.06	92.75	26.26		50.0	
		Z	74.47	117.68	32.39		50.0	
10023- DAC	GPRS-FDD (TDMA, GMSK, TN 0)	X	29.01	100.99	27.69	9.57	50.0	$\pm 9.6\%$
		Y	15.70	91.12	25.76		50.0	
		Z	50.86	111.27	30.76		50.0	
10024- DAC	GPRS-FDD (TDMA, GMSK, TN 0-1)	X	100.00	118.25	30.37	6.56	60.0	$\pm 9.6\%$
		Y	79.14	117.46	31.45		60.0	
		Z	100.00	119.51	30.92		60.0	
10025- DAC	EDGE-FDD (TDMA, 8PSK, TN 0)	X	18.01	104.77	39.73	12.57	50.0	$\pm 9.6\%$
		Y	13.85	93.70	35.01		50.0	
		Z	19.28	108.70	41.83		50.0	
10026- DAC	EDGE-FDD (TDMA, 8PSK, TN 0-1)	X	22.37	106.73	36.71	9.56	60.0	$\pm 9.6\%$
		Y	15.21	95.13	32.50		60.0	
		Z	23.85	109.99	38.29		60.0	
10027- DAC	GPRS-FDD (TDMA, GMSK, TN 0-1-2)	X	100.00	117.60	29.16	4.80	80.0	$\pm 9.6\%$
		Y	100.00	119.86	30.73		80.0	
		Z	100.00	118.96	29.76		80.0	
10028- DAC	GPRS-FDD (TDMA, GMSK, TN 0-1-2-3)	X	100.00	118.56	28.79	3.55	100.0	$\pm 9.6\%$
		Y	100.00	119.98	29.90		100.0	
		Z	100.00	119.90	29.38		100.0	
10029- DAC	EDGE-FDD (TDMA, 8PSK, TN 0-1-2)	X	14.79	97.42	32.53	7.80	80.0	$\pm 9.6\%$
		Y	11.52	89.75	29.55		80.0	
		Z	14.18	97.61	32.99		80.0	
10030- CAA	IEEE 802.15.1 Bluetooth (GFSK, DH1)	X	100.00	116.89	29.16	5.30	70.0	$\pm 9.6\%$
		Y	100.00	119.53	30.94		70.0	
		Z	100.00	118.05	29.66		70.0	
10031- CAA	IEEE 802.15.1 Bluetooth (GFSK, DH3)	X	100.00	122.60	28.99	1.88	100.0	$\pm 9.6\%$
		Y	100.00	121.51	28.91		100.0	
		Z	100.00	122.48	28.93		100.0	

10032-CAA	IEEE 802.15.1 Bluetooth (GFSK, DH5)	X	100.00	133.16	32.27	1.17	100.0	± 9.6 %
		Y	100.00	126.43	29.83		100.0	
		Z	100.00	130.02	30.96		100.0	
10033-CAA	IEEE 802.15.1 Bluetooth (PI/4-DQPSK, DH1)	X	32.57	106.74	29.49	5.30	70.0	± 9.6 %
		Y	13.39	91.56	25.42		70.0	
		Z	28.98	104.37	28.55		70.0	
10034-CAA	IEEE 802.15.1 Bluetooth (PI/4-DQPSK, DH3)	X	45.93	114.88	30.10	1.88	100.0	± 9.6 %
		Y	7.50	87.12	22.45		100.0	
		Z	20.04	100.44	25.46		100.0	
10035-CAA	IEEE 802.15.1 Bluetooth (PI/4-DQPSK, DH5)	X	21.96	105.92	27.68	1.17	100.0	± 9.6 %
		Y	4.51	81.47	20.26		100.0	
		Z	9.42	91.44	22.56		100.0	
10036-CAA	IEEE 802.15.1 Bluetooth (8-DPSK, DH1)	X	45.23	112.33	31.05	5.30	70.0	± 9.6 %
		Y	15.39	94.09	26.30		70.0	
		Z	38.95	109.34	29.96		70.0	
10037-CAA	IEEE 802.15.1 Bluetooth (8-DPSK, DH3)	X	39.94	112.82	29.55	1.88	100.0	± 9.6 %
		Y	7.15	86.45	22.19		100.0	
		Z	17.08	98.28	24.84		100.0	
10038-CAA	IEEE 802.15.1 Bluetooth (8-DPSK, DH5)	X	24.74	108.13	28.38	1.17	100.0	± 9.6 %
		Y	4.66	82.21	20.61		100.0	
		Z	9.87	92.45	22.99		100.0	
10039-CAB	CDMA2000 (1xRTT, RC1)	X	7.01	92.94	24.21	0.00	150.0	± 9.6 %
		Y	2.15	73.76	17.15		150.0	
		Z	2.61	77.73	17.80		150.0	
10042-CAB	IS-54 / IS-136 FDD (TDMA/FDM, PI/4-DQPSK, Halfrate)	X	100.00	117.06	30.06	7.78	50.0	± 9.6 %
		Y	33.54	102.85	27.66		50.0	
		Z	100.00	118.08	30.50		50.0	
10044-CAA	IS-91/EIA/TIA-553 FDD (FDMA, FM)	X	0.00	127.60	2.39	0.00	150.0	± 9.6 %
		Y	0.00	96.78	0.00		150.0	
		Z	0.01	122.93	2.94		150.0	
10048-CAA	DECT (TDD, TDMA/FDM, GFSK, Full Slot, 24)	X	13.06	86.13	24.73	13.80	25.0	± 9.6 %
		Y	11.09	82.14	24.36		25.0	
		Z	16.17	90.99	26.57		25.0	
10049-CAA	DECT (TDD, TDMA/FDM, GFSK, Double Slot, 12)	X	16.50	91.24	25.09	10.79	40.0	± 9.6 %
		Y	12.58	86.37	24.53		40.0	
		Z	22.30	97.25	27.17		40.0	
10056-CAA	UMTS-TDD (TD-SCDMA, 1.28 Mcps)	X	15.28	90.62	25.52	9.03	50.0	± 9.6 %
		Y	11.72	85.08	24.19		50.0	
		Z	17.40	93.38	26.42		50.0	
10058-DAC	EDGE-FDD (TDMA, 8PSK, TN 0-1-2-3)	X	10.69	91.04	29.62	6.55	100.0	± 9.6 %
		Y	9.07	85.67	27.37		100.0	
		Z	9.88	90.10	29.57		100.0	
10059-CAB	IEEE 802.11b WiFi 2.4 GHz (DSSS, 2 Mbps)	X	1.68	70.66	19.16	0.61	110.0	± 9.6 %
		Y	1.55	67.69	17.16		110.0	
		Z	1.56	68.66	17.81		110.0	
10060-CAB	IEEE 802.11b WiFi 2.4 GHz (DSSS, 5.5 Mbps)	X	100.00	135.64	35.63	1.30	110.0	± 9.6 %
		Y	100.00	131.50	34.05		110.0	
		Z	100.00	134.30	35.03		110.0	

10061-CAB	IEEE 802.11b WiFi 2.4 GHz (DSSS, 11 Mbps)	X	54.02	125.97	35.38	2.04	110.0	± 9.6 %
		Y	8.96	93.29	26.14		110.0	
		Z	19.56	108.50	30.84		110.0	
10062-CAB	IEEE 802.11a/h WiFi 5 GHz (OFDM, 6 Mbps)	X	4.87	67.49	17.06	0.49	100.0	± 9.6 %
		Y	4.91	67.10	16.78		100.0	
		Z	4.75	67.38	16.89		100.0	
10063-CAB	IEEE 802.11a/h WiFi 5 GHz (OFDM, 9 Mbps)	X	4.91	67.64	17.19	0.72	100.0	± 9.6 %
		Y	4.96	67.27	16.93		100.0	
		Z	4.80	67.55	17.03		100.0	
10064-CAB	IEEE 802.11a/h WiFi 5 GHz (OFDM, 12 Mbps)	X	5.22	67.92	17.42	0.86	100.0	± 9.6 %
		Y	5.29	67.61	17.19		100.0	
		Z	5.08	67.80	17.26		100.0	
10065-CAB	IEEE 802.11a/h WiFi 5 GHz (OFDM, 18 Mbps)	X	5.13	67.94	17.58	1.21	100.0	± 9.6 %
		Y	5.21	67.67	17.37		100.0	
		Z	5.00	67.84	17.45		100.0	
10066-CAB	IEEE 802.11a/h WiFi 5 GHz (OFDM, 24 Mbps)	X	5.18	68.06	17.79	1.46	100.0	± 9.6 %
		Y	5.27	67.81	17.60		100.0	
		Z	5.05	67.98	17.68		100.0	
10067-CAB	IEEE 802.11a/h WiFi 5 GHz (OFDM, 36 Mbps)	X	5.49	68.19	18.21	2.04	100.0	± 9.6 %
		Y	5.60	67.98	18.05		100.0	
		Z	5.39	68.30	18.20		100.0	
10068-CAB	IEEE 802.11a/h WiFi 5 GHz (OFDM, 48 Mbps)	X	5.62	68.50	18.55	2.55	100.0	± 9.6 %
		Y	5.76	68.37	18.43		100.0	
		Z	5.50	68.48	18.50		100.0	
10069-CAB	IEEE 802.11a/h WiFi 5 GHz (OFDM, 54 Mbps)	X	5.69	68.44	18.72	2.67	100.0	± 9.6 %
		Y	5.84	68.31	18.60		100.0	
		Z	5.58	68.54	18.73		100.0	
10071-CAB	IEEE 802.11g WiFi 2.4 GHz (DSSS/OFDM, 9 Mbps)	X	5.27	67.84	18.05	1.99	100.0	± 9.6 %
		Y	5.37	67.63	17.89		100.0	
		Z	5.20	67.92	18.02		100.0	
10072-CAB	IEEE 802.11g WiFi 2.4 GHz (DSSS/OFDM, 12 Mbps)	X	5.34	68.42	18.38	2.30	100.0	± 9.6 %
		Y	5.45	68.23	18.22		100.0	
		Z	5.25	68.45	18.35		100.0	
10073-CAB	IEEE 802.11g WiFi 2.4 GHz (DSSS/OFDM, 18 Mbps)	X	5.47	68.76	18.79	2.83	100.0	± 9.6 %
		Y	5.61	68.62	18.66		100.0	
		Z	5.40	68.87	18.81		100.0	
10074-CAB	IEEE 802.11g WiFi 2.4 GHz (DSSS/OFDM, 24 Mbps)	X	5.51	68.83	19.02	3.30	100.0	± 9.6 %
		Y	5.66	68.73	18.92		100.0	
		Z	5.46	68.99	19.07		100.0	
10075-CAB	IEEE 802.11g WiFi 2.4 GHz (DSSS/OFDM, 36 Mbps)	X	5.65	69.27	19.49	3.82	90.0	± 9.6 %
		Y	5.85	69.26	19.43		90.0	
		Z	5.60	69.37	19.53		90.0	
10076-CAB	IEEE 802.11g WiFi 2.4 GHz (DSSS/OFDM, 48 Mbps)	X	5.67	69.08	19.61	4.15	90.0	± 9.6 %
		Y	5.87	69.08	19.56		90.0	
		Z	5.65	69.30	19.73		90.0	
10077-CAB	IEEE 802.11g WiFi 2.4 GHz (DSSS/OFDM, 54 Mbps)	X	5.72	69.19	19.72	4.30	90.0	± 9.6 %
		Y	5.92	69.19	19.67		90.0	
		Z	5.70	69.44	19.85		90.0	

10081-CAB	CDMA2000 (1xRTT, RC3)	X	2.28	81.48	20.27	0.00	150.0	± 9.6 %
		Y	1.00	67.64	14.10		150.0	
		Z	1.04	69.66	14.21		150.0	
10082-CAB	IS-54 / IS-136 FDD (TDMA/FDM, PI/4-DQPSK, Fullrate)	X	2.13	64.08	8.83	4.77	80.0	± 9.6 %
		Y	2.57	65.34	10.16		80.0	
		Z	2.13	64.35	9.02		80.0	
10090-DAC	GPRS-FDD (TDMA, GMSK, TN 0-4)	X	100.00	118.32	30.42	6.56	60.0	± 9.6 %
		Y	75.01	116.70	31.30		60.0	
		Z	100.00	119.58	30.97		60.0	
10097-CAB	UMTS-FDD (HSDPA)	X	2.20	71.50	18.09	0.00	150.0	± 9.6 %
		Y	1.90	67.97	16.04		150.0	
		Z	1.97	69.50	16.62		150.0	
10098-CAB	UMTS-FDD (HSUPA, Subtest 2)	X	2.16	71.55	18.11	0.00	150.0	± 9.6 %
		Y	1.86	67.93	16.01		150.0	
		Z	1.93	69.49	16.61		150.0	
10099-DAC	EDGE-FDD (TDMA, 8PSK, TN 0-4)	X	22.24	106.54	36.64	9.56	60.0	± 9.6 %
		Y	15.16	95.02	32.46		60.0	
		Z	23.72	109.80	38.22		60.0	
10100-CAD	LTE-FDD (SC-FDMA, 100% RB, 20 MHz, QPSK)	X	3.77	73.97	18.60	0.00	150.0	± 9.6 %
		Y	3.32	71.02	16.99		150.0	
		Z	3.27	71.57	17.41		150.0	
10101-CAD	LTE-FDD (SC-FDMA, 100% RB, 20 MHz, 16-QAM)	X	3.50	69.24	17.00	0.00	150.0	± 9.6 %
		Y	3.39	67.99	16.16		150.0	
		Z	3.29	68.22	16.35		150.0	
10102-CAD	LTE-FDD (SC-FDMA, 100% RB, 20 MHz, 64-QAM)	X	3.59	69.07	17.02	0.00	150.0	± 9.6 %
		Y	3.49	67.92	16.24		150.0	
		Z	3.39	68.14	16.41		150.0	
10103-CAD	LTE-TDD (SC-FDMA, 100% RB, 20 MHz, QPSK)	X	9.27	79.88	21.95	3.98	65.0	± 9.6 %
		Y	8.43	77.27	20.93		65.0	
		Z	9.22	80.33	22.26		65.0	
10104-CAD	LTE-TDD (SC-FDMA, 100% RB, 20 MHz, 16-QAM)	X	8.81	77.80	21.97	3.98	65.0	± 9.6 %
		Y	8.62	76.41	21.37		65.0	
		Z	8.59	77.82	22.06		65.0	
10105-CAD	LTE-TDD (SC-FDMA, 100% RB, 20 MHz, 64-QAM)	X	8.19	76.36	21.65	3.98	65.0	± 9.6 %
		Y	7.71	74.18	20.67		65.0	
		Z	7.86	76.00	21.56		65.0	
10108-CAE	LTE-FDD (SC-FDMA, 100% RB, 10 MHz, QPSK)	X	3.29	73.14	18.47	0.00	150.0	± 9.6 %
		Y	2.93	70.22	16.82		150.0	
		Z	2.85	70.87	17.28		150.0	
10109-CAE	LTE-FDD (SC-FDMA, 100% RB, 10 MHz, 16-QAM)	X	3.18	69.27	17.05	0.00	150.0	± 9.6 %
		Y	3.05	67.82	16.11		150.0	
		Z	2.94	68.18	16.29		150.0	
10110-CAE	LTE-FDD (SC-FDMA, 100% RB, 5 MHz, QPSK)	X	2.72	72.52	18.35	0.00	150.0	± 9.6 %
		Y	2.40	69.28	16.49		150.0	
		Z	2.33	70.22	16.99		150.0	
10111-CAE	LTE-FDD (SC-FDMA, 100% RB, 5 MHz, 16-QAM)	X	2.96	70.65	17.72	0.00	150.0	± 9.6 %
		Y	2.76	68.51	16.45		150.0	
		Z	2.69	69.33	16.67		150.0	

10112-CAE	LTE-FDD (SC-FDMA, 100% RB, 10 MHz, 64-QAM)	X	3.29	69.10	17.02	0.00	150.0	± 9.6 %
		Y	3.17	67.76	16.14		150.0	
		Z	3.06	68.15	16.32		150.0	
10113-CAE	LTE-FDD (SC-FDMA, 100% RB, 5 MHz, 64-QAM)	X	3.11	70.58	17.73	0.00	150.0	± 9.6 %
		Y	2.92	68.59	16.56		150.0	
		Z	2.83	69.41	16.76		150.0	
10114-CAB	IEEE 802.11n (HT Greenfield, 13.5 Mbps, BPSK)	X	5.26	67.86	16.86	0.00	150.0	± 9.6 %
		Y	5.25	67.40	16.53		150.0	
		Z	5.14	67.65	16.68		150.0	
10115-CAB	IEEE 802.11n (HT Greenfield, 81 Mbps, 16-QAM)	X	5.60	68.11	16.98	0.00	150.0	± 9.6 %
		Y	5.62	67.73	16.70		150.0	
		Z	5.40	67.70	16.71		150.0	
10116-CAB	IEEE 802.11n (HT Greenfield, 135 Mbps, 64-QAM)	X	5.38	68.12	16.91	0.00	150.0	± 9.6 %
		Y	5.38	67.68	16.59		150.0	
		Z	5.23	67.82	16.70		150.0	
10117-CAB	IEEE 802.11n (HT Mixed, 13.5 Mbps, BPSK)	X	5.24	67.79	16.84	0.00	150.0	± 9.6 %
		Y	5.25	67.40	16.55		150.0	
		Z	5.10	67.49	16.62		150.0	
10118-CAB	IEEE 802.11n (HT Mixed, 81 Mbps, 16-QAM)	X	5.68	68.30	17.08	0.00	150.0	± 9.6 %
		Y	5.70	67.92	16.80		150.0	
		Z	5.48	67.91	16.83		150.0	
10119-CAB	IEEE 802.11n (HT Mixed, 135 Mbps, 64-QAM)	X	5.35	68.04	16.89	0.00	150.0	± 9.6 %
		Y	5.35	67.63	16.58		150.0	
		Z	5.21	67.79	16.69		150.0	
10140-CAD	LTE-FDD (SC-FDMA, 100% RB, 15 MHz, 16-QAM)	X	3.63	69.06	16.93	0.00	150.0	± 9.6 %
		Y	3.53	67.92	16.17		150.0	
		Z	3.42	68.16	16.33		150.0	
10141-CAD	LTE-FDD (SC-FDMA, 100% RB, 15 MHz, 64-QAM)	X	3.75	69.06	17.04	0.00	150.0	± 9.6 %
		Y	3.65	67.98	16.31		150.0	
		Z	3.54	68.23	16.48		150.0	
10142-CAD	LTE-FDD (SC-FDMA, 100% RB, 3 MHz, QPSK)	X	2.58	73.34	18.51	0.00	150.0	± 9.6 %
		Y	2.18	69.29	16.31		150.0	
		Z	2.13	70.56	16.73		150.0	
10143-CAD	LTE-FDD (SC-FDMA, 100% RB, 3 MHz, 16-QAM)	X	3.01	72.46	18.03	0.00	150.0	± 9.6 %
		Y	2.65	69.32	16.38		150.0	
		Z	2.60	70.44	16.44		150.0	
10144-CAD	LTE-FDD (SC-FDMA, 100% RB, 3 MHz, 64-QAM)	X	2.64	69.45	16.13	0.00	150.0	± 9.6 %
		Y	2.44	67.23	14.90		150.0	
		Z	2.30	67.73	14.62		150.0	
10145-CAE	LTE-FDD (SC-FDMA, 100% RB, 1.4 MHz, QPSK)	X	2.19	73.84	16.83	0.00	150.0	± 9.6 %
		Y	1.54	67.56	13.92		150.0	
		Z	1.24	66.10	11.96		150.0	
10146-CAE	LTE-FDD (SC-FDMA, 100% RB, 1.4 MHz, 16-QAM)	X	6.00	80.94	18.56	0.00	150.0	± 9.6 %
		Y	2.97	71.15	15.11		150.0	
		Z	2.39	68.87	12.55		150.0	
10147-CAE	LTE-FDD (SC-FDMA, 100% RB, 1.4 MHz, 64-QAM)	X	13.14	91.59	22.17	0.00	150.0	± 9.6 %
		Y	3.76	74.52	16.70		150.0	
		Z	3.21	72.37	14.16		150.0	

10149-CAD	LTE-FDD (SC-FDMA, 50% RB, 20 MHz, 16-QAM)	X	3.19	69.34	17.10	0.00	150.0	± 9.6 %
		Y	3.06	67.89	16.15		150.0	
		Z	2.95	68.25	16.34		150.0	
10150-CAD	LTE-FDD (SC-FDMA, 50% RB, 20 MHz, 64-QAM)	X	3.29	69.16	17.06	0.00	150.0	± 9.6 %
		Y	3.18	67.81	16.18		150.0	
		Z	3.07	68.20	16.36		150.0	
10151-CAD	LTE-TDD (SC-FDMA, 50% RB, 20 MHz, QPSK)	X	10.08	82.65	23.10	3.98	65.0	± 9.6 %
		Y	9.04	79.65	21.96		65.0	
		Z	10.06	83.26	23.42		65.0	
10152-CAD	LTE-TDD (SC-FDMA, 50% RB, 20 MHz, 16-QAM)	X	8.50	78.17	21.88	3.98	65.0	± 9.6 %
		Y	8.23	76.54	21.20		65.0	
		Z	8.27	78.18	21.88		65.0	
10153-CAD	LTE-TDD (SC-FDMA, 50% RB, 20 MHz, 64-QAM)	X	8.91	78.99	22.55	3.98	65.0	± 9.6 %
		Y	8.60	77.29	21.85		65.0	
		Z	8.71	79.10	22.58		65.0	
10154-CAE	LTE-FDD (SC-FDMA, 50% RB, 10 MHz, QPSK)	X	2.81	73.15	18.70	0.00	150.0	± 9.6 %
		Y	2.46	69.77	16.80		150.0	
		Z	2.38	70.62	17.23		150.0	
10155-CAE	LTE-FDD (SC-FDMA, 50% RB, 10 MHz, 16-QAM)	X	2.96	70.66	17.73	0.00	150.0	± 9.6 %
		Y	2.76	68.51	16.46		150.0	
		Z	2.69	69.35	16.69		150.0	
10156-CAE	LTE-FDD (SC-FDMA, 50% RB, 5 MHz, QPSK)	X	2.55	74.52	18.86	0.00	150.0	± 9.6 %
		Y	2.05	69.58	16.30		150.0	
		Z	2.00	70.89	16.58		150.0	
10157-CAE	LTE-FDD (SC-FDMA, 50% RB, 5 MHz, 16-QAM)	X	2.62	71.06	16.72	0.00	150.0	± 9.6 %
		Y	2.30	67.95	15.09		150.0	
		Z	2.17	68.55	14.74		150.0	
10158-CAE	LTE-FDD (SC-FDMA, 50% RB, 10 MHz, 64-QAM)	X	3.11	70.65	17.78	0.00	150.0	± 9.6 %
		Y	2.92	68.65	16.60		150.0	
		Z	2.84	69.48	16.81		150.0	
10159-CAE	LTE-FDD (SC-FDMA, 50% RB, 5 MHz, 64-QAM)	X	2.77	71.67	17.06	0.00	150.0	± 9.6 %
		Y	2.42	68.44	15.40		150.0	
		Z	2.27	68.98	14.99		150.0	
10160-CAD	LTE-FDD (SC-FDMA, 50% RB, 15 MHz, QPSK)	X	3.14	71.31	17.89	0.00	150.0	± 9.6 %
		Y	2.90	69.12	16.57		150.0	
		Z	2.85	69.90	17.00		150.0	
10161-CAD	LTE-FDD (SC-FDMA, 50% RB, 15 MHz, 16-QAM)	X	3.19	69.15	17.05	0.00	150.0	± 9.6 %
		Y	3.08	67.73	16.13		150.0	
		Z	2.97	68.19	16.30		150.0	
10162-CAD	LTE-FDD (SC-FDMA, 50% RB, 15 MHz, 64-QAM)	X	3.30	69.19	17.10	0.00	150.0	± 9.6 %
		Y	3.18	67.80	16.21		150.0	
		Z	3.08	68.34	16.41		150.0	
10166-CAE	LTE-FDD (SC-FDMA, 50% RB, 1.4 MHz, QPSK)	X	4.14	72.27	20.63	3.01	150.0	± 9.6 %
		Y	3.92	70.06	19.35		150.0	
		Z	3.85	71.64	20.32		150.0	
10167-CAE	LTE-FDD (SC-FDMA, 50% RB, 1.4 MHz, 16-QAM)	X	5.70	76.91	21.68	3.01	150.0	± 9.6 %
		Y	4.94	72.92	19.80		150.0	
		Z	5.14	76.11	21.32		150.0	

10168-CAE	LTE-FDD (SC-FDMA, 50% RB, 1.4 MHz, 64-QAM)	X	6.50	79.76	23.17	3.01	150.0	± 9.6 %
		Y	5.42	74.94	21.01		150.0	
		Z	5.85	78.93	22.82		150.0	
10169-CAD	LTE-FDD (SC-FDMA, 1 RB, 20 MHz, QPSK)	X	3.88	74.16	21.49	3.01	150.0	± 9.6 %
		Y	3.53	70.80	19.64		150.0	
		Z	3.37	71.79	20.43		150.0	
10170-CAD	LTE-FDD (SC-FDMA, 1 RB, 20 MHz, 16-QAM)	X	7.14	85.17	25.38	3.01	150.0	± 9.6 %
		Y	5.02	76.66	21.81		150.0	
		Z	5.41	80.65	23.72		150.0	
10171-AAD	LTE-FDD (SC-FDMA, 1 RB, 20 MHz, 64-QAM)	X	5.21	78.32	21.78	3.01	150.0	± 9.6 %
		Y	4.13	72.50	19.15		150.0	
		Z	4.25	75.40	20.64		150.0	
10172-CAD	LTE-TDD (SC-FDMA, 1 RB, 20 MHz, QPSK)	X	82.16	130.26	39.09	6.02	65.0	± 9.6 %
		Y	17.62	97.94	29.93		65.0	
		Z	65.78	128.99	39.45		65.0	
10173-CAD	LTE-TDD (SC-FDMA, 1 RB, 20 MHz, 16-QAM)	X	91.21	124.95	35.70	6.02	65.0	± 9.6 %
		Y	19.75	96.35	28.03		65.0	
		Z	100.00	129.35	37.29		65.0	
10174-CAD	LTE-TDD (SC-FDMA, 1 RB, 20 MHz, 64-QAM)	X	55.61	114.43	32.46	6.02	65.0	± 9.6 %
		Y	16.76	92.45	26.36		65.0	
		Z	70.56	121.14	34.65		65.0	
10175-CAE	LTE-FDD (SC-FDMA, 1 RB, 10 MHz, QPSK)	X	3.81	73.71	21.19	3.01	150.0	± 9.6 %
		Y	3.48	70.45	19.37		150.0	
		Z	3.32	71.46	20.19		150.0	
10176-CAE	LTE-FDD (SC-FDMA, 1 RB, 10 MHz, 16-QAM)	X	7.15	85.21	25.39	3.01	150.0	± 9.6 %
		Y	5.03	76.68	21.82		150.0	
		Z	5.42	80.68	23.74		150.0	
10177-CAG	LTE-FDD (SC-FDMA, 1 RB, 5 MHz, QPSK)	X	3.85	73.93	21.31	3.01	150.0	± 9.6 %
		Y	3.51	70.63	19.48		150.0	
		Z	3.35	71.61	20.27		150.0	
10178-CAE	LTE-FDD (SC-FDMA, 1 RB, 5 MHz, 16-QAM)	X	7.01	84.77	25.21	3.01	150.0	± 9.6 %
		Y	4.96	76.40	21.67		150.0	
		Z	5.36	80.45	23.62		150.0	
10179-CAE	LTE-FDD (SC-FDMA, 1 RB, 10 MHz, 64-QAM)	X	6.07	81.52	23.41	3.01	150.0	± 9.6 %
		Y	4.53	74.41	20.33		150.0	
		Z	4.79	77.92	22.06		150.0	
10180-CAE	LTE-FDD (SC-FDMA, 1 RB, 5 MHz, 64-QAM)	X	5.18	78.18	21.70	3.01	150.0	± 9.6 %
		Y	4.12	72.40	19.09		150.0	
		Z	4.24	75.33	20.60		150.0	
10181-CAD	LTE-FDD (SC-FDMA, 1 RB, 15 MHz, QPSK)	X	3.84	73.91	21.30	3.01	150.0	± 9.6 %
		Y	3.51	70.61	19.47		150.0	
		Z	3.35	71.60	20.27		150.0	
10182-CAD	LTE-FDD (SC-FDMA, 1 RB, 15 MHz, 16-QAM)	X	6.99	84.74	25.19	3.01	150.0	± 9.6 %
		Y	4.95	76.38	21.66		150.0	
		Z	5.35	80.42	23.61		150.0	
10183-AAC	LTE-FDD (SC-FDMA, 1 RB, 15 MHz, 64-QAM)	X	5.17	78.15	21.69	3.01	150.0	± 9.6 %
		Y	4.11	72.38	19.08		150.0	
		Z	4.23	75.30	20.59		150.0	

10184-CAD	LTE-FDD (SC-FDMA, 1 RB, 3 MHz, QPSK)	X	3.86	73.96	21.33	3.01	150.0	± 9.6 %
		Y	3.52	70.65	19.50		150.0	
		Z	3.36	71.64	20.29		150.0	
10185-CAD	LTE-FDD (SC-FDMA, 1 RB, 3 MHz, 16-QAM)	X	7.04	84.85	25.24	3.01	150.0	± 9.6 %
		Y	4.98	76.45	21.70		150.0	
		Z	5.38	80.50	23.65		150.0	
10186-AAD	LTE-FDD (SC-FDMA, 1 RB, 3 MHz, 64-QAM)	X	5.20	78.24	21.73	3.01	150.0	± 9.6 %
		Y	4.13	72.45	19.11		150.0	
		Z	4.25	75.38	20.62		150.0	
10187-CAE	LTE-FDD (SC-FDMA, 1 RB, 1.4 MHz, QPSK)	X	3.87	74.02	21.39	3.01	150.0	± 9.6 %
		Y	3.53	70.69	19.55		150.0	
		Z	3.37	71.71	20.36		150.0	
10188-CAE	LTE-FDD (SC-FDMA, 1 RB, 1.4 MHz, 16-QAM)	X	7.44	86.01	25.76	3.01	150.0	± 9.6 %
		Y	5.15	77.16	22.09		150.0	
		Z	5.58	81.30	24.05		150.0	
10189-AAE	LTE-FDD (SC-FDMA, 1 RB, 1.4 MHz, 64-QAM)	X	5.39	78.94	22.10	3.01	150.0	± 9.6 %
		Y	4.22	72.89	19.39		150.0	
		Z	4.36	75.91	20.93		150.0	
10193-CAB	IEEE 802.11n (HT Greenfield, 6.5 Mbps, BPSK)	X	4.67	67.32	16.65	0.00	150.0	± 9.6 %
		Y	4.67	66.82	16.30		150.0	
		Z	4.53	67.11	16.38		150.0	
10194-CAB	IEEE 802.11n (HT Greenfield, 39 Mbps, 16-QAM)	X	4.85	67.66	16.76	0.00	150.0	± 9.6 %
		Y	4.86	67.18	16.41		150.0	
		Z	4.69	67.40	16.51		150.0	
10195-CAB	IEEE 802.11n (HT Greenfield, 65 Mbps, 64-QAM)	X	4.89	67.68	16.77	0.00	150.0	± 9.6 %
		Y	4.90	67.20	16.42		150.0	
		Z	4.73	67.43	16.52		150.0	
10196-CAB	IEEE 802.11n (HT Mixed, 6.5 Mbps, BPSK)	X	4.68	67.41	16.68	0.00	150.0	± 9.6 %
		Y	4.68	66.91	16.33		150.0	
		Z	4.52	67.15	16.39		150.0	
10197-CAB	IEEE 802.11n (HT Mixed, 39 Mbps, 16-QAM)	X	4.87	67.69	16.78	0.00	150.0	± 9.6 %
		Y	4.88	67.20	16.42		150.0	
		Z	4.70	67.42	16.52		150.0	
10198-CAB	IEEE 802.11n (HT Mixed, 65 Mbps, 64-QAM)	X	4.90	67.70	16.79	0.00	150.0	± 9.6 %
		Y	4.91	67.21	16.43		150.0	
		Z	4.73	67.45	16.54		150.0	
10219-CAB	IEEE 802.11n (HT Mixed, 7.2 Mbps, BPSK)	X	4.63	67.43	16.65	0.00	150.0	± 9.6 %
		Y	4.63	66.93	16.29		150.0	
		Z	4.47	67.18	16.36		150.0	
10220-CAB	IEEE 802.11n (HT Mixed, 43.3 Mbps, 16-QAM)	X	4.86	67.66	16.77	0.00	150.0	± 9.6 %
		Y	4.88	67.19	16.42		150.0	
		Z	4.69	67.38	16.50		150.0	
10221-CAB	IEEE 802.11n (HT Mixed, 72.2 Mbps, 64-QAM)	X	4.90	67.62	16.76	0.00	150.0	± 9.6 %
		Y	4.91	67.14	16.42		150.0	
		Z	4.74	67.37	16.52		150.0	
10222-CAB	IEEE 802.11n (HT Mixed, 15 Mbps, BPSK)	X	5.22	67.81	16.85	0.00	150.0	± 9.6 %
		Y	5.23	67.42	16.55		150.0	
		Z	5.08	67.50	16.62		150.0	

10223-CAB	IEEE 802.11n (HT Mixed, 90 Mbps, 16-QAM)	X	5.53	67.97	16.94	0.00	150.0	± 9.6 %
		Y	5.59	67.74	16.73		150.0	
		Z	5.38	67.75	16.76		150.0	
10224-CAB	IEEE 802.11n (HT Mixed, 150 Mbps, 64-QAM)	X	5.26	67.91	16.83	0.00	150.0	± 9.6 %
		Y	5.27	67.51	16.52		150.0	
		Z	5.12	67.61	16.60		150.0	
10225-CAB	UMTS-FDD (HSPA+)	X	3.00	67.51	16.39	0.00	150.0	± 9.6 %
		Y	2.93	66.39	15.65		150.0	
		Z	2.82	66.88	15.63		150.0	
10226-CAA	LTE-TDD (SC-FDMA, 1 RB, 1.4 MHz, 16-QAM)	X	100.00	126.81	36.25	6.02	65.0	± 9.6 %
		Y	20.60	97.21	28.37		65.0	
		Z	100.00	129.54	37.41		65.0	
10227-CAA	LTE-TDD (SC-FDMA, 1 RB, 1.4 MHz, 64-QAM)	X	65.64	117.49	33.34	6.02	65.0	± 9.6 %
		Y	18.22	94.00	26.93		65.0	
		Z	85.61	124.65	35.59		65.0	
10228-CAA	LTE-TDD (SC-FDMA, 1 RB, 1.4 MHz, QPSK)	X	79.85	130.36	39.26	6.02	65.0	± 9.6 %
		Y	20.21	101.07	31.01		65.0	
		Z	65.84	129.47	39.67		65.0	
10229-CAB	LTE-TDD (SC-FDMA, 1 RB, 3 MHz, 16-QAM)	X	91.11	124.93	35.70	6.02	65.0	± 9.6 %
		Y	19.80	96.38	28.04		65.0	
		Z	100.00	129.35	37.29		65.0	
10230-CAB	LTE-TDD (SC-FDMA, 1 RB, 3 MHz, 64-QAM)	X	60.15	115.83	32.84	6.02	65.0	± 9.6 %
		Y	17.60	93.31	26.65		65.0	
		Z	77.12	122.67	35.03		65.0	
10231-CAB	LTE-TDD (SC-FDMA, 1 RB, 3 MHz, QPSK)	X	72.28	128.22	38.64	6.02	65.0	± 9.6 %
		Y	19.39	100.17	30.67		65.0	
		Z	59.87	127.39	39.07		65.0	
10232-CAD	LTE-TDD (SC-FDMA, 1 RB, 5 MHz, 16-QAM)	X	91.25	124.96	35.71	6.02	65.0	± 9.6 %
		Y	19.78	96.37	28.04		65.0	
		Z	100.00	129.36	37.30		65.0	
10233-CAD	LTE-TDD (SC-FDMA, 1 RB, 5 MHz, 64-QAM)	X	60.26	115.87	32.85	6.02	65.0	± 9.6 %
		Y	17.59	93.32	26.66		65.0	
		Z	77.19	122.70	35.04		65.0	
10234-CAD	LTE-TDD (SC-FDMA, 1 RB, 5 MHz, QPSK)	X	65.41	125.97	37.96	6.02	65.0	± 9.6 %
		Y	18.62	99.23	30.29		65.0	
		Z	54.84	125.34	38.42		65.0	
10235-CAD	LTE-TDD (SC-FDMA, 1 RB, 10 MHz, 16-QAM)	X	91.93	125.11	35.75	6.02	65.0	± 9.6 %
		Y	19.81	96.41	28.05		65.0	
		Z	100.00	129.37	37.30		65.0	
10236-CAD	LTE-TDD (SC-FDMA, 1 RB, 10 MHz, 64-QAM)	X	61.00	116.05	32.90	6.02	65.0	± 9.6 %
		Y	17.69	93.40	26.68		65.0	
		Z	78.43	122.94	35.10		65.0	
10237-CAD	LTE-TDD (SC-FDMA, 1 RB, 10 MHz, QPSK)	X	73.61	128.60	38.74	6.02	65.0	± 9.6 %
		Y	19.49	100.29	30.70		65.0	
		Z	60.90	127.76	39.16		65.0	
10238-CAD	LTE-TDD (SC-FDMA, 1 RB, 15 MHz, 16-QAM)	X	91.47	125.02	35.72	6.02	65.0	± 9.6 %
		Y	19.78	96.38	28.04		65.0	
		Z	100.00	129.37	37.30		65.0	

10239-CAD	LTE-TDD (SC-FDMA, 1 RB, 15 MHz, 64-QAM)	X	60.36	115.92	32.87	6.02	65.0	± 9.6 %
		Y	17.58	93.32	26.66		65.0	
		Z	77.24	122.72	35.05		65.0	
10240-CAD	LTE-TDD (SC-FDMA, 1 RB, 15 MHz, QPSK)	X	73.31	128.53	38.72	6.02	65.0	± 9.6 %
		Y	19.44	100.25	30.69		65.0	
		Z	60.69	127.70	39.15		65.0	
10241-CAA	LTE-TDD (SC-FDMA, 50% RB, 1.4 MHz, 16-QAM)	X	14.22	90.30	28.70	6.98	65.0	± 9.6 %
		Y	11.91	84.78	26.56		65.0	
		Z	15.04	92.96	29.82		65.0	
10242-CAA	LTE-TDD (SC-FDMA, 50% RB, 1.4 MHz, 64-QAM)	X	12.20	86.96	27.37	6.98	65.0	± 9.6 %
		Y	11.04	83.09	25.82		65.0	
		Z	14.66	92.40	29.55		65.0	
10243-CAA	LTE-TDD (SC-FDMA, 50% RB, 1.4 MHz, QPSK)	X	9.46	83.32	26.91	6.98	65.0	± 9.6 %
		Y	9.15	80.79	25.71		65.0	
		Z	10.96	87.97	28.96		65.0	
10244-CAB	LTE-TDD (SC-FDMA, 50% RB, 3 MHz, 16-QAM)	X	10.76	82.68	21.60	3.98	65.0	± 9.6 %
		Y	9.17	79.37	20.74		65.0	
		Z	9.65	80.90	20.36		65.0	
10245-CAB	LTE-TDD (SC-FDMA, 50% RB, 3 MHz, 64-QAM)	X	10.44	81.95	21.29	3.98	65.0	± 9.6 %
		Y	9.07	78.96	20.54		65.0	
		Z	9.24	79.99	19.97		65.0	
10246-CAB	LTE-TDD (SC-FDMA, 50% RB, 3 MHz, QPSK)	X	11.35	86.57	23.09	3.98	65.0	± 9.6 %
		Y	8.94	81.85	21.69		65.0	
		Z	10.01	84.49	21.88		65.0	
10247-CAD	LTE-TDD (SC-FDMA, 50% RB, 5 MHz, 16-QAM)	X	8.24	79.27	21.01	3.98	65.0	± 9.6 %
		Y	7.74	77.28	20.43		65.0	
		Z	7.64	78.13	20.10		65.0	
10248-CAD	LTE-TDD (SC-FDMA, 50% RB, 5 MHz, 64-QAM)	X	8.11	78.56	20.72	3.98	65.0	± 9.6 %
		Y	7.73	76.82	20.23		65.0	
		Z	7.48	77.39	19.79		65.0	
10249-CAD	LTE-TDD (SC-FDMA, 50% RB, 5 MHz, QPSK)	X	12.62	88.79	24.56	3.98	65.0	± 9.6 %
		Y	9.64	83.20	22.76		65.0	
		Z	12.16	88.40	24.15		65.0	
10250-CAD	LTE-TDD (SC-FDMA, 50% RB, 10 MHz, 16-QAM)	X	9.13	81.24	23.10	3.98	65.0	± 9.6 %
		Y	8.50	78.84	22.20		65.0	
		Z	8.86	81.11	22.89		65.0	
10251-CAD	LTE-TDD (SC-FDMA, 50% RB, 10 MHz, 64-QAM)	X	8.47	78.74	21.83	3.98	65.0	± 9.6 %
		Y	8.10	76.89	21.13		65.0	
		Z	8.20	78.63	21.61		65.0	
10252-CAD	LTE-TDD (SC-FDMA, 50% RB, 10 MHz, QPSK)	X	11.59	86.92	24.65	3.98	65.0	± 9.6 %
		Y	9.53	82.29	23.01		65.0	
		Z	11.63	87.60	24.87		65.0	
10253-CAD	LTE-TDD (SC-FDMA, 50% RB, 15 MHz, 16-QAM)	X	8.27	77.55	21.65	3.98	65.0	± 9.6 %
		Y	8.04	76.02	21.02		65.0	
		Z	8.09	77.65	21.62		65.0	
10254-CAD	LTE-TDD (SC-FDMA, 50% RB, 15 MHz, 64-QAM)	X	8.67	78.35	22.26	3.98	65.0	± 9.6 %
		Y	8.41	76.75	21.61		65.0	
		Z	8.50	78.49	22.25		65.0	

10255-CAD	LTE-TDD (SC-FDMA, 50% RB, 15 MHz, QPSK)	X	9.69	82.20	23.16	3.98	65.0	± 9.6 %
		Y	8.77	79.29	22.03		65.0	
		Z	9.70	82.84	23.45		65.0	
10256-CAA	LTE-TDD (SC-FDMA, 100% RB, 1.4 MHz, 16-QAM)	X	9.10	79.45	19.54	3.98	65.0	± 9.6 %
		Y	8.28	77.46	19.27		65.0	
		Z	7.50	76.38	17.64		65.0	
10257-CAA	LTE-TDD (SC-FDMA, 100% RB, 1.4 MHz, 64-QAM)	X	8.71	78.44	19.07	3.98	65.0	± 9.6 %
		Y	8.14	76.86	18.96		65.0	
		Z	7.10	75.27	17.09		65.0	
10258-CAA	LTE-TDD (SC-FDMA, 100% RB, 1.4 MHz, QPSK)	X	9.16	82.49	20.98	3.98	65.0	± 9.6 %
		Y	7.92	79.54	20.28		65.0	
		Z	7.29	78.75	18.94		65.0	
10259-CAB	LTE-TDD (SC-FDMA, 100% RB, 3 MHz, 16-QAM)	X	8.59	79.95	21.73	3.98	65.0	± 9.6 %
		Y	8.03	77.80	21.03		65.0	
		Z	8.13	79.27	21.11		65.0	
10260-CAB	LTE-TDD (SC-FDMA, 100% RB, 3 MHz, 64-QAM)	X	8.53	79.55	21.59	3.98	65.0	± 9.6 %
		Y	8.06	77.57	20.96		65.0	
		Z	8.06	78.82	20.93		65.0	
10261-CAB	LTE-TDD (SC-FDMA, 100% RB, 3 MHz, QPSK)	X	11.51	87.11	24.32	3.98	65.0	± 9.6 %
		Y	9.26	82.24	22.68		65.0	
		Z	11.28	87.12	24.13		65.0	
10262-CAD	LTE-TDD (SC-FDMA, 100% RB, 5 MHz, 16-QAM)	X	9.12	81.19	23.06	3.98	65.0	± 9.6 %
		Y	8.49	78.79	22.16		65.0	
		Z	8.84	81.05	22.85		65.0	
10263-CAD	LTE-TDD (SC-FDMA, 100% RB, 5 MHz, 64-QAM)	X	8.46	78.73	21.82	3.98	65.0	± 9.6 %
		Y	8.09	76.88	21.13		65.0	
		Z	8.19	78.61	21.60		65.0	
10264-CAD	LTE-TDD (SC-FDMA, 100% RB, 5 MHz, QPSK)	X	11.49	86.74	24.57	3.98	65.0	± 9.6 %
		Y	9.47	82.16	22.94		65.0	
		Z	11.51	87.39	24.78		65.0	
10265-CAD	LTE-TDD (SC-FDMA, 100% RB, 10 MHz, 16-QAM)	X	8.50	78.18	21.88	3.98	65.0	± 9.6 %
		Y	8.22	76.54	21.21		65.0	
		Z	8.27	78.18	21.88		65.0	
10266-CAD	LTE-TDD (SC-FDMA, 100% RB, 10 MHz, 64-QAM)	X	8.90	78.98	22.54	3.98	65.0	± 9.6 %
		Y	8.60	77.28	21.84		65.0	
		Z	8.71	79.09	22.57		65.0	
10267-CAD	LTE-TDD (SC-FDMA, 100% RB, 10 MHz, QPSK)	X	10.06	82.61	23.09	3.98	65.0	± 9.6 %
		Y	9.03	79.62	21.95		65.0	
		Z	10.04	83.22	23.41		65.0	
10268-CAD	LTE-TDD (SC-FDMA, 100% RB, 15 MHz, 16-QAM)	X	8.87	77.45	21.95	3.98	65.0	± 9.6 %
		Y	8.72	76.18	21.40		65.0	
		Z	8.67	77.54	22.05		65.0	
10269-CAD	LTE-TDD (SC-FDMA, 100% RB, 15 MHz, 64-QAM)	X	8.77	76.99	21.83	3.98	65.0	± 9.6 %
		Y	8.66	75.80	21.31		65.0	
		Z	8.60	77.10	21.92		65.0	
10270-CAD	LTE-TDD (SC-FDMA, 100% RB, 15 MHz, QPSK)	X	9.16	79.20	21.93	3.98	65.0	± 9.6 %
		Y	8.71	77.35	21.19		65.0	
		Z	9.06	79.57	22.19		65.0	

10274-CAB	UMTS-FDD (HSUPA, Subtest 5, 3GPP Rel8.10)	X	2.80	68.17	16.47	0.00	150.0	± 9.6 %
		Y	2.67	66.63	15.50		150.0	
		Z	2.65	67.51	15.70		150.0	
10275-CAB	UMTS-FDD (HSUPA, Subtest 5, 3GPP Rel8.4)	X	2.12	73.27	18.65	0.00	150.0	± 9.6 %
		Y	1.72	68.53	16.00		150.0	
		Z	1.76	70.05	16.72		150.0	
10277-CAA	PHS (QPSK)	X	5.32	68.96	13.42	9.03	50.0	± 9.6 %
		Y	6.41	71.20	15.49		50.0	
		Z	5.12	68.74	13.08		50.0	
10278-CAA	PHS (QPSK, BW 884MHz, Rolloff 0.5)	X	9.11	79.62	20.31	9.03	50.0	± 9.6 %
		Y	9.22	79.31	21.03		50.0	
		Z	8.20	77.78	19.21		50.0	
10279-CAA	PHS (QPSK, BW 884MHz, Rolloff 0.38)	X	9.25	79.80	20.39	9.03	50.0	± 9.6 %
		Y	9.36	79.46	21.09		50.0	
		Z	8.30	77.91	19.28		50.0	
10290-AAB	CDMA2000, RC1, SO55, Full Rate	X	3.59	82.57	20.48	0.00	150.0	± 9.6 %
		Y	1.73	70.44	15.45		150.0	
		Z	1.75	72.09	15.26		150.0	
10291-AAB	CDMA2000, RC3, SO55, Full Rate	X	2.13	80.55	19.92	0.00	150.0	± 9.6 %
		Y	0.98	67.37	13.95		150.0	
		Z	1.01	69.27	14.02		150.0	
10292-AAB	CDMA2000, RC3, SO32, Full Rate	X	12.02	108.71	29.17	0.00	150.0	± 9.6 %
		Y	1.26	72.03	16.54		150.0	
		Z	1.93	79.12	18.49		150.0	
10293-AAB	CDMA2000, RC3, SO3, Full Rate	X	100.00	144.61	38.38	0.00	150.0	± 9.6 %
		Y	1.90	78.46	19.68		150.0	
		Z	6.64	97.19	24.86		150.0	
10295-AAB	CDMA2000, RC1, SO3, 1/8th Rate 25 fr.	X	11.58	85.59	24.60	9.03	50.0	± 9.6 %
		Y	10.44	82.50	23.85		50.0	
		Z	13.98	88.93	25.45		50.0	
10297-AAC	LTE-FDD (SC-FDMA, 50% RB, 20 MHz, QPSK)	X	3.31	73.28	18.55	0.00	150.0	± 9.6 %
		Y	2.94	70.32	16.89		150.0	
		Z	2.86	70.97	17.35		150.0	
10298-AAC	LTE-FDD (SC-FDMA, 50% RB, 3 MHz, QPSK)	X	2.53	75.50	18.42	0.00	150.0	± 9.6 %
		Y	1.83	69.14	15.39		150.0	
		Z	1.69	69.62	14.84		150.0	
10299-AAC	LTE-FDD (SC-FDMA, 50% RB, 3 MHz, 16-QAM)	X	6.61	82.78	20.21	0.00	150.0	± 9.6 %
		Y	3.43	72.67	16.51		150.0	
		Z	3.82	74.80	16.21		150.0	
10300-AAC	LTE-FDD (SC-FDMA, 50% RB, 3 MHz, 64-QAM)	X	3.24	71.51	15.06	0.00	150.0	± 9.6 %
		Y	2.57	67.68	13.54		150.0	
		Z	2.21	66.93	12.03		150.0	
10301-AAA	IEEE 802.16e WiMAX (29:18, 5ms, 10MHz, QPSK, PUSC)	X	5.62	68.28	18.87	4.17	80.0	± 9.6 %
		Y	5.93	68.63	18.94		80.0	
		Z	5.89	69.91	19.47		80.0	
10302-AAA	IEEE 802.16e WiMAX (29:18, 5ms, 10MHz, QPSK, PUSC, 3 CTRL symbols)	X	6.17	69.25	19.82	4.96	80.0	± 9.6 %
		Y	6.38	69.08	19.58		80.0	
		Z	6.23	69.95	19.93		80.0	

10303-AAA	IEEE 802.16e WiMAX (31:15, 5ms, 10MHz, 64QAM, PUSC)	X	6.02	69.32	19.87	4.96	80.0	± 9.6 %
		Y	6.26	69.22	19.66		80.0	
		Z	6.09	70.04	19.96		80.0	
10304-AAA	IEEE 802.16e WiMAX (29:18, 5ms, 10MHz, 64QAM, PUSC)	X	5.67	68.65	19.09	4.17	80.0	± 9.6 %
		Y	5.85	68.42	18.82		80.0	
		Z	5.71	69.28	19.12		80.0	
10305-AAA	IEEE 802.16e WiMAX (31:15, 10ms, 10MHz, 64QAM, PUSC, 15 symbols)	X	9.13	83.00	26.75	6.02	50.0	± 9.6 %
		Y	11.08	85.83	27.58		50.0	
		Z	11.97	88.64	28.23		50.0	
10306-AAA	IEEE 802.16e WiMAX (29:18, 10ms, 10MHz, 64QAM, PUSC, 18 symbols)	X	6.47	72.26	21.90	6.02	50.0	± 9.6 %
		Y	6.84	72.27	21.68		50.0	
		Z	6.81	73.77	22.17		50.0	
10307-AAA	IEEE 802.16e WiMAX (29:18, 10ms, 10MHz, QPSK, PUSC, 18 symbols)	X	6.58	73.04	22.08	6.02	50.0	± 9.6 %
		Y	8.34	78.37	24.64		50.0	
		Z	6.92	74.46	22.29		50.0	
10308-AAA	IEEE 802.16e WiMAX (29:18, 10ms, 10MHz, 16QAM, PUSC)	X	6.66	73.56	22.34	6.02	50.0	± 9.6 %
		Y	8.60	79.30	25.04		50.0	
		Z	7.08	75.16	22.62		50.0	
10309-AAA	IEEE 802.16e WiMAX (29:18, 10ms, 10MHz, 16QAM, AMC 2x3, 18 symbols)	X	6.58	72.60	22.09	6.02	50.0	± 9.6 %
		Y	6.95	72.58	21.85		50.0	
		Z	6.90	74.05	22.35		50.0	
10310-AAA	IEEE 802.16e WiMAX (29:18, 10ms, 10MHz, QPSK, AMC 2x3, 18 symbols)	X	6.50	72.56	21.95	6.02	50.0	± 9.6 %
		Y	6.87	72.52	21.70		50.0	
		Z	6.86	74.10	22.23		50.0	
10311-AAC	LTE-FDD (SC-FDMA, 100% RB, 15 MHz, QPSK)	X	3.70	72.28	18.01	0.00	150.0	± 9.6 %
		Y	3.30	69.61	16.53		150.0	
		Z	3.23	70.11	16.90		150.0	
10313-AAA	iDEN 1:3	X	9.18	81.61	19.86	6.99	70.0	± 9.6 %
		Y	7.64	78.40	19.13		70.0	
		Z	9.78	83.14	20.58		70.0	
10314-AAA	iDEN 1:6	X	13.83	90.60	25.32	10.00	30.0	± 9.6 %
		Y	9.35	83.01	23.15		30.0	
		Z	14.01	91.81	25.99		30.0	
10315-AAB	IEEE 802.11b WiFi 2.4 GHz (DSSS, 1 Mbps, 96pc duty cycle)	X	1.27	67.24	17.67	0.17	150.0	± 9.6 %
		Y	1.20	64.93	15.83		150.0	
		Z	1.21	65.68	16.36		150.0	
10316-AAB	IEEE 802.11g WiFi 2.4 GHz (ERP-OFDM, 6 Mbps, 96pc duty cycle)	X	4.76	67.47	16.83	0.17	150.0	± 9.6 %
		Y	4.78	67.03	16.51		150.0	
		Z	4.63	67.31	16.62		150.0	
10317-AAB	IEEE 802.11a WiFi 5 GHz (OFDM, 6 Mbps, 96pc duty cycle)	X	4.76	67.47	16.83	0.17	150.0	± 9.6 %
		Y	4.78	67.03	16.51		150.0	
		Z	4.63	67.31	16.62		150.0	
10400-AAC	IEEE 802.11ac WiFi (20MHz, 64-QAM, 99pc duty cycle)	X	4.86	67.74	16.77	0.00	150.0	± 9.6 %
		Y	4.87	67.24	16.40		150.0	
		Z	4.68	67.47	16.52		150.0	
10401-AAC	IEEE 802.11ac WiFi (40MHz, 64-QAM, 99pc duty cycle)	X	5.51	67.76	16.81	0.00	150.0	± 9.6 %
		Y	5.52	67.36	16.52		150.0	
		Z	5.41	67.67	16.70		150.0	

10402-AAC	IEEE 802.11ac WiFi (80MHz, 64-QAM, 99pc duty cycle)	X	5.79	68.18	16.86	0.00	150.0	± 9.6 %
		Y	5.81	67.85	16.61		150.0	
		Z	5.64	67.83	16.63		150.0	
10403-AAB	CDMA2000 (1xEV-DO, Rev. 0)	X	3.59	82.57	20.48	0.00	115.0	± 9.6 %
		Y	1.73	70.44	15.45		115.0	
		Z	1.75	72.09	15.26		115.0	
10404-AAB	CDMA2000 (1xEV-DO, Rev. A)	X	3.59	82.57	20.48	0.00	115.0	± 9.6 %
		Y	1.73	70.44	15.45		115.0	
		Z	1.75	72.09	15.26		115.0	
10406-AAB	CDMA2000, RC3, SO32, SCH0, Full Rate	X	100.00	122.57	31.18	0.00	100.0	± 9.6 %
		Y	18.35	99.60	26.20		100.0	
		Z	100.00	120.33	29.78		100.0	
10410-AAC	LTE-TDD (SC-FDMA, 1 RB, 10 MHz, QPSK, UL Subframe=2,3,4,7,8,9)	X	100.00	120.29	30.51	3.23	80.0	± 9.6 %
		Y	100.00	120.68	31.13		80.0	
		Z	100.00	122.62	31.38		80.0	
10415-AAA	IEEE 802.11b WiFi 2.4 GHz (DSSS, 1 Mbps, 99pc duty cycle)	X	1.09	65.33	16.67	0.00	150.0	± 9.6 %
		Y	1.03	63.31	14.91		150.0	
		Z	1.05	64.05	15.43		150.0	
10416-AAA	IEEE 802.11g WiFi 2.4 GHz (ERP-OFDM, 6 Mbps, 99pc duty cycle)	X	4.67	67.36	16.71	0.00	150.0	± 9.6 %
		Y	4.67	66.86	16.34		150.0	
		Z	4.53	67.14	16.45		150.0	
10417-AAA	IEEE 802.11a/h WiFi 5 GHz (OFDM, 6 Mbps, 99pc duty cycle)	X	4.67	67.36	16.71	0.00	150.0	± 9.6 %
		Y	4.67	66.86	16.34		150.0	
		Z	4.53	67.14	16.45		150.0	
10418-AAA	IEEE 802.11g WiFi 2.4 GHz (DSSS-OFDM, 6 Mbps, 99pc duty cycle, Long preamble)	X	4.66	67.53	16.73	0.00	150.0	± 9.6 %
		Y	4.66	67.00	16.35		150.0	
		Z	4.52	67.33	16.49		150.0	
10419-AAA	IEEE 802.11g WiFi 2.4 GHz (DSSS-OFDM, 6 Mbps, 99pc duty cycle, Short preamble)	X	4.68	67.47	16.73	0.00	150.0	± 9.6 %
		Y	4.68	66.95	16.36		150.0	
		Z	4.54	67.26	16.48		150.0	
10422-AAA	IEEE 802.11n (HT Greenfield, 7.2 Mbps, BPSK)	X	4.80	67.45	16.73	0.00	150.0	± 9.6 %
		Y	4.81	66.96	16.37		150.0	
		Z	4.65	67.24	16.49		150.0	
10423-AAA	IEEE 802.11n (HT Greenfield, 43.3 Mbps, 16-QAM)	X	4.99	67.80	16.85	0.00	150.0	± 9.6 %
		Y	5.00	67.33	16.51		150.0	
		Z	4.80	67.54	16.59		150.0	
10424-AAA	IEEE 802.11n (HT Greenfield, 72.2 Mbps, 64-QAM)	X	4.90	67.76	16.83	0.00	150.0	± 9.6 %
		Y	4.91	67.27	16.47		150.0	
		Z	4.73	67.50	16.57		150.0	
10425-AAA	IEEE 802.11n (HT Greenfield, 15 Mbps, BPSK)	X	5.49	68.02	16.94	0.00	150.0	± 9.6 %
		Y	5.50	67.62	16.64		150.0	
		Z	5.34	67.73	16.73		150.0	
10426-AAA	IEEE 802.11n (HT Greenfield, 90 Mbps, 16-QAM)	X	5.49	68.02	16.94	0.00	150.0	± 9.6 %
		Y	5.51	67.65	16.65		150.0	
		Z	5.36	67.83	16.78		150.0	

10427-AAA	IEEE 802.11n (HT Greenfield, 150 Mbps, 64-QAM)	X	5.50	68.00	16.93	0.00	150.0	± 9.6 %
		Y	5.52	67.64	16.64		150.0	
		Z	5.36	67.74	16.73		150.0	
10430-AAB	LTE-FDD (OFDMA, 5 MHz, E-TM 3.1)	X	4.54	72.09	19.09	0.00	150.0	± 9.6 %
		Y	4.40	70.73	18.36		150.0	
		Z	4.26	71.56	18.37		150.0	
10431-AAB	LTE-FDD (OFDMA, 10 MHz, E-TM 3.1)	X	4.40	68.10	16.85	0.00	150.0	± 9.6 %
		Y	4.40	67.42	16.40		150.0	
		Z	4.19	67.79	16.46		150.0	
10432-AAB	LTE-FDD (OFDMA, 15 MHz, E-TM 3.1)	X	4.68	67.87	16.83	0.00	150.0	± 9.6 %
		Y	4.69	67.31	16.44		150.0	
		Z	4.50	67.59	16.53		150.0	
10433-AAB	LTE-FDD (OFDMA, 20 MHz, E-TM 3.1)	X	4.92	67.80	16.85	0.00	150.0	± 9.6 %
		Y	4.93	67.31	16.50		150.0	
		Z	4.74	67.53	16.59		150.0	
10434-AAA	W-CDMA (BS Test Model 1, 64 DPCH)	X	4.73	73.25	19.23	0.00	150.0	± 9.6 %
		Y	4.51	71.54	18.38		150.0	
		Z	4.38	72.53	18.34		150.0	
10435-AAC	LTE-TDD (SC-FDMA, 1 RB, 20 MHz, QPSK, UL Subframe=2,3,4,7,8,9)	X	100.00	120.11	30.42	3.23	80.0	± 9.6 %
		Y	100.00	120.53	31.07		80.0	
		Z	100.00	122.42	31.29		80.0	
10447-AAB	LTE-FDD (OFDMA, 5 MHz, E-TM 3.1, Clipping 44%)	X	3.76	68.51	16.50	0.00	150.0	± 9.6 %
		Y	3.71	67.48	15.90		150.0	
		Z	3.49	67.91	15.73		150.0	
10448-AAB	LTE-FDD (OFDMA, 10 MHz, E-TM 3.1, Clipping 44%)	X	4.23	67.89	16.73	0.00	150.0	± 9.6 %
		Y	4.22	67.19	16.26		150.0	
		Z	4.04	67.58	16.33		150.0	
10449-AAB	LTE-FDD (OFDMA, 15 MHz, E-TM 3.1, Clipping 44%)	X	4.49	67.72	16.75	0.00	150.0	± 9.6 %
		Y	4.48	67.13	16.34		150.0	
		Z	4.32	67.42	16.43		150.0	
10450-AAB	LTE-FDD (OFDMA, 20 MHz, E-TM 3.1, Clipping 44%)	X	4.67	67.59	16.73	0.00	150.0	± 9.6 %
		Y	4.66	67.07	16.35		150.0	
		Z	4.52	67.31	16.45		150.0	
10451-AAA	W-CDMA (BS Test Model 1, 64 DPCH, Clipping 44%)	X	3.71	68.96	16.29	0.00	150.0	± 9.6 %
		Y	3.63	67.76	15.64		150.0	
		Z	3.37	68.05	15.28		150.0	
10456-AAA	IEEE 802.11ac WiFi (160MHz, 64-QAM, 99pc duty cycle)	X	6.34	68.51	17.03	0.00	150.0	± 9.6 %
		Y	6.36	68.23	16.81		150.0	
		Z	6.24	68.31	16.89		150.0	
10457-AAA	UMTS-FDD (DC-HSDPA)	X	3.87	65.97	16.44	0.00	150.0	± 9.6 %
		Y	3.87	65.48	16.06		150.0	
		Z	3.81	65.79	16.17		150.0	
10458-AAA	CDMA2000 (1xEV-DO, Rev. B, 2 carriers)	X	4.35	72.54	18.72	0.00	150.0	± 9.6 %
		Y	4.10	70.59	17.78		150.0	
		Z	4.02	71.83	17.67		150.0	
10459-AAA	CDMA2000 (1xEV-DO, Rev. B, 3 carriers)	X	5.25	68.89	18.60	0.00	150.0	± 9.6 %
		Y	5.22	68.08	18.20		150.0	
		Z	4.96	68.66	18.04		150.0	

10460-AAA	UMTS-FDD (WCDMA, AMR)	X	1.62	80.44	22.68	0.00	150.0	± 9.6 %
		Y	0.96	69.05	16.73		150.0	
		Z	1.09	72.04	18.32		150.0	
10461-AAA	LTE-TDD (SC-FDMA, 1 RB, 1.4 MHz, QPSK, UL Subframe=2,3,4,7,8,9)	X	100.00	125.40	32.90	3.29	80.0	± 9.6 %
		Y	100.00	122.42	32.02		80.0	
		Z	100.00	127.89	33.84		80.0	
10462-AAA	LTE-TDD (SC-FDMA, 1 RB, 1.4 MHz, 16-QAM, UL Subframe=2,3,4,7,8,9)	X	100.00	109.25	25.21	3.23	80.0	± 9.6 %
		Y	100.00	110.42	26.29		80.0	
		Z	100.00	110.45	25.54		80.0	
10463-AAA	LTE-TDD (SC-FDMA, 1 RB, 1.4 MHz, 64-QAM, UL Subframe=2,3,4,7,8,9)	X	100.00	106.10	23.70	3.23	80.0	± 9.6 %
		Y	31.87	95.11	22.04		80.0	
		Z	100.00	107.01	23.88		80.0	
10464-AAA	LTE-TDD (SC-FDMA, 1 RB, 3 MHz, QPSK, UL Subframe=2,3,4,7,8,9)	X	100.00	123.48	31.85	3.23	80.0	± 9.6 %
		Y	100.00	120.78	31.11		80.0	
		Z	100.00	125.94	32.77		80.0	
10465-AAA	LTE-TDD (SC-FDMA, 1 RB, 3 MHz, 16-QAM, UL Subframe=2,3,4,7,8,9)	X	100.00	108.73	24.95	3.23	80.0	± 9.6 %
		Y	57.38	103.50	24.59		80.0	
		Z	100.00	109.93	25.28		80.0	
10466-AAA	LTE-TDD (SC-FDMA, 1 RB, 3 MHz, 64-QAM, UL Subframe=2,3,4,7,8,9)	X	100.00	105.62	23.47	3.23	80.0	± 9.6 %
		Y	19.30	89.18	20.39		80.0	
		Z	100.00	106.51	23.65		80.0	
10467-AAC	LTE-TDD (SC-FDMA, 1 RB, 5 MHz, QPSK, UL Subframe=2,3,4,7,8,9)	X	100.00	123.71	31.96	3.23	80.0	± 9.6 %
		Y	100.00	120.96	31.19		80.0	
		Z	100.00	126.19	32.89		80.0	
10468-AAC	LTE-TDD (SC-FDMA, 1 RB, 5 MHz, 16-QAM, UL Subframe=2,3,4,7,8,9)	X	100.00	108.89	25.03	3.23	80.0	± 9.6 %
		Y	68.69	105.73	25.14		80.0	
		Z	100.00	110.12	25.37		80.0	
10469-AAC	LTE-TDD (SC-FDMA, 1 RB, 5 MHz, 64-QAM, UL Subframe=2,3,4,7,8,9)	X	100.00	105.63	23.47	3.23	80.0	± 9.6 %
		Y	19.75	89.45	20.46		80.0	
		Z	100.00	106.53	23.66		80.0	
10470-AAC	LTE-TDD (SC-FDMA, 1 RB, 10 MHz, QPSK, UL Subframe=2,3,4,7,8,9)	X	100.00	123.74	31.96	3.23	80.0	± 9.6 %
		Y	100.00	120.98	31.20		80.0	
		Z	100.00	126.22	32.89		80.0	
10471-AAC	LTE-TDD (SC-FDMA, 1 RB, 10 MHz, 16-QAM, UL Subframe=2,3,4,7,8,9)	X	100.00	108.84	25.00	3.23	80.0	± 9.6 %
		Y	69.00	105.75	25.13		80.0	
		Z	100.00	110.07	25.35		80.0	
10472-AAC	LTE-TDD (SC-FDMA, 1 RB, 10 MHz, 64-QAM, UL Subframe=2,3,4,7,8,9)	X	100.00	105.58	23.44	3.23	80.0	± 9.6 %
		Y	19.79	89.46	20.45		80.0	
		Z	100.00	106.47	23.62		80.0	
10473-AAC	LTE-TDD (SC-FDMA, 1 RB, 15 MHz, QPSK, UL Subframe=2,3,4,7,8,9)	X	100.00	123.71	31.95	3.23	80.0	± 9.6 %
		Y	100.00	120.96	31.18		80.0	
		Z	100.00	126.20	32.88		80.0	
10474-AAC	LTE-TDD (SC-FDMA, 1 RB, 15 MHz, 16-QAM, UL Subframe=2,3,4,7,8,9)	X	100.00	108.85	25.00	3.23	80.0	± 9.6 %
		Y	67.79	105.55	25.09		80.0	
		Z	100.00	110.08	25.35		80.0	
10475-AAC	LTE-TDD (SC-FDMA, 1 RB, 15 MHz, 64-QAM, UL Subframe=2,3,4,7,8,9)	X	100.00	105.59	23.45	3.23	80.0	± 9.6 %
		Y	19.52	89.31	20.41		80.0	
		Z	100.00	106.49	23.63		80.0	

10477-AAC	LTE-TDD (SC-FDMA, 1 RB, 20 MHz, 16-QAM, UL Subframe=2,3,4,7,8,9)	X	100.00	108.68	24.92	3.23	80.0	± 9.6 %
		Y	60.00	104.00	24.69		80.0	
		Z	100.00	109.90	25.26		80.0	
10478-AAC	LTE-TDD (SC-FDMA, 1 RB, 20 MHz, 64-QAM, UL Subframe=2,3,4,7,8,9)	X	100.00	105.53	23.42	3.23	80.0	± 9.6 %
		Y	19.24	89.12	20.35		80.0	
		Z	100.00	106.43	23.60		80.0	
10479-AAA	LTE-TDD (SC-FDMA, 50% RB, 1.4 MHz, QPSK, UL Subframe=2,3,4,7,8,9)	X	94.50	124.14	33.84	3.23	80.0	± 9.6 %
		Y	12.50	90.83	25.02		80.0	
		Z	100.00	124.95	33.67		80.0	
10480-AAA	LTE-TDD (SC-FDMA, 50% RB, 1.4 MHz, 16-QAM, UL Subframe=2,3,4,7,8,9)	X	95.67	115.16	29.54	3.23	80.0	± 9.6 %
		Y	12.83	86.63	22.28		80.0	
		Z	100.00	114.83	28.84		80.0	
10481-AAA	LTE-TDD (SC-FDMA, 50% RB, 1.4 MHz, 64-QAM, UL Subframe=2,3,4,7,8,9)	X	58.64	107.02	27.16	3.23	80.0	± 9.6 %
		Y	11.35	84.25	21.22		80.0	
		Z	80.09	110.11	27.23		80.0	
10482-AAA	LTE-TDD (SC-FDMA, 50% RB, 3 MHz, QPSK, UL Subframe=2,3,4,7,8,9)	X	12.89	91.14	23.86	2.23	80.0	± 9.6 %
		Y	6.25	79.51	20.15		80.0	
		Z	8.39	84.42	21.05		80.0	
10483-AAA	LTE-TDD (SC-FDMA, 50% RB, 3 MHz, 16-QAM, UL Subframe=2,3,4,7,8,9)	X	18.92	92.85	24.00	2.23	80.0	± 9.6 %
		Y	8.58	80.90	20.47		80.0	
		Z	13.62	87.31	21.48		80.0	
10484-AAA	LTE-TDD (SC-FDMA, 50% RB, 3 MHz, 64-QAM, UL Subframe=2,3,4,7,8,9)	X	15.36	89.71	23.07	2.23	80.0	± 9.6 %
		Y	7.99	79.65	20.04		80.0	
		Z	10.91	84.16	20.49		80.0	
10485-AAC	LTE-TDD (SC-FDMA, 50% RB, 5 MHz, QPSK, UL Subframe=2,3,4,7,8,9)	X	10.83	89.50	24.25	2.23	80.0	± 9.6 %
		Y	6.29	79.77	20.91		80.0	
		Z	8.35	85.48	22.54		80.0	
10486-AAC	LTE-TDD (SC-FDMA, 50% RB, 5 MHz, 16-QAM, UL Subframe=2,3,4,7,8,9)	X	6.33	78.08	19.97	2.23	80.0	± 9.6 %
		Y	5.11	73.82	18.38		80.0	
		Z	5.40	75.74	18.50		80.0	
10487-AAC	LTE-TDD (SC-FDMA, 50% RB, 5 MHz, 64-QAM, UL Subframe=2,3,4,7,8,9)	X	6.09	77.15	19.61	2.23	80.0	± 9.6 %
		Y	5.06	73.33	18.18		80.0	
		Z	5.20	74.88	18.15		80.0	
10488-AAC	LTE-TDD (SC-FDMA, 50% RB, 10 MHz, QPSK, UL Subframe=2,3,4,7,8,9)	X	7.97	83.54	22.89	2.23	80.0	± 9.6 %
		Y	6.02	77.67	20.60		80.0	
		Z	6.66	81.06	21.92		80.0	
10489-AAC	LTE-TDD (SC-FDMA, 50% RB, 10 MHz, 16-QAM, UL Subframe=2,3,4,7,8,9)	X	5.54	75.17	19.93	2.23	80.0	± 9.6 %
		Y	5.05	72.55	18.77		80.0	
		Z	5.10	74.15	19.29		80.0	
10490-AAC	LTE-TDD (SC-FDMA, 50% RB, 10 MHz, 64-QAM, UL Subframe=2,3,4,7,8,9)	X	5.52	74.58	19.72	2.23	80.0	± 9.6 %
		Y	5.10	72.20	18.66		80.0	
		Z	5.11	73.70	19.12		80.0	
10491-AAC	LTE-TDD (SC-FDMA, 50% RB, 15 MHz, QPSK, UL Subframe=2,3,4,7,8,9)	X	6.68	78.67	21.27	2.23	80.0	± 9.6 %
		Y	5.75	75.05	19.71		80.0	
		Z	5.90	77.08	20.64		80.0	
10492-AAC	LTE-TDD (SC-FDMA, 50% RB, 15 MHz, 16-QAM, UL Subframe=2,3,4,7,8,9)	X	5.47	73.05	19.35	2.23	80.0	± 9.6 %
		Y	5.22	71.31	18.50		80.0	
		Z	5.12	72.35	18.92		80.0	

10493-AAC	LTE-TDD (SC-FDMA, 50% RB, 15 MHz, 64-QAM, UL Subframe=2,3,4,7,8,9)	X	5.48	72.72	19.22	2.23	80.0	± 9.6 %
		Y	5.27	71.08	18.43		80.0	
		Z	5.15	72.07	18.82		80.0	
10494-AAC	LTE-TDD (SC-FDMA, 50% RB, 20 MHz, QPSK, UL Subframe=2,3,4,7,8,9)	X	7.90	81.45	22.09	2.23	80.0	± 9.6 %
		Y	6.41	76.92	20.25		80.0	
		Z	6.69	79.16	21.27		80.0	
10495-AAC	LTE-TDD (SC-FDMA, 50% RB, 20 MHz, 16-QAM, UL Subframe=2,3,4,7,8,9)	X	5.61	73.73	19.62	2.23	80.0	± 9.6 %
		Y	5.32	71.86	18.72		80.0	
		Z	5.21	72.81	19.16		80.0	
10496-AAC	LTE-TDD (SC-FDMA, 50% RB, 20 MHz, 64-QAM, UL Subframe=2,3,4,7,8,9)	X	5.57	73.09	19.41	2.23	80.0	± 9.6 %
		Y	5.35	71.43	18.59		80.0	
		Z	5.21	72.31	18.99		80.0	
10497-AAA	LTE-TDD (SC-FDMA, 100% RB, 1.4 MHz, QPSK, UL Subframe=2,3,4,7,8,9)	X	10.14	86.59	21.54	2.23	80.0	± 9.6 %
		Y	5.12	76.51	18.39		80.0	
		Z	5.35	77.20	17.46		80.0	
10498-AAA	LTE-TDD (SC-FDMA, 100% RB, 1.4 MHz, 16-QAM, UL Subframe=2,3,4,7,8,9)	X	4.29	72.00	15.43	2.23	80.0	± 9.6 %
		Y	3.72	69.52	14.77		80.0	
		Z	2.43	65.17	11.54		80.0	
10499-AAA	LTE-TDD (SC-FDMA, 100% RB, 1.4 MHz, 64-QAM, UL Subframe=2,3,4,7,8,9)	X	3.97	70.70	14.77	2.23	80.0	± 9.6 %
		Y	3.61	68.83	14.36		80.0	
		Z	2.26	64.14	10.91		80.0	
10500-AAA	LTE-TDD (SC-FDMA, 100% RB, 3 MHz, QPSK, UL Subframe=2,3,4,7,8,9)	X	8.79	85.79	23.33	2.23	80.0	± 9.6 %
		Y	5.95	78.30	20.59		80.0	
		Z	7.25	82.97	22.08		80.0	
10501-AAA	LTE-TDD (SC-FDMA, 100% RB, 3 MHz, 16-QAM, UL Subframe=2,3,4,7,8,9)	X	5.90	76.65	19.85	2.23	80.0	± 9.6 %
		Y	5.06	73.18	18.47		80.0	
		Z	5.28	75.13	18.80		80.0	
10502-AAA	LTE-TDD (SC-FDMA, 100% RB, 3 MHz, 64-QAM, UL Subframe=2,3,4,7,8,9)	X	5.87	76.18	19.62	2.23	80.0	± 9.6 %
		Y	5.09	72.91	18.33		80.0	
		Z	5.26	74.71	18.58		80.0	
10503-AAC	LTE-TDD (SC-FDMA, 100% RB, 5 MHz, QPSK, UL Subframe=2,3,4,7,8,9)	X	7.83	83.24	22.77	2.23	80.0	± 9.6 %
		Y	5.94	77.45	20.51		80.0	
		Z	6.55	80.79	21.81		80.0	
10504-AAC	LTE-TDD (SC-FDMA, 100% RB, 5 MHz, 16-QAM, UL Subframe=2,3,4,7,8,9)	X	5.51	75.05	19.87	2.23	80.0	± 9.6 %
		Y	5.02	72.46	18.72		80.0	
		Z	5.07	74.04	19.23		80.0	
10505-AAC	LTE-TDD (SC-FDMA, 100% RB, 5 MHz, 64-QAM, UL Subframe=2,3,4,7,8,9)	X	5.49	74.47	19.66	2.23	80.0	± 9.6 %
		Y	5.07	72.10	18.60		80.0	
		Z	5.08	73.60	19.06		80.0	
10506-AAC	LTE-TDD (SC-FDMA, 100% RB, 10 MHz, QPSK, UL Subframe=2,3,4,7,8,9)	X	7.81	81.23	22.00	2.23	80.0	± 9.6 %
		Y	6.35	76.76	20.18		80.0	
		Z	6.62	78.99	21.19		80.0	
10507-AAC	LTE-TDD (SC-FDMA, 100% RB, 10 MHz, 16-QAM, UL Subframe=2,3,4,7,8,9)	X	5.58	73.65	19.59	2.23	80.0	± 9.6 %
		Y	5.30	71.80	18.69		80.0	
		Z	5.19	72.75	19.13		80.0	

10508-AAC	LTE-TDD (SC-FDMA, 100% RB, 10 MHz, 64-QAM, UL Subframe=2,3,4,7,8,9)	X	5.55	73.01	19.36	2.23	80.0	± 9.6 %
		Y	5.33	71.35	18.55		80.0	
		Z	5.19	72.24	18.95		80.0	
10509-AAC	LTE-TDD (SC-FDMA, 100% RB, 15 MHz, QPSK, UL Subframe=2,3,4,7,8,9)	X	7.03	77.40	20.60	2.23	80.0	± 9.6 %
		Y	6.25	74.54	19.35		80.0	
		Z	6.27	75.89	20.05		80.0	
10510-AAC	LTE-TDD (SC-FDMA, 100% RB, 15 MHz, 16-QAM, UL Subframe=2,3,4,7,8,9)	X	5.86	72.49	19.18	2.23	80.0	± 9.6 %
		Y	5.70	71.14	18.49		80.0	
		Z	5.51	71.73	18.83		80.0	
10511-AAC	LTE-TDD (SC-FDMA, 100% RB, 15 MHz, 64-QAM, UL Subframe=2,3,4,7,8,9)	X	5.83	72.01	19.03	2.23	80.0	± 9.6 %
		Y	5.71	70.79	18.40		80.0	
		Z	5.52	71.35	18.71		80.0	
10512-AAC	LTE-TDD (SC-FDMA, 100% RB, 20 MHz, QPSK, UL Subframe=2,3,4,7,8,9)	X	8.18	80.50	21.58	2.23	80.0	± 9.6 %
		Y	6.82	76.59	19.98		80.0	
		Z	6.97	78.23	20.79		80.0	
10513-AAC	LTE-TDD (SC-FDMA, 100% RB, 20 MHz, 16-QAM, UL Subframe=2,3,4,7,8,9)	X	5.86	73.15	19.44	2.23	80.0	± 9.6 %
		Y	5.65	71.64	18.67		80.0	
		Z	5.45	72.18	19.02		80.0	
10514-AAC	LTE-TDD (SC-FDMA, 100% RB, 20 MHz, 64-QAM, UL Subframe=2,3,4,7,8,9)	X	5.75	72.41	19.20	2.23	80.0	± 9.6 %
		Y	5.60	71.07	18.51		80.0	
		Z	5.40	71.58	18.82		80.0	
10515-AAA	IEEE 802.11b WiFi 2.4 GHz (DSSS, 2 Mbps, 99pc duty cycle)	X	1.06	65.76	16.90	0.00	150.0	± 9.6 %
		Y	1.00	63.51	14.99		150.0	
		Z	1.02	64.32	15.55		150.0	
10516-AAA	IEEE 802.11b WiFi 2.4 GHz (DSSS, 5.5 Mbps, 99pc duty cycle)	X	5.87	117.81	35.86	0.00	150.0	± 9.6 %
		Y	0.66	71.85	18.17		150.0	
		Z	0.94	79.02	21.78		150.0	
10517-AAA	IEEE 802.11b WiFi 2.4 GHz (DSSS, 11 Mbps, 99pc duty cycle)	X	1.03	70.61	19.18	0.00	150.0	± 9.6 %
		Y	0.86	65.67	15.75		150.0	
		Z	0.90	67.08	16.71		150.0	
10518-AAA	IEEE 802.11a/h WiFi 5 GHz (OFDM, 9 Mbps, 99pc duty cycle)	X	4.67	67.45	16.69	0.00	150.0	± 9.6 %
		Y	4.67	66.94	16.33		150.0	
		Z	4.52	67.23	16.44		150.0	
10519-AAA	IEEE 802.11a/h WiFi 5 GHz (OFDM, 12 Mbps, 99pc duty cycle)	X	4.87	67.70	16.81	0.00	150.0	± 9.6 %
		Y	4.88	67.22	16.46		150.0	
		Z	4.69	67.43	16.54		150.0	
10520-AAA	IEEE 802.11a/h WiFi 5 GHz (OFDM, 18 Mbps, 99pc duty cycle)	X	4.72	67.70	16.76	0.00	150.0	± 9.6 %
		Y	4.73	67.19	16.39		150.0	
		Z	4.54	67.39	16.47		150.0	
10521-AAA	IEEE 802.11a/h WiFi 5 GHz (OFDM, 24 Mbps, 99pc duty cycle)	X	4.66	67.72	16.76	0.00	150.0	± 9.6 %
		Y	4.66	67.20	16.38		150.0	
		Z	4.48	67.38	16.46		150.0	
10522-AAA	IEEE 802.11a/h WiFi 5 GHz (OFDM, 36 Mbps, 99pc duty cycle)	X	4.71	67.76	16.82	0.00	150.0	± 9.6 %
		Y	4.71	67.20	16.42		150.0	
		Z	4.54	67.51	16.56		150.0	

10523-AAA	IEEE 802.11a/h WiFi 5 GHz (OFDM, 48 Mbps, 99pc duty cycle)	X	4.59	67.65	16.68	0.00	150.0	± 9.6 %
		Y	4.58	67.09	16.28		150.0	
		Z	4.43	67.41	16.42		150.0	
10524-AAA	IEEE 802.11a/h WiFi 5 GHz (OFDM, 54 Mbps, 99pc duty cycle)	X	4.66	67.69	16.79	0.00	150.0	± 9.6 %
		Y	4.66	67.15	16.40		150.0	
		Z	4.48	67.43	16.53		150.0	
10525-AAA	IEEE 802.11ac WiFi (20MHz, MCS0, 99pc duty cycle)	X	4.63	66.73	16.38	0.00	150.0	± 9.6 %
		Y	4.62	66.18	15.99		150.0	
		Z	4.49	66.49	16.12		150.0	
10526-AAA	IEEE 802.11ac WiFi (20MHz, MCS1, 99pc duty cycle)	X	4.82	67.13	16.53	0.00	150.0	± 9.6 %
		Y	4.82	66.58	16.14		150.0	
		Z	4.64	66.83	16.26		150.0	
10527-AAA	IEEE 802.11ac WiFi (20MHz, MCS2, 99pc duty cycle)	X	4.74	67.11	16.49	0.00	150.0	± 9.6 %
		Y	4.73	66.55	16.09		150.0	
		Z	4.57	66.80	16.20		150.0	
10528-AAA	IEEE 802.11ac WiFi (20MHz, MCS3, 99pc duty cycle)	X	4.76	67.13	16.52	0.00	150.0	± 9.6 %
		Y	4.75	66.57	16.12		150.0	
		Z	4.58	66.81	16.23		150.0	
10529-AAA	IEEE 802.11ac WiFi (20MHz, MCS4, 99pc duty cycle)	X	4.76	67.13	16.52	0.00	150.0	± 9.6 %
		Y	4.75	66.57	16.12		150.0	
		Z	4.58	66.81	16.23		150.0	
10531-AAA	IEEE 802.11ac WiFi (20MHz, MCS6, 99pc duty cycle)	X	4.77	67.27	16.55	0.00	150.0	± 9.6 %
		Y	4.76	66.71	16.15		150.0	
		Z	4.56	66.89	16.24		150.0	
10532-AAA	IEEE 802.11ac WiFi (20MHz, MCS7, 99pc duty cycle)	X	4.62	67.15	16.50	0.00	150.0	± 9.6 %
		Y	4.61	66.57	16.09		150.0	
		Z	4.43	66.75	16.17		150.0	
10533-AAA	IEEE 802.11ac WiFi (20MHz, MCS8, 99pc duty cycle)	X	4.77	67.17	16.50	0.00	150.0	± 9.6 %
		Y	4.76	66.59	16.10		150.0	
		Z	4.59	66.88	16.23		150.0	
10534-AAA	IEEE 802.11ac WiFi (40MHz, MCS0, 99pc duty cycle)	X	5.27	67.15	16.50	0.00	150.0	± 9.6 %
		Y	5.27	66.72	16.17		150.0	
		Z	5.12	66.84	16.26		150.0	
10535-AAA	IEEE 802.11ac WiFi (40MHz, MCS1, 99pc duty cycle)	X	5.34	67.31	16.57	0.00	150.0	± 9.6 %
		Y	5.34	66.86	16.23		150.0	
		Z	5.19	67.03	16.35		150.0	
10536-AAA	IEEE 802.11ac WiFi (40MHz, MCS2, 99pc duty cycle)	X	5.22	67.31	16.55	0.00	150.0	± 9.6 %
		Y	5.21	66.84	16.21		150.0	
		Z	5.06	66.99	16.32		150.0	
10537-AAA	IEEE 802.11ac WiFi (40MHz, MCS3, 99pc duty cycle)	X	5.27	67.26	16.52	0.00	150.0	± 9.6 %
		Y	5.28	66.82	16.20		150.0	
		Z	5.12	66.94	16.29		150.0	
10538-AAA	IEEE 802.11ac WiFi (40MHz, MCS4, 99pc duty cycle)	X	5.37	67.28	16.57	0.00	150.0	± 9.6 %
		Y	5.39	66.89	16.27		150.0	
		Z	5.20	66.94	16.33		150.0	
10540-AAA	IEEE 802.11ac WiFi (40MHz, MCS6, 99pc duty cycle)	X	5.29	67.28	16.59	0.00	150.0	± 9.6 %
		Y	5.29	66.84	16.26		150.0	
		Z	5.13	66.94	16.35		150.0	

10541-AAA	IEEE 802.11ac WiFi (40MHz, MCS7, 99pc duty cycle)	X	5.26	67.15	16.52	0.00	150.0	± 9.6 %
		Y	5.27	66.73	16.20		150.0	
		Z	5.11	66.82	16.27		150.0	
10542-AAA	IEEE 802.11ac WiFi (40MHz, MCS8, 99pc duty cycle)	X	5.42	67.19	16.55	0.00	150.0	± 9.6 %
		Y	5.42	66.79	16.25		150.0	
		Z	5.26	66.90	16.33		150.0	
10543-AAA	IEEE 802.11ac WiFi (40MHz, MCS9, 99pc duty cycle)	X	5.49	67.21	16.57	0.00	150.0	± 9.6 %
		Y	5.51	66.80	16.27		150.0	
		Z	5.32	66.91	16.36		150.0	
10544-AAA	IEEE 802.11ac WiFi (80MHz, MCS0, 99pc duty cycle)	X	5.57	67.22	16.46	0.00	150.0	± 9.6 %
		Y	5.56	66.82	16.16		150.0	
		Z	5.45	66.92	16.24		150.0	
10545-AAA	IEEE 802.11ac WiFi (80MHz, MCS1, 99pc duty cycle)	X	5.77	67.65	16.61	0.00	150.0	± 9.6 %
		Y	5.78	67.25	16.32		150.0	
		Z	5.64	67.38	16.42		150.0	
10546-AAA	IEEE 802.11ac WiFi (80MHz, MCS2, 99pc duty cycle)	X	5.65	67.48	16.55	0.00	150.0	± 9.6 %
		Y	5.65	67.10	16.26		150.0	
		Z	5.50	67.09	16.30		150.0	
10547-AAA	IEEE 802.11ac WiFi (80MHz, MCS3, 99pc duty cycle)	X	5.73	67.53	16.56	0.00	150.0	± 9.6 %
		Y	5.74	67.18	16.29		150.0	
		Z	5.57	67.16	16.32		150.0	
10548-AAA	IEEE 802.11ac WiFi (80MHz, MCS4, 99pc duty cycle)	X	6.02	68.59	17.06	0.00	150.0	± 9.6 %
		Y	6.08	68.34	16.83		150.0	
		Z	5.80	68.04	16.74		150.0	
10550-AAA	IEEE 802.11ac WiFi (80MHz, MCS6, 99pc duty cycle)	X	5.67	67.46	16.54	0.00	150.0	± 9.6 %
		Y	5.67	67.06	16.25		150.0	
		Z	5.54	67.19	16.36		150.0	
10551-AAA	IEEE 802.11ac WiFi (80MHz, MCS7, 99pc duty cycle)	X	5.68	67.52	16.53	0.00	150.0	± 9.6 %
		Y	5.69	67.13	16.25		150.0	
		Z	5.53	67.15	16.30		150.0	
10552-AAA	IEEE 802.11ac WiFi (80MHz, MCS8, 99pc duty cycle)	X	5.59	67.30	16.44	0.00	150.0	± 9.6 %
		Y	5.59	66.90	16.14		150.0	
		Z	5.46	67.00	16.23		150.0	
10553-AAA	IEEE 802.11ac WiFi (80MHz, MCS9, 99pc duty cycle)	X	5.68	67.34	16.48	0.00	150.0	± 9.6 %
		Y	5.68	66.95	16.20		150.0	
		Z	5.53	67.00	16.26		150.0	
10554-AAB	IEEE 802.11ac WiFi (160MHz, MCS0, 99pc duty cycle)	X	5.97	67.57	16.52	0.00	150.0	± 9.6 %
		Y	5.97	67.21	16.26		150.0	
		Z	5.86	67.27	16.32		150.0	
10555-AAB	IEEE 802.11ac WiFi (160MHz, MCS1, 99pc duty cycle)	X	6.11	67.88	16.66	0.00	150.0	± 9.6 %
		Y	6.11	67.54	16.39		150.0	
		Z	5.98	67.57	16.45		150.0	
10556-AAB	IEEE 802.11ac WiFi (160MHz, MCS2, 99pc duty cycle)	X	6.13	67.93	16.67	0.00	150.0	± 9.6 %
		Y	6.13	67.56	16.40		150.0	
		Z	6.01	67.63	16.48		150.0	
10557-AAB	IEEE 802.11ac WiFi (160MHz, MCS3, 99pc duty cycle)	X	6.10	67.85	16.65	0.00	150.0	± 9.6 %
		Y	6.11	67.51	16.40		150.0	
		Z	5.97	67.50	16.43		150.0	

10558-AAB	IEEE 802.11ac WiFi (160MHz, MCS4, 99pc duty cycle)	X	6.16	68.03	16.76	0.00	150.0	± 9.6 %
		Y	6.17	67.70	16.50		150.0	
		Z	6.01	67.66	16.53		150.0	
10560-AAB	IEEE 802.11ac WiFi (160MHz, MCS6, 99pc duty cycle)	X	6.15	67.86	16.71	0.00	150.0	± 9.6 %
		Y	6.16	67.52	16.45		150.0	
		Z	6.00	67.50	16.49		150.0	
10561-AAB	IEEE 802.11ac WiFi (160MHz, MCS7, 99pc duty cycle)	X	6.06	67.83	16.73	0.00	150.0	± 9.6 %
		Y	6.07	67.48	16.47		150.0	
		Z	5.94	67.50	16.52		150.0	
10562-AAB	IEEE 802.11ac WiFi (160MHz, MCS8, 99pc duty cycle)	X	6.21	68.28	16.96	0.00	150.0	± 9.6 %
		Y	6.23	67.97	16.72		150.0	
		Z	6.03	67.79	16.67		150.0	
10563-AAB	IEEE 802.11ac WiFi (160MHz, MCS9, 99pc duty cycle)	X	6.55	68.85	17.19	0.00	150.0	± 9.6 %
		Y	6.59	68.58	16.96		150.0	
		Z	6.12	67.71	16.59		150.0	
10564-AAA	IEEE 802.11g WiFi 2.4 GHz (DSSS-OFDM, 9 Mbps, 99pc duty cycle)	X	4.99	67.50	16.82	0.46	150.0	± 9.6 %
		Y	5.01	67.06	16.50		150.0	
		Z	4.85	67.32	16.61		150.0	
10565-AAA	IEEE 802.11g WiFi 2.4 GHz (DSSS-OFDM, 12 Mbps, 99pc duty cycle)	X	5.24	67.95	17.13	0.46	150.0	± 9.6 %
		Y	5.26	67.54	16.83		150.0	
		Z	5.06	67.72	16.90		150.0	
10566-AAA	IEEE 802.11g WiFi 2.4 GHz (DSSS-OFDM, 18 Mbps, 99pc duty cycle)	X	5.07	67.84	16.98	0.46	150.0	± 9.6 %
		Y	5.10	67.41	16.66		150.0	
		Z	4.90	67.58	16.73		150.0	
10567-AAA	IEEE 802.11g WiFi 2.4 GHz (DSSS-OFDM, 24 Mbps, 99pc duty cycle)	X	5.11	68.24	17.33	0.46	150.0	± 9.6 %
		Y	5.13	67.80	17.01		150.0	
		Z	4.93	67.94	17.07		150.0	
10568-AAA	IEEE 802.11g WiFi 2.4 GHz (DSSS-OFDM, 36 Mbps, 99pc duty cycle)	X	4.99	67.61	16.75	0.46	150.0	± 9.6 %
		Y	5.01	67.15	16.42		150.0	
		Z	4.83	67.42	16.55		150.0	
10569-AAA	IEEE 802.11g WiFi 2.4 GHz (DSSS-OFDM, 48 Mbps, 99pc duty cycle)	X	5.06	68.33	17.39	0.46	150.0	± 9.6 %
		Y	5.07	67.85	17.05		150.0	
		Z	4.91	68.11	17.17		150.0	
10570-AAA	IEEE 802.11g WiFi 2.4 GHz (DSSS-OFDM, 54 Mbps, 99pc duty cycle)	X	5.09	68.14	17.31	0.46	150.0	± 9.6 %
		Y	5.11	67.68	16.98		150.0	
		Z	4.92	67.93	17.09		150.0	
10571-AAA	IEEE 802.11b WiFi 2.4 GHz (DSSS, 1 Mbps, 90pc duty cycle)	X	1.50	68.95	18.38	0.46	130.0	± 9.6 %
		Y	1.40	66.38	16.51		130.0	
		Z	1.40	67.23	17.09		130.0	
10572-AAA	IEEE 802.11b WiFi 2.4 GHz (DSSS, 2 Mbps, 90pc duty cycle)	X	1.55	69.98	18.93	0.46	130.0	± 9.6 %
		Y	1.43	67.06	16.91		130.0	
		Z	1.44	67.99	17.53		130.0	
10573-AAA	IEEE 802.11b WiFi 2.4 GHz (DSSS, 5.5 Mbps, 90pc duty cycle)	X	100.00	153.35	41.94	0.46	130.0	± 9.6 %
		Y	5.15	96.81	26.53		130.0	
		Z	50.11	136.49	37.17		130.0	
10574-AAA	IEEE 802.11b WiFi 2.4 GHz (DSSS, 11 Mbps, 90pc duty cycle)	X	2.59	83.81	24.92	0.46	130.0	± 9.6 %
		Y	1.75	74.27	20.26		130.0	
		Z	1.86	76.56	21.49		130.0	

10575-AAA	IEEE 802.11g WiFi 2.4 GHz (DSSS-OFDM, 6 Mbps, 90pc duty cycle)	X	4.81	67.37	16.92	0.46	130.0	± 9.6 %
		Y	4.84	66.96	16.62		130.0	
		Z	4.68	67.23	16.73		130.0	
10576-AAA	IEEE 802.11g WiFi 2.4 GHz (DSSS-OFDM, 9 Mbps, 90pc duty cycle)	X	4.84	67.54	16.99	0.46	130.0	± 9.6 %
		Y	4.86	67.12	16.68		130.0	
		Z	4.71	67.40	16.79		130.0	
10577-AAA	IEEE 802.11g WiFi 2.4 GHz (DSSS-OFDM, 12 Mbps, 90pc duty cycle)	X	5.05	67.83	17.14	0.46	130.0	± 9.6 %
		Y	5.09	67.44	16.86		130.0	
		Z	4.89	67.64	16.94		130.0	
10578-AAA	IEEE 802.11g WiFi 2.4 GHz (DSSS-OFDM, 18 Mbps, 90pc duty cycle)	X	4.96	68.04	17.27	0.46	130.0	± 9.6 %
		Y	4.99	67.62	16.97		130.0	
		Z	4.79	67.80	17.04		130.0	
10579-AAA	IEEE 802.11g WiFi 2.4 GHz (DSSS-OFDM, 24 Mbps, 90pc duty cycle)	X	4.73	67.38	16.62	0.46	130.0	± 9.6 %
		Y	4.76	66.96	16.31		130.0	
		Z	4.57	67.14	16.40		130.0	
10580-AAA	IEEE 802.11g WiFi 2.4 GHz (DSSS-OFDM, 36 Mbps, 90pc duty cycle)	X	4.77	67.37	16.62	0.46	130.0	± 9.6 %
		Y	4.80	66.94	16.31		130.0	
		Z	4.61	67.21	16.43		130.0	
10581-AAA	IEEE 802.11g WiFi 2.4 GHz (DSSS-OFDM, 48 Mbps, 90pc duty cycle)	X	4.86	68.14	17.25	0.46	130.0	± 9.6 %
		Y	4.89	67.70	16.92		130.0	
		Z	4.70	67.90	17.02		130.0	
10582-AAA	IEEE 802.11g WiFi 2.4 GHz (DSSS-OFDM, 54 Mbps, 90pc duty cycle)	X	4.67	67.12	16.41	0.46	130.0	± 9.6 %
		Y	4.71	66.71	16.10		130.0	
		Z	4.51	66.92	16.20		130.0	
10583-AAA	IEEE 802.11a/h WiFi 5 GHz (OFDM, 6 Mbps, 90pc duty cycle)	X	4.81	67.37	16.92	0.46	130.0	± 9.6 %
		Y	4.84	66.96	16.62		130.0	
		Z	4.68	67.23	16.73		130.0	
10584-AAA	IEEE 802.11a/h WiFi 5 GHz (OFDM, 9 Mbps, 90pc duty cycle)	X	4.84	67.54	16.99	0.46	130.0	± 9.6 %
		Y	4.86	67.12	16.68		130.0	
		Z	4.71	67.40	16.79		130.0	
10585-AAA	IEEE 802.11a/h WiFi 5 GHz (OFDM, 12 Mbps, 90pc duty cycle)	X	5.05	67.83	17.14	0.46	130.0	± 9.6 %
		Y	5.09	67.44	16.86		130.0	
		Z	4.89	67.64	16.94		130.0	
10586-AAA	IEEE 802.11a/h WiFi 5 GHz (OFDM, 18 Mbps, 90pc duty cycle)	X	4.96	68.04	17.27	0.46	130.0	± 9.6 %
		Y	4.99	67.62	16.97		130.0	
		Z	4.79	67.80	17.04		130.0	
10587-AAA	IEEE 802.11a/h WiFi 5 GHz (OFDM, 24 Mbps, 90pc duty cycle)	X	4.73	67.38	16.62	0.46	130.0	± 9.6 %
		Y	4.76	66.96	16.31		130.0	
		Z	4.57	67.14	16.40		130.0	
10588-AAA	IEEE 802.11a/h WiFi 5 GHz (OFDM, 36 Mbps, 90pc duty cycle)	X	4.77	67.37	16.62	0.46	130.0	± 9.6 %
		Y	4.80	66.94	16.31		130.0	
		Z	4.61	67.21	16.43		130.0	
10589-AAA	IEEE 802.11a/h WiFi 5 GHz (OFDM, 48 Mbps, 90pc duty cycle)	X	4.86	68.14	17.25	0.46	130.0	± 9.6 %
		Y	4.89	67.70	16.92		130.0	
		Z	4.70	67.90	17.02		130.0	
10590-AAA	IEEE 802.11a/h WiFi 5 GHz (OFDM, 54 Mbps, 90pc duty cycle)	X	4.67	67.12	16.41	0.46	130.0	± 9.6 %
		Y	4.71	66.71	16.10		130.0	
		Z	4.51	66.92	16.20		130.0	

10591-AAA	IEEE 802.11n (HT Mixed, 20MHz, MCS0, 90pc duty cycle)	X	4.95	67.39	16.99	0.46	130.0	± 9.6 %
		Y	4.98	67.01	16.71		130.0	
		Z	4.83	67.26	16.81		130.0	
10592-AAA	IEEE 802.11n (HT Mixed, 20MHz, MCS1, 90pc duty cycle)	X	5.12	67.74	17.12	0.46	130.0	± 9.6 %
		Y	5.15	67.35	16.84		130.0	
		Z	4.97	67.58	16.94		130.0	
10593-AAA	IEEE 802.11n (HT Mixed, 20MHz, MCS2, 90pc duty cycle)	X	5.04	67.68	17.02	0.46	130.0	± 9.6 %
		Y	5.08	67.30	16.74		130.0	
		Z	4.89	67.49	16.82		130.0	
10594-AAA	IEEE 802.11n (HT Mixed, 20MHz, MCS3, 90pc duty cycle)	X	5.10	67.84	17.17	0.46	130.0	± 9.6 %
		Y	5.14	67.45	16.88		130.0	
		Z	4.94	67.65	16.97		130.0	
10595-AAA	IEEE 802.11n (HT Mixed, 20MHz, MCS4, 90pc duty cycle)	X	5.07	67.81	17.07	0.46	130.0	± 9.6 %
		Y	5.11	67.42	16.78		130.0	
		Z	4.91	67.63	16.88		130.0	
10596-AAA	IEEE 802.11n (HT Mixed, 20MHz, MCS5, 90pc duty cycle)	X	5.01	67.82	17.09	0.46	130.0	± 9.6 %
		Y	5.05	67.42	16.79		130.0	
		Z	4.85	67.64	16.90		130.0	
10597-AAA	IEEE 802.11n (HT Mixed, 20MHz, MCS6, 90pc duty cycle)	X	4.96	67.75	16.98	0.46	130.0	± 9.6 %
		Y	5.00	67.35	16.69		130.0	
		Z	4.80	67.53	16.77		130.0	
10598-AAA	IEEE 802.11n (HT Mixed, 20MHz, MCS7, 90pc duty cycle)	X	4.95	68.01	17.26	0.46	130.0	± 9.6 %
		Y	4.98	67.61	16.96		130.0	
		Z	4.78	67.73	17.01		130.0	
10599-AAA	IEEE 802.11n (HT Mixed, 40MHz, MCS0, 90pc duty cycle)	X	5.60	67.86	17.12	0.46	130.0	± 9.6 %
		Y	5.66	67.61	16.91		130.0	
		Z	5.48	67.70	16.99		130.0	
10600-AAA	IEEE 802.11n (HT Mixed, 40MHz, MCS1, 90pc duty cycle)	X	5.78	68.39	17.36	0.46	130.0	± 9.6 %
		Y	5.85	68.19	17.17		130.0	
		Z	5.62	68.16	17.20		130.0	
10601-AAA	IEEE 802.11n (HT Mixed, 40MHz, MCS2, 90pc duty cycle)	X	5.65	68.09	17.22	0.46	130.0	± 9.6 %
		Y	5.71	67.83	17.01		130.0	
		Z	5.51	67.89	17.08		130.0	
10602-AAA	IEEE 802.11n (HT Mixed, 40MHz, MCS3, 90pc duty cycle)	X	5.73	68.07	17.13	0.46	130.0	± 9.6 %
		Y	5.79	67.82	16.93		130.0	
		Z	5.63	68.04	17.07		130.0	
10603-AAA	IEEE 802.11n (HT Mixed, 40MHz, MCS4, 90pc duty cycle)	X	5.82	68.41	17.43	0.46	130.0	± 9.6 %
		Y	5.87	68.11	17.19		130.0	
		Z	5.69	68.27	17.32		130.0	
10604-AAA	IEEE 802.11n (HT Mixed, 40MHz, MCS5, 90pc duty cycle)	X	5.61	67.82	17.13	0.46	130.0	± 9.6 %
		Y	5.66	67.56	16.91		130.0	
		Z	5.56	67.91	17.12		130.0	
10605-AAA	IEEE 802.11n (HT Mixed, 40MHz, MCS6, 90pc duty cycle)	X	5.73	68.17	17.30	0.46	130.0	± 9.6 %
		Y	5.77	67.87	17.07		130.0	
		Z	5.62	68.08	17.21		130.0	
10606-AAA	IEEE 802.11n (HT Mixed, 40MHz, MCS7, 90pc duty cycle)	X	5.50	67.62	16.90	0.46	130.0	± 9.6 %
		Y	5.53	67.31	16.65		130.0	
		Z	5.35	67.34	16.70		130.0	

10607-AAA	IEEE 802.11ac WiFi (20MHz, MCS0, 90pc duty cycle)	X	4.80	66.75	16.64	0.46	130.0	± 9.6 %
		Y	4.81	66.30	16.32		130.0	
		Z	4.67	66.60	16.45		130.0	
10608-AAA	IEEE 802.11ac WiFi (20MHz, MCS1, 90pc duty cycle)	X	5.00	67.18	16.81	0.46	130.0	± 9.6 %
		Y	5.02	66.72	16.48		130.0	
		Z	4.84	66.98	16.61		130.0	
10609-AAA	IEEE 802.11ac WiFi (20MHz, MCS2, 90pc duty cycle)	X	4.89	67.06	16.67	0.46	130.0	± 9.6 %
		Y	4.91	66.60	16.34		130.0	
		Z	4.73	66.84	16.45		130.0	
10610-AAA	IEEE 802.11ac WiFi (20MHz, MCS3, 90pc duty cycle)	X	4.94	67.21	16.82	0.46	130.0	± 9.6 %
		Y	4.96	66.76	16.50		130.0	
		Z	4.78	66.99	16.61		130.0	
10611-AAA	IEEE 802.11ac WiFi (20MHz, MCS4, 90pc duty cycle)	X	4.86	67.03	16.68	0.46	130.0	± 9.6 %
		Y	4.89	66.59	16.36		130.0	
		Z	4.70	66.81	16.46		130.0	
10612-AAA	IEEE 802.11ac WiFi (20MHz, MCS5, 90pc duty cycle)	X	4.88	67.21	16.74	0.46	130.0	± 9.6 %
		Y	4.90	66.74	16.40		130.0	
		Z	4.71	66.99	16.53		130.0	
10613-AAA	IEEE 802.11ac WiFi (20MHz, MCS6, 90pc duty cycle)	X	4.89	67.11	16.63	0.46	130.0	± 9.6 %
		Y	4.91	66.65	16.30		130.0	
		Z	4.71	66.83	16.39		130.0	
10614-AAA	IEEE 802.11ac WiFi (20MHz, MCS7, 90pc duty cycle)	X	4.83	67.31	16.87	0.46	130.0	± 9.6 %
		Y	4.85	66.84	16.53		130.0	
		Z	4.66	67.02	16.61		130.0	
10615-AAA	IEEE 802.11ac WiFi (20MHz, MCS8, 90pc duty cycle)	X	4.86	66.85	16.46	0.46	130.0	± 9.6 %
		Y	4.89	66.40	16.13		130.0	
		Z	4.70	66.67	16.26		130.0	
10616-AAA	IEEE 802.11ac WiFi (40MHz, MCS0, 90pc duty cycle)	X	5.44	67.18	16.77	0.46	130.0	± 9.6 %
		Y	5.47	66.84	16.51		130.0	
		Z	5.30	66.94	16.59		130.0	
10617-AAA	IEEE 802.11ac WiFi (40MHz, MCS1, 90pc duty cycle)	X	5.50	67.33	16.81	0.46	130.0	± 9.6 %
		Y	5.52	66.94	16.53		130.0	
		Z	5.38	67.17	16.68		130.0	
10618-AAA	IEEE 802.11ac WiFi (40MHz, MCS2, 90pc duty cycle)	X	5.40	67.39	16.87	0.46	130.0	± 9.6 %
		Y	5.42	67.02	16.59		130.0	
		Z	5.27	67.18	16.70		130.0	
10619-AAA	IEEE 802.11ac WiFi (40MHz, MCS3, 90pc duty cycle)	X	5.42	67.21	16.71	0.46	130.0	± 9.6 %
		Y	5.44	66.85	16.44		130.0	
		Z	5.28	66.96	16.53		130.0	
10620-AAA	IEEE 802.11ac WiFi (40MHz, MCS4, 90pc duty cycle)	X	5.51	67.25	16.78	0.46	130.0	± 9.6 %
		Y	5.56	66.94	16.53		130.0	
		Z	5.36	66.98	16.59		130.0	
10621-AAA	IEEE 802.11ac WiFi (40MHz, MCS5, 90pc duty cycle)	X	5.50	67.33	16.93	0.46	130.0	± 9.6 %
		Y	5.53	67.00	16.68		130.0	
		Z	5.36	67.10	16.76		130.0	
10622-AAA	IEEE 802.11ac WiFi (40MHz, MCS6, 90pc duty cycle)	X	5.51	67.50	17.01	0.46	130.0	± 9.6 %
		Y	5.53	67.13	16.73		130.0	
		Z	5.38	67.30	16.85		130.0	

10623-AAA	IEEE 802.11ac WiFi (40MHz, MCS7, 90pc duty cycle)	X	5.39	67.03	16.66	0.46	130.0	± 9.6 %
		Y	5.41	66.69	16.40		130.0	
		Z	5.25	66.80	16.48		130.0	
10624-AAA	IEEE 802.11ac WiFi (40MHz, MCS8, 90pc duty cycle)	X	5.58	67.21	16.80	0.46	130.0	± 9.6 %
		Y	5.61	66.88	16.56		130.0	
		Z	5.44	66.99	16.64		130.0	
10625-AAA	IEEE 802.11ac WiFi (40MHz, MCS9, 90pc duty cycle)	X	5.99	68.31	17.39	0.46	130.0	± 9.6 %
		Y	6.04	68.02	17.17		130.0	
		Z	5.71	67.69	17.04		130.0	
10626-AAA	IEEE 802.11ac WiFi (80MHz, MCS0, 90pc duty cycle)	X	5.71	67.19	16.69	0.46	130.0	± 9.6 %
		Y	5.72	66.86	16.44		130.0	
		Z	5.61	66.97	16.54		130.0	
10627-AAA	IEEE 802.11ac WiFi (80MHz, MCS1, 90pc duty cycle)	X	5.96	67.77	16.93	0.46	130.0	± 9.6 %
		Y	5.99	67.46	16.69		130.0	
		Z	5.86	67.59	16.81		130.0	
10628-AAA	IEEE 802.11ac WiFi (80MHz, MCS2, 90pc duty cycle)	X	5.76	67.34	16.66	0.46	130.0	± 9.6 %
		Y	5.79	67.03	16.42		130.0	
		Z	5.63	67.03	16.47		130.0	
10629-AAA	IEEE 802.11ac WiFi (80MHz, MCS3, 90pc duty cycle)	X	5.85	67.42	16.69	0.46	130.0	± 9.6 %
		Y	5.87	67.09	16.44		130.0	
		Z	5.71	67.12	16.51		130.0	
10630-AAA	IEEE 802.11ac WiFi (80MHz, MCS4, 90pc duty cycle)	X	6.37	69.15	17.55	0.46	130.0	± 9.6 %
		Y	6.48	69.04	17.41		130.0	
		Z	6.10	68.51	17.21		130.0	
10631-AAA	IEEE 802.11ac WiFi (80MHz, MCS5, 90pc duty cycle)	X	6.23	68.84	17.58	0.46	130.0	± 9.6 %
		Y	6.30	68.64	17.40		130.0	
		Z	6.00	68.26	17.26		130.0	
10632-AAA	IEEE 802.11ac WiFi (80MHz, MCS6, 90pc duty cycle)	X	5.93	67.81	17.09	0.46	130.0	± 9.6 %
		Y	5.96	67.50	16.85		130.0	
		Z	5.82	67.64	16.97		130.0	
10633-AAA	IEEE 802.11ac WiFi (80MHz, MCS7, 90pc duty cycle)	X	5.83	67.50	16.76	0.46	130.0	± 9.6 %
		Y	5.88	67.25	16.56		130.0	
		Z	5.69	67.21	16.59		130.0	
10634-AAA	IEEE 802.11ac WiFi (80MHz, MCS8, 90pc duty cycle)	X	5.81	67.52	16.84	0.46	130.0	± 9.6 %
		Y	5.85	67.23	16.61		130.0	
		Z	5.67	67.21	16.64		130.0	
10635-AAA	IEEE 802.11ac WiFi (80MHz, MCS9, 90pc duty cycle)	X	5.70	66.87	16.25	0.46	130.0	± 9.6 %
		Y	5.74	66.58	16.02		130.0	
		Z	5.55	66.58	16.07		130.0	
10636-AAB	IEEE 802.11ac WiFi (160MHz, MCS0, 90pc duty cycle)	X	6.12	67.55	16.76	0.46	130.0	± 9.6 %
		Y	6.14	67.26	16.54		130.0	
		Z	6.03	67.32	16.61		130.0	
10637-AAB	IEEE 802.11ac WiFi (160MHz, MCS1, 90pc duty cycle)	X	6.28	67.94	16.93	0.46	130.0	± 9.6 %
		Y	6.31	67.65	16.72		130.0	
		Z	6.19	67.72	16.79		130.0	
10638-AAB	IEEE 802.11ac WiFi (160MHz, MCS2, 90pc duty cycle)	X	6.28	67.91	16.90	0.46	130.0	± 9.6 %
		Y	6.31	67.62	16.68		130.0	
		Z	6.18	67.68	16.75		130.0	

10639-AAB	IEEE 802.11ac WiFi (160MHz, MCS3, 90pc duty cycle)	X	6.27	67.88	16.93	0.46	130.0	± 9.6 %
		Y	6.30	67.62	16.73		130.0	
		Z	6.15	67.59	16.75		130.0	
10640-AAB	IEEE 802.11ac WiFi (160MHz, MCS4, 90pc duty cycle)	X	6.29	67.93	16.90	0.46	130.0	± 9.6 %
		Y	6.33	67.70	16.71		130.0	
		Z	6.15	67.62	16.71		130.0	
10641-AAB	IEEE 802.11ac WiFi (160MHz, MCS5, 90pc duty cycle)	X	6.30	67.74	16.81	0.46	130.0	± 9.6 %
		Y	6.32	67.44	16.59		130.0	
		Z	6.22	67.59	16.72		130.0	
10642-AAB	IEEE 802.11ac WiFi (160MHz, MCS6, 90pc duty cycle)	X	6.36	68.03	17.13	0.46	130.0	± 9.6 %
		Y	6.39	67.76	16.92		130.0	
		Z	6.23	67.75	16.95		130.0	
10643-AAB	IEEE 802.11ac WiFi (160MHz, MCS7, 90pc duty cycle)	X	6.19	67.72	16.88	0.46	130.0	± 9.6 %
		Y	6.22	67.45	16.67		130.0	
		Z	6.09	67.50	16.74		130.0	
10644-AAB	IEEE 802.11ac WiFi (160MHz, MCS8, 90pc duty cycle)	X	6.39	68.34	17.21	0.46	130.0	± 9.6 %
		Y	6.45	68.14	17.04		130.0	
		Z	6.20	67.86	16.93		130.0	
10645-AAB	IEEE 802.11ac WiFi (160MHz, MCS9, 90pc duty cycle)	X	6.86	69.27	17.61	0.46	130.0	± 9.6 %
		Y	6.87	68.89	17.35		130.0	
		Z	6.34	67.93	16.93		130.0	
10646-AAD	LTE-TDD (SC-FDMA, 1 RB, 5 MHz, QPSK, UL Subframe=2,7)	X	58.91	128.47	41.72	9.30	60.0	± 9.6 %
		Y	22.23	103.66	34.19		60.0	
		Z	97.77	144.05	46.65		60.0	
10647-AAC	LTE-TDD (SC-FDMA, 1 RB, 20 MHz, QPSK, UL Subframe=2,7)	X	62.96	130.94	42.54	9.30	60.0	± 9.6 %
		Y	22.84	105.02	34.74		60.0	
		Z	100.00	145.78	47.28		60.0	
10648-AAA	CDMA2000 (1x Advanced)	X	1.21	71.90	15.83	0.00	150.0	± 9.6 %
		Y	0.81	64.89	12.16		150.0	
		Z	0.74	65.22	11.47		150.0	
10652-AAB	LTE-TDD (OFDMA, 5 MHz, E-TM 3.1, Clipping 44%)	X	4.72	70.40	18.28	2.23	80.0	± 9.6 %
		Y	4.59	69.04	17.59		80.0	
		Z	4.50	69.96	17.82		80.0	
10653-AAB	LTE-TDD (OFDMA, 10 MHz, E-TM 3.1, Clipping 44%)	X	5.05	69.01	18.05	2.23	80.0	± 9.6 %
		Y	5.03	68.18	17.58		80.0	
		Z	4.88	68.67	17.76		80.0	
10654-AAB	LTE-TDD (OFDMA, 15 MHz, E-TM 3.1, Clipping 44%)	X	4.97	68.58	18.01	2.23	80.0	± 9.6 %
		Y	4.96	67.84	17.57		80.0	
		Z	4.83	68.24	17.75		80.0	
10655-AAB	LTE-TDD (OFDMA, 20 MHz, E-TM 3.1, Clipping 44%)	X	5.02	68.56	18.04	2.23	80.0	± 9.6 %
		Y	5.02	67.86	17.60		80.0	
		Z	4.89	68.17	17.77		80.0	

^E Uncertainty is determined using the max. deviation from linear response applying rectangular distribution and is expressed for the square of the field value.

**Calibration Laboratory of
Schmid & Partner
Engineering AG**
Zeughausstrasse 43, 8004 Zurich, Switzerland



S Schweizerischer Kalibrierdienst
C Service suisse d'étalonnage
S Servizio svizzero di taratura
Swiss Calibration Service

Accredited by the Swiss Accreditation Service (SAS)
The Swiss Accreditation Service is one of the signatories to the EA
Multilateral Agreement for the recognition of calibration certificates

Accreditation No.: **SCS 0108**

Client **PC Test**

Certificate No: **ES3-3318_Sep17**

CALIBRATION CERTIFICATE

Object: **ES3DV3 - SN:3318**

Calibration procedure(s): **QA CAL-01.v9, QA CAL-23.v5, QA CAL-25.v6**
Calibration procedure for dosimetric E-field probes

Calibration date: **September 22, 2017**

SLV
10/03/2017

This calibration certificate documents the traceability to national standards, which realize the physical units of measurements (SI).
The measurements and the uncertainties with confidence probability are given on the following pages and are part of the certificate.

All calibrations have been conducted in the closed laboratory facility: environment temperature (22 ± 3)°C and humidity < 70%.

Calibration Equipment used (M&TE critical for calibration)

Primary Standards	ID	Cal Date (Certificate No.)	Scheduled Calibration
Power meter NRP	SN: 104778	04-Apr-17 (No. 217-02521/02522)	Apr-18
Power sensor NRP-Z91	SN: 103244	04-Apr-17 (No. 217-02521)	Apr-18
Power sensor NRP-Z91	SN: 103245	04-Apr-17 (No. 217-02525)	Apr-18
Reference 20 dB Attenuator	SN: S5277 (20x)	07-Apr-17 (No. 217-02528)	Apr-18
Reference Probe ES3DV2	SN: 3013	31-Dec-16 (No. ES3-3013_Dec16)	Dec-17
DAE4	SN: 660	7-Dec-16 (No. DAE4-660_Dec16)	Dec-17
Secondary Standards	ID	Check Date (in house)	Scheduled Check
Power meter E4419B	SN: GB41293874	06-Apr-16 (in house check Jun-16)	In house check: Jun-18
Power sensor E4412A	SN: MY41498087	06-Apr-16 (in house check Jun-16)	In house check: Jun-18
Power sensor E4412A	SN: 000110210	06-Apr-16 (in house check Jun-16)	In house check: Jun-18
RF generator HP 8648C	SN: US3642U01700	04-Aug-99 (in house check Jun-16)	In house check: Jun-18
Network Analyzer HP 8753E	SN: US37390585	18-Oct-01 (in house check Oct-16)	In house check: Oct-17

Calibrated by:	Name Jeton Kastrati	Function Laboratory Technician	Signature
Approved by:	Name Katja Pokovic	Function Technical Manager	

Issued: September 22, 2017

This calibration certificate shall not be reproduced except in full without written approval of the laboratory.



Accredited by the Swiss Accreditation Service (SAS)

Accreditation No.: **SCS 0108**

The Swiss Accreditation Service is one of the signatories to the EA
Multilateral Agreement for the recognition of calibration certificates

Glossary:

TSL	tissue simulating liquid
NORM _{x,y,z}	sensitivity in free space
ConvF	sensitivity in TSL / NORM _{x,y,z}
DCP	diode compression point
CF	crest factor (1/duty_cycle) of the RF signal
A, B, C, D	modulation dependent linearization parameters
Polarization φ	φ rotation around probe axis
Polarization ϑ	ϑ rotation around an axis that is in the plane normal to probe axis (at measurement center), i.e., $\vartheta = 0$ is normal to probe axis
Connector Angle	information used in DASY system to align probe sensor X to the robot coordinate system

Calibration is Performed According to the Following Standards:

- IEEE Std 1528-2013, "IEEE Recommended Practice for Determining the Peak Spatial-Averaged Specific Absorption Rate (SAR) in the Human Head from Wireless Communications Devices: Measurement Techniques", June 2013
- IEC 62209-1, "Measurement procedure for the assessment of Specific Absorption Rate (SAR) from hand-held and body-mounted devices used next to the ear (frequency range of 300 MHz to 6 GHz)", July 2016
- IEC 62209-2, "Procedure to determine the Specific Absorption Rate (SAR) for wireless communication devices used in close proximity to the human body (frequency range of 30 MHz to 6 GHz)", March 2010
- KDB 865664, "SAR Measurement Requirements for 100 MHz to 6 GHz"

Methods Applied and Interpretation of Parameters:

- NORM_{x,y,z}**: Assessed for E-field polarization $\vartheta = 0$ ($f \leq 900$ MHz in TEM-cell; $f > 1800$ MHz: R22 waveguide). NORM_{x,y,z} are only intermediate values, i.e., the uncertainties of NORM_{x,y,z} does not affect the E²-field uncertainty inside TSL (see below ConvF).
- NORM(f)_{x,y,z}** = NORM_{x,y,z} * frequency_response (see Frequency Response Chart). This linearization is implemented in DASY4 software versions later than 4.2. The uncertainty of the frequency response is included in the stated uncertainty of ConvF.
- DCP_{x,y,z}**: DCP are numerical linearization parameters assessed based on the data of power sweep with CW signal (no uncertainty required). DCP does not depend on frequency nor media.
- PAR**: PAR is the Peak to Average Ratio that is not calibrated but determined based on the signal characteristics
- A_{x,y,z}; B_{x,y,z}; C_{x,y,z}; D_{x,y,z}; VR_{x,y,z}; A, B, C, D** are numerical linearization parameters assessed based on the data of power sweep for specific modulation signal. The parameters do not depend on frequency nor media. VR is the maximum calibration range expressed in RMS voltage across the diode.
- ConvF and Boundary Effect Parameters**: Assessed in flat phantom using E-field (or Temperature Transfer Standard for $f \leq 800$ MHz) and inside waveguide using analytical field distributions based on power measurements for $f > 800$ MHz. The same setups are used for assessment of the parameters applied for boundary compensation (alpha, depth) of which typical uncertainty values are given. These parameters are used in DASY4 software to improve probe accuracy close to the boundary. The sensitivity in TSL corresponds to NORM_{x,y,z} * ConvF whereby the uncertainty corresponds to that given for ConvF. A frequency dependent ConvF is used in DASY version 4.4 and higher which allows extending the validity from ± 50 MHz to ± 100 MHz.
- Spherical isotropy (3D deviation from isotropy)**: in a field of low gradients realized using a flat phantom exposed by a patch antenna.
- Sensor Offset**: The sensor offset corresponds to the offset of virtual measurement center from the probe tip (on probe axis). No tolerance required.
- Connector Angle**: The angle is assessed using the information gained by determining the NORM_x (no uncertainty required).

Probe ES3DV3

SN:3318

Manufactured:	January 10, 2012
Repaired:	September 18, 2017
Calibrated:	September 22, 2017

Calibrated for DASY/EASY Systems
(Note: non-compatible with DASY2 system!)

DASY/EASY - Parameters of Probe: ES3DV3 - SN:3318

Basic Calibration Parameters

	Sensor X	Sensor Y	Sensor Z	Unc (k=2)
Norm ($\mu\text{V}/(\text{V}/\text{m})^2$) ^A	1.02	1.12	0.98	$\pm 10.1 \%$
DCP (mV) ^B	103.7	104.0	102.5	

Modulation Calibration Parameters

UID	Communication System Name		A dB	B dB $\sqrt{\mu\text{V}}$	C	D dB	VR mV	Unc ^E (k=2)
0	CW	X	0.0	0.0	1.0	0.00	183.4	$\pm 3.5 \%$
		Y	0.0	0.0	1.0		193.5	
		Z	0.0	0.0	1.0		183.0	

Note: For details on UID parameters see Appendix.

Sensor Model Parameters

	C1 fF	C2 fF	α V^{-1}	T1 $\text{ms}\cdot\text{V}^{-2}$	T2 $\text{ms}\cdot\text{V}^{-1}$	T3 ms	T4 V^{-2}	T5 V^{-1}	T6
X	40.36	285.5	34.97	23.53	0.939	5.100	1.568	0.156	1.011
Y	40.15	284.7	34.96	25.8	1.330	5.092	1.283	0.265	1.008
Z	38.32	269.2	34.28	24.09	0.917	5.100	0.995	0.237	1.007

The reported uncertainty of measurement is stated as the standard uncertainty of measurement multiplied by the coverage factor $k=2$, which for a normal distribution corresponds to a coverage probability of approximately 95%.

^A The uncertainties of Norm X,Y,Z do not affect the E^2 -field uncertainty inside TSL (see Pages 5 and 6).

^B Numerical linearization parameter: uncertainty not required.

^E Uncertainty is determined using the max. deviation from linear response applying rectangular distribution and is expressed for the square of the field value.

DASY/EASY - Parameters of Probe: ES3DV3 - SN:3318

Calibration Parameter Determined in Head Tissue Simulating Media

f (MHz) ^C	Relative Permittivity ^F	Conductivity (S/m) ^F	ConvF X	ConvF Y	ConvF Z	Alpha ^G	Depth (mm) ^G	Unc (k=2)
750	41.9	0.89	6.72	6.72	6.72	0.80	1.15	± 12.0 %
835	41.5	0.90	6.42	6.42	6.42	0.71	1.26	± 12.0 %
1750	40.1	1.37	5.50	5.50	5.50	0.49	1.50	± 12.0 %
1900	40.0	1.40	5.31	5.31	5.31	0.65	1.29	± 12.0 %
2300	39.5	1.67	4.96	4.96	4.96	0.72	1.27	± 12.0 %
2450	39.2	1.80	4.71	4.71	4.71	0.77	1.26	± 12.0 %
2600	39.0	1.96	4.58	4.58	4.58	0.75	1.32	± 12.0 %

^C Frequency validity above 300 MHz of ± 100 MHz only applies for DASY v4.4 and higher (see Page 2), else it is restricted to ± 50 MHz. The uncertainty is the RSS of the ConvF uncertainty at calibration frequency and the uncertainty for the indicated frequency band. Frequency validity below 300 MHz is ± 10, 25, 40, 50 and 70 MHz for ConvF assessments at 30, 64, 128, 150 and 220 MHz respectively. Above 5 GHz frequency validity can be extended to ± 110 MHz.

^F At frequencies below 3 GHz, the validity of tissue parameters (ϵ and σ) can be relaxed to ± 10% if liquid compensation formula is applied to measured SAR values. At frequencies above 3 GHz, the validity of tissue parameters (ϵ and σ) is restricted to ± 5%. The uncertainty is the RSS of the ConvF uncertainty for indicated target tissue parameters.

^G Alpha/Depth are determined during calibration. SPEAG warrants that the remaining deviation due to the boundary effect after compensation is always less than ± 1% for frequencies below 3 GHz and below ± 2% for frequencies between 3-6 GHz at any distance larger than half the probe tip diameter from the boundary.

DASY/EASY - Parameters of Probe: ES3DV3 - SN:3318

Calibration Parameter Determined in Body Tissue Simulating Media

f (MHz) ^C	Relative Permittivity ^F	Conductivity (S/m) ^F	ConvF X	ConvF Y	ConvF Z	Alpha ^G	Depth ^G (mm)	Unc (k=2)
750	55.5	0.96	6.46	6.46	6.46	0.80	1.21	± 12.0 %
835	55.2	0.97	6.32	6.32	6.32	0.80	1.20	± 12.0 %
1750	53.4	1.49	5.18	5.18	5.18	0.65	1.36	± 12.0 %
1900	53.3	1.52	4.96	4.96	4.96	0.57	1.49	± 12.0 %
2300	52.9	1.81	4.71	4.71	4.71	0.73	1.33	± 12.0 %
2450	52.7	1.95	4.55	4.55	4.55	0.80	1.12	± 12.0 %
2600	52.5	2.16	4.34	4.34	4.34	0.80	1.13	± 12.0 %

^C Frequency validity above 300 MHz of ± 100 MHz only applies for DASY v4.4 and higher (see Page 2), else it is restricted to ± 50 MHz. The uncertainty is the RSS of the ConvF uncertainty at calibration frequency and the uncertainty for the indicated frequency band. Frequency validity below 300 MHz is ± 10, 25, 40, 50 and 70 MHz for ConvF assessments at 30, 64, 128, 150 and 220 MHz respectively. Above 5 GHz frequency validity can be extended to ± 110 MHz.

^F At frequencies below 3 GHz, the validity of tissue parameters (ϵ and σ) can be relaxed to ± 10% if liquid compensation formula is applied to measured SAR values. At frequencies above 3 GHz, the validity of tissue parameters (ϵ and σ) is restricted to ± 5%. The uncertainty is the RSS of the ConvF uncertainty for indicated target tissue parameters.

^G Alpha/Depth are determined during calibration. SPEAG warrants that the remaining deviation due to the boundary effect after compensation is always less than ± 1% for frequencies below 3 GHz and below ± 2% for frequencies between 3-6 GHz at any distance larger than half the probe tip diameter from the boundary.

Frequency Response of E-Field (TEM-Cell:ifi110 EXX, Waveguide: R22)

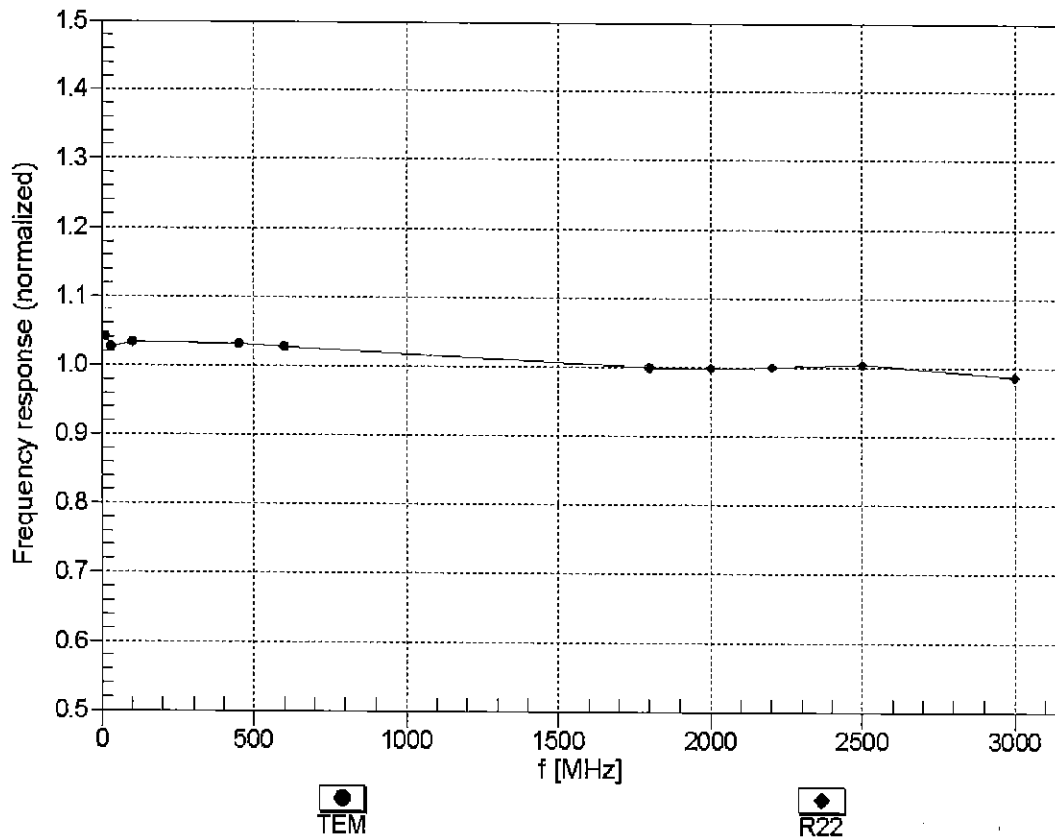

Uncertainty of Frequency Response of E-field: $\pm 6.3\%$ ($k=2$)

Receiving Pattern (ϕ), $\theta = 0^\circ$

f=600 MHz, TEM

f=1800 MHz, R22

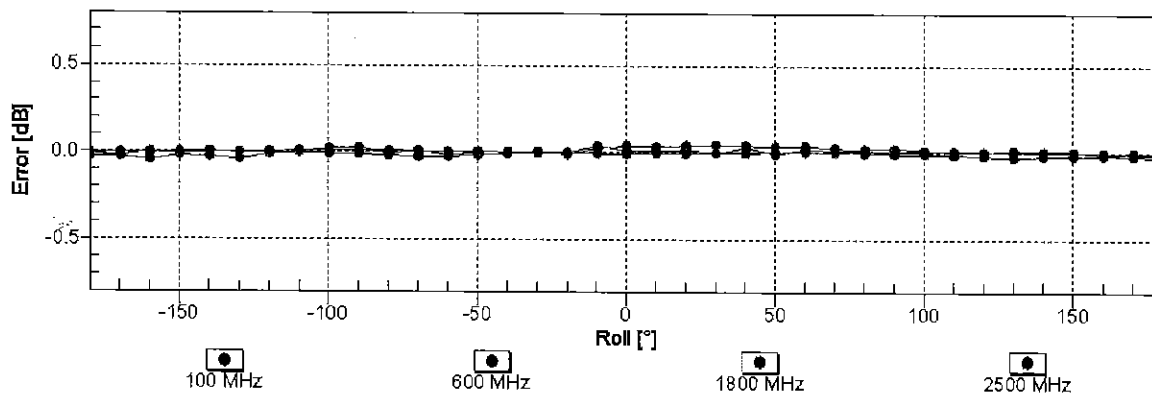
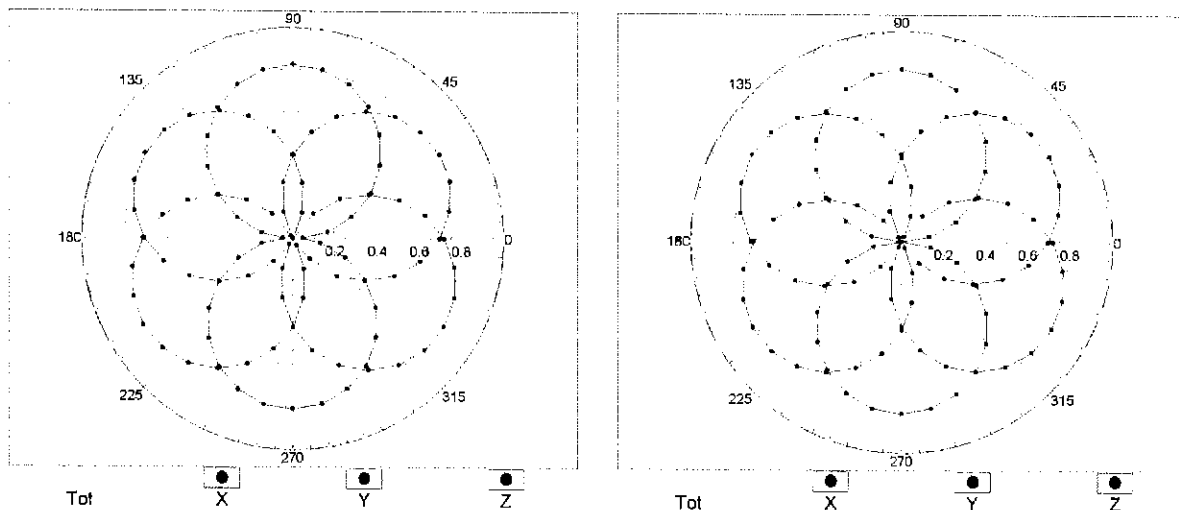

Uncertainty of Axial Isotropy Assessment: $\pm 0.5\%$ (k=2)

Dynamic Range $f(SAR_{head})$ (TEM cell , $f_{eval} = 1900$ MHz)

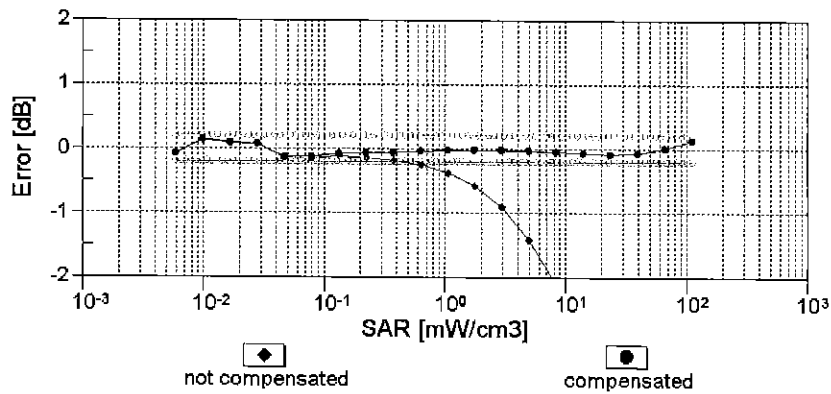
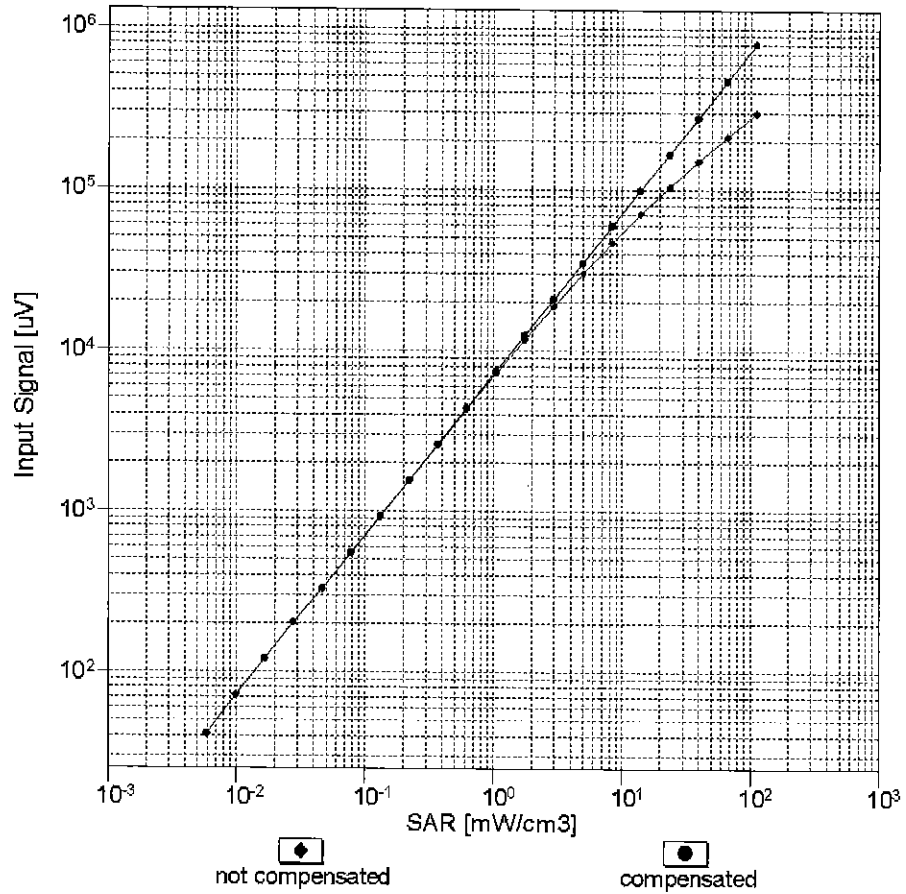

Uncertainty of Linearity Assessment: ± 0.6% (k=2)

Conversion Factor Assessment

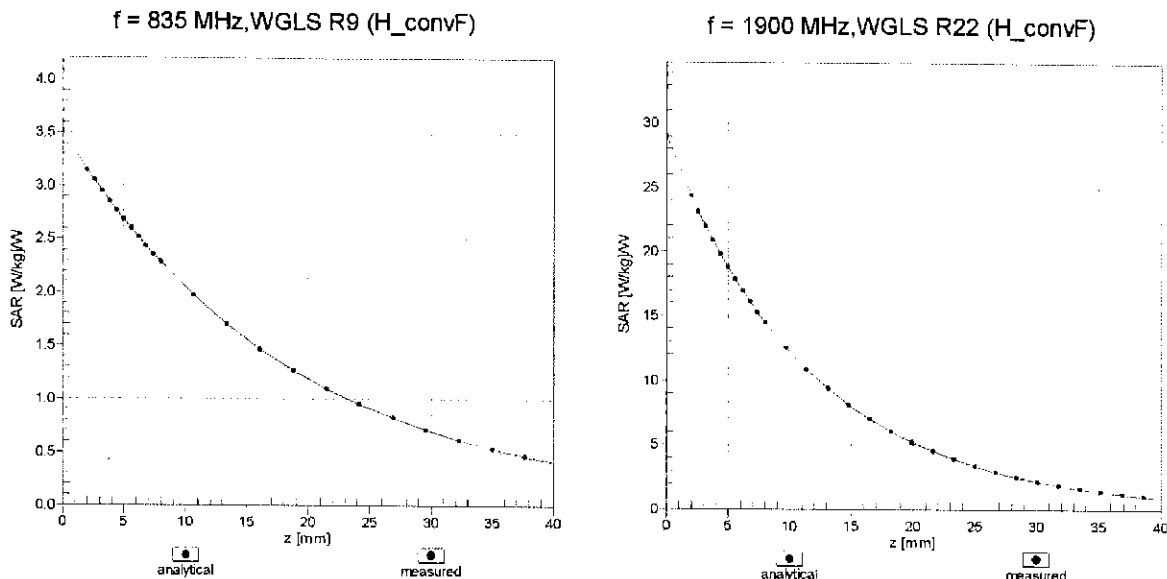

Deviation from Isotropy in Liquid Error (ϕ, θ), f = 900 MHz

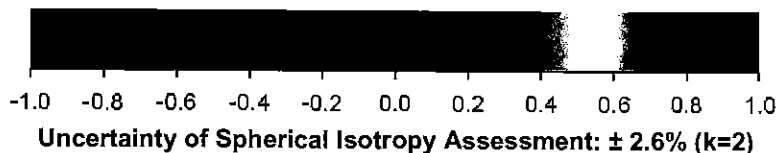
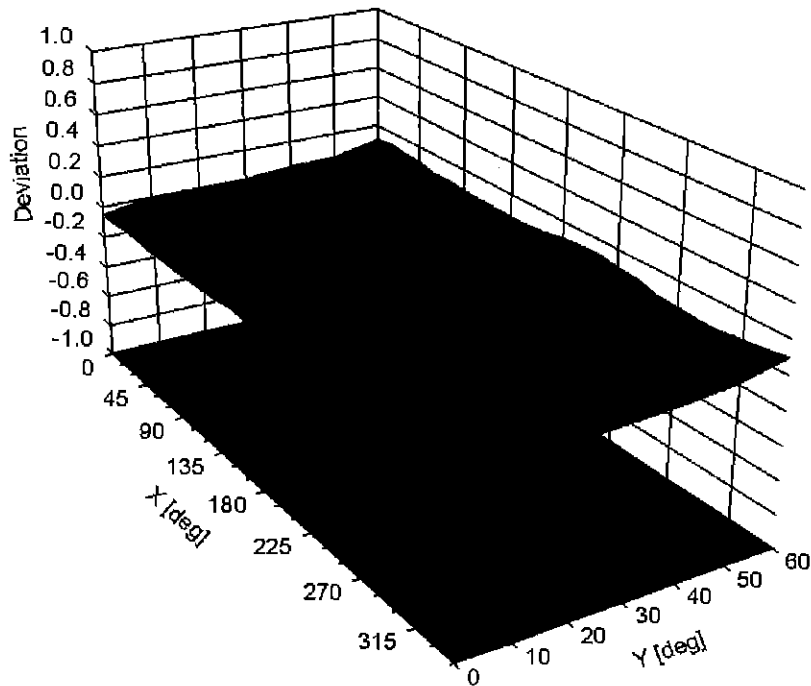

DASY/EASY - Parameters of Probe: ES3DV3 - SN:3318**Other Probe Parameters**

Sensor Arrangement	Triangular
Connector Angle (°)	80.2
Mechanical Surface Detection Mode	enabled
Optical Surface Detection Mode	disabled
Probe Overall Length	337 mm
Probe Body Diameter	10 mm
Tip Length	10 mm
Tip Diameter	4 mm
Probe Tip to Sensor X Calibration Point	2 mm
Probe Tip to Sensor Y Calibration Point	2 mm
Probe Tip to Sensor Z Calibration Point	2 mm
Recommended Measurement Distance from Surface	3 mm

Appendix: Modulation Calibration Parameters

UID	Communication System Name		A dB	B dB/μV	C	D dB	VR mV	Max Unc ^E (k=2)
0	CW	X	0.00	0.00	1.00	0.00	183.4	± 3.5 %
		Y	0.00	0.00	1.00		193.5	
		Z	0.00	0.00	1.00		183.0	
10010- CAA	SAR Validation (Square, 100ms, 10ms)	X	100.00	113.13	27.11	10.00	25.0	± 9.6 %
		Y	56.27	106.32	26.04		25.0	
		Z	48.42	102.92	24.36		25.0	
10011- CAB	UMTS-FDD (WCDMA)	X	2.66	86.53	24.90	0.00	150.0	± 9.6 %
		Y	1.68	77.14	20.67		150.0	
		Z	1.29	72.20	18.01		150.0	
10012- CAB	IEEE 802.11b WiFi 2.4 GHz (DSSS, 1 Mbps)	X	1.46	68.78	18.94	0.41	150.0	± 9.6 %
		Y	1.42	67.66	17.93		150.0	
		Z	1.34	66.38	16.88		150.0	
10013- CAB	IEEE 802.11g WiFi 2.4 GHz (DSSS-OFDM, 6 Mbps)	X	5.02	68.02	18.09	1.46	150.0	± 9.6 %
		Y	5.02	67.88	17.89		150.0	
		Z	4.94	67.70	17.67		150.0	
10021- DAC	GSM-FDD (TDMA, GMSK)	X	100.00	121.76	31.97	9.39	50.0	± 9.6 %
		Y	100.00	121.57	32.33		50.0	
		Z	100.00	120.24	31.25		50.0	
10023- DAC	GPRS-FDD (TDMA, GMSK, TN 0)	X	100.00	121.43	31.86	9.57	50.0	± 9.6 %
		Y	100.00	121.34	32.26		50.0	
		Z	100.00	119.95	31.15		50.0	
10024- DAC	GPRS-FDD (TDMA, GMSK, TN 0-1)	X	100.00	120.99	30.63	6.56	60.0	± 9.6 %
		Y	100.00	119.61	30.34		60.0	
		Z	100.00	118.45	29.44		60.0	
10025- DAC	EDGE-FDD (TDMA, 8PSK, TN 0)	X	27.34	129.78	51.29	12.57	50.0	± 9.6 %
		Y	16.72	108.51	42.49		50.0	
		Z	41.36	141.52	54.29		50.0	
10026- DAC	EDGE-FDD (TDMA, 8PSK, TN 0-1)	X	51.11	136.85	47.83	9.56	60.0	± 9.6 %
		Y	25.23	114.58	40.30		60.0	
		Z	34.77	125.06	43.92		60.0	
10027- DAC	GPRS-FDD (TDMA, GMSK, TN 0-1-2)	X	100.00	123.21	30.86	4.80	80.0	± 9.6 %
		Y	100.00	120.40	29.90		80.0	
		Z	100.00	119.24	29.05		80.0	
10028- DAC	GPRS-FDD (TDMA, GMSK, TN 0-1-2-3)	X	100.00	127.88	32.20	3.55	100.0	± 9.6 %
		Y	100.00	123.11	30.36		100.0	
		Z	100.00	121.73	29.45		100.0	
10029- DAC	EDGE-FDD (TDMA, 8PSK, TN 0-1-2)	X	16.47	106.41	37.26	7.80	80.0	± 9.6 %
		Y	13.16	98.31	33.75		80.0	
		Z	13.79	100.84	34.87		80.0	
10030- CAA	IEEE 802.15.1 Bluetooth (GFSK, DH1)	X	100.00	120.38	29.87	5.30	70.0	± 9.6 %
		Y	100.00	118.42	29.28		70.0	
		Z	100.00	117.17	28.39		70.0	
10031- CAA	IEEE 802.15.1 Bluetooth (GFSK, DH3)	X	100.00	140.58	36.01	1.88	100.0	± 9.6 %
		Y	100.00	129.80	31.70		100.0	
		Z	100.00	126.35	29.95		100.0	

10032-CAA	IEEE 802.15.1 Bluetooth (GFSK, DH5)	X	100.00	168.14	46.04	1.17	100.0	± 9.6 %
		Y	100.00	146.16	37.32		100.0	
		Z	100.00	139.03	34.08		100.0	
10033-CAA	IEEE 802.15.1 Bluetooth (PI/4-DQPSK, DH1)	X	100.00	128.00	34.78	5.30	70.0	± 9.6 %
		Y	100.00	125.47	33.78		70.0	
		Z	100.00	124.94	33.27		70.0	
10034-CAA	IEEE 802.15.1 Bluetooth (PI/4-DQPSK, DH3)	X	100.00	127.76	32.85	1.88	100.0	± 9.6 %
		Y	100.00	124.38	31.40		100.0	
		Z	100.00	122.39	30.30		100.0	
10035-CAA	IEEE 802.15.1 Bluetooth (PI/4-DQPSK, DH5)	X	100.00	129.00	32.88	1.17	100.0	± 9.6 %
		Y	100.00	125.22	31.24		100.0	
		Z	42.89	111.69	27.45		100.0	
10036-CAA	IEEE 802.15.1 Bluetooth (8-DPSK, DH1)	X	100.00	128.35	34.94	5.30	70.0	± 9.6 %
		Y	100.00	125.78	33.93		70.0	
		Z	100.00	125.27	33.42		70.0	
10037-CAA	IEEE 802.15.1 Bluetooth (8-DPSK, DH3)	X	100.00	127.83	32.85	1.88	100.0	± 9.6 %
		Y	100.00	124.40	31.38		100.0	
		Z	100.00	122.41	30.28		100.0	
10038-CAA	IEEE 802.15.1 Bluetooth (8-DPSK, DH5)	X	100.00	129.90	33.29	1.17	100.0	± 9.6 %
		Y	100.00	126.04	31.61		100.0	
		Z	46.73	113.50	28.05		100.0	
10039-CAB	CDMA2000 (1xRTT, RC1)	X	100.00	131.54	33.19	0.00	150.0	± 9.6 %
		Y	52.05	119.24	29.67		150.0	
		Z	3.76	82.84	19.15		150.0	
10042-CAB	IS-54 / IS-136 FDD (TDMA/FDM, PI/4-DQPSK, Halfrate)	X	100.00	118.03	29.44	7.78	50.0	± 9.6 %
		Y	100.00	117.44	29.54		50.0	
		Z	100.00	116.07	28.52		50.0	
10044-CAA	IS-91/EIA/TIA-553 FDD (FDMA, FM)	X	0.01	105.46	9.85	0.00	150.0	± 9.6 %
		Y	0.03	60.00	39.49		150.0	
		Z	0.02	60.00	28.89		150.0	
10048-CAA	DECT (TDD, TDMA/FDM, GFSK, Full Slot, 24)	X	100.00	123.25	33.96	13.80	25.0	± 9.6 %
		Y	100.00	123.00	34.45		25.0	
		Z	100.00	122.08	33.38		25.0	
10049-CAA	DECT (TDD, TDMA/FDM, GFSK, Double Slot, 12)	X	100.00	121.02	31.95	10.79	40.0	± 9.6 %
		Y	100.00	121.43	32.63		40.0	
		Z	100.00	119.80	31.36		40.0	
10056-CAA	UMTS-TDD (TD-SCDMA, 1.28 Mcps)	X	100.00	126.02	35.11	9.03	50.0	± 9.6 %
		Y	69.75	118.57	33.24		50.0	
		Z	100.00	124.37	34.25		50.0	
10058-DAC	EDGE-FDD (TDMA, 8PSK, TN 0-1-2-3)	X	9.73	93.83	32.07	6.55	100.0	± 9.6 %
		Y	8.94	89.89	29.98		100.0	
		Z	8.70	90.23	30.24		100.0	
10059-CAB	IEEE 802.11b WiFi 2.4 GHz (DSSS, 2 Mbps)	X	1.70	72.06	20.55	0.61	110.0	± 9.6 %
		Y	1.64	70.58	19.34		110.0	
		Z	1.50	68.77	18.10		110.0	
10060-CAB	IEEE 802.11b WiFi 2.4 GHz (DSSS, 5.5 Mbps)	X	100.00	148.21	40.90	1.30	110.0	± 9.6 %
		Y	100.00	141.35	37.99		110.0	
		Z	100.00	139.41	36.95		110.0	

10061-CAB	IEEE 802.11b WiFi 2.4 GHz (DSSS, 11 Mbps)	X	100.00	146.12	41.94	2.04	110.0	± 9.6 %
		Y	100.00	141.22	39.79		110.0	
		Z	39.08	124.31	35.57		110.0	
10062-CAB	IEEE 802.11a/h WiFi 5 GHz (OFDM, 6 Mbps)	X	4.78	67.89	17.44	0.49	100.0	± 9.6 %
		Y	4.76	67.70	17.22		100.0	
		Z	4.68	67.49	16.96		100.0	
10063-CAB	IEEE 802.11a/h WiFi 5 GHz (OFDM, 9 Mbps)	X	4.81	68.05	17.58	0.72	100.0	± 9.6 %
		Y	4.79	67.86	17.35		100.0	
		Z	4.71	67.65	17.10		100.0	
10064-CAB	IEEE 802.11a/h WiFi 5 GHz (OFDM, 12 Mbps)	X	5.07	68.24	17.76	0.86	100.0	± 9.6 %
		Y	5.05	68.06	17.55		100.0	
		Z	4.97	67.86	17.30		100.0	
10065-CAB	IEEE 802.11a/h WiFi 5 GHz (OFDM, 18 Mbps)	X	4.97	68.22	17.93	1.21	100.0	± 9.6 %
		Y	4.96	68.06	17.72		100.0	
		Z	4.87	67.84	17.47		100.0	
10066-CAB	IEEE 802.11a/h WiFi 5 GHz (OFDM, 24 Mbps)	X	5.00	68.29	18.13	1.46	100.0	± 9.6 %
		Y	5.00	68.14	17.92		100.0	
		Z	4.91	67.92	17.68		100.0	
10067-CAB	IEEE 802.11a/h WiFi 5 GHz (OFDM, 36 Mbps)	X	5.32	68.56	18.62	2.04	100.0	± 9.6 %
		Y	5.32	68.43	18.41		100.0	
		Z	5.23	68.26	18.21		100.0	
10068-CAB	IEEE 802.11a/h WiFi 5 GHz (OFDM, 48 Mbps)	X	5.38	68.60	18.85	2.55	100.0	± 9.6 %
		Y	5.39	68.49	18.65		100.0	
		Z	5.29	68.30	18.45		100.0	
10069-CAB	IEEE 802.11a/h WiFi 5 GHz (OFDM, 54 Mbps)	X	5.45	68.63	19.05	2.67	100.0	± 9.6 %
		Y	5.47	68.52	18.85		100.0	
		Z	5.37	68.35	18.66		100.0	
10071-CAB	IEEE 802.11g WiFi 2.4 GHz (DSSS/OFDM, 9 Mbps)	X	5.14	68.16	18.43	1.99	100.0	± 9.6 %
		Y	5.15	68.05	18.24		100.0	
		Z	5.06	67.88	18.03		100.0	
10072-CAB	IEEE 802.11g WiFi 2.4 GHz (DSSS/OFDM, 12 Mbps)	X	5.16	68.64	18.75	2.30	100.0	± 9.6 %
		Y	5.17	68.53	18.56		100.0	
		Z	5.08	68.32	18.34		100.0	
10073-CAB	IEEE 802.11g WiFi 2.4 GHz (DSSS/OFDM, 18 Mbps)	X	5.27	68.97	19.18	2.83	100.0	± 9.6 %
		Y	5.29	68.88	18.98		100.0	
		Z	5.19	68.68	18.77		100.0	
10074-CAB	IEEE 802.11g WiFi 2.4 GHz (DSSS/OFDM, 24 Mbps)	X	5.29	68.99	19.39	3.30	100.0	± 9.6 %
		Y	5.33	68.94	19.20		100.0	
		Z	5.23	68.74	19.00		100.0	
10075-CAB	IEEE 802.11g WiFi 2.4 GHz (DSSS/OFDM, 36 Mbps)	X	5.36	69.20	19.76	3.82	90.0	± 9.6 %
		Y	5.42	69.18	19.58		90.0	
		Z	5.30	68.95	19.38		90.0	
10076-CAB	IEEE 802.11g WiFi 2.4 GHz (DSSS/OFDM, 48 Mbps)	X	5.40	69.06	19.93	4.15	90.0	± 9.6 %
		Y	5.47	69.07	19.76		90.0	
		Z	5.35	68.86	19.58		90.0	
10077-CAB	IEEE 802.11g WiFi 2.4 GHz (DSSS/OFDM, 54 Mbps)	X	5.44	69.18	20.05	4.30	90.0	± 9.6 %
		Y	5.51	69.19	19.88		90.0	
		Z	5.40	68.99	19.71		90.0	

10081-CAB	CDMA2000 (1xRTT, RC3)	X	100.00	135.94	34.03	0.00	150.0	± 9.6 %
		Y	4.36	89.76	21.79		150.0	
		Z	1.23	72.30	14.98		150.0	
10082-CAB	IS-54 / IS-136 FDD (TDMA/FDM, PI/4-DQPSK, Fullrate)	X	1.46	62.74	7.36	4.77	80.0	± 9.6 %
		Y	1.67	63.13	7.83		80.0	
		Z	1.40	62.09	6.92		80.0	
10090-DAC	GPRS-FDD (TDMA, GMSK, TN 0-4)	X	100.00	121.01	30.66	6.56	60.0	± 9.6 %
		Y	100.00	119.66	30.39		60.0	
		Z	100.00	118.49	29.48		60.0	
10097-CAB	UMTS-FDD (HSDPA)	X	2.68	75.81	20.12	0.00	150.0	± 9.6 %
		Y	2.34	73.02	18.58		150.0	
		Z	2.07	70.78	17.18		150.0	
10098-CAB	UMTS-FDD (HSUPA, Subtest 2)	X	2.65	75.95	20.19	0.00	150.0	± 9.6 %
		Y	2.30	73.06	18.61		150.0	
		Z	2.03	70.77	17.19		150.0	
10099-DAC	EDGE-FDD (TDMA, 8PSK, TN 0-4)	X	51.37	136.92	47.83	9.56	60.0	± 9.6 %
		Y	25.26	114.55	40.28		60.0	
		Z	34.93	125.12	43.92		60.0	
10100-CAD	LTE-FDD (SC-FDMA, 100% RB, 20 MHz, QPSK)	X	3.91	75.35	19.66	0.00	150.0	± 9.6 %
		Y	3.58	73.57	18.67		150.0	
		Z	3.29	72.01	17.75		150.0	
10101-CAD	LTE-FDD (SC-FDMA, 100% RB, 20 MHz, 16-QAM)	X	3.50	69.80	17.58	0.00	150.0	± 9.6 %
		Y	3.39	69.08	17.05		150.0	
		Z	3.27	68.42	16.53		150.0	
10102-CAD	LTE-FDD (SC-FDMA, 100% RB, 20 MHz, 64-QAM)	X	3.58	69.60	17.56	0.00	150.0	± 9.6 %
		Y	3.49	68.97	17.09		150.0	
		Z	3.37	68.35	16.58		150.0	
10103-CAD	LTE-TDD (SC-FDMA, 100% RB, 20 MHz, QPSK)	X	10.46	84.85	24.49	3.98	65.0	± 9.6 %
		Y	9.76	82.69	23.44		65.0	
		Z	9.49	82.61	23.35		65.0	
10104-CAD	LTE-TDD (SC-FDMA, 100% RB, 20 MHz, 16-QAM)	X	8.62	79.80	23.37	3.98	65.0	± 9.6 %
		Y	8.54	78.80	22.69		65.0	
		Z	8.26	78.63	22.58		65.0	
10105-CAD	LTE-TDD (SC-FDMA, 100% RB, 20 MHz, 64-QAM)	X	8.48	79.41	23.51	3.98	65.0	± 9.6 %
		Y	7.84	77.04	22.24		65.0	
		Z	7.95	77.81	22.54		65.0	
10108-CAE	LTE-FDD (SC-FDMA, 100% RB, 10 MHz, QPSK)	X	3.42	74.91	19.71	0.00	150.0	± 9.6 %
		Y	3.13	73.04	18.65		150.0	
		Z	2.86	71.41	17.66		150.0	
10109-CAE	LTE-FDD (SC-FDMA, 100% RB, 10 MHz, 16-QAM)	X	3.19	70.21	17.75	0.00	150.0	± 9.6 %
		Y	3.07	69.34	17.14		150.0	
		Z	2.93	68.52	16.50		150.0	
10110-CAE	LTE-FDD (SC-FDMA, 100% RB, 5 MHz, QPSK)	X	2.94	75.32	19.95	0.00	150.0	± 9.6 %
		Y	2.62	72.92	18.60		150.0	
		Z	2.34	70.98	17.41		150.0	
10111-CAE	LTE-FDD (SC-FDMA, 100% RB, 5 MHz, 16-QAM)	X	3.13	72.86	18.80	0.00	150.0	± 9.6 %
		Y	2.95	71.56	17.99		150.0	
		Z	2.72	70.10	16.99		150.0	

10112-CAE	LTE-FDD (SC-FDMA, 100% RB, 10 MHz, 64-QAM)	X	3.29	70.03	17.69	0.00	150.0	± 9.6 %
		Y	3.18	69.26	17.13		150.0	
		Z	3.05	68.50	16.53		150.0	
10113-CAE	LTE-FDD (SC-FDMA, 100% RB, 5 MHz, 64-QAM)	X	3.26	72.71	18.75	0.00	150.0	± 9.6 %
		Y	3.09	71.55	18.02		150.0	
		Z	2.86	70.17	17.07		150.0	
10114-CAB	IEEE 802.11n (HT Greenfield, 13.5 Mbps, BPSK)	X	5.20	68.15	17.23	0.00	150.0	± 9.6 %
		Y	5.17	67.92	17.01		150.0	
		Z	5.08	67.68	16.75		150.0	
10115-CAB	IEEE 802.11n (HT Greenfield, 81 Mbps, 16-QAM)	X	5.45	68.16	17.22	0.00	150.0	± 9.6 %
		Y	5.42	67.95	17.02		150.0	
		Z	5.33	67.74	16.77		150.0	
10116-CAB	IEEE 802.11n (HT Greenfield, 135 Mbps, 64-QAM)	X	5.30	68.36	17.26	0.00	150.0	± 9.6 %
		Y	5.26	68.13	17.04		150.0	
		Z	5.17	67.89	16.78		150.0	
10117-CAB	IEEE 802.11n (HT Mixed, 13.5 Mbps, BPSK)	X	5.18	68.04	17.19	0.00	150.0	± 9.6 %
		Y	5.14	67.83	16.98		150.0	
		Z	5.07	67.63	16.74		150.0	
10118-CAB	IEEE 802.11n (HT Mixed, 81 Mbps, 16-QAM)	X	5.54	68.41	17.35	0.00	150.0	± 9.6 %
		Y	5.51	68.19	17.14		150.0	
		Z	5.41	67.95	16.89		150.0	
10119-CAB	IEEE 802.11n (HT Mixed, 135 Mbps, 64-QAM)	X	5.29	68.34	17.26	0.00	150.0	± 9.6 %
		Y	5.25	68.12	17.04		150.0	
		Z	5.16	67.88	16.78		150.0	
10140-CAD	LTE-FDD (SC-FDMA, 100% RB, 15 MHz, 16-QAM)	X	3.61	69.64	17.49	0.00	150.0	± 9.6 %
		Y	3.52	68.99	17.00		150.0	
		Z	3.39	68.38	16.51		150.0	
10141-CAD	LTE-FDD (SC-FDMA, 100% RB, 15 MHz, 64-QAM)	X	3.73	69.64	17.59	0.00	150.0	± 9.6 %
		Y	3.64	69.06	17.15		150.0	
		Z	3.51	68.48	16.66		150.0	
10142-CAD	LTE-FDD (SC-FDMA, 100% RB, 3 MHz, QPSK)	X	3.10	78.13	20.64	0.00	150.0	± 9.6 %
		Y	2.57	74.51	18.81		150.0	
		Z	2.18	71.67	17.19		150.0	
10143-CAD	LTE-FDD (SC-FDMA, 100% RB, 3 MHz, 16-QAM)	X	3.55	76.59	19.53	0.00	150.0	± 9.6 %
		Y	3.13	74.18	18.27		150.0	
		Z	2.68	71.54	16.74		150.0	
10144-CAD	LTE-FDD (SC-FDMA, 100% RB, 3 MHz, 64-QAM)	X	2.79	71.64	16.81	0.00	150.0	± 9.6 %
		Y	2.50	69.67	15.66		150.0	
		Z	2.26	68.10	14.57		150.0	
10145-CAE	LTE-FDD (SC-FDMA, 100% RB, 1.4 MHz, QPSK)	X	3.29	79.35	17.65	0.00	150.0	± 9.6 %
		Y	1.58	69.65	13.52		150.0	
		Z	1.10	65.19	10.91		150.0	
10146-CAE	LTE-FDD (SC-FDMA, 100% RB, 1.4 MHz, 16-QAM)	X	10.51	86.51	18.78	0.00	150.0	± 9.6 %
		Y	2.34	69.06	12.29		150.0	
		Z	1.46	64.05	9.40		150.0	
10147-CAE	LTE-FDD (SC-FDMA, 100% RB, 1.4 MHz, 64-QAM)	X	100.00	112.53	25.58	0.00	150.0	± 9.6 %
		Y	3.94	74.93	14.77		150.0	
		Z	1.65	65.37	10.17		150.0	

10149-CAD	LTE-FDD (SC-FDMA, 50% RB, 20 MHz, 16-QAM)	X	3.20	70.28	17.80	0.00	150.0	± 9.6 %
		Y	3.08	69.42	17.19		150.0	
		Z	2.94	68.59	16.55		150.0	
10150-CAD	LTE-FDD (SC-FDMA, 50% RB, 20 MHz, 64-QAM)	X	3.30	70.10	17.74	0.00	150.0	± 9.6 %
		Y	3.19	69.33	17.18		150.0	
		Z	3.06	68.56	16.57		150.0	
10151-CAD	LTE-TDD (SC-FDMA, 50% RB, 20 MHz, QPSK)	X	12.94	90.52	26.60	3.98	65.0	± 9.6 %
		Y	11.63	87.44	25.23		65.0	
		Z	11.21	87.22	25.07		65.0	
10152-CAD	LTE-TDD (SC-FDMA, 50% RB, 20 MHz, 16-QAM)	X	8.51	80.82	23.41	3.98	65.0	± 9.6 %
		Y	8.31	79.48	22.59		65.0	
		Z	8.01	79.28	22.44		65.0	
10153-CAD	LTE-TDD (SC-FDMA, 50% RB, 20 MHz, 64-QAM)	X	9.02	81.90	24.19	3.98	65.0	± 9.6 %
		Y	8.86	80.67	23.43		65.0	
		Z	8.54	80.43	23.26		65.0	
10154-CAE	LTE-FDD (SC-FDMA, 50% RB, 10 MHz, QPSK)	X	3.03	75.93	20.26	0.00	150.0	± 9.6 %
		Y	2.70	73.52	18.93		150.0	
		Z	2.40	71.40	17.66		150.0	
10155-CAE	LTE-FDD (SC-FDMA, 50% RB, 10 MHz, 16-QAM)	X	3.14	72.90	18.83	0.00	150.0	± 9.6 %
		Y	2.95	71.60	18.01		150.0	
		Z	2.72	70.14	17.02		150.0	
10156-CAE	LTE-FDD (SC-FDMA, 50% RB, 5 MHz, QPSK)	X	3.42	81.12	21.46	0.00	150.0	± 9.6 %
		Y	2.60	76.04	19.11		150.0	
		Z	2.06	72.15	17.02		150.0	
10157-CAE	LTE-FDD (SC-FDMA, 50% RB, 5 MHz, 16-QAM)	X	3.03	74.63	17.79	0.00	150.0	± 9.6 %
		Y	2.53	71.54	16.20		150.0	
		Z	2.15	69.02	14.66		150.0	
10158-CAE	LTE-FDD (SC-FDMA, 50% RB, 10 MHz, 64-QAM)	X	3.27	72.81	18.82	0.00	150.0	± 9.6 %
		Y	3.10	71.66	18.08		150.0	
		Z	2.87	70.26	17.13		150.0	
10159-CAE	LTE-FDD (SC-FDMA, 50% RB, 5 MHz, 64-QAM)	X	3.21	75.21	18.07	0.00	150.0	± 9.6 %
		Y	2.69	72.18	16.53		150.0	
		Z	2.25	69.45	14.90		150.0	
10160-CAD	LTE-FDD (SC-FDMA, 50% RB, 15 MHz, QPSK)	X	3.31	73.32	19.12	0.00	150.0	± 9.6 %
		Y	3.09	71.84	18.22		150.0	
		Z	2.86	70.49	17.35		150.0	
10161-CAD	LTE-FDD (SC-FDMA, 50% RB, 15 MHz, 16-QAM)	X	3.21	70.26	17.75	0.00	150.0	± 9.6 %
		Y	3.10	69.43	17.16		150.0	
		Z	2.95	68.59	16.50		150.0	
10162-CAD	LTE-FDD (SC-FDMA, 50% RB, 15 MHz, 64-QAM)	X	3.33	70.39	17.83	0.00	150.0	± 9.6 %
		Y	3.21	69.59	17.26		150.0	
		Z	3.06	68.78	16.62		150.0	
10166-CAE	LTE-FDD (SC-FDMA, 50% RB, 1.4 MHz, QPSK)	X	3.94	73.38	21.77	3.01	150.0	± 9.6 %
		Y	3.79	72.11	20.84		150.0	
		Z	3.50	70.74	19.96		150.0	
10167-CAE	LTE-FDD (SC-FDMA, 50% RB, 1.4 MHz, 16-QAM)	X	5.65	79.78	23.51	3.01	150.0	± 9.6 %
		Y	5.10	77.08	22.03		150.0	
		Z	4.43	74.72	20.82		150.0	

10168-CAE	LTE-FDD (SC-FDMA, 50% RB, 1.4 MHz, 64-QAM)	X	6.73	83.76	25.44	3.01	150.0	± 9.6 %
		Y	6.02	80.78	23.93		150.0	
		Z	5.04	77.58	22.39		150.0	
10169-CAD	LTE-FDD (SC-FDMA, 1 RB, 20 MHz, QPSK)	X	3.37	73.36	21.96	3.01	150.0	± 9.6 %
		Y	3.23	71.75	20.78		150.0	
		Z	2.89	69.73	19.58		150.0	
10170-CAD	LTE-FDD (SC-FDMA, 1 RB, 20 MHz, 16-QAM)	X	6.39	86.84	27.07	3.01	150.0	± 9.6 %
		Y	5.38	82.06	24.76		150.0	
		Z	4.13	77.19	22.57		150.0	
10171-AAD	LTE-FDD (SC-FDMA, 1 RB, 20 MHz, 64-QAM)	X	4.69	79.68	23.25	3.01	150.0	± 9.6 %
		Y	4.06	75.75	21.17		150.0	
		Z	3.35	72.68	19.64		150.0	
10172-CAD	LTE-TDD (SC-FDMA, 1 RB, 20 MHz, QPSK)	X	100.00	146.59	45.53	6.02	65.0	± 9.6 %
		Y	40.14	123.32	38.78		65.0	
		Z	46.23	127.51	39.93		65.0	
10173-CAD	LTE-TDD (SC-FDMA, 1 RB, 20 MHz, 16-QAM)	X	100.00	136.26	40.09	6.02	65.0	± 9.6 %
		Y	100.00	132.71	38.54		65.0	
		Z	100.00	133.96	38.85		65.0	
10174-CAD	LTE-TDD (SC-FDMA, 1 RB, 20 MHz, 64-QAM)	X	100.00	133.98	38.85	6.02	65.0	± 9.6 %
		Y	100.00	130.96	37.56		65.0	
		Z	100.00	131.78	37.67		65.0	
10175-CAE	LTE-FDD (SC-FDMA, 1 RB, 10 MHz, QPSK)	X	3.32	73.00	21.69	3.01	150.0	± 9.6 %
		Y	3.19	71.38	20.50		150.0	
		Z	2.86	69.46	19.35		150.0	
10176-CAE	LTE-FDD (SC-FDMA, 1 RB, 10 MHz, 16-QAM)	X	6.41	86.88	27.08	3.01	150.0	± 9.6 %
		Y	5.39	82.10	24.78		150.0	
		Z	4.14	77.22	22.58		150.0	
10177-CAG	LTE-FDD (SC-FDMA, 1 RB, 5 MHz, QPSK)	X	3.35	73.17	21.78	3.01	150.0	± 9.6 %
		Y	3.21	71.55	20.60		150.0	
		Z	2.88	69.58	19.42		150.0	
10178-CAE	LTE-FDD (SC-FDMA, 1 RB, 5 MHz, 16-QAM)	X	6.32	86.56	26.94	3.01	150.0	± 9.6 %
		Y	5.33	81.82	24.65		150.0	
		Z	4.11	77.04	22.49		150.0	
10179-CAE	LTE-FDD (SC-FDMA, 1 RB, 10 MHz, 64-QAM)	X	5.51	83.28	25.09	3.01	150.0	± 9.6 %
		Y	4.67	78.80	22.85		150.0	
		Z	3.72	74.89	21.01		150.0	
10180-CAE	LTE-FDD (SC-FDMA, 1 RB, 5 MHz, 64-QAM)	X	4.68	79.60	23.20	3.01	150.0	± 9.6 %
		Y	4.04	75.67	21.12		150.0	
		Z	3.35	72.63	19.61		150.0	
10181-CAD	LTE-FDD (SC-FDMA, 1 RB, 15 MHz, QPSK)	X	3.35	73.15	21.78	3.01	150.0	± 9.6 %
		Y	3.21	71.53	20.59		150.0	
		Z	2.87	69.57	19.42		150.0	
10182-CAD	LTE-FDD (SC-FDMA, 1 RB, 15 MHz, 16-QAM)	X	6.31	86.52	26.93	3.01	150.0	± 9.6 %
		Y	5.32	81.78	24.63		150.0	
		Z	4.10	77.02	22.48		150.0	
10183-AAC	LTE-FDD (SC-FDMA, 1 RB, 15 MHz, 64-QAM)	X	4.66	79.56	23.19	3.01	150.0	± 9.6 %
		Y	4.04	75.64	21.10		150.0	
		Z	3.34	72.61	19.60		150.0	

10184-CAD	LTE-FDD (SC-FDMA, 1 RB, 3 MHz, QPSK)	X	3.36	73.20	21.80	3.01	150.0	± 9.6 %
		Y	3.22	71.58	20.61		150.0	
		Z	2.88	69.61	19.44		150.0	
10185-CAD	LTE-FDD (SC-FDMA, 1 RB, 3 MHz, 16-QAM)	X	6.35	86.64	26.98	3.01	150.0	± 9.6 %
		Y	5.35	81.89	24.68		150.0	
		Z	4.12	77.10	22.52		150.0	
10186-AAD	LTE-FDD (SC-FDMA, 1 RB, 3 MHz, 64-QAM)	X	4.70	79.67	23.24	3.01	150.0	± 9.6 %
		Y	4.06	75.73	21.14		150.0	
		Z	3.36	72.68	19.63		150.0	
10187-CAE	LTE-FDD (SC-FDMA, 1 RB, 1.4 MHz, QPSK)	X	3.37	73.27	21.88	3.01	150.0	± 9.6 %
		Y	3.23	71.66	20.69		150.0	
		Z	2.89	69.68	19.51		150.0	
10188-CAE	LTE-FDD (SC-FDMA, 1 RB, 1.4 MHz, 16-QAM)	X	6.67	87.77	27.49	3.01	150.0	± 9.6 %
		Y	5.59	82.87	25.16		150.0	
		Z	4.25	77.76	22.89		150.0	
10189-AAE	LTE-FDD (SC-FDMA, 1 RB, 1.4 MHz, 64-QAM)	X	4.86	80.38	23.61	3.01	150.0	± 9.6 %
		Y	4.18	76.34	21.49		150.0	
		Z	3.43	73.12	19.92		150.0	
10193-CAB	IEEE 802.11n (HT Greenfield, 6.5 Mbps, BPSK)	X	4.60	67.78	17.00	0.00	150.0	± 9.6 %
		Y	4.56	67.53	16.75		150.0	
		Z	4.48	67.31	16.48		150.0	
10194-CAB	IEEE 802.11n (HT Greenfield, 39 Mbps, 16-QAM)	X	4.76	68.05	17.13	0.00	150.0	± 9.6 %
		Y	4.72	67.80	16.88		150.0	
		Z	4.63	67.57	16.61		150.0	
10195-CAB	IEEE 802.11n (HT Greenfield, 65 Mbps, 64-QAM)	X	4.80	68.07	17.14	0.00	150.0	± 9.6 %
		Y	4.75	67.82	16.90		150.0	
		Z	4.67	67.59	16.62		150.0	
10196-CAB	IEEE 802.11n (HT Mixed, 6.5 Mbps, BPSK)	X	4.59	67.81	17.01	0.00	150.0	± 9.6 %
		Y	4.55	67.56	16.76		150.0	
		Z	4.47	67.33	16.48		150.0	
10197-CAB	IEEE 802.11n (HT Mixed, 39 Mbps, 16-QAM)	X	4.77	68.06	17.13	0.00	150.0	± 9.6 %
		Y	4.73	67.81	16.89		150.0	
		Z	4.64	67.58	16.62		150.0	
10198-CAB	IEEE 802.11n (HT Mixed, 65 Mbps, 64-QAM)	X	4.79	68.08	17.15	0.00	150.0	± 9.6 %
		Y	4.75	67.83	16.90		150.0	
		Z	4.66	67.60	16.63		150.0	
10219-CAB	IEEE 802.11n (HT Mixed, 7.2 Mbps, BPSK)	X	4.55	67.87	16.99	0.00	150.0	± 9.6 %
		Y	4.51	67.61	16.74		150.0	
		Z	4.43	67.37	16.45		150.0	
10220-CAB	IEEE 802.11n (HT Mixed, 43.3 Mbps, 16-QAM)	X	4.76	68.02	17.12	0.00	150.0	± 9.6 %
		Y	4.72	67.77	16.87		150.0	
		Z	4.63	67.54	16.60		150.0	
10221-CAB	IEEE 802.11n (HT Mixed, 72.2 Mbps, 64-QAM)	X	4.80	67.99	17.12	0.00	150.0	± 9.6 %
		Y	4.76	67.75	16.88		150.0	
		Z	4.68	67.53	16.61		150.0	
10222-CAB	IEEE 802.11n (HT Mixed, 15 Mbps, BPSK)	X	5.15	68.03	17.18	0.00	150.0	± 9.6 %
		Y	5.11	67.81	16.96		150.0	
		Z	5.04	67.60	16.72		150.0	

10223-CAB	IEEE 802.11n (HT Mixed, 90 Mbps, 16-QAM)	X	5.44	68.23	17.28	0.00	150.0	± 9.6 %
		Y	5.40	68.03	17.07		150.0	
		Z	5.32	67.81	16.83		150.0	
10224-CAB	IEEE 802.11n (HT Mixed, 150 Mbps, 64-QAM)	X	5.20	68.15	17.16	0.00	150.0	± 9.6 %
		Y	5.16	67.93	16.95		150.0	
		Z	5.08	67.72	16.70		150.0	
10225-CAB	UMTS-FDD (HSPA+)	X	3.00	68.59	16.83	0.00	150.0	± 9.6 %
		Y	2.92	67.92	16.31		150.0	
		Z	2.80	67.25	15.70		150.0	
10226-CAA	LTE-TDD (SC-FDMA, 1 RB, 1.4 MHz, 16-QAM)	X	100.00	136.47	40.23	6.02	65.0	± 9.6 %
		Y	100.00	132.93	38.68		65.0	
		Z	100.00	134.18	38.99		65.0	
10227-CAA	LTE-TDD (SC-FDMA, 1 RB, 1.4 MHz, 64-QAM)	X	100.00	133.67	38.75	6.02	65.0	± 9.6 %
		Y	100.00	130.47	37.37		65.0	
		Z	100.00	131.50	37.57		65.0	
10228-CAA	LTE-TDD (SC-FDMA, 1 RB, 1.4 MHz, QPSK)	X	100.00	146.91	45.69	6.02	65.0	± 9.6 %
		Y	100.00	142.38	43.59		65.0	
		Z	62.29	133.89	41.59		65.0	
10229-CAB	LTE-TDD (SC-FDMA, 1 RB, 3 MHz, 16-QAM)	X	100.00	136.23	40.09	6.02	65.0	± 9.6 %
		Y	100.00	132.70	38.54		65.0	
		Z	100.00	133.95	38.85		65.0	
10230-CAB	LTE-TDD (SC-FDMA, 1 RB, 3 MHz, 64-QAM)	X	100.00	133.55	38.67	6.02	65.0	± 9.6 %
		Y	100.00	130.33	37.27		65.0	
		Z	100.00	131.37	37.48		65.0	
10231-CAB	LTE-TDD (SC-FDMA, 1 RB, 3 MHz, QPSK)	X	100.00	146.76	45.58	6.02	65.0	± 9.6 %
		Y	98.12	141.81	43.38		65.0	
		Z	54.79	131.03	40.79		65.0	
10232-CAD	LTE-TDD (SC-FDMA, 1 RB, 5 MHz, 16-QAM)	X	100.00	136.25	40.10	6.02	65.0	± 9.6 %
		Y	100.00	132.72	38.55		65.0	
		Z	100.00	133.96	38.86		65.0	
10233-CAD	LTE-TDD (SC-FDMA, 1 RB, 5 MHz, 64-QAM)	X	100.00	133.57	38.68	6.02	65.0	± 9.6 %
		Y	100.00	130.35	37.28		65.0	
		Z	100.00	131.40	37.49		65.0	
10234-CAD	LTE-TDD (SC-FDMA, 1 RB, 5 MHz, QPSK)	X	100.00	146.41	45.37	6.02	65.0	± 9.6 %
		Y	85.73	138.62	42.48		65.0	
		Z	49.48	128.58	40.03		65.0	
10235-CAD	LTE-TDD (SC-FDMA, 1 RB, 10 MHz, 16-QAM)	X	100.00	136.27	40.10	6.02	65.0	± 9.6 %
		Y	100.00	132.73	38.55		65.0	
		Z	100.00	133.98	38.86		65.0	
10236-CAD	LTE-TDD (SC-FDMA, 1 RB, 10 MHz, 64-QAM)	X	100.00	133.50	38.65	6.02	65.0	± 9.6 %
		Y	100.00	130.29	37.26		65.0	
		Z	100.00	131.33	37.46		65.0	
10237-CAD	LTE-TDD (SC-FDMA, 1 RB, 10 MHz, QPSK)	X	100.00	146.81	45.60	6.02	65.0	± 9.6 %
		Y	99.93	142.23	43.48		65.0	
		Z	55.78	131.45	40.90		65.0	
10238-CAD	LTE-TDD (SC-FDMA, 1 RB, 15 MHz, 16-QAM)	X	100.00	136.27	40.10	6.02	65.0	± 9.6 %
		Y	100.00	132.73	38.55		65.0	
		Z	100.00	133.98	38.86		65.0	

10239-CAD	LTE-TDD (SC-FDMA, 1 RB, 15 MHz, 64-QAM)	X	100.00	133.60	38.69	6.02	65.0	± 9.6 %
		Y	100.00	130.37	37.29		65.0	
		Z	100.00	131.42	37.50		65.0	
10240-CAD	LTE-TDD (SC-FDMA, 1 RB, 15 MHz, QPSK)	X	100.00	146.82	45.60	6.02	65.0	± 9.6 %
		Y	99.77	142.20	43.47		65.0	
		Z	55.59	131.39	40.89		65.0	
10241-CAA	LTE-TDD (SC-FDMA, 50% RB, 1.4 MHz, 16-QAM)	X	17.87	100.55	33.28	6.98	65.0	± 9.6 %
		Y	15.07	94.94	30.80		65.0	
		Z	13.77	93.88	30.45		65.0	
10242-CAA	LTE-TDD (SC-FDMA, 50% RB, 1.4 MHz, 64-QAM)	X	17.67	100.29	33.12	6.98	65.0	± 9.6 %
		Y	12.29	90.51	29.15		65.0	
		Z	12.81	92.35	29.83		65.0	
10243-CAA	LTE-TDD (SC-FDMA, 50% RB, 1.4 MHz, QPSK)	X	11.06	91.58	31.22	6.98	65.0	± 9.6 %
		Y	8.79	84.63	27.92		65.0	
		Z	9.16	86.51	28.72		65.0	
10244-CAB	LTE-TDD (SC-FDMA, 50% RB, 3 MHz, 16-QAM)	X	15.61	90.37	23.65	3.98	65.0	± 9.6 %
		Y	11.28	84.18	21.28		65.0	
		Z	8.72	80.34	19.49		65.0	
10245-CAB	LTE-TDD (SC-FDMA, 50% RB, 3 MHz, 64-QAM)	X	13.68	88.02	22.81	3.98	65.0	± 9.6 %
		Y	10.35	82.60	20.65		65.0	
		Z	8.13	79.04	18.94		65.0	
10246-CAB	LTE-TDD (SC-FDMA, 50% RB, 3 MHz, QPSK)	X	25.39	101.46	27.34	3.98	65.0	± 9.6 %
		Y	15.71	92.64	24.44		65.0	
		Z	12.87	89.62	23.18		65.0	
10247-CAD	LTE-TDD (SC-FDMA, 50% RB, 5 MHz, 16-QAM)	X	9.04	82.99	22.10	3.98	65.0	± 9.6 %
		Y	8.34	80.70	21.02		65.0	
		Z	7.61	79.49	20.32		65.0	
10248-CAD	LTE-TDD (SC-FDMA, 50% RB, 5 MHz, 64-QAM)	X	8.42	81.37	21.47	3.98	65.0	± 9.6 %
		Y	7.88	79.34	20.47		65.0	
		Z	7.23	78.25	19.81		65.0	
10249-CAD	LTE-TDD (SC-FDMA, 50% RB, 5 MHz, QPSK)	X	33.71	108.55	30.66	3.98	65.0	± 9.6 %
		Y	20.64	98.74	27.50		65.0	
		Z	18.25	96.85	26.70		65.0	
10250-CAD	LTE-TDD (SC-FDMA, 50% RB, 10 MHz, 16-QAM)	X	10.08	85.96	25.19	3.98	65.0	± 9.6 %
		Y	9.64	84.09	24.21		65.0	
		Z	9.09	83.41	23.82		65.0	
10251-CAD	LTE-TDD (SC-FDMA, 50% RB, 10 MHz, 64-QAM)	X	8.74	81.98	23.31	3.98	65.0	± 9.6 %
		Y	8.42	80.36	22.40		65.0	
		Z	8.02	79.93	22.11		65.0	
10252-CAD	LTE-TDD (SC-FDMA, 50% RB, 10 MHz, QPSK)	X	20.41	100.95	29.84	3.98	65.0	± 9.6 %
		Y	15.89	94.95	27.60		65.0	
		Z	15.09	94.44	27.31		65.0	
10253-CAD	LTE-TDD (SC-FDMA, 50% RB, 15 MHz, 16-QAM)	X	8.27	80.12	23.07	3.98	65.0	± 9.6 %
		Y	8.11	78.88	22.29		65.0	
		Z	7.82	78.68	22.13		65.0	
10254-CAD	LTE-TDD (SC-FDMA, 50% RB, 15 MHz, 64-QAM)	X	8.73	81.09	23.75	3.98	65.0	± 9.6 %
		Y	8.60	79.94	23.01		65.0	
		Z	8.29	79.69	22.83		65.0	

10255-CAD	LTE-TDD (SC-FDMA, 50% RB, 15 MHz, QPSK)	X	12.08	89.56	26.46	3.98	65.0	± 9.6 %
		Y	11.00	86.69	25.13		65.0	
		Z	10.61	86.49	24.98		65.0	
10256-CAA	LTE-TDD (SC-FDMA, 100% RB, 1.4 MHz, 16-QAM)	X	9.73	81.73	19.44	3.98	65.0	± 9.6 %
		Y	7.42	76.93	17.43		65.0	
		Z	5.73	73.50	15.63		65.0	
10257-CAA	LTE-TDD (SC-FDMA, 100% RB, 1.4 MHz, 64-QAM)	X	8.33	79.13	18.36	3.98	65.0	± 9.6 %
		Y	6.73	75.21	16.63		65.0	
		Z	5.32	72.16	14.95		65.0	
10258-CAA	LTE-TDD (SC-FDMA, 100% RB, 1.4 MHz, QPSK)	X	12.04	87.95	22.05	3.98	65.0	± 9.6 %
		Y	8.85	82.44	20.00		65.0	
		Z	7.11	79.43	18.57		65.0	
10259-CAB	LTE-TDD (SC-FDMA, 100% RB, 3 MHz, 16-QAM)	X	9.53	84.22	23.26	3.98	65.0	± 9.6 %
		Y	8.90	82.06	22.20		65.0	
		Z	8.25	81.09	21.63		65.0	
10260-CAB	LTE-TDD (SC-FDMA, 100% RB, 3 MHz, 64-QAM)	X	9.20	83.27	22.90	3.98	65.0	± 9.6 %
		Y	8.68	81.32	21.91		65.0	
		Z	8.06	80.39	21.35		65.0	
10261-CAB	LTE-TDD (SC-FDMA, 100% RB, 3 MHz, QPSK)	X	23.02	102.54	29.52	3.98	65.0	± 9.6 %
		Y	16.54	95.31	26.97		65.0	
		Z	15.22	94.17	26.42		65.0	
10262-CAD	LTE-TDD (SC-FDMA, 100% RB, 5 MHz, 16-QAM)	X	10.05	85.86	25.14	3.98	65.0	± 9.6 %
		Y	9.60	83.99	24.15		65.0	
		Z	9.05	83.31	23.76		65.0	
10263-CAD	LTE-TDD (SC-FDMA, 100% RB, 5 MHz, 64-QAM)	X	8.72	81.95	23.30	3.98	65.0	± 9.6 %
		Y	8.40	80.33	22.40		65.0	
		Z	8.01	79.90	22.10		65.0	
10264-CAD	LTE-TDD (SC-FDMA, 100% RB, 5 MHz, QPSK)	X	19.99	100.52	29.68	3.98	65.0	± 9.6 %
		Y	15.61	94.59	27.46		65.0	
		Z	14.84	94.09	27.18		65.0	
10265-CAD	LTE-TDD (SC-FDMA, 100% RB, 10 MHz, 16-QAM)	X	8.51	80.83	23.42	3.98	65.0	± 9.6 %
		Y	8.31	79.48	22.60		65.0	
		Z	8.01	79.28	22.45		65.0	
10266-CAD	LTE-TDD (SC-FDMA, 100% RB, 10 MHz, 64-QAM)	X	9.02	81.88	24.18	3.98	65.0	± 9.6 %
		Y	8.86	80.66	23.42		65.0	
		Z	8.53	80.41	23.25		65.0	
10267-CAD	LTE-TDD (SC-FDMA, 100% RB, 10 MHz, QPSK)	X	12.89	90.43	26.57	3.98	65.0	± 9.6 %
		Y	11.59	87.37	25.20		65.0	
		Z	11.17	87.15	25.04		65.0	
10268-CAD	LTE-TDD (SC-FDMA, 100% RB, 15 MHz, 16-QAM)	X	8.65	79.35	23.27	3.98	65.0	± 9.6 %
		Y	8.60	78.47	22.65		65.0	
		Z	8.34	78.33	22.54		65.0	
10269-CAD	LTE-TDD (SC-FDMA, 100% RB, 15 MHz, 64-QAM)	X	8.50	78.69	23.04	3.98	65.0	± 9.6 %
		Y	8.49	77.91	22.46		65.0	
		Z	8.23	77.77	22.36		65.0	
10270-CAD	LTE-TDD (SC-FDMA, 100% RB, 15 MHz, QPSK)	X	9.87	83.32	24.17	3.98	65.0	± 9.6 %
		Y	9.54	81.82	23.34		65.0	
		Z	9.23	81.64	23.20		65.0	

10274-CAB	UMTS-FDD (HSUPA, Subtest 5, 3GPP Rel8.10)	X	2.93	69.92	17.28	0.00	150.0	± 9.6 %
		Y	2.80	68.92	16.59		150.0	
		Z	2.67	68.10	15.90		150.0	
10275-CAB	UMTS-FDD (HSUPA, Subtest 5, 3GPP Rel8.4)	X	2.65	78.26	21.12	0.00	150.0	± 9.6 %
		Y	2.15	74.09	18.99		150.0	
		Z	1.84	71.24	17.33		150.0	
10277-CAA	PHS (QPSK)	X	3.36	65.20	9.94	9.03	50.0	± 9.6 %
		Y	3.89	66.16	10.82		50.0	
		Z	3.28	64.75	9.58		50.0	
10278-CAA	PHS (QPSK, BW 884MHz, Rolloff 0.5)	X	9.68	82.05	19.91	9.03	50.0	± 9.6 %
		Y	8.39	79.03	18.95		50.0	
		Z	7.49	77.63	17.92		50.0	
10279-CAA	PHS (QPSK, BW 884MHz, Rolloff 0.38)	X	9.79	82.20	20.01	9.03	50.0	± 9.6 %
		Y	8.47	79.14	19.03		50.0	
		Z	7.60	77.79	18.03		50.0	
10290-AAB	CDMA2000, RC1, SO55, Full Rate	X	100.00	128.73	31.86	0.00	150.0	± 9.6 %
		Y	5.46	88.02	21.05		150.0	
		Z	1.91	73.76	15.51		150.0	
10291-AAB	CDMA2000, RC3, SO55, Full Rate	X	100.00	135.73	33.92	0.00	150.0	± 9.6 %
		Y	3.79	87.86	21.18		150.0	
		Z	1.18	71.73	14.72		150.0	
10292-AAB	CDMA2000, RC3, SO32, Full Rate	X	100.00	142.87	36.94	0.00	150.0	± 9.6 %
		Y	100.00	136.51	34.18		150.0	
		Z	5.31	92.64	22.43		150.0	
10293-AAB	CDMA2000, RC3, SO3, Full Rate	X	100.00	147.53	39.13	0.00	150.0	± 9.6 %
		Y	100.00	141.37	36.44		150.0	
		Z	100.00	134.56	33.36		150.0	
10295-AAB	CDMA2000, RC1, SO3, 1/8th Rate 25 fr.	X	51.26	114.86	33.17	9.03	50.0	± 9.6 %
		Y	27.72	102.36	29.45		50.0	
		Z	34.06	106.19	30.27		50.0	
10297-AAC	LTE-FDD (SC-FDMA, 50% RB, 20 MHz, QPSK)	X	3.44	75.06	19.80	0.00	150.0	± 9.6 %
		Y	3.15	73.19	18.73		150.0	
		Z	2.87	71.52	17.73		150.0	
10298-AAC	LTE-FDD (SC-FDMA, 50% RB, 3 MHz, QPSK)	X	4.53	85.32	21.43	0.00	150.0	± 9.6 %
		Y	2.49	75.98	17.66		150.0	
		Z	1.68	70.19	14.73		150.0	
10299-AAC	LTE-FDD (SC-FDMA, 50% RB, 3 MHz, 16-QAM)	X	35.97	105.52	25.86	0.00	150.0	± 9.6 %
		Y	5.66	80.41	18.09		150.0	
		Z	2.55	70.20	13.62		150.0	
10300-AAC	LTE-FDD (SC-FDMA, 50% RB, 3 MHz, 64-QAM)	X	3.08	71.93	14.32	0.00	150.0	± 9.6 %
		Y	2.13	67.03	11.85		150.0	
		Z	1.63	64.24	10.02		150.0	
10301-AAA	IEEE 802.16e WiMAX (29:18, 5ms, 10MHz, QPSK, PUSC)	X	5.45	69.13	19.39	4.17	80.0	± 9.6 %
		Y	5.47	68.97	19.13		80.0	
		Z	5.25	68.28	18.65		80.0	
10302-AAA	IEEE 802.16e WiMAX (29:18, 5ms, 10MHz, QPSK, PUSC, 3 CTRL symbols)	X	5.78	69.10	19.80	4.96	80.0	± 9.6 %
		Y	5.77	68.75	19.42		80.0	
		Z	5.66	68.63	19.27		80.0	

10303-AAA	IEEE 802.16e WiMAX (31:15, 5ms, 10MHz, 64QAM, PUSC)	X	5.58	68.98	19.73	4.96	80.0	± 9.6 %
		Y	5.58	68.66	19.35		80.0	
		Z	5.46	68.50	19.18		80.0	
10304-AAA	IEEE 802.16e WiMAX (29:18, 5ms, 10MHz, 64QAM, PUSC)	X	5.34	68.67	19.12	4.17	80.0	± 9.6 %
		Y	5.33	68.32	18.76		80.0	
		Z	5.21	68.15	18.55		80.0	
10305-AAA	IEEE 802.16e WiMAX (31:15, 10ms, 10MHz, 64QAM, PUSC, 15 symbols)	X	6.61	77.30	24.10	6.02	50.0	± 9.6 %
		Y	7.10	78.07	24.03		50.0	
		Z	6.42	76.34	23.21		50.0	
10306-AAA	IEEE 802.16e WiMAX (29:18, 10ms, 10MHz, 64QAM, PUSC, 18 symbols)	X	5.68	70.99	21.21	6.02	50.0	± 9.6 %
		Y	6.11	72.92	22.11		50.0	
		Z	5.54	70.33	20.52		50.0	
10307-AAA	IEEE 802.16e WiMAX (29:18, 10ms, 10MHz, QPSK, PUSC, 18 symbols)	X	5.65	71.36	21.23	6.02	50.0	± 9.6 %
		Y	6.19	73.69	22.31		50.0	
		Z	5.79	72.63	21.74		50.0	
10308-AAA	IEEE 802.16e WiMAX (29:18, 10ms, 10MHz, 16QAM, PUSC)	X	6.01	73.91	22.77	6.02	50.0	± 9.6 %
		Y	6.30	74.37	22.65		50.0	
		Z	5.88	73.25	22.07		50.0	
10309-AAA	IEEE 802.16e WiMAX (29:18, 10ms, 10MHz, 16QAM, AMC 2x3, 18 symbols)	X	5.73	71.20	21.36	6.02	50.0	± 9.6 %
		Y	6.16	73.11	22.25		50.0	
		Z	5.58	70.50	20.65		50.0	
10310-AAA	IEEE 802.16e WiMAX (29:18, 10ms, 10MHz, QPSK, AMC 2x3, 18 symbols)	X	5.67	71.20	21.24	6.02	50.0	± 9.6 %
		Y	6.15	73.31	22.23		50.0	
		Z	5.52	70.51	20.54		50.0	
10311-AAC	LTE-FDD (SC-FDMA, 100% RB, 15 MHz, QPSK)	X	3.80	73.58	19.01	0.00	150.0	± 9.6 %
		Y	3.53	72.03	18.12		150.0	
		Z	3.24	70.56	17.24		150.0	
10313-AAA	iDEN 1:3	X	59.05	112.13	29.07	6.99	70.0	± 9.6 %
		Y	21.12	95.82	24.56		70.0	
		Z	18.22	93.85	23.73		70.0	
10314-AAA	iDEN 1:6	X	100.00	130.93	37.14	10.00	30.0	± 9.6 %
		Y	75.09	122.91	34.76		30.0	
		Z	51.44	117.42	33.31		30.0	
10315-AAB	IEEE 802.11b WiFi 2.4 GHz (DSSS, 1 Mbps, 96pc duty cycle)	X	1.34	68.63	18.94	0.17	150.0	± 9.6 %
		Y	1.29	67.42	17.86		150.0	
		Z	1.21	66.04	16.71		150.0	
10316-AAB	IEEE 802.11g WiFi 2.4 GHz (ERP-OFDM, 6 Mbps, 96pc duty cycle)	X	4.67	67.89	17.21	0.17	150.0	± 9.6 %
		Y	4.64	67.66	16.96		150.0	
		Z	4.56	67.44	16.70		150.0	
10317-AAB	IEEE 802.11a WiFi 5 GHz (OFDM, 6 Mbps, 96pc duty cycle)	X	4.67	67.89	17.21	0.17	150.0	± 9.6 %
		Y	4.64	67.66	16.96		150.0	
		Z	4.56	67.44	16.70		150.0	
10400-AAC	IEEE 802.11ac WiFi (20MHz, 64-QAM, 99pc duty cycle)	X	4.74	68.13	17.15	0.00	150.0	± 9.6 %
		Y	4.69	67.85	16.88		150.0	
		Z	4.60	67.62	16.61		150.0	
10401-AAC	IEEE 802.11ac WiFi (40MHz, 64-QAM, 99pc duty cycle)	X	5.46	68.11	17.20	0.00	150.0	± 9.6 %
		Y	5.42	67.87	16.96		150.0	
		Z	5.29	67.51	16.65		150.0	

10402-AAC	IEEE 802.11ac WiFi (80MHz, 64-QAM, 99pc duty cycle)	X	5.70	68.27	17.13	0.00	150.0	± 9.6 %
		Y	5.67	68.08	16.93		150.0	
		Z	5.59	67.90	16.71		150.0	
10403-AAB	CDMA2000 (1xEV-DO, Rev. 0)	X	100.00	128.73	31.86	0.00	115.0	± 9.6 %
		Y	5.46	88.02	21.05		115.0	
		Z	1.91	73.76	15.51		115.0	
10404-AAB	CDMA2000 (1xEV-DO, Rev. A)	X	100.00	128.73	31.86	0.00	115.0	± 9.6 %
		Y	5.46	88.02	21.05		115.0	
		Z	1.91	73.76	15.51		115.0	
10406-AAB	CDMA2000, RC3, SO32, SCH0, Full Rate	X	100.00	125.52	31.82	0.00	100.0	± 9.6 %
		Y	100.00	122.74	30.63		100.0	
		Z	100.00	121.04	29.50		100.0	
10410-AAC	LTE-TDD (SC-FDMA, 1 RB, 10 MHz, QPSK, UL Subframe=2,3,4,7,8,9)	X	100.00	131.41	34.92	3.23	80.0	± 9.6 %
		Y	100.00	126.46	32.79		80.0	
		Z	100.00	125.69	32.11		80.0	
10415-AAA	IEEE 802.11b WiFi 2.4 GHz (DSSS, 1 Mbps, 99pc duty cycle)	X	1.18	66.83	17.95	0.00	150.0	± 9.6 %
		Y	1.13	65.66	16.89		150.0	
		Z	1.08	64.56	15.83		150.0	
10416-AAA	IEEE 802.11g WiFi 2.4 GHz (ERP-OFDM, 6 Mbps, 99pc duty cycle)	X	4.60	67.79	17.08	0.00	150.0	± 9.6 %
		Y	4.56	67.54	16.83		150.0	
		Z	4.48	67.32	16.55		150.0	
10417-AAA	IEEE 802.11a/h WiFi 5 GHz (OFDM, 6 Mbps, 99pc duty cycle)	X	4.60	67.79	17.08	0.00	150.0	± 9.6 %
		Y	4.56	67.54	16.83		150.0	
		Z	4.48	67.32	16.55		150.0	
10418-AAA	IEEE 802.11g WiFi 2.4 GHz (DSSS-OFDM, 6 Mbps, 99pc duty cycle, Long preamble)	X	4.60	68.04	17.15	0.00	150.0	± 9.6 %
		Y	4.56	67.77	16.89		150.0	
		Z	4.48	67.54	16.61		150.0	
10419-AAA	IEEE 802.11g WiFi 2.4 GHz (DSSS-OFDM, 6 Mbps, 99pc duty cycle, Short preamble)	X	4.61	67.95	17.12	0.00	150.0	± 9.6 %
		Y	4.57	67.69	16.87		150.0	
		Z	4.49	67.46	16.60		150.0	
10422-AAA	IEEE 802.11n (HT Greenfield, 7.2 Mbps, BPSK)	X	4.72	67.88	17.10	0.00	150.0	± 9.6 %
		Y	4.68	67.64	16.86		150.0	
		Z	4.60	67.42	16.59		150.0	
10423-AAA	IEEE 802.11n (HT Greenfield, 43.3 Mbps, 16-QAM)	X	4.86	68.17	17.20	0.00	150.0	± 9.6 %
		Y	4.82	67.92	16.96		150.0	
		Z	4.73	67.70	16.69		150.0	
10424-AAA	IEEE 802.11n (HT Greenfield, 72.2 Mbps, 64-QAM)	X	4.79	68.14	17.19	0.00	150.0	± 9.6 %
		Y	4.75	67.89	16.94		150.0	
		Z	4.66	67.66	16.67		150.0	
10425-AAA	IEEE 802.11n (HT Greenfield, 15 Mbps, BPSK)	X	5.41	68.25	17.27	0.00	150.0	± 9.6 %
		Y	5.37	68.04	17.06		150.0	
		Z	5.28	67.83	16.82		150.0	
10426-AAA	IEEE 802.11n (HT Greenfield, 90 Mbps, 16-QAM)	X	5.44	68.38	17.34	0.00	150.0	± 9.6 %
		Y	5.40	68.16	17.12		150.0	
		Z	5.31	67.93	16.86		150.0	

10427-AAA	IEEE 802.11n (HT Greenfield, 150 Mbps, 64-QAM)	X	5.41	68.20	17.24	0.00	150.0	± 9.6 %
		Y	5.37	67.99	17.02		150.0	
		Z	5.27	67.73	16.76		150.0	
10430-AAB	LTE-FDD (OFDMA, 5 MHz, E-TM 3.1)	X	4.68	74.13	19.83	0.00	150.0	± 9.6 %
		Y	4.66	73.98	19.65		150.0	
		Z	4.33	72.57	18.70		150.0	
10431-AAB	LTE-FDD (OFDMA, 10 MHz, E-TM 3.1)	X	4.30	68.76	17.23	0.00	150.0	± 9.6 %
		Y	4.24	68.39	16.91		150.0	
		Z	4.13	68.04	16.54		150.0	
10432-AAB	LTE-FDD (OFDMA, 15 MHz, E-TM 3.1)	X	4.58	68.36	17.21	0.00	150.0	± 9.6 %
		Y	4.53	68.06	16.94		150.0	
		Z	4.43	67.79	16.63		150.0	
10433-AAB	LTE-FDD (OFDMA, 20 MHz, E-TM 3.1)	X	4.81	68.17	17.21	0.00	150.0	± 9.6 %
		Y	4.77	67.92	16.96		150.0	
		Z	4.68	67.69	16.69		150.0	
10434-AAA	W-CDMA (BS Test Model 1, 64 DPCH)	X	5.03	75.87	20.06	0.00	150.0	± 9.6 %
		Y	4.99	75.61	19.83		150.0	
		Z	4.49	73.69	18.66		150.0	
10435-AAC	LTE-TDD (SC-FDMA, 1 RB, 20 MHz, QPSK, UL Subframe=2,3,4,7,8,9)	X	100.00	131.13	34.80	3.23	80.0	± 9.6 %
		Y	100.00	126.21	32.67		80.0	
		Z	100.00	125.44	31.99		80.0	
10447-AAB	LTE-FDD (OFDMA, 5 MHz, E-TM 3.1, Clipping 44%)	X	3.69	69.53	16.77	0.00	150.0	± 9.6 %
		Y	3.58	68.87	16.29		150.0	
		Z	3.42	68.21	15.70		150.0	
10448-AAB	LTE-FDD (OFDMA, 10 MHz, E-TM 3.1, Clipping 44%)	X	4.15	68.58	17.12	0.00	150.0	± 9.6 %
		Y	4.09	68.20	16.80		150.0	
		Z	3.99	67.84	16.42		150.0	
10449-AAB	LTE-FDD (OFDMA, 15 MHz, E-TM 3.1, Clipping 44%)	X	4.41	68.22	17.14	0.00	150.0	± 9.6 %
		Y	4.36	67.92	16.86		150.0	
		Z	4.27	67.63	16.54		150.0	
10450-AAB	LTE-FDD (OFDMA, 20 MHz, E-TM 3.1, Clipping 44%)	X	4.60	67.99	17.10	0.00	150.0	± 9.6 %
		Y	4.55	67.72	16.84		150.0	
		Z	4.47	67.48	16.56		150.0	
10451-AAA	W-CDMA (BS Test Model 1, 64 DPCH, Clipping 44%)	X	3.62	69.93	16.40	0.00	150.0	± 9.6 %
		Y	3.47	69.09	15.83		150.0	
		Z	3.27	68.23	15.13		150.0	
10456-AAA	IEEE 802.11ac WiFi (160MHz, 64-QAM, 99pc duty cycle)	X	6.36	68.84	17.42	0.00	150.0	± 9.6 %
		Y	6.32	68.67	17.24		150.0	
		Z	6.23	68.46	17.01		150.0	
10457-AAA	UMTS-FDD (DC-HSDPA)	X	3.88	66.43	16.81	0.00	150.0	± 9.6 %
		Y	3.85	66.20	16.55		150.0	
		Z	3.80	66.01	16.28		150.0	
10458-AAA	CDMA2000 (1xEV-DO, Rev. B, 2 carriers)	X	4.65	75.19	19.34	0.00	150.0	± 9.6 %
		Y	4.52	74.56	18.92		150.0	
		Z	4.04	72.55	17.67		150.0	
10459-AAA	CDMA2000 (1xEV-DO, Rev. B, 3 carriers)	X	5.15	69.96	18.79	0.00	150.0	± 9.6 %
		Y	5.22	70.24	18.85		150.0	
		Z	4.92	69.20	18.07		150.0	

10460-AAA	UMTS-FDD (WCDMA, AMR)	X	3.37	95.81	29.07	0.00	150.0	± 9.6 %
		Y	1.74	81.67	23.23		150.0	
		Z	1.21	74.42	19.58		150.0	
10461-AAA	LTE-TDD (SC-FDMA, 1 RB, 1.4 MHz, QPSK, UL Subframe=2,3,4,7,8,9)	X	100.00	143.01	40.15	3.29	80.0	± 9.6 %
		Y	100.00	134.90	36.63		80.0	
		Z	100.00	132.97	35.44		80.0	
10462-AAA	LTE-TDD (SC-FDMA, 1 RB, 1.4 MHz, 16-QAM, UL Subframe=2,3,4,7,8,9)	X	100.00	119.25	28.85	3.23	80.0	± 9.6 %
		Y	100.00	113.20	26.37		80.0	
		Z	100.00	110.00	24.63		80.0	
10463-AAA	LTE-TDD (SC-FDMA, 1 RB, 1.4 MHz, 64-QAM, UL Subframe=2,3,4,7,8,9)	X	100.00	113.75	26.28	3.23	80.0	± 9.6 %
		Y	100.00	108.57	24.18		80.0	
		Z	100.00	105.07	22.33		80.0	
10464-AAA	LTE-TDD (SC-FDMA, 1 RB, 3 MHz, QPSK, UL Subframe=2,3,4,7,8,9)	X	100.00	141.23	39.11	3.23	80.0	± 9.6 %
		Y	100.00	132.81	35.48		80.0	
		Z	100.00	130.60	34.16		80.0	
10465-AAA	LTE-TDD (SC-FDMA, 1 RB, 3 MHz, 16-QAM, UL Subframe=2,3,4,7,8,9)	X	100.00	118.41	28.46	3.23	80.0	± 9.6 %
		Y	100.00	112.48	26.02		80.0	
		Z	100.00	109.28	24.29		80.0	
10466-AAA	LTE-TDD (SC-FDMA, 1 RB, 3 MHz, 64-QAM, UL Subframe=2,3,4,7,8,9)	X	100.00	112.90	25.90	3.23	80.0	± 9.6 %
		Y	100.00	107.89	23.87		80.0	
		Z	100.00	104.43	22.04		80.0	
10467-AAC	LTE-TDD (SC-FDMA, 1 RB, 5 MHz, QPSK, UL Subframe=2,3,4,7,8,9)	X	100.00	141.61	39.28	3.23	80.0	± 9.6 %
		Y	100.00	133.15	35.63		80.0	
		Z	100.00	130.94	34.31		80.0	
10468-AAC	LTE-TDD (SC-FDMA, 1 RB, 5 MHz, 16-QAM, UL Subframe=2,3,4,7,8,9)	X	100.00	118.75	28.61	3.23	80.0	± 9.6 %
		Y	100.00	112.75	26.15		80.0	
		Z	100.00	109.56	24.42		80.0	
10469-AAC	LTE-TDD (SC-FDMA, 1 RB, 5 MHz, 64-QAM, UL Subframe=2,3,4,7,8,9)	X	100.00	112.98	25.93	3.23	80.0	± 9.6 %
		Y	100.00	107.94	23.89		80.0	
		Z	100.00	104.47	22.05		80.0	
10470-AAC	LTE-TDD (SC-FDMA, 1 RB, 10 MHz, QPSK, UL Subframe=2,3,4,7,8,9)	X	100.00	141.70	39.31	3.23	80.0	± 9.6 %
		Y	100.00	133.21	35.65		80.0	
		Z	100.00	130.98	34.32		80.0	
10471-AAC	LTE-TDD (SC-FDMA, 1 RB, 10 MHz, 16-QAM, UL Subframe=2,3,4,7,8,9)	X	100.00	118.69	28.58	3.23	80.0	± 9.6 %
		Y	100.00	112.69	26.12		80.0	
		Z	100.00	109.48	24.38		80.0	
10472-AAC	LTE-TDD (SC-FDMA, 1 RB, 10 MHz, 64-QAM, UL Subframe=2,3,4,7,8,9)	X	100.00	112.90	25.89	3.23	80.0	± 9.6 %
		Y	100.00	107.86	23.85		80.0	
		Z	100.00	104.38	22.01		80.0	
10473-AAC	LTE-TDD (SC-FDMA, 1 RB, 15 MHz, QPSK, UL Subframe=2,3,4,7,8,9)	X	100.00	141.67	39.29	3.23	80.0	± 9.6 %
		Y	100.00	133.18	35.63		80.0	
		Z	100.00	130.96	34.31		80.0	
10474-AAC	LTE-TDD (SC-FDMA, 1 RB, 15 MHz, 16-QAM, UL Subframe=2,3,4,7,8,9)	X	100.00	118.71	28.58	3.23	80.0	± 9.6 %
		Y	100.00	112.70	26.12		80.0	
		Z	100.00	109.49	24.38		80.0	
10475-AAC	LTE-TDD (SC-FDMA, 1 RB, 15 MHz, 64-QAM, UL Subframe=2,3,4,7,8,9)	X	100.00	112.93	25.90	3.23	80.0	± 9.6 %
		Y	100.00	107.88	23.85		80.0	
		Z	100.00	104.40	22.02		80.0	

10477-AAC	LTE-TDD (SC-FDMA, 1 RB, 20 MHz, 16-QAM, UL Subframe=2,3,4,7,8,9)	X	100.00	118.43	28.45	3.23	80.0	± 9.6 %
		Y	100.00	112.46	26.00		80.0	
		Z	100.00	109.24	24.26		80.0	
10478-AAC	LTE-TDD (SC-FDMA, 1 RB, 20 MHz, 64-QAM, UL Subframe=2,3,4,7,8,9)	X	100.00	112.82	25.85	3.23	80.0	± 9.6 %
		Y	100.00	107.79	23.82		80.0	
		Z	100.00	104.31	21.98		80.0	
10479-AAA	LTE-TDD (SC-FDMA, 50% RB, 1.4 MHz, QPSK, UL Subframe=2,3,4,7,8,9)	X	100.00	132.85	37.00	3.23	80.0	± 9.6 %
		Y	100.00	128.47	35.00		80.0	
		Z	100.00	127.00	34.04		80.0	
10480-AAA	LTE-TDD (SC-FDMA, 50% RB, 1.4 MHz, 16-QAM, UL Subframe=2,3,4,7,8,9)	X	100.00	120.16	30.90	3.23	80.0	± 9.6 %
		Y	100.00	116.69	29.36		80.0	
		Z	100.00	114.91	28.26		80.0	
10481-AAA	LTE-TDD (SC-FDMA, 50% RB, 1.4 MHz, 64-QAM, UL Subframe=2,3,4,7,8,9)	X	100.00	117.70	29.67	3.23	80.0	± 9.6 %
		Y	100.00	114.39	28.21		80.0	
		Z	100.00	112.46	27.04		80.0	
10482-AAA	LTE-TDD (SC-FDMA, 50% RB, 3 MHz, QPSK, UL Subframe=2,3,4,7,8,9)	X	100.00	122.13	31.51	2.23	80.0	± 9.6 %
		Y	54.92	111.25	28.42		80.0	
		Z	13.32	91.56	22.86		80.0	
10483-AAA	LTE-TDD (SC-FDMA, 50% RB, 3 MHz, 16-QAM, UL Subframe=2,3,4,7,8,9)	X	100.00	116.38	29.36	2.23	80.0	± 9.6 %
		Y	100.00	113.46	28.01		80.0	
		Z	11.26	84.75	19.89		80.0	
10484-AAA	LTE-TDD (SC-FDMA, 50% RB, 3 MHz, 64-QAM, UL Subframe=2,3,4,7,8,9)	X	100.00	115.90	29.19	2.23	80.0	± 9.6 %
		Y	50.77	104.49	25.86		80.0	
		Z	8.43	80.95	18.67		80.0	
10485-AAC	LTE-TDD (SC-FDMA, 50% RB, 5 MHz, QPSK, UL Subframe=2,3,4,7,8,9)	X	65.25	120.82	33.02	2.23	80.0	± 9.6 %
		Y	24.29	103.39	28.10		80.0	
		Z	11.52	91.94	24.54		80.0	
10486-AAC	LTE-TDD (SC-FDMA, 50% RB, 5 MHz, 16-QAM, UL Subframe=2,3,4,7,8,9)	X	10.69	87.70	22.97	2.23	80.0	± 9.6 %
		Y	8.09	82.63	21.00		80.0	
		Z	5.71	77.63	18.94		80.0	
10487-AAC	LTE-TDD (SC-FDMA, 50% RB, 5 MHz, 64-QAM, UL Subframe=2,3,4,7,8,9)	X	9.28	85.21	22.13	2.23	80.0	± 9.6 %
		Y	7.33	80.85	20.36		80.0	
		Z	5.35	76.37	18.44		80.0	
10488-AAC	LTE-TDD (SC-FDMA, 50% RB, 10 MHz, QPSK, UL Subframe=2,3,4,7,8,9)	X	11.48	93.02	26.74	2.23	80.0	± 9.6 %
		Y	9.12	87.88	24.67		80.0	
		Z	6.88	83.40	22.96		80.0	
10489-AAC	LTE-TDD (SC-FDMA, 50% RB, 10 MHz, 16-QAM, UL Subframe=2,3,4,7,8,9)	X	6.05	78.94	21.72	2.23	80.0	± 9.6 %
		Y	5.74	77.30	20.79		80.0	
		Z	4.98	75.13	19.74		80.0	
10490-AAC	LTE-TDD (SC-FDMA, 50% RB, 10 MHz, 64-QAM, UL Subframe=2,3,4,7,8,9)	X	5.92	78.02	21.35	2.23	80.0	± 9.6 %
		Y	5.66	76.55	20.49		80.0	
		Z	4.96	74.57	19.51		80.0	
10491-AAC	LTE-TDD (SC-FDMA, 50% RB, 15 MHz, QPSK, UL Subframe=2,3,4,7,8,9)	X	7.36	83.03	23.55	2.23	80.0	± 9.6 %
		Y	6.73	80.60	22.34		80.0	
		Z	5.73	78.11	21.25		80.0	
10492-AAC	LTE-TDD (SC-FDMA, 50% RB, 15 MHz, 16-QAM, UL Subframe=2,3,4,7,8,9)	X	5.42	74.92	20.52	2.23	80.0	± 9.6 %
		Y	5.33	74.03	19.90		80.0	
		Z	4.87	72.71	19.18		80.0	

10493-AAC	LTE-TDD (SC-FDMA, 50% RB, 15 MHz, 64-QAM, UL Subframe=2,3,4,7,8,9)	X	5.40	74.45	20.32	2.23	80.0	± 9.6 %
		Y	5.32	73.63	19.73		80.0	
		Z	4.88	72.39	19.05		80.0	
10494-AAC	LTE-TDD (SC-FDMA, 50% RB, 20 MHz, QPSK, UL Subframe=2,3,4,7,8,9)	X	9.17	86.80	24.72	2.23	80.0	± 9.6 %
		Y	8.03	83.58	23.27		80.0	
		Z	6.60	80.52	22.02		80.0	
10495-AAC	LTE-TDD (SC-FDMA, 50% RB, 20 MHz, 16-QAM, UL Subframe=2,3,4,7,8,9)	X	5.52	75.46	20.81	2.23	80.0	± 9.6 %
		Y	5.42	74.52	20.17		80.0	
		Z	4.93	73.12	19.44		80.0	
10496-AAC	LTE-TDD (SC-FDMA, 50% RB, 20 MHz, 64-QAM, UL Subframe=2,3,4,7,8,9)	X	5.45	74.64	20.50	2.23	80.0	± 9.6 %
		Y	5.38	73.84	19.92		80.0	
		Z	4.93	72.57	19.24		80.0	
10497-AAA	LTE-TDD (SC-FDMA, 100% RB, 1.4 MHz, QPSK, UL Subframe=2,3,4,7,8,9)	X	100.00	115.27	27.88	2.23	80.0	± 9.6 %
		Y	25.28	96.48	22.93		80.0	
		Z	5.87	78.71	17.31		80.0	
10498-AAA	LTE-TDD (SC-FDMA, 100% RB, 1.4 MHz, 16-QAM, UL Subframe=2,3,4,7,8,9)	X	2.96	68.45	12.76	2.23	80.0	± 9.6 %
		Y	2.21	64.78	11.01		80.0	
		Z	1.67	62.18	9.40		80.0	
10499-AAA	LTE-TDD (SC-FDMA, 100% RB, 1.4 MHz, 64-QAM, UL Subframe=2,3,4,7,8,9)	X	2.39	65.91	11.50	2.23	80.0	± 9.6 %
		Y	1.96	63.35	10.16		80.0	
		Z	1.55	61.26	8.77		80.0	
10500-AAA	LTE-TDD (SC-FDMA, 100% RB, 3 MHz, QPSK, UL Subframe=2,3,4,7,8,9)	X	21.96	103.85	29.24	2.23	80.0	± 9.6 %
		Y	13.48	94.40	26.05		80.0	
		Z	8.53	87.25	23.57		80.0	
10501-AAA	LTE-TDD (SC-FDMA, 100% RB, 3 MHz, 16-QAM, UL Subframe=2,3,4,7,8,9)	X	8.02	83.54	22.29	2.23	80.0	± 9.6 %
		Y	6.90	80.32	20.86		80.0	
		Z	5.43	76.80	19.30		80.0	
10502-AAA	LTE-TDD (SC-FDMA, 100% RB, 3 MHz, 64-QAM, UL Subframe=2,3,4,7,8,9)	X	7.77	82.58	21.87	2.23	80.0	± 9.6 %
		Y	6.74	79.56	20.50		80.0	
		Z	5.37	76.23	19.00		80.0	
10503-AAC	LTE-TDD (SC-FDMA, 100% RB, 5 MHz, QPSK, UL Subframe=2,3,4,7,8,9)	X	11.17	92.54	26.57	2.23	80.0	± 9.6 %
		Y	8.90	87.45	24.51		80.0	
		Z	6.74	83.07	22.83		80.0	
10504-AAC	LTE-TDD (SC-FDMA, 100% RB, 5 MHz, 16-QAM, UL Subframe=2,3,4,7,8,9)	X	6.00	78.78	21.64	2.23	80.0	± 9.6 %
		Y	5.69	77.13	20.71		80.0	
		Z	4.94	74.99	19.66		80.0	
10505-AAC	LTE-TDD (SC-FDMA, 100% RB, 5 MHz, 64-QAM, UL Subframe=2,3,4,7,8,9)	X	5.88	77.87	21.28	2.23	80.0	± 9.6 %
		Y	5.62	76.40	20.42		80.0	
		Z	4.93	74.45	19.44		80.0	
10506-AAC	LTE-TDD (SC-FDMA, 100% RB, 10 MHz, QPSK, UL Subframe=2,3,4,7,8,9)	X	9.03	86.51	24.60	2.23	80.0	± 9.6 %
		Y	7.91	83.32	23.16		80.0	
		Z	6.52	80.31	21.93		80.0	
10507-AAC	LTE-TDD (SC-FDMA, 100% RB, 10 MHz, 16-QAM, UL Subframe=2,3,4,7,8,9)	X	5.50	75.38	20.77	2.23	80.0	± 9.6 %
		Y	5.39	74.44	20.13		80.0	
		Z	4.91	73.05	19.40		80.0	

10508-AAC	LTE-TDD (SC-FDMA, 100% RB, 10 MHz, 64-QAM, UL Subframe=2,3,4,7,8,9)	X	5.43	74.55	20.45	2.23	80.0	± 9.6 %
		Y	5.35	73.74	19.86		80.0	
		Z	4.91	72.49	19.19		80.0	
10509-AAC	LTE-TDD (SC-FDMA, 100% RB, 15 MHz, QPSK, UL Subframe=2,3,4,7,8,9)	X	7.27	80.16	22.31	2.23	80.0	± 9.6 %
		Y	6.86	78.46	21.40		80.0	
		Z	6.07	76.60	20.55		80.0	
10510-AAC	LTE-TDD (SC-FDMA, 100% RB, 15 MHz, 16-QAM, UL Subframe=2,3,4,7,8,9)	X	5.60	73.37	20.04	2.23	80.0	± 9.6 %
		Y	5.56	72.76	19.56		80.0	
		Z	5.19	71.77	19.01		80.0	
10511-AAC	LTE-TDD (SC-FDMA, 100% RB, 15 MHz, 64-QAM, UL Subframe=2,3,4,7,8,9)	X	5.57	72.82	19.83	2.23	80.0	± 9.6 %
		Y	5.55	72.29	19.39		80.0	
		Z	5.21	71.39	18.87		80.0	
10512-AAC	LTE-TDD (SC-FDMA, 100% RB, 20 MHz, QPSK, UL Subframe=2,3,4,7,8,9)	X	8.90	84.26	23.64	2.23	80.0	± 9.6 %
		Y	8.02	81.72	22.45		80.0	
		Z	6.83	79.22	21.40		80.0	
10513-AAC	LTE-TDD (SC-FDMA, 100% RB, 20 MHz, 16-QAM, UL Subframe=2,3,4,7,8,9)	X	5.59	74.00	20.32	2.23	80.0	± 9.6 %
		Y	5.54	73.30	19.79		80.0	
		Z	5.13	72.20	19.19		80.0	
10514-AAC	LTE-TDD (SC-FDMA, 100% RB, 20 MHz, 64-QAM, UL Subframe=2,3,4,7,8,9)	X	5.48	73.14	20.00	2.23	80.0	± 9.6 %
		Y	5.45	72.55	19.53		80.0	
		Z	5.09	71.56	18.98		80.0	
10515-AAA	IEEE 802.11b WiFi 2.4 GHz (DSSS, 2 Mbps, 99pc duty cycle)	X	1.15	67.44	18.30	0.00	150.0	± 9.6 %
		Y	1.10	66.10	17.12		150.0	
		Z	1.04	64.87	15.98		150.0	
10516-AAA	IEEE 802.11b WiFi 2.4 GHz (DSSS, 5.5 Mbps, 99pc duty cycle)	X	100.00	185.02	53.92	0.00	150.0	± 9.6 %
		Y	4.08	110.19	34.01		150.0	
		Z	1.21	84.34	24.35		150.0	
10517-AAA	IEEE 802.11b WiFi 2.4 GHz (DSSS, 11 Mbps, 99pc duty cycle)	X	1.23	74.63	21.82	0.00	150.0	± 9.6 %
		Y	1.06	70.88	19.41		150.0	
		Z	0.94	68.06	17.43		150.0	
10518-AAA	IEEE 802.11a/h WiFi 5 GHz (OFDM, 9 Mbps, 99pc duty cycle)	X	4.59	67.92	17.08	0.00	150.0	± 9.6 %
		Y	4.55	67.66	16.83		150.0	
		Z	4.47	67.43	16.55		150.0	
10519-AAA	IEEE 802.11a/h WiFi 5 GHz (OFDM, 12 Mbps, 99pc duty cycle)	X	4.75	68.08	17.16	0.00	150.0	± 9.6 %
		Y	4.71	67.83	16.91		150.0	
		Z	4.62	67.60	16.63		150.0	
10520-AAA	IEEE 802.11a/h WiFi 5 GHz (OFDM, 18 Mbps, 99pc duty cycle)	X	4.61	68.08	17.11	0.00	150.0	± 9.6 %
		Y	4.57	67.81	16.85		150.0	
		Z	4.48	67.55	16.56		150.0	
10521-AAA	IEEE 802.11a/h WiFi 5 GHz (OFDM, 24 Mbps, 99pc duty cycle)	X	4.55	68.08	17.11	0.00	150.0	± 9.6 %
		Y	4.50	67.80	16.85		150.0	
		Z	4.42	67.54	16.55		150.0	
10522-AAA	IEEE 802.11a/h WiFi 5 GHz (OFDM, 36 Mbps, 99pc duty cycle)	X	4.61	68.22	17.21	0.00	150.0	± 9.6 %
		Y	4.56	67.94	16.95		150.0	
		Z	4.47	67.67	16.65		150.0	

10523-AAA	IEEE 802.11a/h WiFi 5 GHz (OFDM, 48 Mbps, 99pc duty cycle)	X	4.52	68.18	17.12	0.00	150.0	± 9.6 %
		Y	4.48	67.89	16.85		150.0	
		Z	4.39	67.64	16.56		150.0	
10524-AAA	IEEE 802.11a/h WiFi 5 GHz (OFDM, 54 Mbps, 99pc duty cycle)	X	4.56	68.16	17.20	0.00	150.0	± 9.6 %
		Y	4.51	67.87	16.93		150.0	
		Z	4.42	67.62	16.64		150.0	
10525-AAA	IEEE 802.11ac WiFi (20MHz, MCS0, 99pc duty cycle)	X	4.58	67.22	16.79	0.00	150.0	± 9.6 %
		Y	4.53	66.96	16.53		150.0	
		Z	4.45	66.71	16.25		150.0	
10526-AAA	IEEE 802.11ac WiFi (20MHz, MCS1, 99pc duty cycle)	X	4.73	67.55	16.92	0.00	150.0	± 9.6 %
		Y	4.68	67.28	16.66		150.0	
		Z	4.58	67.01	16.37		150.0	
10527-AAA	IEEE 802.11ac WiFi (20MHz, MCS2, 99pc duty cycle)	X	4.66	67.55	16.87	0.00	150.0	± 9.6 %
		Y	4.61	67.26	16.61		150.0	
		Z	4.51	66.98	16.31		150.0	
10528-AAA	IEEE 802.11ac WiFi (20MHz, MCS3, 99pc duty cycle)	X	4.67	67.56	16.90	0.00	150.0	± 9.6 %
		Y	4.62	67.27	16.64		150.0	
		Z	4.53	67.00	16.34		150.0	
10529-AAA	IEEE 802.11ac WiFi (20MHz, MCS4, 99pc duty cycle)	X	4.67	67.56	16.90	0.00	150.0	± 9.6 %
		Y	4.62	67.27	16.64		150.0	
		Z	4.53	67.00	16.34		150.0	
10531-AAA	IEEE 802.11ac WiFi (20MHz, MCS6, 99pc duty cycle)	X	4.65	67.64	16.91	0.00	150.0	± 9.6 %
		Y	4.60	67.34	16.64		150.0	
		Z	4.50	67.04	16.33		150.0	
10532-AAA	IEEE 802.11ac WiFi (20MHz, MCS7, 99pc duty cycle)	X	4.52	67.51	16.86	0.00	150.0	± 9.6 %
		Y	4.47	67.22	16.59		150.0	
		Z	4.37	66.91	16.27		150.0	
10533-AAA	IEEE 802.11ac WiFi (20MHz, MCS8, 99pc duty cycle)	X	4.68	67.65	16.91	0.00	150.0	± 9.6 %
		Y	4.63	67.36	16.65		150.0	
		Z	4.53	67.08	16.35		150.0	
10534-AAA	IEEE 802.11ac WiFi (40MHz, MCS0, 99pc duty cycle)	X	5.20	67.39	16.83	0.00	150.0	± 9.6 %
		Y	5.16	67.18	16.61		150.0	
		Z	5.07	66.93	16.35		150.0	
10535-AAA	IEEE 802.11ac WiFi (40MHz, MCS1, 99pc duty cycle)	X	5.27	67.58	16.92	0.00	150.0	± 9.6 %
		Y	5.22	67.35	16.70		150.0	
		Z	5.12	67.09	16.43		150.0	
10536-AAA	IEEE 802.11ac WiFi (40MHz, MCS2, 99pc duty cycle)	X	5.15	67.59	16.91	0.00	150.0	± 9.6 %
		Y	5.11	67.36	16.68		150.0	
		Z	5.02	67.10	16.41		150.0	
10537-AAA	IEEE 802.11ac WiFi (40MHz, MCS3, 99pc duty cycle)	X	5.20	67.53	16.88	0.00	150.0	± 9.6 %
		Y	5.16	67.30	16.66		150.0	
		Z	5.07	67.07	16.40		150.0	
10538-AAA	IEEE 802.11ac WiFi (40MHz, MCS4, 99pc duty cycle)	X	5.27	67.48	16.89	0.00	150.0	± 9.6 %
		Y	5.23	67.27	16.67		150.0	
		Z	5.14	67.03	16.42		150.0	
10540-AAA	IEEE 802.11ac WiFi (40MHz, MCS6, 99pc duty cycle)	X	5.20	67.48	16.91	0.00	150.0	± 9.6 %
		Y	5.16	67.26	16.69		150.0	
		Z	5.07	67.00	16.42		150.0	

10541-AAA	IEEE 802.11ac WiFi (40MHz, MCS7, 99pc duty cycle)	X	5.18	67.34	16.82	0.00	150.0	± 9.6 %
		Y	5.14	67.12	16.61		150.0	
		Z	5.05	66.89	16.35		150.0	
10542-AAA	IEEE 802.11ac WiFi (40MHz, MCS8, 99pc duty cycle)	X	5.33	67.42	16.87	0.00	150.0	± 9.6 %
		Y	5.29	67.21	16.66		150.0	
		Z	5.20	66.99	16.41		150.0	
10543-AAA	IEEE 802.11ac WiFi (40MHz, MCS9, 99pc duty cycle)	X	5.40	67.44	16.90	0.00	150.0	± 9.6 %
		Y	5.36	67.24	16.70		150.0	
		Z	5.27	67.04	16.47		150.0	
10544-AAA	IEEE 802.11ac WiFi (80MHz, MCS0, 99pc duty cycle)	X	5.53	67.39	16.75	0.00	150.0	± 9.6 %
		Y	5.49	67.20	16.56		150.0	
		Z	5.41	66.99	16.32		150.0	
10545-AAA	IEEE 802.11ac WiFi (80MHz, MCS1, 99pc duty cycle)	X	5.74	67.91	16.97	0.00	150.0	± 9.6 %
		Y	5.70	67.70	16.77		150.0	
		Z	5.60	67.47	16.52		150.0	
10546-AAA	IEEE 802.11ac WiFi (80MHz, MCS2, 99pc duty cycle)	X	5.57	67.55	16.80	0.00	150.0	± 9.6 %
		Y	5.53	67.35	16.60		150.0	
		Z	5.45	67.13	16.36		150.0	
10547-AAA	IEEE 802.11ac WiFi (80MHz, MCS3, 99pc duty cycle)	X	5.66	67.65	16.84	0.00	150.0	± 9.6 %
		Y	5.62	67.45	16.64		150.0	
		Z	5.53	67.23	16.41		150.0	
10548-AAA	IEEE 802.11ac WiFi (80MHz, MCS4, 99pc duty cycle)	X	5.90	68.59	17.29	0.00	150.0	± 9.6 %
		Y	5.84	68.33	17.06		150.0	
		Z	5.71	67.98	16.76		150.0	
10550-AAA	IEEE 802.11ac WiFi (80MHz, MCS6, 99pc duty cycle)	X	5.64	67.75	16.92	0.00	150.0	± 9.6 %
		Y	5.60	67.54	16.71		150.0	
		Z	5.51	67.32	16.47		150.0	
10551-AAA	IEEE 802.11ac WiFi (80MHz, MCS7, 99pc duty cycle)	X	5.59	67.58	16.79	0.00	150.0	± 9.6 %
		Y	5.55	67.38	16.59		150.0	
		Z	5.45	67.11	16.33		150.0	
10552-AAA	IEEE 802.11ac WiFi (80MHz, MCS8, 99pc duty cycle)	X	5.54	67.49	16.75	0.00	150.0	± 9.6 %
		Y	5.50	67.29	16.55		150.0	
		Z	5.42	67.10	16.32		150.0	
10553-AAA	IEEE 802.11ac WiFi (80MHz, MCS9, 99pc duty cycle)	X	5.60	67.45	16.75	0.00	150.0	± 9.6 %
		Y	5.56	67.25	16.56		150.0	
		Z	5.48	67.05	16.33		150.0	
10554-AAB	IEEE 802.11ac WiFi (160MHz, MCS0, 99pc duty cycle)	X	5.95	67.70	16.80	0.00	150.0	± 9.6 %
		Y	5.91	67.51	16.61		150.0	
		Z	5.83	67.32	16.39		150.0	
10555-AAB	IEEE 802.11ac WiFi (160MHz, MCS1, 99pc duty cycle)	X	6.07	68.00	16.93	0.00	150.0	± 9.6 %
		Y	6.03	67.81	16.74		150.0	
		Z	5.94	67.58	16.50		150.0	
10556-AAB	IEEE 802.11ac WiFi (160MHz, MCS2, 99pc duty cycle)	X	6.11	68.10	16.97	0.00	150.0	± 9.6 %
		Y	6.07	67.90	16.78		150.0	
		Z	5.98	67.68	16.55		150.0	
10557-AAB	IEEE 802.11ac WiFi (160MHz, MCS3, 99pc duty cycle)	X	6.05	67.93	16.91	0.00	150.0	± 9.6 %
		Y	6.01	67.74	16.72		150.0	
		Z	5.92	67.53	16.49		150.0	

10558-AAB	IEEE 802.11ac WiFi (160MHz, MCS4, 99pc duty cycle)	X	6.09	68.07	16.99	0.00	150.0	± 9.6 %
		Y	6.04	67.87	16.80		150.0	
		Z	5.95	67.63	16.56		150.0	
10560-AAB	IEEE 802.11ac WiFi (160MHz, MCS6, 99pc duty cycle)	X	6.08	67.92	16.95	0.00	150.0	± 9.6 %
		Y	6.04	67.73	16.77		150.0	
		Z	5.95	67.52	16.54		150.0	
10561-AAB	IEEE 802.11ac WiFi (160MHz, MCS7, 99pc duty cycle)	X	6.02	67.94	17.00	0.00	150.0	± 9.6 %
		Y	5.98	67.74	16.81		150.0	
		Z	5.89	67.52	16.58		150.0	
10562-AAB	IEEE 802.11ac WiFi (160MHz, MCS8, 99pc duty cycle)	X	6.09	68.17	17.12	0.00	150.0	± 9.6 %
		Y	6.05	67.96	16.92		150.0	
		Z	5.95	67.72	16.67		150.0	
10563-AAB	IEEE 802.11ac WiFi (160MHz, MCS9, 99pc duty cycle)	X	6.19	68.10	17.04	0.00	150.0	± 9.6 %
		Y	6.15	67.90	16.85		150.0	
		Z	6.04	67.65	16.60		150.0	
10564-AAA	IEEE 802.11g WiFi 2.4 GHz (DSSS-OFDM, 9 Mbps, 99pc duty cycle)	X	4.91	67.89	17.17	0.46	150.0	± 9.6 %
		Y	4.87	67.64	16.93		150.0	
		Z	4.80	67.46	16.69		150.0	
10565-AAA	IEEE 802.11g WiFi 2.4 GHz (DSSS-OFDM, 12 Mbps, 99pc duty cycle)	X	5.11	68.27	17.46	0.46	150.0	± 9.6 %
		Y	5.08	68.05	17.23		150.0	
		Z	4.99	67.85	16.98		150.0	
10566-AAA	IEEE 802.11g WiFi 2.4 GHz (DSSS-OFDM, 18 Mbps, 99pc duty cycle)	X	4.96	68.15	17.30	0.46	150.0	± 9.6 %
		Y	4.92	67.91	17.06		150.0	
		Z	4.83	67.70	16.81		150.0	
10567-AAA	IEEE 802.11g WiFi 2.4 GHz (DSSS-OFDM, 24 Mbps, 99pc duty cycle)	X	4.99	68.55	17.66	0.46	150.0	± 9.6 %
		Y	4.96	68.34	17.45		150.0	
		Z	4.87	68.08	17.17		150.0	
10568-AAA	IEEE 802.11g WiFi 2.4 GHz (DSSS-OFDM, 36 Mbps, 99pc duty cycle)	X	4.88	67.99	17.11	0.46	150.0	± 9.6 %
		Y	4.83	67.70	16.84		150.0	
		Z	4.75	67.51	16.61		150.0	
10569-AAA	IEEE 802.11g WiFi 2.4 GHz (DSSS-OFDM, 48 Mbps, 99pc duty cycle)	X	4.98	68.78	17.81	0.46	150.0	± 9.6 %
		Y	4.95	68.58	17.60		150.0	
		Z	4.86	68.32	17.31		150.0	
10570-AAA	IEEE 802.11g WiFi 2.4 GHz (DSSS-OFDM, 54 Mbps, 99pc duty cycle)	X	4.98	68.56	17.69	0.46	150.0	± 9.6 %
		Y	4.95	68.33	17.47		150.0	
		Z	4.86	68.09	17.20		150.0	
10571-AAA	IEEE 802.11b WiFi 2.4 GHz (DSSS, 1 Mbps, 90pc duty cycle)	X	1.53	70.26	19.68	0.46	130.0	± 9.6 %
		Y	1.48	68.95	18.55		130.0	
		Z	1.37	67.40	17.39		130.0	
10572-AAA	IEEE 802.11b WiFi 2.4 GHz (DSSS, 2 Mbps, 90pc duty cycle)	X	1.59	71.46	20.33	0.46	130.0	± 9.6 %
		Y	1.53	70.00	19.13		130.0	
		Z	1.41	68.22	17.86		130.0	
10573-AAA	IEEE 802.11b WiFi 2.4 GHz (DSSS, 5.5 Mbps, 90pc duty cycle)	X	100.00	167.17	47.85	0.46	130.0	± 9.6 %
		Y	100.00	157.87	43.89		130.0	
		Z	100.00	153.13	41.71		130.0	
10574-AAA	IEEE 802.11b WiFi 2.4 GHz (DSSS, 11 Mbps, 90pc duty cycle)	X	3.10	89.83	28.24	0.46	130.0	± 9.6 %
		Y	2.51	83.93	25.32		130.0	
		Z	1.87	77.75	22.34		130.0	

10575-AAA	IEEE 802.11g WiFi 2.4 GHz (DSSS-OFDM, 6 Mbps, 90pc duty cycle)	X	4.72	67.77	17.29	0.46	130.0	± 9.6 %
		Y	4.68	67.55	17.05		130.0	
		Z	4.61	67.35	16.79		130.0	
10576-AAA	IEEE 802.11g WiFi 2.4 GHz (DSSS-OFDM, 9 Mbps, 90pc duty cycle)	X	4.75	67.98	17.37	0.46	130.0	± 9.6 %
		Y	4.72	67.76	17.14		130.0	
		Z	4.64	67.55	16.88		130.0	
10577-AAA	IEEE 802.11g WiFi 2.4 GHz (DSSS-OFDM, 12 Mbps, 90pc duty cycle)	X	4.92	68.19	17.49	0.46	130.0	± 9.6 %
		Y	4.89	67.98	17.27		130.0	
		Z	4.80	67.76	17.01		130.0	
10578-AAA	IEEE 802.11g WiFi 2.4 GHz (DSSS-OFDM, 18 Mbps, 90pc duty cycle)	X	4.83	68.39	17.63	0.46	130.0	± 9.6 %
		Y	4.80	68.19	17.41		130.0	
		Z	4.71	67.93	17.12		130.0	
10579-AAA	IEEE 802.11g WiFi 2.4 GHz (DSSS-OFDM, 24 Mbps, 90pc duty cycle)	X	4.60	67.68	16.96	0.46	130.0	± 9.6 %
		Y	4.56	67.40	16.68		130.0	
		Z	4.48	67.20	16.44		130.0	
10580-AAA	IEEE 802.11g WiFi 2.4 GHz (DSSS-OFDM, 36 Mbps, 90pc duty cycle)	X	4.64	67.76	17.00	0.46	130.0	± 9.6 %
		Y	4.60	67.47	16.71		130.0	
		Z	4.52	67.27	16.47		130.0	
10581-AAA	IEEE 802.11g WiFi 2.4 GHz (DSSS-OFDM, 48 Mbps, 90pc duty cycle)	X	4.75	68.54	17.65	0.46	130.0	± 9.6 %
		Y	4.72	68.32	17.42		130.0	
		Z	4.63	68.05	17.12		130.0	
10582-AAA	IEEE 802.11g WiFi 2.4 GHz (DSSS-OFDM, 54 Mbps, 90pc duty cycle)	X	4.53	67.47	16.77	0.46	130.0	± 9.6 %
		Y	4.49	67.15	16.46		130.0	
		Z	4.41	66.99	16.24		130.0	
10583-AAA	IEEE 802.11a/h WiFi 5 GHz (OFDM, 6 Mbps, 90pc duty cycle)	X	4.72	67.77	17.29	0.46	130.0	± 9.6 %
		Y	4.68	67.55	17.05		130.0	
		Z	4.61	67.35	16.79		130.0	
10584-AAA	IEEE 802.11a/h WiFi 5 GHz (OFDM, 9 Mbps, 90pc duty cycle)	X	4.75	67.98	17.37	0.46	130.0	± 9.6 %
		Y	4.72	67.76	17.14		130.0	
		Z	4.64	67.55	16.88		130.0	
10585-AAA	IEEE 802.11a/h WiFi 5 GHz (OFDM, 12 Mbps, 90pc duty cycle)	X	4.92	68.19	17.49	0.46	130.0	± 9.6 %
		Y	4.89	67.98	17.27		130.0	
		Z	4.80	67.76	17.01		130.0	
10586-AAA	IEEE 802.11a/h WiFi 5 GHz (OFDM, 18 Mbps, 90pc duty cycle)	X	4.83	68.39	17.63	0.46	130.0	± 9.6 %
		Y	4.80	68.19	17.41		130.0	
		Z	4.71	67.93	17.12		130.0	
10587-AAA	IEEE 802.11a/h WiFi 5 GHz (OFDM, 24 Mbps, 90pc duty cycle)	X	4.60	67.68	16.96	0.46	130.0	± 9.6 %
		Y	4.56	67.40	16.68		130.0	
		Z	4.48	67.20	16.44		130.0	
10588-AAA	IEEE 802.11a/h WiFi 5 GHz (OFDM, 36 Mbps, 90pc duty cycle)	X	4.64	67.76	17.00	0.46	130.0	± 9.6 %
		Y	4.60	67.47	16.71		130.0	
		Z	4.52	67.27	16.47		130.0	
10589-AAA	IEEE 802.11a/h WiFi 5 GHz (OFDM, 48 Mbps, 90pc duty cycle)	X	4.75	68.54	17.65	0.46	130.0	± 9.6 %
		Y	4.72	68.32	17.42		130.0	
		Z	4.63	68.05	17.12		130.0	
10590-AAA	IEEE 802.11a/h WiFi 5 GHz (OFDM, 54 Mbps, 90pc duty cycle)	X	4.53	67.47	16.77	0.46	130.0	± 9.6 %
		Y	4.49	67.15	16.46		130.0	
		Z	4.41	66.99	16.24		130.0	

10591-AAA	IEEE 802.11n (HT Mixed, 20MHz, MCS0, 90pc duty cycle)	X	4.86	67.77	17.35	0.46	130.0	± 9.6 %
		Y	4.83	67.57	17.13		130.0	
		Z	4.76	67.39	16.89		130.0	
10592-AAA	IEEE 802.11n (HT Mixed, 20MHz, MCS1, 90pc duty cycle)	X	5.00	68.10	17.48	0.46	130.0	± 9.6 %
		Y	4.97	67.89	17.26		130.0	
		Z	4.88	67.69	17.01		130.0	
10593-AAA	IEEE 802.11n (HT Mixed, 20MHz, MCS2, 90pc duty cycle)	X	4.92	68.01	17.36	0.46	130.0	± 9.6 %
		Y	4.89	67.79	17.13		130.0	
		Z	4.80	67.59	16.88		130.0	
10594-AAA	IEEE 802.11n (HT Mixed, 20MHz, MCS3, 90pc duty cycle)	X	4.97	68.18	17.52	0.46	130.0	± 9.6 %
		Y	4.94	67.97	17.30		130.0	
		Z	4.86	67.76	17.04		130.0	
10595-AAA	IEEE 802.11n (HT Mixed, 20MHz, MCS4, 90pc duty cycle)	X	4.95	68.18	17.45	0.46	130.0	± 9.6 %
		Y	4.91	67.96	17.21		130.0	
		Z	4.83	67.75	16.96		130.0	
10596-AAA	IEEE 802.11n (HT Mixed, 20MHz, MCS5, 90pc duty cycle)	X	4.88	68.19	17.46	0.46	130.0	± 9.6 %
		Y	4.85	67.95	17.22		130.0	
		Z	4.76	67.74	16.97		130.0	
10597-AAA	IEEE 802.11n (HT Mixed, 20MHz, MCS6, 90pc duty cycle)	X	4.83	68.07	17.33	0.46	130.0	± 9.6 %
		Y	4.80	67.83	17.08		130.0	
		Z	4.71	67.61	16.83		130.0	
10598-AAA	IEEE 802.11n (HT Mixed, 20MHz, MCS7, 90pc duty cycle)	X	4.82	68.29	17.59	0.46	130.0	± 9.6 %
		Y	4.79	68.08	17.36		130.0	
		Z	4.70	67.83	17.08		130.0	
10599-AAA	IEEE 802.11n (HT Mixed, 40MHz, MCS0, 90pc duty cycle)	X	5.54	68.17	17.50	0.46	130.0	± 9.6 %
		Y	5.51	67.99	17.30		130.0	
		Z	5.43	67.80	17.08		130.0	
10600-AAA	IEEE 802.11n (HT Mixed, 40MHz, MCS1, 90pc duty cycle)	X	5.69	68.70	17.74	0.46	130.0	± 9.6 %
		Y	5.65	68.47	17.52		130.0	
		Z	5.55	68.23	17.28		130.0	
10601-AAA	IEEE 802.11n (HT Mixed, 40MHz, MCS2, 90pc duty cycle)	X	5.56	68.37	17.60	0.46	130.0	± 9.6 %
		Y	5.53	68.17	17.39		130.0	
		Z	5.44	67.97	17.16		130.0	
10602-AAA	IEEE 802.11n (HT Mixed, 40MHz, MCS3, 90pc duty cycle)	X	5.70	68.54	17.60	0.46	130.0	± 9.6 %
		Y	5.66	68.33	17.38		130.0	
		Z	5.58	68.16	17.17		130.0	
10603-AAA	IEEE 802.11n (HT Mixed, 40MHz, MCS4, 90pc duty cycle)	X	5.78	68.87	17.89	0.46	130.0	± 9.6 %
		Y	5.75	68.67	17.69		130.0	
		Z	5.64	68.42	17.44		130.0	
10604-AAA	IEEE 802.11n (HT Mixed, 40MHz, MCS5, 90pc duty cycle)	X	5.65	68.51	17.70	0.46	130.0	± 9.6 %
		Y	5.62	68.31	17.49		130.0	
		Z	5.52	68.06	17.24		130.0	
10605-AAA	IEEE 802.11n (HT Mixed, 40MHz, MCS6, 90pc duty cycle)	X	5.67	68.56	17.73	0.46	130.0	± 9.6 %
		Y	5.64	68.34	17.50		130.0	
		Z	5.54	68.11	17.26		130.0	
10606-AAA	IEEE 802.11n (HT Mixed, 40MHz, MCS7, 90pc duty cycle)	X	5.41	67.85	17.23	0.46	130.0	± 9.6 %
		Y	5.38	67.63	17.01		130.0	
		Z	5.31	67.50	16.82		130.0	

10607-AAA	IEEE 802.11ac WiFi (20MHz, MCS0, 90pc duty cycle)	X	4.73	67.22	17.05	0.46	130.0	± 9.6 %
		Y	4.69	66.99	16.81		130.0	
		Z	4.61	66.77	16.55		130.0	
10608-AAA	IEEE 802.11ac WiFi (20MHz, MCS1, 90pc duty cycle)	X	4.89	67.59	17.21	0.46	130.0	± 9.6 %
		Y	4.85	67.36	16.97		130.0	
		Z	4.76	67.12	16.70		130.0	
10609-AAA	IEEE 802.11ac WiFi (20MHz, MCS2, 90pc duty cycle)	X	4.79	67.47	17.06	0.46	130.0	± 9.6 %
		Y	4.75	67.21	16.81		130.0	
		Z	4.66	66.98	16.54		130.0	
10610-AAA	IEEE 802.11ac WiFi (20MHz, MCS3, 90pc duty cycle)	X	4.84	67.62	17.21	0.46	130.0	± 9.6 %
		Y	4.80	67.38	16.98		130.0	
		Z	4.71	67.13	16.70		130.0	
10611-AAA	IEEE 802.11ac WiFi (20MHz, MCS4, 90pc duty cycle)	X	4.75	67.43	17.07	0.46	130.0	± 9.6 %
		Y	4.71	67.19	16.83		130.0	
		Z	4.62	66.94	16.55		130.0	
10612-AAA	IEEE 802.11ac WiFi (20MHz, MCS5, 90pc duty cycle)	X	4.76	67.63	17.15	0.46	130.0	± 9.6 %
		Y	4.72	67.36	16.89		130.0	
		Z	4.62	67.11	16.61		130.0	
10613-AAA	IEEE 802.11ac WiFi (20MHz, MCS6, 90pc duty cycle)	X	4.76	67.45	16.99	0.46	130.0	± 9.6 %
		Y	4.71	67.17	16.73		130.0	
		Z	4.62	66.92	16.46		130.0	
10614-AAA	IEEE 802.11ac WiFi (20MHz, MCS7, 90pc duty cycle)	X	4.71	67.65	17.23	0.46	130.0	± 9.6 %
		Y	4.68	67.41	16.99		130.0	
		Z	4.58	67.13	16.69		130.0	
10615-AAA	IEEE 802.11ac WiFi (20MHz, MCS8, 90pc duty cycle)	X	4.75	67.29	16.86	0.46	130.0	± 9.6 %
		Y	4.71	67.01	16.59		130.0	
		Z	4.62	66.80	16.34		130.0	
10616-AAA	IEEE 802.11ac WiFi (40MHz, MCS0, 90pc duty cycle)	X	5.36	67.41	17.11	0.46	130.0	± 9.6 %
		Y	5.32	67.22	16.91		130.0	
		Z	5.24	67.01	16.67		130.0	
10617-AAA	IEEE 802.11ac WiFi (40MHz, MCS1, 90pc duty cycle)	X	5.44	67.66	17.21	0.46	130.0	± 9.6 %
		Y	5.40	67.45	17.00		130.0	
		Z	5.30	67.20	16.74		130.0	
10618-AAA	IEEE 802.11ac WiFi (40MHz, MCS2, 90pc duty cycle)	X	5.34	67.71	17.26	0.46	130.0	± 9.6 %
		Y	5.30	67.51	17.04		130.0	
		Z	5.21	67.26	16.79		130.0	
10619-AAA	IEEE 802.11ac WiFi (40MHz, MCS3, 90pc duty cycle)	X	5.34	67.48	17.07	0.46	130.0	± 9.6 %
		Y	5.30	67.27	16.86		130.0	
		Z	5.22	67.06	16.62		130.0	
10620-AAA	IEEE 802.11ac WiFi (40MHz, MCS4, 90pc duty cycle)	X	5.41	67.47	17.11	0.46	130.0	± 9.6 %
		Y	5.38	67.26	16.90		130.0	
		Z	5.29	67.06	16.67		130.0	
10621-AAA	IEEE 802.11ac WiFi (40MHz, MCS5, 90pc duty cycle)	X	5.41	67.55	17.27	0.46	130.0	± 9.6 %
		Y	5.38	67.38	17.08		130.0	
		Z	5.29	67.14	16.82		130.0	
10622-AAA	IEEE 802.11ac WiFi (40MHz, MCS6, 90pc duty cycle)	X	5.42	67.70	17.34	0.46	130.0	± 9.6 %
		Y	5.38	67.50	17.14		130.0	
		Z	5.29	67.26	16.88		130.0	

10623-AAA	IEEE 802.11ac WiFi (40MHz, MCS7, 90pc duty cycle)	X	5.29	67.21	16.97	0.46	130.0	± 9.6 %
		Y	5.26	67.01	16.75		130.0	
		Z	5.17	66.80	16.52		130.0	
10624-AAA	IEEE 802.11ac WiFi (40MHz, MCS8, 90pc duty cycle)	X	5.49	67.44	17.13	0.46	130.0	± 9.6 %
		Y	5.46	67.25	16.93		130.0	
		Z	5.37	67.04	16.70		130.0	
10625-AAA	IEEE 802.11ac WiFi (40MHz, MCS9, 90pc duty cycle)	X	5.67	67.85	17.40	0.46	130.0	± 9.6 %
		Y	5.63	67.64	17.18		130.0	
		Z	5.49	67.29	16.88		130.0	
10626-AAA	IEEE 802.11ac WiFi (80MHz, MCS0, 90pc duty cycle)	X	5.67	67.37	17.01	0.46	130.0	± 9.6 %
		Y	5.64	67.20	16.82		130.0	
		Z	5.56	67.01	16.60		130.0	
10627-AAA	IEEE 802.11ac WiFi (80MHz, MCS1, 90pc duty cycle)	X	5.95	68.11	17.34	0.46	130.0	± 9.6 %
		Y	5.91	67.91	17.14		130.0	
		Z	5.81	67.67	16.90		130.0	
10628-AAA	IEEE 802.11ac WiFi (80MHz, MCS2, 90pc duty cycle)	X	5.68	67.42	16.93	0.46	130.0	± 9.6 %
		Y	5.65	67.22	16.73		130.0	
		Z	5.56	67.03	16.51		130.0	
10629-AAA	IEEE 802.11ac WiFi (80MHz, MCS3, 90pc duty cycle)	X	5.78	67.58	17.01	0.46	130.0	± 9.6 %
		Y	5.75	67.38	16.80		130.0	
		Z	5.66	67.19	16.59		130.0	
10630-AAA	IEEE 802.11ac WiFi (80MHz, MCS4, 90pc duty cycle)	X	6.18	69.00	17.72	0.46	130.0	± 9.6 %
		Y	6.12	68.72	17.47		130.0	
		Z	5.97	68.32	17.16		130.0	
10631-AAA	IEEE 802.11ac WiFi (80MHz, MCS5, 90pc duty cycle)	X	6.05	68.69	17.74	0.46	130.0	± 9.6 %
		Y	6.02	68.51	17.56		130.0	
		Z	5.90	68.19	17.27		130.0	
10632-AAA	IEEE 802.11ac WiFi (80MHz, MCS6, 90pc duty cycle)	X	5.92	68.20	17.52	0.46	130.0	± 9.6 %
		Y	5.89	68.03	17.34		130.0	
		Z	5.79	67.79	17.09		130.0	
10633-AAA	IEEE 802.11ac WiFi (80MHz, MCS7, 90pc duty cycle)	X	5.75	67.61	17.06	0.46	130.0	± 9.6 %
		Y	5.71	67.43	16.87		130.0	
		Z	5.61	67.18	16.62		130.0	
10634-AAA	IEEE 802.11ac WiFi (80MHz, MCS8, 90pc duty cycle)	X	5.73	67.62	17.12	0.46	130.0	± 9.6 %
		Y	5.70	67.45	16.93		130.0	
		Z	5.61	67.26	16.71		130.0	
10635-AAA	IEEE 802.11ac WiFi (80MHz, MCS9, 90pc duty cycle)	X	5.59	66.93	16.52	0.46	130.0	± 9.6 %
		Y	5.55	66.70	16.29		130.0	
		Z	5.48	66.56	16.11		130.0	
10636-AAB	IEEE 802.11ac WiFi (160MHz, MCS0, 90pc duty cycle)	X	6.10	67.70	17.06	0.46	130.0	± 9.6 %
		Y	6.07	67.53	16.88		130.0	
		Z	5.99	67.35	16.67		130.0	
10637-AAB	IEEE 802.11ac WiFi (160MHz, MCS1, 90pc duty cycle)	X	6.26	68.11	17.25	0.46	130.0	± 9.6 %
		Y	6.22	67.93	17.06		130.0	
		Z	6.13	67.70	16.83		130.0	
10638-AAB	IEEE 802.11ac WiFi (160MHz, MCS2, 90pc duty cycle)	X	6.27	68.11	17.23	0.46	130.0	± 9.6 %
		Y	6.23	67.92	17.04		130.0	
		Z	6.14	67.72	16.82		130.0	

10639-AAB	IEEE 802.11ac WiFi (160MHz, MCS3, 90pc duty cycle)	X	6.22	67.97	17.20	0.46	130.0	± 9.6 %
		Y	6.18	67.80	17.02		130.0	
		Z	6.10	67.60	16.80		130.0	
10640-AAB	IEEE 802.11ac WiFi (160MHz, MCS4, 90pc duty cycle)	X	6.21	67.98	17.15	0.46	130.0	± 9.6 %
		Y	6.17	67.78	16.95		130.0	
		Z	6.08	67.56	16.73		130.0	
10641-AAB	IEEE 802.11ac WiFi (160MHz, MCS5, 90pc duty cycle)	X	6.30	68.00	17.18	0.46	130.0	± 9.6 %
		Y	6.26	67.81	16.98		130.0	
		Z	6.17	67.61	16.77		130.0	
10642-AAB	IEEE 802.11ac WiFi (160MHz, MCS6, 90pc duty cycle)	X	6.30	68.13	17.40	0.46	130.0	± 9.6 %
		Y	6.27	67.97	17.23		130.0	
		Z	6.18	67.76	17.01		130.0	
10643-AAB	IEEE 802.11ac WiFi (160MHz, MCS7, 90pc duty cycle)	X	6.16	67.91	17.20	0.46	130.0	± 9.6 %
		Y	6.12	67.71	17.00		130.0	
		Z	6.03	67.50	16.78		130.0	
10644-AAB	IEEE 802.11ac WiFi (160MHz, MCS8, 90pc duty cycle)	X	6.24	68.16	17.34	0.46	130.0	± 9.6 %
		Y	6.20	67.95	17.14		130.0	
		Z	6.10	67.72	16.91		130.0	
10645-AAB	IEEE 802.11ac WiFi (160MHz, MCS9, 90pc duty cycle)	X	6.44	68.39	17.42	0.46	130.0	± 9.6 %
		Y	6.39	68.17	17.21		130.0	
		Z	6.27	67.87	16.95		130.0	
10646-AAD	LTE-TDD (SC-FDMA, 1 RB, 5 MHz, QPSK, UL Subframe=2,7)	X	100.00	154.07	50.96	9.30	60.0	± 9.6 %
		Y	100.00	149.19	48.64		60.0	
		Z	100.00	151.77	49.64		60.0	
10647-AAC	LTE-TDD (SC-FDMA, 1 RB, 20 MHz, QPSK, UL Subframe=2,7)	X	100.00	155.63	51.65	9.30	60.0	± 9.6 %
		Y	100.00	150.58	49.25		60.0	
		Z	100.00	153.26	50.29		60.0	
10648-AAA	CDMA2000 (1x Advanced)	X	7.29	96.44	23.44	0.00	150.0	± 9.6 %
		Y	1.15	71.60	14.63		150.0	
		Z	0.73	65.79	11.39		150.0	
10652-AAB	LTE-TDD (OFDMA, 5 MHz, E-TM 3.1, Clipping 44%)	X	4.70	71.99	19.13	2.23	80.0	± 9.6 %
		Y	4.65	71.36	18.64		80.0	
		Z	4.32	70.31	17.98		80.0	
10653-AAB	LTE-TDD (OFDMA, 10 MHz, E-TM 3.1, Clipping 44%)	X	4.86	69.58	18.56	2.23	80.0	± 9.6 %
		Y	4.87	69.28	18.24		80.0	
		Z	4.66	68.67	17.81		80.0	
10654-AAB	LTE-TDD (OFDMA, 15 MHz, E-TM 3.1, Clipping 44%)	X	4.78	68.93	18.47	2.23	80.0	± 9.6 %
		Y	4.81	68.69	18.18		80.0	
		Z	4.62	68.14	17.78		80.0	
10655-AAB	LTE-TDD (OFDMA, 20 MHz, E-TM 3.1, Clipping 44%)	X	4.83	68.76	18.45	2.23	80.0	± 9.6 %
		Y	4.86	68.54	18.16		80.0	
		Z	4.67	68.01	17.79		80.0	

^E Uncertainty is determined using the max. deviation from linear response applying rectangular distribution and is expressed for the square of the field value.



Accredited by the Swiss Accreditation Service (SAS)
The Swiss Accreditation Service is one of the signatories to the EA
Multilateral Agreement for the recognition of calibration certificates

Accreditation No.: **SCS 0108**

Client **PC Test**

Certificate No: **ES3-3332_Aug17**

CALIBRATION CERTIFICATE

Object **ES3DV3 - SN:3332**

Calibration procedure(s) **QA CAL-01.v9, QA CAL-23.v5, QA CAL-25.v6
Calibration procedure for dosimetric E-field probes**

Calibration date: **August 14, 2017**

This calibration certificate documents the traceability to national standards, which realize the physical units of measurements (SI).
The measurements and the uncertainties with confidence probability are given on the following pages and are part of the certificate.

All calibrations have been conducted in the closed laboratory facility: environment temperature (22 ± 3)°C and humidity < 70%.

Calibration Equipment used (M&TE critical for calibration)

PHY
8/27/17

Primary Standards	ID	Cal Date (Certificate No.)	Scheduled Calibration
Power meter NRP	SN: 104778	04-Apr-17 (No. 217-02521/02522)	Apr-18
Power sensor NRP-Z91	SN: 103244	04-Apr-17 (No. 217-02521)	Apr-18
Power sensor NRP-Z91	SN: 103245	04-Apr-17 (No. 217-02525)	Apr-18
Reference 20 dB Attenuator	SN: S5277 (20x)	07-Apr-17 (No. 217-02528)	Apr-18
Reference Probe ES3DV2	SN: 3013	31-Dec-16 (No. ES3-3013_Dec16)	Dec-17
DAE4	SN: 660	7-Dec-16 (No. DAE4-660_Dec16)	Dec-17
Secondary Standards	ID	Check Date (in house)	Scheduled Check
Power meter E4419B	SN: GB41293874	06-Apr-16 (in house check Jun-16)	In house check: Jun-18
Power sensor E4412A	SN: MY41498087	06-Apr-16 (in house check Jun-16)	In house check: Jun-18
Power sensor E4412A	SN: 000110210	06-Apr-16 (in house check Jun-16)	In house check: Jun-18
RF generator HP 8648C	SN: US3642U01700	04-Aug-99 (in house check Jun-16)	In house check: Jun-18
Network Analyzer HP 8753E	SN: US37390585	18-Oct-01 (in house check Oct-16)	In house check: Oct-17

Calibrated by:	Name Jeton Kastrati	Function Laboratory Technician	Signature
Approved by:	Name Katja Pokovic	Function Technical Manager	Signature
			Issued: August 16, 2017

This calibration certificate shall not be reproduced except in full without written approval of the laboratory.



Accredited by the Swiss Accreditation Service (SAS)

Accreditation No.: **SCS 0108**

The Swiss Accreditation Service is one of the signatories to the EA
Multilateral Agreement for the recognition of calibration certificates

Glossary:

TSL	tissue simulating liquid
NORM _{x,y,z}	sensitivity in free space
ConvF	sensitivity in TSL / NORM _{x,y,z}
DCP	diode compression point
CF	crest factor (1/duty_cycle) of the RF signal
A, B, C, D	modulation dependent linearization parameters
Polarization φ	φ rotation around probe axis
Polarization θ	θ rotation around an axis that is in the plane normal to probe axis (at measurement center), i.e., θ = 0 is normal to probe axis
Connector Angle	information used in DASY system to align probe sensor X to the robot coordinate system

Calibration is Performed According to the Following Standards:

- a) IEEE Std 1528-2013, "IEEE Recommended Practice for Determining the Peak Spatial-Averaged Specific Absorption Rate (SAR) in the Human Head from Wireless Communications Devices: Measurement Techniques", June 2013
- b) IEC 62209-1, "Measurement procedure for the assessment of Specific Absorption Rate (SAR) from hand-held and body-mounted devices used next to the ear (frequency range of 300 MHz to 6 GHz)", July 2016
- c) IEC 62209-2, "Procedure to determine the Specific Absorption Rate (SAR) for wireless communication devices used in close proximity to the human body (frequency range of 30 MHz to 6 GHz)", March 2010
- d) KDB 865664, "SAR Measurement Requirements for 100 MHz to 6 GHz"

Methods Applied and Interpretation of Parameters:

- *NORM_{x,y,z}*: Assessed for E-field polarization θ = 0 (f ≤ 900 MHz in TEM-cell; f > 1800 MHz: R22 waveguide). *NORM_{x,y,z}* are only intermediate values, i.e., the uncertainties of *NORM_{x,y,z}* does not affect the E²-field uncertainty inside TSL (see below *ConvF*).
- *NORM(f)_{x,y,z}* = *NORM_{x,y,z}* * *frequency_response* (see Frequency Response Chart). This linearization is implemented in DASY4 software versions later than 4.2. The uncertainty of the frequency response is included in the stated uncertainty of *ConvF*.
- *DCP_{x,y,z}*: DCP are numerical linearization parameters assessed based on the data of power sweep with CW signal (no uncertainty required). DCP does not depend on frequency nor media.
- *PAR*: *PAR* is the Peak to Average Ratio that is not calibrated but determined based on the signal characteristics
- *A_{x,y,z}*; *B_{x,y,z}*; *C_{x,y,z}*; *D_{x,y,z}*; *VR_{x,y,z}*; *A, B, C, D* are numerical linearization parameters assessed based on the data of power sweep for specific modulation signal. The parameters do not depend on frequency nor media. *VR* is the maximum calibration range expressed in RMS voltage across the diode.
- *ConvF* and *Boundary Effect Parameters*: Assessed in flat phantom using E-field (or Temperature Transfer Standard for f ≤ 800 MHz) and inside waveguide using analytical field distributions based on power measurements for f > 800 MHz. The same setups are used for assessment of the parameters applied for boundary compensation (alpha, depth) of which typical uncertainty values are given. These parameters are used in DASY4 software to improve probe accuracy close to the boundary. The sensitivity in TSL corresponds to *NORM_{x,y,z}* * *ConvF* whereby the uncertainty corresponds to that given for *ConvF*. A frequency dependent *ConvF* is used in DASY version 4.4 and higher which allows extending the validity from ± 50 MHz to ± 100 MHz.
- *Spherical isotropy (3D deviation from isotropy)*: in a field of low gradients realized using a flat phantom exposed by a patch antenna.
- *Sensor Offset*: The sensor offset corresponds to the offset of virtual measurement center from the probe tip (on probe axis). No tolerance required.
- *Connector Angle*: The angle is assessed using the information gained by determining the *NORM_x* (no uncertainty required).

Probe ES3DV3

SN:3332

Manufactured: January 24, 2012
Calibrated: August 14, 2017

Calibrated for DASY/EASY Systems
(Note: non-compatible with DASY2 system!)

DASY/EASY - Parameters of Probe: ES3DV3 - SN:3332

Basic Calibration Parameters

	Sensor X	Sensor Y	Sensor Z	Unc (k=2)
Norm ($\mu\text{V}/(\text{V}/\text{m})^2$) ^A	1.00	0.93	0.88	$\pm 10.1 \%$
DCP (mV) ^B	104.0	103.0	103.0	

Modulation Calibration Parameters

UID	Communication System Name		A dB	B dB $\sqrt{\mu\text{V}}$	C	D dB	VR mV	Unc ^E (k=2)
0	CW	X	0.0	0.0	1.0	0.00	192.0	$\pm 3.5 \%$
		Y	0.0	0.0	1.0		194.3	
		Z	0.0	0.0	1.0		179.9	

Note: For details on UID parameters see Appendix.

Sensor Model Parameters

	C1 fF	C2 fF	α V ⁻¹	T1 ms.V ⁻²	T2 ms.V ⁻¹	T3 ms	T4 V ⁻²	T5 V ⁻¹	T6
X	76.72	548.9	35.46	56.44	4.600	5.1	0.000	0.903	1.011
Y	44.78	323.3	35.85	29.01	2.529	5.1	0.000	0.546	1.009
Z	38.01	268.3	34.56	26.38	1.777	5.1	0.096	0.424	1.004

The reported uncertainty of measurement is stated as the standard uncertainty of measurement multiplied by the coverage factor k=2, which for a normal distribution corresponds to a coverage probability of approximately 95%.

^A The uncertainties of Norm X,Y,Z do not affect the E²-field uncertainty inside TSL (see Pages 5 and 6).

^B Numerical linearization parameter: uncertainty not required.

^E Uncertainty is determined using the max. deviation from linear response applying rectangular distribution and is expressed for the square of the field value.

DASY/EASY - Parameters of Probe: ES3DV3 - SN:3332

Calibration Parameter Determined in Head Tissue Simulating Media

f (MHz) ^C	Relative Permittivity ^F	Conductivity (S/m) ^F	ConvF X	ConvF Y	ConvF Z	Alpha ^G	Depth ^G (mm)	Unc (k=2)
750	41.9	0.89	6.81	6.81	6.81	0.72	1.31	± 12.0 %
835	41.5	0.90	6.64	6.64	6.64	0.80	1.21	± 12.0 %
1750	40.1	1.37	5.56	5.56	5.56	0.80	1.20	± 12.0 %
1900	40.0	1.40	5.33	5.33	5.33	0.76	1.26	± 12.0 %
2300	39.5	1.67	4.99	4.99	4.99	0.70	1.36	± 12.0 %
2450	39.2	1.80	4.68	4.68	4.68	0.63	1.48	± 12.0 %
2600	39.0	1.96	4.56	4.56	4.56	0.80	1.23	± 12.0 %

^C Frequency validity above 300 MHz of ± 100 MHz only applies for DASY v4.4 and higher (see Page 2), else it is restricted to ± 50 MHz. The uncertainty is the RSS of the ConvF uncertainty at calibration frequency and the uncertainty for the indicated frequency band. Frequency validity below 300 MHz is ± 10, 25, 40, 50 and 70 MHz for ConvF assessments at 30, 64, 128, 150 and 220 MHz respectively. Above 5 GHz frequency validity can be extended to ± 110 MHz.

^F At frequencies below 3 GHz, the validity of tissue parameters (ϵ and σ) can be relaxed to ± 10% if liquid compensation formula is applied to measured SAR values. At frequencies above 3 GHz, the validity of tissue parameters (ϵ and σ) is restricted to ± 5%. The uncertainty is the RSS of the ConvF uncertainty for indicated target tissue parameters.

^G Alpha/Depth are determined during calibration. SPEAG warrants that the remaining deviation due to the boundary effect after compensation is always less than ± 1% for frequencies below 3 GHz and below ± 2% for frequencies between 3-6 GHz at any distance larger than half the probe tip diameter from the boundary.

DASY/EASY - Parameters of Probe: ES3DV3 - SN:3332

Calibration Parameter Determined in Body Tissue Simulating Media

f (MHz) ^C	Relative Permittivity ^F	Conductivity (S/m) ^F	ConvF X	ConvF Y	ConvF Z	Alpha ^G	Depth ^G (mm)	Unc (k=2)
750	55.5	0.96	6.54	6.54	6.54	0.55	1.43	± 12.0 %
835	55.2	0.97	6.47	6.47	6.47	0.71	1.27	± 12.0 %
1750	53.4	1.49	5.16	5.16	5.16	0.80	1.22	± 12.0 %
1900	53.3	1.52	4.95	4.95	4.95	0.54	1.56	± 12.0 %
2300	52.9	1.81	4.74	4.74	4.74	0.80	1.30	± 12.0 %
2450	52.7	1.95	4.55	4.55	4.55	0.80	1.17	± 12.0 %
2600	52.5	2.16	4.43	4.43	4.43	0.80	1.12	± 12.0 %

^C Frequency validity above 300 MHz of ± 100 MHz only applies for DASY v4.4 and higher (see Page 2), else it is restricted to ± 50 MHz. The uncertainty is the RSS of the ConvF uncertainty at calibration frequency and the uncertainty for the indicated frequency band. Frequency validity below 300 MHz is ± 10, 25, 40, 50 and 70 MHz for ConvF assessments at 30, 64, 128, 150 and 220 MHz respectively. Above 5 GHz frequency validity can be extended to ± 110 MHz.

^F At frequencies below 3 GHz, the validity of tissue parameters (ϵ and σ) can be relaxed to ± 10% if liquid compensation formula is applied to measured SAR values. At frequencies above 3 GHz, the validity of tissue parameters (ϵ and σ) is restricted to ± 5%. The uncertainty is the RSS of the ConvF uncertainty for indicated target tissue parameters.

^G Alpha/Depth are determined during calibration. SPEAG warrants that the remaining deviation due to the boundary effect after compensation is always less than ± 1% for frequencies below 3 GHz and below ± 2% for frequencies between 3-6 GHz at any distance larger than half the probe tip diameter from the boundary.

Frequency Response of E-Field

(TEM-Cell:ifi110 EXX, Waveguide: R22)

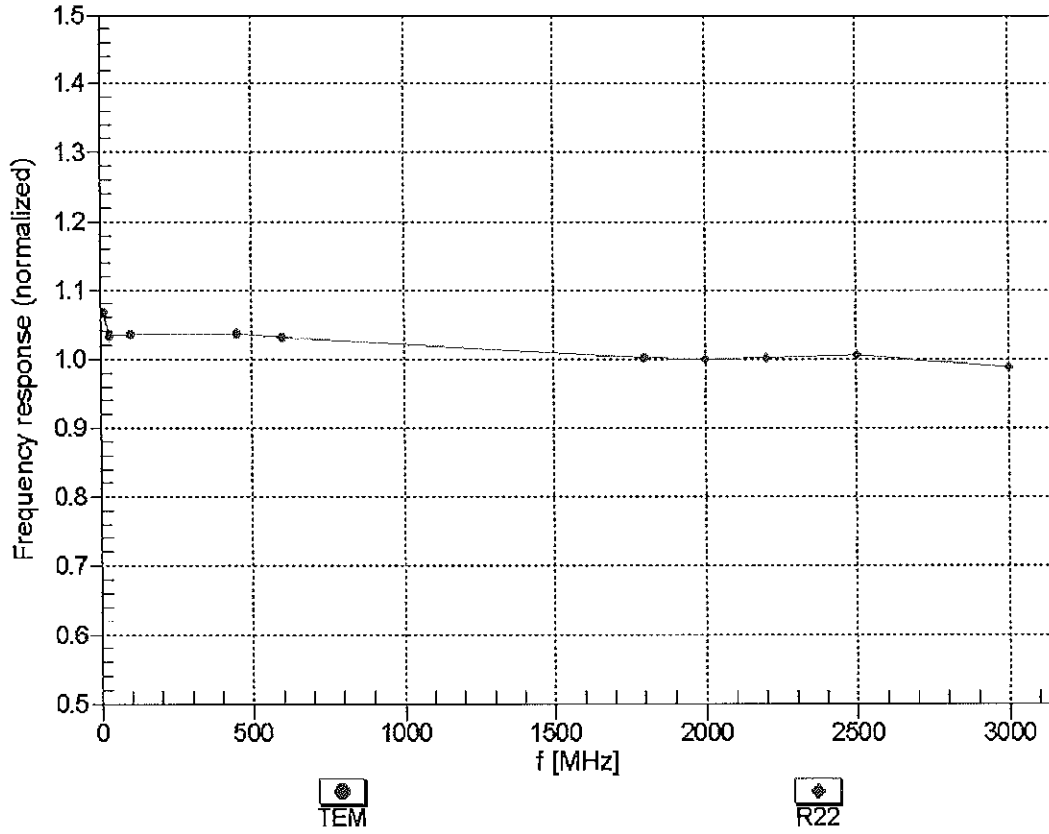

Uncertainty of Frequency Response of E-field: $\pm 6.3\%$ (k=2)

Receiving Pattern (ϕ), $\vartheta = 0^\circ$

f=600 MHz,TEM

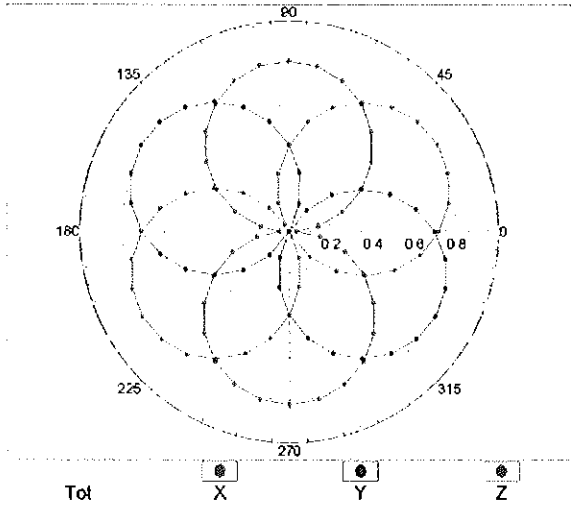

f=1800 MHz,R22

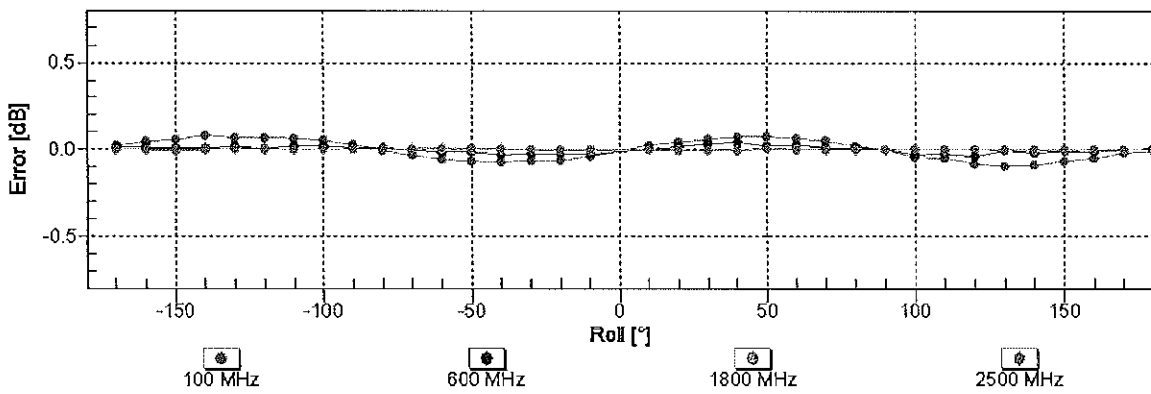
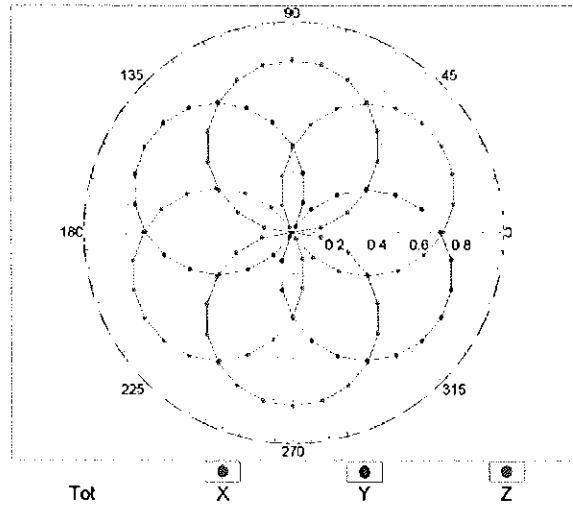

Uncertainty of Axial Isotropy Assessment: $\pm 0.5\%$ (k=2)

Dynamic Range $f(SAR_{head})$ (TEM cell, $f_{eval} = 1900$ MHz)

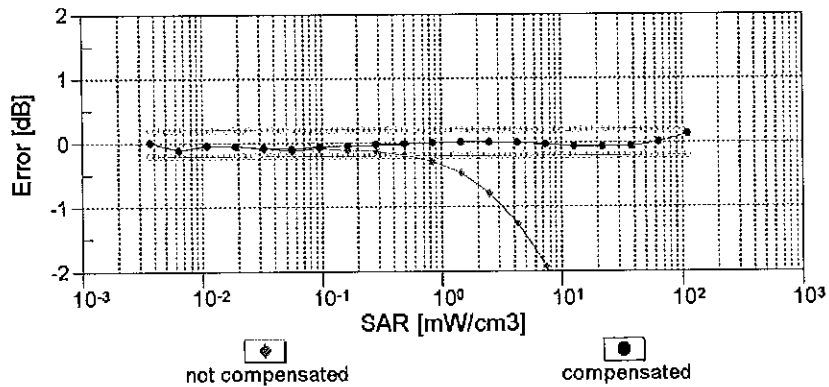
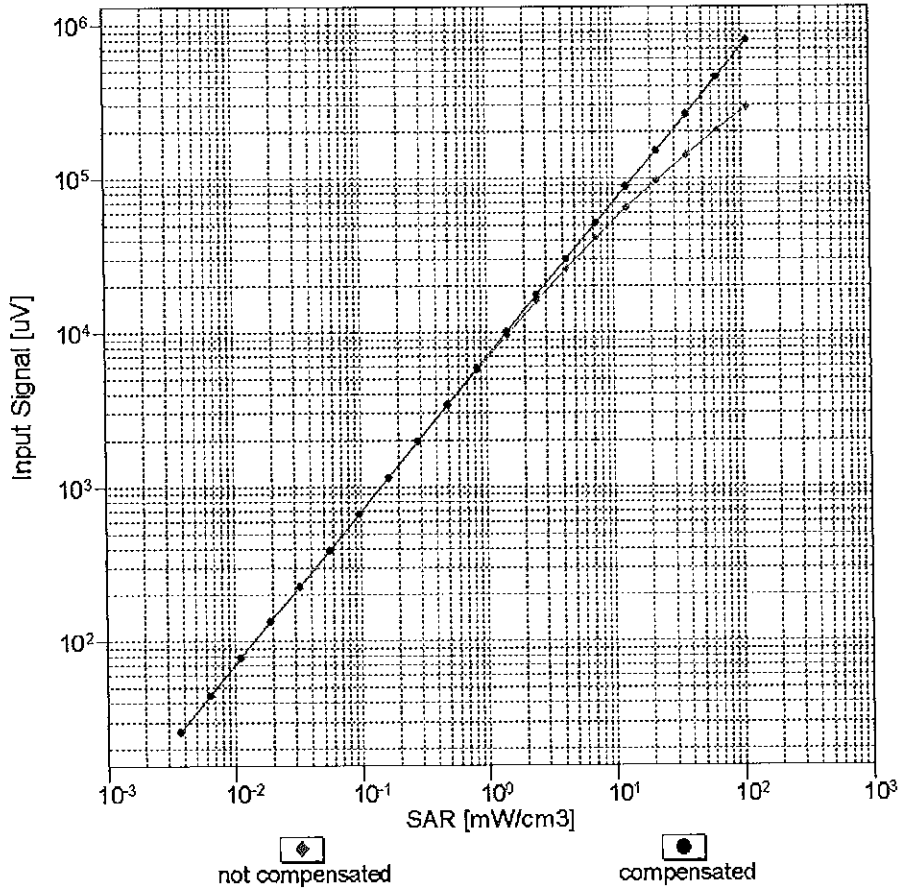

Uncertainty of Linearity Assessment: $\pm 0.6\%$ ($k=2$)

Conversion Factor Assessment

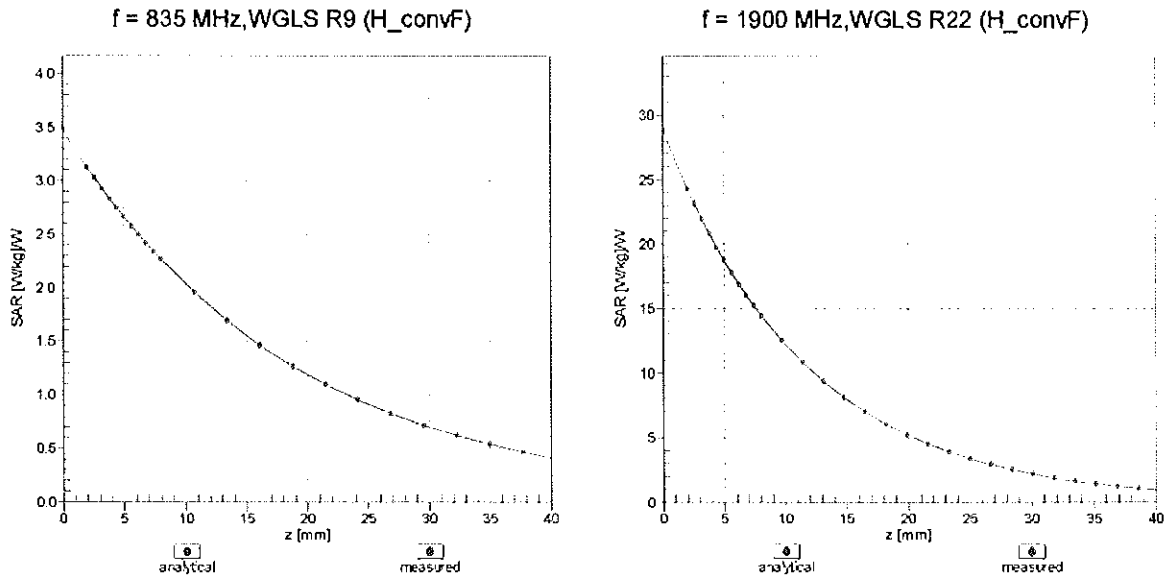

Deviation from Isotropy in Liquid Error (ϕ, ϑ), f = 900 MHz

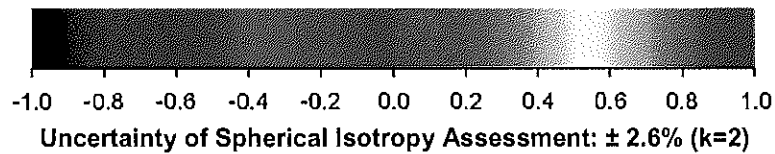
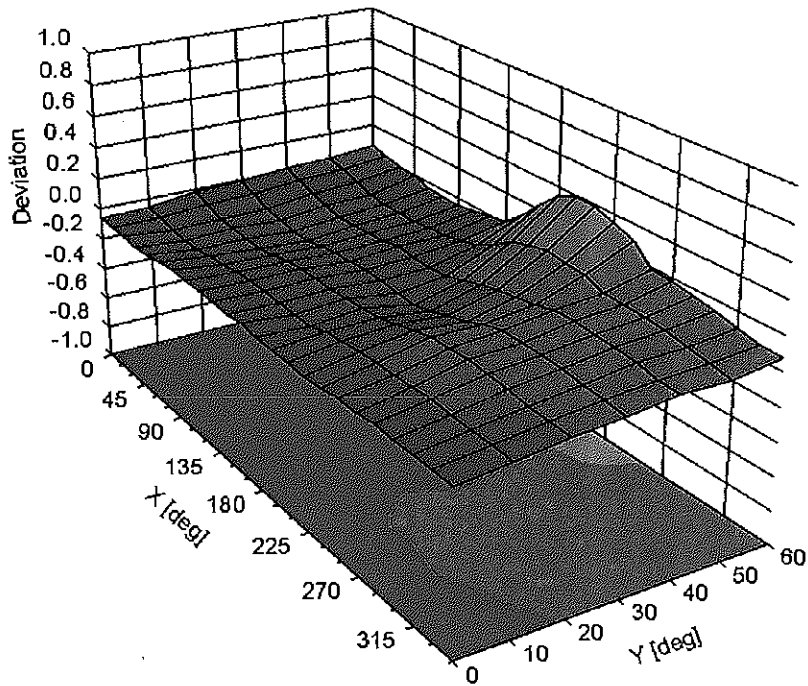

DASY/EASY - Parameters of Probe: ES3DV3 - SN:3332**Other Probe Parameters**

Sensor Arrangement	Triangular
Connector Angle (°)	50
Mechanical Surface Detection Mode	enabled
Optical Surface Detection Mode	disabled
Probe Overall Length	337 mm
Probe Body Diameter	10 mm
Tip Length	10 mm
Tip Diameter	4 mm
Probe Tip to Sensor X Calibration Point	2 mm
Probe Tip to Sensor Y Calibration Point	2 mm
Probe Tip to Sensor Z Calibration Point	2 mm
Recommended Measurement Distance from Surface	3 mm

Appendix: Modulation Calibration Parameters

UID	Communication System Name		A dB	B dB $\sqrt{\mu V}$	C	D dB	VR mV	Max Unc ^E (k=2)
0	CW	X	0.00	0.00	1.00	0.00	192.0	$\pm 3.5\%$
		Y	0.00	0.00	1.00		194.3	
		Z	0.00	0.00	1.00		179.9	
10010- CAA	SAR Validation (Square, 100ms, 10ms)	X	9.02	77.08	18.94	10.00	25.0	$\pm 9.6\%$
		Y	12.19	85.73	21.41		25.0	
		Z	23.02	95.31	23.86		25.0	
10011- CAB	UMTS-FDD (WCDMA)	X	1.60	76.05	19.77	0.00	150.0	$\pm 9.6\%$
		Y	1.08	68.15	15.73		150.0	
		Z	1.25	71.36	17.60		150.0	
10012- CAB	IEEE 802.11b WiFi 2.4 GHz (DSSS, 1 Mbps)	X	1.52	68.53	17.98	0.41	150.0	$\pm 9.6\%$
		Y	1.33	65.39	16.06		150.0	
		Z	1.37	66.35	16.79		150.0	
10013- CAB	IEEE 802.11g WiFi 2.4 GHz (DSSS-OFDM, 6 Mbps)	X	5.37	67.71	17.82	1.46	150.0	$\pm 9.6\%$
		Y	5.07	67.50	17.57		150.0	
		Z	4.99	67.81	17.71		150.0	
10021- DAC	GSM-FDD (TDMA, GMSK)	X	11.16	81.48	22.11	9.39	50.0	$\pm 9.6\%$
		Y	61.59	115.23	32.13		50.0	
		Z	100.00	122.78	33.35		50.0	
10023- DAC	GPRS-FDD (TDMA, GMSK, TN 0)	X	11.07	81.20	22.06	9.57	50.0	$\pm 9.6\%$
		Y	43.11	109.07	30.52		50.0	
		Z	100.00	122.63	33.33		50.0	
10024- DAC	GPRS-FDD (TDMA, GMSK, TN 0-1)	X	12.88	85.34	22.06	6.56	60.0	$\pm 9.6\%$
		Y	100.00	120.15	31.36		60.0	
		Z	100.00	120.25	30.99		60.0	
10025- DAC	EDGE-FDD (TDMA, 8PSK, TN 0)	X	19.49	99.22	36.41	12.57	50.0	$\pm 9.6\%$
		Y	15.67	100.74	38.44		50.0	
		Z	29.43	124.69	47.97		50.0	
10026- DAC	EDGE-FDD (TDMA, 8PSK, TN 0-1)	X	18.92	96.32	32.19	9.56	60.0	$\pm 9.6\%$
		Y	17.33	101.02	35.08		60.0	
		Z	24.89	113.23	39.81		60.0	
10027- DAC	GPRS-FDD (TDMA, GMSK, TN 0-1-2)	X	24.19	95.70	24.33	4.80	80.0	$\pm 9.6\%$
		Y	100.00	119.30	30.03		80.0	
		Z	100.00	120.36	30.17		80.0	
10028- DAC	GPRS-FDD (TDMA, GMSK, TN 0-1-2-3)	X	100.00	115.36	28.49	3.55	100.0	$\pm 9.6\%$
		Y	100.00	119.83	29.45		100.0	
		Z	100.00	122.10	30.18		100.0	
10029- DAC	EDGE-FDD (TDMA, 8PSK, TN 0-1-2)	X	16.27	93.78	30.32	7.80	80.0	$\pm 9.6\%$
		Y	11.67	92.24	30.90		80.0	
		Z	13.37	97.80	33.46		80.0	
10030- CAA	IEEE 802.15.1 Bluetooth (GFSK, DH1)	X	15.68	88.86	22.54	5.30	70.0	$\pm 9.6\%$
		Y	100.00	118.49	29.99		70.0	
		Z	100.00	118.88	29.80		70.0	
10031- CAA	IEEE 802.15.1 Bluetooth (GFSK, DH3)	X	100.00	116.01	27.12	1.88	100.0	$\pm 9.6\%$
		Y	100.00	121.13	28.42		100.0	
		Z	100.00	126.03	30.32		100.0	

10032-CAA	IEEE 802.15.1 Bluetooth (GFSK, DH5)	X	100.00	119.38	27.36	1.17	100.0	± 9.6 %
		Y	100.00	126.54	29.58		100.0	
		Z	100.00	136.16	33.43		100.0	
10033-CAA	IEEE 802.15.1 Bluetooth (PI/4-DQPSK, DH1)	X	13.27	88.21	24.10	5.30	70.0	± 9.6 %
		Y	20.91	99.02	27.13		70.0	
		Z	58.05	115.59	31.27		70.0	
10034-CAA	IEEE 802.15.1 Bluetooth (PI/4-DQPSK, DH3)	X	16.18	96.67	25.44	1.88	100.0	± 9.6 %
		Y	10.83	91.57	22.94		100.0	
		Z	52.78	113.06	28.24		100.0	
10035-CAA	IEEE 802.15.1 Bluetooth (PI/4-DQPSK, DH5)	X	12.45	95.04	24.79	1.17	100.0	± 9.6 %
		Y	5.49	83.70	20.10		100.0	
		Z	18.62	100.06	24.56		100.0	
10036-CAA	IEEE 802.15.1 Bluetooth (8-DPSK, DH1)	X	14.34	89.63	24.62	5.30	70.0	± 9.6 %
		Y	26.79	103.24	28.41		70.0	
		Z	95.10	123.67	33.30		70.0	
10037-CAA	IEEE 802.15.1 Bluetooth (8-DPSK, DH3)	X	15.98	96.45	25.32	1.88	100.0	± 9.6 %
		Y	9.62	89.98	22.43		100.0	
		Z	37.04	108.35	27.08		100.0	
10038-CAA	IEEE 802.15.1 Bluetooth (8-DPSK, DH5)	X	13.91	96.94	25.41	1.17	100.0	± 9.6 %
		Y	5.69	84.50	20.47		100.0	
		Z	19.52	101.18	25.01		100.0	
10039-CAB	CDMA2000 (1xRTT, RC1)	X	3.28	80.46	20.53	0.00	150.0	± 9.6 %
		Y	1.92	73.09	15.89		150.0	
		Z	3.08	80.13	18.22		150.0	
10042-CAB	IS-54 / IS-136 FDD (TDMA/FDM, PI/4-DQPSK, Halfrate)	X	11.60	82.51	21.10	7.78	50.0	± 9.6 %
		Y	100.00	118.83	31.00		50.0	
		Z	100.00	118.47	30.39		50.0	
10044-CAA	IS-91/EIA/TIA-553 FDD (FDMA, FM)	X	0.02	128.88	9.05	0.00	150.0	± 9.6 %
		Y	0.00	96.92	0.26		150.0	
		Z	0.02	60.00	140.78		150.0	
10048-CAA	DECT (TDD, TDMA/FDM, GFSK, Full Slot, 24)	X	10.75	78.30	22.86	13.80	25.0	± 9.6 %
		Y	15.61	90.30	26.65		25.0	
		Z	32.75	104.57	30.45		25.0	
10049-CAA	DECT (TDD, TDMA/FDM, GFSK, Double Slot, 12)	X	10.92	80.23	22.15	10.79	40.0	± 9.6 %
		Y	20.87	96.36	27.22		40.0	
		Z	64.62	115.72	32.06		40.0	
10056-CAA	UMTS-TDD (TD-SCDMA, 1.28 Mcps)	X	11.51	81.76	22.84	9.03	50.0	± 9.6 %
		Y	15.28	90.93	25.77		50.0	
		Z	25.94	101.11	28.65		50.0	
10058-DAC	EDGE-FDD (TDMA, 8PSK, TN 0-1-2-3)	X	14.19	91.88	29.00	6.55	100.0	± 9.6 %
		Y	8.68	86.53	28.09		100.0	
		Z	9.12	89.51	29.70		100.0	
10059-CAB	IEEE 802.11b WiFi 2.4 GHz (DSSS, 2 Mbps)	X	2.01	72.72	19.70	0.61	110.0	± 9.6 %
		Y	1.51	67.62	17.16		110.0	
		Z	1.56	68.78	17.99		110.0	
10060-CAB	IEEE 802.11b WiFi 2.4 GHz (DSSS, 5.5 Mbps)	X	100.00	126.29	32.07	1.30	110.0	± 9.6 %
		Y	100.00	132.71	34.39		110.0	
		Z	100.00	137.07	36.21		110.0	

10061-CAB	IEEE 802.11b WiFi 2.4 GHz (DSSS, 11 Mbps)	X	36.66	112.50	30.92	2.04	110.0	± 9.6 %
		Y	11.07	98.15	27.76		110.0	
		Z	22.12	112.16	32.18		110.0	
10062-CAB	IEEE 802.11a/h WiFi 5 GHz (OFDM, 6 Mbps)	X	5.03	67.33	17.05	0.49	100.0	± 9.6 %
		Y	4.77	67.19	16.82		100.0	
		Z	4.70	67.51	16.97		100.0	
10063-CAB	IEEE 802.11a/h WiFi 5 GHz (OFDM, 9 Mbps)	X	5.09	67.56	17.23	0.72	100.0	± 9.6 %
		Y	4.81	67.36	16.96		100.0	
		Z	4.74	67.68	17.11		100.0	
10064-CAB	IEEE 802.11a/h WiFi 5 GHz (OFDM, 12 Mbps)	X	5.47	67.93	17.49	0.86	100.0	± 9.6 %
		Y	5.10	67.63	17.20		100.0	
		Z	5.00	67.90	17.32		100.0	
10065-CAB	IEEE 802.11a/h WiFi 5 GHz (OFDM, 18 Mbps)	X	5.40	68.08	17.70	1.21	100.0	± 9.6 %
		Y	5.02	67.68	17.39		100.0	
		Z	4.92	67.92	17.50		100.0	
10066-CAB	IEEE 802.11a/h WiFi 5 GHz (OFDM, 24 Mbps)	X	5.49	68.31	17.98	1.46	100.0	± 9.6 %
		Y	5.08	67.82	17.62		100.0	
		Z	4.97	68.04	17.73		100.0	
10067-CAB	IEEE 802.11a/h WiFi 5 GHz (OFDM, 36 Mbps)	X	5.84	68.47	18.45	2.04	100.0	± 9.6 %
		Y	5.42	68.13	18.14		100.0	
		Z	5.31	68.42	18.28		100.0	
10068-CAB	IEEE 802.11a/h WiFi 5 GHz (OFDM, 48 Mbps)	X	6.07	69.08	18.91	2.55	100.0	± 9.6 %
		Y	5.53	68.32	18.44		100.0	
		Z	5.39	68.51	18.54		100.0	
10069-CAB	IEEE 802.11a/h WiFi 5 GHz (OFDM, 54 Mbps)	X	6.13	68.90	19.06	2.67	100.0	± 9.6 %
		Y	5.61	68.37	18.66		100.0	
		Z	5.48	68.58	18.76		100.0	
10071-CAB	IEEE 802.11g WiFi 2.4 GHz (DSSS/OFDM, 9 Mbps)	X	5.56	68.08	18.26	1.99	100.0	± 9.6 %
		Y	5.22	67.75	17.96		100.0	
		Z	5.14	68.03	18.10		100.0	
10072-CAB	IEEE 802.11g WiFi 2.4 GHz (DSSS/OFDM, 12 Mbps)	X	5.71	68.87	18.66	2.30	100.0	± 9.6 %
		Y	5.28	68.28	18.29		100.0	
		Z	5.18	68.53	18.42		100.0	
10073-CAB	IEEE 802.11g WiFi 2.4 GHz (DSSS/OFDM, 18 Mbps)	X	5.93	69.43	19.17	2.83	100.0	± 9.6 %
		Y	5.43	68.68	18.74		100.0	
		Z	5.32	68.95	18.89		100.0	
10074-CAB	IEEE 802.11g WiFi 2.4 GHz (DSSS/OFDM, 24 Mbps)	X	6.04	69.75	19.56	3.30	100.0	± 9.6 %
		Y	5.49	68.80	18.99		100.0	
		Z	5.38	69.07	19.15		100.0	
10075-CAB	IEEE 802.11g WiFi 2.4 GHz (DSSS/OFDM, 36 Mbps)	X	6.35	70.65	20.23	3.82	90.0	± 9.6 %
		Y	5.63	69.18	19.44		90.0	
		Z	5.49	69.37	19.56		90.0	
10076-CAB	IEEE 802.11g WiFi 2.4 GHz (DSSS/OFDM, 48 Mbps)	X	6.37	70.50	20.38	4.15	90.0	± 9.6 %
		Y	5.68	69.10	19.63		90.0	
		Z	5.56	69.34	19.78		90.0	
10077-CAB	IEEE 802.11g WiFi 2.4 GHz (DSSS/OFDM, 54 Mbps)	X	6.43	70.65	20.50	4.30	90.0	± 9.6 %
		Y	5.73	69.22	19.75		90.0	
		Z	5.61	69.48	19.91		90.0	

10081-CAB	CDMA2000 (1xRTT, RC3)	X	1.62	75.66	18.40	0.00	150.0	± 9.6 %
		Y	0.87	66.71	12.69		150.0	
		Z	1.13	71.02	14.45		150.0	
10082-CAB	IS-54 / IS-136 FDD (TDMA/FDM, PI/4-DQPSK, Fullrate)	X	3.53	66.20	10.93	4.77	80.0	± 9.6 %
		Y	2.19	64.40	9.18		80.0	
		Z	1.96	64.15	8.74		80.0	
10090-DAC	GPRS-FDD (TDMA, GMSK, TN 0-4)	X	12.79	85.25	22.06	6.56	60.0	± 9.6 %
		Y	100.00	120.23	31.42		60.0	
		Z	100.00	120.31	31.04		60.0	
10097-CAB	UMTS-FDD (HSDPA)	X	2.06	70.06	17.46	0.00	150.0	± 9.6 %
		Y	1.88	68.31	15.96		150.0	
		Z	2.04	70.38	16.98		150.0	
10098-CAB	UMTS-FDD (HSUPA, Subtest 2)	X	2.02	70.12	17.47	0.00	150.0	± 9.6 %
		Y	1.84	68.27	15.94		150.0	
		Z	2.00	70.37	16.98		150.0	
10099-DAC	EDGE-FDD (TDMA, 8PSK, TN 0-4)	X	18.80	96.14	32.13	9.56	60.0	± 9.6 %
		Y	17.28	100.91	35.04		60.0	
		Z	24.81	113.10	39.77		60.0	
10100-CAD	LTE-FDD (SC-FDMA, 100% RB, 20 MHz, QPSK)	X	3.84	73.61	18.19	0.00	150.0	± 9.6 %
		Y	3.15	70.58	16.91		150.0	
		Z	3.25	71.69	17.61		150.0	
10101-CAD	LTE-FDD (SC-FDMA, 100% RB, 20 MHz, 16-QAM)	X	3.58	69.11	16.83	0.00	150.0	± 9.6 %
		Y	3.26	67.74	16.10		150.0	
		Z	3.26	68.29	16.47		150.0	
10102-CAD	LTE-FDD (SC-FDMA, 100% RB, 20 MHz, 64-QAM)	X	3.66	68.88	16.84	0.00	150.0	± 9.6 %
		Y	3.36	67.71	16.19		150.0	
		Z	3.36	68.23	16.52		150.0	
10103-CAD	LTE-TDD (SC-FDMA, 100% RB, 20 MHz, QPSK)	X	9.75	77.78	20.81	3.98	65.0	± 9.6 %
		Y	8.78	79.16	21.83		65.0	
		Z	9.34	81.38	22.82		65.0	
10104-CAD	LTE-TDD (SC-FDMA, 100% RB, 20 MHz, 16-QAM)	X	9.87	77.22	21.49	3.98	65.0	± 9.6 %
		Y	8.42	77.09	21.77		65.0	
		Z	8.44	78.16	22.31		65.0	
10105-CAD	LTE-TDD (SC-FDMA, 100% RB, 20 MHz, 64-QAM)	X	9.19	75.82	21.15	3.98	65.0	± 9.6 %
		Y	8.07	76.20	21.66		65.0	
		Z	8.27	77.70	22.41		65.0	
10108-CAE	LTE-FDD (SC-FDMA, 100% RB, 10 MHz, QPSK)	X	3.37	72.69	18.02	0.00	150.0	± 9.6 %
		Y	2.75	69.90	16.77		150.0	
		Z	2.82	71.09	17.51		150.0	
10109-CAE	LTE-FDD (SC-FDMA, 100% RB, 10 MHz, 16-QAM)	X	3.26	68.97	16.85	0.00	150.0	± 9.6 %
		Y	2.91	67.66	16.01		150.0	
		Z	2.92	68.36	16.42		150.0	
10110-CAE	LTE-FDD (SC-FDMA, 100% RB, 5 MHz, QPSK)	X	2.79	71.81	17.85	0.00	150.0	± 9.6 %
		Y	2.23	69.12	16.39		150.0	
		Z	2.31	70.62	17.23		150.0	
10111-CAE	LTE-FDD (SC-FDMA, 100% RB, 5 MHz, 16-QAM)	X	2.96	69.58	17.27	0.00	150.0	± 9.6 %
		Y	2.63	68.64	16.31		150.0	
		Z	2.69	69.84	16.85		150.0	

10112-CAE	LTE-FDD (SC-FDMA, 100% RB, 10 MHz, 64-QAM)	X	3.36	68.71	16.80	0.00	150.0	± 9.6 %
		Y	3.03	67.66	16.06		150.0	
		Z	3.04	68.35	16.45		150.0	
10113-CAE	LTE-FDD (SC-FDMA, 100% RB, 5 MHz, 64-QAM)	X	3.10	69.46	17.27	0.00	150.0	± 9.6 %
		Y	2.78	68.78	16.44		150.0	
		Z	2.83	69.92	16.93		150.0	
10114-CAB	IEEE 802.11n (HT Greenfield, 13.5 Mbps, BPSK)	X	5.34	67.65	16.76	0.00	150.0	± 9.6 %
		Y	5.17	67.50	16.64		150.0	
		Z	5.08	67.64	16.74		150.0	
10115-CAB	IEEE 802.11n (HT Greenfield, 81 Mbps, 16-QAM)	X	5.80	68.17	17.01	0.00	150.0	± 9.6 %
		Y	5.44	67.60	16.69		150.0	
		Z	5.33	67.71	16.77		150.0	
10116-CAB	IEEE 802.11n (HT Greenfield, 135 Mbps, 64-QAM)	X	5.47	67.90	16.79	0.00	150.0	± 9.6 %
		Y	5.25	67.68	16.65		150.0	
		Z	5.17	67.85	16.77		150.0	
10117-CAB	IEEE 802.11n (HT Mixed, 13.5 Mbps, BPSK)	X	5.34	67.65	16.78	0.00	150.0	± 9.6 %
		Y	5.12	67.32	16.56		150.0	
		Z	5.07	67.59	16.73		150.0	
10118-CAB	IEEE 802.11n (HT Mixed, 81 Mbps, 16-QAM)	X	5.79	68.04	16.95	0.00	150.0	± 9.6 %
		Y	5.52	67.82	16.81		150.0	
		Z	5.42	67.93	16.89		150.0	
10119-CAB	IEEE 802.11n (HT Mixed, 135 Mbps, 64-QAM)	X	5.44	67.84	16.78	0.00	150.0	± 9.6 %
		Y	5.24	67.66	16.65		150.0	
		Z	5.17	67.84	16.77		150.0	
10140-CAD	LTE-FDD (SC-FDMA, 100% RB, 15 MHz, 16-QAM)	X	3.72	68.86	16.76	0.00	150.0	± 9.6 %
		Y	3.39	67.72	16.10		150.0	
		Z	3.39	68.26	16.45		150.0	
10141-CAD	LTE-FDD (SC-FDMA, 100% RB, 15 MHz, 64-QAM)	X	3.82	68.79	16.84	0.00	150.0	± 9.6 %
		Y	3.51	67.83	16.27		150.0	
		Z	3.51	68.36	16.60		150.0	
10142-CAD	LTE-FDD (SC-FDMA, 100% RB, 3 MHz, QPSK)	X	2.57	71.96	17.88	0.00	150.0	± 9.6 %
		Y	2.01	69.21	16.02		150.0	
		Z	2.13	71.18	16.95		150.0	
10143-CAD	LTE-FDD (SC-FDMA, 100% RB, 3 MHz, 16-QAM)	X	2.89	70.53	17.42	0.00	150.0	± 9.6 %
		Y	2.49	69.45	15.95		150.0	
		Z	2.62	71.11	16.52		150.0	
10144-CAD	LTE-FDD (SC-FDMA, 100% RB, 3 MHz, 64-QAM)	X	2.69	68.52	16.05	0.00	150.0	± 9.6 %
		Y	2.23	66.92	14.20		150.0	
		Z	2.23	67.85	14.42		150.0	
10145-CAE	LTE-FDD (SC-FDMA, 100% RB, 1.4 MHz, QPSK)	X	2.07	72.06	16.97	0.00	150.0	± 9.6 %
		Y	1.17	64.90	11.31		150.0	
		Z	1.08	64.84	10.72		150.0	
10146-CAE	LTE-FDD (SC-FDMA, 100% RB, 1.4 MHz, 16-QAM)	X	4.64	77.66	18.95	0.00	150.0	± 9.6 %
		Y	1.89	66.33	11.57		150.0	
		Z	1.28	62.78	8.70		150.0	
10147-CAE	LTE-FDD (SC-FDMA, 100% RB, 1.4 MHz, 64-QAM)	X	5.86	81.36	20.54	0.00	150.0	± 9.6 %
		Y	2.26	68.50	12.73		150.0	
		Z	1.39	63.59	9.24		150.0	

10149-CAD	LTE-FDD (SC-FDMA, 50% RB, 20 MHz, 16-QAM)	X	3.27	69.03	16.89	0.00	150.0	± 9.6 %
		Y	2.92	67.72	16.06		150.0	
		Z	2.93	68.43	16.47		150.0	
10150-CAD	LTE-FDD (SC-FDMA, 50% RB, 20 MHz, 64-QAM)	X	3.37	68.76	16.84	0.00	150.0	± 9.6 %
		Y	3.04	67.71	16.11		150.0	
		Z	3.05	68.41	16.50		150.0	
10151-CAD	LTE-TDD (SC-FDMA, 50% RB, 20 MHz, QPSK)	X	9.88	78.98	21.39	3.98	65.0	± 9.6 %
		Y	9.54	82.00	22.98		65.0	
		Z	10.52	85.01	24.21		65.0	
10152-CAD	LTE-TDD (SC-FDMA, 50% RB, 20 MHz, 16-QAM)	X	9.59	77.49	21.44	3.98	65.0	± 9.6 %
		Y	8.05	77.33	21.53		65.0	
		Z	8.15	78.63	22.11		65.0	
10153-CAD	LTE-TDD (SC-FDMA, 50% RB, 20 MHz, 64-QAM)	X	9.88	78.01	21.96	3.98	65.0	± 9.6 %
		Y	8.51	78.32	22.28		65.0	
		Z	8.64	79.68	22.87		65.0	
10154-CAE	LTE-FDD (SC-FDMA, 50% RB, 10 MHz, QPSK)	X	2.88	72.43	18.21	0.00	150.0	± 9.6 %
		Y	2.28	69.53	16.65		150.0	
		Z	2.36	71.01	17.47		150.0	
10155-CAE	LTE-FDD (SC-FDMA, 50% RB, 10 MHz, 16-QAM)	X	2.96	69.57	17.27	0.00	150.0	± 9.6 %
		Y	2.63	68.66	16.33		150.0	
		Z	2.70	69.87	16.88		150.0	
10156-CAE	LTE-FDD (SC-FDMA, 50% RB, 5 MHz, QPSK)	X	2.50	72.75	18.17	0.00	150.0	± 9.6 %
		Y	1.86	69.32	15.77		150.0	
		Z	2.00	71.53	16.72		150.0	
10157-CAE	LTE-FDD (SC-FDMA, 50% RB, 5 MHz, 16-QAM)	X	2.58	69.56	16.46	0.00	150.0	± 9.6 %
		Y	2.07	67.52	14.21		150.0	
		Z	2.11	68.66	14.46		150.0	
10158-CAE	LTE-FDD (SC-FDMA, 50% RB, 10 MHz, 64-QAM)	X	3.11	69.51	17.31	0.00	150.0	± 9.6 %
		Y	2.79	68.85	16.49		150.0	
		Z	2.84	70.00	16.99		150.0	
10159-CAE	LTE-FDD (SC-FDMA, 50% RB, 5 MHz, 64-QAM)	X	2.70	69.94	16.71	0.00	150.0	± 9.6 %
		Y	2.17	67.94	14.47		150.0	
		Z	2.21	69.05	14.68		150.0	
10160-CAD	LTE-FDD (SC-FDMA, 50% RB, 15 MHz, QPSK)	X	3.17	70.70	17.47	0.00	150.0	± 9.6 %
		Y	2.80	69.22	16.63		150.0	
		Z	2.84	70.27	17.24		150.0	
10161-CAD	LTE-FDD (SC-FDMA, 50% RB, 15 MHz, 16-QAM)	X	3.25	68.62	16.80	0.00	150.0	± 9.6 %
		Y	2.93	67.68	16.03		150.0	
		Z	2.94	68.43	16.42		150.0	
10162-CAD	LTE-FDD (SC-FDMA, 50% RB, 15 MHz, 64-QAM)	X	3.34	68.54	16.80	0.00	150.0	± 9.6 %
		Y	3.04	67.85	16.15		150.0	
		Z	3.05	68.62	16.54		150.0	
10166-CAE	LTE-FDD (SC-FDMA, 50% RB, 1.4 MHz, QPSK)	X	4.29	71.19	20.11	3.01	150.0	± 9.6 %
		Y	3.58	69.86	19.45		150.0	
		Z	3.34	69.55	19.26		150.0	
10167-CAE	LTE-FDD (SC-FDMA, 50% RB, 1.4 MHz, 16-QAM)	X	5.65	74.34	20.64	3.01	150.0	± 9.6 %
		Y	4.34	72.64	19.86		150.0	
		Z	3.97	72.28	19.65		150.0	

10168-CAE	LTE-FDD (SC-FDMA, 50% RB, 1.4 MHz, 64-QAM)	X	6.08	75.90	21.58	3.01	150.0	± 9.6 %
		Y	4.83	75.01	21.26		150.0	
		Z	4.38	74.50	20.98		150.0	
10169-CAD	LTE-FDD (SC-FDMA, 1 RB, 20 MHz, QPSK)	X	4.41	74.54	21.42	3.01	150.0	± 9.6 %
		Y	2.96	68.83	19.02		150.0	
		Z	2.72	67.99	18.57		150.0	
10170-CAD	LTE-FDD (SC-FDMA, 1 RB, 20 MHz, 16-QAM)	X	6.70	80.82	23.44	3.01	150.0	± 9.6 %
		Y	3.91	74.17	21.18		150.0	
		Z	3.42	72.70	20.49		150.0	
10171-AAD	LTE-FDD (SC-FDMA, 1 RB, 20 MHz, 64-QAM)	X	5.50	76.54	20.93	3.01	150.0	± 9.6 %
		Y	3.29	70.45	18.57		150.0	
		Z	2.94	69.58	18.14		150.0	
10172-CAD	LTE-TDD (SC-FDMA, 1 RB, 20 MHz, QPSK)	X	25.76	101.07	30.32	6.02	65.0	± 9.6 %
		Y	18.45	102.75	32.10		65.0	
		Z	20.86	107.70	33.85		65.0	
10173-CAD	LTE-TDD (SC-FDMA, 1 RB, 20 MHz, 16-QAM)	X	19.21	92.24	26.33	6.02	65.0	± 9.6 %
		Y	26.29	105.14	31.12		65.0	
		Z	28.49	108.55	32.12		65.0	
10174-CAD	LTE-TDD (SC-FDMA, 1 RB, 20 MHz, 64-QAM)	X	17.46	89.68	25.13	6.02	65.0	± 9.6 %
		Y	21.35	100.13	29.12		65.0	
		Z	22.92	103.28	30.05		65.0	
10175-CAE	LTE-FDD (SC-FDMA, 1 RB, 10 MHz, QPSK)	X	4.34	74.12	21.15	3.01	150.0	± 9.6 %
		Y	2.93	68.55	18.79		150.0	
		Z	2.70	67.77	18.36		150.0	
10176-CAE	LTE-FDD (SC-FDMA, 1 RB, 10 MHz, 16-QAM)	X	6.71	80.84	23.45	3.01	150.0	± 9.6 %
		Y	3.92	74.20	21.19		150.0	
		Z	3.42	72.72	20.50		150.0	
10177-CAG	LTE-FDD (SC-FDMA, 1 RB, 5 MHz, QPSK)	X	4.38	74.32	21.26	3.01	150.0	± 9.6 %
		Y	2.95	68.69	18.87		150.0	
		Z	2.71	67.87	18.43		150.0	
10178-CAE	LTE-FDD (SC-FDMA, 1 RB, 5 MHz, 16-QAM)	X	6.59	80.50	23.29	3.01	150.0	± 9.6 %
		Y	3.89	74.02	21.09		150.0	
		Z	3.41	72.61	20.43		150.0	
10179-CAE	LTE-FDD (SC-FDMA, 1 RB, 10 MHz, 64-QAM)	X	6.03	78.45	22.01	3.01	150.0	± 9.6 %
		Y	3.58	72.24	19.76		150.0	
		Z	3.16	71.11	19.23		150.0	
10180-CAE	LTE-FDD (SC-FDMA, 1 RB, 5 MHz, 64-QAM)	X	5.47	76.42	20.86	3.01	150.0	± 9.6 %
		Y	3.28	70.40	18.53		150.0	
		Z	2.94	69.55	18.12		150.0	
10181-CAD	LTE-FDD (SC-FDMA, 1 RB, 15 MHz, QPSK)	X	4.38	74.30	21.25	3.01	150.0	± 9.6 %
		Y	2.95	68.67	18.87		150.0	
		Z	2.71	67.86	18.43		150.0	
10182-CAD	LTE-FDD (SC-FDMA, 1 RB, 15 MHz, 16-QAM)	X	6.58	80.48	23.29	3.01	150.0	± 9.6 %
		Y	3.88	74.00	21.08		150.0	
		Z	3.40	72.59	20.42		150.0	
10183-AAC	LTE-FDD (SC-FDMA, 1 RB, 15 MHz, 64-QAM)	X	5.46	76.40	20.85	3.01	150.0	± 9.6 %
		Y	3.28	70.38	18.52		150.0	
		Z	2.93	69.53	18.11		150.0	

10184-CAD	LTE-FDD (SC-FDMA, 1 RB, 3 MHz, QPSK)	X	4.39	74.34	21.27	3.01	150.0	± 9.6 %
		Y	2.96	68.71	18.89		150.0	
		Z	2.72	67.89	18.44		150.0	
10185-CAD	LTE-FDD (SC-FDMA, 1 RB, 3 MHz, 16-QAM)	X	6.61	80.55	23.32	3.01	150.0	± 9.6 %
		Y	3.90	74.06	21.11		150.0	
		Z	3.42	72.64	20.45		150.0	
10186-AAD	LTE-FDD (SC-FDMA, 1 RB, 3 MHz, 64-QAM)	X	5.49	76.46	20.88	3.01	150.0	± 9.6 %
		Y	3.29	70.44	18.55		150.0	
		Z	2.95	69.59	18.14		150.0	
10187-CAE	LTE-FDD (SC-FDMA, 1 RB, 1.4 MHz, QPSK)	X	4.40	74.38	21.31	3.01	150.0	± 9.6 %
		Y	2.97	68.77	18.95		150.0	
		Z	2.73	67.95	18.51		150.0	
10188-CAE	LTE-FDD (SC-FDMA, 1 RB, 1.4 MHz, 16-QAM)	X	6.86	81.30	23.70	3.01	150.0	± 9.6 %
		Y	4.01	74.64	21.46		150.0	
		Z	3.49	73.09	20.74		150.0	
10189-AAE	LTE-FDD (SC-FDMA, 1 RB, 1.4 MHz, 64-QAM)	X	5.63	76.95	21.16	3.01	150.0	± 9.6 %
		Y	3.36	70.82	18.81		150.0	
		Z	3.00	69.90	18.37		150.0	
10193-CAB	IEEE 802.11n (HT Greenfield, 6.5 Mbps, BPSK)	X	4.76	66.98	16.56	0.00	150.0	± 9.6 %
		Y	4.53	66.89	16.29		150.0	
		Z	4.48	67.27	16.46		150.0	
10194-CAB	IEEE 802.11n (HT Greenfield, 39 Mbps, 16-QAM)	X	4.98	67.40	16.66	0.00	150.0	± 9.6 %
		Y	4.70	67.19	16.42		150.0	
		Z	4.63	67.53	16.59		150.0	
10195-CAB	IEEE 802.11n (HT Greenfield, 65 Mbps, 64-QAM)	X	5.02	67.38	16.65	0.00	150.0	± 9.6 %
		Y	4.74	67.22	16.44		150.0	
		Z	4.67	67.55	16.61		150.0	
10196-CAB	IEEE 802.11n (HT Mixed, 6.5 Mbps, BPSK)	X	4.79	67.12	16.61	0.00	150.0	± 9.6 %
		Y	4.53	66.94	16.30		150.0	
		Z	4.47	67.29	16.46		150.0	
10197-CAB	IEEE 802.11n (HT Mixed, 39 Mbps, 16-QAM)	X	5.00	67.41	16.67	0.00	150.0	± 9.6 %
		Y	4.71	67.21	16.43		150.0	
		Z	4.64	67.54	16.60		150.0	
10198-CAB	IEEE 802.11n (HT Mixed, 65 Mbps, 64-QAM)	X	5.02	67.39	16.66	0.00	150.0	± 9.6 %
		Y	4.74	67.23	16.45		150.0	
		Z	4.67	67.55	16.61		150.0	
10219-CAB	IEEE 802.11n (HT Mixed, 7.2 Mbps, BPSK)	X	4.75	67.15	16.58	0.00	150.0	± 9.6 %
		Y	4.48	66.96	16.27		150.0	
		Z	4.43	67.33	16.43		150.0	
10220-CAB	IEEE 802.11n (HT Mixed, 43.3 Mbps, 16-QAM)	X	5.00	67.42	16.67	0.00	150.0	± 9.6 %
		Y	4.70	67.17	16.42		150.0	
		Z	4.63	67.50	16.58		150.0	
10221-CAB	IEEE 802.11n (HT Mixed, 72.2 Mbps, 64-QAM)	X	5.03	67.33	16.65	0.00	150.0	± 9.6 %
		Y	4.75	67.16	16.44		150.0	
		Z	4.68	67.49	16.60		150.0	
10222-CAB	IEEE 802.11n (HT Mixed, 15 Mbps, BPSK)	X	5.32	67.70	16.79	0.00	150.0	± 9.6 %
		Y	5.10	67.32	16.56		150.0	
		Z	5.04	67.57	16.71		150.0	

10223-CAB	IEEE 802.11n (HT Mixed, 90 Mbps, 16-QAM)	X	5.69	67.90	16.90	0.00	150.0	± 9.6 %
		Y	5.41	67.62	16.73		150.0	
		Z	5.32	67.79	16.83		150.0	
10224-CAB	IEEE 802.11n (HT Mixed, 150 Mbps, 64-QAM)	X	5.40	67.86	16.79	0.00	150.0	± 9.6 %
		Y	5.14	67.44	16.54		150.0	
		Z	5.08	67.68	16.69		150.0	
10225-CAB	UMTS-FDD (HSPA+)	X	3.04	66.91	16.27	0.00	150.0	± 9.6 %
		Y	2.80	66.45	15.40		150.0	
		Z	2.79	67.13	15.62		150.0	
10226-CAA	LTE-TDD (SC-FDMA, 1 RB, 1.4 MHz, 16-QAM)	X	19.62	92.68	26.54	6.02	65.0	± 9.6 %
		Y	28.14	106.53	31.60		65.0	
		Z	30.74	110.09	32.63		65.0	
10227-CAA	LTE-TDD (SC-FDMA, 1 RB, 1.4 MHz, 64-QAM)	X	17.31	89.65	25.20	6.02	65.0	± 9.6 %
		Y	25.62	103.45	30.17		65.0	
		Z	27.71	106.63	31.05		65.0	
10228-CAA	LTE-TDD (SC-FDMA, 1 RB, 1.4 MHz, QPSK)	X	25.12	101.14	30.46	6.02	65.0	± 9.6 %
		Y	22.85	107.40	33.58		65.0	
		Z	23.56	110.42	34.69		65.0	
10229-CAB	LTE-TDD (SC-FDMA, 1 RB, 3 MHz, 16-QAM)	X	19.21	92.22	26.33	6.02	65.0	± 9.6 %
		Y	26.37	105.18	31.14		65.0	
		Z	28.56	108.58	32.13		65.0	
10230-CAB	LTE-TDD (SC-FDMA, 1 RB, 3 MHz, 64-QAM)	X	16.99	89.27	25.02	6.02	65.0	± 9.6 %
		Y	24.08	102.25	29.76		65.0	
		Z	25.76	105.25	30.60		65.0	
10231-CAB	LTE-TDD (SC-FDMA, 1 RB, 3 MHz, QPSK)	X	24.47	100.57	30.23	6.02	65.0	± 9.6 %
		Y	21.54	106.10	33.13		65.0	
		Z	22.10	109.02	34.22		65.0	
10232-CAD	LTE-TDD (SC-FDMA, 1 RB, 5 MHz, 16-QAM)	X	19.21	92.23	26.33	6.02	65.0	± 9.6 %
		Y	26.35	105.17	31.13		65.0	
		Z	28.56	108.59	32.14		65.0	
10233-CAD	LTE-TDD (SC-FDMA, 1 RB, 5 MHz, 64-QAM)	X	16.99	89.29	25.03	6.02	65.0	± 9.6 %
		Y	24.05	102.24	29.76		65.0	
		Z	25.73	105.25	30.60		65.0	
10234-CAD	LTE-TDD (SC-FDMA, 1 RB, 5 MHz, QPSK)	X	23.75	99.87	29.94	6.02	65.0	± 9.6 %
		Y	20.44	104.88	32.66		65.0	
		Z	20.94	107.73	33.73		65.0	
10235-CAD	LTE-TDD (SC-FDMA, 1 RB, 10 MHz, 16-QAM)	X	19.23	92.26	26.34	6.02	65.0	± 9.6 %
		Y	26.43	105.24	31.16		65.0	
		Z	28.68	108.68	32.16		65.0	
10236-CAD	LTE-TDD (SC-FDMA, 1 RB, 10 MHz, 64-QAM)	X	17.05	89.34	25.04	6.02	65.0	± 9.6 %
		Y	24.28	102.38	29.79		65.0	
		Z	26.05	105.43	30.64		65.0	
10237-CAD	LTE-TDD (SC-FDMA, 1 RB, 10 MHz, QPSK)	X	24.65	100.72	30.28	6.02	65.0	± 9.6 %
		Y	21.67	106.26	33.17		65.0	
		Z	22.28	109.22	34.28		65.0	
10238-CAD	LTE-TDD (SC-FDMA, 1 RB, 15 MHz, 16-QAM)	X	19.21	92.24	26.33	6.02	65.0	± 9.6 %
		Y	26.34	105.18	31.13		65.0	
		Z	28.55	108.60	32.14		65.0	

10239-CAD	LTE-TDD (SC-FDMA, 1 RB, 15 MHz, 64-QAM)	X	17.00	89.31	25.04	6.02	65.0	± 9.6 %
		Y	24.00	102.22	29.75		65.0	
		Z	25.68	105.23	30.60		65.0	
10240-CAD	LTE-TDD (SC-FDMA, 1 RB, 15 MHz, QPSK)	X	24.60	100.69	30.26	6.02	65.0	± 9.6 %
		Y	21.61	106.21	33.16		65.0	
		Z	22.24	109.18	34.27		65.0	
10241-CAA	LTE-TDD (SC-FDMA, 50% RB, 1.4 MHz, 16-QAM)	X	14.83	87.15	27.43	6.98	65.0	± 9.6 %
		Y	11.87	87.25	27.69		65.0	
		Z	12.27	89.81	28.71		65.0	
10242-CAA	LTE-TDD (SC-FDMA, 50% RB, 1.4 MHz, 64-QAM)	X	14.03	85.86	26.85	6.98	65.0	± 9.6 %
		Y	11.07	85.73	27.03		65.0	
		Z	11.88	89.15	28.39		65.0	
10243-CAA	LTE-TDD (SC-FDMA, 50% RB, 1.4 MHz, QPSK)	X	12.50	85.61	27.61	6.98	65.0	± 9.6 %
		Y	8.91	82.53	26.67		65.0	
		Z	9.40	85.62	28.06		65.0	
10244-CAB	LTE-TDD (SC-FDMA, 50% RB, 3 MHz, 16-QAM)	X	10.84	80.28	21.46	3.98	65.0	± 9.6 %
		Y	8.60	79.06	19.82		65.0	
		Z	7.30	76.79	18.14		65.0	
10245-CAB	LTE-TDD (SC-FDMA, 50% RB, 3 MHz, 64-QAM)	X	10.80	80.00	21.33	3.98	65.0	± 9.6 %
		Y	8.32	78.30	19.47		65.0	
		Z	7.01	75.95	17.75		65.0	
10246-CAB	LTE-TDD (SC-FDMA, 50% RB, 3 MHz, QPSK)	X	10.19	81.67	21.72	3.98	65.0	± 9.6 %
		Y	9.19	82.92	21.40		65.0	
		Z	10.28	85.26	21.82		65.0	
10247-CAD	LTE-TDD (SC-FDMA, 50% RB, 5 MHz, 16-QAM)	X	9.24	78.33	20.99	3.98	65.0	± 9.6 %
		Y	7.42	77.41	19.87		65.0	
		Z	7.44	78.18	19.81		65.0	
10248-CAD	LTE-TDD (SC-FDMA, 50% RB, 5 MHz, 64-QAM)	X	9.29	78.02	20.88	3.98	65.0	± 9.6 %
		Y	7.28	76.69	19.57		65.0	
		Z	7.17	77.21	19.40		65.0	
10249-CAD	LTE-TDD (SC-FDMA, 50% RB, 5 MHz, QPSK)	X	10.52	82.18	22.29	3.98	65.0	± 9.6 %
		Y	10.94	86.37	23.51		65.0	
		Z	13.59	90.89	24.82		65.0	
10250-CAD	LTE-TDD (SC-FDMA, 50% RB, 10 MHz, 16-QAM)	X	9.84	79.38	22.27	3.98	65.0	± 9.6 %
		Y	8.59	80.24	22.59		65.0	
		Z	8.91	81.95	23.17		65.0	
10251-CAD	LTE-TDD (SC-FDMA, 50% RB, 10 MHz, 64-QAM)	X	9.48	77.77	21.45	3.98	65.0	± 9.6 %
		Y	7.96	77.76	21.28		65.0	
		Z	8.06	79.03	21.69		65.0	
10252-CAD	LTE-TDD (SC-FDMA, 50% RB, 10 MHz, QPSK)	X	10.35	81.23	22.32	3.98	65.0	± 9.6 %
		Y	10.67	85.75	24.25		65.0	
		Z	12.80	90.26	25.85		65.0	
10253-CAD	LTE-TDD (SC-FDMA, 50% RB, 15 MHz, 16-QAM)	X	9.41	77.10	21.37	3.98	65.0	± 9.6 %
		Y	7.89	76.83	21.30		65.0	
		Z	7.98	78.11	21.82		65.0	
10254-CAD	LTE-TDD (SC-FDMA, 50% RB, 15 MHz, 64-QAM)	X	9.73	77.64	21.86	3.98	65.0	± 9.6 %
		Y	8.31	77.74	21.96		65.0	
		Z	8.42	79.03	22.48		65.0	

10255-CAD	LTE-TDD (SC-FDMA, 50% RB, 15 MHz, QPSK)	X	9.76	78.98	21.63	3.98	65.0	± 9.6 %
		Y	9.21	81.58	22.99		65.0	
		Z	10.10	84.50	24.17		65.0	
10256-CAA	LTE-TDD (SC-FDMA, 100% RB, 1.4 MHz, 16-QAM)	X	10.36	79.33	20.55	3.98	65.0	± 9.6 %
		Y	6.89	75.10	17.29		65.0	
		Z	5.38	71.84	15.02		65.0	
10257-CAA	LTE-TDD (SC-FDMA, 100% RB, 1.4 MHz, 64-QAM)	X	10.33	78.98	20.36	3.98	65.0	± 9.6 %
		Y	6.60	74.15	16.79		65.0	
		Z	5.14	70.90	14.50		65.0	
10258-CAA	LTE-TDD (SC-FDMA, 100% RB, 1.4 MHz, QPSK)	X	9.84	80.89	21.06	3.98	65.0	± 9.6 %
		Y	6.93	77.80	18.67		65.0	
		Z	6.67	77.68	18.06		65.0	
10259-CAB	LTE-TDD (SC-FDMA, 100% RB, 3 MHz, 16-QAM)	X	9.48	78.65	21.42	3.98	65.0	± 9.6 %
		Y	7.89	78.48	20.85		65.0	
		Z	8.05	79.67	21.05		65.0	
10260-CAB	LTE-TDD (SC-FDMA, 100% RB, 3 MHz, 64-QAM)	X	9.52	78.48	21.39	3.98	65.0	± 9.6 %
		Y	7.84	78.08	20.70		65.0	
		Z	7.93	79.11	20.83		65.0	
10261-CAB	LTE-TDD (SC-FDMA, 100% RB, 3 MHz, QPSK)	X	10.28	81.56	22.27	3.98	65.0	± 9.6 %
		Y	10.28	85.25	23.51		65.0	
		Z	12.40	89.51	24.85		65.0	
10262-CAD	LTE-TDD (SC-FDMA, 100% RB, 5 MHz, 16-QAM)	X	9.83	79.35	22.25	3.98	65.0	± 9.6 %
		Y	8.56	80.18	22.55		65.0	
		Z	8.88	81.87	23.12		65.0	
10263-CAD	LTE-TDD (SC-FDMA, 100% RB, 5 MHz, 64-QAM)	X	9.48	77.78	21.46	3.98	65.0	± 9.6 %
		Y	7.94	77.74	21.28		65.0	
		Z	8.05	79.01	21.68		65.0	
10264-CAD	LTE-TDD (SC-FDMA, 100% RB, 5 MHz, QPSK)	X	10.32	81.15	22.28	3.98	65.0	± 9.6 %
		Y	10.57	85.55	24.15		65.0	
		Z	12.63	90.00	25.74		65.0	
10265-CAD	LTE-TDD (SC-FDMA, 100% RB, 10 MHz, 16-QAM)	X	9.59	77.50	21.45	3.98	65.0	± 9.6 %
		Y	8.04	77.33	21.54		65.0	
		Z	8.14	78.63	22.11		65.0	
10266-CAD	LTE-TDD (SC-FDMA, 100% RB, 10 MHz, 64-QAM)	X	9.89	78.01	21.96	3.98	65.0	± 9.6 %
		Y	8.50	78.31	22.27		65.0	
		Z	8.64	79.67	22.86		65.0	
10267-CAD	LTE-TDD (SC-FDMA, 100% RB, 10 MHz, QPSK)	X	9.88	78.96	21.38	3.98	65.0	± 9.6 %
		Y	9.52	81.96	22.96		65.0	
		Z	10.50	84.95	24.19		65.0	
10268-CAD	LTE-TDD (SC-FDMA, 100% RB, 15 MHz, 16-QAM)	X	9.95	76.96	21.54	3.98	65.0	± 9.6 %
		Y	8.52	76.88	21.79		65.0	
		Z	8.53	77.92	22.30		65.0	
10269-CAD	LTE-TDD (SC-FDMA, 100% RB, 15 MHz, 64-QAM)	X	9.89	76.68	21.52	3.98	65.0	± 9.6 %
		Y	8.46	76.46	21.67		65.0	
		Z	8.45	77.44	22.15		65.0	
10270-CAD	LTE-TDD (SC-FDMA, 100% RB, 15 MHz, QPSK)	X	9.66	77.24	20.86	3.98	65.0	± 9.6 %
		Y	8.81	78.78	21.90		65.0	
		Z	9.16	80.58	22.73		65.0	

10274-CAB	UMTS-FDD (HSUPA, Subtest 5, 3GPP Rel8.10)	X	2.74	67.26	16.17	0.00	150.0	± 9.6 %
		Y	2.61	66.92	15.38		150.0	
		Z	2.66	67.94	15.80		150.0	
10275-CAB	UMTS-FDD (HSUPA, Subtest 5, 3GPP Rel8.4)	X	2.05	72.21	18.03	0.00	150.0	± 9.6 %
		Y	1.65	68.50	15.87		150.0	
		Z	1.80	70.74	17.08		150.0	
10277-CAA	PHS (QPSK)	X	8.03	72.61	16.76	9.03	50.0	± 9.6 %
		Y	5.31	69.07	13.45		50.0	
		Z	4.52	67.70	12.08		50.0	
10278-CAA	PHS (QPSK, BW 884MHz, Rolloff 0.5)	X	10.53	79.27	21.29	9.03	50.0	± 9.6 %
		Y	8.21	77.64	19.35		50.0	
		Z	7.62	76.93	18.36		50.0	
10279-CAA	PHS (QPSK, BW 884MHz, Rolloff 0.38)	X	10.71	79.48	21.37	9.03	50.0	± 9.6 %
		Y	8.29	77.74	19.41		50.0	
		Z	7.68	77.01	18.42		50.0	
10290-AAB	CDMA2000, RC1, SO55, Full Rate	X	2.46	75.92	18.53	0.00	150.0	± 9.6 %
		Y	1.45	69.17	13.90		150.0	
		Z	1.74	72.52	15.01		150.0	
10291-AAB	CDMA2000, RC3, SO55, Full Rate	X	1.54	75.02	18.13	0.00	150.0	± 9.6 %
		Y	0.85	66.46	12.55		150.0	
		Z	1.09	70.54	14.22		150.0	
10292-AAB	CDMA2000, RC3, SO32, Full Rate	X	2.85	86.00	22.76	0.00	150.0	± 9.6 %
		Y	1.20	72.00	15.52		150.0	
		Z	3.37	86.48	20.58		150.0	
10293-AAB	CDMA2000, RC3, SO3, Full Rate	X	6.08	98.98	27.50	0.00	150.0	± 9.6 %
		Y	2.38	81.80	19.81		150.0	
		Z	91.77	132.75	32.89		150.0	
10295-AAB	CDMA2000, RC1, SO3, 1/8th Rate 25 fr.	X	11.42	82.00	23.75	9.03	50.0	± 9.6 %
		Y	13.54	88.04	25.23		50.0	
		Z	20.14	95.71	27.34		50.0	
10297-AAC	LTE-FDD (SC-FDMA, 50% RB, 20 MHz, QPSK)	X	3.39	72.81	18.09	0.00	150.0	± 9.6 %
		Y	2.76	70.00	16.84		150.0	
		Z	2.84	71.20	17.58		150.0	
10298-AAC	LTE-FDD (SC-FDMA, 50% RB, 3 MHz, QPSK)	X	2.33	72.89	17.78	0.00	150.0	± 9.6 %
		Y	1.54	67.89	13.96		150.0	
		Z	1.61	69.51	14.40		150.0	
10299-AAC	LTE-FDD (SC-FDMA, 50% RB, 3 MHz, 16-QAM)	X	4.61	76.96	19.19	0.00	150.0	± 9.6 %
		Y	2.70	70.48	14.61		150.0	
		Z	1.96	66.96	12.10		150.0	
10300-AAC	LTE-FDD (SC-FDMA, 50% RB, 3 MHz, 64-QAM)	X	3.49	71.59	16.26	0.00	150.0	± 9.6 %
		Y	1.91	65.24	11.36		150.0	
		Z	1.47	63.13	9.40		150.0	
10301-AAA	IEEE 802.16e WiMAX (29:18, 5ms, 10MHz, QPSK, PUSC)	X	6.59	70.34	20.04	4.17	80.0	± 9.6 %
		Y	5.68	68.74	18.85		80.0	
		Z	5.70	69.67	19.26		80.0	
10302-AAA	IEEE 802.16e WiMAX (29:18, 5ms, 10MHz, QPSK, PUSC, 3 CTRL symbols)	X	7.28	71.73	21.22	4.96	80.0	± 9.6 %
		Y	6.10	69.04	19.43		80.0	
		Z	6.04	69.77	19.77		80.0	

10303-AAA	IEEE 802.16e WiMAX (31:15, 5ms, 10MHz, 64QAM, PUSC)	X	7.35	72.51	21.62	4.96	80.0	± 9.6 %
		Y	5.94	69.06	19.41		80.0	
		Z	5.89	69.82	19.76		80.0	
10304-AAA	IEEE 802.16e WiMAX (29:18, 5ms, 10MHz, 64QAM, PUSC)	X	6.69	70.97	20.39	4.17	80.0	± 9.6 %
		Y	5.59	68.42	18.66		80.0	
		Z	5.56	69.20	19.00		80.0	
10305-AAA	IEEE 802.16e WiMAX (31:15, 10ms, 10MHz, 64QAM, PUSC, 15 symbols)	X	14.75	90.64	29.58	6.02	50.0	± 9.6 %
		Y	10.18	84.38	26.41		50.0	
		Z	10.30	85.54	26.72		50.0	
10306-AAA	IEEE 802.16e WiMAX (29:18, 10ms, 10MHz, 64QAM, PUSC, 18 symbols)	X	9.44	79.58	25.56	6.02	50.0	± 9.6 %
		Y	7.33	75.98	23.40		50.0	
		Z	6.44	73.04	21.64		50.0	
10307-AAA	IEEE 802.16e WiMAX (29:18, 10ms, 10MHz, QPSK, PUSC, 18 symbols)	X	10.22	81.50	26.08	6.02	50.0	± 9.6 %
		Y	7.67	77.32	23.80		50.0	
		Z	7.49	77.77	23.93		50.0	
10308-AAA	IEEE 802.16e WiMAX (29:18, 10ms, 10MHz, 16QAM, PUSC)	X	10.67	82.66	26.55	6.02	50.0	± 9.6 %
		Y	7.93	78.29	24.23		50.0	
		Z	7.77	78.85	24.42		50.0	
10309-AAA	IEEE 802.16e WiMAX (29:18, 10ms, 10MHz, 16QAM, AMC 2x3, 18 symbols)	X	9.59	79.83	25.67	6.02	50.0	± 9.6 %
		Y	7.43	76.26	23.57		50.0	
		Z	6.50	73.23	21.79		50.0	
10310-AAA	IEEE 802.16e WiMAX (29:18, 10ms, 10MHz, QPSK, AMC 2x3, 18 symbols)	X	9.69	80.24	25.70	6.02	50.0	± 9.6 %
		Y	7.48	76.59	23.59		50.0	
		Z	7.35	77.19	23.79		50.0	
10311-AAC	LTE-FDD (SC-FDMA, 100% RB, 15 MHz, QPSK)	X	3.76	71.88	17.62	0.00	150.0	± 9.6 %
		Y	3.12	69.22	16.46		150.0	
		Z	3.20	70.27	17.11		150.0	
10313-AAA	IDEN 1:3	X	8.04	75.55	17.71	6.99	70.0	± 9.6 %
		Y	8.89	81.65	20.17		70.0	
		Z	12.54	87.83	22.26		70.0	
10314-AAA	IDEN 1:6	X	10.06	79.94	21.38	10.00	30.0	± 9.6 %
		Y	12.66	89.89	25.48		30.0	
		Z	20.06	99.62	28.65		30.0	
10315-AAB	IEEE 802.11b WiFi 2.4 GHz (DSSS, 1 Mbps, 96pc duty cycle)	X	1.30	67.68	17.69	0.17	150.0	± 9.6 %
		Y	1.18	64.90	15.80		150.0	
		Z	1.23	65.94	16.59		150.0	
10316-AAB	IEEE 802.11g WiFi 2.4 GHz (ERP-OFDM, 6 Mbps, 96pc duty cycle)	X	4.90	67.26	16.78	0.17	150.0	± 9.6 %
		Y	4.64	67.10	16.54		150.0	
		Z	4.58	67.43	16.69		150.0	
10317-AAB	IEEE 802.11a WiFi 5 GHz (OFDM, 6 Mbps, 96pc duty cycle)	X	4.90	67.26	16.78	0.17	150.0	± 9.6 %
		Y	4.64	67.10	16.54		150.0	
		Z	4.58	67.43	16.69		150.0	
10400-AAC	IEEE 802.11ac WiFi (20MHz, 64-QAM, 99pc duty cycle)	X	5.01	67.47	16.66	0.00	150.0	± 9.6 %
		Y	4.68	67.24	16.42		150.0	
		Z	4.61	67.58	16.60		150.0	
10401-AAC	IEEE 802.11ac WiFi (40MHz, 64-QAM, 99pc duty cycle)	X	5.58	67.43	16.66	0.00	150.0	± 9.6 %
		Y	5.46	67.62	16.70		150.0	
		Z	5.29	67.47	16.64		150.0	

10402-AAC	IEEE 802.11ac WiFi (80MHz, 64-QAM, 99pc duty cycle)	X	5.90	68.07	16.80	0.00	150.0	± 9.6 %
		Y	5.66	67.67	16.59		150.0	
		Z	5.60	67.87	16.71		150.0	
10403-AAB	CDMA2000 (1xEV-DO, Rev. 0)	X	2.46	75.92	18.53	0.00	115.0	± 9.6 %
		Y	1.45	69.17	13.90		115.0	
		Z	1.74	72.52	15.01		115.0	
10404-AAB	CDMA2000 (1xEV-DO, Rev. A)	X	2.46	75.92	18.53	0.00	115.0	± 9.6 %
		Y	1.45	69.17	13.90		115.0	
		Z	1.74	72.52	15.01		115.0	
10406-AAB	CDMA2000, RC3, SO32, SCH0, Full Rate	X	38.96	111.40	30.01	0.00	100.0	± 9.6 %
		Y	96.63	125.46	32.24		100.0	
		Z	100.00	123.89	30.87		100.0	
10410-AAC	LTE-TDD (SC-FDMA, 1 RB, 10 MHz, QPSK, UL Subframe=2,3,4,7,8,9)	X	79.33	113.95	29.40	3.23	80.0	± 9.6 %
		Y	100.00	123.80	32.02		80.0	
		Z	100.00	124.20	31.74		80.0	
10415-AAA	IEEE 802.11b WiFi 2.4 GHz (DSSS, 1 Mbps, 99pc duty cycle)	X	1.01	64.64	16.23	0.00	150.0	± 9.6 %
		Y	1.03	63.36	14.90		150.0	
		Z	1.08	64.37	15.69		150.0	
10416-AAA	IEEE 802.11g WiFi 2.4 GHz (ERP-OFDM, 6 Mbps, 99pc duty cycle)	X	4.76	67.00	16.58	0.00	150.0	± 9.6 %
		Y	4.53	66.92	16.37		150.0	
		Z	4.48	67.28	16.53		150.0	
10417-AAA	IEEE 802.11a/h WiFi 5 GHz (OFDM, 6 Mbps, 99pc duty cycle)	X	4.76	67.00	16.58	0.00	150.0	± 9.6 %
		Y	4.53	66.92	16.37		150.0	
		Z	4.48	67.28	16.53		150.0	
10418-AAA	IEEE 802.11g WiFi 2.4 GHz (DSSS-OFDM, 6 Mbps, 99pc duty cycle, Long preamble)	X	4.74	67.14	16.57	0.00	150.0	± 9.6 %
		Y	4.53	67.10	16.40		150.0	
		Z	4.48	67.49	16.59		150.0	
10419-AAA	IEEE 802.11g WiFi 2.4 GHz (DSSS-OFDM, 6 Mbps, 99pc duty cycle, Short preamble)	X	4.77	67.10	16.59	0.00	150.0	± 9.6 %
		Y	4.55	67.04	16.39		150.0	
		Z	4.49	67.42	16.58		150.0	
10422-AAA	IEEE 802.11n (HT Greenfield, 7.2 Mbps, BPSK)	X	4.90	67.10	16.59	0.00	150.0	± 9.6 %
		Y	4.66	67.03	16.41		150.0	
		Z	4.60	67.38	16.58		150.0	
10423-AAA	IEEE 802.11n (HT Greenfield, 43.3 Mbps, 16-QAM)	X	5.14	67.54	16.75	0.00	150.0	± 9.6 %
		Y	4.81	67.33	16.51		150.0	
		Z	4.74	67.65	16.67		150.0	
10424-AAA	IEEE 802.11n (HT Greenfield, 72.2 Mbps, 64-QAM)	X	5.04	67.47	16.71	0.00	150.0	± 9.6 %
		Y	4.74	67.28	16.49		150.0	
		Z	4.66	67.61	16.65		150.0	
10425-AAA	IEEE 802.11n (HT Greenfield, 15 Mbps, BPSK)	X	5.61	67.86	16.86	0.00	150.0	± 9.6 %
		Y	5.36	67.59	16.69		150.0	
		Z	5.29	67.80	16.81		150.0	
10426-AAA	IEEE 802.11n (HT Greenfield, 90 Mbps, 16-QAM)	X	5.62	67.87	16.86	0.00	150.0	± 9.6 %
		Y	5.40	67.74	16.76		150.0	
		Z	5.31	67.91	16.86		150.0	

10427-AAA	IEEE 802.11n (HT Greenfield, 150 Mbps, 64-QAM)	X	5.65	67.92	16.88	0.00	150.0	± 9.6 %
		Y	5.39	67.63	16.70		150.0	
		Z	5.28	67.70	16.75		150.0	
10430-AAB	LTE-FDD (OFDMA, 5 MHz, E-TM 3.1)	X	4.50	70.33	18.46	0.00	150.0	± 9.6 %
		Y	4.28	71.46	18.38		150.0	
		Z	4.28	72.32	18.56		150.0	
10431-AAB	LTE-FDD (OFDMA, 10 MHz, E-TM 3.1)	X	4.56	67.66	16.75	0.00	150.0	± 9.6 %
		Y	4.19	67.51	16.33		150.0	
		Z	4.12	67.97	16.50		150.0	
10432-AAB	LTE-FDD (OFDMA, 15 MHz, E-TM 3.1)	X	4.83	67.55	16.72	0.00	150.0	± 9.6 %
		Y	4.50	67.35	16.43		150.0	
		Z	4.43	67.74	16.61		150.0	
10433-AAB	LTE-FDD (OFDMA, 20 MHz, E-TM 3.1)	X	5.06	67.54	16.75	0.00	150.0	± 9.6 %
		Y	4.75	67.32	16.51		150.0	
		Z	4.68	67.64	16.67		150.0	
10434-AAA	W-CDMA (BS Test Model 1, 64 DPCH)	X	4.58	70.97	18.48	0.00	150.0	± 9.6 %
		Y	4.39	72.38	18.32		150.0	
		Z	4.42	73.36	18.48		150.0	
10435-AAC	LTE-TDD (SC-FDMA, 1 RB, 20 MHz, QPSK, UL Subframe=2,3,4,7,8,9)	X	73.07	112.66	29.06	3.23	80.0	± 9.6 %
		Y	100.00	123.60	31.93		80.0	
		Z	100.00	123.98	31.64		80.0	
10447-AAB	LTE-FDD (OFDMA, 5 MHz, E-TM 3.1, Clipping 44%)	X	3.91	67.87	16.49	0.00	150.0	± 9.6 %
		Y	3.47	67.50	15.53		150.0	
		Z	3.41	68.08	15.62		150.0	
10448-AAB	LTE-FDD (OFDMA, 10 MHz, E-TM 3.1, Clipping 44%)	X	4.36	67.43	16.61	0.00	150.0	± 9.6 %
		Y	4.04	67.29	16.20		150.0	
		Z	3.99	67.77	16.38		150.0	
10449-AAB	LTE-FDD (OFDMA, 15 MHz, E-TM 3.1, Clipping 44%)	X	4.59	67.37	16.63	0.00	150.0	± 9.6 %
		Y	4.32	67.18	16.33		150.0	
		Z	4.27	67.58	16.51		150.0	
10450-AAB	LTE-FDD (OFDMA, 20 MHz, E-TM 3.1, Clipping 44%)	X	4.75	67.29	16.62	0.00	150.0	± 9.6 %
		Y	4.52	67.08	16.36		150.0	
		Z	4.47	67.43	16.54		150.0	
10451-AAA	W-CDMA (BS Test Model 1, 64 DPCH, Clipping 44%)	X	3.88	68.25	16.35	0.00	150.0	± 9.6 %
		Y	3.34	67.60	15.06		150.0	
		Z	3.25	68.08	15.03		150.0	
10456-AAA	IEEE 802.11ac WiFi (160MHz, 64-QAM, 99pc duty cycle)	X	6.45	68.48	17.01	0.00	150.0	± 9.6 %
		Y	6.28	68.20	16.88		150.0	
		Z	6.24	68.43	17.01		150.0	
10457-AAA	UMTS-FDD (DC-HSDPA)	X	3.87	65.68	16.38	0.00	150.0	± 9.6 %
		Y	3.81	65.57	16.07		150.0	
		Z	3.81	65.98	16.26		150.0	
10458-AAA	CDMA2000 (1xEV-DO, Rev. B, 2 carriers)	X	3.63	67.17	15.82	0.00	150.0	± 9.6 %
		Y	3.13	66.82	14.32		150.0	
		Z	2.97	66.93	13.99		150.0	
10459-AAA	CDMA2000 (1xEV-DO, Rev. B, 3 carriers)	X	4.79	65.36	16.37	0.00	150.0	± 9.6 %
		Y	4.24	65.27	15.46		150.0	
		Z	4.13	65.72	15.38		150.0	

10460-AAA	UMTS-FDD (WCDMA, AMR)	X	1.54	79.74	21.99	0.00	150.0	± 9.6 %
		Y	0.95	69.06	16.64		150.0	
		Z	1.16	73.20	19.00		150.0	
10461-AAA	LTE-TDD (SC-FDMA, 1 RB, 1.4 MHz, QPSK, UL Subframe=2,3,4,7,8,9)	X	100.00	118.00	30.59	3.29	80.0	± 9.6 %
		Y	100.00	127.27	33.69		80.0	
		Z	100.00	128.13	33.61		80.0	
10462-AAA	LTE-TDD (SC-FDMA, 1 RB, 1.4 MHz, 16-QAM, UL Subframe=2,3,4,7,8,9)	X	100.00	108.76	26.18	3.23	80.0	± 9.6 %
		Y	100.00	111.69	26.26		80.0	
		Z	100.00	109.78	24.92		80.0	
10463-AAA	LTE-TDD (SC-FDMA, 1 RB, 1.4 MHz, 64-QAM, UL Subframe=2,3,4,7,8,9)	X	61.06	101.21	23.94	3.23	80.0	± 9.6 %
		Y	100.00	108.45	24.70		80.0	
		Z	9.38	82.48	17.38		80.0	
10464-AAA	LTE-TDD (SC-FDMA, 1 RB, 3 MHz, QPSK, UL Subframe=2,3,4,7,8,9)	X	100.00	116.66	29.84	3.23	80.0	± 9.6 %
		Y	100.00	125.35	32.64		80.0	
		Z	100.00	125.94	32.43		80.0	
10465-AAA	LTE-TDD (SC-FDMA, 1 RB, 3 MHz, 16-QAM, UL Subframe=2,3,4,7,8,9)	X	100.00	108.47	26.02	3.23	80.0	± 9.6 %
		Y	100.00	111.17	26.01		80.0	
		Z	44.16	100.58	22.73		80.0	
10466-AAA	LTE-TDD (SC-FDMA, 1 RB, 3 MHz, 64-QAM, UL Subframe=2,3,4,7,8,9)	X	42.58	96.75	22.75	3.23	80.0	± 9.6 %
		Y	42.99	98.93	22.41		80.0	
		Z	5.89	77.61	15.84		80.0	
10467-AAC	LTE-TDD (SC-FDMA, 1 RB, 5 MHz, QPSK, UL Subframe=2,3,4,7,8,9)	X	100.00	116.79	29.90	3.23	80.0	± 9.6 %
		Y	100.00	125.60	32.75		80.0	
		Z	100.00	126.22	32.56		80.0	
10468-AAC	LTE-TDD (SC-FDMA, 1 RB, 5 MHz, 16-QAM, UL Subframe=2,3,4,7,8,9)	X	100.00	108.56	26.07	3.23	80.0	± 9.6 %
		Y	100.00	111.35	26.09		80.0	
		Z	61.74	104.33	23.64		80.0	
10469-AAC	LTE-TDD (SC-FDMA, 1 RB, 5 MHz, 64-QAM, UL Subframe=2,3,4,7,8,9)	X	43.83	97.08	22.83	3.23	80.0	± 9.6 %
		Y	46.06	99.70	22.59		80.0	
		Z	6.04	77.89	15.93		80.0	
10470-AAC	LTE-TDD (SC-FDMA, 1 RB, 10 MHz, QPSK, UL Subframe=2,3,4,7,8,9)	X	100.00	116.81	29.90	3.23	80.0	± 9.6 %
		Y	100.00	125.63	32.76		80.0	
		Z	100.00	126.25	32.56		80.0	
10471-AAC	LTE-TDD (SC-FDMA, 1 RB, 10 MHz, 16-QAM, UL Subframe=2,3,4,7,8,9)	X	100.00	108.53	26.05	3.23	80.0	± 9.6 %
		Y	100.00	111.31	26.07		80.0	
		Z	61.64	104.26	23.61		80.0	
10472-AAC	LTE-TDD (SC-FDMA, 1 RB, 10 MHz, 64-QAM, UL Subframe=2,3,4,7,8,9)	X	44.10	97.14	22.84	3.23	80.0	± 9.6 %
		Y	46.39	99.73	22.59		80.0	
		Z	6.02	77.83	15.90		80.0	
10473-AAC	LTE-TDD (SC-FDMA, 1 RB, 15 MHz, QPSK, UL Subframe=2,3,4,7,8,9)	X	100.00	116.79	29.89	3.23	80.0	± 9.6 %
		Y	100.00	125.60	32.74		80.0	
		Z	100.00	126.23	32.55		80.0	
10474-AAC	LTE-TDD (SC-FDMA, 1 RB, 15 MHz, 16-QAM, UL Subframe=2,3,4,7,8,9)	X	100.00	108.54	26.05	3.23	80.0	± 9.6 %
		Y	100.00	111.32	26.07		80.0	
		Z	60.20	104.02	23.55		80.0	
10475-AAC	LTE-TDD (SC-FDMA, 1 RB, 15 MHz, 64-QAM, UL Subframe=2,3,4,7,8,9)	X	43.66	97.03	22.81	3.23	80.0	± 9.6 %
		Y	44.87	99.39	22.51		80.0	
		Z	5.94	77.72	15.87		80.0	

10477-AAC	LTE-TDD (SC-FDMA, 1 RB, 20 MHz, 16-QAM, UL Subframe=2,3,4,7,8,9)	X	100.00	108.43	26.00	3.23	80.0	± 9.6 %
		Y	100.00	111.14	25.99		80.0	
		Z	48.11	101.47	22.92		80.0	
10478-AAC	LTE-TDD (SC-FDMA, 1 RB, 20 MHz, 64-QAM, UL Subframe=2,3,4,7,8,9)	X	43.04	96.84	22.76	3.23	80.0	± 9.6 %
		Y	43.24	98.94	22.39		80.0	
		Z	5.86	77.55	15.80		80.0	
10479-AAA	LTE-TDD (SC-FDMA, 50% RB, 1.4 MHz, QPSK, UL Subframe=2,3,4,7,8,9)	X	18.43	95.26	26.62	3.23	80.0	± 9.6 %
		Y	47.63	113.17	30.89		80.0	
		Z	79.42	120.84	32.18		80.0	
10480-AAA	LTE-TDD (SC-FDMA, 50% RB, 1.4 MHz, 16-QAM, UL Subframe=2,3,4,7,8,9)	X	15.38	87.90	23.16	3.23	80.0	± 9.6 %
		Y	35.80	101.51	25.84		80.0	
		Z	33.10	99.76	24.57		80.0	
10481-AAA	LTE-TDD (SC-FDMA, 50% RB, 1.4 MHz, 64-QAM, UL Subframe=2,3,4,7,8,9)	X	14.20	86.14	22.35	3.23	80.0	± 9.6 %
		Y	23.64	94.76	23.60		80.0	
		Z	17.83	90.68	21.64		80.0	
10482-AAA	LTE-TDD (SC-FDMA, 50% RB, 3 MHz, QPSK, UL Subframe=2,3,4,7,8,9)	X	11.00	86.13	22.59	2.23	80.0	± 9.6 %
		Y	6.54	80.66	19.81		80.0	
		Z	10.00	86.91	21.46		80.0	
10483-AAA	LTE-TDD (SC-FDMA, 50% RB, 3 MHz, 16-QAM, UL Subframe=2,3,4,7,8,9)	X	11.81	84.53	22.26	2.23	80.0	± 9.6 %
		Y	9.59	82.56	20.08		80.0	
		Z	5.79	75.74	16.81		80.0	
10484-AAA	LTE-TDD (SC-FDMA, 50% RB, 3 MHz, 64-QAM, UL Subframe=2,3,4,7,8,9)	X	11.16	83.50	21.93	2.23	80.0	± 9.6 %
		Y	8.15	80.18	19.27		80.0	
		Z	5.05	73.86	16.10		80.0	
10485-AAC	LTE-TDD (SC-FDMA, 50% RB, 5 MHz, QPSK, UL Subframe=2,3,4,7,8,9)	X	11.03	86.44	23.15	2.23	80.0	± 9.6 %
		Y	6.87	82.16	21.41		80.0	
		Z	9.87	88.59	23.41		80.0	
10486-AAC	LTE-TDD (SC-FDMA, 50% RB, 5 MHz, 16-QAM, UL Subframe=2,3,4,7,8,9)	X	6.95	77.02	19.85	2.23	80.0	± 9.6 %
		Y	4.98	74.27	17.96		80.0	
		Z	5.53	76.50	18.48		80.0	
10487-AAC	LTE-TDD (SC-FDMA, 50% RB, 5 MHz, 64-QAM, UL Subframe=2,3,4,7,8,9)	X	6.82	76.43	19.65	2.23	80.0	± 9.6 %
		Y	4.85	73.54	17.65		80.0	
		Z	5.25	75.41	18.04		80.0	
10488-AAC	LTE-TDD (SC-FDMA, 50% RB, 10 MHz, QPSK, UL Subframe=2,3,4,7,8,9)	X	9.46	82.96	22.30	2.23	80.0	± 9.6 %
		Y	5.99	78.96	21.12		80.0	
		Z	6.82	82.33	22.47		80.0	
10489-AAC	LTE-TDD (SC-FDMA, 50% RB, 10 MHz, 16-QAM, UL Subframe=2,3,4,7,8,9)	X	6.62	75.52	19.96	2.23	80.0	± 9.6 %
		Y	4.91	73.20	18.90		80.0	
		Z	5.11	74.84	19.54		80.0	
10490-AAC	LTE-TDD (SC-FDMA, 50% RB, 10 MHz, 64-QAM, UL Subframe=2,3,4,7,8,9)	X	6.56	74.88	19.76	2.23	80.0	± 9.6 %
		Y	4.94	72.82	18.76		80.0	
		Z	5.10	74.33	19.33		80.0	
10491-AAC	LTE-TDD (SC-FDMA, 50% RB, 15 MHz, QPSK, UL Subframe=2,3,4,7,8,9)	X	7.98	78.75	20.93	2.23	80.0	± 9.6 %
		Y	5.56	75.73	20.09		80.0	
		Z	5.84	77.68	21.00		80.0	
10492-AAC	LTE-TDD (SC-FDMA, 50% RB, 15 MHz, 16-QAM, UL Subframe=2,3,4,7,8,9)	X	6.52	73.74	19.47	2.23	80.0	± 9.6 %
		Y	5.01	71.66	18.63		80.0	
		Z	5.04	72.68	19.10		80.0	

10493-AAC	LTE-TDD (SC-FDMA, 50% RB, 15 MHz, 64-QAM, UL Subframe=2,3,4,7,8,9)	X	6.52	73.38	19.36	2.23	80.0	± 9.6 %
		Y	5.05	71.42	18.55		80.0	
		Z	5.05	72.38	18.97		80.0	
10494-AAC	LTE-TDD (SC-FDMA, 50% RB, 20 MHz, QPSK, UL Subframe=2,3,4,7,8,9)	X	9.30	81.16	21.56	2.23	80.0	± 9.6 %
		Y	6.19	77.55	20.65		80.0	
		Z	6.63	79.81	21.68		80.0	
10495-AAC	LTE-TDD (SC-FDMA, 50% RB, 20 MHz, 16-QAM, UL Subframe=2,3,4,7,8,9)	X	6.75	74.54	19.74	2.23	80.0	± 9.6 %
		Y	5.09	72.10	18.86		80.0	
		Z	5.10	73.07	19.34		80.0	
10496-AAC	LTE-TDD (SC-FDMA, 50% RB, 20 MHz, 64-QAM, UL Subframe=2,3,4,7,8,9)	X	6.67	73.87	19.53	2.23	80.0	± 9.6 %
		Y	5.11	71.66	18.72		80.0	
		Z	5.11	72.57	19.16		80.0	
10497-AAA	LTE-TDD (SC-FDMA, 100% RB, 1.4 MHz, QPSK, UL Subframe=2,3,4,7,8,9)	X	9.58	84.00	21.43	2.23	80.0	± 9.6 %
		Y	4.27	74.12	16.39		80.0	
		Z	5.12	76.54	16.66		80.0	
10498-AAA	LTE-TDD (SC-FDMA, 100% RB, 1.4 MHz, 16-QAM, UL Subframe=2,3,4,7,8,9)	X	6.19	75.19	17.72	2.23	80.0	± 9.6 %
		Y	2.33	64.39	11.23		80.0	
		Z	1.83	62.54	9.68		80.0	
10499-AAA	LTE-TDD (SC-FDMA, 100% RB, 1.4 MHz, 64-QAM, UL Subframe=2,3,4,7,8,9)	X	6.08	74.60	17.40	2.23	80.0	± 9.6 %
		Y	2.20	63.55	10.68		80.0	
		Z	1.70	61.64	9.07		80.0	
10500-AAA	LTE-TDD (SC-FDMA, 100% RB, 3 MHz, QPSK, UL Subframe=2,3,4,7,8,9)	X	9.69	83.97	22.50	2.23	80.0	± 9.6 %
		Y	6.26	80.30	21.12		80.0	
		Z	7.99	85.23	22.80		80.0	
10501-AAA	LTE-TDD (SC-FDMA, 100% RB, 3 MHz, 16-QAM, UL Subframe=2,3,4,7,8,9)	X	6.73	76.14	19.79	2.23	80.0	± 9.6 %
		Y	4.97	73.89	18.33		80.0	
		Z	5.41	76.03	18.94		80.0	
10502-AAA	LTE-TDD (SC-FDMA, 100% RB, 3 MHz, 64-QAM, UL Subframe=2,3,4,7,8,9)	X	6.66	75.65	19.59	2.23	80.0	± 9.6 %
		Y	4.97	73.54	18.13		80.0	
		Z	5.36	75.51	18.67		80.0	
10503-AAC	LTE-TDD (SC-FDMA, 100% RB, 5 MHz, QPSK, UL Subframe=2,3,4,7,8,9)	X	9.33	82.74	22.21	2.23	80.0	± 9.6 %
		Y	5.90	78.70	21.01		80.0	
		Z	6.71	82.03	22.35		80.0	
10504-AAC	LTE-TDD (SC-FDMA, 100% RB, 5 MHz, 16-QAM, UL Subframe=2,3,4,7,8,9)	X	6.59	75.44	19.92	2.23	80.0	± 9.6 %
		Y	4.88	73.08	18.84		80.0	
		Z	5.07	74.71	19.47		80.0	
10505-AAC	LTE-TDD (SC-FDMA, 100% RB, 5 MHz, 64-QAM, UL Subframe=2,3,4,7,8,9)	X	6.52	74.79	19.72	2.23	80.0	± 9.6 %
		Y	4.91	72.71	18.70		80.0	
		Z	5.07	74.21	19.27		80.0	
10506-AAC	LTE-TDD (SC-FDMA, 100% RB, 10 MHz, QPSK, UL Subframe=2,3,4,7,8,9)	X	9.21	81.00	21.50	2.23	80.0	± 9.6 %
		Y	6.13	77.37	20.57		80.0	
		Z	6.56	79.62	21.60		80.0	
10507-AAC	LTE-TDD (SC-FDMA, 100% RB, 10 MHz, 16-QAM, UL Subframe=2,3,4,7,8,9)	X	6.72	74.48	19.71	2.23	80.0	± 9.6 %
		Y	5.07	72.03	18.82		80.0	
		Z	5.08	73.01	19.31		80.0	

10508-AAC	LTE-TDD (SC-FDMA, 100% RB, 10 MHz, 64-QAM, UL Subframe=2,3,4,7,8,9)	X	6.65	73.80	19.50	2.23	80.0	± 9.6 %
		Y	5.09	71.58	18.67		80.0	
		Z	5.09	72.48	19.12		80.0	
10509-AAC	LTE-TDD (SC-FDMA, 100% RB, 15 MHz, QPSK, UL Subframe=2,3,4,7,8,9)	X	8.15	77.43	20.26	2.23	80.0	± 9.6 %
		Y	5.99	74.82	19.62		80.0	
		Z	6.17	76.24	20.35		80.0	
10510-AAC	LTE-TDD (SC-FDMA, 100% RB, 15 MHz, 16-QAM, UL Subframe=2,3,4,7,8,9)	X	6.94	73.36	19.32	2.23	80.0	± 9.6 %
		Y	5.42	71.16	18.60		80.0	
		Z	5.37	71.81	18.97		80.0	
10511-AAC	LTE-TDD (SC-FDMA, 100% RB, 15 MHz, 64-QAM, UL Subframe=2,3,4,7,8,9)	X	6.87	72.87	19.19	2.23	80.0	± 9.6 %
		Y	5.44	70.83	18.50		80.0	
		Z	5.39	71.45	18.85		80.0	
10512-AAC	LTE-TDD (SC-FDMA, 100% RB, 20 MHz, QPSK, UL Subframe=2,3,4,7,8,9)	X	9.41	80.22	21.09	2.23	80.0	± 9.6 %
		Y	6.52	76.83	20.24		80.0	
		Z	6.84	78.58	21.10		80.0	
10513-AAC	LTE-TDD (SC-FDMA, 100% RB, 20 MHz, 16-QAM, UL Subframe=2,3,4,7,8,9)	X	7.03	74.19	19.61	2.23	80.0	± 9.6 %
		Y	5.36	71.56	18.76		80.0	
		Z	5.31	72.21	19.14		80.0	
10514-AAC	LTE-TDD (SC-FDMA, 100% RB, 20 MHz, 64-QAM, UL Subframe=2,3,4,7,8,9)	X	6.85	73.42	19.39	2.23	80.0	± 9.6 %
		Y	5.32	71.03	18.59		80.0	
		Z	5.27	71.61	18.94		80.0	
10515-AAA	IEEE 802.11b WiFi 2.4 GHz (DSSS, 2 Mbps, 99pc duty cycle)	X	0.98	65.05	16.44	0.00	150.0	± 9.6 %
		Y	1.00	63.56	14.97		150.0	
		Z	1.05	64.66	15.82		150.0	
10516-AAA	IEEE 802.11b WiFi 2.4 GHz (DSSS, 5.5 Mbps, 99pc duty cycle)	X	100.00	168.11	45.87	0.00	150.0	± 9.6 %
		Y	0.67	71.83	18.15		150.0	
		Z	1.04	80.65	22.82		150.0	
10517-AAA	IEEE 802.11b WiFi 2.4 GHz (DSSS, 11 Mbps, 99pc duty cycle)	X	0.96	70.11	18.69	0.00	150.0	± 9.6 %
		Y	0.85	65.61	15.70		150.0	
		Z	0.93	67.57	17.12		150.0	
10518-AAA	IEEE 802.11a/h WiFi 5 GHz (OFDM, 9 Mbps, 99pc duty cycle)	X	4.76	67.10	16.57	0.00	150.0	± 9.6 %
		Y	4.53	67.01	16.35		150.0	
		Z	4.47	67.38	16.53		150.0	
10519-AAA	IEEE 802.11a/h WiFi 5 GHz (OFDM, 12 Mbps, 99pc duty cycle)	X	5.02	67.44	16.72	0.00	150.0	± 9.6 %
		Y	4.70	67.22	16.46		150.0	
		Z	4.63	67.55	16.62		150.0	
10520-AAA	IEEE 802.11a/h WiFi 5 GHz (OFDM, 18 Mbps, 99pc duty cycle)	X	4.86	67.45	16.66	0.00	150.0	± 9.6 %
		Y	4.55	67.17	16.38		150.0	
		Z	4.48	67.50	16.54		150.0	
10521-AAA	IEEE 802.11a/h WiFi 5 GHz (OFDM, 24 Mbps, 99pc duty cycle)	X	4.79	67.47	16.66	0.00	150.0	± 9.6 %
		Y	4.48	67.16	16.36		150.0	
		Z	4.42	67.48	16.53		150.0	
10522-AAA	IEEE 802.11a/h WiFi 5 GHz (OFDM, 36 Mbps, 99pc duty cycle)	X	4.82	67.32	16.63	0.00	150.0	± 9.6 %
		Y	4.55	67.29	16.46		150.0	
		Z	4.47	67.62	16.63		150.0	

10523-AAA	IEEE 802.11a/h WiFi 5 GHz (OFDM, 48 Mbps, 99pc duty cycle)	X	4.69	67.31	16.53	0.00	150.0	± 9.6 %
		Y	4.44	67.17	16.32		150.0	
		Z	4.39	67.59	16.54		150.0	
10524-AAA	IEEE 802.11a/h WiFi 5 GHz (OFDM, 54 Mbps, 99pc duty cycle)	X	4.78	67.32	16.64	0.00	150.0	± 9.6 %
		Y	4.49	67.20	16.43		150.0	
		Z	4.42	67.57	16.62		150.0	
10525-AAA	IEEE 802.11ac WiFi (20MHz, MCS0, 99pc duty cycle)	X	4.72	66.35	16.23	0.00	150.0	± 9.6 %
		Y	4.49	66.26	16.02		150.0	
		Z	4.45	66.66	16.22		150.0	
10526-AAA	IEEE 802.11ac WiFi (20MHz, MCS1, 99pc duty cycle)	X	4.95	66.78	16.37	0.00	150.0	± 9.6 %
		Y	4.64	66.60	16.16		150.0	
		Z	4.58	66.96	16.34		150.0	
10527-AAA	IEEE 802.11ac WiFi (20MHz, MCS2, 99pc duty cycle)	X	4.86	66.80	16.35	0.00	150.0	± 9.6 %
		Y	4.57	66.56	16.10		150.0	
		Z	4.51	66.93	16.29		150.0	
10528-AAA	IEEE 802.11ac WiFi (20MHz, MCS3, 99pc duty cycle)	X	4.89	66.82	16.38	0.00	150.0	± 9.6 %
		Y	4.58	66.57	16.13		150.0	
		Z	4.52	66.94	16.32		150.0	
10529-AAA	IEEE 802.11ac WiFi (20MHz, MCS4, 99pc duty cycle)	X	4.89	66.82	16.38	0.00	150.0	± 9.6 %
		Y	4.58	66.57	16.13		150.0	
		Z	4.52	66.94	16.32		150.0	
10531-AAA	IEEE 802.11ac WiFi (20MHz, MCS6, 99pc duty cycle)	X	4.92	67.00	16.42	0.00	150.0	± 9.6 %
		Y	4.57	66.66	16.14		150.0	
		Z	4.49	66.99	16.31		150.0	
10532-AAA	IEEE 802.11ac WiFi (20MHz, MCS7, 99pc duty cycle)	X	4.76	66.93	16.40	0.00	150.0	± 9.6 %
		Y	4.43	66.51	16.07		150.0	
		Z	4.37	66.85	16.25		150.0	
10533-AAA	IEEE 802.11ac WiFi (20MHz, MCS8, 99pc duty cycle)	X	4.90	66.82	16.35	0.00	150.0	± 9.6 %
		Y	4.59	66.64	16.13		150.0	
		Z	4.53	67.03	16.33		150.0	
10534-AAA	IEEE 802.11ac WiFi (40MHz, MCS0, 99pc duty cycle)	X	5.38	66.99	16.41	0.00	150.0	± 9.6 %
		Y	5.14	66.65	16.20		150.0	
		Z	5.08	66.89	16.34		150.0	
10535-AAA	IEEE 802.11ac WiFi (40MHz, MCS1, 99pc duty cycle)	X	5.47	67.13	16.46	0.00	150.0	± 9.6 %
		Y	5.21	66.87	16.30		150.0	
		Z	5.13	67.05	16.42		150.0	
10536-AAA	IEEE 802.11ac WiFi (40MHz, MCS2, 99pc duty cycle)	X	5.32	67.12	16.45	0.00	150.0	± 9.6 %
		Y	5.08	66.81	16.25		150.0	
		Z	5.02	67.06	16.40		150.0	
10537-AAA	IEEE 802.11ac WiFi (40MHz, MCS3, 99pc duty cycle)	X	5.39	67.07	16.42	0.00	150.0	± 9.6 %
		Y	5.13	66.76	16.23		150.0	
		Z	5.08	67.03	16.39		150.0	
10538-AAA	IEEE 802.11ac WiFi (40MHz, MCS4, 99pc duty cycle)	X	5.52	67.19	16.52	0.00	150.0	± 9.6 %
		Y	5.21	66.77	16.27		150.0	
		Z	5.14	66.99	16.41		150.0	
10540-AAA	IEEE 802.11ac WiFi (40MHz, MCS6, 99pc duty cycle)	X	5.40	67.10	16.49	0.00	150.0	± 9.6 %
		Y	5.15	66.79	16.30		150.0	
		Z	5.07	66.96	16.41		150.0	

10541-AAA	IEEE 802.11ac WiFi (40MHz, MCS7, 99pc duty cycle)	X	5.41	67.10	16.49	0.00	150.0	± 9.6 %
		Y	5.12	66.64	16.21		150.0	
		Z	5.05	66.85	16.34		150.0	
10542-AAA	IEEE 802.11ac WiFi (40MHz, MCS8, 99pc duty cycle)	X	5.53	67.02	16.46	0.00	150.0	± 9.6 %
		Y	5.28	66.73	16.27		150.0	
		Z	5.21	66.95	16.40		150.0	
10543-AAA	IEEE 802.11ac WiFi (40MHz, MCS9, 99pc duty cycle)	X	5.65	67.09	16.50	0.00	150.0	± 9.6 %
		Y	5.35	66.75	16.31		150.0	
		Z	5.28	67.01	16.46		150.0	
10544-AAA	IEEE 802.11ac WiFi (80MHz, MCS0, 99pc duty cycle)	X	5.63	67.05	16.36	0.00	150.0	± 9.6 %
		Y	5.46	66.75	16.19		150.0	
		Z	5.42	66.95	16.31		150.0	
10545-AAA	IEEE 802.11ac WiFi (80MHz, MCS1, 99pc duty cycle)	X	5.85	67.43	16.48	0.00	150.0	± 9.6 %
		Y	5.67	67.24	16.39		150.0	
		Z	5.61	67.44	16.52		150.0	
10546-AAA	IEEE 802.11ac WiFi (80MHz, MCS2, 99pc duty cycle)	X	5.76	67.40	16.49	0.00	150.0	± 9.6 %
		Y	5.52	66.93	16.25		150.0	
		Z	5.45	67.09	16.35		150.0	
10547-AAA	IEEE 802.11ac WiFi (80MHz, MCS3, 99pc duty cycle)	X	5.86	67.50	16.53	0.00	150.0	± 9.6 %
		Y	5.59	67.00	16.28		150.0	
		Z	5.54	67.20	16.40		150.0	
10548-AAA	IEEE 802.11ac WiFi (80MHz, MCS4, 99pc duty cycle)	X	6.21	68.68	17.08	0.00	150.0	± 9.6 %
		Y	5.87	68.02	16.76		150.0	
		Z	5.72	67.95	16.76		150.0	
10550-AAA	IEEE 802.11ac WiFi (80MHz, MCS6, 99pc duty cycle)	X	5.77	67.31	16.45	0.00	150.0	± 9.6 %
		Y	5.57	67.05	16.32		150.0	
		Z	5.52	67.30	16.47		150.0	
10551-AAA	IEEE 802.11ac WiFi (80MHz, MCS7, 99pc duty cycle)	X	5.80	67.45	16.48	0.00	150.0	± 9.6 %
		Y	5.55	67.00	16.26		150.0	
		Z	5.45	67.07	16.32		150.0	
10552-AAA	IEEE 802.11ac WiFi (80MHz, MCS8, 99pc duty cycle)	X	5.69	67.19	16.37	0.00	150.0	± 9.6 %
		Y	5.47	66.81	16.17		150.0	
		Z	5.43	67.06	16.31		150.0	
10553-AAA	IEEE 802.11ac WiFi (80MHz, MCS9, 99pc duty cycle)	X	5.78	67.21	16.40	0.00	150.0	± 9.6 %
		Y	5.54	66.82	16.20		150.0	
		Z	5.48	67.01	16.32		150.0	
10554-AAB	IEEE 802.11ac WiFi (160MHz, MCS0, 99pc duty cycle)	X	6.03	67.43	16.45	0.00	150.0	± 9.6 %
		Y	5.89	67.12	16.28		150.0	
		Z	5.84	67.28	16.38		150.0	
10555-AAB	IEEE 802.11ac WiFi (160MHz, MCS1, 99pc duty cycle)	X	6.22	67.88	16.64	0.00	150.0	± 9.6 %
		Y	6.02	67.44	16.43		150.0	
		Z	5.95	67.54	16.50		150.0	
10556-AAB	IEEE 802.11ac WiFi (160MHz, MCS2, 99pc duty cycle)	X	6.20	67.79	16.59	0.00	150.0	± 9.6 %
		Y	6.04	67.49	16.44		150.0	
		Z	5.99	67.66	16.55		150.0	
10557-AAB	IEEE 802.11ac WiFi (160MHz, MCS3, 99pc duty cycle)	X	6.21	67.81	16.62	0.00	150.0	± 9.6 %
		Y	5.99	67.35	16.39		150.0	
		Z	5.93	67.50	16.49		150.0	

10558-AAB	IEEE 802.11ac WiFi (160MHz, MCS4, 99pc duty cycle)	X	6.28	68.03	16.75	0.00	150.0	± 9.6 %
		Y	6.04	67.52	16.49		150.0	
		Z	5.95	67.59	16.55		150.0	
10560-AAB	IEEE 802.11ac WiFi (160MHz, MCS6, 99pc duty cycle)	X	6.28	67.87	16.71	0.00	150.0	± 9.6 %
		Y	6.03	67.35	16.44		150.0	
		Z	5.96	67.49	16.53		150.0	
10561-AAB	IEEE 802.11ac WiFi (160MHz, MCS7, 99pc duty cycle)	X	6.18	67.80	16.71	0.00	150.0	± 9.6 %
		Y	5.96	67.36	16.48		150.0	
		Z	5.90	67.49	16.57		150.0	
10562-AAB	IEEE 802.11ac WiFi (160MHz, MCS8, 99pc duty cycle)	X	6.37	68.38	17.01	0.00	150.0	± 9.6 %
		Y	6.06	67.66	16.63		150.0	
		Z	5.96	67.67	16.66		150.0	
10563-AAB	IEEE 802.11ac WiFi (160MHz, MCS9, 99pc duty cycle)	X	6.58	68.54	17.02	0.00	150.0	± 9.6 %
		Y	6.18	67.65	16.59		150.0	
		Z	6.05	67.62	16.60		150.0	
10564-AAA	IEEE 802.11g WiFi 2.4 GHz (DSSS-OFDM, 9 Mbps, 99pc duty cycle)	X	5.11	67.26	16.76	0.46	150.0	± 9.6 %
		Y	4.86	67.10	16.52		150.0	
		Z	4.80	67.44	16.68		150.0	
10565-AAA	IEEE 802.11g WiFi 2.4 GHz (DSSS-OFDM, 12 Mbps, 99pc duty cycle)	X	5.41	67.77	17.08	0.46	150.0	± 9.6 %
		Y	5.08	67.53	16.83		150.0	
		Z	5.00	67.82	16.97		150.0	
10566-AAA	IEEE 802.11g WiFi 2.4 GHz (DSSS-OFDM, 18 Mbps, 99pc duty cycle)	X	5.23	67.67	16.93	0.46	150.0	± 9.6 %
		Y	4.92	67.38	16.66		150.0	
		Z	4.84	67.67	16.80		150.0	
10567-AAA	IEEE 802.11g WiFi 2.4 GHz (DSSS-OFDM, 24 Mbps, 99pc duty cycle)	X	5.26	68.03	17.24	0.46	150.0	± 9.6 %
		Y	4.95	67.77	17.01		150.0	
		Z	4.87	68.04	17.15		150.0	
10568-AAA	IEEE 802.11g WiFi 2.4 GHz (DSSS-OFDM, 36 Mbps, 99pc duty cycle)	X	5.14	67.36	16.67	0.46	150.0	± 9.6 %
		Y	4.84	67.19	16.45		150.0	
		Z	4.75	67.49	16.60		150.0	
10569-AAA	IEEE 802.11g WiFi 2.4 GHz (DSSS-OFDM, 48 Mbps, 99pc duty cycle)	X	5.19	68.02	17.24	0.46	150.0	± 9.6 %
		Y	4.92	67.92	17.11		150.0	
		Z	4.86	68.27	17.29		150.0	
10570-AAA	IEEE 802.11g WiFi 2.4 GHz (DSSS-OFDM, 54 Mbps, 99pc duty cycle)	X	5.23	67.81	17.17	0.46	150.0	± 9.6 %
		Y	4.94	67.74	17.02		150.0	
		Z	4.86	68.06	17.18		150.0	
10571-AAA	IEEE 802.11b WiFi 2.4 GHz (DSSS, 1 Mbps, 90pc duty cycle)	X	1.68	70.36	18.73	0.46	130.0	± 9.6 %
		Y	1.37	66.32	16.49		130.0	
		Z	1.41	67.39	17.29		130.0	
10572-AAA	IEEE 802.11b WiFi 2.4 GHz (DSSS, 2 Mbps, 90pc duty cycle)	X	1.75	71.47	19.28	0.46	130.0	± 9.6 %
		Y	1.40	67.01	16.89		130.0	
		Z	1.45	68.17	17.74		130.0	
10573-AAA	IEEE 802.11b WiFi 2.4 GHz (DSSS, 5.5 Mbps, 90pc duty cycle)	X	100.00	142.31	37.38	0.46	130.0	± 9.6 %
		Y	5.69	99.12	27.30		130.0	
		Z	66.26	143.73	39.41		130.0	
10574-AAA	IEEE 802.11b WiFi 2.4 GHz (DSSS, 11 Mbps, 90pc duty cycle)	X	3.57	87.71	25.60	0.46	130.0	± 9.6 %
		Y	1.70	74.22	20.29		130.0	
		Z	1.88	76.94	21.86		130.0	

10575-AAA	IEEE 802.11g WiFi 2.4 GHz (DSSS-OFDM, 6 Mbps, 90pc duty cycle)	X	4.95	67.19	16.89	0.46	130.0	± 9.6 %
		Y	4.69	67.03	16.64		130.0	
		Z	4.63	67.35	16.80		130.0	
10576-AAA	IEEE 802.11g WiFi 2.4 GHz (DSSS-OFDM, 9 Mbps, 90pc duty cycle)	X	4.98	67.35	16.96	0.46	130.0	± 9.6 %
		Y	4.72	67.20	16.72		130.0	
		Z	4.66	67.55	16.88		130.0	
10577-AAA	IEEE 802.11g WiFi 2.4 GHz (DSSS-OFDM, 12 Mbps, 90pc duty cycle)	X	5.24	67.69	17.13	0.46	130.0	± 9.6 %
		Y	4.90	67.46	16.87		130.0	
		Z	4.82	67.76	17.01		130.0	
10578-AAA	IEEE 802.11g WiFi 2.4 GHz (DSSS-OFDM, 18 Mbps, 90pc duty cycle)	X	5.14	67.89	17.23	0.46	130.0	± 9.6 %
		Y	4.81	67.63	16.98		130.0	
		Z	4.73	67.92	17.12		130.0	
10579-AAA	IEEE 802.11g WiFi 2.4 GHz (DSSS-OFDM, 24 Mbps, 90pc duty cycle)	X	4.94	67.39	16.68	0.46	130.0	± 9.6 %
		Y	4.58	66.91	16.29		130.0	
		Z	4.50	67.21	16.45		130.0	
10580-AAA	IEEE 802.11g WiFi 2.4 GHz (DSSS-OFDM, 36 Mbps, 90pc duty cycle)	X	4.98	67.29	16.65	0.46	130.0	± 9.6 %
		Y	4.62	66.97	16.32		130.0	
		Z	4.54	67.27	16.48		130.0	
10581-AAA	IEEE 802.11g WiFi 2.4 GHz (DSSS-OFDM, 48 Mbps, 90pc duty cycle)	X	5.07	68.07	17.23	0.46	130.0	± 9.6 %
		Y	4.72	67.70	16.95		130.0	
		Z	4.65	68.04	17.12		130.0	
10582-AAA	IEEE 802.11g WiFi 2.4 GHz (DSSS-OFDM, 54 Mbps, 90pc duty cycle)	X	4.90	67.13	16.49	0.46	130.0	± 9.6 %
		Y	4.51	66.68	16.07		130.0	
		Z	4.43	67.00	16.24		130.0	
10583-AAA	IEEE 802.11a/h WiFi 5 GHz (OFDM, 6 Mbps, 90pc duty cycle)	X	4.95	67.19	16.89	0.46	130.0	± 9.6 %
		Y	4.69	67.03	16.64		130.0	
		Z	4.63	67.35	16.80		130.0	
10584-AAA	IEEE 802.11a/h WiFi 5 GHz (OFDM, 9 Mbps, 90pc duty cycle)	X	4.98	67.35	16.96	0.46	130.0	± 9.6 %
		Y	4.72	67.20	16.72		130.0	
		Z	4.66	67.55	16.88		130.0	
10585-AAA	IEEE 802.11a/h WiFi 5 GHz (OFDM, 12 Mbps, 90pc duty cycle)	X	5.24	67.69	17.13	0.46	130.0	± 9.6 %
		Y	4.90	67.46	16.87		130.0	
		Z	4.82	67.76	17.01		130.0	
10586-AAA	IEEE 802.11a/h WiFi 5 GHz (OFDM, 18 Mbps, 90pc duty cycle)	X	5.14	67.89	17.23	0.46	130.0	± 9.6 %
		Y	4.81	67.63	16.98		130.0	
		Z	4.73	67.92	17.12		130.0	
10587-AAA	IEEE 802.11a/h WiFi 5 GHz (OFDM, 24 Mbps, 90pc duty cycle)	X	4.94	67.39	16.68	0.46	130.0	± 9.6 %
		Y	4.58	66.91	16.29		130.0	
		Z	4.50	67.21	16.45		130.0	
10588-AAA	IEEE 802.11a/h WiFi 5 GHz (OFDM, 36 Mbps, 90pc duty cycle)	X	4.98	67.29	16.65	0.46	130.0	± 9.6 %
		Y	4.62	66.97	16.32		130.0	
		Z	4.54	67.27	16.48		130.0	
10589-AAA	IEEE 802.11a/h WiFi 5 GHz (OFDM, 48 Mbps, 90pc duty cycle)	X	5.07	68.07	17.23	0.46	130.0	± 9.6 %
		Y	4.72	67.70	16.95		130.0	
		Z	4.65	68.04	17.12		130.0	
10590-AAA	IEEE 802.11a/h WiFi 5 GHz (OFDM, 54 Mbps, 90pc duty cycle)	X	4.90	67.13	16.49	0.46	130.0	± 9.6 %
		Y	4.51	66.68	16.07		130.0	
		Z	4.43	67.00	16.24		130.0	

10591-AAA	IEEE 802.11n (HT Mixed, 20MHz, MCS0, 90pc duty cycle)	X	5.10	67.21	16.96	0.46	130.0	± 9.6 %
		Y	4.84	67.07	16.74		130.0	
		Z	4.77	67.39	16.89		130.0	
10592-AAA	IEEE 802.11n (HT Mixed, 20MHz, MCS1, 90pc duty cycle)	X	5.29	67.56	17.07	0.46	130.0	± 9.6 %
		Y	4.98	67.40	16.87		130.0	
		Z	4.90	67.69	17.01		130.0	
10593-AAA	IEEE 802.11n (HT Mixed, 20MHz, MCS2, 90pc duty cycle)	X	5.23	67.57	17.01	0.46	130.0	± 9.6 %
		Y	4.90	67.30	16.75		130.0	
		Z	4.82	67.59	16.88		130.0	
10594-AAA	IEEE 802.11n (HT Mixed, 20MHz, MCS3, 90pc duty cycle)	X	5.28	67.68	17.13	0.46	130.0	± 9.6 %
		Y	4.96	67.47	16.91		130.0	
		Z	4.88	67.75	17.04		130.0	
10595-AAA	IEEE 802.11n (HT Mixed, 20MHz, MCS4, 90pc duty cycle)	X	5.27	67.71	17.06	0.46	130.0	± 9.6 %
		Y	4.93	67.44	16.81		130.0	
		Z	4.85	67.75	16.96		130.0	
10596-AAA	IEEE 802.11n (HT Mixed, 20MHz, MCS5, 90pc duty cycle)	X	5.21	67.70	17.06	0.46	130.0	± 9.6 %
		Y	4.86	67.44	16.81		130.0	
		Z	4.78	67.74	16.97		130.0	
10597-AAA	IEEE 802.11n (HT Mixed, 20MHz, MCS6, 90pc duty cycle)	X	5.16	67.68	17.00	0.46	130.0	± 9.6 %
		Y	4.81	67.32	16.68		130.0	
		Z	4.73	67.61	16.83		130.0	
10598-AAA	IEEE 802.11n (HT Mixed, 20MHz, MCS7, 90pc duty cycle)	X	5.15	67.96	17.27	0.46	130.0	± 9.6 %
		Y	4.80	67.55	16.95		130.0	
		Z	4.72	67.82	17.08		130.0	
10599-AAA	IEEE 802.11n (HT Mixed, 40MHz, MCS0, 90pc duty cycle)	X	5.77	67.84	17.13	0.46	130.0	± 9.6 %
		Y	5.52	67.58	16.96		130.0	
		Z	5.45	67.81	17.10		130.0	
10600-AAA	IEEE 802.11n (HT Mixed, 40MHz, MCS1, 90pc duty cycle)	X	6.05	68.67	17.52	0.46	130.0	± 9.6 %
		Y	5.68	68.13	17.21		130.0	
		Z	5.58	68.26	17.30		130.0	
10601-AAA	IEEE 802.11n (HT Mixed, 40MHz, MCS2, 90pc duty cycle)	X	5.85	68.16	17.28	0.46	130.0	± 9.6 %
		Y	5.55	67.80	17.06		130.0	
		Z	5.46	67.98	17.17		130.0	
10602-AAA	IEEE 802.11n (HT Mixed, 40MHz, MCS3, 90pc duty cycle)	X	5.99	68.30	17.27	0.46	130.0	± 9.6 %
		Y	5.68	67.95	17.06		130.0	
		Z	5.60	68.17	17.19		130.0	
10603-AAA	IEEE 802.11n (HT Mixed, 40MHz, MCS4, 90pc duty cycle)	X	6.09	68.64	17.55	0.46	130.0	± 9.6 %
		Y	5.74	68.19	17.31		130.0	
		Z	5.66	68.42	17.44		130.0	
10604-AAA	IEEE 802.11n (HT Mixed, 40MHz, MCS5, 90pc duty cycle)	X	5.79	67.86	17.16	0.46	130.0	± 9.6 %
		Y	5.59	67.76	17.08		130.0	
		Z	5.54	68.06	17.25		130.0	
10605-AAA	IEEE 802.11n (HT Mixed, 40MHz, MCS6, 90pc duty cycle)	X	5.90	68.15	17.31	0.46	130.0	± 9.6 %
		Y	5.67	68.01	17.21		130.0	
		Z	5.56	68.12	17.28		130.0	
10606-AAA	IEEE 802.11n (HT Mixed, 40MHz, MCS7, 90pc duty cycle)	X	5.65	67.59	16.91	0.46	130.0	± 9.6 %
		Y	5.37	67.19	16.65		130.0	
		Z	5.33	67.51	16.83		130.0	

10607-AAA	IEEE 802.11ac WiFi (20MHz, MCS0, 90pc duty cycle)	X	4.92	66.49	16.57	0.46	130.0	± 9.6 %
		Y	4.68	66.39	16.37		130.0	
		Z	4.62	66.76	16.54		130.0	
10608-AAA	IEEE 802.11ac WiFi (20MHz, MCS1, 90pc duty cycle)	X	5.16	66.93	16.72	0.46	130.0	± 9.6 %
		Y	4.85	66.77	16.53		130.0	
		Z	4.77	67.10	16.69		130.0	
10609-AAA	IEEE 802.11ac WiFi (20MHz, MCS2, 90pc duty cycle)	X	5.06	66.87	16.62	0.46	130.0	± 9.6 %
		Y	4.74	66.62	16.36		130.0	
		Z	4.67	66.96	16.53		130.0	
10610-AAA	IEEE 802.11ac WiFi (20MHz, MCS3, 90pc duty cycle)	X	5.11	67.01	16.76	0.46	130.0	± 9.6 %
		Y	4.79	66.78	16.53		130.0	
		Z	4.72	67.11	16.69		130.0	
10611-AAA	IEEE 802.11ac WiFi (20MHz, MCS4, 90pc duty cycle)	X	5.05	66.92	16.66	0.46	130.0	± 9.6 %
		Y	4.71	66.59	16.38		130.0	
		Z	4.64	66.93	16.55		130.0	
10612-AAA	IEEE 802.11ac WiFi (20MHz, MCS5, 90pc duty cycle)	X	5.07	67.04	16.68	0.46	130.0	± 9.6 %
		Y	4.72	66.76	16.43		130.0	
		Z	4.64	67.09	16.61		130.0	
10613-AAA	IEEE 802.11ac WiFi (20MHz, MCS6, 90pc duty cycle)	X	5.09	66.98	16.60	0.46	130.0	± 9.6 %
		Y	4.71	66.61	16.29		130.0	
		Z	4.63	66.91	16.45		130.0	
10614-AAA	IEEE 802.11ac WiFi (20MHz, MCS7, 90pc duty cycle)	X	5.02	67.21	16.84	0.46	130.0	± 9.6 %
		Y	4.67	66.81	16.53		130.0	
		Z	4.59	67.11	16.69		130.0	
10615-AAA	IEEE 802.11ac WiFi (20MHz, MCS8, 90pc duty cycle)	X	5.05	66.70	16.43	0.46	130.0	± 9.6 %
		Y	4.71	66.43	16.16		130.0	
		Z	4.64	66.79	16.34		130.0	
10616-AAA	IEEE 802.11ac WiFi (40MHz, MCS0, 90pc duty cycle)	X	5.58	67.10	16.74	0.46	130.0	± 9.6 %
		Y	5.33	66.79	16.55		130.0	
		Z	5.25	67.00	16.67		130.0	
10617-AAA	IEEE 802.11ac WiFi (40MHz, MCS1, 90pc duty cycle)	X	5.66	67.25	16.77	0.46	130.0	± 9.6 %
		Y	5.41	67.04	16.65		130.0	
		Z	5.31	67.19	16.74		130.0	
10618-AAA	IEEE 802.11ac WiFi (40MHz, MCS2, 90pc duty cycle)	X	5.54	67.29	16.82	0.46	130.0	± 9.6 %
		Y	5.29	67.03	16.66		130.0	
		Z	5.22	67.24	16.78		130.0	
10619-AAA	IEEE 802.11ac WiFi (40MHz, MCS3, 90pc duty cycle)	X	5.56	67.09	16.66	0.46	130.0	± 9.6 %
		Y	5.30	66.81	16.48		130.0	
		Z	5.23	67.05	16.63		130.0	
10620-AAA	IEEE 802.11ac WiFi (40MHz, MCS4, 90pc duty cycle)	X	5.71	67.30	16.81	0.46	130.0	± 9.6 %
		Y	5.38	66.84	16.54		130.0	
		Z	5.30	67.04	16.67		130.0	
10621-AAA	IEEE 802.11ac WiFi (40MHz, MCS5, 90pc duty cycle)	X	5.66	67.28	16.90	0.46	130.0	± 9.6 %
		Y	5.39	66.98	16.73		130.0	
		Z	5.30	67.12	16.82		130.0	
10622-AAA	IEEE 802.11ac WiFi (40MHz, MCS6, 90pc duty cycle)	X	5.65	67.37	16.94	0.46	130.0	± 9.6 %
		Y	5.40	67.13	16.80		130.0	
		Z	5.30	67.22	16.87		130.0	

10623-AAA	IEEE 802.11ac WiFi (40MHz, MCS7, 90pc duty cycle)	X	5.58	67.14	16.73	0.46	130.0	± 9.6 %
		Y	5.28	66.65	16.43		130.0	
		Z	5.18	66.78	16.52		130.0	
10624-AAA	IEEE 802.11ac WiFi (40MHz, MCS8, 90pc duty cycle)	X	5.72	67.10	16.77	0.46	130.0	± 9.6 %
		Y	5.47	66.85	16.60		130.0	
		Z	5.38	67.03	16.70		130.0	
10625-AAA	IEEE 802.11ac WiFi (40MHz, MCS9, 90pc duty cycle)	X	6.05	67.87	17.19	0.46	130.0	± 9.6 %
		Y	5.77	67.66	17.06		130.0	
		Z	5.49	67.24	16.87		130.0	
10626-AAA	IEEE 802.11ac WiFi (80MHz, MCS0, 90pc duty cycle)	X	5.80	67.08	16.64	0.46	130.0	± 9.6 %
		Y	5.63	66.82	16.50		130.0	
		Z	5.57	66.99	16.60		130.0	
10627-AAA	IEEE 802.11ac WiFi (80MHz, MCS1, 90pc duty cycle)	X	6.05	67.56	16.82	0.46	130.0	± 9.6 %
		Y	5.90	67.51	16.81		130.0	
		Z	5.83	67.67	16.91		130.0	
10628-AAA	IEEE 802.11ac WiFi (80MHz, MCS2, 90pc duty cycle)	X	5.89	67.33	16.66	0.46	130.0	± 9.6 %
		Y	5.66	66.90	16.43		130.0	
		Z	5.58	67.01	16.51		130.0	
10629-AAA	IEEE 802.11ac WiFi (80MHz, MCS3, 90pc duty cycle)	X	6.01	67.46	16.71	0.46	130.0	± 9.6 %
		Y	5.74	67.00	16.48		130.0	
		Z	5.68	67.19	16.60		130.0	
10630-AAA	IEEE 802.11ac WiFi (80MHz, MCS4, 90pc duty cycle)	X	6.66	69.52	17.74	0.46	130.0	± 9.6 %
		Y	6.23	68.64	17.29		130.0	
		Z	5.99	68.32	17.17		130.0	
10631-AAA	IEEE 802.11ac WiFi (80MHz, MCS5, 90pc duty cycle)	X	6.51	69.16	17.72	0.46	130.0	± 9.6 %
		Y	6.05	68.21	17.27		130.0	
		Z	5.91	68.16	17.27		130.0	
10632-AAA	IEEE 802.11ac WiFi (80MHz, MCS6, 90pc duty cycle)	X	6.07	67.76	17.04	0.46	130.0	± 9.6 %
		Y	5.87	67.57	16.97		130.0	
		Z	5.81	67.79	17.10		130.0	
10633-AAA	IEEE 802.11ac WiFi (80MHz, MCS7, 90pc duty cycle)	X	6.04	67.71	16.86	0.46	130.0	± 9.6 %
		Y	5.71	67.04	16.54		130.0	
		Z	5.62	67.14	16.61		130.0	
10634-AAA	IEEE 802.11ac WiFi (80MHz, MCS8, 90pc duty cycle)	X	6.01	67.64	16.89	0.46	130.0	± 9.6 %
		Y	5.69	67.06	16.60		130.0	
		Z	5.63	67.23	16.71		130.0	
10635-AAA	IEEE 802.11ac WiFi (80MHz, MCS9, 90pc duty cycle)	X	5.88	66.99	16.33	0.46	130.0	± 9.6 %
		Y	5.57	66.39	16.00		130.0	
		Z	5.49	66.55	16.11		130.0	
10636-AAB	IEEE 802.11ac WiFi (160MHz, MCS0, 90pc duty cycle)	X	6.20	67.47	16.73	0.46	130.0	± 9.6 %
		Y	6.06	67.19	16.58		130.0	
		Z	6.01	67.33	16.67		130.0	
10637-AAB	IEEE 802.11ac WiFi (160MHz, MCS1, 90pc duty cycle)	X	6.43	68.00	16.96	0.46	130.0	± 9.6 %
		Y	6.23	67.63	16.79		130.0	
		Z	6.14	67.69	16.84		130.0	
10638-AAB	IEEE 802.11ac WiFi (160MHz, MCS2, 90pc duty cycle)	X	6.38	67.82	16.85	0.46	130.0	± 9.6 %
		Y	6.23	67.59	16.75		130.0	
		Z	6.16	67.71	16.83		130.0	

10639-AAB	IEEE 802.11ac WiFi (160MHz, MCS3, 90pc duty cycle)	X	6.40	67.91	16.95	0.46	130.0	± 9.6 %
		Y	6.18	67.47	16.73		130.0	
		Z	6.11	67.58	16.80		130.0	
10640-AAB	IEEE 802.11ac WiFi (160MHz, MCS4, 90pc duty cycle)	X	6.45	68.06	16.97	0.46	130.0	± 9.6 %
		Y	6.19	67.49	16.68		130.0	
		Z	6.09	67.54	16.73		130.0	
10641-AAB	IEEE 802.11ac WiFi (160MHz, MCS5, 90pc duty cycle)	X	6.42	67.72	16.82	0.46	130.0	± 9.6 %
		Y	6.26	67.48	16.70		130.0	
		Z	6.18	67.60	16.78		130.0	
10642-AAB	IEEE 802.11ac WiFi (160MHz, MCS6, 90pc duty cycle)	X	6.51	68.09	17.16	0.46	130.0	± 9.6 %
		Y	6.27	67.64	16.94		130.0	
		Z	6.19	67.74	17.01		130.0	
10643-AAB	IEEE 802.11ac WiFi (160MHz, MCS7, 90pc duty cycle)	X	6.33	67.78	16.92	0.46	130.0	± 9.6 %
		Y	6.13	67.39	16.71		130.0	
		Z	6.05	67.49	16.79		130.0	
10644-AAB	IEEE 802.11ac WiFi (160MHz, MCS8, 90pc duty cycle)	X	6.62	68.66	17.38	0.46	130.0	± 9.6 %
		Y	6.24	67.74	16.91		130.0	
		Z	6.11	67.69	16.91		130.0	
10645-AAB	IEEE 802.11ac WiFi (160MHz, MCS9, 90pc duty cycle)	X	6.82	68.76	17.37	0.46	130.0	± 9.6 %
		Y	6.42	67.94	16.97		130.0	
		Z	6.29	67.89	16.97		130.0	
10646-AAD	LTE-TDD (SC-FDMA, 1 RB, 5 MHz, QPSK, UL Subframe=2,7)	X	22.37	99.45	32.18	9.30	60.0	± 9.6 %
		Y	34.93	118.52	39.50		60.0	
		Z	65.31	137.01	45.15		60.0	
10647-AAC	LTE-TDD (SC-FDMA, 1 RB, 20 MHz, QPSK, UL Subframe=2,7)	X	23.87	101.54	32.95	9.30	60.0	± 9.6 %
		Y	35.03	119.53	39.96		60.0	
		Z	61.92	136.93	45.35		60.0	
10648-AAA	CDMA2000 (1x Advanced)	X	1.11	70.04	15.37	0.00	150.0	± 9.6 %
		Y	0.68	63.85	10.64		150.0	
		Z	0.72	65.39	11.21		150.0	
10652-AAB	LTE-TDD (OFDMA, 5 MHz, E-TM 3.1, Clipping 44%)	X	5.43	70.91	18.53	2.23	80.0	± 9.6 %
		Y	4.44	69.41	17.59		80.0	
		Z	4.46	70.35	17.94		80.0	
10653-AAB	LTE-TDD (OFDMA, 10 MHz, E-TM 3.1, Clipping 44%)	X	5.75	69.79	18.37	2.23	80.0	± 9.6 %
		Y	4.85	68.29	17.59		80.0	
		Z	4.80	68.81	17.83		80.0	
10654-AAB	LTE-TDD (OFDMA, 15 MHz, E-TM 3.1, Clipping 44%)	X	5.63	69.47	18.36	2.23	80.0	± 9.6 %
		Y	4.81	67.88	17.59		80.0	
		Z	4.76	68.31	17.81		80.0	
10655-AAB	LTE-TDD (OFDMA, 20 MHz, E-TM 3.1, Clipping 44%)	X	5.69	69.55	18.41	2.23	80.0	± 9.6 %
		Y	4.87	67.81	17.62		80.0	
		Z	4.82	68.18	17.82		80.0	

^F Uncertainty is determined using the max. deviation from linear response applying rectangular distribution and is expressed for the square of the field value.



Accredited by the Swiss Accreditation Service (SAS)
The Swiss Accreditation Service is one of the signatories to the EA
Multilateral Agreement for the recognition of calibration certificates

Accreditation No.: **SCS 0108**

Client **PC Test**

Certificate No: **ES3-3347_Mar18**

CALIBRATION CERTIFICATE

Object **ES3DV3 - SN:3347**

Calibration procedure(s) **QA CAL-01.v9, QA CAL-23.v5, QA CAL-25.v6
Calibration procedure for dosimetric E-field probes**

*BM
04-05-2018*

Calibration date: **March 27, 2018**

This calibration certificate documents the traceability to national standards, which realize the physical units of measurements (SI).
The measurements and the uncertainties with confidence probability are given on the following pages and are part of the certificate.

All calibrations have been conducted in the closed laboratory facility: environment temperature (22 ± 3)°C and humidity < 70%.

Calibration Equipment used (M&TE critical for calibration)

Primary Standards	ID	Cal Date (Certificate No.)	Scheduled Calibration
Power meter NRP	SN: 104778	04-Apr-17 (No. 217-02521/02522)	Apr-18
Power sensor NRP-Z91	SN: 103244	04-Apr-17 (No. 217-02521)	Apr-18
Power sensor NRP-Z91	SN: 103245	04-Apr-17 (No. 217-02525)	Apr-18
Reference 20 dB Attenuator	SN: S5277 (20x)	07-Apr-17 (No. 217-02528)	Apr-18
Reference Probe ES3DV2	SN: 3013	30-Dec-17 (No. ES3-3013_Dec17)	Dec-18
DAE4	SN: 660	21-Dec-17 (No. DAE4-660_Dec17)	Dec-18
Secondary Standards	ID	Check Date (in house)	Scheduled Check
Power meter E4419B	SN: GB41293874	06-Apr-16 (in house check Jun-16)	In house check: Jun-18
Power sensor E4412A	SN: MY41498087	06-Apr-16 (in house check Jun-16)	In house check: Jun-18
Power sensor E4412A	SN: 000110210	06-Apr-16 (in house check Jun-16)	In house check: Jun-18
RF generator HP 8648C	SN: US3642U01700	04-Aug-99 (in house check Jun-16)	In house check: Jun-18
Network Analyzer HP 8753E	SN: US37390585	18-Oct-01 (in house check Oct-17)	In house check: Oct-18

Calibrated by:	Name Michael Weber	Function Laboratory Technician	Signature
Approved by:	Name Katja Pokovic	Technical Manager	

Issued: March 27, 2018

This calibration certificate shall not be reproduced except in full without written approval of the laboratory.



Accredited by the Swiss Accreditation Service (SAS)

Accreditation No.: **SCS 0108**

The Swiss Accreditation Service is one of the signatories to the EA Multilateral Agreement for the recognition of calibration certificates

Glossary:

TSL	tissue simulating liquid
NORM _{x,y,z}	sensitivity in free space
ConvF	sensitivity in TSL / NORM _{x,y,z}
DCP	diode compression point
CF	crest factor (1/duty_cycle) of the RF signal
A, B, C, D	modulation dependent linearization parameters
Polarization φ	φ rotation around probe axis
Polarization ϑ	ϑ rotation around an axis that is in the plane normal to probe axis (at measurement center), i.e., $\vartheta = 0$ is normal to probe axis
Connector Angle	information used in DASY system to align probe sensor X to the robot coordinate system

Calibration is Performed According to the Following Standards:

- a) IEEE Std 1528-2013, "IEEE Recommended Practice for Determining the Peak Spatial-Averaged Specific Absorption Rate (SAR) in the Human Head from Wireless Communications Devices: Measurement Techniques", June 2013
- b) IEC 62209-1, "Measurement procedure for the assessment of Specific Absorption Rate (SAR) from hand-held and body-mounted devices used next to the ear (frequency range of 300 MHz to 6 GHz)", July 2016
- c) IEC 62209-2, "Procedure to determine the Specific Absorption Rate (SAR) for wireless communication devices used in close proximity to the human body (frequency range of 30 MHz to 6 GHz)", March 2010
- d) KDB 865664, "SAR Measurement Requirements for 100 MHz to 6 GHz"

Methods Applied and Interpretation of Parameters:

- **NORM_{x,y,z}:** Assessed for E-field polarization $\vartheta = 0$ ($f \leq 900$ MHz in TEM-cell; $f > 1800$ MHz: R22 waveguide). NORM_{x,y,z} are only intermediate values, i.e., the uncertainties of NORM_{x,y,z} does not affect the E²-field uncertainty inside TSL (see below ConvF).
- **NORM(f)_{x,y,z} = NORM_{x,y,z} * frequency_response** (see Frequency Response Chart). This linearization is implemented in DASY4 software versions later than 4.2. The uncertainty of the frequency response is included in the stated uncertainty of ConvF.
- **DCP_{x,y,z}:** DCP are numerical linearization parameters assessed based on the data of power sweep with CW signal (no uncertainty required). DCP does not depend on frequency nor media.
- **PAR:** PAR is the Peak to Average Ratio that is not calibrated but determined based on the signal characteristics
- **A_{x,y,z}; B_{x,y,z}; C_{x,y,z}; D_{x,y,z}; VR_{x,y,z}:** A, B, C, D are numerical linearization parameters assessed based on the data of power sweep for specific modulation signal. The parameters do not depend on frequency nor media. VR is the maximum calibration range expressed in RMS voltage across the diode.
- **ConvF and Boundary Effect Parameters:** Assessed in flat phantom using E-field (or Temperature Transfer Standard for $f \leq 800$ MHz) and inside waveguide using analytical field distributions based on power measurements for $f > 800$ MHz. The same setups are used for assessment of the parameters applied for boundary compensation (alpha, depth) of which typical uncertainty values are given. These parameters are used in DASY4 software to improve probe accuracy close to the boundary. The sensitivity in TSL corresponds to NORM_{x,y,z} * ConvF whereby the uncertainty corresponds to that given for ConvF. A frequency dependent ConvF is used in DASY version 4.4 and higher which allows extending the validity from ± 50 MHz to ± 100 MHz.
- **Spherical isotropy (3D deviation from isotropy):** in a field of low gradients realized using a flat phantom exposed by a patch antenna.
- **Sensor Offset:** The sensor offset corresponds to the offset of virtual measurement center from the probe tip (on probe axis). No tolerance required.
- **Connector Angle:** The angle is assessed using the information gained by determining the NORM_x (no uncertainty required).

Probe ES3DV3

SN:3347

Manufactured:	March 15, 2012
Repaired:	March 15, 2018
Calibrated:	March 27, 2018

Calibrated for DASY/EASY Systems
(Note: non-compatible with DASY2 system!)

DASY/EASY - Parameters of Probe: ES3DV3 - SN:3347

Basic Calibration Parameters

	Sensor X	Sensor Y	Sensor Z	Unc (k=2)
Norm ($\mu\text{V}/(\text{V}/\text{m})^2$) ^A	1.15	1.18	1.21	± 10.1 %
DCP (mV) ^B	101.9	105.1	102.9	

Modulation Calibration Parameters

UID	Communication System Name		A dB	B dB/ μV	C	D dB	VR mV	Unc ^E (k=2)
0	CW	X	0.0	0.0	1.0	0.00	201.8	±3.3 %
		Y	0.0	0.0	1.0		203.9	
		Z	0.0	0.0	1.0		204.8	

Note: For details on UID parameters see Appendix.

Sensor Model Parameters

	C1 fF	C2 fF	α V^{-1}	T1 $\text{ms}\cdot\text{V}^{-2}$	T2 $\text{ms}\cdot\text{V}^{-1}$	T3 ms	T4 V^{-2}	T5 V^{-1}	T6
X	52.41	376.6	35.43	28.01	1.852	5.10	0.578	0.488	1.008
Y	42.65	300.9	34.31	25.12	1.310	5.10	1.279	0.204	1.011
Z	48.12	344.8	35.26	27.10	1.587	5.10	0.868	0.385	1.009

The reported uncertainty of measurement is stated as the standard uncertainty of measurement multiplied by the coverage factor k=2, which for a normal distribution corresponds to a coverage probability of approximately 95%.

^A The uncertainties of Norm X,Y,Z do not affect the E²-field uncertainty inside TSL (see Pages 5 and 6).

^B Numerical linearization parameter: uncertainty not required.

^E Uncertainty is determined using the max. deviation from linear response applying rectangular distribution and is expressed for the square of the field value.

DASY/EASY - Parameters of Probe: ES3DV3 - SN:3347

Calibration Parameter Determined in Head Tissue Simulating Media

f (MHz) ^C	Relative Permittivity ^F	Conductivity (S/m) ^F	ConvF X	ConvF Y	ConvF Z	Alpha ^G	Depth ^G (mm)	Unc (k=2)
750	41.9	0.89	6.77	6.77	6.77	0.65	1.32	± 12.0 %
835	41.5	0.90	6.41	6.41	6.41	0.40	1.64	± 12.0 %
1750	40.1	1.37	5.58	5.58	5.58	0.54	1.42	± 12.0 %
1900	40.0	1.40	5.36	5.36	5.36	0.80	1.16	± 12.0 %
2300	39.5	1.67	5.11	5.11	5.11	0.74	1.29	± 12.0 %
2450	39.2	1.80	4.81	4.81	4.81	0.80	1.24	± 12.0 %
2600	39.0	1.96	4.66	4.66	4.66	0.75	1.25	± 12.0 %

^C Frequency validity above 300 MHz of ± 100 MHz only applies for DASY v4.4 and higher (see Page 2), else it is restricted to ± 50 MHz. The uncertainty is the RSS of the ConvF uncertainty at calibration frequency and the uncertainty for the indicated frequency band. Frequency validity below 300 MHz is ± 10, 25, 40, 50 and 70 MHz for ConvF assessments at 30, 64, 128, 150 and 220 MHz respectively. Above 5 GHz frequency validity can be extended to ± 110 MHz.

^F At frequencies below 3 GHz, the validity of tissue parameters (ϵ and σ) can be relaxed to ± 10% if liquid compensation formula is applied to measured SAR values. At frequencies above 3 GHz, the validity of tissue parameters (ϵ and σ) is restricted to ± 5%. The uncertainty is the RSS of the ConvF uncertainty for indicated target tissue parameters.

^G Alpha/Depth are determined during calibration. SPEAG warrants that the remaining deviation due to the boundary effect after compensation is always less than ± 1% for frequencies below 3 GHz and below ± 2% for frequencies between 3-6 GHz at any distance larger than half the probe tip diameter from the boundary.

DASY/EASY - Parameters of Probe: ES3DV3 - SN:3347

Calibration Parameter Determined in Body Tissue Simulating Media

f (MHz) ^C	Relative Permittivity ^F	Conductivity (S/m) ^F	ConvF X	ConvF Y	ConvF Z	Alpha ^G	Depth ^G (mm)	Unc (k=2)
750	55.5	0.96	6.59	6.59	6.59	0.77	1.22	± 12.0 %
835	55.2	0.97	6.37	6.37	6.37	0.80	1.17	± 12.0 %
1750	53.4	1.49	5.17	5.17	5.17	0.49	1.59	± 12.0 %
1900	53.3	1.52	4.94	4.94	4.94	0.52	1.49	± 12.0 %
2300	52.9	1.81	4.74	4.74	4.74	0.80	1.25	± 12.0 %
2450	52.7	1.95	4.64	4.64	4.64	0.75	1.20	± 12.0 %
2600	52.5	2.16	4.49	4.49	4.49	0.80	1.20	± 12.0 %

^C Frequency validity above 300 MHz of ± 100 MHz only applies for DASY v4.4 and higher (see Page 2), else it is restricted to ± 50 MHz. The uncertainty is the RSS of the ConvF uncertainty at calibration frequency and the uncertainty for the indicated frequency band. Frequency validity below 300 MHz is ± 10, 25, 40, 50 and 70 MHz for ConvF assessments at 30, 64, 128, 150 and 220 MHz respectively. Above 5 GHz frequency validity can be extended to ± 110 MHz.

^F At frequencies below 3 GHz, the validity of tissue parameters (ϵ and σ) can be relaxed to ± 10% if liquid compensation formula is applied to measured SAR values. At frequencies above 3 GHz, the validity of tissue parameters (ϵ and σ) is restricted to ± 5%. The uncertainty is the RSS of the ConvF uncertainty for indicated target tissue parameters.

^G Alpha/Depth are determined during calibration. SPEAG warrants that the remaining deviation due to the boundary effect after compensation is always less than ± 1% for frequencies below 3 GHz and below ± 2% for frequencies between 3-6 GHz at any distance larger than half the probe tip diameter from the boundary.

Frequency Response of E-Field (TEM-Cell:ifi110 EXX, Waveguide: R22)

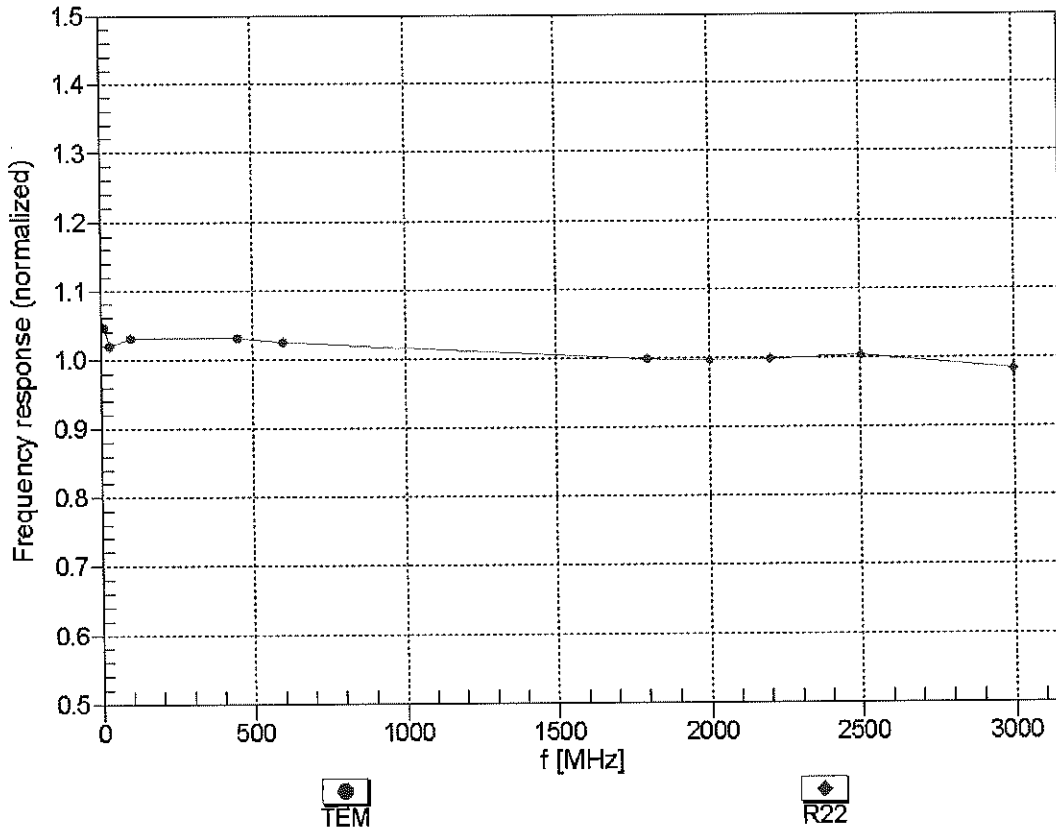

Uncertainty of Frequency Response of E-field: $\pm 6.3\%$ (k=2)

Receiving Pattern (ϕ), $\theta = 0^\circ$

f=600 MHz, TEM

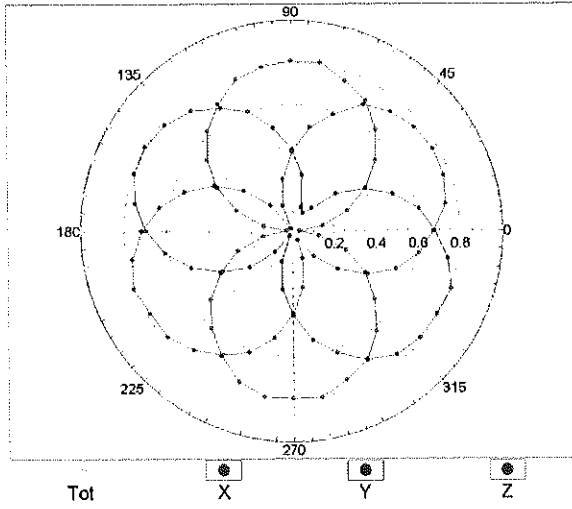

f=1800 MHz, R22

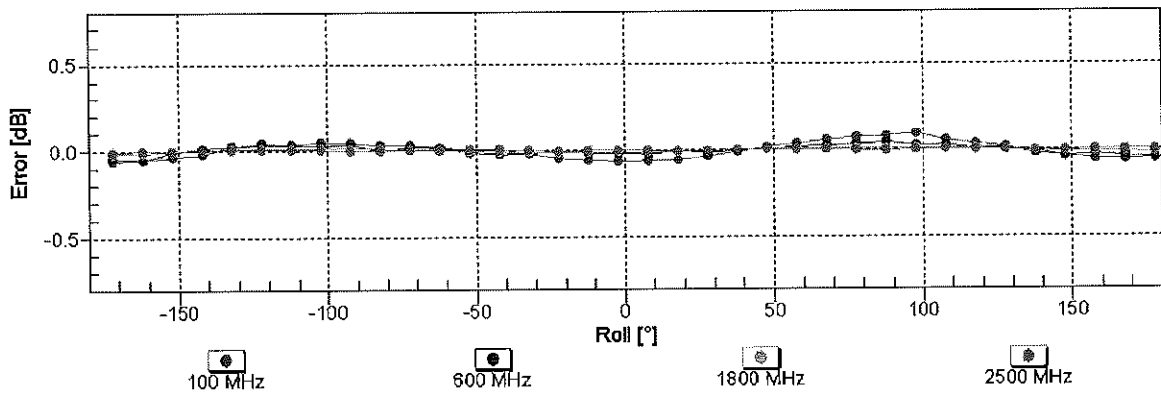
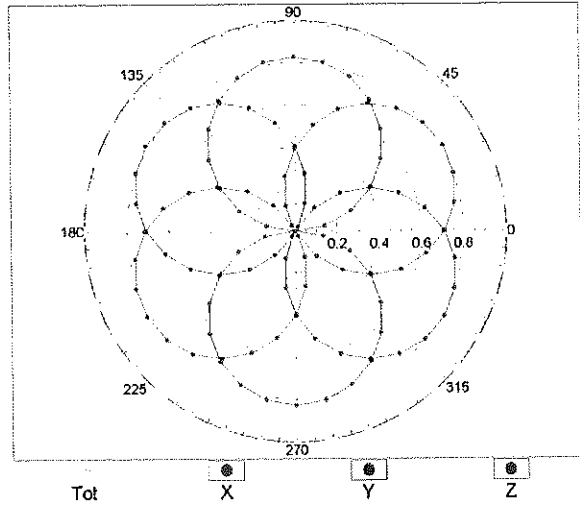

Uncertainty of Axial Isotropy Assessment: $\pm 0.5\%$ (k=2)

Dynamic Range f(SAR_{head}) (TEM cell , f_{eval}= 1900 MHz)

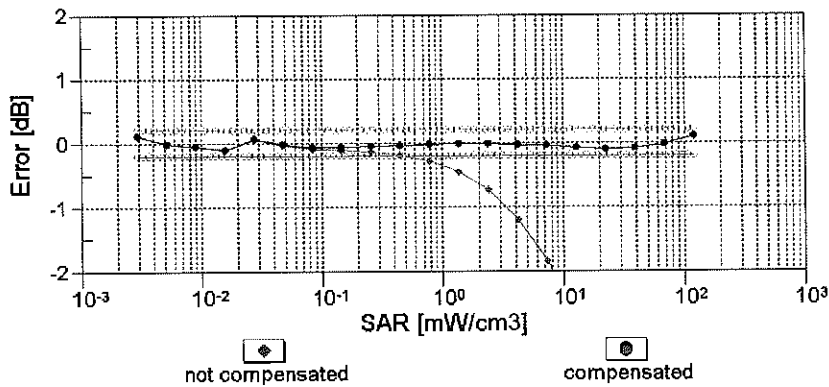
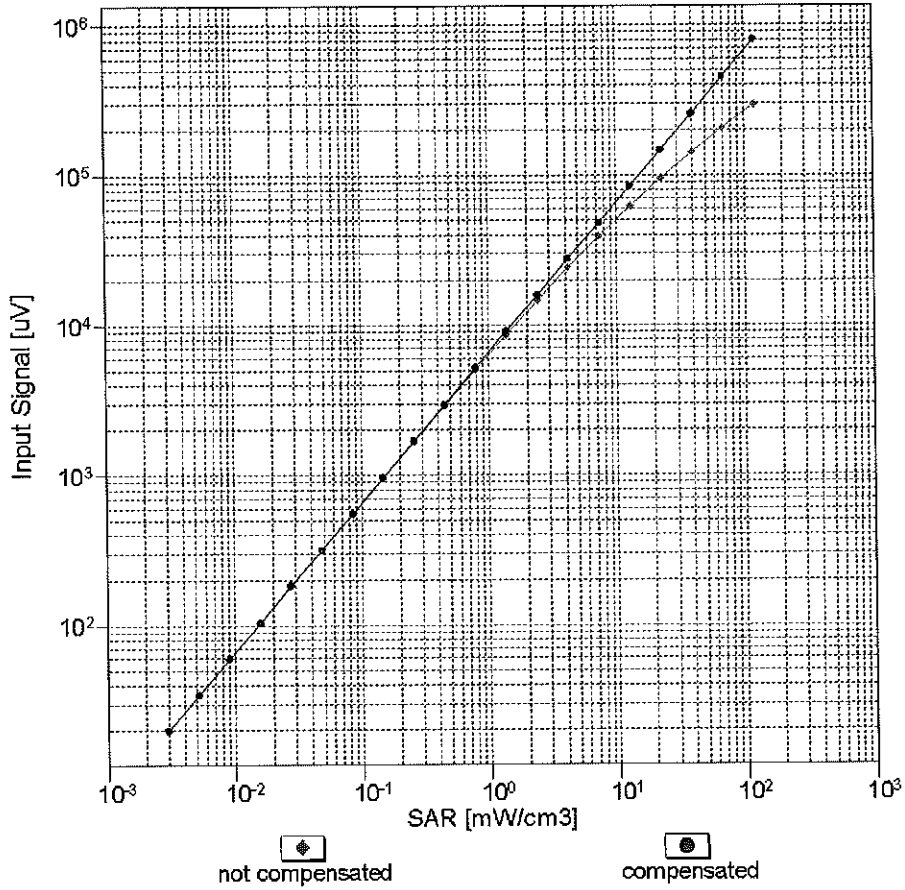

Uncertainty of Linearity Assessment: ± 0.6% (k=2)

Conversion Factor Assessment

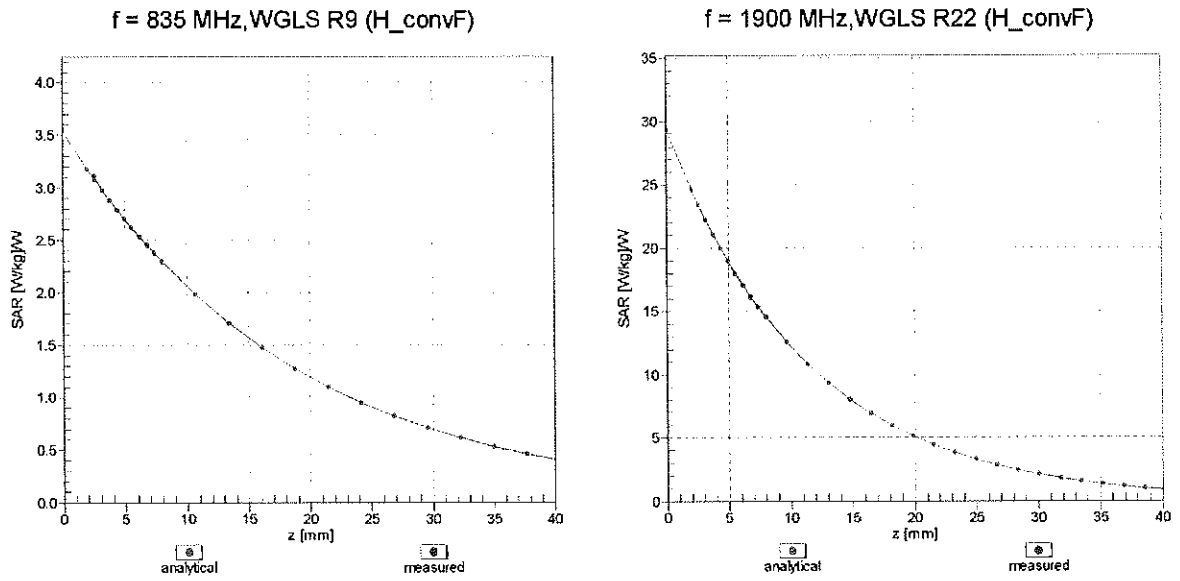

Deviation from Isotropy in Liquid Error (ϕ, θ), f = 900 MHz

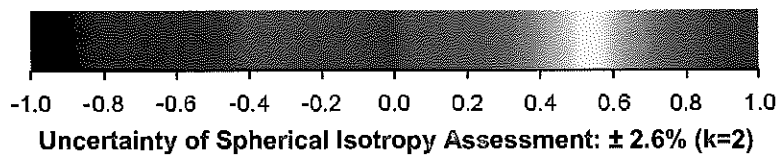
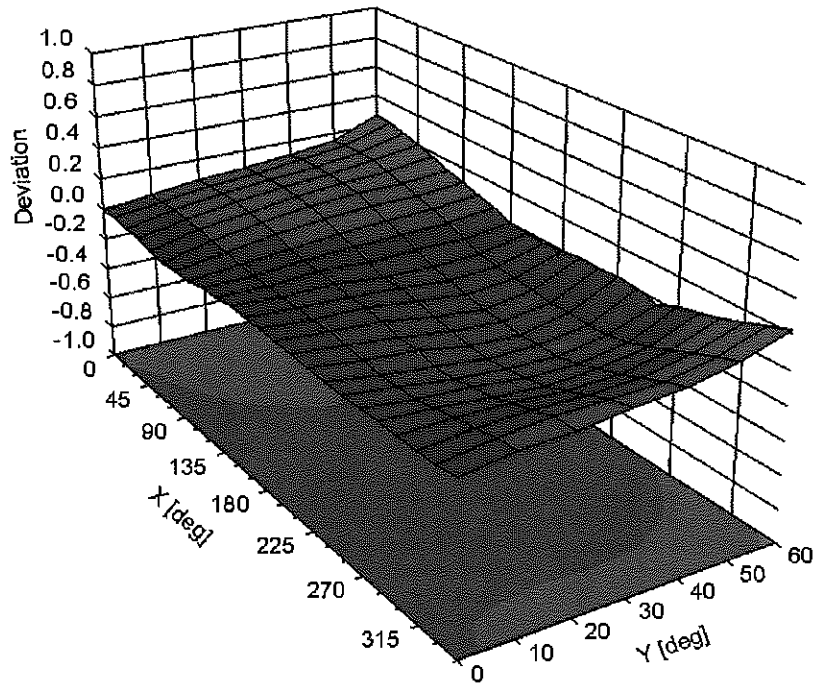

DASY/EASY - Parameters of Probe: ES3DV3 - SN:3347**Other Probe Parameters**

Sensor Arrangement	Triangular
Connector Angle (°)	-16.5
Mechanical Surface Detection Mode	enabled
Optical Surface Detection Mode	disabled
Probe Overall Length	337 mm
Probe Body Diameter	10 mm
Tip Length	10 mm
Tip Diameter	4 mm
Probe Tip to Sensor X Calibration Point	2 mm
Probe Tip to Sensor Y Calibration Point	2 mm
Probe Tip to Sensor Z Calibration Point	2 mm
Recommended Measurement Distance from Surface	3 mm

Appendix: Modulation Calibration Parameters

UID	Communication System Name		A dB	B dB $\sqrt{\mu V}$	C	D dB	VR mV	Max Unc ^E (k=2)
0	CW	X	0.00	0.00	1.00	0.00	201.8	± 3.3 %
		Y	0.00	0.00	1.00		203.9	
		Z	0.00	0.00	1.00		204.8	
10010- CAA	SAR Validation (Square, 100ms, 10ms)	X	7.57	78.06	17.49	10.00	25.0	± 9.6 %
		Y	9.85	82.39	18.69		25.0	
		Z	7.35	77.81	17.08		25.0	
10011- CAB	UMTS-FDD (WCDMA)	X	0.93	66.02	14.08	0.00	150.0	± 9.6 %
		Y	0.97	66.67	14.52		150.0	
		Z	0.93	66.21	14.17		150.0	
10012- CAB	IEEE 802.11b WiFi 2.4 GHz (DSSS, 1 Mbps)	X	1.22	64.40	15.16	0.41	150.0	± 9.6 %
		Y	1.24	64.68	15.35		150.0	
		Z	1.21	64.49	15.23		150.0	
10013- CAB	IEEE 802.11g WiFi 2.4 GHz (DSSS-OFDM, 6 Mbps)	X	5.02	67.09	17.26	1.46	150.0	± 9.6 %
		Y	4.93	67.32	17.31		150.0	
		Z	4.97	67.16	17.27		150.0	
10021- DAC	GSM-FDD (TDMA, GMSK)	X	91.36	118.07	31.34	9.39	50.0	± 9.6 %
		Y	100.00	119.30	31.14		50.0	
		Z	100.00	118.75	31.10		50.0	
10023- DAC	GPRS-FDD (TDMA, GMSK, TN 0)	X	58.54	111.16	29.65	9.57	50.0	± 9.6 %
		Y	100.00	119.20	31.14		50.0	
		Z	100.00	118.71	31.13		50.0	
10024- DAC	GPRS-FDD (TDMA, GMSK, TN 0-1)	X	100.00	115.85	28.82	6.56	60.0	± 9.6 %
		Y	100.00	116.32	28.70		60.0	
		Z	100.00	115.26	28.36		60.0	
10025- DAC	EDGE-FDD (TDMA, 8PSK, TN 0)	X	19.84	109.66	41.73	12.57	50.0	± 9.6 %
		Y	49.03	143.08	53.86		50.0	
		Z	21.37	113.26	43.24		50.0	
10026- DAC	EDGE-FDD (TDMA, 8PSK, TN 0-1)	X	21.22	106.46	36.65	9.56	60.0	± 9.6 %
		Y	31.58	119.85	41.69		60.0	
		Z	22.56	108.96	37.62		60.0	
10027- DAC	GPRS-FDD (TDMA, GMSK, TN 0-1-2)	X	100.00	114.36	27.28	4.80	80.0	± 9.6 %
		Y	100.00	115.58	27.56		80.0	
		Z	100.00	113.91	26.92		80.0	
10028- DAC	GPRS-FDD (TDMA, GMSK, TN 0-1-2-3)	X	100.00	113.86	26.30	3.55	100.0	± 9.6 %
		Y	100.00	115.98	27.02		100.0	
		Z	100.00	113.53	26.01		100.0	
10029- DAC	EDGE-FDD (TDMA, 8PSK, TN 0-1-2)	X	12.94	95.02	31.64	7.80	80.0	± 9.6 %
		Y	14.07	99.40	33.81		80.0	
		Z	12.89	95.72	32.02		80.0	
10030- CAA	IEEE 802.15.1 Bluetooth (GFSK, DH1)	X	100.00	113.99	27.43	5.30	70.0	± 9.6 %
		Y	100.00	114.60	27.41		70.0	
		Z	100.00	113.38	26.98		70.0	
10031- CAA	IEEE 802.15.1 Bluetooth (GFSK, DH3)	X	100.00	111.77	23.93	1.88	100.0	± 9.6 %
		Y	100.00	115.39	25.33		100.0	
		Z	100.00	111.26	23.59		100.0	

10032-CAA	IEEE 802.15.1 Bluetooth (GFSK, DH5)	X	100.00	111.85	22.94	1.17	100.0	± 9.6 %
		Y	100.00	118.40	25.59		100.0	
		Z	100.00	111.34	22.62		100.0	
10033-CAA	IEEE 802.15.1 Bluetooth (PI/4-DQPSK, DH1)	X	23.91	101.19	27.41	5.30	70.0	± 9.6 %
		Y	36.18	107.81	28.88		70.0	
		Z	30.63	104.89	28.18		70.0	
10034-CAA	IEEE 802.15.1 Bluetooth (PI/4-DQPSK, DH3)	X	6.24	84.08	20.44	1.88	100.0	± 9.6 %
		Y	7.24	85.92	20.55		100.0	
		Z	6.85	85.19	20.50		100.0	
10035-CAA	IEEE 802.15.1 Bluetooth (PI/4-DQPSK, DH5)	X	3.29	76.95	17.63	1.17	100.0	± 9.6 %
		Y	3.58	78.09	17.57		100.0	
		Z	3.42	77.43	17.51		100.0	
10036-CAA	IEEE 802.15.1 Bluetooth (8-DPSK, DH1)	X	32.79	106.39	28.91	5.30	70.0	± 9.6 %
		Y	55.24	114.58	30.68		70.0	
		Z	45.73	111.34	29.95		70.0	
10037-CAA	IEEE 802.15.1 Bluetooth (8-DPSK, DH3)	X	5.86	83.28	20.13	1.88	100.0	± 9.6 %
		Y	6.54	84.66	20.12		100.0	
		Z	6.31	84.13	20.12		100.0	
10038-CAA	IEEE 802.15.1 Bluetooth (8-DPSK, DH5)	X	3.39	77.59	17.96	1.17	100.0	± 9.6 %
		Y	3.66	78.64	17.87		100.0	
		Z	3.53	78.11	17.85		100.0	
10039-CAB	CDMA2000 (1xRTT, RC1)	X	1.52	69.16	14.18	0.00	150.0	± 9.6 %
		Y	1.40	68.90	13.55		150.0	
		Z	1.46	69.03	13.83		150.0	
10042-CAB	IS-54 / IS-136 FDD (TDMA/FDM, PI/4-DQPSK, Halfrate)	X	100.00	114.62	28.47	7.78	50.0	± 9.6 %
		Y	100.00	114.70	28.14		50.0	
		Z	100.00	113.88	27.92		50.0	
10044-CAA	IS-91/EIA/TIA-553 FDD (FDMA, FM)	X	0.01	121.88	0.68	0.00	150.0	± 9.6 %
		Y	0.00	97.83	1.91		150.0	
		Z	0.01	122.55	0.35		150.0	
10048-CAA	DECT (TDD, TDMA/FDM, GFSK, Full Slot, 24)	X	17.94	92.17	26.06	13.80	25.0	± 9.6 %
		Y	42.19	107.21	29.95		25.0	
		Z	24.74	97.63	27.36		25.0	
10049-CAA	DECT (TDD, TDMA/FDM, GFSK, Double Slot, 12)	X	22.69	96.29	25.94	10.79	40.0	± 9.6 %
		Y	68.20	113.74	30.23		40.0	
		Z	32.65	101.85	27.19		40.0	
10056-CAA	UMTS-TDD (TD-SCDMA, 1.28 Mcps)	X	16.99	92.79	25.84	9.03	50.0	± 9.6 %
		Y	27.63	101.84	28.34		50.0	
		Z	20.13	95.81	26.57		50.0	
10058-DAC	EDGE-FDD (TDMA, 8PSK, TN 0-1-2-3)	X	9.12	87.95	28.36	6.55	100.0	± 9.6 %
		Y	8.98	89.45	29.43		100.0	
		Z	8.90	88.06	28.51		100.0	
10059-CAB	IEEE 802.11b WiFi 2.4 GHz (DSSS, 2 Mbps)	X	1.37	66.39	16.16	0.61	110.0	± 9.6 %
		Y	1.38	66.59	16.33		110.0	
		Z	1.36	66.49	16.23		110.0	
10060-CAB	IEEE 802.11b WiFi 2.4 GHz (DSSS, 5.5 Mbps)	X	100.00	128.08	31.98	1.30	110.0	± 9.6 %
		Y	100.00	131.22	33.31		110.0	
		Z	100.00	128.65	32.15		110.0	

10061-CAB	IEEE 802.11b WiFi 2.4 GHz (DSSS, 11 Mbps)	X	9.25	94.71	26.12	2.04	110.0	± 9.6 %
		Y	9.59	96.73	27.06		110.0	
		Z	10.28	96.95	26.85		110.0	
10062-CAC	IEEE 802.11a/h WiFi 5 GHz (OFDM, 6 Mbps)	X	4.74	66.85	16.53	0.49	100.0	± 9.6 %
		Y	4.66	67.04	16.57		100.0	
		Z	4.70	66.90	16.54		100.0	
10063-CAC	IEEE 802.11a/h WiFi 5 GHz (OFDM, 9 Mbps)	X	4.78	67.00	16.67	0.72	100.0	± 9.6 %
		Y	4.69	67.19	16.70		100.0	
		Z	4.73	67.05	16.68		100.0	
10064-CAC	IEEE 802.11a/h WiFi 5 GHz (OFDM, 12 Mbps)	X	5.09	67.32	16.93	0.86	100.0	± 9.6 %
		Y	4.97	67.46	16.94		100.0	
		Z	5.03	67.35	16.93		100.0	
10065-CAC	IEEE 802.11a/h WiFi 5 GHz (OFDM, 18 Mbps)	X	4.99	67.34	17.10	1.21	100.0	± 9.6 %
		Y	4.88	67.46	17.11		100.0	
		Z	4.93	67.36	17.10		100.0	
10066-CAC	IEEE 802.11a/h WiFi 5 GHz (OFDM, 24 Mbps)	X	5.05	67.46	17.33	1.46	100.0	± 9.6 %
		Y	4.92	67.57	17.33		100.0	
		Z	4.98	67.48	17.32		100.0	
10067-CAC	IEEE 802.11a/h WiFi 5 GHz (OFDM, 36 Mbps)	X	5.36	67.67	17.81	2.04	100.0	± 9.6 %
		Y	5.25	67.92	17.88		100.0	
		Z	5.30	67.73	17.82		100.0	
10068-CAC	IEEE 802.11a/h WiFi 5 GHz (OFDM, 48 Mbps)	X	5.48	67.95	18.15	2.55	100.0	± 9.6 %
		Y	5.33	68.04	18.16		100.0	
		Z	5.40	67.94	18.13		100.0	
10069-CAC	IEEE 802.11a/h WiFi 5 GHz (OFDM, 54 Mbps)	X	5.56	67.94	18.35	2.67	100.0	± 9.6 %
		Y	5.42	68.11	18.40		100.0	
		Z	5.49	67.96	18.34		100.0	
10071-CAB	IEEE 802.11g WiFi 2.4 GHz (DSSS/OFDM, 9 Mbps)	X	5.16	67.32	17.64	1.99	100.0	± 9.6 %
		Y	5.07	67.53	17.70		100.0	
		Z	5.11	67.37	17.65		100.0	
10072-CAB	IEEE 802.11g WiFi 2.4 GHz (DSSS/OFDM, 12 Mbps)	X	5.20	67.83	17.95	2.30	100.0	± 9.6 %
		Y	5.09	67.99	18.00		100.0	
		Z	5.14	67.86	17.96		100.0	
10073-CAB	IEEE 802.11g WiFi 2.4 GHz (DSSS/OFDM, 18 Mbps)	X	5.32	68.17	18.37	2.83	100.0	± 9.6 %
		Y	5.22	68.36	18.44		100.0	
		Z	5.26	68.20	18.38		100.0	
10074-CAB	IEEE 802.11g WiFi 2.4 GHz (DSSS/OFDM, 24 Mbps)	X	5.35	68.22	18.60	3.30	100.0	± 9.6 %
		Y	5.26	68.43	18.68		100.0	
		Z	5.29	68.25	18.61		100.0	
10075-CAB	IEEE 802.11g WiFi 2.4 GHz (DSSS/OFDM, 36 Mbps)	X	5.48	68.62	19.07	3.82	90.0	± 9.6 %
		Y	5.35	68.73	19.11		90.0	
		Z	5.40	68.60	19.05		90.0	
10076-CAB	IEEE 802.11g WiFi 2.4 GHz (DSSS/OFDM, 48 Mbps)	X	5.50	68.45	19.21	4.15	90.0	± 9.6 %
		Y	5.40	68.64	19.31		90.0	
		Z	5.44	68.46	19.21		90.0	
10077-CAB	IEEE 802.11g WiFi 2.4 GHz (DSSS/OFDM, 54 Mbps)	X	5.54	68.54	19.31	4.30	90.0	± 9.6 %
		Y	5.44	68.76	19.43		90.0	
		Z	5.48	68.56	19.32		90.0	

10081-CAB	CDMA2000 (1xRTT, RC3)	X	0.74	64.32	11.31	0.00	150.0	± 9.6 %
		Y	0.70	64.20	10.81		150.0	
		Z	0.71	64.15	10.92		150.0	
10082-CAB	IS-54 / IS-136 FDD (TDMA/FDM, PI/4-DQPSK, Fullrate)	X	1.69	62.26	7.32	4.77	80.0	± 9.6 %
		Y	1.49	62.02	6.99		80.0	
		Z	1.55	61.83	6.90		80.0	
10090-DAC	GPRS-FDD (TDMA, GMSK, TN 0-4)	X	100.00	115.94	28.89	6.56	60.0	± 9.6 %
		Y	100.00	116.39	28.75		60.0	
		Z	100.00	115.35	28.42		60.0	
10097-CAB	UMTS-FDD (HSDPA)	X	1.73	66.76	14.97	0.00	150.0	± 9.6 %
		Y	1.76	67.41	15.16		150.0	
		Z	1.72	67.00	15.02		150.0	
10098-CAB	UMTS-FDD (HSUPA, Subtest 2)	X	1.69	66.71	14.93	0.00	150.0	± 9.6 %
		Y	1.72	67.36	15.13		150.0	
		Z	1.69	66.94	14.98		150.0	
10099-DAC	EDGE-FDD (TDMA, 8PSK, TN 0-4)	X	21.17	106.37	36.62	9.56	60.0	± 9.6 %
		Y	31.53	119.75	41.66		60.0	
		Z	22.53	108.88	37.59		60.0	
10100-CAD	LTE-FDD (SC-FDMA, 100% RB, 20 MHz, QPSK)	X	3.02	69.66	16.13	0.00	150.0	± 9.6 %
		Y	2.98	69.86	16.33		150.0	
		Z	2.99	69.71	16.19		150.0	
10101-CAD	LTE-FDD (SC-FDMA, 100% RB, 20 MHz, 16-QAM)	X	3.20	67.30	15.63	0.00	150.0	± 9.6 %
		Y	3.15	67.42	15.72		150.0	
		Z	3.17	67.31	15.65		150.0	
10102-CAD	LTE-FDD (SC-FDMA, 100% RB, 20 MHz, 64-QAM)	X	3.31	67.28	15.74	0.00	150.0	± 9.6 %
		Y	3.26	67.39	15.81		150.0	
		Z	3.27	67.30	15.76		150.0	
10103-CAD	LTE-TDD (SC-FDMA, 100% RB, 20 MHz, QPSK)	X	8.39	78.42	21.27	3.98	65.0	± 9.6 %
		Y	8.55	79.75	21.92		65.0	
		Z	8.43	78.92	21.50		65.0	
10104-CAD	LTE-TDD (SC-FDMA, 100% RB, 20 MHz, 16-QAM)	X	8.28	76.92	21.52	3.98	65.0	± 9.6 %
		Y	8.11	77.48	21.85		65.0	
		Z	8.18	77.09	21.61		65.0	
10105-CAD	LTE-TDD (SC-FDMA, 100% RB, 20 MHz, 64-QAM)	X	7.63	75.31	21.13	3.98	65.0	± 9.6 %
		Y	7.72	76.48	21.73		65.0	
		Z	7.57	75.55	21.26		65.0	
10108-CAE	LTE-FDD (SC-FDMA, 100% RB, 10 MHz, QPSK)	X	2.65	68.92	15.95	0.00	150.0	± 9.6 %
		Y	2.59	69.14	16.15		150.0	
		Z	2.61	68.99	16.01		150.0	
10109-CAE	LTE-FDD (SC-FDMA, 100% RB, 10 MHz, 16-QAM)	X	2.86	67.08	15.50	0.00	150.0	± 9.6 %
		Y	2.80	67.24	15.55		150.0	
		Z	2.82	67.11	15.51		150.0	
10110-CAE	LTE-FDD (SC-FDMA, 100% RB, 5 MHz, QPSK)	X	2.15	67.97	15.52	0.00	150.0	± 9.6 %
		Y	2.09	68.27	15.68		150.0	
		Z	2.11	68.06	15.56		150.0	
10111-CAE	LTE-FDD (SC-FDMA, 100% RB, 5 MHz, 16-QAM)	X	2.54	67.60	15.65	0.00	150.0	± 9.6 %
		Y	2.49	67.90	15.64		150.0	
		Z	2.51	67.74	15.66		150.0	

10112-CAE	LTE-FDD (SC-FDMA, 100% RB, 10 MHz, 64-QAM)	X	2.98	67.08	15.57	0.00	150.0	± 9.6 %
		Y	2.92	67.27	15.62		150.0	
		Z	2.94	67.13	15.58		150.0	
10113-CAE	LTE-FDD (SC-FDMA, 100% RB, 5 MHz, 64-QAM)	X	2.70	67.76	15.81	0.00	150.0	± 9.6 %
		Y	2.63	68.07	15.78		150.0	
		Z	2.66	67.92	15.82		150.0	
10114-CAC	IEEE 802.11n (HT Greenfield, 13.5 Mbps, BPSK)	X	5.13	67.22	16.34	0.00	150.0	± 9.6 %
		Y	5.06	67.35	16.39		150.0	
		Z	5.10	67.28	16.37		150.0	
10115-CAC	IEEE 802.11n (HT Greenfield, 81 Mbps, 16-QAM)	X	5.46	67.47	16.48	0.00	150.0	± 9.6 %
		Y	5.32	67.42	16.43		150.0	
		Z	5.39	67.43	16.46		150.0	
10116-CAC	IEEE 802.11n (HT Greenfield, 135 Mbps, 64-QAM)	X	5.25	67.46	16.39	0.00	150.0	± 9.6 %
		Y	5.15	67.53	16.41		150.0	
		Z	5.20	67.47	16.40		150.0	
10117-CAC	IEEE 802.11n (HT Mixed, 13.5 Mbps, BPSK)	X	5.10	67.11	16.30	0.00	150.0	± 9.6 %
		Y	5.03	67.22	16.34		150.0	
		Z	5.06	67.11	16.31		150.0	
10118-CAC	IEEE 802.11n (HT Mixed, 81 Mbps, 16-QAM)	X	5.56	67.71	16.61	0.00	150.0	± 9.6 %
		Y	5.40	67.63	16.55		150.0	
		Z	5.48	67.67	16.59		150.0	
10119-CAC	IEEE 802.11n (HT Mixed, 135 Mbps, 64-QAM)	X	5.22	67.39	16.37	0.00	150.0	± 9.6 %
		Y	5.13	67.49	16.40		150.0	
		Z	5.18	67.42	16.38		150.0	
10140-CAD	LTE-FDD (SC-FDMA, 100% RB, 15 MHz, 16-QAM)	X	3.35	67.28	15.66	0.00	150.0	± 9.6 %
		Y	3.29	67.41	15.73		150.0	
		Z	3.31	67.30	15.68		150.0	
10141-CAD	LTE-FDD (SC-FDMA, 100% RB, 15 MHz, 64-QAM)	X	3.47	67.38	15.84	0.00	150.0	± 9.6 %
		Y	3.41	67.52	15.90		150.0	
		Z	3.43	67.42	15.86		150.0	
10142-CAD	LTE-FDD (SC-FDMA, 100% RB, 3 MHz, QPSK)	X	1.91	67.75	15.10	0.00	150.0	± 9.6 %
		Y	1.84	68.07	15.11		150.0	
		Z	1.87	67.86	15.08		150.0	
10143-CAD	LTE-FDD (SC-FDMA, 100% RB, 3 MHz, 16-QAM)	X	2.37	68.04	15.25	0.00	150.0	± 9.6 %
		Y	2.29	68.28	15.02		150.0	
		Z	2.33	68.17	15.16		150.0	
10144-CAD	LTE-FDD (SC-FDMA, 100% RB, 3 MHz, 64-QAM)	X	2.20	66.14	13.84	0.00	150.0	± 9.6 %
		Y	2.08	66.17	13.48		150.0	
		Z	2.13	66.11	13.65		150.0	
10145-CAE	LTE-FDD (SC-FDMA, 100% RB, 1.4 MHz, QPSK)	X	1.17	64.40	11.32	0.00	150.0	± 9.6 %
		Y	0.99	63.23	9.93		150.0	
		Z	1.08	63.80	10.61		150.0	
10146-CAE	LTE-FDD (SC-FDMA, 100% RB, 1.4 MHz, 16-QAM)	X	2.07	66.79	12.08	0.00	150.0	± 9.6 %
		Y	1.74	65.46	10.58		150.0	
		Z	1.93	66.25	11.43		150.0	
10147-CAE	LTE-FDD (SC-FDMA, 100% RB, 1.4 MHz, 64-QAM)	X	2.41	68.68	13.11	0.00	150.0	± 9.6 %
		Y	2.02	67.13	11.50		150.0	
		Z	2.26	68.13	12.45		150.0	

10149-CAD	LTE-FDD (SC-FDMA, 50% RB, 20 MHz, 16-QAM)	X	2.87	67.13	15.54	0.00	150.0	± 9.6 %
		Y	2.81	67.29	15.59		150.0	
		Z	2.83	67.17	15.55		150.0	
10150-CAD	LTE-FDD (SC-FDMA, 50% RB, 20 MHz, 64-QAM)	X	2.99	67.13	15.61	0.00	150.0	± 9.6 %
		Y	2.93	67.31	15.66		150.0	
		Z	2.95	67.18	15.62		150.0	
10151-CAD	LTE-TDD (SC-FDMA, 50% RB, 20 MHz, QPSK)	X	9.21	81.33	22.45	3.98	65.0	± 9.6 %
		Y	9.55	83.12	23.24		65.0	
		Z	9.38	82.15	22.79		65.0	
10152-CAD	LTE-TDD (SC-FDMA, 50% RB, 20 MHz, 16-QAM)	X	7.89	77.12	21.32	3.98	65.0	± 9.6 %
		Y	7.75	77.78	21.62		65.0	
		Z	7.80	77.32	21.39		65.0	
10153-CAD	LTE-TDD (SC-FDMA, 50% RB, 20 MHz, 64-QAM)	X	8.33	78.05	22.06	3.98	65.0	± 9.6 %
		Y	8.20	78.76	22.36		65.0	
		Z	8.27	78.34	22.17		65.0	
10154-CAE	LTE-FDD (SC-FDMA, 50% RB, 10 MHz, QPSK)	X	2.19	68.34	15.77	0.00	150.0	± 9.6 %
		Y	2.13	68.58	15.88		150.0	
		Z	2.15	68.43	15.80		150.0	
10155-CAE	LTE-FDD (SC-FDMA, 50% RB, 10 MHz, 16-QAM)	X	2.54	67.61	15.66	0.00	150.0	± 9.6 %
		Y	2.49	67.93	15.66		150.0	
		Z	2.51	67.76	15.67		150.0	
10156-CAE	LTE-FDD (SC-FDMA, 50% RB, 5 MHz, QPSK)	X	1.75	67.70	14.83	0.00	150.0	± 9.6 %
		Y	1.67	67.86	14.67		150.0	
		Z	1.70	67.75	14.73		150.0	
10157-CAE	LTE-FDD (SC-FDMA, 50% RB, 5 MHz, 16-QAM)	X	2.01	66.49	13.77	0.00	150.0	± 9.6 %
		Y	1.89	66.41	13.28		150.0	
		Z	1.95	66.44	13.53		150.0	
10158-CAE	LTE-FDD (SC-FDMA, 50% RB, 10 MHz, 64-QAM)	X	2.70	67.82	15.85	0.00	150.0	± 9.6 %
		Y	2.64	68.13	15.83		150.0	
		Z	2.67	67.98	15.86		150.0	
10159-CAE	LTE-FDD (SC-FDMA, 50% RB, 5 MHz, 64-QAM)	X	2.11	66.90	14.04	0.00	150.0	± 9.6 %
		Y	1.98	66.74	13.50		150.0	
		Z	2.04	66.83	13.79		150.0	
10160-CAD	LTE-FDD (SC-FDMA, 50% RB, 15 MHz, QPSK)	X	2.69	68.21	15.87	0.00	150.0	± 9.6 %
		Y	2.64	68.50	16.02		150.0	
		Z	2.66	68.34	15.93		150.0	
10161-CAD	LTE-FDD (SC-FDMA, 50% RB, 15 MHz, 16-QAM)	X	2.88	67.04	15.53	0.00	150.0	± 9.6 %
		Y	2.82	67.25	15.56		150.0	
		Z	2.84	67.11	15.53		150.0	
10162-CAD	LTE-FDD (SC-FDMA, 50% RB, 15 MHz, 64-QAM)	X	2.99	67.17	15.64	0.00	150.0	± 9.6 %
		Y	2.93	67.43	15.68		150.0	
		Z	2.96	67.27	15.66		150.0	
10166-CAE	LTE-FDD (SC-FDMA, 50% RB, 1.4 MHz, QPSK)	X	3.67	69.76	19.07	3.01	150.0	± 9.6 %
		Y	3.59	70.61	19.72		150.0	
		Z	3.64	70.17	19.36		150.0	
10167-CAE	LTE-FDD (SC-FDMA, 50% RB, 1.4 MHz, 16-QAM)	X	4.60	72.78	19.56	3.01	150.0	± 9.6 %
		Y	4.59	74.59	20.58		150.0	
		Z	4.60	73.54	19.97		150.0	

10168-CAE	LTE-FDD (SC-FDMA, 50% RB, 1.4 MHz, 64-QAM)	X	5.10	75.00	20.86	3.01	150.0	± 9.6 %
		Y	5.17	77.15	22.00		150.0	
		Z	5.18	76.08	21.41		150.0	
10169-CAD	LTE-FDD (SC-FDMA, 1 RB, 20 MHz, QPSK)	X	3.14	69.82	19.09	3.01	150.0	± 9.6 %
		Y	2.99	70.11	19.57		150.0	
		Z	3.08	69.99	19.30		150.0	
10170-CAD	LTE-FDD (SC-FDMA, 1 RB, 20 MHz, 16-QAM)	X	4.48	76.11	21.47	3.01	150.0	± 9.6 %
		Y	4.42	77.92	22.61		150.0	
		Z	4.51	77.09	22.03		150.0	
10171-AAD	LTE-FDD (SC-FDMA, 1 RB, 20 MHz, 64-QAM)	X	3.64	71.74	18.65	3.01	150.0	± 9.6 %
		Y	3.56	73.31	19.70		150.0	
		Z	3.59	72.29	19.01		150.0	
10172-CAD	LTE-TDD (SC-FDMA, 1 RB, 20 MHz, QPSK)	X	21.10	104.74	32.18	6.02	65.0	± 9.6 %
		Y	44.31	124.23	38.59		65.0	
		Z	24.87	109.58	33.89		65.0	
10173-CAD	LTE-TDD (SC-FDMA, 1 RB, 20 MHz, 16-QAM)	X	37.36	109.91	31.76	6.02	65.0	± 9.6 %
		Y	100.00	131.53	37.83		65.0	
		Z	66.45	121.49	34.95		65.0	
10174-CAD	LTE-TDD (SC-FDMA, 1 RB, 20 MHz, 64-QAM)	X	28.71	103.81	29.50	6.02	65.0	± 9.6 %
		Y	93.12	128.22	36.43		65.0	
		Z	36.57	109.34	31.20		65.0	
10175-CAE	LTE-FDD (SC-FDMA, 1 RB, 10 MHz, QPSK)	X	3.10	69.50	18.83	3.01	150.0	± 9.6 %
		Y	2.96	69.84	19.35		150.0	
		Z	3.04	69.66	19.04		150.0	
10176-CAE	LTE-FDD (SC-FDMA, 1 RB, 10 MHz, 16-QAM)	X	4.49	76.13	21.48	3.01	150.0	± 9.6 %
		Y	4.43	77.95	22.63		150.0	
		Z	4.52	77.11	22.04		150.0	
10177-CAG	LTE-FDD (SC-FDMA, 1 RB, 5 MHz, QPSK)	X	3.13	69.65	18.93	3.01	150.0	± 9.6 %
		Y	2.98	69.97	19.42		150.0	
		Z	3.07	69.81	19.14		150.0	
10178-CAE	LTE-FDD (SC-FDMA, 1 RB, 5 MHz, 16-QAM)	X	4.43	75.88	21.35	3.01	150.0	± 9.6 %
		Y	4.39	77.75	22.52		150.0	
		Z	4.47	76.86	21.91		150.0	
10179-CAE	LTE-FDD (SC-FDMA, 1 RB, 10 MHz, 64-QAM)	X	4.01	73.75	19.90	3.01	150.0	± 9.6 %
		Y	3.96	75.54	21.04		150.0	
		Z	4.01	74.52	20.37		150.0	
10180-CAE	LTE-FDD (SC-FDMA, 1 RB, 5 MHz, 64-QAM)	X	3.63	71.66	18.60	3.01	150.0	± 9.6 %
		Y	3.55	73.25	19.66		150.0	
		Z	3.59	72.21	18.96		150.0	
10181-CAD	LTE-FDD (SC-FDMA, 1 RB, 15 MHz, QPSK)	X	3.13	69.64	18.92	3.01	150.0	± 9.6 %
		Y	2.98	69.95	19.42		150.0	
		Z	3.06	69.80	19.13		150.0	
10182-CAD	LTE-FDD (SC-FDMA, 1 RB, 15 MHz, 16-QAM)	X	4.42	75.86	21.34	3.01	150.0	± 9.6 %
		Y	4.38	77.72	22.51		150.0	
		Z	4.46	76.83	21.90		150.0	
10183-AAC	LTE-FDD (SC-FDMA, 1 RB, 15 MHz, 64-QAM)	X	3.62	71.63	18.59	3.01	150.0	± 9.6 %
		Y	3.55	73.22	19.65		150.0	
		Z	3.58	72.19	18.94		150.0	

10184-CAD	LTE-FDD (SC-FDMA, 1 RB, 3 MHz, QPSK)	X	3.14	69.68	18.95	3.01	150.0	± 9.6 %
		Y	2.99	69.99	19.44		150.0	
		Z	3.07	69.84	19.16		150.0	
10185-CAD	LTE-FDD (SC-FDMA, 1 RB, 3 MHz, 16-QAM)	X	4.45	75.93	21.38	3.01	150.0	± 9.6 %
		Y	4.40	77.80	22.55		150.0	
		Z	4.48	76.92	21.94		150.0	
10186-AAD	LTE-FDD (SC-FDMA, 1 RB, 3 MHz, 64-QAM)	X	3.64	71.70	18.62	3.01	150.0	± 9.6 %
		Y	3.56	73.30	19.69		150.0	
		Z	3.60	72.26	18.98		150.0	
10187-CAE	LTE-FDD (SC-FDMA, 1 RB, 1.4 MHz, QPSK)	X	3.15	69.73	19.01	3.01	150.0	± 9.6 %
		Y	3.00	70.06	19.51		150.0	
		Z	3.08	69.90	19.22		150.0	
10188-CAE	LTE-FDD (SC-FDMA, 1 RB, 1.4 MHz, 16-QAM)	X	4.60	76.65	21.77	3.01	150.0	± 9.6 %
		Y	4.55	78.49	22.93		150.0	
		Z	4.65	77.69	22.36		150.0	
10189-AAE	LTE-FDD (SC-FDMA, 1 RB, 1.4 MHz, 64-QAM)	X	3.72	72.15	18.90	3.01	150.0	± 9.6 %
		Y	3.65	73.76	19.97		150.0	
		Z	3.69	72.74	19.28		150.0	
10193-CAC	IEEE 802.11n (HT Greenfield, 6.5 Mbps, BPSK)	X	4.52	66.58	16.02	0.00	150.0	± 9.6 %
		Y	4.45	66.79	16.05		150.0	
		Z	4.48	66.63	16.03		150.0	
10194-CAC	IEEE 802.11n (HT Greenfield, 39 Mbps, 16-QAM)	X	4.70	66.91	16.15	0.00	150.0	± 9.6 %
		Y	4.60	67.08	16.18		150.0	
		Z	4.65	66.95	16.16		150.0	
10195-CAC	IEEE 802.11n (HT Greenfield, 65 Mbps, 64-QAM)	X	4.74	66.94	16.17	0.00	150.0	± 9.6 %
		Y	4.65	67.11	16.20		150.0	
		Z	4.69	66.98	16.18		150.0	
10196-CAC	IEEE 802.11n (HT Mixed, 6.5 Mbps, BPSK)	X	4.53	66.65	16.05	0.00	150.0	± 9.6 %
		Y	4.44	66.83	16.06		150.0	
		Z	4.48	66.69	16.05		150.0	
10197-CAC	IEEE 802.11n (HT Mixed, 39 Mbps, 16-QAM)	X	4.72	66.93	16.16	0.00	150.0	± 9.6 %
		Y	4.62	67.10	16.19		150.0	
		Z	4.66	66.97	16.17		150.0	
10198-CAC	IEEE 802.11n (HT Mixed, 65 Mbps, 64-QAM)	X	4.75	66.96	16.18	0.00	150.0	± 9.6 %
		Y	4.64	67.13	16.21		150.0	
		Z	4.69	67.00	16.19		150.0	
10219-CAC	IEEE 802.11n (HT Mixed, 7.2 Mbps, BPSK)	X	4.48	66.66	16.00	0.00	150.0	± 9.6 %
		Y	4.39	66.84	16.01		150.0	
		Z	4.43	66.70	16.00		150.0	
10220-CAC	IEEE 802.11n (HT Mixed, 43.3 Mbps, 16-QAM)	X	4.71	66.91	16.16	0.00	150.0	± 9.6 %
		Y	4.61	67.06	16.18		150.0	
		Z	4.66	66.94	16.16		150.0	
10221-CAC	IEEE 802.11n (HT Mixed, 72.2 Mbps, 64-QAM)	X	4.76	66.89	16.17	0.00	150.0	± 9.6 %
		Y	4.65	67.06	16.20		150.0	
		Z	4.70	66.93	16.18		150.0	
10222-CAC	IEEE 802.11n (HT Mixed, 15 Mbps, BPSK)	X	5.08	67.11	16.29	0.00	150.0	± 9.6 %
		Y	5.00	67.21	16.33		150.0	
		Z	5.03	67.12	16.30		150.0	

10223-CAC	IEEE 802.11n (HT Mixed, 90 Mbps, 16-QAM)	X	5.40	67.34	16.44	0.00	150.0	± 9.6 %
		Y	5.30	67.47	16.48		150.0	
		Z	5.35	67.37	16.45		150.0	
10224-CAC	IEEE 802.11n (HT Mixed, 150 Mbps, 64-QAM)	X	5.12	67.22	16.27	0.00	150.0	± 9.6 %
		Y	5.04	67.32	16.31		150.0	
		Z	5.08	67.23	16.28		150.0	
10225-CAB	UMTS-FDD (HSPA+)	X	2.77	65.87	15.07	0.00	150.0	± 9.6 %
		Y	2.71	66.11	14.95		150.0	
		Z	2.73	65.95	15.01		150.0	
10226-CAA	LTE-TDD (SC-FDMA, 1 RB, 1.4 MHz, 16-QAM)	X	40.90	111.69	32.33	6.02	65.0	± 9.6 %
		Y	100.00	131.74	37.97		65.0	
		Z	76.08	124.13	35.71		65.0	
10227-CAA	LTE-TDD (SC-FDMA, 1 RB, 1.4 MHz, 64-QAM)	X	32.04	105.79	30.14	6.02	65.0	± 9.6 %
		Y	100.00	129.20	36.63		65.0	
		Z	56.03	116.66	33.17		65.0	
10228-CAA	LTE-TDD (SC-FDMA, 1 RB, 1.4 MHz, QPSK)	X	32.49	113.40	34.73	6.02	65.0	± 9.6 %
		Y	63.93	131.79	40.55		65.0	
		Z	42.68	120.45	36.94		65.0	
10229-CAB	LTE-TDD (SC-FDMA, 1 RB, 3 MHz, 16-QAM)	X	37.48	109.96	31.78	6.02	65.0	± 9.6 %
		Y	100.00	131.51	37.84		65.0	
		Z	66.68	121.54	34.97		65.0	
10230-CAB	LTE-TDD (SC-FDMA, 1 RB, 3 MHz, 64-QAM)	X	29.78	104.42	29.68	6.02	65.0	± 9.6 %
		Y	100.00	129.07	36.54		65.0	
		Z	50.21	114.61	32.57		65.0	
10231-CAB	LTE-TDD (SC-FDMA, 1 RB, 3 MHz, QPSK)	X	30.12	111.79	34.20	6.02	65.0	± 9.6 %
		Y	57.30	129.38	39.87		65.0	
		Z	38.78	118.39	36.30		65.0	
10232-CAD	LTE-TDD (SC-FDMA, 1 RB, 5 MHz, 16-QAM)	X	37.48	109.97	31.78	6.02	65.0	± 9.6 %
		Y	100.00	131.53	37.84		65.0	
		Z	66.72	121.56	34.98		65.0	
10233-CAD	LTE-TDD (SC-FDMA, 1 RB, 5 MHz, 64-QAM)	X	29.77	104.42	29.68	6.02	65.0	± 9.6 %
		Y	100.00	129.09	36.55		65.0	
		Z	50.19	114.62	32.57		65.0	
10234-CAD	LTE-TDD (SC-FDMA, 1 RB, 5 MHz, QPSK)	X	28.05	110.17	33.63	6.02	65.0	± 9.6 %
		Y	51.99	127.09	39.16		65.0	
		Z	35.54	116.41	35.65		65.0	
10235-CAD	LTE-TDD (SC-FDMA, 1 RB, 10 MHz, 16-QAM)	X	37.64	110.05	31.80	6.02	65.0	± 9.6 %
		Y	100.00	131.54	37.84		65.0	
		Z	67.18	121.70	35.01		65.0	
10236-CAD	LTE-TDD (SC-FDMA, 1 RB, 10 MHz, 64-QAM)	X	30.09	104.58	29.72	6.02	65.0	± 9.6 %
		Y	100.00	129.03	36.52		65.0	
		Z	50.96	114.84	32.62		65.0	
10237-CAD	LTE-TDD (SC-FDMA, 1 RB, 10 MHz, QPSK)	X	30.42	112.00	34.26	6.02	65.0	± 9.6 %
		Y	58.39	129.80	39.98		65.0	
		Z	39.25	118.66	36.38		65.0	
10238-CAD	LTE-TDD (SC-FDMA, 1 RB, 15 MHz, 16-QAM)	X	37.48	109.98	31.78	6.02	65.0	± 9.6 %
		Y	100.00	131.54	37.84		65.0	
		Z	66.77	121.59	34.98		65.0	

10239-CAD	LTE-TDD (SC-FDMA, 1 RB, 15 MHz, 64-QAM)	X	29.75	104.43	29.68	6.02	65.0	± 9.6 %
		Y	100.00	129.11	36.55		65.0	
		Z	50.17	114.63	32.57		65.0	
10240-CAD	LTE-TDD (SC-FDMA, 1 RB, 15 MHz, QPSK)	X	30.30	111.94	34.24	6.02	65.0	± 9.6 %
		Y	58.14	129.72	39.96		65.0	
		Z	39.09	118.59	36.36		65.0	
10241-CAA	LTE-TDD (SC-FDMA, 50% RB, 1.4 MHz, 16-QAM)	X	11.80	86.80	27.35	6.98	65.0	± 9.6 %
		Y	13.67	92.53	29.81		65.0	
		Z	12.27	88.56	28.08		65.0	
10242-CAA	LTE-TDD (SC-FDMA, 50% RB, 1.4 MHz, 64-QAM)	X	10.15	83.59	26.03	6.98	65.0	± 9.6 %
		Y	12.26	90.20	28.90		65.0	
		Z	10.49	85.23	26.75		65.0	
10243-CAA	LTE-TDD (SC-FDMA, 50% RB, 1.4 MHz, QPSK)	X	8.15	80.45	25.67	6.98	65.0	± 9.6 %
		Y	9.07	85.16	28.03		65.0	
		Z	8.20	81.43	26.18		65.0	
10244-CAB	LTE-TDD (SC-FDMA, 50% RB, 3 MHz, 16-QAM)	X	8.77	79.58	20.12	3.98	65.0	± 9.6 %
		Y	8.68	79.98	19.73		65.0	
		Z	8.93	80.10	20.07		65.0	
10245-CAB	LTE-TDD (SC-FDMA, 50% RB, 3 MHz, 64-QAM)	X	8.56	78.94	19.83	3.98	65.0	± 9.6 %
		Y	8.27	79.00	19.30		65.0	
		Z	8.60	79.28	19.71		65.0	
10246-CAB	LTE-TDD (SC-FDMA, 50% RB, 3 MHz, QPSK)	X	9.05	82.96	21.42	3.98	65.0	± 9.6 %
		Y	8.67	82.79	20.89		65.0	
		Z	9.07	83.18	21.25		65.0	
10247-CAD	LTE-TDD (SC-FDMA, 50% RB, 5 MHz, 16-QAM)	X	7.31	77.47	20.01	3.98	65.0	± 9.6 %
		Y	6.88	77.10	19.42		65.0	
		Z	7.16	77.42	19.78		65.0	
10248-CAD	LTE-TDD (SC-FDMA, 50% RB, 5 MHz, 64-QAM)	X	7.23	76.85	19.75	3.98	65.0	± 9.6 %
		Y	6.75	76.40	19.13		65.0	
		Z	7.04	76.72	19.48		65.0	
10249-CAD	LTE-TDD (SC-FDMA, 50% RB, 5 MHz, QPSK)	X	10.55	85.88	23.24	3.98	65.0	± 9.6 %
		Y	11.23	87.71	23.62		65.0	
		Z	11.08	87.02	23.49		65.0	
10250-CAD	LTE-TDD (SC-FDMA, 50% RB, 10 MHz, 16-QAM)	X	8.37	79.97	22.44	3.98	65.0	± 9.6 %
		Y	8.25	80.64	22.58		65.0	
		Z	8.37	80.40	22.54		65.0	
10251-CAD	LTE-TDD (SC-FDMA, 50% RB, 10 MHz, 64-QAM)	X	7.79	77.55	21.17	3.98	65.0	± 9.6 %
		Y	7.62	78.12	21.26		65.0	
		Z	7.71	77.78	21.18		65.0	
10252-CAD	LTE-TDD (SC-FDMA, 50% RB, 10 MHz, QPSK)	X	10.26	85.03	23.77	3.98	65.0	± 9.6 %
		Y	11.07	87.53	24.67		65.0	
		Z	10.72	86.30	24.20		65.0	
10253-CAD	LTE-TDD (SC-FDMA, 50% RB, 15 MHz, 16-QAM)	X	7.69	76.53	21.09	3.98	65.0	± 9.6 %
		Y	7.57	77.22	21.35		65.0	
		Z	7.61	76.75	21.15		65.0	
10254-CAD	LTE-TDD (SC-FDMA, 50% RB, 15 MHz, 64-QAM)	X	8.11	77.42	21.76	3.98	65.0	± 9.6 %
		Y	7.99	78.11	22.01		65.0	
		Z	8.04	77.70	21.84		65.0	

10255-CAD	LTE-TDD (SC-FDMA, 50% RB, 15 MHz, QPSK)	X	8.87	80.90	22.51	3.98	65.0	± 9.6 %
		Y	9.18	82.66	23.26		65.0	
		Z	9.01	81.69	22.82		65.0	
10256-CAA	LTE-TDD (SC-FDMA, 100% RB, 1.4 MHz, 16-QAM)	X	7.19	76.04	17.83	3.98	65.0	± 9.6 %
		Y	6.37	74.72	16.60		65.0	
		Z	6.91	75.63	17.34		65.0	
10257-CAA	LTE-TDD (SC-FDMA, 100% RB, 1.4 MHz, 64-QAM)	X	6.95	75.20	17.41	3.98	65.0	± 9.6 %
		Y	6.01	73.59	16.03		65.0	
		Z	6.60	74.62	16.84		65.0	
10258-CAA	LTE-TDD (SC-FDMA, 100% RB, 1.4 MHz, QPSK)	X	7.08	78.57	19.08	3.98	65.0	± 9.6 %
		Y	5.96	76.36	17.58		65.0	
		Z	6.63	77.70	18.41		65.0	
10259-CAB	LTE-TDD (SC-FDMA, 100% RB, 3 MHz, 16-QAM)	X	7.72	78.37	20.87	3.98	65.0	± 9.6 %
		Y	7.43	78.48	20.58		65.0	
		Z	7.64	78.54	20.77		65.0	
10260-CAB	LTE-TDD (SC-FDMA, 100% RB, 3 MHz, 64-QAM)	X	7.71	78.04	20.75	3.98	65.0	± 9.6 %
		Y	7.37	78.04	20.41		65.0	
		Z	7.60	78.14	20.63		65.0	
10261-CAB	LTE-TDD (SC-FDMA, 100% RB, 3 MHz, QPSK)	X	9.91	84.71	23.20	3.98	65.0	± 9.6 %
		Y	10.51	86.66	23.72		65.0	
		Z	10.31	85.78	23.47		65.0	
10262-CAD	LTE-TDD (SC-FDMA, 100% RB, 5 MHz, 16-QAM)	X	8.35	79.91	22.40	3.98	65.0	± 9.6 %
		Y	8.23	80.57	22.53		65.0	
		Z	8.35	80.33	22.49		65.0	
10263-CAD	LTE-TDD (SC-FDMA, 100% RB, 5 MHz, 64-QAM)	X	7.78	77.53	21.17	3.98	65.0	± 9.6 %
		Y	7.61	78.09	21.25		65.0	
		Z	7.70	77.76	21.18		65.0	
10264-CAD	LTE-TDD (SC-FDMA, 100% RB, 5 MHz, QPSK)	X	10.16	84.83	23.68	3.98	65.0	± 9.6 %
		Y	10.94	87.30	24.57		65.0	
		Z	10.60	86.08	24.10		65.0	
10265-CAD	LTE-TDD (SC-FDMA, 100% RB, 10 MHz, 16-QAM)	X	7.89	77.12	21.33	3.98	65.0	± 9.6 %
		Y	7.75	77.78	21.62		65.0	
		Z	7.80	77.33	21.40		65.0	
10266-CAD	LTE-TDD (SC-FDMA, 100% RB, 10 MHz, 64-QAM)	X	8.32	78.04	22.05	3.98	65.0	± 9.6 %
		Y	8.20	78.75	22.36		65.0	
		Z	8.26	78.33	22.16		65.0	
10267-CAD	LTE-TDD (SC-FDMA, 100% RB, 10 MHz, QPSK)	X	9.19	81.29	22.44	3.98	65.0	± 9.6 %
		Y	9.53	83.07	23.22		65.0	
		Z	9.36	82.10	22.77		65.0	
10268-CAD	LTE-TDD (SC-FDMA, 100% RB, 15 MHz, 16-QAM)	X	8.37	76.65	21.54	3.98	65.0	± 9.6 %
		Y	8.20	77.22	21.85		65.0	
		Z	8.27	76.83	21.63		65.0	
10269-CAD	LTE-TDD (SC-FDMA, 100% RB, 15 MHz, 64-QAM)	X	8.29	76.22	21.43	3.98	65.0	± 9.6 %
		Y	8.13	76.76	21.72		65.0	
		Z	8.20	76.38	21.51		65.0	
10270-CAD	LTE-TDD (SC-FDMA, 100% RB, 15 MHz, QPSK)	X	8.55	78.25	21.44	3.98	65.0	± 9.6 %
		Y	8.58	79.32	21.98		65.0	
		Z	8.56	78.72	21.66		65.0	

10274-CAB	UMTS-FDD (HSUPA, Subtest 5, 3GPP Rel8.10)	X	2.53	66.08	14.88	0.00	150.0	± 9.6 %
		Y	2.52	66.54	14.91		150.0	
		Z	2.51	66.24	14.87		150.0	
10275-CAB	UMTS-FDD (HSUPA, Subtest 5, 3GPP Rel8.4)	X	1.51	66.90	14.72	0.00	150.0	± 9.6 %
		Y	1.52	67.44	14.98		150.0	
		Z	1.50	67.06	14.77		150.0	
10277-CAA	PHS (QPSK)	X	4.49	67.07	11.86	9.03	50.0	± 9.6 %
		Y	3.76	65.67	10.51		50.0	
		Z	4.09	66.15	11.03		50.0	
10278-CAA	PHS (QPSK, BW 884MHz, Rolloff 0.5)	X	8.37	78.55	19.37	9.03	50.0	± 9.6 %
		Y	7.19	76.56	17.89		50.0	
		Z	7.75	77.39	18.52		50.0	
10279-CAA	PHS (QPSK, BW 884MHz, Rolloff 0.38)	X	8.51	78.75	19.47	9.03	50.0	± 9.6 %
		Y	7.31	76.76	18.01		50.0	
		Z	7.88	77.58	18.63		50.0	
10290-AAB	CDMA2000, RC1, SO55, Full Rate	X	1.28	66.85	12.83	0.00	150.0	± 9.6 %
		Y	1.15	66.36	12.07		150.0	
		Z	1.21	66.57	12.40		150.0	
10291-AAB	CDMA2000, RC3, SO55, Full Rate	X	0.73	64.15	11.20	0.00	150.0	± 9.6 %
		Y	0.69	64.04	10.71		150.0	
		Z	0.69	63.98	10.82		150.0	
10292-AAB	CDMA2000, RC3, SO32, Full Rate	X	0.85	66.79	12.92	0.00	150.0	± 9.6 %
		Y	0.83	67.15	12.67		150.0	
		Z	0.82	66.81	12.63		150.0	
10293-AAB	CDMA2000, RC3, SO3, Full Rate	X	1.14	70.77	15.25	0.00	150.0	± 9.6 %
		Y	1.22	72.07	15.35		150.0	
		Z	1.16	71.38	15.20		150.0	
10295-AAB	CDMA2000, RC1, SO3, 1/8th Rate 25 fr.	X	11.92	86.64	24.71	9.03	50.0	± 9.6 %
		Y	15.63	91.98	26.09		50.0	
		Z	13.21	88.61	25.13		50.0	
10297-AAC	LTE-FDD (SC-FDMA, 50% RB, 20 MHz, QPSK)	X	2.66	69.01	16.01	0.00	150.0	± 9.6 %
		Y	2.60	69.22	16.21		150.0	
		Z	2.62	69.08	16.08		150.0	
10298-AAC	LTE-FDD (SC-FDMA, 50% RB, 3 MHz, QPSK)	X	1.46	66.51	13.33	0.00	150.0	± 9.6 %
		Y	1.32	65.99	12.56		150.0	
		Z	1.39	66.26	12.94		150.0	
10299-AAC	LTE-FDD (SC-FDMA, 50% RB, 3 MHz, 16-QAM)	X	2.70	69.70	14.37	0.00	150.0	± 9.6 %
		Y	2.67	70.31	14.00		150.0	
		Z	2.72	70.11	14.27		150.0	
10300-AAC	LTE-FDD (SC-FDMA, 50% RB, 3 MHz, 64-QAM)	X	2.09	65.56	11.69	0.00	150.0	± 9.6 %
		Y	1.84	65.02	10.77		150.0	
		Z	1.98	65.35	11.29		150.0	
10301-AAA	IEEE 802.16e WiMAX (29:18, 5ms, 10MHz, QPSK, PUSC)	X	5.46	67.87	18.50	4.17	80.0	± 9.6 %
		Y	5.32	68.03	18.43		80.0	
		Z	5.39	67.94	18.48		80.0	
10302-AAA	IEEE 802.16e WiMAX (29:18, 5ms, 10MHz, QPSK, PUSC, 3 CTRL symbols)	X	5.85	67.98	18.95	4.96	80.0	± 9.6 %
		Y	5.80	68.69	19.24		80.0	
		Z	5.75	67.96	18.88		80.0	

10303-AAA	IEEE 802.16e WiMAX (31:15, 5ms, 10MHz, 64QAM, PUSC)	X	5.66	67.92	18.92	4.96	80.0	± 9.6 %
		Y	5.61	68.61	19.19		80.0	
		Z	5.56	67.86	18.83		80.0	
10304-AAA	IEEE 802.16e WiMAX (29:18, 5ms, 10MHz, 64QAM, PUSC)	X	5.35	67.35	18.18	4.17	80.0	± 9.6 %
		Y	5.30	68.04	18.43		80.0	
		Z	5.26	67.36	18.12		80.0	
10305-AAA	IEEE 802.16e WiMAX (31:15, 10ms, 10MHz, 64QAM, PUSC, 15 symbols)	X	7.05	76.99	23.82	6.02	50.0	± 9.6 %
		Y	7.19	78.32	24.16		50.0	
		Z	6.80	76.50	23.43		50.0	
10306-AAA	IEEE 802.16e WiMAX (29:18, 10ms, 10MHz, 64QAM, PUSC, 18 symbols)	X	5.82	69.84	20.44	6.02	50.0	± 9.6 %
		Y	5.84	70.99	20.86		50.0	
		Z	6.02	71.90	21.62		50.0	
10307-AAA	IEEE 802.16e WiMAX (29:18, 10ms, 10MHz, QPSK, PUSC, 18 symbols)	X	6.31	73.07	22.13	6.02	50.0	± 9.6 %
		Y	5.83	71.38	20.88		50.0	
		Z	6.11	72.72	21.84		50.0	
10308-AAA	IEEE 802.16e WiMAX (29:18, 10ms, 10MHz, 16QAM, PUSC)	X	6.39	73.64	22.41	6.02	50.0	± 9.6 %
		Y	5.90	71.88	21.13		50.0	
		Z	6.20	73.31	22.13		50.0	
10309-AAA	IEEE 802.16e WiMAX (29:18, 10ms, 10MHz, 16QAM, AMC 2x3, 18 symbols)	X	5.91	70.12	20.60	6.02	50.0	± 9.6 %
		Y	5.91	71.23	21.02		50.0	
		Z	6.11	72.19	21.79		50.0	
10310-AAA	IEEE 802.16e WiMAX (29:18, 10ms, 10MHz, QPSK, AMC 2x3, 18 symbols)	X	6.22	72.50	21.95	6.02	50.0	± 9.6 %
		Y	5.84	71.19	20.88		50.0	
		Z	6.05	72.25	21.70		50.0	
10311-AAC	LTE-FDD (SC-FDMA, 100% RB, 15 MHz, QPSK)	X	3.00	68.33	15.71	0.00	150.0	± 9.6 %
		Y	2.96	68.52	15.89		150.0	
		Z	2.97	68.38	15.77		150.0	
10313-AAA	iDEN 1:3	X	6.99	77.76	18.02	6.99	70.0	± 9.6 %
		Y	8.29	81.34	19.42		70.0	
		Z	7.24	78.54	18.23		70.0	
10314-AAA	iDEN 1:6	X	10.49	86.54	23.63	10.00	30.0	± 9.6 %
		Y	12.83	91.81	25.63		30.0	
		Z	11.85	89.04	24.41		30.0	
10315-AAB	IEEE 802.11b WiFi 2.4 GHz (DSSS, 1 Mbps, 96pc duty cycle)	X	1.08	63.85	14.84	0.17	150.0	± 9.6 %
		Y	1.11	64.19	15.04		150.0	
		Z	1.08	63.97	14.91		150.0	
10316-AAB	IEEE 802.11g WiFi 2.4 GHz (ERP-OFDM, 6 Mbps, 96pc duty cycle)	X	4.62	66.77	16.25	0.17	150.0	± 9.6 %
		Y	4.54	66.97	16.29		150.0	
		Z	4.57	66.82	16.26		150.0	
10317-AAC	IEEE 802.11a WiFi 5 GHz (OFDM, 6 Mbps, 96pc duty cycle)	X	4.62	66.77	16.25	0.17	150.0	± 9.6 %
		Y	4.54	66.97	16.29		150.0	
		Z	4.57	66.82	16.26		150.0	
10400-AAD	IEEE 802.11ac WiFi (20MHz, 64-QAM, 99pc duty cycle)	X	4.70	66.97	16.15	0.00	150.0	± 9.6 %
		Y	4.59	67.15	16.19		150.0	
		Z	4.64	67.01	16.16		150.0	
10401-AAD	IEEE 802.11ac WiFi (40MHz, 64-QAM, 99pc duty cycle)	X	5.41	67.24	16.37	0.00	150.0	± 9.6 %
		Y	5.32	67.38	16.42		150.0	
		Z	5.38	67.33	16.41		150.0	

10402-AAD	IEEE 802.11ac WiFi (80MHz, 64-QAM, 99pc duty cycle)	X	5.66	67.55	16.37	0.00	150.0	± 9.6 %
		Y	5.56	67.58	16.37		150.0	
		Z	5.60	67.52	16.36		150.0	
10403-AAB	CDMA2000 (1xEV-DO, Rev. 0)	X	1.28	66.85	12.83	0.00	115.0	± 9.6 %
		Y	1.15	66.36	12.07		115.0	
		Z	1.21	66.57	12.40		115.0	
10404-AAB	CDMA2000 (1xEV-DO, Rev. A)	X	1.28	66.85	12.83	0.00	115.0	± 9.6 %
		Y	1.15	66.36	12.07		115.0	
		Z	1.21	66.57	12.40		115.0	
10406-AAB	CDMA2000, RC3, SO32, SCH0, Full Rate	X	31.97	105.65	26.52	0.00	100.0	± 9.6 %
		Y	100.00	119.11	28.78		100.0	
		Z	100.00	120.25	29.60		100.0	
10410-AAD	LTE-TDD (SC-FDMA, 1 RB, 10 MHz, QPSK, UL Subframe=2,3,4,7,8,9, Subframe Conf=4)	X	100.00	119.16	29.68	3.23	80.0	± 9.6 %
		Y	100.00	122.81	30.98		80.0	
		Z	100.00	120.19	29.97		80.0	
10415-AAA	IEEE 802.11b WiFi 2.4 GHz (DSSS, 1 Mbps, 99pc duty cycle)	X	0.96	62.46	13.98	0.00	150.0	± 9.6 %
		Y	0.99	62.90	14.23		150.0	
		Z	0.95	62.59	14.06		150.0	
10416-AAA	IEEE 802.11g WiFi 2.4 GHz (ERP-OFDM, 6 Mbps, 99pc duty cycle)	X	4.53	66.62	16.09	0.00	150.0	± 9.6 %
		Y	4.45	66.83	16.13		150.0	
		Z	4.48	66.68	16.10		150.0	
10417-AAB	IEEE 802.11a/h WiFi 5 GHz (OFDM, 6 Mbps, 99pc duty cycle)	X	4.53	66.62	16.09	0.00	150.0	± 9.6 %
		Y	4.45	66.83	16.13		150.0	
		Z	4.48	66.68	16.10		150.0	
10418-AAA	IEEE 802.11g WiFi 2.4 GHz (DSSS-OFDM, 6 Mbps, 99pc duty cycle, Long preamble)	X	4.51	66.76	16.09	0.00	150.0	± 9.6 %
		Y	4.44	67.00	16.16		150.0	
		Z	4.47	66.83	16.12		150.0	
10419-AAA	IEEE 802.11g WiFi 2.4 GHz (DSSS-OFDM, 6 Mbps, 99pc duty cycle, Short preamble)	X	4.54	66.72	16.10	0.00	150.0	± 9.6 %
		Y	4.46	66.94	16.15		150.0	
		Z	4.49	66.78	16.12		150.0	
10422-AAB	IEEE 802.11n (HT Greenfield, 7.2 Mbps, BPSK)	X	4.66	66.73	16.13	0.00	150.0	± 9.6 %
		Y	4.57	66.94	16.17		150.0	
		Z	4.61	66.79	16.14		150.0	
10423-AAB	IEEE 802.11n (HT Greenfield, 43.3 Mbps, 16-QAM)	X	4.83	67.07	16.25	0.00	150.0	± 9.6 %
		Y	4.72	67.22	16.28		150.0	
		Z	4.77	67.10	16.25		150.0	
10424-AAB	IEEE 802.11n (HT Greenfield, 72.2 Mbps, 64-QAM)	X	4.75	67.01	16.22	0.00	150.0	± 9.6 %
		Y	4.64	67.18	16.25		150.0	
		Z	4.69	67.05	16.23		150.0	
10425-AAB	IEEE 802.11n (HT Greenfield, 15 Mbps, BPSK)	X	5.37	67.43	16.45	0.00	150.0	± 9.6 %
		Y	5.26	67.46	16.45		150.0	
		Z	5.32	67.43	16.46		150.0	
10426-AAB	IEEE 802.11n (HT Greenfield, 90 Mbps, 16-QAM)	X	5.37	67.44	16.46	0.00	150.0	± 9.6 %
		Y	5.28	67.55	16.49		150.0	
		Z	5.33	67.49	16.49		150.0	

10427-AAB	IEEE 802.11n (HT Greenfield, 150 Mbps, 64-QAM)	X	5.38	67.41	16.44	0.00	150.0	± 9.6 %
		Y	5.27	67.46	16.44		150.0	
		Z	5.33	67.43	16.45		150.0	
10430-AAB	LTE-FDD (OFDMA, 5 MHz, E-TM 3.1)	X	4.17	70.27	17.81	0.00	150.0	± 9.6 %
		Y	4.03	70.48	17.58		150.0	
		Z	4.14	70.57	17.85		150.0	
10431-AAB	LTE-FDD (OFDMA, 10 MHz, E-TM 3.1)	X	4.21	67.11	16.05	0.00	150.0	± 9.6 %
		Y	4.09	67.33	16.03		150.0	
		Z	4.15	67.18	16.04		150.0	
10432-AAB	LTE-FDD (OFDMA, 15 MHz, E-TM 3.1)	X	4.51	67.03	16.15	0.00	150.0	± 9.6 %
		Y	4.40	67.23	16.17		150.0	
		Z	4.46	67.08	16.15		150.0	
10433-AAB	LTE-FDD (OFDMA, 20 MHz, E-TM 3.1)	X	4.76	67.04	16.24	0.00	150.0	± 9.6 %
		Y	4.66	67.21	16.27		150.0	
		Z	4.71	67.08	16.24		150.0	
10434-AAA	W-CDMA (BS Test Model 1, 64 DPCH)	X	4.23	70.97	17.72	0.00	150.0	± 9.6 %
		Y	4.07	71.14	17.40		150.0	
		Z	4.21	71.31	17.74		150.0	
10435-AAC	LTE-TDD (SC-FDMA, 1 RB, 20 MHz, QPSK, UL Subframe=2,3,4,7,8,9)	X	100.00	118.98	29.60	3.23	80.0	± 9.6 %
		Y	100.00	122.59	30.87		80.0	
		Z	100.00	119.99	29.88		80.0	
10447-AAB	LTE-FDD (OFDMA, 5 MHz, E-TM 3.1, Clipping 44%)	X	3.49	66.99	15.32	0.00	150.0	± 9.6 %
		Y	3.34	67.16	15.09		150.0	
		Z	3.41	67.04	15.22		150.0	
10448-AAB	LTE-FDD (OFDMA, 10 MHz, E-TM 3.1, Clipping 44%)	X	4.04	66.88	15.90	0.00	150.0	± 9.6 %
		Y	3.94	67.12	15.89		150.0	
		Z	3.99	66.95	15.89		150.0	
10449-AAB	LTE-FDD (OFDMA, 15 MHz, E-TM 3.1, Clipping 44%)	X	4.32	66.84	16.03	0.00	150.0	± 9.6 %
		Y	4.23	67.04	16.06		150.0	
		Z	4.27	66.90	16.04		150.0	
10450-AAB	LTE-FDD (OFDMA, 20 MHz, E-TM 3.1, Clipping 44%)	X	4.51	66.79	16.08	0.00	150.0	± 9.6 %
		Y	4.44	66.97	16.11		150.0	
		Z	4.47	66.83	16.09		150.0	
10451-AAA	W-CDMA (BS Test Model 1, 64 DPCH, Clipping 44%)	X	3.37	67.12	14.92	0.00	150.0	± 9.6 %
		Y	3.19	67.13	14.54		150.0	
		Z	3.28	67.11	14.76		150.0	
10456-AAB	IEEE 802.11ac WiFi (160MHz, 64-QAM, 99pc duty cycle)	X	6.23	67.99	16.62	0.00	150.0	± 9.6 %
		Y	6.17	68.10	16.67		150.0	
		Z	6.19	67.99	16.63		150.0	
10457-AAA	UMTS-FDD (DC-HSDPA)	X	3.77	65.25	15.79	0.00	150.0	± 9.6 %
		Y	3.75	65.50	15.83		150.0	
		Z	3.75	65.32	15.80		150.0	
10458-AAA	CDMA2000 (1xEV-DO, Rev. B, 2 carriers)	X	3.87	70.16	17.10	0.00	150.0	± 9.6 %
		Y	3.71	70.34	16.66		150.0	
		Z	3.84	70.49	17.05		150.0	
10459-AAA	CDMA2000 (1xEV-DO, Rev. B, 3 carriers)	X	5.00	67.94	17.87	0.00	150.0	± 9.6 %
		Y	4.81	68.13	17.56		150.0	
		Z	4.96	68.23	17.89		150.0	

10460-AAA	UMTS-FDD (WCDMA, AMR)	X	0.79	66.34	14.61	0.00	150.0	± 9.6 %
		Y	0.84	67.16	15.15		150.0	
		Z	0.79	66.65	14.76		150.0	
10461-AAA	LTE-TDD (SC-FDMA, 1 RB, 1.4 MHz, QPSK, UL Subframe=2,3,4,7,8,9)	X	100.00	122.59	31.33	3.29	80.0	± 9.6 %
		Y	100.00	128.70	33.71		80.0	
		Z	100.00	124.88	32.17		80.0	
10462-AAA	LTE-TDD (SC-FDMA, 1 RB, 1.4 MHz, 16-QAM, UL Subframe=2,3,4,7,8,9)	X	21.46	90.49	19.92	3.23	80.0	± 9.6 %
		Y	100.00	107.87	23.85		80.0	
		Z	100.00	106.49	23.49		80.0	
10463-AAA	LTE-TDD (SC-FDMA, 1 RB, 1.4 MHz, 64-QAM, UL Subframe=2,3,4,7,8,9)	X	5.25	74.65	14.70	3.23	80.0	± 9.6 %
		Y	19.71	88.51	18.38		80.0	
		Z	7.19	78.06	15.56		80.0	
10464-AAA	LTE-TDD (SC-FDMA, 1 RB, 3 MHz, QPSK, UL Subframe=2,3,4,7,8,9)	X	100.00	120.34	30.14	3.23	80.0	± 9.6 %
		Y	100.00	126.35	32.46		80.0	
		Z	100.00	122.50	30.92		80.0	
10465-AAA	LTE-TDD (SC-FDMA, 1 RB, 3 MHz, 16-QAM, UL Subframe=2,3,4,7,8,9)	X	11.73	83.97	18.05	3.23	80.0	± 9.6 %
		Y	100.00	107.24	23.55		80.0	
		Z	41.80	97.17	21.26		80.0	
10466-AAA	LTE-TDD (SC-FDMA, 1 RB, 3 MHz, 64-QAM, UL Subframe=2,3,4,7,8,9)	X	4.09	72.04	13.74	3.23	80.0	± 9.6 %
		Y	8.97	80.87	16.24		80.0	
		Z	4.77	73.97	14.19		80.0	
10467-AAC	LTE-TDD (SC-FDMA, 1 RB, 5 MHz, QPSK, UL Subframe=2,3,4,7,8,9)	X	100.00	120.57	30.24	3.23	80.0	± 9.6 %
		Y	100.00	126.64	32.58		80.0	
		Z	100.00	122.76	31.03		80.0	
10468-AAC	LTE-TDD (SC-FDMA, 1 RB, 5 MHz, 16-QAM, UL Subframe=2,3,4,7,8,9)	X	13.52	85.52	18.51	3.23	80.0	± 9.6 %
		Y	100.00	107.47	23.65		80.0	
		Z	60.78	101.09	22.20		80.0	
10469-AAC	LTE-TDD (SC-FDMA, 1 RB, 5 MHz, 64-QAM, UL Subframe=2,3,4,7,8,9)	X	4.11	72.11	13.77	3.23	80.0	± 9.6 %
		Y	9.29	81.22	16.33		80.0	
		Z	4.83	74.11	14.24		80.0	
10470-AAC	LTE-TDD (SC-FDMA, 1 RB, 10 MHz, QPSK, UL Subframe=2,3,4,7,8,9)	X	100.00	120.59	30.24	3.23	80.0	± 9.6 %
		Y	100.00	126.67	32.59		80.0	
		Z	100.00	122.78	31.03		80.0	
10471-AAC	LTE-TDD (SC-FDMA, 1 RB, 10 MHz, 16-QAM, UL Subframe=2,3,4,7,8,9)	X	13.37	85.38	18.46	3.23	80.0	± 9.6 %
		Y	100.00	107.40	23.62		80.0	
		Z	59.33	100.79	22.11		80.0	
10472-AAC	LTE-TDD (SC-FDMA, 1 RB, 10 MHz, 64-QAM, UL Subframe=2,3,4,7,8,9)	X	4.08	72.03	13.72	3.23	80.0	± 9.6 %
		Y	9.15	81.05	16.27		80.0	
		Z	4.78	73.98	14.18		80.0	
10473-AAC	LTE-TDD (SC-FDMA, 1 RB, 15 MHz, QPSK, UL Subframe=2,3,4,7,8,9)	X	100.00	120.56	30.23	3.23	80.0	± 9.6 %
		Y	100.00	126.64	32.58		80.0	
		Z	100.00	122.75	31.02		80.0	
10474-AAC	LTE-TDD (SC-FDMA, 1 RB, 15 MHz, 16-QAM, UL Subframe=2,3,4,7,8,9)	X	13.19	85.24	18.42	3.23	80.0	± 9.6 %
		Y	100.00	107.40	23.61		80.0	
		Z	57.55	100.49	22.04		80.0	
10475-AAC	LTE-TDD (SC-FDMA, 1 RB, 15 MHz, 64-QAM, UL Subframe=2,3,4,7,8,9)	X	4.06	71.97	13.71	3.23	80.0	± 9.6 %
		Y	8.99	80.90	16.23		80.0	
		Z	4.73	73.90	14.15		80.0	

10477-AAC	LTE-TDD (SC-FDMA, 1 RB, 20 MHz, 16-QAM, UL Subframe=2,3,4,7,8,9)	X	11.86	84.06	18.05	3.23	80.0	± 9.6 %
		Y	100.00	107.19	23.51		80.0	
		Z	43.65	97.56	21.32		80.0	
10478-AAC	LTE-TDD (SC-FDMA, 1 RB, 20 MHz, 64-QAM, UL Subframe=2,3,4,7,8,9)	X	4.02	71.87	13.66	3.23	80.0	± 9.6 %
		Y	8.76	80.61	16.13		80.0	
		Z	4.66	73.74	14.09		80.0	
10479-AAA	LTE-TDD (SC-FDMA, 50% RB, 1.4 MHz, QPSK, UL Subframe=2,3,4,7,8,9)	X	14.17	93.60	25.28	3.23	80.0	± 9.6 %
		Y	63.86	118.32	31.85		80.0	
		Z	30.71	105.97	28.68		80.0	
10480-AAA	LTE-TDD (SC-FDMA, 50% RB, 1.4 MHz, 16-QAM, UL Subframe=2,3,4,7,8,9)	X	12.48	86.47	21.39	3.23	80.0	± 9.6 %
		Y	53.06	106.13	26.31		80.0	
		Z	23.73	95.20	23.69		80.0	
10481-AAA	LTE-TDD (SC-FDMA, 50% RB, 1.4 MHz, 64-QAM, UL Subframe=2,3,4,7,8,9)	X	9.79	82.49	19.78	3.23	80.0	± 9.6 %
		Y	26.62	95.88	23.20		80.0	
		Z	15.46	88.60	21.40		80.0	
10482-AAA	LTE-TDD (SC-FDMA, 50% RB, 3 MHz, QPSK, UL Subframe=2,3,4,7,8,9)	X	4.76	76.35	18.33	2.23	80.0	± 9.6 %
		Y	4.38	75.77	17.66		80.0	
		Z	4.74	76.54	18.16		80.0	
10483-AAA	LTE-TDD (SC-FDMA, 50% RB, 3 MHz, 16-QAM, UL Subframe=2,3,4,7,8,9)	X	6.86	78.09	18.71	2.23	80.0	± 9.6 %
		Y	7.58	79.80	18.72		80.0	
		Z	7.91	80.19	19.17		80.0	
10484-AAA	LTE-TDD (SC-FDMA, 50% RB, 3 MHz, 64-QAM, UL Subframe=2,3,4,7,8,9)	X	6.29	76.73	18.22	2.23	80.0	± 9.6 %
		Y	6.51	77.64	17.97		80.0	
		Z	6.95	78.27	18.51		80.0	
10485-AAC	LTE-TDD (SC-FDMA, 50% RB, 5 MHz, QPSK, UL Subframe=2,3,4,7,8,9)	X	5.21	77.92	19.79	2.23	80.0	± 9.6 %
		Y	5.14	78.56	19.82		80.0	
		Z	5.34	78.68	19.95		80.0	
10486-AAC	LTE-TDD (SC-FDMA, 50% RB, 5 MHz, 16-QAM, UL Subframe=2,3,4,7,8,9)	X	4.30	72.12	17.19	2.23	80.0	± 9.6 %
		Y	4.02	71.85	16.65		80.0	
		Z	4.23	72.22	17.03		80.0	
10487-AAC	LTE-TDD (SC-FDMA, 50% RB, 5 MHz, 64-QAM, UL Subframe=2,3,4,7,8,9)	X	4.25	71.63	16.98	2.23	80.0	± 9.6 %
		Y	3.95	71.26	16.39		80.0	
		Z	4.16	71.66	16.79		80.0	
10488-AAC	LTE-TDD (SC-FDMA, 50% RB, 10 MHz, QPSK, UL Subframe=2,3,4,7,8,9)	X	5.17	76.41	19.90	2.23	80.0	± 9.6 %
		Y	5.01	76.93	20.15		80.0	
		Z	5.17	76.91	20.10		80.0	
10489-AAC	LTE-TDD (SC-FDMA, 50% RB, 10 MHz, 16-QAM, UL Subframe=2,3,4,7,8,9)	X	4.47	71.61	18.14	2.23	80.0	± 9.6 %
		Y	4.30	71.84	18.12		80.0	
		Z	4.42	71.84	18.19		80.0	
10490-AAC	LTE-TDD (SC-FDMA, 50% RB, 10 MHz, 64-QAM, UL Subframe=2,3,4,7,8,9)	X	4.53	71.33	18.05	2.23	80.0	± 9.6 %
		Y	4.36	71.56	18.01		80.0	
		Z	4.48	71.55	18.09		80.0	
10491-AAC	LTE-TDD (SC-FDMA, 50% RB, 15 MHz, QPSK, UL Subframe=2,3,4,7,8,9)	X	5.06	74.04	19.16	2.23	80.0	± 9.6 %
		Y	4.88	74.37	19.37		80.0	
		Z	5.01	74.33	19.30		80.0	
10492-AAC	LTE-TDD (SC-FDMA, 50% RB, 15 MHz, 16-QAM, UL Subframe=2,3,4,7,8,9)	X	4.71	70.55	18.02	2.23	80.0	± 9.6 %
		Y	4.54	70.71	18.05		80.0	
		Z	4.64	70.68	18.06		80.0	

10493-AAC	LTE-TDD (SC-FDMA, 50% RB, 15 MHz, 64-QAM, UL Subframe=2,3,4,7,8,9)	X	4.76	70.36	17.96	2.23	80.0	± 9.6 %
		Y	4.58	70.52	17.98		80.0	
		Z	4.69	70.49	18.00		80.0	
10494-AAC	LTE-TDD (SC-FDMA, 50% RB, 20 MHz, QPSK, UL Subframe=2,3,4,7,8,9)	X	5.60	75.75	19.64	2.23	80.0	± 9.6 %
		Y	5.37	76.02	19.87		80.0	
		Z	5.56	76.06	19.81		80.0	
10495-AAC	LTE-TDD (SC-FDMA, 50% RB, 20 MHz, 16-QAM, UL Subframe=2,3,4,7,8,9)	X	4.78	71.03	18.23	2.23	80.0	± 9.6 %
		Y	4.59	71.11	18.27		80.0	
		Z	4.71	71.14	18.28		80.0	
10496-AAC	LTE-TDD (SC-FDMA, 50% RB, 20 MHz, 64-QAM, UL Subframe=2,3,4,7,8,9)	X	4.83	70.65	18.12	2.23	80.0	± 9.6 %
		Y	4.64	70.74	18.15		80.0	
		Z	4.75	70.76	18.17		80.0	
10497-AAA	LTE-TDD (SC-FDMA, 100% RB, 1.4 MHz, QPSK, UL Subframe=2,3,4,7,8,9)	X	3.37	71.45	15.57	2.23	80.0	± 9.6 %
		Y	2.72	69.17	13.95		80.0	
		Z	3.09	70.50	14.83		80.0	
10498-AAA	LTE-TDD (SC-FDMA, 100% RB, 1.4 MHz, 16-QAM, UL Subframe=2,3,4,7,8,9)	X	2.40	64.81	11.76	2.23	80.0	± 9.6 %
		Y	1.75	62.03	9.60		80.0	
		Z	2.07	63.39	10.68		80.0	
10499-AAA	LTE-TDD (SC-FDMA, 100% RB, 1.4 MHz, 64-QAM, UL Subframe=2,3,4,7,8,9)	X	2.32	64.18	11.33	2.23	80.0	± 9.6 %
		Y	1.68	61.41	9.14		80.0	
		Z	1.99	62.76	10.23		80.0	
10500-AAA	LTE-TDD (SC-FDMA, 100% RB, 3 MHz, QPSK, UL Subframe=2,3,4,7,8,9)	X	5.05	76.85	19.69	2.23	80.0	± 9.6 %
		Y	4.98	77.59	19.85		80.0	
		Z	5.12	77.53	19.88		80.0	
10501-AAA	LTE-TDD (SC-FDMA, 100% RB, 3 MHz, 16-QAM, UL Subframe=2,3,4,7,8,9)	X	4.38	71.91	17.55	2.23	80.0	± 9.6 %
		Y	4.19	72.01	17.27		80.0	
		Z	4.33	72.13	17.50		80.0	
10502-AAA	LTE-TDD (SC-FDMA, 100% RB, 3 MHz, 64-QAM, UL Subframe=2,3,4,7,8,9)	X	4.41	71.66	17.40	2.23	80.0	± 9.6 %
		Y	4.21	71.71	17.09		80.0	
		Z	4.36	71.85	17.33		80.0	
10503-AAC	LTE-TDD (SC-FDMA, 100% RB, 5 MHz, QPSK, UL Subframe=2,3,4,7,8,9)	X	5.10	76.19	19.80	2.23	80.0	± 9.6 %
		Y	4.94	76.71	20.05		80.0	
		Z	5.10	76.67	19.99		80.0	
10504-AAC	LTE-TDD (SC-FDMA, 100% RB, 5 MHz, 16-QAM, UL Subframe=2,3,4,7,8,9)	X	4.44	71.51	18.08	2.23	80.0	± 9.6 %
		Y	4.28	71.74	18.06		80.0	
		Z	4.39	71.73	18.13		80.0	
10505-AAC	LTE-TDD (SC-FDMA, 100% RB, 5 MHz, 64-QAM, UL Subframe=2,3,4,7,8,9)	X	4.51	71.23	18.00	2.23	80.0	± 9.6 %
		Y	4.34	71.46	17.96		80.0	
		Z	4.45	71.44	18.03		80.0	
10506-AAC	LTE-TDD (SC-FDMA, 100% RB, 10 MHz, QPSK, UL Subframe=2,3,4,7,8,9)	X	5.55	75.59	19.57	2.23	80.0	± 9.6 %
		Y	5.33	75.87	19.80		80.0	
		Z	5.51	75.90	19.73		80.0	
10507-AAC	LTE-TDD (SC-FDMA, 100% RB, 10 MHz, 16-QAM, UL Subframe=2,3,4,7,8,9)	X	4.76	70.96	18.19	2.23	80.0	± 9.6 %
		Y	4.57	71.05	18.23		80.0	
		Z	4.69	71.07	18.24		80.0	

10508-AAC	LTE-TDD (SC-FDMA, 100% RB, 10 MHz, 64-QAM, UL Subframe=2,3,4,7,8,9)	X	4.81	70.58	18.08	2.23	80.0	± 9.6 %
		Y	4.62	70.68	18.11		80.0	
		Z	4.73	70.68	18.12		80.0	
10509-AAC	LTE-TDD (SC-FDMA, 100% RB, 15 MHz, QPSK, UL Subframe=2,3,4,7,8,9)	X	5.59	73.58	18.84	2.23	80.0	± 9.6 %
		Y	5.39	73.76	19.02		80.0	
		Z	5.53	73.76	18.95		80.0	
10510-AAC	LTE-TDD (SC-FDMA, 100% RB, 15 MHz, 16-QAM, UL Subframe=2,3,4,7,8,9)	X	5.20	70.42	18.08	2.23	80.0	± 9.6 %
		Y	4.99	70.43	18.12		80.0	
		Z	5.11	70.45	18.12		80.0	
10511-AAC	LTE-TDD (SC-FDMA, 100% RB, 15 MHz, 64-QAM, UL Subframe=2,3,4,7,8,9)	X	5.22	70.10	18.00	2.23	80.0	± 9.6 %
		Y	5.03	70.13	18.04		80.0	
		Z	5.14	70.14	18.03		80.0	
10512-AAC	LTE-TDD (SC-FDMA, 100% RB, 20 MHz, QPSK, UL Subframe=2,3,4,7,8,9)	X	6.02	75.44	19.39	2.23	80.0	± 9.6 %
		Y	5.78	75.56	19.57		80.0	
		Z	5.97	75.65	19.51		80.0	
10513-AAC	LTE-TDD (SC-FDMA, 100% RB, 20 MHz, 16-QAM, UL Subframe=2,3,4,7,8,9)	X	5.12	70.82	18.23	2.23	80.0	± 9.6 %
		Y	4.91	70.75	18.25		80.0	
		Z	5.03	70.83	18.26		80.0	
10514-AAC	LTE-TDD (SC-FDMA, 100% RB, 20 MHz, 64-QAM, UL Subframe=2,3,4,7,8,9)	X	5.09	70.31	18.08	2.23	80.0	± 9.6 %
		Y	4.90	70.27	18.11		80.0	
		Z	5.01	70.33	18.11		80.0	
10515-AAA	IEEE 802.11b WiFi 2.4 GHz (DSSS, 2 Mbps, 99pc duty cycle)	X	0.92	62.60	13.99	0.00	150.0	± 9.6 %
		Y	0.95	63.05	14.27		150.0	
		Z	0.91	62.72	14.07		150.0	
10516-AAA	IEEE 802.11b WiFi 2.4 GHz (DSSS, 5.5 Mbps, 99pc duty cycle)	X	0.48	67.26	14.71	0.00	150.0	± 9.6 %
		Y	0.54	68.48	15.75		150.0	
		Z	0.49	67.82	15.05		150.0	
10517-AAA	IEEE 802.11b WiFi 2.4 GHz (DSSS, 11 Mbps, 99pc duty cycle)	X	0.75	64.05	14.24	0.00	150.0	± 9.6 %
		Y	0.79	64.60	14.65		150.0	
		Z	0.75	64.23	14.37		150.0	
10518-AAB	IEEE 802.11a/h WiFi 5 GHz (OFDM, 9 Mbps, 99pc duty cycle)	X	4.52	66.69	16.06	0.00	150.0	± 9.6 %
		Y	4.44	66.90	16.10		150.0	
		Z	4.47	66.75	16.07		150.0	
10519-AAB	IEEE 802.11a/h WiFi 5 GHz (OFDM, 12 Mbps, 99pc duty cycle)	X	4.71	66.95	16.20	0.00	150.0	± 9.6 %
		Y	4.60	67.11	16.21		150.0	
		Z	4.65	66.98	16.20		150.0	
10520-AAB	IEEE 802.11a/h WiFi 5 GHz (OFDM, 18 Mbps, 99pc duty cycle)	X	4.56	66.90	16.11	0.00	150.0	± 9.6 %
		Y	4.46	67.05	16.12		150.0	
		Z	4.50	66.93	16.11		150.0	
10521-AAB	IEEE 802.11a/h WiFi 5 GHz (OFDM, 24 Mbps, 99pc duty cycle)	X	4.49	66.89	16.09	0.00	150.0	± 9.6 %
		Y	4.39	67.03	16.11		150.0	
		Z	4.44	66.91	16.09		150.0	
10522-AAB	IEEE 802.11a/h WiFi 5 GHz (OFDM, 36 Mbps, 99pc duty cycle)	X	4.55	66.96	16.17	0.00	150.0	± 9.6 %
		Y	4.45	67.16	16.21		150.0	
		Z	4.50	67.02	16.19		150.0	

10523-AAB	IEEE 802.11a/h WiFi 5 GHz (OFDM, 48 Mbps, 99pc duty cycle)	X	4.43	66.81	16.00	0.00	150.0	± 9.6 %
		Y	4.35	67.05	16.07		150.0	
		Z	4.38	66.88	16.02		150.0	
10524-AAB	IEEE 802.11a/h WiFi 5 GHz (OFDM, 54 Mbps, 99pc duty cycle)	X	4.50	66.89	16.14	0.00	150.0	± 9.6 %
		Y	4.39	67.08	16.18		150.0	
		Z	4.44	66.94	16.15		150.0	
10525-AAB	IEEE 802.11ac WiFi (20MHz, MCS0, 99pc duty cycle)	X	4.47	65.92	15.72	0.00	150.0	± 9.6 %
		Y	4.40	66.15	15.78		150.0	
		Z	4.43	65.98	15.74		150.0	
10526-AAB	IEEE 802.11ac WiFi (20MHz, MCS1, 99pc duty cycle)	X	4.65	66.29	15.87	0.00	150.0	± 9.6 %
		Y	4.55	66.47	15.91		150.0	
		Z	4.59	66.34	15.88		150.0	
10527-AAB	IEEE 802.11ac WiFi (20MHz, MCS2, 99pc duty cycle)	X	4.57	66.25	15.81	0.00	150.0	± 9.6 %
		Y	4.47	66.43	15.85		150.0	
		Z	4.52	66.29	15.82		150.0	
10528-AAB	IEEE 802.11ac WiFi (20MHz, MCS3, 99pc duty cycle)	X	4.58	66.27	15.84	0.00	150.0	± 9.6 %
		Y	4.49	66.45	15.88		150.0	
		Z	4.53	66.31	15.85		150.0	
10529-AAB	IEEE 802.11ac WiFi (20MHz, MCS4, 99pc duty cycle)	X	4.58	66.27	15.84	0.00	150.0	± 9.6 %
		Y	4.49	66.45	15.88		150.0	
		Z	4.53	66.31	15.85		150.0	
10531-AAB	IEEE 802.11ac WiFi (20MHz, MCS6, 99pc duty cycle)	X	4.58	66.38	15.85	0.00	150.0	± 9.6 %
		Y	4.46	66.51	15.87		150.0	
		Z	4.52	66.40	15.86		150.0	
10532-AAB	IEEE 802.11ac WiFi (20MHz, MCS7, 99pc duty cycle)	X	4.44	66.22	15.78	0.00	150.0	± 9.6 %
		Y	4.33	66.36	15.80		150.0	
		Z	4.38	66.25	15.78		150.0	
10533-AAB	IEEE 802.11ac WiFi (20MHz, MCS8, 99pc duty cycle)	X	4.59	66.30	15.83	0.00	150.0	± 9.6 %
		Y	4.49	66.51	15.88		150.0	
		Z	4.54	66.36	15.84		150.0	
10534-AAB	IEEE 802.11ac WiFi (40MHz, MCS0, 99pc duty cycle)	X	5.13	66.43	15.94	0.00	150.0	± 9.6 %
		Y	5.04	66.54	15.97		150.0	
		Z	5.08	66.45	15.95		150.0	
10535-AAB	IEEE 802.11ac WiFi (40MHz, MCS1, 99pc duty cycle)	X	5.20	66.61	16.01	0.00	150.0	± 9.6 %
		Y	5.10	66.71	16.05		150.0	
		Z	5.15	66.64	16.04		150.0	
10536-AAB	IEEE 802.11ac WiFi (40MHz, MCS2, 99pc duty cycle)	X	5.06	66.54	15.96	0.00	150.0	± 9.6 %
		Y	4.98	66.67	16.01		150.0	
		Z	5.01	66.57	15.98		150.0	
10537-AAB	IEEE 802.11ac WiFi (40MHz, MCS3, 99pc duty cycle)	X	5.12	66.52	15.95	0.00	150.0	± 9.6 %
		Y	5.03	66.63	15.99		150.0	
		Z	5.07	66.54	15.97		150.0	
10538-AAB	IEEE 802.11ac WiFi (40MHz, MCS4, 99pc duty cycle)	X	5.22	66.56	16.02	0.00	150.0	± 9.6 %
		Y	5.11	66.64	16.04		150.0	
		Z	5.16	66.56	16.02		150.0	
10540-AAB	IEEE 802.11ac WiFi (40MHz, MCS6, 99pc duty cycle)	X	5.14	66.57	16.03	0.00	150.0	± 9.6 %
		Y	5.04	66.62	16.05		150.0	
		Z	5.10	66.60	16.05		150.0	

10541-AAB	IEEE 802.11ac WiFi (40MHz, MCS7, 99pc duty cycle)	X	5.11	66.43	15.96	0.00	150.0	± 9.6 %
		Y	5.02	66.51	15.98		150.0	
		Z	5.07	66.45	15.97		150.0	
10542-AAB	IEEE 802.11ac WiFi (40MHz, MCS8, 99pc duty cycle)	X	5.27	66.51	16.02	0.00	150.0	± 9.6 %
		Y	5.18	66.61	16.04		150.0	
		Z	5.22	66.53	16.03		150.0	
10543-AAB	IEEE 802.11ac WiFi (40MHz, MCS9, 99pc duty cycle)	X	5.36	66.57	16.06	0.00	150.0	± 9.6 %
		Y	5.24	66.63	16.08		150.0	
		Z	5.30	66.57	16.07		150.0	
10544-AAB	IEEE 802.11ac WiFi (80MHz, MCS0, 99pc duty cycle)	X	5.43	66.55	15.94	0.00	150.0	± 9.6 %
		Y	5.37	66.65	15.97		150.0	
		Z	5.40	66.56	15.95		150.0	
10545-AAB	IEEE 802.11ac WiFi (80MHz, MCS1, 99pc duty cycle)	X	5.64	67.00	16.11	0.00	150.0	± 9.6 %
		Y	5.55	67.08	16.15		150.0	
		Z	5.60	67.02	16.13		150.0	
10546-AAB	IEEE 802.11ac WiFi (80MHz, MCS2, 99pc duty cycle)	X	5.50	66.78	16.02	0.00	150.0	± 9.6 %
		Y	5.41	66.80	16.02		150.0	
		Z	5.46	66.76	16.01		150.0	
10547-AAB	IEEE 802.11ac WiFi (80MHz, MCS3, 99pc duty cycle)	X	5.58	66.83	16.03	0.00	150.0	± 9.6 %
		Y	5.49	66.87	16.05		150.0	
		Z	5.53	66.81	16.03		150.0	
10548-AAB	IEEE 802.11ac WiFi (80MHz, MCS4, 99pc duty cycle)	X	5.89	67.94	16.56	0.00	150.0	± 9.6 %
		Y	5.69	67.68	16.43		150.0	
		Z	5.80	67.83	16.51		150.0	
10550-AAB	IEEE 802.11ac WiFi (80MHz, MCS6, 99pc duty cycle)	X	5.53	66.79	16.03	0.00	150.0	± 9.6 %
		Y	5.46	66.91	16.08		150.0	
		Z	5.49	66.81	16.05		150.0	
10551-AAB	IEEE 802.11ac WiFi (80MHz, MCS7, 99pc duty cycle)	X	5.53	66.82	16.01	0.00	150.0	± 9.6 %
		Y	5.44	66.85	16.02		150.0	
		Z	5.49	66.83	16.02		150.0	
10552-AAB	IEEE 802.11ac WiFi (80MHz, MCS8, 99pc duty cycle)	X	5.44	66.61	15.91	0.00	150.0	± 9.6 %
		Y	5.38	66.72	15.95		150.0	
		Z	5.40	66.62	15.92		150.0	
10553-AAB	IEEE 802.11ac WiFi (80MHz, MCS9, 99pc duty cycle)	X	5.53	66.66	15.96	0.00	150.0	± 9.6 %
		Y	5.45	66.72	15.99		150.0	
		Z	5.48	66.65	15.97		150.0	
10554-AAC	IEEE 802.11ac WiFi (160MHz, MCS0, 99pc duty cycle)	X	5.84	66.93	16.04	0.00	150.0	± 9.6 %
		Y	5.78	67.01	16.06		150.0	
		Z	5.81	66.94	16.05		150.0	
10555-AAC	IEEE 802.11ac WiFi (160MHz, MCS1, 99pc duty cycle)	X	5.98	67.25	16.17	0.00	150.0	± 9.6 %
		Y	5.90	67.29	16.19		150.0	
		Z	5.94	67.25	16.18		150.0	
10556-AAC	IEEE 802.11ac WiFi (160MHz, MCS2, 99pc duty cycle)	X	6.00	67.29	16.19	0.00	150.0	± 9.6 %
		Y	5.93	67.35	16.21		150.0	
		Z	5.96	67.30	16.20		150.0	
10557-AAC	IEEE 802.11ac WiFi (160MHz, MCS3, 99pc duty cycle)	X	5.96	67.20	16.16	0.00	150.0	± 9.6 %
		Y	5.88	67.23	16.17		150.0	
		Z	5.92	67.18	16.16		150.0	

10558-AAC	IEEE 802.11ac WiFi (160MHz, MCS4, 99pc duty cycle)	X	6.01	67.37	16.26	0.00	150.0	± 9.6 %
		Y	5.92	67.38	16.26		150.0	
		Z	5.97	67.35	16.26		150.0	
10560-AAC	IEEE 802.11ac WiFi (160MHz, MCS6, 99pc duty cycle)	X	6.01	67.21	16.22	0.00	150.0	± 9.6 %
		Y	5.92	67.24	16.23		150.0	
		Z	5.96	67.19	16.22		150.0	
10561-AAC	IEEE 802.11ac WiFi (160MHz, MCS7, 99pc duty cycle)	X	5.93	67.18	16.25	0.00	150.0	± 9.6 %
		Y	5.85	67.23	16.26		150.0	
		Z	5.89	67.18	16.25		150.0	
10562-AAC	IEEE 802.11ac WiFi (160MHz, MCS8, 99pc duty cycle)	X	6.07	67.61	16.46	0.00	150.0	± 9.6 %
		Y	5.94	67.50	16.40		150.0	
		Z	6.01	67.54	16.43		150.0	
10563-AAC	IEEE 802.11ac WiFi (160MHz, MCS9, 99pc duty cycle)	X	6.39	68.16	16.69	0.00	150.0	± 9.6 %
		Y	6.02	67.41	16.31		150.0	
		Z	6.19	67.71	16.48		150.0	
10564-AAA	IEEE 802.11g WiFi 2.4 GHz (DSSS-OFDM, 9 Mbps, 99pc duty cycle)	X	4.86	66.83	16.26	0.46	150.0	± 9.6 %
		Y	4.78	67.03	16.31		150.0	
		Z	4.81	66.87	16.27		150.0	
10565-AAA	IEEE 802.11g WiFi 2.4 GHz (DSSS-OFDM, 12 Mbps, 99pc duty cycle)	X	5.09	67.28	16.58	0.46	150.0	± 9.6 %
		Y	4.98	67.43	16.60		150.0	
		Z	5.03	67.31	16.59		150.0	
10566-AAA	IEEE 802.11g WiFi 2.4 GHz (DSSS-OFDM, 18 Mbps, 99pc duty cycle)	X	4.93	67.13	16.40	0.46	150.0	± 9.6 %
		Y	4.82	67.27	16.42		150.0	
		Z	4.87	67.15	16.40		150.0	
10567-AAA	IEEE 802.11g WiFi 2.4 GHz (DSSS-OFDM, 24 Mbps, 99pc duty cycle)	X	4.95	67.50	16.74	0.46	150.0	± 9.6 %
		Y	4.84	67.61	16.74		150.0	
		Z	4.90	67.52	16.74		150.0	
10568-AAA	IEEE 802.11g WiFi 2.4 GHz (DSSS-OFDM, 36 Mbps, 99pc duty cycle)	X	4.85	66.93	16.19	0.46	150.0	± 9.6 %
		Y	4.74	67.12	16.24		150.0	
		Z	4.79	66.97	16.19		150.0	
10569-AAA	IEEE 802.11g WiFi 2.4 GHz (DSSS-OFDM, 48 Mbps, 99pc duty cycle)	X	4.91	67.57	16.79	0.46	150.0	± 9.6 %
		Y	4.82	67.76	16.84		150.0	
		Z	4.86	67.64	16.82		150.0	
10570-AAA	IEEE 802.11g WiFi 2.4 GHz (DSSS-OFDM, 54 Mbps, 99pc duty cycle)	X	4.94	67.43	16.73	0.46	150.0	± 9.6 %
		Y	4.84	67.60	16.77		150.0	
		Z	4.89	67.48	16.75		150.0	
10571-AAA	IEEE 802.11b WiFi 2.4 GHz (DSSS, 1 Mbps, 90pc duty cycle)	X	1.25	65.19	15.53	0.46	130.0	± 9.6 %
		Y	1.27	65.45	15.71		130.0	
		Z	1.24	65.29	15.60		130.0	
10572-AAA	IEEE 802.11b WiFi 2.4 GHz (DSSS, 2 Mbps, 90pc duty cycle)	X	1.27	65.79	15.87	0.46	130.0	± 9.6 %
		Y	1.28	66.03	16.05		130.0	
		Z	1.26	65.90	15.96		130.0	
10573-AAA	IEEE 802.11b WiFi 2.4 GHz (DSSS, 5.5 Mbps, 90pc duty cycle)	X	2.61	85.52	21.81	0.46	130.0	± 9.6 %
		Y	2.97	88.51	23.34		130.0	
		Z	3.01	88.05	22.71		130.0	
10574-AAA	IEEE 802.11b WiFi 2.4 GHz (DSSS, 11 Mbps, 90pc duty cycle)	X	1.44	71.64	18.59	0.46	130.0	± 9.6 %
		Y	1.44	71.68	18.74		130.0	
		Z	1.45	72.00	18.80		130.0	

10575-AAA	IEEE 802.11g WiFi 2.4 GHz (DSSS-OFDM, 6 Mbps, 90pc duty cycle)	X	4.68	66.71	16.37	0.46	130.0	± 9.6 %
		Y	4.59	66.91	16.41		130.0	
		Z	4.63	66.76	16.38		130.0	
10576-AAA	IEEE 802.11g WiFi 2.4 GHz (DSSS-OFDM, 9 Mbps, 90pc duty cycle)	X	4.70	66.86	16.43	0.46	130.0	± 9.6 %
		Y	4.61	67.07	16.47		130.0	
		Z	4.65	66.92	16.44		130.0	
10577-AAA	IEEE 802.11g WiFi 2.4 GHz (DSSS-OFDM, 12 Mbps, 90pc duty cycle)	X	4.91	67.16	16.60	0.46	130.0	± 9.6 %
		Y	4.79	67.31	16.62		130.0	
		Z	4.85	67.20	16.60		130.0	
10578-AAA	IEEE 802.11g WiFi 2.4 GHz (DSSS-OFDM, 18 Mbps, 90pc duty cycle)	X	4.81	67.32	16.69	0.46	130.0	± 9.6 %
		Y	4.69	67.44	16.70		130.0	
		Z	4.75	67.35	16.70		130.0	
10579-AAA	IEEE 802.11g WiFi 2.4 GHz (DSSS-OFDM, 24 Mbps, 90pc duty cycle)	X	4.58	66.65	16.03	0.46	130.0	± 9.6 %
		Y	4.47	66.80	16.06		130.0	
		Z	4.52	66.66	16.02		130.0	
10580-AAA	IEEE 802.11g WiFi 2.4 GHz (DSSS-OFDM, 36 Mbps, 90pc duty cycle)	X	4.63	66.68	16.05	0.46	130.0	± 9.6 %
		Y	4.52	66.87	16.11		130.0	
		Z	4.57	66.71	16.05		130.0	
10581-AAA	IEEE 802.11g WiFi 2.4 GHz (DSSS-OFDM, 48 Mbps, 90pc duty cycle)	X	4.71	67.36	16.64	0.46	130.0	± 9.6 %
		Y	4.60	67.52	16.66		130.0	
		Z	4.65	67.41	16.65		130.0	
10582-AAA	IEEE 802.11g WiFi 2.4 GHz (DSSS-OFDM, 54 Mbps, 90pc duty cycle)	X	4.53	66.42	15.83	0.46	130.0	± 9.6 %
		Y	4.41	66.60	15.88		130.0	
		Z	4.46	66.43	15.82		130.0	
10583-AAB	IEEE 802.11a/h WiFi 5 GHz (OFDM, 6 Mbps, 90pc duty cycle)	X	4.68	66.71	16.37	0.46	130.0	± 9.6 %
		Y	4.59	66.91	16.41		130.0	
		Z	4.63	66.76	16.38		130.0	
10584-AAB	IEEE 802.11a/h WiFi 5 GHz (OFDM, 9 Mbps, 90pc duty cycle)	X	4.70	66.86	16.43	0.46	130.0	± 9.6 %
		Y	4.61	67.07	16.47		130.0	
		Z	4.65	66.92	16.44		130.0	
10585-AAB	IEEE 802.11a/h WiFi 5 GHz (OFDM, 12 Mbps, 90pc duty cycle)	X	4.91	67.16	16.60	0.46	130.0	± 9.6 %
		Y	4.79	67.31	16.62		130.0	
		Z	4.85	67.20	16.60		130.0	
10586-AAB	IEEE 802.11a/h WiFi 5 GHz (OFDM, 18 Mbps, 90pc duty cycle)	X	4.81	67.32	16.69	0.46	130.0	± 9.6 %
		Y	4.69	67.44	16.70		130.0	
		Z	4.75	67.35	16.70		130.0	
10587-AAB	IEEE 802.11a/h WiFi 5 GHz (OFDM, 24 Mbps, 90pc duty cycle)	X	4.58	66.65	16.03	0.46	130.0	± 9.6 %
		Y	4.47	66.80	16.06		130.0	
		Z	4.52	66.66	16.02		130.0	
10588-AAB	IEEE 802.11a/h WiFi 5 GHz (OFDM, 36 Mbps, 90pc duty cycle)	X	4.63	66.68	16.05	0.46	130.0	± 9.6 %
		Y	4.52	66.87	16.11		130.0	
		Z	4.57	66.71	16.05		130.0	
10589-AAB	IEEE 802.11a/h WiFi 5 GHz (OFDM, 48 Mbps, 90pc duty cycle)	X	4.71	67.36	16.64	0.46	130.0	± 9.6 %
		Y	4.60	67.52	16.66		130.0	
		Z	4.65	67.41	16.65		130.0	
10590-AAB	IEEE 802.11a/h WiFi 5 GHz (OFDM, 54 Mbps, 90pc duty cycle)	X	4.53	66.42	15.83	0.46	130.0	± 9.6 %
		Y	4.41	66.60	15.88		130.0	
		Z	4.46	66.43	15.82		130.0	

10591-AAB	IEEE 802.11n (HT Mixed, 20MHz, MCS0, 90pc duty cycle)	X	4.83	66.77	16.47	0.46	130.0	± 9.6 %
		Y	4.74	66.96	16.50		130.0	
		Z	4.78	66.82	16.48		130.0	
10592-AAB	IEEE 802.11n (HT Mixed, 20MHz, MCS1, 90pc duty cycle)	X	4.98	67.10	16.60	0.46	130.0	± 9.6 %
		Y	4.87	67.27	16.63		130.0	
		Z	4.93	67.14	16.61		130.0	
10593-AAB	IEEE 802.11n (HT Mixed, 20MHz, MCS2, 90pc duty cycle)	X	4.91	67.02	16.48	0.46	130.0	± 9.6 %
		Y	4.80	67.17	16.51		130.0	
		Z	4.85	67.05	16.49		130.0	
10594-AAB	IEEE 802.11n (HT Mixed, 20MHz, MCS3, 90pc duty cycle)	X	4.96	67.18	16.63	0.46	130.0	± 9.6 %
		Y	4.85	67.33	16.66		130.0	
		Z	4.90	67.22	16.64		130.0	
10595-AAB	IEEE 802.11n (HT Mixed, 20MHz, MCS4, 90pc duty cycle)	X	4.93	67.14	16.53	0.46	130.0	± 9.6 %
		Y	4.82	67.31	16.57		130.0	
		Z	4.87	67.18	16.54		130.0	
10596-AAB	IEEE 802.11n (HT Mixed, 20MHz, MCS5, 90pc duty cycle)	X	4.87	67.14	16.54	0.46	130.0	± 9.6 %
		Y	4.76	67.30	16.57		130.0	
		Z	4.81	67.18	16.54		130.0	
10597-AAB	IEEE 802.11n (HT Mixed, 20MHz, MCS6, 90pc duty cycle)	X	4.82	67.05	16.42	0.46	130.0	± 9.6 %
		Y	4.71	67.19	16.44		130.0	
		Z	4.76	67.07	16.42		130.0	
10598-AAB	IEEE 802.11n (HT Mixed, 20MHz, MCS7, 90pc duty cycle)	X	4.80	67.28	16.68	0.46	130.0	± 9.6 %
		Y	4.69	67.37	16.67		130.0	
		Z	4.74	67.29	16.67		130.0	
10599-AAB	IEEE 802.11n (HT Mixed, 40MHz, MCS0, 90pc duty cycle)	X	5.50	67.33	16.69	0.46	130.0	± 9.6 %
		Y	5.40	67.43	16.72		130.0	
		Z	5.46	67.38	16.72		130.0	
10600-AAB	IEEE 802.11n (HT Mixed, 40MHz, MCS1, 90pc duty cycle)	X	5.67	67.87	16.93	0.46	130.0	± 9.6 %
		Y	5.53	67.86	16.92		130.0	
		Z	5.61	67.87	16.94		130.0	
10601-AAB	IEEE 802.11n (HT Mixed, 40MHz, MCS2, 90pc duty cycle)	X	5.54	67.56	16.79	0.46	130.0	± 9.6 %
		Y	5.42	67.61	16.80		130.0	
		Z	5.48	67.56	16.80		130.0	
10602-AAB	IEEE 802.11n (HT Mixed, 40MHz, MCS3, 90pc duty cycle)	X	5.63	67.58	16.72	0.46	130.0	± 9.6 %
		Y	5.55	67.79	16.82		130.0	
		Z	5.59	67.64	16.76		130.0	
10603-AAB	IEEE 802.11n (HT Mixed, 40MHz, MCS4, 90pc duty cycle)	X	5.71	67.86	16.99	0.46	130.0	± 9.6 %
		Y	5.61	68.00	17.05		130.0	
		Z	5.65	67.89	17.01		130.0	
10604-AAB	IEEE 802.11n (HT Mixed, 40MHz, MCS5, 90pc duty cycle)	X	5.50	67.29	16.70	0.46	130.0	± 9.6 %
		Y	5.49	67.68	16.88		130.0	
		Z	5.47	67.39	16.75		130.0	
10605-AAB	IEEE 802.11n (HT Mixed, 40MHz, MCS6, 90pc duty cycle)	X	5.63	67.69	16.90	0.46	130.0	± 9.6 %
		Y	5.53	67.80	16.94		130.0	
		Z	5.59	67.74	16.92		130.0	
10606-AAB	IEEE 802.11n (HT Mixed, 40MHz, MCS7, 90pc duty cycle)	X	5.39	67.07	16.45	0.46	130.0	± 9.6 %
		Y	5.27	67.10	16.45		130.0	
		Z	5.31	66.99	16.41		130.0	

10607-AAB	IEEE 802.11ac WiFi (20MHz, MCS0, 90pc duty cycle)	X	4.65	66.04	16.07	0.46	130.0	± 9.6 %
		Y	4.58	66.26	16.12		130.0	
		Z	4.61	66.10	16.08		130.0	
10608-AAB	IEEE 802.11ac WiFi (20MHz, MCS1, 90pc duty cycle)	X	4.85	66.45	16.23	0.46	130.0	± 9.6 %
		Y	4.74	66.63	16.28		130.0	
		Z	4.79	66.50	16.25		130.0	
10609-AAB	IEEE 802.11ac WiFi (20MHz, MCS2, 90pc duty cycle)	X	4.74	66.30	16.07	0.46	130.0	± 9.6 %
		Y	4.63	66.48	16.11		130.0	
		Z	4.68	66.35	16.08		130.0	
10610-AAB	IEEE 802.11ac WiFi (20MHz, MCS3, 90pc duty cycle)	X	4.79	66.46	16.23	0.46	130.0	± 9.6 %
		Y	4.68	66.63	16.27		130.0	
		Z	4.73	66.50	16.25		130.0	
10611-AAB	IEEE 802.11ac WiFi (20MHz, MCS4, 90pc duty cycle)	X	4.70	66.28	16.09	0.46	130.0	± 9.6 %
		Y	4.60	66.45	16.12		130.0	
		Z	4.65	66.31	16.10		130.0	
10612-AAB	IEEE 802.11ac WiFi (20MHz, MCS5, 90pc duty cycle)	X	4.72	66.43	16.13	0.46	130.0	± 9.6 %
		Y	4.60	66.61	16.18		130.0	
		Z	4.66	66.47	16.14		130.0	
10613-AAB	IEEE 802.11ac WiFi (20MHz, MCS6, 90pc duty cycle)	X	4.72	66.33	16.02	0.46	130.0	± 9.6 %
		Y	4.60	66.47	16.05		130.0	
		Z	4.66	66.35	16.02		130.0	
10614-AAB	IEEE 802.11ac WiFi (20MHz, MCS7, 90pc duty cycle)	X	4.66	66.50	16.24	0.46	130.0	± 9.6 %
		Y	4.55	66.62	16.25		130.0	
		Z	4.60	66.53	16.25		130.0	
10615-AAB	IEEE 802.11ac WiFi (20MHz, MCS8, 90pc duty cycle)	X	4.71	66.12	15.87	0.46	130.0	± 9.6 %
		Y	4.60	66.33	15.93		130.0	
		Z	4.65	66.16	15.88		130.0	
10616-AAB	IEEE 802.11ac WiFi (40MHz, MCS0, 90pc duty cycle)	X	5.31	66.56	16.28	0.46	130.0	± 9.6 %
		Y	5.21	66.65	16.31		130.0	
		Z	5.26	66.57	16.29		130.0	
10617-AAB	IEEE 802.11ac WiFi (40MHz, MCS1, 90pc duty cycle)	X	5.38	66.74	16.35	0.46	130.0	± 9.6 %
		Y	5.29	66.86	16.39		130.0	
		Z	5.34	66.79	16.37		130.0	
10618-AAB	IEEE 802.11ac WiFi (40MHz, MCS2, 90pc duty cycle)	X	5.26	66.74	16.36	0.46	130.0	± 9.6 %
		Y	5.18	66.87	16.40		130.0	
		Z	5.22	66.77	16.38		130.0	
10619-AAB	IEEE 802.11ac WiFi (40MHz, MCS3, 90pc duty cycle)	X	5.29	66.59	16.22	0.46	130.0	± 9.6 %
		Y	5.19	66.67	16.25		130.0	
		Z	5.23	66.58	16.22		130.0	
10620-AAB	IEEE 802.11ac WiFi (40MHz, MCS4, 90pc duty cycle)	X	5.38	66.62	16.29	0.46	130.0	± 9.6 %
		Y	5.27	66.70	16.31		130.0	
		Z	5.32	66.62	16.29		130.0	
10621-AAB	IEEE 802.11ac WiFi (40MHz, MCS5, 90pc duty cycle)	X	5.37	66.71	16.45	0.46	130.0	± 9.6 %
		Y	5.27	66.80	16.47		130.0	
		Z	5.32	66.74	16.47		130.0	
10622-AAB	IEEE 802.11ac WiFi (40MHz, MCS6, 90pc duty cycle)	X	5.39	66.89	16.53	0.46	130.0	± 9.6 %
		Y	5.29	66.97	16.55		130.0	
		Z	5.34	66.92	16.55		130.0	

10623-AAB	IEEE 802.11ac WiFi (40MHz, MCS7, 90pc duty cycle)	X	5.26	66.41	16.17	0.46	130.0	± 9.6 %
		Y	5.16	66.51	16.20		130.0	
		Z	5.21	66.44	16.19		130.0	
10624-AAB	IEEE 802.11ac WiFi (40MHz, MCS8, 90pc duty cycle)	X	5.45	66.63	16.34	0.46	130.0	± 9.6 %
		Y	5.35	66.71	16.36		130.0	
		Z	5.40	66.64	16.35		130.0	
10625-AAB	IEEE 802.11ac WiFi (40MHz, MCS9, 90pc duty cycle)	X	5.87	67.75	16.95	0.46	130.0	± 9.6 %
		Y	5.59	67.32	16.72		130.0	
		Z	5.77	67.62	16.89		130.0	
10626-AAB	IEEE 802.11ac WiFi (80MHz, MCS0, 90pc duty cycle)	X	5.59	66.61	16.24	0.46	130.0	± 9.6 %
		Y	5.53	66.71	16.27		130.0	
		Z	5.56	66.63	16.25		130.0	
10627-AAB	IEEE 802.11ac WiFi (80MHz, MCS1, 90pc duty cycle)	X	5.86	67.23	16.51	0.46	130.0	± 9.6 %
		Y	5.77	67.31	16.54		130.0	
		Z	5.82	67.26	16.53		130.0	
10628-AAB	IEEE 802.11ac WiFi (80MHz, MCS2, 90pc duty cycle)	X	5.64	66.75	16.20	0.46	130.0	± 9.6 %
		Y	5.54	66.76	16.20		130.0	
		Z	5.59	66.73	16.20		130.0	
10629-AAB	IEEE 802.11ac WiFi (80MHz, MCS3, 90pc duty cycle)	X	5.74	66.86	16.25	0.46	130.0	± 9.6 %
		Y	5.63	66.85	16.25		130.0	
		Z	5.67	66.78	16.22		130.0	
10630-AAB	IEEE 802.11ac WiFi (80MHz, MCS4, 90pc duty cycle)	X	6.27	68.62	17.13	0.46	130.0	± 9.6 %
		Y	5.98	68.12	16.89		130.0	
		Z	6.16	68.44	17.05		130.0	
10631-AAB	IEEE 802.11ac WiFi (80MHz, MCS5, 90pc duty cycle)	X	6.08	68.18	17.10	0.46	130.0	± 9.6 %
		Y	5.89	67.92	16.96		130.0	
		Z	6.00	68.07	17.05		130.0	
10632-AAB	IEEE 802.11ac WiFi (80MHz, MCS6, 90pc duty cycle)	X	5.81	67.25	16.65	0.46	130.0	± 9.6 %
		Y	5.73	67.36	16.70		130.0	
		Z	5.78	67.29	16.68		130.0	
10633-AAB	IEEE 802.11ac WiFi (80MHz, MCS7, 90pc duty cycle)	X	5.70	66.88	16.30	0.46	130.0	± 9.6 %
		Y	5.61	66.94	16.32		130.0	
		Z	5.64	66.86	16.29		130.0	
10634-AAB	IEEE 802.11ac WiFi (80MHz, MCS8, 90pc duty cycle)	X	5.68	66.90	16.36	0.46	130.0	± 9.6 %
		Y	5.59	66.94	16.37		130.0	
		Z	5.63	66.89	16.36		130.0	
10635-AAB	IEEE 802.11ac WiFi (80MHz, MCS9, 90pc duty cycle)	X	5.57	66.28	15.80	0.46	130.0	± 9.6 %
		Y	5.47	66.33	15.83		130.0	
		Z	5.52	66.25	15.79		130.0	
10636-AAC	IEEE 802.11ac WiFi (160MHz, MCS0, 90pc duty cycle)	X	6.01	67.00	16.34	0.46	130.0	± 9.6 %
		Y	5.95	67.08	16.37		130.0	
		Z	5.98	67.00	16.35		130.0	
10637-AAC	IEEE 802.11ac WiFi (160MHz, MCS1, 90pc duty cycle)	X	6.18	67.41	16.53	0.46	130.0	± 9.6 %
		Y	6.10	67.45	16.54		130.0	
		Z	6.14	67.41	16.54		130.0	
10638-AAC	IEEE 802.11ac WiFi (160MHz, MCS2, 90pc duty cycle)	X	6.18	67.38	16.49	0.46	130.0	± 9.6 %
		Y	6.10	67.42	16.51		130.0	
		Z	6.14	67.38	16.50		130.0	

10639-AAC	IEEE 802.11ac WiFi (160MHz, MCS3, 90pc duty cycle)	X	6.15	67.32	16.51	0.46	130.0	± 9.6 %
		Y	6.07	67.34	16.50		130.0	
		Z	6.11	67.30	16.50		130.0	
10640-AAC	IEEE 802.11ac WiFi (160MHz, MCS4, 90pc duty cycle)	X	6.17	67.36	16.47	0.46	130.0	± 9.6 %
		Y	6.07	67.36	16.47		130.0	
		Z	6.11	67.32	16.45		130.0	
10641-AAC	IEEE 802.11ac WiFi (160MHz, MCS5, 90pc duty cycle)	X	6.20	67.22	16.42	0.46	130.0	± 9.6 %
		Y	6.14	67.34	16.48		130.0	
		Z	6.17	67.26	16.44		130.0	
10642-AAC	IEEE 802.11ac WiFi (160MHz, MCS6, 90pc duty cycle)	X	6.24	67.47	16.71	0.46	130.0	± 9.6 %
		Y	6.15	67.50	16.71		130.0	
		Z	6.19	67.46	16.71		130.0	
10643-AAC	IEEE 802.11ac WiFi (160MHz, MCS7, 90pc duty cycle)	X	6.08	67.18	16.46	0.46	130.0	± 9.6 %
		Y	6.01	67.25	16.50		130.0	
		Z	6.04	67.18	16.47		130.0	
10644-AAC	IEEE 802.11ac WiFi (160MHz, MCS8, 90pc duty cycle)	X	6.27	67.76	16.77	0.46	130.0	± 9.6 %
		Y	6.11	67.57	16.67		130.0	
		Z	6.19	67.64	16.72		130.0	
10645-AAC	IEEE 802.11ac WiFi (160MHz, MCS9, 90pc duty cycle)	X	6.75	68.75	17.22	0.46	130.0	± 9.6 %
		Y	6.24	67.62	16.66		130.0	
		Z	6.47	68.11	16.92		130.0	
10646-AAD	LTE-TDD (SC-FDMA, 1 RB, 5 MHz, QPSK, UL Subframe=2,7)	X	46.96	124.69	40.77	9.30	60.0	± 9.6 %
		Y	100.00	148.37	48.20		60.0	
		Z	67.01	134.85	43.85		60.0	
10647-AAC	LTE-TDD (SC-FDMA, 1 RB, 20 MHz, QPSK, UL Subframe=2,7)	X	46.42	125.36	41.11	9.30	60.0	± 9.6 %
		Y	100.00	149.72	48.78		60.0	
		Z	63.71	134.73	44.00		60.0	
10648-AAA	CDMA2000 (1x Advanced)	X	0.63	62.54	9.79	0.00	150.0	± 9.6 %
		Y	0.58	62.24	9.19		150.0	
		Z	0.59	62.30	9.35		150.0	
10652-AAB	LTE-TDD (OFDMA, 5 MHz, E-TM 3.1, Clipping 44%)	X	4.19	68.34	17.06	2.23	80.0	± 9.6 %
		Y	4.08	68.62	17.03		80.0	
		Z	4.14	68.48	17.06		80.0	
10653-AAB	LTE-TDD (OFDMA, 10 MHz, E-TM 3.1, Clipping 44%)	X	4.68	67.61	17.18	2.23	80.0	± 9.6 %
		Y	4.56	67.77	17.19		80.0	
		Z	4.62	67.66	17.19		80.0	
10654-AAB	LTE-TDD (OFDMA, 15 MHz, E-TM 3.1, Clipping 44%)	X	4.63	67.27	17.19	2.23	80.0	± 9.6 %
		Y	4.54	67.39	17.21		80.0	
		Z	4.58	67.31	17.20		80.0	
10655-AAB	LTE-TDD (OFDMA, 20 MHz, E-TM 3.1, Clipping 44%)	X	4.69	67.27	17.23	2.23	80.0	± 9.6 %
		Y	4.60	67.35	17.25		80.0	
		Z	4.64	67.28	17.23		80.0	
10658-AAA	Pulse Waveform (200Hz, 10%)	X	19.17	92.59	24.24	10.00	50.0	± 9.6 %
		Y	41.94	104.68	27.26		50.0	
		Z	24.50	96.17	24.98		50.0	
10659-AAA	Pulse Waveform (200Hz, 20%)	X	100.00	114.36	28.32	6.99	60.0	± 9.6 %
		Y	100.00	114.20	27.89		60.0	
		Z	100.00	113.56	27.75		60.0	

10660-AAA	Pulse Waveform (200Hz, 40%)	X	100.00	111.43	25.50	3.98	80.0	± 9.6 %
		Y	100.00	112.46	25.73		80.0	
		Z	100.00	110.79	25.07		80.0	
10661-AAA	Pulse Waveform (200Hz, 60%)	X	100.00	110.47	23.74	2.22	100.0	± 9.6 %
		Y	100.00	113.22	24.78		100.0	
		Z	100.00	109.90	23.38		100.0	
10662-AAA	Pulse Waveform (200Hz, 80%)	X	100.00	107.83	20.92	0.97	120.0	± 9.6 %
		Y	100.00	115.39	23.98		120.0	
		Z	100.00	107.00	20.48		120.0	

^E Uncertainty is determined using the max. deviation from linear response applying rectangular distribution and is expressed for the square of the field value.



Accredited by the Swiss Accreditation Service (SAS)
The Swiss Accreditation Service is one of the signatories to the EA
Multilateral Agreement for the recognition of calibration certificates

Accreditation No.: **SCS 0108**

Client **PC Test**

Certificate No: **EX3-3589_Jan18**

CALIBRATION CERTIFICATE

Object: **EX3DV4 - SN:3589**

Calibration procedure(s): **QA CAL-01.v9, QA CAL-23.v5, QA CAL-25.v6
Calibration procedure for dosimetric E-field probes**

Calibration date: **January 16, 2018**

BNV
01-24-2018

This calibration certificate documents the traceability to national standards, which realize the physical units of measurements (SI).
The measurements and the uncertainties with confidence probability are given on the following pages and are part of the certificate.

All calibrations have been conducted in the closed laboratory facility: environment temperature (22 ± 3)°C and humidity < 70%.

Calibration Equipment used (M&TE critical for calibration)

Primary Standards	ID	Cal Date (Certificate No.)	Scheduled Calibration
Power meter NRP	SN: 104778	04-Apr-17 (No. 217-02521/02522)	Apr-18
Power sensor NRP-Z91	SN: 103244	04-Apr-17 (No. 217-02521)	Apr-18
Power sensor NRP-Z91	SN: 103245	04-Apr-17 (No. 217-02525)	Apr-18
Reference 20 dB Attenuator	SN: S5277 (20x)	07-Apr-17 (No. 217-02528)	Apr-18
Reference Probe ES3DV2	SN: 3013	30-Dec-17 (No. ES3-3013_Dec17)	Dec-18
DAE4	SN: 660	21-Dec-17 (No. DAE4-660_Dec17)	Dec-18
Secondary Standards	ID	Check Date (in house)	Scheduled Check
Power meter E4419B	SN: GB41293874	06-Apr-16 (in house check Jun-16)	In house check: Jun-18
Power sensor E4412A	SN: MY41498087	06-Apr-16 (in house check Jun-16)	In house check: Jun-18
Power sensor E4412A	SN: 000110210	06-Apr-16 (in house check Jun-16)	In house check: Jun-18
RF generator HP 8648C	SN: US3642U01700	04-Aug-99 (in house check Jun-16)	In house check: Jun-18
Network Analyzer HP 8753E	SN: US37390585	18-Oct-01 (in house check Oct-17)	In house check: Oct-18

Calibrated by:	Name Jeton Kastrioti	Function Laboratory Technician	Signature
Approved by:	Name Katja Pokovic	Function Technical Manager	

Issued: January 16, 2018

This calibration certificate shall not be reproduced except in full without written approval of the laboratory.



Accredited by the Swiss Accreditation Service (SAS)

The Swiss Accreditation Service is one of the signatories to the EA
Multilateral Agreement for the recognition of calibration certificates

Accreditation No.: **SCS 0108**

Glossary:

TSL	tissue simulating liquid
NORM _{x,y,z}	sensitivity in free space
ConvF	sensitivity in TSL / NORM _{x,y,z}
DCP	diode compression point
CF	crest factor (1/duty_cycle) of the RF signal
A, B, C, D	modulation dependent linearization parameters
Polarization φ	φ rotation around probe axis
Polarization ϑ	ϑ rotation around an axis that is in the plane normal to probe axis (at measurement center), i.e., $\vartheta = 0$ is normal to probe axis
Connector Angle	information used in DASY system to align probe sensor X to the robot coordinate system

Calibration is Performed According to the Following Standards:

- a) IEEE Std 1528-2013, "IEEE Recommended Practice for Determining the Peak Spatial-Averaged Specific Absorption Rate (SAR) in the Human Head from Wireless Communications Devices: Measurement Techniques", June 2013
- b) IEC 62209-1, "Measurement procedure for the assessment of Specific Absorption Rate (SAR) from hand-held and body-mounted devices used next to the ear (frequency range of 300 MHz to 6 GHz)", July 2016
- c) IEC 62209-2, "Procedure to determine the Specific Absorption Rate (SAR) for wireless communication devices used in close proximity to the human body (frequency range of 30 MHz to 6 GHz)", March 2010
- d) KDB 865664, "SAR Measurement Requirements for 100 MHz to 6 GHz"

Methods Applied and Interpretation of Parameters:

- *NORM_{x,y,z}*: Assessed for E-field polarization $\vartheta = 0$ ($f \leq 900$ MHz in TEM-cell; $f > 1800$ MHz: R22 waveguide). *NORM_{x,y,z}* are only intermediate values, i.e., the uncertainties of *NORM_{x,y,z}* does not affect the E^2 -field uncertainty inside TSL (see below *ConvF*).
- *NORM(f)_{x,y,z}* = *NORM_{x,y,z}* * *frequency_response* (see Frequency Response Chart). This linearization is implemented in DASY4 software versions later than 4.2. The uncertainty of the frequency response is included in the stated uncertainty of *ConvF*.
- *DCP_{x,y,z}*: DCP are numerical linearization parameters assessed based on the data of power sweep with CW signal (no uncertainty required). DCP does not depend on frequency nor media.
- *PAR*: PAR is the Peak to Average Ratio that is not calibrated but determined based on the signal characteristics
- *A_{x,y,z}; B_{x,y,z}; C_{x,y,z}; D_{x,y,z}; VR_{x,y,z}; A, B, C, D* are numerical linearization parameters assessed based on the data of power sweep for specific modulation signal. The parameters do not depend on frequency nor media. *VR* is the maximum calibration range expressed in RMS voltage across the diode.
- *ConvF and Boundary Effect Parameters*: Assessed in flat phantom using E-field (or Temperature Transfer Standard for $f \leq 800$ MHz) and inside waveguide using analytical field distributions based on power measurements for $f > 800$ MHz. The same setups are used for assessment of the parameters applied for boundary compensation (alpha, depth) of which typical uncertainty values are given. These parameters are used in DASY4 software to improve probe accuracy close to the boundary. The sensitivity in TSL corresponds to *NORM_{x,y,z}* * *ConvF* whereby the uncertainty corresponds to that given for *ConvF*. A frequency dependent *ConvF* is used in DASY version 4.4 and higher which allows extending the validity from ± 50 MHz to ± 100 MHz.
- *Spherical isotropy (3D deviation from isotropy)*: in a field of low gradients realized using a flat phantom exposed by a patch antenna.
- *Sensor Offset*: The sensor offset corresponds to the offset of virtual measurement center from the probe tip (on probe axis). No tolerance required.
- *Connector Angle*: The angle is assessed using the information gained by determining the *NORM_x* (no uncertainty required).

Probe EX3DV4

SN:3589

Manufactured: March 30, 2006
Calibrated: January 16, 2018

Calibrated for DASY/EASY Systems
(Note: non-compatible with DASY2 system!)

DASY/EASY - Parameters of Probe: EX3DV4 - SN:3589

Basic Calibration Parameters

	Sensor X	Sensor Y	Sensor Z	Unc (k=2)
Norm ($\mu\text{V}/(\text{V}/\text{m})^2$) ^A	0.46	0.40	0.38	$\pm 10.1 \%$
DCP (mV) ^B	101.9	98.2	100.6	

Modulation Calibration Parameters

UID	Communication System Name		A dB	B dB $\sqrt{\mu\text{V}}$	C	D dB	VR mV	Unc ^E (k=2)
0	CW	X	0.0	0.0	1.0	0.00	145.6	$\pm 3.0 \%$
		Y	0.0	0.0	1.0		149.6	
		Z	0.0	0.0	1.0		140.9	

Note: For details on UID parameters see Appendix.

Sensor Model Parameters

	C1 fF	C2 fF	α V ⁻¹	T1 ms.V ⁻²	T2 ms.V ⁻¹	T3 ms	T4 V ⁻²	T5 V ⁻¹	T6
X	54.53	405.9	35.45	27.61	1.364	5.100	0.831	0.591	1.009
Y	48.12	366.5	36.73	22.62	1.695	5.057	0.000	0.758	1.010
Z	46.44	344.4	35.16	24.05	1.187	5.077	1.521	0.435	1.010

The reported uncertainty of measurement is stated as the standard uncertainty of measurement multiplied by the coverage factor k=2, which for a normal distribution corresponds to a coverage probability of approximately 95%.

^A The uncertainties of Norm X,Y,Z do not affect the E²-field uncertainty inside TSL (see Pages 5 and 6).

^B Numerical linearization parameter: uncertainty not required.

^E Uncertainty is determined using the max. deviation from linear response applying rectangular distribution and is expressed for the square of the field value.

DASY/EASY - Parameters of Probe: EX3DV4 - SN:3589

Calibration Parameter Determined in Head Tissue Simulating Media

f (MHz) ^C	Relative Permittivity ^F	Conductivity (S/m) ^F	ConvF X	ConvF Y	ConvF Z	Alpha ^G	Depth ^G (mm)	Unc (k=2)
5250	35.9	4.71	4.69	4.69	4.69	0.35	1.80	± 13.1 %
5600	35.5	5.07	4.17	4.17	4.17	0.40	1.80	± 13.1 %
5750	35.4	5.22	4.42	4.42	4.42	0.40	1.80	± 13.1 %

^C Frequency validity above 300 MHz of ± 100 MHz only applies for DASY v4.4 and higher (see Page 2), else it is restricted to ± 50 MHz. The uncertainty is the RSS of the ConvF uncertainty at calibration frequency and the uncertainty for the indicated frequency band. Frequency validity below 300 MHz is ± 10, 25, 40, 50 and 70 MHz for ConvF assessments at 30, 64, 128, 150 and 220 MHz respectively. Above 5 GHz frequency validity can be extended to ± 110 MHz.

^F At frequencies below 3 GHz, the validity of tissue parameters (ϵ and σ) can be relaxed to ± 10% if liquid compensation formula is applied to measured SAR values. At frequencies above 3 GHz, the validity of tissue parameters (ϵ and σ) is restricted to ± 5%. The uncertainty is the RSS of the ConvF uncertainty for indicated target tissue parameters.

^G Alpha/Depth are determined during calibration. SPEAG warrants that the remaining deviation due to the boundary effect after compensation is always less than ± 1% for frequencies below 3 GHz and below ± 2% for frequencies between 3-6 GHz at any distance larger than half the probe tip diameter from the boundary.

DASY/EASY - Parameters of Probe: EX3DV4 - SN:3589

Calibration Parameter Determined in Body Tissue Simulating Media

f (MHz) ^C	Relative Permittivity ^F	Conductivity (S/m) ^F	ConvF X	ConvF Y	ConvF Z	Alpha ^G	Depth (mm) ^G	Unc (k=2)
5250	48.9	5.36	4.22	4.22	4.22	0.35	1.90	± 13.1 %
5600	48.5	5.77	3.69	3.69	3.69	0.40	1.90	± 13.1 %
5750	48.3	5.94	3.97	3.97	3.97	0.40	1.90	± 13.1 %

^C Frequency validity above 300 MHz of ± 100 MHz only applies for DASY v4.4 and higher (see Page 2), else it is restricted to ± 50 MHz. The uncertainty is the RSS of the ConvF uncertainty at calibration frequency and the uncertainty for the indicated frequency band. Frequency validity below 300 MHz is ± 10, 25, 40, 50 and 70 MHz for ConvF assessments at 30, 64, 128, 150 and 220 MHz respectively. Above 5 GHz frequency validity can be extended to ± 110 MHz.

^F At frequencies below 3 GHz, the validity of tissue parameters (ϵ and σ) can be relaxed to ± 10% if liquid compensation formula is applied to measured SAR values. At frequencies above 3 GHz, the validity of tissue parameters (ϵ and σ) is restricted to ± 5%. The uncertainty is the RSS of the ConvF uncertainty for indicated target tissue parameters.

^G Alpha/Depth are determined during calibration. SPEAG warrants that the remaining deviation due to the boundary effect after compensation is always less than ± 1% for frequencies below 3 GHz and below ± 2% for frequencies between 3-6 GHz at any distance larger than half the probe tip diameter from the boundary.

Frequency Response of E-Field

(TEM-Cell:ifi110 EXX, Waveguide: R22)

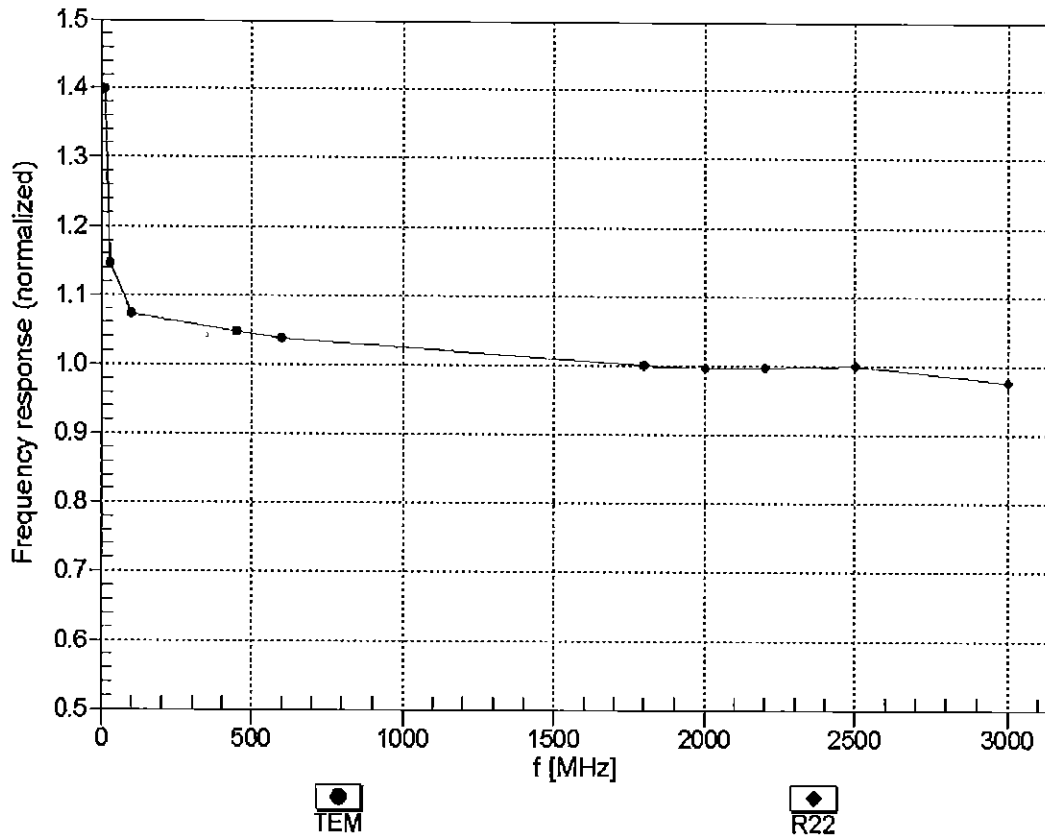

Uncertainty of Frequency Response of E-field: $\pm 6.3\%$ ($k=2$)

Receiving Pattern (ϕ), $\theta = 0^\circ$

f=600 MHz, TEM

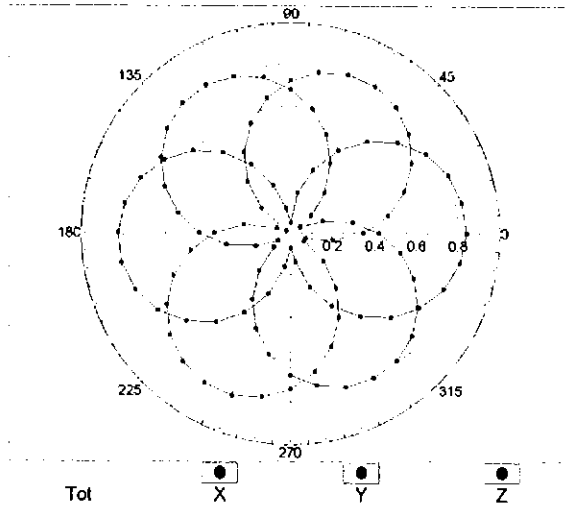

f=1800 MHz, R22

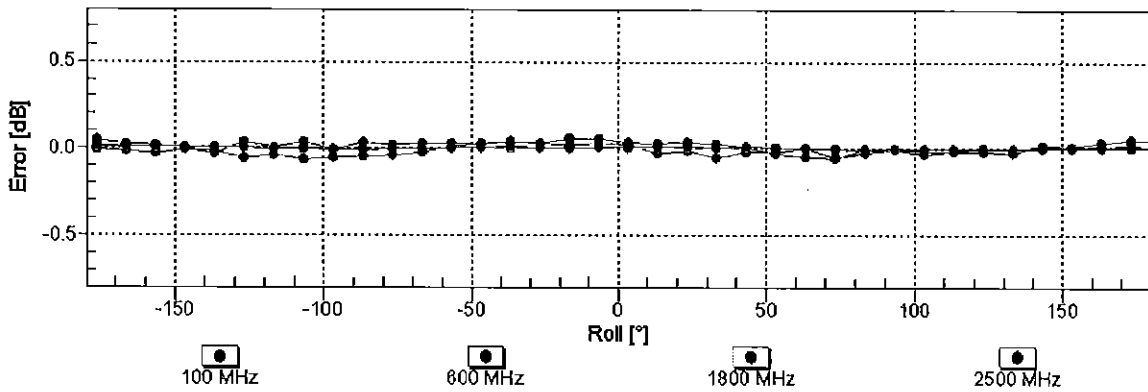
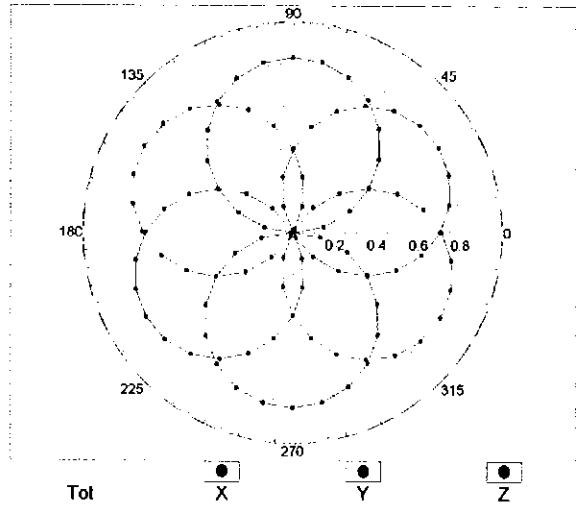

Uncertainty of Axial Isotropy Assessment: $\pm 0.5\%$ ($k=2$)

Dynamic Range f(SAR_{head}) (TEM cell , f_{eval}= 1900 MHz)

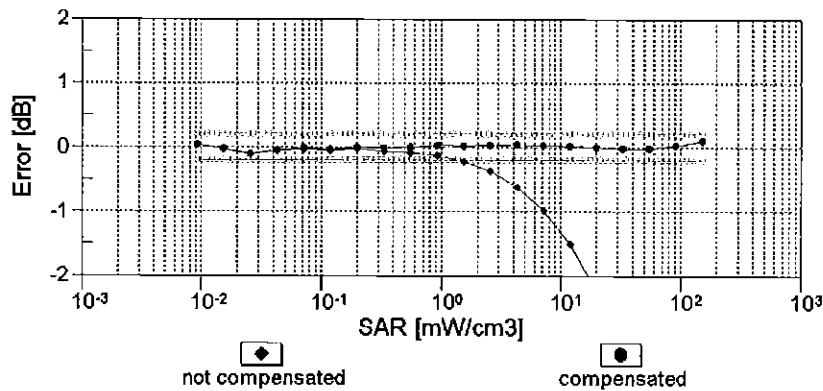
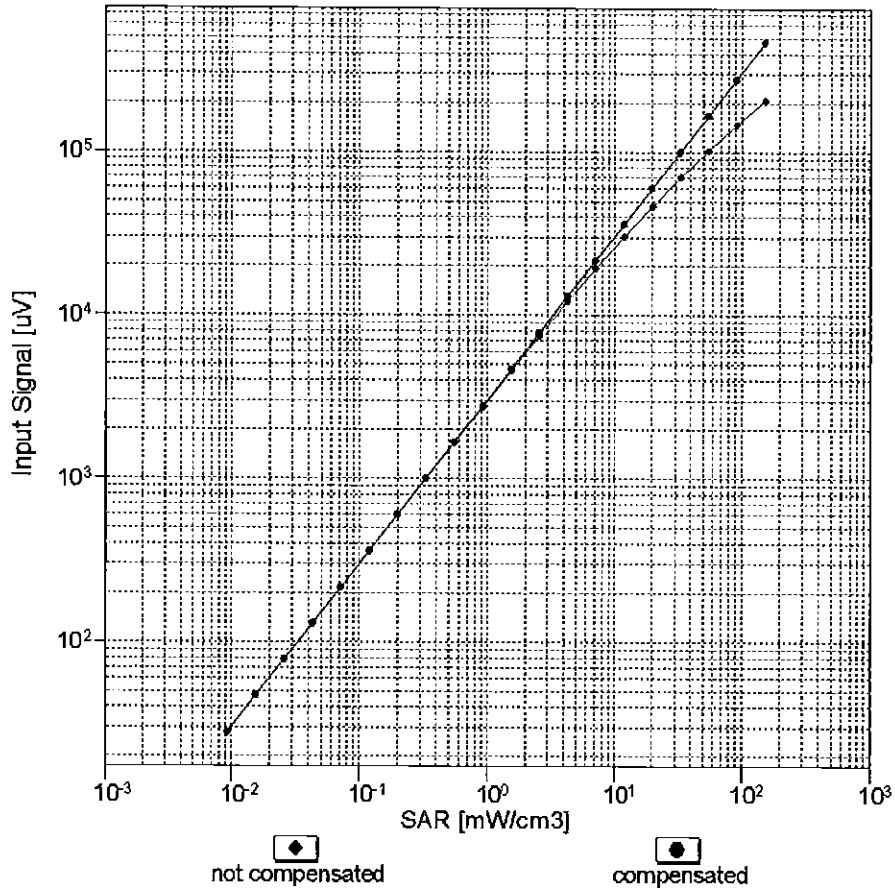

Uncertainty of Linearity Assessment: ± 0.6% (k=2)

Conversion Factor Assessment

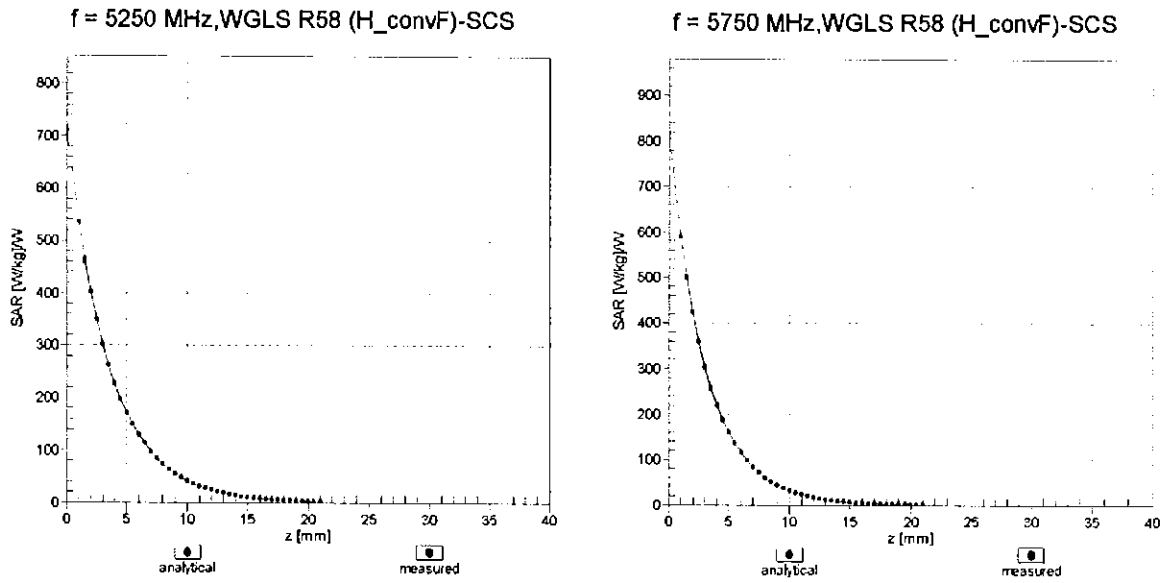

Deviation from Isotropy in Liquid Error (ϕ, θ), f = 900 MHz

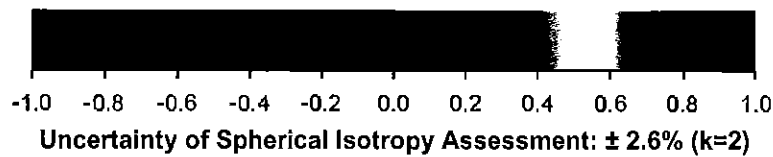
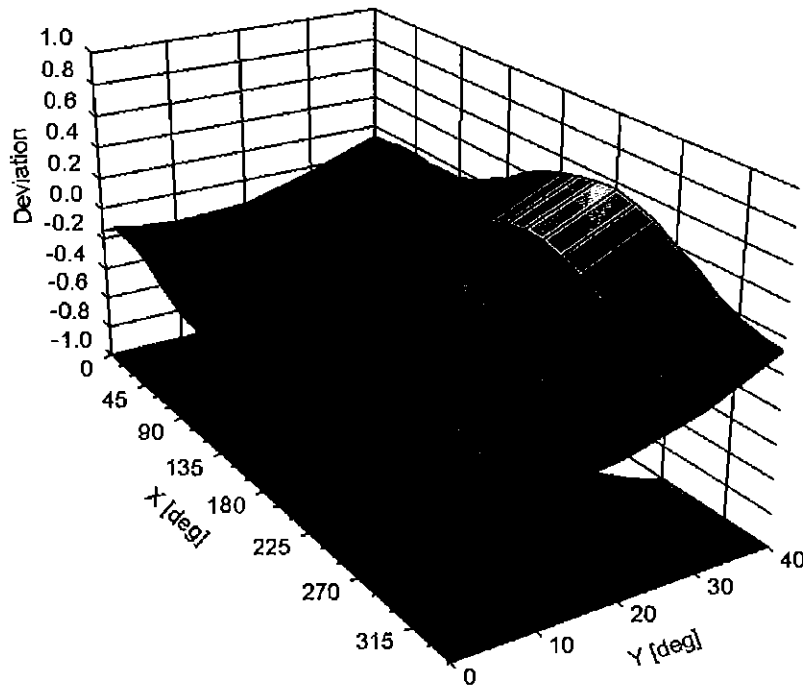

DASY/EASY - Parameters of Probe: EX3DV4 - SN:3589

Other Probe Parameters

Sensor Arrangement	Triangular
Connector Angle (°)	-36.7
Mechanical Surface Detection Mode	enabled
Optical Surface Detection Mode	disabled
Probe Overall Length	337 mm
Probe Body Diameter	10 mm
Tip Length	9 mm
Tip Diameter	2.5 mm
Probe Tip to Sensor X Calibration Point	1 mm
Probe Tip to Sensor Y Calibration Point	1 mm
Probe Tip to Sensor Z Calibration Point	1 mm
Recommended Measurement Distance from Surface	1.4 mm

Appendix: Modulation Calibration Parameters

UID	Communication System Name		A dB	B dB μ V	C	D dB	VR mV	Max Unc ^E (k=2)
0	CW	X	0.00	0.00	1.00	0.00	145.6	$\pm 3.0\%$
		Y	0.00	0.00	1.00		149.6	
		Z	0.00	0.00	1.00		140.9	
10010- CAA	SAR Validation (Square, 100ms, 10ms)	X	9.99	82.03	18.50	10.00	20.0	$\pm 9.6\%$
		Y	3.61	68.62	12.70		20.0	
		Z	6.12	76.04	15.89		20.0	
10011- CAB	UMTS-FDD (WCDMA)	X	1.07	68.14	15.72	0.00	150.0	$\pm 9.6\%$
		Y	0.81	64.60	12.95		150.0	
		Z	0.96	66.53	14.61		150.0	
10012- CAB	IEEE 802.11b WiFi 2.4 GHz (DSSS, 1 Mbps)	X	1.26	64.97	15.89	0.41	150.0	$\pm 9.6\%$
		Y	1.09	63.16	14.28		150.0	
		Z	1.20	64.25	15.26		150.0	
10013- CAB	IEEE 802.11g WiFi 2.4 GHz (DSSS-OFDM, 6 Mbps)	X	5.02	66.95	17.30	1.46	150.0	$\pm 9.6\%$
		Y	4.84	66.53	16.88		150.0	
		Z	4.90	66.87	17.12		150.0	
10021- DAC	GSM-FDD (TDMA, GMSK)	X	100.00	118.58	30.90	9.39	50.0	$\pm 9.6\%$
		Y	26.12	96.77	24.34		50.0	
		Z	100.00	117.35	29.93		50.0	
10023- DAC	GPRS-FDD (TDMA, GMSK, TN 0)	X	100.00	118.53	30.93	9.57	50.0	$\pm 9.6\%$
		Y	18.86	92.09	23.00		50.0	
		Z	100.00	117.23	29.92		50.0	
10024- DAC	GPRS-FDD (TDMA, GMSK, TN 0-1)	X	100.00	115.85	28.57	6.56	60.0	$\pm 9.6\%$
		Y	100.00	111.10	26.02		60.0	
		Z	100.00	114.31	27.50		60.0	
10025- DAC	EDGE-FDD (TDMA, 8PSK, TN 0)	X	15.59	105.48	41.04	12.57	50.0	$\pm 9.6\%$
		Y	4.26	66.41	22.61		50.0	
		Z	6.75	80.99	30.81		50.0	
10026- DAC	EDGE-FDD (TDMA, 8PSK, TN 0-1)	X	26.87	114.05	39.53	9.56	60.0	$\pm 9.6\%$
		Y	12.16	93.46	31.76		60.0	
		Z	17.01	103.53	36.03		60.0	
10027- DAC	GPRS-FDD (TDMA, GMSK, TN 0-1-2)	X	100.00	115.28	27.52	4.80	80.0	$\pm 9.6\%$
		Y	100.00	108.67	24.10		80.0	
		Z	100.00	113.48	26.36		80.0	
10028- DAC	GPRS-FDD (TDMA, GMSK, TN 0-1-2-3)	X	100.00	115.90	27.07	3.55	100.0	$\pm 9.6\%$
		Y	100.00	106.89	22.60		100.0	
		Z	100.00	113.76	25.79		100.0	
10029- DAC	EDGE-FDD (TDMA, 8PSK, TN 0-1-2)	X	13.97	98.08	33.11	7.80	80.0	$\pm 9.6\%$
		Y	8.37	85.77	27.91		80.0	
		Z	9.97	90.97	30.48		80.0	
10030- CAA	IEEE 802.15.1 Bluetooth (GFSK, DH1)	X	100.00	114.41	27.43	5.30	70.0	$\pm 9.6\%$
		Y	87.04	107.07	24.03		70.0	
		Z	100.00	112.49	26.20		70.0	
10031- CAA	IEEE 802.15.1 Bluetooth (GFSK, DH3)	X	100.00	116.58	25.91	1.88	100.0	$\pm 9.6\%$
		Y	6.32	79.53	13.62		100.0	
		Z	100.00	112.45	23.86		100.0	

10032-CAA	IEEE 802.15.1 Bluetooth (GFSK, DH5)	X	100.00	121.24	26.80	1.17	100.0	± 9.6 %
		Y	0.57	63.68	7.10		100.0	
		Z	100.00	115.03	23.96		100.0	
10033-CAA	IEEE 802.15.1 Bluetooth (PI/4-DQPSK, DH1)	X	100.00	126.01	34.21	5.30	70.0	± 9.6 %
		Y	9.48	86.17	21.89		70.0	
		Z	36.97	108.65	29.12		70.0	
10034-CAA	IEEE 802.15.1 Bluetooth (PI/4-DQPSK, DH3)	X	12.93	96.17	24.85	1.88	100.0	± 9.6 %
		Y	2.97	73.87	15.92		100.0	
		Z	6.70	85.72	20.80		100.0	
10035-CAA	IEEE 802.15.1 Bluetooth (PI/4-DQPSK, DH5)	X	5.17	84.55	21.02	1.17	100.0	± 9.6 %
		Y	1.93	70.01	14.08		100.0	
		Z	3.33	77.79	17.83		100.0	
10036-CAA	IEEE 802.15.1 Bluetooth (8-DPSK, DH1)	X	100.00	126.30	34.35	5.30	70.0	± 9.6 %
		Y	11.77	89.53	23.03		70.0	
		Z	64.78	117.54	31.43		70.0	
10037-CAA	IEEE 802.15.1 Bluetooth (8-DPSK, DH3)	X	11.80	94.89	24.44	1.88	100.0	± 9.6 %
		Y	2.82	73.30	15.67		100.0	
		Z	6.03	84.36	20.32		100.0	
10038-CAA	IEEE 802.15.1 Bluetooth (8-DPSK, DH5)	X	5.40	85.48	21.44	1.17	100.0	± 9.6 %
		Y	1.96	70.41	14.34		100.0	
		Z	3.42	78.42	18.17		100.0	
10039-CAB	CDMA2000 (1xRTT, RC1)	X	2.08	73.52	16.75	0.00	150.0	± 9.6 %
		Y	1.21	66.59	12.35		150.0	
		Z	1.63	70.60	14.79		150.0	
10042-CAB	IS-54 / IS-136 FDD (TDMA/FDM, PI/4-DQPSK, Halfrate)	X	100.00	114.16	27.98	7.78	50.0	± 9.6 %
		Y	18.08	89.51	20.47		50.0	
		Z	100.00	112.63	26.92		50.0	
10044-CAA	IS-91/EI/TIA-553 FDD (FDMA, FM)	X	0.00	107.14	5.87	0.00	150.0	± 9.6 %
		Y	0.21	123.93	6.31		150.0	
		Z	0.01	111.19	11.86		150.0	
10048-CAA	DECT (TDD, TDMA/FDM, GFSK, Full Slot, 24)	X	69.67	114.61	31.81	13.80	25.0	± 9.6 %
		Y	9.51	81.03	21.19		25.0	
		Z	70.93	113.80	30.88		25.0	
10049-CAA	DECT (TDD, TDMA/FDM, GFSK, Double Slot, 12)	X	100.00	119.03	31.49	10.79	40.0	± 9.6 %
		Y	11.04	84.08	20.83		40.0	
		Z	100.00	117.60	30.41		40.0	
10056-CAA	UMTS-TDD (TD-SCDMA, 1.28 Mcps)	X	34.83	106.19	29.98	9.03	50.0	± 9.6 %
		Y	10.33	84.00	22.00		50.0	
		Z	26.35	100.92	27.85		50.0	
10058-DAC	EDGE-FDD (TDMA, 8PSK, TN 0-1-2-3)	X	9.27	89.32	29.23	6.55	100.0	± 9.6 %
		Y	6.37	80.89	25.35		100.0	
		Z	7.13	84.12	27.15		100.0	
10059-CAB	IEEE 802.11b WiFi 2.4 GHz (DSSS, 2 Mbps)	X	1.41	67.11	16.98	0.61	110.0	± 9.6 %
		Y	1.18	64.62	14.99		110.0	
		Z	1.31	65.99	16.14		110.0	
10060-CAB	IEEE 802.11b WiFi 2.4 GHz (DSSS, 5.5 Mbps)	X	100.00	132.86	34.11	1.30	110.0	± 9.6 %
		Y	8.12	92.52	22.19		110.0	
		Z	100.00	131.22	33.18		110.0	

10061-CAB	IEEE 802.11b WiFi 2.4 GHz (DSSS, 11 Mbps)	X	16.26	106.04	30.06	2.04	110.0	± 9.6 %
		Y	4.18	82.31	21.49		110.0	
		Z	7.27	92.62	25.78		110.0	
10062-CAC	IEEE 802.11a/h WiFi 5 GHz (OFDM, 6 Mbps)	X	4.78	66.80	16.63	0.49	100.0	± 9.6 %
		Y	4.59	66.36	16.23		100.0	
		Z	4.66	66.72	16.47		100.0	
10063-CAC	IEEE 802.11a/h WiFi 5 GHz (OFDM, 9 Mbps)	X	4.81	66.94	16.76	0.72	100.0	± 9.6 %
		Y	4.62	66.48	16.34		100.0	
		Z	4.69	66.85	16.59		100.0	
10064-CAC	IEEE 802.11a/h WiFi 5 GHz (OFDM, 12 Mbps)	X	5.12	67.25	17.01	0.86	100.0	± 9.6 %
		Y	4.91	66.78	16.59		100.0	
		Z	4.97	67.11	16.82		100.0	
10065-CAC	IEEE 802.11a/h WiFi 5 GHz (OFDM, 18 Mbps)	X	5.01	67.24	17.17	1.21	100.0	± 9.6 %
		Y	4.80	66.73	16.70		100.0	
		Z	4.87	67.07	16.96		100.0	
10066-CAC	IEEE 802.11a/h WiFi 5 GHz (OFDM, 24 Mbps)	X	5.05	67.33	17.38	1.46	100.0	± 9.6 %
		Y	4.84	66.81	16.90		100.0	
		Z	4.90	67.15	17.15		100.0	
10067-CAC	IEEE 802.11a/h WiFi 5 GHz (OFDM, 36 Mbps)	X	5.36	67.48	17.83	2.04	100.0	± 9.6 %
		Y	5.15	67.05	17.38		100.0	
		Z	5.21	67.38	17.63		100.0	
10068-CAC	IEEE 802.11a/h WiFi 5 GHz (OFDM, 48 Mbps)	X	5.46	67.74	18.16	2.55	100.0	± 9.6 %
		Y	5.24	67.20	17.64		100.0	
		Z	5.29	67.50	17.90		100.0	
10069-CAC	IEEE 802.11a/h WiFi 5 GHz (OFDM, 54 Mbps)	X	5.54	67.67	18.33	2.67	100.0	± 9.6 %
		Y	5.32	67.21	17.84		100.0	
		Z	5.37	67.50	18.08		100.0	
10071-CAB	IEEE 802.11g WiFi 2.4 GHz (DSSS/OFDM, 9 Mbps)	X	5.14	67.13	17.66	1.99	100.0	± 9.6 %
		Y	4.96	66.70	17.22		100.0	
		Z	5.02	67.03	17.47		100.0	
10072-CAB	IEEE 802.11g WiFi 2.4 GHz (DSSS/OFDM, 12 Mbps)	X	5.18	67.63	17.97	2.30	100.0	± 9.6 %
		Y	4.97	67.11	17.46		100.0	
		Z	5.03	67.45	17.74		100.0	
10073-CAB	IEEE 802.11g WiFi 2.4 GHz (DSSS/OFDM, 18 Mbps)	X	5.28	67.91	18.36	2.83	100.0	± 9.6 %
		Y	5.07	67.38	17.83		100.0	
		Z	5.13	67.72	18.12		100.0	
10074-CAB	IEEE 802.11g WiFi 2.4 GHz (DSSS/OFDM, 24 Mbps)	X	5.29	67.91	18.59	3.30	100.0	± 9.6 %
		Y	5.09	67.38	18.02		100.0	
		Z	5.15	67.72	18.32		100.0	
10075-CAB	IEEE 802.11g WiFi 2.4 GHz (DSSS/OFDM, 36 Mbps)	X	5.40	68.27	19.03	3.82	90.0	± 9.6 %
		Y	5.18	67.65	18.40		90.0	
		Z	5.23	67.97	18.70		90.0	
10076-CAB	IEEE 802.11g WiFi 2.4 GHz (DSSS/OFDM, 48 Mbps)	X	5.40	68.04	19.14	4.15	90.0	± 9.6 %
		Y	5.21	67.49	18.53		90.0	
		Z	5.25	67.79	18.84		90.0	
10077-CAB	IEEE 802.11g WiFi 2.4 GHz (DSSS/OFDM, 54 Mbps)	X	5.43	68.12	19.24	4.30	90.0	± 9.6 %
		Y	5.24	67.58	18.64		90.0	
		Z	5.29	67.89	18.95		90.0	

10081-CAB	CDMA2000 (1xRTT, RC3)	X	0.92	67.03	13.48	0.00	150.0	± 9.6 %
		Y	0.59	62.42	9.51		150.0	
		Z	0.75	64.90	11.66		150.0	
10082-CAB	IS-54 / IS-136 FDD (TDMA/FDM, PI/4-DQPSK, Fullrate)	X	1.45	61.55	6.80	4.77	80.0	± 9.6 %
		Y	1.13	60.00	5.38		80.0	
		Z	1.17	60.40	5.80		80.0	
10090-DAC	GPRS-FDD (TDMA, GMSK, TN 0-4)	X	100.00	115.92	28.63	6.56	60.0	± 9.6 %
		Y	100.00	111.20	26.09		60.0	
		Z	100.00	114.38	27.55		60.0	
10097-CAB	UMTS-FDD (HSDPA)	X	1.85	67.86	15.91	0.00	150.0	± 9.6 %
		Y	1.59	65.86	14.27		150.0	
		Z	1.76	67.30	15.32		150.0	
10098-CAB	UMTS-FDD (HSUPA, Subtest 2)	X	1.82	67.83	15.88	0.00	150.0	± 9.6 %
		Y	1.56	65.79	14.21		150.0	
		Z	1.73	67.24	15.29		150.0	
10099-DAC	EDGE-FDD (TDMA, 8PSK, TN 0-4)	X	26.88	114.00	39.51	9.56	60.0	± 9.6 %
		Y	12.18	93.46	31.75		60.0	
		Z	17.07	103.56	36.04		60.0	
10100-CAD	LTE-FDD (SC-FDMA, 100% RB, 20 MHz, QPSK)	X	3.25	70.85	16.89	0.00	150.0	± 9.6 %
		Y	2.82	68.69	15.58		150.0	
		Z	3.04	69.96	16.42		150.0	
10101-CAD	LTE-FDD (SC-FDMA, 100% RB, 20 MHz, 16-QAM)	X	3.31	67.75	16.04	0.00	150.0	± 9.6 %
		Y	3.05	66.63	15.24		150.0	
		Z	3.18	67.32	15.73		150.0	
10102-CAD	LTE-FDD (SC-FDMA, 100% RB, 20 MHz, 64-QAM)	X	3.41	67.69	16.12	0.00	150.0	± 9.6 %
		Y	3.17	66.67	15.38		150.0	
		Z	3.28	67.31	15.84		150.0	
10103-CAD	LTE-TDD (SC-FDMA, 100% RB, 20 MHz, QPSK)	X	8.79	79.64	21.90	3.98	65.0	± 9.6 %
		Y	6.79	75.26	19.82		65.0	
		Z	8.10	78.75	21.47		65.0	
10104-CAD	LTE-TDD (SC-FDMA, 100% RB, 20 MHz, 16-QAM)	X	8.30	77.30	21.84	3.98	65.0	± 9.6 %
		Y	7.10	74.52	20.35		65.0	
		Z	7.59	76.13	21.24		65.0	
10105-CAD	LTE-TDD (SC-FDMA, 100% RB, 20 MHz, 64-QAM)	X	8.21	77.11	22.09	3.98	65.0	± 9.6 %
		Y	6.30	72.23	19.66		65.0	
		Z	7.24	75.16	21.14		65.0	
10108-CAE	LTE-FDD (SC-FDMA, 100% RB, 10 MHz, QPSK)	X	2.85	70.02	16.71	0.00	150.0	± 9.6 %
		Y	2.45	67.95	15.38		150.0	
		Z	2.64	69.18	16.23		150.0	
10109-CAE	LTE-FDD (SC-FDMA, 100% RB, 10 MHz, 16-QAM)	X	2.97	67.58	15.97	0.00	150.0	± 9.6 %
		Y	2.71	66.39	15.06		150.0	
		Z	2.83	67.15	15.62		150.0	
10110-CAE	LTE-FDD (SC-FDMA, 100% RB, 5 MHz, QPSK)	X	2.32	69.07	16.36	0.00	150.0	± 9.6 %
		Y	1.96	66.93	14.84		150.0	
		Z	2.13	68.23	15.78		150.0	
10111-CAE	LTE-FDD (SC-FDMA, 100% RB, 5 MHz, 16-QAM)	X	2.68	68.33	16.30	0.00	150.0	± 9.6 %
		Y	2.39	66.94	15.16		150.0	
		Z	2.55	67.98	15.88		150.0	

10112-CAE	LTE-FDD (SC-FDMA, 100% RB, 10 MHz, 64-QAM)	X	3.09	67.53	16.01	0.00	150.0	± 9.6 %
		Y	2.84	66.45	15.17		150.0	
		Z	2.96	67.17	15.69		150.0	
10113-CAE	LTE-FDD (SC-FDMA, 100% RB, 5 MHz, 64-QAM)	X	2.84	68.42	16.41	0.00	150.0	± 9.6 %
		Y	2.55	67.17	15.36		150.0	
		Z	2.70	68.15	16.04		150.0	
10114-CAC	IEEE 802.11n (HT Greenfield, 13.5 Mbps, BPSK)	X	5.16	67.17	16.41	0.00	150.0	± 9.6 %
		Y	5.01	66.82	16.13		150.0	
		Z	5.07	67.12	16.32		150.0	
10115-CAC	IEEE 802.11n (HT Greenfield, 81 Mbps, 16-QAM)	X	5.50	67.45	16.56	0.00	150.0	± 9.6 %
		Y	5.30	66.98	16.23		150.0	
		Z	5.35	67.23	16.39		150.0	
10116-CAC	IEEE 802.11n (HT Greenfield, 135 Mbps, 64-QAM)	X	5.27	67.41	16.46	0.00	150.0	± 9.6 %
		Y	5.10	67.01	16.16		150.0	
		Z	5.16	67.30	16.34		150.0	
10117-CAC	IEEE 802.11n (HT Mixed, 13.5 Mbps, BPSK)	X	5.14	67.12	16.41	0.00	150.0	± 9.6 %
		Y	4.97	66.67	16.08		150.0	
		Z	5.04	66.98	16.27		150.0	
10118-CAC	IEEE 802.11n (HT Mixed, 81 Mbps, 16-QAM)	X	5.57	67.61	16.64	0.00	150.0	± 9.6 %
		Y	5.39	67.20	16.35		150.0	
		Z	5.43	67.42	16.49		150.0	
10119-CAC	IEEE 802.11n (HT Mixed, 135 Mbps, 64-QAM)	X	5.24	67.35	16.44	0.00	150.0	± 9.6 %
		Y	5.08	66.96	16.14		150.0	
		Z	5.14	67.25	16.33		150.0	
10140-CAD	LTE-FDD (SC-FDMA, 100% RB, 15 MHz, 16-QAM)	X	3.45	67.69	16.04	0.00	150.0	± 9.6 %
		Y	3.20	66.67	15.30		150.0	
		Z	3.32	67.31	15.76		150.0	
10141-CAD	LTE-FDD (SC-FDMA, 100% RB, 15 MHz, 64-QAM)	X	3.57	67.75	16.20	0.00	150.0	± 9.6 %
		Y	3.33	66.82	15.50		150.0	
		Z	3.44	67.44	15.94		150.0	
10142-CAD	LTE-FDD (SC-FDMA, 100% RB, 3 MHz, QPSK)	X	2.10	69.09	16.14	0.00	150.0	± 9.6 %
		Y	1.72	66.61	14.28		150.0	
		Z	1.90	68.15	15.38		150.0	
10143-CAD	LTE-FDD (SC-FDMA, 100% RB, 3 MHz, 16-QAM)	X	2.57	69.15	16.17	0.00	150.0	± 9.6 %
		Y	2.19	67.18	14.56		150.0	
		Z	2.40	68.64	15.52		150.0	
10144-CAD	LTE-FDD (SC-FDMA, 100% RB, 3 MHz, 64-QAM)	X	2.35	66.96	14.64	0.00	150.0	± 9.6 %
		Y	2.01	65.20	13.08		150.0	
		Z	2.16	66.27	13.86		150.0	
10145-CAE	LTE-FDD (SC-FDMA, 100% RB, 1.4 MHz, QPSK)	X	1.41	66.68	13.17	0.00	150.0	± 9.6 %
		Y	0.96	62.51	9.67		150.0	
		Z	1.12	64.29	11.10		150.0	
10146-CAE	LTE-FDD (SC-FDMA, 100% RB, 1.4 MHz, 16-QAM)	X	3.10	71.59	14.90	0.00	150.0	± 9.6 %
		Y	1.79	64.92	10.83		150.0	
		Z	2.43	68.48	12.61		150.0	
10147-CAE	LTE-FDD (SC-FDMA, 100% RB, 1.4 MHz, 64-QAM)	X	4.18	75.64	16.70	0.00	150.0	± 9.6 %
		Y	2.03	66.39	11.70		150.0	
		Z	3.22	71.87	14.21		150.0	

10149-CAD	LTE-FDD (SC-FDMA, 50% RB, 20 MHz, 16-QAM)	X	2.98	67.64	16.01	0.00	150.0	± 9.6 %
		Y	2.71	66.45	15.11		150.0	
		Z	2.84	67.21	15.66		150.0	
10150-CAD	LTE-FDD (SC-FDMA, 50% RB, 20 MHz, 64-QAM)	X	3.10	67.58	16.05	0.00	150.0	± 9.6 %
		Y	2.84	66.51	15.21		150.0	
		Z	2.97	67.23	15.73		150.0	
10151-CAD	LTE-TDD (SC-FDMA, 50% RB, 20 MHz, QPSK)	X	9.77	82.83	23.21	3.98	65.0	± 9.6 %
		Y	7.53	78.32	21.06		65.0	
		Z	8.80	81.58	22.62		65.0	
10152-CAD	LTE-TDD (SC-FDMA, 50% RB, 20 MHz, 16-QAM)	X	7.95	77.63	21.74	3.98	65.0	± 9.6 %
		Y	6.62	74.40	19.97		65.0	
		Z	7.17	76.26	20.98		65.0	
10153-CAD	LTE-TDD (SC-FDMA, 50% RB, 20 MHz, 64-QAM)	X	8.37	78.52	22.46	3.98	65.0	± 9.6 %
		Y	7.08	75.55	20.84		65.0	
		Z	7.65	77.37	21.81		65.0	
10154-CAE	LTE-FDD (SC-FDMA, 50% RB, 10 MHz, QPSK)	X	2.37	69.54	16.64	0.00	150.0	± 9.6 %
		Y	2.00	67.32	15.10		150.0	
		Z	2.18	68.65	16.05		150.0	
10155-CAE	LTE-FDD (SC-FDMA, 50% RB, 10 MHz, 16-QAM)	X	2.69	68.33	16.31	0.00	150.0	± 9.6 %
		Y	2.39	66.95	15.18		150.0	
		Z	2.55	67.99	15.90		150.0	
10156-CAE	LTE-FDD (SC-FDMA, 50% RB, 5 MHz, QPSK)	X	1.96	69.34	16.07	0.00	150.0	± 9.6 %
		Y	1.55	66.39	13.86		150.0	
		Z	1.74	68.16	15.11		150.0	
10157-CAE	LTE-FDD (SC-FDMA, 50% RB, 5 MHz, 16-QAM)	X	2.20	67.66	14.79	0.00	150.0	± 9.6 %
		Y	1.81	65.37	12.85		150.0	
		Z	1.99	66.75	13.83		150.0	
10158-CAE	LTE-FDD (SC-FDMA, 50% RB, 10 MHz, 64-QAM)	X	2.84	68.47	16.45	0.00	150.0	± 9.6 %
		Y	2.55	67.23	15.41		150.0	
		Z	2.71	68.22	16.08		150.0	
10159-CAE	LTE-FDD (SC-FDMA, 50% RB, 5 MHz, 64-QAM)	X	2.32	68.16	15.10	0.00	150.0	± 9.6 %
		Y	1.90	65.77	13.13		150.0	
		Z	2.10	67.23	14.13		150.0	
10160-CAD	LTE-FDD (SC-FDMA, 50% RB, 15 MHz, QPSK)	X	2.81	68.83	16.41	0.00	150.0	± 9.6 %
		Y	2.51	67.36	15.34		150.0	
		Z	2.66	68.30	16.03		150.0	
10161-CAD	LTE-FDD (SC-FDMA, 50% RB, 15 MHz, 16-QAM)	X	2.99	67.51	15.99	0.00	150.0	± 9.6 %
		Y	2.74	66.42	15.12		150.0	
		Z	2.86	67.17	15.66		150.0	
10162-CAD	LTE-FDD (SC-FDMA, 50% RB, 15 MHz, 64-QAM)	X	3.10	67.61	16.08	0.00	150.0	± 9.6 %
		Y	2.85	66.59	15.25		150.0	
		Z	2.97	67.33	15.78		150.0	
10166-CAE	LTE-FDD (SC-FDMA, 50% RB, 1.4 MHz, QPSK)	X	3.94	70.56	19.62	3.01	150.0	± 9.6 %
		Y	3.62	69.51	18.92		150.0	
		Z	3.88	71.03	19.81		150.0	
10167-CAE	LTE-FDD (SC-FDMA, 50% RB, 1.4 MHz, 16-QAM)	X	5.13	74.04	20.28	3.01	150.0	± 9.6 %
		Y	4.50	72.11	19.19		150.0	
		Z	5.19	75.12	20.64		150.0	

10168-CAE	LTE-FDD (SC-FDMA, 50% RB, 1.4 MHz, 64-QAM)	X	5.71	76.34	21.57	3.01	150.0	± 9.6 %
		Y	5.08	74.75	20.72		150.0	
		Z	5.99	78.20	22.27		150.0	
10169-CAD	LTE-FDD (SC-FDMA, 1 RB, 20 MHz, QPSK)	X	3.58	71.57	20.04	3.01	150.0	± 9.6 %
		Y	3.13	69.16	18.69		150.0	
		Z	3.49	71.65	20.05		150.0	
10170-CAD	LTE-FDD (SC-FDMA, 1 RB, 20 MHz, 16-QAM)	X	5.52	78.92	22.69	3.01	150.0	± 9.6 %
		Y	4.42	74.92	20.91		150.0	
		Z	5.83	80.69	23.36		150.0	
10171-AAD	LTE-FDD (SC-FDMA, 1 RB, 20 MHz, 64-QAM)	X	4.37	73.98	19.76	3.01	150.0	± 9.6 %
		Y	3.54	70.32	17.92		150.0	
		Z	4.35	74.54	19.90		150.0	
10172-CAD	LTE-TDD (SC-FDMA, 1 RB, 20 MHz, QPSK)	X	31.66	113.22	34.95	6.02	65.0	± 9.6 %
		Y	9.38	89.05	26.85		65.0	
		Z	27.88	112.00	34.58		65.0	
10173-CAD	LTE-TDD (SC-FDMA, 1 RB, 20 MHz, 16-QAM)	X	63.77	119.68	34.61	6.02	65.0	± 9.6 %
		Y	15.75	94.23	26.84		65.0	
		Z	78.46	124.11	35.52		65.0	
10174-CAD	LTE-TDD (SC-FDMA, 1 RB, 20 MHz, 64-QAM)	X	43.93	111.32	31.85	6.02	65.0	± 9.6 %
		Y	9.41	84.90	23.38		65.0	
		Z	45.51	112.81	32.05		65.0	
10175-CAE	LTE-FDD (SC-FDMA, 1 RB, 10 MHz, QPSK)	X	3.52	71.19	19.77	3.01	150.0	± 9.6 %
		Y	3.08	68.79	18.41		150.0	
		Z	3.43	71.23	19.76		150.0	
10176-CAE	LTE-FDD (SC-FDMA, 1 RB, 10 MHz, 16-QAM)	X	5.53	78.94	22.70	3.01	150.0	± 9.6 %
		Y	4.42	74.94	20.92		150.0	
		Z	5.84	80.72	23.37		150.0	
10177-CAG	LTE-FDD (SC-FDMA, 1 RB, 5 MHz, QPSK)	X	3.56	71.37	19.87	3.01	150.0	± 9.6 %
		Y	3.11	68.97	18.52		150.0	
		Z	3.47	71.42	19.87		150.0	
10178-CAE	LTE-FDD (SC-FDMA, 1 RB, 5 MHz, 16-QAM)	X	5.45	78.64	22.56	3.01	150.0	± 9.6 %
		Y	4.37	74.68	20.78		150.0	
		Z	5.75	80.40	23.22		150.0	
10179-CAE	LTE-FDD (SC-FDMA, 1 RB, 10 MHz, 64-QAM)	X	4.88	76.27	21.07	3.01	150.0	± 9.6 %
		Y	3.91	72.36	19.22		150.0	
		Z	5.00	77.35	21.45		150.0	
10180-CAE	LTE-FDD (SC-FDMA, 1 RB, 5 MHz, 64-QAM)	X	4.35	73.89	19.70	3.01	150.0	± 9.6 %
		Y	3.53	70.24	17.87		150.0	
		Z	4.34	74.43	19.84		150.0	
10181-CAD	LTE-FDD (SC-FDMA, 1 RB, 15 MHz, QPSK)	X	3.55	71.35	19.86	3.01	150.0	± 9.6 %
		Y	3.11	68.95	18.51		150.0	
		Z	3.46	71.40	19.86		150.0	
10182-CAD	LTE-FDD (SC-FDMA, 1 RB, 15 MHz, 16-QAM)	X	5.44	78.62	22.55	3.01	150.0	± 9.6 %
		Y	4.36	74.65	20.76		150.0	
		Z	5.74	80.37	23.20		150.0	
10183-AAC	LTE-FDD (SC-FDMA, 1 RB, 15 MHz, 64-QAM)	X	4.34	73.86	19.69	3.01	150.0	± 9.6 %
		Y	3.53	70.21	17.86		150.0	
		Z	4.33	74.40	19.83		150.0	

10184-CAD	LTE-FDD (SC-FDMA, 1 RB, 3 MHz, QPSK)	X	3.57	71.40	19.89	3.01	150.0	± 9.6 %
		Y	3.12	69.00	18.54		150.0	
		Z	3.48	71.45	19.88		150.0	
10185-CAD	LTE-FDD (SC-FDMA, 1 RB, 3 MHz, 16-QAM)	X	5.46	78.70	22.58	3.01	150.0	± 9.6 %
		Y	4.38	74.73	20.80		150.0	
		Z	5.78	80.46	23.25		150.0	
10186-AAD	LTE-FDD (SC-FDMA, 1 RB, 3 MHz, 64-QAM)	X	4.37	73.93	19.73	3.01	150.0	± 9.6 %
		Y	3.54	70.28	17.89		150.0	
		Z	4.35	74.48	19.86		150.0	
10187-CAE	LTE-FDD (SC-FDMA, 1 RB, 1.4 MHz, QPSK)	X	3.57	71.45	19.95	3.01	150.0	± 9.6 %
		Y	3.13	69.05	18.60		150.0	
		Z	3.49	71.53	19.95		150.0	
10188-CAE	LTE-FDD (SC-FDMA, 1 RB, 1.4 MHz, 16-QAM)	X	5.68	79.51	23.00	3.01	150.0	± 9.6 %
		Y	4.55	75.50	21.23		150.0	
		Z	6.06	81.46	23.73		150.0	
10189-AAE	LTE-FDD (SC-FDMA, 1 RB, 1.4 MHz, 64-QAM)	X	4.48	74.44	20.02	3.01	150.0	± 9.6 %
		Y	3.62	70.71	18.18		150.0	
		Z	4.49	75.08	20.20		150.0	
10193-CAC	IEEE 802.11n (HT Greenfield, 6.5 Mbps, BPSK)	X	4.58	66.61	16.17	0.00	150.0	± 9.6 %
		Y	4.39	66.18	15.79		150.0	
		Z	4.47	66.55	16.02		150.0	
10194-CAC	IEEE 802.11n (HT Greenfield, 39 Mbps, 16-QAM)	X	4.76	66.95	16.29	0.00	150.0	± 9.6 %
		Y	4.56	66.50	15.92		150.0	
		Z	4.64	66.85	16.15		150.0	
10195-CAC	IEEE 802.11n (HT Greenfield, 65 Mbps, 64-QAM)	X	4.80	66.97	16.30	0.00	150.0	± 9.6 %
		Y	4.60	66.53	15.94		150.0	
		Z	4.68	66.88	16.17		150.0	
10196-CAC	IEEE 802.11n (HT Mixed, 6.5 Mbps, BPSK)	X	4.59	66.69	16.20	0.00	150.0	± 9.6 %
		Y	4.40	66.24	15.81		150.0	
		Z	4.47	66.60	16.04		150.0	
10197-CAC	IEEE 802.11n (HT Mixed, 39 Mbps, 16-QAM)	X	4.78	66.97	16.30	0.00	150.0	± 9.6 %
		Y	4.58	66.52	15.93		150.0	
		Z	4.65	66.87	16.16		150.0	
10198-CAC	IEEE 802.11n (HT Mixed, 65 Mbps, 64-QAM)	X	4.81	66.99	16.31	0.00	150.0	± 9.6 %
		Y	4.61	66.55	15.95		150.0	
		Z	4.68	66.90	16.18		150.0	
10219-CAC	IEEE 802.11n (HT Mixed, 7.2 Mbps, BPSK)	X	4.54	66.70	16.16	0.00	150.0	± 9.6 %
		Y	4.34	66.24	15.76		150.0	
		Z	4.42	66.61	16.00		150.0	
10220-CAC	IEEE 802.11n (HT Mixed, 43.3 Mbps, 16-QAM)	X	4.77	66.95	16.30	0.00	150.0	± 9.6 %
		Y	4.57	66.49	15.92		150.0	
		Z	4.64	66.84	16.15		150.0	
10221-CAC	IEEE 802.11n (HT Mixed, 72.2 Mbps, 64-QAM)	X	4.81	66.92	16.30	0.00	150.0	± 9.6 %
		Y	4.62	66.48	15.94		150.0	
		Z	4.69	66.83	16.16		150.0	
10222-CAC	IEEE 802.11n (HT Mixed, 15 Mbps, BPSK)	X	5.12	67.14	16.41	0.00	150.0	± 9.6 %
		Y	4.95	66.68	16.07		150.0	
		Z	5.01	66.99	16.27		150.0	

10223-CAC	IEEE 802.11n (HT Mixed, 90 Mbps, 16-QAM)	X	5.44	67.33	16.52	0.00	150.0	± 9.6 %
		Y	5.25	66.92	16.22		150.0	
		Z	5.31	67.18	16.39		150.0	
10224-CAC	IEEE 802.11n (HT Mixed, 150 Mbps, 64-QAM)	X	5.17	67.24	16.38	0.00	150.0	± 9.6 %
		Y	4.99	66.79	16.05		150.0	
		Z	5.06	67.10	16.25		150.0	
10225-CAB	UMTS-FDD (HSPA+)	X	2.86	66.19	15.49	0.00	150.0	± 9.6 %
		Y	2.63	65.32	14.64		150.0	
		Z	2.74	65.98	15.11		150.0	
10226-CAA	LTE-TDD (SC-FDMA, 1 RB, 1.4 MHz, 16-QAM)	X	71.24	121.88	35.27	6.02	65.0	± 9.6 %
		Y	16.91	95.59	27.35		65.0	
		Z	92.42	127.27	36.40		65.0	
10227-CAA	LTE-TDD (SC-FDMA, 1 RB, 1.4 MHz, 64-QAM)	X	50.30	113.83	32.60	6.02	65.0	± 9.6 %
		Y	15.15	92.51	25.87		65.0	
		Z	68.30	119.77	33.89		65.0	
10228-CAA	LTE-TDD (SC-FDMA, 1 RB, 1.4 MHz, QPSK)	X	55.50	124.73	38.12	6.02	65.0	± 9.6 %
		Y	14.70	97.88	29.79		65.0	
		Z	38.30	118.72	36.53		65.0	
10229-CAB	LTE-TDD (SC-FDMA, 1 RB, 3 MHz, 16-QAM)	X	63.93	119.72	34.63	6.02	65.0	± 9.6 %
		Y	15.85	94.32	26.88		65.0	
		Z	79.00	124.23	35.56		65.0	
10230-CAB	LTE-TDD (SC-FDMA, 1 RB, 3 MHz, 64-QAM)	X	46.15	112.18	32.09	6.02	65.0	± 9.6 %
		Y	14.25	91.41	25.45		65.0	
		Z	59.72	117.30	33.19		65.0	
10231-CAB	LTE-TDD (SC-FDMA, 1 RB, 3 MHz, QPSK)	X	50.49	122.68	37.51	6.02	65.0	± 9.6 %
		Y	13.80	96.56	29.30		65.0	
		Z	34.60	116.55	35.86		65.0	
10232-CAD	LTE-TDD (SC-FDMA, 1 RB, 5 MHz, 16-QAM)	X	64.00	119.75	34.64	6.02	65.0	± 9.6 %
		Y	15.83	94.31	26.87		65.0	
		Z	79.03	124.24	35.57		65.0	
10233-CAD	LTE-TDD (SC-FDMA, 1 RB, 5 MHz, 64-QAM)	X	46.17	112.21	32.10	6.02	65.0	± 9.6 %
		Y	14.23	91.39	25.44		65.0	
		Z	59.65	117.30	33.19		65.0	
10234-CAD	LTE-TDD (SC-FDMA, 1 RB, 5 MHz, QPSK)	X	46.07	120.60	36.84	6.02	65.0	± 9.6 %
		Y	13.04	95.31	28.79		65.0	
		Z	31.63	114.51	35.18		65.0	
10235-CAD	LTE-TDD (SC-FDMA, 1 RB, 10 MHz, 16-QAM)	X	64.33	119.85	34.67	6.02	65.0	± 9.6 %
		Y	15.85	94.34	26.88		65.0	
		Z	79.51	124.37	35.60		65.0	
10236-CAD	LTE-TDD (SC-FDMA, 1 RB, 10 MHz, 64-QAM)	X	46.79	112.40	32.14	6.02	65.0	± 9.6 %
		Y	14.34	91.49	25.47		65.0	
		Z	60.62	117.54	33.24		65.0	
10237-CAD	LTE-TDD (SC-FDMA, 1 RB, 10 MHz, QPSK)	X	51.22	123.00	37.59	6.02	65.0	± 9.6 %
		Y	13.84	96.65	29.32		65.0	
		Z	34.93	116.77	35.92		65.0	
10238-CAD	LTE-TDD (SC-FDMA, 1 RB, 15 MHz, 16-QAM)	X	64.07	119.77	34.64	6.02	65.0	± 9.6 %
		Y	15.80	94.29	26.87		65.0	
		Z	79.05	124.26	35.57		65.0	

10239-CAD	LTE-TDD (SC-FDMA, 1 RB, 15 MHz, 64-QAM)	X	46.17	112.22	32.10	6.02	65.0	± 9.6 %
		Y	14.20	91.37	25.44		65.0	
		Z	59.56	117.29	33.19		65.0	
10240-CAD	LTE-TDD (SC-FDMA, 1 RB, 15 MHz, QPSK)	X	51.02	122.93	37.57	6.02	65.0	± 9.6 %
		Y	13.80	96.60	29.31		65.0	
		Z	34.81	116.71	35.90		65.0	
10241-CAA	LTE-TDD (SC-FDMA, 50% RB, 1.4 MHz, 16-QAM)	X	12.30	87.67	27.92	6.98	65.0	± 9.6 %
		Y	9.73	82.62	25.44		65.0	
		Z	11.99	88.11	27.90		65.0	
10242-CAA	LTE-TDD (SC-FDMA, 50% RB, 1.4 MHz, 64-QAM)	X	12.00	87.14	27.64	6.98	65.0	± 9.6 %
		Y	8.11	78.88	23.86		65.0	
		Z	10.85	86.00	27.03		65.0	
10243-CAA	LTE-TDD (SC-FDMA, 50% RB, 1.4 MHz, QPSK)	X	9.42	83.90	27.37	6.98	65.0	± 9.6 %
		Y	6.64	76.16	23.58		65.0	
		Z	8.16	81.56	26.26		65.0	
10244-CAB	LTE-TDD (SC-FDMA, 50% RB, 3 MHz, 16-QAM)	X	10.44	82.93	21.79	3.98	65.0	± 9.6 %
		Y	6.79	75.71	18.18		65.0	
		Z	9.21	80.92	20.37		65.0	
10245-CAB	LTE-TDD (SC-FDMA, 50% RB, 3 MHz, 64-QAM)	X	10.08	82.11	21.44	3.98	65.0	± 9.6 %
		Y	6.62	75.11	17.89		65.0	
		Z	8.78	79.92	19.95		65.0	
10246-CAB	LTE-TDD (SC-FDMA, 50% RB, 3 MHz, QPSK)	X	11.42	87.52	23.40	3.98	65.0	± 9.6 %
		Y	5.98	76.83	18.54		65.0	
		Z	8.49	82.82	21.13		65.0	
10247-CAD	LTE-TDD (SC-FDMA, 50% RB, 5 MHz, 16-QAM)	X	7.75	79.05	20.99	3.98	65.0	± 9.6 %
		Y	5.69	73.82	18.06		65.0	
		Z	6.60	76.66	19.49		65.0	
10248-CAD	LTE-TDD (SC-FDMA, 50% RB, 5 MHz, 64-QAM)	X	7.60	78.24	20.65	3.98	65.0	± 9.6 %
		Y	5.66	73.30	17.84		65.0	
		Z	6.46	75.86	19.15		65.0	
10249-CAD	LTE-TDD (SC-FDMA, 50% RB, 5 MHz, QPSK)	X	12.84	89.97	24.97	3.98	65.0	± 9.6 %
		Y	7.45	80.54	20.84		65.0	
		Z	10.45	86.75	23.43		65.0	
10250-CAD	LTE-TDD (SC-FDMA, 50% RB, 10 MHz, 16-QAM)	X	8.59	80.97	23.10	3.98	65.0	± 9.6 %
		Y	6.88	77.02	21.00		65.0	
		Z	7.71	79.50	22.24		65.0	
10251-CAD	LTE-TDD (SC-FDMA, 50% RB, 10 MHz, 64-QAM)	X	7.91	78.24	21.71	3.98	65.0	± 9.6 %
		Y	6.42	74.62	19.67		65.0	
		Z	7.08	76.75	20.80		65.0	
10252-CAD	LTE-TDD (SC-FDMA, 50% RB, 10 MHz, QPSK)	X	11.43	87.56	24.93	3.98	65.0	± 9.6 %
		Y	7.91	81.04	22.00		65.0	
		Z	9.97	85.71	24.05		65.0	
10253-CAD	LTE-TDD (SC-FDMA, 50% RB, 15 MHz, 16-QAM)	X	7.70	76.94	21.48	3.98	65.0	± 9.6 %
		Y	6.48	73.90	19.75		65.0	
		Z	7.00	75.70	20.74		65.0	
10254-CAD	LTE-TDD (SC-FDMA, 50% RB, 15 MHz, 64-QAM)	X	8.12	77.80	22.14	3.98	65.0	± 9.6 %
		Y	6.90	74.95	20.52		65.0	
		Z	7.44	76.71	21.47		65.0	

10255-CAD	LTE-TDD (SC-FDMA, 50% RB, 15 MHz, QPSK)	X	9.27	82.17	23.21	3.98	65.0	± 9.6 %
		Y	7.25	77.88	21.10		65.0	
		Z	8.37	80.94	22.58		65.0	
10256-CAA	LTE-TDD (SC-FDMA, 100% RB, 1.4 MHz, 16-QAM)	X	8.78	79.64	19.68	3.98	65.0	± 9.6 %
		Y	5.26	71.61	15.48		65.0	
		Z	6.86	75.83	17.39		65.0	
10257-CAA	LTE-TDD (SC-FDMA, 100% RB, 1.4 MHz, 64-QAM)	X	8.34	78.50	19.16	3.98	65.0	± 9.6 %
		Y	5.12	70.92	15.09		65.0	
		Z	6.46	74.63	16.81		65.0	
10258-CAA	LTE-TDD (SC-FDMA, 100% RB, 1.4 MHz, QPSK)	X	8.92	82.95	21.11	3.98	65.0	± 9.6 %
		Y	4.50	72.26	15.88		65.0	
		Z	6.02	76.94	18.10		65.0	
10259-CAB	LTE-TDD (SC-FDMA, 100% RB, 3 MHz, 16-QAM)	X	8.07	79.69	21.71	3.98	65.0	± 9.6 %
		Y	6.15	75.00	19.12		65.0	
		Z	7.04	77.72	20.48		65.0	
10260-CAB	LTE-TDD (SC-FDMA, 100% RB, 3 MHz, 64-QAM)	X	8.02	79.27	21.57	3.98	65.0	± 9.6 %
		Y	6.17	74.75	19.03		65.0	
		Z	7.00	77.32	20.33		65.0	
10261-CAB	LTE-TDD (SC-FDMA, 100% RB, 3 MHz, QPSK)	X	11.37	87.81	24.60	3.98	65.0	± 9.6 %
		Y	7.29	80.02	21.07		65.0	
		Z	9.57	85.23	23.32		65.0	
10262-CAD	LTE-TDD (SC-FDMA, 100% RB, 5 MHz, 16-QAM)	X	8.58	80.91	23.06	3.98	65.0	± 9.6 %
		Y	6.86	76.94	20.95		65.0	
		Z	7.69	79.43	22.19		65.0	
10263-CAD	LTE-TDD (SC-FDMA, 100% RB, 5 MHz, 64-QAM)	X	7.90	78.22	21.71	3.98	65.0	± 9.6 %
		Y	6.41	74.61	19.67		65.0	
		Z	7.06	76.73	20.79		65.0	
10264-CAD	LTE-TDD (SC-FDMA, 100% RB, 5 MHz, QPSK)	X	11.30	87.33	24.83	3.98	65.0	± 9.6 %
		Y	7.82	80.82	21.90		65.0	
		Z	9.85	85.46	23.94		65.0	
10265-CAD	LTE-TDD (SC-FDMA, 100% RB, 10 MHz, 16-QAM)	X	7.95	77.63	21.74	3.98	65.0	± 9.6 %
		Y	6.61	74.40	19.97		65.0	
		Z	7.17	76.26	20.99		65.0	
10266-CAD	LTE-TDD (SC-FDMA, 100% RB, 10 MHz, 64-QAM)	X	8.37	78.51	22.45	3.98	65.0	± 9.6 %
		Y	7.07	75.53	20.83		65.0	
		Z	7.65	77.35	21.80		65.0	
10267-CAD	LTE-TDD (SC-FDMA, 100% RB, 10 MHz, QPSK)	X	9.74	82.78	23.19	3.98	65.0	± 9.6 %
		Y	7.51	78.28	21.05		65.0	
		Z	8.78	81.53	22.59		65.0	
10268-CAD	LTE-TDD (SC-FDMA, 100% RB, 15 MHz, 16-QAM)	X	8.35	76.91	21.81	3.98	65.0	± 9.6 %
		Y	7.25	74.40	20.43		65.0	
		Z	7.70	75.89	21.26		65.0	
10269-CAD	LTE-TDD (SC-FDMA, 100% RB, 15 MHz, 64-QAM)	X	8.25	76.41	21.67	3.98	65.0	± 9.6 %
		Y	7.21	74.02	20.34		65.0	
		Z	7.64	75.43	21.12		65.0	
10270-CAD	LTE-TDD (SC-FDMA, 100% RB, 15 MHz, QPSK)	X	8.73	79.00	21.90	3.98	65.0	± 9.6 %
		Y	7.29	75.91	20.32		65.0	
		Z	8.05	78.09	21.45		65.0	

10274-CAB	UMTS-FDD (HSUPA, Subtest 5, 3GPP Rel8.10)	X	2.62	66.51	15.38	0.00	150.0	± 9.6 %
		Y	2.40	65.49	14.41		150.0	
		Z	2.53	66.32	15.01		150.0	
10275-CAB	UMTS-FDD (HSUPA, Subtest 5, 3GPP Rel8.4)	X	1.66	68.37	15.85	0.00	150.0	± 9.6 %
		Y	1.36	65.72	13.86		150.0	
		Z	1.53	67.34	15.09		150.0	
10277-CAA	PHS (QPSK)	X	4.01	66.28	11.28	9.03	50.0	± 9.6 %
		Y	3.27	63.73	9.40		50.0	
		Z	3.24	64.17	9.56		50.0	
10278-CAA	PHS (QPSK, BW 884MHz, Rolloff 0.5)	X	10.72	83.49	21.29	9.03	50.0	± 9.6 %
		Y	5.37	71.76	15.68		50.0	
		Z	6.95	76.49	17.84		50.0	
10279-CAA	PHS (QPSK, BW 884MHz, Rolloff 0.38)	X	10.91	83.69	21.40	9.03	50.0	± 9.6 %
		Y	5.48	71.97	15.81		50.0	
		Z	7.09	76.71	17.97		50.0	
10290-AAB	CDMA2000, RC1, SO55, Full Rate	X	1.63	69.96	14.95	0.00	150.0	± 9.6 %
		Y	1.04	64.71	11.14		150.0	
		Z	1.29	67.48	13.09		150.0	
10291-AAB	CDMA2000, RC3, SO55, Full Rate	X	0.90	66.75	13.33	0.00	150.0	± 9.6 %
		Y	0.58	62.29	9.42		150.0	
		Z	0.74	64.70	11.54		150.0	
10292-AAB	CDMA2000, RC3, SO32, Full Rate	X	1.21	71.81	16.09	0.00	150.0	± 9.6 %
		Y	0.65	64.19	10.77		150.0	
		Z	0.93	68.53	13.82		150.0	
10293-AAB	CDMA2000, RC3, SO3, Full Rate	X	1.97	79.16	19.55	0.00	150.0	± 9.6 %
		Y	0.85	67.30	12.80		150.0	
		Z	1.50	75.07	17.10		150.0	
10295-AAB	CDMA2000, RC1, SO3, 1/8th Rate 25 fr.	X	12.27	88.66	25.82	9.03	50.0	± 9.6 %
		Y	8.75	80.85	21.80		50.0	
		Z	11.52	87.13	24.56		50.0	
10297-AAC	LTE-FDD (SC-FDMA, 50% RB, 20 MHz, QPSK)	X	2.86	70.12	16.78	0.00	150.0	± 9.6 %
		Y	2.47	68.04	15.44		150.0	
		Z	2.66	69.28	16.30		150.0	
10298-AAC	LTE-FDD (SC-FDMA, 50% RB, 3 MHz, QPSK)	X	1.72	68.67	14.95	0.00	150.0	± 9.6 %
		Y	1.25	64.84	11.99		150.0	
		Z	1.45	66.83	13.43		150.0	
10299-AAC	LTE-FDD (SC-FDMA, 50% RB, 3 MHz, 16-QAM)	X	3.76	73.98	16.75	0.00	150.0	± 9.6 %
		Y	2.44	68.23	13.44		150.0	
		Z	3.56	73.19	15.68		150.0	
10300-AAC	LTE-FDD (SC-FDMA, 50% RB, 3 MHz, 64-QAM)	X	2.57	67.80	13.32	0.00	150.0	± 9.6 %
		Y	1.89	64.33	10.83		150.0	
		Z	2.25	66.42	11.95		150.0	
10301-AAA	IEEE 802.16e WiMAX (29:18, 5ms, 10MHz, QPSK, PUSC)	X	5.34	67.21	18.36	4.17	50.0	± 9.6 %
		Y	4.92	66.04	17.49		50.0	
		Z	5.00	66.39	17.73		50.0	
10302-AAA	IEEE 802.16e WiMAX (29:18, 5ms, 10MHz, QPSK, PUSC, 3 CTRL symbols)	X	5.75	67.51	18.91	4.96	50.0	± 9.6 %
		Y	5.39	66.46	18.07		50.0	
		Z	5.48	66.98	18.44		50.0	

10303-AAA	IEEE 802.16e WiMAX (31:15, 5ms, 10MHz, 64QAM, PUSC)	X	5.55	67.40	18.88	4.96	50.0	± 9.6 %
		Y	5.18	66.25	17.96		50.0	
		Z	5.26	66.77	18.34		50.0	
10304-AAA	IEEE 802.16e WiMAX (29:18, 5ms, 10MHz, 64QAM, PUSC)	X	5.27	66.95	18.19	4.17	50.0	± 9.6 %
		Y	4.92	65.91	17.36		50.0	
		Z	5.02	66.46	17.74		50.0	
10305-AAA	IEEE 802.16e WiMAX (31:15, 10ms, 10MHz, 64QAM, PUSC, 15 symbols)	X	6.02	73.68	22.76	6.02	35.0	± 9.6 %
		Y	5.62	72.10	21.29		35.0	
		Z	5.50	71.99	21.48		35.0	
10306-AAA	IEEE 802.16e WiMAX (29:18, 10ms, 10MHz, 64QAM, PUSC, 18 symbols)	X	5.71	70.24	21.22	6.02	35.0	± 9.6 %
		Y	5.41	69.23	20.17		35.0	
		Z	5.36	69.27	20.36		35.0	
10307-AAA	IEEE 802.16e WiMAX (29:18, 10ms, 10MHz, QPSK, PUSC, 18 symbols)	X	5.75	70.97	21.43	6.02	35.0	± 9.6 %
		Y	5.41	69.78	20.28		35.0	
		Z	5.34	69.76	20.46		35.0	
10308-AAA	IEEE 802.16e WiMAX (29:18, 10ms, 10MHz, 16QAM, PUSC)	X	5.78	71.40	21.67	6.02	35.0	± 9.6 %
		Y	5.44	70.16	20.49		35.0	
		Z	5.37	70.16	20.68		35.0	
10309-AAA	IEEE 802.16e WiMAX (29:18, 10ms, 10MHz, 16QAM, AMC 2x3, 18 symbols)	X	5.81	70.57	21.41	6.02	35.0	± 9.6 %
		Y	5.47	69.45	20.31		35.0	
		Z	5.42	69.49	20.51		35.0	
10310-AAA	IEEE 802.16e WiMAX (29:18, 10ms, 10MHz, QPSK, AMC 2x3, 18 symbols)	X	5.71	70.51	21.28	6.02	35.0	± 9.6 %
		Y	5.40	69.46	20.21		35.0	
		Z	5.35	69.48	20.40		35.0	
10311-AAC	LTE-FDD (SC-FDMA, 100% RB, 15 MHz, QPSK)	X	3.22	69.41	16.42	0.00	150.0	± 9.6 %
		Y	2.80	67.40	15.19		150.0	
		Z	3.01	68.61	15.98		150.0	
10313-AAA	iDEN 1:3	X	8.72	81.59	19.46	6.99	70.0	± 9.6 %
		Y	4.16	71.30	14.92		70.0	
		Z	6.60	78.28	18.09		70.0	
10314-AAA	iDEN 1:6	X	16.37	95.12	26.54	10.00	30.0	± 9.6 %
		Y	5.55	77.14	19.77		30.0	
		Z	11.38	90.04	24.85		30.0	
10315-AAB	IEEE 802.11b WiFi 2.4 GHz (DSSS, 1 Mbps, 96pc duty cycle)	X	1.13	64.52	15.64	0.17	150.0	± 9.6 %
		Y	0.98	62.76	14.03		150.0	
		Z	1.08	63.88	15.03		150.0	
10316-AAB	IEEE 802.11g WiFi 2.4 GHz (ERP-OFDM, 6 Mbps, 96pc duty cycle)	X	4.66	66.76	16.37	0.17	150.0	± 9.6 %
		Y	4.47	66.30	15.96		150.0	
		Z	4.54	66.67	16.21		150.0	
10317-AAC	IEEE 802.11a WiFi 5 GHz (OFDM, 6 Mbps, 96pc duty cycle)	X	4.66	66.76	16.37	0.17	150.0	± 9.6 %
		Y	4.47	66.30	15.96		150.0	
		Z	4.54	66.67	16.21		150.0	
10400-AAD	IEEE 802.11ac WiFi (20MHz, 64-QAM, 99pc duty cycle)	X	4.76	67.01	16.29	0.00	150.0	± 9.6 %
		Y	4.55	66.53	15.90		150.0	
		Z	4.62	66.89	16.13		150.0	
10401-AAD	IEEE 802.11ac WiFi (40MHz, 64-QAM, 99pc duty cycle)	X	5.41	67.10	16.39	0.00	150.0	± 9.6 %
		Y	5.28	66.83	16.15		150.0	
		Z	5.32	67.06	16.30		150.0	

10402-AAD	IEEE 802.11ac WiFi (80MHz, 64-QAM, 99pc duty cycle)	X	5.69	67.55	16.46	0.00	150.0	± 9.6 %
		Y	5.51	67.10	16.14		150.0	
		Z	5.58	67.39	16.32		150.0	
10403-AAB	CDMA2000 (1xEV-DO, Rev. 0)	X	1.63	69.96	14.95	0.00	115.0	± 9.6 %
		Y	1.04	64.71	11.14		115.0	
		Z	1.29	67.48	13.09		115.0	
10404-AAB	CDMA2000 (1xEV-DO, Rev. A)	X	1.63	69.96	14.95	0.00	115.0	± 9.6 %
		Y	1.04	64.71	11.14		115.0	
		Z	1.29	67.48	13.09		115.0	
10406-AAB	CDMA2000, RC3, SO32, SCH0, Full Rate	X	100.00	121.60	30.91	0.00	100.0	± 9.6 %
		Y	14.90	94.78	23.76		100.0	
		Z	100.00	118.00	28.98		100.0	
10410-AAD	LTE-TDD (SC-FDMA, 1 RB, 10 MHz, QPSK, UL Subframe=2,3,4,7,8,9, Subframe Conf=4)	X	100.00	120.72	30.61	3.23	80.0	± 9.6 %
		Y	52.68	109.61	27.00		80.0	
		Z	100.00	120.47	30.13		80.0	
10415-AAA	IEEE 802.11b WiFi 2.4 GHz (DSSS, 1 Mbps, 99pc duty cycle)	X	1.00	63.11	14.78	0.00	150.0	± 9.6 %
		Y	0.88	61.69	13.34		150.0	
		Z	0.97	62.68	14.28		150.0	
10416-AAA	IEEE 802.11g WiFi 2.4 GHz (ERP-OFDM, 6 Mbps, 99pc duty cycle)	X	4.58	66.65	16.23	0.00	150.0	± 9.6 %
		Y	4.40	66.22	15.86		150.0	
		Z	4.47	66.58	16.09		150.0	
10417-AAB	IEEE 802.11a/h WiFi 5 GHz (OFDM, 6 Mbps, 99pc duty cycle)	X	4.58	66.65	16.23	0.00	150.0	± 9.6 %
		Y	4.40	66.22	15.86		150.0	
		Z	4.47	66.58	16.09		150.0	
10418-AAA	IEEE 802.11g WiFi 2.4 GHz (DSSS-OFDM, 6 Mbps, 99pc duty cycle, Long preamble)	X	4.57	66.80	16.24	0.00	150.0	± 9.6 %
		Y	4.38	66.37	15.87		150.0	
		Z	4.46	66.75	16.11		150.0	
10419-AAA	IEEE 802.11g WiFi 2.4 GHz (DSSS-OFDM, 6 Mbps, 99pc duty cycle, Short preamble)	X	4.59	66.75	16.24	0.00	150.0	± 9.6 %
		Y	4.41	66.32	15.88		150.0	
		Z	4.48	66.69	16.11		150.0	
10422-AAB	IEEE 802.11n (HT Greenfield, 7.2 Mbps, BPSK)	X	4.71	66.75	16.26	0.00	150.0	± 9.6 %
		Y	4.52	66.34	15.90		150.0	
		Z	4.60	66.69	16.13		150.0	
10423-AAB	IEEE 802.11n (HT Greenfield, 43.3 Mbps, 16-QAM)	X	4.89	67.10	16.38	0.00	150.0	± 9.6 %
		Y	4.69	66.65	16.02		150.0	
		Z	4.76	67.00	16.24		150.0	
10424-AAB	IEEE 802.11n (HT Greenfield, 72.2 Mbps, 64-QAM)	X	4.81	67.04	16.35	0.00	150.0	± 9.6 %
		Y	4.61	66.59	15.99		150.0	
		Z	4.68	66.95	16.21		150.0	
10425-AAB	IEEE 802.11n (HT Greenfield, 15 Mbps, BPSK)	X	5.39	67.34	16.50	0.00	150.0	± 9.6 %
		Y	5.22	66.97	16.22		150.0	
		Z	5.27	67.22	16.38		150.0	
10426-AAB	IEEE 802.11n (HT Greenfield, 90 Mbps, 16-QAM)	X	5.39	67.34	16.50	0.00	150.0	± 9.6 %
		Y	5.23	67.01	16.23		150.0	
		Z	5.28	67.26	16.39		150.0	

10427-AAB	IEEE 802.11n (HT Greenfield, 150 Mbps, 64-QAM)	X	5.41	67.34	16.49	0.00	150.0	± 9.6 %
		Y	5.24	66.97	16.22		150.0	
		Z	5.29	67.23	16.38		150.0	
10430-AAB	LTE-FDD (OFDMA, 5 MHz, E-TM 3.1)	X	4.30	70.55	18.18	0.00	150.0	± 9.6 %
		Y	4.12	70.52	17.85		150.0	
		Z	4.23	71.03	18.16		150.0	
10431-AAB	LTE-FDD (OFDMA, 10 MHz, E-TM 3.1)	X	4.29	67.21	16.27	0.00	150.0	± 9.6 %
		Y	4.05	66.67	15.77		150.0	
		Z	4.14	67.11	16.06		150.0	
10432-AAB	LTE-FDD (OFDMA, 15 MHz, E-TM 3.1)	X	4.58	67.09	16.31	0.00	150.0	± 9.6 %
		Y	4.37	66.61	15.90		150.0	
		Z	4.44	66.99	16.15		150.0	
10433-AAB	LTE-FDD (OFDMA, 20 MHz, E-TM 3.1)	X	4.82	67.08	16.38	0.00	150.0	± 9.6 %
		Y	4.62	66.63	16.01		150.0	
		Z	4.69	66.98	16.23		150.0	
10434-AAA	W-CDMA (BS Test Model 1, 64 DPCH)	X	4.41	71.40	18.19	0.00	150.0	± 9.6 %
		Y	4.20	71.25	17.73		150.0	
		Z	4.35	71.94	18.12		150.0	
10435-AAC	LTE-TDD (SC-FDMA, 1 RB, 20 MHz, QPSK, UL Subframe=2,3,4,7,8,9)	X	100.00	120.54	30.53	3.23	80.0	± 9.6 %
		Y	46.85	107.92	26.54		80.0	
		Z	100.00	120.26	30.03		80.0	
10447-AAB	LTE-FDD (OFDMA, 5 MHz, E-TM 3.1, Clipping 44%)	X	3.60	67.27	15.72	0.00	150.0	± 9.6 %
		Y	3.31	66.43	14.88		150.0	
		Z	3.42	67.06	15.30		150.0	
10448-AAB	LTE-FDD (OFDMA, 10 MHz, E-TM 3.1, Clipping 44%)	X	4.12	66.99	16.13	0.00	150.0	± 9.6 %
		Y	3.90	66.44	15.61		150.0	
		Z	3.98	66.89	15.92		150.0	
10449-AAB	LTE-FDD (OFDMA, 15 MHz, E-TM 3.1, Clipping 44%)	X	4.38	66.92	16.22	0.00	150.0	± 9.6 %
		Y	4.18	66.42	15.78		150.0	
		Z	4.26	66.82	16.05		150.0	
10450-AAB	LTE-FDD (OFDMA, 20 MHz, E-TM 3.1, Clipping 44%)	X	4.57	66.85	16.23	0.00	150.0	± 9.6 %
		Y	4.38	66.38	15.84		150.0	
		Z	4.46	66.75	16.09		150.0	
10451-AAA	W-CDMA (BS Test Model 1, 64 DPCH, Clipping 44%)	X	3.51	67.52	15.42	0.00	150.0	± 9.6 %
		Y	3.17	66.45	14.38		150.0	
		Z	3.30	67.16	14.86		150.0	
10456-AAB	IEEE 802.11ac WiFi (160MHz, 64-QAM, 99pc duty cycle)	X	6.24	67.91	16.66	0.00	150.0	± 9.6 %
		Y	6.09	67.55	16.40		150.0	
		Z	6.14	67.78	16.54		150.0	
10457-AAA	UMTS-FDD (DC-HSDPA)	X	3.80	65.28	15.95	0.00	150.0	± 9.6 %
		Y	3.67	64.86	15.55		150.0	
		Z	3.74	65.24	15.80		150.0	
10458-AAA	CDMA2000 (1xEV-DO, Rev. B, 2 carriers)	X	4.04	70.60	17.63	0.00	150.0	± 9.6 %
		Y	3.78	70.18	16.90		150.0	
		Z	3.96	71.06	17.41		150.0	
10459-AAA	CDMA2000 (1xEV-DO, Rev. B, 3 carriers)	X	5.10	67.92	18.04	0.00	150.0	± 9.6 %
		Y	5.04	68.55	18.14		150.0	
		Z	5.06	68.63	18.14		150.0	

10460-AAA	UMTS-FDD (WCDMA, AMR)	X	0.93	69.01	16.61	0.00	150.0	± 9.6 %
		Y	0.67	64.78	13.34		150.0	
		Z	0.83	67.12	15.33		150.0	
10461-AAA	LTE-TDD (SC-FDMA, 1 RB, 1.4 MHz, QPSK, UL Subframe=2,3,4,7,8,9)	X	100.00	125.37	32.80	3.29	80.0	± 9.6 %
		Y	100.00	120.09	30.00		80.0	
		Z	100.00	125.85	32.64		80.0	
10462-AAA	LTE-TDD (SC-FDMA, 1 RB, 1.4 MHz, 16-QAM, UL Subframe=2,3,4,7,8,9)	X	100.00	109.15	25.16	3.23	80.0	± 9.6 %
		Y	2.88	68.96	12.87		80.0	
		Z	100.00	106.54	23.80		80.0	
10463-AAA	LTE-TDD (SC-FDMA, 1 RB, 1.4 MHz, 64-QAM, UL Subframe=2,3,4,7,8,9)	X	100.00	105.92	23.62	3.23	80.0	± 9.6 %
		Y	1.89	64.22	10.46		80.0	
		Z	16.73	86.00	17.87		80.0	
10464-AAA	LTE-TDD (SC-FDMA, 1 RB, 3 MHz, QPSK, UL Subframe=2,3,4,7,8,9)	X	100.00	123.34	31.70	3.23	80.0	± 9.6 %
		Y	100.00	117.53	28.68		80.0	
		Z	100.00	123.49	31.39		80.0	
10465-AAA	LTE-TDD (SC-FDMA, 1 RB, 3 MHz, 16-QAM, UL Subframe=2,3,4,7,8,9)	X	100.00	108.60	24.90	3.23	80.0	± 9.6 %
		Y	2.49	67.43	12.20		80.0	
		Z	100.00	105.93	23.31		80.0	
10466-AAA	LTE-TDD (SC-FDMA, 1 RB, 3 MHz, 64-QAM, UL Subframe=2,3,4,7,8,9)	X	99.93	105.40	23.38	3.23	80.0	± 9.6 %
		Y	1.76	63.52	10.09		80.0	
		Z	7.76	78.49	15.68		80.0	
10467-AAC	LTE-TDD (SC-FDMA, 1 RB, 5 MHz, QPSK, UL Subframe=2,3,4,7,8,9)	X	100.00	123.57	31.81	3.23	80.0	± 9.6 %
		Y	100.00	117.78	28.79		80.0	
		Z	100.00	123.77	31.51		80.0	
10468-AAC	LTE-TDD (SC-FDMA, 1 RB, 5 MHz, 16-QAM, UL Subframe=2,3,4,7,8,9)	X	100.00	108.77	24.97	3.23	80.0	± 9.6 %
		Y	2.58	67.81	12.37		80.0	
		Z	100.00	106.13	23.39		80.0	
10469-AAC	LTE-TDD (SC-FDMA, 1 RB, 5 MHz, 64-QAM, UL Subframe=2,3,4,7,8,9)	X	100.00	105.42	23.38	3.23	80.0	± 9.6 %
		Y	1.76	63.54	10.10		80.0	
		Z	7.98	78.76	15.76		80.0	
10470-AAC	LTE-TDD (SC-FDMA, 1 RB, 10 MHz, QPSK, UL Subframe=2,3,4,7,8,9)	X	100.00	123.60	31.81	3.23	80.0	± 9.6 %
		Y	100.00	117.78	28.78		80.0	
		Z	100.00	123.80	31.51		80.0	
10471-AAC	LTE-TDD (SC-FDMA, 1 RB, 10 MHz, 16-QAM, UL Subframe=2,3,4,7,8,9)	X	100.00	108.72	24.94	3.23	80.0	± 9.6 %
		Y	2.56	67.74	12.33		80.0	
		Z	100.00	106.06	23.36		80.0	
10472-AAC	LTE-TDD (SC-FDMA, 1 RB, 10 MHz, 64-QAM, UL Subframe=2,3,4,7,8,9)	X	99.99	105.37	23.35	3.23	80.0	± 9.6 %
		Y	1.76	63.49	10.07		80.0	
		Z	7.85	78.59	15.70		80.0	
10473-AAC	LTE-TDD (SC-FDMA, 1 RB, 15 MHz, QPSK, UL Subframe=2,3,4,7,8,9)	X	100.00	123.57	31.80	3.23	80.0	± 9.6 %
		Y	100.00	117.75	28.77		80.0	
		Z	100.00	123.76	31.50		80.0	
10474-AAC	LTE-TDD (SC-FDMA, 1 RB, 15 MHz, 16-QAM, UL Subframe=2,3,4,7,8,9)	X	100.00	108.72	24.94	3.23	80.0	± 9.6 %
		Y	2.55	67.70	12.31		80.0	
		Z	100.00	106.07	23.36		80.0	
10475-AAC	LTE-TDD (SC-FDMA, 1 RB, 15 MHz, 64-QAM, UL Subframe=2,3,4,7,8,9)	X	100.00	105.38	23.36	3.23	80.0	± 9.6 %
		Y	1.75	63.48	10.06		80.0	
		Z	7.74	78.46	15.66		80.0	

10477-AAC	LTE-TDD (SC-FDMA, 1 RB, 20 MHz, 16-QAM, UL Subframe=2,3,4,7,8,9)	X	100.00	108.56	24.86	3.23	80.0	± 9.6 %
		Y	2.48	67.39	12.17		80.0	
		Z	100.00	105.88	23.27		80.0	
10478-AAC	LTE-TDD (SC-FDMA, 1 RB, 20 MHz, 64-QAM, UL Subframe=2,3,4,7,8,9)	X	99.93	105.32	23.33	3.23	80.0	± 9.6 %
		Y	1.75	63.43	10.04		80.0	
		Z	7.52	78.16	15.56		80.0	
10479-AAA	LTE-TDD (SC-FDMA, 50% RB, 1.4 MHz, QPSK, UL Subframe=2,3,4,7,8,9)	X	24.99	103.36	28.63	3.23	80.0	± 9.6 %
		Y	10.71	88.94	23.39		80.0	
		Z	51.18	114.04	30.82		80.0	
10480-AAA	LTE-TDD (SC-FDMA, 50% RB, 1.4 MHz, 16-QAM, UL Subframe=2,3,4,7,8,9)	X	27.08	97.74	25.20	3.23	80.0	± 9.6 %
		Y	7.39	78.93	18.50		80.0	
		Z	49.11	104.52	26.12		80.0	
10481-AAA	LTE-TDD (SC-FDMA, 50% RB, 1.4 MHz, 64-QAM, UL Subframe=2,3,4,7,8,9)	X	20.64	93.00	23.51	3.23	80.0	± 9.6 %
		Y	5.77	75.21	16.85		80.0	
		Z	27.39	95.68	23.40		80.0	
10482-AAA	LTE-TDD (SC-FDMA, 50% RB, 3 MHz, QPSK, UL Subframe=2,3,4,7,8,9)	X	6.61	81.76	20.77	2.23	80.0	± 9.6 %
		Y	2.69	68.93	14.80		80.0	
		Z	4.28	75.68	17.93		80.0	
10483-AAA	LTE-TDD (SC-FDMA, 50% RB, 3 MHz, 16-QAM, UL Subframe=2,3,4,7,8,9)	X	11.30	85.70	21.82	2.23	80.0	± 9.6 %
		Y	4.71	72.93	16.32		80.0	
		Z	10.22	83.74	20.39		80.0	
10484-AAA	LTE-TDD (SC-FDMA, 50% RB, 3 MHz, 64-QAM, UL Subframe=2,3,4,7,8,9)	X	9.81	83.50	21.12	2.23	80.0	± 9.6 %
		Y	4.39	71.84	15.90		80.0	
		Z	8.50	81.12	19.54		80.0	
10485-AAC	LTE-TDD (SC-FDMA, 50% RB, 5 MHz, QPSK, UL Subframe=2,3,4,7,8,9)	X	6.41	81.73	21.60	2.23	80.0	± 9.6 %
		Y	3.29	71.60	16.89		80.0	
		Z	4.73	77.46	19.61		80.0	
10486-AAC	LTE-TDD (SC-FDMA, 50% RB, 5 MHz, 16-QAM, UL Subframe=2,3,4,7,8,9)	X	4.82	74.22	18.45	2.23	80.0	± 9.6 %
		Y	3.14	68.00	14.98		80.0	
		Z	3.94	71.61	16.84		80.0	
10487-AAC	LTE-TDD (SC-FDMA, 50% RB, 5 MHz, 64-QAM, UL Subframe=2,3,4,7,8,9)	X	4.72	73.57	18.19	2.23	80.0	± 9.6 %
		Y	3.14	67.70	14.85		80.0	
		Z	3.89	71.06	16.60		80.0	
10488-AAC	LTE-TDD (SC-FDMA, 50% RB, 10 MHz, QPSK, UL Subframe=2,3,4,7,8,9)	X	5.77	78.61	21.05	2.23	80.0	± 9.6 %
		Y	3.74	71.84	17.80		80.0	
		Z	4.64	75.66	19.71		80.0	
10489-AAC	LTE-TDD (SC-FDMA, 50% RB, 10 MHz, 16-QAM, UL Subframe=2,3,4,7,8,9)	X	4.63	72.48	18.80	2.23	80.0	± 9.6 %
		Y	3.63	68.80	16.66		80.0	
		Z	4.11	71.03	17.91		80.0	
10490-AAC	LTE-TDD (SC-FDMA, 50% RB, 10 MHz, 64-QAM, UL Subframe=2,3,4,7,8,9)	X	4.68	72.08	18.66	2.23	80.0	± 9.6 %
		Y	3.73	68.67	16.64		80.0	
		Z	4.18	70.76	17.81		80.0	
10491-AAC	LTE-TDD (SC-FDMA, 50% RB, 15 MHz, QPSK, UL Subframe=2,3,4,7,8,9)	X	5.40	75.41	19.95	2.23	80.0	± 9.6 %
		Y	3.98	70.66	17.54		80.0	
		Z	4.61	73.35	18.98		80.0	
10492-AAC	LTE-TDD (SC-FDMA, 50% RB, 15 MHz, 16-QAM, UL Subframe=2,3,4,7,8,9)	X	4.79	71.03	18.46	2.23	80.0	± 9.6 %
		Y	4.01	68.31	16.84		80.0	
		Z	4.35	69.91	17.78		80.0	

10493-AAC	LTE-TDD (SC-FDMA, 50% RB, 15 MHz, 64-QAM, UL Subframe=2,3,4,7,8,9)	X	4.84	70.78	18.38	2.23	80.0	± 9.6 %
		Y	4.07	68.21	16.82		80.0	
		Z	4.41	69.73	17.72		80.0	
10494-AAC	LTE-TDD (SC-FDMA, 50% RB, 20 MHz, QPSK, UL Subframe=2,3,4,7,8,9)	X	6.18	77.69	20.63	2.23	80.0	± 9.6 %
		Y	4.27	71.91	17.89		80.0	
		Z	5.10	75.11	19.51		80.0	
10495-AAC	LTE-TDD (SC-FDMA, 50% RB, 20 MHz, 16-QAM, UL Subframe=2,3,4,7,8,9)	X	4.89	71.61	18.71	2.23	80.0	± 9.6 %
		Y	4.04	68.68	17.03		80.0	
		Z	4.41	70.35	18.00		80.0	
10496-AAC	LTE-TDD (SC-FDMA, 50% RB, 20 MHz, 64-QAM, UL Subframe=2,3,4,7,8,9)	X	4.91	71.12	18.55	2.23	80.0	± 9.6 %
		Y	4.12	68.46	16.98		80.0	
		Z	4.46	69.99	17.89		80.0	
10497-AAA	LTE-TDD (SC-FDMA, 100% RB, 1.4 MHz, QPSK, UL Subframe=2,3,4,7,8,9)	X	5.03	77.46	18.40	2.23	80.0	± 9.6 %
		Y	1.85	64.41	11.81		80.0	
		Z	2.83	69.89	14.64		80.0	
10498-AAA	LTE-TDD (SC-FDMA, 100% RB, 1.4 MHz, 16-QAM, UL Subframe=2,3,4,7,8,9)	X	3.04	68.00	13.73	2.23	80.0	± 9.6 %
		Y	1.58	60.64	9.01		80.0	
		Z	1.87	62.71	10.38		80.0	
10499-AAA	LTE-TDD (SC-FDMA, 100% RB, 1.4 MHz, 64-QAM, UL Subframe=2,3,4,7,8,9)	X	2.89	67.10	13.20	2.23	80.0	± 9.6 %
		Y	1.55	60.27	8.69		80.0	
		Z	1.80	62.06	9.91		80.0	
10500-AAA	LTE-TDD (SC-FDMA, 100% RB, 3 MHz, QPSK, UL Subframe=2,3,4,7,8,9)	X	5.85	79.67	21.13	2.23	80.0	± 9.6 %
		Y	3.43	71.51	17.20		80.0	
		Z	4.56	76.29	19.51		80.0	
10501-AAA	LTE-TDD (SC-FDMA, 100% RB, 3 MHz, 16-QAM, UL Subframe=2,3,4,7,8,9)	X	4.71	73.38	18.53	2.23	80.0	± 9.6 %
		Y	3.37	68.44	15.69		80.0	
		Z	4.04	71.45	17.28		80.0	
10502-AAA	LTE-TDD (SC-FDMA, 100% RB, 3 MHz, 64-QAM, UL Subframe=2,3,4,7,8,9)	X	4.74	73.07	18.35	2.23	80.0	± 9.6 %
		Y	3.42	68.30	15.58		80.0	
		Z	4.07	71.20	17.12		80.0	
10503-AAC	LTE-TDD (SC-FDMA, 100% RB, 5 MHz, QPSK, UL Subframe=2,3,4,7,8,9)	X	5.68	78.36	20.94	2.23	80.0	± 9.6 %
		Y	3.69	71.63	17.70		80.0	
		Z	4.57	75.41	19.60		80.0	
10504-AAC	LTE-TDD (SC-FDMA, 100% RB, 5 MHz, 16-QAM, UL Subframe=2,3,4,7,8,9)	X	4.61	72.37	18.74	2.23	80.0	± 9.6 %
		Y	3.61	68.70	16.60		80.0	
		Z	4.08	70.92	17.85		80.0	
10505-AAC	LTE-TDD (SC-FDMA, 100% RB, 5 MHz, 64-QAM, UL Subframe=2,3,4,7,8,9)	X	4.65	71.98	18.60	2.23	80.0	± 9.6 %
		Y	3.70	68.57	16.58		80.0	
		Z	4.15	70.65	17.75		80.0	
10506-AAC	LTE-TDD (SC-FDMA, 100% RB, 10 MHz, QPSK, UL Subframe=2,3,4,7,8,9)	X	6.12	77.51	20.55	2.23	80.0	± 9.6 %
		Y	4.23	71.76	17.81		80.0	
		Z	5.05	74.93	19.43		80.0	
10507-AAC	LTE-TDD (SC-FDMA, 100% RB, 10 MHz, 16-QAM, UL Subframe=2,3,4,7,8,9)	X	4.87	71.54	18.67	2.23	80.0	± 9.6 %
		Y	4.03	68.61	16.98		80.0	
		Z	4.39	70.28	17.95		80.0	

10508-AAC	LTE-TDD (SC-FDMA, 100% RB, 10 MHz, 64-QAM, UL Subframe=2,3,4,7,8,9)	X	4.89	71.05	18.50	2.23	80.0	± 9.6 %
		Y	4.11	68.38	16.94		80.0	
		Z	4.44	69.91	17.84		80.0	
10509-AAC	LTE-TDD (SC-FDMA, 100% RB, 15 MHz, QPSK, UL Subframe=2,3,4,7,8,9)	X	5.96	74.88	19.56	2.23	80.0	± 9.6 %
		Y	4.57	70.72	17.48		80.0	
		Z	5.19	73.07	18.73		80.0	
10510-AAC	LTE-TDD (SC-FDMA, 100% RB, 15 MHz, 16-QAM, UL Subframe=2,3,4,7,8,9)	X	5.27	70.82	18.44	2.23	80.0	± 9.6 %
		Y	4.52	68.43	17.07		80.0	
		Z	4.83	69.75	17.85		80.0	
10511-AAC	LTE-TDD (SC-FDMA, 100% RB, 15 MHz, 64-QAM, UL Subframe=2,3,4,7,8,9)	X	5.27	70.43	18.33	2.23	80.0	± 9.6 %
		Y	4.58	68.22	17.03		80.0	
		Z	4.86	69.45	17.77		80.0	
10512-AAC	LTE-TDD (SC-FDMA, 100% RB, 20 MHz, QPSK, UL Subframe=2,3,4,7,8,9)	X	6.66	77.38	20.34	2.23	80.0	± 9.6 %
		Y	4.73	71.97	17.80		80.0	
		Z	5.58	74.94	19.30		80.0	
10513-AAC	LTE-TDD (SC-FDMA, 100% RB, 20 MHz, 16-QAM, UL Subframe=2,3,4,7,8,9)	X	5.21	71.34	18.64	2.23	80.0	± 9.6 %
		Y	4.41	68.67	17.14		80.0	
		Z	4.74	70.10	17.99		80.0	
10514-AAC	LTE-TDD (SC-FDMA, 100% RB, 20 MHz, 64-QAM, UL Subframe=2,3,4,7,8,9)	X	5.16	70.71	18.44	2.23	80.0	± 9.6 %
		Y	4.43	68.30	17.06		80.0	
		Z	4.73	69.61	17.84		80.0	
10515-AAA	IEEE 802.11b WiFi 2.4 GHz (DSSS, 2 Mbps, 99pc duty cycle)	X	0.96	63.31	14.85	0.00	150.0	± 9.6 %
		Y	0.84	61.78	13.32		150.0	
		Z	0.94	62.83	14.31		150.0	
10516-AAA	IEEE 802.11b WiFi 2.4 GHz (DSSS, 5.5 Mbps, 99pc duty cycle)	X	0.65	72.36	18.25	0.00	150.0	± 9.6 %
		Y	0.38	65.35	12.87		150.0	
		Z	0.52	68.34	15.90		150.0	
10517-AAA	IEEE 802.11b WiFi 2.4 GHz (DSSS, 11 Mbps, 99pc duty cycle)	X	0.82	65.48	15.61	0.00	150.0	± 9.6 %
		Y	0.66	62.90	13.28		150.0	
		Z	0.77	64.43	14.74		150.0	
10518-AAB	IEEE 802.11a/h WiFi 5 GHz (OFDM, 9 Mbps, 99pc duty cycle)	X	4.57	66.72	16.21	0.00	150.0	± 9.6 %
		Y	4.39	66.29	15.83		150.0	
		Z	4.46	66.66	16.07		150.0	
10519-AAB	IEEE 802.11a/h WiFi 5 GHz (OFDM, 12 Mbps, 99pc duty cycle)	X	4.77	66.98	16.33	0.00	150.0	± 9.6 %
		Y	4.57	66.53	15.96		150.0	
		Z	4.64	66.88	16.18		150.0	
10520-AAB	IEEE 802.11a/h WiFi 5 GHz (OFDM, 18 Mbps, 99pc duty cycle)	X	4.62	66.95	16.26	0.00	150.0	± 9.6 %
		Y	4.42	66.47	15.86		150.0	
		Z	4.49	66.83	16.10		150.0	
10521-AAB	IEEE 802.11a/h WiFi 5 GHz (OFDM, 24 Mbps, 99pc duty cycle)	X	4.56	66.96	16.25	0.00	150.0	± 9.6 %
		Y	4.35	66.45	15.84		150.0	
		Z	4.43	66.82	16.08		150.0	
10522-AAB	IEEE 802.11a/h WiFi 5 GHz (OFDM, 36 Mbps, 99pc duty cycle)	X	4.61	67.00	16.31	0.00	150.0	± 9.6 %
		Y	4.41	66.56	15.94		150.0	
		Z	4.49	66.93	16.18		150.0	

10523-AAB	IEEE 802.11a/h WiFi 5 GHz (OFDM, 48 Mbps, 99pc duty cycle)	X	4.49	66.88	16.16	0.00	150.0	± 9.6 %
		Y	4.29	66.41	15.77		150.0	
		Z	4.37	66.81	16.03		150.0	
10524-AAB	IEEE 802.11a/h WiFi 5 GHz (OFDM, 54 Mbps, 99pc duty cycle)	X	4.56	66.93	16.29	0.00	150.0	± 9.6 %
		Y	4.35	66.47	15.90		150.0	
		Z	4.43	66.84	16.14		150.0	
10525-AAB	IEEE 802.11ac WiFi (20MHz, MCS0, 99pc duty cycle)	X	4.53	65.97	15.88	0.00	150.0	± 9.6 %
		Y	4.34	65.51	15.50		150.0	
		Z	4.42	65.91	15.75		150.0	
10526-AAB	IEEE 802.11ac WiFi (20MHz, MCS1, 99pc duty cycle)	X	4.72	66.36	16.02	0.00	150.0	± 9.6 %
		Y	4.50	65.86	15.64		150.0	
		Z	4.58	66.26	15.88		150.0	
10527-AAB	IEEE 802.11ac WiFi (20MHz, MCS2, 99pc duty cycle)	X	4.63	66.33	15.97	0.00	150.0	± 9.6 %
		Y	4.42	65.81	15.57		150.0	
		Z	4.50	66.22	15.82		150.0	
10528-AAB	IEEE 802.11ac WiFi (20MHz, MCS3, 99pc duty cycle)	X	4.65	66.35	16.00	0.00	150.0	± 9.6 %
		Y	4.44	65.83	15.60		150.0	
		Z	4.52	66.23	15.85		150.0	
10529-AAB	IEEE 802.11ac WiFi (20MHz, MCS4, 99pc duty cycle)	X	4.65	66.35	16.00	0.00	150.0	± 9.6 %
		Y	4.44	65.83	15.60		150.0	
		Z	4.52	66.23	15.85		150.0	
10531-AAB	IEEE 802.11ac WiFi (20MHz, MCS6, 99pc duty cycle)	X	4.65	66.47	16.02	0.00	150.0	± 9.6 %
		Y	4.43	65.92	15.60		150.0	
		Z	4.51	66.32	15.86		150.0	
10532-AAB	IEEE 802.11ac WiFi (20MHz, MCS7, 99pc duty cycle)	X	4.51	66.33	15.96	0.00	150.0	± 9.6 %
		Y	4.29	65.76	15.53		150.0	
		Z	4.37	66.17	15.79		150.0	
10533-AAB	IEEE 802.11ac WiFi (20MHz, MCS8, 99pc duty cycle)	X	4.66	66.38	15.99	0.00	150.0	± 9.6 %
		Y	4.45	65.88	15.59		150.0	
		Z	4.53	66.29	15.85		150.0	
10534-AAB	IEEE 802.11ac WiFi (40MHz, MCS0, 99pc duty cycle)	X	5.17	66.46	16.05	0.00	150.0	± 9.6 %
		Y	4.99	66.00	15.72		150.0	
		Z	5.06	66.33	15.92		150.0	
10535-AAB	IEEE 802.11ac WiFi (40MHz, MCS1, 99pc duty cycle)	X	5.23	66.61	16.11	0.00	150.0	± 9.6 %
		Y	5.05	66.18	15.80		150.0	
		Z	5.12	66.50	16.00		150.0	
10536-AAB	IEEE 802.11ac WiFi (40MHz, MCS2, 99pc duty cycle)	X	5.11	66.59	16.08	0.00	150.0	± 9.6 %
		Y	4.92	66.11	15.74		150.0	
		Z	4.99	66.46	15.96		150.0	
10537-AAB	IEEE 802.11ac WiFi (40MHz, MCS3, 99pc duty cycle)	X	5.17	66.55	16.07	0.00	150.0	± 9.6 %
		Y	4.98	66.09	15.73		150.0	
		Z	5.05	66.42	15.94		150.0	
10538-AAB	IEEE 802.11ac WiFi (40MHz, MCS4, 99pc duty cycle)	X	5.27	66.59	16.13	0.00	150.0	± 9.6 %
		Y	5.07	66.11	15.79		150.0	
		Z	5.13	66.43	15.99		150.0	
10540-AAB	IEEE 802.11ac WiFi (40MHz, MCS6, 99pc duty cycle)	X	5.18	66.58	16.14	0.00	150.0	± 9.6 %
		Y	5.00	66.14	15.81		150.0	
		Z	5.06	66.43	16.00		150.0	

10541-AAB	IEEE 802.11ac WiFi (40MHz, MCS7, 99pc duty cycle)	X	5.16	66.47	16.08	0.00	150.0	± 9.6 %
		Y	4.98	66.00	15.74		150.0	
		Z	5.04	66.33	15.94		150.0	
10542-AAB	IEEE 802.11ac WiFi (40MHz, MCS8, 99pc duty cycle)	X	5.31	66.52	16.12	0.00	150.0	± 9.6 %
		Y	5.13	66.08	15.80		150.0	
		Z	5.20	66.40	15.99		150.0	
10543-AAB	IEEE 802.11ac WiFi (40MHz, MCS9, 99pc duty cycle)	X	5.39	66.55	16.15	0.00	150.0	± 9.6 %
		Y	5.21	66.12	15.85		150.0	
		Z	5.27	66.42	16.03		150.0	
10544-AAB	IEEE 802.11ac WiFi (80MHz, MCS0, 99pc duty cycle)	X	5.46	66.58	16.04	0.00	150.0	± 9.6 %
		Y	5.30	66.13	15.73		150.0	
		Z	5.37	66.45	15.92		150.0	
10545-AAB	IEEE 802.11ac WiFi (80MHz, MCS1, 99pc duty cycle)	X	5.66	66.96	16.17	0.00	150.0	± 9.6 %
		Y	5.49	66.55	15.89		150.0	
		Z	5.55	66.83	16.06		150.0	
10546-AAB	IEEE 802.11ac WiFi (80MHz, MCS2, 99pc duty cycle)	X	5.54	66.82	16.12	0.00	150.0	± 9.6 %
		Y	5.36	66.33	15.79		150.0	
		Z	5.43	66.63	15.98		150.0	
10547-AAB	IEEE 802.11ac WiFi (80MHz, MCS3, 99pc duty cycle)	X	5.62	66.87	16.14	0.00	150.0	± 9.6 %
		Y	5.43	66.37	15.81		150.0	
		Z	5.50	66.68	15.99		150.0	
10548-AAB	IEEE 802.11ac WiFi (80MHz, MCS4, 99pc duty cycle)	X	5.86	67.74	16.55	0.00	150.0	± 9.6 %
		Y	5.67	67.27	16.23		150.0	
		Z	5.69	67.44	16.35		150.0	
10550-AAB	IEEE 802.11ac WiFi (80MHz, MCS6, 99pc duty cycle)	X	5.56	66.80	16.12	0.00	150.0	± 9.6 %
		Y	5.39	66.36	15.82		150.0	
		Z	5.46	66.66	16.01		150.0	
10551-AAB	IEEE 802.11ac WiFi (80MHz, MCS7, 99pc duty cycle)	X	5.57	66.85	16.11	0.00	150.0	± 9.6 %
		Y	5.40	66.39	15.80		150.0	
		Z	5.46	66.70	15.98		150.0	
10552-AAB	IEEE 802.11ac WiFi (80MHz, MCS8, 99pc duty cycle)	X	5.49	66.65	16.02	0.00	150.0	± 9.6 %
		Y	5.31	66.19	15.71		150.0	
		Z	5.39	66.53	15.91		150.0	
10553-AAB	IEEE 802.11ac WiFi (80MHz, MCS9, 99pc duty cycle)	X	5.58	66.70	16.08	0.00	150.0	± 9.6 %
		Y	5.40	66.23	15.76		150.0	
		Z	5.46	66.55	15.95		150.0	
10554-AAC	IEEE 802.11ac WiFi (160MHz, MCS0, 99pc duty cycle)	X	5.86	66.94	16.13	0.00	150.0	± 9.6 %
		Y	5.71	66.51	15.83		150.0	
		Z	5.78	66.81	16.01		150.0	
10555-AAC	IEEE 802.11ac WiFi (160MHz, MCS1, 99pc duty cycle)	X	5.99	67.23	16.25	0.00	150.0	± 9.6 %
		Y	5.84	66.80	15.96		150.0	
		Z	5.90	67.08	16.13		150.0	
10556-AAC	IEEE 802.11ac WiFi (160MHz, MCS2, 99pc duty cycle)	X	6.01	67.27	16.26	0.00	150.0	± 9.6 %
		Y	5.86	66.85	15.98		150.0	
		Z	5.92	67.13	16.14		150.0	
10557-AAC	IEEE 802.11ac WiFi (160MHz, MCS3, 99pc duty cycle)	X	5.99	67.21	16.25	0.00	150.0	± 9.6 %
		Y	5.82	66.75	15.94		150.0	
		Z	5.88	67.04	16.12		150.0	

10558-AAC	IEEE 802.11ac WiFi (160MHz, MCS4, 99pc duty cycle)	X	6.04	67.37	16.35	0.00	150.0	± 9.6 %
		Y	5.87	66.91	16.04		150.0	
		Z	5.93	67.19	16.21		150.0	
10560-AAC	IEEE 802.11ac WiFi (160MHz, MCS6, 99pc duty cycle)	X	6.04	67.24	16.32	0.00	150.0	± 9.6 %
		Y	5.86	66.76	16.01		150.0	
		Z	5.93	67.06	16.18		150.0	
10561-AAC	IEEE 802.11ac WiFi (160MHz, MCS7, 99pc duty cycle)	X	5.96	67.19	16.33	0.00	150.0	± 9.6 %
		Y	5.79	66.74	16.03		150.0	
		Z	5.85	67.02	16.20		150.0	
10562-AAC	IEEE 802.11ac WiFi (160MHz, MCS8, 99pc duty cycle)	X	6.09	67.59	16.54	0.00	150.0	± 9.6 %
		Y	5.90	67.09	16.20		150.0	
		Z	5.95	67.34	16.36		150.0	
10563-AAC	IEEE 802.11ac WiFi (160MHz, MCS9, 99pc duty cycle)	X	6.40	68.10	16.74	0.00	150.0	± 9.6 %
		Y	6.09	67.26	16.25		150.0	
		Z	6.10	67.40	16.34		150.0	
10564-AAA	IEEE 802.11g WiFi 2.4 GHz (DSSS-OFDM, 9 Mbps, 99pc duty cycle)	X	4.91	66.83	16.38	0.46	150.0	± 9.6 %
		Y	4.72	66.39	16.00		150.0	
		Z	4.79	66.74	16.23		150.0	
10565-AAA	IEEE 802.11g WiFi 2.4 GHz (DSSS-OFDM, 12 Mbps, 99pc duty cycle)	X	5.15	67.28	16.70	0.46	150.0	± 9.6 %
		Y	4.95	66.86	16.35		150.0	
		Z	5.01	67.18	16.55		150.0	
10566-AAA	IEEE 802.11g WiFi 2.4 GHz (DSSS-OFDM, 18 Mbps, 99pc duty cycle)	X	4.98	67.15	16.53	0.46	150.0	± 9.6 %
		Y	4.78	66.68	16.14		150.0	
		Z	4.85	67.02	16.37		150.0	
10567-AAA	IEEE 802.11g WiFi 2.4 GHz (DSSS-OFDM, 24 Mbps, 99pc duty cycle)	X	5.01	67.53	16.87	0.46	150.0	± 9.6 %
		Y	4.81	67.10	16.52		150.0	
		Z	4.88	67.43	16.73		150.0	
10568-AAA	IEEE 802.11g WiFi 2.4 GHz (DSSS-OFDM, 36 Mbps, 99pc duty cycle)	X	4.90	66.92	16.31	0.46	150.0	± 9.6 %
		Y	4.69	66.43	15.89		150.0	
		Z	4.76	66.79	16.13		150.0	
10569-AAA	IEEE 802.11g WiFi 2.4 GHz (DSSS-OFDM, 48 Mbps, 99pc duty cycle)	X	4.96	67.60	16.92	0.46	150.0	± 9.6 %
		Y	4.77	67.21	16.59		150.0	
		Z	4.85	67.56	16.82		150.0	
10570-AAA	IEEE 802.11g WiFi 2.4 GHz (DSSS-OFDM, 54 Mbps, 99pc duty cycle)	X	5.00	67.44	16.85	0.46	150.0	± 9.6 %
		Y	4.80	67.04	16.52		150.0	
		Z	4.87	67.38	16.73		150.0	
10571-AAA	IEEE 802.11b WiFi 2.4 GHz (DSSS, 1 Mbps, 90pc duty cycle)	X	1.29	65.85	16.32	0.46	130.0	± 9.6 %
		Y	1.10	63.71	14.50		130.0	
		Z	1.22	64.94	15.58		130.0	
10572-AAA	IEEE 802.11b WiFi 2.4 GHz (DSSS, 2 Mbps, 90pc duty cycle)	X	1.31	66.54	16.72	0.46	130.0	± 9.6 %
		Y	1.11	64.23	14.81		130.0	
		Z	1.23	65.55	15.95		130.0	
10573-AAA	IEEE 802.11b WiFi 2.4 GHz (DSSS, 5.5 Mbps, 90pc duty cycle)	X	9.74	108.45	29.70	0.46	130.0	± 9.6 %
		Y	1.30	75.72	17.45		130.0	
		Z	2.64	87.43	23.09		130.0	
10574-AAA	IEEE 802.11b WiFi 2.4 GHz (DSSS, 11 Mbps, 90pc duty cycle)	X	1.61	74.07	20.25	0.46	130.0	± 9.6 %
		Y	1.18	69.07	17.08		130.0	
		Z	1.41	71.71	18.93		130.0	

10575-AAA	IEEE 802.11g WiFi 2.4 GHz (DSSS-OFDM, 6 Mbps, 90pc duty cycle)	X	4.71	66.68	16.48	0.46	130.0	± 9.6 %
		Y	4.52	66.23	16.07		130.0	
		Z	4.60	66.59	16.31		130.0	
10576-AAA	IEEE 802.11g WiFi 2.4 GHz (DSSS-OFDM, 9 Mbps, 90pc duty cycle)	X	4.74	66.84	16.54	0.46	130.0	± 9.6 %
		Y	4.55	66.40	16.14		130.0	
		Z	4.62	66.76	16.38		130.0	
10577-AAA	IEEE 802.11g WiFi 2.4 GHz (DSSS-OFDM, 12 Mbps, 90pc duty cycle)	X	4.95	67.14	16.71	0.46	130.0	± 9.6 %
		Y	4.75	66.69	16.32		130.0	
		Z	4.81	67.03	16.54		130.0	
10578-AAA	IEEE 802.11g WiFi 2.4 GHz (DSSS-OFDM, 18 Mbps, 90pc duty cycle)	X	4.85	67.32	16.81	0.46	130.0	± 9.6 %
		Y	4.65	66.85	16.42		130.0	
		Z	4.72	67.20	16.65		130.0	
10579-AAA	IEEE 802.11g WiFi 2.4 GHz (DSSS-OFDM, 24 Mbps, 90pc duty cycle)	X	4.62	66.66	16.16	0.46	130.0	± 9.6 %
		Y	4.40	66.07	15.67		130.0	
		Z	4.48	66.45	15.94		130.0	
10580-AAA	IEEE 802.11g WiFi 2.4 GHz (DSSS-OFDM, 36 Mbps, 90pc duty cycle)	X	4.67	66.65	16.17	0.46	130.0	± 9.6 %
		Y	4.45	66.12	15.69		130.0	
		Z	4.52	66.50	15.96		130.0	
10581-AAA	IEEE 802.11g WiFi 2.4 GHz (DSSS-OFDM, 48 Mbps, 90pc duty cycle)	X	4.76	67.38	16.77	0.46	130.0	± 9.6 %
		Y	4.54	66.88	16.35		130.0	
		Z	4.62	67.26	16.61		130.0	
10582-AAA	IEEE 802.11g WiFi 2.4 GHz (DSSS-OFDM, 54 Mbps, 90pc duty cycle)	X	4.57	66.41	15.96	0.46	130.0	± 9.6 %
		Y	4.35	65.82	15.45		130.0	
		Z	4.42	66.20	15.72		130.0	
10583-AAB	IEEE 802.11a/h WiFi 5 GHz (OFDM, 6 Mbps, 90pc duty cycle)	X	4.71	66.68	16.48	0.46	130.0	± 9.6 %
		Y	4.52	66.23	16.07		130.0	
		Z	4.60	66.59	16.31		130.0	
10584-AAB	IEEE 802.11a/h WiFi 5 GHz (OFDM, 9 Mbps, 90pc duty cycle)	X	4.74	66.84	16.54	0.46	130.0	± 9.6 %
		Y	4.55	66.40	16.14		130.0	
		Z	4.62	66.76	16.38		130.0	
10585-AAB	IEEE 802.11a/h WiFi 5 GHz (OFDM, 12 Mbps, 90pc duty cycle)	X	4.95	67.14	16.71	0.46	130.0	± 9.6 %
		Y	4.75	66.69	16.32		130.0	
		Z	4.81	67.03	16.54		130.0	
10586-AAB	IEEE 802.11a/h WiFi 5 GHz (OFDM, 18 Mbps, 90pc duty cycle)	X	4.85	67.32	16.81	0.46	130.0	± 9.6 %
		Y	4.65	66.85	16.42		130.0	
		Z	4.72	67.20	16.65		130.0	
10587-AAB	IEEE 802.11a/h WiFi 5 GHz (OFDM, 24 Mbps, 90pc duty cycle)	X	4.62	66.66	16.16	0.46	130.0	± 9.6 %
		Y	4.40	66.07	15.67		130.0	
		Z	4.48	66.45	15.94		130.0	
10588-AAB	IEEE 802.11a/h WiFi 5 GHz (OFDM, 36 Mbps, 90pc duty cycle)	X	4.67	66.65	16.17	0.46	130.0	± 9.6 %
		Y	4.45	66.12	15.69		130.0	
		Z	4.52	66.50	15.96		130.0	
10589-AAB	IEEE 802.11a/h WiFi 5 GHz (OFDM, 48 Mbps, 90pc duty cycle)	X	4.76	67.38	16.77	0.46	130.0	± 9.6 %
		Y	4.54	66.88	16.35		130.0	
		Z	4.62	67.26	16.61		130.0	
10590-AAB	IEEE 802.11a/h WiFi 5 GHz (OFDM, 54 Mbps, 90pc duty cycle)	X	4.57	66.41	15.96	0.46	130.0	± 9.6 %
		Y	4.35	65.82	15.45		130.0	
		Z	4.42	66.20	15.72		130.0	

10591-AAB	IEEE 802.11n (HT Mixed, 20MHz, MCS0, 90pc duty cycle)	X	4.86	66.73	16.57	0.46	130.0	± 9.6 %
		Y	4.68	66.31	16.19		130.0	
		Z	4.75	66.65	16.42		130.0	
10592-AAB	IEEE 802.11n (HT Mixed, 20MHz, MCS1, 90pc duty cycle)	X	5.03	67.07	16.70	0.46	130.0	± 9.6 %
		Y	4.82	66.64	16.32		130.0	
		Z	4.89	66.98	16.55		130.0	
10593-AAB	IEEE 802.11n (HT Mixed, 20MHz, MCS2, 90pc duty cycle)	X	4.95	67.01	16.59	0.46	130.0	± 9.6 %
		Y	4.74	66.53	16.19		130.0	
		Z	4.81	66.88	16.42		130.0	
10594-AAB	IEEE 802.11n (HT Mixed, 20MHz, MCS3, 90pc duty cycle)	X	5.00	67.16	16.74	0.46	130.0	± 9.6 %
		Y	4.80	66.71	16.35		130.0	
		Z	4.87	67.05	16.58		130.0	
10595-AAB	IEEE 802.11n (HT Mixed, 20MHz, MCS4, 90pc duty cycle)	X	4.98	67.12	16.64	0.46	130.0	± 9.6 %
		Y	4.77	66.66	16.24		130.0	
		Z	4.84	67.01	16.48		130.0	
10596-AAB	IEEE 802.11n (HT Mixed, 20MHz, MCS5, 90pc duty cycle)	X	4.91	67.13	16.65	0.46	130.0	± 9.6 %
		Y	4.70	66.64	16.23		130.0	
		Z	4.77	67.00	16.48		130.0	
10597-AAB	IEEE 802.11n (HT Mixed, 20MHz, MCS6, 90pc duty cycle)	X	4.86	67.05	16.54	0.46	130.0	± 9.6 %
		Y	4.65	66.53	16.11		130.0	
		Z	4.72	66.89	16.35		130.0	
10598-AAB	IEEE 802.11n (HT Mixed, 20MHz, MCS7, 90pc duty cycle)	X	4.85	67.29	16.80	0.46	130.0	± 9.6 %
		Y	4.64	66.79	16.39		130.0	
		Z	4.71	67.14	16.62		130.0	
10599-AAB	IEEE 802.11n (HT Mixed, 40MHz, MCS0, 90pc duty cycle)	X	5.52	67.26	16.75	0.46	130.0	± 9.6 %
		Y	5.35	66.89	16.44		130.0	
		Z	5.40	67.12	16.60		130.0	
10600-AAB	IEEE 802.11n (HT Mixed, 40MHz, MCS1, 90pc duty cycle)	X	5.66	67.69	16.93	0.46	130.0	± 9.6 %
		Y	5.48	67.29	16.61		130.0	
		Z	5.51	67.49	16.75		130.0	
10601-AAB	IEEE 802.11n (HT Mixed, 40MHz, MCS2, 90pc duty cycle)	X	5.55	67.44	16.82	0.46	130.0	± 9.6 %
		Y	5.37	67.03	16.50		130.0	
		Z	5.41	67.28	16.67		130.0	
10602-AAB	IEEE 802.11n (HT Mixed, 40MHz, MCS3, 90pc duty cycle)	X	5.63	67.42	16.73	0.46	130.0	± 9.6 %
		Y	5.47	67.07	16.43		130.0	
		Z	5.52	67.35	16.62		130.0	
10603-AAB	IEEE 802.11n (HT Mixed, 40MHz, MCS4, 90pc duty cycle)	X	5.73	67.77	17.03	0.46	130.0	± 9.6 %
		Y	5.54	67.38	16.72		130.0	
		Z	5.59	67.61	16.88		130.0	
10604-AAB	IEEE 802.11n (HT Mixed, 40MHz, MCS5, 90pc duty cycle)	X	5.52	67.21	16.74	0.46	130.0	± 9.6 %
		Y	5.37	66.89	16.47		130.0	
		Z	5.43	67.20	16.66		130.0	
10605-AAB	IEEE 802.11n (HT Mixed, 40MHz, MCS6, 90pc duty cycle)	X	5.62	67.51	16.90	0.46	130.0	± 9.6 %
		Y	5.47	67.18	16.61		130.0	
		Z	5.51	67.41	16.77		130.0	
10606-AAB	IEEE 802.11n (HT Mixed, 40MHz, MCS7, 90pc duty cycle)	X	5.41	67.01	16.51	0.46	130.0	± 9.6 %
		Y	5.20	66.48	16.11		130.0	
		Z	5.26	66.76	16.30		130.0	

10607-AAB	IEEE 802.11ac WiFi (20MHz, MCS0, 90pc duty cycle)	X	4.70	66.05	16.19	0.46	130.0	± 9.6 %
		Y	4.50	65.58	15.79		130.0	
		Z	4.58	65.97	16.04		130.0	
10608-AAB	IEEE 802.11ac WiFi (20MHz, MCS1, 90pc duty cycle)	X	4.90	66.46	16.36	0.46	130.0	± 9.6 %
		Y	4.68	65.97	15.95		130.0	
		Z	4.76	66.35	16.20		130.0	
10609-AAB	IEEE 802.11ac WiFi (20MHz, MCS2, 90pc duty cycle)	X	4.79	66.33	16.21	0.46	130.0	± 9.6 %
		Y	4.57	65.80	15.77		130.0	
		Z	4.65	66.20	16.03		130.0	
10610-AAB	IEEE 802.11ac WiFi (20MHz, MCS3, 90pc duty cycle)	X	4.84	66.49	16.37	0.46	130.0	± 9.6 %
		Y	4.62	65.97	15.94		130.0	
		Z	4.70	66.36	16.20		130.0	
10611-AAB	IEEE 802.11ac WiFi (20MHz, MCS4, 90pc duty cycle)	X	4.76	66.30	16.22	0.46	130.0	± 9.6 %
		Y	4.54	65.77	15.78		130.0	
		Z	4.62	66.16	16.05		130.0	
10612-AAB	IEEE 802.11ac WiFi (20MHz, MCS5, 90pc duty cycle)	X	4.77	66.46	16.27	0.46	130.0	± 9.6 %
		Y	4.54	65.90	15.81		130.0	
		Z	4.62	66.31	16.09		130.0	
10613-AAB	IEEE 802.11ac WiFi (20MHz, MCS6, 90pc duty cycle)	X	4.78	66.37	16.16	0.46	130.0	± 9.6 %
		Y	4.54	65.78	15.69		130.0	
		Z	4.62	66.17	15.96		130.0	
10614-AAB	IEEE 802.11ac WiFi (20MHz, MCS7, 90pc duty cycle)	X	4.71	66.54	16.39	0.46	130.0	± 9.6 %
		Y	4.49	65.99	15.94		130.0	
		Z	4.57	66.38	16.21		130.0	
10615-AAB	IEEE 802.11ac WiFi (20MHz, MCS8, 90pc duty cycle)	X	4.76	66.13	16.01	0.46	130.0	± 9.6 %
		Y	4.53	65.58	15.54		130.0	
		Z	4.61	65.99	15.82		130.0	
10616-AAB	IEEE 802.11ac WiFi (40MHz, MCS0, 90pc duty cycle)	X	5.34	66.54	16.37	0.46	130.0	± 9.6 %
		Y	5.15	66.08	16.02		130.0	
		Z	5.22	66.40	16.23		130.0	
10617-AAB	IEEE 802.11ac WiFi (40MHz, MCS1, 90pc duty cycle)	X	5.40	66.66	16.40	0.46	130.0	± 9.6 %
		Y	5.22	66.26	16.08		130.0	
		Z	5.28	66.57	16.28		130.0	
10618-AAB	IEEE 802.11ac WiFi (40MHz, MCS2, 90pc duty cycle)	X	5.29	66.72	16.45	0.46	130.0	± 9.6 %
		Y	5.11	66.26	16.09		130.0	
		Z	5.17	66.59	16.31		130.0	
10619-AAB	IEEE 802.11ac WiFi (40MHz, MCS3, 90pc duty cycle)	X	5.31	66.54	16.30	0.46	130.0	± 9.6 %
		Y	5.12	66.05	15.93		130.0	
		Z	5.19	66.37	16.14		130.0	
10620-AAB	IEEE 802.11ac WiFi (40MHz, MCS4, 90pc duty cycle)	X	5.42	66.61	16.38	0.46	130.0	± 9.6 %
		Y	5.21	66.11	16.00		130.0	
		Z	5.27	66.42	16.21		130.0	
10621-AAB	IEEE 802.11ac WiFi (40MHz, MCS5, 90pc duty cycle)	X	5.40	66.69	16.53	0.46	130.0	± 9.6 %
		Y	5.22	66.26	16.21		130.0	
		Z	5.28	66.57	16.40		130.0	
10622-AAB	IEEE 802.11ac WiFi (40MHz, MCS6, 90pc duty cycle)	X	5.40	66.82	16.59	0.46	130.0	± 9.6 %
		Y	5.23	66.42	16.28		130.0	
		Z	5.29	66.72	16.47		130.0	

10623-AAB	IEEE 802.11ac WiFi (40MHz, MCS7, 90pc duty cycle)	X	5.29	66.39	16.26	0.46	130.0	± 9.6 %
		Y	5.10	65.92	15.89		130.0	
		Z	5.17	66.24	16.10		130.0	
10624-AAB	IEEE 802.11ac WiFi (40MHz, MCS8, 90pc duty cycle)	X	5.48	66.58	16.41	0.46	130.0	± 9.6 %
		Y	5.30	66.14	16.07		130.0	
		Z	5.36	66.44	16.27		130.0	
10625-AAB	IEEE 802.11ac WiFi (40MHz, MCS9, 90pc duty cycle)	X	5.86	67.56	16.95	0.46	130.0	± 9.6 %
		Y	5.64	67.07	16.59		130.0	
		Z	5.66	67.24	16.72		130.0	
10626-AAB	IEEE 802.11ac WiFi (80MHz, MCS0, 90pc duty cycle)	X	5.61	66.59	16.31	0.46	130.0	± 9.6 %
		Y	5.45	66.15	15.99		130.0	
		Z	5.52	66.46	16.19		130.0	
10627-AAB	IEEE 802.11ac WiFi (80MHz, MCS1, 90pc duty cycle)	X	5.85	67.11	16.53	0.46	130.0	± 9.6 %
		Y	5.69	66.72	16.24		130.0	
		Z	5.74	66.98	16.41		130.0	
10628-AAB	IEEE 802.11ac WiFi (80MHz, MCS2, 90pc duty cycle)	X	5.66	66.72	16.28	0.46	130.0	± 9.6 %
		Y	5.48	66.22	15.91		130.0	
		Z	5.54	66.51	16.11		130.0	
10629-AAB	IEEE 802.11ac WiFi (80MHz, MCS3, 90pc duty cycle)	X	5.75	66.81	16.31	0.46	130.0	± 9.6 %
		Y	5.55	66.27	15.93		130.0	
		Z	5.61	66.56	16.12		130.0	
10630-AAB	IEEE 802.11ac WiFi (80MHz, MCS4, 90pc duty cycle)	X	6.18	68.27	17.04	0.46	130.0	± 9.6 %
		Y	5.98	67.75	16.67		130.0	
		Z	5.96	67.79	16.74		130.0	
10631-AAB	IEEE 802.11ac WiFi (80MHz, MCS5, 90pc duty cycle)	X	6.10	68.12	17.15	0.46	130.0	± 9.6 %
		Y	5.88	67.58	16.79		130.0	
		Z	5.92	67.78	16.93		130.0	
10632-AAB	IEEE 802.11ac WiFi (80MHz, MCS6, 90pc duty cycle)	X	5.82	67.18	16.70	0.46	130.0	± 9.6 %
		Y	5.67	66.81	16.43		130.0	
		Z	5.72	67.07	16.59		130.0	
10633-AAB	IEEE 802.11ac WiFi (80MHz, MCS7, 90pc duty cycle)	X	5.73	66.90	16.39	0.46	130.0	± 9.6 %
		Y	5.54	66.39	16.03		130.0	
		Z	5.61	66.71	16.24		130.0	
10634-AAB	IEEE 802.11ac WiFi (80MHz, MCS8, 90pc duty cycle)	X	5.72	66.92	16.46	0.46	130.0	± 9.6 %
		Y	5.53	66.43	16.11		130.0	
		Z	5.60	66.74	16.31		130.0	
10635-AAB	IEEE 802.11ac WiFi (80MHz, MCS9, 90pc duty cycle)	X	5.61	66.29	15.89	0.46	130.0	± 9.6 %
		Y	5.40	65.72	15.48		130.0	
		Z	5.47	66.04	15.69		130.0	
10636-AAC	IEEE 802.11ac WiFi (160MHz, MCS0, 90pc duty cycle)	X	6.02	66.96	16.40	0.46	130.0	± 9.6 %
		Y	5.87	66.52	16.09		130.0	
		Z	5.93	66.81	16.27		130.0	
10637-AAC	IEEE 802.11ac WiFi (160MHz, MCS1, 90pc duty cycle)	X	6.18	67.32	16.56	0.46	130.0	± 9.6 %
		Y	6.02	66.91	16.26		130.0	
		Z	6.07	67.17	16.43		130.0	
10638-AAC	IEEE 802.11ac WiFi (160MHz, MCS2, 90pc duty cycle)	X	6.18	67.31	16.53	0.46	130.0	± 9.6 %
		Y	6.02	66.87	16.22		130.0	
		Z	6.08	67.16	16.40		130.0	

10639-AAC	IEEE 802.11ac WiFi (160MHz, MCS3, 90pc duty cycle)	X	6.17	67.29	16.57	0.46	130.0	± 9.6 %
		Y	6.00	66.82	16.24		130.0	
		Z	6.05	67.10	16.42		130.0	
10640-AAC	IEEE 802.11ac WiFi (160MHz, MCS4, 90pc duty cycle)	X	6.18	67.33	16.53	0.46	130.0	± 9.6 %
		Y	6.00	66.82	16.18		130.0	
		Z	6.05	67.09	16.35		130.0	
10641-AAC	IEEE 802.11ac WiFi (160MHz, MCS5, 90pc duty cycle)	X	6.20	67.15	16.46	0.46	130.0	± 9.6 %
		Y	6.05	66.75	16.16		130.0	
		Z	6.10	67.02	16.33		130.0	
10642-AAC	IEEE 802.11ac WiFi (160MHz, MCS6, 90pc duty cycle)	X	6.26	67.46	16.78	0.46	130.0	± 9.6 %
		Y	6.09	67.01	16.47		130.0	
		Z	6.15	67.28	16.64		130.0	
10643-AAC	IEEE 802.11ac WiFi (160MHz, MCS7, 90pc duty cycle)	X	6.09	67.13	16.52	0.46	130.0	± 9.6 %
		Y	5.92	66.67	16.19		130.0	
		Z	5.98	66.95	16.36		130.0	
10644-AAC	IEEE 802.11ac WiFi (160MHz, MCS8, 90pc duty cycle)	X	6.28	67.70	16.83	0.46	130.0	± 9.6 %
		Y	6.07	67.13	16.44		130.0	
		Z	6.12	67.37	16.60		130.0	
10645-AAC	IEEE 802.11ac WiFi (160MHz, MCS9, 90pc duty cycle)	X	6.69	68.48	17.16	0.46	130.0	± 9.6 %
		Y	6.34	67.56	16.61		130.0	
		Z	6.31	67.59	16.66		130.0	
10646-AAD	LTE-TDD (SC-FDMA, 1 RB, 5 MHz, QPSK, UL Subframe=2,7)	X	81.88	138.93	44.99	9.30	60.0	± 9.6 %
		Y	20.09	105.55	34.68		60.0	
		Z	49.56	129.13	42.50		60.0	
10647-AAC	LTE-TDD (SC-FDMA, 1 RB, 20 MHz, QPSK, UL Subframe=2,7)	X	77.69	138.77	45.14	9.30	60.0	± 9.6 %
		Y	19.01	105.10	34.68		60.0	
		Z	43.65	127.19	42.16		60.0	
10648-AAA	CDMA2000 (1x Advanced)	X	0.73	64.13	11.44	0.00	150.0	± 9.6 %
		Y	0.50	60.94	8.11		150.0	
		Z	0.62	62.66	9.90		150.0	
10652-AAB	LTE-TDD (OFDMA, 5 MHz, E-TM 3.1, Clipping 44%)	X	4.23	68.60	17.43	2.23	80.0	± 9.6 %
		Y	3.70	66.70	16.11		80.0	
		Z	3.95	67.96	16.88		80.0	
10653-AAB	LTE-TDD (OFDMA, 10 MHz, E-TM 3.1, Clipping 44%)	X	4.67	67.66	17.40	2.23	80.0	± 9.6 %
		Y	4.26	66.28	16.44		80.0	
		Z	4.43	67.13	16.98		80.0	
10654-AAB	LTE-TDD (OFDMA, 15 MHz, E-TM 3.1, Clipping 44%)	X	4.61	67.29	17.38	2.23	80.0	± 9.6 %
		Y	4.24	65.98	16.48		80.0	
		Z	4.40	66.77	16.98		80.0	
10655-AAB	LTE-TDD (OFDMA, 20 MHz, E-TM 3.1, Clipping 44%)	X	4.67	67.29	17.41	2.23	80.0	± 9.6 %
		Y	4.30	65.98	16.52		80.0	
		Z	4.46	66.74	17.01		80.0	
10658-AAA	Pulse Waveform (200Hz, 10%)	X	77.76	113.37	29.51	10.00	50.0	± 9.6 %
		Y	8.85	80.14	18.93		50.0	
		Z	55.85	107.32	27.27		50.0	
10659-AAA	Pulse Waveform (200Hz, 20%)	X	100.00	113.86	27.83	6.99	60.0	± 9.6 %
		Y	15.18	87.15	19.66		60.0	
		Z	100.00	112.04	26.63		60.0	

10660- AAA	Pulse Waveform (200Hz, 40%)	X	100.00	112.50	25.83	3.98	80.0	± 9.6 %
		Y	63.58	100.49	21.01		80.0	
		Z	100.00	110.06	24.42		80.0	
10661- AAA	Pulse Waveform (200Hz, 60%)	X	100.00	114.00	25.19	2.22	100.0	± 9.6 %
		Y	13.64	84.95	15.36		100.0	
		Z	100.00	110.38	23.34		100.0	
10662- AAA	Pulse Waveform (200Hz, 80%)	X	100.00	118.57	25.30	0.97	120.0	± 9.6 %
		Y	0.28	60.00	4.66		120.0	
		Z	100.00	111.08	22.00		120.0	

^E Uncertainty is determined using the max. deviation from linear response applying rectangular distribution and is expressed for the square of the field value.



Accredited by the Swiss Accreditation Service (SAS)
The Swiss Accreditation Service is one of the signatories to the EA
Multilateral Agreement for the recognition of calibration certificates

Accreditation No.: **SCS 0108**

Client **PC Test**

Certificate No: **EX3-7308_Aug17**

CALIBRATION CERTIFICATE

Object: **EX3DV4 - SN:7308**

Calibration procedure(s): **QA CAL-01.v9, QA CAL-14.v4, QA CAL-23.v5, QA CAL-25.v6
Calibration procedure for dosimetric E-field probes**

*PNV
8/27/17*

Calibration date: **August 16, 2017**

This calibration certificate documents the traceability to national standards, which realize the physical units of measurements (SI).
The measurements and the uncertainties with confidence probability are given on the following pages and are part of the certificate.

All calibrations have been conducted in the closed laboratory facility: environment temperature (22 ± 3)°C and humidity < 70%.

Calibration Equipment used (M&TE critical for calibration)

Primary Standards	ID	Cal Date (Certificate No.)	Scheduled Calibration
Power meter NRP	SN: 104778	04-Apr-17 (No. 217-02521/02522)	Apr-18
Power sensor NRP-Z91	SN: 103244	04-Apr-17 (No. 217-02521)	Apr-18
Power sensor NRP-Z91	SN: 103245	04-Apr-17 (No. 217-02525)	Apr-18
Reference 20 dB Attenuator	SN: S5277 (20x)	07-Apr-17 (No. 217-02528)	Apr-18
Reference Probe ES3DV2	SN: 3013	31-Dec-16 (No. ES3-3013_Dec16)	Dec-17
DAE4	SN: 660	7-Dec-16 (No. DAE4-660_Dec16)	Dec-17
Secondary Standards	ID	Check Date (in house)	Scheduled Check
Power meter E4419B	SN: GB41293874	06-Apr-16 (in house check Jun-16)	In house check: Jun-18
Power sensor E4412A	SN: MY41498087	06-Apr-16 (in house check Jun-16)	In house check: Jun-18
Power sensor E4412A	SN: 000110210	06-Apr-16 (in house check Jun-16)	In house check: Jun-18
RF generator HP 8648C	SN: US3642U01700	04-Aug-99 (in house check Jun-16)	In house check: Jun-18
Network Analyzer HP 8753E	SN: US37390585	18-Oct-01 (in house check Oct-16)	In house check: Oct-17

Calibrated by:	Name Leif Klysnar	Function Laboratory Technician	Signature
Approved by:	Name Katja Pokovic	Function Technical Manager	Signature

Issued: August 16, 2017

This calibration certificate shall not be reproduced except in full without written approval of the laboratory.



Accredited by the Swiss Accreditation Service (SAS)

Accreditation No.: **SCS 0108**

The Swiss Accreditation Service is one of the signatories to the EA
Multilateral Agreement for the recognition of calibration certificates

Glossary:

TSL	tissue simulating liquid
NORM _{x,y,z}	sensitivity in free space
ConvF	sensitivity in TSL / NORM _{x,y,z}
DCP	diode compression point
CF	crest factor (1/duty_cycle) of the RF signal
A, B, C, D	modulation dependent linearization parameters
Polarization φ	φ rotation around probe axis
Polarization ϑ	ϑ rotation around an axis that is in the plane normal to probe axis (at measurement center), i.e., $\vartheta = 0$ is normal to probe axis
Connector Angle	information used in DASY system to align probe sensor X to the robot coordinate system

Calibration is Performed According to the Following Standards:

- a) IEEE Std 1528-2013, "IEEE Recommended Practice for Determining the Peak Spatial-Averaged Specific Absorption Rate (SAR) in the Human Head from Wireless Communications Devices: Measurement Techniques", June 2013
- b) IEC 62209-1, "Measurement procedure for the assessment of Specific Absorption Rate (SAR) from hand-held and body-mounted devices used next to the ear (frequency range of 300 MHz to 6 GHz)", July 2016
- c) IEC 62209-2, "Procedure to determine the Specific Absorption Rate (SAR) for wireless communication devices used in close proximity to the human body (frequency range of 30 MHz to 6 GHz)", March 2010
- d) KDB 865664, "SAR Measurement Requirements for 100 MHz to 6 GHz"

Methods Applied and Interpretation of Parameters:

- *NORM_{x,y,z}*: Assessed for E-field polarization $\vartheta = 0$ ($f \leq 900$ MHz in TEM-cell; $f > 1800$ MHz: R22 waveguide). *NORM_{x,y,z}* are only intermediate values, i.e., the uncertainties of *NORM_{x,y,z}* does not affect the E^2 -field uncertainty inside TSL (see below *ConvF*).
- *NORM(f)_{x,y,z} = NORM_{x,y,z} * frequency_response* (see Frequency Response Chart). This linearization is implemented in DASY4 software versions later than 4.2. The uncertainty of the frequency response is included in the stated uncertainty of *ConvF*.
- *DCP_{x,y,z}*: DCP are numerical linearization parameters assessed based on the data of power sweep with CW signal (no uncertainty required). DCP does not depend on frequency nor media.
- *PAR*: PAR is the Peak to Average Ratio that is not calibrated but determined based on the signal characteristics
- *A_{x,y,z}; B_{x,y,z}; C_{x,y,z}; D_{x,y,z}; VR_{x,y,z}; A, B, C, D* are numerical linearization parameters assessed based on the data of power sweep for specific modulation signal. The parameters do not depend on frequency nor media. VR is the maximum calibration range expressed in RMS voltage across the diode.
- *ConvF and Boundary Effect Parameters*: Assessed in flat phantom using E-field (or Temperature Transfer Standard for $f \leq 800$ MHz) and inside waveguide using analytical field distributions based on power measurements for $f > 800$ MHz. The same setups are used for assessment of the parameters applied for boundary compensation (alpha, depth) of which typical uncertainty values are given. These parameters are used in DASY4 software to improve probe accuracy close to the boundary. The sensitivity in TSL corresponds to *NORM_{x,y,z} * ConvF* whereby the uncertainty corresponds to that given for *ConvF*. A frequency dependent *ConvF* is used in DASY version 4.4 and higher which allows extending the validity from ± 50 MHz to ± 100 MHz.
- *Spherical isotropy (3D deviation from isotropy)*: in a field of low gradients realized using a flat phantom exposed by a patch antenna.
- *Sensor Offset*: The sensor offset corresponds to the offset of virtual measurement center from the probe tip (on probe axis). No tolerance required.
- *Connector Angle*: The angle is assessed using the information gained by determining the *NORM_x* (no uncertainty required).

Probe EX3DV4

SN:7308

Manufactured: March 11, 2014
Calibrated: August 16, 2017

Calibrated for DASY/EASY Systems
(Note: non-compatible with DASY2 system!)

DASY/EASY - Parameters of Probe: EX3DV4 - SN:7308

Basic Calibration Parameters

	Sensor X	Sensor Y	Sensor Z	Unc (k=2)
Norm ($\mu\text{V}/(\text{V}/\text{m})^2$) ^A	0.49	0.60	0.44	$\pm 10.1 \%$
DCP (mV) ^B	97.0	91.7	98.5	

Modulation Calibration Parameters

UID	Communication System Name		A dB	B dB $\sqrt{\mu\text{V}}$	C	D dB	VR mV	Unc ^E (k=2)
0	CW	X	0.0	0.0	1.0	0.00	134.5	$\pm 3.3 \%$
		Y	0.0	0.0	1.0		130.8	
		Z	0.0	0.0	1.0		149.9	

Note: For details on UID parameters see Appendix.

Sensor Model Parameters

	C1 fF	C2 fF	α V ⁻¹	T1 ms.V ⁻²	T2 ms.V ⁻¹	T3 ms	T4 V ⁻²	T5 V ⁻¹	T6
X	46.65	351.1	36.16	14.68	0.000	5.088	0.834	0.399	1.005
Y	52.88	402.1	36.74	19.55	0.309	5.100	0.477	0.605	1.007
Z	36.70	273.3	35.48	9.322	0.000	5.034	0.373	0.314	1.002

The reported uncertainty of measurement is stated as the standard uncertainty of measurement multiplied by the coverage factor k=2, which for a normal distribution corresponds to a coverage probability of approximately 95%.

^A The uncertainties of Norm X,Y,Z do not affect the E²-field uncertainty inside TSL (see Pages 5 and 6).

^B Numerical linearization parameter: uncertainty not required.

^E Uncertainty is determined using the max. deviation from linear response applying rectangular distribution and is expressed for the square of the field value.

DASY/EASY - Parameters of Probe: EX3DV4 - SN:7308

Calibration Parameter Determined in Head Tissue Simulating Media

f (MHz) ^C	Relative Permittivity ^F	Conductivity (S/m) ^F	ConvF X	ConvF Y	ConvF Z	Alpha ^G	Depth ^G (mm)	Unc (k=2)
5250	35.9	4.71	5.25	5.25	5.25	0.35	1.80	± 13.1 %
5600	35.5	5.07	4.83	4.83	4.83	0.40	1.80	± 13.1 %
5750	35.4	5.22	5.11	5.11	5.11	0.40	1.80	± 13.1 %

^C Frequency validity above 300 MHz of ± 100 MHz only applies for DASY v4.4 and higher (see Page 2), else it is restricted to ± 50 MHz. The uncertainty is the RSS of the ConvF uncertainty at calibration frequency and the uncertainty for the indicated frequency band. Frequency validity below 300 MHz is ± 10, 25, 40, 50 and 70 MHz for ConvF assessments at 30, 64, 128, 150 and 220 MHz respectively. Above 5 GHz frequency validity can be extended to ± 110 MHz.

^F At frequencies below 3 GHz, the validity of tissue parameters (ϵ and σ) can be relaxed to ± 10% if liquid compensation formula is applied to measured SAR values. At frequencies above 3 GHz, the validity of tissue parameters (ϵ and σ) is restricted to ± 5%. The uncertainty is the RSS of the ConvF uncertainty for indicated target tissue parameters.

^G Alpha/Depth are determined during calibration. SPEAG warrants that the remaining deviation due to the boundary effect after compensation is always less than ± 1% for frequencies below 3 GHz and below ± 2% for frequencies between 3-6 GHz at any distance larger than half the probe tip diameter from the boundary.

DASY/EASY - Parameters of Probe: EX3DV4 - SN:7308

Calibration Parameter Determined in Body Tissue Simulating Media

f (MHz) ^C	Relative Permittivity ^F	Conductivity (S/m) ^F	ConvF X	ConvF Y	ConvF Z	Alpha ^G	Depth ^G (mm)	Unc (k=2)
750	55.5	0.96	10.39	10.39	10.39	0.54	0.85	± 12.0 %
835	55.2	0.97	10.21	10.21	10.21	0.47	0.84	± 12.0 %
1750	53.4	1.49	8.24	8.24	8.24	0.41	0.84	± 12.0 %
1900	53.3	1.52	7.96	7.96	7.96	0.37	0.80	± 12.0 %
2300	52.9	1.81	7.77	7.77	7.77	0.39	0.86	± 12.0 %
2450	52.7	1.95	7.66	7.66	7.66	0.35	0.85	± 12.0 %
2600	52.5	2.16	7.46	7.46	7.46	0.31	0.95	± 12.0 %
5250	48.9	5.36	4.84	4.84	4.84	0.35	1.90	± 13.1 %
5600	48.5	5.77	4.23	4.23	4.23	0.40	1.90	± 13.1 %
5750	48.3	5.94	4.50	4.50	4.50	0.40	1.90	± 13.1 %

^C Frequency validity above 300 MHz of ± 100 MHz only applies for DASY v4.4 and higher (see Page 2), else it is restricted to ± 50 MHz. The uncertainty is the RSS of the ConvF uncertainty at calibration frequency and the uncertainty for the indicated frequency band. Frequency validity below 300 MHz is ± 10, 25, 40, 50 and 70 MHz for ConvF assessments at 30, 64, 128, 150 and 220 MHz respectively. Above 5 GHz frequency validity can be extended to ± 110 MHz.

^F At frequencies below 3 GHz, the validity of tissue parameters (ϵ and σ) can be relaxed to ± 10% if liquid compensation formula is applied to measured SAR values. At frequencies above 3 GHz, the validity of tissue parameters (ϵ and σ) is restricted to ± 5%. The uncertainty is the RSS of the ConvF uncertainty for indicated target tissue parameters.

^G Alpha/Depth are determined during calibration. SPEAG warrants that the remaining deviation due to the boundary effect after compensation is always less than ± 1% for frequencies below 3 GHz and below ± 2% for frequencies between 3-6 GHz at any distance larger than half the probe tip diameter from the boundary.

Frequency Response of E-Field (TEM-Cell:ifi110 EXX, Waveguide: R22)

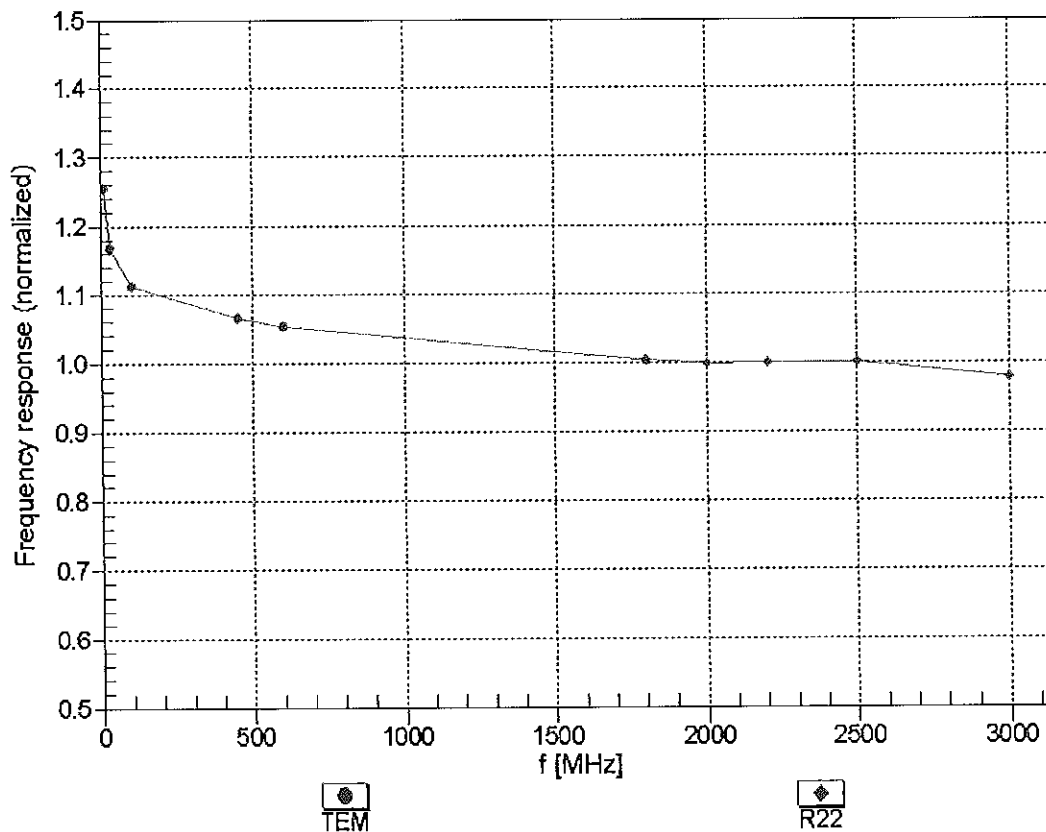

Uncertainty of Frequency Response of E-field: $\pm 6.3\%$ (k=2)

Receiving Pattern (ϕ), $\theta = 0^\circ$

f=600 MHz,TEM

f=1800 MHz,R22

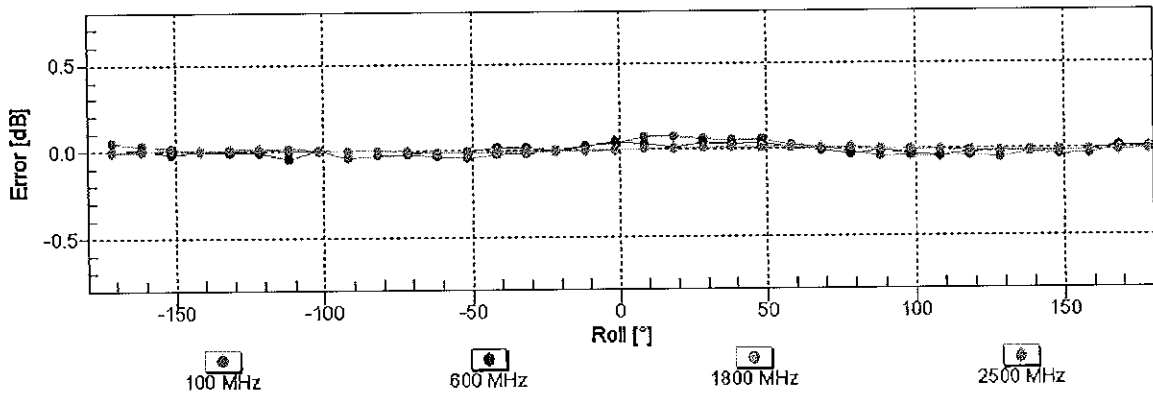
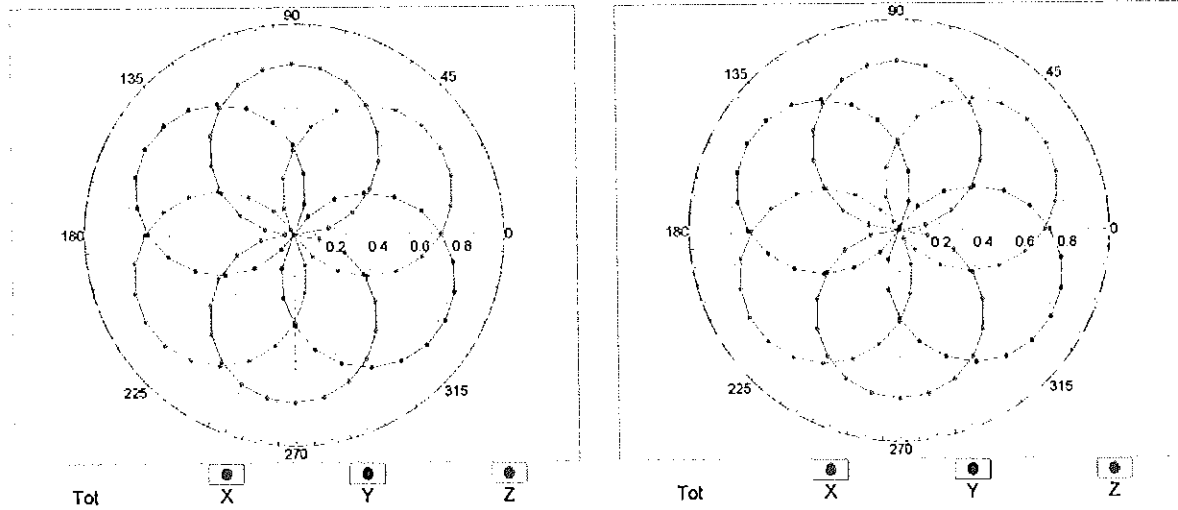

Uncertainty of Axial Isotropy Assessment: $\pm 0.5\%$ (k=2)

Dynamic Range $f(SAR_{head})$ (TEM cell , $f_{eval} = 1900$ MHz)

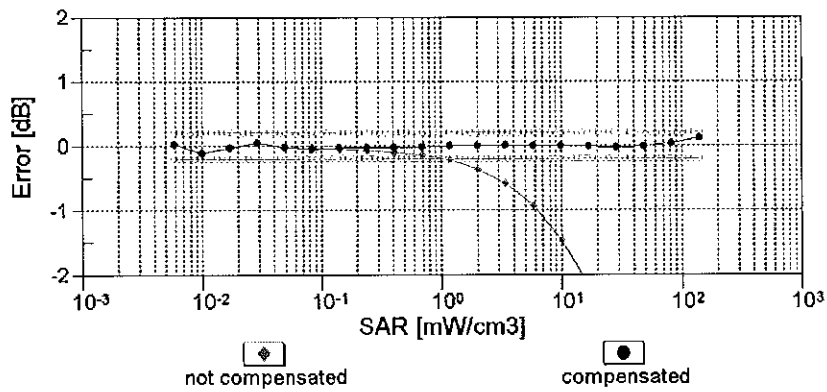
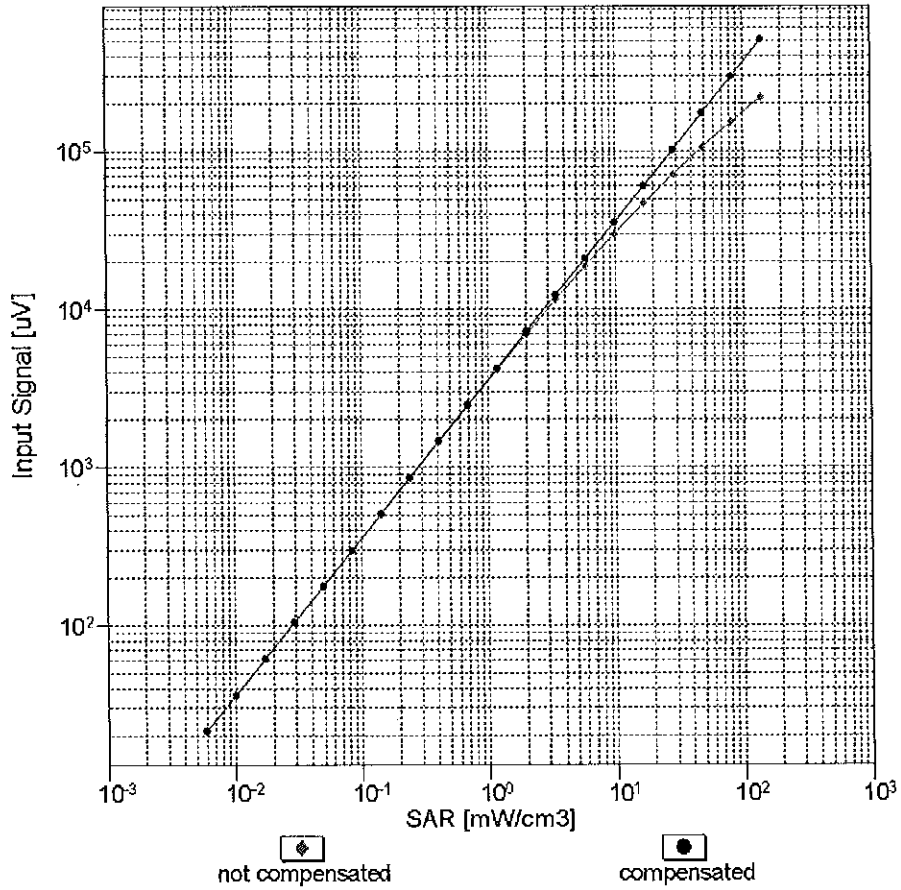

Uncertainty of Linearity Assessment: $\pm 0.6\%$ (k=2)

Conversion Factor Assessment

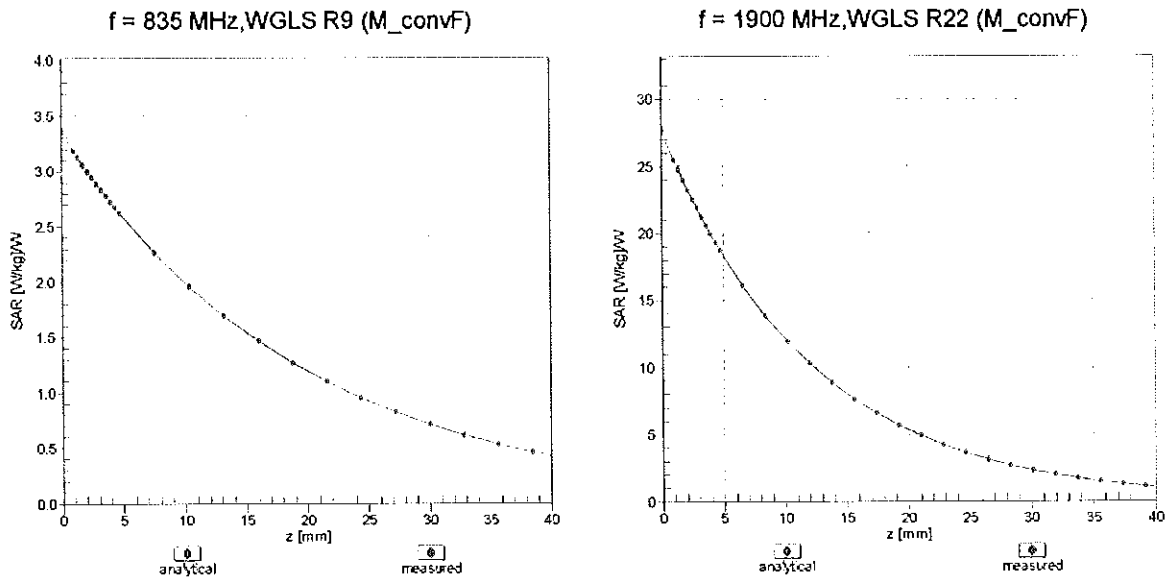

Deviation from Isotropy in Liquid Error (ϕ, θ), f = 900 MHz

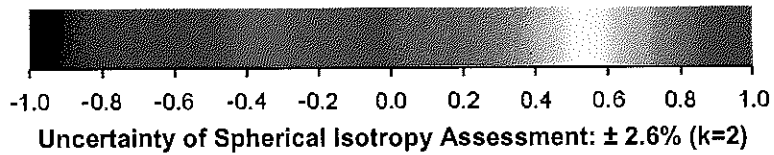
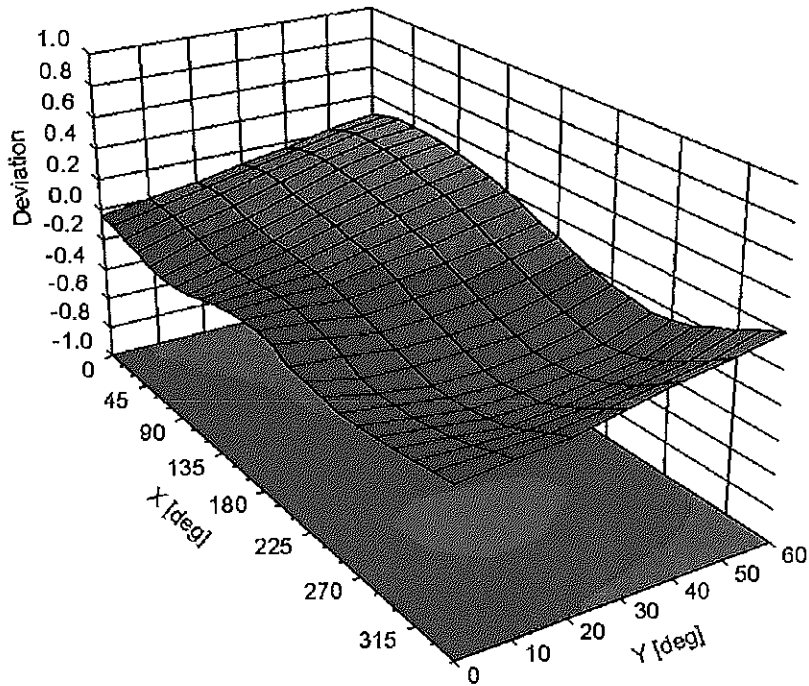

DASY/EASY - Parameters of Probe: EX3DV4 - SN:7308

Other Probe Parameters

Sensor Arrangement	Triangular
Connector Angle (°)	108.4
Mechanical Surface Detection Mode	enabled
Optical Surface Detection Mode	disabled
Probe Overall Length	337 mm
Probe Body Diameter	10 mm
Tip Length	9 mm
Tip Diameter	2.5 mm
Probe Tip to Sensor X Calibration Point	1 mm
Probe Tip to Sensor Y Calibration Point	1 mm
Probe Tip to Sensor Z Calibration Point	1 mm
Recommended Measurement Distance from Surface	1.4 mm

Appendix: Modulation Calibration Parameters

UID	Communication System Name		A dB	B dB $\sqrt{\mu V}$	C	D dB	VR mV	Max Unc ^E (k=2)
0	CW	X	0.00	0.00	1.00	0.00	134.5	$\pm 3.3\%$
		Y	0.00	0.00	1.00		130.8	
		Z	0.00	0.00	1.00		149.9	
10010- CAA	SAR Validation (Square, 100ms, 10ms)	X	2.82	69.38	11.47	10.00	20.0	$\pm 9.6\%$
		Y	8.85	81.60	16.75		20.0	
		Z	1.57	63.55	8.34		20.0	
10011- CAB	UMTS-FDD (WCDMA)	X	1.10	68.34	15.94	0.00	150.0	$\pm 9.6\%$
		Y	1.03	66.61	14.91		150.0	
		Z	1.05	68.21	15.74		150.0	
10012- CAB	IEEE 802.11b WiFi 2.4 GHz (DSSS, 1 Mbps)	X	1.19	64.20	15.65	0.41	150.0	$\pm 9.6\%$
		Y	1.20	63.83	15.29		150.0	
		Z	1.16	63.91	15.33		150.0	
10013- CAB	IEEE 802.11g WiFi 2.4 GHz (DSSS-OFDM, 6 Mbps)	X	4.89	66.77	17.26	1.46	150.0	$\pm 9.6\%$
		Y	4.97	66.66	17.21		150.0	
		Z	4.71	66.76	17.06		150.0	
10021- DAC	GSM-FDD (TDMA, GMSK)	X	100.00	115.21	27.27	9.39	50.0	$\pm 9.6\%$
		Y	100.00	118.99	29.62		50.0	
		Z	100.00	108.16	23.75		50.0	
10023- DAC	GPRS-FDD (TDMA, GMSK, TN 0)	X	100.00	114.49	26.98	9.57	50.0	$\pm 9.6\%$
		Y	100.00	118.59	29.46		50.0	
		Z	100.00	107.44	23.48		50.0	
10024- DAC	GPRS-FDD (TDMA, GMSK, TN 0-1)	X	100.00	117.36	27.41	6.56	60.0	$\pm 9.6\%$
		Y	100.00	118.20	28.43		60.0	
		Z	100.00	109.72	23.49		60.0	
10025- DAC	EDGE-FDD (TDMA, 8PSK, TN 0)	X	9.43	102.43	43.37	12.57	50.0	$\pm 9.6\%$
		Y	5.76	81.81	33.21		50.0	
		Z	6.64	89.92	37.39		50.0	
10026- DAC	EDGE-FDD (TDMA, 8PSK, TN 0-1)	X	12.23	103.58	38.33	9.56	60.0	$\pm 9.6\%$
		Y	13.89	103.56	37.54		60.0	
		Z	6.87	89.09	32.73		60.0	
10027- DAC	GPRS-FDD (TDMA, GMSK, TN 0-1-2)	X	100.00	121.12	28.38	4.80	80.0	$\pm 9.6\%$
		Y	100.00	119.35	28.26		80.0	
		Z	100.00	113.58	24.47		80.0	
10028- DAC	GPRS-FDD (TDMA, GMSK, TN 0-1-2-3)	X	100.00	126.40	29.97	3.55	100.0	$\pm 9.6\%$
		Y	100.00	121.68	28.61		100.0	
		Z	100.00	119.83	26.46		100.0	
10029- DAC	EDGE-FDD (TDMA, 8PSK, TN 0-1-2)	X	6.36	85.88	30.18	7.80	80.0	$\pm 9.6\%$
		Y	7.77	88.44	30.64		80.0	
		Z	4.37	77.58	26.51		80.0	
10030- CAA	IEEE 802.15.1 Bluetooth (GFSK, DH1)	X	100.00	116.71	26.74	5.30	70.0	$\pm 9.6\%$
		Y	100.00	116.86	27.45		70.0	
		Z	100.00	108.46	22.53		70.0	
10031- CAA	IEEE 802.15.1 Bluetooth (GFSK, DH3)	X	100.00	130.68	30.26	1.88	100.0	$\pm 9.6\%$
		Y	100.00	122.76	27.68		100.0	
		Z	100.00	121.33	25.72		100.0	

10032-CAA	IEEE 802.15.1 Bluetooth (GFSK, DH5)	X	100.00	146.47	35.43	1.17	100.0	± 9.6 %
		Y	100.00	130.05	29.64		100.0	
		Z	100.00	142.38	32.95		100.0	
10033-CAA	IEEE 802.15.1 Bluetooth (PI/4-DQPSK, DH1)	X	100.00	133.81	36.67	5.30	70.0	± 9.6 %
		Y	100.00	132.56	36.57		70.0	
		Z	18.79	102.95	27.19		70.0	
10034-CAA	IEEE 802.15.1 Bluetooth (PI/4-DQPSK, DH3)	X	7.76	92.37	23.91	1.88	100.0	± 9.6 %
		Y	6.00	87.65	22.68		100.0	
		Z	3.22	78.87	18.00		100.0	
10035-CAA	IEEE 802.15.1 Bluetooth (PI/4-DQPSK, DH5)	X	3.37	81.04	19.87	1.17	100.0	± 9.6 %
		Y	2.89	77.85	18.94		100.0	
		Z	2.06	74.00	15.93		100.0	
10036-CAA	IEEE 802.15.1 Bluetooth (8-DPSK, DH1)	X	100.00	134.35	36.91	5.30	70.0	± 9.6 %
		Y	100.00	133.01	36.79		70.0	
		Z	38.41	113.99	30.14		70.0	
10037-CAA	IEEE 802.15.1 Bluetooth (8-DPSK, DH3)	X	6.72	90.40	23.29	1.88	100.0	± 9.6 %
		Y	5.52	86.51	22.28		100.0	
		Z	2.77	77.09	17.35		100.0	
10038-CAA	IEEE 802.15.1 Bluetooth (8-DPSK, DH5)	X	3.40	81.53	20.18	1.17	100.0	± 9.6 %
		Y	2.93	78.34	19.24		100.0	
		Z	2.07	74.35	16.21		100.0	
10039-CAB	CDMA2000 (1xRTT, RC1)	X	2.05	73.74	16.48	0.00	150.0	± 9.6 %
		Y	1.78	70.97	15.59		150.0	
		Z	1.68	71.87	14.68		150.0	
10042-CAB	IS-54 / IS-136 FDD (TDMA/FDM, PI/4-DQPSK, Halfrate)	X	100.00	111.92	25.18	7.78	50.0	± 9.6 %
		Y	100.00	114.62	26.97		50.0	
		Z	100.00	105.38	21.87		50.0	
10044-CAA	IS-91/EIA/TIA-553 FDD (FDMA, FM)	X	0.00	97.13	0.41	0.00	150.0	± 9.6 %
		Y	0.00	93.19	1.28		150.0	
		Z	0.01	94.96	0.54		150.0	
10048-CAA	DECT (TDD, TDMA/FDM, GFSK, Full Slot, 24)	X	100.00	111.98	26.96	13.80	25.0	± 9.6 %
		Y	100.00	121.05	31.60		25.0	
		Z	34.07	91.91	20.28		25.0	
10049-CAA	DECT (TDD, TDMA/FDM, GFSK, Double Slot, 12)	X	1284.72	142.21	32.21	10.79	40.0	± 9.6 %
		Y	100.00	117.51	29.18		40.0	
		Z	145.96	109.32	23.74		40.0	
10056-CAA	UMTS-TDD (TD-SCDMA, 1.28 Mcps)	X	100.00	128.20	35.15	9.03	50.0	± 9.6 %
		Y	100.00	128.83	35.96		50.0	
		Z	100.00	122.10	31.77		50.0	
10058-DAC	EDGE-FDD (TDMA, 8PSK, TN 0-1-2-3)	X	4.71	78.88	26.31	6.55	100.0	± 9.6 %
		Y	5.67	81.33	26.92		100.0	
		Z	3.54	73.15	23.60		100.0	
10059-CAB	IEEE 802.11b WiFi 2.4 GHz (DSSS, 2 Mbps)	X	1.24	65.47	16.42	0.61	110.0	± 9.6 %
		Y	1.27	65.23	16.10		110.0	
		Z	1.17	64.77	15.84		110.0	
10060-CAB	IEEE 802.11b WiFi 2.4 GHz (DSSS, 5.5 Mbps)	X	100.00	144.38	38.50	1.30	110.0	± 9.6 %
		Y	100.00	138.88	36.40		110.0	
		Z	13.09	112.30	30.84		110.0	

10061-CAB	IEEE 802.11b WiFi 2.4 GHz (DSSS, 11 Mbps)	X	4.05	88.33	25.97	2.04	110.0	± 9.6 %
		Y	4.75	88.86	25.68		110.0	
		Z	2.16	77.73	21.68		110.0	
10062-CAB	IEEE 802.11a/h WiFi 5 GHz (OFDM, 6 Mbps)	X	4.69	66.76	16.65	0.49	100.0	± 9.6 %
		Y	4.76	66.60	16.58		100.0	
		Z	4.53	66.78	16.51		100.0	
10063-CAB	IEEE 802.11a/h WiFi 5 GHz (OFDM, 9 Mbps)	X	4.71	66.86	16.76	0.72	100.0	± 9.6 %
		Y	4.78	66.72	16.70		100.0	
		Z	4.54	66.86	16.60		100.0	
10064-CAB	IEEE 802.11a/h WiFi 5 GHz (OFDM, 12 Mbps)	X	4.99	67.12	16.99	0.86	100.0	± 9.6 %
		Y	5.09	67.02	16.95		100.0	
		Z	4.78	67.06	16.80		100.0	
10065-CAB	IEEE 802.11a/h WiFi 5 GHz (OFDM, 18 Mbps)	X	4.86	67.02	17.11	1.21	100.0	± 9.6 %
		Y	4.96	66.95	17.08		100.0	
		Z	4.65	66.90	16.87		100.0	
10066-CAB	IEEE 802.11a/h WiFi 5 GHz (OFDM, 24 Mbps)	X	4.88	67.05	17.29	1.46	100.0	± 9.6 %
		Y	4.99	66.99	17.27		100.0	
		Z	4.65	66.88	17.02		100.0	
10067-CAB	IEEE 802.11a/h WiFi 5 GHz (OFDM, 36 Mbps)	X	5.16	67.22	17.75	2.04	100.0	± 9.6 %
		Y	5.27	67.12	17.71		100.0	
		Z	4.93	67.13	17.49		100.0	
10068-CAB	IEEE 802.11a/h WiFi 5 GHz (OFDM, 48 Mbps)	X	5.20	67.26	17.98	2.55	100.0	± 9.6 %
		Y	5.34	67.28	18.00		100.0	
		Z	4.95	67.02	17.64		100.0	
10069-CAB	IEEE 802.11a/h WiFi 5 GHz (OFDM, 54 Mbps)	X	5.28	67.26	18.18	2.67	100.0	± 9.6 %
		Y	5.42	67.23	18.17		100.0	
		Z	5.02	67.05	17.83		100.0	
10071-CAB	IEEE 802.11g WiFi 2.4 GHz (DSSS/OFDM, 9 Mbps)	X	4.98	66.86	17.58	1.99	100.0	± 9.6 %
		Y	5.07	66.77	17.55		100.0	
		Z	4.79	66.80	17.35		100.0	
10072-CAB	IEEE 802.11g WiFi 2.4 GHz (DSSS/OFDM, 12 Mbps)	X	4.95	67.19	17.81	2.30	100.0	± 9.6 %
		Y	5.06	67.16	17.80		100.0	
		Z	4.74	67.03	17.53		100.0	
10073-CAB	IEEE 802.11g WiFi 2.4 GHz (DSSS/OFDM, 18 Mbps)	X	5.00	67.34	18.16	2.83	100.0	± 9.6 %
		Y	5.12	67.33	18.16		100.0	
		Z	4.79	67.17	17.85		100.0	
10074-CAB	IEEE 802.11g WiFi 2.4 GHz (DSSS/OFDM, 24 Mbps)	X	4.97	67.20	18.31	3.30	100.0	± 9.6 %
		Y	5.10	67.22	18.33		100.0	
		Z	4.78	67.07	17.99		100.0	
10075-CAB	IEEE 802.11g WiFi 2.4 GHz (DSSS/OFDM, 36 Mbps)	X	5.00	67.30	18.63	3.82	90.0	± 9.6 %
		Y	5.15	67.40	18.70		90.0	
		Z	4.78	67.05	18.23		90.0	
10076-CAB	IEEE 802.11g WiFi 2.4 GHz (DSSS/OFDM, 48 Mbps)	X	5.00	67.05	18.74	4.15	90.0	± 9.6 %
		Y	5.14	67.12	18.78		90.0	
		Z	4.81	66.90	18.39		90.0	
10077-CAB	IEEE 802.11g WiFi 2.4 GHz (DSSS/OFDM, 54 Mbps)	X	5.02	67.11	18.84	4.30	90.0	± 9.6 %
		Y	5.16	67.16	18.87		90.0	
		Z	4.84	66.97	18.50		90.0	

10081-CAB	CDMA2000 (1xRTT, RC3)	X	0.91	67.10	13.23	0.00	150.0	± 9.6 %
		Y	0.87	65.55	12.69		150.0	
		Z	0.76	65.80	11.60		150.0	
10082-CAB	IS-54 / IS-136 FDD (TDMA/FDM, PI/4-DQPSK, Fullrate)	X	0.67	60.00	4.34	4.77	80.0	± 9.6 %
		Y	0.83	60.00	4.98		80.0	
		Z	1.32	62.68	4.53		80.0	
10090-DAC	GPRS-FDD (TDMA, GMSK, TN 0-4)	X	100.00	117.37	27.43	6.56	60.0	± 9.6 %
		Y	100.00	118.23	28.46		60.0	
		Z	100.00	109.70	23.50		60.0	
10097-CAB	UMTS-FDD (HSDPA)	X	1.89	68.18	16.03	0.00	150.0	± 9.6 %
		Y	1.82	67.06	15.47		150.0	
		Z	1.87	68.73	15.97		150.0	
10098-CAB	UMTS-FDD (HSUPA, Subtest 2)	X	1.85	68.15	16.01	0.00	150.0	± 9.6 %
		Y	1.78	67.01	15.43		150.0	
		Z	1.83	68.68	15.95		150.0	
10099-DAC	EDGE-FDD (TDMA, 8PSK, TN 0-4)	X	12.41	103.93	38.44	9.56	60.0	± 9.6 %
		Y	14.05	103.81	37.62		60.0	
		Z	6.94	89.30	32.81		60.0	
10100-CAD	LTE-FDD (SC-FDMA, 100% RB, 20 MHz, QPSK)	X	3.20	70.68	16.98	0.00	150.0	± 9.6 %
		Y	3.15	69.96	16.53		150.0	
		Z	3.05	70.44	16.91		150.0	
10101-CAD	LTE-FDD (SC-FDMA, 100% RB, 20 MHz, 16-QAM)	X	3.27	67.67	16.10	0.00	150.0	± 9.6 %
		Y	3.29	67.34	15.87		150.0	
		Z	3.15	67.56	16.02		150.0	
10102-CAD	LTE-FDD (SC-FDMA, 100% RB, 20 MHz, 64-QAM)	X	3.37	67.61	16.17	0.00	150.0	± 9.6 %
		Y	3.39	67.30	15.96		150.0	
		Z	3.26	67.54	16.10		150.0	
10103-CAD	LTE-TDD (SC-FDMA, 100% RB, 20 MHz, QPSK)	X	6.70	77.76	21.71	3.98	65.0	± 9.6 %
		Y	7.25	78.01	21.66		65.0	
		Z	5.31	74.49	20.24		65.0	
10104-CAD	LTE-TDD (SC-FDMA, 100% RB, 20 MHz, 16-QAM)	X	6.39	74.88	21.30	3.98	65.0	± 9.6 %
		Y	7.01	75.63	21.49		65.0	
		Z	5.41	72.53	20.08		65.0	
10105-CAD	LTE-TDD (SC-FDMA, 100% RB, 20 MHz, 64-QAM)	X	5.93	73.22	20.87	3.98	65.0	± 9.6 %
		Y	6.37	73.62	20.93		65.0	
		Z	4.98	70.66	19.52		65.0	
10108-CAE	LTE-FDD (SC-FDMA, 100% RB, 10 MHz, QPSK)	X	2.79	69.92	16.81	0.00	150.0	± 9.6 %
		Y	2.76	69.17	16.35		150.0	
		Z	2.63	69.76	16.75		150.0	
10109-CAE	LTE-FDD (SC-FDMA, 100% RB, 10 MHz, 16-QAM)	X	2.93	67.55	16.01	0.00	150.0	± 9.6 %
		Y	2.94	67.14	15.76		150.0	
		Z	2.80	67.54	15.90		150.0	
10110-CAE	LTE-FDD (SC-FDMA, 100% RB, 5 MHz, QPSK)	X	2.27	69.10	16.46	0.00	150.0	± 9.6 %
		Y	2.25	68.23	15.96		150.0	
		Z	2.13	69.06	16.32		150.0	
10111-CAE	LTE-FDD (SC-FDMA, 100% RB, 5 MHz, 16-QAM)	X	2.65	68.45	16.32	0.00	150.0	± 9.6 %
		Y	2.64	67.76	16.00		150.0	
		Z	2.55	68.78	16.20		150.0	

10112-CAE	LTE-FDD (SC-FDMA, 100% RB, 10 MHz, 64-QAM)	X	3.05	67.53	16.06	0.00	150.0	± 9.6 %
		Y	3.07	67.13	15.82		150.0	
		Z	2.92	67.58	15.97		150.0	
10113-CAE	LTE-FDD (SC-FDMA, 100% RB, 5 MHz, 64-QAM)	X	2.80	68.56	16.43	0.00	150.0	± 9.6 %
		Y	2.80	67.90	16.13		150.0	
		Z	2.69	68.93	16.32		150.0	
10114-CAB	IEEE 802.11n (HT Greenfield, 13.5 Mbps, BPSK)	X	5.15	67.26	16.54	0.00	150.0	± 9.6 %
		Y	5.19	67.08	16.42		150.0	
		Z	4.99	67.20	16.47		150.0	
10115-CAB	IEEE 802.11n (HT Greenfield, 81 Mbps, 16-QAM)	X	5.43	67.37	16.60	0.00	150.0	± 9.6 %
		Y	5.52	67.34	16.56		150.0	
		Z	5.24	67.27	16.51		150.0	
10116-CAB	IEEE 802.11n (HT Greenfield, 135 Mbps, 64-QAM)	X	5.24	67.44	16.56	0.00	150.0	± 9.6 %
		Y	5.30	67.32	16.46		150.0	
		Z	5.08	67.39	16.50		150.0	
10117-CAB	IEEE 802.11n (HT Mixed, 13.5 Mbps, BPSK)	X	5.11	67.11	16.48	0.00	150.0	± 9.6 %
		Y	5.16	66.99	16.39		150.0	
		Z	4.99	67.15	16.47		150.0	
10118-CAB	IEEE 802.11n (HT Mixed, 81 Mbps, 16-QAM)	X	5.51	67.58	16.71	0.00	150.0	± 9.6 %
		Y	5.61	67.54	16.67		150.0	
		Z	5.31	67.44	16.61		150.0	
10119-CAB	IEEE 802.11n (HT Mixed, 135 Mbps, 64-QAM)	X	5.22	67.40	16.54	0.00	150.0	± 9.6 %
		Y	5.27	67.25	16.44		150.0	
		Z	5.07	67.38	16.51		150.0	
10140-CAD	LTE-FDD (SC-FDMA, 100% RB, 15 MHz, 16-QAM)	X	3.41	67.63	16.10	0.00	150.0	± 9.6 %
		Y	3.43	67.31	15.88		150.0	
		Z	3.28	67.57	16.02		150.0	
10141-CAD	LTE-FDD (SC-FDMA, 100% RB, 15 MHz, 64-QAM)	X	3.53	67.71	16.25	0.00	150.0	± 9.6 %
		Y	3.55	67.40	16.05		150.0	
		Z	3.40	67.71	16.20		150.0	
10142-CAD	LTE-FDD (SC-FDMA, 100% RB, 3 MHz, QPSK)	X	2.05	69.21	16.15	0.00	150.0	± 9.6 %
		Y	2.02	68.14	15.65		150.0	
		Z	1.90	69.18	15.79		150.0	
10143-CAD	LTE-FDD (SC-FDMA, 100% RB, 3 MHz, 16-QAM)	X	2.53	69.32	16.06	0.00	150.0	± 9.6 %
		Y	2.50	68.40	15.76		150.0	
		Z	2.39	69.52	15.59		150.0	
10144-CAD	LTE-FDD (SC-FDMA, 100% RB, 3 MHz, 64-QAM)	X	2.28	66.94	14.41	0.00	150.0	± 9.6 %
		Y	2.31	66.41	14.31		150.0	
		Z	2.06	66.49	13.57		150.0	
10145-CAE	LTE-FDD (SC-FDMA, 100% RB, 1.4 MHz, QPSK)	X	1.26	65.57	12.06	0.00	150.0	± 9.6 %
		Y	1.33	65.51	12.47		150.0	
		Z	0.90	62.72	9.31		150.0	
10146-CAE	LTE-FDD (SC-FDMA, 100% RB, 1.4 MHz, 16-QAM)	X	1.87	65.71	11.26	0.00	150.0	± 9.6 %
		Y	2.34	67.84	13.03		150.0	
		Z	1.05	60.97	7.27		150.0	
10147-CAE	LTE-FDD (SC-FDMA, 100% RB, 1.4 MHz, 64-QAM)	X	2.17	67.47	12.23	0.00	150.0	± 9.6 %
		Y	2.79	70.16	14.23		150.0	
		Z	1.11	61.38	7.60		150.0	

10149-CAD	LTE-FDD (SC-FDMA, 50% RB, 20 MHz, 16-QAM)	X	2.93	67.61	16.06	0.00	150.0	± 9.6 %
		Y	2.95	67.20	15.81		150.0	
		Z	2.81	67.60	15.95		150.0	
10150-CAD	LTE-FDD (SC-FDMA, 50% RB, 20 MHz, 64-QAM)	X	3.06	67.58	16.10	0.00	150.0	± 9.6 %
		Y	3.08	67.18	15.86		150.0	
		Z	2.93	67.64	16.01		150.0	
10151-CAD	LTE-TDD (SC-FDMA, 50% RB, 20 MHz, QPSK)	X	7.47	81.50	23.31	3.98	65.0	± 9.6 %
		Y	8.13	81.64	23.19		65.0	
		Z	5.82	78.02	21.74		65.0	
10152-CAD	LTE-TDD (SC-FDMA, 50% RB, 20 MHz, 16-QAM)	X	5.96	75.09	21.13	3.98	65.0	± 9.6 %
		Y	6.59	75.82	21.34		65.0	
		Z	4.95	72.53	19.69		65.0	
10153-CAD	LTE-TDD (SC-FDMA, 50% RB, 20 MHz, 64-QAM)	X	6.33	76.00	21.87	3.98	65.0	± 9.6 %
		Y	6.98	76.72	22.08		65.0	
		Z	5.31	73.57	20.52		65.0	
10154-CAE	LTE-FDD (SC-FDMA, 50% RB, 10 MHz, QPSK)	X	2.32	69.50	16.70	0.00	150.0	± 9.6 %
		Y	2.30	68.63	16.21		150.0	
		Z	2.17	69.43	16.55		150.0	
10155-CAE	LTE-FDD (SC-FDMA, 50% RB, 10 MHz, 16-QAM)	X	2.65	68.47	16.34	0.00	150.0	± 9.6 %
		Y	2.64	67.77	16.01		150.0	
		Z	2.55	68.82	16.23		150.0	
10156-CAE	LTE-FDD (SC-FDMA, 50% RB, 5 MHz, QPSK)	X	1.90	69.38	15.98	0.00	150.0	± 9.6 %
		Y	1.87	68.22	15.49		150.0	
		Z	1.73	69.10	15.35		150.0	
10157-CAE	LTE-FDD (SC-FDMA, 50% RB, 5 MHz, 16-QAM)	X	2.13	67.61	14.49	0.00	150.0	± 9.6 %
		Y	2.14	66.94	14.37		150.0	
		Z	1.88	66.88	13.39		150.0	
10158-CAE	LTE-FDD (SC-FDMA, 50% RB, 10 MHz, 64-QAM)	X	2.80	68.62	16.48	0.00	150.0	± 9.6 %
		Y	2.80	67.95	16.18		150.0	
		Z	2.70	69.02	16.37		150.0	
10159-CAE	LTE-FDD (SC-FDMA, 50% RB, 5 MHz, 64-QAM)	X	2.24	68.05	14.76	0.00	150.0	± 9.6 %
		Y	2.25	67.38	14.65		150.0	
		Z	1.97	67.26	13.62		150.0	
10160-CAD	LTE-FDD (SC-FDMA, 50% RB, 15 MHz, QPSK)	X	2.79	68.96	16.56	0.00	150.0	± 9.6 %
		Y	2.78	68.29	16.16		150.0	
		Z	2.67	69.03	16.52		150.0	
10161-CAD	LTE-FDD (SC-FDMA, 50% RB, 15 MHz, 16-QAM)	X	2.95	67.54	16.03	0.00	150.0	± 9.6 %
		Y	2.97	67.10	15.79		150.0	
		Z	2.82	67.63	15.91		150.0	
10162-CAD	LTE-FDD (SC-FDMA, 50% RB, 15 MHz, 64-QAM)	X	3.06	67.69	16.14	0.00	150.0	± 9.6 %
		Y	3.08	67.22	15.89		150.0	
		Z	2.94	67.84	16.05		150.0	
10166-CAE	LTE-FDD (SC-FDMA, 50% RB, 1.4 MHz, QPSK)	X	3.60	69.71	19.22	3.01	150.0	± 9.6 %
		Y	3.76	69.53	19.10		150.0	
		Z	3.14	68.43	18.52		150.0	
10167-CAE	LTE-FDD (SC-FDMA, 50% RB, 1.4 MHz, 16-QAM)	X	4.49	72.92	19.79	3.01	150.0	± 9.6 %
		Y	4.71	72.48	19.58		150.0	
		Z	3.64	70.88	18.81		150.0	

10168-CAE	LTE-FDD (SC-FDMA, 50% RB, 1.4 MHz, 64-QAM)	X	4.99	75.19	21.10	3.01	150.0	± 9.6 %
		Y	5.19	74.57	20.82		150.0	
		Z	4.03	73.14	20.19		150.0	
10169-CAD	LTE-FDD (SC-FDMA, 1 RB, 20 MHz, QPSK)	X	3.02	69.31	19.06	3.01	150.0	± 9.6 %
		Y	3.27	69.70	19.15		150.0	
		Z	2.51	66.78	17.76		150.0	
10170-CAD	LTE-FDD (SC-FDMA, 1 RB, 20 MHz, 16-QAM)	X	4.24	75.66	21.52	3.01	150.0	± 9.6 %
		Y	4.60	75.59	21.37		150.0	
		Z	3.08	71.28	19.66		150.0	
10171-AAD	LTE-FDD (SC-FDMA, 1 RB, 20 MHz, 64-QAM)	X	3.48	71.52	18.79	3.01	150.0	± 9.6 %
		Y	3.80	71.54	18.73		150.0	
		Z	2.62	68.04	17.18		150.0	
10172-CAD	LTE-TDD (SC-FDMA, 1 RB, 20 MHz, QPSK)	X	9.86	97.03	31.31	6.02	65.0	± 9.6 %
		Y	11.94	97.60	31.03		65.0	
		Z	3.49	77.54	23.86		65.0	
10173-CAD	LTE-TDD (SC-FDMA, 1 RB, 20 MHz, 16-QAM)	X	35.90	116.24	34.55	6.02	65.0	± 9.6 %
		Y	33.36	111.72	33.12		65.0	
		Z	6.56	87.15	25.45		65.0	
10174-CAD	LTE-TDD (SC-FDMA, 1 RB, 20 MHz, 64-QAM)	X	21.48	105.16	30.85	6.02	65.0	± 9.6 %
		Y	20.65	101.59	29.68		65.0	
		Z	4.70	80.63	22.56		65.0	
10175-CAE	LTE-FDD (SC-FDMA, 1 RB, 10 MHz, QPSK)	X	2.98	69.02	18.83	3.01	150.0	± 9.6 %
		Y	3.23	69.39	18.90		150.0	
		Z	2.49	66.55	17.55		150.0	
10176-CAE	LTE-FDD (SC-FDMA, 1 RB, 10 MHz, 16-QAM)	X	4.24	75.68	21.53	3.01	150.0	± 9.6 %
		Y	4.61	75.61	21.38		150.0	
		Z	3.09	71.30	19.67		150.0	
10177-CAG	LTE-FDD (SC-FDMA, 1 RB, 5 MHz, QPSK)	X	3.01	69.16	18.92	3.01	150.0	± 9.6 %
		Y	3.26	69.54	19.00		150.0	
		Z	2.50	66.65	17.62		150.0	
10178-CAE	LTE-FDD (SC-FDMA, 1 RB, 5 MHz, 16-QAM)	X	4.21	75.48	21.42	3.01	150.0	± 9.6 %
		Y	4.56	75.38	21.26		150.0	
		Z	3.07	71.19	19.60		150.0	
10179-CAE	LTE-FDD (SC-FDMA, 1 RB, 10 MHz, 64-QAM)	X	3.83	73.49	20.03	3.01	150.0	± 9.6 %
		Y	4.16	73.42	19.91		150.0	
		Z	2.83	69.59	18.31		150.0	
10180-CAE	LTE-FDD (SC-FDMA, 1 RB, 5 MHz, 64-QAM)	X	3.47	71.46	18.75	3.01	150.0	± 9.6 %
		Y	3.79	71.47	18.68		150.0	
		Z	2.62	68.01	17.15		150.0	
10181-CAD	LTE-FDD (SC-FDMA, 1 RB, 15 MHz, QPSK)	X	3.00	69.14	18.91	3.01	150.0	± 9.6 %
		Y	3.26	69.52	18.99		150.0	
		Z	2.50	66.64	17.62		150.0	
10182-CAD	LTE-FDD (SC-FDMA, 1 RB, 15 MHz, 16-QAM)	X	4.20	75.46	21.41	3.01	150.0	± 9.6 %
		Y	4.55	75.36	21.25		150.0	
		Z	3.07	71.17	19.59		150.0	
10183-AAC	LTE-FDD (SC-FDMA, 1 RB, 15 MHz, 64-QAM)	X	3.46	71.44	18.74	3.01	150.0	± 9.6 %
		Y	3.78	71.45	18.67		150.0	
		Z	2.62	68.00	17.14		150.0	

10184-CAD	LTE-FDD (SC-FDMA, 1 RB, 3 MHz, QPSK)	X	3.01	69.18	18.93	3.01	150.0	± 9.6 %
		Y	3.27	69.56	19.01		150.0	
		Z	2.51	66.67	17.63		150.0	
10185-CAD	LTE-FDD (SC-FDMA, 1 RB, 3 MHz, 16-QAM)	X	4.22	75.53	21.45	3.01	150.0	± 9.6 %
		Y	4.57	75.42	21.28		150.0	
		Z	3.08	71.23	19.63		150.0	
10186-AAD	LTE-FDD (SC-FDMA, 1 RB, 3 MHz, 64-QAM)	X	3.48	71.51	18.77	3.01	150.0	± 9.6 %
		Y	3.80	71.51	18.70		150.0	
		Z	2.63	68.05	17.17		150.0	
10187-CAE	LTE-FDD (SC-FDMA, 1 RB, 1.4 MHz, QPSK)	X	3.02	69.24	19.00	3.01	150.0	± 9.6 %
		Y	3.28	69.61	19.07		150.0	
		Z	2.52	66.73	17.71		150.0	
10188-CAE	LTE-FDD (SC-FDMA, 1 RB, 1.4 MHz, 16-QAM)	X	4.35	76.17	21.80	3.01	150.0	± 9.6 %
		Y	4.72	76.08	21.65		150.0	
		Z	3.15	71.69	19.93		150.0	
10189-AAE	LTE-FDD (SC-FDMA, 1 RB, 1.4 MHz, 64-QAM)	X	3.56	71.93	19.04	3.01	150.0	± 9.6 %
		Y	3.88	71.93	18.97		150.0	
		Z	2.67	68.37	17.41		150.0	
10193-CAB	IEEE 802.11n (HT Greenfield, 6.5 Mbps, BPSK)	X	4.54	66.68	16.24	0.00	150.0	± 9.6 %
		Y	4.59	66.47	16.13		150.0	
		Z	4.40	66.85	16.19		150.0	
10194-CAB	IEEE 802.11n (HT Greenfield, 39 Mbps, 16-QAM)	X	4.70	66.99	16.36	0.00	150.0	± 9.6 %
		Y	4.77	66.80	16.26		150.0	
		Z	4.55	67.09	16.33		150.0	
10195-CAB	IEEE 802.11n (HT Greenfield, 65 Mbps, 64-QAM)	X	4.74	67.02	16.38	0.00	150.0	± 9.6 %
		Y	4.81	66.83	16.27		150.0	
		Z	4.58	67.11	16.34		150.0	
10196-CAB	IEEE 802.11n (HT Mixed, 6.5 Mbps, BPSK)	X	4.54	66.74	16.25	0.00	150.0	± 9.6 %
		Y	4.60	66.55	16.16		150.0	
		Z	4.39	66.85	16.19		150.0	
10197-CAB	IEEE 802.11n (HT Mixed, 39 Mbps, 16-QAM)	X	4.72	67.01	16.37	0.00	150.0	± 9.6 %
		Y	4.78	66.83	16.27		150.0	
		Z	4.56	67.10	16.33		150.0	
10198-CAB	IEEE 802.11n (HT Mixed, 65 Mbps, 64-QAM)	X	4.75	67.04	16.39	0.00	150.0	± 9.6 %
		Y	4.81	66.85	16.28		150.0	
		Z	4.58	67.11	16.34		150.0	
10219-CAB	IEEE 802.11n (HT Mixed, 7.2 Mbps, BPSK)	X	4.49	66.76	16.22	0.00	150.0	± 9.6 %
		Y	4.55	66.56	16.12		150.0	
		Z	4.34	66.89	16.16		150.0	
10220-CAB	IEEE 802.11n (HT Mixed, 43.3 Mbps, 16-QAM)	X	4.71	66.98	16.36	0.00	150.0	± 9.6 %
		Y	4.78	66.81	16.26		150.0	
		Z	4.55	67.06	16.32		150.0	
10221-CAB	IEEE 802.11n (HT Mixed, 72.2 Mbps, 64-QAM)	X	4.75	66.96	16.37	0.00	150.0	± 9.6 %
		Y	4.82	66.78	16.27		150.0	
		Z	4.59	67.05	16.33		150.0	
10222-CAB	IEEE 802.11n (HT Mixed, 15 Mbps, BPSK)	X	5.08	67.12	16.48	0.00	150.0	± 9.6 %
		Y	5.14	67.00	16.39		150.0	
		Z	4.96	67.13	16.45		150.0	

10223-CAB	IEEE 802.11n (HT Mixed, 90 Mbps, 16-QAM)	X	5.38	67.33	16.60	0.00	150.0	± 9.6 %
		Y	5.45	67.20	16.51		150.0	
		Z	5.23	67.33	16.56		150.0	
10224-CAB	IEEE 802.11n (HT Mixed, 150 Mbps, 64-QAM)	X	5.13	67.23	16.46	0.00	150.0	± 9.6 %
		Y	5.19	67.11	16.37		150.0	
		Z	4.99	67.25	16.44		150.0	
10225-CAB	UMTS-FDD (HSPA+)	X	2.82	66.29	15.44	0.00	150.0	± 9.6 %
		Y	2.85	65.89	15.31		150.0	
		Z	2.69	66.42	15.13		150.0	
10226-CAA	LTE-TDD (SC-FDMA, 1 RB, 1.4 MHz, 16-QAM)	X	40.58	118.73	35.31	6.02	65.0	± 9.6 %
		Y	36.88	113.76	33.77		65.0	
		Z	6.94	88.26	25.92		65.0	
10227-CAA	LTE-TDD (SC-FDMA, 1 RB, 1.4 MHz, 64-QAM)	X	36.33	114.29	33.35	6.02	65.0	± 9.6 %
		Y	31.30	108.87	31.78		65.0	
		Z	6.95	87.06	24.80		65.0	
10228-CAA	LTE-TDD (SC-FDMA, 1 RB, 1.4 MHz, QPSK)	X	13.65	104.05	33.59	6.02	65.0	± 9.6 %
		Y	18.81	107.23	34.08		65.0	
		Z	4.50	82.80	25.97		65.0	
10229-CAB	LTE-TDD (SC-FDMA, 1 RB, 3 MHz, 16-QAM)	X	36.18	116.36	34.59	6.02	65.0	± 9.6 %
		Y	33.58	111.82	33.15		65.0	
		Z	6.61	87.25	25.49		65.0	
10230-CAB	LTE-TDD (SC-FDMA, 1 RB, 3 MHz, 64-QAM)	X	32.38	112.10	32.69	6.02	65.0	± 9.6 %
		Y	28.70	107.19	31.24		65.0	
		Z	6.54	85.97	24.36		65.0	
10231-CAB	LTE-TDD (SC-FDMA, 1 RB, 3 MHz, QPSK)	X	12.84	102.68	33.09	6.02	65.0	± 9.6 %
		Y	17.62	105.78	33.56		65.0	
		Z	4.35	82.09	25.62		65.0	
10232-CAD	LTE-TDD (SC-FDMA, 1 RB, 5 MHz, 16-QAM)	X	36.15	116.36	34.59	6.02	65.0	± 9.6 %
		Y	33.55	111.82	33.15		65.0	
		Z	6.59	87.23	25.48		65.0	
10233-CAD	LTE-TDD (SC-FDMA, 1 RB, 5 MHz, 64-QAM)	X	32.28	112.07	32.68	6.02	65.0	± 9.6 %
		Y	28.65	107.18	31.24		65.0	
		Z	6.52	85.93	24.35		65.0	
10234-CAD	LTE-TDD (SC-FDMA, 1 RB, 5 MHz, QPSK)	X	12.22	101.47	32.58	6.02	65.0	± 9.6 %
		Y	16.65	104.42	33.04		65.0	
		Z	4.24	81.51	25.28		65.0	
10235-CAD	LTE-TDD (SC-FDMA, 1 RB, 10 MHz, 16-QAM)	X	36.31	116.46	34.62	6.02	65.0	± 9.6 %
		Y	33.66	111.90	33.18		65.0	
		Z	6.60	87.26	25.49		65.0	
10236-CAD	LTE-TDD (SC-FDMA, 1 RB, 10 MHz, 64-QAM)	X	33.06	112.44	32.77	6.02	65.0	± 9.6 %
		Y	29.12	107.43	31.30		65.0	
		Z	6.60	86.11	24.40		65.0	
10237-CAD	LTE-TDD (SC-FDMA, 1 RB, 10 MHz, QPSK)	X	12.90	102.82	33.13	6.02	65.0	± 9.6 %
		Y	17.72	105.93	33.61		65.0	
		Z	4.35	82.12	25.64		65.0	
10238-CAD	LTE-TDD (SC-FDMA, 1 RB, 15 MHz, 16-QAM)	X	36.09	116.34	34.59	6.02	65.0	± 9.6 %
		Y	33.52	111.82	33.15		65.0	
		Z	6.58	87.20	25.47		65.0	

10239-CAD	LTE-TDD (SC-FDMA, 1 RB, 15 MHz, 64-QAM)	X	32.17	112.03	32.67	6.02	65.0	± 9.6 %
		Y	28.59	107.16	31.23		65.0	
		Z	6.49	85.89	24.34		65.0	
10240-CAD	LTE-TDD (SC-FDMA, 1 RB, 15 MHz, QPSK)	X	12.85	102.75	33.11	6.02	65.0	± 9.6 %
		Y	17.65	105.86	33.59		65.0	
		Z	4.34	82.09	25.63		65.0	
10241-CAA	LTE-TDD (SC-FDMA, 50% RB, 1.4 MHz, 16-QAM)	X	8.52	83.40	26.72	6.98	65.0	± 9.6 %
		Y	9.34	83.46	26.63		65.0	
		Z	6.49	79.39	24.77		65.0	
10242-CAA	LTE-TDD (SC-FDMA, 50% RB, 1.4 MHz, 64-QAM)	X	7.72	81.29	25.79	6.98	65.0	± 9.6 %
		Y	8.22	80.66	25.42		65.0	
		Z	5.72	76.85	23.63		65.0	
10243-CAA	LTE-TDD (SC-FDMA, 50% RB, 1.4 MHz, QPSK)	X	5.95	76.72	24.82	6.98	65.0	± 9.6 %
		Y	6.41	76.67	24.65		65.0	
		Z	4.75	73.34	22.98		65.0	
10244-CAB	LTE-TDD (SC-FDMA, 50% RB, 3 MHz, 16-QAM)	X	6.67	78.45	19.67	3.98	65.0	± 9.6 %
		Y	8.20	80.91	21.14		65.0	
		Z	3.50	69.23	14.35		65.0	
10245-CAB	LTE-TDD (SC-FDMA, 50% RB, 3 MHz, 64-QAM)	X	6.39	77.48	19.23	3.98	65.0	± 9.6 %
		Y	7.92	80.07	20.76		65.0	
		Z	3.42	68.65	14.03		65.0	
10246-CAB	LTE-TDD (SC-FDMA, 50% RB, 3 MHz, QPSK)	X	8.15	85.97	22.95	3.98	65.0	± 9.6 %
		Y	9.24	86.80	23.49		65.0	
		Z	4.03	75.23	17.77		65.0	
10247-CAD	LTE-TDD (SC-FDMA, 50% RB, 5 MHz, 16-QAM)	X	5.50	76.42	20.00	3.98	65.0	± 9.6 %
		Y	6.26	77.49	20.66		65.0	
		Z	3.95	71.61	16.94		65.0	
10248-CAD	LTE-TDD (SC-FDMA, 50% RB, 5 MHz, 64-QAM)	X	5.40	75.54	19.60	3.98	65.0	± 9.6 %
		Y	6.16	76.66	20.28		65.0	
		Z	3.89	70.88	16.59		65.0	
10249-CAD	LTE-TDD (SC-FDMA, 50% RB, 5 MHz, QPSK)	X	9.66	89.43	25.19	3.98	65.0	± 9.6 %
		Y	10.35	89.11	25.13		65.0	
		Z	5.64	80.91	21.33		65.0	
10250-CAD	LTE-TDD (SC-FDMA, 50% RB, 10 MHz, 16-QAM)	X	6.21	78.20	22.44	3.98	65.0	± 9.6 %
		Y	6.93	79.00	22.73		65.0	
		Z	4.95	74.96	20.57		65.0	
10251-CAD	LTE-TDD (SC-FDMA, 50% RB, 10 MHz, 64-QAM)	X	5.85	75.76	21.03	3.98	65.0	± 9.6 %
		Y	6.49	76.44	21.31		65.0	
		Z	4.69	72.73	19.17		65.0	
10252-CAD	LTE-TDD (SC-FDMA, 50% RB, 10 MHz, QPSK)	X	8.41	86.24	25.10	3.98	65.0	± 9.6 %
		Y	9.13	86.11	24.91		65.0	
		Z	5.95	81.04	22.79		65.0	
10253-CAD	LTE-TDD (SC-FDMA, 50% RB, 15 MHz, 16-QAM)	X	5.81	74.45	20.83	3.98	65.0	± 9.6 %
		Y	6.39	75.11	21.05		65.0	
		Z	4.88	72.13	19.42		65.0	
10254-CAD	LTE-TDD (SC-FDMA, 50% RB, 15 MHz, 64-QAM)	X	6.16	75.32	21.51	3.98	65.0	± 9.6 %
		Y	6.77	75.99	21.73		65.0	
		Z	5.19	73.05	20.14		65.0	

10255-CAD	LTE-TDD (SC-FDMA, 50% RB, 15 MHz, QPSK)	X	6.96	80.42	23.12	3.98	65.0	± 9.6 %
		Y	7.59	80.64	23.06		65.0	
		Z	5.51	77.21	21.58		65.0	
10256-CAA	LTE-TDD (SC-FDMA, 100% RB, 1.4 MHz, 16-QAM)	X	4.89	73.41	16.49	3.98	65.0	± 9.6 %
		Y	6.68	77.30	18.76		65.0	
		Z	2.46	64.75	10.88		65.0	
10257-CAA	LTE-TDD (SC-FDMA, 100% RB, 1.4 MHz, 64-QAM)	X	4.63	72.26	15.89	3.98	65.0	± 9.6 %
		Y	6.35	76.13	18.19		65.0	
		Z	2.42	64.27	10.52		65.0	
10258-CAA	LTE-TDD (SC-FDMA, 100% RB, 1.4 MHz, QPSK)	X	5.50	79.01	19.45	3.98	65.0	± 9.6 %
		Y	7.01	81.77	20.90		65.0	
		Z	2.56	68.30	13.54		65.0	
10259-CAB	LTE-TDD (SC-FDMA, 100% RB, 3 MHz, 16-QAM)	X	5.80	77.14	20.90	3.98	65.0	± 9.6 %
		Y	6.53	78.01	21.38		65.0	
		Z	4.38	73.08	18.36		65.0	
10260-CAB	LTE-TDD (SC-FDMA, 100% RB, 3 MHz, 64-QAM)	X	5.78	76.67	20.70	3.98	65.0	± 9.6 %
		Y	6.51	77.60	21.22		65.0	
		Z	4.39	72.73	18.19		65.0	
10261-CAB	LTE-TDD (SC-FDMA, 100% RB, 3 MHz, QPSK)	X	8.27	86.47	24.62	3.98	65.0	± 9.6 %
		Y	9.00	86.40	24.57		65.0	
		Z	5.46	80.05	21.57		65.0	
10262-CAD	LTE-TDD (SC-FDMA, 100% RB, 5 MHz, 16-QAM)	X	6.19	78.15	22.39	3.98	65.0	± 9.6 %
		Y	6.92	78.95	22.69		65.0	
		Z	4.94	74.88	20.51		65.0	
10263-CAD	LTE-TDD (SC-FDMA, 100% RB, 5 MHz, 64-QAM)	X	5.84	75.72	21.02	3.98	65.0	± 9.6 %
		Y	6.48	76.42	21.31		65.0	
		Z	4.68	72.71	19.16		65.0	
10264-CAD	LTE-TDD (SC-FDMA, 100% RB, 5 MHz, QPSK)	X	8.30	85.98	24.99	3.98	65.0	± 9.6 %
		Y	9.03	85.88	24.80		65.0	
		Z	5.88	80.81	22.67		65.0	
10265-CAD	LTE-TDD (SC-FDMA, 100% RB, 10 MHz, 16-QAM)	X	5.96	75.09	21.13	3.98	65.0	± 9.6 %
		Y	6.59	75.82	21.35		65.0	
		Z	4.95	72.53	19.70		65.0	
10266-CAD	LTE-TDD (SC-FDMA, 100% RB, 10 MHz, 64-QAM)	X	6.33	75.99	21.86	3.98	65.0	± 9.6 %
		Y	6.97	76.70	22.07		65.0	
		Z	5.31	73.56	20.51		65.0	
10267-CAD	LTE-TDD (SC-FDMA, 100% RB, 10 MHz, QPSK)	X	7.45	81.44	23.28	3.98	65.0	± 9.6 %
		Y	8.11	81.58	23.17		65.0	
		Z	5.81	77.97	21.72		65.0	
10268-CAD	LTE-TDD (SC-FDMA, 100% RB, 15 MHz, 16-QAM)	X	6.50	74.59	21.27	3.98	65.0	± 9.6 %
		Y	7.11	75.29	21.47		65.0	
		Z	5.58	72.49	20.14		65.0	
10269-CAD	LTE-TDD (SC-FDMA, 100% RB, 15 MHz, 64-QAM)	X	6.45	74.07	21.10	3.98	65.0	± 9.6 %
		Y	7.04	74.76	21.30		65.0	
		Z	5.59	72.11	20.01		65.0	
10270-CAD	LTE-TDD (SC-FDMA, 100% RB, 15 MHz, QPSK)	X	6.83	77.38	21.77	3.98	65.0	± 9.6 %
		Y	7.44	77.78	21.79		65.0	
		Z	5.71	75.01	20.64		65.0	

10274-CAB	UMTS-FDD (HSUPA, Subtest 5, 3GPP Rel8.10)	X	2.62	66.75	15.42	0.00	150.0	± 9.6 %
		Y	2.61	66.15	15.17		150.0	
		Z	2.54	67.07	15.23		150.0	
10275-CAB	UMTS-FDD (HSUPA, Subtest 5, 3GPP Rel8.4)	X	1.67	68.55	15.99	0.00	150.0	± 9.6 %
		Y	1.61	67.31	15.31		150.0	
		Z	1.61	68.63	15.84		150.0	
10277-CAA	PHS (QPSK)	X	1.74	60.91	6.37	9.03	50.0	± 9.6 %
		Y	2.31	62.75	8.24		50.0	
		Z	1.34	59.32	4.61		50.0	
10278-CAA	PHS (QPSK, BW 884MHz, Rolloff 0.5)	X	9.23	83.71	19.86	9.03	50.0	± 9.6 %
		Y	16.13	92.59	23.80		50.0	
		Z	2.80	66.68	11.50		50.0	
10279-CAA	PHS (QPSK, BW 884MHz, Rolloff 0.38)	X	9.55	84.14	20.09	9.03	50.0	± 9.6 %
		Y	16.22	92.62	23.87		50.0	
		Z	2.90	67.01	11.74		50.0	
10290-AAB	CDMA2000, RC1, SO55, Full Rate	X	1.55	69.78	14.51	0.00	150.0	± 9.6 %
		Y	1.48	68.23	14.09		150.0	
		Z	1.19	67.52	12.47		150.0	
10291-AAB	CDMA2000, RC3, SO55, Full Rate	X	0.89	66.83	13.08	0.00	150.0	± 9.6 %
		Y	0.85	65.35	12.57		150.0	
		Z	0.74	65.55	11.46		150.0	
10292-AAB	CDMA2000, RC3, SO32, Full Rate	X	1.27	72.61	16.13	0.00	150.0	± 9.6 %
		Y	1.03	68.80	14.67		150.0	
		Z	1.20	72.32	14.93		150.0	
10293-AAB	CDMA2000, RC3, SO3, Full Rate	X	2.34	81.60	20.09	0.00	150.0	± 9.6 %
		Y	1.43	73.64	17.27		150.0	
		Z	3.93	87.90	20.92		150.0	
10295-AAB	CDMA2000, RC1, SO3, 1/8th Rate 25 fr.	X	16.32	98.49	29.02	9.03	50.0	± 9.6 %
		Y	11.98	92.39	27.58		50.0	
		Z	18.77	96.90	26.52		50.0	
10297-AAC	LTE-FDD (SC-FDMA, 50% RB, 20 MHz, QPSK)	X	2.80	70.02	16.88	0.00	150.0	± 9.6 %
		Y	2.77	69.27	16.41		150.0	
		Z	2.65	69.87	16.82		150.0	
10298-AAC	LTE-FDD (SC-FDMA, 50% RB, 3 MHz, QPSK)	X	1.62	68.28	14.44	0.00	150.0	± 9.6 %
		Y	1.62	67.40	14.26		150.0	
		Z	1.32	66.56	12.71		150.0	
10299-AAC	LTE-FDD (SC-FDMA, 50% RB, 3 MHz, 16-QAM)	X	2.59	69.34	14.00	0.00	150.0	± 9.6 %
		Y	2.92	70.30	15.01		150.0	
		Z	1.54	64.05	10.22		150.0	
10300-AAC	LTE-FDD (SC-FDMA, 50% RB, 3 MHz, 64-QAM)	X	1.92	64.86	11.14	0.00	150.0	± 9.6 %
		Y	2.24	65.95	12.27		150.0	
		Z	1.26	61.60	8.20		150.0	
10301-AAA	IEEE 802.16e WiMAX (29:18, 5ms, 10MHz, QPSK, PUSC)	X	4.85	66.06	17.86	4.17	50.0	± 9.6 %
		Y	4.97	65.84	17.76		50.0	
		Z	4.42	65.27	17.23		50.0	
10302-AAA	IEEE 802.16e WiMAX (29:18, 5ms, 10MHz, QPSK, PUSC, 3 CTRL symbols)	X	5.22	66.19	18.31	4.96	50.0	± 9.6 %
		Y	5.38	66.17	18.31		50.0	
		Z	4.86	65.76	17.88		50.0	

10303-AAA	IEEE 802.16e WiMAX (31:15, 5ms, 10MHz, 64QAM, PUSC)	X	4.96	65.79	18.13	4.96	50.0	± 9.6 %
		Y	5.14	65.84	18.17		50.0	
		Z	4.61	65.34	17.65		50.0	
10304-AAA	IEEE 802.16e WiMAX (29:18, 5ms, 10MHz, 64QAM, PUSC)	X	4.78	65.69	17.62	4.17	50.0	± 9.6 %
		Y	4.94	65.66	17.62		50.0	
		Z	4.45	65.35	17.22		50.0	
10305-AAA	IEEE 802.16e WiMAX (31:15, 10ms, 10MHz, 64QAM, PUSC, 15 symbols)	X	4.24	66.91	19.40	6.02	35.0	± 9.6 %
		Y	4.54	67.57	19.86		35.0	
		Z	3.84	65.89	18.29		35.0	
10306-AAA	IEEE 802.16e WiMAX (29:18, 10ms, 10MHz, 64QAM, PUSC, 18 symbols)	X	4.62	66.22	19.11	6.02	35.0	± 9.6 %
		Y	4.86	66.59	19.39		35.0	
		Z	4.26	65.53	18.31		35.0	
10307-AAA	IEEE 802.16e WiMAX (29:18, 10ms, 10MHz, QPSK, PUSC, 18 symbols)	X	4.50	66.31	19.05	6.02	35.0	± 9.6 %
		Y	4.77	66.81	19.39		35.0	
		Z	4.12	65.47	18.17		35.0	
10308-AAA	IEEE 802.16e WiMAX (29:18, 10ms, 10MHz, 16QAM, PUSC)	X	4.47	66.49	19.18	6.02	35.0	± 9.6 %
		Y	4.73	66.98	19.51		35.0	
		Z	4.09	65.63	18.30		35.0	
10309-AAA	IEEE 802.16e WiMAX (29:18, 10ms, 10MHz, 16QAM, AMC 2x3, 18 symbols)	X	4.68	66.45	19.27	6.02	35.0	± 9.6 %
		Y	4.93	66.86	19.56		35.0	
		Z	4.28	65.63	18.41		35.0	
10310-AAA	IEEE 802.16e WiMAX (29:18, 10ms, 10MHz, QPSK, AMC 2x3, 18 symbols)	X	4.56	66.25	19.08	6.02	35.0	± 9.6 %
		Y	4.81	66.65	19.36		35.0	
		Z	4.20	65.54	18.28		35.0	
10311-AAC	LTE-FDD (SC-FDMA, 100% RB, 15 MHz, QPSK)	X	3.16	69.26	16.50	0.00	150.0	± 9.6 %
		Y	3.13	68.60	16.08		150.0	
		Z	3.01	69.09	16.45		150.0	
10313-AAA	IDEN 1:3	X	8.00	86.23	21.34	6.99	70.0	± 9.6 %
		Y	8.53	85.21	20.95		70.0	
		Z	3.31	75.28	17.31		70.0	
10314-AAA	IDEN 1:6	X	12.68	100.31	29.33	10.00	30.0	± 9.6 %
		Y	13.31	98.73	28.67		30.0	
		Z	5.19	85.23	24.17		30.0	
10315-AAB	IEEE 802.11b WiFi 2.4 GHz (DSSS, 1 Mbps, 96pc duty cycle)	X	1.10	64.07	15.53	0.17	150.0	± 9.6 %
		Y	1.10	63.56	15.08		150.0	
		Z	1.08	63.95	15.31		150.0	
10316-AAB	IEEE 802.11g WiFi 2.4 GHz (ERP-OFDM, 6 Mbps, 96pc duty cycle)	X	4.59	66.75	16.41	0.17	150.0	± 9.6 %
		Y	4.66	66.58	16.32		150.0	
		Z	4.43	66.78	16.29		150.0	
10317-AAB	IEEE 802.11a WiFi 5 GHz (OFDM, 6 Mbps, 96pc duty cycle)	X	4.59	66.75	16.41	0.17	150.0	± 9.6 %
		Y	4.66	66.58	16.32		150.0	
		Z	4.43	66.78	16.29		150.0	
10400-AAC	IEEE 802.11ac WiFi (20MHz, 64-QAM, 99pc duty cycle)	X	4.69	67.06	16.37	0.00	150.0	± 9.6 %
		Y	4.77	66.86	16.25		150.0	
		Z	4.51	67.11	16.31		150.0	
10401-AAC	IEEE 802.11ac WiFi (40MHz, 64-QAM, 99pc duty cycle)	X	5.41	67.26	16.54	0.00	150.0	± 9.6 %
		Y	5.45	67.06	16.42		150.0	
		Z	5.18	66.94	16.33		150.0	

10402-AAC	IEEE 802.11ac WiFi (80MHz, 64-QAM, 99pc duty cycle)	X	5.65	67.49	16.51	0.00	150.0	± 9.6 %
		Y	5.72	67.43	16.45		150.0	
		Z	5.51	67.47	16.48		150.0	
10403-AAB	CDMA2000 (1xEV-DO, Rev. 0)	X	1.55	69.78	14.51	0.00	115.0	± 9.6 %
		Y	1.48	68.23	14.09		115.0	
		Z	1.19	67.52	12.47		115.0	
10404-AAB	CDMA2000 (1xEV-DO, Rev. A)	X	1.55	69.78	14.51	0.00	115.0	± 9.6 %
		Y	1.48	68.23	14.09		115.0	
		Z	1.19	67.52	12.47		115.0	
10406-AAB	CDMA2000, RC3, SO32, SCH0, Full Rate	X	100.00	120.41	29.76	0.00	100.0	± 9.6 %
		Y	19.72	99.25	25.38		100.0	
		Z	22.86	100.95	24.14		100.0	
10410-AAC	LTE-TDD (SC-FDMA, 1 RB, 10 MHz, QPSK, UL Subframe=2,3,4,7,8,9)	X	100.00	125.71	31.88	3.23	80.0	± 9.6 %
		Y	100.00	124.16	31.78		80.0	
		Z	8.15	91.76	22.46		80.0	
10415-AAA	IEEE 802.11b WiFi 2.4 GHz (DSSS, 1 Mbps, 99pc duty cycle)	X	1.03	63.26	14.92	0.00	150.0	± 9.6 %
		Y	1.02	62.63	14.41		150.0	
		Z	1.03	63.39	14.88		150.0	
10416-AAA	IEEE 802.11g WiFi 2.4 GHz (ERP-OFDM, 6 Mbps, 99pc duty cycle)	X	4.54	66.72	16.31	0.00	150.0	± 9.6 %
		Y	4.59	66.51	16.19		150.0	
		Z	4.40	66.84	16.26		150.0	
10417-AAA	IEEE 802.11a/h WiFi 5 GHz (OFDM, 6 Mbps, 99pc duty cycle)	X	4.54	66.72	16.31	0.00	150.0	± 9.6 %
		Y	4.59	66.51	16.19		150.0	
		Z	4.40	66.84	16.26		150.0	
10418-AAA	IEEE 802.11g WiFi 2.4 GHz (DSSS-OFDM, 6 Mbps, 99pc duty cycle, Long preamble)	X	4.53	66.89	16.33	0.00	150.0	± 9.6 %
		Y	4.58	66.66	16.20		150.0	
		Z	4.40	67.05	16.32		150.0	
10419-AAA	IEEE 802.11g WiFi 2.4 GHz (DSSS-OFDM, 6 Mbps, 99pc duty cycle, Short preamble)	X	4.55	66.83	16.33	0.00	150.0	± 9.6 %
		Y	4.60	66.61	16.21		150.0	
		Z	4.41	66.98	16.30		150.0	
10422-AAA	IEEE 802.11n (HT Greenfield, 7.2 Mbps, BPSK)	X	4.66	66.83	16.34	0.00	150.0	± 9.6 %
		Y	4.72	66.62	16.23		150.0	
		Z	4.52	66.95	16.31		150.0	
10423-AAA	IEEE 802.11n (HT Greenfield, 43.3 Mbps, 16-QAM)	X	4.82	67.13	16.45	0.00	150.0	± 9.6 %
		Y	4.90	66.96	16.35		150.0	
		Z	4.65	67.21	16.40		150.0	
10424-AAA	IEEE 802.11n (HT Greenfield, 72.2 Mbps, 64-QAM)	X	4.75	67.09	16.43	0.00	150.0	± 9.6 %
		Y	4.82	66.90	16.32		150.0	
		Z	4.58	67.17	16.38		150.0	
10425-AAA	IEEE 802.11n (HT Greenfield, 15 Mbps, BPSK)	X	5.35	67.37	16.60	0.00	150.0	± 9.6 %
		Y	5.42	67.27	16.52		150.0	
		Z	5.19	67.35	16.55		150.0	
10426-AAA	IEEE 802.11n (HT Greenfield, 90 Mbps, 16-QAM)	X	5.36	67.42	16.62	0.00	150.0	± 9.6 %
		Y	5.42	67.27	16.52		150.0	
		Z	5.21	67.42	16.58		150.0	

10427-AAA	IEEE 802.11n (HT Greenfield, 150 Mbps, 64-QAM)	X	5.37	67.38	16.60	0.00	150.0	± 9.6 %
		Y	5.43	67.25	16.50		150.0	
		Z	5.18	67.23	16.48		150.0	
10430-AAB	LTE-FDD (OFDMA, 5 MHz, E-TM 3.1)	X	4.24	70.83	18.17	0.00	150.0	± 9.6 %
		Y	4.26	70.25	18.02		150.0	
		Z	4.20	71.89	18.27		150.0	
10431-AAB	LTE-FDD (OFDMA, 10 MHz, E-TM 3.1)	X	4.21	67.30	16.30	0.00	150.0	± 9.6 %
		Y	4.28	67.03	16.19		150.0	
		Z	4.03	67.45	16.18		150.0	
10432-AAB	LTE-FDD (OFDMA, 15 MHz, E-TM 3.1)	X	4.51	67.15	16.38	0.00	150.0	± 9.6 %
		Y	4.58	66.93	16.27		150.0	
		Z	4.34	67.27	16.32		150.0	
10433-AAB	LTE-FDD (OFDMA, 20 MHz, E-TM 3.1)	X	4.76	67.12	16.45	0.00	150.0	± 9.6 %
		Y	4.83	66.94	16.34		150.0	
		Z	4.59	67.20	16.40		150.0	
10434-AAA	W-CDMA (BS Test Model 1, 64 DPCH)	X	4.34	71.72	18.14	0.00	150.0	± 9.6 %
		Y	4.35	71.03	17.99		150.0	
		Z	4.31	72.81	18.12		150.0	
10435-AAC	LTE-TDD (SC-FDMA, 1 RB, 20 MHz, QPSK, UL Subframe=2,3,4,7,8,9)	X	100.00	125.48	31.77	3.23	80.0	± 9.6 %
		Y	100.00	123.97	31.69		80.0	
		Z	7.63	90.76	22.11		80.0	
10447-AAB	LTE-FDD (OFDMA, 5 MHz, E-TM 3.1, Clipping 44%)	X	3.51	67.35	15.60	0.00	150.0	± 9.6 %
		Y	3.58	66.99	15.55		150.0	
		Z	3.28	67.36	15.16		150.0	
10448-AAB	LTE-FDD (OFDMA, 10 MHz, E-TM 3.1, Clipping 44%)	X	4.06	67.09	16.17	0.00	150.0	± 9.6 %
		Y	4.12	66.80	16.05		150.0	
		Z	3.89	67.25	16.05		150.0	
10449-AAB	LTE-FDD (OFDMA, 15 MHz, E-TM 3.1, Clipping 44%)	X	4.33	66.98	16.28	0.00	150.0	± 9.6 %
		Y	4.39	66.75	16.16		150.0	
		Z	4.18	67.10	16.22		150.0	
10450-AAB	LTE-FDD (OFDMA, 20 MHz, E-TM 3.1, Clipping 44%)	X	4.53	66.89	16.30	0.00	150.0	± 9.6 %
		Y	4.58	66.69	16.19		150.0	
		Z	4.39	66.98	16.26		150.0	
10451-AAA	W-CDMA (BS Test Model 1, 64 DPCH, Clipping 44%)	X	3.39	67.51	15.20	0.00	150.0	± 9.6 %
		Y	3.48	67.19	15.21		150.0	
		Z	3.10	67.22	14.48		150.0	
10456-AAA	IEEE 802.11ac WiFi (160MHz, 64-QAM, 99pc duty cycle)	X	6.22	67.91	16.74	0.00	150.0	± 9.6 %
		Y	6.28	67.83	16.68		150.0	
		Z	6.11	67.90	16.72		150.0	
10457-AAA	UMTS-FDD (DC-HSDPA)	X	3.80	65.37	16.02	0.00	150.0	± 9.6 %
		Y	3.83	65.15	15.90		150.0	
		Z	3.74	65.57	15.99		150.0	
10458-AAA	CDMA2000 (1xEV-DO, Rev. B, 2 carriers)	X	3.21	66.83	14.57	0.00	150.0	± 9.6 %
		Y	3.31	66.55	14.68		150.0	
		Z	2.82	66.01	13.39		150.0	
10459-AAA	CDMA2000 (1xEV-DO, Rev. B, 3 carriers)	X	4.29	65.14	15.57	0.00	150.0	± 9.6 %
		Y	4.36	64.71	15.51		150.0	
		Z	4.04	65.27	15.07		150.0	

10460-AAA	UMTS-FDD (WCDMA, AMR)	X	0.96	69.26	16.86	0.00	150.0	± 9.6 %
		Y	0.88	67.02	15.53		150.0	
		Z	0.94	69.35	16.76		150.0	
10461-AAA	LTE-TDD (SC-FDMA, 1 RB, 1.4 MHz, QPSK, UL Subframe=2,3,4,7,8,9)	X	100.00	131.25	34.47	3.29	80.0	± 9.6 %
		Y	100.00	128.59	33.89		80.0	
		Z	3.16	81.29	20.28		80.0	
10462-AAA	LTE-TDD (SC-FDMA, 1 RB, 1.4 MHz, 16-QAM, UL Subframe=2,3,4,7,8,9)	X	18.15	90.54	19.55	3.23	80.0	± 9.6 %
		Y	100.00	110.06	25.23		80.0	
		Z	0.71	60.00	7.72		80.0	
10463-AAA	LTE-TDD (SC-FDMA, 1 RB, 1.4 MHz, 64-QAM, UL Subframe=2,3,4,7,8,9)	X	2.32	68.92	12.27	3.23	80.0	± 9.6 %
		Y	12.78	85.50	18.46		80.0	
		Z	0.72	60.00	7.06		80.0	
10464-AAA	LTE-TDD (SC-FDMA, 1 RB, 3 MHz, QPSK, UL Subframe=2,3,4,7,8,9)	X	100.00	128.50	33.02	3.23	80.0	± 9.6 %
		Y	100.00	126.31	32.66		80.0	
		Z	2.43	77.27	18.20		80.0	
10465-AAA	LTE-TDD (SC-FDMA, 1 RB, 3 MHz, 16-QAM, UL Subframe=2,3,4,7,8,9)	X	7.48	81.44	16.98	3.23	80.0	± 9.6 %
		Y	53.06	102.63	23.42		80.0	
		Z	0.71	60.00	7.65		80.0	
10466-AAA	LTE-TDD (SC-FDMA, 1 RB, 3 MHz, 64-QAM, UL Subframe=2,3,4,7,8,9)	X	1.86	66.75	11.37	3.23	80.0	± 9.6 %
		Y	7.10	79.26	16.56		80.0	
		Z	0.72	60.00	7.01		80.0	
10467-AAC	LTE-TDD (SC-FDMA, 1 RB, 5 MHz, QPSK, UL Subframe=2,3,4,7,8,9)	X	100.00	128.82	33.16	3.23	80.0	± 9.6 %
		Y	100.00	126.57	32.78		80.0	
		Z	2.60	78.29	18.60		80.0	
10468-AAC	LTE-TDD (SC-FDMA, 1 RB, 5 MHz, 16-QAM, UL Subframe=2,3,4,7,8,9)	X	9.21	83.60	17.62	3.23	80.0	± 9.6 %
		Y	76.07	106.68	24.37		80.0	
		Z	0.70	60.00	7.67		80.0	
10469-AAC	LTE-TDD (SC-FDMA, 1 RB, 5 MHz, 64-QAM, UL Subframe=2,3,4,7,8,9)	X	1.87	66.82	11.40	3.23	80.0	± 9.6 %
		Y	7.22	79.45	16.62		80.0	
		Z	0.72	60.00	7.01		80.0	
10470-AAC	LTE-TDD (SC-FDMA, 1 RB, 10 MHz, QPSK, UL Subframe=2,3,4,7,8,9)	X	100.00	128.87	33.17	3.23	80.0	± 9.6 %
		Y	100.00	126.61	32.79		80.0	
		Z	2.61	78.33	18.61		80.0	
10471-AAC	LTE-TDD (SC-FDMA, 1 RB, 10 MHz, 16-QAM, UL Subframe=2,3,4,7,8,9)	X	9.03	83.37	17.54	3.23	80.0	± 9.6 %
		Y	75.72	106.57	24.32		80.0	
		Z	0.70	60.00	7.66		80.0	
10472-AAC	LTE-TDD (SC-FDMA, 1 RB, 10 MHz, 64-QAM, UL Subframe=2,3,4,7,8,9)	X	1.85	66.72	11.34	3.23	80.0	± 9.6 %
		Y	7.17	79.36	16.58		80.0	
		Z	0.72	60.00	6.99		80.0	
10473-AAC	LTE-TDD (SC-FDMA, 1 RB, 15 MHz, QPSK, UL Subframe=2,3,4,7,8,9)	X	100.00	128.83	33.15	3.23	80.0	± 9.6 %
		Y	100.00	126.57	32.77		80.0	
		Z	2.60	78.28	18.59		80.0	
10474-AAC	LTE-TDD (SC-FDMA, 1 RB, 15 MHz, 16-QAM, UL Subframe=2,3,4,7,8,9)	X	8.86	83.19	17.49	3.23	80.0	± 9.6 %
		Y	73.20	106.22	24.25		80.0	
		Z	0.70	60.00	7.66		80.0	
10475-AAC	LTE-TDD (SC-FDMA, 1 RB, 15 MHz, 64-QAM, UL Subframe=2,3,4,7,8,9)	X	1.84	66.67	11.33	3.23	80.0	± 9.6 %
		Y	7.07	79.22	16.54		80.0	
		Z	0.72	60.00	6.99		80.0	

10477-AAC	LTE-TDD (SC-FDMA, 1 RB, 20 MHz, 16-QAM, UL Subframe=2,3,4,7,8,9)	X	7.55	81.52	16.98	3.23	80.0	± 9.6 %
		Y	56.45	103.26	23.54		80.0	
		Z	0.70	60.00	7.63		80.0	
10478-AAC	LTE-TDD (SC-FDMA, 1 RB, 20 MHz, 64-QAM, UL Subframe=2,3,4,7,8,9)	X	1.82	66.56	11.27	3.23	80.0	± 9.6 %
		Y	6.95	79.03	16.47		80.0	
		Z	0.72	60.00	6.98		80.0	
10479-AAA	LTE-TDD (SC-FDMA, 50% RB, 1.4 MHz, QPSK, UL Subframe=2,3,4,7,8,9)	X	10.99	93.23	25.61	3.23	80.0	± 9.6 %
		Y	9.79	90.18	24.96		80.0	
		Z	4.54	80.48	20.41		80.0	
10480-AAA	LTE-TDD (SC-FDMA, 50% RB, 1.4 MHz, 16-QAM, UL Subframe=2,3,4,7,8,9)	X	12.16	88.23	21.88	3.23	80.0	± 9.6 %
		Y	11.98	87.55	22.28		80.0	
		Z	2.88	70.37	14.48		80.0	
10481-AAA	LTE-TDD (SC-FDMA, 50% RB, 1.4 MHz, 64-QAM, UL Subframe=2,3,4,7,8,9)	X	8.71	82.91	19.80	3.23	80.0	± 9.6 %
		Y	9.82	84.02	20.80		80.0	
		Z	2.18	66.77	12.57		80.0	
10482-AAA	LTE-TDD (SC-FDMA, 50% RB, 3 MHz, QPSK, UL Subframe=2,3,4,7,8,9)	X	4.05	77.33	19.19	2.23	80.0	± 9.6 %
		Y	4.17	76.68	19.19		80.0	
		Z	2.07	68.66	14.58		80.0	
10483-AAA	LTE-TDD (SC-FDMA, 50% RB, 3 MHz, 16-QAM, UL Subframe=2,3,4,7,8,9)	X	4.93	75.57	17.70	2.23	80.0	± 9.6 %
		Y	6.34	78.50	19.36		80.0	
		Z	1.80	63.38	11.04		80.0	
10484-AAA	LTE-TDD (SC-FDMA, 50% RB, 3 MHz, 64-QAM, UL Subframe=2,3,4,7,8,9)	X	4.47	74.01	17.11	2.23	80.0	± 9.6 %
		Y	5.79	76.98	18.82		80.0	
		Z	1.76	62.89	10.79		80.0	
10485-AAC	LTE-TDD (SC-FDMA, 50% RB, 5 MHz, QPSK, UL Subframe=2,3,4,7,8,9)	X	4.05	77.49	20.34	2.23	80.0	± 9.6 %
		Y	4.20	76.76	20.09		80.0	
		Z	2.71	72.24	17.50		80.0	
10486-AAC	LTE-TDD (SC-FDMA, 50% RB, 5 MHz, 16-QAM, UL Subframe=2,3,4,7,8,9)	X	3.54	71.63	17.34	2.23	80.0	± 9.6 %
		Y	3.76	71.58	17.54		80.0	
		Z	2.51	67.51	14.60		80.0	
10487-AAC	LTE-TDD (SC-FDMA, 50% RB, 5 MHz, 64-QAM, UL Subframe=2,3,4,7,8,9)	X	3.49	71.03	17.07	2.23	80.0	± 9.6 %
		Y	3.74	71.08	17.31		80.0	
		Z	2.49	67.04	14.35		80.0	
10488-AAC	LTE-TDD (SC-FDMA, 50% RB, 10 MHz, QPSK, UL Subframe=2,3,4,7,8,9)	X	3.92	74.84	20.03	2.23	80.0	± 9.6 %
		Y	4.21	74.77	19.87		80.0	
		Z	2.99	71.49	18.31		80.0	
10489-AAC	LTE-TDD (SC-FDMA, 50% RB, 10 MHz, 16-QAM, UL Subframe=2,3,4,7,8,9)	X	3.58	70.14	18.01	2.23	80.0	± 9.6 %
		Y	3.82	70.22	18.04		80.0	
		Z	3.03	68.36	16.75		80.0	
10490-AAC	LTE-TDD (SC-FDMA, 50% RB, 10 MHz, 64-QAM, UL Subframe=2,3,4,7,8,9)	X	3.66	69.89	17.90	2.23	80.0	± 9.6 %
		Y	3.90	69.97	17.95		80.0	
		Z	3.10	68.21	16.67		80.0	
10491-AAC	LTE-TDD (SC-FDMA, 50% RB, 15 MHz, QPSK, UL Subframe=2,3,4,7,8,9)	X	4.00	72.50	19.16	2.23	80.0	± 9.6 %
		Y	4.28	72.62	19.08		80.0	
		Z	3.25	70.05	17.90		80.0	
10492-AAC	LTE-TDD (SC-FDMA, 50% RB, 15 MHz, 16-QAM, UL Subframe=2,3,4,7,8,9)	X	3.86	68.99	17.79	2.23	80.0	± 9.6 %
		Y	4.11	69.18	17.85		80.0	
		Z	3.37	67.61	16.86		80.0	

10493-AAC	LTE-TDD (SC-FDMA, 50% RB, 15 MHz, 64-QAM, UL Subframe=2,3,4,7,8,9)	X	3.92	68.82	17.72	2.23	80.0	± 9.6 %
		Y	4.17	69.02	17.78		80.0	
		Z	3.43	67.50	16.80		80.0	
10494-AAC	LTE-TDD (SC-FDMA, 50% RB, 20 MHz, QPSK, UL Subframe=2,3,4,7,8,9)	X	4.43	74.41	19.78	2.23	80.0	± 9.6 %
		Y	4.75	74.52	19.68		80.0	
		Z	3.49	71.39	18.37		80.0	
10495-AAC	LTE-TDD (SC-FDMA, 50% RB, 20 MHz, 16-QAM, UL Subframe=2,3,4,7,8,9)	X	3.90	69.39	18.01	2.23	80.0	± 9.6 %
		Y	4.16	69.65	18.06		80.0	
		Z	3.39	67.86	17.06		80.0	
10496-AAC	LTE-TDD (SC-FDMA, 50% RB, 20 MHz, 64-QAM, UL Subframe=2,3,4,7,8,9)	X	3.97	69.05	17.88	2.23	80.0	± 9.6 %
		Y	4.22	69.30	17.94		80.0	
		Z	3.47	67.65	16.99		80.0	
10497-AAA	LTE-TDD (SC-FDMA, 100% RB, 1.4 MHz, QPSK, UL Subframe=2,3,4,7,8,9)	X	2.87	72.14	16.05	2.23	80.0	± 9.6 %
		Y	3.23	72.92	16.83		80.0	
		Z	1.19	62.14	10.12		80.0	
10498-AAA	LTE-TDD (SC-FDMA, 100% RB, 1.4 MHz, 16-QAM, UL Subframe=2,3,4,7,8,9)	X	1.73	63.11	10.85	2.23	80.0	± 9.6 %
		Y	2.27	65.45	12.56		80.0	
		Z	1.15	60.00	7.68		80.0	
10499-AAA	LTE-TDD (SC-FDMA, 100% RB, 1.4 MHz, 64-QAM, UL Subframe=2,3,4,7,8,9)	X	1.65	62.30	10.28	2.23	80.0	± 9.6 %
		Y	2.18	64.69	12.05		80.0	
		Z	1.17	60.00	7.51		80.0	
10500-AAA	LTE-TDD (SC-FDMA, 100% RB, 3 MHz, QPSK, UL Subframe=2,3,4,7,8,9)	X	3.87	75.87	20.03	2.23	80.0	± 9.6 %
		Y	4.07	75.40	19.81		80.0	
		Z	2.80	71.83	17.80		80.0	
10501-AAA	LTE-TDD (SC-FDMA, 100% RB, 3 MHz, 16-QAM, UL Subframe=2,3,4,7,8,9)	X	3.57	71.05	17.60	2.23	80.0	± 9.6 %
		Y	3.78	70.97	17.70		80.0	
		Z	2.79	68.23	15.59		80.0	
10502-AAA	LTE-TDD (SC-FDMA, 100% RB, 3 MHz, 64-QAM, UL Subframe=2,3,4,7,8,9)	X	3.61	70.84	17.44	2.23	80.0	± 9.6 %
		Y	3.84	70.79	17.56		80.0	
		Z	2.82	68.03	15.41		80.0	
10503-AAC	LTE-TDD (SC-FDMA, 100% RB, 5 MHz, QPSK, UL Subframe=2,3,4,7,8,9)	X	3.87	74.62	19.92	2.23	80.0	± 9.6 %
		Y	4.15	74.55	19.77		80.0	
		Z	2.95	71.29	18.21		80.0	
10504-AAC	LTE-TDD (SC-FDMA, 100% RB, 5 MHz, 16-QAM, UL Subframe=2,3,4,7,8,9)	X	3.57	70.04	17.95	2.23	80.0	± 9.6 %
		Y	3.80	70.13	17.99		80.0	
		Z	3.01	68.26	16.69		80.0	
10505-AAC	LTE-TDD (SC-FDMA, 100% RB, 5 MHz, 64-QAM, UL Subframe=2,3,4,7,8,9)	X	3.64	69.79	17.85	2.23	80.0	± 9.6 %
		Y	3.88	69.88	17.89		80.0	
		Z	3.09	68.12	16.62		80.0	
10506-AAC	LTE-TDD (SC-FDMA, 100% RB, 10 MHz, QPSK, UL Subframe=2,3,4,7,8,9)	X	4.39	74.26	19.71	2.23	80.0	± 9.6 %
		Y	4.71	74.37	19.61		80.0	
		Z	3.46	71.26	18.30		80.0	
10507-AAC	LTE-TDD (SC-FDMA, 100% RB, 10 MHz, 16-QAM, UL Subframe=2,3,4,7,8,9)	X	3.89	69.33	17.97	2.23	80.0	± 9.6 %
		Y	4.14	69.59	18.03		80.0	
		Z	3.38	67.80	17.02		80.0	

10508-AAC	LTE-TDD (SC-FDMA, 100% RB, 10 MHz, 64-QAM, UL Subframe=2,3,4,7,8,9)	X	3.95	68.98	17.84	2.23	80.0	± 9.6 %
		Y	4.21	69.23	17.90		80.0	
		Z	3.46	67.59	16.95		80.0	
10509-AAC	LTE-TDD (SC-FDMA, 100% RB, 15 MHz, QPSK, UL Subframe=2,3,4,7,8,9)	X	4.62	72.40	18.91	2.23	80.0	± 9.6 %
		Y	4.92	72.59	18.86		80.0	
		Z	3.86	70.20	17.85		80.0	
10510-AAC	LTE-TDD (SC-FDMA, 100% RB, 15 MHz, 16-QAM, UL Subframe=2,3,4,7,8,9)	X	4.34	68.87	17.84	2.23	80.0	± 9.6 %
		Y	4.61	69.18	17.91		80.0	
		Z	3.85	67.53	17.06		80.0	
10511-AAC	LTE-TDD (SC-FDMA, 100% RB, 15 MHz, 64-QAM, UL Subframe=2,3,4,7,8,9)	X	4.39	68.57	17.74	2.23	80.0	± 9.6 %
		Y	4.65	68.86	17.81		80.0	
		Z	3.92	67.35	17.00		80.0	
10512-AAC	LTE-TDD (SC-FDMA, 100% RB, 20 MHz, QPSK, UL Subframe=2,3,4,7,8,9)	X	4.95	74.43	19.59	2.23	80.0	± 9.6 %
		Y	5.29	74.60	19.52		80.0	
		Z	3.97	71.52	18.28		80.0	
10513-AAC	LTE-TDD (SC-FDMA, 100% RB, 20 MHz, 16-QAM, UL Subframe=2,3,4,7,8,9)	X	4.24	69.19	17.98	2.23	80.0	± 9.6 %
		Y	4.52	69.55	18.06		80.0	
		Z	3.73	67.67	17.13		80.0	
10514-AAC	LTE-TDD (SC-FDMA, 100% RB, 20 MHz, 64-QAM, UL Subframe=2,3,4,7,8,9)	X	4.25	68.69	17.82	2.23	80.0	± 9.6 %
		Y	4.51	69.03	17.90		80.0	
		Z	3.78	67.33	17.02		80.0	
10515-AAA	IEEE 802.11b WiFi 2.4 GHz (DSSS, 2 Mbps, 99pc duty cycle)	X	0.99	63.46	15.00	0.00	150.0	± 9.6 %
		Y	0.98	62.78	14.45		150.0	
		Z	0.99	63.59	14.96		150.0	
10516-AAA	IEEE 802.11b WiFi 2.4 GHz (DSSS, 5.5 Mbps, 99pc duty cycle)	X	0.69	72.54	18.63	0.00	150.0	± 9.6 %
		Y	0.56	68.11	16.08		150.0	
		Z	0.67	72.15	18.45		150.0	
10517-AAA	IEEE 802.11b WiFi 2.4 GHz (DSSS, 11 Mbps, 99pc duty cycle)	X	0.85	65.62	15.80	0.00	150.0	± 9.6 %
		Y	0.82	64.42	14.91		150.0	
		Z	0.84	65.62	15.72		150.0	
10518-AAA	IEEE 802.11a/h WiFi 5 GHz (OFDM, 9 Mbps, 99pc duty cycle)	X	4.53	66.80	16.29	0.00	150.0	± 9.6 %
		Y	4.59	66.58	16.17		150.0	
		Z	4.39	66.94	16.26		150.0	
10519-AAA	IEEE 802.11a/h WiFi 5 GHz (OFDM, 12 Mbps, 99pc duty cycle)	X	4.71	67.02	16.40	0.00	150.0	± 9.6 %
		Y	4.78	66.84	16.30		150.0	
		Z	4.54	67.11	16.34		150.0	
10520-AAA	IEEE 802.11a/h WiFi 5 GHz (OFDM, 18 Mbps, 99pc duty cycle)	X	4.56	66.98	16.32	0.00	150.0	± 9.6 %
		Y	4.63	66.80	16.22		150.0	
		Z	4.40	67.05	16.26		150.0	
10521-AAA	IEEE 802.11a/h WiFi 5 GHz (OFDM, 24 Mbps, 99pc duty cycle)	X	4.49	66.97	16.31	0.00	150.0	± 9.6 %
		Y	4.56	66.79	16.20		150.0	
		Z	4.33	67.02	16.25		150.0	
10522-AAA	IEEE 802.11a/h WiFi 5 GHz (OFDM, 36 Mbps, 99pc duty cycle)	X	4.56	67.08	16.40	0.00	150.0	± 9.6 %
		Y	4.62	66.86	16.28		150.0	
		Z	4.38	67.14	16.34		150.0	

10523-AAA	IEEE 802.11a/h WiFi 5 GHz (OFDM, 48 Mbps, 99pc duty cycle)	X	4.44	66.96	16.26	0.00	150.0	± 9.6 %
		Y	4.50	66.72	16.12		150.0	
		Z	4.31	67.14	16.26		150.0	
10524-AAA	IEEE 802.11a/h WiFi 5 GHz (OFDM, 54 Mbps, 99pc duty cycle)	X	4.50	67.00	16.37	0.00	150.0	± 9.6 %
		Y	4.57	66.78	16.25		150.0	
		Z	4.33	67.10	16.33		150.0	
10525-AAA	IEEE 802.11ac WiFi (20MHz, MCS0, 99pc duty cycle)	X	4.49	66.06	15.96	0.00	150.0	± 9.6 %
		Y	4.54	65.82	15.83		150.0	
		Z	4.36	66.21	15.95		150.0	
10526-AAA	IEEE 802.11ac WiFi (20MHz, MCS1, 99pc duty cycle)	X	4.65	66.41	16.10	0.00	150.0	± 9.6 %
		Y	4.72	66.20	15.98		150.0	
		Z	4.49	66.49	16.07		150.0	
10527-AAA	IEEE 802.11ac WiFi (20MHz, MCS2, 99pc duty cycle)	X	4.58	66.37	16.05	0.00	150.0	± 9.6 %
		Y	4.64	66.16	15.92		150.0	
		Z	4.42	66.47	16.01		150.0	
10528-AAA	IEEE 802.11ac WiFi (20MHz, MCS3, 99pc duty cycle)	X	4.59	66.39	16.08	0.00	150.0	± 9.6 %
		Y	4.65	66.18	15.96		150.0	
		Z	4.43	66.48	16.04		150.0	
10529-AAA	IEEE 802.11ac WiFi (20MHz, MCS4, 99pc duty cycle)	X	4.59	66.39	16.08	0.00	150.0	± 9.6 %
		Y	4.65	66.18	15.96		150.0	
		Z	4.43	66.48	16.04		150.0	
10531-AAA	IEEE 802.11ac WiFi (20MHz, MCS6, 99pc duty cycle)	X	4.58	66.48	16.09	0.00	150.0	± 9.6 %
		Y	4.65	66.29	15.97		150.0	
		Z	4.40	66.51	16.02		150.0	
10532-AAA	IEEE 802.11ac WiFi (20MHz, MCS7, 99pc duty cycle)	X	4.44	66.34	16.02	0.00	150.0	± 9.6 %
		Y	4.51	66.14	15.90		150.0	
		Z	4.28	66.37	15.96		150.0	
10533-AAA	IEEE 802.11ac WiFi (20MHz, MCS8, 99pc duty cycle)	X	4.60	66.44	16.07	0.00	150.0	± 9.6 %
		Y	4.66	66.22	15.94		150.0	
		Z	4.44	66.56	16.05		150.0	
10534-AAA	IEEE 802.11ac WiFi (40MHz, MCS0, 99pc duty cycle)	X	5.13	66.46	16.12	0.00	150.0	± 9.6 %
		Y	5.19	66.32	16.03		150.0	
		Z	4.99	66.46	16.09		150.0	
10535-AAA	IEEE 802.11ac WiFi (40MHz, MCS1, 99pc duty cycle)	X	5.20	66.64	16.21	0.00	150.0	± 9.6 %
		Y	5.25	66.49	16.10		150.0	
		Z	5.03	66.59	16.15		150.0	
10536-AAA	IEEE 802.11ac WiFi (40MHz, MCS2, 99pc duty cycle)	X	5.07	66.60	16.17	0.00	150.0	± 9.6 %
		Y	5.12	66.44	16.06		150.0	
		Z	4.92	66.60	16.13		150.0	
10537-AAA	IEEE 802.11ac WiFi (40MHz, MCS3, 99pc duty cycle)	X	5.12	66.56	16.15	0.00	150.0	± 9.6 %
		Y	5.18	66.41	16.05		150.0	
		Z	4.98	66.58	16.13		150.0	
10538-AAA	IEEE 802.11ac WiFi (40MHz, MCS4, 99pc duty cycle)	X	5.21	66.56	16.19	0.00	150.0	± 9.6 %
		Y	5.28	66.45	16.11		150.0	
		Z	5.05	66.54	16.15		150.0	
10540-AAA	IEEE 802.11ac WiFi (40MHz, MCS6, 99pc duty cycle)	X	5.14	66.58	16.22	0.00	150.0	± 9.6 %
		Y	5.20	66.45	16.12		150.0	
		Z	4.98	66.51	16.15		150.0	

10541-AAA	IEEE 802.11ac WiFi (40MHz, MCS7, 99pc duty cycle)	X	5.12	66.46	16.14	0.00	150.0	± 9.6 %
		Y	5.18	66.32	16.05		150.0	
		Z	4.96	66.43	16.09		150.0	
10542-AAA	IEEE 802.11ac WiFi (40MHz, MCS8, 99pc duty cycle)	X	5.27	66.53	16.19	0.00	150.0	± 9.6 %
		Y	5.33	66.40	16.10		150.0	
		Z	5.12	66.52	16.15		150.0	
10543-AAA	IEEE 802.11ac WiFi (40MHz, MCS9, 99pc duty cycle)	X	5.34	66.55	16.23	0.00	150.0	± 9.6 %
		Y	5.41	66.44	16.14		150.0	
		Z	5.19	66.58	16.21		150.0	
10544-AAA	IEEE 802.11ac WiFi (80MHz, MCS0, 99pc duty cycle)	X	5.45	66.57	16.12	0.00	150.0	± 9.6 %
		Y	5.49	66.44	16.03		150.0	
		Z	5.33	66.54	16.08		150.0	
10545-AAA	IEEE 802.11ac WiFi (80MHz, MCS1, 99pc duty cycle)	X	5.64	66.98	16.28	0.00	150.0	± 9.6 %
		Y	5.69	66.86	16.18		150.0	
		Z	5.50	66.96	16.25		150.0	
10546-AAA	IEEE 802.11ac WiFi (80MHz, MCS2, 99pc duty cycle)	X	5.50	66.75	16.18	0.00	150.0	± 9.6 %
		Y	5.56	66.68	16.11		150.0	
		Z	5.36	66.66	16.11		150.0	
10547-AAA	IEEE 802.11ac WiFi (80MHz, MCS3, 99pc duty cycle)	X	5.57	66.80	16.19	0.00	150.0	± 9.6 %
		Y	5.64	66.72	16.12		150.0	
		Z	5.44	66.76	16.16		150.0	
10548-AAA	IEEE 802.11ac WiFi (80MHz, MCS4, 99pc duty cycle)	X	5.80	67.67	16.61	0.00	150.0	± 9.6 %
		Y	5.91	67.72	16.59		150.0	
		Z	5.58	67.38	16.44		150.0	
10550-AAA	IEEE 802.11ac WiFi (80MHz, MCS6, 99pc duty cycle)	X	5.54	66.80	16.21	0.00	150.0	± 9.6 %
		Y	5.59	66.67	16.11		150.0	
		Z	5.42	66.83	16.21		150.0	
10551-AAA	IEEE 802.11ac WiFi (80MHz, MCS7, 99pc duty cycle)	X	5.54	66.82	16.18	0.00	150.0	± 9.6 %
		Y	5.59	66.72	16.10		150.0	
		Z	5.36	66.63	16.07		150.0	
10552-AAA	IEEE 802.11ac WiFi (80MHz, MCS8, 99pc duty cycle)	X	5.46	66.64	16.10	0.00	150.0	± 9.6 %
		Y	5.51	66.51	16.00		150.0	
		Z	5.34	66.66	16.08		150.0	
10553-AAA	IEEE 802.11ac WiFi (80MHz, MCS9, 99pc duty cycle)	X	5.54	66.66	16.14	0.00	150.0	± 9.6 %
		Y	5.59	66.56	16.06		150.0	
		Z	5.39	66.61	16.09		150.0	
10554-AAB	IEEE 802.11ac WiFi (160MHz, MCS0, 99pc duty cycle)	X	5.86	66.92	16.20	0.00	150.0	± 9.6 %
		Y	5.89	66.81	16.12		150.0	
		Z	5.75	66.87	16.15		150.0	
10555-AAB	IEEE 802.11ac WiFi (160MHz, MCS1, 99pc duty cycle)	X	5.98	67.22	16.33	0.00	150.0	± 9.6 %
		Y	6.03	67.12	16.25		150.0	
		Z	5.84	67.10	16.25		150.0	
10556-AAB	IEEE 802.11ac WiFi (160MHz, MCS2, 99pc duty cycle)	X	6.00	67.27	16.35	0.00	150.0	± 9.6 %
		Y	6.05	67.16	16.27		150.0	
		Z	5.88	67.20	16.30		150.0	
10557-AAB	IEEE 802.11ac WiFi (160MHz, MCS3, 99pc duty cycle)	X	5.96	67.16	16.31	0.00	150.0	± 9.6 %
		Y	6.02	67.08	16.25		150.0	
		Z	5.84	67.08	16.25		150.0	

10558-AAB	IEEE 802.11ac WiFi (160MHz, MCS4, 99pc duty cycle)	X	6.01	67.32	16.41	0.00	150.0	± 9.6 %
		Y	6.07	67.25	16.34		150.0	
		Z	5.85	67.15	16.31		150.0	
10560-AAB	IEEE 802.11ac WiFi (160MHz, MCS6, 99pc duty cycle)	X	6.01	67.17	16.37	0.00	150.0	± 9.6 %
		Y	6.06	67.10	16.31		150.0	
		Z	5.87	67.07	16.30		150.0	
10561-AAB	IEEE 802.11ac WiFi (160MHz, MCS7, 99pc duty cycle)	X	5.93	67.15	16.40	0.00	150.0	± 9.6 %
		Y	5.98	67.06	16.32		150.0	
		Z	5.80	67.05	16.32		150.0	
10562-AAB	IEEE 802.11ac WiFi (160MHz, MCS8, 99pc duty cycle)	X	6.04	67.49	16.57	0.00	150.0	± 9.6 %
		Y	6.12	67.48	16.53		150.0	
		Z	5.85	67.23	16.41		150.0	
10563-AAB	IEEE 802.11ac WiFi (160MHz, MCS9, 99pc duty cycle)	X	6.18	67.55	16.56	0.00	150.0	± 9.6 %
		Y	6.43	68.00	16.75		150.0	
		Z	5.95	67.17	16.35		150.0	
10564-AAA	IEEE 802.11g WiFi 2.4 GHz (DSSS-OFDM, 9 Mbps, 99pc duty cycle)	X	4.86	66.88	16.45	0.46	150.0	± 9.6 %
		Y	4.92	66.69	16.36		150.0	
		Z	4.71	66.96	16.39		150.0	
10565-AAA	IEEE 802.11g WiFi 2.4 GHz (DSSS-OFDM, 12 Mbps, 99pc duty cycle)	X	5.08	67.30	16.76	0.46	150.0	± 9.6 %
		Y	5.16	67.15	16.67		150.0	
		Z	4.90	67.36	16.69		150.0	
10566-AAA	IEEE 802.11g WiFi 2.4 GHz (DSSS-OFDM, 18 Mbps, 99pc duty cycle)	X	4.91	67.15	16.58	0.46	150.0	± 9.6 %
		Y	4.99	67.00	16.50		150.0	
		Z	4.74	67.18	16.50		150.0	
10567-AAA	IEEE 802.11g WiFi 2.4 GHz (DSSS-OFDM, 24 Mbps, 99pc duty cycle)	X	4.94	67.52	16.92	0.46	150.0	± 9.6 %
		Y	5.01	67.38	16.84		150.0	
		Z	4.77	67.57	16.87		150.0	
10568-AAA	IEEE 802.11g WiFi 2.4 GHz (DSSS-OFDM, 36 Mbps, 99pc duty cycle)	X	4.83	66.96	16.38	0.46	150.0	± 9.6 %
		Y	4.90	66.77	16.27		150.0	
		Z	4.63	66.92	16.25		150.0	
10569-AAA	IEEE 802.11g WiFi 2.4 GHz (DSSS-OFDM, 48 Mbps, 99pc duty cycle)	X	4.90	67.63	17.00	0.46	150.0	± 9.6 %
		Y	4.96	67.44	16.88		150.0	
		Z	4.75	67.78	17.00		150.0	
10570-AAA	IEEE 802.11g WiFi 2.4 GHz (DSSS-OFDM, 54 Mbps, 99pc duty cycle)	X	4.93	67.48	16.92	0.46	150.0	± 9.6 %
		Y	5.00	67.29	16.82		150.0	
		Z	4.76	67.58	16.89		150.0	
10571-AAA	IEEE 802.11b WiFi 2.4 GHz (DSSS, 1 Mbps, 90pc duty cycle)	X	1.18	64.69	15.93	0.46	130.0	± 9.6 %
		Y	1.20	64.37	15.58		130.0	
		Z	1.13	64.22	15.49		130.0	
10572-AAA	IEEE 802.11b WiFi 2.4 GHz (DSSS, 2 Mbps, 90pc duty cycle)	X	1.19	65.27	16.29	0.46	130.0	± 9.6 %
		Y	1.21	64.91	15.92		130.0	
		Z	1.14	64.74	15.83		130.0	
10573-AAA	IEEE 802.11b WiFi 2.4 GHz (DSSS, 5.5 Mbps, 90pc duty cycle)	X	2.77	92.16	26.12	0.46	130.0	± 9.6 %
		Y	1.86	83.27	22.47		130.0	
		Z	1.57	83.20	23.00		130.0	
10574-AAA	IEEE 802.11b WiFi 2.4 GHz (DSSS, 11 Mbps, 90pc duty cycle)	X	1.31	71.26	19.39	0.46	130.0	± 9.6 %
		Y	1.31	70.26	18.63		130.0	
		Z	1.20	70.00	18.67		130.0	

10575-AAA	IEEE 802.11g WiFi 2.4 GHz (DSSS-OFDM, 6 Mbps, 90pc duty cycle)	X	4.64	66.67	16.51	0.46	130.0	± 9.6 %
		Y	4.71	66.50	16.43		130.0	
		Z	4.47	66.69	16.39		130.0	
10576-AAA	IEEE 802.11g WiFi 2.4 GHz (DSSS-OFDM, 9 Mbps, 90pc duty cycle)	X	4.66	66.83	16.58	0.46	130.0	± 9.6 %
		Y	4.73	66.66	16.49		130.0	
		Z	4.50	66.89	16.47		130.0	
10577-AAA	IEEE 802.11g WiFi 2.4 GHz (DSSS-OFDM, 12 Mbps, 90pc duty cycle)	X	4.86	67.11	16.74	0.46	130.0	± 9.6 %
		Y	4.94	66.97	16.66		130.0	
		Z	4.67	67.12	16.61		130.0	
10578-AAA	IEEE 802.11g WiFi 2.4 GHz (DSSS-OFDM, 18 Mbps, 90pc duty cycle)	X	4.76	67.25	16.83	0.46	130.0	± 9.6 %
		Y	4.84	67.12	16.76		130.0	
		Z	4.57	67.26	16.72		130.0	
10579-AAA	IEEE 802.11g WiFi 2.4 GHz (DSSS-OFDM, 24 Mbps, 90pc duty cycle)	X	4.52	66.57	16.17	0.46	130.0	± 9.6 %
		Y	4.61	66.44	16.10		130.0	
		Z	4.33	66.48	15.99		130.0	
10580-AAA	IEEE 802.11g WiFi 2.4 GHz (DSSS-OFDM, 36 Mbps, 90pc duty cycle)	X	4.57	66.63	16.21	0.46	130.0	± 9.6 %
		Y	4.66	66.47	16.12		130.0	
		Z	4.36	66.53	16.01		130.0	
10581-AAA	IEEE 802.11g WiFi 2.4 GHz (DSSS-OFDM, 48 Mbps, 90pc duty cycle)	X	4.65	67.30	16.78	0.46	130.0	± 9.6 %
		Y	4.73	67.15	16.70		130.0	
		Z	4.48	67.34	16.69		130.0	
10582-AAA	IEEE 802.11g WiFi 2.4 GHz (DSSS-OFDM, 54 Mbps, 90pc duty cycle)	X	4.47	66.35	15.97	0.46	130.0	± 9.6 %
		Y	4.56	66.21	15.89		130.0	
		Z	4.26	66.25	15.78		130.0	
10583-AAA	IEEE 802.11a/h WiFi 5 GHz (OFDM, 6 Mbps, 90pc duty cycle)	X	4.64	66.67	16.51	0.46	130.0	± 9.6 %
		Y	4.71	66.50	16.43		130.0	
		Z	4.47	66.69	16.39		130.0	
10584-AAA	IEEE 802.11a/h WiFi 5 GHz (OFDM, 9 Mbps, 90pc duty cycle)	X	4.66	66.83	16.58	0.46	130.0	± 9.6 %
		Y	4.73	66.66	16.49		130.0	
		Z	4.50	66.89	16.47		130.0	
10585-AAA	IEEE 802.11a/h WiFi 5 GHz (OFDM, 12 Mbps, 90pc duty cycle)	X	4.86	67.11	16.74	0.46	130.0	± 9.6 %
		Y	4.94	66.97	16.66		130.0	
		Z	4.67	67.12	16.61		130.0	
10586-AAA	IEEE 802.11a/h WiFi 5 GHz (OFDM, 18 Mbps, 90pc duty cycle)	X	4.76	67.25	16.83	0.46	130.0	± 9.6 %
		Y	4.84	67.12	16.76		130.0	
		Z	4.57	67.26	16.72		130.0	
10587-AAA	IEEE 802.11a/h WiFi 5 GHz (OFDM, 24 Mbps, 90pc duty cycle)	X	4.52	66.57	16.17	0.46	130.0	± 9.6 %
		Y	4.61	66.44	16.10		130.0	
		Z	4.33	66.48	15.99		130.0	
10588-AAA	IEEE 802.11a/h WiFi 5 GHz (OFDM, 36 Mbps, 90pc duty cycle)	X	4.57	66.63	16.21	0.46	130.0	± 9.6 %
		Y	4.66	66.47	16.12		130.0	
		Z	4.36	66.53	16.01		130.0	
10589-AAA	IEEE 802.11a/h WiFi 5 GHz (OFDM, 48 Mbps, 90pc duty cycle)	X	4.65	67.30	16.78	0.46	130.0	± 9.6 %
		Y	4.73	67.15	16.70		130.0	
		Z	4.48	67.34	16.69		130.0	
10590-AAA	IEEE 802.11a/h WiFi 5 GHz (OFDM, 54 Mbps, 90pc duty cycle)	X	4.47	66.35	15.97	0.46	130.0	± 9.6 %
		Y	4.56	66.21	15.89		130.0	
		Z	4.26	66.25	15.78		130.0	

10591-AAA	IEEE 802.11n (HT Mixed, 20MHz, MCS0, 90pc duty cycle)	X	4.79	66.72	16.61	0.46	130.0	± 9.6 %
		Y	4.86	66.57	16.53		130.0	
		Z	4.63	66.78	16.50		130.0	
10592-AAA	IEEE 802.11n (HT Mixed, 20MHz, MCS1, 90pc duty cycle)	X	4.94	67.05	16.74	0.46	130.0	± 9.6 %
		Y	5.02	66.91	16.66		130.0	
		Z	4.75	67.07	16.63		130.0	
10593-AAA	IEEE 802.11n (HT Mixed, 20MHz, MCS2, 90pc duty cycle)	X	4.86	66.96	16.62	0.46	130.0	± 9.6 %
		Y	4.94	66.83	16.55		130.0	
		Z	4.67	66.95	16.49		130.0	
10594-AAA	IEEE 802.11n (HT Mixed, 20MHz, MCS3, 90pc duty cycle)	X	4.91	67.12	16.77	0.46	130.0	± 9.6 %
		Y	5.00	66.98	16.70		130.0	
		Z	4.72	67.12	16.65		130.0	
10595-AAA	IEEE 802.11n (HT Mixed, 20MHz, MCS4, 90pc duty cycle)	X	4.88	67.08	16.67	0.46	130.0	± 9.6 %
		Y	4.96	66.94	16.59		130.0	
		Z	4.69	67.10	16.56		130.0	
10596-AAA	IEEE 802.11n (HT Mixed, 20MHz, MCS5, 90pc duty cycle)	X	4.82	67.08	16.68	0.46	130.0	± 9.6 %
		Y	4.90	66.94	16.60		130.0	
		Z	4.62	67.07	16.55		130.0	
10597-AAA	IEEE 802.11n (HT Mixed, 20MHz, MCS6, 90pc duty cycle)	X	4.77	66.98	16.56	0.46	130.0	± 9.6 %
		Y	4.85	66.85	16.49		130.0	
		Z	4.57	66.94	16.41		130.0	
10598-AAA	IEEE 802.11n (HT Mixed, 20MHz, MCS7, 90pc duty cycle)	X	4.75	67.19	16.80	0.46	130.0	± 9.6 %
		Y	4.83	67.08	16.74		130.0	
		Z	4.56	67.16	16.67		130.0	
10599-AAA	IEEE 802.11n (HT Mixed, 40MHz, MCS0, 90pc duty cycle)	X	5.46	67.23	16.81	0.46	130.0	± 9.6 %
		Y	5.53	67.13	16.74		130.0	
		Z	5.31	67.22	16.74		130.0	
10600-AAA	IEEE 802.11n (HT Mixed, 40MHz, MCS1, 90pc duty cycle)	X	5.59	67.67	17.00	0.46	130.0	± 9.6 %
		Y	5.69	67.62	16.95		130.0	
		Z	5.40	67.56	16.88		130.0	
10601-AAA	IEEE 802.11n (HT Mixed, 40MHz, MCS2, 90pc duty cycle)	X	5.48	67.41	16.88	0.46	130.0	± 9.6 %
		Y	5.56	67.33	16.83		130.0	
		Z	5.31	67.36	16.79		130.0	
10602-AAA	IEEE 802.11n (HT Mixed, 40MHz, MCS3, 90pc duty cycle)	X	5.59	67.49	16.85	0.46	130.0	± 9.6 %
		Y	5.65	67.34	16.75		130.0	
		Z	5.41	67.42	16.75		130.0	
10603-AAA	IEEE 802.11n (HT Mixed, 40MHz, MCS4, 90pc duty cycle)	X	5.65	67.74	17.10	0.46	130.0	± 9.6 %
		Y	5.74	67.66	17.04		130.0	
		Z	5.48	67.71	17.02		130.0	
10604-AAA	IEEE 802.11n (HT Mixed, 40MHz, MCS5, 90pc duty cycle)	X	5.49	67.31	16.87	0.46	130.0	± 9.6 %
		Y	5.53	67.10	16.74		130.0	
		Z	5.37	67.37	16.83		130.0	
10605-AAA	IEEE 802.11n (HT Mixed, 40MHz, MCS6, 90pc duty cycle)	X	5.58	67.57	17.01	0.46	130.0	± 9.6 %
		Y	5.65	67.44	16.92		130.0	
		Z	5.40	67.46	16.88		130.0	
10606-AAA	IEEE 802.11n (HT Mixed, 40MHz, MCS7, 90pc duty cycle)	X	5.32	66.88	16.52	0.46	130.0	± 9.6 %
		Y	5.42	66.88	16.50		130.0	
		Z	5.18	66.90	16.45		130.0	

10607-AAA	IEEE 802.11ac WiFi (20MHz, MCS0, 90pc duty cycle)	X	4.63	66.06	16.24	0.46	130.0	± 9.6 %
		Y	4.69	65.87	16.14		130.0	
		Z	4.48	66.14	16.16		130.0	
10608-AAA	IEEE 802.11ac WiFi (20MHz, MCS1, 90pc duty cycle)	X	4.81	66.46	16.41	0.46	130.0	± 9.6 %
		Y	4.89	66.28	16.31		130.0	
		Z	4.62	66.47	16.30		130.0	
10609-AAA	IEEE 802.11ac WiFi (20MHz, MCS2, 90pc duty cycle)	X	4.70	66.31	16.25	0.46	130.0	± 9.6 %
		Y	4.78	66.14	16.15		130.0	
		Z	4.52	66.31	16.13		130.0	
10610-AAA	IEEE 802.11ac WiFi (20MHz, MCS3, 90pc duty cycle)	X	4.75	66.46	16.40	0.46	130.0	± 9.6 %
		Y	4.83	66.29	16.31		130.0	
		Z	4.57	66.47	16.29		130.0	
10611-AAA	IEEE 802.11ac WiFi (20MHz, MCS4, 90pc duty cycle)	X	4.67	66.27	16.25	0.46	130.0	± 9.6 %
		Y	4.74	66.11	16.17		130.0	
		Z	4.48	66.27	16.14		130.0	
10612-AAA	IEEE 802.11ac WiFi (20MHz, MCS5, 90pc duty cycle)	X	4.68	66.43	16.31	0.46	130.0	± 9.6 %
		Y	4.76	66.26	16.21		130.0	
		Z	4.47	66.40	16.18		130.0	
10613-AAA	IEEE 802.11ac WiFi (20MHz, MCS6, 90pc duty cycle)	X	4.68	66.30	16.19	0.46	130.0	± 9.6 %
		Y	4.76	66.16	16.10		130.0	
		Z	4.47	66.22	16.03		130.0	
10614-AAA	IEEE 802.11ac WiFi (20MHz, MCS7, 90pc duty cycle)	X	4.62	66.47	16.40	0.46	130.0	± 9.6 %
		Y	4.70	66.33	16.32		130.0	
		Z	4.44	66.44	16.27		130.0	
10615-AAA	IEEE 802.11ac WiFi (20MHz, MCS8, 90pc duty cycle)	X	4.67	66.12	16.05	0.46	130.0	± 9.6 %
		Y	4.75	65.95	15.95		130.0	
		Z	4.48	66.11	15.92		130.0	
10616-AAA	IEEE 802.11ac WiFi (40MHz, MCS0, 90pc duty cycle)	X	5.28	66.50	16.42	0.46	130.0	± 9.6 %
		Y	5.35	66.40	16.35		130.0	
		Z	5.12	66.44	16.33		130.0	
10617-AAA	IEEE 802.11ac WiFi (40MHz, MCS1, 90pc duty cycle)	X	5.35	66.70	16.50	0.46	130.0	± 9.6 %
		Y	5.42	66.55	16.40		130.0	
		Z	5.16	66.57	16.37		130.0	
10618-AAA	IEEE 802.11ac WiFi (40MHz, MCS2, 90pc duty cycle)	X	5.24	66.70	16.51	0.46	130.0	± 9.6 %
		Y	5.30	66.57	16.42		130.0	
		Z	5.08	66.64	16.42		130.0	
10619-AAA	IEEE 802.11ac WiFi (40MHz, MCS3, 90pc duty cycle)	X	5.25	66.50	16.35	0.46	130.0	± 9.6 %
		Y	5.33	66.41	16.28		130.0	
		Z	5.09	66.45	16.26		130.0	
10620-AAA	IEEE 802.11ac WiFi (40MHz, MCS4, 90pc duty cycle)	X	5.34	66.53	16.41	0.46	130.0	± 9.6 %
		Y	5.42	66.46	16.35		130.0	
		Z	5.16	66.45	16.31		130.0	
10621-AAA	IEEE 802.11ac WiFi (40MHz, MCS5, 90pc duty cycle)	X	5.34	66.65	16.59	0.46	130.0	± 9.6 %
		Y	5.41	66.55	16.51		130.0	
		Z	5.17	66.56	16.48		130.0	
10622-AAA	IEEE 802.11ac WiFi (40MHz, MCS6, 90pc duty cycle)	X	5.35	66.81	16.66	0.46	130.0	± 9.6 %
		Y	5.42	66.71	16.59		130.0	
		Z	5.16	66.65	16.52		130.0	

10623-AAA	IEEE 802.11ac WiFi (40MHz, MCS7, 90pc duty cycle)	X	5.23	66.36	16.32	0.46	130.0	± 9.6 %
		Y	5.30	66.25	16.24		130.0	
		Z	5.05	66.22	16.17		130.0	
10624-AAA	IEEE 802.11ac WiFi (40MHz, MCS8, 90pc duty cycle)	X	5.42	66.55	16.47	0.46	130.0	± 9.6 %
		Y	5.50	66.45	16.40		130.0	
		Z	5.25	66.47	16.36		130.0	
10625-AAA	IEEE 802.11ac WiFi (40MHz, MCS9, 90pc duty cycle)	X	5.75	67.41	16.95	0.46	130.0	± 9.6 %
		Y	5.89	67.51	16.98		130.0	
		Z	5.34	66.63	16.50		130.0	
10626-AAA	IEEE 802.11ac WiFi (80MHz, MCS0, 90pc duty cycle)	X	5.59	66.56	16.38	0.46	130.0	± 9.6 %
		Y	5.64	66.46	16.31		130.0	
		Z	5.45	66.47	16.28		130.0	
10627-AAA	IEEE 802.11ac WiFi (80MHz, MCS1, 90pc duty cycle)	X	5.82	67.13	16.63	0.46	130.0	± 9.6 %
		Y	5.88	67.03	16.55		130.0	
		Z	5.67	67.05	16.54		130.0	
10628-AAA	IEEE 802.11ac WiFi (80MHz, MCS2, 90pc duty cycle)	X	5.61	66.64	16.32	0.46	130.0	± 9.6 %
		Y	5.68	66.59	16.27		130.0	
		Z	5.44	66.46	16.18		130.0	
10629-AAA	IEEE 802.11ac WiFi (80MHz, MCS3, 90pc duty cycle)	X	5.69	66.69	16.34	0.46	130.0	± 9.6 %
		Y	5.78	66.69	16.31		130.0	
		Z	5.54	66.62	16.26		130.0	
10630-AAA	IEEE 802.11ac WiFi (80MHz, MCS4, 90pc duty cycle)	X	6.09	68.10	17.05	0.46	130.0	± 9.6 %
		Y	6.25	68.29	17.11		130.0	
		Z	5.78	67.54	16.72		130.0	
10631-AAA	IEEE 802.11ac WiFi (80MHz, MCS5, 90pc duty cycle)	X	5.99	67.90	17.13	0.46	130.0	± 9.6 %
		Y	6.12	67.99	17.15		130.0	
		Z	5.75	67.56	16.92		130.0	
10632-AAA	IEEE 802.11ac WiFi (80MHz, MCS6, 90pc duty cycle)	X	5.79	67.18	16.78	0.46	130.0	± 9.6 %
		Y	5.85	67.07	16.70		130.0	
		Z	5.67	67.21	16.76		130.0	
10633-AAA	IEEE 802.11ac WiFi (80MHz, MCS7, 90pc duty cycle)	X	5.68	66.80	16.43	0.46	130.0	± 9.6 %
		Y	5.74	66.74	16.37		130.0	
		Z	5.48	66.57	16.27		130.0	
10634-AAA	IEEE 802.11ac WiFi (80MHz, MCS8, 90pc duty cycle)	X	5.66	66.82	16.49	0.46	130.0	± 9.6 %
		Y	5.73	66.76	16.44		130.0	
		Z	5.50	66.72	16.40		130.0	
10635-AAA	IEEE 802.11ac WiFi (80MHz, MCS9, 90pc duty cycle)	X	5.54	66.19	15.93	0.46	130.0	± 9.6 %
		Y	5.62	66.14	15.87		130.0	
		Z	5.36	66.00	15.77		130.0	
10636-AAB	IEEE 802.11ac WiFi (160MHz, MCS0, 90pc duty cycle)	X	6.00	66.92	16.46	0.46	130.0	± 9.6 %
		Y	6.05	66.85	16.41		130.0	
		Z	5.88	66.82	16.36		130.0	
10637-AAB	IEEE 802.11ac WiFi (160MHz, MCS1, 90pc duty cycle)	X	6.16	67.31	16.64	0.46	130.0	± 9.6 %
		Y	6.21	67.23	16.58		130.0	
		Z	6.00	67.12	16.50		130.0	
10638-AAB	IEEE 802.11ac WiFi (160MHz, MCS2, 90pc duty cycle)	X	6.16	67.28	16.60	0.46	130.0	± 9.6 %
		Y	6.21	67.20	16.54		130.0	
		Z	6.02	67.18	16.51		130.0	

10639-AAB	IEEE 802.11ac WiFi (160MHz, MCS3, 90pc duty cycle)	X	6.13	67.21	16.61	0.46	130.0	± 9.6 %
		Y	6.20	67.17	16.57		130.0	
		Z	5.98	67.06	16.49		130.0	
10640-AAB	IEEE 802.11ac WiFi (160MHz, MCS4, 90pc duty cycle)	X	6.13	67.23	16.57	0.46	130.0	± 9.6 %
		Y	6.21	67.21	16.53		130.0	
		Z	5.95	66.98	16.40		130.0	
10641-AAB	IEEE 802.11ac WiFi (160MHz, MCS5, 90pc duty cycle)	X	6.19	67.17	16.55	0.46	130.0	± 9.6 %
		Y	6.24	67.06	16.48		130.0	
		Z	6.04	67.04	16.44		130.0	
10642-AAB	IEEE 802.11ac WiFi (160MHz, MCS6, 90pc duty cycle)	X	6.22	67.37	16.82	0.46	130.0	± 9.6 %
		Y	6.28	67.33	16.77		130.0	
		Z	6.06	67.23	16.70		130.0	
10643-AAB	IEEE 802.11ac WiFi (160MHz, MCS7, 90pc duty cycle)	X	6.06	67.09	16.58	0.46	130.0	± 9.6 %
		Y	6.12	67.02	16.52		130.0	
		Z	5.91	66.93	16.45		130.0	
10644-AAB	IEEE 802.11ac WiFi (160MHz, MCS8, 90pc duty cycle)	X	6.20	67.52	16.82	0.46	130.0	± 9.6 %
		Y	6.31	67.59	16.83		130.0	
		Z	5.97	67.13	16.57		130.0	
10645-AAB	IEEE 802.11ac WiFi (160MHz, MCS9, 90pc duty cycle)	X	6.41	67.77	16.91	0.46	130.0	± 9.6 %
		Y	6.76	68.49	17.23		130.0	
		Z	6.10	67.18	16.56		130.0	
10646-AAD	LTE-TDD (SC-FDMA, 1 RB, 5 MHz, QPSK, UL Subframe=2,7)	X	32.54	128.38	44.23	9.30	60.0	± 9.6 %
		Y	33.21	124.21	42.28		60.0	
		Z	8.58	97.27	34.21		60.0	
10647-AAC	LTE-TDD (SC-FDMA, 1 RB, 20 MHz, QPSK, UL Subframe=2,7)	X	24.86	122.50	42.74	9.30	60.0	± 9.6 %
		Y	27.83	120.75	41.46		60.0	
		Z	7.33	94.04	33.20		60.0	
10648-AAA	CDMA2000 (1x Advanced)	X	0.71	63.99	11.07	0.00	150.0	± 9.6 %
		Y	0.72	63.38	11.01		150.0	
		Z	0.57	62.72	9.40		150.0	
10652-AAB	LTE-TDD (OFDMA, 5 MHz, E-TM 3.1, Clipping 44%)	X	3.64	67.29	16.91	2.23	80.0	± 9.6 %
		Y	3.79	67.25	16.93		80.0	
		Z	3.31	66.63	16.20		80.0	
10653-AAB	LTE-TDD (OFDMA, 10 MHz, E-TM 3.1, Clipping 44%)	X	4.13	66.44	16.95	2.23	80.0	± 9.6 %
		Y	4.30	66.53	16.99		80.0	
		Z	3.84	65.89	16.44		80.0	
10654-AAB	LTE-TDD (OFDMA, 15 MHz, E-TM 3.1, Clipping 44%)	X	4.11	66.04	16.93	2.23	80.0	± 9.6 %
		Y	4.26	66.17	16.97		80.0	
		Z	3.86	65.50	16.46		80.0	
10655-AAB	LTE-TDD (OFDMA, 20 MHz, E-TM 3.1, Clipping 44%)	X	4.17	66.02	16.96	2.23	80.0	± 9.6 %
		Y	4.32	66.18	17.01		80.0	
		Z	3.93	65.42	16.50		80.0	

^E Uncertainty is determined using the max. deviation from linear response applying rectangular distribution and is expressed for the square of the field value.



Accredited by the Swiss Accreditation Service (SAS)
The Swiss Accreditation Service is one of the signatories to the EA
Multilateral Agreement for the recognition of calibration certificates

Accreditation No.: **SCS 0108**

Client **PC Test**

Certificate No: **EX3-7410_Jul17**

CALIBRATION CERTIFICATE

Object: **EX3DV4 - SN:7410**

Calibration procedure(s): **QA CAL-01.v9, QA CAL-23.v5, QA CAL-25.v6
Calibration procedure for dosimetric E-field probes**

Calibration date: **July 17, 2017**

*BN ✓
8/3/2017*

This calibration certificate documents the traceability to national standards, which realize the physical units of measurements (SI).
The measurements and the uncertainties with confidence probability are given on the following pages and are part of the certificate.

All calibrations have been conducted in the closed laboratory facility: environment temperature (22 ± 3)°C and humidity < 70%.

Calibration Equipment used (M&TE critical for calibration)

Primary Standards	ID	Cal Date (Certificate No.)	Scheduled Calibration
Power meter NRP	SN: 104778	04-Apr-17 (No. 217-02521/02522)	Apr-18
Power sensor NRP-Z91	SN: 103244	04-Apr-17 (No. 217-02521)	Apr-18
Power sensor NRP-Z91	SN: 103245	04-Apr-17 (No. 217-02525)	Apr-18
Reference 20 dB Attenuator	SN: S5277 (20x)	07-Apr-17 (No. 217-02528)	Apr-18
Reference Probe ES3DV2	SN: 3013	31-Dec-16 (No. ES3-3013_Dec16)	Dec-17
DAE4	SN: 660	7-Dec-16 (No. DAE4-660_Dec16)	Dec-17
Secondary Standards	ID	Check Date (in house)	Scheduled Check
Power meter E4419B	SN: GB41293874	06-Apr-16 (in house check Jun-16)	In house check: Jun-18
Power sensor E4412A	SN: MY41498087	06-Apr-16 (in house check Jun-16)	In house check: Jun-18
Power sensor E4412A	SN: 000110210	06-Apr-16 (in house check Jun-16)	In house check: Jun-18
RF generator HP 8648C	SN: US3642U01700	04-Aug-99 (in house check Jun-16)	In house check: Jun-18
Network Analyzer HP 8753E	SN: US37390585	18-Oct-01 (in house check Oct-16)	In house check: Oct-17

Calibrated by:	Name Jeton Kastrati	Function Laboratory Technician	Signature
Approved by:	Name Katja Pokovic	Technical Manager	

Issued: July 17, 2017

This calibration certificate shall not be reproduced except in full without written approval of the laboratory.



Accredited by the Swiss Accreditation Service (SAS)

The Swiss Accreditation Service is one of the signatories to the EA
Multilateral Agreement for the recognition of calibration certificates

Accreditation No.: **SCS 0108**

Glossary:

TSL	tissue simulating liquid
NORM _{x,y,z}	sensitivity in free space
ConvF	sensitivity in TSL / NORM _{x,y,z}
DCP	diode compression point
CF	crest factor (1/duty_cycle) of the RF signal
A, B, C, D	modulation dependent linearization parameters
Polarization φ	φ rotation around probe axis
Polarization ϑ	ϑ rotation around an axis that is in the plane normal to probe axis (at measurement center), i.e., $\vartheta = 0$ is normal to probe axis
Connector Angle	information used in DASY system to align probe sensor X to the robot coordinate system

Calibration is Performed According to the Following Standards:

- a) IEEE Std 1528-2013, "IEEE Recommended Practice for Determining the Peak Spatial-Averaged Specific Absorption Rate (SAR) in the Human Head from Wireless Communications Devices: Measurement Techniques", June 2013
- b) IEC 62209-1, "Measurement procedure for the assessment of Specific Absorption Rate (SAR) from hand-held and body-mounted devices used next to the ear (frequency range of 300 MHz to 6 GHz)", July 2016
- c) IEC 62209-2, "Procedure to determine the Specific Absorption Rate (SAR) for wireless communication devices used in close proximity to the human body (frequency range of 30 MHz to 6 GHz)", March 2010
- d) KDB 865664, "SAR Measurement Requirements for 100 MHz to 6 GHz"

Methods Applied and Interpretation of Parameters:

- **NORM_{x,y,z}**: Assessed for E-field polarization $\vartheta = 0$ ($f \leq 900$ MHz in TEM-cell; $f > 1800$ MHz: R22 waveguide). NORM_{x,y,z} are only intermediate values, i.e., the uncertainties of NORM_{x,y,z} does not affect the E²-field uncertainty inside TSL (see below ConvF).
- **NORM(f)_{x,y,z}** = NORM_{x,y,z} * frequency_response (see Frequency Response Chart). This linearization is implemented in DASY4 software versions later than 4.2. The uncertainty of the frequency response is included in the stated uncertainty of ConvF.
- **DCP_{x,y,z}**: DCP are numerical linearization parameters assessed based on the data of power sweep with CW signal (no uncertainty required). DCP does not depend on frequency nor media.
- **PAR**: PAR is the Peak to Average Ratio that is not calibrated but determined based on the signal characteristics
- **A_{x,y,z}; B_{x,y,z}; C_{x,y,z}; D_{x,y,z}; VR_{x,y,z}**: A, B, C, D are numerical linearization parameters assessed based on the data of power sweep for specific modulation signal. The parameters do not depend on frequency nor media. VR is the maximum calibration range expressed in RMS voltage across the diode.
- **ConvF and Boundary Effect Parameters**: Assessed in flat phantom using E-field (or Temperature Transfer Standard for $f \leq 800$ MHz) and inside waveguide using analytical field distributions based on power measurements for $f > 800$ MHz. The same setups are used for assessment of the parameters applied for boundary compensation (alpha, depth) of which typical uncertainty values are given. These parameters are used in DASY4 software to improve probe accuracy close to the boundary. The sensitivity in TSL corresponds to NORM_{x,y,z} * ConvF whereby the uncertainty corresponds to that given for ConvF. A frequency dependent ConvF is used in DASY version 4.4 and higher which allows extending the validity from ± 50 MHz to ± 100 MHz.
- **Spherical isotropy (3D deviation from isotropy)**: in a field of low gradients realized using a flat phantom exposed by a patch antenna.
- **Sensor Offset**: The sensor offset corresponds to the offset of virtual measurement center from the probe tip (on probe axis). No tolerance required.
- **Connector Angle**: The angle is assessed using the information gained by determining the NORM_x (no uncertainty required).

Probe EX3DV4

SN:7410

Manufactured: November 24, 2015
Calibrated: July 17, 2017

Calibrated for DASY/EASY Systems
(Note: non-compatible with DASY2 system!)

DASY/EASY - Parameters of Probe: EX3DV4 - SN:7410

Basic Calibration Parameters

	Sensor X	Sensor Y	Sensor Z	Unc (k=2)
Norm ($\mu\text{V}/(\text{V}/\text{m})^{2.5}$) ^A	0.40	0.46	0.43	$\pm 10.1 \%$
DCP (mV) ^B	95.4	94.7	91.2	

Modulation Calibration Parameters

UID	Communication System Name		A dB	B dB $\sqrt{\mu\text{V}}$	C	D dB	VR mV	Unc ^E (k=2)
0	CW	X	0.0	0.0	1.0	0.00	130.7	$\pm 3.5 \%$
		Y	0.0	0.0	1.0		146.7	
		Z	0.0	0.0	1.0		132.5	

Note: For details on UID parameters see Appendix.

Sensor Model Parameters

	C1 fF	C2 fF	α V^{-1}	T1 $\text{ms}\cdot\text{V}^{-2}$	T2 $\text{ms}\cdot\text{V}^{-1}$	T3 ms	T4 V^{-2}	T5 V^{-1}	T6
X	41.43	313.6	36.54	8.525	0.381	5.024	0.000	0.467	1.003
Y	41.67	315.5	36.57	10.32	0.000	5.055	0.334	0.426	1.004
Z	51.58	393.9	37.05	11.42	0.427	5.066	0.000	0.561	1.006

The reported uncertainty of measurement is stated as the standard uncertainty of measurement multiplied by the coverage factor $k=2$, which for a normal distribution corresponds to a coverage probability of approximately 95%.

^A The uncertainties of Norm X,Y,Z do not affect the E^2 -field uncertainty inside TSL (see Pages 5 and 6).

^B Numerical linearization parameter: uncertainty not required.

^E Uncertainty is determined using the max. deviation from linear response applying rectangular distribution and is expressed for the square of the field value.

DASY/EASY - Parameters of Probe: EX3DV4 - SN:7410

Calibration Parameter Determined in Head Tissue Simulating Media

f (MHz) ^C	Relative Permittivity ^F	Conductivity (S/m) ^F	ConvF X	ConvF Y	ConvF Z	Alpha ^G	Depth (mm) ^G	Unc (k=2)
750	41.9	0.89	10.60	10.60	10.60	0.53	0.80	± 12.0 %
835	41.5	0.90	10.08	10.08	10.08	0.41	0.98	± 12.0 %
1750	40.1	1.37	8.66	8.66	8.66	0.41	0.82	± 12.0 %
1900	40.0	1.40	8.37	8.37	8.37	0.28	1.19	± 12.0 %
2300	39.5	1.67	8.02	8.02	8.02	0.35	0.80	± 12.0 %
2450	39.2	1.80	7.68	7.68	7.68	0.33	0.89	± 12.0 %
2600	39.0	1.96	7.42	7.42	7.42	0.40	0.80	± 12.0 %

^C Frequency validity above 300 MHz of ± 100 MHz only applies for DASY v4.4 and higher (see Page 2), else it is restricted to ± 50 MHz. The uncertainty is the RSS of the ConvF uncertainty at calibration frequency and the uncertainty for the indicated frequency band. Frequency validity below 300 MHz is ± 10, 25, 40, 50 and 70 MHz for ConvF assessments at 30, 64, 128, 150 and 220 MHz respectively. Above 5 GHz frequency validity can be extended to ± 110 MHz.

^F At frequencies below 3 GHz, the validity of tissue parameters (ϵ and σ) can be relaxed to ± 10% if liquid compensation formula is applied to measured SAR values. At frequencies above 3 GHz, the validity of tissue parameters (ϵ and σ) is restricted to ± 5%. The uncertainty is the RSS of the ConvF uncertainty for indicated target tissue parameters.

^G Alpha/Depth are determined during calibration. SPEAG warrants that the remaining deviation due to the boundary effect after compensation is always less than ± 1% for frequencies below 3 GHz and below ± 2% for frequencies between 3-6 GHz at any distance larger than half the probe tip diameter from the boundary.

DASY/EASY - Parameters of Probe: EX3DV4 - SN:7410

Calibration Parameter Determined in Body Tissue Simulating Media

f (MHz) ^C	Relative Permittivity ^F	Conductivity (S/m) ^F	ConvF X	ConvF Y	ConvF Z	Alpha ^G	Depth ^G (mm)	Unc (k=2)
750	55.5	0.96	10.19	10.19	10.19	0.33	1.02	± 12.0 %
835	55.2	0.97	9.95	9.95	9.95	0.50	0.80	± 12.0 %
1750	53.4	1.49	8.32	8.32	8.32	0.39	0.86	± 12.0 %
1900	53.3	1.52	7.98	7.98	7.98	0.44	0.86	± 12.0 %
2300	52.9	1.81	7.85	7.85	7.85	0.44	0.84	± 12.0 %
2450	52.7	1.95	7.69	7.69	7.69	0.37	0.89	± 12.0 %
2600	52.5	2.16	7.43	7.43	7.43	0.28	0.99	± 12.0 %

^C Frequency validity above 300 MHz of ± 100 MHz only applies for DASY v4.4 and higher (see Page 2), else it is restricted to ± 50 MHz. The uncertainty is the RSS of the ConvF uncertainty at calibration frequency and the uncertainty for the indicated frequency band. Frequency validity below 300 MHz is ± 10, 25, 40, 50 and 70 MHz for ConvF assessments at 30, 64, 128, 150 and 220 MHz respectively. Above 5 GHz frequency validity can be extended to ± 110 MHz.

^F At frequencies below 3 GHz, the validity of tissue parameters (ϵ and σ) can be relaxed to ± 10% if liquid compensation formula is applied to measured SAR values. At frequencies above 3 GHz, the validity of tissue parameters (ϵ and σ) is restricted to ± 5%. The uncertainty is the RSS of the ConvF uncertainty for indicated target tissue parameters.

^G Alpha/Depth are determined during calibration. SPEAG warrants that the remaining deviation due to the boundary effect after compensation is always less than ± 1% for frequencies below 3 GHz and below ± 2% for frequencies between 3-6 GHz at any distance larger than half the probe tip diameter from the boundary.

Frequency Response of E-Field (TEM-Cell:ifi110 EXX, Waveguide: R22)

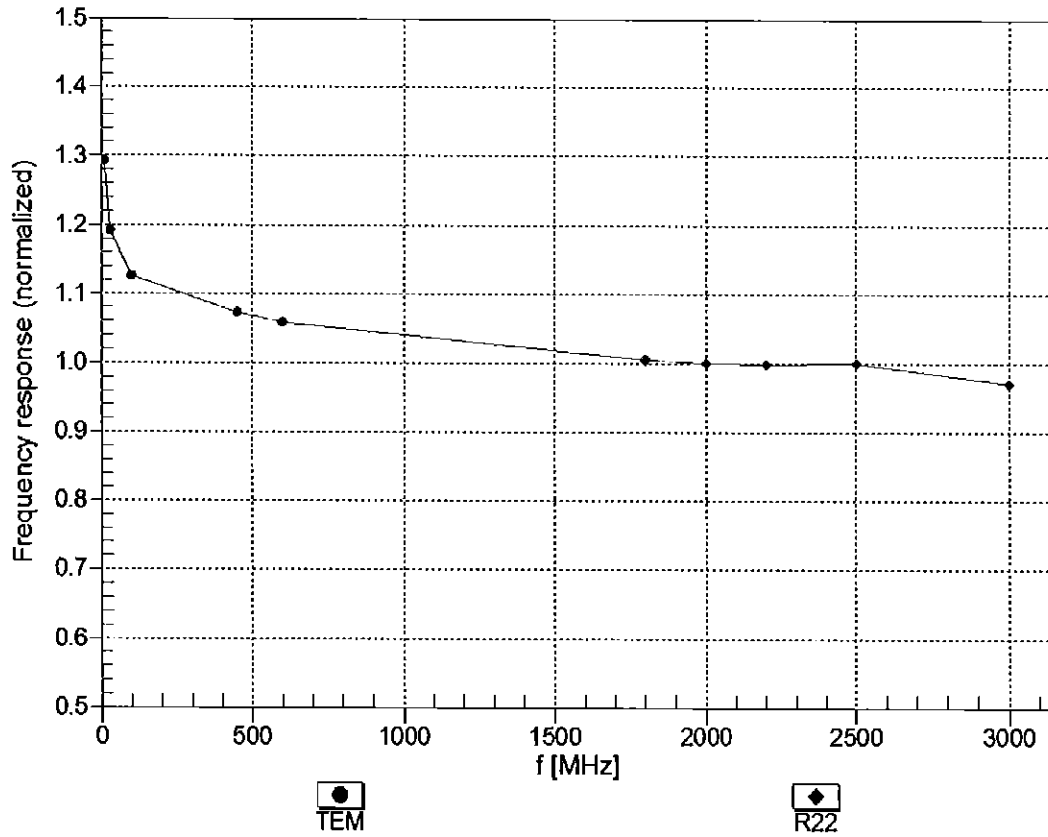

Uncertainty of Frequency Response of E-field: $\pm 6.3\%$ (k=2)

Receiving Pattern (ϕ), $\theta = 0^\circ$

f=600 MHz,TEM

f=1800 MHz,R22

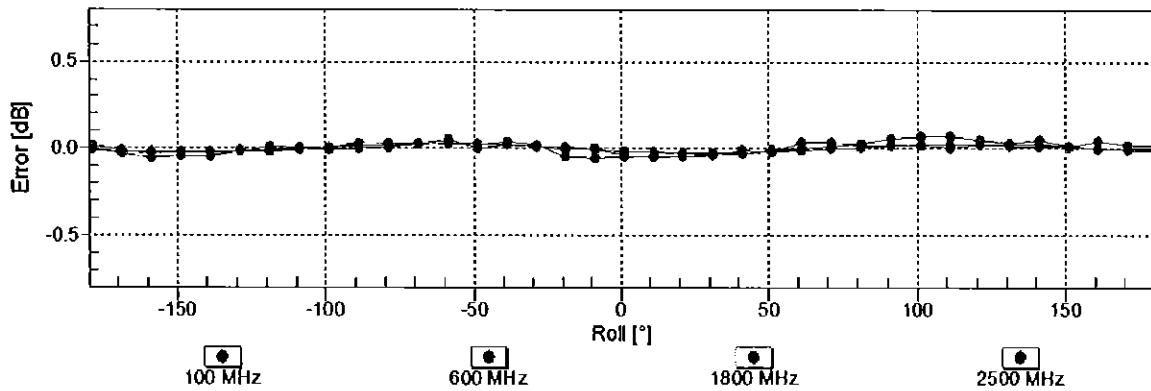
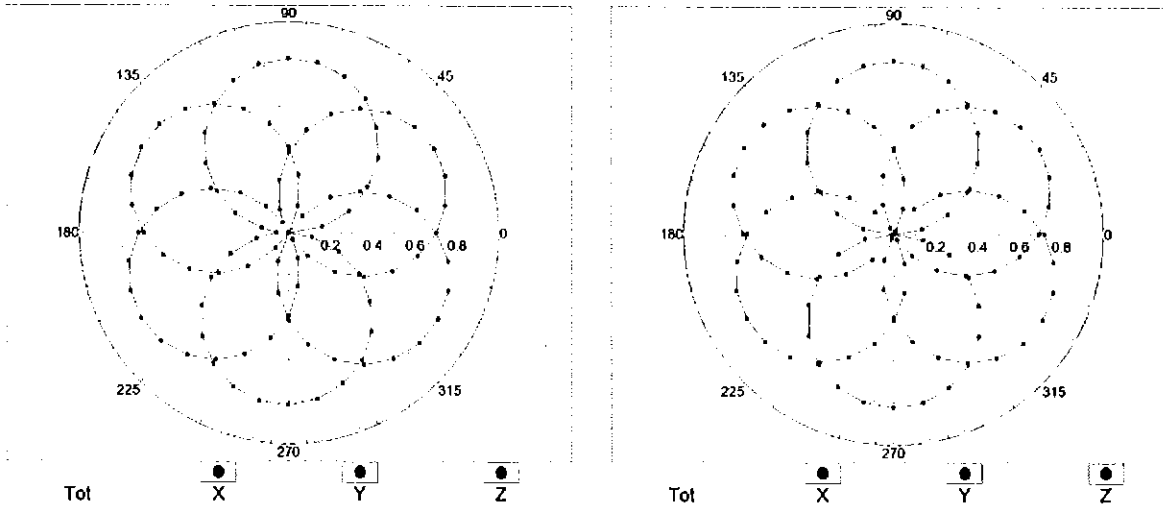

Uncertainty of Axial Isotropy Assessment: $\pm 0.5\%$ ($k=2$)

Dynamic Range $f(SAR_{head})$ (TEM cell, $f_{eval}=1900$ MHz)

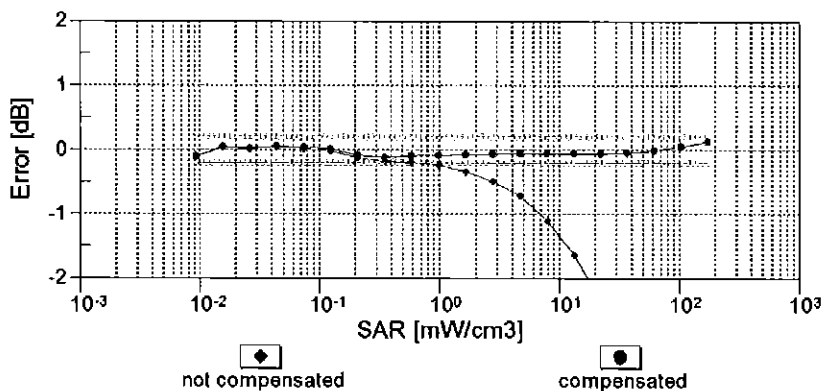
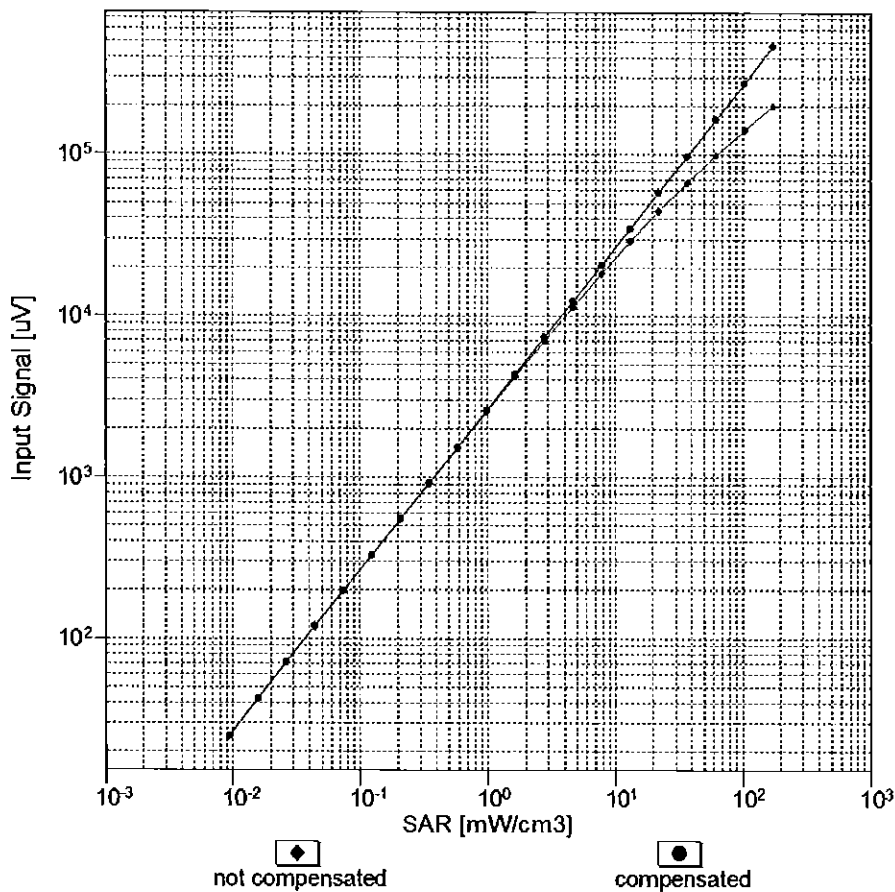

Uncertainty of Linearity Assessment: $\pm 0.6\%$ ($k=2$)

Conversion Factor Assessment

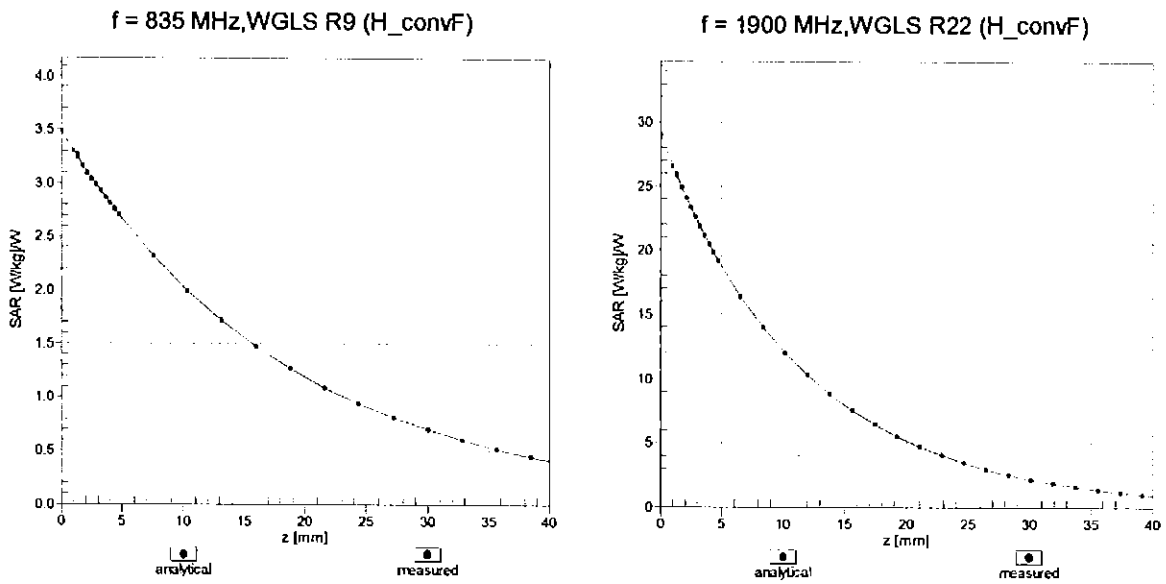

Deviation from Isotropy in Liquid

Error (ϕ, ϑ), f = 900 MHz

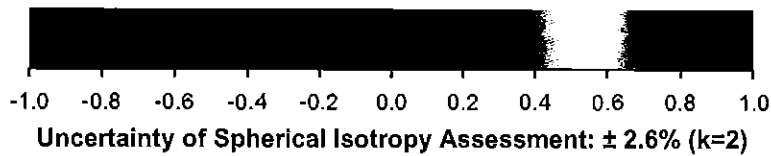
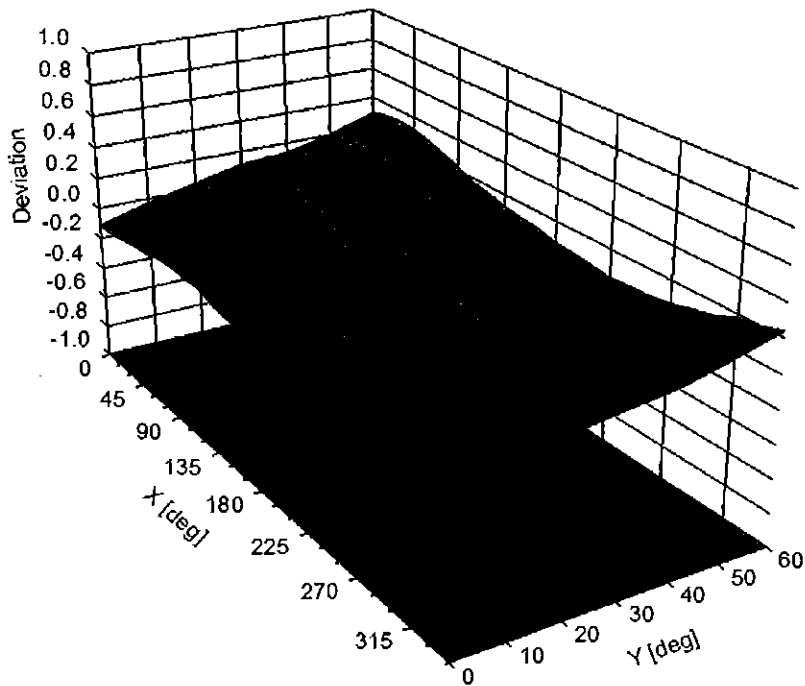

DASY/EASY - Parameters of Probe: EX3DV4 - SN:7410**Other Probe Parameters**

Sensor Arrangement	Triangular
Connector Angle (°)	1.2
Mechanical Surface Detection Mode	enabled
Optical Surface Detection Mode	disabled
Probe Overall Length	337 mm
Probe Body Diameter	10 mm
Tip Length	9 mm
Tip Diameter	2.5 mm
Probe Tip to Sensor X Calibration Point	1 mm
Probe Tip to Sensor Y Calibration Point	1 mm
Probe Tip to Sensor Z Calibration Point	1 mm
Recommended Measurement Distance from Surface	1.4 mm

Appendix: Modulation Calibration Parameters

UID	Communication System Name		A dB	B dB $\sqrt{\mu}$ V	C	D dB	VR mV	Max Unc ^E (k=2)
0	CW	X	0.00	0.00	1.00	0.00	130.7	$\pm 3.5\%$
		Y	0.00	0.00	1.00		146.7	
		Z	0.00	0.00	1.00		132.5	
10010- CAA	SAR Validation (Square, 100ms, 10ms)	X	2.07	65.38	9.86	10.00	20.0	$\pm 9.6\%$
		Y	1.71	64.71	9.07		20.0	
		Z	3.44	71.14	12.92		20.0	
10011- CAB	UMTS-FDD (WCDMA)	X	1.05	67.82	15.62	0.00	150.0	$\pm 9.6\%$
		Y	1.11	68.91	16.28		150.0	
		Z	1.02	66.59	14.94		150.0	
10012- CAB	IEEE 802.11b WiFi 2.4 GHz (DSSS, 1 Mbps)	X	1.16	63.70	15.28	0.41	150.0	$\pm 9.6\%$
		Y	1.18	64.10	15.65		150.0	
		Z	1.17	63.41	15.09		150.0	
10013- CAB	IEEE 802.11g WiFi 2.4 GHz (DSSS-OFDM, 6 Mbps)	X	4.78	66.61	17.05	1.46	150.0	$\pm 9.6\%$
		Y	4.80	66.74	17.21		150.0	
		Z	4.93	66.52	17.11		150.0	
10021- DAC	GSM-FDD (TDMA, GMSK)	X	100.00	111.37	25.72	9.39	50.0	$\pm 9.6\%$
		Y	100.00	111.58	25.35		50.0	
		Z	100.00	117.02	28.59		50.0	
10023- DAC	GPRS-FDD (TDMA, GMSK, TN 0)	X	100.00	110.83	25.53	9.57	50.0	$\pm 9.6\%$
		Y	1707.76	142.54	31.32		50.0	
		Z	100.00	116.46	28.39		50.0	
10024- DAC	GPRS-FDD (TDMA, GMSK, TN 0-1)	X	100.00	111.84	24.81	6.56	60.0	$\pm 9.6\%$
		Y	100.00	114.48	25.68		60.0	
		Z	100.00	118.35	28.09		60.0	
10025- DAC	EDGE-FDD (TDMA, 8PSK, TN 0)	X	3.46	65.17	23.20	12.57	50.0	$\pm 9.6\%$
		Y	5.27	82.06	33.95		50.0	
		Z	3.61	65.78	23.81		50.0	
10026- DAC	EDGE-FDD (TDMA, 8PSK, TN 0-1)	X	6.19	83.69	29.67	9.56	60.0	$\pm 9.6\%$
		Y	7.27	90.43	33.46		60.0	
		Z	7.46	87.49	31.34		60.0	
10027- DAC	GPRS-FDD (TDMA, GMSK, TN 0-1-2)	X	100.00	114.23	25.06	4.80	80.0	$\pm 9.6\%$
		Y	100.00	119.65	27.19		80.0	
		Z	100.00	121.09	28.48		80.0	
10028- DAC	GPRS-FDD (TDMA, GMSK, TN 0-1-2-3)	X	100.00	118.39	26.12	3.55	100.0	$\pm 9.6\%$
		Y	100.00	127.35	29.74		100.0	
		Z	100.00	125.00	29.42		100.0	
10029- DAC	EDGE-FDD (TDMA, 8PSK, TN 0-1-2)	X	4.31	75.70	25.15	7.80	80.0	$\pm 9.6\%$
		Y	4.62	78.76	27.21		80.0	
		Z	5.10	78.80	26.60		80.0	
10030- CAA	IEEE 802.15.1 Bluetooth (GFSK, DH1)	X	100.00	110.42	23.70	5.30	70.0	$\pm 9.6\%$
		Y	100.00	113.76	24.95		70.0	
		Z	100.00	117.44	27.22		70.0	
10031- CAA	IEEE 802.15.1 Bluetooth (GFSK, DH3)	X	100.00	118.50	24.77	1.88	100.0	$\pm 9.6\%$
		Y	100.00	132.66	30.37		100.0	
		Z	100.00	126.29	28.44		100.0	

10032-CAA	IEEE 802.15.1 Bluetooth (GFSK, DH5)	X	100.00	133.47	29.67	1.17	100.0	± 9.6 %
		Y	100.00	157.48	38.89		100.0	
		Z	100.00	136.04	31.29		100.0	
10033-CAA	IEEE 802.15.1 Bluetooth (PI/4-DQPSK, DH1)	X	8.66	91.15	24.16	5.30	70.0	± 9.6 %
		Y	61.92	124.81	33.89		70.0	
		Z	18.44	105.53	29.79		70.0	
10034-CAA	IEEE 802.15.1 Bluetooth (PI/4-DQPSK, DH3)	X	2.66	76.47	17.66	1.88	100.0	± 9.6 %
		Y	4.91	85.76	21.28		100.0	
		Z	3.14	79.12	19.77		100.0	
10035-CAA	IEEE 802.15.1 Bluetooth (PI/4-DQPSK, DH5)	X	1.87	72.76	15.96	1.17	100.0	± 9.6 %
		Y	2.71	78.22	18.36		100.0	
		Z	2.01	73.50	17.25		100.0	
10036-CAA	IEEE 802.15.1 Bluetooth (8-DPSK, DH1)	X	12.89	97.56	26.18	5.30	70.0	± 9.6 %
		Y	100.00	133.04	35.90		70.0	
		Z	33.52	115.95	32.67		70.0	
10037-CAA	IEEE 802.15.1 Bluetooth (8-DPSK, DH3)	X	2.40	75.20	17.16	1.88	100.0	± 9.6 %
		Y	4.17	83.65	20.57		100.0	
		Z	2.91	78.15	19.38		100.0	
10038-CAA	IEEE 802.15.1 Bluetooth (8-DPSK, DH5)	X	1.89	73.11	16.24	1.17	100.0	± 9.6 %
		Y	2.73	78.67	18.67		100.0	
		Z	2.03	73.85	17.51		100.0	
10039-CAB	CDMA2000 (1xRTT, RC1)	X	1.93	73.30	15.79	0.00	150.0	± 9.6 %
		Y	2.16	74.82	16.50		150.0	
		Z	1.82	71.39	15.74		150.0	
10042-CAB	IS-54 / IS-136 FDD (TDMA/FDM, PI/4-DQPSK, Halfrate)	X	100.00	108.18	23.51	7.78	50.0	± 9.6 %
		Y	100.00	108.75	23.44		50.0	
		Z	100.00	113.77	26.32		50.0	
10044-CAA	IS-91/EIA/TIA-553 FDD (FDMA, FM)	X	0.00	97.63	1.20	0.00	150.0	± 9.6 %
		Y	0.00	97.90	0.75		150.0	
		Z	0.00	95.09	2.63		150.0	
10048-CAA	DECT (TDD, TDMA/FDM, GFSK, Full Slot, 24)	X	29.38	92.85	22.01	13.80	25.0	± 9.6 %
		Y	100.00	106.19	24.33		25.0	
		Z	100.00	113.54	28.60		25.0	
10049-CAA	DECT (TDD, TDMA/FDM, GFSK, Double Slot, 12)	X	92.32	108.50	25.07	10.79	40.0	± 9.6 %
		Y	100.00	108.13	24.14		40.0	
		Z	100.00	114.66	27.93		40.0	
10056-CAA	UMTS-TDD (TD-SCDMA, 1.28 Mcps)	X	28.80	103.53	27.62	9.03	50.0	± 9.6 %
		Y	100.00	125.87	33.73		50.0	
		Z	90.56	125.80	34.77		50.0	
10058-DAC	EDGE-FDD (TDMA, 8PSK, TN 0-1-2-3)	X	3.55	72.15	22.79	6.55	100.0	± 9.6 %
		Y	3.72	74.09	24.21		100.0	
		Z	4.11	74.59	23.97		100.0	
10059-CAB	IEEE 802.11b WiFi 2.4 GHz (DSSS, 2 Mbps)	X	1.17	64.52	15.76	0.61	110.0	± 9.6 %
		Y	1.20	65.09	16.25		110.0	
		Z	1.19	64.38	15.68		110.0	
10060-CAB	IEEE 802.11b WiFi 2.4 GHz (DSSS, 5.5 Mbps)	X	5.38	97.28	26.54	1.30	110.0	± 9.6 %
		Y	94.12	145.74	39.06		110.0	
		Z	7.25	100.99	27.69		110.0	

10061-CAB	IEEE 802.11b WiFi 2.4 GHz (DSSS, 11 Mbps)	X	2.03	75.84	20.79	2.04	110.0	± 9.6 %
		Y	2.53	80.86	23.32		110.0	
		Z	2.46	78.49	22.05		110.0	
10062-CAB	IEEE 802.11a/h WiFi 5 GHz (OFDM, 6 Mbps)	X	4.60	66.68	16.54	0.49	100.0	± 9.6 %
		Y	4.62	66.77	16.65		100.0	
		Z	4.74	66.54	16.54		100.0	
10063-CAB	IEEE 802.11a/h WiFi 5 GHz (OFDM, 9 Mbps)	X	4.61	66.74	16.62	0.72	100.0	± 9.6 %
		Y	4.63	66.85	16.75		100.0	
		Z	4.75	66.63	16.64		100.0	
10064-CAB	IEEE 802.11a/h WiFi 5 GHz (OFDM, 12 Mbps)	X	4.88	66.97	16.83	0.86	100.0	± 9.6 %
		Y	4.90	67.08	16.96		100.0	
		Z	5.06	66.93	16.89		100.0	
10065-CAB	IEEE 802.11a/h WiFi 5 GHz (OFDM, 18 Mbps)	X	4.74	66.82	16.90	1.21	100.0	± 9.6 %
		Y	4.76	66.95	17.05		100.0	
		Z	4.91	66.81	16.98		100.0	
10066-CAB	IEEE 802.11a/h WiFi 5 GHz (OFDM, 24 Mbps)	X	4.74	66.80	17.04	1.46	100.0	± 9.6 %
		Y	4.77	66.94	17.21		100.0	
		Z	4.93	66.83	17.15		100.0	
10067-CAB	IEEE 802.11a/h WiFi 5 GHz (OFDM, 36 Mbps)	X	5.03	66.98	17.46	2.04	100.0	± 9.6 %
		Y	5.05	67.14	17.66		100.0	
		Z	5.21	66.94	17.57		100.0	
10068-CAB	IEEE 802.11a/h WiFi 5 GHz (OFDM, 48 Mbps)	X	5.05	66.91	17.63	2.55	100.0	± 9.6 %
		Y	5.07	67.08	17.84		100.0	
		Z	5.27	67.04	17.82		100.0	
10069-CAB	IEEE 802.11a/h WiFi 5 GHz (OFDM, 54 Mbps)	X	5.12	66.93	17.81	2.67	100.0	± 9.6 %
		Y	5.15	67.10	18.04		100.0	
		Z	5.34	66.99	17.99		100.0	
10071-CAB	IEEE 802.11g WiFi 2.4 GHz (DSSS/OFDM, 9 Mbps)	X	4.86	66.65	17.32	1.99	100.0	± 9.6 %
		Y	4.89	66.79	17.50		100.0	
		Z	5.01	66.60	17.41		100.0	
10072-CAB	IEEE 802.11g WiFi 2.4 GHz (DSSS/OFDM, 12 Mbps)	X	4.82	66.89	17.50	2.30	100.0	± 9.6 %
		Y	4.84	67.05	17.70		100.0	
		Z	4.99	66.92	17.63		100.0	
10073-CAB	IEEE 802.11g WiFi 2.4 GHz (DSSS/OFDM, 18 Mbps)	X	4.86	67.00	17.79	2.83	100.0	± 9.6 %
		Y	4.89	67.17	18.02		100.0	
		Z	5.04	67.03	17.94		100.0	
10074-CAB	IEEE 802.11g WiFi 2.4 GHz (DSSS/OFDM, 24 Mbps)	X	4.85	66.87	17.91	3.30	100.0	± 9.6 %
		Y	4.86	67.04	18.15		100.0	
		Z	5.01	66.88	18.08		100.0	
10075-CAB	IEEE 802.11g WiFi 2.4 GHz (DSSS/OFDM, 36 Mbps)	X	4.86	66.89	18.16	3.82	90.0	± 9.6 %
		Y	4.87	67.06	18.42		90.0	
		Z	5.04	67.00	18.40		90.0	
10076-CAB	IEEE 802.11g WiFi 2.4 GHz (DSSS/OFDM, 48 Mbps)	X	4.88	66.70	18.29	4.15	90.0	± 9.6 %
		Y	4.89	66.85	18.55		90.0	
		Z	5.03	66.71	18.47		90.0	
10077-CAB	IEEE 802.11g WiFi 2.4 GHz (DSSS/OFDM, 54 Mbps)	X	4.91	66.76	18.38	4.30	90.0	± 9.6 %
		Y	4.91	66.91	18.65		90.0	
		Z	5.05	66.76	18.56		90.0	

10081-CAB	CDMA2000 (1xRTT, RC3)	X	0.83	66.43	12.40	0.00	150.0	± 9.6 %
		Y	0.90	67.46	13.02		150.0	
		Z	0.87	65.72	12.74		150.0	
10082-CAB	IS-54 / IS-136 FDD (TDMA/FDM, PI/4-DQPSK, Fullrate)	X	0.60	60.00	4.03	4.77	80.0	± 9.6 %
		Y	1.74	63.67	4.99		80.0	
		Z	0.50	57.10	2.51		80.0	
10090-DAC	GPRS-FDD (TDMA, GMSK, TN 0-4)	X	100.00	111.84	24.82	6.56	60.0	± 9.6 %
		Y	100.00	114.47	25.69		60.0	
		Z	100.00	118.36	28.12		60.0	
10097-CAB	UMTS-FDD (HSDPA)	X	1.87	68.36	15.98	0.00	150.0	± 9.6 %
		Y	1.92	68.79	16.27		150.0	
		Z	1.83	67.16	15.53		150.0	
10098-CAB	UMTS-FDD (HSUPA, Subtest 2)	X	1.83	68.30	15.96	0.00	150.0	± 9.6 %
		Y	1.88	68.76	16.25		150.0	
		Z	1.79	67.10	15.49		150.0	
10099-DAC	EDGE-FDD (TDMA, 8PSK, TN 0-4)	X	6.23	83.81	29.72	9.56	60.0	± 9.6 %
		Y	7.34	90.66	33.54		60.0	
		Z	7.51	87.64	31.39		60.0	
10100-CAC	LTE-FDD (SC-FDMA, 100% RB, 20 MHz, QPSK)	X	3.10	70.42	16.91	0.00	150.0	± 9.6 %
		Y	3.17	70.79	17.14		150.0	
		Z	3.14	69.95	16.56		150.0	
10101-CAC	LTE-FDD (SC-FDMA, 100% RB, 20 MHz, 16-QAM)	X	3.21	67.53	16.05	0.00	150.0	± 9.6 %
		Y	3.24	67.71	16.18		150.0	
		Z	3.28	67.33	15.89		150.0	
10102-CAC	LTE-FDD (SC-FDMA, 100% RB, 20 MHz, 64-QAM)	X	3.31	67.53	16.15	0.00	150.0	± 9.6 %
		Y	3.34	67.67	16.26		150.0	
		Z	3.39	67.31	16.00		150.0	
10103-CAC	LTE-TDD (SC-FDMA, 100% RB, 20 MHz, QPSK)	X	5.23	73.47	19.72	3.98	65.0	± 9.6 %
		Y	5.84	75.95	21.01		65.0	
		Z	5.88	74.83	20.39		65.0	
10104-CAC	LTE-TDD (SC-FDMA, 100% RB, 20 MHz, 16-QAM)	X	5.46	71.98	19.77	3.98	65.0	± 9.6 %
		Y	5.63	73.01	20.49		65.0	
		Z	6.00	73.07	20.39		65.0	
10105-CAC	LTE-TDD (SC-FDMA, 100% RB, 20 MHz, 64-QAM)	X	5.42	71.61	19.91	3.98	65.0	± 9.6 %
		Y	5.43	72.06	20.36		65.0	
		Z	5.47	71.05	19.77		65.0	
10108-CAD	LTE-FDD (SC-FDMA, 100% RB, 10 MHz, QPSK)	X	2.70	69.72	16.76	0.00	150.0	± 9.6 %
		Y	2.76	70.10	16.99		150.0	
		Z	2.75	69.19	16.39		150.0	
10109-CAD	LTE-FDD (SC-FDMA, 100% RB, 10 MHz, 16-QAM)	X	2.86	67.48	15.96	0.00	150.0	± 9.6 %
		Y	2.89	67.67	16.11		150.0	
		Z	2.94	67.16	15.80		150.0	
10110-CAD	LTE-FDD (SC-FDMA, 100% RB, 5 MHz, QPSK)	X	2.18	68.93	16.34	0.00	150.0	± 9.6 %
		Y	2.24	69.40	16.63		150.0	
		Z	2.24	68.24	15.99		150.0	
10111-CAD	LTE-FDD (SC-FDMA, 100% RB, 5 MHz, 16-QAM)	X	2.61	68.71	16.36	0.00	150.0	± 9.6 %
		Y	2.63	68.84	16.47		150.0	
		Z	2.65	67.91	16.10		150.0	

10112-CAD	LTE-FDD (SC-FDMA, 100% RB, 10 MHz, 64-QAM)	X	2.99	67.52	16.03	0.00	150.0	± 9.6 %
		Y	3.01	67.67	16.15		150.0	
		Z	3.06	67.16	15.86		150.0	
10113-CAD	LTE-FDD (SC-FDMA, 100% RB, 5 MHz, 64-QAM)	X	2.77	68.89	16.50	0.00	150.0	± 9.6 %
		Y	2.78	68.97	16.58		150.0	
		Z	2.81	68.06	16.24		150.0	
10114-CAB	IEEE 802.11n (HT Greenfield, 13.5 Mbps, BPSK)	X	5.09	67.23	16.55	0.00	150.0	± 9.6 %
		Y	5.10	67.28	16.60		150.0	
		Z	5.19	67.11	16.46		150.0	
10115-CAB	IEEE 802.11n (HT Greenfield, 81 Mbps, 16-QAM)	X	5.34	67.29	16.58	0.00	150.0	± 9.6 %
		Y	5.35	67.33	16.63		150.0	
		Z	5.51	67.33	16.58		150.0	
10116-CAB	IEEE 802.11n (HT Greenfield, 135 Mbps, 64-QAM)	X	5.18	67.42	16.57	0.00	150.0	± 9.6 %
		Y	5.19	67.47	16.62		150.0	
		Z	5.30	67.34	16.50		150.0	
10117-CAB	IEEE 802.11n (HT Mixed, 13.5 Mbps, BPSK)	X	5.06	67.11	16.50	0.00	150.0	± 9.6 %
		Y	5.07	67.16	16.56		150.0	
		Z	5.16	66.99	16.42		150.0	
10118-CAB	IEEE 802.11n (HT Mixed, 81 Mbps, 16-QAM)	X	5.42	67.49	16.69	0.00	150.0	± 9.6 %
		Y	5.44	67.54	16.74		150.0	
		Z	5.60	67.55	16.70		150.0	
10119-CAB	IEEE 802.11n (HT Mixed, 135 Mbps, 64-QAM)	X	5.16	67.38	16.56	0.00	150.0	± 9.6 %
		Y	5.17	67.43	16.62		150.0	
		Z	5.27	67.27	16.48		150.0	
10140-CAC	LTE-FDD (SC-FDMA, 100% RB, 15 MHz, 16-QAM)	X	3.34	67.53	16.06	0.00	150.0	± 9.6 %
		Y	3.37	67.68	16.18		150.0	
		Z	3.42	67.31	15.91		150.0	
10141-CAC	LTE-FDD (SC-FDMA, 100% RB, 15 MHz, 64-QAM)	X	3.47	67.67	16.25	0.00	150.0	± 9.6 %
		Y	3.49	67.79	16.35		150.0	
		Z	3.55	67.42	16.09		150.0	
10142-CAD	LTE-FDD (SC-FDMA, 100% RB, 3 MHz, QPSK)	X	1.97	69.09	15.95	0.00	150.0	± 9.6 %
		Y	2.03	69.63	16.28		150.0	
		Z	2.02	68.20	15.69		150.0	
10143-CAD	LTE-FDD (SC-FDMA, 100% RB, 3 MHz, 16-QAM)	X	2.49	69.65	15.98	0.00	150.0	± 9.6 %
		Y	2.52	69.83	16.12		150.0	
		Z	2.51	68.62	15.86		150.0	
10144-CAD	LTE-FDD (SC-FDMA, 100% RB, 3 MHz, 64-QAM)	X	2.16	66.67	13.99	0.00	150.0	± 9.6 %
		Y	2.21	66.99	14.22		150.0	
		Z	2.30	66.43	14.30		150.0	
10145-CAD	LTE-FDD (SC-FDMA, 100% RB, 1.4 MHz, QPSK)	X	1.07	64.11	10.67	0.00	150.0	± 9.6 %
		Y	1.11	64.57	11.01		150.0	
		Z	1.31	65.51	12.40		150.0	
10146-CAD	LTE-FDD (SC-FDMA, 100% RB, 1.4 MHz, 16-QAM)	X	1.34	62.65	9.02	0.00	150.0	± 9.6 %
		Y	1.43	63.27	9.42		150.0	
		Z	2.01	66.35	12.18		150.0	
10147-CAD	LTE-FDD (SC-FDMA, 100% RB, 1.4 MHz, 64-QAM)	X	1.45	63.47	9.57	0.00	150.0	± 9.6 %
		Y	1.57	64.27	10.06		150.0	
		Z	2.34	68.34	13.28		150.0	

10149-CAC	LTE-FDD (SC-FDMA, 50% RB, 20 MHz, 16-QAM)	X	2.87	67.55	16.01	0.00	150.0	± 9.6 %
		Y	2.90	67.73	16.15		150.0	
		Z	2.95	67.22	15.84		150.0	
10150-CAC	LTE-FDD (SC-FDMA, 50% RB, 20 MHz, 64-QAM)	X	3.00	67.58	16.08	0.00	150.0	± 9.6 %
		Y	3.02	67.73	16.20		150.0	
		Z	3.07	67.21	15.90		150.0	
10151-CAC	LTE-TDD (SC-FDMA, 50% RB, 20 MHz, QPSK)	X	5.65	76.57	21.08	3.98	65.0	± 9.6 %
		Y	6.17	78.83	22.29		65.0	
		Z	6.35	77.82	21.74		65.0	
10152-CAC	LTE-TDD (SC-FDMA, 50% RB, 20 MHz, 16-QAM)	X	4.98	71.84	19.37	3.98	65.0	± 9.6 %
		Y	5.18	73.09	20.20		65.0	
		Z	5.53	73.00	20.11		65.0	
10153-CAC	LTE-TDD (SC-FDMA, 50% RB, 20 MHz, 64-QAM)	X	5.35	72.93	20.23	3.98	65.0	± 9.6 %
		Y	5.53	74.06	20.99		65.0	
		Z	5.88	73.94	20.90		65.0	
10154-CAD	LTE-FDD (SC-FDMA, 50% RB, 10 MHz, QPSK)	X	2.24	69.40	16.63	0.00	150.0	± 9.6 %
		Y	2.29	69.81	16.88		150.0	
		Z	2.29	68.69	16.27		150.0	
10155-CAD	LTE-FDD (SC-FDMA, 50% RB, 10 MHz, 16-QAM)	X	2.62	68.74	16.38	0.00	150.0	± 9.6 %
		Y	2.64	68.87	16.49		150.0	
		Z	2.65	67.91	16.11		150.0	
10156-CAD	LTE-FDD (SC-FDMA, 50% RB, 5 MHz, QPSK)	X	1.81	69.21	15.68	0.00	150.0	± 9.6 %
		Y	1.88	69.80	16.04		150.0	
		Z	1.87	68.31	15.53		150.0	
10157-CAD	LTE-FDD (SC-FDMA, 50% RB, 5 MHz, 16-QAM)	X	2.01	67.27	13.98	0.00	150.0	± 9.6 %
		Y	2.06	67.66	14.24		150.0	
		Z	2.13	67.00	14.37		150.0	
10158-CAD	LTE-FDD (SC-FDMA, 50% RB, 10 MHz, 64-QAM)	X	2.78	68.97	16.55	0.00	150.0	± 9.6 %
		Y	2.79	69.05	16.63		150.0	
		Z	2.81	68.12	16.28		150.0	
10159-CAD	LTE-FDD (SC-FDMA, 50% RB, 5 MHz, 64-QAM)	X	2.12	67.76	14.27	0.00	150.0	± 9.6 %
		Y	2.17	68.10	14.50		150.0	
		Z	2.25	67.49	14.68		150.0	
10160-CAC	LTE-FDD (SC-FDMA, 50% RB, 15 MHz, QPSK)	X	2.73	68.96	16.55	0.00	150.0	± 9.6 %
		Y	2.78	69.27	16.76		150.0	
		Z	2.78	68.34	16.22		150.0	
10161-CAC	LTE-FDD (SC-FDMA, 50% RB, 15 MHz, 16-QAM)	X	2.89	67.56	16.00	0.00	150.0	± 9.6 %
		Y	2.92	67.72	16.12		150.0	
		Z	2.97	67.14	15.84		150.0	
10162-CAC	LTE-FDD (SC-FDMA, 50% RB, 15 MHz, 64-QAM)	X	3.00	67.76	16.13	0.00	150.0	± 9.6 %
		Y	3.03	67.89	16.24		150.0	
		Z	3.08	67.27	15.94		150.0	
10166-CAD	LTE-FDD (SC-FDMA, 50% RB, 1.4 MHz, QPSK)	X	3.29	68.55	18.62	3.01	150.0	± 9.6 %
		Y	3.39	69.14	19.00		150.0	
		Z	3.56	68.77	18.74		150.0	
10167-CAD	LTE-FDD (SC-FDMA, 50% RB, 1.4 MHz, 16-QAM)	X	3.85	70.83	18.84	3.01	150.0	± 9.6 %
		Y	4.06	71.87	19.39		150.0	
		Z	4.27	71.19	19.04		150.0	

10168-CAD	LTE-FDD (SC-FDMA, 50% RB, 1.4 MHz, 64-QAM)	X	4.31	73.34	20.36	3.01	150.0	± 9.6 %
		Y	4.51	74.19	20.77		150.0	
		Z	4.72	73.40	20.38		150.0	
10169-CAC	LTE-FDD (SC-FDMA, 1 RB, 20 MHz, QPSK)	X	2.65	67.07	17.95	3.01	150.0	± 9.6 %
		Y	2.76	67.90	18.46		150.0	
		Z	2.95	68.18	18.47		150.0	
10170-CAC	LTE-FDD (SC-FDMA, 1 RB, 20 MHz, 16-QAM)	X	3.35	71.83	19.98	3.01	150.0	± 9.6 %
		Y	3.58	73.08	20.56		150.0	
		Z	3.90	73.37	20.58		150.0	
10171-AAC	LTE-FDD (SC-FDMA, 1 RB, 20 MHz, 64-QAM)	X	2.80	68.11	17.24	3.01	150.0	± 9.6 %
		Y	3.01	69.49	17.99		150.0	
		Z	3.23	69.44	17.85		150.0	
10172-CAC	LTE-TDD (SC-FDMA, 1 RB, 20 MHz, QPSK)	X	3.65	76.31	22.99	6.02	65.0	± 9.6 %
		Y	5.48	85.89	27.40		65.0	
		Z	5.55	83.03	25.87		65.0	
10173-CAC	LTE-TDD (SC-FDMA, 1 RB, 20 MHz, 16-QAM)	X	6.66	85.15	24.55	6.02	65.0	± 9.6 %
		Y	10.56	95.03	28.43		65.0	
		Z	12.26	94.72	28.10		65.0	
10174-CAC	LTE-TDD (SC-FDMA, 1 RB, 20 MHz, 64-QAM)	X	4.93	79.32	21.92	6.02	65.0	± 9.6 %
		Y	8.98	90.91	26.48		65.0	
		Z	8.81	87.78	25.30		65.0	
10175-CAD	LTE-FDD (SC-FDMA, 1 RB, 10 MHz, QPSK)	X	2.62	66.79	17.70	3.01	150.0	± 9.6 %
		Y	2.73	67.64	18.24		150.0	
		Z	2.91	67.87	18.21		150.0	
10176-CAD	LTE-FDD (SC-FDMA, 1 RB, 10 MHz, 16-QAM)	X	3.35	71.86	19.99	3.01	150.0	± 9.6 %
		Y	3.58	73.10	20.58		150.0	
		Z	3.90	73.39	20.59		150.0	
10177-CAF	LTE-FDD (SC-FDMA, 1 RB, 5 MHz, QPSK)	X	2.64	66.92	17.79	3.01	150.0	± 9.6 %
		Y	2.75	67.76	18.31		150.0	
		Z	2.94	68.03	18.32		150.0	
10178-CAD	LTE-FDD (SC-FDMA, 1 RB, 5 MHz, 16-QAM)	X	3.33	71.68	19.88	3.01	150.0	± 9.6 %
		Y	3.56	72.95	20.49		150.0	
		Z	3.86	73.15	20.45		150.0	
10179-CAD	LTE-FDD (SC-FDMA, 1 RB, 10 MHz, 64-QAM)	X	3.04	69.83	18.46	3.01	150.0	± 9.6 %
		Y	3.27	71.21	19.16		150.0	
		Z	3.53	71.24	19.06		150.0	
10180-CAD	LTE-FDD (SC-FDMA, 1 RB, 5 MHz, 64-QAM)	X	2.79	68.06	17.20	3.01	150.0	± 9.6 %
		Y	3.00	69.44	17.95		150.0	
		Z	3.23	69.37	17.80		150.0	
10181-CAC	LTE-FDD (SC-FDMA, 1 RB, 15 MHz, QPSK)	X	2.64	66.91	17.79	3.01	150.0	± 9.6 %
		Y	2.74	67.75	18.31		150.0	
		Z	2.93	68.01	18.31		150.0	
10182-CAC	LTE-FDD (SC-FDMA, 1 RB, 15 MHz, 16-QAM)	X	3.32	71.66	19.87	3.01	150.0	± 9.6 %
		Y	3.55	72.93	20.48		150.0	
		Z	3.85	73.13	20.44		150.0	
10183-AAB	LTE-FDD (SC-FDMA, 1 RB, 15 MHz, 64-QAM)	X	2.79	68.04	17.19	3.01	150.0	± 9.6 %
		Y	3.00	69.42	17.94		150.0	
		Z	3.22	69.35	17.79		150.0	

10184-CAD	LTE-FDD (SC-FDMA, 1 RB, 3 MHz, QPSK)	X	2.65	66.95	17.81	3.01	150.0	± 9.6 %
		Y	2.75	67.79	18.33		150.0	
		Z	2.95	68.05	18.33		150.0	
10185-CAD	LTE-FDD (SC-FDMA, 1 RB, 3 MHz, 16-QAM)	X	3.34	71.72	19.91	3.01	150.0	± 9.6 %
		Y	3.57	72.99	20.51		150.0	
		Z	3.87	73.20	20.48		150.0	
10186-AAD	LTE-FDD (SC-FDMA, 1 RB, 3 MHz, 64-QAM)	X	2.80	68.09	17.22	3.01	150.0	± 9.6 %
		Y	3.01	69.48	17.97		150.0	
		Z	3.23	69.41	17.82		150.0	
10187-CAD	LTE-FDD (SC-FDMA, 1 RB, 1.4 MHz, QPSK)	X	2.66	67.00	17.88	3.01	150.0	± 9.6 %
		Y	2.76	67.84	18.40		150.0	
		Z	2.95	68.09	18.39		150.0	
10188-CAD	LTE-FDD (SC-FDMA, 1 RB, 1.4 MHz, 16-QAM)	X	3.43	72.31	20.28	3.01	150.0	± 9.6 %
		Y	3.66	73.53	20.84		150.0	
		Z	4.00	73.86	20.87		150.0	
10189-AAD	LTE-FDD (SC-FDMA, 1 RB, 1.4 MHz, 64-QAM)	X	2.85	68.45	17.48	3.01	150.0	± 9.6 %
		Y	3.07	69.84	18.22		150.0	
		Z	3.30	69.81	18.09		150.0	
10193-CAB	IEEE 802.11n (HT Greenfield, 6.5 Mbps, BPSK)	X	4.48	66.73	16.24	0.00	150.0	± 9.6 %
		Y	4.49	66.78	16.30		150.0	
		Z	4.58	66.49	16.16		150.0	
10194-CAB	IEEE 802.11n (HT Greenfield, 39 Mbps, 16-QAM)	X	4.63	67.01	16.37	0.00	150.0	± 9.6 %
		Y	4.65	67.06	16.43		150.0	
		Z	4.76	66.82	16.28		150.0	
10195-CAB	IEEE 802.11n (HT Greenfield, 65 Mbps, 64-QAM)	X	4.67	67.04	16.38	0.00	150.0	± 9.6 %
		Y	4.69	67.09	16.44		150.0	
		Z	4.80	66.85	16.30		150.0	
10196-CAB	IEEE 802.11n (HT Mixed, 6.5 Mbps, BPSK)	X	4.47	66.77	16.24	0.00	150.0	± 9.6 %
		Y	4.48	66.82	16.30		150.0	
		Z	4.59	66.56	16.19		150.0	
10197-CAB	IEEE 802.11n (HT Mixed, 39 Mbps, 16-QAM)	X	4.64	67.02	16.38	0.00	150.0	± 9.6 %
		Y	4.66	67.08	16.44		150.0	
		Z	4.78	66.84	16.30		150.0	
10198-CAB	IEEE 802.11n (HT Mixed, 65 Mbps, 64-QAM)	X	4.67	67.05	16.39	0.00	150.0	± 9.6 %
		Y	4.68	67.10	16.45		150.0	
		Z	4.81	66.86	16.31		150.0	
10219-CAB	IEEE 802.11n (HT Mixed, 7.2 Mbps, BPSK)	X	4.42	66.79	16.21	0.00	150.0	± 9.6 %
		Y	4.44	66.84	16.27		150.0	
		Z	4.54	66.57	16.15		150.0	
10220-CAB	IEEE 802.11n (HT Mixed, 43.3 Mbps, 16-QAM)	X	4.64	66.99	16.36	0.00	150.0	± 9.6 %
		Y	4.65	67.04	16.42		150.0	
		Z	4.77	66.82	16.29		150.0	
10221-CAB	IEEE 802.11n (HT Mixed, 72.2 Mbps, 64-QAM)	X	4.68	66.98	16.38	0.00	150.0	± 9.6 %
		Y	4.69	67.03	16.44		150.0	
		Z	4.81	66.80	16.30		150.0	
10222-CAB	IEEE 802.11n (HT Mixed, 15 Mbps, BPSK)	X	5.03	67.11	16.49	0.00	150.0	± 9.6 %
		Y	5.04	67.15	16.55		150.0	
		Z	5.14	67.00	16.41		150.0	

10223-CAB	IEEE 802.11n (HT Mixed, 90 Mbps, 16-QAM)	X	5.33	67.33	16.62	0.00	150.0	± 9.6 %
		Y	5.34	67.38	16.68		150.0	
		Z	5.45	67.21	16.54		150.0	
10224-CAB	IEEE 802.11n (HT Mixed, 150 Mbps, 64-QAM)	X	5.07	67.22	16.48	0.00	150.0	± 9.6 %
		Y	5.09	67.26	16.53		150.0	
		Z	5.18	67.11	16.40		150.0	
10225-CAB	UMTS-FDD (HSPA+)	X	2.76	66.33	15.32	0.00	150.0	± 9.6 %
		Y	2.78	66.46	15.44		150.0	
		Z	2.85	65.93	15.34		150.0	
10226-CAA	LTE-TDD (SC-FDMA, 1 RB, 1.4 MHz, 16-QAM)	X	7.05	86.26	25.03	6.02	65.0	± 9.6 %
		Y	11.33	96.43	28.97		65.0	
		Z	13.18	96.17	28.66		65.0	
10227-CAA	LTE-TDD (SC-FDMA, 1 RB, 1.4 MHz, 64-QAM)	X	7.07	85.23	24.04	6.02	65.0	± 9.6 %
		Y	11.45	95.09	27.83		65.0	
		Z	12.76	94.16	27.40		65.0	
10228-CAA	LTE-TDD (SC-FDMA, 1 RB, 1.4 MHz, QPSK)	X	4.84	82.15	25.37	6.02	65.0	± 9.6 %
		Y	6.17	88.64	28.46		65.0	
		Z	7.76	90.12	28.51		65.0	
10229-CAB	LTE-TDD (SC-FDMA, 1 RB, 3 MHz, 16-QAM)	X	6.71	85.26	24.59	6.02	65.0	± 9.6 %
		Y	10.65	95.13	28.47		65.0	
		Z	12.36	94.84	28.14		65.0	
10230-CAB	LTE-TDD (SC-FDMA, 1 RB, 3 MHz, 64-QAM)	X	6.68	84.20	23.61	6.02	65.0	± 9.6 %
		Y	10.65	93.73	27.33		65.0	
		Z	11.94	92.89	26.92		65.0	
10231-CAB	LTE-TDD (SC-FDMA, 1 RB, 3 MHz, QPSK)	X	4.67	81.40	24.99	6.02	65.0	± 9.6 %
		Y	5.94	87.77	28.07		65.0	
		Z	7.43	89.17	28.10		65.0	
10232-CAC	LTE-TDD (SC-FDMA, 1 RB, 5 MHz, 16-QAM)	X	6.69	85.24	24.58	6.02	65.0	± 9.6 %
		Y	10.63	95.12	28.47		65.0	
		Z	12.34	94.82	28.14		65.0	
10233-CAC	LTE-TDD (SC-FDMA, 1 RB, 5 MHz, 64-QAM)	X	6.66	84.17	23.60	6.02	65.0	± 9.6 %
		Y	10.62	93.69	27.32		65.0	
		Z	11.91	92.86	26.91		65.0	
10234-CAC	LTE-TDD (SC-FDMA, 1 RB, 5 MHz, QPSK)	X	4.54	80.75	24.63	6.02	65.0	± 9.6 %
		Y	5.76	87.05	27.69		65.0	
		Z	7.17	88.32	27.68		65.0	
10235-CAC	LTE-TDD (SC-FDMA, 1 RB, 10 MHz, 16-QAM)	X	6.69	85.26	24.59	6.02	65.0	± 9.6 %
		Y	10.64	95.16	28.48		65.0	
		Z	12.35	94.85	28.15		65.0	
10236-CAC	LTE-TDD (SC-FDMA, 1 RB, 10 MHz, 64-QAM)	X	6.73	84.30	23.64	6.02	65.0	± 9.6 %
		Y	10.78	93.91	27.38		65.0	
		Z	12.05	93.03	26.96		65.0	
10237-CAC	LTE-TDD (SC-FDMA, 1 RB, 10 MHz, QPSK)	X	4.67	81.42	25.00	6.02	65.0	± 9.6 %
		Y	5.94	87.83	28.10		65.0	
		Z	7.43	89.21	28.12		65.0	
10238-CAC	LTE-TDD (SC-FDMA, 1 RB, 15 MHz, 16-QAM)	X	6.68	85.21	24.57	6.02	65.0	± 9.6 %
		Y	10.60	95.09	28.46		65.0	
		Z	12.31	94.79	28.13		65.0	

10239-CAC	LTE-TDD (SC-FDMA, 1 RB, 15 MHz, 64-QAM)	X	6.64	84.13	23.58	6.02	65.0	± 9.6 %
		Y	10.57	93.64	27.30		65.0	
		Z	11.87	92.82	26.90		65.0	
10240-CAC	LTE-TDD (SC-FDMA, 1 RB, 15 MHz, QPSK)	X	4.66	81.38	24.99	6.02	65.0	± 9.6 %
		Y	5.92	87.78	28.08		65.0	
		Z	7.41	89.16	28.10		65.0	
10241-CAA	LTE-TDD (SC-FDMA, 50% RB, 1.4 MHz, 16-QAM)	X	6.49	77.69	23.88	6.98	65.0	± 9.6 %
		Y	7.06	80.22	25.34		65.0	
		Z	7.33	78.75	24.61		65.0	
10242-CAA	LTE-TDD (SC-FDMA, 50% RB, 1.4 MHz, 64-QAM)	X	5.69	74.96	22.63	6.98	65.0	± 9.6 %
		Y	6.72	79.20	24.84		65.0	
		Z	6.48	76.10	23.39		65.0	
10243-CAA	LTE-TDD (SC-FDMA, 50% RB, 1.4 MHz, QPSK)	X	5.22	73.93	23.04	6.98	65.0	± 9.6 %
		Y	5.37	75.23	24.06		65.0	
		Z	5.30	72.76	22.72		65.0	
10244-CAB	LTE-TDD (SC-FDMA, 50% RB, 3 MHz, 16-QAM)	X	4.03	70.70	15.63	3.98	65.0	± 9.6 %
		Y	4.63	73.27	17.01		65.0	
		Z	5.80	76.12	19.17		65.0	
10245-CAB	LTE-TDD (SC-FDMA, 50% RB, 3 MHz, 64-QAM)	X	3.94	70.12	15.32	3.98	65.0	± 9.6 %
		Y	4.47	72.48	16.60		65.0	
		Z	5.67	75.49	18.85		65.0	
10246-CAB	LTE-TDD (SC-FDMA, 50% RB, 3 MHz, QPSK)	X	4.17	75.16	18.15	3.98	65.0	± 9.6 %
		Y	5.29	79.64	20.23		65.0	
		Z	5.81	80.17	21.10		65.0	
10247-CAC	LTE-TDD (SC-FDMA, 50% RB, 5 MHz, 16-QAM)	X	4.10	71.58	17.29	3.98	65.0	± 9.6 %
		Y	4.43	73.43	18.37		65.0	
		Z	4.92	74.07	19.21		65.0	
10248-CAC	LTE-TDD (SC-FDMA, 50% RB, 5 MHz, 64-QAM)	X	4.07	70.96	16.98	3.98	65.0	± 9.6 %
		Y	4.37	72.65	17.99		65.0	
		Z	4.90	73.42	18.88		65.0	
10249-CAC	LTE-TDD (SC-FDMA, 50% RB, 5 MHz, QPSK)	X	5.33	79.24	20.92	3.98	65.0	± 9.6 %
		Y	6.73	84.01	23.05		65.0	
		Z	6.62	82.34	22.76		65.0	
10250-CAC	LTE-TDD (SC-FDMA, 50% RB, 10 MHz, 16-QAM)	X	4.99	74.32	20.40	3.98	65.0	± 9.6 %
		Y	5.24	75.79	21.30		65.0	
		Z	5.59	75.60	21.35		65.0	
10251-CAC	LTE-TDD (SC-FDMA, 50% RB, 10 MHz, 64-QAM)	X	4.75	72.14	19.02	3.98	65.0	± 9.6 %
		Y	4.99	73.56	19.92		65.0	
		Z	5.35	73.44	20.02		65.0	
10252-CAC	LTE-TDD (SC-FDMA, 50% RB, 10 MHz, QPSK)	X	5.62	79.05	22.01	3.98	65.0	± 9.6 %
		Y	6.48	82.42	23.65		65.0	
		Z	6.49	80.72	22.96		65.0	
10253-CAC	LTE-TDD (SC-FDMA, 50% RB, 15 MHz, 16-QAM)	X	4.91	71.43	19.12	3.98	65.0	± 9.6 %
		Y	5.09	72.60	19.93		65.0	
		Z	5.40	72.41	19.86		65.0	
10254-CAC	LTE-TDD (SC-FDMA, 50% RB, 15 MHz, 64-QAM)	X	5.23	72.40	19.88	3.98	65.0	± 9.6 %
		Y	5.41	73.49	20.63		65.0	
		Z	5.73	73.30	20.57		65.0	

10255-CAC	LTE-TDD (SC-FDMA, 50% RB, 15 MHz, QPSK)	X	5.37	75.82	20.95	3.98	65.0	± 9.6 %
		Y	5.81	77.90	22.11		65.0	
		Z	5.98	76.90	21.60		65.0	
10256-CAA	LTE-TDD (SC-FDMA, 100% RB, 1.4 MHz, 16-QAM)	X	2.95	66.44	12.43	3.98	65.0	± 9.6 %
		Y	3.25	68.14	13.47		65.0	
		Z	4.63	72.57	16.66		65.0	
10257-CAA	LTE-TDD (SC-FDMA, 100% RB, 1.4 MHz, 64-QAM)	X	2.90	65.89	12.05	3.98	65.0	± 9.6 %
		Y	3.14	67.36	12.98		65.0	
		Z	4.49	71.73	16.18		65.0	
10258-CAA	LTE-TDD (SC-FDMA, 100% RB, 1.4 MHz, QPSK)	X	2.90	69.51	14.64	3.98	65.0	± 9.6 %
		Y	3.44	72.54	16.25		65.0	
		Z	4.52	75.89	18.60		65.0	
10259-CAB	LTE-TDD (SC-FDMA, 100% RB, 3 MHz, 16-QAM)	X	4.46	72.72	18.47	3.98	65.0	± 9.6 %
		Y	4.78	74.47	19.50		65.0	
		Z	5.19	74.62	19.97		65.0	
10260-CAB	LTE-TDD (SC-FDMA, 100% RB, 3 MHz, 64-QAM)	X	4.49	72.43	18.33	3.98	65.0	± 9.6 %
		Y	4.79	74.08	19.32		65.0	
		Z	5.22	74.34	19.84		65.0	
10261-CAB	LTE-TDD (SC-FDMA, 100% RB, 3 MHz, QPSK)	X	5.17	78.27	21.02	3.98	65.0	± 9.6 %
		Y	6.16	82.12	22.85		65.0	
		Z	6.14	80.53	22.44		65.0	
10262-CAC	LTE-TDD (SC-FDMA, 100% RB, 5 MHz, 16-QAM)	X	4.98	74.25	20.35	3.98	65.0	± 9.6 %
		Y	5.23	75.73	21.26		65.0	
		Z	5.58	75.55	21.31		65.0	
10263-CAC	LTE-TDD (SC-FDMA, 100% RB, 5 MHz, 64-QAM)	X	4.74	72.12	19.01	3.98	65.0	± 9.6 %
		Y	4.98	73.53	19.91		65.0	
		Z	5.34	73.42	20.01		65.0	
10264-CAC	LTE-TDD (SC-FDMA, 100% RB, 5 MHz, QPSK)	X	5.56	78.83	21.90	3.98	65.0	± 9.6 %
		Y	6.41	82.18	23.54		65.0	
		Z	6.42	80.51	22.86		65.0	
10265-CAC	LTE-TDD (SC-FDMA, 100% RB, 10 MHz, 16-QAM)	X	4.98	71.84	19.37	3.98	65.0	± 9.6 %
		Y	5.18	73.09	20.20		65.0	
		Z	5.53	73.00	20.12		65.0	
10266-CAC	LTE-TDD (SC-FDMA, 100% RB, 10 MHz, 64-QAM)	X	5.34	72.91	20.22	3.98	65.0	± 9.6 %
		Y	5.53	74.04	20.98		65.0	
		Z	5.88	73.92	20.89		65.0	
10267-CAC	LTE-TDD (SC-FDMA, 100% RB, 10 MHz, QPSK)	X	5.64	76.53	21.06	3.98	65.0	± 9.6 %
		Y	6.16	78.78	22.27		65.0	
		Z	6.34	77.78	21.72		65.0	
10268-CAC	LTE-TDD (SC-FDMA, 100% RB, 15 MHz, 16-QAM)	X	5.63	71.94	19.85	3.98	65.0	± 9.6 %
		Y	5.78	72.88	20.51		65.0	
		Z	6.14	72.88	20.41		65.0	
10269-CAC	LTE-TDD (SC-FDMA, 100% RB, 15 MHz, 64-QAM)	X	5.64	71.57	19.72	3.98	65.0	± 9.6 %
		Y	5.77	72.45	20.36		65.0	
		Z	6.12	72.44	20.27		65.0	
10270-CAC	LTE-TDD (SC-FDMA, 100% RB, 15 MHz, QPSK)	X	5.66	74.09	20.17	3.98	65.0	± 9.6 %
		Y	5.94	75.48	21.01		65.0	
		Z	6.22	75.05	20.69		65.0	

10274-CAB	UMTS-FDD (HSUPA, Subtest 5, 3GPP Rel8.10)	X	2.58	66.84	15.32	0.00	150.0	± 9.6 %
		Y	2.61	67.05	15.49		150.0	
		Z	2.61	66.19	15.19		150.0	
10275-CAB	UMTS-FDD (HSUPA, Subtest 5, 3GPP Rel8.4)	X	1.62	68.33	15.81	0.00	150.0	± 9.6 %
		Y	1.68	69.01	16.23		150.0	
		Z	1.61	67.33	15.34		150.0	
10277-CAA	PHS (QPSK)	X	1.71	60.26	5.85	9.03	50.0	± 9.6 %
		Y	1.46	60.00	5.35		50.0	
		Z	2.08	61.87	7.57		50.0	
10278-CAA	PHS (QPSK, BW 884MHz, Rolloff 0.5)	X	3.48	68.77	13.21	9.03	50.0	± 9.6 %
		Y	3.86	71.42	14.38		50.0	
		Z	7.61	81.06	19.61		50.0	
10279-CAA	PHS (QPSK, BW 884MHz, Rolloff 0.38)	X	3.59	69.09	13.42	9.03	50.0	± 9.6 %
		Y	4.03	71.88	14.65		50.0	
		Z	7.80	81.31	19.76		50.0	
10290-AAB	CDMA2000, RC1, SO55, Full Rate	X	1.38	68.75	13.54	0.00	150.0	± 9.6 %
		Y	1.49	69.81	14.11		150.0	
		Z	1.48	68.40	14.11		150.0	
10291-AAB	CDMA2000, RC3, SO55, Full Rate	X	0.81	66.18	12.25	0.00	150.0	± 9.6 %
		Y	0.88	67.15	12.85		150.0	
		Z	0.85	65.51	12.62		150.0	
10292-AAB	CDMA2000, RC3, SO32, Full Rate	X	1.25	72.63	15.60	0.00	150.0	± 9.6 %
		Y	1.48	75.02	16.70		150.0	
		Z	1.05	69.24	14.85		150.0	
10293-AAB	CDMA2000, RC3, SO3, Full Rate	X	3.55	87.18	21.36	0.00	150.0	± 9.6 %
		Y	4.57	90.90	22.67		150.0	
		Z	1.55	74.98	17.80		150.0	
10295-AAB	CDMA2000, RC1, SO3, 1/8th Rate 25 fr.	X	10.90	87.79	24.10	9.03	50.0	± 9.6 %
		Y	17.38	97.96	27.91		50.0	
		Z	9.27	86.92	25.25		50.0	
10297-AAB	LTE-FDD (SC-FDMA, 50% RB, 20 MHz, QPSK)	X	2.71	69.84	16.83	0.00	150.0	± 9.6 %
		Y	2.77	70.21	17.06		150.0	
		Z	2.77	69.29	16.46		150.0	
10298-AAC	LTE-FDD (SC-FDMA, 50% RB, 3 MHz, QPSK)	X	1.47	67.49	13.62	0.00	150.0	± 9.6 %
		Y	1.54	68.13	14.02		150.0	
		Z	1.61	67.49	14.26		150.0	
10299-AAC	LTE-FDD (SC-FDMA, 50% RB, 3 MHz, 16-QAM)	X	1.91	66.04	11.93	0.00	150.0	± 9.6 %
		Y	2.08	67.06	12.49		150.0	
		Z	2.55	68.88	14.29		150.0	
10300-AAC	LTE-FDD (SC-FDMA, 50% RB, 3 MHz, 64-QAM)	X	1.52	62.84	9.56	0.00	150.0	± 9.6 %
		Y	1.60	63.32	9.89		150.0	
		Z	2.01	64.97	11.67		150.0	
10301-AAA	IEEE 802.16e WiMAX (29:18, 5ms, 10MHz, QPSK, PUSC)	X	4.49	64.94	17.15	4.17	50.0	± 9.6 %
		Y	4.51	65.12	17.33		50.0	
		Z	4.77	65.09	17.35		50.0	
10302-AAA	IEEE 802.16e WiMAX (29:18, 5ms, 10MHz, QPSK, PUSC, 3 CTRL symbols)	X	4.98	65.58	17.87	4.96	50.0	± 9.6 %
		Y	5.02	65.83	18.08		50.0	
		Z	5.23	65.61	18.00		50.0	

10303-AAA	IEEE 802.16e WiMAX (31:15, 5ms, 10MHz, 64QAM, PUSC)	X	4.72	65.17	17.66	4.96	50.0	± 9.6 %
		Y	4.76	65.39	17.86		50.0	
		Z	4.98	65.24	17.83		50.0	
10304-AAA	IEEE 802.16e WiMAX (29:18, 5ms, 10MHz, 64QAM, PUSC)	X	4.56	65.16	17.23	4.17	50.0	± 9.6 %
		Y	4.60	65.38	17.42		50.0	
		Z	4.79	65.14	17.34		50.0	
10305-AAA	IEEE 802.16e WiMAX (31:15, 10ms, 10MHz, 64QAM, PUSC, 15 symbols)	X	4.06	66.26	18.68	6.02	35.0	± 9.6 %
		Y	3.98	66.05	18.73		35.0	
		Z	4.32	66.47	19.19		35.0	
10306-AAA	IEEE 802.16e WiMAX (29:18, 10ms, 10MHz, 64QAM, PUSC, 18 symbols)	X	4.43	65.65	18.52	6.02	35.0	± 9.6 %
		Y	4.40	65.62	18.63		35.0	
		Z	4.69	65.80	18.88		35.0	
10307-AAA	IEEE 802.16e WiMAX (29:18, 10ms, 10MHz, QPSK, PUSC, 18 symbols)	X	4.31	65.69	18.43	6.02	35.0	± 9.6 %
		Y	4.27	65.62	18.52		35.0	
		Z	4.59	65.95	18.85		35.0	
10308-AAA	IEEE 802.16e WiMAX (29:18, 10ms, 10MHz, 16QAM, PUSC)	X	4.28	65.86	18.56	6.02	35.0	± 9.6 %
		Y	4.24	65.78	18.65		35.0	
		Z	4.55	66.08	18.95		35.0	
10309-AAA	IEEE 802.16e WiMAX (29:18, 10ms, 10MHz, 16QAM, AMC 2x3, 18 symbols)	X	4.47	65.79	18.63	6.02	35.0	± 9.6 %
		Y	4.44	65.78	18.76		35.0	
		Z	4.75	66.03	19.03		35.0	
10310-AAA	IEEE 802.16e WiMAX (29:18, 10ms, 10MHz, QPSK, AMC 2x3, 18 symbols)	X	4.38	65.69	18.49	6.02	35.0	± 9.6 %
		Y	4.34	65.63	18.59		35.0	
		Z	4.64	65.84	18.85		35.0	
10311-AAB	LTE-FDD (SC-FDMA, 100% RB, 15 MHz, QPSK)	X	3.08	69.08	16.47	0.00	150.0	± 9.6 %
		Y	3.14	69.40	16.66		150.0	
		Z	3.12	68.62	16.13		150.0	
10313-AAA	iDEN 1:3	X	2.89	72.65	16.29	6.99	70.0	± 9.6 %
		Y	4.19	78.79	18.89		70.0	
		Z	4.02	76.71	18.18		70.0	
10314-AAA	iDEN 1:6	X	5.30	83.78	23.47	10.00	30.0	± 9.6 %
		Y	6.55	89.94	26.15		30.0	
		Z	6.97	88.50	25.50		30.0	
10315-AAB	IEEE 802.11b WiFi 2.4 GHz (DSSS, 1 Mbps, 96pc duty cycle)	X	1.08	63.77	15.30	0.17	150.0	± 9.6 %
		Y	1.10	64.11	15.62		150.0	
		Z	1.08	63.32	14.99		150.0	
10316-AAB	IEEE 802.11g WiFi 2.4 GHz (ERP-OFDM, 6 Mbps, 96pc duty cycle)	X	4.51	66.68	16.32	0.17	150.0	± 9.6 %
		Y	4.53	66.78	16.42		150.0	
		Z	4.64	66.54	16.30		150.0	
10317-AAB	IEEE 802.11a WiFi 5 GHz (OFDM, 6 Mbps, 96pc duty cycle)	X	4.51	66.68	16.32	0.17	150.0	± 9.6 %
		Y	4.53	66.78	16.42		150.0	
		Z	4.64	66.54	16.30		150.0	
10400-AAC	IEEE 802.11ac WiFi (20MHz, 64-QAM, 99pc duty cycle)	X	4.61	67.03	16.35	0.00	150.0	± 9.6 %
		Y	4.63	67.11	16.42		150.0	
		Z	4.76	66.86	16.27		150.0	
10401-AAC	IEEE 802.11ac WiFi (40MHz, 64-QAM, 99pc duty cycle)	X	5.34	67.18	16.51	0.00	150.0	± 9.6 %
		Y	5.36	67.26	16.59		150.0	
		Z	5.46	67.09	16.45		150.0	

10402-AAC	IEEE 802.11ac WiFi (80MHz, 64-QAM, 99pc duty cycle)	X	5.59	67.45	16.52	0.00	150.0	± 9.6 %
		Y	5.60	67.49	16.57		150.0	
		Z	5.71	67.42	16.48		150.0	
10403-AAB	CDMA2000 (1xEV-DO, Rev. 0)	X	1.38	68.75	13.54	0.00	115.0	± 9.6 %
		Y	1.49	69.81	14.11		115.0	
		Z	1.48	68.40	14.11		115.0	
10404-AAB	CDMA2000 (1xEV-DO, Rev. A)	X	1.38	68.75	13.54	0.00	115.0	± 9.6 %
		Y	1.49	69.81	14.11		115.0	
		Z	1.48	68.40	14.11		115.0	
10406-AAB	CDMA2000, RC3, SO32, SCH0, Full Rate	X	17.35	99.43	24.90	0.00	100.0	± 9.6 %
		Y	63.25	115.82	28.80		100.0	
		Z	11.61	93.88	24.12		100.0	
10410-AAB	LTE-TDD (SC-FDMA, 1 RB, 10 MHz, QPSK, UL Subframe=2,3,4,7,8,9)	X	8.36	91.25	22.62	3.23	80.0	± 9.6 %
		Y	100.00	127.16	32.13		80.0	
		Z	100.00	125.70	32.09		80.0	
10415-AAA	IEEE 802.11b WiFi 2.4 GHz (DSSS, 1 Mbps, 99pc duty cycle)	X	1.03	63.22	14.88	0.00	150.0	± 9.6 %
		Y	1.04	63.49	15.13		150.0	
		Z	1.02	62.64	14.46		150.0	
10416-AAA	IEEE 802.11g WiFi 2.4 GHz (ERP-OFDM, 6 Mbps, 99pc duty cycle)	X	4.48	66.75	16.31	0.00	150.0	± 9.6 %
		Y	4.49	66.81	16.37		150.0	
		Z	4.59	66.53	16.22		150.0	
10417-AAA	IEEE 802.11a/h WiFi 5 GHz (OFDM, 6 Mbps, 99pc duty cycle)	X	4.48	66.75	16.31	0.00	150.0	± 9.6 %
		Y	4.49	66.81	16.37		150.0	
		Z	4.59	66.53	16.22		150.0	
10418-AAA	IEEE 802.11g WiFi 2.4 GHz (DSSS-OFDM, 6 Mbps, 99pc duty cycle, Long preamble)	X	4.47	66.94	16.35	0.00	150.0	± 9.6 %
		Y	4.48	67.00	16.41		150.0	
		Z	4.58	66.68	16.24		150.0	
10419-AAA	IEEE 802.11g WiFi 2.4 GHz (DSSS-OFDM, 6 Mbps, 99pc duty cycle, Short preamble)	X	4.49	66.88	16.34	0.00	150.0	± 9.6 %
		Y	4.50	66.93	16.40		150.0	
		Z	4.60	66.63	16.24		150.0	
10422-AAA	IEEE 802.11n (HT Greenfield, 7.2 Mbps, BPSK)	X	4.60	66.86	16.35	0.00	150.0	± 9.6 %
		Y	4.61	66.91	16.41		150.0	
		Z	4.72	66.64	16.26		150.0	
10423-AAA	IEEE 802.11n (HT Greenfield, 43.3 Mbps, 16-QAM)	X	4.74	67.14	16.45	0.00	150.0	± 9.6 %
		Y	4.76	67.20	16.51		150.0	
		Z	4.89	66.97	16.38		150.0	
10424-AAA	IEEE 802.11n (HT Greenfield, 72.2 Mbps, 64-QAM)	X	4.67	67.10	16.43	0.00	150.0	± 9.6 %
		Y	4.68	67.15	16.49		150.0	
		Z	4.81	66.91	16.35		150.0	
10425-AAA	IEEE 802.11n (HT Greenfield, 15 Mbps, BPSK)	X	5.29	67.34	16.60	0.00	150.0	± 9.6 %
		Y	5.30	67.39	16.66		150.0	
		Z	5.42	67.29	16.55		150.0	
10426-AAA	IEEE 802.11n (HT Greenfield, 90 Mbps, 16-QAM)	X	5.31	67.43	16.64	0.00	150.0	± 9.6 %
		Y	5.32	67.48	16.70		150.0	
		Z	5.43	67.30	16.56		150.0	

10427-AAA	IEEE 802.11n (HT Greenfield, 150 Mbps, 64-QAM)	X	5.30	67.32	16.58	0.00	150.0	± 9.6 %
		Y	5.31	67.37	16.64		150.0	
		Z	5.44	67.28	16.54		150.0	
10430-AAA	LTE-FDD (OFDMA, 5 MHz, E-TM 3.1)	X	4.41	72.30	18.78	0.00	150.0	± 9.6 %
		Y	4.28	71.61	18.44		150.0	
		Z	4.35	70.84	18.35		150.0	
10431-AAA	LTE-FDD (OFDMA, 10 MHz, E-TM 3.1)	X	4.12	67.35	16.27	0.00	150.0	± 9.6 %
		Y	4.14	67.43	16.34		150.0	
		Z	4.27	67.06	16.22		150.0	
10432-AAA	LTE-FDD (OFDMA, 15 MHz, E-TM 3.1)	X	4.43	67.18	16.37	0.00	150.0	± 9.6 %
		Y	4.45	67.24	16.44		150.0	
		Z	4.58	66.95	16.29		150.0	
10433-AAA	LTE-FDD (OFDMA, 20 MHz, E-TM 3.1)	X	4.69	67.13	16.45	0.00	150.0	± 9.6 %
		Y	4.70	67.18	16.51		150.0	
		Z	4.82	66.95	16.37		150.0	
10434-AAA	W-CDMA (BS Test Model 1, 64 DPCH)	X	4.58	73.43	18.77	0.00	150.0	± 9.6 %
		Y	4.41	72.61	18.39		150.0	
		Z	4.46	71.72	18.35		150.0	
10435-AAB	LTE-TDD (SC-FDMA, 1 RB, 20 MHz, QPSK, UL Subframe=2,3,4,7,8,9)	X	7.84	90.24	22.26	3.23	80.0	± 9.6 %
		Y	100.00	126.90	32.00		80.0	
		Z	100.00	125.48	31.98		80.0	
10447-AAA	LTE-FDD (OFDMA, 5 MHz, E-TM 3.1, Clipping 44%)	X	3.40	67.35	15.41	0.00	150.0	± 9.6 %
		Y	3.42	67.47	15.52		150.0	
		Z	3.56	67.03	15.56		150.0	
10448-AAA	LTE-FDD (OFDMA, 10 MHz, E-TM 3.1, Clipping 44%)	X	3.98	67.14	16.14	0.00	150.0	± 9.6 %
		Y	4.00	67.22	16.21		150.0	
		Z	4.11	66.83	16.08		150.0	
10449-AAA	LTE-FDD (OFDMA, 15 MHz, E-TM 3.1, Clipping 44%)	X	4.26	67.02	16.27	0.00	150.0	± 9.6 %
		Y	4.28	67.08	16.34		150.0	
		Z	4.38	66.77	16.19		150.0	
10450-AAA	LTE-FDD (OFDMA, 20 MHz, E-TM 3.1, Clipping 44%)	X	4.47	66.91	16.31	0.00	150.0	± 9.6 %
		Y	4.48	66.96	16.37		150.0	
		Z	4.58	66.71	16.22		150.0	
10451-AAA	W-CDMA (BS Test Model 1, 64 DPCH, Clipping 44%)	X	3.25	67.38	14.88	0.00	150.0	± 9.6 %
		Y	3.28	67.53	15.01		150.0	
		Z	3.46	67.22	15.21		150.0	
10456-AAA	IEEE 802.11ac WiFi (160MHz, 64-QAM, 99pc duty cycle)	X	6.22	67.99	16.81	0.00	150.0	± 9.6 %
		Y	6.22	68.02	16.86		150.0	
		Z	6.28	67.84	16.71		150.0	
10457-AAA	UMTS-FDD (DC-HSDPA)	X	3.78	65.43	16.02	0.00	150.0	± 9.6 %
		Y	3.79	65.48	16.08		150.0	
		Z	3.83	65.16	15.92		150.0	
10458-AAA	CDMA2000 (1xEV-DO, Rev. B, 2 carriers)	X	3.02	66.44	14.01	0.00	150.0	± 9.6 %
		Y	3.06	66.64	14.18		150.0	
		Z	3.28	66.54	14.63		150.0	
10459-AAA	CDMA2000 (1xEV-DO, Rev. B, 3 carriers)	X	4.18	65.23	15.36	0.00	150.0	± 9.6 %
		Y	4.18	65.21	15.41		150.0	
		Z	4.47	65.25	15.75		150.0	

10460-AAA	UMTS-FDD (WCDMA, AMR)	X	0.93	68.87	16.62	0.00	150.0	± 9.6 %
		Y	1.00	70.16	17.38		150.0	
		Z	0.88	67.06	15.60		150.0	
10461-AAA	LTE-TDD (SC-FDMA, 1 RB, 1.4 MHz, QPSK, UL Subframe=2,3,4,7,8,9)	X	4.32	84.19	21.37	3.29	80.0	± 9.6 %
		Y	46.98	120.39	31.74		80.0	
		Z	70.92	123.84	32.55		80.0	
10462-AAA	LTE-TDD (SC-FDMA, 1 RB, 1.4 MHz, 16-QAM, UL Subframe=2,3,4,7,8,9)	X	0.93	61.17	8.92	3.23	80.0	± 9.6 %
		Y	1.50	66.22	11.48		80.0	
		Z	4.18	75.74	15.77		80.0	
10463-AAA	LTE-TDD (SC-FDMA, 1 RB, 1.4 MHz, 64-QAM, UL Subframe=2,3,4,7,8,9)	X	0.83	60.00	7.74	3.23	80.0	± 9.6 %
		Y	0.90	60.95	8.47		80.0	
		Z	1.89	66.55	11.77		80.0	
10464-AAA	LTE-TDD (SC-FDMA, 1 RB, 3 MHz, QPSK, UL Subframe=2,3,4,7,8,9)	X	3.27	79.79	19.27	3.23	80.0	± 9.6 %
		Y	44.63	117.13	30.10		80.0	
		Z	63.16	119.86	30.88		80.0	
10465-AAA	LTE-TDD (SC-FDMA, 1 RB, 3 MHz, 16-QAM, UL Subframe=2,3,4,7,8,9)	X	0.88	60.65	8.58	3.23	80.0	± 9.6 %
		Y	1.28	64.64	10.73		80.0	
		Z	2.98	72.01	14.38		80.0	
10466-AAA	LTE-TDD (SC-FDMA, 1 RB, 3 MHz, 64-QAM, UL Subframe=2,3,4,7,8,9)	X	0.83	60.00	7.69	3.23	80.0	± 9.6 %
		Y	0.85	60.44	8.16		80.0	
		Z	1.66	65.17	11.12		80.0	
10467-AAB	LTE-TDD (SC-FDMA, 1 RB, 5 MHz, QPSK, UL Subframe=2,3,4,7,8,9)	X	3.54	80.96	19.70	3.23	80.0	± 9.6 %
		Y	60.93	121.68	31.18		80.0	
		Z	84.88	124.19	31.89		80.0	
10468-AAB	LTE-TDD (SC-FDMA, 1 RB, 5 MHz, 16-QAM, UL Subframe=2,3,4,7,8,9)	X	0.89	60.80	8.68	3.23	80.0	± 9.6 %
		Y	1.33	65.06	10.94		80.0	
		Z	3.21	72.86	14.71		80.0	
10469-AAB	LTE-TDD (SC-FDMA, 1 RB, 5 MHz, 64-QAM, UL Subframe=2,3,4,7,8,9)	X	0.83	60.00	7.69	3.23	80.0	± 9.6 %
		Y	0.85	60.46	8.17		80.0	
		Z	1.66	65.20	11.14		80.0	
10470-AAB	LTE-TDD (SC-FDMA, 1 RB, 10 MHz, QPSK, UL Subframe=2,3,4,7,8,9)	X	3.54	80.99	19.71	3.23	80.0	± 9.6 %
		Y	63.11	122.20	31.29		80.0	
		Z	86.48	124.48	31.95		80.0	
10471-AAB	LTE-TDD (SC-FDMA, 1 RB, 10 MHz, 16-QAM, UL Subframe=2,3,4,7,8,9)	X	0.88	60.76	8.65	3.23	80.0	± 9.6 %
		Y	1.32	64.98	10.89		80.0	
		Z	3.18	72.76	14.66		80.0	
10472-AAB	LTE-TDD (SC-FDMA, 1 RB, 10 MHz, 64-QAM, UL Subframe=2,3,4,7,8,9)	X	0.83	60.00	7.68	3.23	80.0	± 9.6 %
		Y	0.84	60.42	8.13		80.0	
		Z	1.65	65.15	11.10		80.0	
10473-AAB	LTE-TDD (SC-FDMA, 1 RB, 15 MHz, QPSK, UL Subframe=2,3,4,7,8,9)	X	3.52	80.93	19.68	3.23	80.0	± 9.6 %
		Y	62.71	122.07	31.26		80.0	
		Z	85.93	124.36	31.91		80.0	
10474-AAB	LTE-TDD (SC-FDMA, 1 RB, 15 MHz, 16-QAM, UL Subframe=2,3,4,7,8,9)	X	0.88	60.74	8.64	3.23	80.0	± 9.6 %
		Y	1.31	64.94	10.87		80.0	
		Z	3.15	72.67	14.63		80.0	
10475-AAB	LTE-TDD (SC-FDMA, 1 RB, 15 MHz, 64-QAM, UL Subframe=2,3,4,7,8,9)	X	0.83	60.00	7.68	3.23	80.0	± 9.6 %
		Y	0.84	60.40	8.12		80.0	
		Z	1.64	65.11	11.08		80.0	

10477-AAB	LTE-TDD (SC-FDMA, 1 RB, 20 MHz, 16-QAM, UL Subframe=2,3,4,7,8,9)	X	0.87	60.61	8.55	3.23	80.0	± 9.6 %
		Y	1.27	64.59	10.69		80.0	
		Z	2.97	71.99	14.36		80.0	
10478-AAB	LTE-TDD (SC-FDMA, 1 RB, 20 MHz, 64-QAM, UL Subframe=2,3,4,7,8,9)	X	0.83	60.00	7.67	3.23	80.0	± 9.6 %
		Y	0.84	60.37	8.09		80.0	
		Z	1.63	65.04	11.04		80.0	
10479-AAA	LTE-TDD (SC-FDMA, 50% RB, 1.4 MHz, QPSK, UL Subframe=2,3,4,7,8,9)	X	4.53	79.52	20.39	3.23	80.0	± 9.6 %
		Y	7.80	88.47	23.78		80.0	
		Z	5.78	82.49	22.28		80.0	
10480-AAA	LTE-TDD (SC-FDMA, 50% RB, 1.4 MHz, 16-QAM, UL Subframe=2,3,4,7,8,9)	X	3.53	72.09	15.68	3.23	80.0	± 9.6 %
		Y	6.36	79.96	18.76		80.0	
		Z	6.52	79.72	19.55		80.0	
10481-AAA	LTE-TDD (SC-FDMA, 50% RB, 1.4 MHz, 64-QAM, UL Subframe=2,3,4,7,8,9)	X	2.81	68.83	13.98	3.23	80.0	± 9.6 %
		Y	4.53	74.98	16.60		80.0	
		Z	5.48	76.73	18.13		80.0	
10482-AAA	LTE-TDD (SC-FDMA, 50% RB, 3 MHz, QPSK, UL Subframe=2,3,4,7,8,9)	X	2.20	68.90	15.09	2.23	80.0	± 9.6 %
		Y	2.93	73.22	17.16		80.0	
		Z	2.97	72.34	17.43		80.0	
10483-AAA	LTE-TDD (SC-FDMA, 50% RB, 3 MHz, 16-QAM, UL Subframe=2,3,4,7,8,9)	X	2.35	65.97	12.90	2.23	80.0	± 9.6 %
		Y	3.02	69.40	14.64		80.0	
		Z	4.23	73.30	17.24		80.0	
10484-AAA	LTE-TDD (SC-FDMA, 50% RB, 3 MHz, 64-QAM, UL Subframe=2,3,4,7,8,9)	X	2.28	65.32	12.60	2.23	80.0	± 9.6 %
		Y	2.83	68.32	14.18		80.0	
		Z	3.99	72.23	16.81		80.0	
10485-AAB	LTE-TDD (SC-FDMA, 50% RB, 5 MHz, QPSK, UL Subframe=2,3,4,7,8,9)	X	2.68	71.36	17.35	2.23	80.0	± 9.6 %
		Y	3.27	74.89	19.08		80.0	
		Z	3.17	72.95	18.56		80.0	
10486-AAB	LTE-TDD (SC-FDMA, 50% RB, 5 MHz, 16-QAM, UL Subframe=2,3,4,7,8,9)	X	2.64	67.61	15.00	2.23	80.0	± 9.6 %
		Y	2.99	69.69	16.14		80.0	
		Z	3.15	69.34	16.51		80.0	
10487-AAB	LTE-TDD (SC-FDMA, 50% RB, 5 MHz, 64-QAM, UL Subframe=2,3,4,7,8,9)	X	2.64	67.21	14.79	2.23	80.0	± 9.6 %
		Y	2.96	69.13	15.87		80.0	
		Z	3.15	68.96	16.33		80.0	
10488-AAB	LTE-TDD (SC-FDMA, 50% RB, 10 MHz, QPSK, UL Subframe=2,3,4,7,8,9)	X	3.00	70.76	18.02	2.23	80.0	± 9.6 %
		Y	3.34	72.92	19.20		80.0	
		Z	3.42	71.88	18.69		80.0	
10489-AAB	LTE-TDD (SC-FDMA, 50% RB, 10 MHz, 16-QAM, UL Subframe=2,3,4,7,8,9)	X	3.07	67.95	16.69	2.23	80.0	± 9.6 %
		Y	3.24	69.09	17.42		80.0	
		Z	3.37	68.53	17.27		80.0	
10490-AAB	LTE-TDD (SC-FDMA, 50% RB, 10 MHz, 64-QAM, UL Subframe=2,3,4,7,8,9)	X	3.16	67.82	16.63	2.23	80.0	± 9.6 %
		Y	3.32	68.90	17.33		80.0	
		Z	3.47	68.38	17.21		80.0	
10491-AAB	LTE-TDD (SC-FDMA, 50% RB, 15 MHz, QPSK, UL Subframe=2,3,4,7,8,9)	X	3.29	69.57	17.67	2.23	80.0	± 9.6 %
		Y	3.53	71.04	18.54		80.0	
		Z	3.67	70.46	18.17		80.0	
10492-AAB	LTE-TDD (SC-FDMA, 50% RB, 15 MHz, 16-QAM, UL Subframe=2,3,4,7,8,9)	X	3.43	67.31	16.78	2.23	80.0	± 9.6 %
		Y	3.55	68.11	17.34		80.0	
		Z	3.72	67.80	17.20		80.0	

10493-AAB	LTE-TDD (SC-FDMA, 50% RB, 15 MHz, 64-QAM, UL Subframe=2,3,4,7,8,9)	X	3.50	67.21	16.74	2.23	80.0	± 9.6 %
		Y	3.62	67.97	17.27		80.0	
		Z	3.79	67.69	17.16		80.0	
10494-AAB	LTE-TDD (SC-FDMA, 50% RB, 20 MHz, QPSK, UL Subframe=2,3,4,7,8,9)	X	3.52	70.87	18.10	2.23	80.0	± 9.6 %
		Y	3.84	72.64	19.08		80.0	
		Z	3.98	72.03	18.67		80.0	
10495-AAB	LTE-TDD (SC-FDMA, 50% RB, 20 MHz, 16-QAM, UL Subframe=2,3,4,7,8,9)	X	3.45	67.59	16.97	2.23	80.0	± 9.6 %
		Y	3.58	68.42	17.54		80.0	
		Z	3.75	68.20	17.40		80.0	
10496-AAB	LTE-TDD (SC-FDMA, 50% RB, 20 MHz, 64-QAM, UL Subframe=2,3,4,7,8,9)	X	3.54	67.39	16.91	2.23	80.0	± 9.6 %
		Y	3.65	68.15	17.44		80.0	
		Z	3.83	67.94	17.32		80.0	
10497-AAA	LTE-TDD (SC-FDMA, 100% RB, 1.4 MHz, QPSK, UL Subframe=2,3,4,7,8,9)	X	1.43	63.58	11.40	2.23	80.0	± 9.6 %
		Y	1.80	66.67	13.09		80.0	
		Z	2.27	68.74	14.99		80.0	
10498-AAA	LTE-TDD (SC-FDMA, 100% RB, 1.4 MHz, 16-QAM, UL Subframe=2,3,4,7,8,9)	X	1.24	60.00	8.33	2.23	80.0	± 9.6 %
		Y	1.23	60.00	8.51		80.0	
		Z	1.81	63.14	11.27		80.0	
10499-AAA	LTE-TDD (SC-FDMA, 100% RB, 1.4 MHz, 64-QAM, UL Subframe=2,3,4,7,8,9)	X	1.26	60.00	8.18	2.23	80.0	± 9.6 %
		Y	1.24	60.00	8.34		80.0	
		Z	1.76	62.56	10.83		80.0	
10500-AAA	LTE-TDD (SC-FDMA, 100% RB, 3 MHz, QPSK, UL Subframe=2,3,4,7,8,9)	X	2.78	70.93	17.56	2.23	80.0	± 9.6 %
		Y	3.23	73.75	19.01		80.0	
		Z	3.21	72.13	18.47		80.0	
10501-AAA	LTE-TDD (SC-FDMA, 100% RB, 3 MHz, 16-QAM, UL Subframe=2,3,4,7,8,9)	X	2.86	67.97	15.75	2.23	80.0	± 9.6 %
		Y	3.13	69.65	16.71		80.0	
		Z	3.25	69.01	16.80		80.0	
10502-AAA	LTE-TDD (SC-FDMA, 100% RB, 3 MHz, 64-QAM, UL Subframe=2,3,4,7,8,9)	X	2.90	67.83	15.61	2.23	80.0	± 9.6 %
		Y	3.18	69.45	16.55		80.0	
		Z	3.31	68.90	16.69		80.0	
10503-AAB	LTE-TDD (SC-FDMA, 100% RB, 5 MHz, QPSK, UL Subframe=2,3,4,7,8,9)	X	2.96	70.56	17.92	2.23	80.0	± 9.6 %
		Y	3.29	72.71	19.10		80.0	
		Z	3.38	71.68	18.59		80.0	
10504-AAB	LTE-TDD (SC-FDMA, 100% RB, 5 MHz, 16-QAM, UL Subframe=2,3,4,7,8,9)	X	3.05	67.84	16.62	2.23	80.0	± 9.6 %
		Y	3.22	69.00	17.36		80.0	
		Z	3.35	68.44	17.21		80.0	
10505-AAB	LTE-TDD (SC-FDMA, 100% RB, 5 MHz, 64-QAM, UL Subframe=2,3,4,7,8,9)	X	3.14	67.73	16.57	2.23	80.0	± 9.6 %
		Y	3.31	68.81	17.27		80.0	
		Z	3.45	68.28	17.16		80.0	
10506-AAB	LTE-TDD (SC-FDMA, 100% RB, 10 MHz, QPSK, UL Subframe=2,3,4,7,8,9)	X	3.49	70.73	18.03	2.23	80.0	± 9.6 %
		Y	3.81	72.49	19.00		80.0	
		Z	3.95	71.88	18.59		80.0	
10507-AAB	LTE-TDD (SC-FDMA, 100% RB, 10 MHz, 16-QAM, UL Subframe=2,3,4,7,8,9)	X	3.44	67.53	16.93	2.23	80.0	± 9.6 %
		Y	3.56	68.36	17.50		80.0	
		Z	3.73	68.13	17.36		80.0	

10508-AAB	LTE-TDD (SC-FDMA, 100% RB, 10 MHz, 64-QAM, UL Subframe=2,3,4,7,8,9)	X	3.53	67.32	16.87	2.23	80.0	± 9.6 %
		Y	3.64	68.08	17.40		80.0	
		Z	3.82	67.87	17.27		80.0	
10509-AAB	LTE-TDD (SC-FDMA, 100% RB, 15 MHz, QPSK, UL Subframe=2,3,4,7,8,9)	X	3.90	69.82	17.65	2.23	80.0	± 9.6 %
		Y	4.14	71.06	18.38		80.0	
		Z	4.30	70.72	18.09		80.0	
10510-AAB	LTE-TDD (SC-FDMA, 100% RB, 15 MHz, 16-QAM, UL Subframe=2,3,4,7,8,9)	X	3.92	67.34	16.97	2.23	80.0	± 9.6 %
		Y	4.03	67.99	17.44		80.0	
		Z	4.22	67.93	17.34		80.0	
10511-AAB	LTE-TDD (SC-FDMA, 100% RB, 15 MHz, 64-QAM, UL Subframe=2,3,4,7,8,9)	X	3.99	67.15	16.93	2.23	80.0	± 9.6 %
		Y	4.09	67.75	17.36		80.0	
		Z	4.28	67.68	17.27		80.0	
10512-AAB	LTE-TDD (SC-FDMA, 100% RB, 20 MHz, QPSK, UL Subframe=2,3,4,7,8,9)	X	4.00	71.09	18.05	2.23	80.0	± 9.6 %
		Y	4.33	72.71	18.93		80.0	
		Z	4.49	72.31	18.60		80.0	
10513-AAB	LTE-TDD (SC-FDMA, 100% RB, 20 MHz, 16-QAM, UL Subframe=2,3,4,7,8,9)	X	3.80	67.50	17.05	2.23	80.0	± 9.6 %
		Y	3.92	68.21	17.54		80.0	
		Z	4.11	68.20	17.45		80.0	
10514-AAB	LTE-TDD (SC-FDMA, 100% RB, 20 MHz, 64-QAM, UL Subframe=2,3,4,7,8,9)	X	3.85	67.16	16.95	2.23	80.0	± 9.6 %
		Y	3.95	67.80	17.41		80.0	
		Z	4.13	67.78	17.32		80.0	
10515-AAA	IEEE 802.11b WiFi 2.4 GHz (DSSS, 2 Mbps, 99pc duty cycle)	X	0.99	63.41	14.95	0.00	150.0	± 9.6 %
		Y	1.00	63.71	15.22		150.0	
		Z	0.98	62.80	14.50		150.0	
10516-AAA	IEEE 802.11b WiFi 2.4 GHz (DSSS, 5.5 Mbps, 99pc duty cycle)	X	0.63	71.18	17.99	0.00	150.0	± 9.6 %
		Y	0.75	74.25	19.60		150.0	
		Z	0.56	68.07	16.15		150.0	
10517-AAA	IEEE 802.11b WiFi 2.4 GHz (DSSS, 11 Mbps, 99pc duty cycle)	X	0.84	65.39	15.66	0.00	150.0	± 9.6 %
		Y	0.87	66.03	16.14		150.0	
		Z	0.82	64.43	14.97		150.0	
10518-AAA	IEEE 802.11a/h WiFi 5 GHz (OFDM, 9 Mbps, 99pc duty cycle)	X	4.47	66.84	16.30	0.00	150.0	± 9.6 %
		Y	4.48	66.90	16.36		150.0	
		Z	4.58	66.60	16.20		150.0	
10519-AAA	IEEE 802.11a/h WiFi 5 GHz (OFDM, 12 Mbps, 99pc duty cycle)	X	4.63	67.03	16.39	0.00	150.0	± 9.6 %
		Y	4.64	67.09	16.46		150.0	
		Z	4.77	66.85	16.33		150.0	
10520-AAA	IEEE 802.11a/h WiFi 5 GHz (OFDM, 18 Mbps, 99pc duty cycle)	X	4.49	66.98	16.32	0.00	150.0	± 9.6 %
		Y	4.50	67.04	16.38		150.0	
		Z	4.62	66.81	16.25		150.0	
10521-AAA	IEEE 802.11a/h WiFi 5 GHz (OFDM, 24 Mbps, 99pc duty cycle)	X	4.42	66.97	16.30	0.00	150.0	± 9.6 %
		Y	4.43	67.03	16.37		150.0	
		Z	4.55	66.80	16.23		150.0	
10522-AAA	IEEE 802.11a/h WiFi 5 GHz (OFDM, 36 Mbps, 99pc duty cycle)	X	4.48	67.10	16.40	0.00	150.0	± 9.6 %
		Y	4.49	67.16	16.47		150.0	
		Z	4.61	66.88	16.31		150.0	

10523-AAA	IEEE 802.11a/h WiFi 5 GHz (OFDM, 48 Mbps, 99pc duty cycle)	X	4.38	67.02	16.28	0.00	150.0	± 9.6 %
		Y	4.40	67.08	16.35		150.0	
		Z	4.49	66.74	16.15		150.0	
10524-AAA	IEEE 802.11a/h WiFi 5 GHz (OFDM, 54 Mbps, 99pc duty cycle)	X	4.42	67.02	16.37	0.00	150.0	± 9.6 %
		Y	4.44	67.08	16.44		150.0	
		Z	4.56	66.80	16.28		150.0	
10525-AAA	IEEE 802.11ac WiFi (20MHz, MCS0, 99pc duty cycle)	X	4.44	66.11	15.98	0.00	150.0	± 9.6 %
		Y	4.45	66.16	16.04		150.0	
		Z	4.54	65.84	15.87		150.0	
10526-AAA	IEEE 802.11ac WiFi (20MHz, MCS1, 99pc duty cycle)	X	4.58	66.42	16.11	0.00	150.0	± 9.6 %
		Y	4.59	66.48	16.17		150.0	
		Z	4.71	66.22	16.01		150.0	
10527-AAA	IEEE 802.11ac WiFi (20MHz, MCS2, 99pc duty cycle)	X	4.51	66.39	16.05	0.00	150.0	± 9.6 %
		Y	4.52	66.45	16.12		150.0	
		Z	4.63	66.17	15.95		150.0	
10528-AAA	IEEE 802.11ac WiFi (20MHz, MCS3, 99pc duty cycle)	X	4.52	66.40	16.08	0.00	150.0	± 9.6 %
		Y	4.54	66.46	16.15		150.0	
		Z	4.65	66.19	15.99		150.0	
10529-AAA	IEEE 802.11ac WiFi (20MHz, MCS4, 99pc duty cycle)	X	4.52	66.40	16.08	0.00	150.0	± 9.6 %
		Y	4.54	66.46	16.15		150.0	
		Z	4.65	66.19	15.99		150.0	
10531-AAA	IEEE 802.11ac WiFi (20MHz, MCS6, 99pc duty cycle)	X	4.50	66.46	16.08	0.00	150.0	± 9.6 %
		Y	4.51	66.53	16.14		150.0	
		Z	4.64	66.30	16.00		150.0	
10532-AAA	IEEE 802.11ac WiFi (20MHz, MCS7, 99pc duty cycle)	X	4.37	66.32	16.01	0.00	150.0	± 9.6 %
		Y	4.39	66.39	16.08		150.0	
		Z	4.50	66.15	15.93		150.0	
10533-AAA	IEEE 802.11ac WiFi (20MHz, MCS8, 99pc duty cycle)	X	4.53	66.48	16.08	0.00	150.0	± 9.6 %
		Y	4.54	66.54	16.15		150.0	
		Z	4.66	66.23	15.97		150.0	
10534-AAA	IEEE 802.11ac WiFi (40MHz, MCS0, 99pc duty cycle)	X	5.07	66.45	16.14	0.00	150.0	± 9.6 %
		Y	5.09	66.50	16.19		150.0	
		Z	5.19	66.33	16.06		150.0	
10535-AAA	IEEE 802.11ac WiFi (40MHz, MCS1, 99pc duty cycle)	X	5.13	66.62	16.22	0.00	150.0	± 9.6 %
		Y	5.14	66.67	16.27		150.0	
		Z	5.25	66.51	16.14		150.0	
10536-AAA	IEEE 802.11ac WiFi (40MHz, MCS2, 99pc duty cycle)	X	5.01	66.59	16.19	0.00	150.0	± 9.6 %
		Y	5.03	66.64	16.24		150.0	
		Z	5.12	66.45	16.09		150.0	
10537-AAA	IEEE 802.11ac WiFi (40MHz, MCS3, 99pc duty cycle)	X	5.07	66.55	16.17	0.00	150.0	± 9.6 %
		Y	5.08	66.59	16.22		150.0	
		Z	5.18	66.42	16.08		150.0	
10538-AAA	IEEE 802.11ac WiFi (40MHz, MCS4, 99pc duty cycle)	X	5.14	66.54	16.20	0.00	150.0	± 9.6 %
		Y	5.15	66.59	16.25		150.0	
		Z	5.27	66.46	16.14		150.0	
10540-AAA	IEEE 802.11ac WiFi (40MHz, MCS6, 99pc duty cycle)	X	5.07	66.52	16.21	0.00	150.0	± 9.6 %
		Y	5.08	66.57	16.26		150.0	
		Z	5.20	66.47	16.16		150.0	

10541-AAA	IIEEE 802.11ac WiFi (40MHz, MCS7, 99pc duty cycle)	X	5.05	66.41	16.14	0.00	150.0	± 9.6 %
		Y	5.06	66.46	16.20		150.0	
		Z	5.17	66.33	16.08		150.0	
10542-AAA	IIEEE 802.11ac WiFi (40MHz, MCS8, 99pc duty cycle)	X	5.21	66.51	16.21	0.00	150.0	± 9.6 %
		Y	5.22	66.55	16.26		150.0	
		Z	5.33	66.41	16.13		150.0	
10543-AAA	IIEEE 802.11ac WiFi (40MHz, MCS9, 99pc duty cycle)	X	5.27	66.52	16.24	0.00	150.0	± 9.6 %
		Y	5.28	66.56	16.29		150.0	
		Z	5.41	66.45	16.18		150.0	
10544-AAA	IIEEE 802.11ac WiFi (80MHz, MCS0, 99pc duty cycle)	X	5.40	66.53	16.13	0.00	150.0	± 9.6 %
		Y	5.42	66.58	16.18		150.0	
		Z	5.49	66.45	16.06		150.0	
10545-AAA	IIEEE 802.11ac WiFi (80MHz, MCS1, 99pc duty cycle)	X	5.59	66.98	16.30	0.00	150.0	± 9.6 %
		Y	5.60	67.03	16.36		150.0	
		Z	5.69	66.88	16.22		150.0	
10546-AAA	IIEEE 802.11ac WiFi (80MHz, MCS2, 99pc duty cycle)	X	5.45	66.68	16.17	0.00	150.0	± 9.6 %
		Y	5.46	66.73	16.22		150.0	
		Z	5.56	66.67	16.13		150.0	
10547-AAA	IIEEE 802.11ac WiFi (80MHz, MCS3, 99pc duty cycle)	X	5.52	66.76	16.20	0.00	150.0	± 9.6 %
		Y	5.53	66.80	16.25		150.0	
		Z	5.63	66.71	16.14		150.0	
10548-AAA	IIEEE 802.11ac WiFi (80MHz, MCS4, 99pc duty cycle)	X	5.72	67.56	16.57	0.00	150.0	± 9.6 %
		Y	5.74	67.62	16.64		150.0	
		Z	5.92	67.73	16.62		150.0	
10550-AAA	IIEEE 802.11ac WiFi (80MHz, MCS6, 99pc duty cycle)	X	5.50	66.81	16.24	0.00	150.0	± 9.6 %
		Y	5.51	66.85	16.30		150.0	
		Z	5.59	66.68	16.14		150.0	
10551-AAA	IIEEE 802.11ac WiFi (80MHz, MCS7, 99pc duty cycle)	X	5.47	66.72	16.16	0.00	150.0	± 9.6 %
		Y	5.48	66.77	16.22		150.0	
		Z	5.59	66.72	16.13		150.0	
10552-AAA	IIEEE 802.11ac WiFi (80MHz, MCS8, 99pc duty cycle)	X	5.41	66.62	16.12	0.00	150.0	± 9.6 %
		Y	5.42	66.66	16.16		150.0	
		Z	5.50	66.51	16.03		150.0	
10553-AAA	IIEEE 802.11ac WiFi (80MHz, MCS9, 99pc duty cycle)	X	5.48	66.60	16.14	0.00	150.0	± 9.6 %
		Y	5.49	66.65	16.19		150.0	
		Z	5.59	66.56	16.08		150.0	
10554-AAA	IIEEE 1602.11ac WiFi (160MHz, MCS0, 99pc duty cycle)	X	5.82	66.88	16.21	0.00	150.0	± 9.6 %
		Y	5.83	66.92	16.26		150.0	
		Z	5.90	66.82	16.15		150.0	
10555-AAA	IIEEE 1602.11ac WiFi (160MHz, MCS1, 99pc duty cycle)	X	5.94	67.15	16.33	0.00	150.0	± 9.6 %
		Y	5.95	67.20	16.38		150.0	
		Z	6.03	67.13	16.28		150.0	
10556-AAA	IIEEE 1602.11ac WiFi (160MHz, MCS2, 99pc duty cycle)	X	5.96	67.23	16.36	0.00	150.0	± 9.6 %
		Y	5.98	67.27	16.41		150.0	
		Z	6.05	67.17	16.30		150.0	
10557-AAA	IIEEE 1602.11ac WiFi (160MHz, MCS3, 99pc duty cycle)	X	5.92	67.10	16.31	0.00	150.0	± 9.6 %
		Y	5.93	67.14	16.36		150.0	
		Z	6.02	67.08	16.27		150.0	

10558-AAA	IEEE 1602.11ac WiFi (160MHz, MCS4, 99pc duty cycle)	X	5.96	67.24	16.39	0.00	150.0	± 9.6 %
		Y	5.97	67.29	16.45		150.0	
		Z	6.07	67.25	16.37		150.0	
10560-AAA	IEEE 1602.11ac WiFi (160MHz, MCS6, 99pc duty cycle)	X	5.95	67.10	16.36	0.00	150.0	± 9.6 %
		Y	5.97	67.14	16.41		150.0	
		Z	6.06	67.09	16.33		150.0	
10561-AAA	IEEE 1602.11ac WiFi (160MHz, MCS7, 99pc duty cycle)	X	5.89	67.09	16.39	0.00	150.0	± 9.6 %
		Y	5.90	67.14	16.45		150.0	
		Z	5.99	67.06	16.35		150.0	
10562-AAA	IEEE 1602.11ac WiFi (160MHz, MCS8, 99pc duty cycle)	X	5.97	67.34	16.52	0.00	150.0	± 9.6 %
		Y	5.98	67.39	16.57		150.0	
		Z	6.12	67.47	16.55		150.0	
10563-AAA	IEEE 1602.11ac WiFi (160MHz, MCS9, 99pc duty cycle)	X	6.05	67.24	16.43	0.00	150.0	± 9.6 %
		Y	6.06	67.29	16.49		150.0	
		Z	6.41	67.91	16.73		150.0	
10564-AAA	IEEE 802.11g WiFi 2.4 GHz (DSSS-OFDM, 9 Mbps, 99pc duty cycle)	X	4.78	66.85	16.41	0.46	150.0	± 9.6 %
		Y	4.80	66.93	16.49		150.0	
		Z	4.91	66.67	16.35		150.0	
10565-AAA	IEEE 802.11g WiFi 2.4 GHz (DSSS-OFDM, 12 Mbps, 99pc duty cycle)	X	4.99	67.29	16.74	0.46	150.0	± 9.6 %
		Y	5.01	67.35	16.80		150.0	
		Z	5.14	67.15	16.69		150.0	
10566-AAA	IEEE 802.11g WiFi 2.4 GHz (DSSS-OFDM, 18 Mbps, 99pc duty cycle)	X	4.83	67.11	16.54	0.46	150.0	± 9.6 %
		Y	4.84	67.18	16.62		150.0	
		Z	4.98	66.99	16.50		150.0	
10567-AAA	IEEE 802.11g WiFi 2.4 GHz (DSSS-OFDM, 24 Mbps, 99pc duty cycle)	X	4.87	67.55	16.94	0.46	150.0	± 9.6 %
		Y	4.87	67.57	16.98		150.0	
		Z	5.01	67.40	16.87		150.0	
10568-AAA	IEEE 802.11g WiFi 2.4 GHz (DSSS-OFDM, 36 Mbps, 99pc duty cycle)	X	4.73	66.85	16.28	0.46	150.0	± 9.6 %
		Y	4.75	66.97	16.39		150.0	
		Z	4.88	66.73	16.25		150.0	
10569-AAA	IEEE 802.11g WiFi 2.4 GHz (DSSS-OFDM, 48 Mbps, 99pc duty cycle)	X	4.84	67.72	17.05	0.46	150.0	± 9.6 %
		Y	4.85	67.73	17.08		150.0	
		Z	4.96	67.48	16.93		150.0	
10570-AAA	IEEE 802.11g WiFi 2.4 GHz (DSSS-OFDM, 54 Mbps, 99pc duty cycle)	X	4.86	67.53	16.95	0.46	150.0	± 9.6 %
		Y	4.87	67.55	16.99		150.0	
		Z	5.00	67.32	16.86		150.0	
10571-AAA	IEEE 802.11b WiFi 2.4 GHz (DSSS, 1 Mbps, 90pc duty cycle)	X	1.13	63.98	15.42	0.46	130.0	± 9.6 %
		Y	1.15	64.46	15.85		130.0	
		Z	1.15	63.75	15.28		130.0	
10572-AAA	IEEE 802.11b WiFi 2.4 GHz (DSSS, 2 Mbps, 90pc duty cycle)	X	1.14	64.53	15.78	0.46	130.0	± 9.6 %
		Y	1.16	65.03	16.22		130.0	
		Z	1.16	64.27	15.61		130.0	
10573-AAA	IEEE 802.11b WiFi 2.4 GHz (DSSS, 5.5 Mbps, 90pc duty cycle)	X	1.37	80.51	21.92	0.46	130.0	± 9.6 %
		Y	2.18	89.24	25.44		130.0	
		Z	1.24	77.68	20.60		130.0	
10574-AAA	IEEE 802.11b WiFi 2.4 GHz (DSSS, 11 Mbps, 90pc duty cycle)	X	1.21	70.03	18.74	0.46	130.0	± 9.6 %
		Y	1.26	70.93	19.36		130.0	
		Z	1.21	69.23	18.24		130.0	

10575-AAA	IEEE 802.11g WiFi 2.4 GHz (DSSS-OFDM, 6 Mbps, 90pc duty cycle)	X	4.55	66.59	16.41	0.46	130.0	± 9.6 %
		Y	4.57	66.69	16.52		130.0	
		Z	4.69	66.45	16.40		130.0	
10576-AAA	IEEE 802.11g WiFi 2.4 GHz (DSSS-OFDM, 9 Mbps, 90pc duty cycle)	X	4.58	66.78	16.50	0.46	130.0	± 9.6 %
		Y	4.60	66.87	16.60		130.0	
		Z	4.71	66.62	16.47		130.0	
10577-AAA	IEEE 802.11g WiFi 2.4 GHz (DSSS-OFDM, 12 Mbps, 90pc duty cycle)	X	4.76	67.04	16.65	0.46	130.0	± 9.6 %
		Y	4.78	67.12	16.75		130.0	
		Z	4.92	66.93	16.65		130.0	
10578-AAA	IEEE 802.11g WiFi 2.4 GHz (DSSS-OFDM, 18 Mbps, 90pc duty cycle)	X	4.67	67.21	16.78	0.46	130.0	± 9.6 %
		Y	4.68	67.27	16.85		130.0	
		Z	4.82	67.09	16.76		130.0	
10579-AAA	IEEE 802.11g WiFi 2.4 GHz (DSSS-OFDM, 24 Mbps, 90pc duty cycle)	X	4.41	66.37	16.00	0.46	130.0	± 9.6 %
		Y	4.44	66.52	16.15		130.0	
		Z	4.58	66.34	16.04		130.0	
10580-AAA	IEEE 802.11g WiFi 2.4 GHz (DSSS-OFDM, 36 Mbps, 90pc duty cycle)	X	4.45	66.43	16.02	0.46	130.0	± 9.6 %
		Y	4.49	66.59	16.18		130.0	
		Z	4.62	66.36	16.05		130.0	
10581-AAA	IEEE 802.11g WiFi 2.4 GHz (DSSS-OFDM, 48 Mbps, 90pc duty cycle)	X	4.57	67.26	16.72	0.46	130.0	± 9.6 %
		Y	4.58	67.33	16.82		130.0	
		Z	4.71	67.12	16.69		130.0	
10582-AAA	IEEE 802.11g WiFi 2.4 GHz (DSSS-OFDM, 54 Mbps, 90pc duty cycle)	X	4.34	66.11	15.76	0.46	130.0	± 9.6 %
		Y	4.38	66.30	15.94		130.0	
		Z	4.52	66.09	15.82		130.0	
10583-AAA	IEEE 802.11a/h WiFi 5 GHz (OFDM, 6 Mbps, 90pc duty cycle)	X	4.55	66.59	16.41	0.46	130.0	± 9.6 %
		Y	4.57	66.69	16.52		130.0	
		Z	4.69	66.45	16.40		130.0	
10584-AAA	IEEE 802.11a/h WiFi 5 GHz (OFDM, 9 Mbps, 90pc duty cycle)	X	4.58	66.78	16.50	0.46	130.0	± 9.6 %
		Y	4.60	66.87	16.60		130.0	
		Z	4.71	66.62	16.47		130.0	
10585-AAA	IEEE 802.11a/h WiFi 5 GHz (OFDM, 12 Mbps, 90pc duty cycle)	X	4.76	67.04	16.65	0.46	130.0	± 9.6 %
		Y	4.78	67.12	16.75		130.0	
		Z	4.92	66.93	16.65		130.0	
10586-AAA	IEEE 802.11a/h WiFi 5 GHz (OFDM, 18 Mbps, 90pc duty cycle)	X	4.67	67.21	16.78	0.46	130.0	± 9.6 %
		Y	4.68	67.27	16.85		130.0	
		Z	4.82	67.09	16.76		130.0	
10587-AAA	IEEE 802.11a/h WiFi 5 GHz (OFDM, 24 Mbps, 90pc duty cycle)	X	4.41	66.37	16.00	0.46	130.0	± 9.6 %
		Y	4.44	66.52	16.15		130.0	
		Z	4.58	66.34	16.04		130.0	
10588-AAA	IEEE 802.11a/h WiFi 5 GHz (OFDM, 36 Mbps, 90pc duty cycle)	X	4.45	66.43	16.02	0.46	130.0	± 9.6 %
		Y	4.49	66.59	16.18		130.0	
		Z	4.62	66.36	16.05		130.0	
10589-AAA	IEEE 802.11a/h WiFi 5 GHz (OFDM, 48 Mbps, 90pc duty cycle)	X	4.57	67.26	16.72	0.46	130.0	± 9.6 %
		Y	4.58	67.33	16.82		130.0	
		Z	4.71	67.12	16.69		130.0	
10590-AAA	IEEE 802.11a/h WiFi 5 GHz (OFDM, 54 Mbps, 90pc duty cycle)	X	4.34	66.11	15.76	0.46	130.0	± 9.6 %
		Y	4.38	66.30	15.94		130.0	
		Z	4.52	66.09	15.82		130.0	

10591-AAA	IEEE 802.11n (HT Mixed, 20MHz, MCS0, 90pc duty cycle)	X	4.71	66.67	16.53	0.46	130.0	± 9.6 %
		Y	4.73	66.75	16.62		130.0	
		Z	4.84	66.53	16.51		130.0	
10592-AAA	IEEE 802.11n (HT Mixed, 20MHz, MCS1, 90pc duty cycle)	X	4.84	66.99	16.66	0.46	130.0	± 9.6 %
		Y	4.86	67.07	16.75		130.0	
		Z	5.00	66.87	16.64		130.0	
10593-AAA	IEEE 802.11n (HT Mixed, 20MHz, MCS2, 90pc duty cycle)	X	4.76	66.86	16.52	0.46	130.0	± 9.6 %
		Y	4.78	66.96	16.62		130.0	
		Z	4.92	66.77	16.52		130.0	
10594-AAA	IEEE 802.11n (HT Mixed, 20MHz, MCS3, 90pc duty cycle)	X	4.82	67.05	16.69	0.46	130.0	± 9.6 %
		Y	4.84	67.13	16.78		130.0	
		Z	4.97	66.94	16.68		130.0	
10595-AAA	IEEE 802.11n (HT Mixed, 20MHz, MCS4, 90pc duty cycle)	X	4.78	67.01	16.59	0.46	130.0	± 9.6 %
		Y	4.80	67.10	16.69		130.0	
		Z	4.94	66.89	16.57		130.0	
10596-AAA	IEEE 802.11n (HT Mixed, 20MHz, MCS5, 90pc duty cycle)	X	4.71	66.98	16.58	0.46	130.0	± 9.6 %
		Y	4.73	67.08	16.69		130.0	
		Z	4.87	66.88	16.57		130.0	
10597-AAA	IEEE 802.11n (HT Mixed, 20MHz, MCS6, 90pc duty cycle)	X	4.66	66.85	16.44	0.46	130.0	± 9.6 %
		Y	4.69	66.96	16.56		130.0	
		Z	4.82	66.78	16.45		130.0	
10598-AAA	IEEE 802.11n (HT Mixed, 20MHz, MCS7, 90pc duty cycle)	X	4.65	67.11	16.73	0.46	130.0	± 9.6 %
		Y	4.67	67.18	16.81		130.0	
		Z	4.81	67.03	16.73		130.0	
10599-AAA	IEEE 802.11n (HT Mixed, 40MHz, MCS0, 90pc duty cycle)	X	5.39	67.16	16.75	0.46	130.0	± 9.6 %
		Y	5.40	67.23	16.84		130.0	
		Z	5.52	67.11	16.73		130.0	
10600-AAA	IEEE 802.11n (HT Mixed, 40MHz, MCS1, 90pc duty cycle)	X	5.51	67.57	16.93	0.46	130.0	± 9.6 %
		Y	5.53	67.67	17.03		130.0	
		Z	5.67	67.58	16.94		130.0	
10601-AAA	IEEE 802.11n (HT Mixed, 40MHz, MCS2, 90pc duty cycle)	X	5.40	67.32	16.82	0.46	130.0	± 9.6 %
		Y	5.42	67.41	16.92		130.0	
		Z	5.55	67.30	16.82		130.0	
10602-AAA	IEEE 802.11n (HT Mixed, 40MHz, MCS3, 90pc duty cycle)	X	5.53	67.48	16.82	0.46	130.0	± 9.6 %
		Y	5.55	67.58	16.92		130.0	
		Z	5.64	67.31	16.73		130.0	
10603-AAA	IEEE 802.11n (HT Mixed, 40MHz, MCS4, 90pc duty cycle)	X	5.60	67.77	17.10	0.46	130.0	± 9.6 %
		Y	5.62	67.84	17.19		130.0	
		Z	5.72	67.63	17.03		130.0	
10604-AAA	IEEE 802.11n (HT Mixed, 40MHz, MCS5, 90pc duty cycle)	X	5.48	67.44	16.92	0.46	130.0	± 9.6 %
		Y	5.50	67.51	17.01		130.0	
		Z	5.52	67.07	16.74		130.0	
10605-AAA	IEEE 802.11n (HT Mixed, 40MHz, MCS6, 90pc duty cycle)	X	5.51	67.48	16.93	0.46	130.0	± 9.6 %
		Y	5.53	67.59	17.04		130.0	
		Z	5.64	67.42	16.91		130.0	
10606-AAA	IEEE 802.11n (HT Mixed, 40MHz, MCS7, 90pc duty cycle)	X	5.24	66.77	16.43	0.46	130.0	± 9.6 %
		Y	5.27	66.88	16.54		130.0	
		Z	5.39	66.79	16.45		130.0	

10607-AAA	IEEE 802.11ac WiFi (20MHz, MCS0, 90pc duty cycle)	X	4.56	66.02	16.17	0.46	130.0	± 9.6 %
		Y	4.58	66.11	16.27		130.0	
		Z	4.68	65.84	16.13		130.0	
10608-AAA	IEEE 802.11ac WiFi (20MHz, MCS1, 90pc duty cycle)	X	4.71	66.38	16.33	0.46	130.0	± 9.6 %
		Y	4.74	66.48	16.43		130.0	
		Z	4.87	66.25	16.30		130.0	
10609-AAA	IEEE 802.11ac WiFi (20MHz, MCS2, 90pc duty cycle)	X	4.60	66.21	16.15	0.46	130.0	± 9.6 %
		Y	4.63	66.32	16.26		130.0	
		Z	4.75	66.09	16.13		130.0	
10610-AAA	IEEE 802.11ac WiFi (20MHz, MCS3, 90pc duty cycle)	X	4.66	66.38	16.32	0.46	130.0	± 9.6 %
		Y	4.68	66.48	16.42		130.0	
		Z	4.81	66.25	16.30		130.0	
10611-AAA	IEEE 802.11ac WiFi (20MHz, MCS4, 90pc duty cycle)	X	4.57	66.17	16.16	0.46	130.0	± 9.6 %
		Y	4.59	66.28	16.27		130.0	
		Z	4.72	66.06	16.14		130.0	
10612-AAA	IEEE 802.11ac WiFi (20MHz, MCS5, 90pc duty cycle)	X	4.57	66.31	16.20	0.46	130.0	± 9.6 %
		Y	4.59	66.44	16.32		130.0	
		Z	4.73	66.20	16.18		130.0	
10613-AAA	IEEE 802.11ac WiFi (20MHz, MCS6, 90pc duty cycle)	X	4.56	66.14	16.05	0.46	130.0	± 9.6 %
		Y	4.59	66.27	16.18		130.0	
		Z	4.73	66.09	16.06		130.0	
10614-AAA	IEEE 802.11ac WiFi (20MHz, MCS7, 90pc duty cycle)	X	4.53	66.39	16.32	0.46	130.0	± 9.6 %
		Y	4.55	66.47	16.42		130.0	
		Z	4.68	66.29	16.31		130.0	
10615-AAA	IEEE 802.11ac WiFi (20MHz, MCS8, 90pc duty cycle)	X	4.56	65.98	15.91	0.46	130.0	± 9.6 %
		Y	4.59	66.13	16.05		130.0	
		Z	4.72	65.87	15.91		130.0	
10616-AAA	IEEE 802.11ac WiFi (40MHz, MCS0, 90pc duty cycle)	X	5.20	66.41	16.36	0.46	130.0	± 9.6 %
		Y	5.22	66.48	16.45		130.0	
		Z	5.34	66.37	16.34		130.0	
10617-AAA	IEEE 802.11ac WiFi (40MHz, MCS1, 90pc duty cycle)	X	5.27	66.60	16.43	0.46	130.0	± 9.6 %
		Y	5.29	66.69	16.53		130.0	
		Z	5.41	66.54	16.40		130.0	
10618-AAA	IEEE 802.11ac WiFi (40MHz, MCS2, 90pc duty cycle)	X	5.17	66.64	16.47	0.46	130.0	± 9.6 %
		Y	5.19	66.72	16.55		130.0	
		Z	5.29	66.54	16.42		130.0	
10619-AAA	IEEE 802.11ac WiFi (40MHz, MCS3, 90pc duty cycle)	X	5.17	66.40	16.28	0.46	130.0	± 9.6 %
		Y	5.19	66.49	16.38		130.0	
		Z	5.31	66.37	16.27		130.0	
10620-AAA	IEEE 802.11ac WiFi (40MHz, MCS4, 90pc duty cycle)	X	5.25	66.42	16.34	0.46	130.0	± 9.6 %
		Y	5.27	66.52	16.44		130.0	
		Z	5.40	66.41	16.34		130.0	
10621-AAA	IEEE 802.11ac WiFi (40MHz, MCS5, 90pc duty cycle)	X	5.27	66.59	16.55	0.46	130.0	± 9.6 %
		Y	5.28	66.65	16.62		130.0	
		Z	5.40	66.53	16.52		130.0	
10622-AAA	IEEE 802.11ac WiFi (40MHz, MCS6, 90pc duty cycle)	X	5.27	66.70	16.60	0.46	130.0	± 9.6 %
		Y	5.28	66.78	16.68		130.0	
		Z	5.41	66.70	16.60		130.0	

10623-AAA	IEEE 802.11ac WiFi (40MHz, MCS7, 90pc duty cycle)	X	5.14	66.21	16.21	0.46	130.0	± 9.6 %
		Y	5.16	66.31	16.32		130.0	
		Z	5.28	66.20	16.22		130.0	
10624-AAA	IEEE 802.11ac WiFi (40MHz, MCS8, 90pc duty cycle)	X	5.34	66.45	16.40	0.46	130.0	± 9.6 %
		Y	5.36	66.54	16.49		130.0	
		Z	5.48	66.42	16.39		130.0	
10625-AAA	IEEE 802.11ac WiFi (40MHz, MCS9, 90pc duty cycle)	X	5.55	66.97	16.72	0.46	130.0	± 9.6 %
		Y	5.57	67.07	16.81		130.0	
		Z	5.88	67.48	16.97		130.0	
10626-AAA	IEEE 802.11ac WiFi (80MHz, MCS0, 90pc duty cycle)	X	5.53	66.46	16.32	0.46	130.0	± 9.6 %
		Y	5.54	66.54	16.40		130.0	
		Z	5.63	66.43	16.30		130.0	
10627-AAA	IEEE 802.11ac WiFi (80MHz, MCS1, 90pc duty cycle)	X	5.77	67.07	16.59	0.46	130.0	± 9.6 %
		Y	5.79	67.16	16.68		130.0	
		Z	5.88	67.02	16.56		130.0	
10628-AAA	IEEE 802.11ac WiFi (80MHz, MCS2, 90pc duty cycle)	X	5.53	66.46	16.22	0.46	130.0	± 9.6 %
		Y	5.55	66.56	16.32		130.0	
		Z	5.67	66.54	16.25		130.0	
10629-AAA	IEEE 802.11ac WiFi (80MHz, MCS3, 90pc duty cycle)	X	5.62	66.57	16.27	0.46	130.0	± 9.6 %
		Y	5.64	66.67	16.37		130.0	
		Z	5.76	66.64	16.29		130.0	
10630-AAA	IEEE 802.11ac WiFi (80MHz, MCS4, 90pc duty cycle)	X	5.96	67.80	16.88	0.46	130.0	± 9.6 %
		Y	5.98	67.92	17.00		130.0	
		Z	6.25	68.26	17.09		130.0	
10631-AAA	IEEE 802.11ac WiFi (80MHz, MCS5, 90pc duty cycle)	X	5.89	67.74	17.06	0.46	130.0	± 9.6 %
		Y	5.91	67.78	17.11		130.0	
		Z	6.11	67.97	17.16		130.0	
10632-AAA	IEEE 802.11ac WiFi (80MHz, MCS6, 90pc duty cycle)	X	5.75	67.20	16.81	0.46	130.0	± 9.6 %
		Y	5.76	67.24	16.86		130.0	
		Z	5.85	67.08	16.73		130.0	
10633-AAA	IEEE 802.11ac WiFi (80MHz, MCS7, 90pc duty cycle)	X	5.60	66.69	16.37	0.46	130.0	± 9.6 %
		Y	5.62	66.77	16.45		130.0	
		Z	5.73	66.69	16.36		130.0	
10634-AAA	IEEE 802.11ac WiFi (80MHz, MCS8, 90pc duty cycle)	X	5.58	66.71	16.44	0.46	130.0	± 9.6 %
		Y	5.60	66.78	16.51		130.0	
		Z	5.72	66.73	16.44		130.0	
10635-AAA	IEEE 802.11ac WiFi (80MHz, MCS9, 90pc duty cycle)	X	5.44	65.95	15.77	0.46	130.0	± 9.6 %
		Y	5.47	66.09	15.91		130.0	
		Z	5.60	66.05	15.82		130.0	
10636-AAA	IEEE 1602.11ac WiFi (160MHz, MCS0, 90pc duty cycle)	X	5.96	66.83	16.41	0.46	130.0	± 9.6 %
		Y	5.97	66.90	16.49		130.0	
		Z	6.05	66.82	16.40		130.0	
10637-AAA	IEEE 1602.11ac WiFi (160MHz, MCS1, 90pc duty cycle)	X	6.10	67.19	16.58	0.46	130.0	± 9.6 %
		Y	6.12	67.27	16.66		130.0	
		Z	6.21	67.21	16.58		130.0	
10638-AAA	IEEE 1602.11ac WiFi (160MHz, MCS2, 90pc duty cycle)	X	6.10	67.17	16.54	0.46	130.0	± 9.6 %
		Y	6.12	67.25	16.63		130.0	
		Z	6.21	67.17	16.54		130.0	

10639-AAA	IEEE 1602.11ac WiFi (160MHz, MCS3, 90pc duty cycle)	X	6.07	67.09	16.55	0.46	130.0	± 9.6 %
		Y	6.09	67.17	16.63		130.0	
		Z	6.19	67.14	16.56		130.0	
10640-AAA	IEEE 1602.11ac WiFi (160MHz, MCS4, 90pc duty cycle)	X	6.06	67.06	16.47	0.46	130.0	± 9.6 %
		Y	6.08	67.16	16.57		130.0	
		Z	6.19	67.15	16.51		130.0	
10641-AAA	IEEE 1602.11ac WiFi (160MHz, MCS5, 90pc duty cycle)	X	6.13	67.06	16.49	0.46	130.0	± 9.6 %
		Y	6.15	67.15	16.59		130.0	
		Z	6.23	67.02	16.46		130.0	
10642-AAA	IEEE 1602.11ac WiFi (160MHz, MCS6, 90pc duty cycle)	X	6.16	67.29	16.78	0.46	130.0	± 9.6 %
		Y	6.17	67.34	16.84		130.0	
		Z	6.28	67.31	16.78		130.0	
10643-AAA	IEEE 1602.11ac WiFi (160MHz, MCS7, 90pc duty cycle)	X	6.00	66.97	16.51	0.46	130.0	± 9.6 %
		Y	6.02	67.06	16.61		130.0	
		Z	6.11	66.97	16.50		130.0	
10644-AAA	IEEE 1602.11ac WiFi (160MHz, MCS8, 90pc duty cycle)	X	6.09	67.26	16.67	0.46	130.0	± 9.6 %
		Y	6.12	67.36	16.77		130.0	
		Z	6.29	67.52	16.80		130.0	
10645-AAA	IEEE 1602.11ac WiFi (160MHz, MCS9, 90pc duty cycle)	X	6.23	67.33	16.67	0.46	130.0	± 9.6 %
		Y	6.26	67.42	16.77		130.0	
		Z	6.72	68.38	17.18		130.0	
10646-AAC	LTE-TDD (SC-FDMA, 1 RB, 5 MHz, QPSK, UL Subframe=2,7)	X	7.97	91.85	31.39	9.30	60.0	± 9.6 %
		Y	11.74	104.28	36.86		60.0	
		Z	11.88	99.49	34.28		60.0	
10647-AAB	LTE-TDD (SC-FDMA, 1 RB, 20 MHz, QPSK, UL Subframe=2,7)	X	7.13	89.84	30.79	9.30	60.0	± 9.6 %
		Y	9.93	100.75	35.82		60.0	
		Z	10.62	97.47	33.72		60.0	
10648-AAA	CDMA2000 (1x Advanced)	X	0.64	63.39	10.24	0.00	150.0	± 9.6 %
		Y	0.67	63.88	10.62		150.0	
		Z	0.72	63.48	11.02		150.0	

^E Uncertainty is determined using the max. deviation from linear response applying rectangular distribution and is expressed for the square of the field value.

APPENDIX D: SAR TISSUE SPECIFICATIONS

Measurement Procedure for Tissue verification:



- 1) The network analyzer and probe system was configured and calibrated.
- 2) The probe was immersed in the tissue. The tissue was placed in a nonmetallic container. Trapped air bubbles beneath the flange were minimized by placing the probe at a slight angle.
- 3) The complex admittance with respect to the probe aperture was measured
- 4) The complex relative permittivity ϵ' can be calculated from the below equation (Pournaropoulos and Misra):

$$Y = \frac{j2\omega\epsilon_r\epsilon_0}{[\ln(b/a)]^2} \int_a^b \int_a^b \int_0^\pi \cos\phi' \frac{\exp[-j\omega r(\mu_0\epsilon_r'\epsilon_0)^{1/2}]}{r} d\phi' d\rho' d\rho$$

where Y is the admittance of the probe in contact with the sample, the primed and unprimed coordinates refer to source and observation points, respectively, $r^2 = \rho^2 + \rho'^2 - 2\rho\rho'\cos\phi'$, ω is the angular frequency, and $j = \sqrt{-1}$.

**Table D-I
Composition of the Tissue Equivalent Matter**

Frequency (MHz)	750	750	835	835	1750	1750	1900	1900	2450	2450	5200-5800	5200-5800
Tissue	Head	Body	Head	Body	Head	Body	Head	Body	Head	Body	Head	Body
Ingredients (% by weight)												
Bactericide	See page 2-3	See page 2	0.1	0.1					See page 4		See page 5	
DGBE					47	31	44.92	29.44		26.7		
HEC			1	1								
NaCl			1.45	0.94	0.4	0.2	0.18	0.39		0.1		
Sucrose			57	44.9								
Polysorbate (Tween) 80												20
Water			40.45	53.06	52.6	68.8	54.9	70.17		73.2		80

FCC ID: ACJFZN1D		SAR EVALUATION REPORT		Approved by: Quality Manager
Test Dates: 05/07/18 - 05/23/18	DUT Type: Portable Handset			APPENDIX D: Page 1 of 5

2 Composition / Information on ingredients

The Item is composed of the following ingredients:

H ₂ O	Water, 35 – 58%
Sucrose	Sugar, white, refined, 40 – 60%
NaCl	Sodium Chloride, 0 – 6%
Hydroxyethyl-cellulose	Medium Viscosity (CAS# 9004-62-0), <0.3%
Preventol-D7	Preservative: aqueous preparation, (CAS# 55965-84-9), containing 5-chloro-2-methyl-3(2H)-isothiazolone and 2-methyl-3(2H)-isothiazolone, 0.1 – 0.7%

Relevant for safety; Refer to the respective Safety Data Sheet*.

Figure D-1
Composition of 750 MHz Head and Body Tissue Equivalent Matter

Note: 750MHz liquid recipes are proprietary SPEAG. Since the composition is approximate to the actual liquids utilized, the manufacturer tissue-equivalent liquid data sheets are provided below.

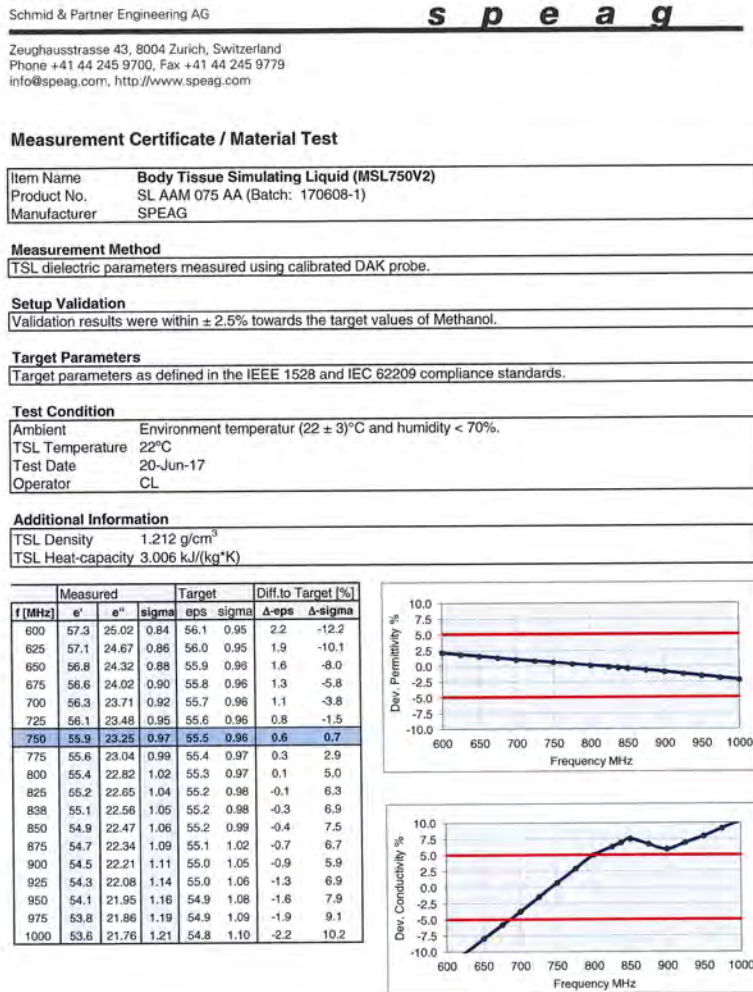

Figure D-2
750MHz Body Tissue Equivalent Matter

FCC ID: ACJFZN1D		SAR EVALUATION REPORT		Approved by: Quality Manager
Test Dates: 05/07/18 - 05/23/18	DUT Type: Portable Handset			APPENDIX D: Page 2 of 5

Measurement Certificate / Material Test

Item Name	Head Tissue Simulating Liquid (HSL750V2)
Product No.	SL AAH 075 AA (Batch: 170612-4)
Manufacturer	SPEAG

Measurement Method

TSL dielectric parameters measured using calibrated DAK probe.

Setup Validation

Validation results were within $\pm 2.5\%$ towards the target values of Methanol.

Target Parameters

Target parameters as defined in the IEEE 1528 and IEC 62209 compliance standards.

Test Condition

Ambient	Environment temperatur (22 ± 3)°C and humidity < 70%.
TSL Temperature	22°C
Test Date	20-Jun-17
Operator	CL

Additional Information

TSL Density	1.284 g/cm ³
TSL Heat-capacity	2.701 kJ/(kg*K)

f [MHz]	Measured			Target		Diff.to Target [%]	
	e'	e''	sigma	eps	sigma	Δ-eps	Δ-sigma
600	45.6	22.97	0.77	42.7	0.88	6.7	-13.1
625	45.2	22.73	0.79	42.6	0.88	6.2	-10.6
650	44.9	22.49	0.81	42.5	0.89	5.6	-8.2
675	44.5	22.27	0.84	42.3	0.89	5.1	-5.8
700	44.2	22.05	0.86	42.2	0.89	4.6	-3.5
725	43.8	21.88	0.88	42.1	0.89	4.2	-1.0
750	43.5	21.72	0.91	41.9	0.89	3.8	1.4
775	43.2	21.55	0.93	41.8	0.90	3.4	-3.7
800	42.9	21.38	0.95	41.7	0.90	2.9	6.0
825	42.6	21.24	0.97	41.6	0.91	2.4	7.5
838	42.5	21.17	0.99	41.5	0.91	2.2	8.2
850	42.3	21.09	1.00	41.5	0.92	2.0	8.9
875	42.0	20.98	1.02	41.5	0.94	1.2	8.3
900	41.7	20.87	1.05	41.5	0.97	0.5	7.7
925	41.5	20.76	1.07	41.5	0.98	0.0	8.7
950	41.2	20.64	1.09	41.4	0.99	-0.6	9.7
975	40.9	20.55	1.11	41.4	1.00	-1.1	10.9
1000	40.6	20.46	1.14	41.3	1.01	-1.7	12.1

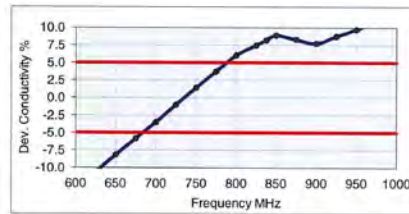
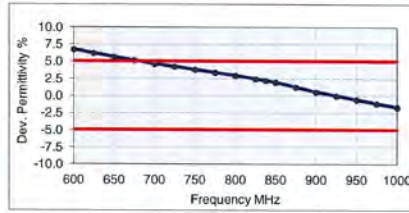



Figure D-3
750MHz Head Tissue Equivalent Matter

FCC ID: ACJFZN1D		SAR EVALUATION REPORT		Approved by: Quality Manager
Test Dates: 05/07/18 - 05/23/18	DUT Type: Portable Handset			APPENDIX D: Page 3 of 5

3 Composition / Information on ingredients

The Item is composed of the following ingredients:

Water	50 – 73 %	
Non-ionic detergents	25 – 50 %	polyoxyethylenesorbitan monolaurate
NaCl	0 – 2 %	
Preservative	0.05 – 0.1%	Preventol-D7

Safety relevant ingredients:

CAS-No. 55965-84-9	< 0.1 %	aqueous preparation, containing 5-chloro-2-methyl-3(2H)-isothiazolone and 2-methyl-3(2H)-isothiazolone
--------------------	---------	--

CAS-No. 9005-64-5	<50 %	polyoxyethylenesorbitan monolaurate
-------------------	-------	-------------------------------------

According to international guidelines, the product is not a dangerous mixture and therefore not required to be marked by symbols.

Figure D-4
Composition of 2.4 GHz Head Tissue Equivalent Matter

Note: 2.4 GHz head liquid recipes are proprietary SPEAG. Since the composition is approximate to the actual liquids utilized, the manufacturer tissue-equivalent liquid data sheets are provided below.

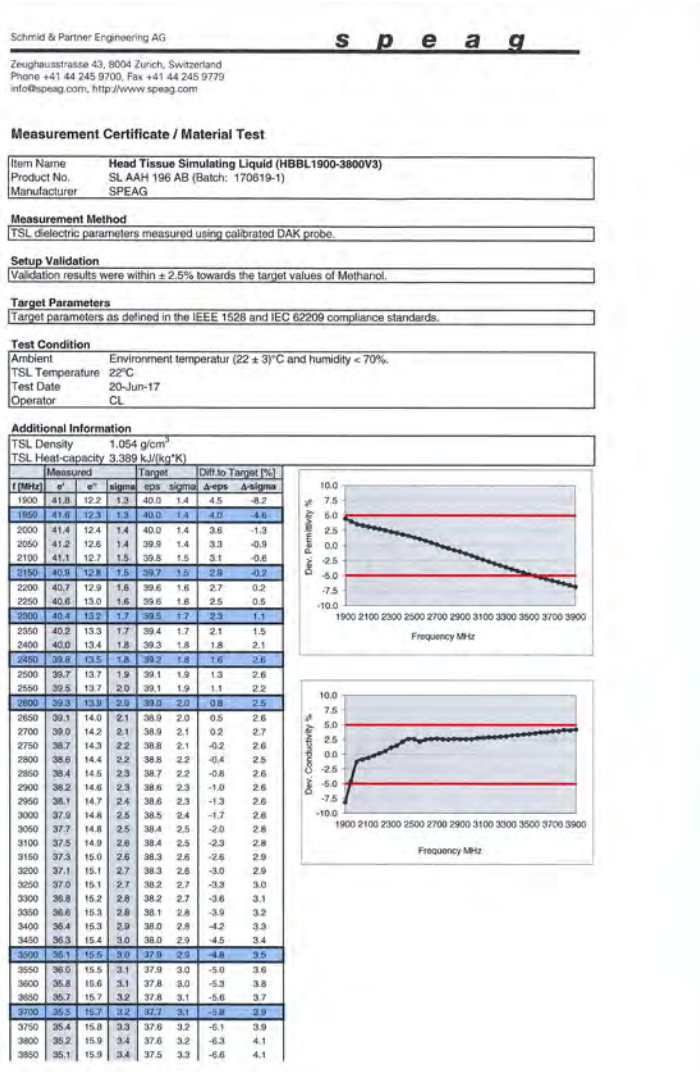

Figure D-5
2.4 GHz Head Tissue Equivalent Matter

FCC ID: ACJFZN1D		SAR EVALUATION REPORT		Approved by: Quality Manager
Test Dates: 05/07/18 - 05/23/18	DUT Type: Portable Handset			APPENDIX D: Page 4 of 5

2 Composition / Information on ingredients

The Item is composed of the following ingredients:

Water	50 – 65%
Mineral oil	10 – 30%
Emulsifiers	8 – 25%
Sodium salt	0 – 1.5%

Figure D-6

Composition of 5 GHz Head Tissue Equivalent Matter

Note: 5GHz head liquid recipes are proprietary SPEAG. Since the composition is approximate to the actual liquids utilized, the manufacturer tissue-equivalent liquid data sheets are provided below.

Schmid & Partner Engineering AG **s p e a g**
 Zeughausstrasse 43, 8004 Zurich, Switzerland
 Phone: +41 44 245 9700, Fax: +41 44 245 9779
 info@speag.com, http://www.speag.com

Measurement Certificate / Material Test

Item Name	Head Tissue Simulating Liquid (HBLL3500-5800V5)
Product No.	SL AAH 502 AG (Batch: 170613-1)
Manufacturer	SPEAG

Measurement Method
 TSL dielectric parameters measured using calibrated DAK probe.

Setup Validation
 Validation results were within ± 2.5% towards the target values of Methanol.

Target Parameters
 Target parameters as defined in the IEEE 1528 and IEC 62209 compliance standards.

Test Condition
 Ambient Environment temperatur (22 ± 3)°C and humidity < 70%.
 TSL Temperature 22°C
 Test Date 20-Jun-17
 Operator CL

Additional Information
 TSL Density 0.985 g/cm³
 TSL Heat-capacity 3.383 kJ/(kg·K)

f [MHz]	Measured			Target			Diff to Target [%]	
	ε'	ε''	sigma	eps	sigma	A-eps	A-sigma	
3400	38.6	15.03	2.84	38.0	2.81	1.5	1.1	
3500	38.5	15.00	2.92	37.9	2.91	1.5	0.3	
3600	38.3	14.98	3.00	37.8	3.02	1.5	-0.5	
3700	38.2	14.96	3.08	37.7	3.12	1.5	-1.2	
3800	38.1	14.95	3.16	37.6	3.22	1.4	-1.9	
3900	38.0	14.95	3.24	37.5	3.32	1.4	-2.5	
4000	37.9	14.95	3.33	37.4	3.43	1.5	-2.8	
4100	37.8	14.96	3.41	37.2	3.53	1.5	-3.3	
4200	37.6	15.00	3.50	37.1	3.63	1.3	-3.6	
4300	37.5	15.05	3.60	37.0	3.73	1.3	-3.5	
4400	37.4	15.11	3.70	36.9	3.84	1.4	-3.5	
4500	37.2	15.18	3.80	36.8	3.94	1.1	-3.5	
4600	37.1	15.24	3.90	36.7	4.04	1.2	-3.5	
4700	37.0	15.29	4.00	36.6	4.14	1.2	-3.4	
4800	36.8	15.35	4.10	36.4	4.25	1.0	-3.4	
4850	36.8	15.35	4.14	36.4	4.30	1.1	-3.6	
4900	36.7	15.38	4.19	36.3	4.35	1.0	-3.6	
4950	36.6	15.39	4.24	36.3	4.40	0.9	-3.6	
5000	36.5	15.42	4.29	36.2	4.45	0.8	-3.6	
5050	36.5	15.43	4.34	36.2	4.50	0.9	-3.6	
5100	36.4	15.46	4.39	36.1	4.55	0.8	-3.6	
5150	36.3	15.48	4.43	36.0	4.60	0.7	-3.8	
5200	36.2	15.50	4.48	36.0	4.66	0.5	-3.8	
5250	36.1	15.53	4.54	35.9	4.71	0.5	-3.5	
5300	36.1	15.55	4.58	35.9	4.76	0.6	-3.7	
5350	36.0	15.56	4.63	35.8	4.81	0.5	-3.7	
5400	35.9	15.57	4.68	35.8	4.86	0.4	-3.7	
5450	35.9	15.59	4.73	35.7	4.91	0.6	-3.7	
5500	35.8	15.61	4.78	35.6	4.96	0.4	-3.7	
5550	35.7	15.65	4.83	35.6	5.01	0.3	-3.7	
5600	35.6	15.68	4.88	35.5	5.07	0.2	-3.7	
5650	35.6	15.70	4.93	35.5	5.12	0.4	-3.6	
5700	35.5	15.72	4.98	35.4	5.17	0.2	-3.6	
5750	35.4	15.76	5.04	35.4	5.22	0.1	-3.4	
5800	35.4	15.78	5.09	35.3	5.27	0.3	-3.4	
5850	35.3	15.81	5.14	35.3	5.34	0.0	-3.7	
5900	35.3	15.82	5.19	35.3	5.40	0.0	-3.9	

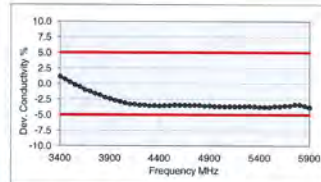
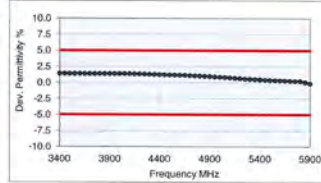

Figure D-7
 5GHz Head Tissue Equivalent Matter

FCC ID: ACJFZN1D		SAR EVALUATION REPORT		Approved by: Quality Manager
Test Dates: 05/07/18 - 05/23/18	DUT Type: Portable Handset			APPENDIX D: Page 5 of 5

APPENDIX E: SAR SYSTEM VALIDATION

Per FCC KDB Publication 865664 D02v01r02, SAR system validation status should be documented to confirm measurement accuracy. The SAR systems (including SAR probes, system components and software versions) used for this device were validated against its performance specifications prior to the SAR measurements. Reference dipoles were used with the required tissue- equivalent media for system validation, according to the procedures outlined in FCC KDB Publication 865664 D01v01r04 and IEEE 1528-2013. Since SAR probe calibrations are frequency dependent, each probe calibration point was validated at a frequency within the valid frequency range of the probe calibration point, using the system that normally operates with the probe for routine SAR measurements and according to the required tissue-equivalent media.

A tabulated summary of the system validation status including the validation date(s), measurement frequencies, SAR probes and tissue dielectric parameters has been included.



Table E-1
SAR System Validation Summary – 1g

SAR SYSTEM #	FREQ. [MHz]	DATE	PROBE SN	PROBE TYPE	PROBE CAL. POINT		COND.	PERM.	CW VALIDATION			MOD. VALIDATION		
							(σ)	(εr)	SENSITIVITY	PROBE LINEARITY	PROBE ISOTROPY	MOD. TYPE	DUTY FACTOR	PAR
E	750	3/11/2018	3213	ES3DV3	750	Head	0.890	40.788	PASS	PASS	PASS	N/A	N/A	N/A
E	835	3/5/2018	3213	ES3DV3	835	Head	0.925	43.335	PASS	PASS	PASS	GMSK	PASS	N/A
E	1750	3/2/2018	3213	ES3DV3	1750	Head	1.397	38.415	PASS	PASS	PASS	N/A	N/A	N/A
G	1900	8/31/2017	3332	ES3DV3	1900	Head	1.457	40.398	PASS	PASS	PASS	GMSK	PASS	N/A
D	2450	12/18/2017	3318	ES3DV3	2450	Body	2.029	51.304	PASS	PASS	PASS	OFDM/TDD	PASS	PASS
H	5250	1/31/2018	3589	EX3DV4	5250	Head	4.516	36.066	PASS	PASS	PASS	OFDM	N/A	PASS
H	5600	1/31/2018	3589	EX3DV4	5600	Head	4.869	35.597	PASS	PASS	PASS	OFDM	N/A	PASS
H	5750	1/31/2018	3589	EX3DV4	5750	Head	5.112	35.351	PASS	PASS	PASS	OFDM	N/A	PASS
I	750	3/6/2018	3287	ES3DV3	750	Body	0.951	56.970	PASS	PASS	PASS	N/A	N/A	N/A
H	750	8/30/2017	7410	EX3DV4	750	Body	0.956	56.276	PASS	PASS	PASS	N/A	N/A	N/A
H	835	8/31/2017	7410	EX3DV4	835	Body	0.992	53.254	PASS	PASS	PASS	GMSK	PASS	N/A
H	1750	8/30/2017	7410	EX3DV4	1750	Body	1.532	51.024	PASS	PASS	PASS	N/A	N/A	N/A
J	1900	4/30/2018	3347	ES3DV3	1900	Body	1.529	53.419	PASS	PASS	PASS	GMSK	PASS	N/A
D	2450	12/18/2017	3318	ES3DV3	2450	Body	2.029	51.304	PASS	PASS	PASS	OFDM/TDD	PASS	PASS
D	5250	10/24/2017	7308	EX3DV4	5250	Body	5.405	48.529	PASS	PASS	PASS	OFDM	N/A	PASS
D	5600	10/24/2017	7308	EX3DV4	5600	Body	5.910	47.818	PASS	PASS	PASS	OFDM	N/A	PASS
D	5750	10/24/2017	7308	EX3DV4	5750	Body	6.135	47.546	PASS	PASS	PASS	OFDM	N/A	PASS

Table E-2
SAR System Validation Summary – 10g

SAR SYSTEM #	FREQ. [MHz]	DATE	PROBE SN	PROBE TYPE	PROBE CAL. POINT		COND.	PERM.	CW VALIDATION			MOD. VALIDATION		
							(σ)	(εr)	SENSITIVITY	PROBE LINEARITY	PROBE ISOTROPY	MOD. TYPE	DUTY FACTOR	PAR
I	750	3/6/2018	3287	ES3DV3	750	Body	0.951	56.970	PASS	PASS	PASS	N/A	N/A	N/A
H	750	8/30/2017	7410	EX3DV4	750	Body	0.956	56.276	PASS	PASS	PASS	N/A	N/A	N/A
H	835	8/31/2017	7410	EX3DV4	835	Body	0.992	53.254	PASS	PASS	PASS	GMSK	PASS	N/A
H	1750	8/30/2017	7410	EX3DV4	1750	Body	1.532	51.024	PASS	PASS	PASS	N/A	N/A	N/A
J	1900	4/30/2018	3347	ES3DV3	1900	Body	1.529	53.419	PASS	PASS	PASS	GMSK	PASS	N/A
D	2450	12/18/2017	3318	ES3DV3	2450	Body	2.029	51.304	PASS	PASS	PASS	OFDM/TDD	PASS	PASS
D	5250	10/24/2017	7308	EX3DV4	5250	Body	5.405	48.529	PASS	PASS	PASS	OFDM	N/A	PASS
D	5600	10/24/2017	7308	EX3DV4	5600	Body	5.910	47.818	PASS	PASS	PASS	OFDM	N/A	PASS
D	5750	10/24/2017	7308	EX3DV4	5750	Body	6.135	47.546	PASS	PASS	PASS	OFDM	N/A	PASS

NOTE: While the probes have been calibrated for both CW and modulated signals, all measurements were performed using communication systems calibrated for CW signals only. Modulations in the table above represent test configurations for which the measurement system has been validated per FCC KDB Publication 865664 D01v01r04 for scenarios when CW probe calibrations are used with other signal types. SAR systems were validated for modulated signals with a periodic duty cycle, such as GMSK, or with a high peak to average ratio (>5 dB), such as OFDM according to FCC KDB Publication 865664 D01v01r04.

FCC ID: ACJFZN1D		SAR EVALUATION REPORT		Approved by: Quality Manager
Test Dates: 05/07/18 - 05/23/18	DUT Type: Portable Handset	APPENDIX E: Page 1 of 1		

- PCC uplink channel, channel bandwidth, modulation and RB configurations were selected based on section C)3)b)ii) of KBD 941225 D05 V01r02. The downlink PCC channel was paired with the selected PCC uplink channel according to normal configurations without carrier aggregation.
- To maximize aggregated bandwidth, highest channel bandwidth available for that CA combination was selected for SCC. For inter-band CA, the SCC downlink channels were selected near the middle of their transmission bands. For contiguous intra-band CA, the downlink channel spacing between the component carriers was set to multiple of 300 kHz less than the nominal channel spacing defined in section 5.4.1A of 3GPP TS 36.521. For non-contiguous intra-band CA, the downlink channel spacing between the component carriers was set to be larger than the nominal channel spacing and provided maximum separation between the component carriers.
- All selected PCC and SCC(s) remained fully within the uplink/downlink transmission band of the respective component carrier.
- When a device supports LTE capabilities with overlapping transmission frequency ranges, the standalone powers from the band with a larger transmission frequency range can be used to select measurement configurations for the band with the fully covered transmission frequency range.

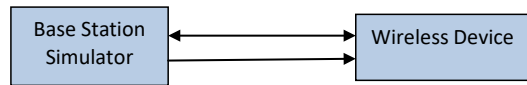



Figure 1
SISO CA Power Measurement Setup

FCC ID: ACJFZN1D	 PCTEST <small>ENGINEERING LABORATORY, INC.</small>	SAR EVALUATION REPORT		Reviewed by: Quality Manager
Test Dates: 05/07/18 - 05/23/18	DUT Type: Portable Handset			APPENDIX G: Page 2 of 4

1.3 SISO Downlink Carrier Aggregation RF Conducted Powers

1.3.1 LTE Band 12 as PCC

Table 1
Maximum Output Powers

Combination	PCC									SCC 1				Power	
	PCC Band	PCC BW [MHz]	PCC (UL) Ch.	PCC (UL) Freq. [MHz]	Mod.	PCC UL# RB	PCC UL RB Offset	PCC (DL) Channel	PCC (DL) Freq. [MHz]	SCC Band	SCC BW [MHz]	SCC (DL) Channel	SCC (DL) Freq. [MHz]	LTE Tx-Power with DL CA Enabled (dBm)	LTE Single Carrier Tx Power (dBm)
CA 2A-12A (1)	LTE B12	3	23095	707.5	QPSK	1	7	5095	737.5	LTE B2	20	900	1960	23.10	22.96
CA 4A-12A (1)	LTE B12	5	23155	713.5	QPSK	1	24	5155	743.5	LTE B4	20	2175	2132.5	23.03	22.95
CA 4A-12A (2)	LTE B12	3	23095	707.5	QPSK	1	7	5095	737.5	LTE B4	20	2175	2132.5	23.11	22.96

1.3.2 LTE Band 13 as PCC

Table 2
Maximum Output Powers

Combination	PCC									SCC 1				Power	
	PCC Band	PCC BW [MHz]	PCC (UL) Ch.	PCC (UL) Freq. [MHz]	Mod.	PCC UL# RB	PCC UL RB Offset	PCC (DL) Channel	PCC (DL) Freq. [MHz]	SCC Band	SCC BW [MHz]	SCC (DL) Channel	SCC (DL) Freq. [MHz]	LTE Tx-Power with DL CA Enabled (dBm)	LTE Single Carrier Tx Power (dBm)
CA 2A-13A	LTE B13	10	23230	782	QPSK	1	25	5230	751	LTE B2	20	900	1960	22.87	22.70
CA 4A-13A	LTE B13	10	23230	782	QPSK	1	25	5230	751	LTE B4	20	2175	2132.5	22.89	22.70

1.3.3 LTE Band 5 as PCC

Table 3
Maximum Output Powers

Combination	PCC									SCC 1				Power	
	PCC Band	PCC BW [MHz]	PCC (UL) Ch.	PCC (UL) Freq. [MHz]	Mod.	PCC UL# RB	PCC UL RB Offset	PCC (DL) Channel	PCC (DL) Freq. [MHz]	SCC Band	SCC BW [MHz]	SCC (DL) Channel	SCC (DL) Freq. [MHz]	LTE Tx-Power with DL CA Enabled (dBm)	LTE Single Carrier Tx Power (dBm)
CA 2A-5A	LTE B5	5	20525	836.5	QPSK	1	0	2525	881.5	LTE B2	20	900	1960	23.07	23.12
CA 4A-5A (1)	LTE B5	5	20525	836.5	QPSK	1	0	2525	881.5	LTE B4	20	2175	2132.5	23.17	23.12

1.3.4 LTE Band 4 as PCC



Table 4
Maximum Output Powers

Combination	PCC									SCC 1				Power	
	PCC Band	PCC BW [MHz]	PCC (UL) Ch.	PCC (UL) Freq. [MHz]	Mod.	PCC UL# RB	PCC UL RB Offset	PCC (DL) Channel	PCC (DL) Freq. [MHz]	SCC Band	SCC BW [MHz]	SCC (DL) Channel	SCC (DL) Freq. [MHz]	LTE Tx-Power with DL CA Enabled (dBm)	LTE Single Carrier Tx Power (dBm)
CA 4A-5A (1)	LTE B4	5	20300	1745	QPSK	1	24	2300	2145	LTE B5	10	2525	881.5	22.88	22.95
CA 4A-12A (1)	LTE B4	3	20300	1745	QPSK	1	7	2300	2145	LTE B12	10	5095	737.5	22.98	23.08
CA 4A-12A (2)	LTE B4	5	20300	1745	QPSK	1	24	2300	2145	LTE B12	10	5095	737.5	22.91	22.95
CA 4A-13A	LTE B4	5	20300	1745	QPSK	1	24	2300	2145	LTE B13	10	5230	751	22.95	22.95

1.3.5 LTE Band 66 as PCC

Table 5
Maximum Output Powers



Combination	PCC									SCC 1				Power	
	PCC Band	PCC BW [MHz]	PCC (UL) Ch.	PCC (UL) Freq. [MHz]	Mod.	PCC UL# RB	PCC UL RB Offset	PCC (DL) Channel	PCC (DL) Freq. [MHz]	SCC Band	SCC BW [MHz]	SCC (DL) Channel	SCC (DL) Freq. [MHz]	LTE Tx-Power with DL CA Enabled (dBm)	LTE Single Carrier Tx Power (dBm)
CA 66A-66A	LTE B66	5	132322	1745	QPSK	1	24	66786	2145	LTE B66	20	67236	2190	23.07	22.95
CA 66B	LTE B66	5	132322	1745	QPSK	1	24	66786	2145	LTE B66	15	66693	2135.7	23.06	22.95
CA 66C	LTE B66	5	132322	1745	QPSK	1	24	66786	2145	LTE B66	20	66669	2133.3	23.07	22.95

FCC ID: ACJFZN1D	 SAR EVALUATION REPORT		Reviewed by: Quality Manager
Test Dates: 05/07/18 - 05/23/18	DUT Type: Portable Handset		APPENDIX G: Page 3 of 4

1.3.6 LTE Band 2 as PCC

Table 6
Maximum Output Powers

Combination	PCC									SCC 1				Power	
	PCC Band	PCC BW [MHz]	PCC (UL) Ch.	PCC (UL) Freq. [MHz]	Mod.	PCC UL# RB	PCC UL RB Offset	PCC (DL) Channel	PCC (DL) Freq. [MHz]	SCC Band	SCC BW [MHz]	SCC (DL) Channel	SCC (DL) Freq. [MHz]	LTE Tx. Power with DL CA Enabled (dBm)	LTE Single Carrier Tx Power (dBm)
CA_2A-5A	LTE B2	20	18700	1860	QPSK	1	0	700	1940	LTE B5	10	2525	881.5	23.45	23.34
CA_2A-12A (1)	LTE B2	20	18700	1860	QPSK	1	0	700	1940	LTE B12	10	5095	737.5	23.40	23.34
CA_2A-13A	LTE B2	20	18700	1860	QPSK	1	0	700	1940	LTE B13	10	5230	751	23.25	23.34

FCC ID: ACJFZN1D	 PCTEST ENGINEERING LABORATORY, INC.	SAR EVALUATION REPORT		Reviewed by: Quality Manager
Test Dates: 05/07/18 - 05/23/18	DUT Type: Portable Handset	APPENDIX G: Page 4 of 4		