

Panasonic[®]



Operating Instructions - Reference Manual

Tablet Computer

Model No. **FZ-L1 series**

Table of Contents

Introduction	4
About this manual	4
Disclaimers	4
Handling cautions	5
Trademarks	7
Getting started	8
Confirming the included items	8
Description of parts	8
Installing and removing the battery	12
Installing a SIM card (models supporting cellular transmission only)	14
Installing an SD card	14
Replacing the battery (Battery warm swap)	15
Charging the battery	16
Turning the unit on and off	17
Screen description	18
Home screen	18
Navigation buttons	18
Status bar	18
Notifications panel	18
Icons	19
Customizing the home screen	20
Input	22
Typing and voice input	22
Using the keyboard	22
Connectivity	24
Mobile network (models supporting cellular transmission only)	24
Wi-Fi	25
Bluetooth	27
Airplane mode	28
USB connection	28
SD memory card	29
Security	30
Locking the screen	30
Encrypting the SD card	30
[DeviceManagement] app	31
Settings	32
[Settings] app	32
Power options menu	33
[Dashboard] app	33
[UserButtonManager] app	34
[Panasonic Enterprise Launcher] app	35
Touch operation settings	35
Accessibility settings	35
Apps	37

Starting apps	37
Preinstalled apps	37
Using the [Phone] app to make phone calls	39
Camera	40
Taking pictures	40
Recording videos	40
Using the option menu	40
Camera settings	41
Barcode reader (equipped models only)	42
Configuring the barcode reader	42
Using the barcode reader	42
NFC card reader/writer	43
Hardware diagnostics	44
About hardware diagnostics	44
Running hardware diagnostics	44
Saving or checking the system log and diagnosis results	46
Supplementary items	47
Protective Film (FZ-VPFL11)	47
Hand Strap (FZ-VSTL11)	49
Hand Strap (BL) (FZ-VSTL12)	51
Hand Strap (BP) (FZ-VSTL13)	53
Troubleshooting	56
General information	56
Starting up	56
Shutting down	56
Screen	56
Indicator	57
Touch screen operation	57
Connectivity	58
Sound	58
Other	58
Appendix	60
Factory data reset	60
Tips for battery usage	60
Updating the software	61
Regulatory information	63
Specifications	64
Accessories	67
WARRANTY for U.S.A	68
WARRANTY for Canada	72
WARRANTY for Europe	76

Introduction

About this manual

Thank you for purchasing this Panasonic product. For optimum performance and safety, please read these instructions carefully.

This manual describes the preparation of the unit for use, and the operations and settings of the main features.

- Descriptions in this document are based on models with GMS (Google Mobile Services).
- Panasonic Corporation and/or its affiliates are referred to collectively as “we” or “Panasonic”.
- This product supports microSD, microSDHC, and microSDXC memory cards. In this document, the term “SD card” is used as a generic term for any supported memory card.
- This product supports Nano SIM cards (certain models only). In this document, the term “SIM card” is used as a generic term for any supported SIM card.
- Information in this document is subject to change without notice.
- For the latest information about optional products, refer to the product catalogs, etc.
- This manual is written with the display language set to US English.

Disclaimers

- Some illustrations in this document may look different from the actual product.
- The details of the descriptions may vary due to differences between the software versions or automatic updates of some software. To confirm the OS version, swipe up the home screen, and then in the app list, tap **[Settings]** → **[System]** → **[About tablet]** → confirm under **[Android version]**.
- Panasonic assumes no liability for damage incurred from customer misuse or use under other irregular conditions, and damage resulting from the use or the unavailable use of the product.
- Panasonic shall not be liable for loss of data or other incidental or consequential damages resulting from the use of this product. This product can download, store, forward, and receive additional content, such as applications, ringtones, contact information, and media files. The use of such content may be restricted or prohibited by the rights of third parties, including but not limited to restriction under applicable copyright laws. You are entirely responsible for additional content that you download to or forward from this product; Panasonic is not responsible for such content or its use. Before using such content, it is your responsibility to verify that your intended use is properly licensed or is otherwise authorized. Panasonic does not warrant or guarantee the accuracy, integrity or quality of any additional content or any other third-party content. Under no circumstances will Panasonic be liable in any way for the improper use of additional content or other third-party content by this product or its operator. This document and any related product documentation may refer to services and applications that are provided by third parties. The use of such services or programs may require separate registration with the third party provider and may be subject to additional terms of use. For applications accessed on or through a third-party web site, please review the web sites’ terms of use and applicable privacy policy in advance. Panasonic does not warrant or guarantee the availability or performance of any third-party web sites, services, or applications.
- The availability of some functions depends on your unit’s specifications and the locale of purchase. See “Specifications” (page 64) for information about your unit.

Handling cautions

General use

- Operating environment

Temperature:

Operation: -10 °C to 50 °C {14 °F to 122 °F} (IEC60068-2-1, 2)^{*1}

Storage: -30 °C to 70 °C {-22 °F to 158 °F}

Humidity:

Operation: 30 % to 80 % RH (No condensation)

Storage: 30 % to 90 % RH (No condensation)

Even within the above temperature/humidity ranges, operation for a long time in extreme environments, smoking nearby, or operation in places where oil is used or where there is a lot of dust will result in product deterioration and will shorten the product life.

Also, when using the product in cold environments, the product may take longer to start up and battery operation time may be reduced.

If the product is wet in temperatures of 0 °C {32 °F} or below, freeze damage may occur. Make sure to dry off the product in such temperatures.

^{*1} Do not directly touch this product with your bare hands when using it in a hot or cold environment.

- Do not place the product in the following areas, as doing so may damage the product.
 - Near electric appliances. The image may be distorted or noise may occur.
- This product is designed to reduce physical shock applied to the LCD and internal electrical components (camera, etc.). However, protection against malfunction due to such shock is not guaranteed. As with any portable device, precautions should be taken to avoid any damage.
- When operating the screen using the dedicated stylus, do not firmly press it down. Doing so may damage the dedicated stylus or result in scratches or dents on the display.
- Do not place objects on the surface of the product or press down hard on the product with sharp objects. The display surface may get scratched.
- Do not damage the panels of the barcode reader (equipped models only), rear camera, and photo light.
- Do not use the dedicated stylus when dust or dirt (e.g., oil) is on the display. Otherwise foreign particles on the screen/dedicated stylus may scratch the display surface or obstruct operation of the dedicated stylus.
- Use the dedicated stylus only for touching the display. Using it for any other purpose may damage the dedicated stylus and result in scratches on the display.
- Confirm the safety and security of software before downloading or installing it on the product. Installing malware or viruses can cause malfunction and the disclosure of any private information stored in the product, or may cause excessive sound volume.
- Turn off the product before removing the SIM card or SD card. Failure to do so can result in data loss or damage to the SIM card, SD card, or product.
- Do not place the product near a television or radio receiver. This may cause television or radio interference.
- Keep the product away from magnets. Failure to do so may cause malfunction.
- When using the product in a vehicle, it may affect electronic devices in the vehicle depending on the vehicle type. Confirm the effects from radio waves with the vehicle manufacturer or sales dealer before use.
- It is illegal in many areas to record a call without permission. Always ask the other party for permission before recording a call.
- Follow these instructions and this manual to avoid any damage to the devices. Carefully read the instruction manuals of the peripheral devices.
 - Use peripheral devices that conform to the product's specifications.
 - Connect to the connectors in the correct direction.
 - If a connector is hard to insert, do not try forcibly. Check its shape, direction, alignment of pins, etc.

Protecting your data

- To prevent accidental loss of data, we recommend that you regularly back up any important data that you store in the product, SIM card, and SD card.
- To prevent the unintended disclosure of private information, always confirm the destination before sending messages, file attachments, or any other communications, such as email.
- To prevent the unintended disclosure of sensitive information stored in the SD card, we recommend using the product's encryption feature (page 30).
- Before disposing of the product or handing the product over to a third party, remove the SIM card, SD card, and any other accessories.
- Before disposing of the product or handing the product over to a third party, perform a factory data reset (page 60) to erase any data stored in the product.
- Before using Wi-Fi or Bluetooth® features, take appropriate action to secure your data.

Waterproof/dustproof

- The product is waterproof/dustproof when the interface cover and headset jack cover are closed, and the battery is attached. Therefore, keep water and dust away from product's internal components, accessories, and optional products.
- To prevent liquids, sand, dust, or any foreign objects from entering the product, always keep the cover and battery clean and make sure to firmly close the cover after opening. Take care not to get anything caught between the cover or battery and the product.
- Do not use the product if the gasket of the interface cover or the battery is damaged, deformed, or peeled off.
- If the product is exposed to water droplets, wipe them off with a dry, soft cloth and shake the product to remove the water droplets, then dry thoroughly.
- Do not leave any water droplets on the product. Water droplets may cause the micro USB port or headset jack to short circuit, or create smears on the screen.
- If the product is wet, wipe off the moisture before connecting with peripheral devices.
- Do not dry the product with an appliance or heat source such as a microwave oven or dryer.
- Use the optional charger while dry and do not use it in places with water such as bathrooms because it is not waterproof/dustproof.

Maintenance

- When cleaning the product, make sure to turn it off.
- When cleaning the product, wipe it with a soft, dry cloth. An alcohol-based disinfectant may be used if necessary.
 - If the product is particularly dirty, thoroughly wring a cloth soaked in water, wipe off the dirt, and then wipe with a dry cloth.
 - Do not clean the product with solvents such as benzene, thinner, or strong alkaline detergent because they may affect the surface of the product.

Battery

- The battery is a consumable item. Depending on the usage conditions, it may swell as it reaches the end of its life. When the typical battery life of approximately one year or about 500 charge cycles is exceeded, the battery deteriorates. If the battery begins to swell, or the amount of time it can be used after a full charge becomes dramatically shorter, the battery should be replaced with a new one. Contact your technical support representative.
- Do not touch the terminals of the battery. Failure to observe this may cause poor contact.
- When the battery is left installed in the product, it discharges electricity gradually in small amounts even if the product's power is off. If left for a long period (several months or more), the battery will over discharge and its performance may deteriorate.
- Store the battery in environments with an ambient temperature of -20 °C to 35 °C (-4 °F to 95 °F). If the battery is stored in other environments, battery performance and battery life may be reduced.

- When storing or transporting the battery, make sure that the battery's terminals do not become dirty and that no foreign objects or debris become attached to the battery's terminals.
- If battery charging is not completed after the specified charging time has passed, remove the battery from the product. The battery protection device may be damaged.
- You cannot charge an installed battery if it is not recognized by the product. Make sure that you use the specified battery.
- Dispose properly in compliance with local waste regulations.

Trademarks

- The Bluetooth® word mark and logos are registered trademarks owned by Bluetooth SIG, Inc. and any use of such marks by Panasonic Corporation is under license.
- microSDXC Logo is a trademark of SD-3C, LLC.



- The N-Mark is a trademark or registered trademark of NFC Forum, Inc. in the United States and in other countries.



- Wi-Fi®, the Wi-Fi logo, the Wi-Fi CERTIFIED logo and Wi-Fi CERTIFIED are trademarks or registered trademarks of Wi-Fi Alliance®.



- "FeliCa" is a contactless IC card technology developed by Sony Corporation. "FeliCa" is a trademark of Sony Corporation.
- All other trademarks identified herein are the property of their respective owners.

Getting started

Confirming the included items

If any items are missing, please contact your technical support representative.

- Main unit × 1
- Battery (Model number FZ-VZSUT10) × 1
- Operating Instructions - Read Me First × 1

Description of parts

Front view / bottom view

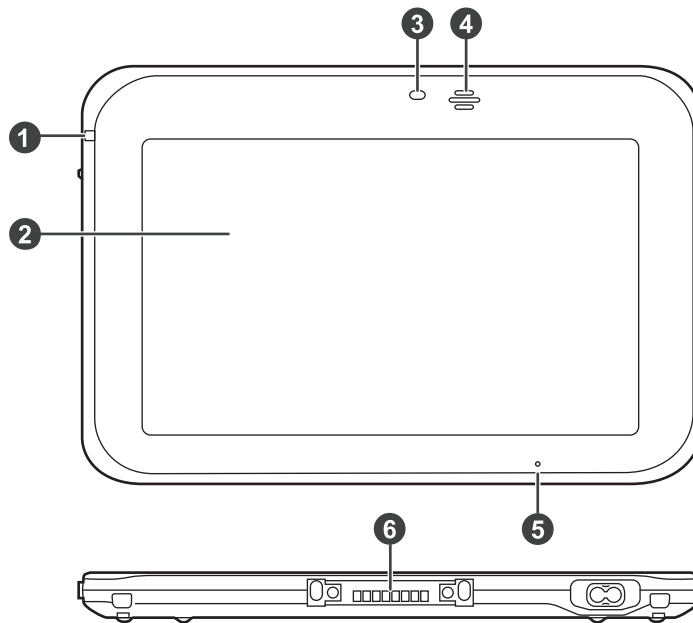

- ❶ Indicator**
Orange, lit: Battery is charging
Green, lit: Battery charging is complete
Red, lit: Battery level is 14 % or less of a full charge
- ❷ Display (touch panel)**
Glove mode: Can be operated while using gloves.
Rain mode: Prevents misoperation in wet conditions.
- ❸ Ambient light sensor, proximity sensor**
The ambient light sensor automatically adjusts the screen brightness.
When the proximity sensor detects a hand, object, etc. during a voice call (hands-free), it decreases the volume.
- ❹ Speaker**
- ❺ Microphone**

⑥ Expansion bus connector

Used when connecting an optional cradle, etc.

■ Top view (for models with a barcode reader)

- The equipped position of the barcode reader varies depending on the model.

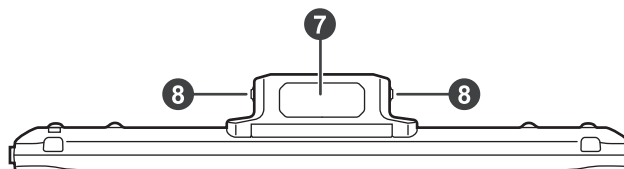
**⑦ Barcode reader****⑧ Side button**

Rear view / side view

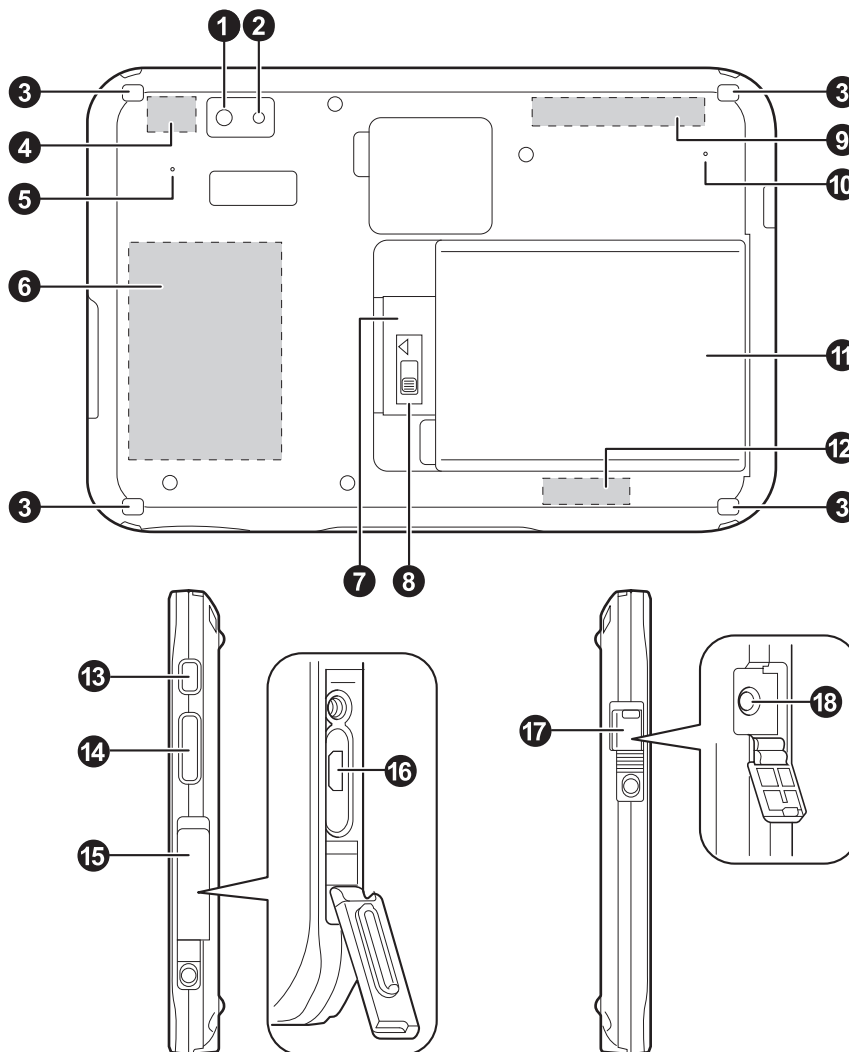

- ❶ Rear camera
- ❷ Photo light
Can be used when taking pictures.
- ❸ Strap attachment hole
- ❹ GPS antenna (internal)
- ❺ Microphone
- ❻ NFC antenna (internal)
When using an NFC card or other NFC device, touch the card/device to this area of the unit.
- ❼ Cover latch
- ❽ Cover latch lock
- ❾ Mobile antenna (internal)
- ❿ Air vent

- ⑪ **Battery (cover integrated type)**
- ⑫ **Wi-Fi, Bluetooth antenna** (internal)
- ⑬ **Power button** (page 17)
- ⑭ **Volume buttons**
- ⑮ **Interface cover**
- ⑯ **micro USB port** (page 16)
- ⑰ **Headset jack cover**
- ⑱ **Headset jack**

IMPORTANT

- Observe the following to ensure the waterproof and dustproof performance of the unit.
 - Make sure the interface cover is securely closed when the micro USB port is not being used.
 - Make sure the headset jack cover is securely closed when the headset jack is not being used.
 - When closing the interface cover or headset jack cover, make sure there is no debris lodged in the gasket that seals the cover.
 - Make sure the gasket of the interface cover is not damaged, deformed, or peeled off.

Installing and removing the battery

- If the cover latch is closed, open it (page 13).

Installing the battery

1. Insert the tabs at the battery's terminal side into the notches of the unit (①), and then lower the battery into place (②).

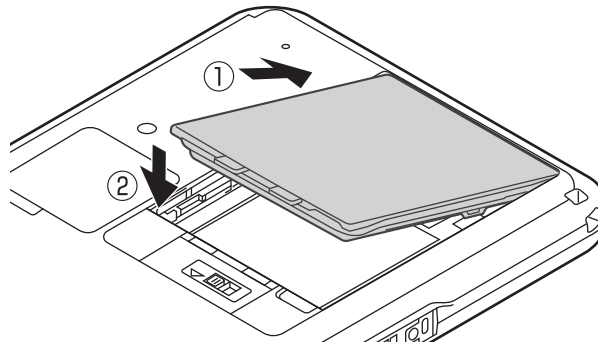

2. Press down firmly on the outside edges of the battery to seal it closed.

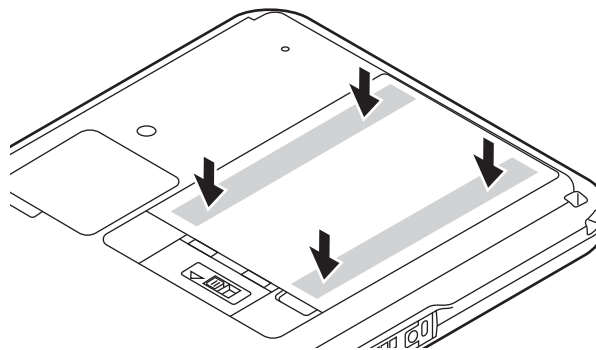

3. Close the cover latch (①) and lock it (②) by sliding the switch (circled in the illustration) toward .



- If the gap above the latch or the red area inside the switch is visible, the latch is not properly closed or locked.

IMPORTANT

- Observe the following to ensure the waterproof and dustproof performance of the unit.
 - When installing the battery, make sure there is no debris lodged in the gasket of the battery and the unit.
 - Make sure the gasket of the unit is not damaged, deformed, or peeled off.
 - Always make sure the battery is securely installed and locked.

Removing the battery

- Make sure to turn off the unit before replacing the battery.
1. Unlock the cover latch by sliding the switch (circled in the illustration) away from  (①), and then open the cover latch by sliding it (②).



2. Insert your fingertip into the bottom-right groove of the battery (circled in the illustration), lift the battery (①) and then remove it (②).

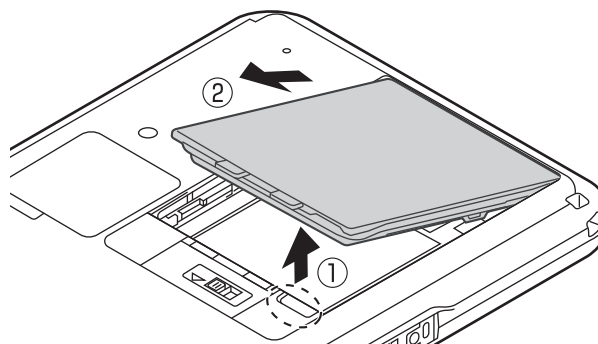

IMPORTANT

- Do not remove the battery while the unit is wet. When the unit is wet, remove the water by wiping off the water droplets and thoroughly drying the unit before removing the battery. (See “Waterproof/dustproof” (page 6).)

Installing a SIM card (models supporting cellular transmission only)

- When installing or removing a SIM card, place the unit on a flat surface.
 - If a battery is installed, remove it (page 13).
1. Insert the Nano SIM card into the Nano SIM card slot.
 - Install only Nano SIM cards.
 - Hold the SIM card so that the metal terminals are facing up, and insert with the notch facing in the same direction of the circled area in the illustration below.

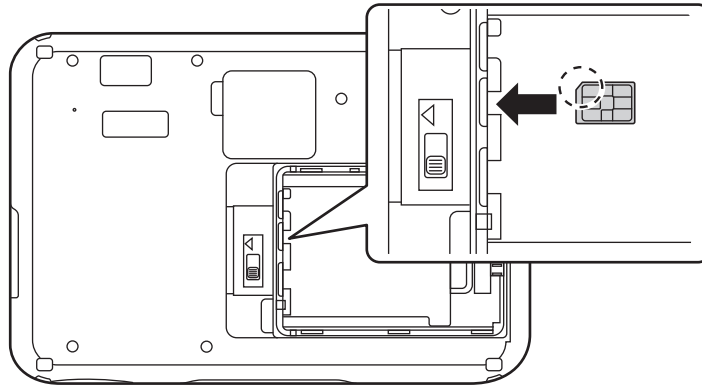

2. Slide the Nano SIM card until you hear a click.
 - To remove a Nano SIM card, push it slightly into the slot to eject it.

Installing an SD card

- When installing or removing an SD card, place the unit on a flat surface.
 - If a battery is installed, remove it (page 13).
1. Insert the microSD card into the microSD card slot.
 - Install only microSD cards.
 - Hold the microSD card so that the metal terminals are facing down, and insert with the notch facing in the same direction of the circled area in the illustration below.

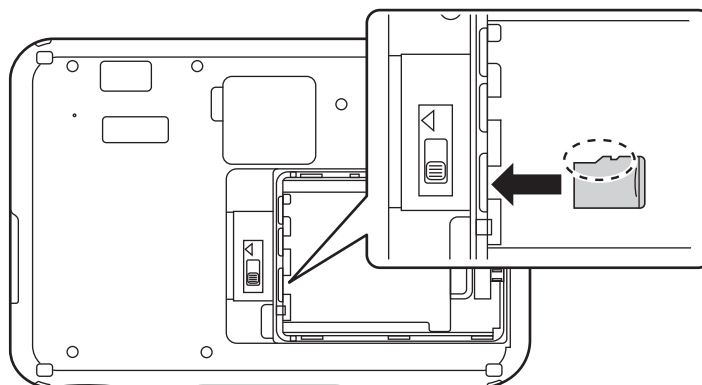

2. Slide the microSD card until you hear a click.
 - To remove a microSD card, push it slightly into the slot to eject it.

Replacing the battery (Battery warm swap)

You can replace the battery without turning the unit off.

- Replace the battery within 30 seconds. If more than 30 seconds has passed, apps that are running are forced to close and you may lose unsaved data.
 - During warm swapping, all wireless functions are turned off temporarily.
1. Press and hold  (power button) until the power options dialog is displayed, and then tap **[Battery Warm Swap]**.
 - You can also operate from **[Warm Swap]** in the app list.
 2. Follow the on-screen instructions.
 - It may take some time until the indicator turns off.
 3. Replace the battery.

IMPORTANT

- When warm swapping the battery, use a sufficiently charged battery.
- Make sure the unit is not accessing the microSD card or SIM card before warm swapping the battery.
- Do not remove the SD card or SIM card while warm swapping the battery.
- Make sure you save any important data before warm swapping the battery.

Charging the battery

The battery is not charged at the time of purchase. Charge the battery before turning on the unit for the first time or after an extended period of storage.

- This section explains how to connect the optional AC adaptor and charge.
AC Adaptor: FZ-AAE184E (USB connection cable included)
- 1. Face the USB mark of the USB connection cable upward, and connect the AC adaptor (①) and the unit (②).
- 2. Plug the power plug (③) of the AC adaptor into a power outlet.
 - The shape of the power plug varies depending on your country.

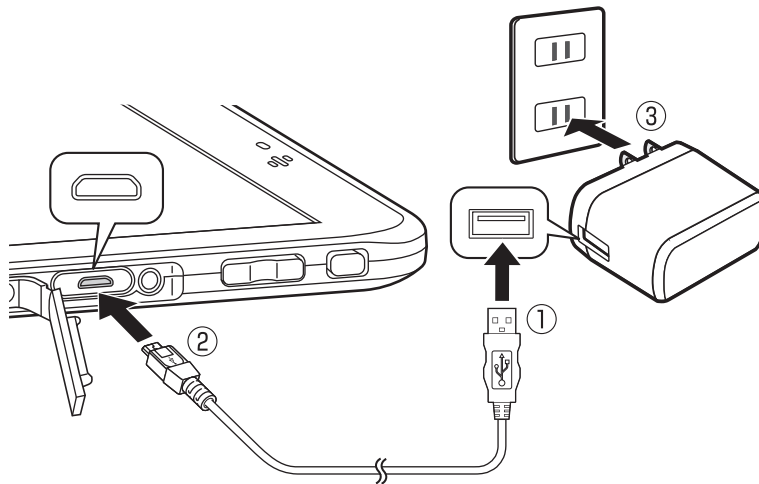

- Charge the battery in environments with an ambient temperature of 10 °C to 35 °C (50 °F to 95 °F).
- The indicator lights in orange while the battery is charging, and lights in green when charging is complete.
- The unit prevents overcharging of the battery by charging only when the remaining battery level is less than approximately 96 % of its full capacity.

Note

- When removing the USB connection cable, make sure to remove it while holding the plug. Do not pull by the cable.
- When connecting a USB connection cable, note the shape of the micro USB plug and the micro USB port. Do not attempt to connect the USB connection cable upside down.
- Remove any dust or water droplets from plugs before connecting them. Do not use excessive force when inserting plugs or insert them at an angle.

Confirming the battery level

The battery level is displayed in the upper-right corner of the screen, in the status bar.



Fully charged



Charging



Very low

You can also confirm the specific amount of battery level remaining. Swipe up the home screen, and then in the App list, tap **[Settings]** → **[Battery]**.

Turning the unit on and off

Turning the unit on

Press and hold  (power button) for more than 2 seconds.

Turning the unit off

1. Press and hold  until the power options dialog is displayed.
2. Tap **[Power off]**.
 - To restart the unit, tap **[Restart]**.

Turning the screen on and off

Going into sleep mode

1. Press .

Waking up from sleep

1. Press .
2. Swipe up the screen to release the screen lock.

Configuring the unit for the first time

The first time you turn the unit on, you will be prompted to configure the initial settings. Follow the on-screen instructions and configure each item as needed. An internet connection is required to configure certain items.

Screen description

Home screen



The home screen is the main screen from which you can launch apps, check widgets, etc. You can customize the home screen to suit your needs by adding, moving, and removing items as desired. (“Customizing the home screen” (page 20))

You can also view a list of all installed apps in the app list by swiping up the home screen.

You can display the home screen at any time by tapping .

Navigation buttons

The navigation buttons are available in most screens and help you navigate the unit’s screens.

-  Returns to the previous screen or closes the current dialog box, menu, etc.
-  Displays the home screen.
-  Displays a list of recently used apps. Once the list is displayed, tap an app to launch it, or swipe left or right to remove an app from the list.
You can also tap and hold this while an app is running to split the screen and display two apps at the same time. To return to single screen, swipe the middle line up or down.

Status bar



The status bar is displayed at the top of the screen when using most apps. It displays icons that let you know the status of the battery, network signal, and other features.



Notifications panel

The notifications panel provides detailed information about incoming email messages, app updates, calendar events, etc. You can open the notifications panel by swiping down from the top of the screen toward the center of the screen. To close the notifications panel, swipe up the screen. While the notifications panel is open, you can swipe down/up or tap “∨” / “∧” to show or hide the hidden items.

While the notifications panel is open, you can tap a notification and open the corresponding app, adjust the screen brightness, or switch the displayed apps on and off. You can also swipe a notification left or right to delete it from the panel.

- Tap  to move to **[Settings]** app.
- Tap  to move or add apps, or to reset the notification panel.

Icons

Status icons

Status icons are displayed in the right side of the status bar. Some commonly displayed icons are explained below.

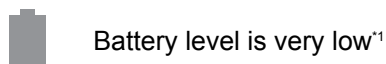
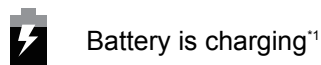
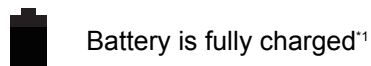

^{*1} You can also use the **[Settings]** app to view details about battery usage. Swipe up the home screen, and then in the app list, tap **[Settings]** → **[Battery]**.

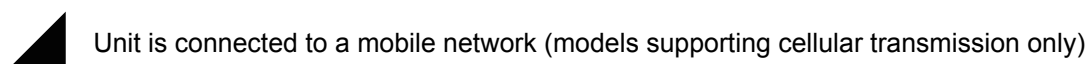
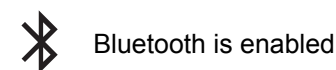
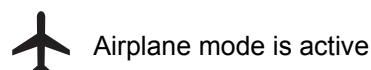
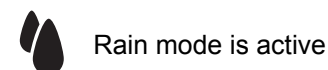
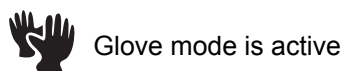
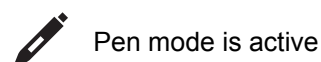
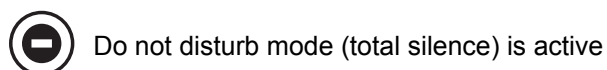
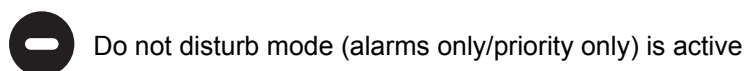



Unit is not connected to a mobile network (models supporting cellular transmission only)

Notification icons

Notification icons are displayed in the left side of the status bar and in the notifications panel. Some commonly displayed icons are explained below.



New email received



New Gmail™ received (models with GMS only)



USB tethering is enabled (models supporting cellular transmission only)



Multiple tethering methods are enabled (models supporting cellular transmission only)



App updates are available (models with GMS only)



App was updated successfully (models with GMS only)

Customizing the home screen

Adding app shortcuts/folders to the home screen

1. Swipe up the home screen, and then in the app list, find the desired app.
2. Tap and hold the desired app, and then move it slightly.
 - The screen switches to the home screen.
3. Drag the app and drop it in the home screen.
 - A folder will be created if you overlap it with another app. To change the folder name, tap **[Unnamed Folder]** while the folder is open.

Adding widgets to the home screen

1. Tap and hold a blank area in the home screen.
2. Tap **[WIDGETS]**.
3. Scroll to find the desired widget.
4. Tap and hold the desired widget.
 - The screen switches to the home screen.
5. Drag the widget and drop it in the home screen.

Moving or deleting items in the home screen

1. Tap and hold the item, and then move it slightly.
2. Drag the item to the desired location (to move) or to **[Remove]** at the top of the screen (to delete).

Changing the wallpaper in the home screen

1. Tap and hold a blank area in the home screen.
2. Tap **[WALLPAPERS]**.

3. Select the app, and then tap **[JUST ONCE]** or **[ALWAYS]**.
4. Select an image to set as the wallpaper, and then tap **[SET WALLPAPER]**.

Configuring the home screen

1. Tap and hold a blank area in the home screen.
2. Tap **[HOME SETTINGS]**.
3. Follow the on-screen instructions and configure the desired settings as necessary.

Input

Typing and voice input

The unit's keyboard is displayed automatically when you tap a text entry field or when you are prompted to enter information. You can type using the on-screen keyboard; in some cases, you can also enter text by speaking.

Using the keyboard

Changing the default keyboard

1. Swipe up the home screen, and then in the app list, tap **[Settings]** → **[System]** → **[Languages & input]**.
2. Tap **[Virtual keyboard]**, and then select the desired keyboard.

Changing the keyboard language

1. Swipe up the home screen, and then in the app list, tap **[Settings]** → **[System]** → **[Languages & input]**.
2. Tap **[Virtual keyboard]**, select the desired keyboard, and then configure the desired settings according to your needs.
 - If the desired keyboard is not shown, tap **[Virtual keyboard]** → **[Manage keyboards]**, and then select the desired keyboard.

Using the SwiftKey keyboard



1 Tool bar/Text replacement

Some commonly displayed icons are explained below. However, while entering text, text replacements are displayed.



: Displays the settings menu.



: Changes the settings related to keyboard and character input.



: Changes the theme of the keyboard.



: Clipboard can be used.

- 2 Uppercase/lowercase letter key**
Switches uppercase and lower case letters. Tap two times to lock to uppercase letters.
- 3 Pictogram key**
Enters pictograms and smileys.
- 4 Input switching key**
Switches to alphabet/number and symbol mode.
- 5 Google voice typing key**
Tap and hold to switch to Google voice typing mode.
- 6 Delete key**
Deletes the character to the left of the cursor.
- 7 Line feed key**
Inserts line feeds in text.
- 8 Keyboard conversion key**
Changes the virtual keyboard (page 22).
- 9 Close the keyboard**

Connectivity

Mobile network (models supporting cellular transmission only)

You can use the unit to connect to a mobile network and access emails and the Internet. Mobile network-related settings are available by swiping up the home screen, and then in the app list, tapping **[Settings]** → **[Network & Internet]** → **[Mobile network]**.

Note

- Attach a SIM card before using a mobile network.
- The wireless WAN antenna is contained in the gray area indicated in the illustration below. Covering the area around the antenna with your hand may affect the signal quality.

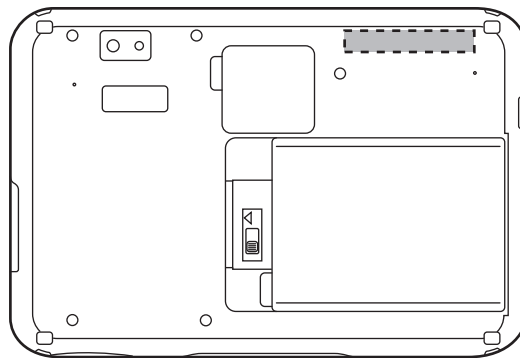

Changing the preferred mobile network mode

You can select the preferred mobile network mode used for mobile network connections.

1. Swipe up the home screen, and then in the app list, tap **[Settings]** → **[Network & Internet]** → **[Mobile network]** → **[Advanced]** → **[Preferred network mode]**¹.

¹ Depending on your model, **[Preferred network type]** may be displayed.

2. Select the preferred network mode.

Wi-Fi

You can use the unit to connect to a wireless LAN access point and access emails and the Internet.

Note

- The Wi-Fi antenna is contained in the gray area indicated in the illustration below. Covering the area around the antenna with your hand may affect the signal quality.

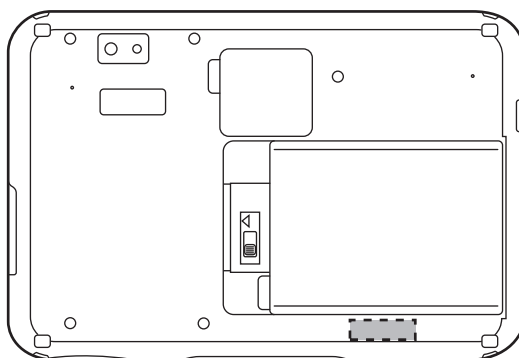

Turning Wi-Fi on and off

1. Swipe up the home screen, and then in the app list, tap **[Settings]** → **[Network & Internet]** → **[Wi-Fi]**.
2. Tap the switch to turn Wi-Fi on or off.

Connecting to a Wi-Fi access point

1. Swipe up the home screen, and then in the app list, tap **[Settings]** → **[Network & Internet]** → **[Wi-Fi]**.
 - Make sure that Wi-Fi is turned on.
2. Select the desired network name.
 - If the desired network name is not displayed, you may need to enter the network name (SSID) manually. See “Entering the network name (SSID) manually” (page 25) for more information.
3. If you are connecting to a network with security protection, enter the password.
4. Tap **[CONNECT]**.

Entering the network name (SSID) manually

1. Swipe up the home screen, and then in the app list, tap **[Settings]** → **[Network & Internet]** → **[Wi-Fi]**.
 - Make sure that Wi-Fi is turned on.
2. Tap **[Add network]**.
3. Enter the network name (SSID), then select the network’s security type and enter the password, if required.
 - Select the security type from **[None]**, **[WEP]**, **[WPA/WPA2 PSK]**, or **[802.1x EAP]**.
4. Tap **[SAVE]**.

Selecting the frequency band used for Wi-Fi

1. Swipe up the home screen, and then in the app list, tap **[Settings]** → **[Network & Internet]** → **[Wi-Fi]**.
 - Make sure that Wi-Fi is turned on.
2. Tap **[Wi-Fi preferences]** → **[Advanced]** → **[Wi-Fi frequency band]**.
3. Select the desired setting.

Setting a portable Wi-Fi access point (models supporting cellular transmission only)

You can use the unit as a Wi-Fi access point to connect other devices that are compatible with wireless LAN to the Internet.

1. Swipe up the home screen, and then in the app list, tap **[Settings]** → **[Network & Internet]** → **[Hotspot & tethering]**.
2. Tap the **[Wi-Fi hotspot]** switch to turn it on.
3. Tap **[Set up Wi-Fi hotspot]**.
4. Configure the network name, security type, and password as desired, and then tap **[SAVE]**.

Using peer-to-peer Wi-Fi connections (Wi-Fi Direct)

The unit can establish peer-to-peer connections with other devices that are compatible with Wi-Fi Direct. This allows you to directly send and receive data between the unit and other devices without using a wireless access point.

1. Swipe up the home screen, and then in the app list, tap **[Settings]** → **[Network & Internet]** → **[Wi-Fi]**.
 - Make sure that Wi-Fi is turned on.
2. Tap **[Wi-Fi preferences]** → **[Advanced]** → **[Wi-Fi Direct]**.
3. Select the desired settings and functions as necessary.
 - Available devices are displayed under **[Peer devices]**.

Bluetooth

You can use the unit to connect to other Bluetooth-compatible devices.

Note

- The Bluetooth antenna is contained in the gray area indicated in the illustration below. Covering the area around the antenna with your hand may affect the signal quality.

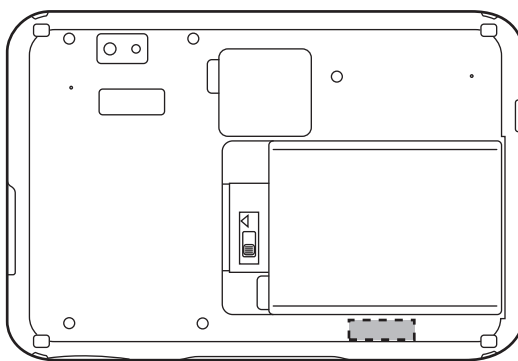

Turning Bluetooth on and off

1. Swipe up the home screen, and then in the app list, tap **[Settings]** → **[Connected devices]** → **[Bluetooth]**.
2. Tap the switch to turn Bluetooth on or off.

Pairing a Bluetooth device

Use this procedure to use the unit to initiate the pairing process, such as when pairing a Bluetooth headset.

- Make sure that Bluetooth is turned on, and set the other Bluetooth device to pairing mode or discoverable mode. (Refer to the instruction manuals included with the other device for details.)
1. Swipe up the home screen, and then in the app list, tap **[Settings]** → **[Connected devices]** → **[Bluetooth]** → **[Pair new device]**.
 - The unit searches for nearby Bluetooth devices, and the names of Bluetooth devices available for pairing are displayed.
 2. Tap the name of the device that you want to pair with the unit.
 3. Follow the on-screen instructions.

Note

- When the unit receives a connection request from the other Bluetooth device, a pairing request screen is displayed. Follow the on-screen instructions.

Removing a paired Bluetooth device

1. Swipe up the home screen, and then in the app list, tap **[Settings]** → **[Connected devices]** → **[Bluetooth]**.
2. Tap  → **[FORGET]** of the paired device that you want to remove.

Sharing the unit's Internet connection via Bluetooth (Bluetooth tethering)

Use this procedure to use the Bluetooth connection and share the Internet connection with a Bluetooth device that supports PAN profiles. You may not be able to share the unit's mobile network connection (models supporting cellular transmission only) depending on your mobile network service provider.

1. Swipe up the home screen, and then in the app list, tap **[Settings]** → **[Network & Internet]** → **[Hotspot & tethering]**.

2. Tap the **[Bluetooth tethering]** switch to turn it on.

Airplane mode

When using the unit where wireless connections are prohibited, such as on airplanes and in hospitals, you can turn off all wireless connections by enabling airplane mode. Once you have turned on airplane mode, you can manually turn certain wireless communication features on again, such as Wi-Fi and Bluetooth.

Turning airplane mode on and off

1. Swipe up the home screen, and then in the app list, tap **[Settings]** → **[Network & Internet]**.
2. Tap the **[Airplane mode]** switch to turn it on or off.

Note

- You can also turn airplane mode on and off by using the **[Dashboard]** app (see page 33).

USB connection

You can use the unit's micro USB port to connect the unit to a computer or other device.

Connecting the unit to a computer

You can connect the unit to a computer and transfer files. Connect the unit to a computer using the USB connection cable and follow the procedure below.

1. Swipe up the home screen, and then in the app list, tap **[Settings]** → **[Connected devices]** → **[USB]**.
2. Tap **[Transfer files]**.

Note

- You can also change the setting by tapping the notification in the notifications panel.
- Do not remove the USB connection cable while the unit is being accessed. Doing so may corrupt the data.

Sharing the unit's Internet connection via USB (USB tethering) (models supporting cellular transmission only)

Use this procedure to use the unit's USB connection to share the unit's Internet connection with a computer. You may not be able to share the unit's mobile network connection (models supporting cellular transmission only) depending on your mobile network service provider.

1. Swipe up the home screen, and then in the app list, tap **[Settings]** → **[Network & Internet]** → **[Hotspot & tethering]**.
2. Tap the **[USB tethering]** switch to turn it on.

SD memory card

See “Installing an SD card” (page 14) for the card installation procedure.

See “Encrypting the SD card” (page 30) for information about encrypting the contents of the SD card.

Confirming the available space on the SD card

Swipe up the home screen, and then in the app list, tap **[Settings]** → **[Storage]**.

Security

Locking the screen

You can lock the screen to prevent accidental operation. You can also enhance security by requiring a PIN, pattern, or password to prevent the screen from being unlocked.

Configuring the screen lock

1. Swipe up the home screen, and then in the app list, tap **[Settings]** → **[Security & location]** → **[Screen lock]**.
 - If the screen lock is already configured, you must unlock the unit before configuring a different unlock method.
2. Select the desired unlock method and then follow the on-screen instructions.

Note

- The risk of unauthorized access to the unit is increased when using the **[None]** and **[Swipe]** unlock methods as these methods provide little to no security. For increased security, select an unlock method that is unknown to others and difficult to guess.
- Do not use a password, etc. that you already use for other features.

Locking the screen

Press  (power button) to put the unit into sleep mode, or wait for the screen to automatically turn off.

Encrypting the SD card

You can encrypt the contents of the SD card. After it is encrypted, the PIN or password used for unlocking the screen must be entered before the SD card can be mounted.

IMPORTANT

- To prevent the unintended disclosure of sensitive information stored on the SD card, we recommend using this feature to encrypt the SD card.
1. Swipe up the home screen, and then in the app list, tap **[Settings]** → **[Security & location]** → **[Encryption & credentials]** → **[Encrypt SD card]**.
 2. Tap the **[Encryption]** switch to turn it on, and then tap **[Next]**.
 3. Enter the unit's PIN or password, and then tap **[>]**.
 - This is the same PIN or password used for the screen lock feature (see "Locking the screen" (page 30)).
 4. Tap **[ENCRYPT SD CARD]**.

Note

- Encryption and disabling encryption takes time. Fully charge the battery before starting and continue to charge until the process is finished.

Decrypting the SD card

1. Swipe up the home screen, and then in the app list, tap **[Settings]** → **[Security & location]** → **[Encryption & credentials]** → **[Encrypt SD card]**.
2. Tap the **[Encryption]** switch to turn it off, and then tap **[Next]**.

3. Enter the unit's PIN or password, and then tap [**>**].
 - This is the same PIN or password used for the screen lock feature (see "Locking the screen" (page 30)).
4. Tap [**DISABLE SD CARD ENCRYPTION**].

[DeviceManagement] app

You can disable the unit's individual hardware features to prevent access to certain functions.

IMPORTANT

- A password must be set in order to use this feature. If you forget this password, there is no way to reset it (it is not erased if the unit is reset using the factory data reset utility) and therefore you will no longer be able to change this feature's settings. If you forget the password, contact your technical support representative.

Enabling and disabling certain hardware features

1. Swipe up the home screen, and then in the app list, tap [**DeviceManagement**] → [**Device setting items**].
2. Select the desired feature and then select the desired setting.
 - Repeat this step to change the settings for other features, if desired.
3. Tap [**APPLY**], enter the password and then tap [**OK**].
 - If a password is not set, you will be prompted to create a new one.

Note

- Some settings will take place the next time the corresponding hardware component is connected, mounted, etc.

Adding the USB storage

1. Swipe up the home screen, and then in the app list, tap [**DeviceManagement**] → [**Device setting items**].
2. Add USB storage with the following procedures.
 - [**Add device**]: Enter the vendor ID or product ID of the USB storage you want to add.
 - [**Do scan**]: Scan the connected USB storage, and then tap the USB storage you want to add.

Restricting the network connection

You can restrict connecting servers or connection methods such as mobile networks or Wi-Fi.

1. Swipe up the home screen, and then in the app list, tap [**DeviceManagement**] → [**IP Filter Settings**].
2. Tap [**Enable IP Filter**] to turn on the checkbox.
3. Tap [**Use Filtering Rule X**] in Filtering Rule 1 to 5 to turn on the checkbox.
4. Tap [**Filtering Network**] or [**Add IP Address to Accept**] of the selected Filtering Rule, and then select the usable connection method or add the allowed server.
5. Tap [**APPLY**], enter the password and then tap [**OK**].
 - If a password is not set, you will be prompted to create a new one.

Changing or deleting the password used for [DeviceManagement]

1. Swipe up the home screen, and then in the app list, tap [**DeviceManagement**] → [**Password settings**].
2. Select the desired item and then follow the on-screen instructions.

Settings

[Settings] app

Configure the unit's settings. Swipe up the home screen, and then in the app list, tap **[Settings]** to display the settings menu. Suggestions for frequently used settings are displayed at the top of the settings menu, and you can display or hide them using “∨” / “∧” at the right side.

The settings are grouped into the categories below.

Network & Internet

Contains settings related to Wi-Fi, mobile networks, Ethernet configuration, hotspots, tethering, etc.

Connected devices

Contains settings related to connected devices, such as Bluetooth, NFC, USB, and external devices^{*1}.

^{*1} Gadget settings are available only for certain models.

Apps & notifications

Contains settings related to apps and notifications.

Battery

Allows you to confirm battery status and usage. Also contains settings related to the battery.

Display

Contains settings related to screen functionality, such as brightness, wallpaper, font size, and touch operation.

Sound

Contains settings related to the unit's various sounds, volume, Do Not Disturb mode, etc.

Storage

Allows you to confirm the available space in the unit's internal storage and SD card, and to manage files.

Security & location

Contains settings that control security-related features such as screen lock and data encryption. Also contains settings related to location information.

Users & accounts

Allows you to register and edit your information. You can also add a new user to share the unit with other users. Also, you can configure settings related to adding accounts and data syncing.

Accessibility

Contains settings that assist the user such as screen readers, display, and interaction controls (“Accessibility settings” (page 35)).

Google

Contains settings related to Google™ services.

System

Allows you to configure the display and input language, date and time, backup, reset, etc. You can also confirm information about the tablet, such as the status of the battery and the network, and the software version.

Power options menu

You can press and hold  (power button) to display the power options menu. From here, you can perform or set the following commonly-used features.

- Power off
- Battery Warm Swap (page 15)
- Restart
- Touch operation mode (page 35)

[Dashboard] app

The **[Dashboard]** app provides quick access to various unit features. You can use this app to perform the following.

- Change screen brightness
- Change speaker volume
- Confirm battery level
- Enable and disable airplane mode, Wi-Fi, WWAN (mobile network connections) (models supporting cellular transmission only)^{*1}, Bluetooth, location information, screen auto rotation, microphone^{*1}.
- Launch apps

^{*1} This item is not displayed by default; you can add it to **[Dashboard]** if desired.

Using [Dashboard]

1. Swipe up the home screen, and then in the app list, tap **[Dashboard]**.
2. Operate the desired function.

Note

- Features that have been disabled using the **[DeviceManagement]** app (see page 31) are not available in **[Dashboard]**.

Adding and deleting tiles

You can add up to 12 tiles.

1. Swipe up the home screen, and then in the app list, tap **[Dashboard]**.
2. **To add tiles**

Tap **[MENU]** → **[Add]**, select the desired tile type, and then follow the on-screen instructions.

- Two types of tiles are available.
 - **[Toggles]**: Tiles that allow you to enable or disable certain features.
 - **[Application]**: Tiles that allow you to launch a specific app.

To remove tiles

Tap and hold the desired tile, and then tap **[YES]**.

To change the color theme

Tap **[MENU]** → **[Skin]**, select the desired theme, and then tap **[OK]**.

Importing and exporting [Dashboard] settings

1. Swipe up the home screen, and then in the app list, tap **[Dashboard]**.

2. To export

Tap **[MENU]** → **[Export]**, enter the desired file name (up to 10 characters), and then tap **[OK]**.

To import



Tap **[MENU]** → **[Import]**, and then select the desired file.

Note

- Settings are exported to:
Swipe up the home screen, and then in the app list, tap **[Settings]** → **[Storage]** → **[Files]** → **[com.panasonic.mobile.dashboard]**.

[UserButtonManager] app

You can customize the unit's function buttons. Some of the available functions that you can assign to the buttons are listed below.

- Back (the same function as )
- Home (the same function as )
- Menu
- Barcode reader trigger
- Flashlight
- Launch an app of your choosing
- Capture a screenshot
- Security mode (turns off the screen and sound)
- Wake up from sleep mode

Changing the functions assigned to the buttons

1. Swipe up the home screen, and then in the app list, tap **[UserButtonManager]**.
2. Tap  next to the item you want to change, and then select the desired function.

Default button assignments

The default button assignments are explained below.

Short press assignments

Left Side button (for models with a barcode reader)

No function by default.

Right Side button (for models with a barcode reader)

No function by default.

Volume up button

Increases the volume.

Volume down button

Decreases the volume.

Long press (press and hold) assignments

Left Side button (for models with a barcode reader)

No function by default.

Right Side button (for models with a barcode reader)

No function by default.

Wakeup Setting



Assigns a button to wake up from sleep mode. (No assignment by default.)

[Panasonic Enterprise Launcher] app

You can change the home app to Panasonic Enterprise Launcher. If Panasonic Enterprise Launcher is set, you can control the use of the functions or apps. In Panasonic Enterprise Launcher, there are two modes, kiosk mode and user mode.

- Administrator login is necessary to customize the Panasonic Enterprise Launcher.
- Launcher3 is the Android standard home app.

Using [Panasonic Enterprise Launcher]

1. Swipe up the home screen, and then in the app list, tap **[Settings]** → **[Apps & notifications]** → **[Advanced]** → **[Default apps]**.
2. Tap **[Home app]** → **[Panasonic Enterprise Launcher]**.
3. Tap , and then tap  → **[Admin login]** → enter the password (default: blank) → **[OK]**.
4. Tap  → **[Settings]**, and then configure the desired settings according to your needs.

Touch operation settings

You can select the following touch operation modes to suit your working conditions.

- **Glove mode:** Makes the screen more sensitive to touch operations. Useful when operating the unit while wearing gloves.
- **Pen mode:** Changes the screen to a sensitivity optimized for stylus pen operations.
- **Rain mode:** Prevents accidental operation when the screen is wet.

1. Swipe up the home screen, and then in the app list, tap **[Settings]** → **[Display]** → **[Advanced]** → **[Touch operation mode]**.
2. Tap the desired modes to turn them on.

Note

- You can also change the touch operation mode by tapping **[Touch operation mode]** in the power options menu (see “Power options menu” (page 33)).
- Turn glove mode off when you are not wearing gloves.
- Even if glove mode is enabled, the unit may not be able to be operated while wearing certain types of gloves.
- Even if rain mode is enabled, the unit may not be able to be operated or may not respond properly to touches when the entire screen is wet or depending on the amount of water on the screen. Temporarily put the unit to sleep mode and wipe the water off of the screen.

Accessibility settings

The unit provides a variety of settings that allow you to change how the user and unit interact.

1. Swipe up the home screen, and then in the app list, tap **[Settings]** → **[Accessibility]**.
2. Select the desired feature or option and configure it as desired.
 - **[Volume key shortcut]:** Allows you to press and hold both volume buttons to start the selected accessibility feature.
 - **[Select to Speak]:** Allows you to tap specific items on your screen to hear them read aloud.
 - **[TalkBack]** (models with GMS only): Reads items on the screen aloud.
 - **[Text-to-speech output]:** Allows you to configure the unit’s text-to-speech features.
 - **[Font size]:** Allows you to make the text on the screen smaller or larger.
 - **[Display size]:** Allows you to make the items on your screen smaller or larger.

- **[Magnification]**: Allows you to turn on the unit's screen magnification feature.
- **[Color correction]**: Allows you to correct the colors in the screen.
- **[Color inversion]**: Allows you to invert the colors in the screen.
- **[Large mouse pointer]**: Allows you to make the pointer size larger when a mouse is connected.
- **[Switch Access]** (models with GSM only): Allows you to use one or more switches to select items, scroll, enter text, and more.
- **[Click after pointer stops moving]**: Allows you to set the connected mouse pointer to click when it stops moving.
- **[Power button ends call]** (models supporting cellular transmission only): Allows you to end a phone call by pressing the power button.
- **[Auto-rotate screen]**: Allows you to configure the unit to rotate the screen automatically when the unit is tilted.
- **[Touch & hold delay]**: Allows you to adjust the amount of time that passes before the unit recognizes a "long tap" as a tap-and-hold operation.
- **[Mono audio]**: Combines channels when playing audio.
- **[Captions]**: Allows the display of captions.
- **[High contrast text]**: Allows you to clearly display text by increasing its contrast.

Apps

Starting apps

There are several ways you can start an app.

- Swipe up the home screen, and then in the app list, tap the app's icon
- Create a shortcut to the app in the home screen (see “Adding app shortcuts/folders to the home screen” (page 20))
- Use the **[UserButtonManager]** app to assign the app to one of the unit's buttons (see “Changing the functions assigned to the buttons” (page 34))
- Add the app to the **[Dashboard]** app (see “Adding and deleting tiles” (page 33))

Preinstalled apps

The unit comes preinstalled with the following apps.



Barcode Reader (equipped models only)
Allows you to configure the barcode reader (“Configuring the barcode reader” (page 42)).



Chrome (models with GMS only)
Internet browser app.



Dashboard
Allows easy access to various features (“[Dashboard] app” (page 33)).



DeviceManagement
Allows you to disable the unit's individual hardware features (“[DeviceManagement] app” (page 31)).



Photos (models with GMS only)
Allows you to display, edit, and manage photos and movies.



Contacts

Allows you to store and manage your contacts.



Phone (models supporting cellular transmission only)

Allows you to make phone calls (“Using the [Phone] app to make phone calls” (page 39)).



UserButtonManager

Allows you to configure the unit’s buttons (“[UserButtonManager] app” (page 34)).



Hardware Diagnostic

Allows you to check if the unit’s functions are operating correctly (“About hardware diagnostics” (page 44)).



File Copy

Allows you to work with files in storage.



Warm Swap

Allows you to replace the battery without turning the unit off (“Replacing the battery (Battery warm swap)” (page 15)).



Log sending app

Allows you to acquire logs from the unit, and save them to storage or send them to the server. It is used for analysis during malfunction.

**Button Handler**

Allows you to select the button handler app. Button handler apps developed independently can be set here.

[UserButtonService] is set at the time of purchase. If it is set to **[Disable]**, the **[UserButtonManager]** app cannot be used.

**Panasonic Rapid Configuration**

Allows you to apply the various settings at once by scanning a QR code.

**WL/BL App**



Displays the apps whitelisted and blacklisted in management tools.

Other apps are preinstalled in addition to those mentioned above.



Using the [Phone] app to make phone calls

You can phone call only by using the headset.

Making calls





1. Swipe up the home screen, and then in the app list, tap **[Phone]**.
2. Tap , tap the keys to enter the phone number, and then tap .
3. When you are finished talking, tap .

Answering calls







1. When you receive a phone call, drag  to the right.
2. When you are finished talking, tap .

Camera

Taking pictures

1. Swipe up the home screen, and then in the app list, tap **[Camera]**.
 - You can also start the **[Camera]** app by swiping  at the bottom right of the lock screen.
2. Confirm that  (camera mode) is displayed.
 - If  is displayed, swipe the screen to the right and then tap  to select camera mode.
3. Tap  to take a picture.
 - You can use the digital zoom by pinching in and out or by pressing the volume buttons to adjust the zoom ratio.

Recording videos

1. Swipe up the home screen, and then in the app list, tap **[Camera]**.
 - You can also start the **[Camera]** app by swiping  at the bottom right of the lock screen.
2. Confirm that  (video mode) is displayed.
 - If  is displayed, swipe the screen to the right and then tap  to select video mode.
3. Tap  to start recording, and tap  to stop recording.
 - You can use the digital zoom by pinching in and out or by pressing the volume buttons to adjust the zoom ratio.

Using the option menu

1. While using the **[Camera]** app, tap  in the lower-right corner of the screen.
2. Tap the desired icon and then select the desired option.

- **Photo light**¹

 : On

 : Off

- **Scene modes**

 : Snow

 : Sunset

 : Night view

 : Landscape

AUTO : Auto

HDR : HDR (mode that reduces blocked out blacks and blown-out highlights in scenes with large differences in brightness)²

- **Grid lines**
Set whether to display guiding grid lines in the shooting screen.



- **Self timer**^{*2}
 3s 10s

- **Exposure**^{*1*2*3}

^{*1} Only when the scene mode is set to **[AUTO]**

^{*2} Only in camera mode

^{*3} Only when **[Manual exposure]** is enabled in the camera settings

Camera settings

1. In the **[Camera]** app, swipe the screen to the right and then tap .
2. Select the desired feature and configure it as desired.
 - **[Resolution]**: Allows you to set the resolution.
 - **[Quality]**: Allows you to set the picture quality.
 - **[Focus mode]**^{*1}: Allows you to set the shooting mode according to the subject.
 - **[White balance]**: Allows you to adjust the color development of images according to the weather and conditions of the shooting location.
 - **[Date stamp]**: Allows you to display the date and time when the picture was taken.
 - **[ISO]**^{*1}: Allows you to set the ISO sensitivity.
 - **[Save location]**: Allows you to save location information in pictures.
 - **[Advanced]**: Allows you to set the exposure, storage location, and shutter sound.

^{*1} Only in camera mode

Barcode reader (equipped models only)

Configuring the barcode reader

Barcode reader settings

1. Swipe up the home screen, and then in the app list, tap **[Barcode Reader]**.
2. Select the desired settings and then configure them according to your needs.

Triggering the barcode reader

You can use the **[UserButtonManager]** app to configure which button is used to start scanning the barcode. See “Changing the functions assigned to the buttons” (page 34) for more information.

Using the barcode reader

Typically, scanned barcodes are entered into the currently selected text field of the app that is in the foreground.

About the demo app

You can try using the barcode reader by launching the demo app.

1. Swipe up the home screen, and then in the app list, tap **[Barcode Reader]** →  → **[Demo]**.

Note

- The barcode scan function is assigned to the side buttons in the demo app. Pressing the buttons emits a laser. Take care not to look directly at the laser or point it at other people’s eyes. Doing so will cause damage to the eyes.

NFC card reader/writer

The unit can read NFC card data. It can also transmit data with other devices that have NFC built in.

Note

- Hold the NFC card in the orientation as shown in the figure.
- When using NFC, unlock the screen.
- If the unit is having difficulty reading, slightly shift the position of the card.
- If your unit is equipped with the barcode reader over the NFC antenna, NFC cannot be used.

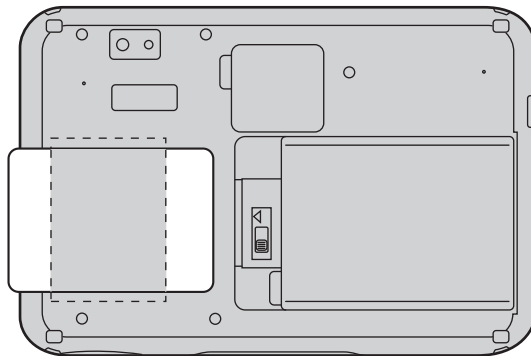

Turning NFC on and off

1. Swipe up the home screen, and then in the app list, tap **[Settings]** → **[Connected devices]**.
2. Tap the **[NFC]** switch to turn it on or off.

Advanced NFC settings

1. Swipe up the home screen, and then in the app list, tap **[Settings]** → **[Connected devices]**.
 - Make sure that NFC is turned on.
2. Tap **[Advanced NFC settings]**.
3. Select the desired settings and then configure them according to your needs.

Hardware diagnostics

About hardware diagnostics

If you suspect that the unit's hardware is not operating correctly, you can use the **[Hardware Diagnostic]** app to check if there are problems with the hardware. If there is a hardware problem, contact your technical support representative. This app cannot check for software problems.

Diagnosable hardware

Automatic Test

Wi-Fi, Bluetooth, Wireless WAN (WWAN) (models supporting cellular transmission only), GPS, microSD card (external SD), USB storage, Ethernet

Manual Test

Touchscreen (Multi-touch, Single-touch), LCD, Sound, Battery Health

Running hardware diagnostics

A result icon is displayed on the left of the diagnosed device.

 : Pass

 : Fail

Diagnosing with the automatic test

1. Swipe up the home screen, and then in the app list, tap **[Hardware Diagnostic]**.
2. Turn on the checkbox by tapping the device name (**[1. Wi-Fi]**, **[2. Bluetooth]**, **[3. WWAN]** (models supporting cellular transmission only), **[4. GPS]**, **[5. External SD]**, **[6. USB storage]**, **[7. Ethernet]**) that you want to diagnose.
 - To diagnose a microSD card or USB storage device, insert the microSD card or USB storage device into the unit. Back up any important data in the microSD card or USB storage device before diagnosis.
3. Tap **[RUN]** to start diagnosis.
4. When a message indicating that diagnosis is finished is displayed, tap **[FINISH]**.

Diagnosing the touchscreen (multi-touch)

1. Swipe up the home screen, and then in the app list, tap **[Hardware Diagnostic]** → **[8. Touchscreen (Multi-touch:5points)]**.
2. Touch the screen with five fingers.
3. When you remove your fingers from the screen and a message indicating that diagnosis is finished is displayed, tap **[PASS]**, **[FAIL]**, or **[RETRY]**.

Diagnosing the touchscreen (single-touch)

1. Swipe up the home screen, and then in the app list, tap **[Hardware Diagnostic]** → **[9. Touchscreen (Single-touch)]**.
2. Touch ① with your finger and trace the screen in order to ⑤.
3. When a message indicating that diagnosis is finished is displayed, tap **[PASS]**, **[FAIL]**, or **[RETRY]**.

Diagnosing the LCD

1. Swipe up the home screen, and then in the app list, tap **[Hardware Diagnostic]** → **[10. LCD]**.
2. Rotate the unit and check that the screen is displayed as follows.
<Vertical>

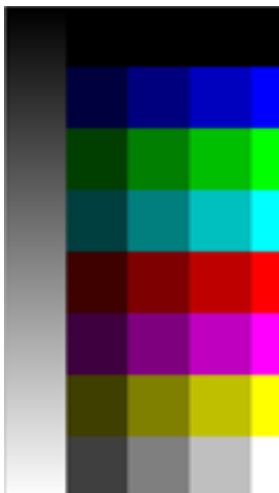



<Horizontal>



3. Tap the screen, and then tap .
4. When the confirmation items are displayed, tap the test result items to turn on the checkboxes, and then tap **[OK]**.

Diagnosing the sound

1. Swipe up the home screen, and then in the app list, tap **[Hardware Diagnostic]** → **[11. Sound]**.
2. Tap , speak into the unit's microphone, and then tap  to stop recording.
3. Tap **[SAVE]**.
4. Tap the saved file to check the sound.
5. Tap  twice, and the confirmation items are displayed. Tap the test result items to turn on the checkboxes, and then tap **[OK]**.

Diagnosing the battery health

1. Swipe up the home screen, and then in the app list, tap **[Hardware Diagnostic]** → **[12. Battery Health]**.
2. Check the details and then tap **[OK]**.

Saving or checking the system log and diagnosis results

Checking the system information

1. Swipe up the home screen, and then in the app list, tap **[Hardware Diagnostic]** → **[System Information]**.
2. Check the details and then tap **[OK]**.

Checking the system log

1. Swipe up the home screen, and then in the app list, tap **[Hardware Diagnostic]** → **[System Log]**.
2. Check the details and then tap **[OK]**.

Saving the test results

1. After running hardware diagnostics, tap  → **[Save test result to the internal storage]**.

Note

- The test results are saved to:
Swipe up the home screen, and then in the app list, tap **[Settings]** → **[Storage]** → **[Files]** → **[DiagnosticResults]**.

Checking saved test results

1. Swipe up the home screen, and then in the app list, tap **[Hardware Diagnostic]** → **[Test Result]**.
2. Select the XML file of a saved test result, and then tap **[OK]**.
3. Check the details, and then tap  to finish displaying the diagnosis results.

Sharing saved test results

1. Swipe up the home screen, and then in the app list, tap **[Hardware Diagnostic]** →  → **[Attach test result to mail]**.
2. Select the zip file of a saved test result, and then tap **[OK]**.
3. Select an app with which to share, and follow the on-screen instructions.

Saving the background Logcat (system log) to the internal storage

1. Swipe up the home screen, and then in the app list, tap **[Hardware Diagnostic]** →  → **[Save Logcat in background]**.
2. Check the details and then tap **[OK]**.
 - To stop saving, tap **[Save Logcat in background]** again to turn off the checkbox, and then tap **[OK]**.

Supplementary items

Protective Film (FZ-VPFL11)

■ Included accessories

- Spatula × 1

Description of parts

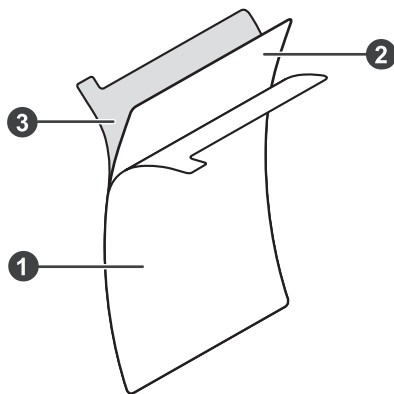

- ① Peel-off sheet (transparent)^{*1}
- ② Protective Film
- ③ Peel-off sheet (blue)^{*2}

^{*1} Only the tab might be white.

^{*2} Only the tab might be blue.

How to apply the Protective Film

Note

- Do not bend the Protective Film. Creases may prevent the Film from being applied smoothly to the screen, and may make the screen difficult to see.
1. Use a soft, dry cloth to remove dirt, dust, fingerprints, etc., from the screen surface.
 - If the Protective Film is applied while foreign matter remains on the screen surface, air bubbles or abrasions may result.
 2. Hold the tab of the peel-off sheet (transparent)^{*1} (①), and peel back about 3 cm of the sheet from the Protective Film.
 - At this time, do not touch the adhesive side (②), or leave the Film lying around, as dust or other foreign matter might settle on it.

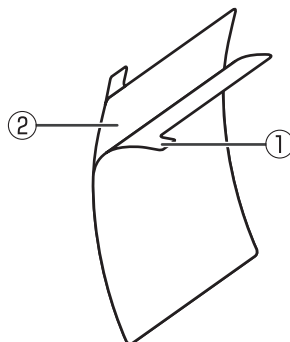

3. Align the adhesive side of the Protective Film (the side of the Film with the peel-off sheet (transparent)) with the screen, and carefully attach the Film to the screen while peeling off the peel-off sheet.
 - If the Film is positioned incorrectly, or if large air bubbles are visible, peel off the Film and re-apply. If dust or other foreign matter should settle on the adhesive side of the Protective Film, remove it with cellophane tape.

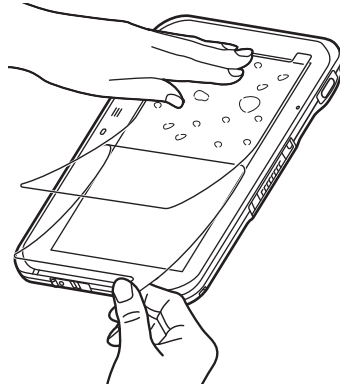

4. Use the spatula provided (③) to remove any remaining air bubbles.
 - Remove air bubbles by pushing them toward the outer edge of the screen, as shown in the figure. Do not apply too much force, as damage to the screen may result. Also, be careful not to scratch the surface of the Protective Film with the corner of the spatula.

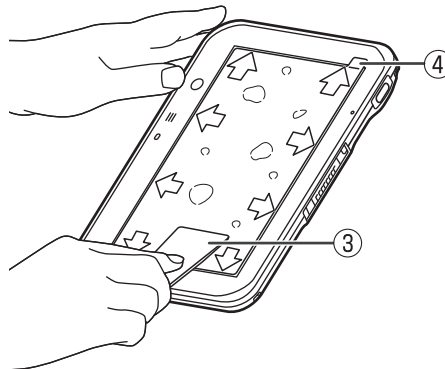

5. Hold the tab of the peel-off sheet (blue)² (④), and peel away the entire sheet from the Protective Film.

Note

- If the surface of the Protective Film becomes dirty, wipe it with a soft, dry cloth.
- When removing the Protective Film, be careful not to scratch the screen with your fingernails, etc.
- Peel off the Protective Film slowly and carefully.

Hand Strap (FZ-VSTL11)

Handling and maintenance

- Take care as there is a risk of the unit dropping when the hand strap is loose.
- Do not use the hand strap if it is worn out or damaged.
- Your hand, hand strap, etc. may appear in the shooting range of the camera depending on the way you hold or the direction of the hand strap. When shooting with the camera, adjust the position of the hand strap so that the hand strap does not enter the shooting range of the camera.
- For typical cleaning, wipe the hand strap with a soft, dry cloth.
 - If the hand strap becomes dirty, wet a soft cloth with water and wring it thoroughly before wiping the hand strap.
 - Do not clean the hand strap with benzene, thinner, alcohol, household cleansers, etc., as these may damage the hand strap.

Attaching

1. Detach the four buckles attached to the hand strap.
 - Press the protrusions (①) of the buckle to detach it.

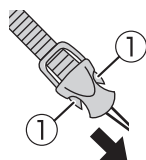

2. Place the unit on a flat surface such as a desk with the screen facing down, then attach the buckles to the strap attachment hole at each corner of the unit.
 - Make sure there are no foreign objects under the unit.

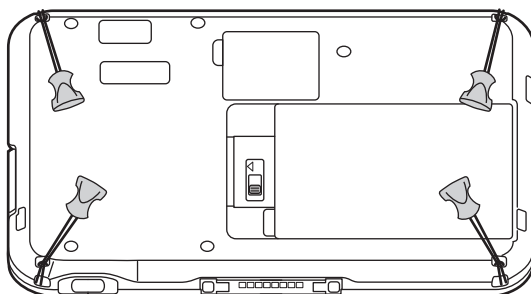

Supplementary items

- Place the hand strap on the back side of the unit in the direction illustrated below, and attach the buckles.
 - When attaching the buckles, make sure the bulge on the catch side (②) faces up. Attaching them in the reverse direction may damage them.
 - Insert the buckles until you hear a click.
 - You can rotate the strap part (③).
- While pulling the hand strap in the direction of the arrow (④), adjust the buckle belts so that the hand strap is not loose (⑤).
 - Pull straight at a low position without lifting the buckle belts.

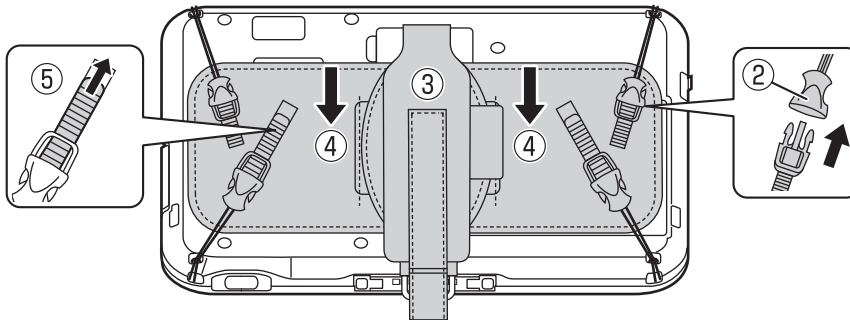

- Adjust the hand strap to fit on your hand, and then fold back and fasten the belt.
 - Fold back and fasten the belt firmly so that the white line (⑥) on the belt is not visible. If the white line is visible, the belt may come loose because it is not fastened enough.
 - A pen holder (⑦) is also attached.

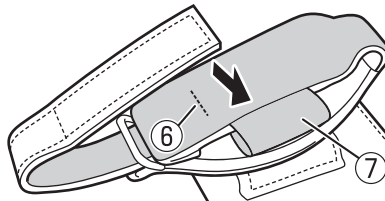

Replacing the battery

To replace the battery, detach two buckles on the expansion bus connector side.

Hand Strap (BL) (FZ-VSTL12)

Handling and maintenance

- Take care as there is a risk of the unit dropping when the hand strap is loose.
- Do not use the hand strap if it is worn out or damaged.
- Your hand, hand strap, etc. may appear in the shooting range of the camera depending on the way you hold or the direction of the hand strap. When shooting with the camera, adjust the position of the hand strap so that the hand strap does not enter the shooting range of the camera.
- For typical cleaning, wipe the hand strap with a soft, dry cloth.
 - If the hand strap becomes dirty, wet a soft cloth with water and wring it thoroughly before wiping the hand strap.
 - Do not clean the hand strap with benzene, thinner, alcohol, household cleansers, etc., as these may damage the hand strap.

Attaching

1. Detach the two buckles attached to the hand strap.
 - Press the protrusions (①) of the buckle to detach it.

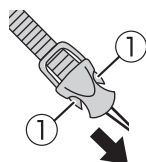

2. Place the unit on a flat surface such as a desk with the screen facing down, then attach the buckles to the strap attachment hole at the lower side of the unit.
 - Make sure there are no foreign objects under the unit.

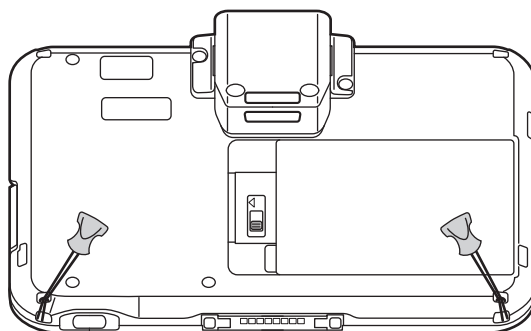

3. Insert the hand strap into the unit in the direction illustrated below (②), fold the belt and firmly fasten it (③), and then lay down the pad (④).

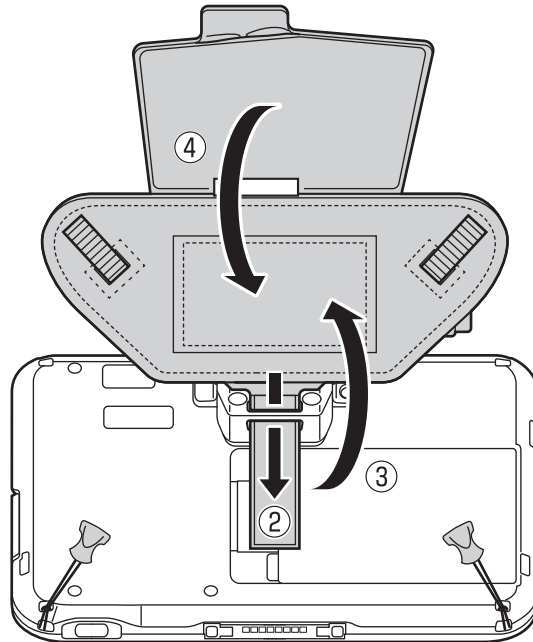

4. Place the hand strap on the back side of the unit in the direction illustrated below, and attach the buckles.
- When attaching the buckles, make sure the bulge on the catch side (⑤) faces up. Attaching them in the reverse direction may damage them.
 - Insert the buckles until you hear a click.
 - You can rotate the strap part (⑥).
5. While pulling the hand strap in the direction of the arrow (⑦), adjust the buckle belts so that the hand strap is not loose (⑧).
- Pull straight at a low position without lifting the buckle belts.

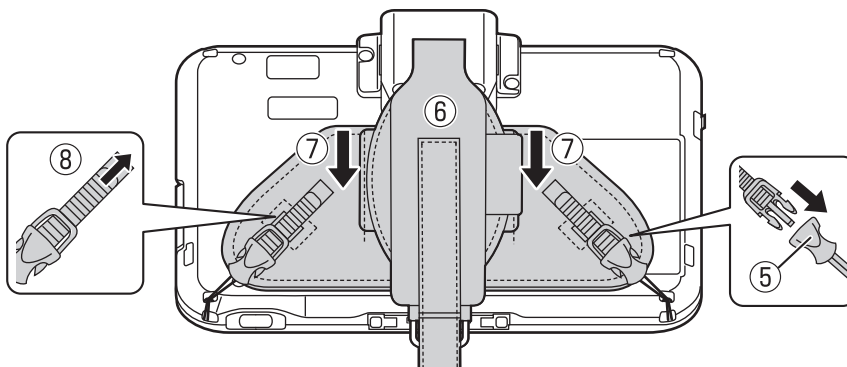

6. Adjust the hand strap to fit on your hand, and then fold back and fasten the belt.
 - Fold back and fasten the belt firmly so that the white line (⑨) on the belt is not visible. If the white line is visible, the belt may come loose because it is not fastened enough.
 - A pen holder (⑩) is also attached.

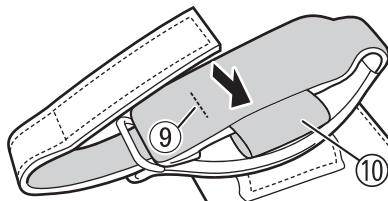

Replacing the battery

To replace the battery, detach the buckles.

Hand Strap (BP) (FZ-VSTL13)

Handling and maintenance

- Take care as there is a risk of the unit dropping when the hand strap is loose.
- Do not use the hand strap if it is worn out or damaged.
- Your hand, hand strap, etc. may appear in the shooting range of the camera depending on the way you hold or the direction of the hand strap. When shooting with the camera, adjust the position of the hand strap so that the hand strap does not enter the shooting range of the camera.
- For typical cleaning, wipe the hand strap with a soft, dry cloth.
 - If the hand strap becomes dirty, wet a soft cloth with water and wring it thoroughly before wiping the hand strap.
 - Do not clean the hand strap with benzene, thinner, alcohol, household cleansers, etc., as these may damage the hand strap.

Attaching

1. Detach the two buckles attached to the hand strap.
 - Press the protrusions (①) of the buckle to detach it.

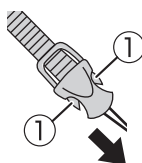

Supplementary items

2. Place the unit on a flat surface such as a desk with the screen facing down, then attach the buckles to the strap attachment hole at the lower side of the unit.
 - Make sure there are no foreign objects under the unit.

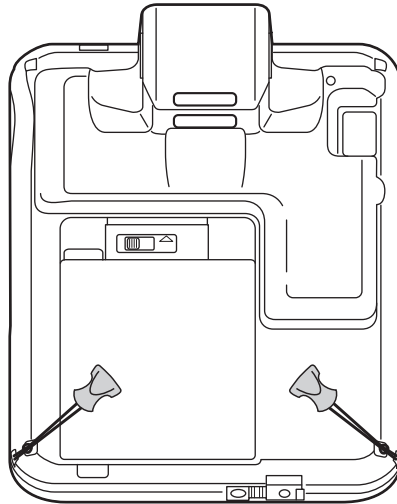

3. Open the hand strap pad (②), insert the belt into the unit in the direction illustrated below (③), fold the belt and firmly fasten it (④), and then close the pad (⑤).

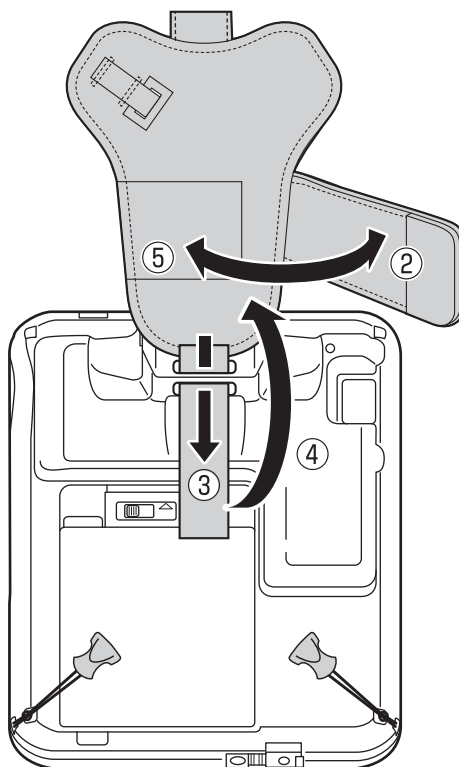

4. Place the hand strap on the back side of the unit in the direction illustrated below, and attach the buckles.
 - When attaching the buckles, make sure the bulge on the catch side (⑥) faces up. Attaching them in the reverse direction may damage them.
 - Insert the buckles until you hear a click.
 - You can rotate the strap part (⑦).
5. While pulling the hand strap in the direction of the arrow (⑧), adjust the buckle belts so that the hand strap is not loose (⑨).
 - Pull straight at a low position without lifting the buckle belts.

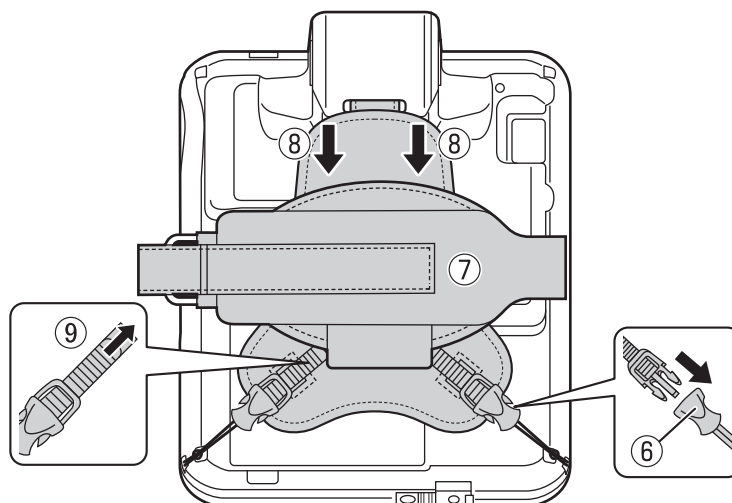

6. Adjust the hand strap to fit on your hand, and then fold back and fasten the belt.
 - Fold back and fasten the belt firmly so that the white line (⑩) on the belt is not visible. If the white line is visible, the belt may come loose because it is not fastened enough.
 - A pen holder (⑪) is also attached.

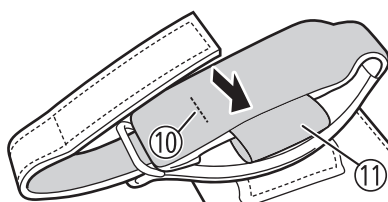

Replacing the battery

To replace the battery, detach the buckles.

Troubleshooting

General information

If you experience any trouble while using the unit, refer to the information in this section for troubleshooting. If the problem persists, contact your technical support representative.

Starting up

The unit does not turn on.

- To turn the unit on, press and hold  (power button) for more than 2 seconds.
- The battery level may be low or completely discharged. Charge the battery.
- The unit may be too hot or too cold. Leave the unit in an environment of 10 °C to 35 °C (50 °F to 95 °F) for about an hour, and then try again.

The unit does not wake up from sleep.

- The battery may have become completely discharged while the unit was in sleep mode. In this case, any data which has not been saved will be lost. Charge the battery.
- The unit may be too hot or too cold. Leave the unit in an environment of 10 °C to 35 °C (50 °F to 95 °F) for about an hour, and then try again.

Nothing appears on the screen.

- The unit is in sleep mode. Press  (power button).
- Charge the battery.
- Install the battery correctly.
- Replace the battery with a fully-charged one.
- The screen is too dark. See “The screen is too dark.” (page 56).

Other startup problems

- Disconnect and remove all peripheral devices.

Shutting down

The unit does not turn off.

- It may take one or two minutes for the unit to turn off. This is not a malfunction.
- Press and hold  (power button) for at least 10 seconds to force the unit to restart, and then try again.
- Disconnect and remove all peripheral devices.

Screen

The screen is too dark.

- The **[Adaptive brightness]** setting reduced the brightness according to the ambient brightness. Manually adjust the screen brightness.
 1. Swipe up the home screen, and then in the app list, tap **[Settings]** → **[Display]**.
 2. Tap the **[Adaptive brightness]** switch to turn it off.
 3. Tap **[Brightness level]** and then adjust the slider.

There are red, green, or blue dots on the screen, or there is unevenness in screen colors or brightness.

- The following are not malfunctions.
 - Although advanced high-precision technologies are used in the production of color LCD screens, a very small number of the screen pixels may be dark or remain constantly lit.
 - Due to the natural characteristics of LCD screens, you may notice unevenness in colors and brightness depending on your angle of view. Hues may also vary by product.

I cannot operate the touchscreen.

The touchscreen operates involuntarily.

- Temporarily put the unit into sleep mode and then wake it up again.

Indicator

The indicator flashes in orange.

- The battery cannot be charged temporarily because the ambient temperature is too low or too high. Leave the unit in an environment of 10 °C to 35 °C (50 °F to 95 °F) for about an hour, then charge again.

The indicator lights in red.

- The remaining battery level is approximately 14 % or less of a full charge. Charge the battery.

The indicator flashes in red.

- Battery authentication failed. Use only a specified battery.
- There may be debris lodged in the battery charge terminals. Remove the battery and remove any debris found.
- Charging may have stopped automatically. Disconnect the charger and then reconnect it.

The indicator does not light during charging.

Battery charging ends quickly, or the battery cannot be charged at all.

- The charger is not connected properly. Confirm all connections.
- There may be debris lodged in the battery charge terminals. Remove the battery and remove any debris found.
- Replace the battery with a new one.

Touch screen operation

The settings described below are explained in “Touch operation settings” (page 35).

I cannot operate the screen while wearing gloves.

Select [**Glove mode**].

The screen responds before I have touched the screen.

Select [**Normal**].

The screen responds incorrectly when it is wet.

Select [**Rain mode**].

The screen seems slightly unresponsive to touches.

Select [**Normal**].

I cannot operate the unit with a stylus pen.

Select [**Pen mode**].

Connectivity

The SD card or other external device does not work.

The unit cannot connect to a network.

- The corresponding hardware feature may be disabled by the **[DeviceManagement]** app (see “Enabling and disabling certain hardware features” (page 31)).

The unit is not recognized as a mass storage device when connected to a computer (models supporting cellular transmission only).

- Make sure that USB tethering is turned off.
 1. Swipe up the home screen, and then in the app list, tap **[Settings]** → **[Network & Internet]** → **[Hotspot & tethering]**.
 2. Tap the **[USB tethering]** switch to turn it off.

I want to confirm the unit’s MAC address.

- Follow the procedure below.
 1. Swipe up the home screen, and then in the app list, tap **[Settings]** → **[System]** → **[About tablet]** → **[Status]**.
 2. Confirm the address.

Sound

No sound is heard.

- Using the **[Dashboard]** app, adjust the speaker volume and make sure that the **[Silent]** checkbox is turned off.
- Do not disturb mode is set to **[Total silence]**. Open the notifications panel, and then turn off Do not disturb mode or change the mode type.

Sound stops or is distorted.

- It is normal for the sound to stop or be distorted in the following situations.
 - When connecting or disconnecting a headset or headphones
 - When rotating the screen

Sounds are heard from the speaker even when a headset or headphones are connected.

- Notification sounds and alarms are played using the speaker even when a headset or headphones are connected to the unit. This is normal.
- Swipe up the home screen, and then in the app list, tap **[Settings]** → **[Sound]** → **[Advanced]**, and then tap the **[Speaker off during earphone use]** switch to turn it on.

The volume decreases during voice calls (hands-free).

- The proximity sensor may have detected a hand, object, etc. and is restricting the volume by decreasing it. Do not cover the proximity sensor with your hands, etc. and keep objects away from it during voice calls (hands-free).

Other

The date and time are incorrect.

- Confirm the date and time settings. Swipe up the home screen, and then in the app list, tap **[Settings]** → **[System]** → **[Date & time]**.
- Set the date and time automatically.
 1. Swipe up the home screen, and then in the app list, tap **[Settings]** → **[System]** → **[Date & time]**.
 2. Tap the **[Automatic date & time]** and **[Automatic time zone]** (models supporting cellular transmission only) switches to turn them on.
 3. Make sure the unit is in an area with good wireless reception, turn the unit off, and then turn it on again.

- The unit will not recognize dates after December 31, 2037.

The unit's operation is slow.

- Ambient temperature may be too low or too high. Leave the unit in an environment of 10 °C to 35 °C (50 °F to 95 °F) for about an hour and then try again.

The unit does not respond.

- Turn the unit off and then on again.
- If an app does not work normally, follow the instructions below to force quit or uninstall the problematic app or process.
 1. Swipe up the home screen, and then in the app list, tap **[Settings]** → **[Apps & notifications]**.
 2. Select the desired app or process and then tap **[UNINSTALL]** or **[FORCE STOP]**.

The screen freezes and no operations can be performed.

- Press and hold  (power button) for at least 10 seconds to force the unit to restart, and then try again.

I cannot enter text using voice recognition.

- An Internet connection is needed to enter text using your voice. Make sure the unit can connect to the Internet.

Some apps do not function after updating the unit's software.

- The apps may not be compatible with the newest version of the unit's software. To return the unit to the previous version of the software, contact your technical support representative.

The unit cannot connect to external services (Google services, mobile networks, etc.).

- Confirm all relevant settings and contact the service provider. If the trouble persists, contact your technical support representative.

Location information is incorrect.

- Mobile networks (models supporting cellular transmission only) and radio waves from satellites are used to acquire location information. Positioning may take time, or location information may be less accurate under the following conditions because radio wave signal reception is poor.
 - Immediately after turning on the unit
 - When acquiring location information for the first time
 - When out of the mobile network range
 - When you are in the following places:
 - Inside a building
 - Inside a vehicle such as car or train
 - Inside a tunnel or underground
 - Under an elevated bridge
 - In a city with skyscrapers
 - In an area dense with trees
 - In a mountainous region

The unit does not wake up after warm swapping the battery.

- The battery level of the warm swapped battery may be low. Replace it with a sufficiently charged battery, or turn off the unit before replacing the battery.

The unit turns off during use.

- The unit may turn off when you use the barcode reader, camera, etc. in low temperature environments. Replace the battery with a sufficiently charged one, or charge the unit in the specified temperature environment.

Appendix

Factory data reset

CAUTION

- The following procedure resets all settings and erases any data you have stored in the unit. Back up important data before performing this procedure.
1. Swipe up the home screen, and then in the app list, tap **[Settings]** → **[System]** → **[Reset options]**.
 2. Tap **[Erase all data (factory reset)]** → **[RESET TABLET]** → **[ERASE EVERYTHING]**.
 - The unit restarts when the factory data reset is complete.
 - Data stored in the SD card will not be erased.

Tips for battery usage

Minimizing battery deterioration

The battery is a consumable and the deterioration of its performance and battery life is accelerated under the following conditions.

- Repeatedly charging the battery
- Using, charging, or storing the battery in a high-temperature environment

To minimize battery deterioration and ensure longer battery life, keep the following tips in mind.

- **Charge in an environment between 10 °C and 35 °C (50 °F to 95 °F)**
If the surrounding temperature is too high or too low, the unit's indicator flashes in orange and the battery cannot be charged temporarily.
- **Avoid charging more than once per day**
Charging the battery too often will cause the battery performance to deteriorate. Therefore, the unit will not charge the battery immediately after it is fully charged unless the remaining charge is below 96 % to avoid overcharging.

Maximizing battery operation time

To maximize the battery operation time, keep the following tips in mind.

- **Reduce the screen's power consumption**
Reduce power consumption by pressing  (power button) to put the unit in sleep mode when not in use, or by reducing the screen's brightness level.
- **Turn off wireless devices when not in use**
You can use the **[Dashboard]** app to easily turn off Wi-Fi, Bluetooth, GPS, and mobile network connections (models supporting cellular transmission only). You can also turn on airplane mode to quickly turn off all wireless connections.
- **Reduce the time taken to automatically go into sleep mode**
Swipe up the home screen, and then in the app list, tap **[Settings]** → **[Display]** → **[Sleep]**, and select a shorter amount of time taken for the unit to automatically go into sleep mode.

Updating the software

You can update the software when a system update is released.

IMPORTANT

- Check the following before starting the update.
 - The remaining battery level is sufficient
 - The unit has available storage space (swipe up the home screen, and then in the app list, tap **[Settings]** → **[Storage]**, and if there is no storage space, make some room for the update)
 - The date and time are correct
1. Swipe up the home screen, and then in the app list, tap **[Settings]** → **[System]** → **[System updates]**.
 2. Follow the on-screen instructions.

License agreement for the system update service

1. Service introduction

The system update service (“this service”) is offered as a way to keep the product’s software¹ up to date after purchase, for feature and performance enhancement.

Without visiting a customer service center, you can take advantage of convenient software updating to check for any required product updates and wirelessly² download and replace outdated software with the latest version.

This service is managed by Panasonic Corporation and/or its affiliates, hereafter referred to collectively as “we” or “Panasonic”.

Read the following terms of use carefully and make sure you understand them before use. By using this service, you agree to accept all terms of use.

2. Disclaimer

Panasonic is not liable for any loss or damage of data with user-installed software from use of this service. Nor are we liable for any malfunction or damage to the product due to user error. For details, see “Precautions” below. No guarantee is made that this service will be suitable for specific purposes, and we are not liable in any way for indirect, incidental, or consequential loss or lost profit to you or third parties arising from or related to use of this service.

Panasonic reserves the right to change or discontinue this service, terms of use, and other matters without prior notice. Check the latest terms of use before using this service. Similarly, we reserve the right to interrupt or discontinue this service without prior notice.

3. Prohibited actions

The following actions are prohibited when using this service. If you violate the terms of use by taking the following actions, Panasonic may interrupt or discontinue this service or terminate the agreement without prior notice, and seek compensation.

- Action that disadvantages Panasonic or third parties, or that causes or poses a risk of loss
- Action that infringes on or may infringe on intellectual property rights (such as copyrights or trademark rights) of Panasonic or third parties
- Action that undermines or may undermine the credibility or dignity of Panasonic, such as action offensive to public order and morals
- Action that is illegal or linked to criminal acts, or which poses a risk of same
- Action that violates or may violate laws, regulations, or ordinances
- Other action that we have deemed inappropriate and have requested you to cease

4. Privacy policy

As this service is used, information identifying the product (such as model or serial numbers) is sent to our software update servers. We use this information only to provide service or support, and not for any other purposes.

5. Limitation on liability

Regarding liability borne by Panasonic in providing this service, and in the context of this license agreement, in the event of willful or gross negligence on our part in providing this service, regardless of the reason, users will be compensated only for an amount equivalent to the value of this service.

6. Precautions

Although user data such as photos, email messages, and downloaded files remain on the product during software updates, in some cases it may not be possible to safeguard this data, depending on the condition of the product. We therefore recommend backing up important data. However, please understand that some data (e.g., downloaded files) cannot be backed up.

Never turn off the product, reset it, or perform similar operations while a download is in progress, or during updates.

If the product's software is already up to date, no update is necessary. Note that updating the software may take some time, as data is being downloaded and uploaded.

Thank you for understanding that you cannot specify the timing of file distribution to the product or the period for which updates will be valid.

This service is not available under the following conditions.

- When the product is not turned on, or when it is in sleep mode
- When the product is not connected to a wireless network
- When the product is in international roaming mode
- When the product is in airplane mode
- When tethering mode is enabled
- When the correct date and time is not set
- When the remaining battery level is less than 50 %
- When the server polling interval of the update application is set to "00"
- While the battery is being replaced ("warm swap")

7. Intellectual property rights

Data provided to you for this service is licensed to you under the same conditions as in the license agreement of the software for which the data is used. Unless otherwise indicated, use of this service does not constitute licensing or transfer of any intellectual property rights from Panasonic to you.

8. Governing law and court of jurisdiction

Japanese law forms the basis for use of this service and interpretation and application of this license agreement. In the case of any disputes over this service, the Tokyo District Court will serve as the competent court of first instance.

9. Service inquiries

For any inquiries regarding this service, please contact the Panasonic customer service center.

^{*1} Only applies to software provided by Panasonic.

^{*2} A fee may be incurred for users enrolled in pay-per-use data plans, as data transmission for this service will be added to the user's other data consumption.

Regulatory information

For USA models

FCC RF exposure information

The highest SAR value for this product as reported to the FCC is listed below:

FCC ID	Highest value (W/kg)
ACJFZL1A	1.09
ACJFZL1B	1.27

For Canada models / Pour les modèles du Canada

RF exposure information

The highest SAR value for this product as reported to the ISED is listed below:

ISED certification number	Highest value (W/kg)
216A-FZL1A	1.09
216A-FZL1B	1.27

Information sur l'exposition aux radiofréquences (RF)

La valeur de DAS la plus élevée obtenue pour ce produit, telle que rapportée à l'ISDE lors des essais pour une utilisation près de l'oreille, est telle que décrite ci-dessous :

Numéro d'homologation d'ISDE	Valeur la plus élevée (W/kg)
216A-FZL1A	1,09
216A-FZL1B	1,27

For Europe models

SAR (Specific Absorption Rates)

For body-worn operation, the highest SAR value for this product is 1.632 W/kg (for models supporting cellular transmission) and 0.045 W/kg (for models supporting Wi-Fi transmission only)¹.

¹ The tests are carried out in accordance with international guidelines for testing.

Disposal of Old Equipment

Only for European Union and countries with recycling systems



This symbol on the products, packaging, and/or accompanying documents means that used electrical and electronic products must not be mixed with general household waste.

For proper treatment, recovery and recycling of old products, please take them to applicable collection points in accordance with your national legislation.

By disposing of them correctly, you will help to save valuable resources and prevent any potential negative effects on human health and the environment. For more information about collection and recycling, please contact your local authority.

Penalties may be applicable for incorrect disposal of this waste, in accordance with national legislation.

Specifications

Typical unit specifications and certain options are described below.

Unit configuration may vary.

Model No.	FZ-L1
CPU	Qualcomm® MSM8909
Memory	2 GB ¹
Storage	16 GB
Display	Internal LCD 7.0 in. HD (1280 × 720 dots), Aspect ratio 16:9 16 777 216 colors
Wi-Fi (for NA models)	<p>Standards supported IEEE 802.11a / IEEE 802.11b / IEEE 802.11g / IEEE 802.11n / IEEE 802.11d / IEEE 802.11h / IEEE 802.11i / IEEE 802.11r</p> <p>Transmission method OFDM system, DSSS system</p> <p>Wireless channels used IEEE 802.11a / IEEE 802.11n (5 GHz)</p> <ul style="list-style-type: none"> • W52 (36, 38, 40, 44, 46, 48 ch) • W53 (52, 54, 56, 60, 62, 64 ch) • W56 (100, 102, 104, 108, 110, 112, 116, 118, 120, 124, 126, 128, 132, 134, 136, 140 ch) • W58 (149, 151, 153, 157, 159, 161, 165 ch) <p>IEEE 802.11b / IEEE 802.11g / IEEE 802.11n (2.4 GHz): 1 ch - 11 ch</p> <p>RF frequency band 2.4 GHz Band: 2.412 GHz - 2.462 GHz 5 GHz Band: 5.18 GHz - 5.32 GHz, 5.5 GHz - 5.7 GHz, 5.745 GHz - 5.825 GHz</p> <p>Data transfer rate IEEE 802.11a: 54 Mbps IEEE 802.11b: 11 Mbps IEEE 802.11g: 54 Mbps IEEE 802.11n:</p> <ul style="list-style-type: none"> • HT20: 72.2 Mbps • HT40: 150 Mbps

Wi-Fi (for EU models)	Standards supported IEEE 802.11a / IEEE 802.11b / IEEE 802.11g / IEEE 802.11n / IEEE 802.11d / IEEE 802.11h / IEEE 802.11i / IEEE 802.11r Transmission method OFDM system, DSSS system Wireless channels used IEEE 802.11a / IEEE 802.11n (5 GHz) <ul style="list-style-type: none"> • W52 (36, 38, 40, 44, 46, 48 ch) • W53 (52, 54, 56, 60, 62, 64 ch) • W56 (100, 102, 104, 108, 110, 112, 116, 118, 120, 124, 126, 128, 132, 134, 136, 140 ch) IEEE 802.11b / IEEE 802.11g / IEEE 802.11n (2.4 GHz): 1 ch - 13 ch RF frequency band 2.4 GHz Band: 2.412 GHz - 2.472 GHz 5 GHz Band: 5.18 GHz - 5.32 GHz, 5.5 GHz - 5.7 GHz Data transfer rate IEEE 802.11a: 54 Mbps IEEE 802.11b: 11 Mbps IEEE 802.11g: 54 Mbps IEEE 802.11n: <ul style="list-style-type: none"> • HT20: 72.2 Mbps • HT40: 150 Mbps
Bluetooth	Bluetooth v4.2, Class 1 Transmission method FHSS system Wireless channels used 0 - 78 ch (Low energy: 0 - 39 ch) RF frequency band 2402 MHz - 2480 MHz Supported profile A2DP, AVRCP, HFP, HID, HOGP, HSP, MAP, OPP, PAN (models supporting cellular transmission only), PBAP, SPP, GAVDP, GATT, DUN (models supporting cellular transmission only)
Mobile networking (for NA models supporting cellular transmission)	LTE, HSPA+, UMTS SIM card slot Nano SIM card slot ×1
Mobile networking (for EU models supporting cellular transmission)	LTE, HSPA+, UMTS, EDGE, GPRS, GSM SIM card slot Nano SIM card slot ×1
Sound	Speaker Single speaker (95 dBA) Microphone 2 microphones, noise suppressor
Security chip	ARM® TrustZone® (built-in)
Camera	8 megapixels Video: 1280 × 720 pixels, 30 fps Still: 3264 × 2448 pixels
GNSS	GPS/GLONASS CEP50 (±2 to 4 m)

Barcode reader (equipped models only)	1D, 2D support
Sensors	Ambient light sensor, Proximity sensor, Acceleration sensor
NFC ^{*2}	Built-in (Type A, B, FeliCa, ISO 15693)
Card slots	microSD card slot ×1 ^{*3} (microSDXC compatible)
Interfaces	USB 2.0 port ×1 ^{*4} , Headset jack ×1, Expansion bus connector
Touchscreen	10-finger touch (capacitive) with: Glove mode ^{*5} Rain mode ^{*6} Pen mode (Passive type)
Power supply	Battery Pack
Battery (FZ-VZSUT10)	Lithium-ion 3200 mAh (typ.) / 3100 mAh (min.) Rated Voltage 3.8 V Operating time (approx.) ^{*7*8} 9 hours Charging time (approx.) ^{*9} 3.0 hours (when using the optional AC adaptor) 3.5 hours (when using the optional cradle)
Rated power consumption	Approx. 9 W
Dimensions ^{*10} (W × D × H)	Approx. 193 mm × 131 mm × 13 mm [7.6 in. × 5.2 in. × 0.5 in.] without protrusions
Weight ^{*11}	Approx. 440 g (0.97 lb) with the Battery Pack
Operating environment ^{*12}	Temperature -10 °C to 50 °C (14 °F to 122 °F) Humidity 30 % to 80 % RH
Storage environment	Temperature -30 °C to 70 °C (-22 °F to 158 °F) Humidity 30 % to 90 % RH
Operating system ^{*13}	Android 8.1
Water and dust resistance	IP65, IP67

Specifications are subject to change without notice.

- *1 1 MB = 1 048 576 bytes, 1 GB = 1 073 741 824 bytes
- *2 If your unit is equipped with the barcode reader over the NFC antenna, NFC cannot be used.
- *3 Operation has been tested and confirmed using the following Panasonic brand memory cards: SD (up to 2 GB), SDHC (up to 32 GB), SDXC (up to 64 GB). Compatibility with other SD devices is not guaranteed.
- *4 Does not guarantee operation of all USB-compatible peripherals.
- *5 This mode may not operate properly depending on the type of glove.
- *6 Only single-finger operation is enabled.
- *7 Actual performance varies depending on usage conditions, connected peripherals, etc. Typically, operating time is reduced in colder environments.
- *8 Measurement results are based on Panasonic testing methods. Varies depending on the usage conditions, or when an optional device is attached.
- *9 Varies depending on usage conditions.
- *10 Actual size may vary by unit configuration.
- *11 Average weight. Actual weight may vary by unit configuration.
- *12 Product or application booting can dependent upon the battery charge level.
Do not expose the skin to this product when using the product in a hot or cold environment.
When using the product in hot or cold environments, some peripherals may not perform properly. Confirm the recommended operation environment of the peripherals.
Using the product continuously in hot environments will shorten the product life. Avoid continuous use in these types of environments.
When using the product in cold environments, the product may take longer to start up and battery operation time may be reduced. Even when using the product within the temperature and humidity ranges listed here, using the product continuously in extreme environments will result in product deterioration and will shorten the life of the product.
- *13 Product functionality cannot be guaranteed if the operating system is modified or replaced by the user or a third party.

Accessories

- For the latest information about optional products, refer to the product catalogs, etc.

Product name	Model number
AC Adaptor	FZ-AAE184E
Battery Pack	FZ-VZSUT10U FZ-VZSUT1AU
Cradle	FZ-VEH1L1AA
5-Bay Cradle	FZ-VEH5L1AA
5-Bay Charge only Cradle	FZ-VCH5L1AA
5-Bay Battery Charger	FZ-VCBT131
Protective Film (5 sheets)	FZ-VPFL11U
Hand Strap	FZ-VSTL11U
Hand Strap (BL) ^{*1}	FZ-VSTL12U
Hand Strap (BP) ^{*2}	FZ-VSTL13U
Stylus Pen	CF-VNP021U

*1 For models with a barcode reader (landscape)

*2 For models with a barcode reader (portrait)

WARRANTY for U.S.A

Panasonic System Solutions Company of North America (PSSNA)
Computer Products - Worldwide Warranties

Section 1: Limited Warranty - Hardware

PSSNA, referred to hereinafter as “Panasonic”, will repair the computer products listed below (“Product(s)”) with new or rebuilt parts, free of charge in a Global Panasonic designated service location or Panasonic Authorized Service Center for the period specified below from the date of original purchase in the event of a defect in materials or workmanship.

These warranties are extended solely to the original purchaser. A purchase receipt or other proof of date of original purchase will be required before warranty performance is rendered.

- Laptop PC (CF-##) – 3 Years
- Tablet PC / Handheld (FZ-## / JT-##) – 3 Years
- Ultra-Mobile (CF-U#/CF-H# Series) – 3 Years
- PDRC - LCD & Keyboard Assembly – 3 Years

Original Battery Warranty

Batteries supplied with the product are covered under the warranty for one (1) year from date of purchase. Batteries purchased separately are covered under the warranty for one (1) year from the date of purchase. A replacement battery furnished under the product warranty is covered for the remaining period of the one year warranty of the original or purchased battery.

Optional: Extended Warranty Program (PC)

If this coverage is purchased, the serial numbered Product is entitled to the same manufacturer’s warranty coverage on the Product with the exception of the battery. The cost of labor, parts, and shipping are included in the price of the Extended Warranty Program.

Optional: Panasonic “Protection Plus” Warranty

Any Product for which the Panasonic “Protection Plus” warranty has been purchased will receive additional coverage for any failure that occurs due to accidental damage. All other terms and conditions of the standard warranty apply and this additional coverage will exist for the duration of the standard warranty period of the Product.

If an extended Protection Plus warranty program is purchased, coverage is extended to the end of the last year of extended coverage purchased.

This warranty does not cover failures or defects that are caused by fire, intentional acts, loss, theft, improper maintenance, modification or service by anyone other than a Panasonic Authorized Service Provider, or damage that is attributable to acts of God.

Cosmetic damage that does not affect functionality is not covered. Cosmetic damage on Products with hardware failures will be repaired in accordance with the warranty terms. This warranty is extended solely to the original purchaser on the Product’s serial number for which it was purchased.

Complete Product replacement fulfills the full obligation and is at the discretion of Panasonic and is limited to once during the coverage term.

Refer to the Panasonic website for full terms and conditions on the above programs.

- Additional exclusions apply – please refer to limited warranty exclusions section below.

Optional: Panasonic “Ultimate Care” Warranty

Any Product for which the Panasonic “Ultimate Care” warranty program has been purchased will receive additional coverage as specified in that program, for any failure that occurs due to accidental damage.

All other terms and conditions of the standard warranty will apply and this additional warranty coverage will exist for the duration of the standard warranty period of the applicable Product. If an extended warranty

is purchased for the Product together with the Ultimate Care warranty program coverage, the warranty term will be extended to the end of the last year of the purchased extended warranty coverage. The Ultimate Care warranty will cover any hardware failures occurring due to accidental damage of the Product with an exclusion only of customer intentional acts and damage caused by events beyond human control, for up to a maximum of 1 % of the total of Products deployed for a specific customer. This includes unlimited replacement of major sub-assemblies and components of the Product during the standard warranty term and any extended warranty term plan that has been purchased by the customer. This also includes cosmetic damages that may result from exposure of the internal components of the Product to the environmental conditions.

- Additional exclusions apply – please refer to limited warranty exclusions section below.

Wireless Module Warranty

Panasonic approved wireless modems installed in Panasonic brand computers and integrated by Panasonic or an Authorized Panasonic Wireless Integrator are covered under the warranty for the remaining warranty period of the device in which the modem is installed. For devices with less than three (3) months remaining on the unit warranty, the wireless modem will be covered for a period of three (3) months from the date of installation of the modem, covering only modem replacement or modem installation related issues.

All modems must be approved by the wireless carrier prior to use. Any use or attempted use of a wireless modem not approved and activated by the carrier for use on their network is strictly prohibited and is not sanctioned or warranted by Panasonic and may result in legal action. In addition, all modems must be approved by Panasonic as compatible with the device hardware before installation or use.

Panasonic's sole responsibility for the warranty or technical support of the software required to install or operate the modem is defined in Section 2 (Limited Software Warranty). Any attempted software installation by anyone other than a Panasonic Authorized Wireless Integrator is not covered under warranty and may result in service charges.

Installation or attempted installation by any party other than Panasonic or an Authorized Panasonic Wireless Integrator is strictly not covered under the warranty and may void the computer warranty if damage results.

Options and Accessories Warranties

The below listed Panasonic brand or supplied options and accessories are covered under this limited warranty for the period specified from the date of purchase or as specifically stated:

- AC adaptor / Power Cord – 3 Years
- Memory Expansion Card (Panasonic Brand) – 3 Years
- Car Mount - Docking Station PCB or Vehicle Docking Station – 3 Years
- Desktop Port Replicator, I-O Box, Docking Cradle (like CF-U1) – 3 Years
- Antenna Pass-through Cable – 3 Years
- Backlit or Full-sized keyboard – 3 Years or assumes warranty of the unit in which it is installed
- Integrated Panasonic supplied options and kits including, but not limited to Wireless Modems, Media Bay Drives (Floppy, CD, DVD, Combo), Camera, GPS, Bluetooth, Smartcard Reader, Magnetic Card Reader, Barcode Scanner, and Fingerprint Reader – 3 Years or assumes warranty period of the unit in which it is installed provided the integration was performed by Panasonic or an Authorized Integrator.
- Hard Drive / Solid State Drive (Internal) - 3 Years
- Separately purchased 2nd Hard Drive – 1 Year
- External USB Drives (CD / DVD / Floppy / Hard Drive) – 1 Year
- Optional Battery – 1 Year
- Battery Charger / Multi-Bay Battery Charger – 1 Year
- Stylus Pens, Digitizer & Standard – 90 Days (physical damage excluded)

Section 2: Limited Warranty - Software

Panasonic warrants to you only that the disk(s) or other media on which the Programs are furnished will be free from defects in material and workmanship under normal use for a period of sixty (60) days from the date of delivery thereof to you, as evidenced by your purchase receipt.

This is the only warranty Panasonic makes to you.

Panasonic does not warrant that the functions contained in the Programs will meet your requirements or that the operation of the Programs will be uninterrupted or error free.

Panasonic shall have no obligation for any defects in the disk(s) or other media on which the Programs are furnished resulting from your storage thereof, or for defects that have been caused by operation of the disk(s) or other media.

Panasonic's entire liability and your exclusive remedy under this warranty shall be limited to the replacement, in the United States or other Panasonic designated location, of any defective disk or other media which is returned to Panasonic's Authorized Service Center, together with a copy of the purchase receipt, within the aforesaid warranty period.

Section 3: Limited Warranty Exclusions - Specifically excluded from the warranty are:

- All consumable items; such as screen protection films, logo badges, labels, cleaning cloths, carry cases, manuals, cables, straps, belts, holsters, tethers, and harnesses and any other options and accessories not listed above or covered under a separate warranty
- The Warranty excludes 3 or less faulty pixels on the LCD screen
- Failures related to the product operating system, hard drive or solid state drive image, software setup, software program, virus, other program(s) or file(s) on any drive or in any computer memory location
- Failures due to BIOS settings or changes, as well as any cosmetic or physical damage to the unit
- Any unit or device with a missing or altered model number or serial number label
- Cosmetic damage or any damage which occurs in shipment
- Failures which are caused by products not supplied by Panasonic
- Failures which result from alteration, accident, misuse, introduction of liquid or other foreign matter into the unit, abuse, neglect, installation, maladjustment of consumer controls, improper maintenance or modification, use not in accordance with product use instructions
- Failures due to service by anyone other than a Panasonic Authorized Service Provider
- Failures caused by improper installation of options or accessories or due to integration by any company other than Panasonic or a Panasonic Authorized Service Center
- Damage, failure, or loss due to the unit being stolen, lost, misplaced, or used by anyone other than the original purchaser
- Damage that is attributable to acts of God
- * Protection Plus and Ultimate Care warranty programs provide protection against accidental damage. Neither program is intended to provide product refurbishment due to normal wear and tear through normal use.
- * Customers who have twenty (20) or more units requiring service are required to contact Panasonic at 800-527-8675 and request Field Engineering assistance to coordinate higher volume repairs.

This limited warranty only covers failures due to defects in materials or workmanship which occur during normal use. If a unit is sent to a Panasonic Authorized Service Center and no hardware failure is found, the customer will be billed for labor to correct a software issue or reimage the applicable Hard Disk, or Solid State Drive plus shipping and applicable administrative fees at the current rates set by the service provider.

THIS PRODUCT IS NOT INTENDED FOR USE AS OR PART OF NUCLEAR EQUIPMENT/SYSTEMS, AIR TRAFFIC CONTROL EQUIPMENT/SYSTEMS, OR AIRCRAFT COCKPIT EQUIPMENT/SYSTEMS¹. PANASONIC WILL NOT BE RESPONSIBLE FOR ANY LIABILITY RESULTING FROM THE USE OF THIS PRODUCT ARISING OUT OF THE FOREGOING USES.

¹ AIRCRAFT COCKPIT EQUIPMENT/SYSTEMS include class 2 Electronic Flight Bag (EFB) Systems and Class 1 EFB Systems when used during critical phases of flight (e.g., during take-off and landing) and/or mounted onto the aircraft. Class 1 EFB Systems and 2 EFB Systems are defined by FAA: AC (Advisory Circular) 120-76A or JAA: JAA TGL (Temporary Guidance Leaflets) No. 36.

Other Limits and Exclusions: There are no other express warranties except as listed above.

PANASONIC SHALL NOT BE LIABLE FOR LOSS OF DATA OR OTHER INCIDENTAL OR CONSEQUENTIAL DAMAGES RESULTING FROM THE USE OF THIS PRODUCT, OR ARISING OUT OF ANY BREACH OF THIS WARRANTY. ALL EXPRESS AND IMPLIED WARRANTIES, INCLUDING THE WARRANTIES OF MERCHANTABILITY AND FITNESS FOR A PARTICULAR PURPOSE ARE LIMITED TO THE APPLICABLE WARRANTY PERIOD SET FORTH ABOVE. Some states do not allow the exclusion or limitation of incidental or consequential damages, or limitations on how long an implied warranty lasts, so the above limitations or exclusions may not apply to you.

This limited warranty gives you specific legal rights, and you may also have other rights which vary from state to state.

For technical support or to arrange for service on your Panasonic computer product, call our toll-free hotline at 1-800-LAPTOP5 [option 1] (800-527-8675).

WARRANTY for Canada

For Canada

PANASONIC COMPUTER AND PERIPHERALS LIMITED WARRANTY

Coverage – Panasonic Canada Inc. (“PCI”) warrants to you, the first end user customer, this computer product (excluding software media), when purchased from PCI or from a PCI authorized reseller, to be free from defects in materials and workmanship under normal use, subject to the terms set forth below, during the period of warranty coverage specified.

Scope of Coverage	Period of Coverage	Type of Failure Coverage
<ul style="list-style-type: none"> • Laptop Computers (except Battery) and AC Adaptor • Factory/PCI installed options including Wireless WAN, GPS, Bluetooth, Finger print reader, Backlit keyboard, Memory Card, Optical Drives, Cameras, Smart card Readers, Magnetic Card Readers and Barcode Scanners • Ultra-Mobile PC • Tablet PC • PDRC – LCD and Keyboard Assemblies • Port Replicator • Cradle • Charging Cup 	Three (3) Years from Date of Original End User Customer Purchase	Defective Materials or Workmanship
<ul style="list-style-type: none"> • Battery • Battery charger • AC Adaptor and Power Cord • Car Adaptor and Power Cord • External USB Drives 	One (1) Year from Date of Original End User Customer Purchase	Defective Materials or Workmanship
<ul style="list-style-type: none"> • Standard or Digitizer Stylus Pen 	Ninety (90) Days from Date of Original End User Customer Purchase	Defective Materials or Workmanship
<ul style="list-style-type: none"> • All consumable items including protection film, cleaning cloth, carry case, tether and harness 	No Coverage	

Remedy – In the event of a warranty claim, contact PCI’s representatives within the applicable warranty period, identifying the nature of the defect claimed, at 1-800-668-8386 between 9:00 A.M. and 5:00 P.M., Eastern Time Zone, Mon. – Fri. (excluding holidays) for instructions on how to obtain service. A purchase receipt or other proof of date of original purchase is required before warranty service is performed. Defective parts covered by this Limited Warranty will be repaired or replaced with new or comparable rebuilt parts on an exchange basis. Warranty replacement or repair is subject to the terms of this Limited Warranty for the balance of the original period of warranty coverage.

No Coverage – This Limited Warranty does not cover products purchased outside Canada. Neither does it cover damage to, failure of, or defects in a product or accessory through mishandling, improper installation, abnormal use, misuse, neglect, accident, introduction of liquid or other foreign matter into the product, alteration or servicing by anyone not authorized by PCI, or act of God.

THIS PRODUCT IS NOT INTENDED FOR USE AS, OR AS PART OF, NUCLEAR EQUIPMENT/ SYSTEMS, AIR TRAFFIC CONTROL EQUIPMENT/SYSTEMS, OR AIRCRAFT COCKPIT EQUIPMENT/

SYSTEMS¹. PANASONIC WILL NOT BE RESPONSIBLE FOR ANY LIABILITY RESULTING FROM THE USE OF THIS PRODUCT ARISING OUT OF THE FOREGOING USES.

¹ AIRCRAFT COCKPIT EQUIPMENT/SYSTEMS include Class2 Electrical Flight Bag (EFB) Systems and Class1 EFB Systems when used during critical phases of flight (e.g., during take-off and landing) and/or mounted on to the aircraft. Class1 EFB Systems and 2 EFB Systems are defined by FAA: AC (Advisory Circular) 120-76A or JAA: JAA TGL (Temporary Guidance Leaflets) No.36

IF YOU SHIP THE PRODUCT FOR WARRANTY SERVICE

Carefully pack the product, preferably in the original carton. Include details of defect claimed and proof of date of original purchase. No liability is assumed for loss or damage to the product while in transit, if you chose your own transportation carrier.

SOFTWARE MEDIA LIMITED WARRANTY

Coverage – PCI warrants to you, the first end user customer, that the disk(s) or other media on which software program(s) is/are supplied will be free from defects in materials and workmanship under normal use in Canada for a period of sixty (60) days from date of receipt as evidenced by your purchase receipt for your Panasonic Computer product.

THIS IS THE ONLY WARRANTY THAT PCI MAKES RESPECTING THE SOFTWARE MEDIA. PCI does not warrant the software. Please refer to the software licensor's written warranty (accompanying the copy of the software) for any software warranty claim.

Claim Procedure – In the event of a defect in material or workmanship in the media during the sixty (60) day warranty period, and you return it, transportation costs prepaid, to Panasonic Canada Inc., Computer Products Marketing, 5770 Ambler Drive, Mississauga, Ontario L4W 2T3, within the warranty period, together with a copy of your purchase receipt, and an explanation of the suspected defect, PCI will replace in Canada the defective disk(s) or other media.

Remedy – PCI's entire liability, and your only remedy for any breach of this software media warranty is limited to replacement of the media only. It does not cover any other damages, including, but not limited to, loss of use or profit loss, or special, indirect or consequential damages, or other claims, whether or not of similar character.

No Coverage – This limited warranty does not apply if the disk(s) or other media has been used in other than a Panasonic product, or in environmental conditions other than those specified by PCI or the manufacturer, or if subjected to misuse, neglect, mishandling, modification or attempted modification of the program, or if damaged by accident or act of God. PCI is not responsible for damage to or loss of any program, data or removable storage media.

GENERAL

NO OTHER WARRANTIES – PCI DISCLAIMS ALL OTHER WARRANTIES, EITHER EXPRESS OR IMPLIED, INCLUDING, BUT NOT LIMITED TO, IMPLIED WARRANTIES OF MERCHANTABILITY AND FITNESS FOR A PARTICULAR PURPOSE, WITH RESPECT TO THE SOFTWARE, SOFTWARE MEDIA, COMPUTER PRODUCT, OPTIONS AND ACCESSORIES.

NO LIABILITY FOR CONSEQUENTIAL DAMAGES – IN NO EVENT SHALL PCI BE LIABLE FOR ANY SPECIAL, INDIRECT OR CONSEQUENTIAL DAMAGES ARISING FROM ANY BREACH OF THE LIMITED WARRANTIES SET OUT IN THIS DOCUMENT, OR FROM THE USE OF THE COMPUTER PRODUCT, INCLUDING, WITHOUT LIMITATION, LOSS OF DATA, BUSINESS, PROFIT OR GOODWILL.

IN ANY EVENT, PCI'S MAXIMUM LIABILITY FOR ANY BREACH SHALL NOT EXCEED THE AMOUNT ACTUALLY PAID BY YOU FOR THE COMPUTER PRODUCT.

NO ACTION, REGARDLESS OF ITS BASIS, MAY BE BEGUN AGAINST PCI MORE THAN TWO (2) YEARS AFTER THE CAUSE OF ACTION AROSE.

Statutory Warranties – Some jurisdictions do not allow these limitations or exclusions, so they may not apply to you.

Pour le Canada**GARANTIE LIMITÉE – ORDINATEURS ET PÉRIPHÉRIQUES PANASONIC**

Couverture – Panasonic Canada Inc. (« PCI ») garantit à l'acheteur original que ce produit informatique (à l'exclusion des supports des logiciels) est, au moment de sa vente par PCI ou d'un revendeur agréé par PCI, exempt de défauts de pièces et de fabrication dans les conditions normales d'utilisation, et ce, pendant la période de couverture de la garantie, sous réserve des modalités décrites ci-dessous.

Éléments couverts	Durée de couverture	Type de couverture
<ul style="list-style-type: none"> • Ordinateurs blocs-notes (sauf batteries) et adaptateur secteur • Options installées en usine/par PCI incluant : WAN sans fil, GPS, Bluetooth, lecteur d'empreintes digitales, clavier rétroéclairé, carte mémoire, lecteurs optiques, caméras, lecteurs de carte à puce, lecteurs de carte magnétique et scanners de code-barres • Ordinateurs personnels ultra-portables • Ordinateurs tablettes • Ensembles PDRC – ACL et clavier • Duplicateur de port • Station d'accueil • Coque de charge 	Trois (3) ans à partir de la date d'achat original.	Défauts de pièces et de fabrication
<ul style="list-style-type: none"> • Batterie • Chargeur de batterie • Adaptateur secteur et cordon d'alimentation • Adaptateur automobile et cordon d'alimentation • Périphériques USB 	Un (1) an à partir de la date d'achat original.	Défauts de pièces et de fabrication
<ul style="list-style-type: none"> • Stylo pointeur standard ou pour numériseur graphique 	Quatre-vingt-dix (90) jours à partir de la date d'achat original.	Défauts de pièces et de fabrication
<ul style="list-style-type: none"> • Tous les articles consommables incluant les pellicules protectrices, chiffons de nettoyage, étuis de transport, longes et sangles 	Aucune couverture	

Recours – Pour obtenir des informations sur la marche à suivre dans le cas où une réclamation en vertu de la garantie deviendrait nécessaire, communiquez par téléphone avec un représentant de PCI au 1-800-668-8386, entre 9h00 et 17h00 (heure de l'Est) du lundi au vendredi (sauf les jours fériés), avant l'échéance de la garantie applicable, en prenant soin d'identifier la nature de la défaillance. Un reçu ou toute autre pièce justificative de la date d'achat original sera exigé avant toute réparation. Toute pièce défectueuse couverte par la présente garantie limitée sera réparée ou remplacée par une pièce neuve ou remise à neuf. Le remplacement ou la réparation sera fait conformément aux modalités de la présente garantie limitée pendant la durée restante de la période originale de la garantie.

Produits non couverts – La présente garantie limitée ne couvre pas les produits achetés à l'extérieur du Canada. Elle ne couvre pas non plus les dommages, la défaillance ou les défauts attribuables à une maintenance inadéquate, une mauvaise installation, une utilisation anormale ou abusive, de la négligence, un accident, un déversement ou la pénétration d'un objet étranger, une modification, un cas fortuit ou une réparation effectuée par une personne non agréée par PCI.

CE PRODUIT N'EST PAS DESTINÉ À ÊTRE UTILISÉ, EN TOUT OU EN PARTIE, COMME SYSTÈME/ÉQUIPEMENT NUCLÉAIRE, SYSTÈME/ÉQUIPEMENT DE CONTRÔLE DU TRAFFIC AÉRIEN OU SYSTÈME/ÉQUIPEMENT DE POSTE DE PILOTAGE D'AVION¹. PANASONIC DÉCLINE TOUTE

RESPONSABILITÉ CONCERNANT L'UTILISATION DE CE PRODUIT DANS LES CAS SUSMENTIONNÉS.

- *1 Les SYSTÈMES/ÉQUIPEMENTS DE POSTE DE PILOTAGE D'AVION sont dotés de systèmes OEPP (organiseur électronique de poste de pilotage) de classe 2 et de classe 1 utilisés pendant des phases critiques de vol (par exemple, pendant le décollage et l'atterrissage) et/ou montés sur l'avion. Les systèmes OEPP de classe 1 et de classe 2 sont définis par le circulaire d'information FAA : AC (Advisory Circular) 120-76A ou le feuillet JAA : JAA TGL (Temporary Guidance Leaflets) No 36.

EXPÉDITION DU PRODUIT POUR SERVICE SOUS GARANTIE

Emballer soigneusement le produit, de préférence dans son emballage d'origine. Joignez une description de la défaillance de même qu'une pièce justificative de la date d'achat. Panasonic Canada Inc. ne peut être tenue responsable pour tout dommage ou perte subi pendant le transport si vous avez choisi le transporteur.

GARANTIE LIMITÉE – SUPPORTS DES LOGICIELS

Couverture – Panasonic Canada Inc. (« PCI ») garantit à l'acheteur original que le ou les disques ou tout autre support sur lequel le ou les programmes sont fournis sont exempts de défauts de pièces et de fabrication dans des conditions normales d'utilisation au Canada, et ce, pour une période de soixante (60) jours suivant la date de réception indiquée sur la preuve d'achat.

LA PRÉSENTE GARANTIE EST LA SEULE OFFERTE PAR PCI COUVRANT LES SUPPORTS DE LOGICIELS. PCI ne garantit pas les logiciels. Reportez-vous à la garantie écrite du concédant de licence d'utilisation du logiciel (qui accompagne la copie du logiciel) pour toute réclamation en vertu de la garantie.

Réclamation – marche à suivre – Panasonic Canada Inc. remplacera tout disque ou support défectueux si l'article en question est retourné, port payé, à son service de Marketing – produits informatiques, 5770 Ambler Drive, Mississauga (Ontario) L4W 2T3, dans les soixante (60) jours suivant la date d'achat original. Joignez à votre envoi une pièce justificative de votre achat et une description du problème.

Recours – La responsabilité de PCI - et votre seul recours - dans le cas de toute défaillance couverte par la garantie sur ce support de logiciel est limitée au seul remplacement du support. Elle ne couvre aucun autre dommage, y compris, mais non exclusivement, la perte d'usage ou de profits, ni aucun dommage spécial, indirect ou consécutif, ni aucune autre réclamation de nature similaire ou autre.

Produits non couverts – La présente garantie limitée ne s'applique pas si le ou les disques ou autre support ont été utilisés dans un produit d'une marque autre que Panasonic ou dans des conditions environnementales autres que celles spécifiées par PCI ou le fabricant, ou soumis à une mauvaise utilisation, à la négligence, à une manutention inadéquate ou encore si le programme a été modifié ou subi une tentative de modification ou des dommages attribuables à un accident ou à un cas fortuit. De plus, PCI n'assume aucune responsabilité pour toute perte de, ou tout dommage à, un programme, des données ou un support de sauvegarde amovible.

GÉNÉRALITÉS

PCI NE RECONNAÎT AUCUNE AUTRE GARANTIE, EXPLICITE OU IMPLICITE, Y COMPRIS, MAIS NON EXCLUSIVEMENT, LES GARANTIES IMPLICITES DE VALEUR COMMERCIALE ET D'UTILITÉ À UNE FIN QUELCONQUE, À L'ÉGARD DU LOGICIEL, SUPPORTS DE LOGICIELS, PRODUITS INFORMATIQUES, PÉRIPHÉRIQUES ET ACCESSOIRES.

SOUS AUCUNE CIRCONSTANCE PCI NE POURRA ÊTRE TENUE RESPONSABLE DES DOMMAGES SPÉCIAUX, INDIRECTS OU CONSÉCUTIFS ATTRIBUABLES À UN MANQUEMENT AUX GARANTIES LIMITÉES DÉCRITES DANS LE PRÉSENT DOCUMENT OU À L'UTILISATION DU PRODUIT INFORMATIQUE, Y COMPRIS, SANS RESTRICTION, LA PERTE DE DONNÉES, D'AFFAIRES, D'ACHALANDAGE OU DE PROFIT.

DANS TOUS LES CAS, LA RESPONSABILITÉ MAXIMALE DE PCI POUR TOUT MANQUEMENT NE POURRA EXCÉDER LE PRIX DE VENTE DU PRODUIT INFORMATIQUE.

AUCUNE RÉCLAMATION, SANS ÉGARD À SES MOTIFS, NE POURRA ÊTRE FAITE AUPRÈS DE PCI PLUS DE DEUX (2) ANS APRÈS LES FAITS INVOQUÉS À LA BASE D'UNE TELLE RÉCLAMATION.

Garantie statutaires – Certaines juridictions interdisent de telles limitations ou exclusions ; aussi, pourraient-elles ne pas s'appliquer.

WARRANTY for Europe

Panasonic System Communications Company Europe (referred to as "Panasonic") will repair this product (other than software, which is treated in a different section of this warranty) with new or refurbished parts, from the date of original purchase in the event of a defect in materials or workmanship. This warranty only applies to new Panasonic Toughbooks or Toughpads purchased in the EEA and Switzerland and Turkey.

Panasonic (or its authorised Service Provider) target to repair your equipment within 48 hours from its receipt in our service centre.

Additional charges may apply for shipment to countries outside of the European Union. Panasonic will use all reasonable endeavours to ensure this service.

This warranty only covers failures due to defects in materials or workmanship which occur during normal use for the applicable Service Agreement Period listed below. In the event that any product (or part thereof) is replaced, Panasonic shall transfer ownership of the replacement product (or part) to the customer and the customer shall transfer ownership of the replaced product (or part) to Panasonic.

Service Agreement Period - from original date of purchase

- Toughbooks (and every accessory included in the original packaging except the battery) - 3 years
- Toughpads (and every accessory included in the original packaging except the battery) - 3 years
- Additional peripherals manufactured by Panasonic (AC Adaptor and Power Cord, Car Adaptor and Power Cord, Cradle, Battery Charger) - 1 year
- Batteries - 6 months. Panasonic Warranty covers the battery for six months. A battery is considered good if it maintains 50 % of its charge capacity during the warranty period. If a battery is returned under this contract and testing determines that it has charge capacity greater than 50 %, the battery will be returned with an invoice for the retail purchase price of a new battery.

This warranty is extended solely to the original purchaser. A purchase receipt or other proof of date of original purchase will be required before warranty performance is rendered.

Limits and Exclusions:

This warranty does not cover and shall be void for:

- Broken or cracked LCD screen.
- Defective pixel in notebook displays and LCD screens within 0.002 %
- Damage that is attributable to fire, theft or acts of God.
- Damage caused by environmental influences (electrical storms, magnetic fields etc.).
- Damage which has not been caused during normal operation
- Repair of damage that is cosmetic only or does not affect product functionality such as wear and tear, scratches and dents.
- Failures caused by products not supplied by Panasonic.
- Failures resulting from alteration, accidental damage, casualty, misuse, abuse or neglect.
- Introduction of liquid or other foreign matter into the unit.
- Improper installation, operation or maintenance.
- Improper connections with peripherals.
- Maladjustment of consumer controls such as function settings.
- Modification or service by anyone other than Panasonic or its approved Service Providers.
- Products used as short term rental or leased equipment.
- Products whose serial number has been removed making the unit warranty condition impossible to clearly determine.

THIS PRODUCT IS NOT INTENDED FOR USE AS, OR AS PART OF, NUCLEAR EQUIPMENT/SYSTEMS, AIR TRAFFIC CONTROL EQUIPMENT/SYSTEMS, OR AIRCRAFT COCKPIT EQUIPMENT/SYSTEMS. PANASONIC WILL NOT BE RESPONSIBLE FOR ANY LIABILITY RESULTING FROM THE USE OF THIS PRODUCT ARISING OUT OF THE FOREGOING USES.

There are no other express warranties except as listed above.

We strongly recommend that customers backup their data before sending back their unit to an Authorised Service Provider.

Panasonic shall not be liable for loss of data or other incidental or consequential damages resulting from the use of this product, or arising out of any breach of this warranty. All express and implied warranties, including the warranties of satisfactory quality and fitness for a particular purpose are limited to the applicable warranty period set forth above. Panasonic shall not be liable for any indirect, special or consequential loss or damage (including without limitation any loss of profits) arising from the use of this product or for any breach of this warranty.

This limited warranty gives you specific legal rights, and you may have other rights that vary from country to country. You must consult the applicable country laws for a full determination of your rights. This limited warranty is in addition to, and does not affect any rights arising out of any contract of sale or by statute.

Panasonic System Communications Company Europe

Data Storage Media

Data Storage Media is the media on which the Operating System, drivers and programs originally installed by Panasonic on the main unit are stored. This media is originally provided with the unit.

Panasonic warrants to you only that the disc(s) or other media on which the Programs are furnished will be free from defects in material and workmanship under normal use for a period of sixty (60) days from the date of delivery thereof to you, as evidenced by your purchase receipt.

This is the only warranty Panasonic makes to you. Panasonic does not warrant that the functions contained in the Programs will meet your requirements or that the operation of the Programs will be uninterrupted or error free.

Panasonic's entire liability and your exclusive remedy under this warranty shall be limited to the replacement of any defective disk or other media which is returned to Panasonic's authorized Service Centre, together with a copy of the purchase receipt, within the aforesaid warranty period.

Panasonic shall have no obligation for any defects in the disk(s) or other media on which the Programs are furnished resulting from your storage thereof, or for defects that have been caused by operation of the disk(s) or other media otherwise than on the Product or in the environment conditions other than those specified by Panasonic by alteration, accident, misuse, abuse, neglect, mishandling, misapplication, installation, maladjustment of consumer controls, improper maintenance, modification or damage that is attributable to acts of God. In addition, Panasonic shall have no obligation for any defects in the disk(s) or other media if you have modified, or attempted to modify any Program.

Duration of implied warranties, if any is limited to sixty (60) days.

Pre-installed software

Pre-installed software means the software shipped pre-loaded by Panasonic, not that loaded by any third party or selling agent.

Panasonic and its suppliers makes no warranty, either express, implied or statutory, with respect to software provided with the Product and licensed to Purchaser, its quality, performance, merchantability, or fitness for a particular purpose. Panasonic does not warrant that the functions contained in the software will be uninterrupted or error free. Panasonic assumes no risk of and shall not in any case be liable for any damages, including, without limitation, any special, incidental, consequential, or punitive damages arising from breach of warranty or contract, negligence or any other legal theory, including, without limitation loss of goodwill, profits or revenue, loss of use of the Programs or Products or any associated equipment, cost of capital, cost of any substitute equipment, facilities, or services, downtime costs, or claims of any party dealing with such damages.

Some countries do not allow the exclusion or limitation of incidental or consequential damages, or limitations on how long an implied warranty lasts, so the above limitations or exclusions may not apply to you.

This limited warranty gives you specific legal rights and you may also have other rights that vary from country to country. You must consult applicable country laws for a full determination of your rights.

Contacts

Appendix

Address	Panasonic System Communications Company Europe Panasonic Manufacturing U.K. Ltd. Service Centre Building B4, Wharfedale Road, Pentwyn Industrial Estate, Cardiff, United Kingdom CF23 7XB
Web page	http://www.toughbook.eu/
Panasonic Helpdesk	
France:	+33(0) 805636449
German:	+49(0) 8007235211
Austria:	+43(0) 800006493
Swiss (German):	+41(0) 800002429
Swiss (French):	+41(0) 800588017
Italy:	+39 800986915
Spain:	+34(0) 901101157
UK:	+44(0) 8000884324
e-mail:	toughbooksupport@eu.panasonic.com
Czech speaking service	0800 143234 (in country only)
Hungarian speaking service	06800 163 67 (in country only)
Polish speaking service	00800 4911558 (in country only)
Romanian speaking service	0800 894 743 (in country only)
Slovakian speaking service	00800 42672627 (in country only)
e-mail:	toughbooksupport@csg.de
Payments	toughbookservicepayments.cardiff@eu.panasonic.com

Panasonic Mobile Communications Co., Ltd.
600 Saedo-cho, Tsuzuki-ku, Yokohama-city,
Kanagawa 224-8539, Japan

DHQP1031ZA/J1 C1218-0