

30MHz-3GHz_WCDMA_B5_LowCH4132-826.4

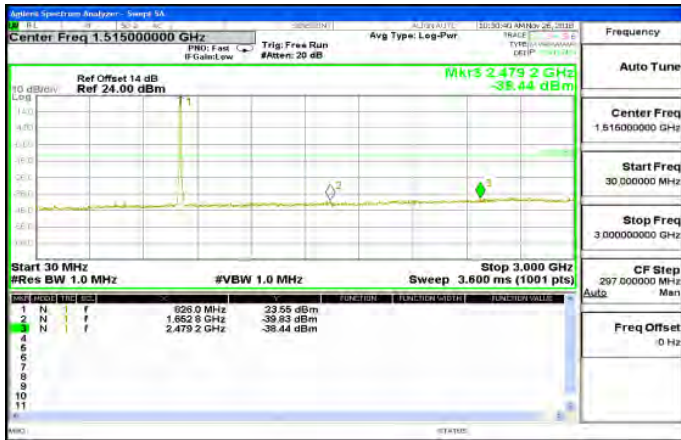

3GHz-10GHz_WCDMA_B5_MidCH4183-836.6

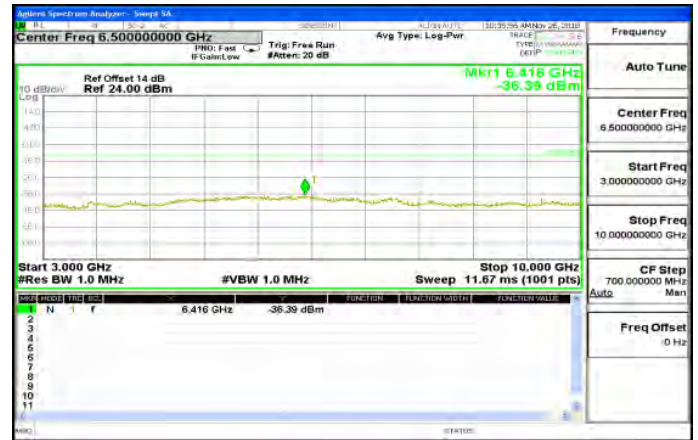

3GHz-10GHz_WCDMA_B5_LowCH4132-826.4

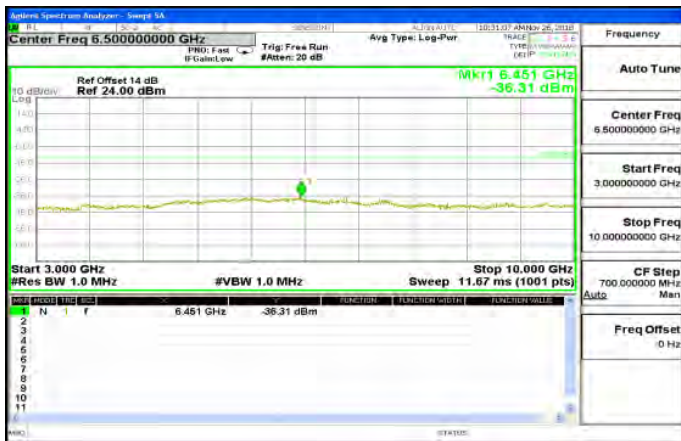

30MHz-3GHz_WCDMA_B5_HighCH4233-846.6



30MHz-3GHz_WCDMA_B5_MidCH4183-836.6



3GHz-10GHz_WCDMA_B5_HighCH4233-846.6

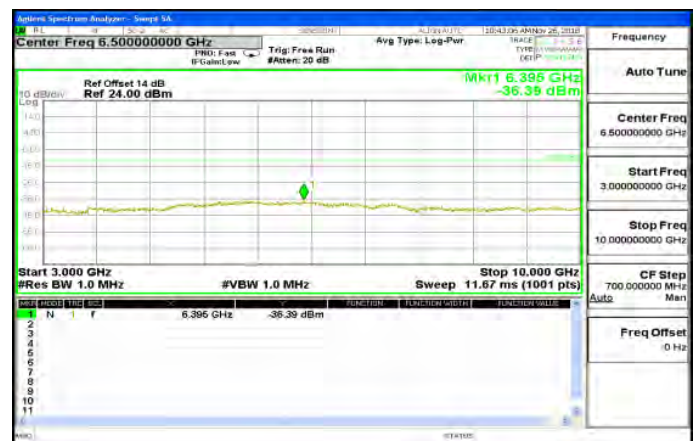

Unless otherwise stated the results shown in this test report refer only to the sample(s) tested and such sample(s) are retained for 90 days only. 除非另有說明，此報告結果僅對測試之樣品負責，同時此樣品僅保留90天。本報告未經本公司書面許可，不可部份複製。

This document is issued by the Company subject to its General Conditions of Service printed overleaf, available on request or accessible at www.sgs.com/terms_and_conditions.htm and, for electronic format documents, subject to Terms and Conditions for Electronic Documents at www.sgs.com/terms_e-document.htm. Attention is drawn to the limitation of liability, indemnification and jurisdiction issues defined therein. Any holder of this document is advised that information contained hereon reflects the Company's findings at the time of its intervention only and within the limits of Client's instructions, if any. The Company's sole responsibility is to its Client and this document does not exonerate parties to a transaction from exercising all their rights and obligations under the transaction documents. This document cannot be reproduced except in full, without prior written approval of the Company. Any unauthorized alteration, forgery or falsification of the content or appearance of this document is unlawful and offenders may be prosecuted to the fullest extent of the law.

30MHz-3GHz_Band2_1_4MHz_QPSK_1_0_LowCH18607-1850.7

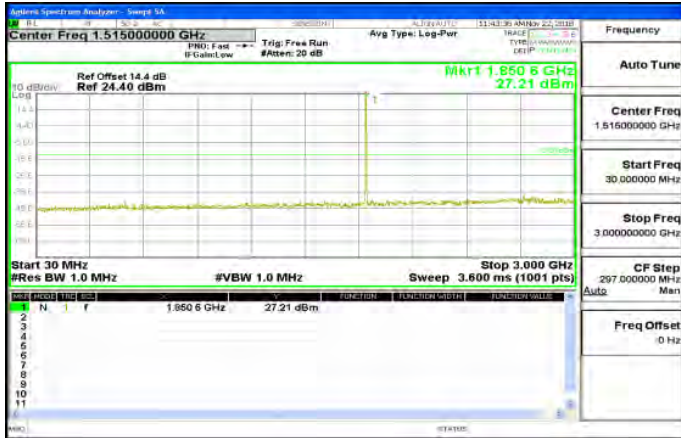

3GHz-20GHz_Band2_1_4MHz_QPSK_1_0_MidCH18900-1880

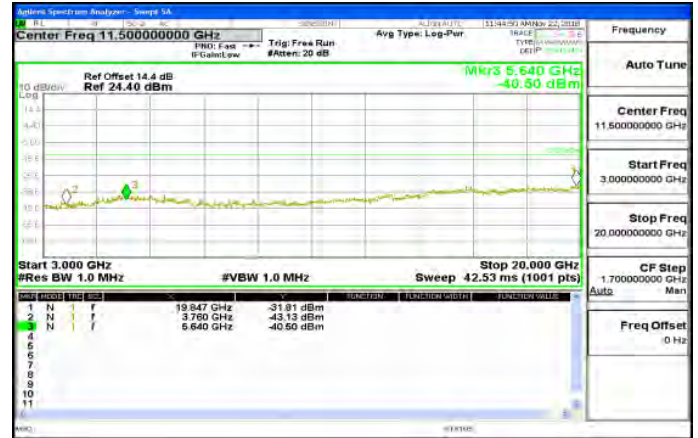

3GHz-20GHz_Band2_1_4MHz_QPSK_1_0_LowCH18607-1850.7



30MHz-3GHz_Band2_1_4MHz_QPSK_1_0_HighCH19193-1909.3

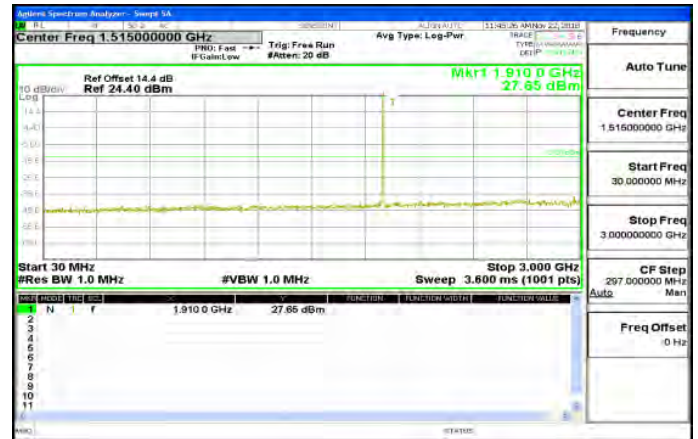

30MHz-3GHz_Band2_1_4MHz_QPSK_1_0_MidCH18900-1880

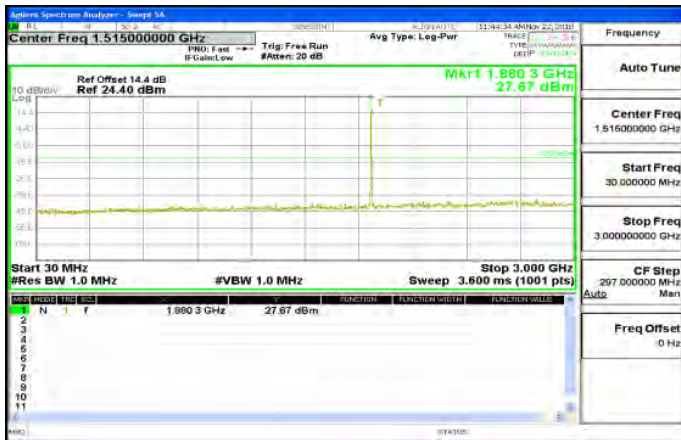

3GHz-20GHz_Band2_1_4MHz_QPSK_1_0_HighCH19193-1909.3



Unless otherwise stated the results shown in this test report refer only to the sample(s) tested and such sample(s) are retained for 90 days only. 除非另有說明，此報告結果僅對測試之樣品負責，同時此樣品僅保留90天。本報告未經本公司書面許可，不可部份複製。

This document is issued by the Company subject to its General Conditions of Service printed overleaf, available on request or accessible at www.sgs.com/terms_and_conditions.htm and, for electronic format documents, subject to Terms and Conditions for Electronic Documents at www.sgs.com/terms_e-document.htm. Attention is drawn to the limitation of liability, indemnification and jurisdiction issues defined therein. Any holder of this document is advised that information contained hereon reflects the Company's findings at the time of its intervention only and within the limits of Client's instructions, if any. The Company's sole responsibility is to its Client and this document does not exonerate parties to a transaction from exercising all their rights and obligations under the transaction documents. This document cannot be reproduced except in full, without prior written approval of the Company. Any unauthorized alteration, forgery or falsification of the content or appearance of this document is unlawful and offenders may be prosecuted to the fullest extent of the law.

30MHz-3GHz_Band2_3MHz_QPSK_1_0_LowCH18615-1851.5

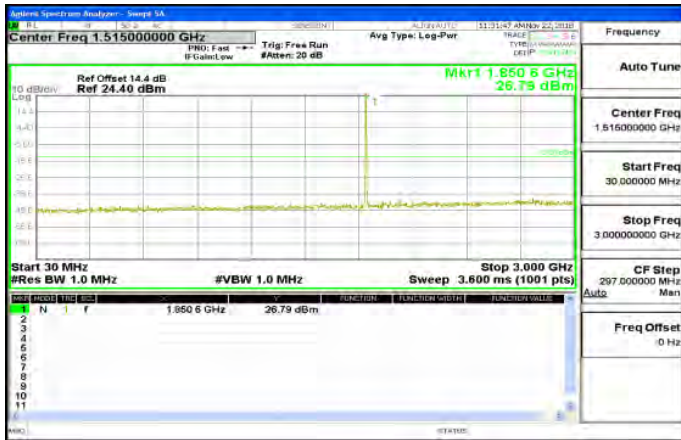

3GHz-20GHz_Band2_3MHz_QPSK_1_0_MidCH18900-1880



3GHz-20GHz_Band2_3MHz_QPSK_1_0_LowCH18615-1851.5

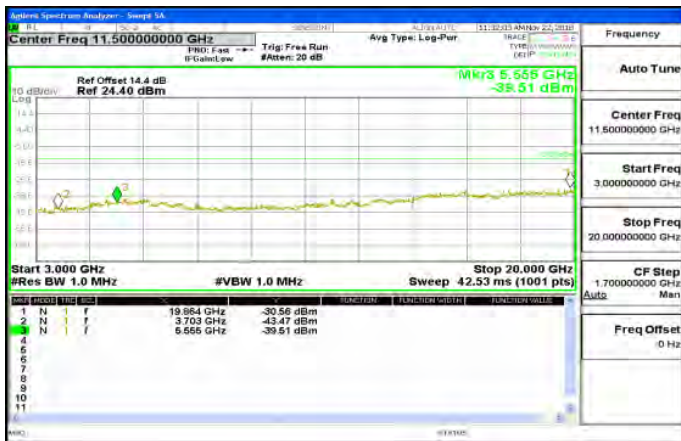

30MHz-3GHz_Band2_3MHz_QPSK_1_0_HighCH19185-1908.5

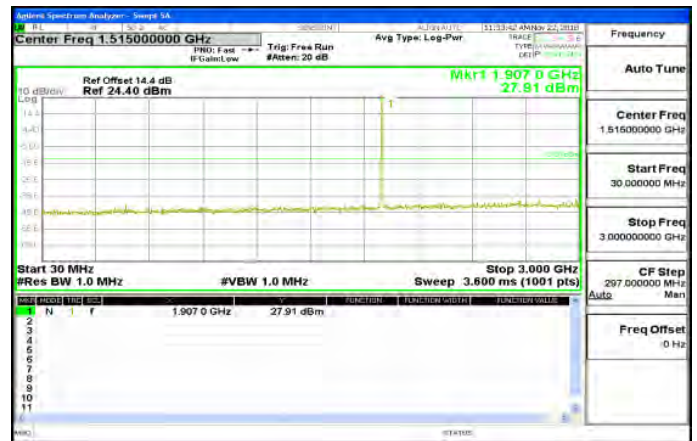

30MHz-3GHz_Band2_3MHz_QPSK_1_0_MidCH18900-1880

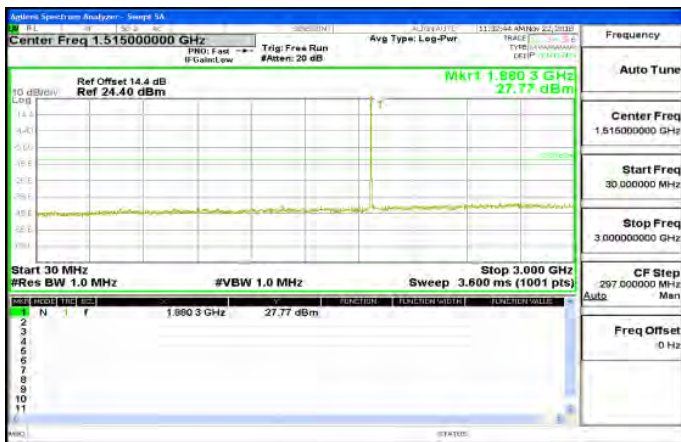

3GHz-20GHz_Band2_3MHz_QPSK_1_0_HighCH19185-1908.5



Unless otherwise stated the results shown in this test report refer only to the sample(s) tested and such sample(s) are retained for 90 days only. 除非另有說明，此報告結果僅對測試之樣品負責，同時此樣品僅保留90天。本報告未經本公司書面許可，不可部份複製。

This document is issued by the Company subject to its General Conditions of Service printed overleaf, available on request or accessible at www.sgs.com/terms_and_conditions.htm and, for electronic format documents, subject to Terms and Conditions for Electronic Documents at www.sgs.com/terms_e-document.htm. Attention is drawn to the limitation of liability, indemnification and jurisdiction issues defined therein. Any holder of this document is advised that information contained hereon reflects the Company's findings at the time of its intervention only and within the limits of Client's instructions, if any. The Company's sole responsibility is to its Client and this document does not exonerate parties to a transaction from exercising all their rights and obligations under the transaction documents. This document cannot be reproduced except in full, without prior written approval of the Company. Any unauthorized alteration, forgery or falsification of the content or appearance of this document is unlawful and offenders may be prosecuted to the fullest extent of the law.

30MHz-3GHz_Band2_5MHz_QPSK_1_0_LowCH18625-1852.5



3GHz-20GHz_Band2_5MHz_QPSK_1_0_MidCH18900-1880



3GHz-20GHz_Band2_5MHz_QPSK_1_0_LowCH18625-1852.5



30MHz-3GHz_Band2_5MHz_QPSK_1_0_HighCH19175-1907.5

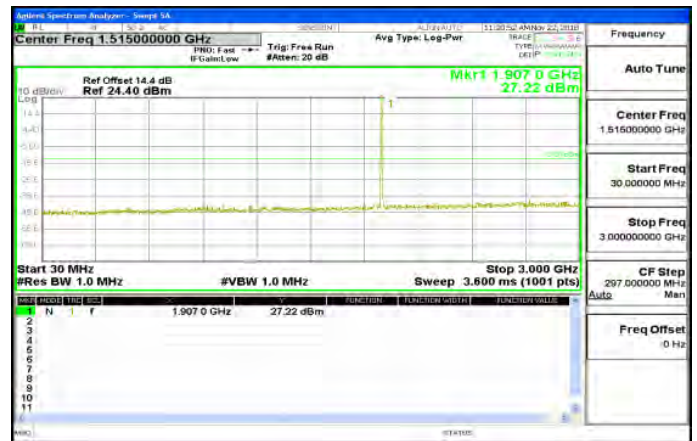

30MHz-3GHz_Band2_5MHz_QPSK_1_0_MidCH18900-1880

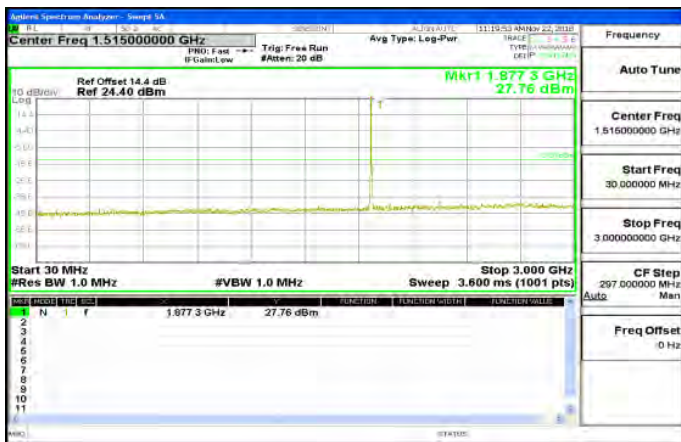

3GHz-20GHz_Band2_5MHz_QPSK_1_0_HighCH19175-1907.5



Unless otherwise stated the results shown in this test report refer only to the sample(s) tested and such sample(s) are retained for 90 days only. 除非另有說明，此報告結果僅對測試之樣品負責，同時此樣品僅保留90天。本報告未經本公司書面許可，不可部份複製。

This document is issued by the Company subject to its General Conditions of Service printed overleaf, available on request or accessible at www.sgs.com/terms_and_conditions.htm and, for electronic format documents, subject to Terms and Conditions for Electronic Documents at www.sgs.com/terms_e-document.htm. Attention is drawn to the limitation of liability, indemnification and jurisdiction issues defined therein. Any holder of this document is advised that information contained hereon reflects the Company's findings at the time of its intervention only and within the limits of Client's instructions, if any. The Company's sole responsibility is to its Client and this document does not exonerate parties to a transaction from exercising all their rights and obligations under the transaction documents. This document cannot be reproduced except in full, without prior written approval of the Company. Any unauthorized alteration, forgery or falsification of the content or appearance of this document is unlawful and offenders may be prosecuted to the fullest extent of the law.

30MHz-3GHz_Band2_10MHz_QPSK_1_0_LowCH18650-1855

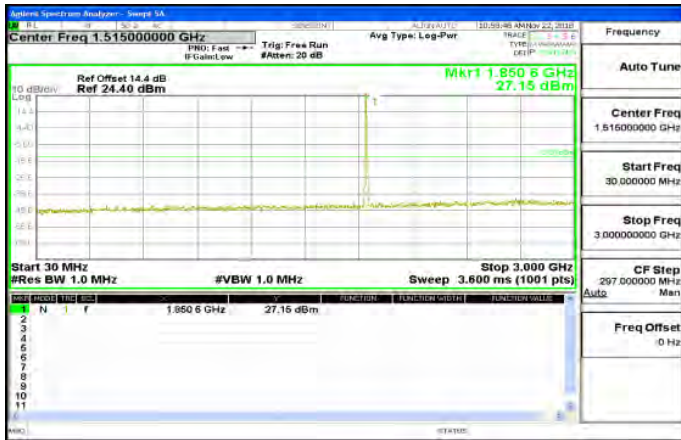

3GHz-20GHz_Band2_10MHz_QPSK_1_0_MidCH18900-1880



3GHz-20GHz_Band2_10MHz_QPSK_1_0_LowCH18650-1855



30MHz-3GHz_Band2_10MHz_QPSK_1_0_HighCH19150-1905



30MHz-3GHz_Band2_10MHz_QPSK_1_0_MidCH18900-1880



3GHz-20GHz_Band2_10MHz_QPSK_1_0_HighCH19150-1905



Unless otherwise stated the results shown in this test report refer only to the sample(s) tested and such sample(s) are retained for 90 days only.

除非另有說明，此報告結果僅對測試之樣品負責，同時此樣品僅保留90天。本報告未經本公司書面許可，不可部份複製。

This document is issued by the Company subject to its General Conditions of Service printed overleaf, available on request or accessible at www.sgs.com/terms_and_conditions.htm and, for electronic format documents, subject to Terms and Conditions for Electronic Documents at www.sgs.com/terms_e-document.htm. Attention is drawn to the limitation of liability, indemnification and jurisdiction issues defined therein. Any holder of this document is advised that information contained hereon reflects the Company's findings at the time of its intervention only and within the limits of Client's instructions, if any. The Company's sole responsibility is to its Client and this document does not exonerate parties to a transaction from exercising all their rights and obligations under the transaction documents. This document cannot be reproduced except in full, without prior written approval of the Company. Any unauthorized alteration, forgery or falsification of the content or appearance of this document is unlawful and offenders may be prosecuted to the fullest extent of the law.

30MHz-3GHz_Band2_15MHz_QPSK_1_0_LowCH18675-1857.5

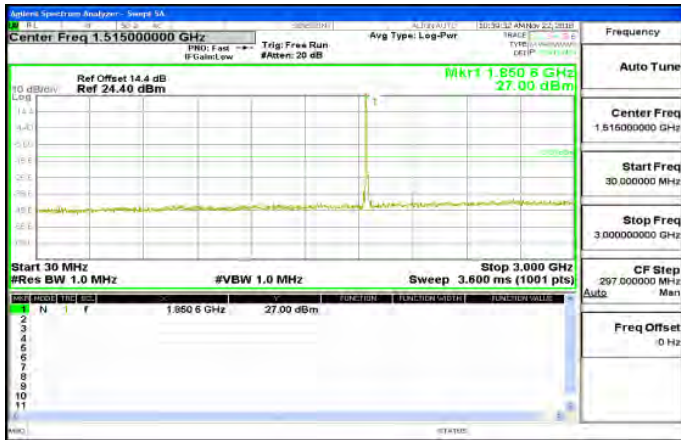

3GHz-20GHz_Band2_15MHz_QPSK_1_0_MidCH18900-1880



3GHz-20GHz_Band2_15MHz_QPSK_1_0_LowCH18675-1857.5



30MHz-3GHz_Band2_15MHz_QPSK_1_0_HighCH19125-1902.5



30MHz-3GHz_Band2_15MHz_QPSK_1_0_MidCH18900-1880



3GHz-20GHz_Band2_15MHz_QPSK_1_0_HighCH19125-1902.5



Unless otherwise stated the results shown in this test report refer only to the sample(s) tested and such sample(s) are retained for 90 days only. 除非另有說明，此報告結果僅對測試之樣品負責，同時此樣品僅保留90天。本報告未經本公司書面許可，不可部份複製。

This document is issued by the Company subject to its General Conditions of Service printed overleaf, available on request or accessible at www.sgs.com/terms_and_conditions.htm and, for electronic format documents, subject to Terms and Conditions for Electronic Documents at www.sgs.com/terms_e-document.htm. Attention is drawn to the limitation of liability, indemnification and jurisdiction issues defined therein. Any holder of this document is advised that information contained hereon reflects the Company's findings at the time of its intervention only and within the limits of Client's instructions, if any. The Company's sole responsibility is to its Client and this document does not exonerate parties to a transaction from exercising all their rights and obligations under the transaction documents. This document cannot be reproduced except in full, without prior written approval of the Company. Any unauthorized alteration, forgery or falsification of the content or appearance of this document is unlawful and offenders may be prosecuted to the fullest extent of the law.

30MHz-3GHz_Band2_20MHz_QPSK_1_0_LowCH18700

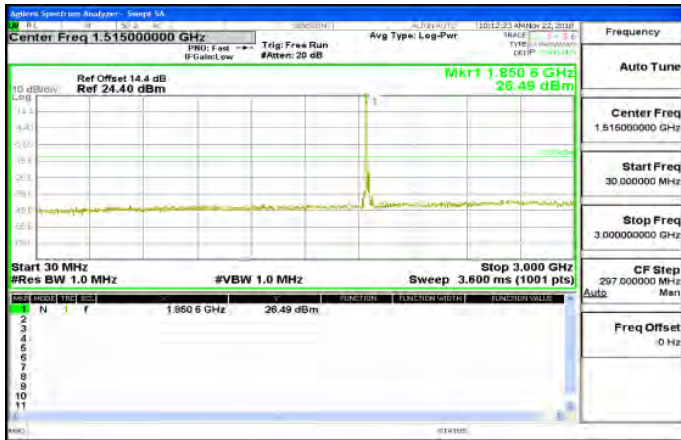

3GHz-20GHz_Band2_20MHz_QPSK_1_0_MidCH18900-1880



3GHz-20GHz_Band2_20MHz_QPSK_1_0_LowCH18700-1860



30MHz-3GHz_Band2_20MHz_QPSK_1_0_HighCH19100-1900

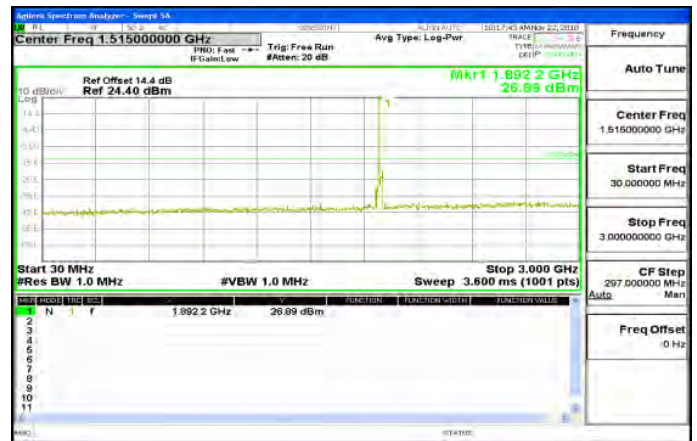

30MHz-3GHz_Band2_20MHz_QPSK_1_0_MidCH18900-1880



3GHz-20GHz_Band2_20MHz_QPSK_1_0_HighCH19100-1900



Unless otherwise stated the results shown in this test report refer only to the sample(s) tested and such sample(s) are retained for 90 days only.

除非另有說明，此報告結果僅對測試之樣品負責，同時此樣品僅保留90天。本報告未經本公司書面許可，不可部份複製。

This document is issued by the Company subject to its General Conditions of Service printed overleaf, available on request or accessible at www.sgs.com/terms_and_conditions.htm and, for electronic format documents, subject to Terms and Conditions for Electronic Documents at www.sgs.com/terms_e-document.htm. Attention is drawn to the limitation of liability, indemnification and jurisdiction issues defined therein. Any holder of this document is advised that information contained hereon reflects the Company's findings at the time of its intervention only and within the limits of Client's instructions, if any. The Company's sole responsibility is to its Client and this document does not exonerate parties to a transaction from exercising all their rights and obligations under the transaction documents. This document cannot be reproduced except in full, without prior written approval of the Company. Any unauthorized alteration, forgery or falsification of the content or appearance of this document is unlawful and offenders may be prosecuted to the fullest extent of the law.

30MHz-3GHz_Band4_1_4MHz_QPSK_1_0_LowCH19957-1710.7

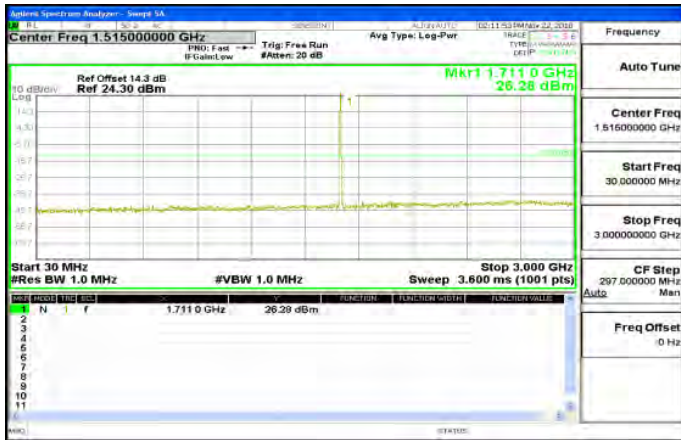

3GHz-20GHz_Band4_1_4MHz_QPSK_1_0_MidCH20175-1732.5



3GHz-20GHz_Band4_1_4MHz_QPSK_1_0_LowCH19957-1710.7



30MHz-3GHz_Band4_1_4MHz_QPSK_1_0_HighCH20393-1754.3

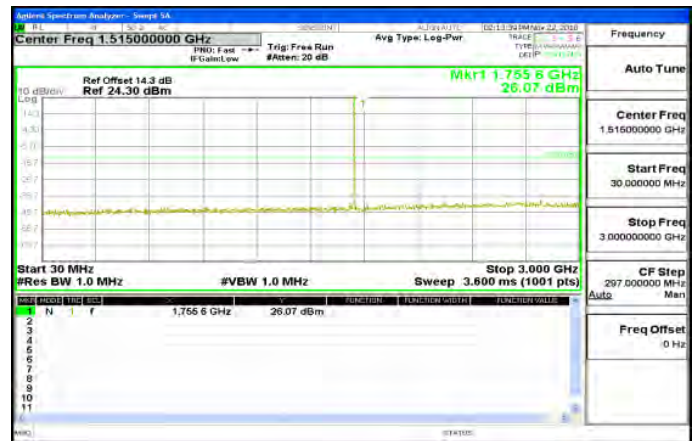

30MHz-3GHz_Band4_1_4MHz_QPSK_1_0_MidCH20175-1732.5

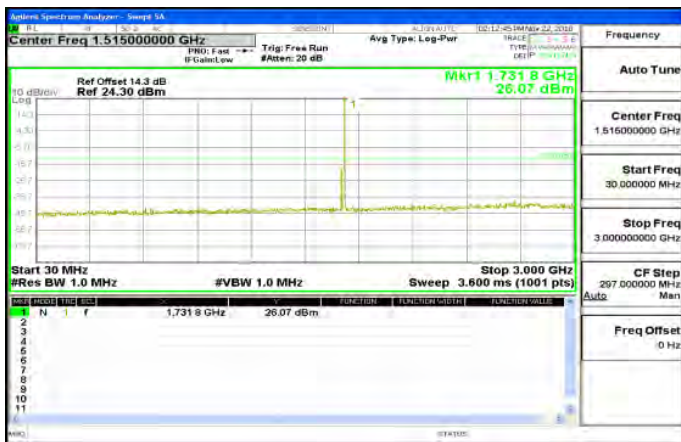

3GHz-20GHz_Band4_1_4MHz_QPSK_1_0_HighCH20393-1754.3



Unless otherwise stated the results shown in this test report refer only to the sample(s) tested and such sample(s) are retained for 90 days only.

除非另有說明，此報告結果僅對測試之樣品負責，同時此樣品僅保留90天。本報告未經本公司書面許可，不可部份複製。
This document is issued by the Company subject to its General Conditions of Service printed overleaf, available on request or accessible at www.sgs.com/terms_and_conditions.htm and, for electronic format documents, subject to Terms and Conditions for Electronic Documents at www.sgs.com/terms_e-document.htm. Attention is drawn to the limitation of liability, indemnification and jurisdiction issues defined therein. Any holder of this document is advised that information contained hereon reflects the Company's findings at the time of its intervention only and within the limits of Client's instructions, if any. The Company's sole responsibility is to its Client and this document does not exonerate parties to a transaction from exercising all their rights and obligations under the transaction documents. This document cannot be reproduced except in full, without prior written approval of the Company. Any unauthorized alteration, forgery or falsification of the content or appearance of this document is unlawful and offenders may be prosecuted to the fullest extent of the law.

30MHz-3GHz_Band4_3MHz_QPSK_1_0_LowCH19965-1711.5

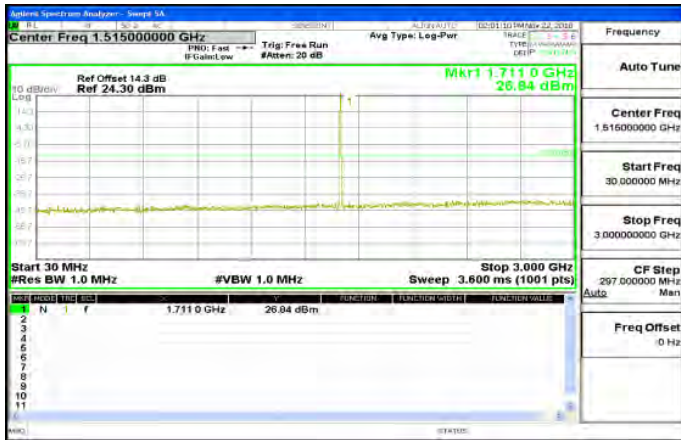

3GHz-20GHz_Band4_3MHz_QPSK_1_0_MidCH20175-1732.5



3GHz-20GHz_Band4_3MHz_QPSK_1_0_LowCH19965-1711.5



30MHz-3GHz_Band4_3MHz_QPSK_1_0_HighCH20385-1753.5

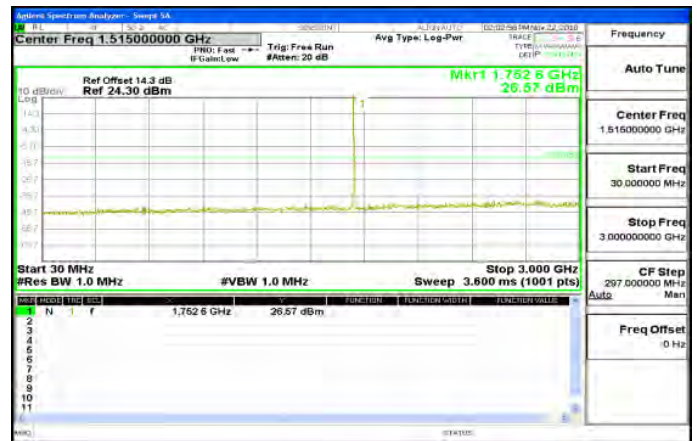

30MHz-3GHz_Band4_3MHz_QPSK_1_0_MidCH20175-1732.5

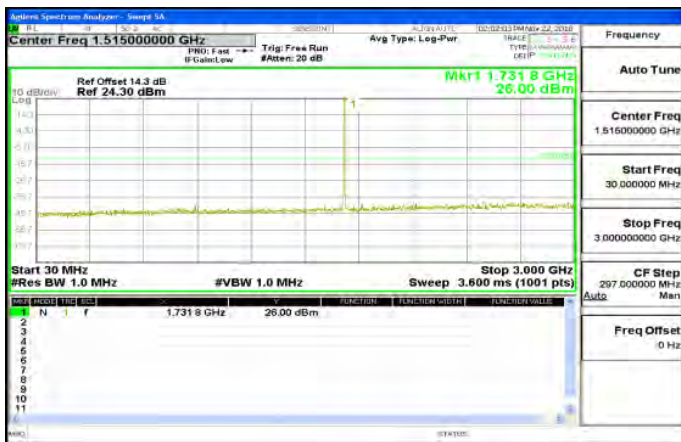

3GHz-20GHz_Band4_3MHz_QPSK_1_0_HighCH20385-1753.5



Unless otherwise stated the results shown in this test report refer only to the sample(s) tested and such sample(s) are retained for 90 days only. 除非另有說明，此報告結果僅對測試之樣品負責，同時此樣品僅保留90天。本報告未經本公司書面許可，不可部份複製。

This document is issued by the Company subject to its General Conditions of Service printed overleaf, available on request or accessible at www.sgs.com/terms_and_conditions.htm and, for electronic format documents, subject to Terms and Conditions for Electronic Documents at www.sgs.com/terms_e-document.htm. Attention is drawn to the limitation of liability, indemnification and jurisdiction issues defined therein. Any holder of this document is advised that information contained hereon reflects the Company's findings at the time of its intervention only and within the limits of Client's instructions, if any. The Company's sole responsibility is to its Client and this document does not exonerate parties to a transaction from exercising all their rights and obligations under the transaction documents. This document cannot be reproduced except in full, without prior written approval of the Company. Any unauthorized alteration, forgery or falsification of the content or appearance of this document is unlawful and offenders may be prosecuted to the fullest extent of the law.

30MHz-3GHz_Band4_5MHz_QPSK_1_0_LowCH19975-1712.5

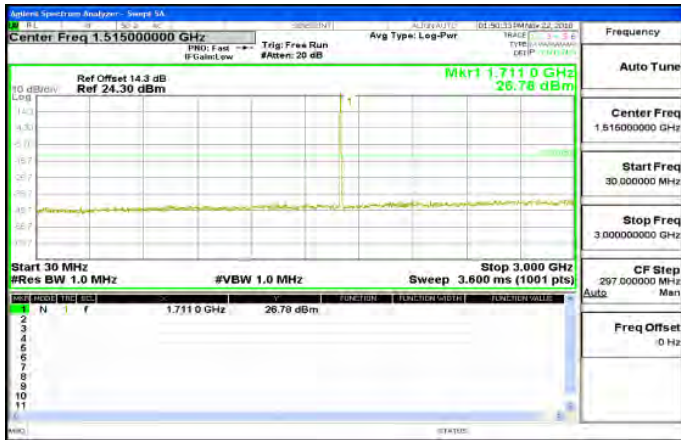

3GHz-20GHz_Band4_5MHz_QPSK_1_0_MidCH20175-1732.5



3GHz-20GHz_Band4_5MHz_QPSK_1_0_LowCH19975-1712.5



30MHz-3GHz_Band4_5MHz_QPSK_1_0_HighCH20375-1752.5

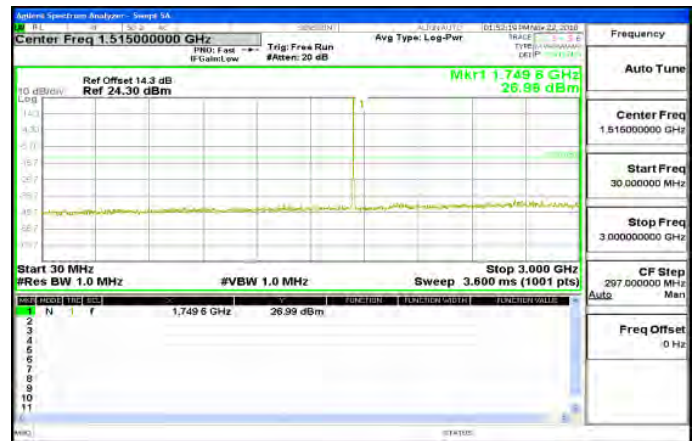

30MHz-3GHz_Band4_5MHz_QPSK_1_0_MidCH20175-1732.5

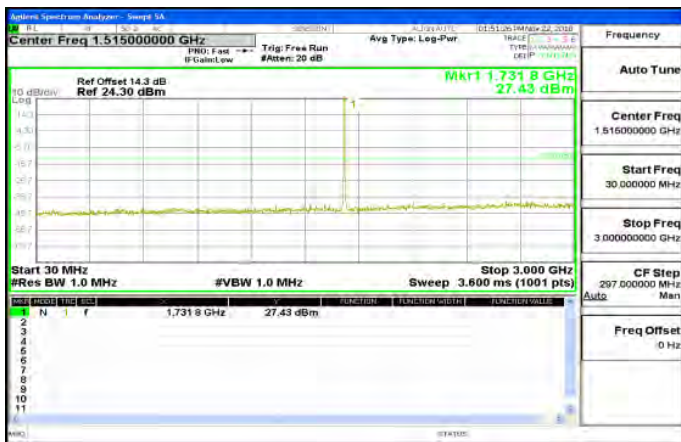

3GHz-20GHz_Band4_5MHz_QPSK_1_0_HighCH20375-1752.5



Unless otherwise stated the results shown in this test report refer only to the sample(s) tested and such sample(s) are retained for 90 days only.

除非另有說明，此報告結果僅對測試之樣品負責，同時此樣品僅保留90天。本報告未經本公司書面許可，不可部份複製。

This document is issued by the Company subject to its General Conditions of Service printed overleaf, available on request or accessible at www.sgs.com/terms_and_conditions.htm and, for electronic format documents, subject to Terms and Conditions for Electronic Documents at www.sgs.com/terms_e-document.htm. Attention is drawn to the limitation of liability, indemnification and jurisdiction issues defined therein. Any holder of this document is advised that information contained hereon reflects the Company's findings at the time of its intervention only and within the limits of Client's instructions, if any. The Company's sole responsibility is to its Client and this document does not exonerate parties to a transaction from exercising all their rights and obligations under the transaction documents. This document cannot be reproduced except in full, without prior written approval of the Company. Any unauthorized alteration, forgery or falsification of the content or appearance of this document is unlawful and offenders may be prosecuted to the fullest extent of the law.

30MHz-3GHz_Band4_10MHz_QPSK_1_0_LowCH20000-1715

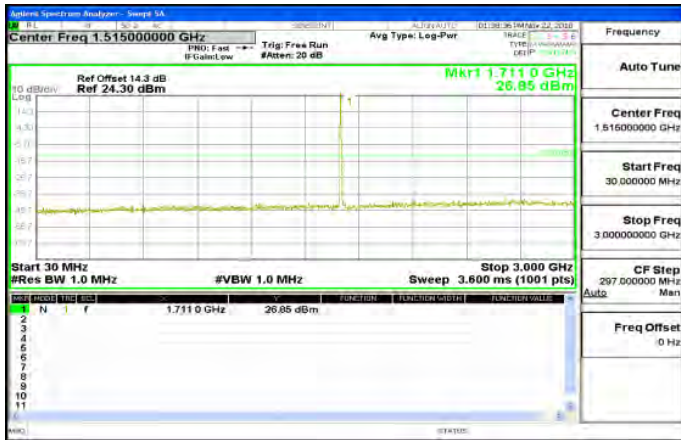

3GHz-20GHz_Band4_10MHz_QPSK_1_0_MidCH20175-1732.5



3GHz-20GHz_Band4_10MHz_QPSK_1_0_LowCH20000-1715



30MHz-3GHz_Band4_10MHz_QPSK_1_0_HighCH20350-1750

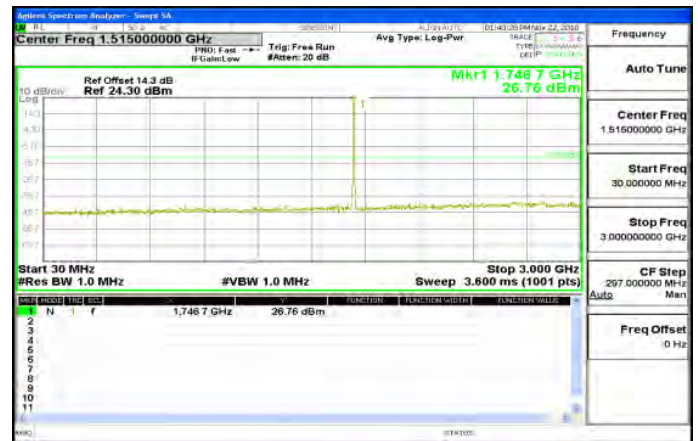

30MHz-3GHz_Band4_10MHz_QPSK_1_0_MidCH20175-1732.5

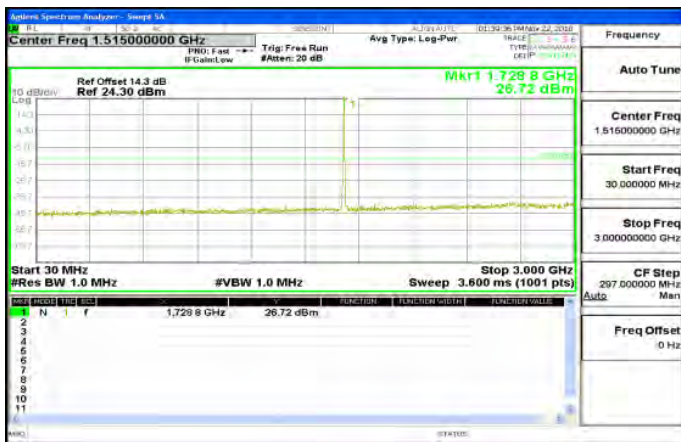

3GHz-20GHz_Band4_10MHz_QPSK_1_0_HighCH20350-1750



Unless otherwise stated the results shown in this test report refer only to the sample(s) tested and such sample(s) are retained for 90 days only. 除非另有說明，此報告結果僅對測試之樣品負責，同時此樣品僅保留90天。本報告未經本公司書面許可，不可部份複製。

This document is issued by the Company subject to its General Conditions of Service printed overleaf, available on request or accessible at www.sgs.com/terms_and_conditions.htm and, for electronic format documents, subject to Terms and Conditions for Electronic Documents at www.sgs.com/terms_e-document.htm. Attention is drawn to the limitation of liability, indemnification and jurisdiction issues defined therein. Any holder of this document is advised that information contained hereon reflects the Company's findings at the time of its intervention only and within the limits of Client's instructions, if any. The Company's sole responsibility is to its Client and this document does not exonerate parties to a transaction from exercising all their rights and obligations under the transaction documents. This document cannot be reproduced except in full, without prior written approval of the Company. Any unauthorized alteration, forgery or falsification of the content or appearance of this document is unlawful and offenders may be prosecuted to the fullest extent of the law.

30MHz-3GHz_Band4_15MHz_QPSK_1_0_LowCH20025-1717.5

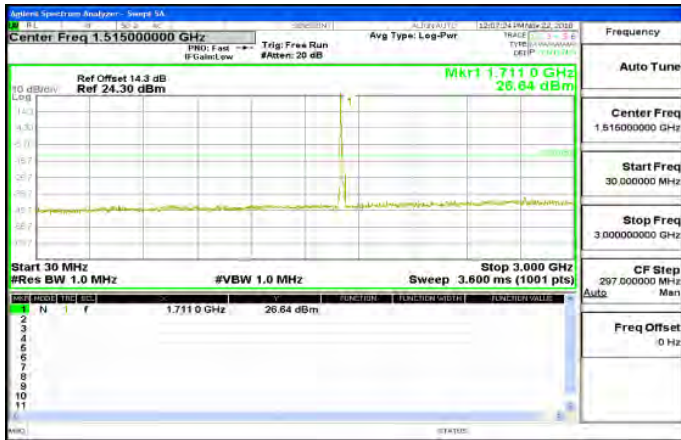

3GHz-20GHz_Band4_15MHz_QPSK_1_0_MidCH20175-1732.5



3GHz-20GHz_Band4_15MHz_QPSK_1_0_LowCH20025-1717.5



30MHz-3GHz_Band4_15MHz_QPSK_1_0_HighCH20325-1747.5

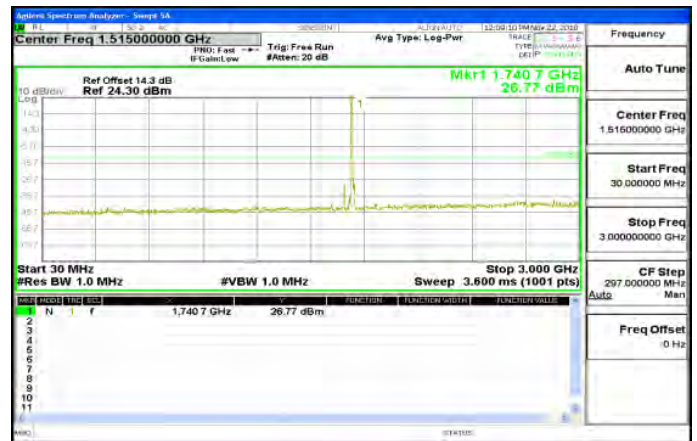

30MHz-3GHz_Band4_15MHz_QPSK_1_0_MidCH20175-1732.5

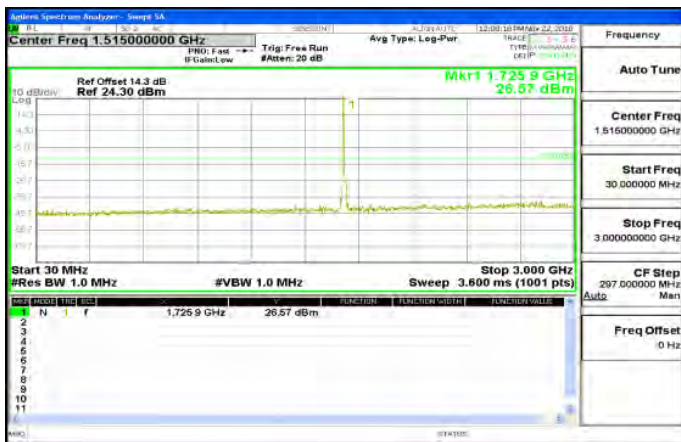

3GHz-20GHz_Band4_15MHz_QPSK_1_0_HighCH20325-1747.5



Unless otherwise stated the results shown in this test report refer only to the sample(s) tested and such sample(s) are retained for 90 days only.

除非另有說明，此報告結果僅對測試之樣品負責，同時此樣品僅保留90天。本報告未經本公司書面許可，不可部份複製。

This document is issued by the Company subject to its General Conditions of Service printed overleaf, available on request or accessible at www.sgs.com/terms_and_conditions.htm and, for electronic format documents, subject to Terms and Conditions for Electronic Documents at www.sgs.com/terms_e-document.htm. Attention is drawn to the limitation of liability, indemnification and jurisdiction issues defined therein. Any holder of this document is advised that information contained hereon reflects the Company's findings at the time of its intervention only and within the limits of Client's instructions, if any. The Company's sole responsibility is to its Client and this document does not exonerate parties to a transaction from exercising all their rights and obligations under the transaction documents. This document cannot be reproduced except in full, without prior written approval of the Company. Any unauthorized alteration, forgery or falsification of the content or appearance of this document is unlawful and offenders may be prosecuted to the fullest extent of the law.

30MHz-3GHz_Band4_20MHz_QPSK_1_0_LowCH20050-1720

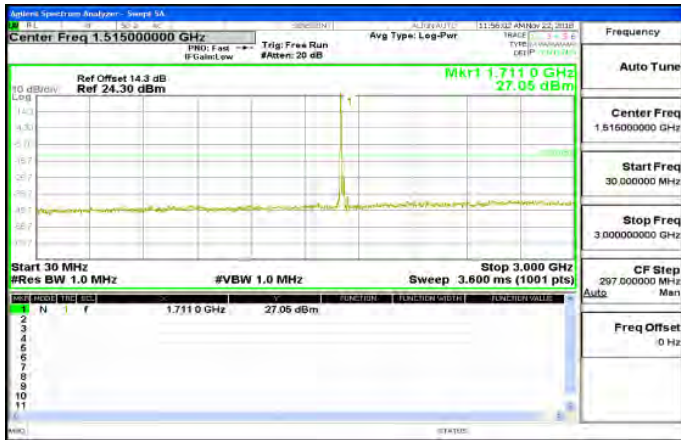

3GHz-20GHz_Band4_20MHz_QPSK_1_0_MidCH20175-1732.5



3GHz-20GHz_Band4_20MHz_QPSK_1_0_LowCH20050-1720



30MHz-3GHz_Band4_20MHz_QPSK_1_0_HighCH20300-1745

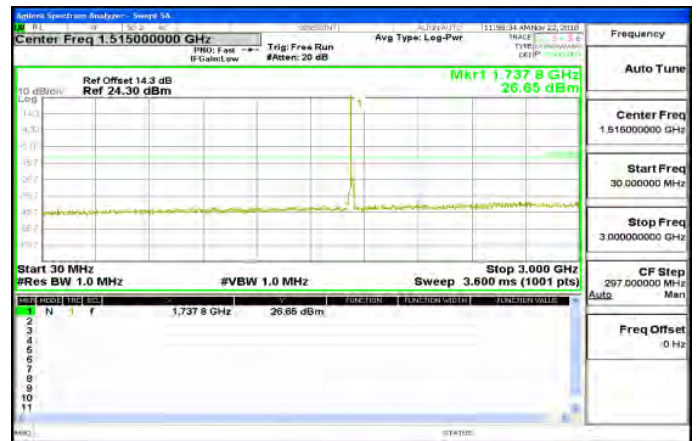

30MHz-3GHz_Band4_20MHz_QPSK_1_0_MidCH20175-1732.5

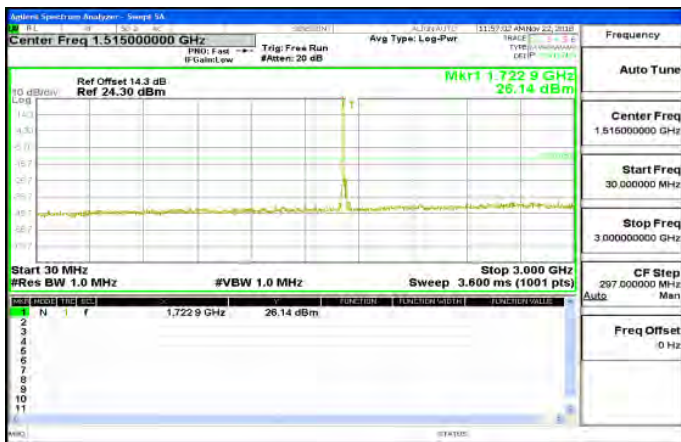

3GHz-20GHz_Band4_20MHz_QPSK_1_0_HighCH20300-1745



Unless otherwise stated the results shown in this test report refer only to the sample(s) tested and such sample(s) are retained for 90 days only.

除非另有說明，此報告結果僅對測試之樣品負責，同時此樣品僅保留90天。本報告未經本公司書面許可，不可部份複製。

This document is issued by the Company subject to its General Conditions of Service printed overleaf, available on request or accessible at www.sgs.com/terms_and_conditions.htm and, for electronic format documents, subject to Terms and Conditions for Electronic Documents at www.sgs.com/terms_e-document.htm. Attention is drawn to the limitation of liability, indemnification and jurisdiction issues defined therein. Any holder of this document is advised that information contained hereon reflects the Company's findings at the time of its intervention only and within the limits of Client's instructions, if any. The Company's sole responsibility is to its Client and this document does not exonerate parties to a transaction from exercising all their rights and obligations under the transaction documents. This document cannot be reproduced except in full, without prior written approval of the Company. Any unauthorized alteration, forgery or falsification of the content or appearance of this document is unlawful and offenders may be prosecuted to the fullest extent of the law.

SGS Taiwan Ltd.

No. 134, WuKungRoad, NewTaipeiIndustrialPark, WukuDistrict, NewTaipeiCity, Taiwan24803/新北市五股區新北產業園區五工路 134 號

台灣檢驗科技股份有限公司

t (886-2) 2299-3279

f (886-2) 2298-0488

www.tw.sgs.com

Member of SGS Group

30MHz-3GHz_Band5_1_4MHz_QPSK_1_0_LowCH20407-824.7



3GHz-20GHz_Band5_1_4MHz_QPSK_1_0_MidCH20525-836.5

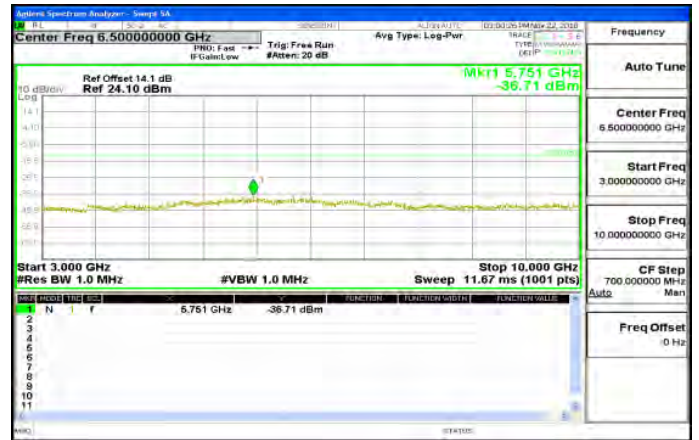

3GHz-20GHz_Band5_1_4MHz_QPSK_1_0_LowCH20407-824.7

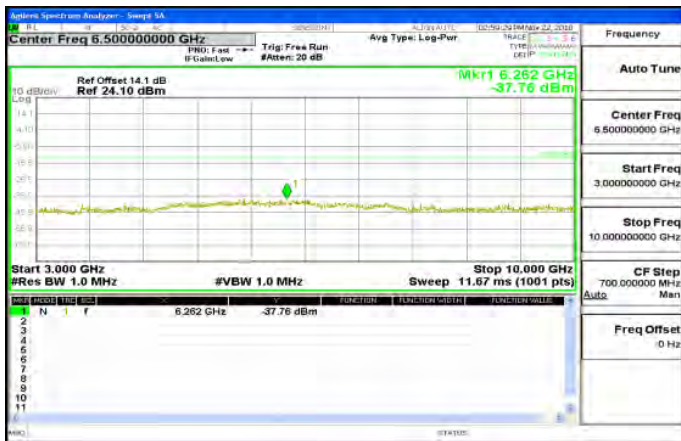

30MHz-3GHz_Band5_1_4MHz_QPSK_1_0_HighCH20643-848.3

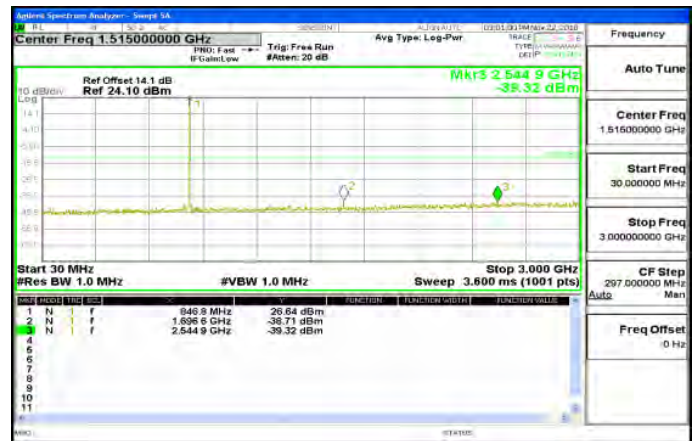

30MHz-3GHz_Band5_1_4MHz_QPSK_1_0_MidCH20525-836.5



3GHz-20GHz_Band5_1_4MHz_QPSK_1_0_HighCH20643-848.3

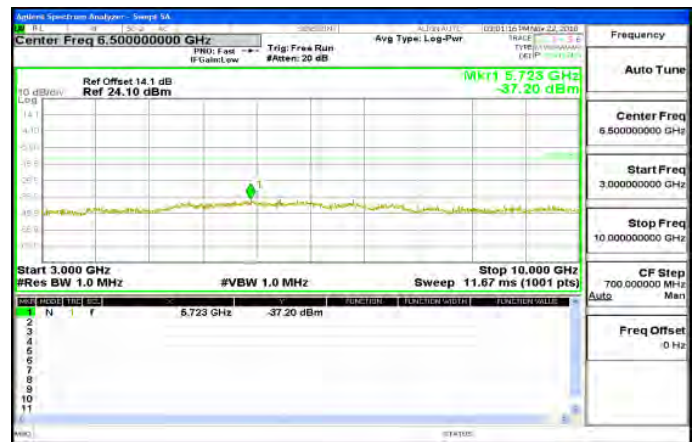

Unless otherwise stated the results shown in this test report refer only to the sample(s) tested and such sample(s) are retained for 90 days only.

除非另有說明，此報告結果僅對測試之樣品負責，同時此樣品僅保留90天。本報告未經本公司書面許可，不可部份複製。

This document is issued by the Company subject to its General Conditions of Service printed overleaf, available on request or accessible at www.sgs.com/terms_and_conditions.htm and, for electronic format documents, subject to Terms and Conditions for Electronic Documents at www.sgs.com/terms_e-document.htm. Attention is drawn to the limitation of liability, indemnification and jurisdiction issues defined therein. Any holder of this document is advised that information contained hereon reflects the Company's findings at the time of its intervention only and within the limits of Client's instructions, if any. The Company's sole responsibility is to its Client and this document does not exonerate parties to a transaction from exercising all their rights and obligations under the transaction documents. This document cannot be reproduced except in full, without prior written approval of the Company. Any unauthorized alteration, forgery or falsification of the content or appearance of this document is unlawful and offenders may be prosecuted to the fullest extent of the law.

SGS Taiwan Ltd.

No. 134, WuKungRoad, New Taipei Industrial Park, WuKu District, New Taipei City, Taiwan 24803/新北市五股區新北產業園區五工路 134 號

台灣檢驗科技股份有限公司

t (886-2) 2299-3279

f (886-2) 2298-0488

www.tw.sgs.com

Member of SGS Group

30MHz-3GHz_Band5_3MHz_QPSK_1_0_LowCH20415-825.5

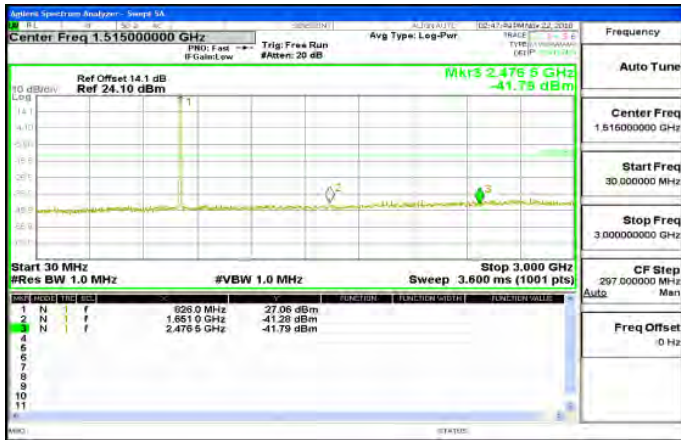

3GHz-20GHz_Band5_3MHz_QPSK_1_0_MidCH20525-836.5

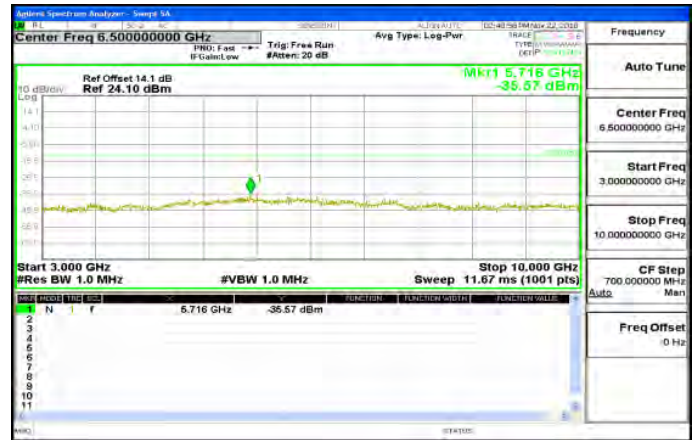

3GHz-20GHz_Band5_3MHz_QPSK_1_0_LowCH20415-825.5



30MHz-3GHz_Band5_3MHz_QPSK_1_0_HighCH20635-847.5



30MHz-3GHz_Band5_3MHz_QPSK_1_0_MidCH20525-836.5

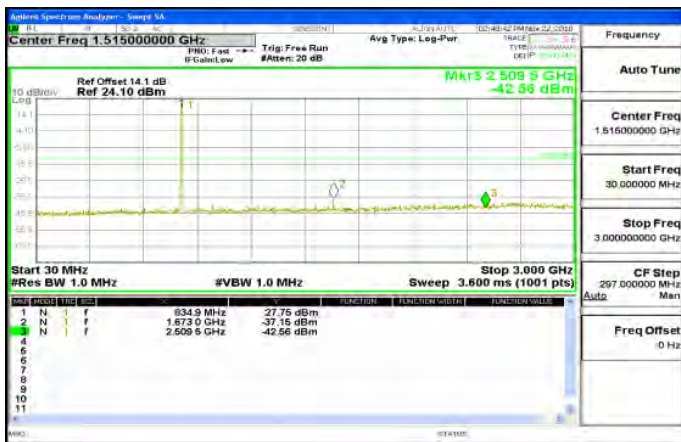

3GHz-20GHz_Band5_3MHz_QPSK_1_0_HighCH20635-847.5

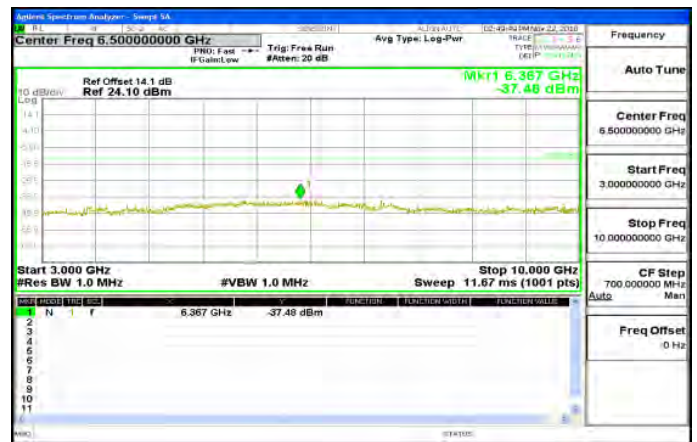

Unless otherwise stated the results shown in this test report refer only to the sample(s) tested and such sample(s) are retained for 90 days only. 除非另有說明，此報告結果僅對測試之樣品負責，同時此樣品僅保留90天。本報告未經本公司書面許可，不可部份複製。

This document is issued by the Company subject to its General Conditions of Service printed overleaf, available on request or accessible at www.sgs.com/terms_and_conditions.htm and, for electronic format documents, subject to Terms and Conditions for Electronic Documents at www.sgs.com/terms_e-document.htm. Attention is drawn to the limitation of liability, indemnification and jurisdiction issues defined therein. Any holder of this document is advised that information contained hereon reflects the Company's findings at the time of its intervention only and within the limits of Client's instructions, if any. The Company's sole responsibility is to its Client and this document does not exonerate parties to a transaction from exercising all their rights and obligations under the transaction documents. This document cannot be reproduced except in full, without prior written approval of the Company. Any unauthorized alteration, forgery or falsification of the content or appearance of this document is unlawful and offenders may be prosecuted to the fullest extent of the law.

30MHz-3GHz_Band5_5MHz_QPSK_1_0_LowCH20425-826.5

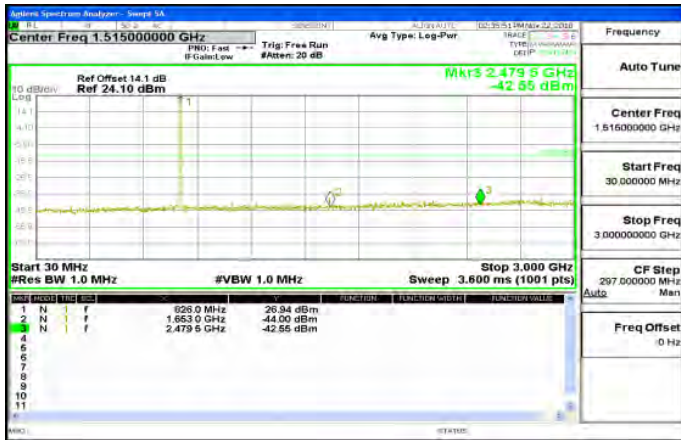

3GHz-20GHz_Band5_5MHz_QPSK_1_0_MidCH20525-836.5

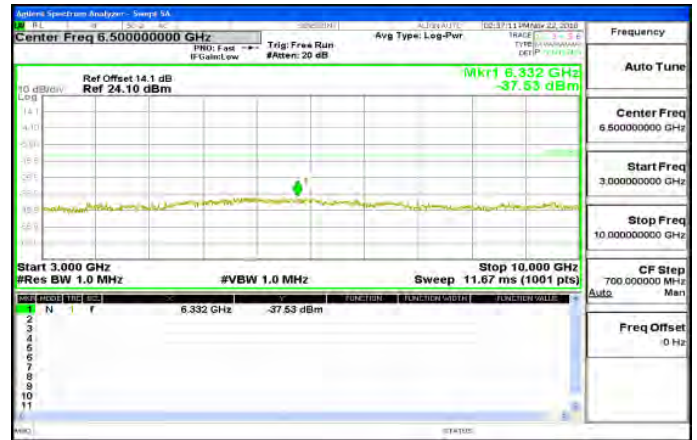

3GHz-20GHz_Band5_5MHz_QPSK_1_0_LowCH20425-826.5

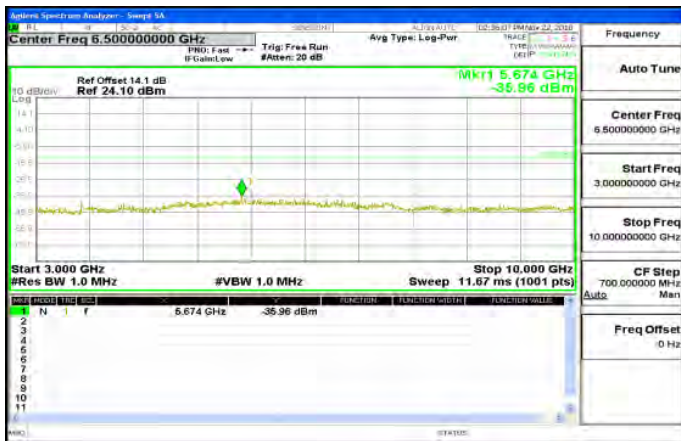

30MHz-3GHz_Band5_5MHz_QPSK_1_0_HighCH20625-846.5

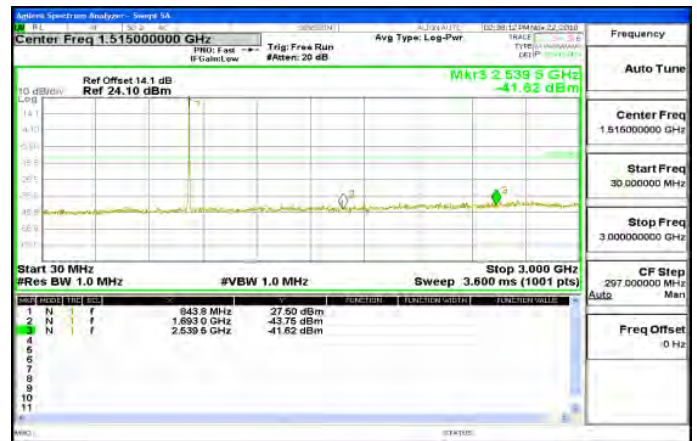

30MHz-3GHz_Band5_5MHz_QPSK_1_0_MidCH20525-836.5



3GHz-20GHz_Band5_5MHz_QPSK_1_0_HighCH20625-846.5

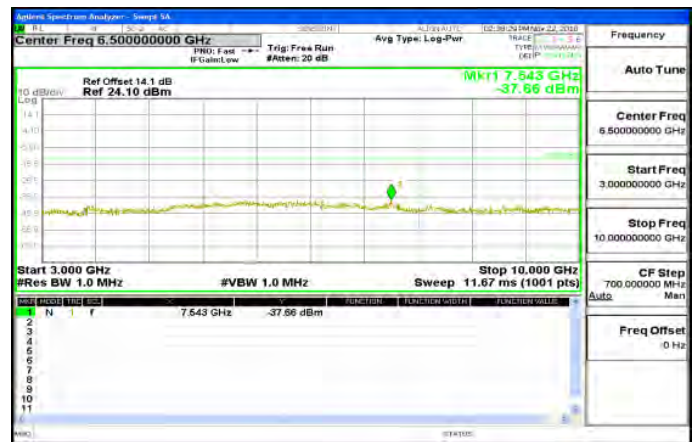

Unless otherwise stated the results shown in this test report refer only to the sample(s) tested and such sample(s) are retained for 90 days only. 除非另有說明，此報告結果僅對測試之樣品負責，同時此樣品僅保留90天。本報告未經本公司書面許可，不可部份複製。

This document is issued by the Company subject to its General Conditions of Service printed overleaf, available on request or accessible at www.sgs.com/terms_and_conditions.htm and, for electronic format documents, subject to Terms and Conditions for Electronic Documents at www.sgs.com/terms_e-document.htm. Attention is drawn to the limitation of liability, indemnification and jurisdiction issues defined therein. Any holder of this document is advised that information contained hereon reflects the Company's findings at the time of its intervention only and within the limits of Client's instructions, if any. The Company's sole responsibility is to its Client and this document does not exonerate parties to a transaction from exercising all their rights and obligations under the transaction documents. This document cannot be reproduced except in full, without prior written approval of the Company. Any unauthorized alteration, forgery or falsification of the content or appearance of this document is unlawful and offenders may be prosecuted to the fullest extent of the law.

30MHz-3GHz_Band5_10MHz_OPSK_1_0_LowCH20450-829



3GHz-20GHz_Band5_10MHz_OPSK_1_0_MidCH20525-836.5

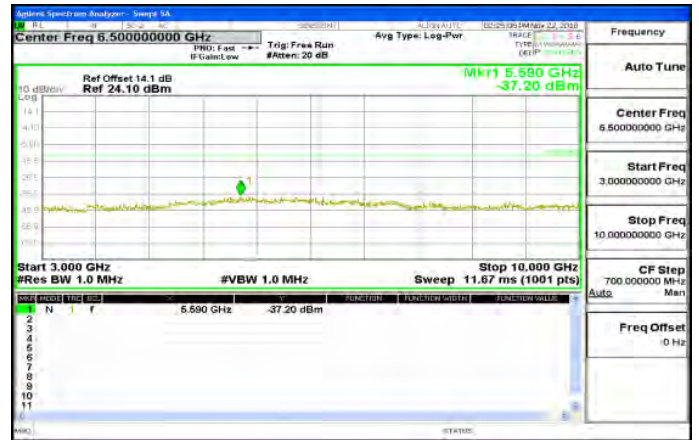

3GHz-20GHz_Band5_10MHz_OPSK_1_0_LowCH20450-829



30MHz-3GHz_Band5_10MHz_OPSK_1_0_HighCH20600-844

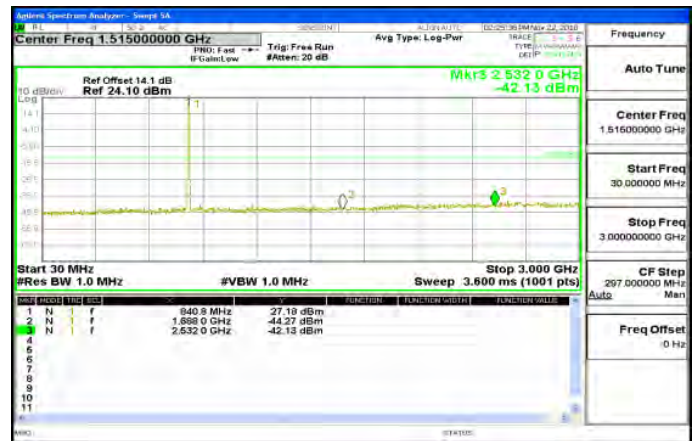

30MHz-3GHz_Band5_10MHz_OPSK_1_0_MidCH20525-836.5



3GHz-20GHz_Band5_10MHz_OPSK_1_0_HighCH20600-844



Unless otherwise stated the results shown in this test report refer only to the sample(s) tested and such sample(s) are retained for 90 days only. 除非另有說明，此報告結果僅對測試之樣品負責，同時此樣品僅保留90天。本報告未經本公司書面許可，不可部份複製。

This document is issued by the Company subject to its General Conditions of Service printed overleaf, available on request or accessible at www.sgs.com/terms_and_conditions.htm and, for electronic format documents, subject to Terms and Conditions for Electronic Documents at www.sgs.com/terms_e-document.htm. Attention is drawn to the limitation of liability, indemnification and jurisdiction issues defined therein. Any holder of this document is advised that information contained hereon reflects the Company's findings at the time of its intervention only and within the limits of Client's instructions, if any. The Company's sole responsibility is to its Client and this document does not exonerate parties to a transaction from exercising all their rights and obligations under the transaction documents. This document cannot be reproduced except in full, without prior written approval of the Company. Any unauthorized alteration, forgery or falsification of the content or appearance of this document is unlawful and offenders may be prosecuted to the fullest extent of the law.

30MHz-3GHz_Band12_1_4MHz_QPSK_1_0_LowCH23017-699.7

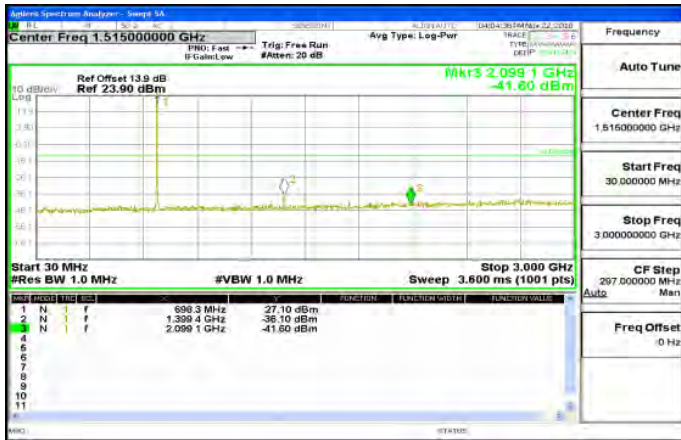

3GHz-20GHz_Band12_1_4MHz_QPSK_1_0_MidCH23095-707.5

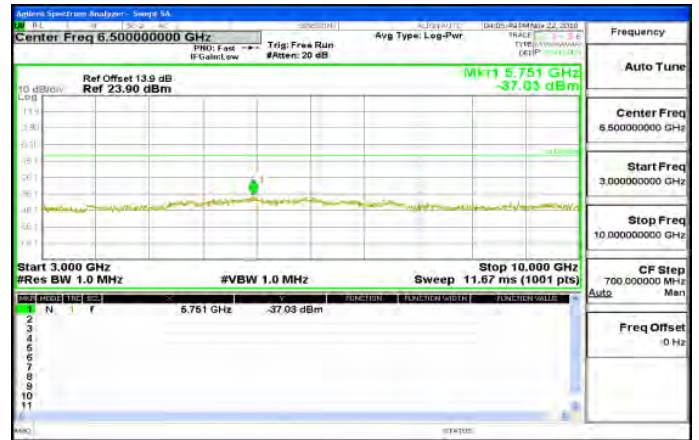

3GHz-20GHz_Band12_1_4MHz_QPSK_1_0_LowCH23017-699.7

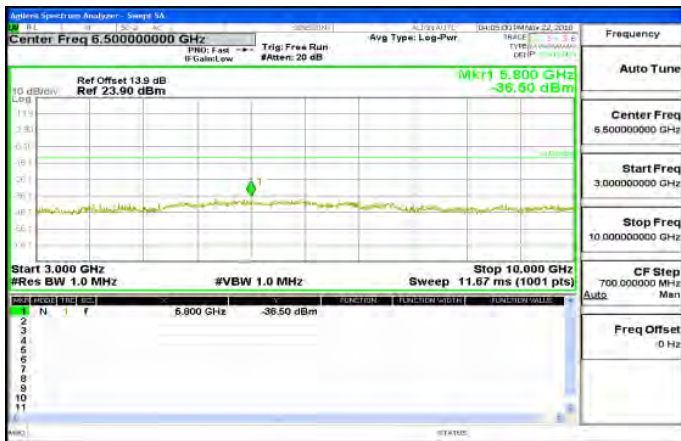

30MHz-3GHz_Band12_1_4MHz_QPSK_1_0_HighCH23173-715.3

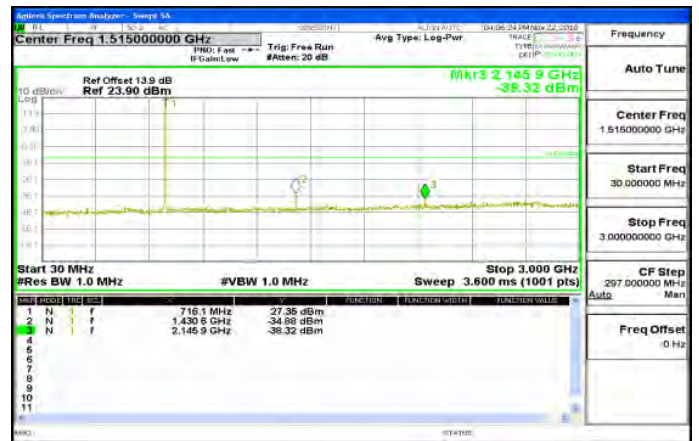

30MHz-3GHz_Band12_1_4MHz_QPSK_1_0_MidCH23095-707.5



3GHz-20GHz_Band12_1_4MHz_QPSK_1_0_HighCH23173-715.3



Unless otherwise stated the results shown in this test report refer only to the sample(s) tested and such sample(s) are retained for 90 days only.

除非另有說明，此報告結果僅對測試之樣品負責，同時此樣品僅保留90天。本報告未經本公司書面許可，不可部份複製。

This document is issued by the Company subject to its General Conditions of Service printed overleaf, available on request or accessible at www.sgs.com/terms_and_conditions.htm and, for electronic format documents, subject to Terms and Conditions for Electronic Documents at www.sgs.com/terms_e-document.htm. Attention is drawn to the limitation of liability, indemnification and jurisdiction issues defined therein. Any holder of this document is advised that information contained hereon reflects the Company's findings at the time of its intervention only and within the limits of Client's instructions, if any. The Company's sole responsibility is to its Client and this document does not exonerate parties to a transaction from exercising all their rights and obligations under the transaction documents. This document cannot be reproduced except in full, without prior written approval of the Company. Any unauthorized alteration, forgery or falsification of the content or appearance of this document is unlawful and offenders may be prosecuted to the fullest extent of the law.

SGS Taiwan Ltd.

No. 134, WuKungRoad, NewTaipeiIndustrialPark, WukuDistrict, NewTaipeiCity, Taiwan24803/新北市五股區新北產業園區五工路 134 號

台灣檢驗科技股份有限公司

t (886-2) 2299-3279

f (886-2) 2298-0488

www.tw.sgs.com

Member of SGS Group

30MHz-3GHz_Band12_3MHz_QPSK_1_0_LowCH23025-700.5

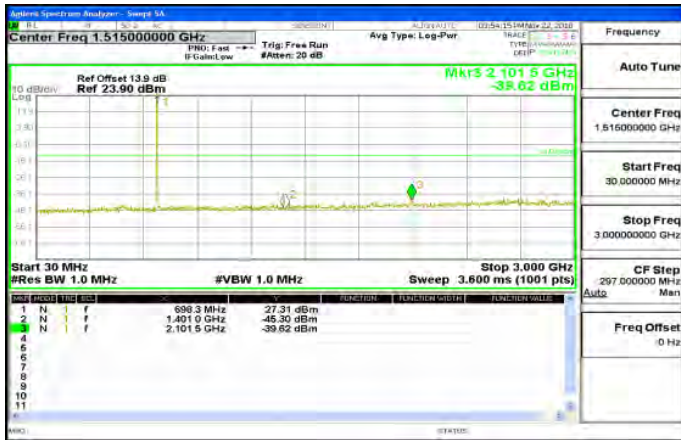

3GHz-20GHz_Band12_3MHz_QPSK_1_0_MidCH23095-707.5



3GHz-20GHz_Band12_3MHz_QPSK_1_0_LowCH23025-700.5



30MHz-3GHz_Band12_3MHz_QPSK_1_0_HighCH23165-714.5

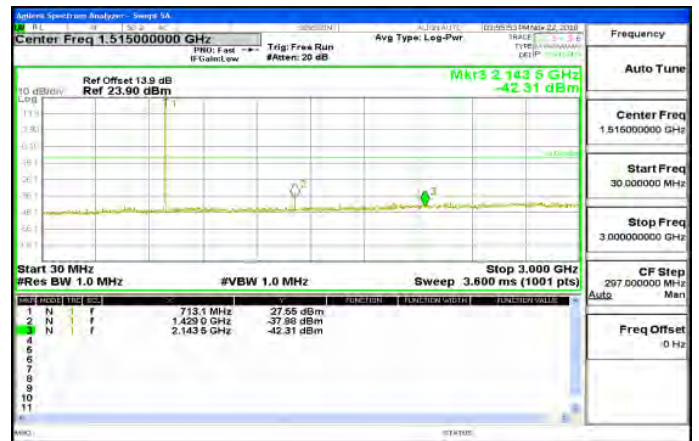

30MHz-3GHz_Band12_3MHz_QPSK_1_0_MidCH23095-707.5

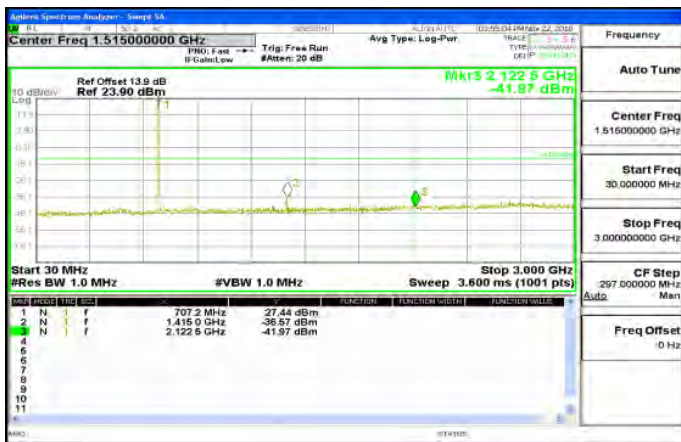

3GHz-20GHz_Band12_3MHz_QPSK_1_0_HighCH23165-714.5

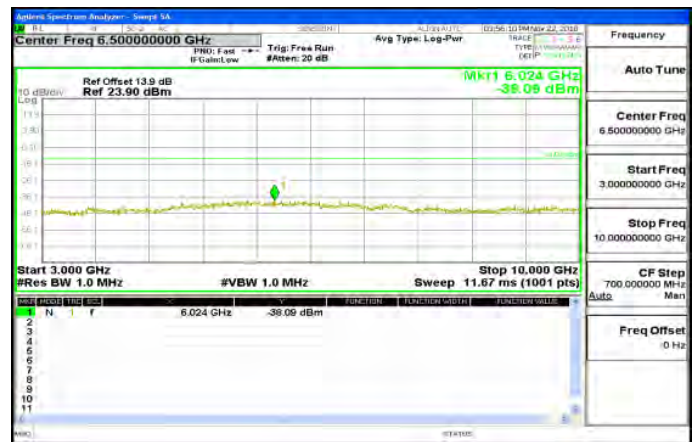

Unless otherwise stated the results shown in this test report refer only to the sample(s) tested and such sample(s) are retained for 90 days only. 除非另有說明，此報告結果僅對測試之樣品負責，同時此樣品僅保留90天。本報告未經本公司書面許可，不可部份複製。

This document is issued by the Company subject to its General Conditions of Service printed overleaf, available on request or accessible at www.sgs.com/terms_and_conditions.htm and, for electronic format documents, subject to Terms and Conditions for Electronic Documents at www.sgs.com/terms_e-document.htm. Attention is drawn to the limitation of liability, indemnification and jurisdiction issues defined therein. Any holder of this document is advised that information contained hereon reflects the Company's findings at the time of its intervention only and within the limits of Client's instructions, if any. The Company's sole responsibility is to its Client and this document does not exonerate parties to a transaction from exercising all their rights and obligations under the transaction documents. This document cannot be reproduced except in full, without prior written approval of the Company. Any unauthorized alteration, forgery or falsification of the content or appearance of this document is unlawful and offenders may be prosecuted to the fullest extent of the law.

30MHz-3GHz_Band12_5MHz_QPSK_1_0_LowCH23035-701.5



3GHz-20GHz_Band12_5MHz_QPSK_1_0_MidCH23095-707.5

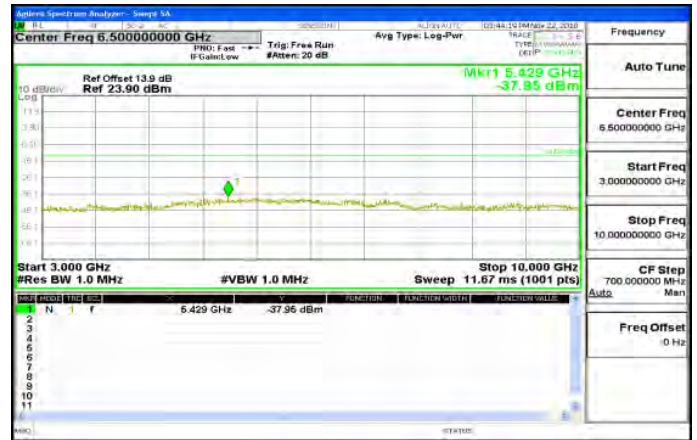

3GHz-20GHz_Band12_5MHz_QPSK_1_0_LowCH23035-701.5



30MHz-3GHz_Band12_5MHz_QPSK_1_0_HighCH23155-713.5

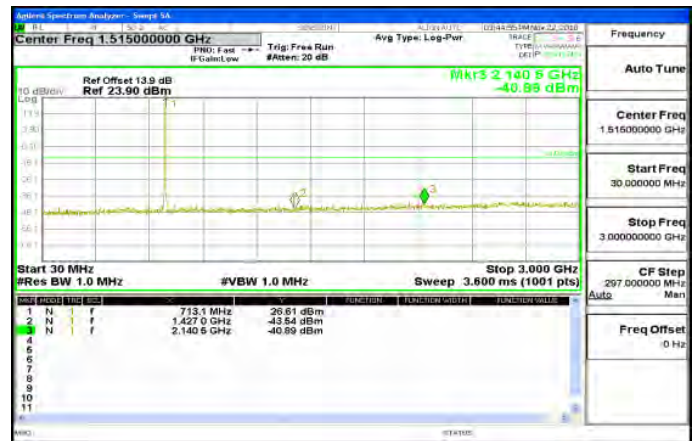

30MHz-3GHz_Band12_5MHz_QPSK_1_0_MidCH23095-707.5

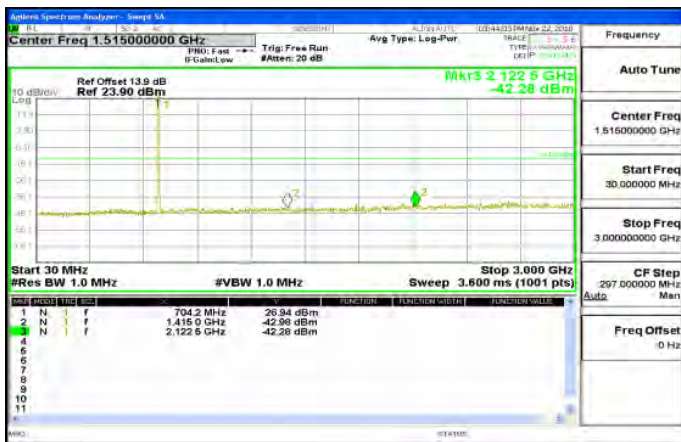

3GHz-20GHz_Band12_5MHz_QPSK_1_0_HighCH23155-713.5

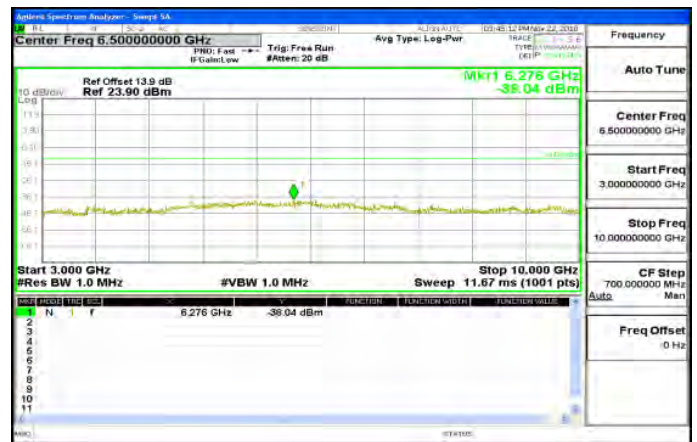

Unless otherwise stated the results shown in this test report refer only to the sample(s) tested and such sample(s) are retained for 90 days only. 除非另有說明，此報告結果僅對測試之樣品負責，同時此樣品僅保留90天。本報告未經本公司書面許可，不可部份複製。

This document is issued by the Company subject to its General Conditions of Service printed overleaf, available on request or accessible at www.sgs.com/terms_and_conditions.htm and, for electronic format documents, subject to Terms and Conditions for Electronic Documents at www.sgs.com/terms_e-document.htm. Attention is drawn to the limitation of liability, indemnification and jurisdiction issues defined therein. Any holder of this document is advised that information contained hereon reflects the Company's findings at the time of its intervention only and within the limits of Client's instructions, if any. The Company's sole responsibility is to its Client and this document does not exonerate parties to a transaction from exercising all their rights and obligations under the transaction documents. This document cannot be reproduced except in full, without prior written approval of the Company. Any unauthorized alteration, forgery or falsification of the content or appearance of this document is unlawful and offenders may be prosecuted to the fullest extent of the law.

30MHz-3GHz_Band12_10MHz_QPSK_1_0_LowCH23060-704

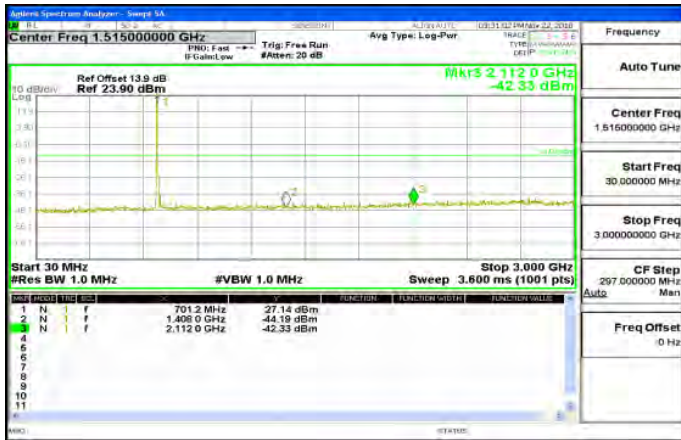

3GHz-20GHz_Band12_10MHz_QPSK_1_0_MidCH23095-707.5

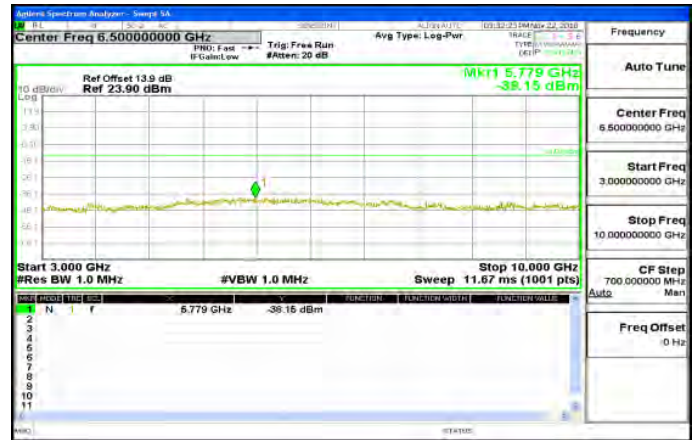

3GHz-20GHz_Band12_10MHz_QPSK_1_0_LowCH23060-704

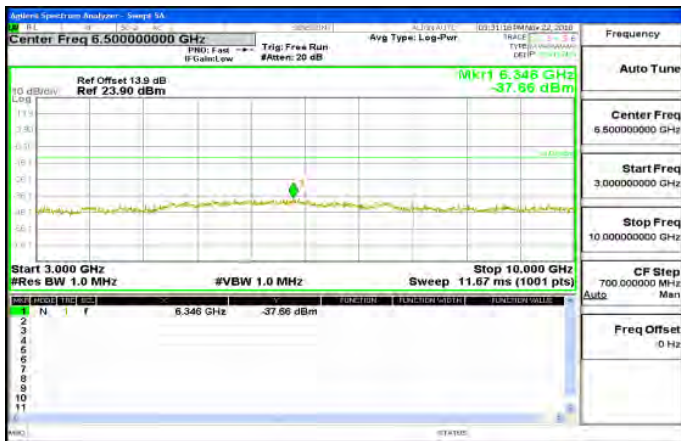

30MHz-3GHz_Band12_10MHz_QPSK_1_0_HighCH23130-711



30MHz-3GHz_Band12_10MHz_QPSK_1_0_MidCH23095-707.5

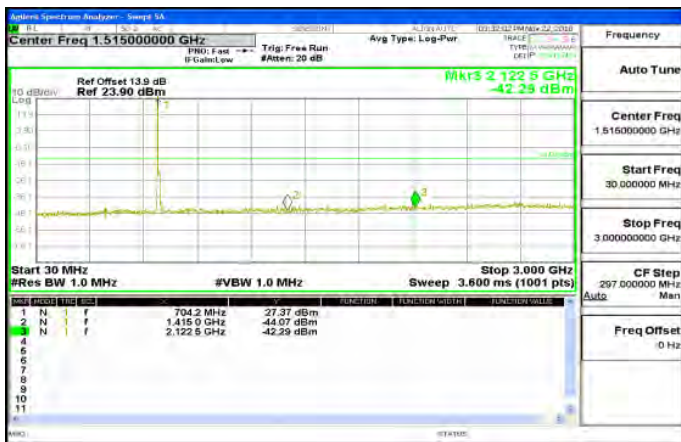

3GHz-20GHz_Band12_10MHz_QPSK_1_0_HighCH23130-711



Unless otherwise stated the results shown in this test report refer only to the sample(s) tested and such sample(s) are retained for 90 days only. 除非另有說明，此報告結果僅對測試之樣品負責，同時此樣品僅保留90天。本報告未經本公司書面許可，不可部份複製。

This document is issued by the Company subject to its General Conditions of Service printed overleaf, available on request or accessible at www.sgs.com/terms_and_conditions.htm and, for electronic format documents, subject to Terms and Conditions for Electronic Documents at www.sgs.com/terms_e-document.htm. Attention is drawn to the limitation of liability, indemnification and jurisdiction issues defined therein. Any holder of this document is advised that information contained hereon reflects the Company's findings at the time of its intervention only and within the limits of Client's instructions, if any. The Company's sole responsibility is to its Client and this document does not exonerate parties to a transaction from exercising all their rights and obligations under the transaction documents. This document cannot be reproduced except in full, without prior written approval of the Company. Any unauthorized alteration, forgery or falsification of the content or appearance of this document is unlawful and offenders may be prosecuted to the fullest extent of the law.

30MHz-3GHz_Band13_5MHz_QPSK_1_0_LowCH23205-779.5

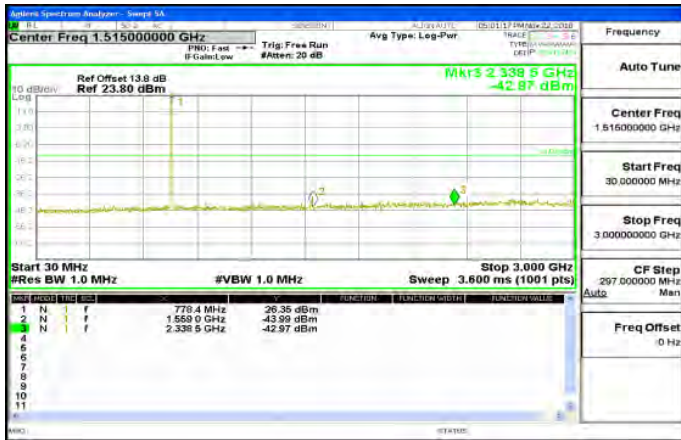

3GHz-20GHz_Band13_5MHz_QPSK_1_0_MidCH23230-782

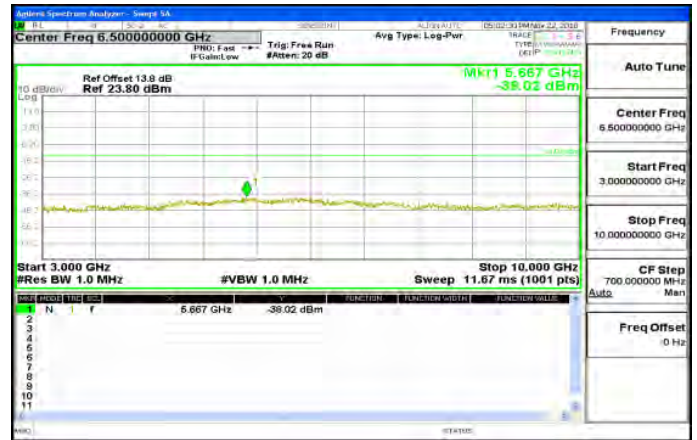

3GHz-20GHz_Band13_5MHz_QPSK_1_0_LowCH23205-779.5

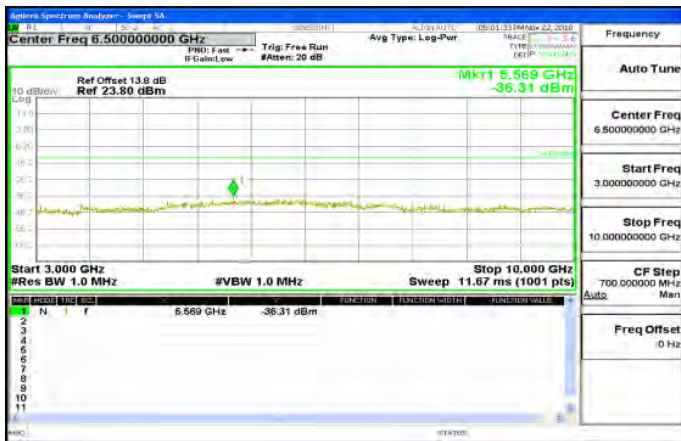

30MHz-3GHz_Band13_5MHz_QPSK_1_0_HighCH23255-784.5

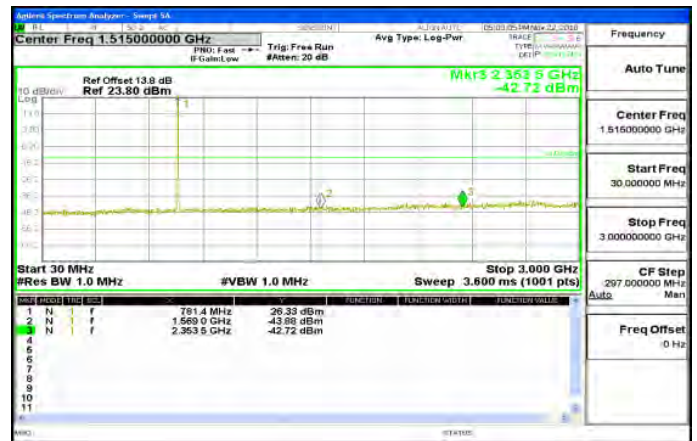

30MHz-3GHz_Band13_5MHz_QPSK_1_0_MidCH23230-782



3GHz-20GHz_Band13_5MHz_QPSK_1_0_HighCH23255-784.5

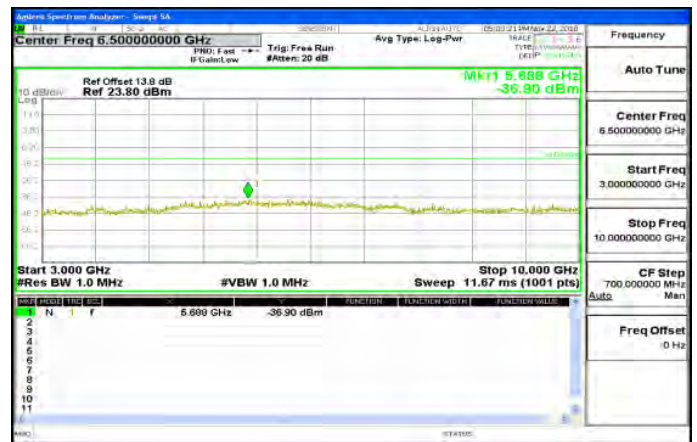

Unless otherwise stated the results shown in this test report refer only to the sample(s) tested and such sample(s) are retained for 90 days only.

除非另有說明，此報告結果僅對測試之樣品負責，同時此樣品僅保留90天。本報告未經本公司書面許可，不可部份複製。

This document is issued by the Company subject to its General Conditions of Service printed overleaf, available on request or accessible at www.sgs.com/terms_and_conditions.htm and, for electronic format documents, subject to Terms and Conditions for Electronic Documents at www.sgs.com/terms_e-document.htm. Attention is drawn to the limitation of liability, indemnification and jurisdiction issues defined therein. Any holder of this document is advised that information contained hereon reflects the Company's findings at the time of its intervention only and within the limits of Client's instructions, if any. The Company's sole responsibility is to its Client and this document does not exonerate parties to a transaction from exercising all their rights and obligations under the transaction documents. This document cannot be reproduced except in full, without prior written approval of the Company. Any unauthorized alteration, forgery or falsification of the content or appearance of this document is unlawful and offenders may be prosecuted to the fullest extent of the law.

SGS Taiwan Ltd.

No. 134, WuKungRoad, NewTaipeiIndustrialPark, WukuDistrict, NewTaipeiCity, Taiwan24803/新北市五股區新北產業園區五工路 134 號

台灣檢驗科技股份有限公司

t (886-2) 2299-3279

f (886-2) 2298-0488

www.tw.sgs.com

Member of SGS Group

30MHz~3GHz_Band13_10MHz_QPSK_1_0_MidCH23230-782



763.3MHz~775MHz_Band13_5MHz_QPSK_1_0_LowCH23205-779.5

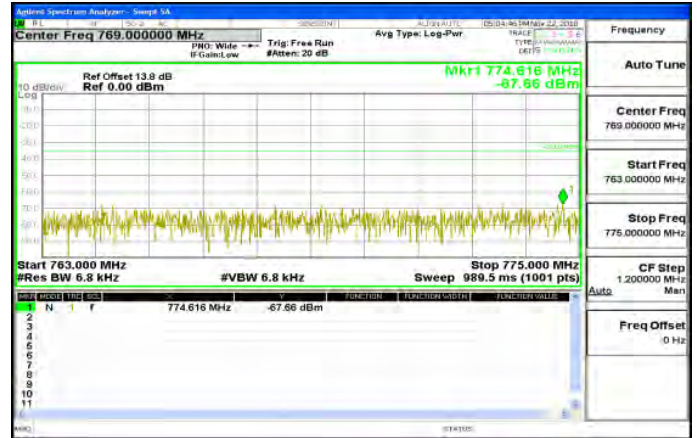

3GHz~20GHz_Band13_10MHz_QPSK_1_0_MidCH23230-782



763.3MHz~775MHz_Band13_5MHz_QPSK_1_0_MidCH23230-782

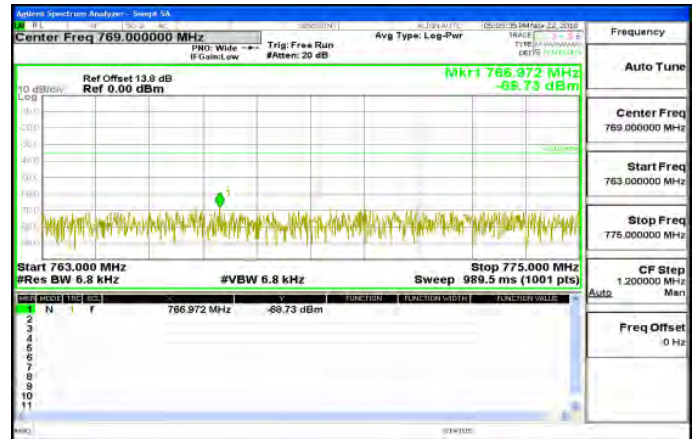

763.3MHz~775MHz_Band13_5MHz_QPSK_1_0_HighCH23255-784.5

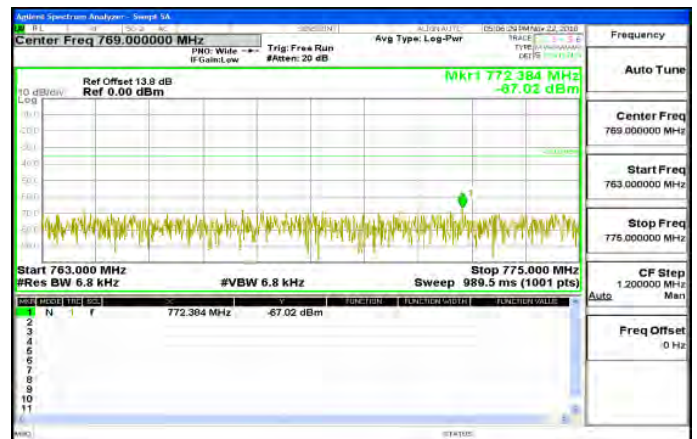

Unless otherwise stated the results shown in this test report refer only to the sample(s) tested and such sample(s) are retained for 90 days only. 除非另有說明，此報告結果僅對測試之樣品負責，同時此樣品僅保留90天。本報告未經本公司書面許可，不可部份複製。

This document is issued by the Company subject to its General Conditions of Service printed overleaf, available on request or accessible at www.sgs.com/terms_and_conditions.htm and, for electronic format documents, subject to Terms and Conditions for Electronic Documents at www.sgs.com/terms_e-document.htm. Attention is drawn to the limitation of liability, indemnification and jurisdiction issues defined therein. Any holder of this document is advised that information contained hereon reflects the Company's findings at the time of its intervention only and within the limits of Client's instructions, if any. The Company's sole responsibility is to its Client and this document does not exonerate parties to a transaction from exercising all their rights and obligations under the transaction documents. This document cannot be reproduced except in full, without prior written approval of the Company. Any unauthorized alteration, forgery or falsification of the content or appearance of this document is unlawful and offenders may be prosecuted to the fullest extent of the law.

793MHz~806MHz_Band13_5MHz_QPSK_1_0_LowCH23205-779.5

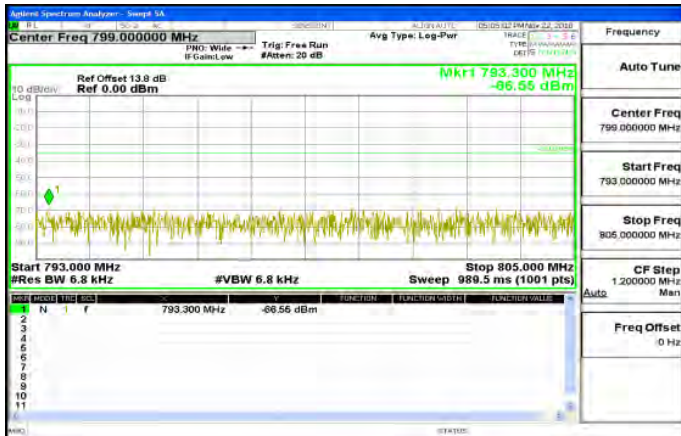

763.3MHz~775MHz_Band13_10MHz_QPSK_1_0_MidCH23230-782

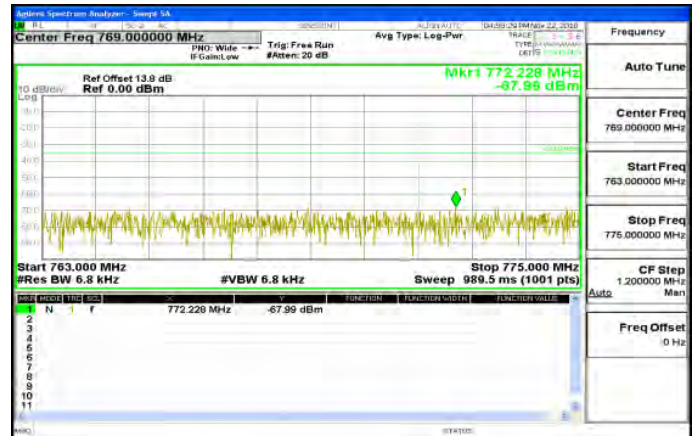

793MHz~806MHz_Band13_5MHz_QPSK_1_0_MidCH23230-782

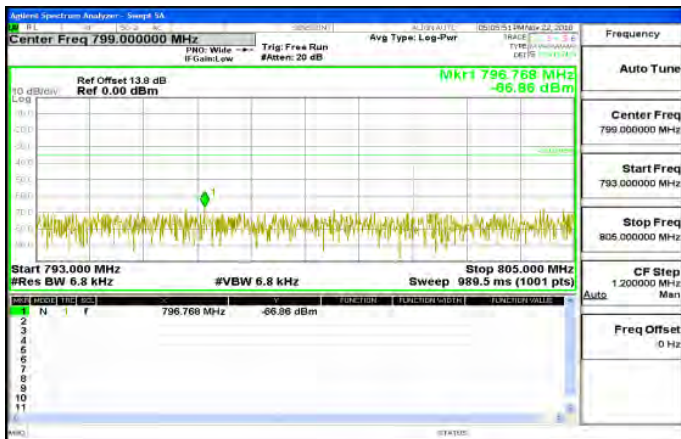

793MHz~806MHz_Band13_10MHz_QPSK_1_0_MidCH23230-782

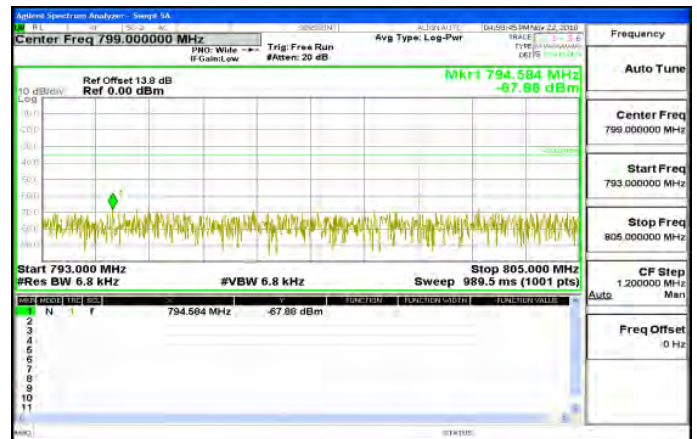

793MHz~806MHz_Band13_5MHz_QPSK_1_0_HighCH23255-784.5

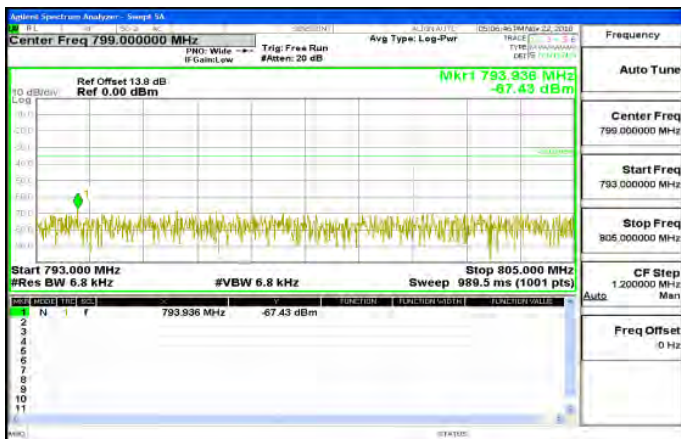

Unless otherwise stated the results shown in this test report refer only to the sample(s) tested and such sample(s) are retained for 90 days only. 除非另有說明，此報告結果僅對測試之樣品負責，同時此樣品僅保留90天。本報告未經本公司書面許可，不可部份複製。

This document is issued by the Company subject to its General Conditions of Service printed overleaf, available on request or accessible at www.sgs.com/terms_and_conditions.htm and, for electronic format documents, subject to Terms and Conditions for Electronic Documents at www.sgs.com/terms_e-document.htm. Attention is drawn to the limitation of liability, indemnification and jurisdiction issues defined therein. Any holder of this document is advised that information contained hereon reflects the Company's findings at the time of its intervention only and within the limits of Client's instructions, if any. The Company's sole responsibility is to its Client and this document does not exonerate parties to a transaction from exercising all their rights and obligations under the transaction documents. This document cannot be reproduced except in full, without prior written approval of the Company. Any unauthorized alteration, forgery or falsification of the content or appearance of this document is unlawful and offenders may be prosecuted to the fullest extent of the law.

9. FIELD STRENGTH OF SPURIOUS RADIATION MEASUREMENT

9.1. Standard Applicable

According to FCC §2.1053,

FCC §22.917(a) , §24.238(a) , §27.53 (h) , the magnitude of each spurious and harmonic emission that can be detected when the equipment is operated under the conditions specified in the instruction manual and/ or alignment procedure, shall not be less than $43 + 10 \log$ (mean output power in watts) dBc below the mean power output outside a license's frequency block (-13dBm).

§27.53 (c)

(2) On any frequency outside the 776– 788 MHz band, the power of any emission shall be attenuated outside the band below the transmitter power (P) by at least $43 + 10 \log$ (P) dB (-13dBm)

(4) On all frequencies between 763-775 MHz and 793-805 MHz, by a factor not less than $65 + 10 \log$ (P) dB in a 6.25 kHz band segment, for mobile and portable stations;

§27.53 (f) For operations in the 746-758 MHz, 775-788 MHz, and 805-806 MHz bands, emissions in the band 1559-1610 MHz shall be limited to -70 dBW/MHz equivalent isotropically radiated power (EIRP) for wideband signals, and -80 dBW EIRP for discrete emissions of less than 700 Hz bandwidth. For the purpose of equipment authorization, a transmitter shall be tested with an antenna that is representative of the type that will be used with the equipment in normal operation.

FCC §27.53(c) (5) & FCC §27.53(g)

Compliance with this provision is based on the use of measurement instrumentation employing a resolution bandwidth of 100 kilohertz or greater. However, in the 100 kilohertz bands immediately outside and adjacent to a licensee's frequency block, a resolution bandwidth of at least 30 kHz may be employed.

FCC §27.53(h) (3)

Compliance with this provision is based on the use of measurement instrumentation employing a resolution bandwidth of 1 megahertz or greater. However, in the 1 megahertz bands immediately outside and adjacent to the licensee's frequency block, a resolution bandwidth of at least one percent of the emission bandwidth of the fundamental emission of the transmitter may be employed. The emission bandwidth is defined as the width of the signal between two points, one below the carrier center frequency and one above the carrier center frequency, outside of which all emissions are attenuated at least 26 dB below the transmitter power.

Unless otherwise stated the results shown in this test report refer only to the sample(s) tested and such sample(s) are retained for 90 days only.

除非另有說明，此報告結果僅對測試之樣品負責，同時此樣品僅保留90天。本報告未經本公司書面許可，不可部份複製。

This document is issued by the Company subject to its General Conditions of Service printed overleaf, available on request or accessible at www.sgs.com/terms_and_conditions.htm and, for electronic format documents, subject to Terms and Conditions for Electronic Documents at www.sgs.com/terms_e-document.htm. Attention is drawn to the limitation of liability, indemnification and jurisdiction issues defined therein. Any holder of this document is advised that information contained hereon reflects the Company's findings at the time of its intervention only and within the limits of Client's instructions, if any. The Company's sole responsibility is to its Client and this document does not exonerate parties to a transaction from exercising all their rights and obligations under the transaction documents. This document cannot be reproduced except in full, without prior written approval of the Company. Any unauthorized alteration, forgery or falsification of the content or appearance of this document is unlawful and offenders may be prosecuted to the fullest extent of the law.

SGS Taiwan Ltd.

台灣檢驗科技股份有限公司

No.134,WuKungRoad,NewTaipeiIndustrialPark,WukuDistrict,NewTaipeiCity,Taiwan24803/新北市五股區新北產業園區五工路 134 號

t (886-2) 2299-3279

f (886-2) 2298-0488

www.tw.sgs.com

Member of SGS Group

FCC §27.53(m) (4) (6)

For mobile digital stations, the attenuation factor shall be not less than $40 + 10 \log (P)$ dB on all frequencies between the channel edge and 5 megahertz from the channel edge, $43 + 10 \log (P)$ dB on all frequencies between 5 megahertz and X megahertz from the channel edge, and $55 + 10 \log (P)$ dB on all frequencies more than X megahertz from the channel edge, where X is the greater of 6 megahertz or the actual emission bandwidth as defined in paragraph (m)(6) of this section. In addition, the attenuation factor shall not be less than $43 + 10 \log (P)$ dB on all frequencies between 2490.5 MHz and 2496 MHz and $55 + 10 \log (P)$ dB on or below 2490.5 MHz. Mobile Satellite Service licensees operating on frequencies below 2495 MHz may also submit a documented interference complaint against BRS licensees operating on channel BRS Channel 1 on the same terms and conditions as adjacent channel BRS or EBS licensees.

Measurement procedure. Compliance with these rules is based on the use of measurement instrumentation employing a resolution bandwidth of 1 megahertz or greater. However, in the 1 MHz bands immediately outside and adjacent to the frequency block a resolution bandwidth of at least one percent of the emission bandwidth of the fundamental emission of the transmitter may be employed; for mobile digital stations, in the 1 megahertz bands immediately outside and adjacent to the frequency block a resolution bandwidth of at least two percent may be employed, except when the 1 megahertz band is 2495-2496 MHz, in which case a resolution bandwidth of at least one percent may be employed. A narrower resolution bandwidth is permitted in all cases to improve measurement accuracy provided the measured power is integrated over the full required measurement bandwidth (i.e. 1 megahertz or 1 percent of emission bandwidth, as specified; or 1 megahertz or 2 percent for mobile digital stations, except in the band 2495-2496 MHz). The emission bandwidth is defined as the width of the signal between two points, one below the carrier center frequency and one above the carrier center frequency, outside of which all emissions are attenuated at least 26 dB below the transmitter power. With respect to television operations, measurements must be made of the separate visual and aural operating powers at sufficiently frequent intervals to ensure compliance with the rules.

Unless otherwise stated the results shown in this test report refer only to the sample(s) tested and such sample(s) are retained for 90 days only.

除非另有說明，此報告結果僅對測試之樣品負責，同時此樣品僅保留90天。本報告未經本公司書面許可，不可部份複製。

This document is issued by the Company subject to its General Conditions of Service printed overleaf, available on request or accessible at www.sgs.com/terms_and_conditions.htm and, for electronic format documents, subject to Terms and Conditions for Electronic Documents at www.sgs.com/terms_e-document.htm. Attention is drawn to the limitation of liability, indemnification and jurisdiction issues defined therein. Any holder of this document is advised that information contained hereon reflects the Company's findings at the time of its intervention only and within the limits of Client's instructions, if any. The Company's sole responsibility is to its Client and this document does not exonerate parties to a transaction from exercising all their rights and obligations under the transaction documents. This document cannot be reproduced except in full, without prior written approval of the Company. Any unauthorized alteration, forgery or falsification of the content or appearance of this document is unlawful and offenders may be prosecuted to the fullest extent of the law.

SGS Taiwan Ltd.

台灣檢驗科技股份有限公司

No.134,WuKungRoad,NewTaipeiIndustrialPark,WukuDistrict,NewTaipeiCity,Taiwan24803/新北市五股區新北產業園區五工路 134 號

t (886-2) 2299-3279

f (886-2) 2298-0488

www.tw.sgs.com

Member of SGS Group

Table 2 — Unwanted Emissions for Mobile, Portable and Low-Power Fixed Subscriber Equipment

Frequency (MHz)	Attenuation (dB)
<2200	$43 + 10 \log_{10}(p)$
2200 - 2288	$70 + 10 \log_{10}(p)$
2288 - 2292	$67 + 10 \log_{10}(p)$
2292 - 2296	$61 + 10 \log_{10}(p)$
2296 - 2300	$55 + 10 \log_{10}(p)$
2300 - 2305	$43 + 10 \log_{10}(p)$
2305 - 2320	$43 + 10 \log_{10}(p)$ ^{Note}
2320 - 2324	$55 + 10 \log_{10}(p)$
2324 - 2328	$61 + 10 \log_{10}(p)$
2328 - 2337	$67 + 10 \log_{10}(p)$
2337 - 2341	$61 + 10 \log_{10}(p)$
2341 - 2345	$55 + 10 \log_{10}(p)$
2345 - 2360	$43 + 10 \log_{10}(p)$ ^{Note}
2360 - 2365	$43 + 10 \log_{10}(p)$
2365 - 2395	$70 + 10 \log_{10}(p)$
>2395	$43 + 10 \log_{10}(p)$

Note: Measured at the edges of the highest and lowest frequency range(s) in which the equipment is designed to operate. See Section 1.2 for the permitted frequency ranges for various equipment types.

Unless otherwise stated the results shown in this test report refer only to the sample(s) tested and such sample(s) are retained for 90 days only.

除非另有說明，此報告結果僅對測試之樣品負責，同時此樣品僅保留90天。本報告未經本公司書面許可，不可部份複製。

This document is issued by the Company subject to its General Conditions of Service printed overleaf, available on request or accessible at www.sgs.com/terms_and_conditions.htm and, for electronic format documents, subject to Terms and Conditions for Electronic Documents at www.sgs.com/terms_e-document.htm. Attention is drawn to the limitation of liability, indemnification and jurisdiction issues defined therein. Any holder of this document is advised that information contained hereon reflects the Company's findings at the time of its intervention only and within the limits of Client's instructions, if any. The Company's sole responsibility is to its Client and this document does not exonerate parties to a transaction from exercising all their rights and obligations under the transaction documents. This document cannot be reproduced except in full, without prior written approval of the Company. Any unauthorized alteration, forgery or falsification of the content or appearance of this document is unlawful and offenders may be prosecuted to the fullest extent of the law.

SGS Taiwan Ltd.

No.134,WuKungRoad,NewTaipeiIndustrialPark,WukuDistrict,NewTaipeiCity,Taiwan24803/新北市五股區新北產業園區五工路 134 號

台灣檢驗科技股份有限公司

t (886-2) 2299-3279

f (886-2) 2298-0488

www.tw.sgs.com

Member of SGS Group

9.2. EUT Setup

Radiated Emission Test Set-Up, Frequency Below 1000MHz

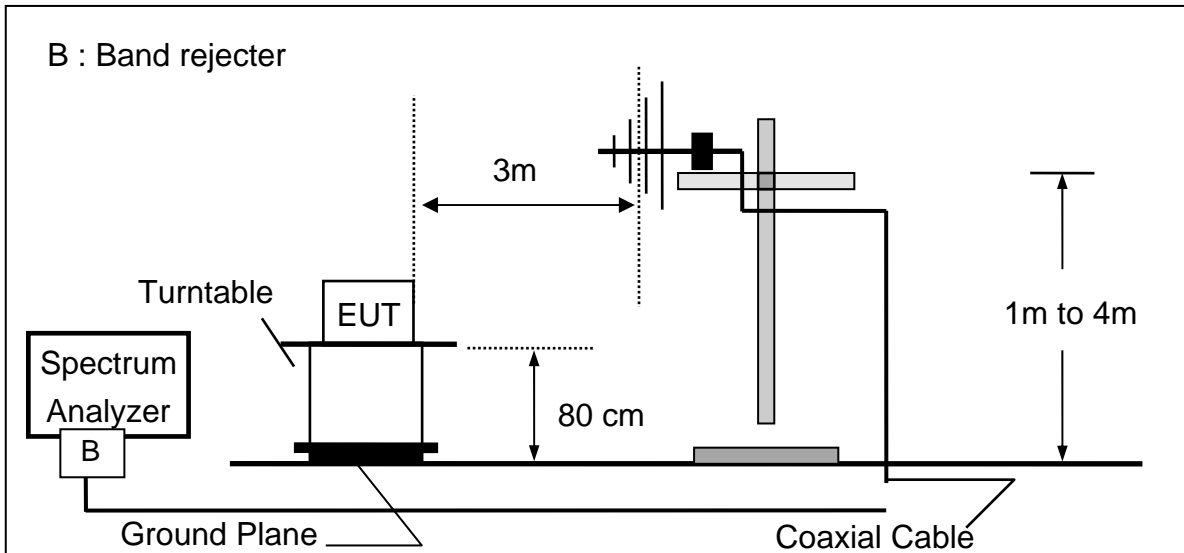

Radiated Emission Test Set-UP Frequency Over 1 GHz

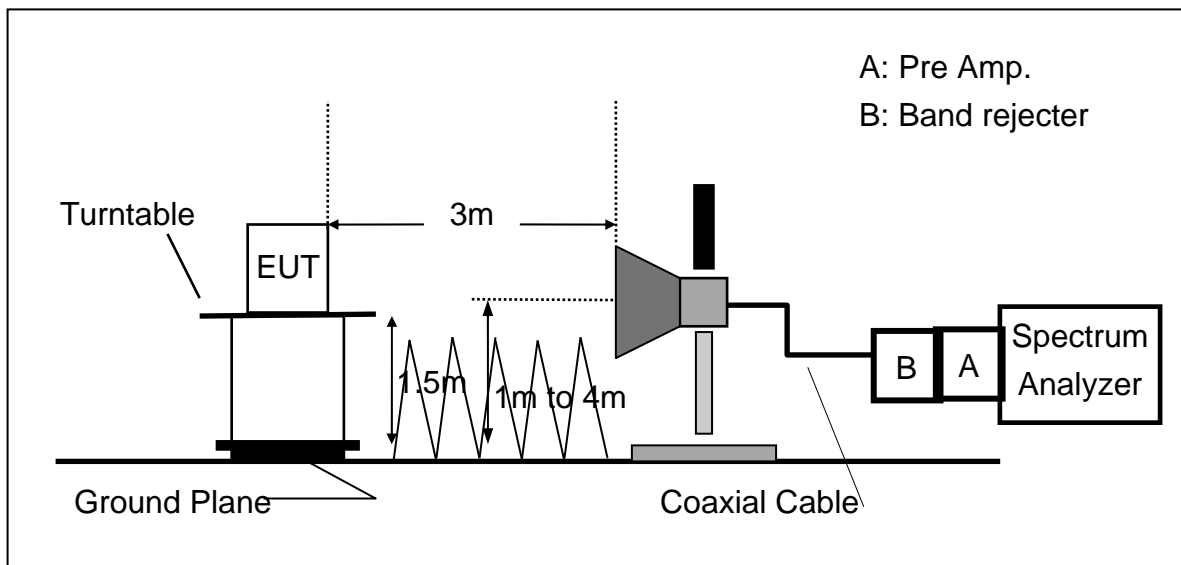

Unless otherwise stated the results shown in this test report refer only to the sample(s) tested and such sample(s) are retained for 90 days only.

除非另有說明，此報告結果僅對測試之樣品負責，同時此樣品僅保留90天。本報告未經本公司書面許可，不可部份複製。

This document is issued by the Company subject to its General Conditions of Service printed overleaf, available on request or accessible at www.sgs.com/terms_and_conditions.htm and, for electronic format documents, subject to Terms and Conditions for Electronic Documents at www.sgs.com/terms_e-document.htm. Attention is drawn to the limitation of liability, indemnification and jurisdiction issues defined therein. Any holder of this document is advised that information contained hereon reflects the Company's findings at the time of its intervention only and within the limits of Client's instructions, if any. The Company's sole responsibility is to its Client and this document does not exonerate parties to a transaction from exercising all their rights and obligations under the transaction documents. This document cannot be reproduced except in full, without prior written approval of the Company. Any unauthorized alteration, forgery or falsification of the content or appearance of this document is unlawful and offenders may be prosecuted to the fullest extent of the law.

9.3. Measurement Procedure:

The EUT was placed on a non-conductive; the measurement antenna was placed at a distance of 3 meters from the EUT. During the tests, the antenna height and the EUT azimuth were varied in order to identify the maximum level of emissions from the EUT. This maximization process was repeated with the EUT positioned in each of its three orthogonal orientations.

The frequency range up to tenth harmonic was investigated for each of three fundamental frequencies (low, middle and high channels). Once spurious emission was identified, the power of the emission was determined using the substitution method.

The spurious emissions attenuation was calculated as the difference between radiated power at the fundamental frequency and the spurious emissions frequency.

$$\text{ERP (dBm)} = \text{SG Level(dBm)} + \text{Antenna Gain(dBd)} + \text{Cable Loss(dB)}$$

$$\text{EIRP (dBm)} = \text{SG Level(dBm)} + \text{Antenna Gain(dBi)} + \text{Cable Loss(dB)}$$

9.4. Measurement Equipment Used:

ERP, EIRP MEASUREMENT EQUIPMENT List 966 Chamber					
EQUIPMENT TYPE	MFR	MODEL NUMBER	SERIAL NUMBER	LAST CAL.	CAL DUE.
Bi-log Antenna	SCHWAZBECK	VULB9168	378	12/29/2017	12/28/2018
Bi-log Antenna	SCHWAZBECK	VULB9168	300	12/20/2017	12/19/2018
Horn Antenna	Schwarzbeck	BBHA9120D	603	04/13/2018	04/12/2019
Horn Antenna	Schwarzbeck	BBHA9120D	1441	08/16/2018	08/15/2019
Horn Antenna	Schwarzbeck	BBHA9170	184	12/12/2017	12/11/2018
3m Site NSA	SGS	966 chamber	N/A	01/02/2018	01/01/2019
Spectrum Analyzer	Agilent	E4446A	MY51100003	05/15/2018	05/14/2019
EMI Test Receiver	R&S	ESC17	100335	02/02/2018	02/01/2019
Radio Communication Analyzer	Anritsu	MT8820C	6201465317	01/17/2018	01/16/2019
Pre-Amplifier	HP	8449B	3008A00578	01/02/2018	01/01/2019
Pre-Amplifier	HP	8447D	2944A07676	01/02/2018	01/01/2019
Pre-Amplifier	EMC Instruments	EMC184045B	980135	10/02/2018	10/01/2019
Attenuator	Mini-Circuit	BW-S10W2+	2	01/02/2018	01/01/2019
1GHz High Pass Filter	Micro-Tronics	HPM50108	32	01/02/2018	01/01/2019
2GHz High Pass Filter	Micro-Tronics	HPM50110	36	01/02/2018	01/01/2019
Low Loss Cable	Huber Suhner	966_RX	9	01/02/2018	01/01/2019
Low Loss Cable	Huber Suhner	966 TX	1	01/02/2018	01/01/2019

Unless otherwise stated the results shown in this test report refer only to the sample(s) tested and such sample(s) are retained for 90 days only.

除非另有說明，此報告結果僅對測試之樣品負責，同時此樣品僅保留90天。本報告未經本公司書面許可，不可部份複製。

This document is issued by the Company subject to its General Conditions of Service printed overleaf, available on request or accessible at www.sgs.com/terms_and_conditions.htm and, for electronic format documents, subject to Terms and Conditions for Electronic Documents at www.sgs.com/terms_e-document.htm. Attention is drawn to the limitation of liability, indemnification and jurisdiction issues defined therein. Any holder of this document is advised that information contained hereon reflects the Company's findings at the time of its intervention only and within the limits of Client's instructions, if any. The Company's sole responsibility is to its Client and this document does not exonerate parties to a transaction from exercising all their rights and obligations under the transaction documents. This document cannot be reproduced except in full, without prior written approval of the Company. Any unauthorized alteration, forgery or falsification of the content or appearance of this document is unlawful and offenders may be prosecuted to the fullest extent of the law.

9.5. Measurement Result:

Radiated Spurious Emission Measurement Result: WCDMA Band 2 Mode

Operation Band	:WCDMA B2	Temp./Humi.	:22 deg_C / 62 RH
Fundamental Frequency	:1852.4 MHz	Engineer	:Tin
Operation Mode	:Tx CH LOW		
EUT Pol.	:E1 Plane	Measurement Antenna Pol.	:VERTICAL

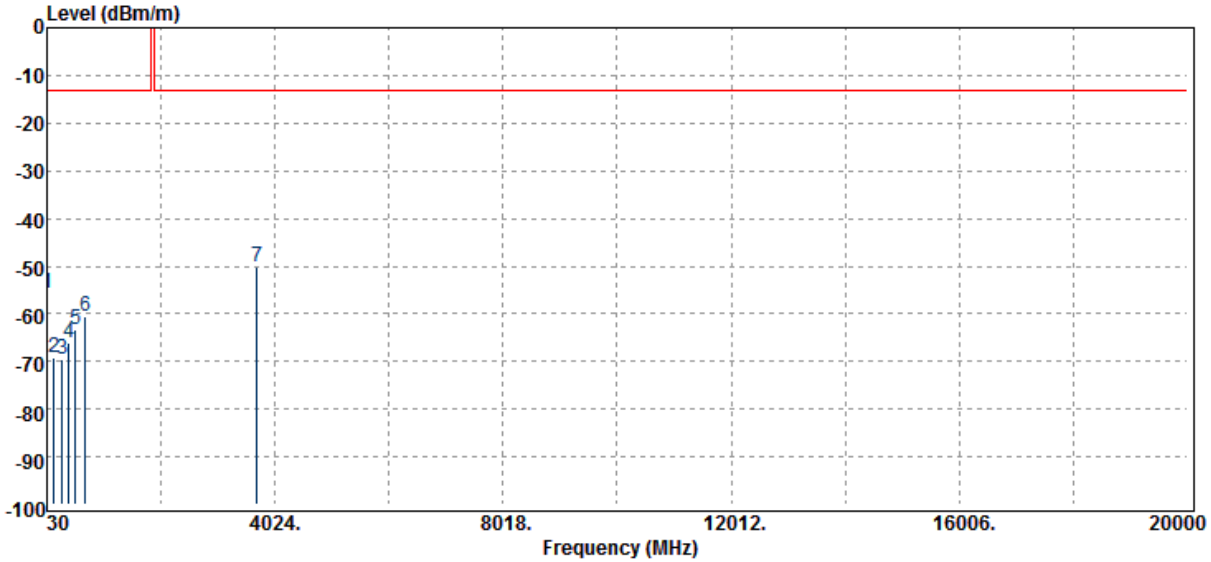

Freq. MHz	ERP/EIRP dBm	SG Output Level dBm	Antenna Gain dBd/dBi	Cable Loss dB	Limit dBm	Margin dB
30.00	-55.60	24.88	-14.58	-0.58	-13.00	-42.60
154.16	-69.23	4.81	-1.57	-1.30	-13.00	-56.23
294.81	-69.63	0.05	3.52	-1.80	-13.00	-56.63
413.15	-66.20	3.30	3.67	-2.13	-13.00	-53.20
531.49	-63.31	4.26	4.01	-2.31	-13.00	-50.31
699.30	-60.49	8.96	3.68	-2.24	-13.00	-47.49
3704.80	-50.27	9.73	12.57	-6.90	-13.00	-37.27

Unless otherwise stated the results shown in this test report refer only to the sample(s) tested and such sample(s) are retained for 90 days only.

除非另有說明，此報告結果僅對測試之樣品負責，同時此樣品僅保留90天。本報告未經本公司書面許可，不可部份複製。

This document is issued by the Company subject to its General Conditions of Service printed overleaf, available on request or accessible at www.sgs.com/terms_and_conditions.htm and, for electronic format documents, subject to Terms and Conditions for Electronic Documents at www.sgs.com/terms_e-document.htm. Attention is drawn to the limitation of liability, indemnification and jurisdiction issues defined therein. Any holder of this document is advised that information contained hereon reflects the Company's findings at the time of its intervention only and within the limits of Client's instructions, if any. The Company's sole responsibility is to its Client and this document does not exonerate parties to a transaction from exercising all their rights and obligations under the transaction documents. This document cannot be reproduced except in full, without prior written approval of the Company. Any unauthorized alteration, forgery or falsification of the content or appearance of this document is unlawful and offenders may be prosecuted to the fullest extent of the law.

SGS Taiwan Ltd.

No.134,WuKungRoad,NewTaipeiIndustrialPark,WukuDistrict,NewTaipeiCity,Taiwan24803/新北市五股區新北產業園區五工路 134 號

台灣檢驗科技股份有限公司

t (886-2) 2299-3279

f (886-2) 2298-0488

www.tw.sgs.com

Member of SGS Group

Operation Band	:WCDMA B2	Temp./Humi.	:22 deg_C / 62 RH
Fundamental Frequency	:1852.4 MHz	Engineer	:Tin
Operation Mode	:Tx CH LOW		
EUT Pol.	:E1 Plane	Measurement Antenna Pol.	:HORIZONTAL

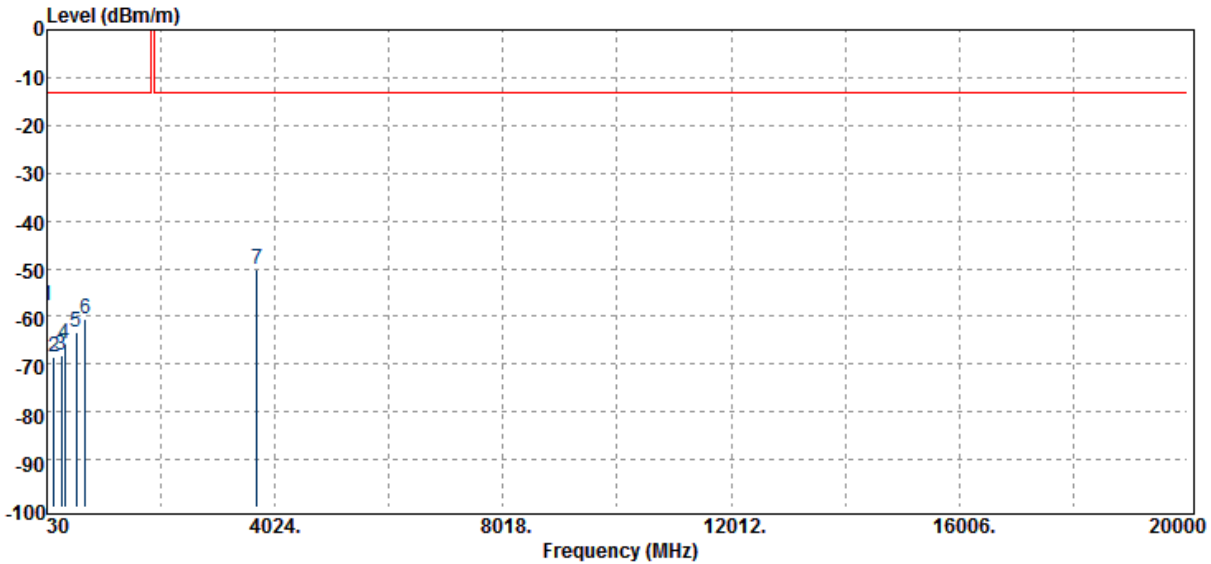

Freq. MHz	ERP/EIRP dBm	SG Output Level dBm	Antenna Gain dBd/dBi	Cable Loss dB	Limit dBm	Margin dB
31.94	-57.73	24.08	-14.08	-0.59	-13.00	-44.73
154.16	-68.57	4.81	-1.57	-1.30	-13.00	-55.57
282.20	-68.20	-0.06	3.42	-1.75	-13.00	-55.20
347.19	-65.86	3.26	3.84	-2.02	-13.00	-52.86
537.31	-63.39	4.53	4.00	-2.07	-13.00	-50.39
699.30	-60.67	8.96	3.68	-2.24	-13.00	-47.67
3704.80	-50.28	9.95	12.57	-6.90	-13.00	-37.28

Unless otherwise stated the results shown in this test report refer only to the sample(s) tested and such sample(s) are retained for 90 days only.

除非另有說明，此報告結果僅對測試之樣品負責，同時此樣品僅保留90天。本報告未經本公司書面許可，不可部份複製。

This document is issued by the Company subject to its General Conditions of Service printed overleaf, available on request or accessible at www.sgs.com/terms_and_conditions.htm and, for electronic format documents, subject to Terms and Conditions for Electronic Documents at www.sgs.com/terms_e-document.htm. Attention is drawn to the limitation of liability, indemnification and jurisdiction issues defined therein. Any holder of this document is advised that information contained hereon reflects the Company's findings at the time of its intervention only and within the limits of Client's instructions, if any. The Company's sole responsibility is to its Client and this document does not exonerate parties to a transaction from exercising all their rights and obligations under the transaction documents. This document cannot be reproduced except in full, without prior written approval of the Company. Any unauthorized alteration, forgery or falsification of the content or appearance of this document is unlawful and offenders may be prosecuted to the fullest extent of the law.

SGS Taiwan Ltd.

No.134,WuKungRoad,NewTaipeiIndustrialPark,WukuDistrict,NewTaipeiCity,Taiwan24803/新北市五股區新北產業園區五工路 134 號

台灣檢驗科技股份有限公司

t (886-2) 2299-3279

f (886-2) 2298-0488

www.tw.sgs.com

Member of SGS Group

Operation Band	:WCDMA B2	Temp./Humi.	:22 deg_C / 62 RH
Fundamental Frequency	:1880 MHz	Engineer	:Tin
Operation Mode	:Tx CH MID		
EUT Pol.	:E1 Plane	Measurement Antenna Pol.	:VERTICAL

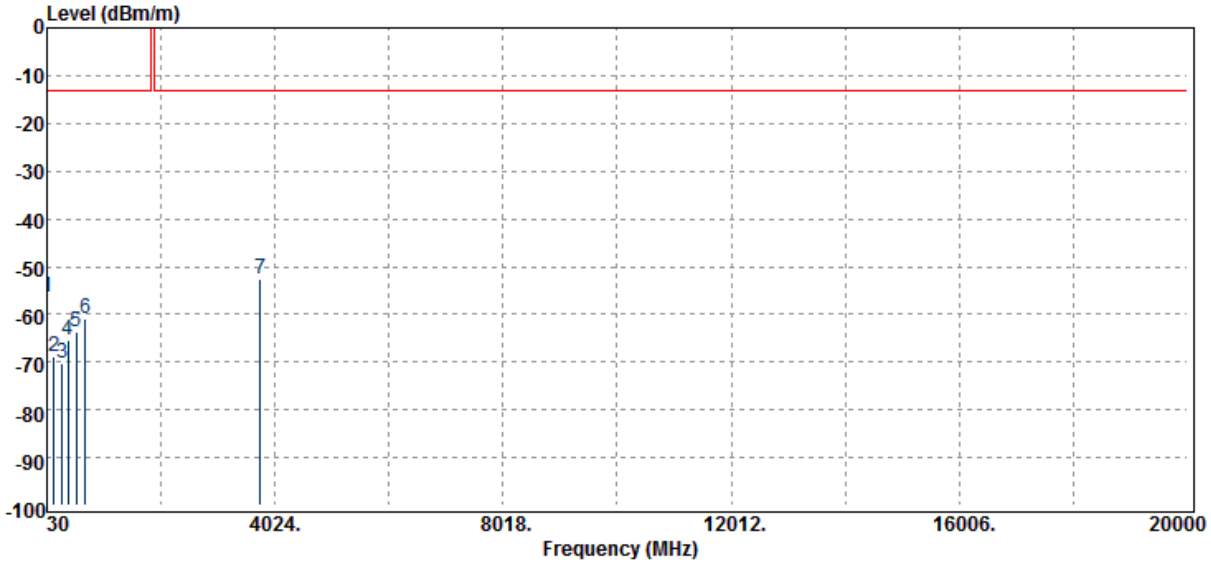

Freq. MHz	ERP/EIRP dBm	SG Output Level dBm	Antenna Gain dBd/dBi	Cable Loss dB	Limit dBm	Margin dB
30.00	-56.46	24.88	-14.58	-0.58	-13.00	-43.46
154.16	-68.92	4.81	-1.57	-1.30	-13.00	-55.92
293.84	-70.17	0.06	3.50	-1.80	-13.00	-57.17
400.54	-65.31	3.15	3.71	-2.12	-13.00	-52.31
546.04	-63.50	4.86	3.99	-1.81	-13.00	-50.50
696.39	-60.93	8.90	3.69	-2.46	-13.00	-47.93
3760.00	-52.71	10.39	12.61	-6.89	-13.00	-39.71

Unless otherwise stated the results shown in this test report refer only to the sample(s) tested and such sample(s) are retained for 90 days only.

除非另有說明，此報告結果僅對測試之樣品負責，同時此樣品僅保留90天。本報告未經本公司書面許可，不可部份複製。

This document is issued by the Company subject to its General Conditions of Service printed overleaf, available on request or accessible at www.sgs.com/terms_and_conditions.htm and, for electronic format documents, subject to Terms and Conditions for Electronic Documents at www.sgs.com/terms_e-document.htm. Attention is drawn to the limitation of liability, indemnification and jurisdiction issues defined therein. Any holder of this document is advised that information contained hereon reflects the Company's findings at the time of its intervention only and within the limits of Client's instructions, if any. The Company's sole responsibility is to its Client and this document does not exonerate parties to a transaction from exercising all their rights and obligations under the transaction documents. This document cannot be reproduced except in full, without prior written approval of the Company. Any unauthorized alteration, forgery or falsification of the content or appearance of this document is unlawful and offenders may be prosecuted to the fullest extent of the law.

SGS Taiwan Ltd.

No.134,WuKungRoad,NewTaipeiIndustrialPark,WukuDistrict,NewTaipeiCity,Taiwan24803/新北市五股區新北產業園區五工路 134 號

台灣檢驗科技股份有限公司

t (886-2) 2299-3279

f (886-2) 2298-0488

www.tw.sgs.com

Member of SGS Group

Operation Band	:WCDMA B2	Temp./Humi.	:22 deg_C / 62 RH
Fundamental Frequency	:1880 MHz	Engineer	:Tin
Operation Mode	:Tx CH MID		
EUT Pol.	:E1 Plane	Measurement Antenna Pol.	:HORIZONTAL

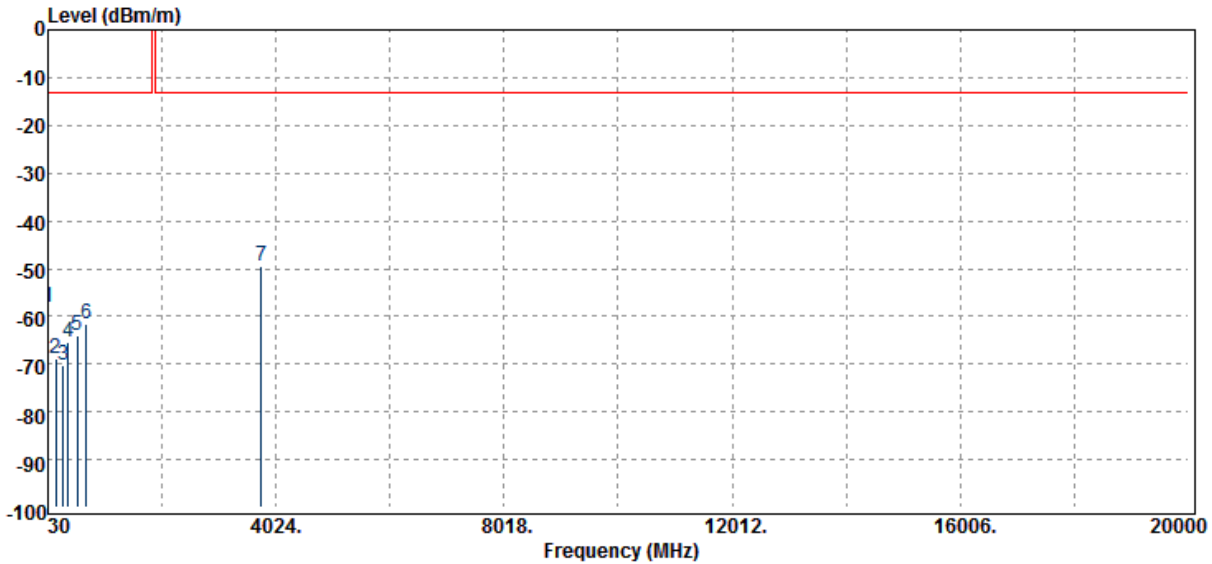

Freq. MHz	ERP/EIRP dBm	SG Output Level dBm	Antenna Gain dBd/dBi	Cable Loss dB	Limit dBm	Margin dB
30.00	-58.00	24.88	-14.58	-0.58	-13.00	-45.00
167.74	-68.80	4.04	-0.76	-1.32	-13.00	-55.80
291.90	-70.21	0.08	3.46	-1.79	-13.00	-57.21
382.11	-65.45	3.50	3.76	-2.02	-13.00	-52.45
544.10	-64.10	4.77	3.99	-1.79	-13.00	-51.10
700.27	-61.45	8.94	3.67	-2.16	-13.00	-48.45
3760.00	-49.48	10.54	12.61	-6.89	-13.00	-36.48

Unless otherwise stated the results shown in this test report refer only to the sample(s) tested and such sample(s) are retained for 90 days only.

除非另有說明，此報告結果僅對測試之樣品負責，同時此樣品僅保留90天。本報告未經本公司書面許可，不可部份複製。

This document is issued by the Company subject to its General Conditions of Service printed overleaf, available on request or accessible at www.sgs.com/terms_and_conditions.htm and, for electronic format documents, subject to Terms and Conditions for Electronic Documents at www.sgs.com/terms_e-document.htm. Attention is drawn to the limitation of liability, indemnification and jurisdiction issues defined therein. Any holder of this document is advised that information contained hereon reflects the Company's findings at the time of its intervention only and within the limits of Client's instructions, if any. The Company's sole responsibility is to its Client and this document does not exonerate parties to a transaction from exercising all their rights and obligations under the transaction documents. This document cannot be reproduced except in full, without prior written approval of the Company. Any unauthorized alteration, forgery or falsification of the content or appearance of this document is unlawful and offenders may be prosecuted to the fullest extent of the law.

SGS Taiwan Ltd.

No.134,WuKungRoad,NewTaipeiIndustrialPark,WukuDistrict,NewTaipeiCity,Taiwan24803/新北市五股區新北產業園區五工路 134 號

台灣檢驗科技股份有限公司

t (886-2) 2299-3279

f (886-2) 2298-0488

www.tw.sgs.com

Member of SGS Group

Operation Band	:WCDMA B2	Temp./Humi.	:22 deg_C / 62 RH
Fundamental Frequency	:1907.6 MHz	Engineer	:Tin
Operation Mode	:Tx CH HIGH		
EUT Pol.	:E1 Plane	Measurement Antenna Pol.	:VERTICAL

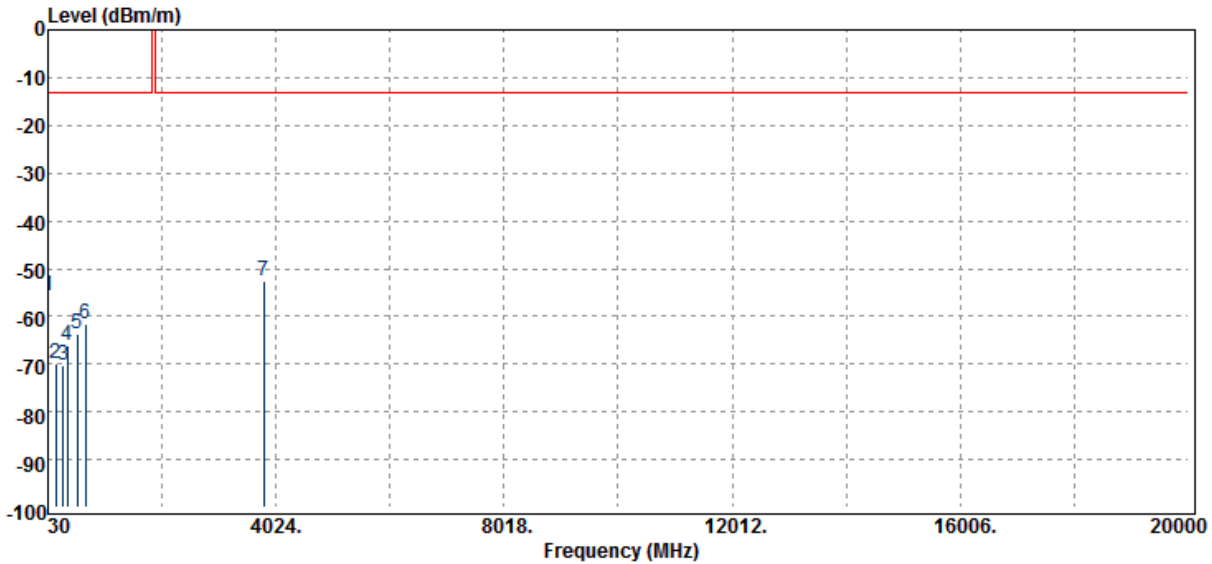

Freq. MHz	ERP/EIRP dBm	SG Output Level dBm	Antenna Gain dBd/dBi	Cable Loss dB	Limit dBm	Margin dB
30.00	-55.80	24.88	-14.58	-0.58	-13.00	-42.80
166.77	-69.72	4.35	-0.82	-1.32	-13.00	-56.72
296.75	-70.17	0.08	3.55	-1.81	-13.00	-57.17
362.71	-66.06	3.29	3.82	-2.07	-13.00	-53.06
542.16	-63.54	4.71	3.99	-1.87	-13.00	-50.54
694.45	-61.48	8.82	3.69	-2.61	-13.00	-48.48
3815.20	-52.61	10.37	12.66	-7.00	-13.00	-39.61

Unless otherwise stated the results shown in this test report refer only to the sample(s) tested and such sample(s) are retained for 90 days only.

除非另有說明，此報告結果僅對測試之樣品負責，同時此樣品僅保留90天。本報告未經本公司書面許可，不可部份複製。

This document is issued by the Company subject to its General Conditions of Service printed overleaf, available on request or accessible at www.sgs.com/terms_and_conditions.htm and, for electronic format documents, subject to Terms and Conditions for Electronic Documents at www.sgs.com/terms_e-document.htm. Attention is drawn to the limitation of liability, indemnification and jurisdiction issues defined therein. Any holder of this document is advised that information contained hereon reflects the Company's findings at the time of its intervention only and within the limits of Client's instructions, if any. The Company's sole responsibility is to its Client and this document does not exonerate parties to a transaction from exercising all their rights and obligations under the transaction documents. This document cannot be reproduced except in full, without prior written approval of the Company. Any unauthorized alteration, forgery or falsification of the content or appearance of this document is unlawful and offenders may be prosecuted to the fullest extent of the law.

SGS Taiwan Ltd.

No.134,WuKungRoad,NewTaipeiIndustrialPark,WukuDistrict,NewTaipeiCity,Taiwan24803/新北市五股區新北產業園區五工路 134 號

台灣檢驗科技股份有限公司

t (886-2) 2299-3279

f (886-2) 2298-0488

www.tw.sgs.com

Member of SGS Group

Operation Band	:WCDMA B2	Temp./Humi.	:22 deg_C / 62 RH
Fundamental Frequency	:1907.6 MHz	Engineer	:Tin
Operation Mode	:Tx CH HIGH		
EUT Pol.	:E1 Plane	Measurement Antenna Pol.	:HORIZONTAL

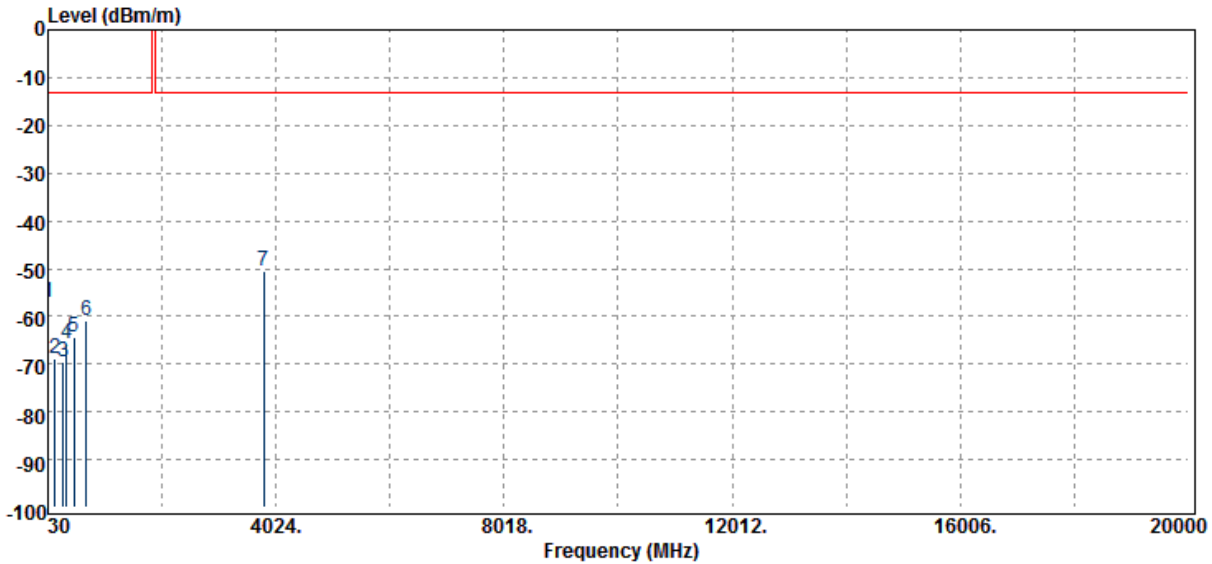

Freq. MHz	ERP/EIRP dBm	SG Output Level dBm	Antenna Gain dBd/dBi	Cable Loss dB	Limit dBm	Margin dB
31.94	-57.20	24.08	-14.08	-0.59	-13.00	-44.20
148.34	-68.84	5.18	-1.89	-1.29	-13.00	-55.84
296.75	-69.64	0.08	3.55	-1.81	-13.00	-56.64
356.89	-65.61	3.23	3.83	-2.05	-13.00	-52.61
484.93	-64.52	3.97	3.90	-1.82	-13.00	-51.52
696.39	-61.01	8.90	3.69	-2.46	-13.00	-48.01
3815.20	-50.44	10.57	12.66	-7.00	-13.00	-37.44

Unless otherwise stated the results shown in this test report refer only to the sample(s) tested and such sample(s) are retained for 90 days only.

除非另有說明，此報告結果僅對測試之樣品負責，同時此樣品僅保留90天。本報告未經本公司書面許可，不可部份複製。

This document is issued by the Company subject to its General Conditions of Service printed overleaf, available on request or accessible at www.sgs.com/terms_and_conditions.htm and, for electronic format documents, subject to Terms and Conditions for Electronic Documents at www.sgs.com/terms_e-document.htm. Attention is drawn to the limitation of liability, indemnification and jurisdiction issues defined therein. Any holder of this document is advised that information contained hereon reflects the Company's findings at the time of its intervention only and within the limits of Client's instructions, if any. The Company's sole responsibility is to its Client and this document does not exonerate parties to a transaction from exercising all their rights and obligations under the transaction documents. This document cannot be reproduced except in full, without prior written approval of the Company. Any unauthorized alteration, forgery or falsification of the content or appearance of this document is unlawful and offenders may be prosecuted to the fullest extent of the law.

SGS Taiwan Ltd.

No.134,WuKungRoad,NewTaipeiIndustrialPark,WukuDistrict,NewTaipeiCity,Taiwan24803/新北市五股區新北產業園區五工路 134 號

台灣檢驗科技股份有限公司

t (886-2) 2299-3279

f (886-2) 2298-0488

www.tw.sgs.com

Member of SGS Group

Radiated Spurious Emission Measurement Result: WCDMA Band 5 Mode

Operation Band :WCDMA B5 Temp./Humi. :24 deg_C / 61 RH
 Fundamental Frequency :826.4 MHz Engineer :Wei
 Operation Mode :Tx CH LOW
 EUT Pol. :E1 Plane Measurement Antenna Pol. :VERTICAL

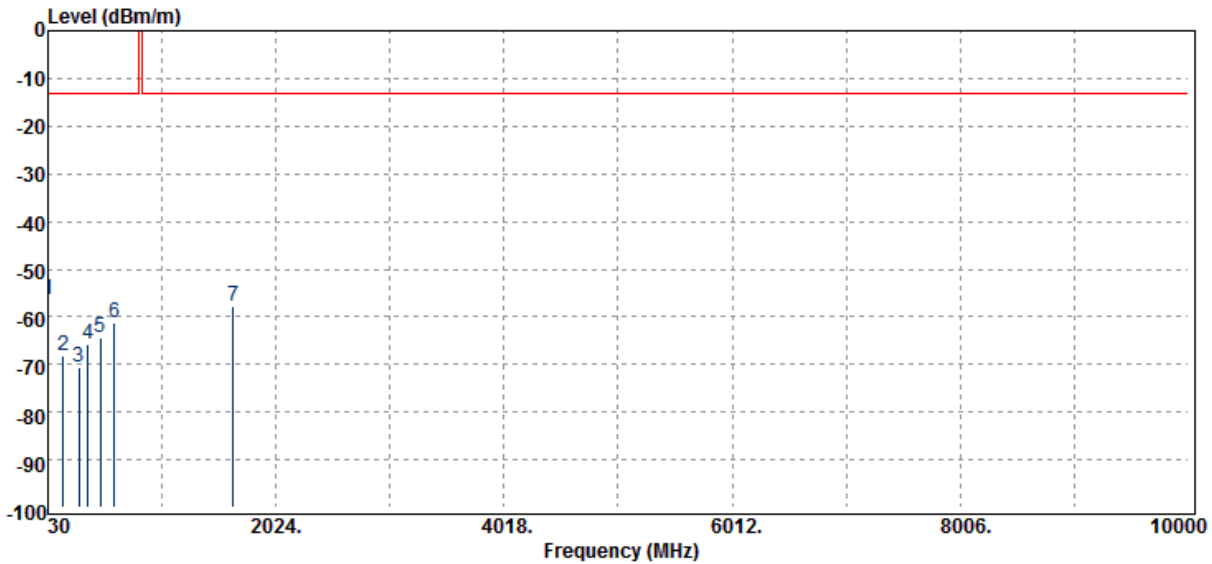

Freq. MHz	ERP/EIRP dBm	SG Output Level dBm	Antenna Gain dBd/dBi	Cable Loss dB	Limit dBm	Margin dB
30.00	-56.25	24.88	-14.58	-0.58	-13.00	-43.25
165.80	-68.17	4.22	-0.88	-1.31	-13.00	-55.17
299.66	-70.68	0.16	3.61	-1.82	-13.00	-57.68
381.14	-65.90	3.49	3.77	-2.02	-13.00	-52.90
488.81	-64.19	3.98	3.94	-1.91	-13.00	-51.19
612.00	-61.32	6.26	3.61	-2.38	-13.00	-48.32
1652.80	-57.70	2.52	9.14	-4.36	-13.00	-44.70

Unless otherwise stated the results shown in this test report refer only to the sample(s) tested and such sample(s) are retained for 90 days only.

除非另有說明，此報告結果僅對測試之樣品負責，同時此樣品僅保留90天。本報告未經本公司書面許可，不可部份複製。

This document is issued by the Company subject to its General Conditions of Service printed overleaf, available on request or accessible at www.sgs.com/terms_and_conditions.htm and, for electronic format documents, subject to Terms and Conditions for Electronic Documents at www.sgs.com/terms_e-document.htm. Attention is drawn to the limitation of liability, indemnification and jurisdiction issues defined therein. Any holder of this document is advised that information contained hereon reflects the Company's findings at the time of its intervention only and within the limits of Client's instructions, if any. The Company's sole responsibility is to its Client and this document does not exonerate parties to a transaction from exercising all their rights and obligations under the transaction documents. This document cannot be reproduced except in full, without prior written approval of the Company. Any unauthorized alteration, forgery or falsification of the content or appearance of this document is unlawful and offenders may be prosecuted to the fullest extent of the law.

SGS Taiwan Ltd.

No.134,WuKungRoad,NewTaipeiIndustrialPark,WukuDistrict,NewTaipeiCity,Taiwan24803/新北市五股區新北產業園區五工路 134 號

台灣檢驗科技股份有限公司

t (886-2) 2299-3279

f (886-2) 2298-0488

www.tw.sgs.com

Member of SGS Group

Operation Band	:WCDMA B5	Temp./Humi.	:24 deg_C / 61 RH
Fundamental Frequency	:826.4 MHz	Engineer	:Wei
Operation Mode	:Tx CH LOW		
EUT Pol.	:E1 Plane	Measurement Antenna Pol.	:HORIZONTAL

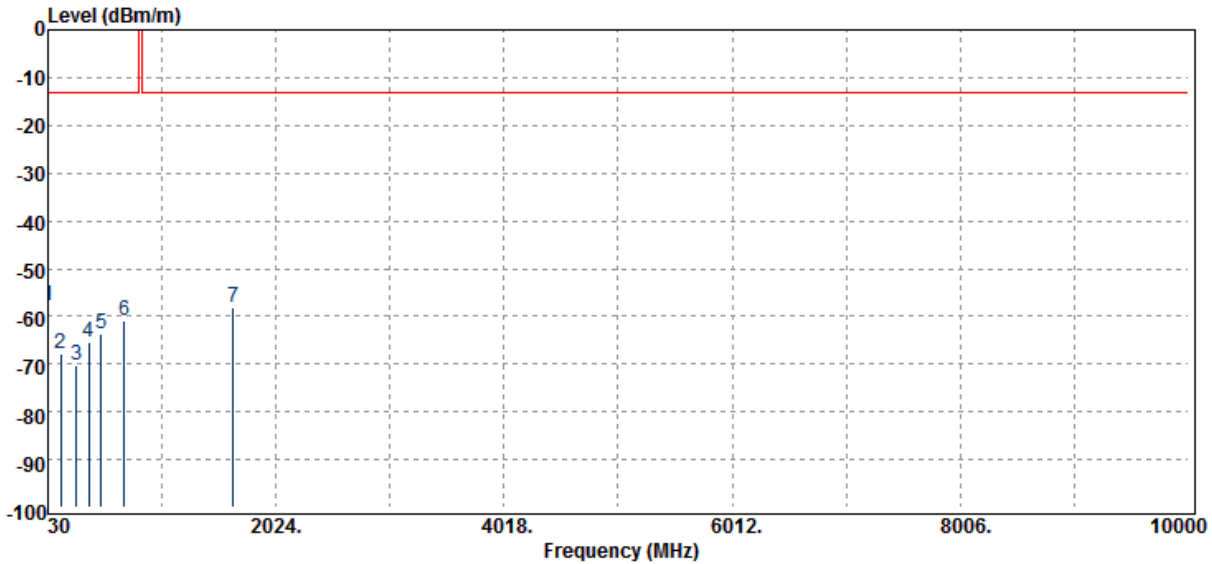

Freq. MHz	ERP/EIRP dBm	SG Output Level dBm	Antenna Gain dBd/dBi	Cable Loss dB	Limit dBm	Margin dB
30.00	-57.89	24.88	-14.58	-0.58	-13.00	-44.89
139.61	-67.75	4.89	-2.29	-1.26	-13.00	-54.75
280.26	-70.36	-0.14	3.42	-1.75	-13.00	-57.36
388.90	-65.56	3.13	3.74	-2.04	-13.00	-52.56
493.66	-63.76	3.90	3.99	-2.04	-13.00	-50.76
696.39	-60.76	8.90	3.69	-2.46	-13.00	-47.76
1652.80	-58.30	3.08	9.14	-4.36	-13.00	-45.30

Unless otherwise stated the results shown in this test report refer only to the sample(s) tested and such sample(s) are retained for 90 days only.

除非另有說明，此報告結果僅對測試之樣品負責，同時此樣品僅保留90天。本報告未經本公司書面許可，不可部份複製。

This document is issued by the Company subject to its General Conditions of Service printed overleaf, available on request or accessible at www.sgs.com/terms_and_conditions.htm and, for electronic format documents, subject to Terms and Conditions for Electronic Documents at www.sgs.com/terms_e-document.htm. Attention is drawn to the limitation of liability, indemnification and jurisdiction issues defined therein. Any holder of this document is advised that information contained hereon reflects the Company's findings at the time of its intervention only and within the limits of Client's instructions, if any. The Company's sole responsibility is to its Client and this document does not exonerate parties to a transaction from exercising all their rights and obligations under the transaction documents. This document cannot be reproduced except in full, without prior written approval of the Company. Any unauthorized alteration, forgery or falsification of the content or appearance of this document is unlawful and offenders may be prosecuted to the fullest extent of the law.

SGS Taiwan Ltd.

No.134,WuKungRoad,NewTaipeiIndustrialPark,WukuDistrict,NewTaipeiCity,Taiwan24803/新北市五股區新北產業園區五工路 134 號

台灣檢驗科技股份有限公司

t (886-2) 2299-3279

f (886-2) 2298-0488

www.tw.sgs.com

Member of SGS Group

Operation Band	:WCDMA B5	Temp./Humi.	:24 deg_C / 61 RH
Fundamental Frequency	:836.6 MHz	Engineer	:Wei
Operation Mode	:Tx CH MID		
EUT Pol.	:E1 Plane	Measurement Antenna Pol.	:VERTICAL

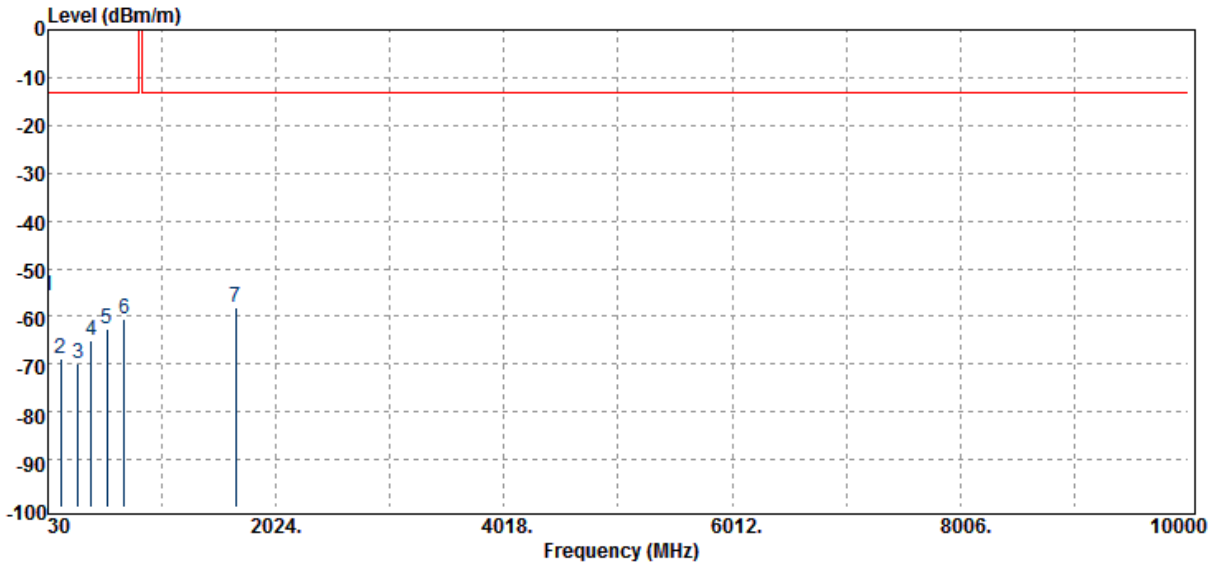

Freq. MHz	ERP/EIRP dBm	SG Output Level dBm	Antenna Gain dBd/dBi	Cable Loss dB	Limit dBm	Margin dB
31.94	-55.61	24.08	-14.08	-0.59	-13.00	-42.61
143.49	-68.72	5.01	-2.13	-1.28	-13.00	-55.72
289.96	-69.73	0.11	3.42	-1.78	-13.00	-56.73
410.24	-64.90	3.31	3.68	-2.13	-13.00	-51.90
544.10	-62.63	4.77	3.99	-1.79	-13.00	-49.63
697.36	-60.60	8.92	3.68	-2.38	-13.00	-47.60
1673.20	-58.05	2.57	9.21	-4.39	-13.00	-45.05

Unless otherwise stated the results shown in this test report refer only to the sample(s) tested and such sample(s) are retained for 90 days only.

除非另有說明，此報告結果僅對測試之樣品負責，同時此樣品僅保留90天。本報告未經本公司書面許可，不可部份複製。

This document is issued by the Company subject to its General Conditions of Service printed overleaf, available on request or accessible at www.sgs.com/terms_and_conditions.htm and, for electronic format documents, subject to Terms and Conditions for Electronic Documents at www.sgs.com/terms_e-document.htm. Attention is drawn to the limitation of liability, indemnification and jurisdiction issues defined therein. Any holder of this document is advised that information contained hereon reflects the Company's findings at the time of its intervention only and within the limits of Client's instructions, if any. The Company's sole responsibility is to its Client and this document does not exonerate parties to a transaction from exercising all their rights and obligations under the transaction documents. This document cannot be reproduced except in full, without prior written approval of the Company. Any unauthorized alteration, forgery or falsification of the content or appearance of this document is unlawful and offenders may be prosecuted to the fullest extent of the law.

SGS Taiwan Ltd.

No.134,WuKungRoad,NewTaipeiIndustrialPark,WukuDistrict,NewTaipeiCity,Taiwan24803/新北市五股區新北產業園區五工路 134 號

台灣檢驗科技股份有限公司

t (886-2) 2299-3279

f (886-2) 2298-0488

www.tw.sgs.com

Member of SGS Group

Operation Band	:WCDMA B5	Temp./Humi.	:24 deg_C / 61 RH
Fundamental Frequency	:836.6 MHz	Engineer	:Wei
Operation Mode	:Tx CH MID		
EUT Pol.	:E1 Plane	Measurement Antenna Pol.	:HORIZONTAL

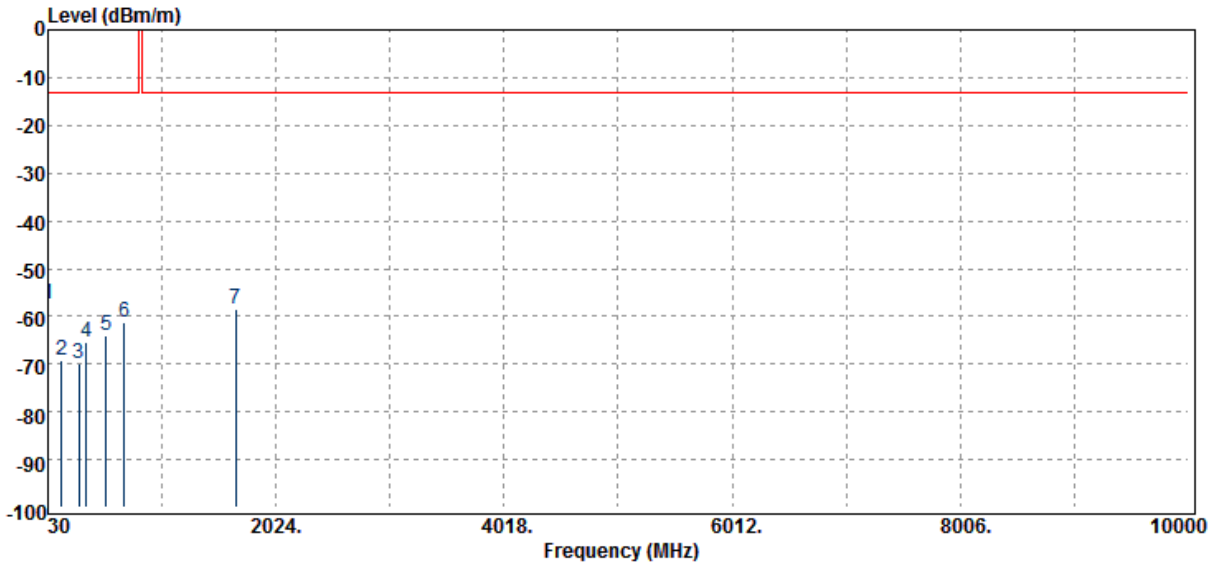

Freq. MHz	ERP/EIRP dBm	SG Output Level dBm	Antenna Gain dBd/dBi	Cable Loss dB	Limit dBm	Margin dB
31.94	-57.58	24.08	-14.08	-0.59	-13.00	-44.58
146.40	-69.30	5.43	-1.98	-1.29	-13.00	-56.30
299.66	-69.87	0.16	3.61	-1.82	-13.00	-56.87
362.71	-65.43	3.29	3.82	-2.07	-13.00	-52.43
537.31	-64.06	4.53	4.00	-2.07	-13.00	-51.06
694.45	-61.18	8.82	3.69	-2.61	-13.00	-48.18
1673.20	-58.36	3.15	9.21	-4.39	-13.00	-45.36

Unless otherwise stated the results shown in this test report refer only to the sample(s) tested and such sample(s) are retained for 90 days only.

除非另有說明，此報告結果僅對測試之樣品負責，同時此樣品僅保留90天。本報告未經本公司書面許可，不可部份複製。

This document is issued by the Company subject to its General Conditions of Service printed overleaf, available on request or accessible at www.sgs.com/terms_and_conditions.htm and, for electronic format documents, subject to Terms and Conditions for Electronic Documents at www.sgs.com/terms_e-document.htm. Attention is drawn to the limitation of liability, indemnification and jurisdiction issues defined therein. Any holder of this document is advised that information contained hereon reflects the Company's findings at the time of its intervention only and within the limits of Client's instructions, if any. The Company's sole responsibility is to its Client and this document does not exonerate parties to a transaction from exercising all their rights and obligations under the transaction documents. This document cannot be reproduced except in full, without prior written approval of the Company. Any unauthorized alteration, forgery or falsification of the content or appearance of this document is unlawful and offenders may be prosecuted to the fullest extent of the law.

SGS Taiwan Ltd.

No.134,WuKungRoad,NewTaipeiIndustrialPark,WukuDistrict,NewTaipeiCity,Taiwan24803/新北市五股區新北產業園區五工路 134 號

台灣檢驗科技股份有限公司

t (886-2) 2299-3279

f (886-2) 2298-0488

www.tw.sgs.com

Member of SGS Group

Operation Band	:WCDMA B5	Temp./Humi.	:24 deg_C / 61 RH
Fundamental Frequency	:846.6 MHz	Engineer	:Wei
Operation Mode	:Tx CH HIGH		
EUT Pol.	:E1 Plane	Measurement Antenna Pol.	:VERTICAL

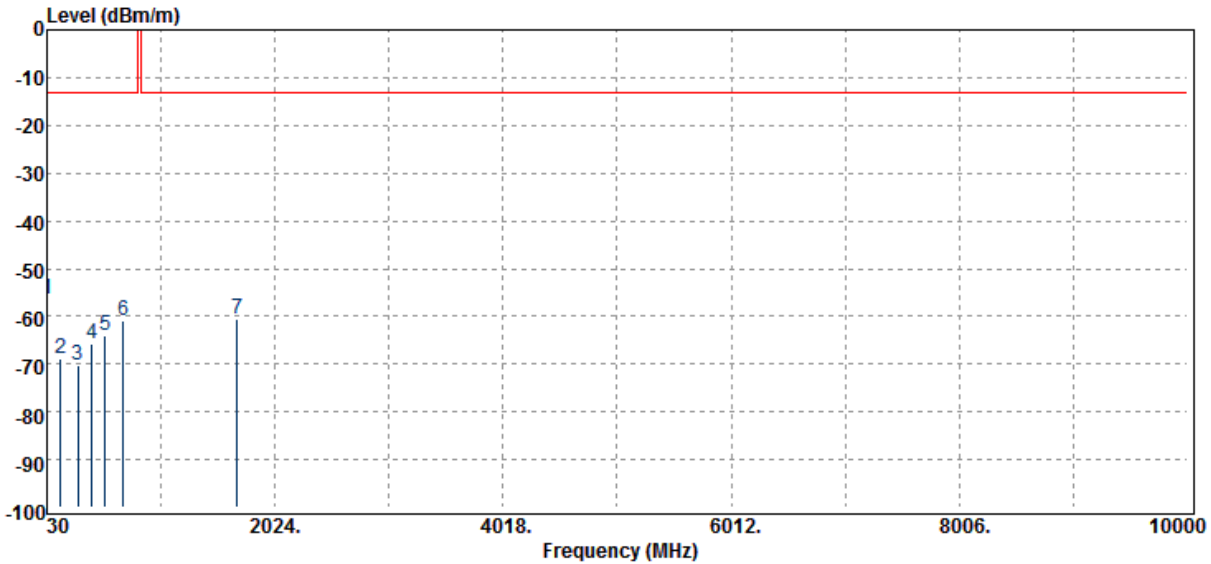

Freq. MHz	ERP/EIRP dBm	SG Output Level dBm	Antenna Gain dBd/dBi	Cable Loss dB	Limit dBm	Margin dB
31.94	-56.43	24.08	-14.08	-0.59	-13.00	-43.43
146.40	-69.00	5.43	-1.98	-1.29	-13.00	-56.00
299.66	-70.31	0.16	3.61	-1.82	-13.00	-57.31
419.94	-65.70	3.13	3.64	-2.11	-13.00	-52.70
537.31	-63.90	4.53	4.00	-2.07	-13.00	-50.90
699.30	-60.87	8.96	3.68	-2.24	-13.00	-47.87
1693.20	-60.67	2.89	7.12	-4.43	-13.00	-47.67

Unless otherwise stated the results shown in this test report refer only to the sample(s) tested and such sample(s) are retained for 90 days only.

除非另有說明，此報告結果僅對測試之樣品負責，同時此樣品僅保留90天。本報告未經本公司書面許可，不可部份複製。

This document is issued by the Company subject to its General Conditions of Service printed overleaf, available on request or accessible at www.sgs.com/terms_and_conditions.htm and, for electronic format documents, subject to Terms and Conditions for Electronic Documents at www.sgs.com/terms_e-document.htm. Attention is drawn to the limitation of liability, indemnification and jurisdiction issues defined therein. Any holder of this document is advised that information contained hereon reflects the Company's findings at the time of its intervention only and within the limits of Client's instructions, if any. The Company's sole responsibility is to its Client and this document does not exonerate parties to a transaction from exercising all their rights and obligations under the transaction documents. This document cannot be reproduced except in full, without prior written approval of the Company. Any unauthorized alteration, forgery or falsification of the content or appearance of this document is unlawful and offenders may be prosecuted to the fullest extent of the law.

SGS Taiwan Ltd.

No.134,WuKungRoad,NewTaipeiIndustrialPark,WukuDistrict,NewTaipeiCity,Taiwan24803/新北市五股區新北產業園區五工路 134 號

台灣檢驗科技股份有限公司

t (886-2) 2299-3279

f (886-2) 2298-0488

www.tw.sgs.com

Member of SGS Group

Operation Band	:WCDMA B5	Temp./Humi.	:24 deg_C / 61 RH
Fundamental Frequency	:846.6 MHz	Engineer	:Wei
Operation Mode	:Tx CH HIGH		
EUT Pol.	:E1 Plane	Measurement Antenna Pol.	:HORIZONTAL

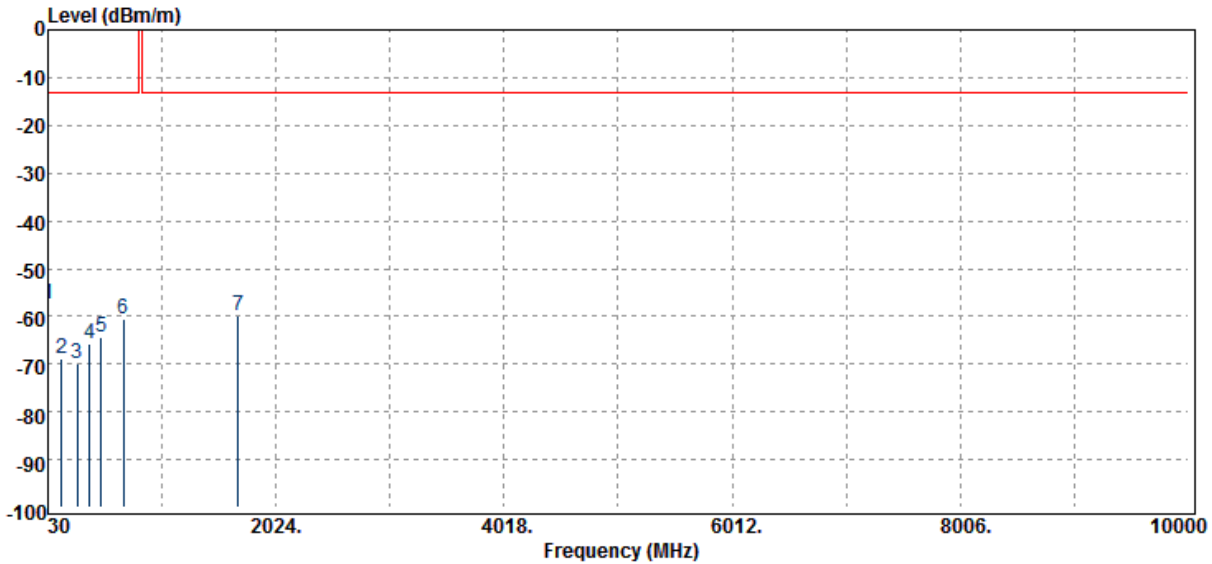

Freq. MHz	ERP/EIRP dBm	SG Output Level dBm	Antenna Gain dBd/dBi	Cable Loss dB	Limit dBm	Margin dB
30.00	-57.52	24.88	-14.58	-0.58	-13.00	-44.52
148.34	-68.85	5.18	-1.89	-1.29	-13.00	-55.85
284.14	-69.83	0.02	3.42	-1.76	-13.00	-56.83
396.66	-65.75	3.09	3.72	-2.09	-13.00	-52.75
492.69	-64.32	3.93	3.98	-2.01	-13.00	-51.32
692.51	-60.62	8.76	3.70	-2.76	-13.00	-47.62
1693.20	-59.76	3.36	7.12	-4.43	-13.00	-46.76

Unless otherwise stated the results shown in this test report refer only to the sample(s) tested and such sample(s) are retained for 90 days only.

除非另有說明，此報告結果僅對測試之樣品負責，同時此樣品僅保留90天。本報告未經本公司書面許可，不可部份複製。

This document is issued by the Company subject to its General Conditions of Service printed overleaf, available on request or accessible at www.sgs.com/terms_and_conditions.htm and, for electronic format documents, subject to Terms and Conditions for Electronic Documents at www.sgs.com/terms_e-document.htm. Attention is drawn to the limitation of liability, indemnification and jurisdiction issues defined therein. Any holder of this document is advised that information contained hereon reflects the Company's findings at the time of its intervention only and within the limits of Client's instructions, if any. The Company's sole responsibility is to its Client and this document does not exonerate parties to a transaction from exercising all their rights and obligations under the transaction documents. This document cannot be reproduced except in full, without prior written approval of the Company. Any unauthorized alteration, forgery or falsification of the content or appearance of this document is unlawful and offenders may be prosecuted to the fullest extent of the law.

SGS Taiwan Ltd.

No.134,WuKungRoad,NewTaipeiIndustrialPark,WukuDistrict,NewTaipeiCity,Taiwan24803/新北市五股區新北產業園區五工路 134 號

台灣檢驗科技股份有限公司

t (886-2) 2299-3279

f (886-2) 2298-0488

www.tw.sgs.com

Member of SGS Group

Radiated Spurious Emission Measurement Result: LTE-Band 2 (The Worst Case)

Operation Band	:LTE B2	Temp./Humi.	:24.1 deg_C / 65 RH
Fundamental Frequency	:1855 MHz	Engineer	:Wei
Operation Mode	:Tx CH LOW		
EUT Pol.	:E1 Plane	Measurement Antenna Pol.	:VERTICAL

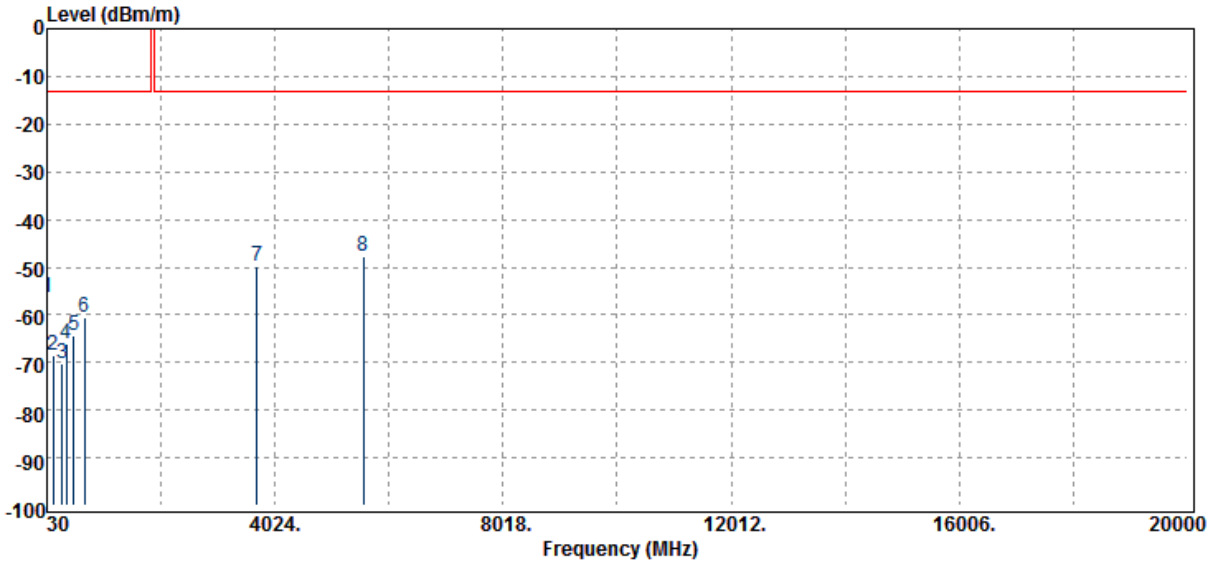

Freq. MHz	ERP/EIRP dBm	SG Output Level dBm	Antenna Gain dBd/dBi	Cable Loss dB	Limit dBm	Margin dB
30.00	-56.28	-41.12	-14.58	-0.58	-13.00	-43.28
138.64	-68.62	-65.11	-2.26	-1.25	-13.00	-55.62
299.66	-70.13	-71.92	3.61	-1.82	-13.00	-57.13
369.50	-66.10	-67.84	3.80	-2.06	-13.00	-53.10
497.54	-64.19	-66.09	4.03	-2.13	-13.00	-51.19
694.45	-60.48	-61.56	3.69	-2.61	-13.00	-47.48
3710.00	-49.80	-54.86	12.57	-6.89	-13.00	-36.80
5565.00	-47.74	-51.84	13.06	-8.41	-13.00	-34.74

Unless otherwise stated the results shown in this test report refer only to the sample(s) tested and such sample(s) are retained for 90 days only.

除非另有說明，此報告結果僅對測試之樣品負責，同時此樣品僅保留90天。本報告未經本公司書面許可，不可部份複製。

This document is issued by the Company subject to its General Conditions of Service printed overleaf, available on request or accessible at www.sgs.com/terms_and_conditions.htm and, for electronic format documents, subject to Terms and Conditions for Electronic Documents at www.sgs.com/terms_e-document.htm. Attention is drawn to the limitation of liability, indemnification and jurisdiction issues defined therein. Any holder of this document is advised that information contained hereon reflects the Company's findings at the time of its intervention only and within the limits of Client's instructions, if any. The Company's sole responsibility is to its Client and this document does not exonerate parties to a transaction from exercising all their rights and obligations under the transaction documents. This document cannot be reproduced except in full, without prior written approval of the Company. Any unauthorized alteration, forgery or falsification of the content or appearance of this document is unlawful and offenders may be prosecuted to the fullest extent of the law.

Operation Band	:LTE B2	Temp./Humi.	:24.1 deg_C / 65 RH
Fundamental Frequency	:1855 MHz	Engineer	:Wei
Operation Mode	:Tx CH LOW		
EUT Pol.	:E1 Plane	Measurement Antenna Pol.	:HORIZONTAL

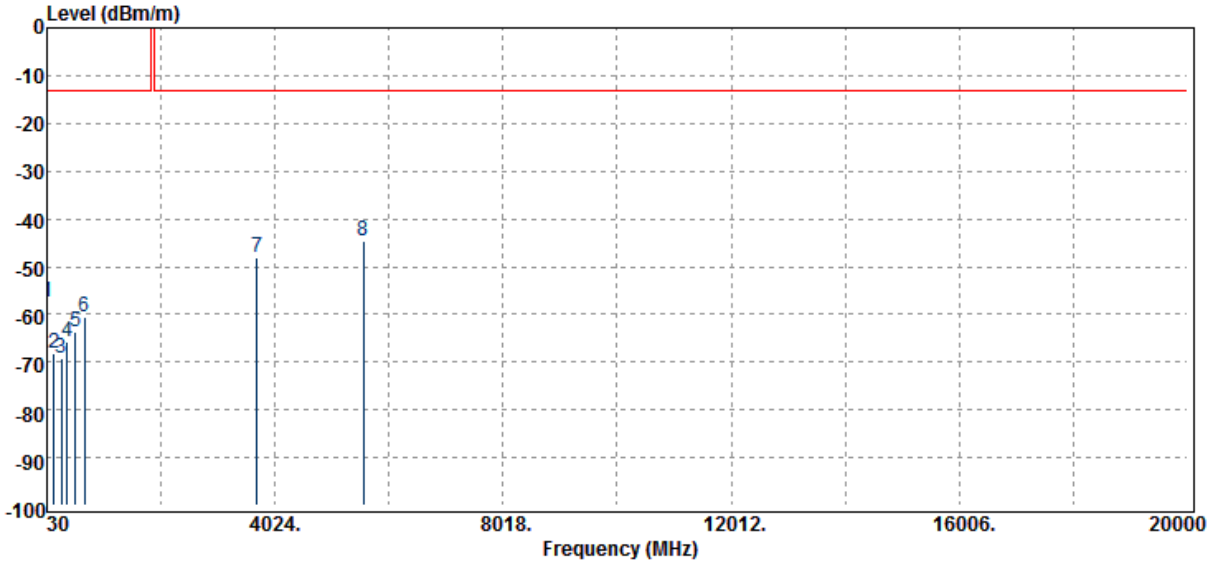

Freq. MHz	ERP/EIRP dBm	SG Output Level dBm	Antenna Gain dBd/dBi	Cable Loss dB	Limit dBm	Margin dB
31.94	-57.43	-42.76	-14.08	-0.59	-13.00	-44.43
146.40	-68.25	-64.98	-1.98	-1.29	-13.00	-55.25
277.35	-69.20	-70.89	3.44	-1.74	-13.00	-56.20
381.14	-65.86	-67.60	3.77	-2.02	-13.00	-52.86
534.40	-63.81	-65.63	4.00	-2.19	-13.00	-50.81
694.45	-60.71	-61.79	3.69	-2.61	-13.00	-47.71
3710.00	-48.19	-53.25	12.57	-6.89	-13.00	-35.19
5565.00	-44.69	-48.79	13.06	-8.41	-13.00	-31.69

Unless otherwise stated the results shown in this test report refer only to the sample(s) tested and such sample(s) are retained for 90 days only.

除非另有說明，此報告結果僅對測試之樣品負責，同時此樣品僅保留90天。本報告未經本公司書面許可，不可部份複製。

This document is issued by the Company subject to its General Conditions of Service printed overleaf, available on request or accessible at www.sgs.com/terms_and_conditions.htm and, for electronic format documents, subject to Terms and Conditions for Electronic Documents at www.sgs.com/terms_e-document.htm. Attention is drawn to the limitation of liability, indemnification and jurisdiction issues defined therein. Any holder of this document is advised that information contained hereon reflects the Company's findings at the time of its intervention only and within the limits of Client's instructions, if any. The Company's sole responsibility is to its Client and this document does not exonerate parties to a transaction from exercising all their rights and obligations under the transaction documents. This document cannot be reproduced except in full, without prior written approval of the Company. Any unauthorized alteration, forgery or falsification of the content or appearance of this document is unlawful and offenders may be prosecuted to the fullest extent of the law.

SGS Taiwan Ltd.

No.134,WuKungRoad,NewTaipeiIndustrialPark,WukuDistrict,NewTaipeiCity,Taiwan24803/新北市五股區新北產業園區五工路 134 號

台灣檢驗科技股份有限公司

t (886-2) 2299-3279

f (886-2) 2298-0488

www.tw.sgs.com

Member of SGS Group

Operation Band	:LTE B2	Temp./Humi.	:24.1 deg_C / 65 RH
Fundamental Frequency	:1880 MHz	Engineer	:Wei
Operation Mode	:Tx CH MID		
EUT Pol.	:E1 Plane	Measurement Antenna Pol.	:VERTICAL

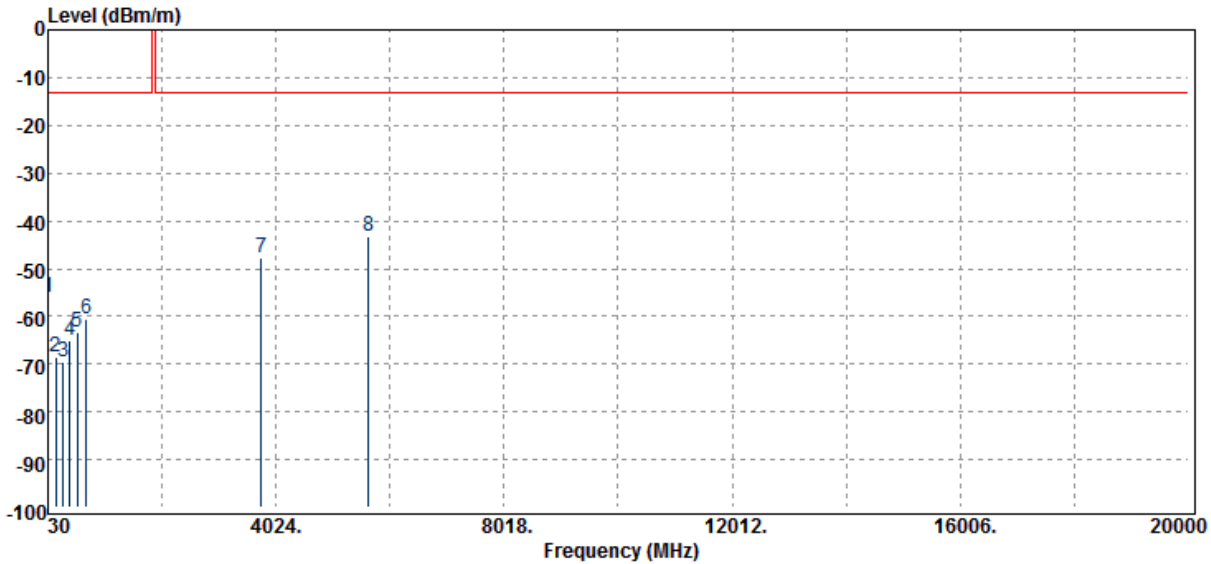

Freq. MHz	ERP/EIRP dBm	SG Output Level dBm	Antenna Gain dBd/dBi	Cable Loss dB	Limit dBm	Margin dB
30.00	-56.12	-40.96	-14.58	-0.58	-13.00	-43.12
167.74	-68.46	-66.38	-0.76	-1.32	-13.00	-55.46
291.90	-69.45	-71.12	3.46	-1.79	-13.00	-56.45
408.30	-65.20	-66.74	3.68	-2.14	-13.00	-52.20
537.31	-63.41	-65.34	4.00	-2.07	-13.00	-50.41
697.36	-60.71	-62.00	3.68	-2.38	-13.00	-47.71
3760.00	-47.67	-52.80	12.61	-6.89	-13.00	-34.67
5640.00	-43.20	-47.11	13.01	-8.53	-13.00	-30.20

Unless otherwise stated the results shown in this test report refer only to the sample(s) tested and such sample(s) are retained for 90 days only.

除非另有說明，此報告結果僅對測試之樣品負責，同時此樣品僅保留90天。本報告未經本公司書面許可，不可部份複製。

This document is issued by the Company subject to its General Conditions of Service printed overleaf, available on request or accessible at www.sgs.com/terms_and_conditions.htm and, for electronic format documents, subject to Terms and Conditions for Electronic Documents at www.sgs.com/terms_e-document.htm. Attention is drawn to the limitation of liability, indemnification and jurisdiction issues defined therein. Any holder of this document is advised that information contained hereon reflects the Company's findings at the time of its intervention only and within the limits of Client's instructions, if any. The Company's sole responsibility is to its Client and this document does not exonerate parties to a transaction from exercising all their rights and obligations under the transaction documents. This document cannot be reproduced except in full, without prior written approval of the Company. Any unauthorized alteration, forgery or falsification of the content or appearance of this document is unlawful and offenders may be prosecuted to the fullest extent of the law.

Operation Band	:LTE B2	Temp./Humi.	:24.1 deg_C / 65 RH
Fundamental Frequency	:1880 MHz	Engineer	:Wei
Operation Mode	:Tx CH MID		
EUT Pol.	:E1 Plane	Measurement Antenna Pol.	:HORIZONTAL

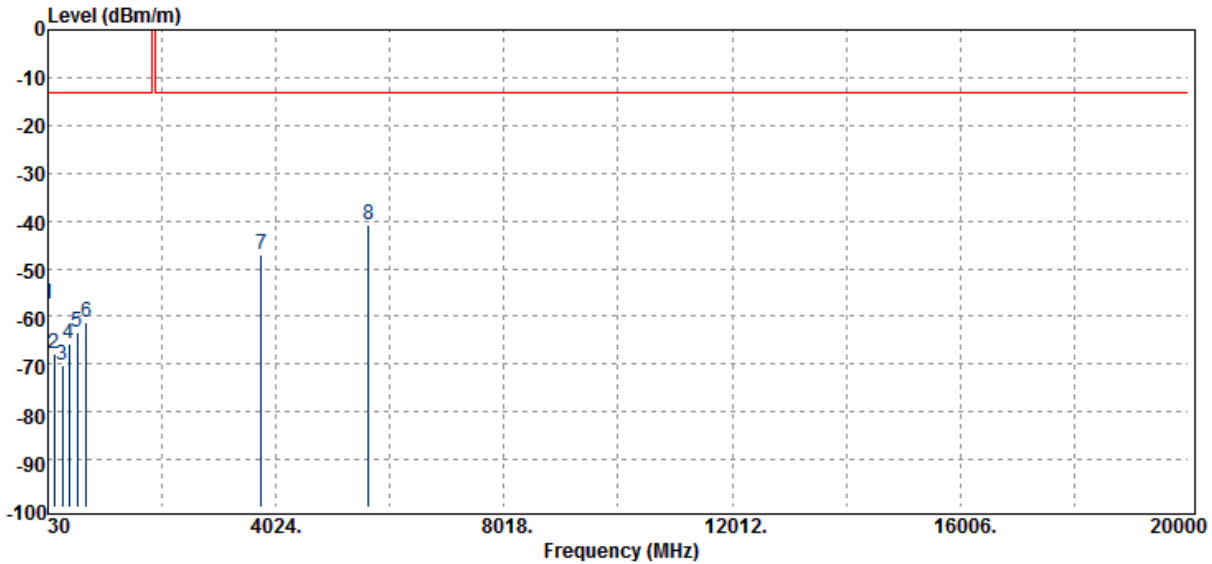

Freq. MHz	ERP/EIRP dBm	SG Output Level dBm	Antenna Gain dBd/dBi	Cable Loss dB	Limit dBm	Margin dB
30.00	-57.53	-42.37	-14.58	-0.58	-13.00	-44.53
141.55	-67.79	-64.30	-2.22	-1.27	-13.00	-54.79
279.29	-70.09	-71.77	3.42	-1.74	-13.00	-57.09
395.69	-65.90	-67.55	3.73	-2.08	-13.00	-52.90
539.25	-63.20	-65.21	4.00	-1.99	-13.00	-50.20
700.27	-61.34	-62.86	3.67	-2.16	-13.00	-48.34
3760.00	-47.13	-52.26	12.61	-6.89	-13.00	-34.13
5640.00	-40.68	-44.60	13.01	-8.53	-13.00	-27.68

Unless otherwise stated the results shown in this test report refer only to the sample(s) tested and such sample(s) are retained for 90 days only.

除非另有說明，此報告結果僅對測試之樣品負責，同時此樣品僅保留90天。本報告未經本公司書面許可，不可部份複製。

This document is issued by the Company subject to its General Conditions of Service printed overleaf, available on request or accessible at www.sgs.com/terms_and_conditions.htm and, for electronic format documents, subject to Terms and Conditions for Electronic Documents at www.sgs.com/terms_e-document.htm. Attention is drawn to the limitation of liability, indemnification and jurisdiction issues defined therein. Any holder of this document is advised that information contained hereon reflects the Company's findings at the time of its intervention only and within the limits of Client's instructions, if any. The Company's sole responsibility is to its Client and this document does not exonerate parties to a transaction from exercising all their rights and obligations under the transaction documents. This document cannot be reproduced except in full, without prior written approval of the Company. Any unauthorized alteration, forgery or falsification of the content or appearance of this document is unlawful and offenders may be prosecuted to the fullest extent of the law.

SGS Taiwan Ltd.

No.134,WuKungRoad,NewTaipeiIndustrialPark,WukuDistrict,NewTaipeiCity,Taiwan24803/新北市五股區新北產業園區五工路 134 號

台灣檢驗科技股份有限公司

t (886-2) 2299-3279

f (886-2) 2298-0488

www.tw.sgs.com

Member of SGS Group

Operation Band	:LTE B2	Temp./Humi.	:24.1 deg_C / 65 RH
Fundamental Frequency	:1905 MHz	Engineer	:Wei
Operation Mode	:Tx CH HIGH		
EUT Pol.	:E1 Plane	Measurement Antenna Pol.	:VERTICAL

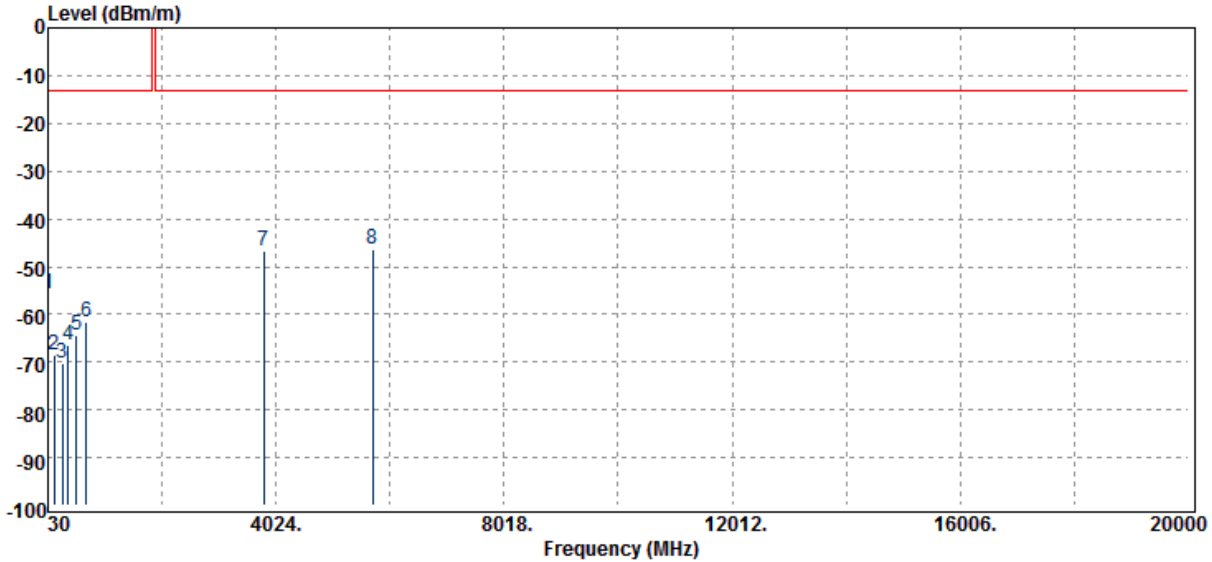

Freq. MHz	ERP/EIRP dBm	SG Output Level dBm	Antenna Gain dBd/dBi	Cable Loss dB	Limit dBm	Margin dB
30.00	-55.77	-40.61	-14.58	-0.58	-13.00	-42.77
140.58	-68.66	-65.12	-2.27	-1.26	-13.00	-55.66
287.05	-70.23	-71.88	3.42	-1.77	-13.00	-57.23
379.20	-66.33	-68.08	3.77	-2.03	-13.00	-53.33
534.40	-64.40	-66.22	4.00	-2.19	-13.00	-51.40
700.27	-61.62	-63.14	3.67	-2.16	-13.00	-48.62
3810.00	-46.89	-51.98	12.65	-6.98	-13.00	-33.89
5715.00	-46.38	-50.20	12.97	-8.56	-13.00	-33.38

Unless otherwise stated the results shown in this test report refer only to the sample(s) tested and such sample(s) are retained for 90 days only.

除非另有說明，此報告結果僅對測試之樣品負責，同時此樣品僅保留90天。本報告未經本公司書面許可，不可部份複製。

This document is issued by the Company subject to its General Conditions of Service printed overleaf, available on request or accessible at www.sgs.com/terms_and_conditions.htm and, for electronic format documents, subject to Terms and Conditions for Electronic Documents at www.sgs.com/terms_e-document.htm. Attention is drawn to the limitation of liability, indemnification and jurisdiction issues defined therein. Any holder of this document is advised that information contained hereon reflects the Company's findings at the time of its intervention only and within the limits of Client's instructions, if any. The Company's sole responsibility is to its Client and this document does not exonerate parties to a transaction from exercising all their rights and obligations under the transaction documents. This document cannot be reproduced except in full, without prior written approval of the Company. Any unauthorized alteration, forgery or falsification of the content or appearance of this document is unlawful and offenders may be prosecuted to the fullest extent of the law.

Operation Band	:LTE B2	Temp./Humi.	:24.1 deg_C / 65 RH
Fundamental Frequency	:1905 MHz	Engineer	:Wei
Operation Mode	:Tx CH HIGH		
EUT Pol.	:E1 Plane	Measurement Antenna Pol.	:HORIZONTAL

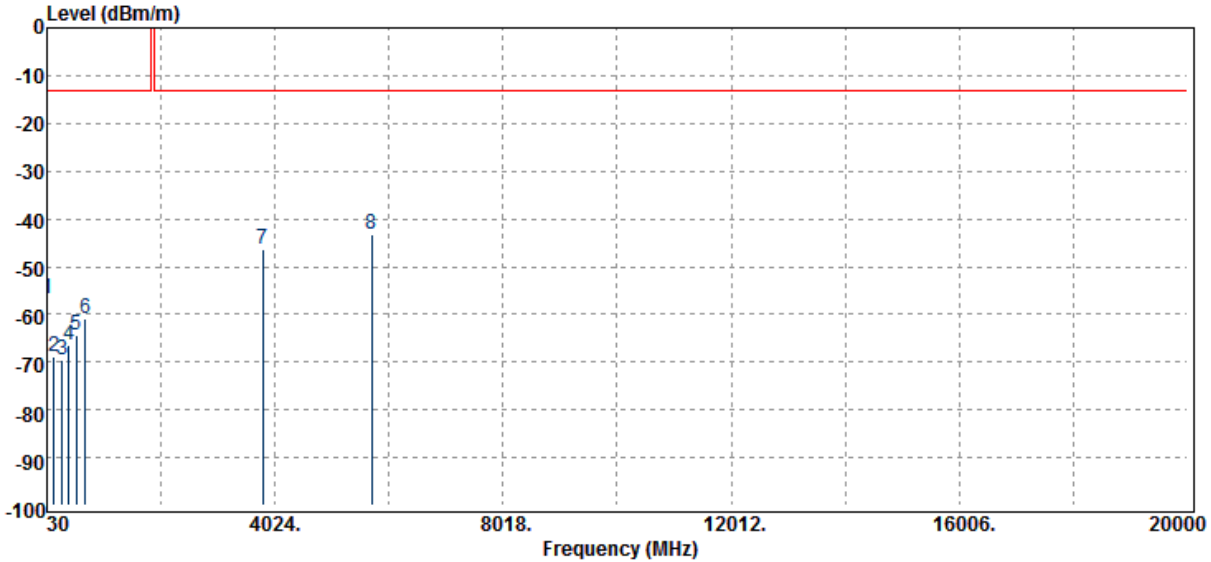

Freq. MHz	ERP/EIRP dBm	SG Output Level dBm	Antenna Gain dBd/dBi	Cable Loss dB	Limit dBm	Margin dB
31.94	-56.73	-42.06	-14.08	-0.59	-13.00	-43.73
154.16	-68.82	-65.96	-1.57	-1.30	-13.00	-55.82
298.69	-69.55	-71.32	3.59	-1.82	-13.00	-56.55
410.24	-66.32	-67.86	3.68	-2.13	-13.00	-53.32
544.10	-64.39	-66.59	3.99	-1.79	-13.00	-51.39
700.27	-60.97	-62.48	3.67	-2.16	-13.00	-47.97
3810.00	-46.39	-51.48	12.65	-6.98	-13.00	-33.39
5715.00	-43.09	-46.92	12.97	-8.56	-13.00	-30.09

Unless otherwise stated the results shown in this test report refer only to the sample(s) tested and such sample(s) are retained for 90 days only.

除非另有說明，此報告結果僅對測試之樣品負責，同時此樣品僅保留90天。本報告未經本公司書面許可，不可部份複製。

This document is issued by the Company subject to its General Conditions of Service printed overleaf, available on request or accessible at www.sgs.com/terms_and_conditions.htm and, for electronic format documents, subject to Terms and Conditions for Electronic Documents at www.sgs.com/terms_e-document.htm. Attention is drawn to the limitation of liability, indemnification and jurisdiction issues defined therein. Any holder of this document is advised that information contained hereon reflects the Company's findings at the time of its intervention only and within the limits of Client's instructions, if any. The Company's sole responsibility is to its Client and this document does not exonerate parties to a transaction from exercising all their rights and obligations under the transaction documents. This document cannot be reproduced except in full, without prior written approval of the Company. Any unauthorized alteration, forgery or falsification of the content or appearance of this document is unlawful and offenders may be prosecuted to the fullest extent of the law.

SGS Taiwan Ltd.

No.134,WuKungRoad,NewTaipeiIndustrialPark,WukuDistrict,NewTaipeiCity,Taiwan24803/新北市五股區新北產業園區五工路 134 號

台灣檢驗科技股份有限公司

t (886-2) 2299-3279

f (886-2) 2298-0488

www.tw.sgs.com

Member of SGS Group

Radiated Spurious Emission Measurement Result: LTE-Band 4 (The Worst Case)

Operation Band :LTE B4 Temp./Humi. :24.1 deg_C / 65 RH
 Fundamental Frequency :1720 MHz Engineer :Wei
 Operation Mode :Tx CH LOW
 EUT Pol. :E1 Plane Measurement Antenna Pol. :VERTICAL

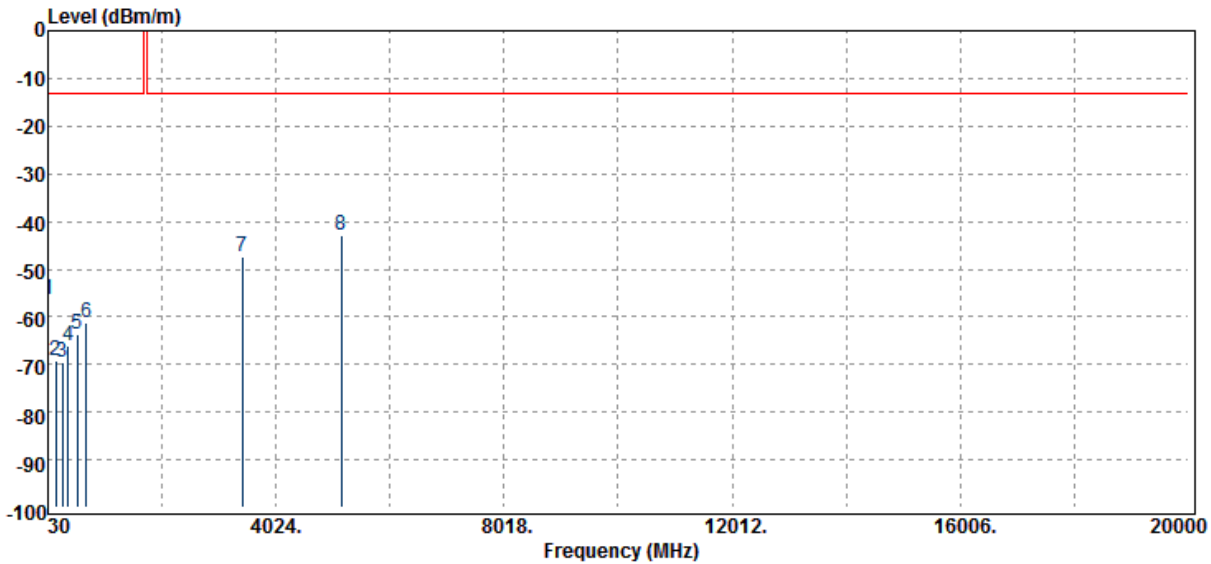

Freq. MHz	ERP/EIRP dBm	SG Output Level dBm	Antenna Gain dBd/dBi	Cable Loss dB	Limit dBm	Margin dB
31.94	-56.33	-41.66	-14.08	-0.59	-13.00	-43.33
162.89	-69.23	-66.86	-1.06	-1.31	-13.00	-56.23
284.14	-69.64	-71.31	3.42	-1.76	-13.00	-56.64
384.05	-66.10	-67.85	3.76	-2.01	-13.00	-53.10
541.19	-63.58	-65.66	3.99	-1.91	-13.00	-50.58
700.27	-61.25	-62.76	3.67	-2.16	-13.00	-48.25
3440.00	-47.40	-52.35	12.27	-6.55	-13.00	-34.40
5160.00	-43.03	-47.04	12.70	-8.12	-13.00	-30.03

Unless otherwise stated the results shown in this test report refer only to the sample(s) tested and such sample(s) are retained for 90 days only.

除非另有說明，此報告結果僅對測試之樣品負責，同時此樣品僅保留90天。本報告未經本公司書面許可，不可部份複製。

This document is issued by the Company subject to its General Conditions of Service printed overleaf, available on request or accessible at www.sgs.com/terms_and_conditions.htm and, for electronic format documents, subject to Terms and Conditions for Electronic Documents at www.sgs.com/terms_e-document.htm. Attention is drawn to the limitation of liability, indemnification and jurisdiction issues defined therein. Any holder of this document is advised that information contained hereon reflects the Company's findings at the time of its intervention only and within the limits of Client's instructions, if any. The Company's sole responsibility is to its Client and this document does not exonerate parties to a transaction from exercising all their rights and obligations under the transaction documents. This document cannot be reproduced except in full, without prior written approval of the Company. Any unauthorized alteration, forgery or falsification of the content or appearance of this document is unlawful and offenders may be prosecuted to the fullest extent of the law.

Operation Band	:LTE B4	Temp./Humi.	:24.1 deg_C / 65 RH
Fundamental Frequency	:1720 MHz	Engineer	:Wei
Operation Mode	:Tx CH LOW		
EUT Pol.	:E1 Plane	Measurement Antenna Pol.	:HORIZONTAL

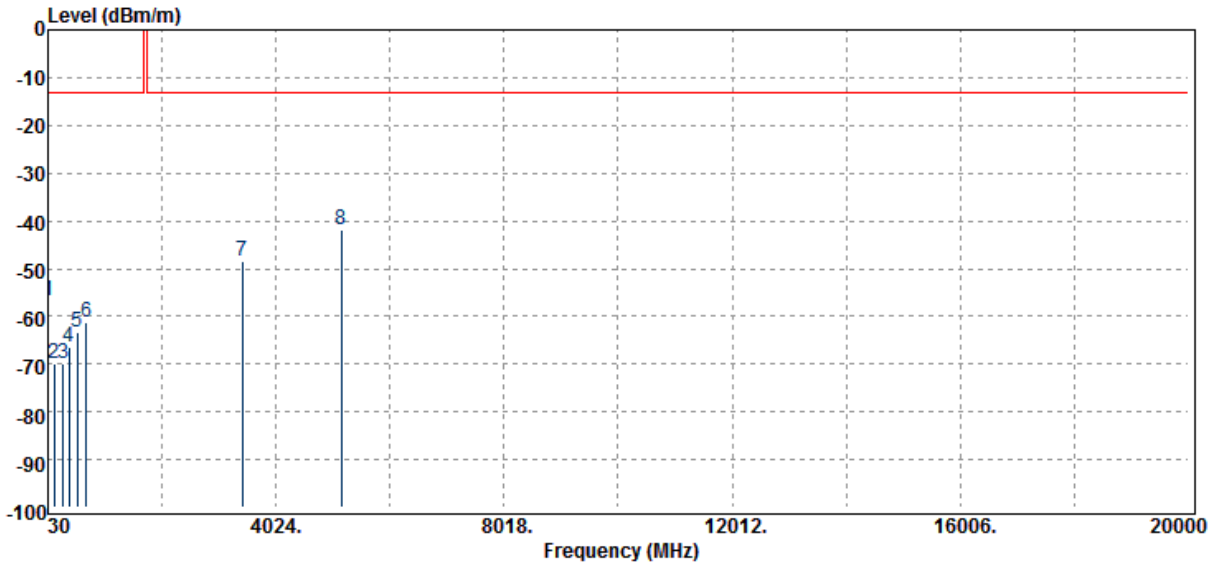

Freq. MHz	ERP/EIRP dBm	SG Output Level dBm	Antenna Gain dBd/dBi	Cable Loss dB	Limit dBm	Margin dB
31.94	-56.85	-42.17	-14.08	-0.59	-13.00	-43.85
139.61	-69.73	-66.18	-2.29	-1.26	-13.00	-56.73
296.75	-69.89	-71.63	3.55	-1.81	-13.00	-56.89
401.51	-66.28	-67.86	3.71	-2.13	-13.00	-53.28
542.16	-63.38	-65.50	3.99	-1.87	-13.00	-50.38
700.27	-61.13	-62.65	3.67	-2.16	-13.00	-48.13
3440.00	-48.55	-53.50	12.27	-6.55	-13.00	-35.55
5160.00	-41.93	-45.94	12.70	-8.12	-13.00	-28.93

Unless otherwise stated the results shown in this test report refer only to the sample(s) tested and such sample(s) are retained for 90 days only.

除非另有說明，此報告結果僅對測試之樣品負責，同時此樣品僅保留90天。本報告未經本公司書面許可，不可部份複製。

This document is issued by the Company subject to its General Conditions of Service printed overleaf, available on request or accessible at www.sgs.com/terms_and_conditions.htm and, for electronic format documents, subject to Terms and Conditions for Electronic Documents at www.sgs.com/terms_e-document.htm. Attention is drawn to the limitation of liability, indemnification and jurisdiction issues defined therein. Any holder of this document is advised that information contained hereon reflects the Company's findings at the time of its intervention only and within the limits of Client's instructions, if any. The Company's sole responsibility is to its Client and this document does not exonerate parties to a transaction from exercising all their rights and obligations under the transaction documents. This document cannot be reproduced except in full, without prior written approval of the Company. Any unauthorized alteration, forgery or falsification of the content or appearance of this document is unlawful and offenders may be prosecuted to the fullest extent of the law.

SGS Taiwan Ltd.

No.134,WuKungRoad,NewTaipeiIndustrialPark,WukuDistrict,NewTaipeiCity,Taiwan24803/新北市五股區新北產業園區五工路 134 號

台灣檢驗科技股份有限公司

t (886-2) 2299-3279

f (886-2) 2298-0488

www.tw.sgs.com

Member of SGS Group

Operation Band	:LTE B4	Temp./Humi.	:24.1 deg_C / 65 RH
Fundamental Frequency	:1732.5 MHz	Engineer	:Wei
Operation Mode	:Tx CH MID		
EUT Pol.	:E1 Plane	Measurement Antenna Pol.	:VERTICAL

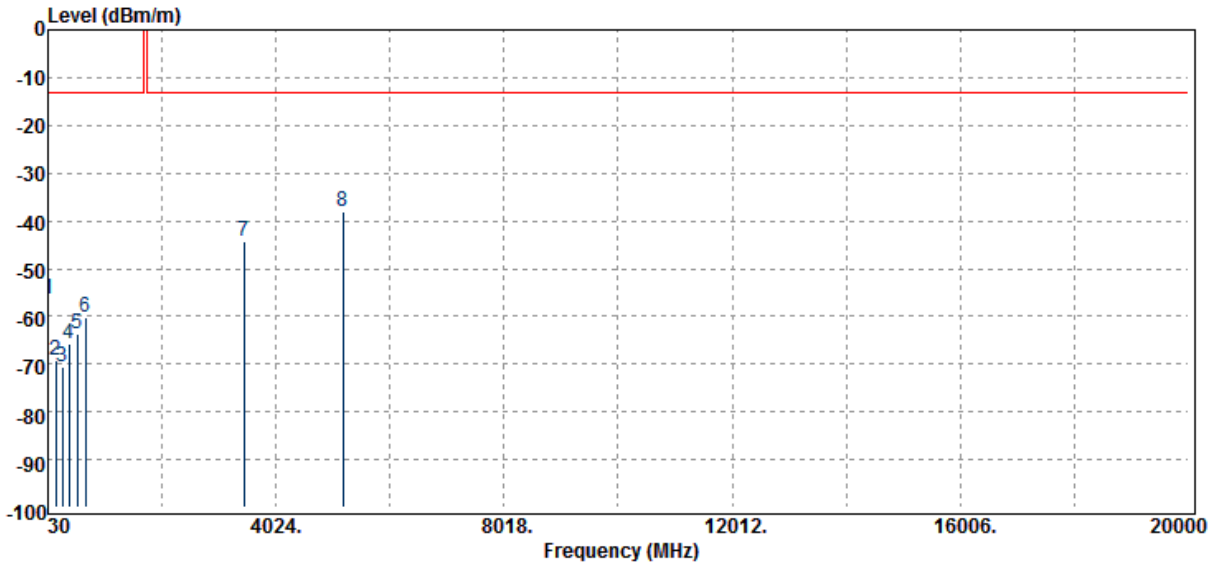

Freq. MHz	ERP/EIRP dBm	SG Output Level dBm	Antenna Gain dBd/dBi	Cable Loss dB	Limit dBm	Margin dB
30.00	-56.56	-41.40	-14.58	-0.58	-13.00	-43.56
170.65	-69.20	-67.35	-0.51	-1.33	-13.00	-56.20
288.99	-70.53	-72.17	3.42	-1.78	-13.00	-57.53
401.51	-65.81	-67.40	3.71	-2.13	-13.00	-52.81
541.19	-63.79	-65.87	3.99	-1.91	-13.00	-50.79
694.45	-60.21	-61.30	3.69	-2.61	-13.00	-47.21
3465.00	-44.35	-49.36	12.32	-6.56	-13.00	-31.35
5197.50	-37.94	-41.90	12.74	-8.21	-13.00	-24.94

Unless otherwise stated the results shown in this test report refer only to the sample(s) tested and such sample(s) are retained for 90 days only.

除非另有說明，此報告結果僅對測試之樣品負責，同時此樣品僅保留90天。本報告未經本公司書面許可，不可部份複製。

This document is issued by the Company subject to its General Conditions of Service printed overleaf, available on request or accessible at www.sgs.com/terms_and_conditions.htm and, for electronic format documents, subject to Terms and Conditions for Electronic Documents at www.sgs.com/terms_e-document.htm. Attention is drawn to the limitation of liability, indemnification and jurisdiction issues defined therein. Any holder of this document is advised that information contained hereon reflects the Company's findings at the time of its intervention only and within the limits of Client's instructions, if any. The Company's sole responsibility is to its Client and this document does not exonerate parties to a transaction from exercising all their rights and obligations under the transaction documents. This document cannot be reproduced except in full, without prior written approval of the Company. Any unauthorized alteration, forgery or falsification of the content or appearance of this document is unlawful and offenders may be prosecuted to the fullest extent of the law.

SGS Taiwan Ltd.

No.134,WuKungRoad,NewTaipeiIndustrialPark,WukuDistrict,NewTaipeiCity,Taiwan24803/新北市五股區新北產業園區五工路 134 號

台灣檢驗科技股份有限公司

t (886-2) 2299-3279

f (886-2) 2298-0488

www.tw.sgs.com

Member of SGS Group

Operation Band	:LTE B4	Temp./Humi.	:24.1 deg_C / 65 RH
Fundamental Frequency	:1732.5 MHz	Engineer	:Wei
Operation Mode	:Tx CH MID		
EUT Pol.	:E1 Plane	Measurement Antenna Pol.	:HORIZONTAL

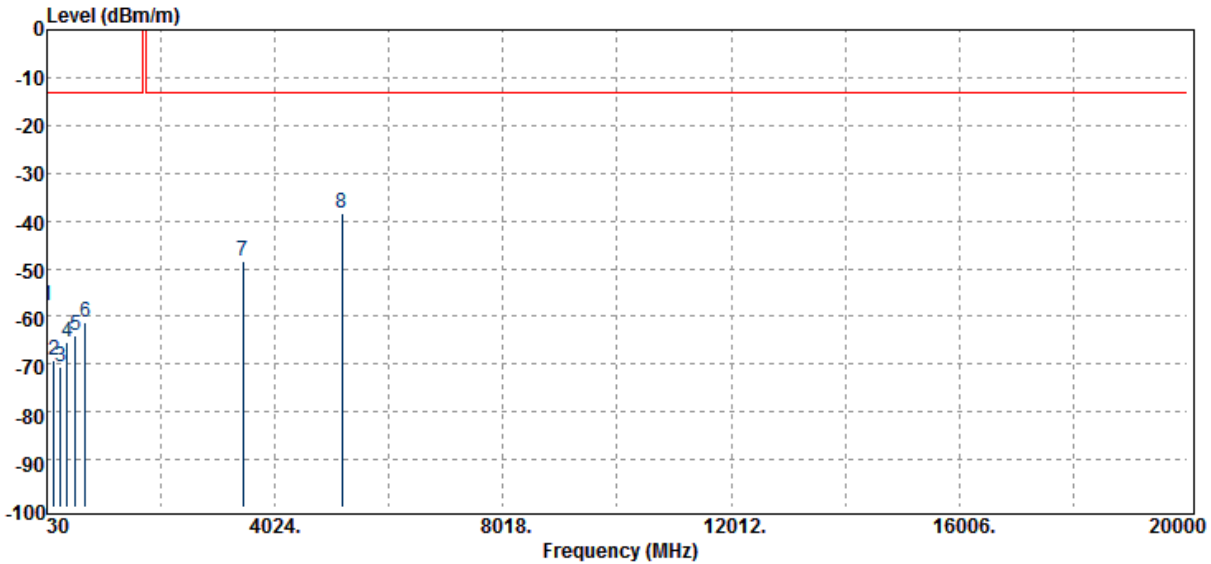

Freq. MHz	ERP/EIRP dBm	SG Output Level dBm	Antenna Gain dBd/dBi	Cable Loss dB	Limit dBm	Margin dB
31.94	-57.63	-42.96	-14.08	-0.59	-13.00	-44.63
148.34	-69.13	-65.96	-1.89	-1.29	-13.00	-56.13
275.41	-70.52	-72.24	3.45	-1.73	-13.00	-57.52
382.11	-65.39	-67.14	3.76	-2.02	-13.00	-52.39
534.40	-64.05	-65.86	4.00	-2.19	-13.00	-51.05
696.39	-61.41	-62.64	3.69	-2.46	-13.00	-48.41
3465.00	-48.34	-53.34	12.32	-6.56	-13.00	-35.34
5197.50	-38.34	-42.31	12.74	-8.21	-13.00	-25.34

Unless otherwise stated the results shown in this test report refer only to the sample(s) tested and such sample(s) are retained for 90 days only.

除非另有說明，此報告結果僅對測試之樣品負責，同時此樣品僅保留90天。本報告未經本公司書面許可，不可部份複製。

This document is issued by the Company subject to its General Conditions of Service printed overleaf, available on request or accessible at www.sgs.com/terms_and_conditions.htm and, for electronic format documents, subject to Terms and Conditions for Electronic Documents at www.sgs.com/terms_e-document.htm. Attention is drawn to the limitation of liability, indemnification and jurisdiction issues defined therein. Any holder of this document is advised that information contained hereon reflects the Company's findings at the time of its intervention only and within the limits of Client's instructions, if any. The Company's sole responsibility is to its Client and this document does not exonerate parties to a transaction from exercising all their rights and obligations under the transaction documents. This document cannot be reproduced except in full, without prior written approval of the Company. Any unauthorized alteration, forgery or falsification of the content or appearance of this document is unlawful and offenders may be prosecuted to the fullest extent of the law.

SGS Taiwan Ltd.

No.134,WuKungRoad,NewTaipeiIndustrialPark,WukuDistrict,NewTaipeiCity,Taiwan24803/新北市五股區新北產業園區五工路 134 號

台灣檢驗科技股份有限公司

t (886-2) 2299-3279

f (886-2) 2298-0488

www.tw.sgs.com

Member of SGS Group

Operation Band	:LTE B4	Temp./Humi.	:24.1 deg_C / 65 RH
Fundamental Frequency	:1745 MHz	Engineer	:Wei
Operation Mode	:Tx CH HIGH		
EUT Pol.	:E1 Plane	Measurement Antenna Pol.	:VERTICAL

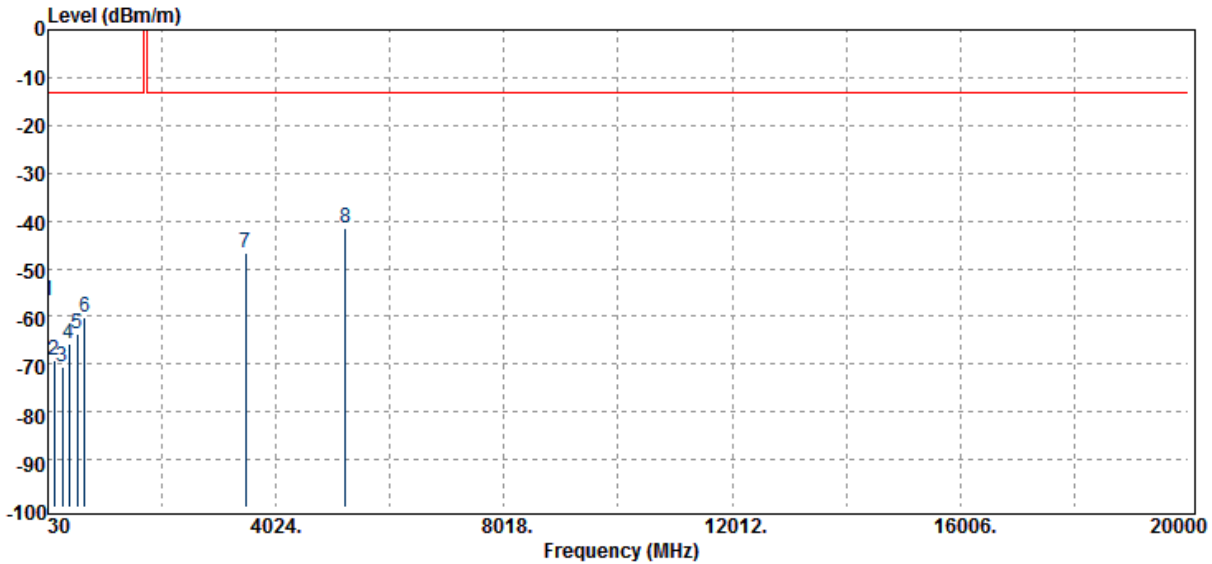

Freq. MHz	ERP/EIRP dBm	SG Output Level dBm	Antenna Gain dBd/dBi	Cable Loss dB	Limit dBm	Margin dB
30.00	-56.61	-41.45	-14.58	-0.58	-13.00	-43.61
143.49	-69.34	-65.93	-2.13	-1.28	-13.00	-56.34
288.99	-70.55	-72.20	3.42	-1.78	-13.00	-57.55
403.45	-65.74	-67.31	3.70	-2.14	-13.00	-52.74
536.34	-63.60	-65.50	4.00	-2.11	-13.00	-50.60
675.05	-60.36	-61.46	3.75	-2.65	-13.00	-47.36
3490.00	-46.60	-51.66	12.38	-6.58	-13.00	-33.60
5235.00	-41.55	-45.56	12.79	-8.21	-13.00	-28.55

Unless otherwise stated the results shown in this test report refer only to the sample(s) tested and such sample(s) are retained for 90 days only.

除非另有說明，此報告結果僅對測試之樣品負責，同時此樣品僅保留90天。本報告未經本公司書面許可，不可部份複製。

This document is issued by the Company subject to its General Conditions of Service printed overleaf, available on request or accessible at www.sgs.com/terms_and_conditions.htm and, for electronic format documents, subject to Terms and Conditions for Electronic Documents at www.sgs.com/terms_e-document.htm. Attention is drawn to the limitation of liability, indemnification and jurisdiction issues defined therein. Any holder of this document is advised that information contained hereon reflects the Company's findings at the time of its intervention only and within the limits of Client's instructions, if any. The Company's sole responsibility is to its Client and this document does not exonerate parties to a transaction from exercising all their rights and obligations under the transaction documents. This document cannot be reproduced except in full, without prior written approval of the Company. Any unauthorized alteration, forgery or falsification of the content or appearance of this document is unlawful and offenders may be prosecuted to the fullest extent of the law.

SGS Taiwan Ltd.

No.134,WuKungRoad,NewTaipeiIndustrialPark,WukuDistrict,NewTaipeiCity,Taiwan24803/新北市五股區新北產業園區五工路 134 號

台灣檢驗科技股份有限公司

t (886-2) 2299-3279

f (886-2) 2298-0488

www.tw.sgs.com

Member of SGS Group

Operation Band	:LTE B4	Temp./Humi.	:24.1 deg_C / 65 RH
Fundamental Frequency	:1745 MHz	Engineer	:Wei
Operation Mode	:Tx CH HIGH		
EUT Pol.	:E1 Plane	Measurement Antenna Pol.	:HORIZONTAL

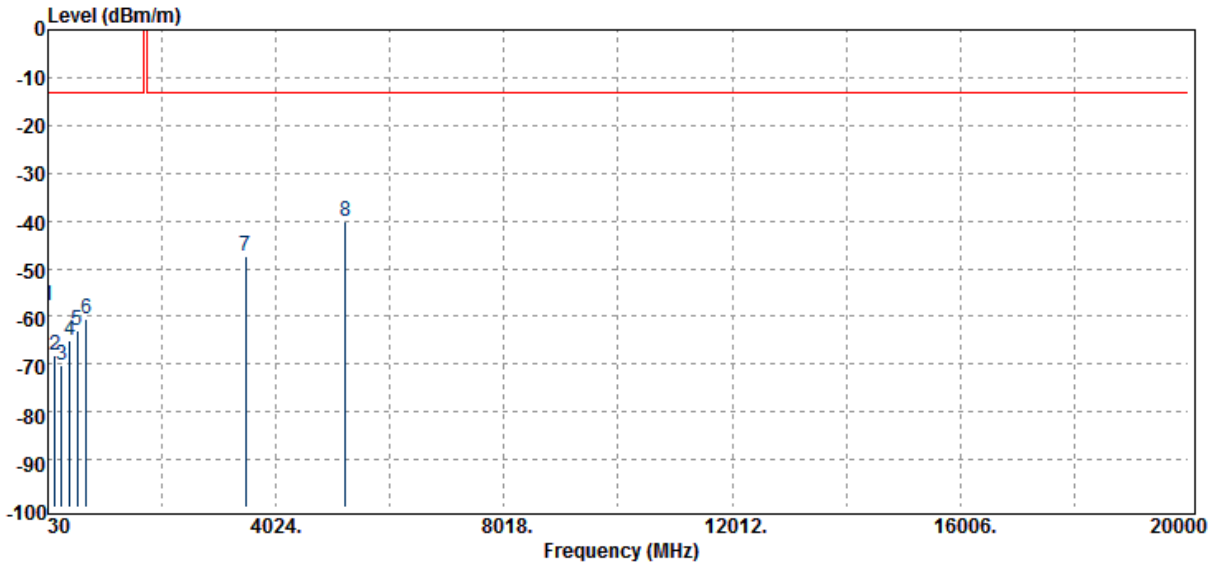

Freq. MHz	ERP/EIRP dBm	SG Output Level dBm	Antenna Gain dBd/dBi	Cable Loss dB	Limit dBm	Margin dB
30.00	-57.83	-42.67	-14.58	-0.58	-13.00	-44.83
149.31	-68.32	-65.19	-1.84	-1.29	-13.00	-55.32
274.44	-70.25	-71.99	3.46	-1.73	-13.00	-57.25
410.24	-65.15	-66.69	3.68	-2.13	-13.00	-52.15
542.16	-62.98	-65.11	3.99	-1.87	-13.00	-49.98
697.36	-60.45	-61.75	3.68	-2.38	-13.00	-47.45
3490.00	-47.29	-52.35	12.38	-6.58	-13.00	-34.29
5235.00	-40.21	-44.23	12.79	-8.21	-13.00	-27.21

Unless otherwise stated the results shown in this test report refer only to the sample(s) tested and such sample(s) are retained for 90 days only.

除非另有說明，此報告結果僅對測試之樣品負責，同時此樣品僅保留90天。本報告未經本公司書面許可，不可部份複製。

This document is issued by the Company subject to its General Conditions of Service printed overleaf, available on request or accessible at www.sgs.com/terms_and_conditions.htm and, for electronic format documents, subject to Terms and Conditions for Electronic Documents at www.sgs.com/terms_e-document.htm. Attention is drawn to the limitation of liability, indemnification and jurisdiction issues defined therein. Any holder of this document is advised that information contained hereon reflects the Company's findings at the time of its intervention only and within the limits of Client's instructions, if any. The Company's sole responsibility is to its Client and this document does not exonerate parties to a transaction from exercising all their rights and obligations under the transaction documents. This document cannot be reproduced except in full, without prior written approval of the Company. Any unauthorized alteration, forgery or falsification of the content or appearance of this document is unlawful and offenders may be prosecuted to the fullest extent of the law.

SGS Taiwan Ltd.

No.134,WuKungRoad,NewTaipeiIndustrialPark,WukuDistrict,NewTaipeiCity,Taiwan24803/新北市五股區新北產業園區五工路 134 號

台灣檢驗科技股份有限公司

t (886-2) 2299-3279

f (886-2) 2298-0488

www.tw.sgs.com

Member of SGS Group

Radiated Spurious Emission Measurement Result: LTE-Band 5 (The Worst Case)

Operation Band	:LTE B5	Temp./Humi.	:24.1 deg_C / 65 RH
Fundamental Frequency	:826.5 MHz	Engineer	:Wei
Operation Mode	:Tx CH LOW		
EUT Pol.	:E1 Plane	Measurement Antenna Pol.	:VERTICAL

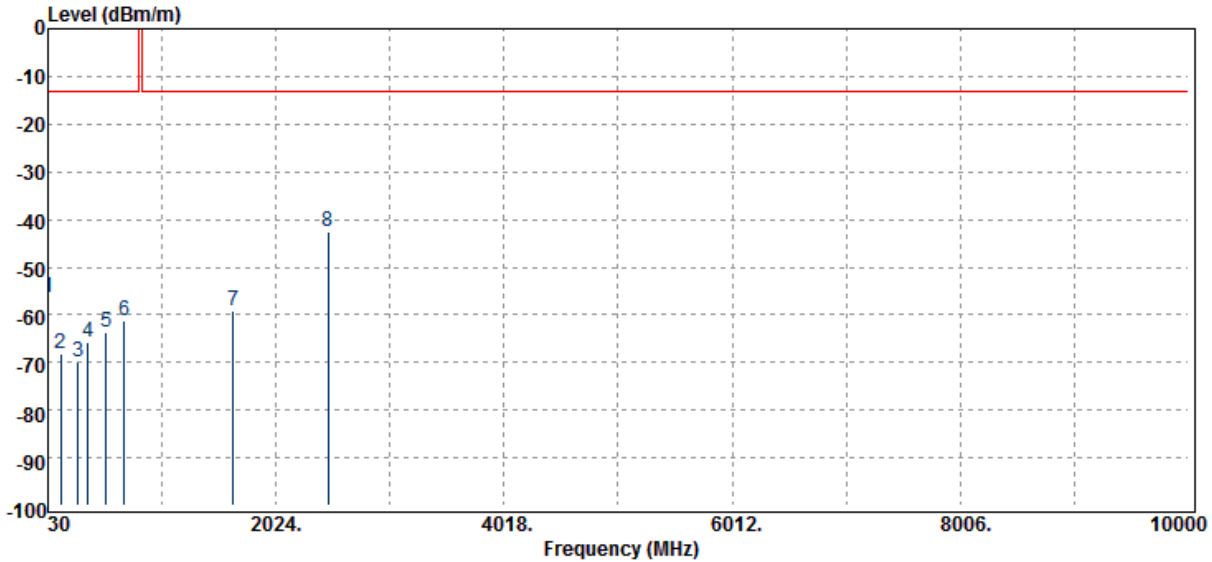

Freq. MHz	ERP/EIRP dBm	SG Output Level dBm	Antenna Gain dBd/dBi	Cable Loss dB	Limit dBm	Margin dB
31.94	-56.38	-41.71	-14.08	-0.59	-13.00	-43.38
141.55	-68.21	-64.72	-2.22	-1.27	-13.00	-55.21
296.75	-69.93	-71.67	3.55	-1.81	-13.00	-56.93
377.26	-65.81	-67.56	3.78	-2.03	-13.00	-52.81
539.25	-63.67	-65.68	4.00	-1.99	-13.00	-50.67
699.30	-61.20	-62.64	3.68	-2.24	-13.00	-48.20
1653.00	-59.13	-63.92	9.14	-4.36	-13.00	-46.13
2479.50	-42.40	-47.39	10.49	-5.50	-13.00	-29.40

Unless otherwise stated the results shown in this test report refer only to the sample(s) tested and such sample(s) are retained for 90 days only.

除非另有說明，此報告結果僅對測試之樣品負責，同時此樣品僅保留90天。本報告未經本公司書面許可，不可部份複製。

This document is issued by the Company subject to its General Conditions of Service printed overleaf, available on request or accessible at www.sgs.com/terms_and_conditions.htm and, for electronic format documents, subject to Terms and Conditions for Electronic Documents at www.sgs.com/terms_e-document.htm. Attention is drawn to the limitation of liability, indemnification and jurisdiction issues defined therein. Any holder of this document is advised that information contained hereon reflects the Company's findings at the time of its intervention only and within the limits of Client's instructions, if any. The Company's sole responsibility is to its Client and this document does not exonerate parties to a transaction from exercising all their rights and obligations under the transaction documents. This document cannot be reproduced except in full, without prior written approval of the Company. Any unauthorized alteration, forgery or falsification of the content or appearance of this document is unlawful and offenders may be prosecuted to the fullest extent of the law.

SGS Taiwan Ltd.

No.134,WuKungRoad,NewTaipeiIndustrialPark,WukuDistrict,NewTaipeiCity,Taiwan24803/新北市五股區新北產業園區五工路 134 號

台灣檢驗科技股份有限公司

t (886-2) 2299-3279

f (886-2) 2298-0488

www.tw.sgs.com

Member of SGS Group

Operation Band	:LTE B5	Temp./Humi.	:24.1 deg_C / 65 RH
Fundamental Frequency	:826.5 MHz	Engineer	:Wei
Operation Mode	:Tx CH LOW		
EUT Pol.	:E1 Plane	Measurement Antenna Pol.	:HORIZONTAL

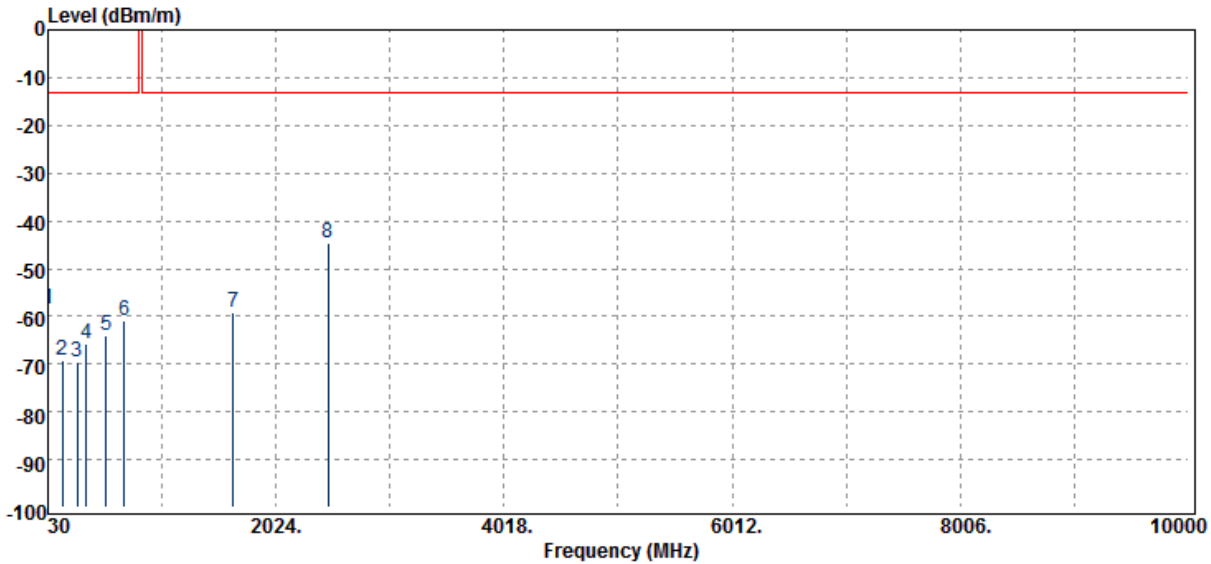

Freq. MHz	ERP/EIRP dBm	SG Output Level dBm	Antenna Gain dBd/dBi	Cable Loss dB	Limit dBm	Margin dB
31.94	-58.37	-43.70	-14.08	-0.59	-13.00	-45.37
153.19	-69.10	-66.18	-1.62	-1.30	-13.00	-56.10
288.99	-69.46	-71.10	3.42	-1.78	-13.00	-56.46
362.71	-65.70	-67.45	3.82	-2.07	-13.00	-52.70
539.25	-64.05	-66.06	4.00	-1.99	-13.00	-51.05
700.27	-60.92	-62.44	3.67	-2.16	-13.00	-47.92
1653.00	-59.09	-63.87	9.14	-4.36	-13.00	-46.09
2479.50	-44.64	-49.63	10.49	-5.50	-13.00	-31.64

Unless otherwise stated the results shown in this test report refer only to the sample(s) tested and such sample(s) are retained for 90 days only.

除非另有說明，此報告結果僅對測試之樣品負責，同時此樣品僅保留90天。本報告未經本公司書面許可，不可部份複製。

This document is issued by the Company subject to its General Conditions of Service printed overleaf, available on request or accessible at www.sgs.com/terms_and_conditions.htm and, for electronic format documents, subject to Terms and Conditions for Electronic Documents at www.sgs.com/terms_e-document.htm. Attention is drawn to the limitation of liability, indemnification and jurisdiction issues defined therein. Any holder of this document is advised that information contained hereon reflects the Company's findings at the time of its intervention only and within the limits of Client's instructions, if any. The Company's sole responsibility is to its Client and this document does not exonerate parties to a transaction from exercising all their rights and obligations under the transaction documents. This document cannot be reproduced except in full, without prior written approval of the Company. Any unauthorized alteration, forgery or falsification of the content or appearance of this document is unlawful and offenders may be prosecuted to the fullest extent of the law.

Operation Band	:LTE B5	Temp./Humi.	:24.1 deg_C / 65 RH
Fundamental Frequency	:836.5 MHz	Engineer	:Wei
Operation Mode	:Tx CH MID		
EUT Pol.	:E1 Plane	Measurement Antenna Pol.	:VERTICAL

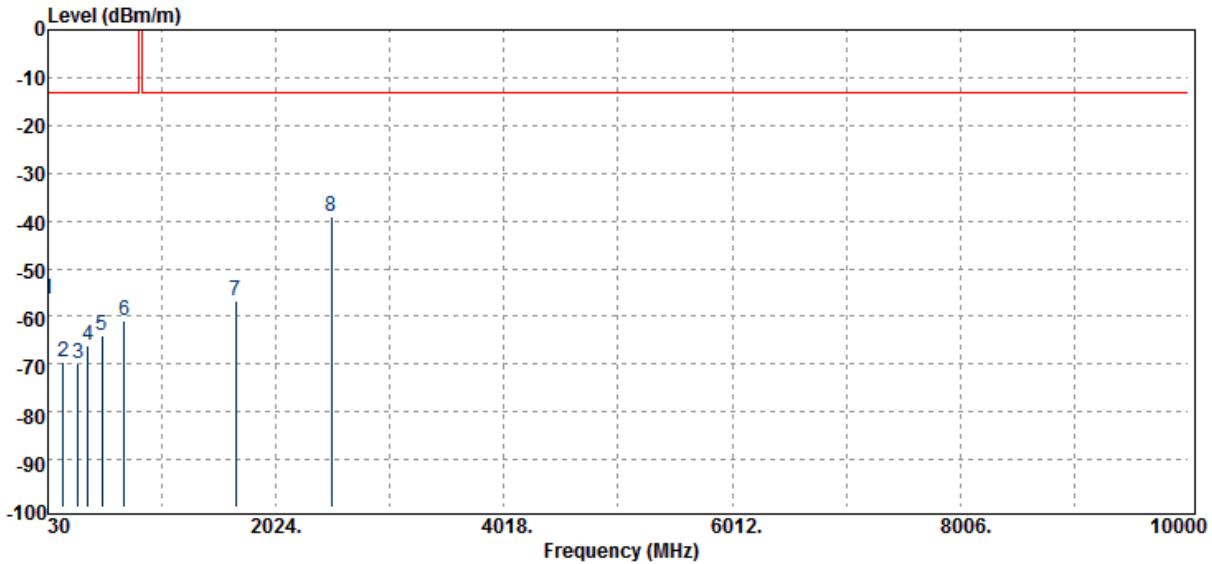

Freq. MHz	ERP/EIRP dBm	SG Output Level dBm	Antenna Gain dBd/dBi	Cable Loss dB	Limit dBm	Margin dB
31.94	-56.46	-41.78	-14.08	-0.59	-13.00	-43.46
160.95	-69.63	-67.14	-1.18	-1.30	-13.00	-56.63
294.81	-70.01	-71.73	3.52	-1.80	-13.00	-57.01
382.11	-66.17	-67.92	3.76	-2.02	-13.00	-53.17
502.39	-64.11	-65.90	4.05	-2.26	-13.00	-51.11
694.45	-60.93	-62.01	3.69	-2.61	-13.00	-47.93
1673.00	-56.62	-61.44	9.21	-4.39	-13.00	-43.62
2509.50	-39.10	-44.08	10.51	-5.53	-13.00	-26.10

Unless otherwise stated the results shown in this test report refer only to the sample(s) tested and such sample(s) are retained for 90 days only.

除非另有說明，此報告結果僅對測試之樣品負責，同時此樣品僅保留90天。本報告未經本公司書面許可，不可部份複製。

This document is issued by the Company subject to its General Conditions of Service printed overleaf, available on request or accessible at www.sgs.com/terms_and_conditions.htm and, for electronic format documents, subject to Terms and Conditions for Electronic Documents at www.sgs.com/terms_e-document.htm. Attention is drawn to the limitation of liability, indemnification and jurisdiction issues defined therein. Any holder of this document is advised that information contained hereon reflects the Company's findings at the time of its intervention only and within the limits of Client's instructions, if any. The Company's sole responsibility is to its Client and this document does not exonerate parties to a transaction from exercising all their rights and obligations under the transaction documents. This document cannot be reproduced except in full, without prior written approval of the Company. Any unauthorized alteration, forgery or falsification of the content or appearance of this document is unlawful and offenders may be prosecuted to the fullest extent of the law.

SGS Taiwan Ltd.

No.134,WuKungRoad,NewTaipeiIndustrialPark,WukuDistrict,NewTaipeiCity,Taiwan24803/新北市五股區新北產業園區五工路 134 號

台灣檢驗科技股份有限公司

t (886-2) 2299-3279

f (886-2) 2298-0488

www.tw.sgs.com

Member of SGS Group

Operation Band	:LTE B5	Temp./Humi.	:24.1 deg_C / 65 RH
Fundamental Frequency	:836.5 MHz	Engineer	:Wei
Operation Mode	:Tx CH MID		
EUT Pol.	:E1 Plane	Measurement Antenna Pol.	:HORIZONTAL

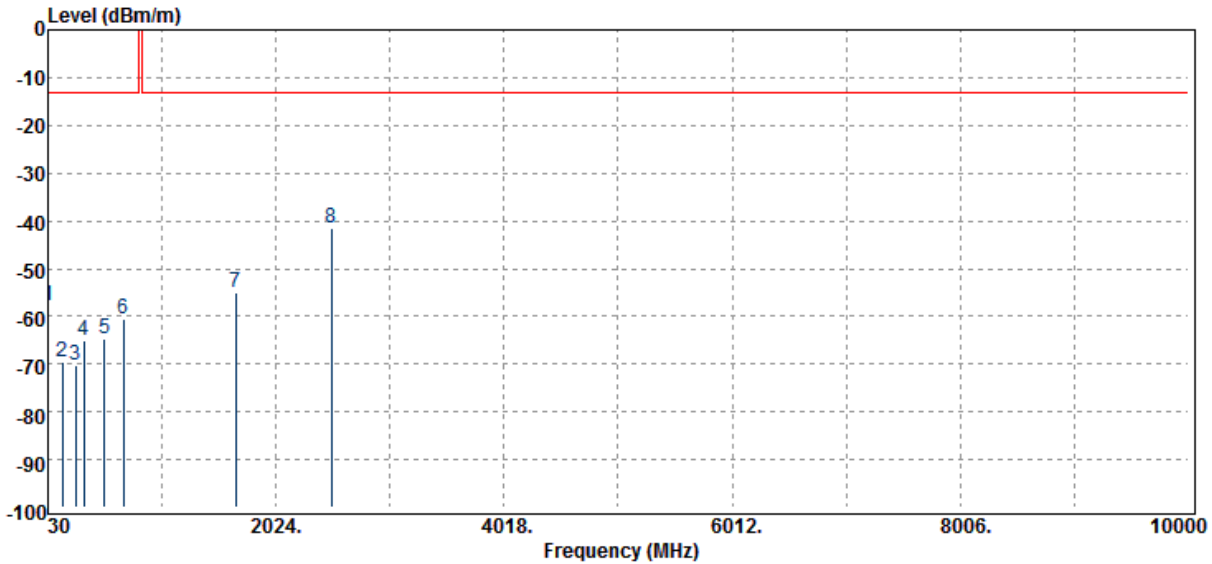

Freq. MHz	ERP/EIRP dBm	SG Output Level dBm	Antenna Gain dBd/dBi	Cable Loss dB	Limit dBm	Margin dB
31.94	-57.77	-43.09	-14.08	-0.59	-13.00	-44.77
154.16	-69.45	-66.58	-1.57	-1.30	-13.00	-56.45
274.44	-70.40	-72.13	3.46	-1.73	-13.00	-57.40
340.40	-65.02	-66.85	3.81	-1.98	-13.00	-52.02
527.61	-64.67	-66.22	4.01	-2.47	-13.00	-51.67
692.51	-60.65	-61.59	3.70	-2.76	-13.00	-47.65
1673.00	-55.01	-59.83	9.21	-4.39	-13.00	-42.01
2509.50	-41.57	-46.56	10.51	-5.53	-13.00	-28.57

Unless otherwise stated the results shown in this test report refer only to the sample(s) tested and such sample(s) are retained for 90 days only.

除非另有說明，此報告結果僅對測試之樣品負責，同時此樣品僅保留90天。本報告未經本公司書面許可，不可部份複製。

This document is issued by the Company subject to its General Conditions of Service printed overleaf, available on request or accessible at www.sgs.com/terms_and_conditions.htm and, for electronic format documents, subject to Terms and Conditions for Electronic Documents at www.sgs.com/terms_e-document.htm. Attention is drawn to the limitation of liability, indemnification and jurisdiction issues defined therein. Any holder of this document is advised that information contained hereon reflects the Company's findings at the time of its intervention only and within the limits of Client's instructions, if any. The Company's sole responsibility is to its Client and this document does not exonerate parties to a transaction from exercising all their rights and obligations under the transaction documents. This document cannot be reproduced except in full, without prior written approval of the Company. Any unauthorized alteration, forgery or falsification of the content or appearance of this document is unlawful and offenders may be prosecuted to the fullest extent of the law.

SGS Taiwan Ltd.

No.134,WuKungRoad,NewTaipeiIndustrialPark,WukuDistrict,NewTaipeiCity,Taiwan24803/新北市五股區新北產業園區五工路 134 號

台灣檢驗科技股份有限公司

t (886-2) 2299-3279

f (886-2) 2298-0488

www.tw.sgs.com

Member of SGS Group

Operation Band	:LTE B5	Temp./Humi.	:24.1 deg_C / 65 RH
Fundamental Frequency	:846.5 MHz	Engineer	:Wei
Operation Mode	:Tx CH HIGH		
EUT Pol.	:E1 Plane	Measurement Antenna Pol.	:VERTICAL

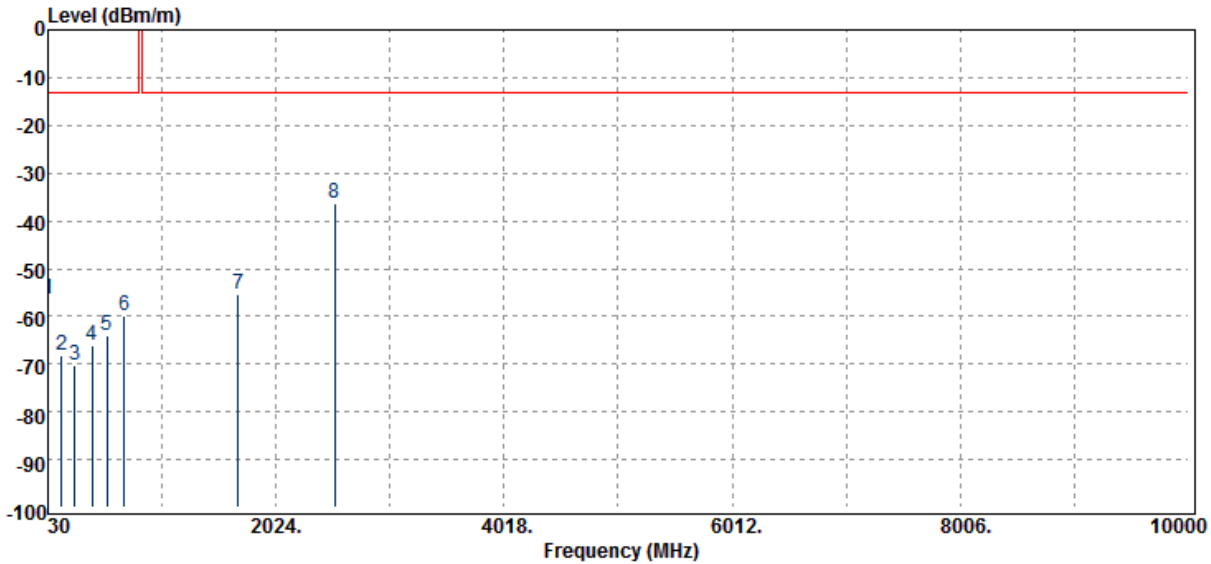

Freq. MHz	ERP/EIRP dBm	SG Output Level dBm	Antenna Gain dBd/dBi	Cable Loss dB	Limit dBm	Margin dB
30.00	-56.29	-41.13	-14.58	-0.58	-13.00	-43.29
146.40	-68.11	-64.85	-1.98	-1.29	-13.00	-55.11
264.74	-70.30	-72.18	3.59	-1.71	-13.00	-57.30
415.09	-65.99	-67.53	3.66	-2.12	-13.00	-52.99
547.01	-64.13	-66.25	3.98	-1.86	-13.00	-51.13
697.36	-59.90	-61.20	3.68	-2.38	-13.00	-46.90
1693.00	-55.23	-60.08	9.27	-4.43	-13.00	-42.23
2539.50	-36.47	-41.47	10.56	-5.57	-13.00	-23.47

Unless otherwise stated the results shown in this test report refer only to the sample(s) tested and such sample(s) are retained for 90 days only.

除非另有說明，此報告結果僅對測試之樣品負責，同時此樣品僅保留90天。本報告未經本公司書面許可，不可部份複製。

This document is issued by the Company subject to its General Conditions of Service printed overleaf, available on request or accessible at www.sgs.com/terms_and_conditions.htm and, for electronic format documents, subject to Terms and Conditions for Electronic Documents at www.sgs.com/terms_e-document.htm. Attention is drawn to the limitation of liability, indemnification and jurisdiction issues defined therein. Any holder of this document is advised that information contained hereon reflects the Company's findings at the time of its intervention only and within the limits of Client's instructions, if any. The Company's sole responsibility is to its Client and this document does not exonerate parties to a transaction from exercising all their rights and obligations under the transaction documents. This document cannot be reproduced except in full, without prior written approval of the Company. Any unauthorized alteration, forgery or falsification of the content or appearance of this document is unlawful and offenders may be prosecuted to the fullest extent of the law.

Operation Band	:LTE B5	Temp./Humi.	:24.1 deg_C / 65 RH
Fundamental Frequency	:846.5 MHz	Engineer	:Wei
Operation Mode	:Tx CH HIGH		
EUT Pol.	:E1 Plane	Measurement Antenna Pol.	:HORIZONTAL

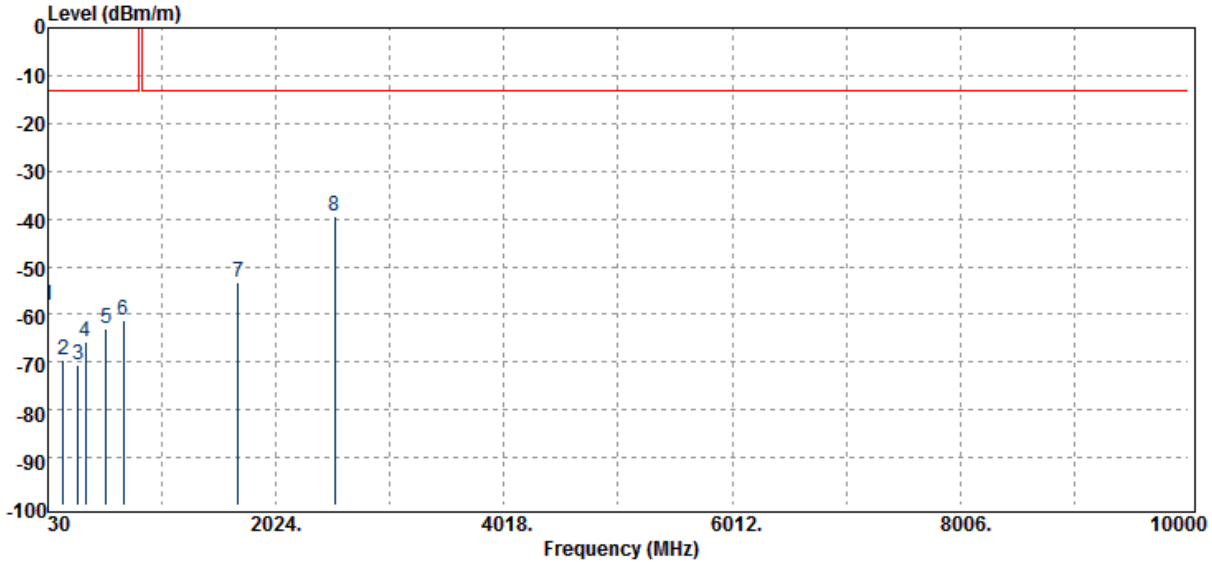

Freq. MHz	ERP/EIRP dBm	SG Output Level dBm	Antenna Gain dBd/dBi	Cable Loss dB	Limit dBm	Margin dB
31.94	-58.06	-43.39	-14.08	-0.59	-13.00	-45.06
160.95	-69.56	-67.07	-1.18	-1.30	-13.00	-56.56
294.81	-70.43	-72.15	3.52	-1.80	-13.00	-57.43
359.80	-65.70	-67.46	3.83	-2.06	-13.00	-52.70
541.19	-62.89	-64.98	3.99	-1.91	-13.00	-49.89
687.66	-61.40	-61.97	3.71	-3.13	-13.00	-48.40
1693.00	-53.25	-58.09	9.27	-4.43	-13.00	-40.25
2539.50	-39.58	-44.58	10.56	-5.57	-13.00	-26.58

Unless otherwise stated the results shown in this test report refer only to the sample(s) tested and such sample(s) are retained for 90 days only.

除非另有說明，此報告結果僅對測試之樣品負責，同時此樣品僅保留90天。本報告未經本公司書面許可，不可部份複製。

This document is issued by the Company subject to its General Conditions of Service printed overleaf, available on request or accessible at www.sgs.com/terms_and_conditions.htm and, for electronic format documents, subject to Terms and Conditions for Electronic Documents at www.sgs.com/terms_e-document.htm. Attention is drawn to the limitation of liability, indemnification and jurisdiction issues defined therein. Any holder of this document is advised that information contained hereon reflects the Company's findings at the time of its intervention only and within the limits of Client's instructions, if any. The Company's sole responsibility is to its Client and this document does not exonerate parties to a transaction from exercising all their rights and obligations under the transaction documents. This document cannot be reproduced except in full, without prior written approval of the Company. Any unauthorized alteration, forgery or falsification of the content or appearance of this document is unlawful and offenders may be prosecuted to the fullest extent of the law.

Radiated Spurious Emission Measurement Result: LTE-Band 12 (The Worst Case)

Operation Band	:LTE B12	Temp./Humi.	:22 deg_C / 62 RH
Fundamental Frequency	:700.5 MHz	Engineer	:Wei
Operation Mode	:Tx CH LOW		
EUT Pol.	:E1 Plane	Measurement Antenna Pol.	:VERTICAL

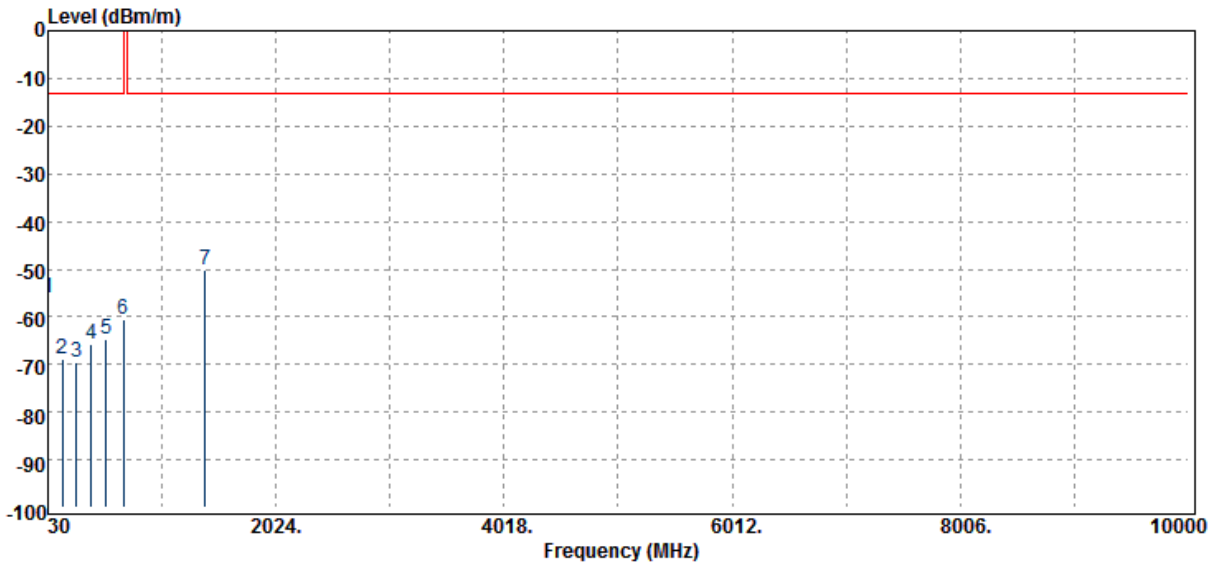

Freq. MHz	ERP/EIRP dBm	SG Output Level dBm	Antenna Gain dBd/dBi	Cable Loss dB	Limit dBm	Margin dB
31.94	-56.20	-41.52	-14.08	-0.59	-13.00	-43.20
153.19	-69.00	-66.08	-1.62	-1.30	-13.00	-56.00
282.20	-69.38	-71.05	3.42	-1.75	-13.00	-56.38
411.21	-65.92	-67.46	3.67	-2.13	-13.00	-52.92
537.31	-64.56	-66.50	4.00	-2.07	-13.00	-51.56
686.69	-60.43	-60.94	3.72	-3.21	-13.00	-47.43
1401.00	-50.23	-54.44	8.20	-3.98	-13.00	-37.23

Unless otherwise stated the results shown in this test report refer only to the sample(s) tested and such sample(s) are retained for 90 days only.

除非另有說明，此報告結果僅對測試之樣品負責，同時此樣品僅保留90天。本報告未經本公司書面許可，不可部份複製。

This document is issued by the Company subject to its General Conditions of Service printed overleaf, available on request or accessible at www.sgs.com/terms_and_conditions.htm and, for electronic format documents, subject to Terms and Conditions for Electronic Documents at www.sgs.com/terms_e-document.htm. Attention is drawn to the limitation of liability, indemnification and jurisdiction issues defined therein. Any holder of this document is advised that information contained hereon reflects the Company's findings at the time of its intervention only and within the limits of Client's instructions, if any. The Company's sole responsibility is to its Client and this document does not exonerate parties to a transaction from exercising all their rights and obligations under the transaction documents. This document cannot be reproduced except in full, without prior written approval of the Company. Any unauthorized alteration, forgery or falsification of the content or appearance of this document is unlawful and offenders may be prosecuted to the fullest extent of the law.

Operation Band	:LTE B12	Temp./Humi.	:22 deg_C / 62 RH
Fundamental Frequency	:700.5 MHz	Engineer	:Wei
Operation Mode	:Tx CH LOW		
EUT Pol.	:E1 Plane	Measurement Antenna Pol.	:HORIZONTAL

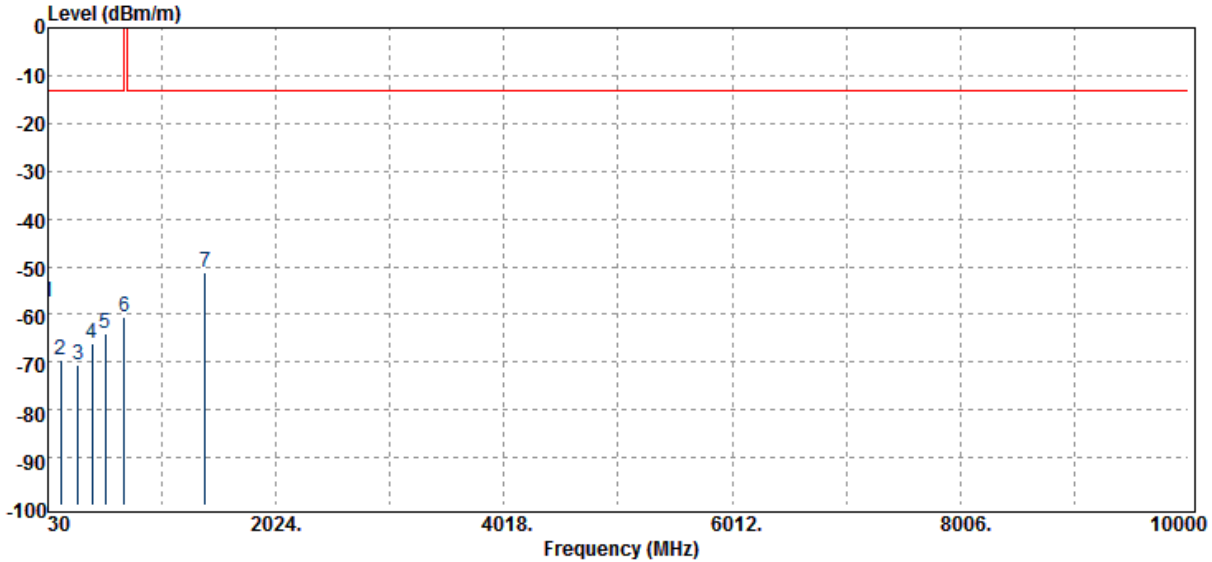

Freq. MHz	ERP/EIRP dBm	SG Output Level dBm	Antenna Gain dBd/dBi	Cable Loss dB	Limit dBm	Margin dB
31.94	-57.44	-42.77	-14.08	-0.59	-13.00	-44.44
139.61	-69.50	-65.95	-2.29	-1.26	-13.00	-56.50
293.84	-70.75	-72.45	3.50	-1.80	-13.00	-57.75
418.00	-66.18	-67.71	3.65	-2.11	-13.00	-53.18
534.40	-63.94	-65.76	4.00	-2.19	-13.00	-50.94
696.39	-60.72	-61.94	3.69	-2.46	-13.00	-47.72
1401.00	-51.22	-55.43	8.20	-3.98	-13.00	-38.22

Unless otherwise stated the results shown in this test report refer only to the sample(s) tested and such sample(s) are retained for 90 days only.

除非另有說明，此報告結果僅對測試之樣品負責，同時此樣品僅保留90天。本報告未經本公司書面許可，不可部份複製。

This document is issued by the Company subject to its General Conditions of Service printed overleaf, available on request or accessible at www.sgs.com/terms_and_conditions.htm and, for electronic format documents, subject to Terms and Conditions for Electronic Documents at www.sgs.com/terms_e-document.htm. Attention is drawn to the limitation of liability, indemnification and jurisdiction issues defined therein. Any holder of this document is advised that information contained hereon reflects the Company's findings at the time of its intervention only and within the limits of Client's instructions, if any. The Company's sole responsibility is to its Client and this document does not exonerate parties to a transaction from exercising all their rights and obligations under the transaction documents. This document cannot be reproduced except in full, without prior written approval of the Company. Any unauthorized alteration, forgery or falsification of the content or appearance of this document is unlawful and offenders may be prosecuted to the fullest extent of the law.

SGS Taiwan Ltd.

No.134,WuKungRoad,NewTaipeiIndustrialPark,WukuDistrict,NewTaipeiCity,Taiwan24803/新北市五股區新北產業園區五工路 134 號

台灣檢驗科技股份有限公司

t (886-2) 2299-3279

f (886-2) 2298-0488

www.tw.sgs.com

Member of SGS Group

Operation Band	:LTE B12	Temp./Humi.	:22 deg_C / 62 RH
Fundamental Frequency	:707.5 MHz	Engineer	:Wei
Operation Mode	:Tx CH MID		
EUT Pol.	:E1 Plane	Measurement Antenna Pol.	:VERTICAL

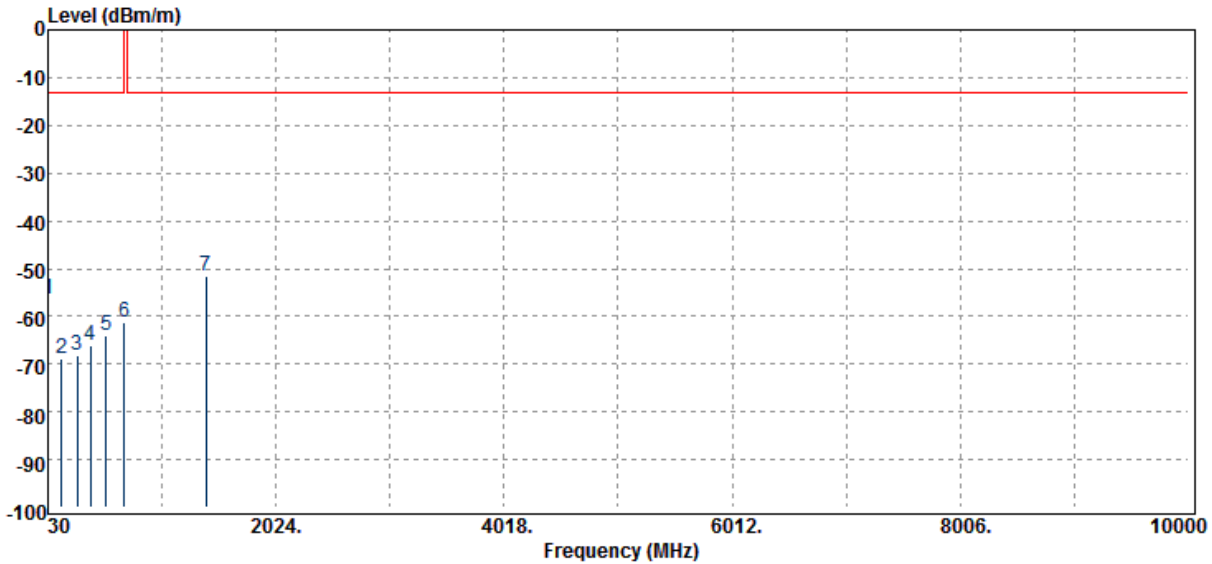

Freq. MHz	ERP/EIRP dBm	SG Output Level dBm	Antenna Gain dBd/dBi	Cable Loss dB	Limit dBm	Margin dB
31.94	-56.49	-41.82	-14.08	-0.59	-13.00	-43.49
148.34	-69.02	-65.85	-1.89	-1.29	-13.00	-56.02
284.14	-68.23	-69.90	3.42	-1.76	-13.00	-55.23
403.45	-66.15	-67.71	3.70	-2.14	-13.00	-53.15
539.25	-63.89	-65.90	4.00	-1.99	-13.00	-50.89
696.39	-61.33	-62.55	3.69	-2.46	-13.00	-48.33
1415.00	-51.62	-55.87	8.25	-4.01	-13.00	-38.62

Unless otherwise stated the results shown in this test report refer only to the sample(s) tested and such sample(s) are retained for 90 days only.

除非另有說明，此報告結果僅對測試之樣品負責，同時此樣品僅保留90天。本報告未經本公司書面許可，不可部份複製。

This document is issued by the Company subject to its General Conditions of Service printed overleaf, available on request or accessible at www.sgs.com/terms_and_conditions.htm and, for electronic format documents, subject to Terms and Conditions for Electronic Documents at www.sgs.com/terms_e-document.htm. Attention is drawn to the limitation of liability, indemnification and jurisdiction issues defined therein. Any holder of this document is advised that information contained hereon reflects the Company's findings at the time of its intervention only and within the limits of Client's instructions, if any. The Company's sole responsibility is to its Client and this document does not exonerate parties to a transaction from exercising all their rights and obligations under the transaction documents. This document cannot be reproduced except in full, without prior written approval of the Company. Any unauthorized alteration, forgery or falsification of the content or appearance of this document is unlawful and offenders may be prosecuted to the fullest extent of the law.

SGS Taiwan Ltd.

No.134,WuKungRoad,NewTaipeiIndustrialPark,WukuDistrict,NewTaipeiCity,Taiwan24803/新北市五股區新北產業園區五工路 134 號

台灣檢驗科技股份有限公司

t (886-2) 2299-3279

f (886-2) 2298-0488

www.tw.sgs.com

Member of SGS Group

Operation Band	:LTE B12	Temp./Humi.	:22 deg_C / 62 RH
Fundamental Frequency	:707.5 MHz	Engineer	:Wei
Operation Mode	:Tx CH MID		
EUT Pol.	:E1 Plane	Measurement Antenna Pol.	:HORIZONTAL

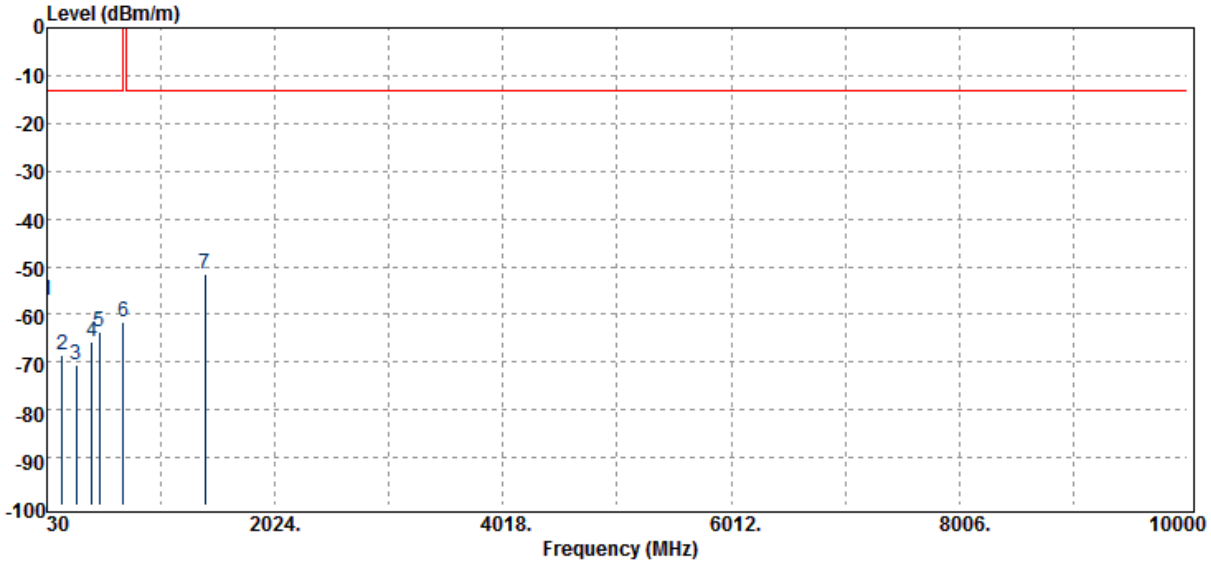

Freq. MHz	ERP/EIRP dBm	SG Output Level dBm	Antenna Gain dBd/dBi	Cable Loss dB	Limit dBm	Margin dB
30.00	-56.98	-41.82	-14.58	-0.58	-13.00	-43.98
163.86	-68.59	-66.28	-1.00	-1.31	-13.00	-55.59
285.11	-70.64	-72.30	3.42	-1.76	-13.00	-57.64
419.94	-65.82	-67.36	3.64	-2.11	-13.00	-52.82
485.90	-63.74	-65.81	3.91	-1.84	-13.00	-50.74
697.36	-61.57	-62.87	3.68	-2.38	-13.00	-48.57
1415.00	-51.73	-55.97	8.25	-4.01	-13.00	-38.73

Unless otherwise stated the results shown in this test report refer only to the sample(s) tested and such sample(s) are retained for 90 days only.

除非另有說明，此報告結果僅對測試之樣品負責，同時此樣品僅保留90天。本報告未經本公司書面許可，不可部份複製。

This document is issued by the Company subject to its General Conditions of Service printed overleaf, available on request or accessible at www.sgs.com/terms_and_conditions.htm and, for electronic format documents, subject to Terms and Conditions for Electronic Documents at www.sgs.com/terms_e-document.htm. Attention is drawn to the limitation of liability, indemnification and jurisdiction issues defined therein. Any holder of this document is advised that information contained hereon reflects the Company's findings at the time of its intervention only and within the limits of Client's instructions, if any. The Company's sole responsibility is to its Client and this document does not exonerate parties to a transaction from exercising all their rights and obligations under the transaction documents. This document cannot be reproduced except in full, without prior written approval of the Company. Any unauthorized alteration, forgery or falsification of the content or appearance of this document is unlawful and offenders may be prosecuted to the fullest extent of the law.

SGS Taiwan Ltd.

No.134,WuKungRoad,NewTaipeiIndustrialPark,WukuDistrict,NewTaipeiCity,Taiwan24803/新北市五股區新北產業園區五工路 134 號

台灣檢驗科技股份有限公司

t (886-2) 2299-3279

f (886-2) 2298-0488

www.tw.sgs.com

Member of SGS Group

Operation Band	:LTE B12	Temp./Humi.	:22 deg_C / 62 RH
Fundamental Frequency	:714.5 MHz	Engineer	:Wei
Operation Mode	:Tx CH HIGH		
EUT Pol.	:E1 Plane	Measurement Antenna Pol.	:VERTICAL

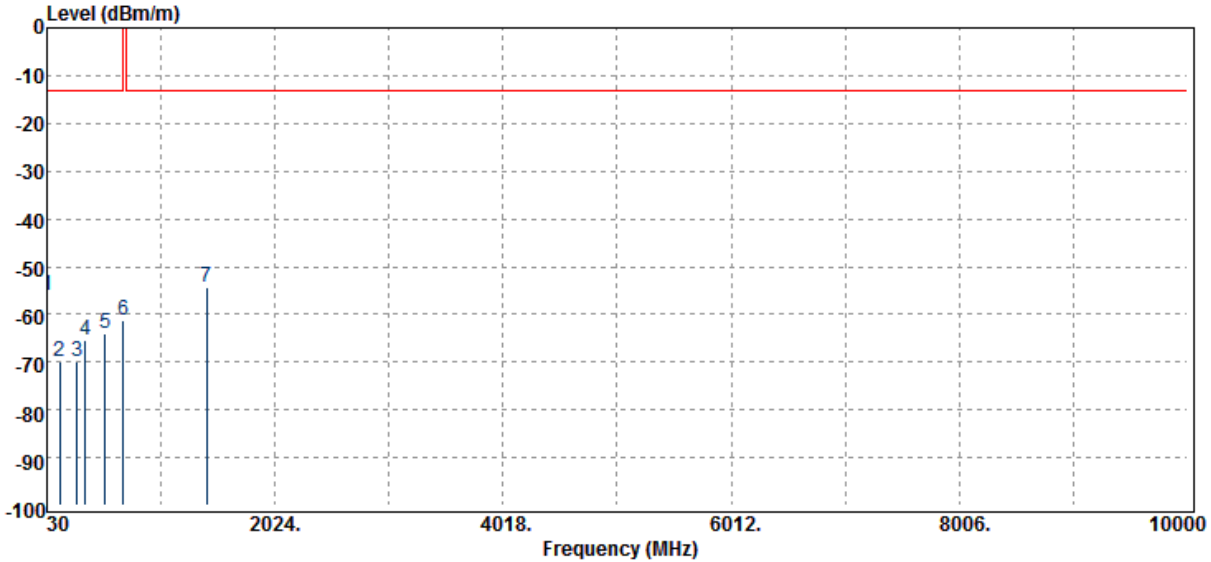

Freq. MHz	ERP/EIRP dBm	SG Output Level dBm	Antenna Gain dBd/dBi	Cable Loss dB	Limit dBm	Margin dB
30.00	-55.98	-40.82	-14.58	-0.58	-13.00	-42.98
143.49	-69.87	-66.46	-2.13	-1.28	-13.00	-56.87
289.96	-69.79	-71.43	3.42	-1.78	-13.00	-56.79
364.65	-65.53	-67.27	3.81	-2.07	-13.00	-52.53
539.25	-63.92	-65.93	4.00	-1.99	-13.00	-50.92
699.30	-61.14	-62.58	3.68	-2.24	34.77	-95.91
1429.00	-54.50	-58.78	8.31	-4.03	-13.00	-41.50

Unless otherwise stated the results shown in this test report refer only to the sample(s) tested and such sample(s) are retained for 90 days only.

除非另有說明，此報告結果僅對測試之樣品負責，同時此樣品僅保留90天。本報告未經本公司書面許可，不可部份複製。

This document is issued by the Company subject to its General Conditions of Service printed overleaf, available on request or accessible at www.sgs.com/terms_and_conditions.htm and, for electronic format documents, subject to Terms and Conditions for Electronic Documents at www.sgs.com/terms_e-document.htm. Attention is drawn to the limitation of liability, indemnification and jurisdiction issues defined therein. Any holder of this document is advised that information contained hereon reflects the Company's findings at the time of its intervention only and within the limits of Client's instructions, if any. The Company's sole responsibility is to its Client and this document does not exonerate parties to a transaction from exercising all their rights and obligations under the transaction documents. This document cannot be reproduced except in full, without prior written approval of the Company. Any unauthorized alteration, forgery or falsification of the content or appearance of this document is unlawful and offenders may be prosecuted to the fullest extent of the law.

Operation Band	:LTE B12	Temp./Humi.	:22 deg_C / 62 RH
Fundamental Frequency	:714.5 MHz	Engineer	:Wei
Operation Mode	:Tx CH HIGH		
EUT Pol.	:E1 Plane	Measurement Antenna Pol.	:HORIZONTAL

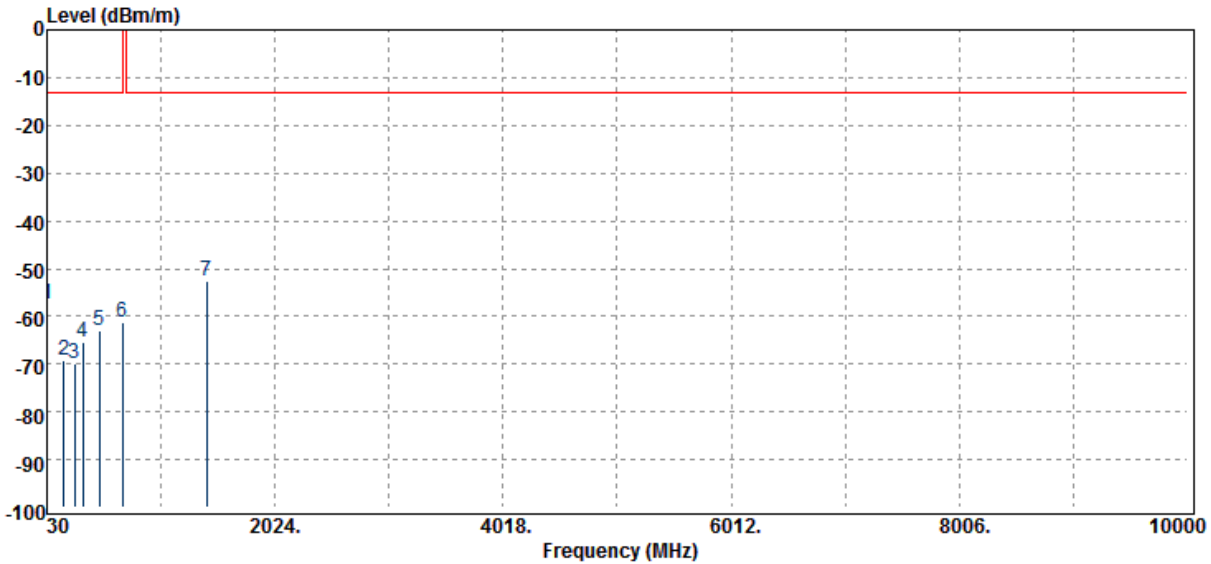

Freq. MHz	ERP/EIRP dBm	SG Output Level dBm	Antenna Gain dBd/dBi	Cable Loss dB	Limit dBm	Margin dB
30.00	-57.49	-42.33	-14.58	-0.58	-13.00	-44.49
180.35	-69.04	-68.69	1.04	-1.38	-13.00	-56.04
270.56	-70.00	-71.77	3.50	-1.72	-13.00	-57.00
343.31	-65.54	-67.37	3.82	-2.00	-13.00	-52.54
490.75	-62.92	-64.92	3.96	-1.96	-13.00	-49.92
689.60	-61.39	-62.11	3.71	-2.98	-13.00	-48.39
1429.00	-52.72	-57.00	8.31	-4.03	-13.00	-39.72

Unless otherwise stated the results shown in this test report refer only to the sample(s) tested and such sample(s) are retained for 90 days only.

除非另有說明，此報告結果僅對測試之樣品負責，同時此樣品僅保留90天。本報告未經本公司書面許可，不可部份複製。

This document is issued by the Company subject to its General Conditions of Service printed overleaf, available on request or accessible at www.sgs.com/terms_and_conditions.htm and, for electronic format documents, subject to Terms and Conditions for Electronic Documents at www.sgs.com/terms_e-document.htm. Attention is drawn to the limitation of liability, indemnification and jurisdiction issues defined therein. Any holder of this document is advised that information contained hereon reflects the Company's findings at the time of its intervention only and within the limits of Client's instructions, if any. The Company's sole responsibility is to its Client and this document does not exonerate parties to a transaction from exercising all their rights and obligations under the transaction documents. This document cannot be reproduced except in full, without prior written approval of the Company. Any unauthorized alteration, forgery or falsification of the content or appearance of this document is unlawful and offenders may be prosecuted to the fullest extent of the law.

Radiated Spurious Emission Measurement Result: LTE-Band 13 (The Worst Case)

Operation Band :LTE B13 Temp./Humi. :24.1 deg_C / 65 RH
 Fundamental Frequency :782.0 MHz Engineer :Tin
 Operation Mode :Tx CH MID
 EUT Pol. :E1 Plane Measurement Antenna Pol. :VERTICAL

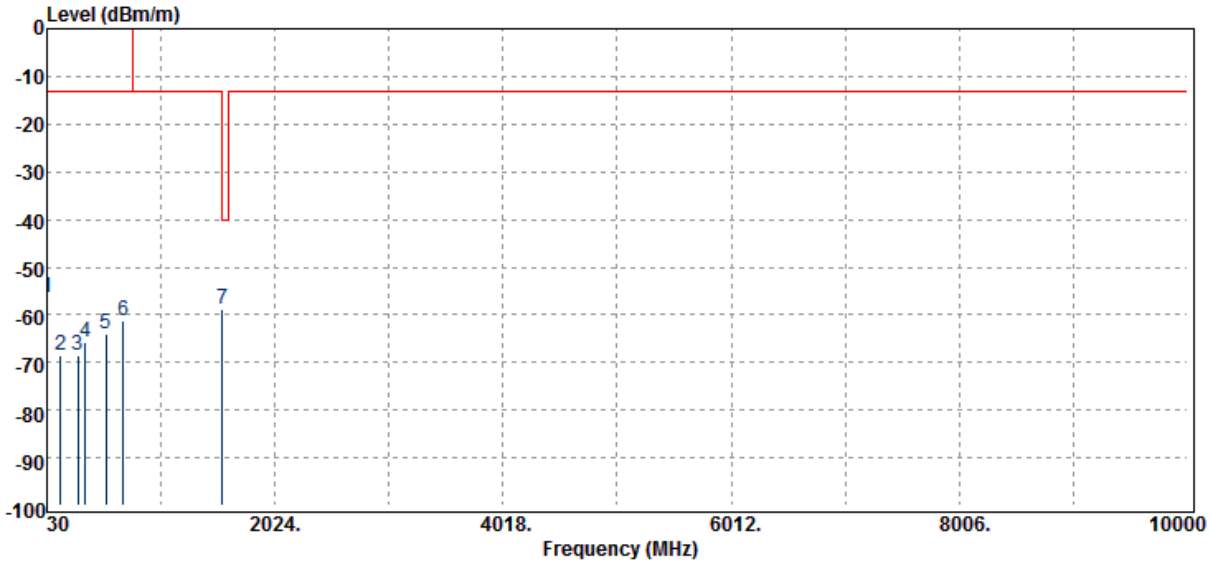

Freq. MHz	ERP/EIRP dBm	SG Output Level dBm	Antenna Gain dBd/dBi	Cable Loss dB	Limit dBm	Margin dB
31.94	-56.36	-41.68	-14.08	-0.59	-13.00	-43.36
149.31	-68.53	-65.40	-1.84	-1.29	-13.00	-55.53
298.69	-68.45	-70.22	3.59	-1.82	-13.00	-55.45
367.56	-65.87	-67.61	3.80	-2.06	-13.00	-52.87
544.10	-63.96	-66.16	3.99	-1.79	-13.00	-50.96
700.27	-61.20	-62.71	3.67	-2.16	-13.00	-48.20
1564.00	-58.99	-63.57	8.83	-4.26	-40.00	-18.99

Unless otherwise stated the results shown in this test report refer only to the sample(s) tested and such sample(s) are retained for 90 days only.

除非另有說明，此報告結果僅對測試之樣品負責，同時此樣品僅保留90天。本報告未經本公司書面許可，不可部份複製。

This document is issued by the Company subject to its General Conditions of Service printed overleaf, available on request or accessible at www.sgs.com/terms_and_conditions.htm and, for electronic format documents, subject to Terms and Conditions for Electronic Documents at www.sgs.com/terms_e-document.htm. Attention is drawn to the limitation of liability, indemnification and jurisdiction issues defined therein. Any holder of this document is advised that information contained hereon reflects the Company's findings at the time of its intervention only and within the limits of Client's instructions, if any. The Company's sole responsibility is to its Client and this document does not exonerate parties to a transaction from exercising all their rights and obligations under the transaction documents. This document cannot be reproduced except in full, without prior written approval of the Company. Any unauthorized alteration, forgery or falsification of the content or appearance of this document is unlawful and offenders may be prosecuted to the fullest extent of the law.

SGS Taiwan Ltd.

No.134,WuKungRoad,NewTaipeiIndustrialPark,WukuDistrict,NewTaipeiCity,Taiwan24803/新北市五股區新北產業園區五工路 134 號

台灣檢驗科技股份有限公司

t (886-2) 2299-3279

f (886-2) 2298-0488

www.tw.sgs.com

Member of SGS Group

Operation Band	:LTE B13	Temp./Humi.	:24.1 deg_C / 65 RH
Fundamental Frequency	:782.0 MHz	Engineer	:Tin
Operation Mode	:Tx CH MID		
EUT Pol.	:E1 Plane	Measurement Antenna Pol.	:HORIZONTAL

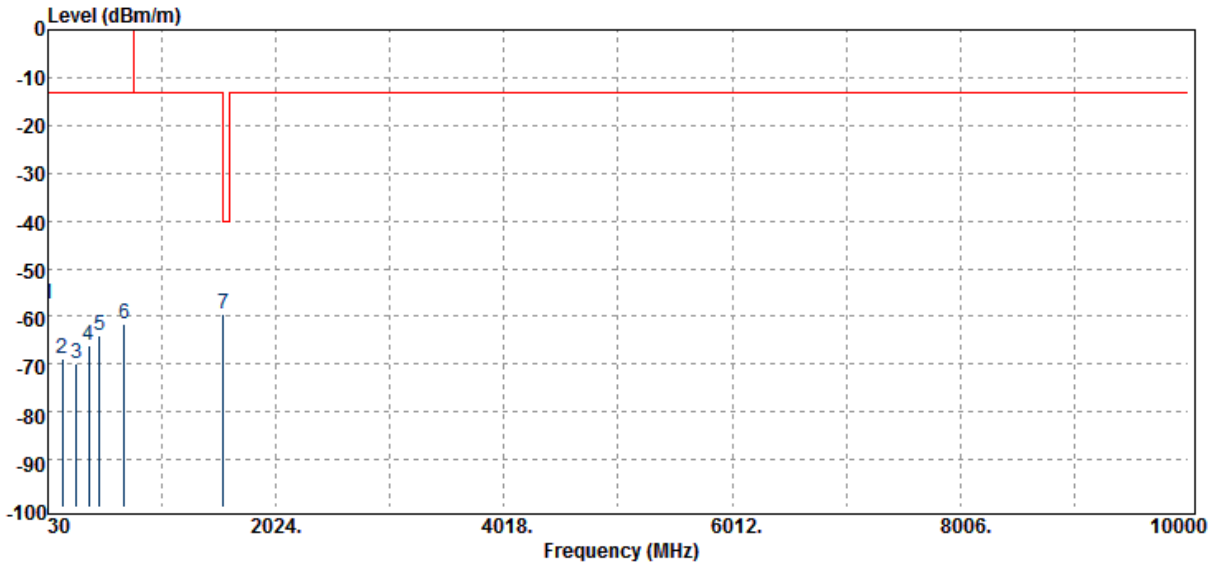

Freq. MHz	ERP/EIRP dBm	SG Output Level dBm	Antenna Gain dBd/dBi	Cable Loss dB	Limit dBm	Margin dB
30.00	-57.53	-42.37	-14.58	-0.58	-13.00	-44.53
153.19	-68.97	-66.05	-1.62	-1.30	-13.00	-55.97
280.26	-70.04	-71.71	3.42	-1.75	-13.00	-57.04
384.05	-66.18	-67.93	3.76	-2.01	-13.00	-53.18
482.99	-63.95	-65.94	3.88	-1.89	-13.00	-50.95
699.30	-61.58	-63.03	3.68	-2.24	-13.00	-48.58
1564.00	-59.38	-63.96	8.83	-4.26	-40.00	-19.38

Unless otherwise stated the results shown in this test report refer only to the sample(s) tested and such sample(s) are retained for 90 days only.

除非另有說明，此報告結果僅對測試之樣品負責，同時此樣品僅保留90天。本報告未經本公司書面許可，不可部份複製。

This document is issued by the Company subject to its General Conditions of Service printed overleaf, available on request or accessible at www.sgs.com/terms_and_conditions.htm and, for electronic format documents, subject to Terms and Conditions for Electronic Documents at www.sgs.com/terms_e-document.htm. Attention is drawn to the limitation of liability, indemnification and jurisdiction issues defined therein. Any holder of this document is advised that information contained hereon reflects the Company's findings at the time of its intervention only and within the limits of Client's instructions, if any. The Company's sole responsibility is to its Client and this document does not exonerate parties to a transaction from exercising all their rights and obligations under the transaction documents. This document cannot be reproduced except in full, without prior written approval of the Company. Any unauthorized alteration, forgery or falsification of the content or appearance of this document is unlawful and offenders may be prosecuted to the fullest extent of the law.

SGS Taiwan Ltd.

No.134,WuKungRoad,NewTaipeiIndustrialPark,WukuDistrict,NewTaipeiCity,Taiwan24803/新北市五股區新北產業園區五工路 134 號

台灣檢驗科技股份有限公司

t (886-2) 2299-3279

f (886-2) 2298-0488

www.tw.sgs.com

Member of SGS Group

Operation Band	:LTE B13	Temp./Humi.	:24.1 deg_C / 65 RH
Fundamental Frequency	:782.0 MHz	Engineer	:Wei
Operation Mode	:Tx CH MID		
EUT Pol.	:E1 Plane	Measurement Antenna Pol.	:VERTICAL

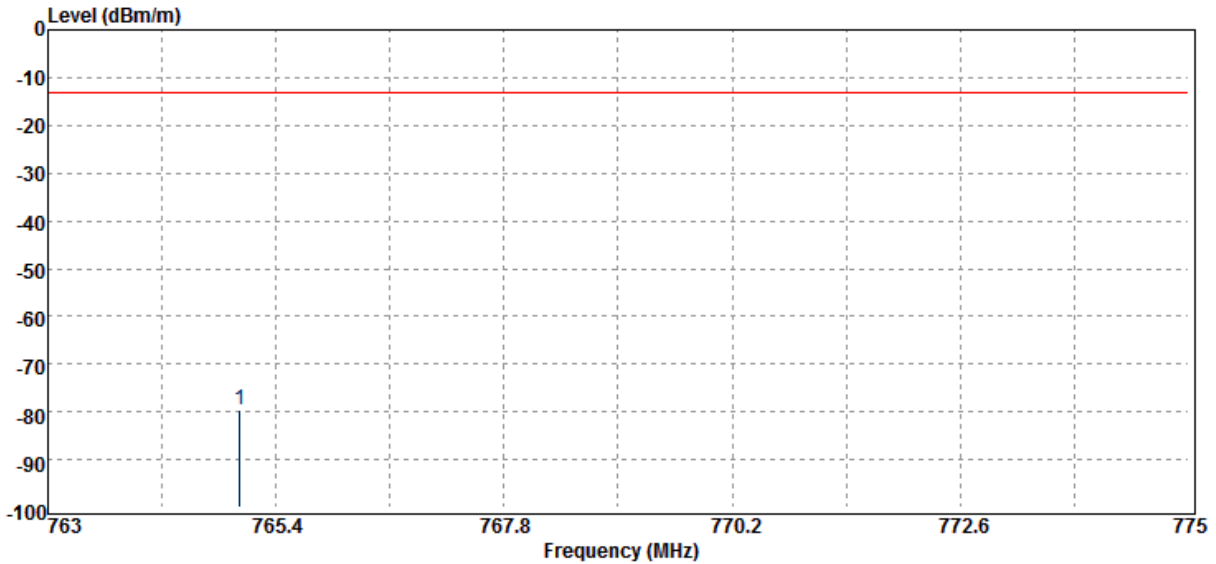

Freq. MHz	ERP/EIRP dBm	SG Output Level dBm	Antenna Gain dBd/dBi	Cable Loss dB	Limit dBm	Margin dB
765.02	-79.54	-81.55	3.46	-1.45	-13.00	-66.54

Unless otherwise stated the results shown in this test report refer only to the sample(s) tested and such sample(s) are retained for 90 days only.

除非另有說明，此報告結果僅對測試之樣品負責，同時此樣品僅保留90天。本報告未經本公司書面許可，不可部份複製。

This document is issued by the Company subject to its General Conditions of Service printed overleaf, available on request or accessible at www.sgs.com/terms_and_conditions.htm and, for electronic format documents, subject to Terms and Conditions for Electronic Documents at www.sgs.com/terms_e-document.htm. Attention is drawn to the limitation of liability, indemnification and jurisdiction issues defined therein. Any holder of this document is advised that information contained hereon reflects the Company's findings at the time of its intervention only and within the limits of Client's instructions, if any. The Company's sole responsibility is to its Client and this document does not exonerate parties to a transaction from exercising all their rights and obligations under the transaction documents. This document cannot be reproduced except in full, without prior written approval of the Company. Any unauthorized alteration, forgery or falsification of the content or appearance of this document is unlawful and offenders may be prosecuted to the fullest extent of the law.

SGS Taiwan Ltd.

No.134,WuKungRoad,NewTaipeiIndustrialPark,WukuDistrict,NewTaipeiCity,Taiwan24803/新北市五股區新北產業園區五工路 134 號

台灣檢驗科技股份有限公司

t (886-2) 2299-3279

f (886-2) 2298-0488

www.tw.sgs.com

Member of SGS Group

Operation Band	:LTE B13	Temp./Humi.	:24.1 deg_C / 65 RH
Fundamental Frequency	:782.0 MHz	Engineer	:Wei
Operation Mode	:Tx CH MID		
EUT Pol.	:E1 Plane	Measurement Antenna Pol.	:HORIZONTAL

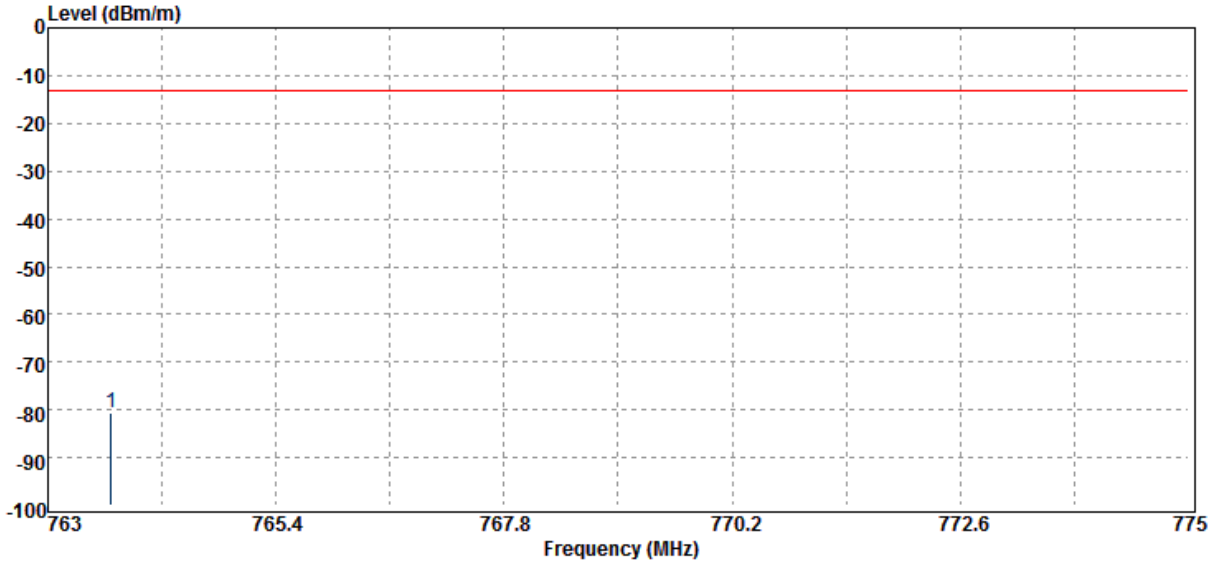

Freq. MHz	ERP/EIRP dBm	SG Output Level dBm	Antenna Gain dBd/dBi	Cable Loss dB	Limit dBm	Margin dB
763.66	-80.59	-82.51	3.46	-1.54	-13.00	-67.59

Unless otherwise stated the results shown in this test report refer only to the sample(s) tested and such sample(s) are retained for 90 days only.

除非另有說明，此報告結果僅對測試之樣品負責，同時此樣品僅保留90天。本報告未經本公司書面許可，不可部份複製。

This document is issued by the Company subject to its General Conditions of Service printed overleaf, available on request or accessible at www.sgs.com/terms_and_conditions.htm and, for electronic format documents, subject to Terms and Conditions for Electronic Documents at www.sgs.com/terms_e-document.htm. Attention is drawn to the limitation of liability, indemnification and jurisdiction issues defined therein. Any holder of this document is advised that information contained hereon reflects the Company's findings at the time of its intervention only and within the limits of Client's instructions, if any. The Company's sole responsibility is to its Client and this document does not exonerate parties to a transaction from exercising all their rights and obligations under the transaction documents. This document cannot be reproduced except in full, without prior written approval of the Company. Any unauthorized alteration, forgery or falsification of the content or appearance of this document is unlawful and offenders may be prosecuted to the fullest extent of the law.

SGS Taiwan Ltd.

No.134,WuKungRoad,NewTaipeiIndustrialPark,WukuDistrict,NewTaipeiCity,Taiwan24803/新北市五股區新北產業園區五工路 134 號

台灣檢驗科技股份有限公司

t (886-2) 2299-3279

f (886-2) 2298-0488

www.tw.sgs.com

Member of SGS Group

Operation Band	:LTE B13	Temp./Humi.	:24.1 deg_C / 65 RH
Fundamental Frequency	:782.0 MHz	Engineer	:Wei
Operation Mode	:Tx CH MID		
EUT Pol.	:E1 Plane	Measurement Antenna Pol.	:VERTICAL

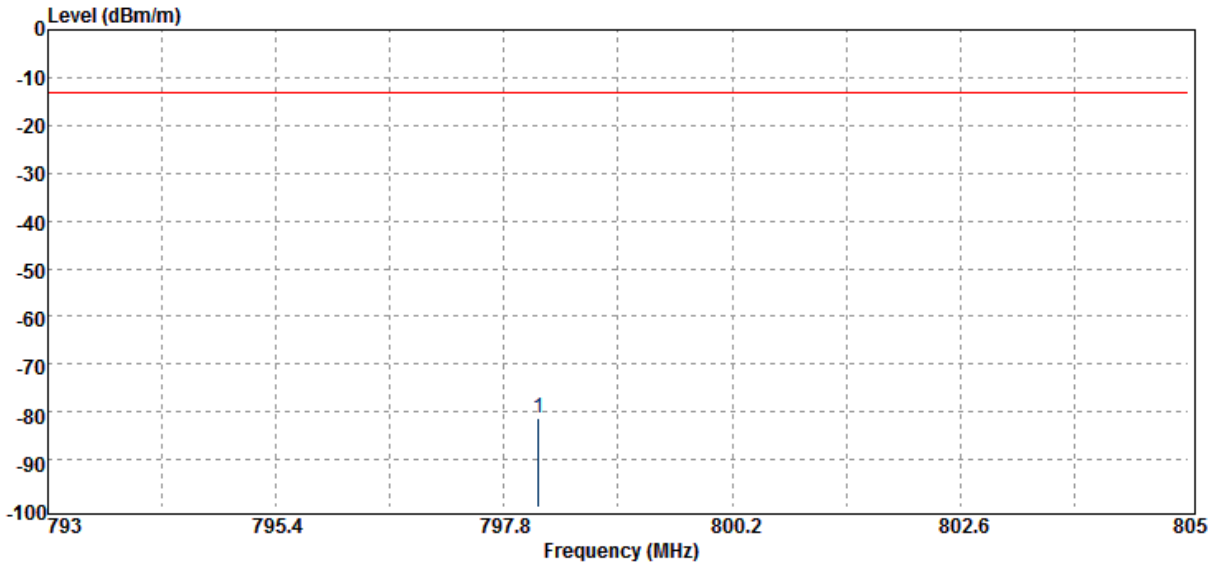

Freq. MHz	ERP/EIRP dBm	SG Output Level dBm	Antenna Gain dBd/dBi	Cable Loss dB	Limit dBm	Margin dB
798.16	-81.43	-82.28	3.44	-2.58	-13.00	-68.43

Unless otherwise stated the results shown in this test report refer only to the sample(s) tested and such sample(s) are retained for 90 days only.

除非另有說明，此報告結果僅對測試之樣品負責，同時此樣品僅保留90天。本報告未經本公司書面許可，不可部份複製。

This document is issued by the Company subject to its General Conditions of Service printed overleaf, available on request or accessible at www.sgs.com/terms_and_conditions.htm and, for electronic format documents, subject to Terms and Conditions for Electronic Documents at www.sgs.com/terms_e-document.htm. Attention is drawn to the limitation of liability, indemnification and jurisdiction issues defined therein. Any holder of this document is advised that information contained hereon reflects the Company's findings at the time of its intervention only and within the limits of Client's instructions, if any. The Company's sole responsibility is to its Client and this document does not exonerate parties to a transaction from exercising all their rights and obligations under the transaction documents. This document cannot be reproduced except in full, without prior written approval of the Company. Any unauthorized alteration, forgery or falsification of the content or appearance of this document is unlawful and offenders may be prosecuted to the fullest extent of the law.

SGS Taiwan Ltd.

No.134,WuKungRoad,NewTaipeiIndustrialPark,WukuDistrict,NewTaipeiCity,Taiwan24803/新北市五股區新北產業園區五工路 134 號

台灣檢驗科技股份有限公司

t (886-2) 2299-3279

f (886-2) 2298-0488

www.tw.sgs.com

Member of SGS Group

Operation Band	:LTE B13	Temp./Humi.	:24.1 deg_C / 65 RH
Fundamental Frequency	:782.0 MHz	Engineer	:Wei
Operation Mode	:Tx CH MID		
EUT Pol.	:E1 Plane	Measurement Antenna Pol.	:HORIZONTAL

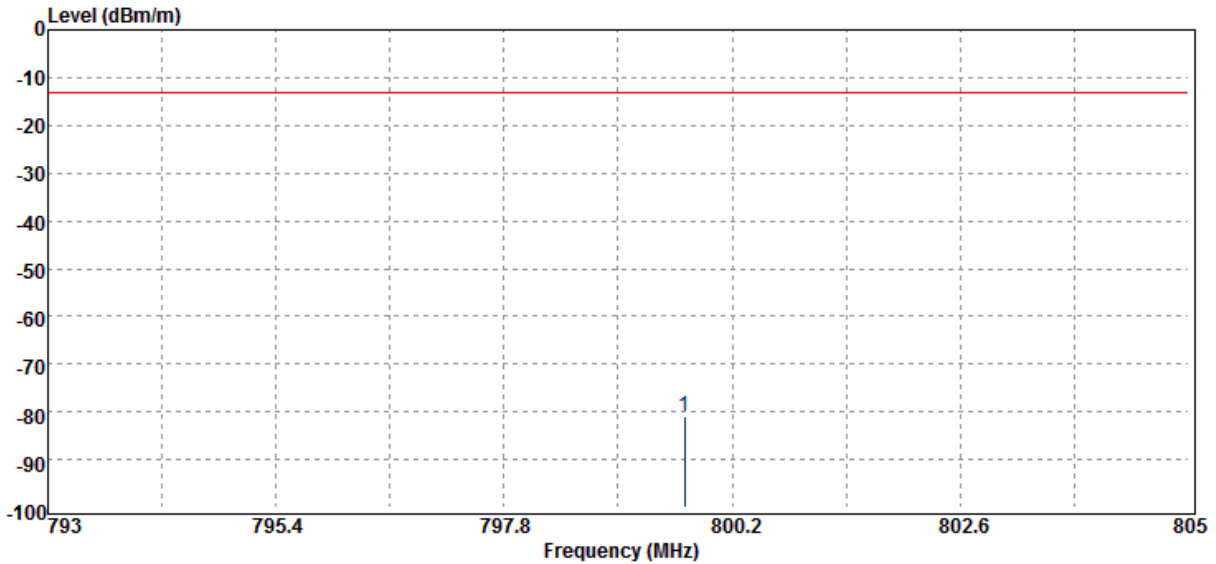

Freq. MHz	ERP/EIRP dBm	SG Output Level dBm	Antenna Gain dBd/dBi	Cable Loss dB	Limit dBm	Margin dB
799.70	-81.14	-82.13	3.44	-2.44	-13.00	-68.14

Unless otherwise stated the results shown in this test report refer only to the sample(s) tested and such sample(s) are retained for 90 days only.

除非另有說明，此報告結果僅對測試之樣品負責，同時此樣品僅保留90天。本報告未經本公司書面許可，不可部份複製。

This document is issued by the Company subject to its General Conditions of Service printed overleaf, available on request or accessible at www.sgs.com/terms_and_conditions.htm and, for electronic format documents, subject to Terms and Conditions for Electronic Documents at www.sgs.com/terms_e-document.htm. Attention is drawn to the limitation of liability, indemnification and jurisdiction issues defined therein. Any holder of this document is advised that information contained hereon reflects the Company's findings at the time of its intervention only and within the limits of Client's instructions, if any. The Company's sole responsibility is to its Client and this document does not exonerate parties to a transaction from exercising all their rights and obligations under the transaction documents. This document cannot be reproduced except in full, without prior written approval of the Company. Any unauthorized alteration, forgery or falsification of the content or appearance of this document is unlawful and offenders may be prosecuted to the fullest extent of the law.

SGS Taiwan Ltd.

No.134,WuKungRoad,NewTaipeiIndustrialPark,WukuDistrict,NewTaipeiCity,Taiwan24803/新北市五股區新北產業園區五工路 134 號

台灣檢驗科技股份有限公司

t (886-2) 2299-3279

f (886-2) 2298-0488

www.tw.sgs.com

Member of SGS Group

Operation Band	:LTE B13	Temp./Humi.	:24.1 deg_C / 65 RH
Fundamental Frequency	:782.0 MHz	Engineer	:Wei
Operation Mode	:Tx CH MID		
EUT Pol.	:E1 Plane	Measurement Antenna Pol.	:VERTICAL

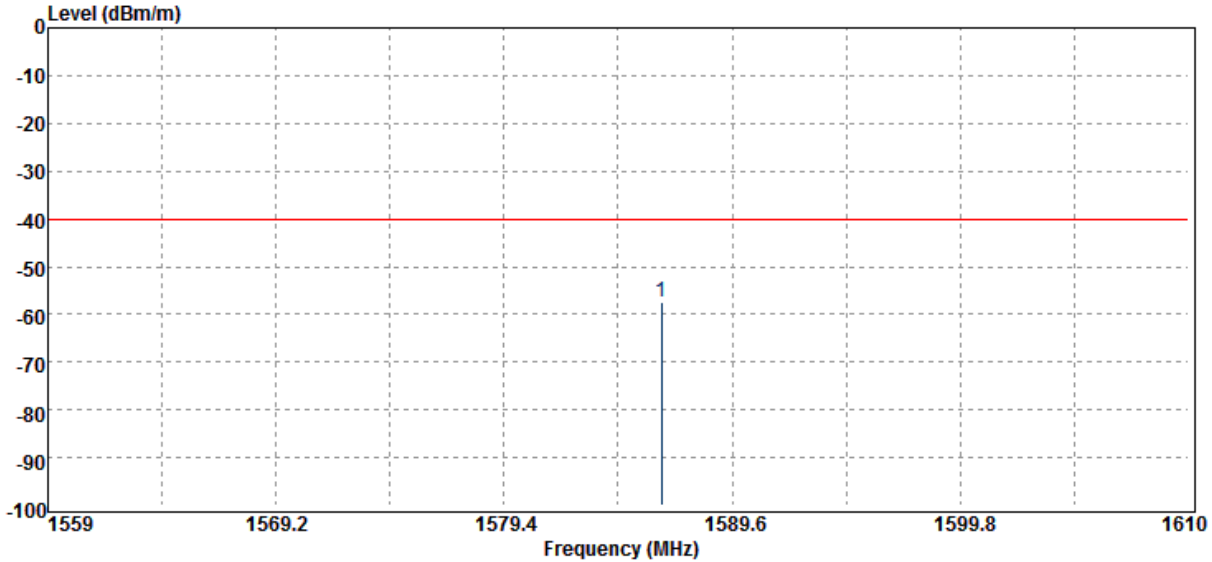

Freq. MHz	ERP/EIRP dBm	SG Output Level dBm	Antenna Gain dBd/dBi	Cable Loss dB	Limit dBm	Margin dB
1586.44	-57.54	-62.17	8.91	-4.28	-40.00	-17.54

Unless otherwise stated the results shown in this test report refer only to the sample(s) tested and such sample(s) are retained for 90 days only.

除非另有說明，此報告結果僅對測試之樣品負責，同時此樣品僅保留90天。本報告未經本公司書面許可，不可部份複製。

This document is issued by the Company subject to its General Conditions of Service printed overleaf, available on request or accessible at www.sgs.com/terms_and_conditions.htm and, for electronic format documents, subject to Terms and Conditions for Electronic Documents at www.sgs.com/terms_e-document.htm. Attention is drawn to the limitation of liability, indemnification and jurisdiction issues defined therein. Any holder of this document is advised that information contained hereon reflects the Company's findings at the time of its intervention only and within the limits of Client's instructions, if any. The Company's sole responsibility is to its Client and this document does not exonerate parties to a transaction from exercising all their rights and obligations under the transaction documents. This document cannot be reproduced except in full, without prior written approval of the Company. Any unauthorized alteration, forgery or falsification of the content or appearance of this document is unlawful and offenders may be prosecuted to the fullest extent of the law.

SGS Taiwan Ltd.

No.134,WuKungRoad,NewTaipeiIndustrialPark,WukuDistrict,NewTaipeiCity,Taiwan24803/新北市五股區新北產業園區五工路 134 號

台灣檢驗科技股份有限公司

t (886-2) 2299-3279

f (886-2) 2298-0488

www.tw.sgs.com

Member of SGS Group

Operation Band	:LTE B13	Temp./Humi.	:24.1 deg_C / 65 RH
Fundamental Frequency	:782.0 MHz	Engineer	:Wei
Operation Mode	:Tx CH MID		
EUT Pol.	:E1 Plane	Measurement Antenna Pol.	:HORIZONTAL



Freq. MHz	ERP/EIRP dBm	SG Output Level dBm	Antenna Gain dBd/dBi	Cable Loss dB	Limit dBm	Margin dB
1595.57	-57.05	-61.70	8.94	-4.29	-40.00	-17.05

Unless otherwise stated the results shown in this test report refer only to the sample(s) tested and such sample(s) are retained for 90 days only.

除非另有說明，此報告結果僅對測試之樣品負責，同時此樣品僅保留90天。本報告未經本公司書面許可，不可部份複製。

This document is issued by the Company subject to its General Conditions of Service printed overleaf, available on request or accessible at www.sgs.com/terms_and_conditions.htm and, for electronic format documents, subject to Terms and Conditions for Electronic Documents at www.sgs.com/terms_e-document.htm. Attention is drawn to the limitation of liability, indemnification and jurisdiction issues defined therein. Any holder of this document is advised that information contained hereon reflects the Company's findings at the time of its intervention only and within the limits of Client's instructions, if any. The Company's sole responsibility is to its Client and this document does not exonerate parties to a transaction from exercising all their rights and obligations under the transaction documents. This document cannot be reproduced except in full, without prior written approval of the Company. Any unauthorized alteration, forgery or falsification of the content or appearance of this document is unlawful and offenders may be prosecuted to the fullest extent of the law.

SGS Taiwan Ltd.

No.134,WuKungRoad,NewTaipeiIndustrialPark,WukuDistrict,NewTaipeiCity,Taiwan24803/新北市五股區新北產業園區五工路 134 號

台灣檢驗科技股份有限公司

t (886-2) 2299-3279

f (886-2) 2298-0488

www.tw.sgs.com

Member of SGS Group

10. FREQUENCY STABILITY MEASUREMENT

10.1. Standard Applicable

The frequency stability shall be sufficient to ensure that the fundamental emission stays within the authorized frequency block.

10.2. Test Set-up

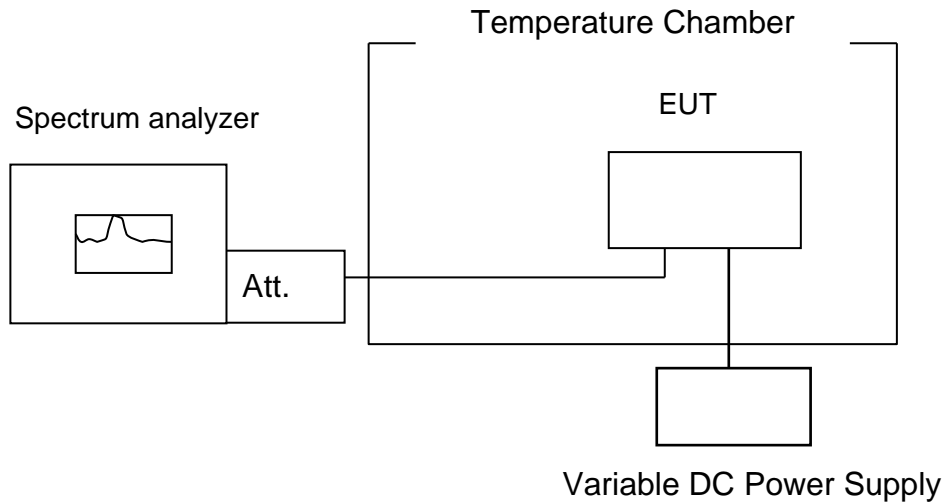

Note: Measurement setup for testing on Antenna connector

Unless otherwise stated the results shown in this test report refer only to the sample(s) tested and such sample(s) are retained for 90 days only.

除非另有說明，此報告結果僅對測試之樣品負責，同時此樣品僅保留90天。本報告未經本公司書面許可，不可部份複製。

This document is issued by the Company subject to its General Conditions of Service printed overleaf, available on request or accessible at www.sgs.com/terms_and_conditions.htm and, for electronic format documents, subject to Terms and Conditions for Electronic Documents at www.sgs.com/terms_e-document.htm. Attention is drawn to the limitation of liability, indemnification and jurisdiction issues defined therein. Any holder of this document is advised that information contained hereon reflects the Company's findings at the time of its intervention only and within the limits of Client's instructions, if any. The Company's sole responsibility is to its Client and this document does not exonerate parties to a transaction from exercising all their rights and obligations under the transaction documents. This document cannot be reproduced except in full, without prior written approval of the Company. Any unauthorized alteration, forgery or falsification of the content or appearance of this document is unlawful and offenders may be prosecuted to the fullest extent of the law.

SGS Taiwan Ltd.

No.134,WuKungRoad,NewTaipeiIndustrialPark,WukuDistrict,NewTaipeiCity,Taiwan24803/新北市五股區新北產業園區五工路 134 號

台灣檢驗科技股份有限公司

t (886-2) 2299-3279

f (886-2) 2298-0488

www.tw.sgs.com

Member of SGS Group

10.3. Measurement Procedure

The equipment under test was connected to an external AC or DC power supply and input rated voltage. RF output was connected to a frequency counter or spectrum analyzer via feed through attenuators. The EUT was placed inside the temperature chamber. Set the spectrum analyzer RBW low enough to obtain the desired frequency resolution and measure EUT 25°C operating frequency as reference frequency. Turn EUT off and set the chamber temperature to -30°C. After the temperature stabilized for approximately 30 minutes recorded the frequency. Repeat step measure with 10°C increased per stage until the highest temperature of +50°C reached.

Set chamber temperature to 25°C. Use a variable AC power supply / DC power source to power the EUT and set the voltage to rated voltage. Set the spectrum analyzer RBW low enough to obtain the desired frequency resolution and recorded the frequency.

Reduce the input voltage to specify extreme voltage variation (+/- 15%) and endpoint as declared by the manufacturer, record the maximum frequency change.

10.4. Measurement Equipment Used

Conducted Emission (measured at antenna port) Test Site					
EQUIPMENT TYPE	MFR	MODEL NUMBER	SERIAL NUMBER	LAST CAL.	CAL DUE.
EXA Spectrum Analyzer	Agilent	N9010A	MY50420195	05/03/2018	05/02/2019
Radio Communication Analyzer	Anritsu	MT8820C	6201465317	01/17/2018	01/16/2019
DC Power Supply	Agilent	E3640A	KR93300208	08/15/2018	08/14/2019
Temperature Chamber	TERCHY	MHG-120LF	911009	05/18/2018	05/17/2019
Attenuator	Mini-Circuit	BW-S10W2+	2	01/02/2018	01/01/2019
DC Block	Mini-Circuits	BLK-18-S+	1	01/02/2018	01/01/2019
Splitter	RF-LAMBAD	RFLT2W1G1-8G	11-JSPF412-018	01/02/2018	01/01/2019
Coaxial Cables	N/A	WK CE Cable	N/A	01/02/2018	01/01/2019

Unless otherwise stated the results shown in this test report refer only to the sample(s) tested and such sample(s) are retained for 90 days only.

除非另有說明，此報告結果僅對測試之樣品負責，同時此樣品僅保留90天。本報告未經本公司書面許可，不可部份複製。

This document is issued by the Company subject to its General Conditions of Service printed overleaf, available on request or accessible at www.sgs.com/terms_and_conditions.htm and, for electronic format documents, subject to Terms and Conditions for Electronic Documents at www.sgs.com/terms_e-document.htm. Attention is drawn to the limitation of liability, indemnification and jurisdiction issues defined therein. Any holder of this document is advised that information contained hereon reflects the Company's findings at the time of its intervention only and within the limits of Client's instructions, if any. The Company's sole responsibility is to its Client and this document does not exonerate parties to a transaction from exercising all their rights and obligations under the transaction documents. This document cannot be reproduced except in full, without prior written approval of the Company. Any unauthorized alteration, forgery or falsification of the content or appearance of this document is unlawful and offenders may be prosecuted to the fullest extent of the law.

SGS Taiwan Ltd.

No.134,WuKungRoad,NewTaipeiIndustrialPark,WukuDistrict,NewTaipeiCity,Taiwan24803/新北市五股區新北產業園區五工路 134 號

台灣檢驗科技股份有限公司

t (886-2) 2299-3279

f (886-2) 2298-0488

www.tw.sgs.com

Member of SGS Group

10.5. Measurement Result

WCDMA II Mid Channel 1880 MHz				
Limit: +/- 2.5 ppm				
Vdc	Temp. (°C)	Freq. (MHz)	Delta (Hz)	Limit (Hz)
FREQUENCY ERROR vs. VOLTAGE				
4.2	20	1879.99868	-1320	4700
3.8	20	1879.99782	-2180	4700
3.4	20	1880.00081	810	4700
2.7 (End point)	20	1880.00042	420.0000001	4700
FREQUENCY ERROR vs. Temp.				
3.8	50	1880.00223	2230	4700
3.8	40	1880.00061	610.0000001	4700
3.8	30	1880.00003	299.9999999	4700
3.8	20	1879.99782	-2180	4700
3.8	10	1879.99916	-839.9999999	4700
3.8	0	1880.00015	150.0000001	4700
3.8	-10	1880.00217	2170	4700
3.8	-20	1879.99912	-880.0000001	4700
3.8	-30	1880.00153	1530	4700

WCDMA V Mid Channel 836.6 MHz				
Limit: +/- 2.5 ppm				
Vdc	Temp. (°C)	Freq. (MHz)	Delta (Hz)	Limit (Hz)
FREQUENCY ERROR vs. VOLTAGE				
4.2	20	836.60034	339.9999999	2091
3.8	20	836.59952	-480	2091
3.4	20	836.59995	-49.99999999	2091
2.7 (End point)	20	836.60078	780	2091
FREQUENCY ERROR vs. Temp.				
3.8	50	836.5987	-1300	2091
3.8	40	836.60102	1020	2091
3.8	30	836.6004	400	2091
3.8	20	836.59952	-480	2091
3.8	10	836.59934	-660	2091
3.8	0	836.6008	800	2091
3.8	-10	836.59967	-330.0000001	2091
3.8	-20	836.60037	370	2091
3.8	-30	836.60021	209.9999999	2091

Unless otherwise stated the results shown in this test report refer only to the sample(s) tested and such sample(s) are retained for 90 days only.

除非另有說明，此報告結果僅對測試之樣品負責，同時此樣品僅保留90天。本報告未經本公司書面許可，不可部份複製。

This document is issued by the Company subject to its General Conditions of Service printed overleaf, available on request or accessible at www.sgs.com/terms_and_conditions.htm and, for electronic format documents, subject to Terms and Conditions for Electronic Documents at www.sgs.com/terms_e-document.htm. Attention is drawn to the limitation of liability, indemnification and jurisdiction issues defined therein. Any holder of this document is advised that information contained hereon reflects the Company's findings at the time of its intervention only and within the limits of Client's instructions, if any. The Company's sole responsibility is to its Client and this document does not exonerate parties to a transaction from exercising all their rights and obligations under the transaction documents. This document cannot be reproduced except in full, without prior written approval of the Company. Any unauthorized alteration, forgery or falsification of the content or appearance of this document is unlawful and offenders may be prosecuted to the fullest extent of the law.

Reference Freq.:		LTE B2 Mid Channel		1880	MHz 20M QPSK CH 18900
Power Supply Vdc	Temp. (°C)	Freq. (MHz)	Delta (Hz)	Limit = +/- 2.5 ppm (Hz)	
Freq. ERROR vs. VOLTAGE					
4.2	25	1880.000005	5.0000001	4700	
3.8	25	1880.000012	12	4700	
3.4	25	1879.999994	-6	4700	
2.7 (End Point)	25	1880.000008	8	4700	
Freq. ERROR vs. Temp.					
3.8	-30	1879.999988	-12	4700	
3.8	-20	1880.000016	16	4700	
3.8	-10	1880.000008	8	4700	
3.8	0	1879.999977	-23	4700	
3.8	10	1880.000008	8	4700	
3.8	20	1880.000012	12	4700	
3.8	30	1879.999998	-2	4700	
3.8	40	1879.999981	-19	4700	
3.8	50	1879.999995	-5	4700	

Reference Freq.:		LTE B4 Mid Channel		1732.5	MHz 20M QPSK CH 20175
Power Supply Vdc	Temp. (°C)	Freq. (MHz)	Delta (Hz)	Limit = +/- 2.5 ppm (Hz)	
Freq. ERROR vs. VOLTAGE					
4.2	25	1732.500008	8	4331	
3.8	25	1732.500012	12	4331	
3.4	25	1732.499986	-14	4331	
2.7 (End Point)	25	1732.500007	7.0000001	4331	
Freq. ERROR vs. Temp.					
3.8	-30	1732.499995	-5	4331	
3.8	-20	1732.500016	16	4331	
3.8	-10	1732.499983	-17	4331	
3.8	0	1732.499992	-8	4331	
3.8	10	1732.499997	-3	4331	
3.8	20	1732.500006	6	4331	
3.8	30	1732.500009	9.0000001	4331	
3.8	40	1732.499996	-4	4331	
3.8	50	1732.500012	12	4331	

Unless otherwise stated the results shown in this test report refer only to the sample(s) tested and such sample(s) are retained for 90 days only.

除非另有說明，此報告結果僅對測試之樣品負責，同時此樣品僅保留90天。本報告未經本公司書面許可，不可部份複製。

This document is issued by the Company subject to its General Conditions of Service printed overleaf, available on request or accessible at www.sgs.com/terms_and_conditions.htm and, for electronic format documents, subject to Terms and Conditions for Electronic Documents at www.sgs.com/terms_e-document.htm. Attention is drawn to the limitation of liability, indemnification and jurisdiction issues defined therein. Any holder of this document is advised that information contained hereon reflects the Company's findings at the time of its intervention only and within the limits of Client's instructions, if any. The Company's sole responsibility is to its Client and this document does not exonerate parties to a transaction from exercising all their rights and obligations under the transaction documents. This document cannot be reproduced except in full, without prior written approval of the Company. Any unauthorized alteration, forgery or falsification of the content or appearance of this document is unlawful and offenders may be prosecuted to the fullest extent of the law.

SGS Taiwan Ltd.

No.134,WuKungRoad,NewTaipeiIndustrialPark,WukuDistrict,NewTaipeiCity,Taiwan24803/新北市五股區新北產業園區五工路 134 號

台灣檢驗科技股份有限公司

t (886-2) 2299-3279

f (886-2) 2298-0488

www.tw.sgs.com

Member of SGS Group

Reference Freq.:		LTE B5 Mid Channel		836.5	MHz 10M QPSK CH 20525
Power Supply Vdc	Temp. (°C)	Freq. (MHz)	Delta (Hz)	Limit = +/- 2.5 ppm (Hz)	
Freq. ERROR vs. VOLTAGE					
4.2	25	836.499988	-12	2091	
3.8	25	836.499998	-2	2091	
3.4	25	836.500008	8	2091	
2.7 (End Point)	25	836.499997	-3	2091	
Freq. ERROR vs. Temp.					
3.8	-30	836.500014	14	2091	
3.8	-20	836.500019	19	2091	
3.8	-10	836.499983	-17	2091	
3.8	0	836.500006	6	2091	
3.8	10	836.499997	-3	2091	
3.8	20	836.500013	13	2091	
3.8	30	836.499982	-18	2091	
3.8	40	836.500015	15	2091	
3.8	50	836.500004	4	2091	

Reference Freq.:		LTE B12 Mid Channel		707.5	MHz 10M QPSK CH 23095
Power Supply Vdc	Temp. (°C)	Freq. (MHz)	Delta (Hz)	Limit = +/- 2.5 ppm (Hz)	
Freq. ERROR vs. VOLTAGE					
4.2	25	707.500021	21	1769	
3.8	25	707.499998	-2	1769	
3.4	25	707.500017	17	1769	
2.7 (End Point)	25	707.499994	-6	1769	
Freq. ERROR vs. Temp.					
3.8	-30	707.499985	-15	1769	
3.8	-20	707.500008	8	1769	
3.8	-10	707.499985	-15	1769	
3.8	0	707.500018	18	1769	
3.8	10	707.500015	15	1769	
3.8	20	707.499997	-3	1769	
3.8	30	707.500011	11	1769	
3.8	40	707.499993	-7	1769	
3.8	50	707.500005	5	1769	

Unless otherwise stated the results shown in this test report refer only to the sample(s) tested and such sample(s) are retained for 90 days only.

除非另有說明，此報告結果僅對測試之樣品負責，同時此樣品僅保留90天。本報告未經本公司書面許可，不可部份複製。

This document is issued by the Company subject to its General Conditions of Service printed overleaf, available on request or accessible at www.sgs.com/terms_and_conditions.htm and, for electronic format documents, subject to Terms and Conditions for Electronic Documents at www.sgs.com/terms_e-document.htm. Attention is drawn to the limitation of liability, indemnification and jurisdiction issues defined therein. Any holder of this document is advised that information contained hereon reflects the Company's findings at the time of its intervention only and within the limits of Client's instructions, if any. The Company's sole responsibility is to its Client and this document does not exonerate parties to a transaction from exercising all their rights and obligations under the transaction documents. This document cannot be reproduced except in full, without prior written approval of the Company. Any unauthorized alteration, forgery or falsification of the content or appearance of this document is unlawful and offenders may be prosecuted to the fullest extent of the law.

Reference Freq.: LTE B13 Mid Channel 782 MHz 10M QPSK CH 23230				
Power Supply Vdc	Temp. (°C)	Freq. (MHz)	Delta (Hz)	Limit = +/- 2.5 ppm (Hz)
Freq. ERROR vs. VOLTAGE				
4.2	25	782.000016	16	1955
3.8	25	781.999992	-8	1955
3.4	25	782.000009	9	1955
2.7 (End Point)	25	781.999988	-12	1955
Freq. ERROR vs. Temp.				
3.8	-30	782.000007	7	1955
3.8	-20	782.000016	16	1955
3.8	-10	782.000013	13	1955
3.8	0	781.999986	-14	1955
3.8	10	781.999982	-18	1955
3.8	20	781.999988	-12	1955
3.8	30	782.000005	5	1955
3.8	40	782.000014	14	1955
3.8	50	781.999987	-13	1955

Note: The battery is rated 3.8Vdc.

Unless otherwise stated the results shown in this test report refer only to the sample(s) tested and such sample(s) are retained for 90 days only.

除非另有說明，此報告結果僅對測試之樣品負責，同時此樣品僅保留90天。本報告未經本公司書面許可，不可部份複製。

This document is issued by the Company subject to its General Conditions of Service printed overleaf, available on request or accessible at www.sgs.com/terms_and_conditions.htm and, for electronic format documents, subject to Terms and Conditions for Electronic Documents at www.sgs.com/terms_e-document.htm. Attention is drawn to the limitation of liability, indemnification and jurisdiction issues defined therein. Any holder of this document is advised that information contained hereon reflects the Company's findings at the time of its intervention only and within the limits of Client's instructions, if any. The Company's sole responsibility is to its Client and this document does not exonerate parties to a transaction from exercising all their rights and obligations under the transaction documents. This document cannot be reproduced except in full, without prior written approval of the Company. Any unauthorized alteration, forgery or falsification of the content or appearance of this document is unlawful and offenders may be prosecuted to the fullest extent of the law.

SGS Taiwan Ltd.

No.134,WuKungRoad,NewTaipeiIndustrialPark,WukuDistrict,NewTaipeiCity,Taiwan24803/新北市五股區新北產業園區五工路 134 號

台灣檢驗科技股份有限公司

t (886-2) 2299-3279

f (886-2) 2298-0488

www.tw.sgs.com

Member of SGS Group

11. PEAK TO AVERAGE RATIO

11.1. Standard Applicable

The peak-to-average ratio (PAR) of the transmission may not exceed 13dB.

11.2. Test SET-UP

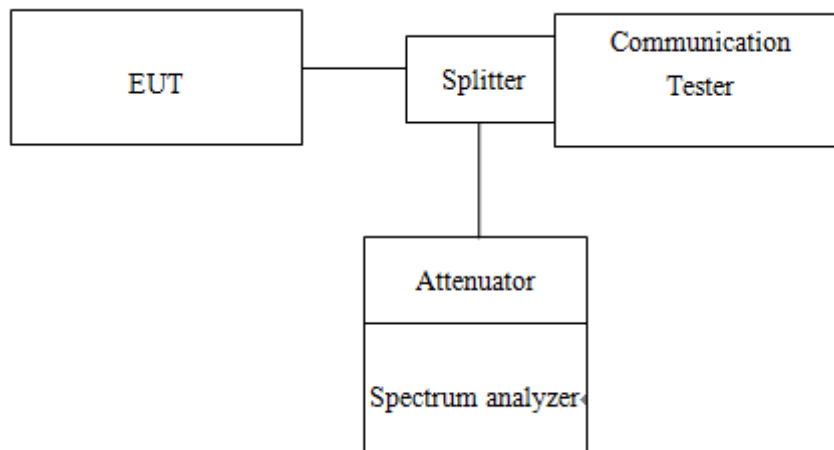

11.3. Measurement Procedure

1. KDB 971168 D01 is employed as the following procedure is proper adjusted accordingly:
2. Set resolution/measurement bandwidth \geq signal's occupied bandwidth; & internal =1ms
3. Set the number of counts to a value that stabilizes the measured CCDF curve.

11.4. Measurement Equipment Used

Conducted Emission (measured at antenna port) Test Site					
EQUIPMENT TYPE	MFR	MODEL NUMBER	SERIAL NUMBER	LAST CAL.	CAL DUE.
EXA Spectrum Analyzer	Agilent	N9010A	MY5042019 5	05/03/2018	05/02/2019
Radio Communication Analyer	Anritsu	MT8820C	6201465317	01/17/2018	01/16/2019
DC Power Supply	Agilent	E3640A	KR9330020 8	08/15/2018	08/14/2019
Temperature Chamber	TERCHY	MHG-120LF	911009	05/18/2018	05/17/2019
Attenuator	Mini-Circuit	BW-S10W2+	2	01/02/2018	01/01/2019
DC Block	Mini-Circuits	BLK-18-S+	1	01/02/2018	01/01/2019
Splitter	RF-LAMBAD	RFLT2W1G18G	11-JSPF412 -018	01/02/2018	01/01/2019
Coaxial Cables	N/A	WK CE Cable	N/A	01/02/2018	01/01/2019

Unless otherwise stated the results shown in this test report refer only to the sample(s) tested and such sample(s) are retained for 90 days only.

除非另有說明，此報告結果僅對測試之樣品負責，同時此樣品僅保留90天。本報告未經本公司書面許可，不可部份複製。

This document is issued by the Company subject to its General Conditions of Service printed overleaf, available on request or accessible at www.sgs.com/terms_and_conditions.htm and, for electronic format documents, subject to Terms and Conditions for Electronic Documents at www.sgs.com/terms_e-document.htm. Attention is drawn to the limitation of liability, indemnification and jurisdiction issues defined therein. Any holder of this document is advised that information contained hereon reflects the Company's findings at the time of its intervention only and within the limits of Client's instructions, if any. The Company's sole responsibility is to its Client and this document does not exonerate parties to a transaction from exercising all their rights and obligations under the transaction documents. This document cannot be reproduced except in full, without prior written approval of the Company. Any unauthorized alteration, forgery or falsification of the content or appearance of this document is unlawful and offenders may be prosecuted to the fullest extent of the law.

11.5. Measurement Result

Tabular Results:

Freq. (MHz)	CH	Peak-to-Average Ratio (dB)		
		WCDMA II	HSDPA II	HSUPA II
1852.4	9262	3.07	3.05	3.14
1880	9400	3.27	3.33	3.29
1907.6	9538	3.38	3.45	3.38

LTE BAND 2							
Channel bandwidth: 1.4MHz				Channel bandwidth: 3MHz			
Freq. (MHz)	CH	PAPR (dB)		Freq. (MHz)	CH	PAPR (dB)	
		16QAM	Limit			16QAM	Limit
1850.7	18607	6.08	13	1851.5	18615	6.11	13
1880.0	18900	6.66	13	1880.0	18900	6.86	13
1909.3	19193	6.68	13	1908.5	19185	6.70	13

LTE BAND 2							
Channel bandwidth: 5MHz				Channel bandwidth: 10MHz			
Freq. (MHz)	CH	PAPR (dB)		Freq. (MHz)	CH	PAPR (dB)	
		16QAM	Limit			16QAM	Limit
1852.5	18625	5.97	13	1855.0	18650	5.93	13
1880.0	18900	6.45	13	1880.0	18900	6.31	13
1907.5	19175	6.55	13	1905.0	19150	6.40	13

LTE BAND 2							
Channel bandwidth: 15MHz				Channel bandwidth: 20MHz			
Freq. (MHz)	CH	PAPR (dB)		Freq. (MHz)	CH	PAPR (dB)	
		16QAM	Limit			16QAM	Limit
1857.5	18675	6.27	13	1860.0	18700	6.65	13
1880.0	18900	6.30	13	1880.0	18900	6.76	13
1902.5	19125	6.40	13	1900.0	19100	6.77	13

Unless otherwise stated the results shown in this test report refer only to the sample(s) tested and such sample(s) are retained for 90 days only.

除非另有說明，此報告結果僅對測試之樣品負責，同時此樣品僅保留90天。本報告未經本公司書面許可，不可部份複製。

This document is issued by the Company subject to its General Conditions of Service printed overleaf, available on request or accessible at www.sgs.com/terms_and_conditions.htm and, for electronic format documents, subject to Terms and Conditions for Electronic Documents at www.sgs.com/terms_e-document.htm. Attention is drawn to the limitation of liability, indemnification and jurisdiction issues defined therein. Any holder of this document is advised that information contained hereon reflects the Company's findings at the time of its intervention only and within the limits of Client's instructions, if any. The Company's sole responsibility is to its Client and this document does not exonerate parties to a transaction from exercising all their rights and obligations under the transaction documents. This document cannot be reproduced except in full, without prior written approval of the Company. Any unauthorized alteration, forgery or falsification of the content or appearance of this document is unlawful and offenders may be prosecuted to the fullest extent of the law.

LTE BAND 4							
Channel bandwidth: 1.4MHz				Channel bandwidth: 3MHz			
Freq. (MHz)	CH	PAPR (dB)		Freq. (MHz)	CH	PAPR (dB)	
		16QAM	Limit			16QAM	Limit
1710.7	19957	5.85	13	1711.5	19965	5.97	13
1732.5	20175	6.01	13	1732.5	20175	6.11	13
1754.3	20393	5.74	13	1753.5	20385	5.98	13

LTE BAND 4							
Channel bandwidth: 5MHz				Channel bandwidth: 10MHz			
Freq. (MHz)	CH	PAPR (dB)		Freq. (MHz)	CH	PAPR (dB)	
		16QAM	Limit			16QAM	Limit
1712.5	19957	5.81	13	1715.0	20000	5.80	13
1732.5	20175	6.05	13	1732.5	20175	6.00	13
1752.5	20375	5.82	13	1750.0	20350	5.88	13

LTE BAND 4							
Channel bandwidth: 15MHz				Channel bandwidth: 20MHz			
Freq. (MHz)	CH	PAPR (dB)		Freq. (MHz)	CH	PAPR (dB)	
		16QAM	Limit			16QAM	Limit
1717.5	20025	6.02	13	1720.0	20050	6.56	13
1732.5	20175	6.17	13	1732.5	20175	6.62	13
1747.5	20325	6.03	13	1745.0	20300	6.60	13

Unless otherwise stated the results shown in this test report refer only to the sample(s) tested and such sample(s) are retained for 90 days only.

除非另有說明，此報告結果僅對測試之樣品負責，同時此樣品僅保留90天。本報告未經本公司書面許可，不可部份複製。

This document is issued by the Company subject to its General Conditions of Service printed overleaf, available on request or accessible at www.sgs.com/terms_and_conditions.htm and, for electronic format documents, subject to Terms and Conditions for Electronic Documents at www.sgs.com/terms_e-document.htm. Attention is drawn to the limitation of liability, indemnification and jurisdiction issues defined therein. Any holder of this document is advised that information contained hereon reflects the Company's findings at the time of its intervention only and within the limits of Client's instructions, if any. The Company's sole responsibility is to its Client and this document does not exonerate parties to a transaction from exercising all their rights and obligations under the transaction documents. This document cannot be reproduced except in full, without prior written approval of the Company. Any unauthorized alteration, forgery or falsification of the content or appearance of this document is unlawful and offenders may be prosecuted to the fullest extent of the law.

LTE BAND 12							
Channel bandwidth: 1.4MHz				Channel bandwidth: 3MHz			
Freq. (MHz)	CH	PAPR (dB)		Freq. (MHz)	CH	PAPR (dB)	
		16QAM	Limit			16QAM	Limit
699.7	23017	5.46	13	700.5	23025	5.75	13
707.5	23095	5.60	13	707.5	23095	6.04	13
715.3	23173	5.67	13	714.5	23165	5.86	13

LTE BAND 12							
Channel bandwidth: 5MHz				Channel bandwidth: 10MHz			
Freq. (MHz)	CH	PAPR (dB)		Freq. (MHz)	CH	PAPR (dB)	
		16QAM	Limit			16QAM	Limit
701.5	23035	5.79	13	704.0	23060	5.86	13
707.5	23095	5.75	13	707.5	23095	5.95	13
713.5	23155	5.78	13	711.0	23130	5.81	13

LTE BAND 13							
Channel bandwidth: 5MHz				Channel bandwidth: 10MHz			
Freq. (MHz)	CH	PAPR (dB)		Freq. (MHz)	CH	PAPR (dB)	
		16QAM	Limit			16QAM	Limit
779.5	23205	5.62	13	782.0	23230	5.52	13
782.0	23230	5.84	13				
784.5	23255	5.58	13				

Please refer to next page for test plots.

Unless otherwise stated the results shown in this test report refer only to the sample(s) tested and such sample(s) are retained for 90 days only.

除非另有說明，此報告結果僅對測試之樣品負責，同時此樣品僅保留90天。本報告未經本公司書面許可，不可部份複製。

This document is issued by the Company subject to its General Conditions of Service printed overleaf, available on request or accessible at www.sgs.com/terms_and_conditions.htm and, for electronic format documents, subject to Terms and Conditions for Electronic Documents at www.sgs.com/terms_e-document.htm. Attention is drawn to the limitation of liability, indemnification and jurisdiction issues defined therein. Any holder of this document is advised that information contained hereon reflects the Company's findings at the time of its intervention only and within the limits of Client's instructions, if any. The Company's sole responsibility is to its Client and this document does not exonerate parties to a transaction from exercising all their rights and obligations under the transaction documents. This document cannot be reproduced except in full, without prior written approval of the Company. Any unauthorized alteration, forgery or falsification of the content or appearance of this document is unlawful and offenders may be prosecuted to the fullest extent of the law.

WCDMA_B2_LowCH9262-1852.4



HSDPA_B2_LowCH9262-1852.4

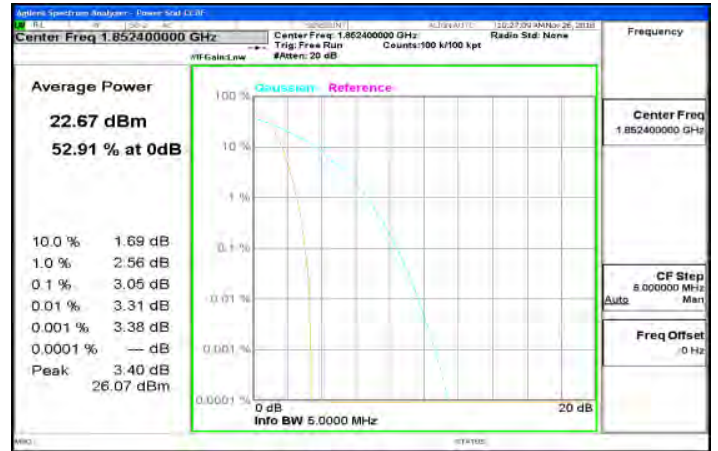

WCDMA_B2_MidCH9400-1880



HSDPA_B2_MidCH9400-1880

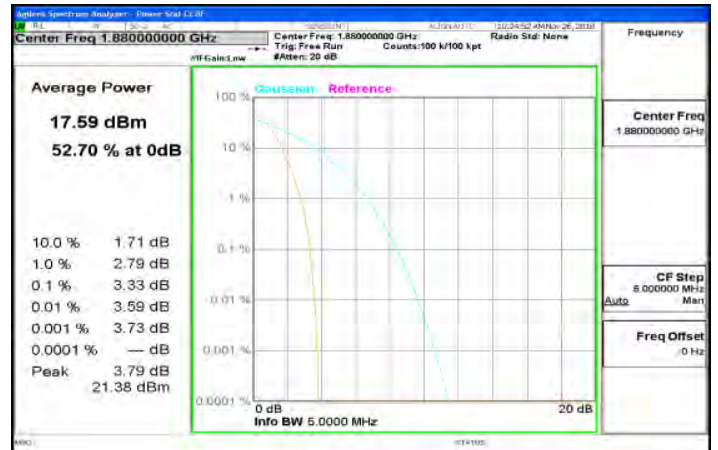

WCDMA_B2_HighCH9538-1907.6

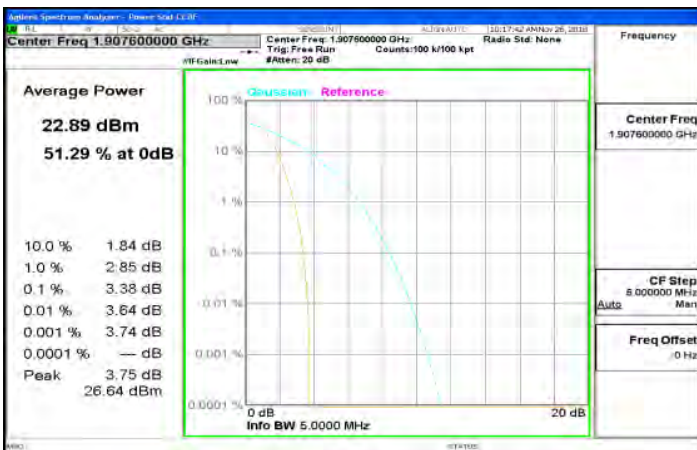

HSDPA_B2_HighCH9538-1907.6

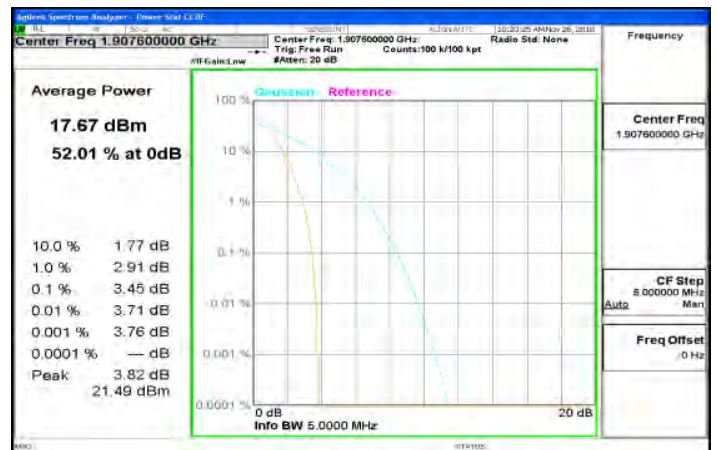

Unless otherwise stated the results shown in this test report refer only to the sample(s) tested and such sample(s) are retained for 90 days only.

除非另有說明，此報告結果僅對測試之樣品負責，同時此樣品僅保留90天。本報告未經本公司書面許可，不可部份複製。

This document is issued by the Company subject to its General Conditions of Service printed overleaf, available on request or accessible at www.sgs.com/terms_and_conditions.htm and, for electronic format documents, subject to Terms and Conditions for Electronic Documents at www.sgs.com/terms_e-document.htm. Attention is drawn to the limitation of liability, indemnification and jurisdiction issues defined therein. Any holder of this document is advised that information contained hereon reflects the Company's findings at the time of its intervention only and within the limits of Client's instructions, if any. The Company's sole responsibility is to its Client and this document does not exonerate parties to a transaction from exercising all their rights and obligations under the transaction documents. This document cannot be reproduced except in full, without prior written approval of the Company. Any unauthorized alteration, forgery or falsification of the content or appearance of this document is unlawful and offenders may be prosecuted to the fullest extent of the law.

HSUPA_B2_LowCH9262-1852.4

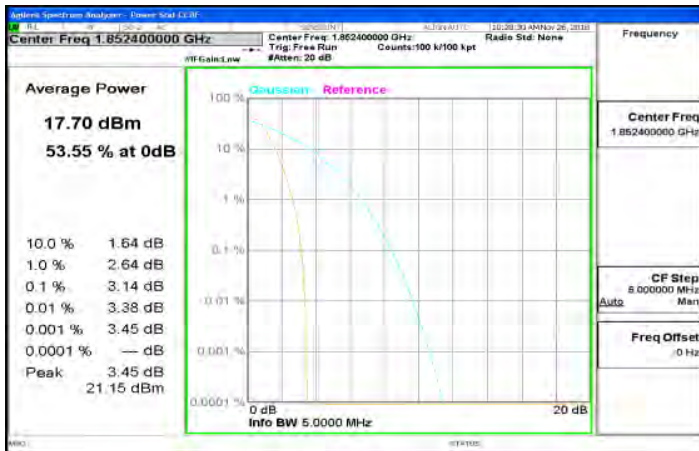

LTE_Band2_1_4MHz_16QAM_6_0_LowCH18607-1850.7

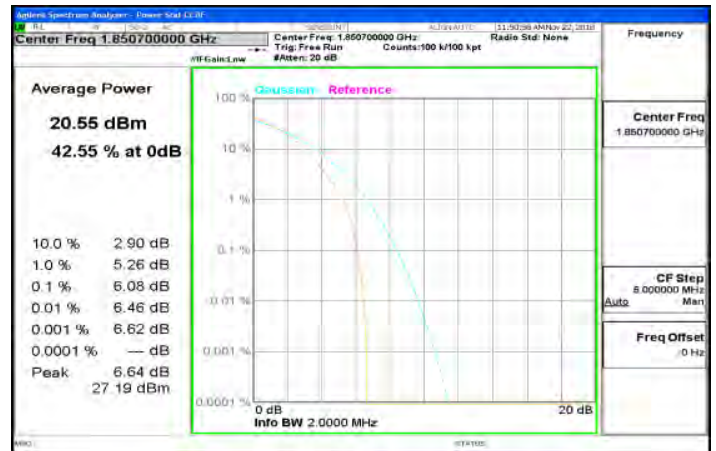

HSUPA_B2_MidCH9400-1880

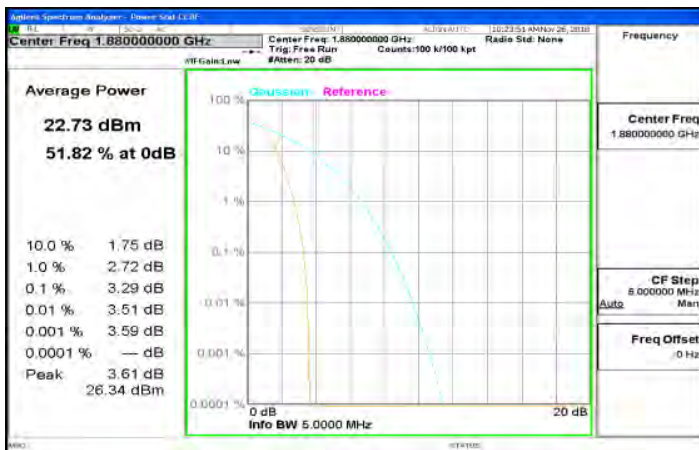

LTE_Band2_1_4MHz_16QAM_6_0_MidCH18900-1880

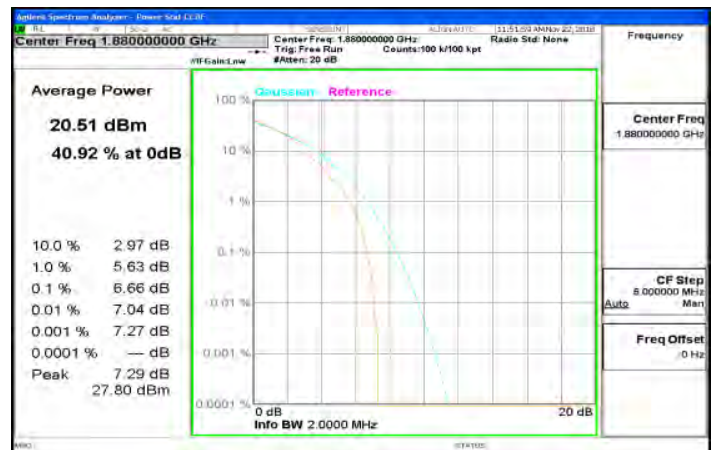

HSUPA_B2_HighCH9538-1907.6

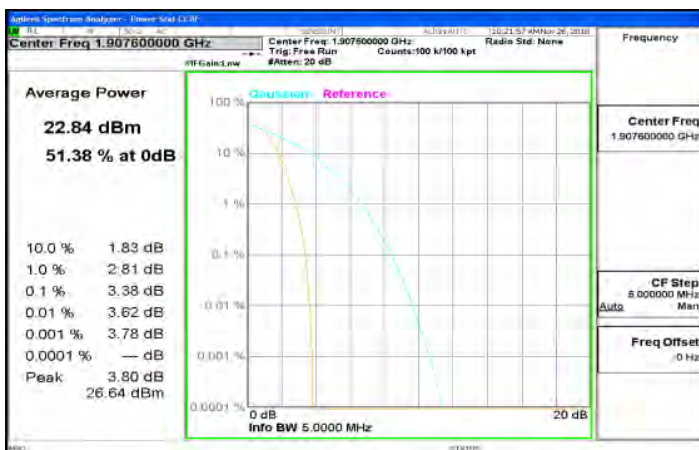

LTE_Band2_1_4MHz_16QAM_6_0_HighCH19193-1909.3

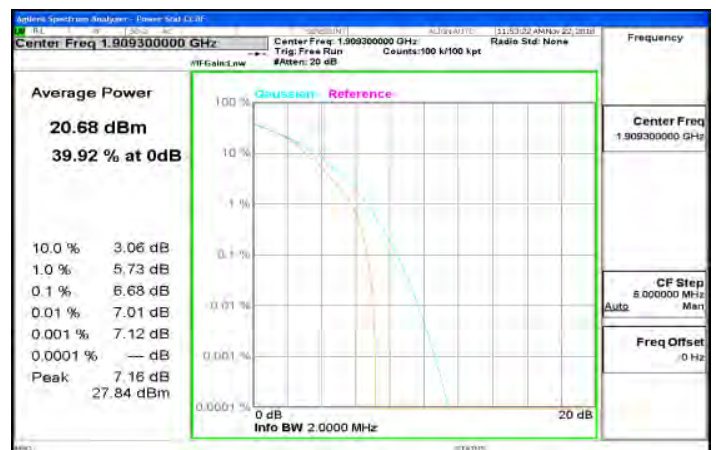

Unless otherwise stated the results shown in this test report refer only to the sample(s) tested and such sample(s) are retained for 90 days only.

除非另有說明，此報告結果僅對測試之樣品負責，同時此樣品僅保留90天。本報告未經本公司書面許可，不可部份複製。

This document is issued by the Company subject to its General Conditions of Service printed overleaf, available on request or accessible at www.sgs.com/terms_and_conditions.htm and, for electronic format documents, subject to Terms and Conditions for Electronic Documents at www.sgs.com/terms_e-document.htm. Attention is drawn to the limitation of liability, indemnification and jurisdiction issues defined therein. Any holder of this document is advised that information contained hereon reflects the Company's findings at the time of its intervention only and within the limits of Client's instructions, if any. The Company's sole responsibility is to its Client and this document does not exonerate parties to a transaction from exercising all their rights and obligations under the transaction documents. This document cannot be reproduced except in full, without prior written approval of the Company. Any unauthorized alteration, forgery or falsification of the content or appearance of this document is unlawful and offenders may be prosecuted to the fullest extent of the law.

LTE_Band2_3MHz_16QAM_15_0_LowCH18615-1851.5

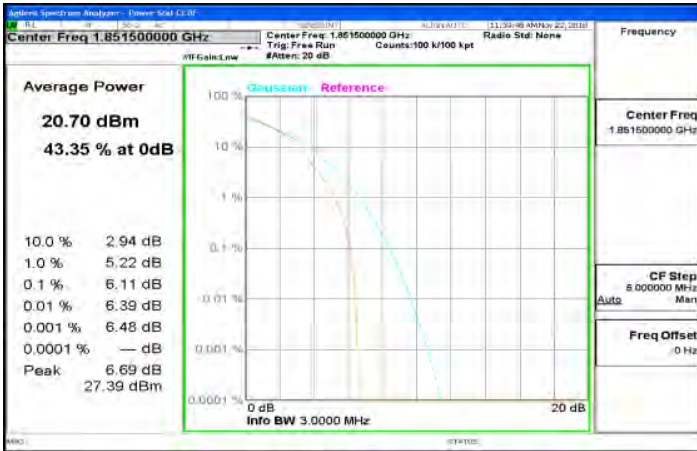

LTE_Band2_5MHz_16QAM_25_0_LowCH18625-1852.5

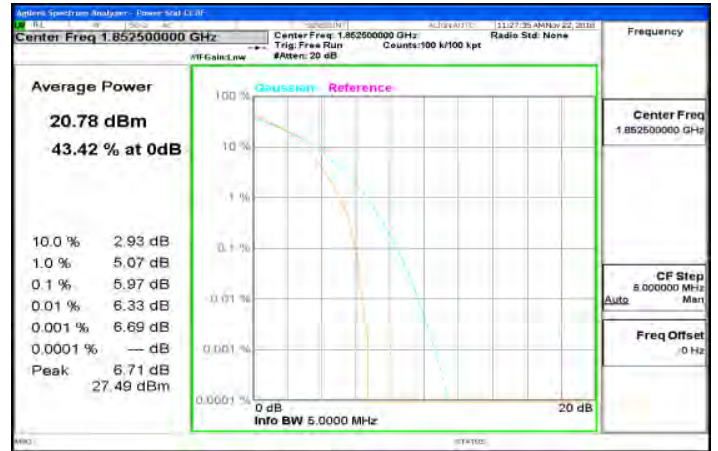

LTE_Band2_3MHz_16QAM_15_0_MidCH18900-1880



LTE_Band2_5MHz_16QAM_25_0_MidCH18900-1880

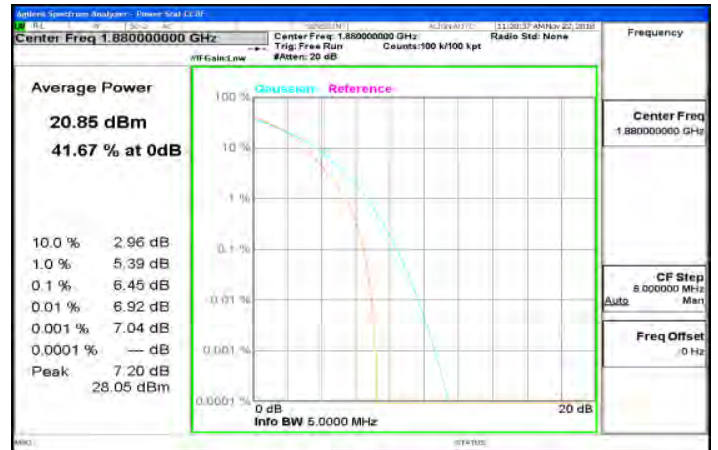

LTE_Band2_3MHz_16QAM_15_0_HighCH19185-1908.5

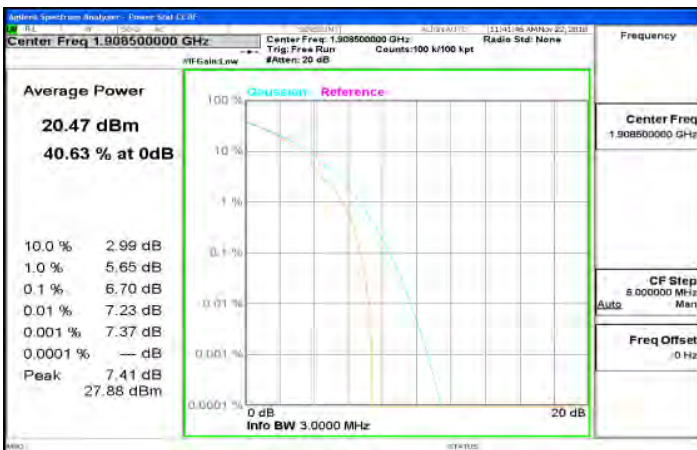

LTE_Band2_5MHz_16QAM_25_0_HighCH19175-1907.5

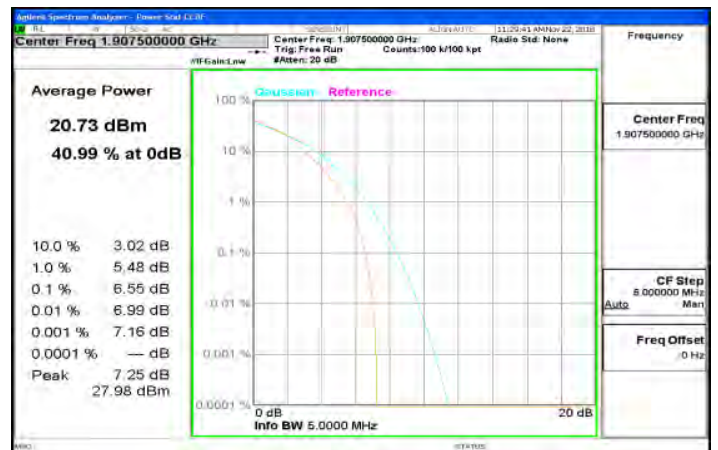

Unless otherwise stated the results shown in this test report refer only to the sample(s) tested and such sample(s) are retained for 90 days only. 除非另有說明，此報告結果僅對測試之樣品負責，同時此樣品僅保留90天。本報告未經本公司書面許可，不可部份複製。

This document is issued by the Company subject to its General Conditions of Service printed overleaf, available on request or accessible at www.sgs.com/terms_and_conditions.htm and, for electronic format documents, subject to Terms and Conditions for Electronic Documents at www.sgs.com/terms_e-document.htm. Attention is drawn to the limitation of liability, indemnification and jurisdiction issues defined therein. Any holder of this document is advised that information contained hereon reflects the Company's findings at the time of its intervention only and within the limits of Client's instructions, if any. The Company's sole responsibility is to its Client and this document does not exonerate parties to a transaction from exercising all their rights and obligations under the transaction documents. This document cannot be reproduced except in full, without prior written approval of the Company. Any unauthorized alteration, forgery or falsification of the content or appearance of this document is unlawful and offenders may be prosecuted to the fullest extent of the law.

LTE_Band2_10MHz_16QAM_50_0_LowCH18650-1855



LTE_Band2_15MHz_16QAM_75_0_LowCH18675-1857.5

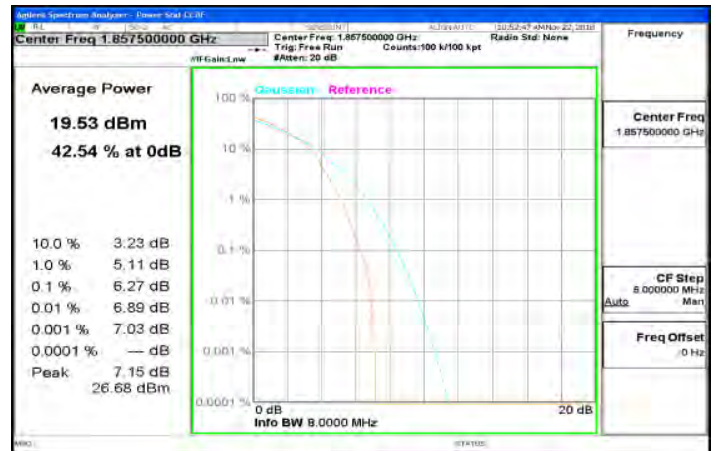

LTE_Band2_10MHz_16QAM_50_0_MidCH18900-1880

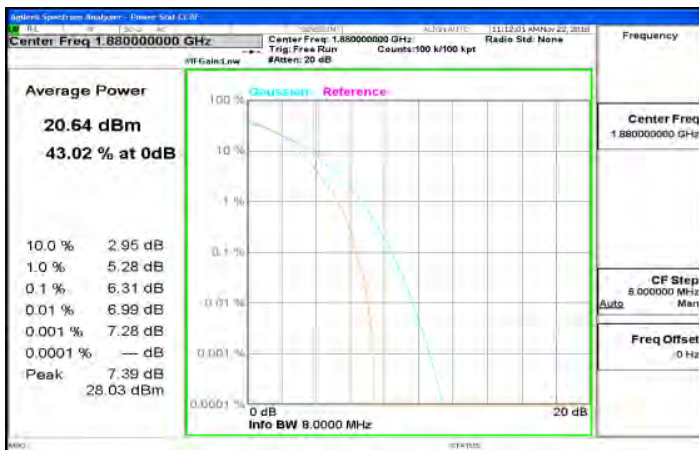

LTE_Band2_15MHz_16QAM_75_0_MidCH18900-1880

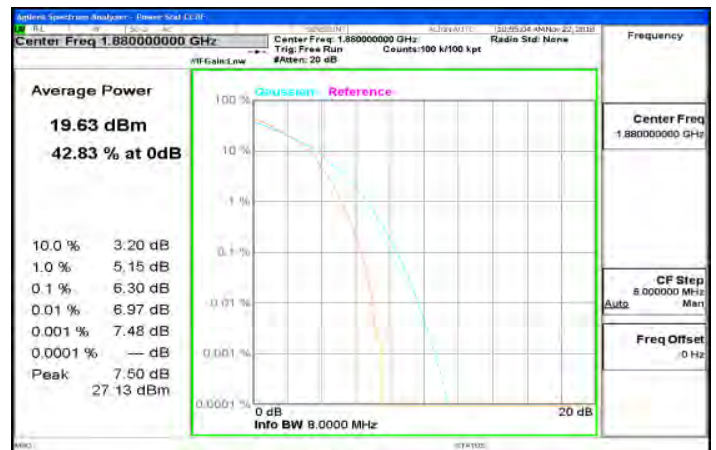

LTE_Band2_10MHz_16QAM_50_0_HighCH19150-1905

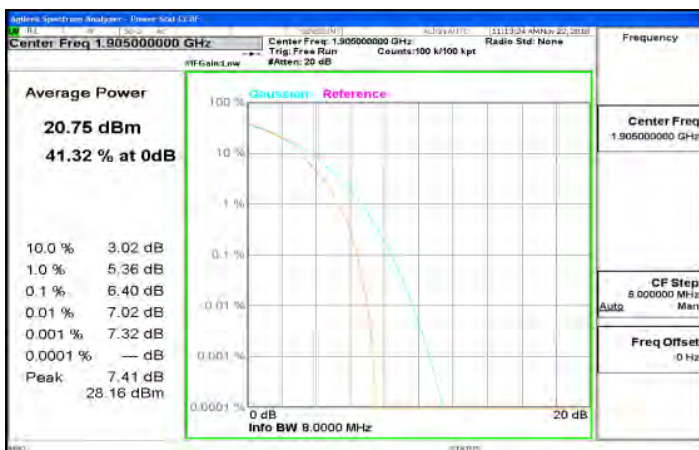

LTE_Band2_15MHz_16QAM_75_0_HighCH19125-1902.5

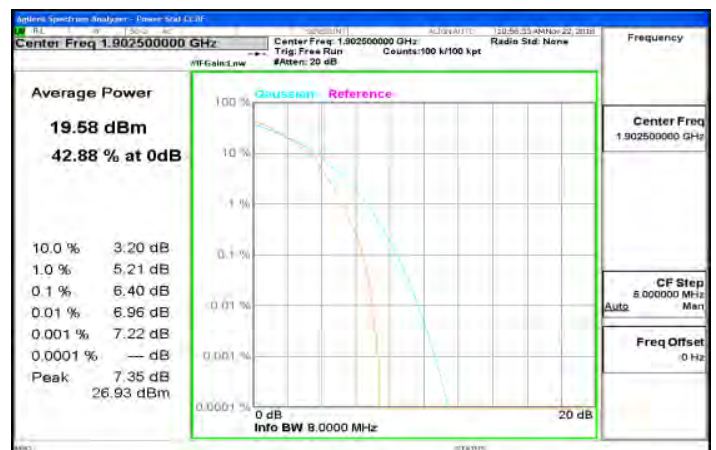

Unless otherwise stated the results shown in this test report refer only to the sample(s) tested and such sample(s) are retained for 90 days only.

除非另有說明，此報告結果僅對測試之樣品負責，同時此樣品僅保留90天。本報告未經本公司書面許可，不可部份複製。

This document is issued by the Company subject to its General Conditions of Service printed overleaf, available on request or accessible at www.sgs.com/terms_and_conditions.htm and, for electronic format documents, subject to Terms and Conditions for Electronic Documents at www.sgs.com/terms_e-document.htm. Attention is drawn to the limitation of liability, indemnification and jurisdiction issues defined therein. Any holder of this document is advised that information contained hereon reflects the Company's findings at the time of its intervention only and within the limits of Client's instructions, if any. The Company's sole responsibility is to its Client and this document does not exonerate parties to a transaction from exercising all their rights and obligations under the transaction documents. This document cannot be reproduced except in full, without prior written approval of the Company. Any unauthorized alteration, forgery or falsification of the content or appearance of this document is unlawful and offenders may be prosecuted to the fullest extent of the law.

LTE_Band2_20MHz_16QAM_100_0_LowCH18700-1860



LTE_Band4_1_4MHz_16QAM_6_0_LowCH19957-1710.7

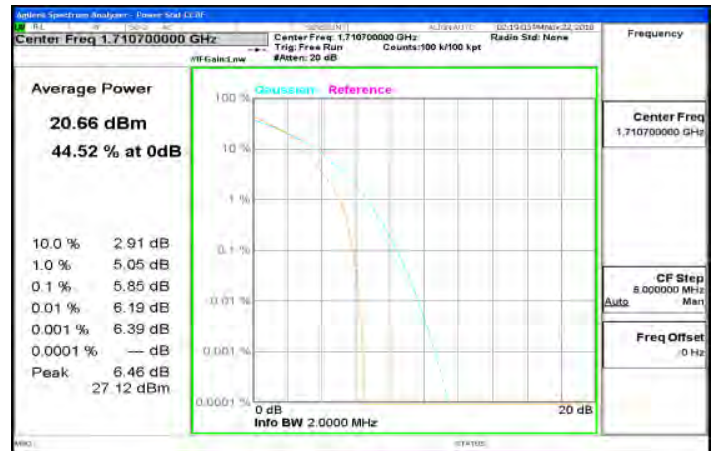

LTE_Band2_20MHz_16QAM_100_0_MidCH18900-1880

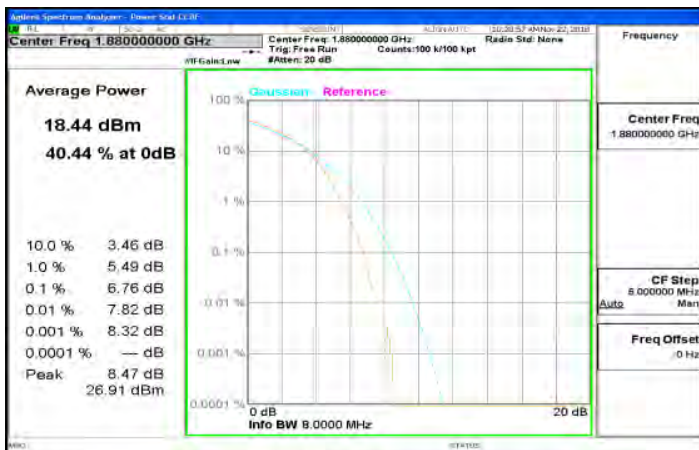

LTE_Band4_1_4MHz_16QAM_6_0_MidCH20175-1732.5

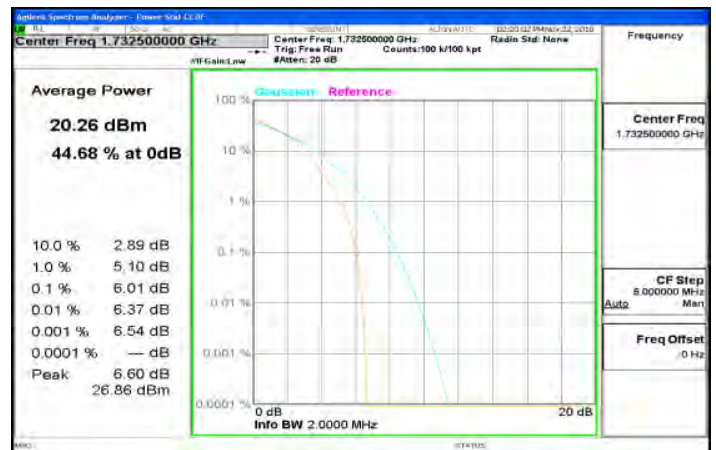

LTE_Band2_20MHz_16QAM_100_0_HighCH19100-1900

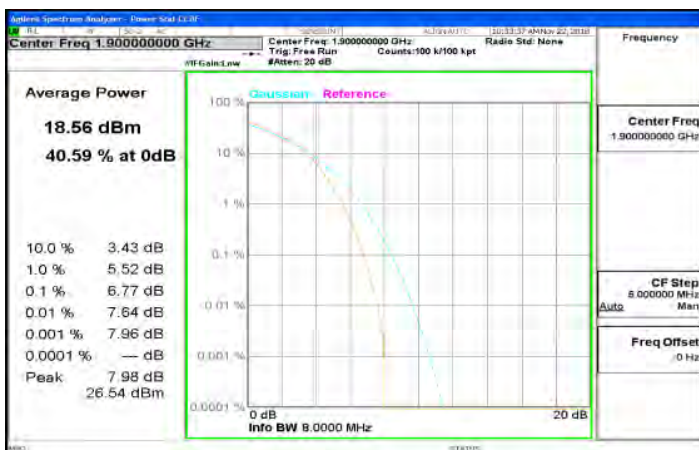

LTE_Band4_1_4MHz_16QAM_6_0_HighCH20393-1754.3

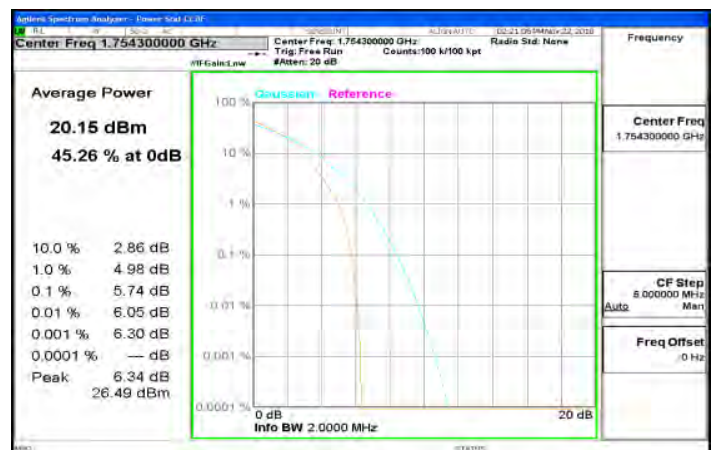

Unless otherwise stated the results shown in this test report refer only to the sample(s) tested and such sample(s) are retained for 90 days only.

除非另有說明，此報告結果僅對測試之樣品負責，同時此樣品僅保留90天。本報告未經本公司書面許可，不可部份複製。

This document is issued by the Company subject to its General Conditions of Service printed overleaf, available on request or accessible at www.sgs.com/terms_and_conditions.htm and, for electronic format documents, subject to Terms and Conditions for Electronic Documents at www.sgs.com/terms_e-document.htm. Attention is drawn to the limitation of liability, indemnification and jurisdiction issues defined therein. Any holder of this document is advised that information contained hereon reflects the Company's findings at the time of its intervention only and within the limits of Client's instructions, if any. The Company's sole responsibility is to its Client and this document does not exonerate parties to a transaction from exercising all their rights and obligations under the transaction documents. This document cannot be reproduced except in full, without prior written approval of the Company. Any unauthorized alteration, forgery or falsification of the content or appearance of this document is unlawful and offenders may be prosecuted to the fullest extent of the law.

LTE_Band4_3MHz_16QAM_15_0_LowCH19965-1711.5



LTE_Band4_5MHz_16QAM_25_0_LowCH19975-1712.5

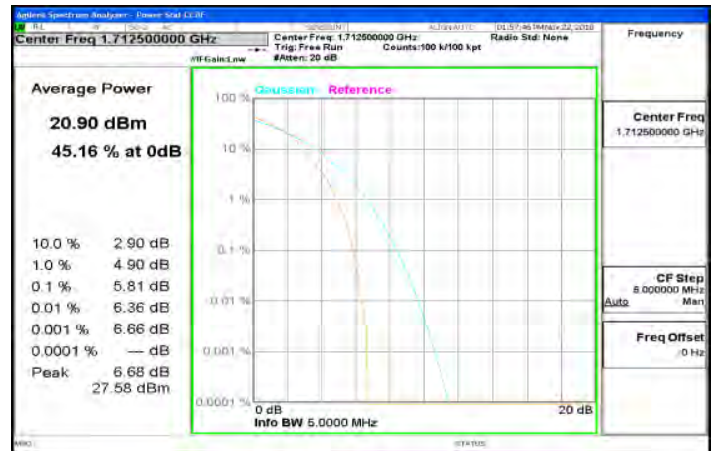

LTE_Band4_3MHz_16QAM_15_0_MidCH20175-1732.5



LTE_Band4_5MHz_16QAM_25_0_MidCH20175-1732.5

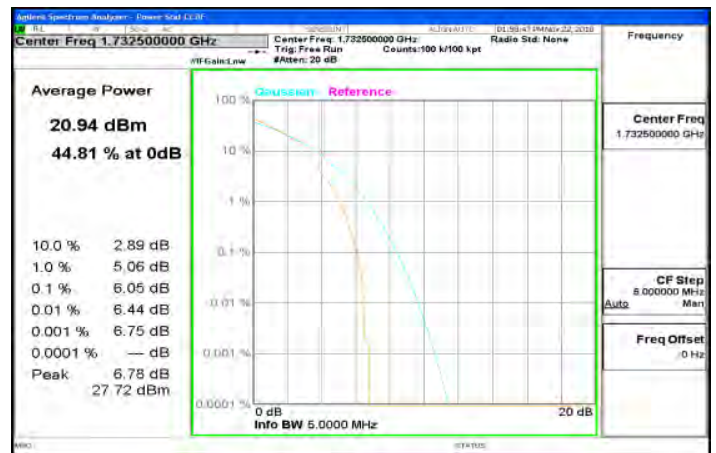

LTE_Band4_3MHz_16QAM_15_0_HighCH20385-1753.5

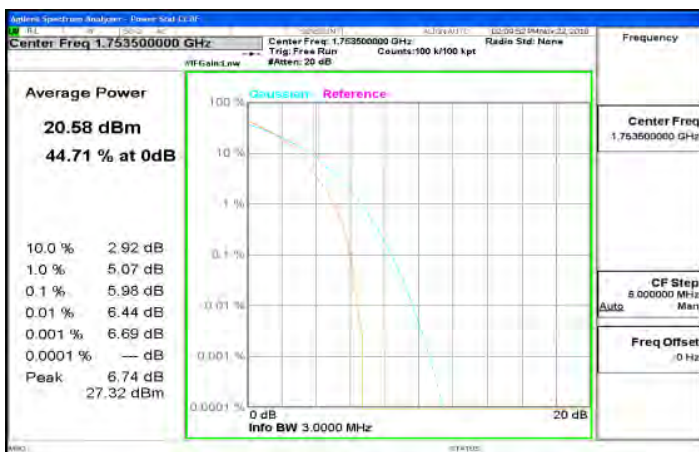

LTE_Band4_5MHz_16QAM_25_0_HighCH20375-1752.5

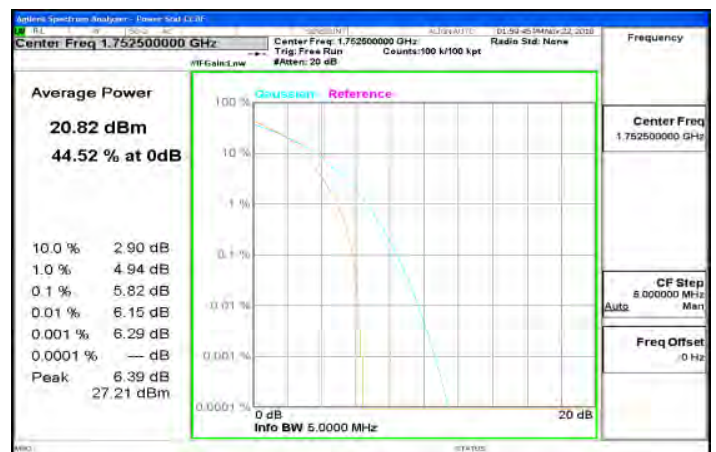

Unless otherwise stated the results shown in this test report refer only to the sample(s) tested and such sample(s) are retained for 90 days only.

除非另有說明，此報告結果僅對測試之樣品負責，同時此樣品僅保留90天。本報告未經本公司書面許可，不可部份複製。

This document is issued by the Company subject to its General Conditions of Service printed overleaf, available on request or accessible at www.sgs.com/terms_and_conditions.htm and, for electronic format documents, subject to Terms and Conditions for Electronic Documents at www.sgs.com/terms_e-document.htm. Attention is drawn to the limitation of liability, indemnification and jurisdiction issues defined therein. Any holder of this document is advised that information contained hereon reflects the Company's findings at the time of its intervention only and within the limits of Client's instructions, if any. The Company's sole responsibility is to its Client and this document does not exonerate parties to a transaction from exercising all their rights and obligations under the transaction documents. This document cannot be reproduced except in full, without prior written approval of the Company. Any unauthorized alteration, forgery or falsification of the content or appearance of this document is unlawful and offenders may be prosecuted to the fullest extent of the law.

SGS Taiwan Ltd.

No. 134, WuKungRoad, NewTaipeiIndustrialPark, WukuDistrict, NewTaipeiCity, Taiwan24803/新北市五股區新北產業園區五工路 134 號

台灣檢驗科技股份有限公司

t (886-2) 2299-3279

f (886-2) 2298-0488

www.tw.sgs.com

Member of SGS Group

LTE_Band4_10MHz_16QAM_50_0_LowCH2000-1715



LTE_Band4_15MHz_16QAM_75_0_LowCH20025-1717.5

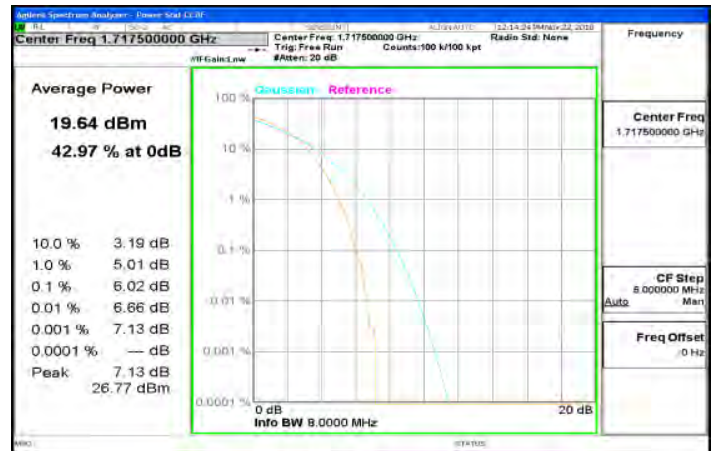

LTE_Band4_10MHz_16QAM_50_0_MidCH20175-1732.5

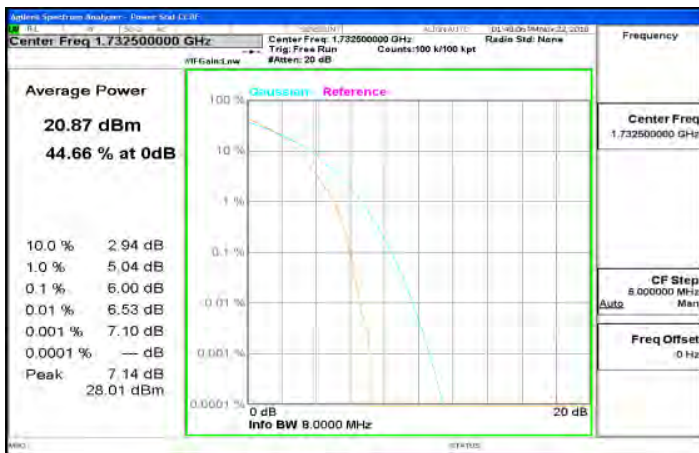

LTE_Band4_15MHz_16QAM_75_0_MidCH20175-1732.5

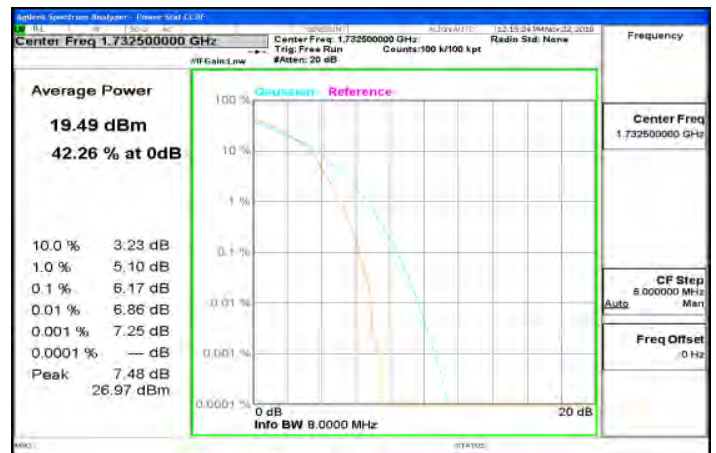

LTE_Band4_10MHz_16QAM_50_0_HighCH20350-1750

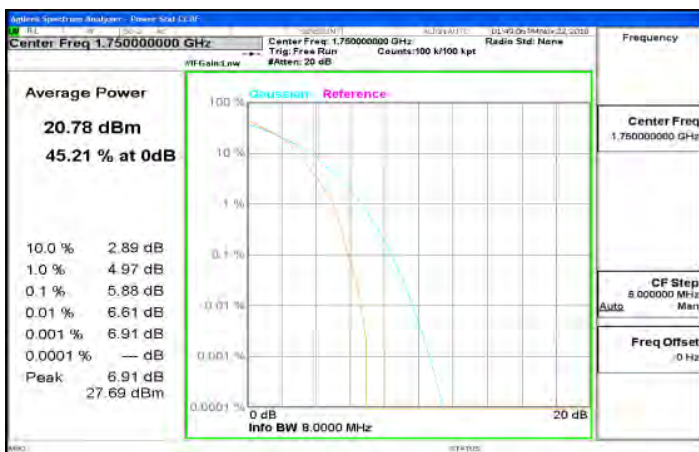

LTE_Band4_15MHz_16QAM_75_0_HighCH20325-1747.5

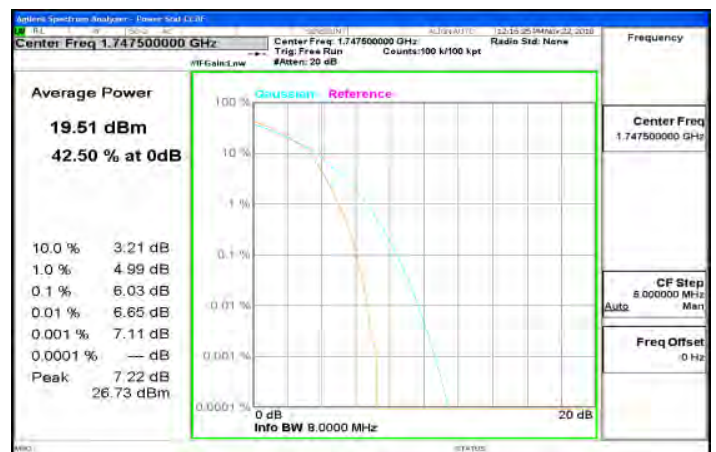

Unless otherwise stated the results shown in this test report refer only to the sample(s) tested and such sample(s) are retained for 90 days only.

除非另有說明，此報告結果僅對測試之樣品負責，同時此樣品僅保留90天。本報告未經本公司書面許可，不可部份複製。

This document is issued by the Company subject to its General Conditions of Service printed overleaf, available on request or accessible at www.sgs.com/terms_and_conditions.htm and, for electronic format documents, subject to Terms and Conditions for Electronic Documents at www.sgs.com/terms_e-document.htm. Attention is drawn to the limitation of liability, indemnification and jurisdiction issues defined therein. Any holder of this document is advised that information contained hereon reflects the Company's findings at the time of its intervention only and within the limits of Client's instructions, if any. The Company's sole responsibility is to its Client and this document does not exonerate parties to a transaction from exercising all their rights and obligations under the transaction documents. This document cannot be reproduced except in full, without prior written approval of the Company. Any unauthorized alteration, forgery or falsification of the content or appearance of this document is unlawful and offenders may be prosecuted to the fullest extent of the law.

LTE_Band4_20MHz_16QAM_100_0_LowCH20050-1720



LTE_Band12_1_4MHz_16QAM_6_0_LowCH23017-699.7

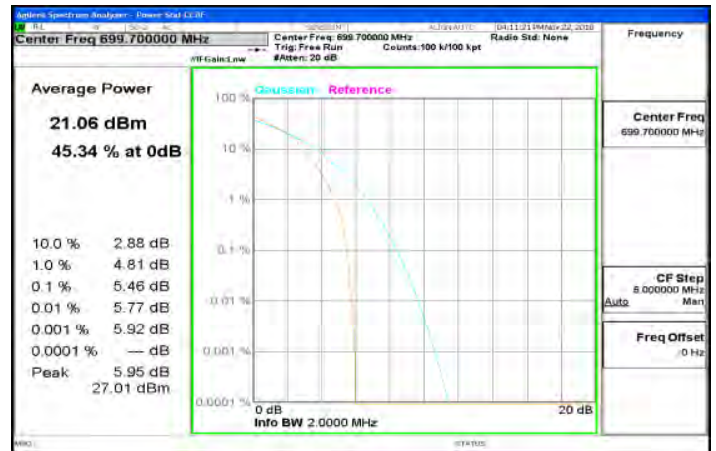

LTE_Band4_20MHz_16QAM_100_0_MidCH20175-1732.5

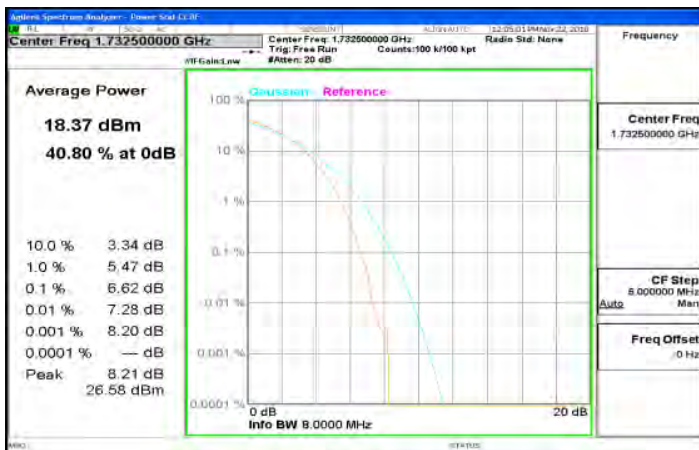

LTE_Band12_1_4MHz_16QAM_6_0_MidCH23095-707.5



LTE_Band4_20MHz_16QAM_100_0_HighCH20300-1745

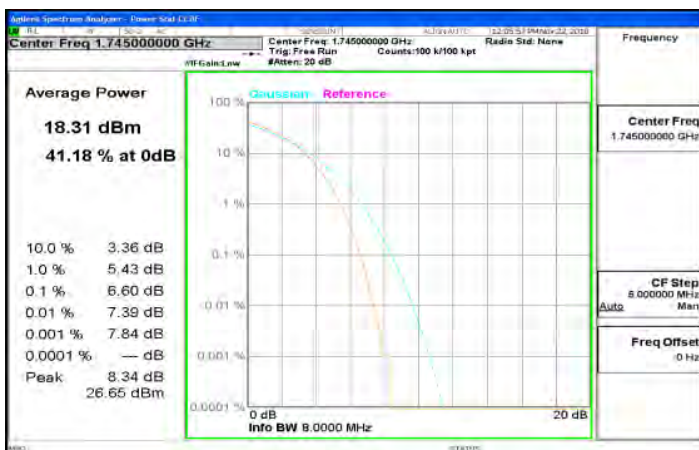

LTE_Band12_1_4MHz_16QAM_6_0_HighCH23173-715.3

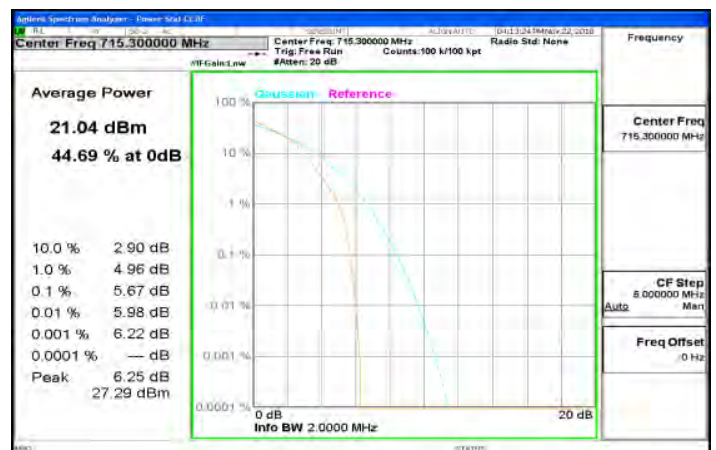

Unless otherwise stated the results shown in this test report refer only to the sample(s) tested and such sample(s) are retained for 90 days only.

除非另有說明，此報告結果僅對測試之樣品負責，同時此樣品僅保留90天。本報告未經本公司書面許可，不可部份複製。

This document is issued by the Company subject to its General Conditions of Service printed overleaf, available on request or accessible at www.sgs.com/terms_and_conditions.htm and, for electronic format documents, subject to Terms and Conditions for Electronic Documents at www.sgs.com/terms_e-document.htm. Attention is drawn to the limitation of liability, indemnification and jurisdiction issues defined therein. Any holder of this document is advised that information contained hereon reflects the Company's findings at the time of its intervention only and within the limits of Client's instructions, if any. The Company's sole responsibility is to its Client and this document does not exonerate parties to a transaction from exercising all their rights and obligations under the transaction documents. This document cannot be reproduced except in full, without prior written approval of the Company. Any unauthorized alteration, forgery or falsification of the content or appearance of this document is unlawful and offenders may be prosecuted to the fullest extent of the law.

SGS Taiwan Ltd.

No. 134, WuKungRoad, NewTaipeiIndustrialPark, WukuDistrict, NewTaipeiCity, Taiwan24803/新北市五股區新北產業園區五工路 134 號

台灣檢驗科技股份有限公司

t (886-2) 2299-3279

f (886-2) 2298-0488

www.tw.sgs.com

Member of SGS Group

LTE_Band12_3MHz_16QAM_15_0_LowCH23025-700.5

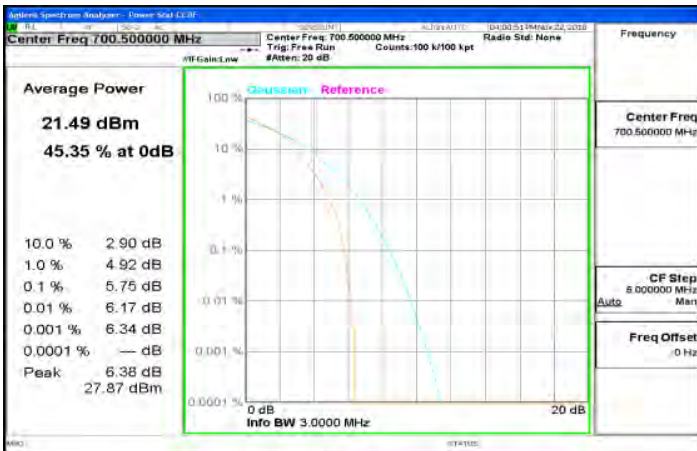

LTE_Band12_5MHz_16QAM_25_0_LowCH23035-701.5

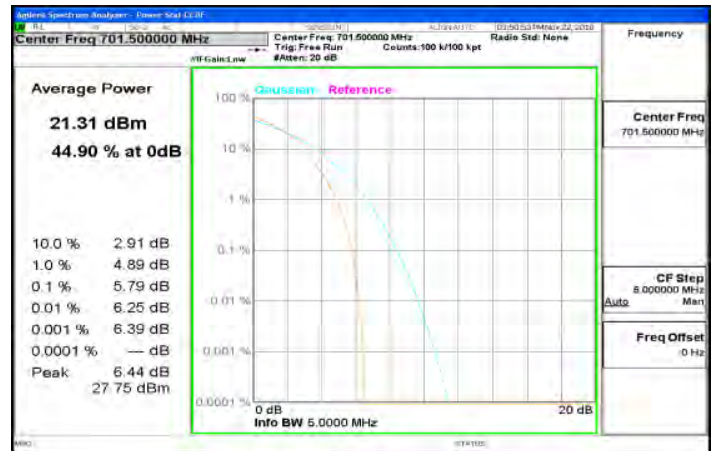

LTE_Band12_3MHz_16QAM_15_0_MidCH23095-707.5

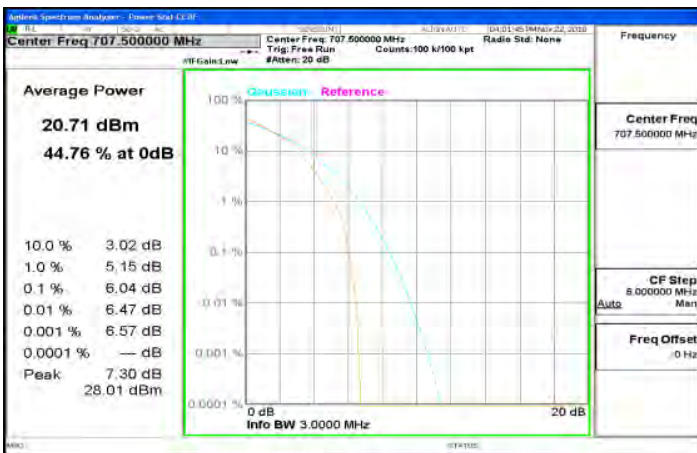

LTE_Band12_5MHz_16QAM_25_0_MidCH23095-707.5

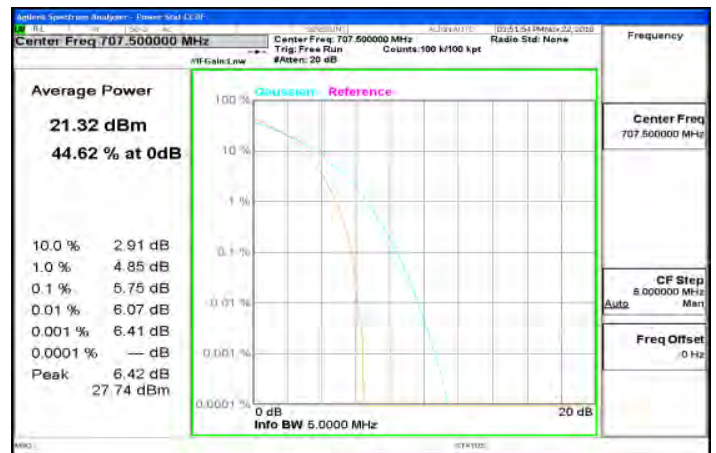

LTE_Band12_3MHz_16QAM_15_0_HighCH23165-714.5

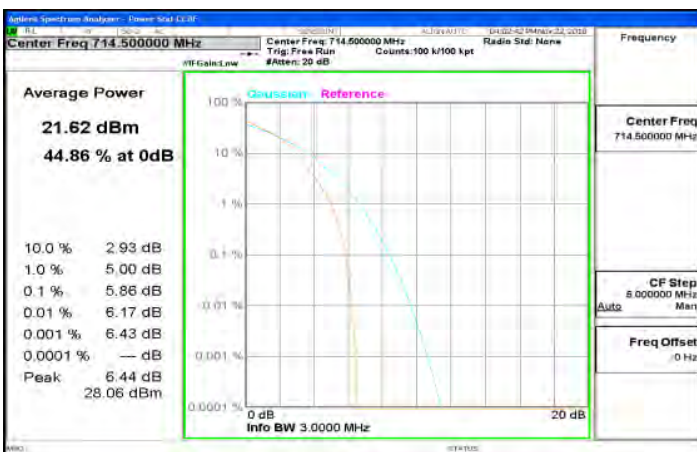

LTE_Band12_5MHz_16QAM_25_0_HighCH23155-713.5

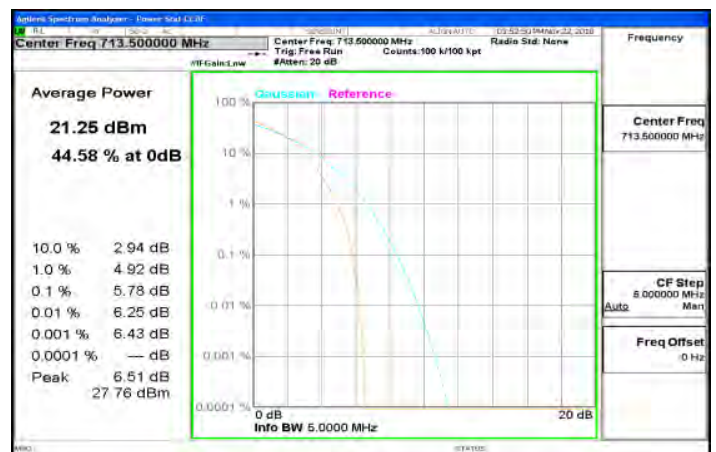

Unless otherwise stated the results shown in this test report refer only to the sample(s) tested and such sample(s) are retained for 90 days only.

除非另有說明，此報告結果僅對測試之樣品負責，同時此樣品僅保留90天。本報告未經本公司書面許可，不可部份複製。

This document is issued by the Company subject to its General Conditions of Service printed overleaf, available on request or accessible at www.sgs.com/terms_and_conditions.htm and, for electronic format documents, subject to Terms and Conditions for Electronic Documents at www.sgs.com/terms_e-document.htm. Attention is drawn to the limitation of liability, indemnification and jurisdiction issues defined therein. Any holder of this document is advised that information contained hereon reflects the Company's findings at the time of its intervention only and within the limits of Client's instructions, if any. The Company's sole responsibility is to its Client and this document does not exonerate parties to a transaction from exercising all their rights and obligations under the transaction documents. This document cannot be reproduced except in full, without prior written approval of the Company. Any unauthorized alteration, forgery or falsification of the content or appearance of this document is unlawful and offenders may be prosecuted to the fullest extent of the law.

SGS Taiwan Ltd.

No. 134, WuKungRoad, NewTaipeiIndustrialPark, WukuDistrict, NewTaipeiCity, Taiwan24803/新北市五股區新北產業園區五工路 134 號

台灣檢驗科技股份有限公司

t (886-2) 2299-3279

f (886-2) 2298-0488

www.tw.sgs.com

Member of SGS Group

LTE_Band12_10MHz_16QAM_50_0_LowCH23060-704



LTE_Band13_5MHz_16QAM_25_0_LowCH23205-779.5

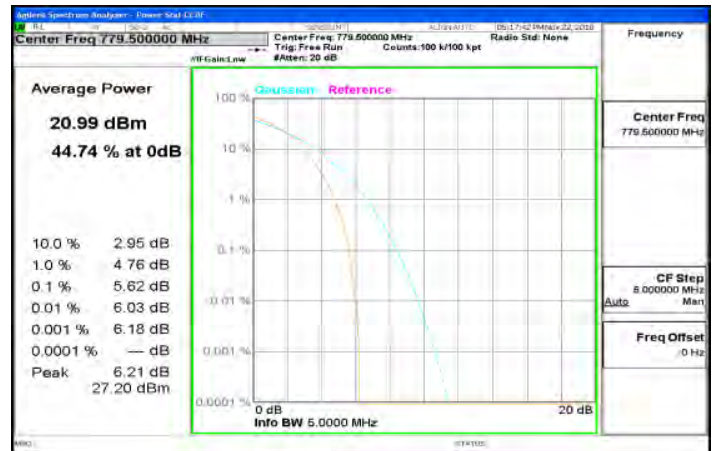

LTE_Band12_10MHz_16QAM_50_0_MidCH23095-707.5

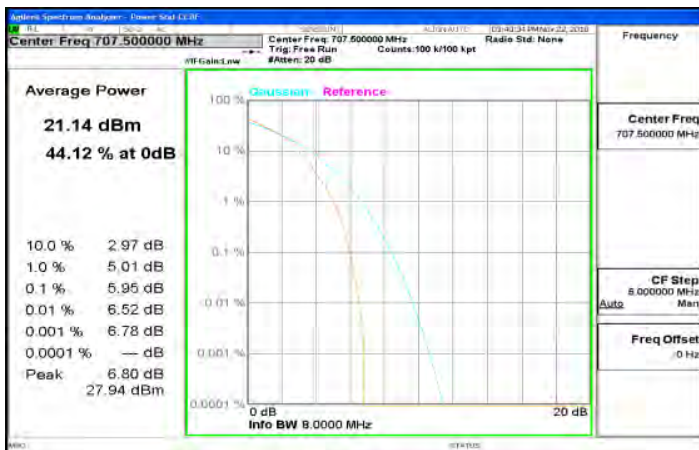

LTE_Band13_5MHz_16QAM_25_0_MidCH23230-782

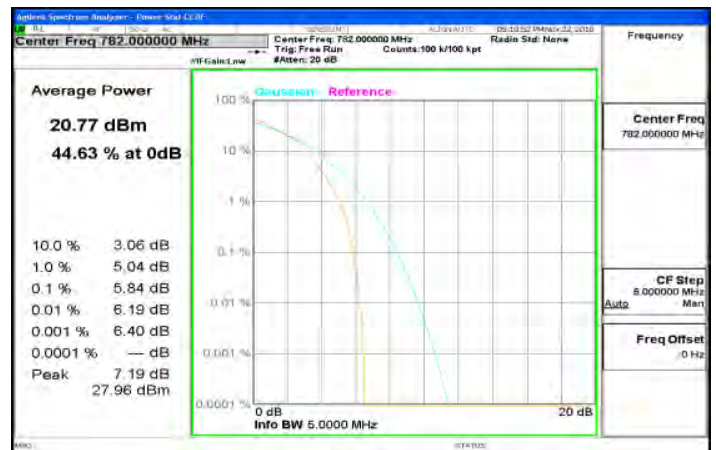

LTE_Band12_10MHz_16QAM_50_0_HighCH23130-711

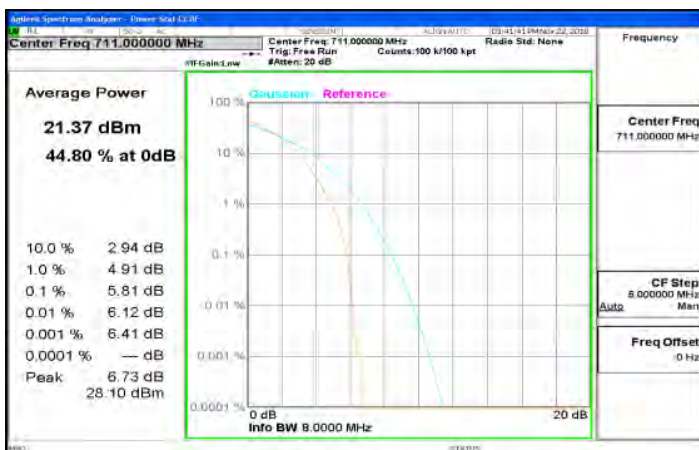

LTE_Band13_5MHz_16QAM_25_0_HighCH23255-784.5

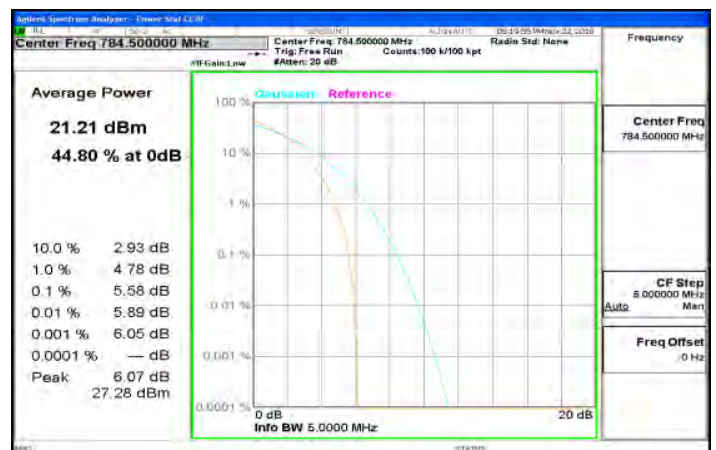

Unless otherwise stated the results shown in this test report refer only to the sample(s) tested and such sample(s) are retained for 90 days only.

除非另有說明，此報告結果僅對測試之樣品負責，同時此樣品僅保留90天。本報告未經本公司書面許可，不可部份複製。

This document is issued by the Company subject to its General Conditions of Service printed overleaf, available on request or accessible at www.sgs.com/terms_and_conditions.htm and, for electronic format documents, subject to Terms and Conditions for Electronic Documents at www.sgs.com/terms_e-document.htm. Attention is drawn to the limitation of liability, indemnification and jurisdiction issues defined therein. Any holder of this document is advised that information contained hereon reflects the Company's findings at the time of its intervention only and within the limits of Client's instructions, if any. The Company's sole responsibility is to its Client and this document does not exonerate parties to a transaction from exercising all their rights and obligations under the transaction documents. This document cannot be reproduced except in full, without prior written approval of the Company. Any unauthorized alteration, forgery or falsification of the content or appearance of this document is unlawful and offenders may be prosecuted to the fullest extent of the law.

SGS Taiwan Ltd.

No. 134, WuKungRoad, NewTaipeiIndustrialPark, WukuDistrict, NewTaipeiCity, Taiwan24803/新北市五股區新北產業園區五工路 134 號

台灣檢驗科技股份有限公司

t (886-2) 2299-3279

f (886-2) 2298-0488

www.tw.sgs.com

Member of SGS Group

LTE_Band13_10MHz_16QAM_50_0_MidCH23230-782

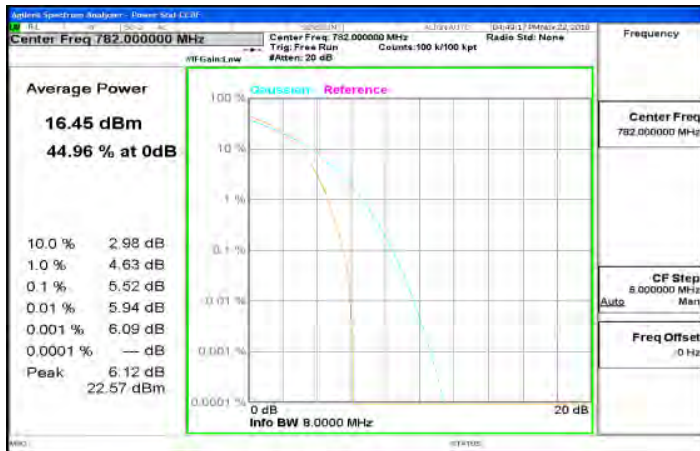

~ End of Report ~

Unless otherwise stated the results shown in this test report refer only to the sample(s) tested and such sample(s) are retained for 90 days only.

除非另有說明，此報告結果僅對測試之樣品負責，同時此樣品僅保留90天。本報告未經本公司書面許可，不可部份複製。

This document is issued by the Company subject to its General Conditions of Service printed overleaf, available on request or accessible at www.sgs.com/terms_and_conditions.htm and, for electronic format documents, subject to Terms and Conditions for Electronic Documents at www.sgs.com/terms_e-document.htm. Attention is drawn to the limitation of liability, indemnification and jurisdiction issues defined therein. Any holder of this document is advised that information contained hereon reflects the Company's findings at the time of its intervention only and within the limits of Client's instructions, if any. The Company's sole responsibility is to its Client and this document does not exonerate parties to a transaction from exercising all their rights and obligations under the transaction documents. This document cannot be reproduced except in full, without prior written approval of the Company. Any unauthorized alteration, forgery or falsification of the content or appearance of this document is unlawful and offenders may be prosecuted to the fullest extent of the law.

SGS Taiwan Ltd.

No. 134, WuKungRoad, NewTaipeiIndustrialPark, WukuDistrict, NewTaipeiCity, Taiwan24803/新北市五股區新北產業園區五工路 134 號

台灣檢驗科技股份有限公司

t (886-2) 2299-3279

f (886-2) 2298-0488

www.tw.sgs.com

Member of SGS Group