



# PCTEST ENGINEERING LABORATORY, INC.

6660 – B Dobbin Road · Columbia, MD 21045 · USA

Telephone 410.290.6652 / Fax 410.290.6654

http://www.pctestlab.com (email: randy@pctestlab.com)

## CERTIFICATE OF COMPLIANCE (SAR EVALUATION)



### APPLICANT NAME & ADDRESS:

Matsushita Electric Industrial Co., Ltd.  
1006 Oaza Kadoma, Kadoma,  
Osaka, 571 JAPAN

### DATE & LOCATION OF TESTING:

Dates of Tests: February 19, 2004  
Test Report S/N: SAR.240206081-R1.ACJ  
Test Site: PCTEST Lab, Columbia, MD USA  
Project Number: ITPD-04-F007A

<b>FCC ID:</b>	<b>ACJ9TGCF-295</b>
<b>APPLICANT NAME:</b>	<b>Matsushita Electric Industrial Co., Ltd.</b>

**EUT Type:** Panasonic Toughbook CF-29mk2 w/ Siemens MC46 GPRS Module FCC ID: QIPMC46, Intel Centrino WLAN FCC ID: PD9WM3B2200BG and Alps Bluetooth Module Model: UGXZ1-116B

**Tx Frequency:** 824.20 – 848.80 MHz (GPRS) / 1851.20 – 1909.80 MHz (PCS GPRS)

**Rx Frequency:** 869.20 – 893.80 MHz (GPRS) / 1931.20 – 1988.80 MHz (PCS GPRS)

**Max. RF Output Power:** 1.995 W GPRS (33.00 dBm) Conducted  
0.933 W PCS GPRS (30.00 dBm) Conducted  
0.056 W (WLAN WM3B2200BG) Conducted

**Max. SAR Measurement:** 0.24 W/kg GPRS Body Lap SAR; 0.57 W/kg GPRS Top SAR;  
0.10 W/kg PCS GPRS Body Lap SAR; 0.16 W/kg PCS GPRS Top SAR

**Trade Name/Model(s):** CF-29mk2

**FCC Rule Part(s):** §2.1093; FCC/OET Bulletin 65 Supplement C [July 2001]

**Application Type:** Certification

**Test Device Serial No.:** Identical Prototype [S/N: 3IKYA001097]



This wireless portable device has been shown to be capable of compliance for localized specific absorption rate (SAR) for uncontrolled environment/general population exposure limits specified in ANSI/IEEE Std. C95.1-1992 and had been tested in accordance with the measurement procedures specified in FCC/OET Bulletin 65 Supplement C (2001) and IEEE Std. P1528 D1.2 (April 2002).

I attest to the accuracy of data. All measurements reported herein were performed by me or were made under my supervision and are correct to the best of my knowledge and belief. I assume full responsibility for the completeness of these measurements and vouch for the qualifications of all persons taking them.

PCTEST certifies that no party to this application has been denied the FCC benefits pursuant to Section 5301 of the Anti-Drug Abuse Act of 1988, 21 U.S.C. 862.



  
 Alfred Cirwithian  
 Vice President Engineering



PCTEST SAR TEST REPORT	 <b>FCC CERTIFICATION</b>			Reviewed by: Quality Manager
SAR Filename: SAR.240206081-R1.ACJ	Test Dates: Feb. 19, 2003	EUT Type: Panasonic Toughbook w/ Siemens GPRS Module, Intel WLAN & Bluetooth	FCC ID: ACJ9TGCF-295	Page 1 of 25

# TABLE OF CONTENTS

1. INTRODUCTION / SAR DEFINITION .....	3
2. SAR MEASUREMENT SETUP .....	4
3. ALIDX-500 E-FIELD PROBE SYSTEM .....	5
4. PROBE CALIBRATION PROCESS .....	6
5. PHANTOM & EQUIVALENT TISSUES.....	7
6. TEST SYSTEM SPECIFICATIONS.....	8
7. DOSIMETRIC ASSESSMENT & PHANTOM SPECS.....	9
8. TEST CONFIGURATION POSITION .....	10
9. ANSI/IEEE C95.1 - 1992 RF EXPOSURE LIMITS.....	11
10. MEASUREMENT UNCERTAINTIES .....	12
11. SAR TEST DATA SUMMARY.....	13
12. SAR TEST EQUIPMENT .....	14
13. CONCLUSION.....	15
14. REFERENCES.....	16
EXHIBIT A. SYSTEM VERIFICATION.....	17
EXHIBIT A. SAR DATA SUMMARY .....	18
EXHIBIT B. SAR TEST DATA .....	22
EXHIBIT C. SAR TEST SETUP PHOTOGRAPHS .....	23
EXHIBIT D. DIPOLE VALIDATION .....	24
EXHIBIT E. PROBE CALIBRATION .....	25

<b>PCTEST SAR TEST REPORT</b>		<b>FCC CERTIFICATION</b>		<b>Reviewed by:</b> Quality Manager
<b>SAR Filename:</b> SAR.240206081-R1.ACJ	<b>Test Dates:</b> Feb. 19, 2003	<b>EUT Type: Panasonic Toughbook w/ Siemens GPRS Module, Intel WLAN &amp; Bluetooth</b>	<b>FCC ID:</b> ACJ9TGCF-295	Page 2 of 25

# 1. INTRODUCTION / SAR DEFINITION

The FCC has adopted the guidelines for evaluating the environmental effects of radiofrequency radiation in ET Docket 93-62 on Aug. 6, 1996 to protect the public and workers from the potential hazards of RF emissions due to FCC-regulated portable devices.[1]

The safety limits used for the environmental evaluation measurements are based on the criteria published by the American National Standards Institute (ANSI) for localized specific absorption rate (SAR) in *IEEE/ANSI C95.1-1992 Standard for Safety Levels with Respect to Human Exposure to Radio Frequency Electromagnetic Fields, 3 kHz to 300 GHz*. (c) 1992 by the Institute of Electrical and Electronics Engineers, Inc., New York, New York 10017.[2] The measurement procedure described in *IEEE/ANSI C95.3-1992 Recommended Practice for the Measurement of Potentially Hazardous Electromagnetic Fields - RF and Microwave*[3] is used for guidance in measuring SAR due to the RF radiation exposure from the Equipment Under Test (EUT). These criteria for SAR evaluation are similar to those recommended by the National Council on Radiation Protection and Measurements (NCRP) in *Biological Effects and Exposure Criteria for Radiofrequency Electromagnetic Fields*, NCRP Report No. 86 (c) NCRP, 1986, Bethesda, MD 20814.[6] SAR is a measure of the rate of energy absorption due to exposure to an RF transmitting source. SAR values have been related to threshold levels for potential biological hazards.

## SAR Definition

Specific Absorption Rate (SAR) is defined as the time derivative (rate) of the incremental energy ( $dU$ ) absorbed by (dissipated in) an incremental mass ( $dm$ ) contained in a volume element ( $dV$ ) of a given density ( $\rho$ ). It is also defined as the rate of RF energy absorption per unit mass at a point in an absorbing body (see Fig. 1.1).

$$SAR = \frac{d}{dt} \left( \frac{dU}{dm} \right) = \frac{d}{dt} \left( \frac{dU}{\rho dV} \right)$$

Figure 1.1  
SAR Mathematical Equation



SAR is expressed in units of Watts per Kilogram (W/kg).

$$SAR = \frac{\sigma E^2}{\rho}$$

where:

- $\sigma$  = conductivity of the tissue-simulant material (S/m)
- $\rho$  = mass density of the tissue-simulant material (kg/m<sup>3</sup>)
- $E$  = Total RMS electric field strength (V/m)

NOTE: The primary factors that control rate of energy absorption were found to be the wavelength of the incident field in relations to the dimensions and geometry of the irradiated organism, the orientation of the organism in relation to the polarity of field vectors, the presence of reflecting surfaces, and whether conductive contact is made by the organism with a ground plane.[6]

PCTEST SAR TEST REPORT		FCC CERTIFICATION		Reviewed by: Quality Manager
SAR Filename: SAR.240206081-R1.ACJ	Test Dates: Feb. 19, 2003	EUT Type: Panasonic Toughbook w/ Siemens GPRS Module, Intel WLAN & Bluetooth	FCC ID: ACJ9TGCF-295	Page 3 of 25

## 2. SAR MEASUREMENT SETUP

### Robotic System

Measurements are performed using the ALIDX-500 automated dosimetric assessment system. The ALIDX-500 is made by IDX Robotics, Inc. (IDX) in the United States and consists of high precision robotics system (CRS), robot controller, Pentium 4 computer, near-field probe, probe alignment sensor, and the Left and Right SAM phantoms containing the head/brain equivalent tissue, and the flat phantoms for body/muscle equivalent. The robot is a six-axis industrial robot performing precise movements to position the probe to the location (points) of maximum electromagnetic field (EMF) (see Fig. 2.1).

### System Hardware

The Robot table consists of the power supply, robot controller, safety computer, teach pendant (Joystick), six-axis robot arm, and the probe. The cell controller consists of DELL Dimension 4300 Pentium-4 1.6 GHz computer with Windows 2000 system and SAR Measurement software, National Instruments analog card, monitor, keyboard, and mouse. The robot controller is connected to the cell controller to communicate between the two computers. The probe data is connected to the cell controller via data acquisition cables.

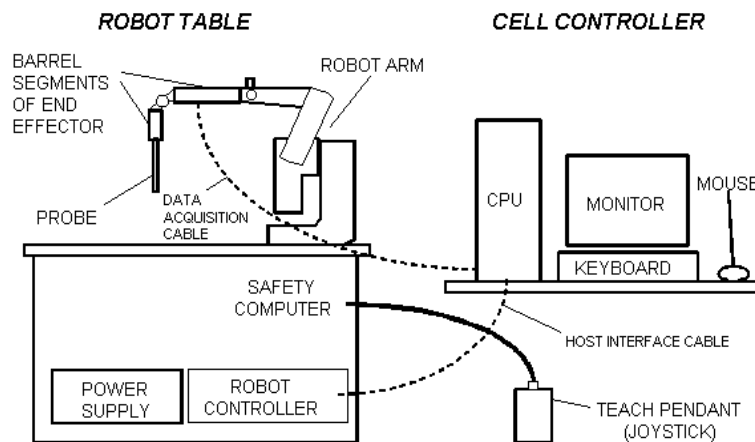

### System Electronics



**Figure 2.1**  
**SAR Measurement System Setup**

When the Robot is in the home position, the Y-axis of the coordinate system parallels the line of intersection between the tabletop and the long axis of the Robot's Large Shoulder. The Teach Pendant may be used to establish the X,Y coordinate directions by depressing the 0-X and 0-Y MOTOR/AXIS switches while in axis mode.

The robot is first taught to position the probe sensor following a specific pattern of points. In the first sweep the sensor enclosure touches the inside of the phantom head. The SAR is measured on a defined grid of points that are concentrated on the surface of the head closest to the antenna of the transmitting device (EUT).

PCTEST SAR TEST REPORT		FCC CERTIFICATION		Reviewed by: Quality Manager
SAR Filename: SAR.240206081-R1.ACJ	Test Dates: Feb. 19, 2003	EUT Type: Panasonic Toughbook w/ Siemens GPRS Module, Intel WLAN & Bluetooth	FCC ID: ACI9TGCF-295	Page 4 of 25

### 3. ALIDX-500 E-FIELD PROBE SYSTEM

#### Probe Measurement System

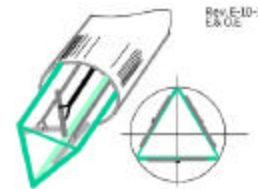

**Fig 3.1**  
IDX System

The near-field probe is an implantable isotropic E-field probe that measures the voltages proportional to the  $|E|^2$  (electric) or  $|H|^2$  (magnetic) fields. The probe is enclosed in a hollow glass protective cylinder 9-mm. outer diameter, 0.5 mm. thickness and 30 cm. in length. The E-probe contains three electrically small array of orthogonal dipoles strategically placed to provide greater accuracy and to compensate for near-field spatial gradients. The probe contains diodes that are placed over the gap of the dipoles to improve RF detection. The electrical signal detected by each diode is amplified by three DC amplifiers and are contained in a shielded container in the robot end effector so its performance is not affected by the presence of incident electromagnetic fields (see Fig. 3.1).

#### Probe Specifications

Frequency Range:	10 kHz – 6.0 GHz
Calibration:	In air from 10 MHz to 6.0 GHz In brain and muscle simulating tissue at Frequencies from 835 up to 5800MHz
Sensitivity:	3.5 mV/mW/cm <sup>2</sup> (air – typical)
DC Resistance:	300 kohm
Isotropic Response:	0.25 dB
Dynamic Range:	10 mW/kg – 100 W/kg
Resistance to Pull:	25 N
Probe Length:	290 mm
Probe Tip Material:	Glass
Probe Tip Length:	40 mm
Probe Tip Diameter:	7 ± 0.2 mm
Application:	SAR Dosimetry Testing HAC (Hearing Aid Compatibility) Compliance tests of mobile phones



**Figure 3.2**  
Triangular Probe Configuration

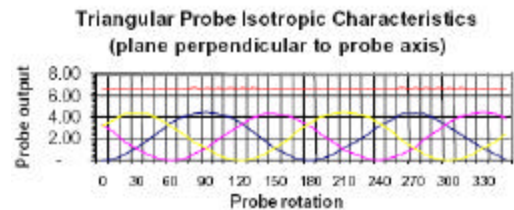

**Figure 3.3**  
Probe Characteristics

PCTEST SAR TEST REPORT		FCC CERTIFICATION		Reviewed by: Quality Manager
SAR Filename: SAR.240206081-R1.ACJ	Test Dates: Feb. 19, 2003	EUT Type: Panasonic Toughbook w/ Siemens GPRS Module, Intel WLAN & Bluetooth	FCC ID: ACJ9TGCF-295	Page 5 of 25

# 4. PROBE CALIBRATION PROCESS

## Dosimetric Assessment Procedure

Each E-Probe/Probe amplifier combination has unique calibration parameters. A TEM calibration procedure is conducted to determine the proper amplifier settings to enter in the probe parameters. The amplifier settings are determined for a given frequency by subjecting the Probe to a known E-field density (1mW/cm<sup>2</sup>) using an RF Signal generator, TEM cell, and RF Power Meter. The SAR measurement software is used for Probe calibration.

## Free Space Assessment

The free space E-field from amplified probe outputs is determined in a test chamber. This calibration can be performed in a TEM cell if the frequency is below 1 GHz and in a waveguide or some other methodologies above 1 GHz for free space. For the free space calibration, we place the probe in the volumetric center of the cavity and at the proper orientation with the field. We then rotate the probe 360 degrees until the three channels show the maximum reading. The power density readings equates to 1mW/cm<sup>2</sup>.

## Temperature Assessment

E-field temperature correlation calibration is performed in a flat phantom filled with the appropriate simulated brain tissue. The measured free space E-field in the medium correlates to temperature rise in a dielectric medium. For temperature correlation calibration a RF transparent thermistor-based temperature probe is used in conjunction with the E-field probe.

$$SAR = C \frac{\Delta T}{\Delta t}$$

where:

- $\Delta t$  = exposure time (30 seconds),
- C = heat capacity of tissue (brain or muscle),
- $\Delta T$  = temperature increase due to RF exposure.

SAR is proportional to  $\Delta T / \Delta t$ , the initial rate of tissue heating, before thermal diffusion takes place. Now it's possible to quantify the electric field in the simulated tissue by equating the thermally derived SAR to the E- field;

$$SAR = \frac{|E|^2 \cdot \sigma}{\rho}$$

where:

- $\sigma$  = simulated tissue conductivity,
- $\rho$  = Tissue density (1.25 g/cm<sup>3</sup> for brain tissue)

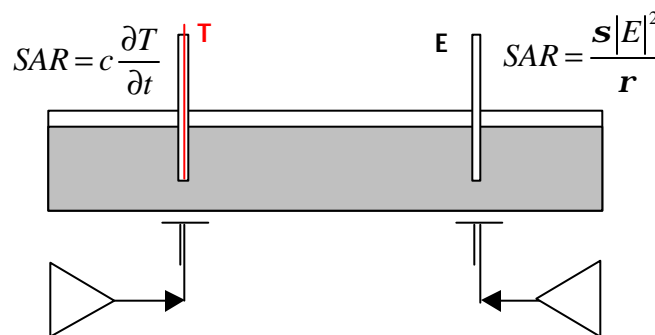



Figure 4.1 Temperature Assessment Test Configuration

PCTEST SAR TEST REPORT		FCC CERTIFICATION		Reviewed by: Quality Manager
SAR Filename: SAR.240206081-R1.ACJ	Test Dates: Feb. 19, 2003	EUT Type: Panasonic Toughbook w/ Siemens GPRS Module, Intel WLAN & Bluetooth	FCC ID: ACJ9TGCF-295	Page 6 of 25

# 5. PHANTOM & EQUIVALENT TISSUES



**Figure 5.1**  
SAM Phantoms

The Left and Right SAM Phantoms are constructed of a vivac composite integrated in a corian stand. The shape of the shell is based on data from an anatomical study designed to determine the maximum exposure in at least 90% of all users [7][8]. It enables the dosimetric evaluation of left and right hand phone usage as well as body mounted usage at the flat phantom region. A cover prevents the evaporation of the liquid. Reference markings on the Phantom allow the complete setup of all predefined phantom positions and measurement grids by manually teaching three points in the robot. (see Fig. 5.1)

## Brain & Muscle Simulating Mixture Characterization

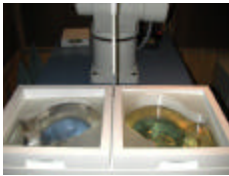

**Figure 5.2**  
Head Simulated Tissue

The brain and muscle mixtures consist of a viscous gel using hydroxyethylcellulose (HEC) gelling agent and saline solution (see Table 6.1). Preservation with a bactericide is added and visual inspection is made to make sure air bubbles are not trapped during the mixing process. The mixture is calibrated to obtain proper dielectric constant (permittivity) and conductivity of the desired tissue. The head tissue dielectric parameters recommended by the IEEE SCC-34/SC-2 have been incorporated in the following table. Other head and body tissue parameters that have not been specified in P1528 are derived from the tissue dielectric parameters computed from the 4-Cole-Cole equations. The mixture characterizations used for the brain and muscle tissue simulating liquids are according to the data by C. Gabriel and G. Hartsgrove [9].(see Table 5.1)

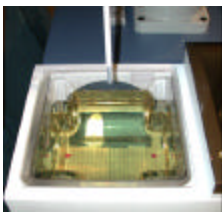

**Figure 5.3**  
Body/Muscle Simulated Tissue

Ingredients (% by weight)	Frequency (MHz)									
	450		835		915		1900		2450	
Tissue Type	Head	Body	Head	Body	Head	Body	Head	Body	Head	Body
Water	38.56	51.16	41.45	52.4	41.05	56.0	54.9	40.4	62.7	73.2
Salt (NaCl)	3.95	1.49	1.45	1.4	1.35	0.76	0.18	0.5	0.5	0.04
Sugar	56.32	46.78	56.0	45.0	56.5	41.76	0.0	58.0	0.0	0.0
HEC	0.98	0.52	1.0	1.0	1.0	1.21	0.0	1.0	0.0	0.0
Bactericide	0.19	0.05	0.1	0.1	0.1	0.27	0.0	0.1	0.0	0.0
Triton X-100	0.0	0.0	0.0	0.0	0.0	0.0	0.0	0.0	36.8	0.0
DGBE	0.0	0.0	0.0	0.0	0.0	0.0	44.92	0.0	0.0	26.7

Salt: 99% Pure Sodium Chloride      Sugar: 98% Pure Sucrose  
 Water: De-ionized, 16 MΩ resistivity      HEC: Hydroxyethyl Cellulose  
 DGBE: 99% Di(ethylene glycol) butyl ether, [2-(2-butoxyethoxy)ethanol]  
 Triton X-100 (ultra pure): Polyethylene glycol mono [4-(1,1,3,3-tetramethylbutyl)phenyl] ether

**Table 5.1**  
Composition of the Brain & Muscle Tissue Equivalent Matter



## Device Holder



**Figure 5.4**  
Device Positioner

In combination with the SAM Phantom, the EUT Holder (see Fig. 6.2) enables the rotation of the mounted transmitter in spherical coordinates whereby the rotation point is the ear opening. Device positioning is accurate and repeatable according to the FCC and CENELEC specifications. The device holder can be locked at different phantom locations (left head, right head, flat phantom).

\* Note: A simulating human hand is not used due to the complex anatomical and geometrical structure of the hand that may produce infinite number of configurations [8]. To produce the worst-case condition (the hand absorbs antenna output power), the hand is omitted during the tests.

PCTEST SAR TEST REPORT		FCC CERTIFICATION		Reviewed by: Quality Manager
SAR Filename: SAR.240206081-R1.ACJ	Test Dates: Feb. 19, 2003	EUT Type: Panasonic Toughbook w/ Siemens GPRS Module, Intel WLAN & Bluetooth	FCC ID: ACI9TGCF-295	Page 7 of 25

## 6. TEST SYSTEM SPECIFICATIONS

### Automated Test System Specifications

#### Positioner

**Robot:** CRS Robotics, Inc. Robot Model: F3  
**Repeatability:** ± 0.05 mm (0.002 in.)  
**No. Of axes:** 6

#### Data Acquisition Electronic (DAE) System

##### Cell Controller

**Processor:** Pentium 4  
**Clock Speed:** 1.6 GHz  
**Operating System:** Windows 2000™ Professional  
**Data Card:** NI DAQ Card (in CPU)

##### Data Converter

**Software:** IDX Flexware  
**Connecting Lines:** Data Acquisition Cable  
 RS-232 Host Interface Cable  
**Sampling Rate:** 6000 samples/sec





**Figure 6.1**  
**ALIDX-500 Test System**

#### E-Field Probes

**Model:** E-010 S/N: PCT003  
**Construction:** Triangular core absolute encoder system  
**Frequency:** 10 MHz to 6.0 GHz

#### Phantom

**Phantom:** SAM Phantoms (Left & Right)  
**Shell Material:** Vivac Composite  
**Thickness:** 2.0 ± 0.2 mm

PCTEST SAR TEST REPORT		FCC CERTIFICATION		Reviewed by: Quality Manager
SAR Filename: SAR.240206081-R1.ACJ	Test Dates: Feb. 19, 2003	EUT Type: Panasonic Toughbook w/ Siemens GPRS Module, Intel WLAN & Bluetooth	FCC ID: ACJ9TGCF-295	Page 8 of 25

## 7. DOSIMETRIC ASSESSMENT & PHANTOM SPECS

### Measurement Procedure

The measurement procedure consists of the process parameters, probe parameters, EUT product data, and measurement scans (teach points). The measurement procedure is a set of predefined points to be scanned and measured by the probe, DC amplified and processed by the cell controller. The corresponding voltages determined by the electric and magnetic fields are extrapolated to determine peak SAR value.



The SAR Measurement System measures field strength by employing two different types of systematic measurement scans; a coarse scan and a fine scan. Coarse and fine scans measure field strength in a rectangular area within the XY plane (a plane parallel to the top of the Robot Table). The measurement area is divided into a grid of small squares defined by equally spaced grid lines. During an actual measurement process, the probe moves along grid lines systematically recording the field strength at grid line intersections. Typically, after a coarse scan is completed, a fine scan is conducted at the peak field strength value (hot spot) that was measured in the coarse scan. The fine scan has a greater resolution (smaller grid squares) than the coarse scan, and covers only a fraction of the measurement area in the coarse scan.

### Specific Anthropomorphic Mannequin (SAM) Specifications

The phantom for handset SAR assessment testing is a low-loss dielectric shell, with shape and dimensions derived from the anthropometric data of the 90<sup>th</sup> percentile adult male head dimensions as tabulated by the US Army. The SAM Phantom shell is bisected along the mid-sagittal plane into right and left halves (see Fig. 7.1). The perimeter sidewalls of each phantom halves are extended to allow filling with liquid to a depth that is sufficient to minimized reflections from the upper surface. The liquid depth is maintained at a minimum depth of 15cm to minimize reflections from the upper surface. The SAM shell thickness is 2.0 ± 0.2 mm.



**Figure 7.1**  
Left and Right SAM Phantom shells

PCTEST SAR TEST REPORT		FCC CERTIFICATION		Reviewed by: Quality Manager
SAR Filename: SAR.240206081-R1.ACJ	Test Dates: Feb. 19, 2003	EUT Type: Panasonic Toughbook w/ Siemens GPRS Module, Intel WLAN & Bluetooth	FCC ID: ACJ9TGCF-295	Page 9 of 25

## 8. TEST CONFIGURATION POSITION

### Body-Worn Configurations

Body-worn operating configurations are tested with the notebook positioned touching against a flat phantom (lap) in a normal use configuration (see Figure 9.1). Body dielectric parameters are used.



In addition to the typical lap position test configuration, a bystander position (See Figure 9.2) is also evaluated for RF safety. The antenna is placed 1.5 cm from the flat phantom from the antenna side of the unit. This ensures that any other part of the body or other bodies touching the transmitting antenna on the notebook meets RF exposure compliance.

In all cases SAR measurements are performed to investigate the worst-case positioning. Worst-case positioning is then documented and used to perform Body SAR testing.

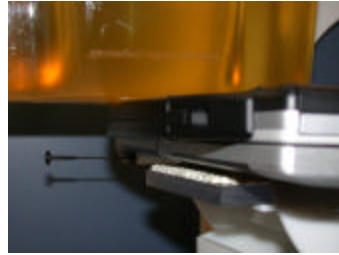
In order for users to be aware of the body-worn operating requirements for meeting RF exposure compliance, operating instructions and a caution statement must be included in the user's manual.



**Figure 8.1 Body SAR Laptop and Bystander Configurations**

PCTEST SAR TEST REPORT	 <b>FCC CERTIFICATION</b>			Reviewed by: Quality Manager
SAR Filename: SAR.240206081-R1.ACJ	Test Dates: Feb. 19, 2003	EUT Type: Panasonic Toughbook w/ Siemens GPRS Module, Intel WLAN & Bluetooth	FCC ID: ACJ9TGCF-295	Page 10 of 25

## 9. ANSI/IEEE C95.1 - 1992 RF EXPOSURE LIMITS

### Uncontrolled Environment

UNCONTROLLED ENVIRONMENTS are defined as locations where there is the exposure of individuals who have no knowledge or control of their exposure. The general population/uncontrolled exposure limits are applicable to situations in which the general public may be exposed or in which persons who are exposed as a consequence of their employment may not be made fully aware of the potential for exposure or cannot exercise control over their exposure. Members of the general public would come under this category when exposure is not employment-related; for example, in the case of a wireless transmitter that exposes persons in its vicinity.

### Controlled Environment

CONTROLLED ENVIRONMENTS are defined as locations where there is exposure that may be incurred by persons who are aware of the potential for exposure, (i.e. as a result of employment or occupation). In general, occupational/controlled exposure limits are applicable to situations in which persons are exposed as a consequence of their employment, who have been made fully aware of the potential for exposure and can exercise control over their exposure. This exposure category is also applicable when the exposure is of a transient nature due to incidental passage through a location where the exposure levels may be higher than the general population/uncontrolled limits, but the exposed person is fully aware of the potential for exposure and can exercise control over his or her exposure by leaving the area or by some other appropriate means.

**Table 10.1. Safety Limits for Partial Body Exposure [2]**

	HUMAN EXPOSURE LIMITS	
	UNCONTROLLED ENVIRONMENT General Population (W/kg) or (mW/g)	CONTROLLED ENVIRONMENT General Population (W/kg) or (mW/g)
SPATIAL PEAK SAR 1 Brain	1.60	8.00
SPATIAL AVERAGE SAR 2 Whole Body	0.08	0.40
SPATIAL PEAK SAR 3 Hands, Feet, Ankles, Wrists	4.00	20.00

1 The Spatial Peak value of the SAR averaged over any 1 gram of tissue (defined as a tissue volume in the shape of a cube) and over the appropriate averaging time.



2 The Spatial Average value of the SAR averaged over the whole body.

3 The Spatial Peak value of the SAR averaged over any 10 grams of tissue (defined as a tissue volume in the shape of a cube) and over the appropriate averaging time.

PCTEST SAR TEST REPORT		FCC CERTIFICATION		Reviewed by: Quality Manager
SAR Filename: SAR.240206081-R1.ACJ	Test Dates: Feb. 19, 2003	EUT Type: Panasonic Toughbook w/ Siemens GPRS Module, Intel WLAN & Bluetooth	FCC ID: ACI9TGCF-295	Page 11 of 25

# 10. MEASUREMENT UNCERTAINTIES

a	b	c	d	e = f(d,k)	f	g	h = cx/f/e	i = cxg/e	k
Uncertainty Component	Sec.	Tol. (± %)	Prob. Dist.	Div.	$c_i$ (1 - g)	$c_i$ (10 - g)	1 - g $u_i$ (± %)	10 - g $u_i$ (± %)	$v_i$
<b>Measurement System</b>									
Probe Calibration	E1.1	11.4	R	1.73	1	1	6.6	6.6	¥
Axial Isotropy	E1.2	3.4	R	1.73	0.7	0.7	1.4	1.4	¥
Hemishperical Isotropy	E1.2	5.2	R	1.73	1	1	3.0	3.0	¥
Boundary Effect	E1.3	4.7	R	1.73	1	1	2.7	2.7	¥
Linearity	E1.4	5.9	R	1.73	1	1	3.4	3.4	¥
System Detection Limits	E1.5	1.0	R	1.73	1	1	0.6	0.6	¥
Readout Electronics	E1.6	1.0	N	1	1	1	1.0	1.0	¥
Response Time	E1.7	0.8	R	1.73	1	1	0.5	0.5	¥
Integration Time	E1.8	1.7	R	1.73	1	1	1.0	1.0	¥
RF Ambient Conditions	E5.1	1.2	R	1.73	1	1	0.7	0.7	¥
Probe Positioner Mechanical Tolerance	E5.2	0.4	R	1.73	1	1	0.2	0.2	¥
Probe Positioning w/ respect to Phantom Shell	E5.3	2.9	R	1.73	1	1	1.7	1.7	¥
Extrapolation, Interpolation & Integration Algorithms for Max. SAR Evaluation	E4.2	3.9	R	1.73	1	1	2.3	2.3	¥
<b>Test Sample Related</b>									
Test Sample Positioning	E3.2.1	10.6	R	1.73	1	1	6.1	6.1	11
Device Holder Uncertainty	E3.1.1	8.7	R	1.73	1	1	5.0	5.0	8
Output Power Variation - SAR drift measurement	5.6.2	5.0	R	1.73	1	1	2.9	2.9	¥
<b>Phantom &amp; Tissue Parameters</b>									
Phantom Uncertainty (Shape & Thickness tolerances)	E2.1	4.0	R	1.73	1	1	2.3	2.3	¥
Liquid Conductivity - deviation from target values	E2.2	5.0	R	1.73	0.7	0.5	2.0	1.4	¥
Liquid Conductivity - measurement uncertainty	E2.2	5.0	R	1.73	0.7	0.5	2.0	1.4	¥
Liquid Permittivity - deviation from target values	E2.2	5.0	R	1.73	0.6	0.5	1.7	1.4	¥
Liquid Permittivity - measurement uncertainty	E2.2	5.0	R	1.73	0.6	0.5	1.7	1.4	¥
<b>Combined Standard Uncertainty (k=1)</b>			RSS				13.2	13.0	
<b>Expanded Uncertainty (k=2)</b> (95% CONFIDENCE LEVEL)							26.6	26.2	

PCTEST SAR TEST REPORT	 <b>FCC CERTIFICATION</b>			Reviewed by: Quality Manager
SAR Filename: SAR.240206081-R1.ACJ	Test Dates: Feb. 19, 2003	EUT Type: Panasonic Toughbook w/ Siemens GPRS Module, Intel WLAN & Bluetooth	FCC ID: ACJ9TGCF-295	Page 12 of 25

## 11. SAR TEST DATA SUMMARY

See Measurement Result Data Pages

### Procedures Used To Establish Test Signal

The device was placed into continuous GPRS transmit mode using a base station simulator. Manufacturer's software codes were used for DSSS and Bluetooth transmission in conjunction with the GPRS function. Such test signals offer a consistent means for testing SAR and are recommended for evaluating SAR [4].

### Device Test Conditions

The internal transmitting device is powered through the host computer. In order to verify that the device was tested at full power, the base station simulator was used during each SAR measurement to maintain the output power. If a power deviation of more than 5% occurred, the test was repeated.

PCTEST SAR TEST REPORT	 <b>FCC CERTIFICATION</b>			Reviewed by: Quality Manager
SAR Filename: SAR.240206081-R1.ACJ	Test Dates: Feb. 19, 2003	EUT Type: Panasonic Toughbook w/ Siemens GPRS Module, Intel WLAN & Bluetooth	FCC ID: ACJ9TGCF-295	Page 13 of 25

## 12. SAR TEST EQUIPMENT



### Equipment Calibration

Table 13.1 Test Equipment Calibration

EQUIPMENT SPECIFICATIONS			
Type	Calibration Date	Serial Number	
CRS Robot F3	February 2003	RAF0134133	
CRS C500C Motion Controller	February 2003	RCB0003303	
CRS Teach Pendant (Joystick)	February 2003	STP0132231	
DELL Computer, Pentium 4 1.6 GHz, Windows 2000™	February 2003	4PJZ111	
E-Field Probe E-010	January 2004	PCT003	
Right Ear SAM Phantom (P-SAM-R)	February 2003	94X-113	
Left Ear SAM Phantom (P-SAM-L)	February 2003	94X-019	
Flat SAM Phantom (P-SAM-FLAT)	February 2003	94X-097	
IDX Robot End Effector (EE-103-C)	February 2003	07111223	
IDX Probe Amplifier	February 2003	07111113	
Validation Dipole D-835S	October 2003	PCT640	
Validation Dipole D-1900S	October 2003	PCT641	
Brain Equivalent Matter (835MHz)	February 2004	PCTBEM101	
Brain Equivalent Matter (1900MHz)	February 2004	PCTBEM301	
Muscle Equivalent Matter (835MHz)	February 2004	PCTMEM201	
Muscle Equivalent Matter (1900MHz)	February 2004	PCTMEM401	
Amplifier Research 5S1G4 Power Amp	January 2004	PCT540	
Agilent E8241A (250kHz ~ 20GHz) Signal Generator	January 2004	US42110432	
HP-8753E (30kHz ~ 6GHz) Network Analyzer	January 2004	PCT552	
HP85070B Dielectric Probe Kit	January 2004	PCT501	
Ambient Noise/Reflection, etc.	<12mW/kg/<3%of SAR	January 2004	Anechoic Room PCT01

**NOTE:**



The brain simulating material is calibrated by PCTEST using the dielectric probe system and network analyzer to determine the conductivity and permittivity (dielectric constant) of the brain-equivalent material.

PCTEST SAR TEST REPORT		FCC CERTIFICATION		Reviewed by: Quality Manager
SAR Filename: SAR.240206081-R1.ACJ	Test Dates: Feb. 19, 2003	EUT Type: Panasonic Toughbook w/ Siemens GPRS Module, Intel WLAN & Bluetooth	FCC ID: ACJ9TGCF-295	Page 14 of 25

## 13. CONCLUSION



### Measurement Conclusion

The SAR measurement indicates that the EUT complies with the RF radiation exposure limits of the FCC. These measurements are taken to simulate the RF effects exposure under worst-case conditions. Precise laboratory measures were taken to assure repeatability of the tests. The tested device complies with the requirements in respect to all parameters subject to the test. The test results and statements relate only to the item(s) tested. Please note that the absorption and distribution of electromagnetic energy in the body are very complex phenomena that depend on the mass, shape, and size of the body, the orientation of the body with respect to the field vectors, and the electrical properties of both the body and the environment. Other variables that may play a substantial role in possible biological effects are those that characterize the environment (e.g. ambient temperature, air velocity, relative humidity, and body insulation) and those that characterize the individual (e.g. age, gender, activity level, debilitation, or disease). Because innumerable factors may interact to determine the specific biological outcome of an exposure to electromagnetic fields, any protection guide shall consider maximal amplification of biological effects as a result of field-body interactions, environmental conditions, and physiological variables.[3]

PCTEST SAR TEST REPORT		FCC CERTIFICATION		Reviewed by: Quality Manager
SAR Filename: SAR.240206081-R1.ACJ	Test Dates: Feb. 19, 2003	EUT Type: Panasonic Toughbook w/ Siemens GPRS Module, Intel WLAN & Bluetooth	FCC ID: ACJ9TGCF-295	Page 15 of 25

## 14. REFERENCES

- [1] Federal Communications Commission, ET Docket 93-62, Guidelines for Evaluating the Environmental Effects of Radiofrequency Radiation, Aug. 1996.
- [2] ANSI/IEEE C95.1 - 1991, *American National Standard safety levels with respect to human exposure to radio frequency electromagnetic fields, 300kHz to 100GHz*, New York: IEEE, Aug. 1992.
- [3] ANSI/IEEE C95.3 - 1991, *IEEE Recommended Practice for the Measurement of Potentially Hazardous Electromagnetic Fields - RF and Microwave*, New York: IEEE, 1992.
- [4] Federal Communications Commission, OET Bulletin 65 (Edition 97-01), Supplement C (Edition 01-01), *Evaluating Compliance with FCC Guidelines for Human Exposure to Radiofrequency Electromagnetic Fields*, July 2001.
- [5] IEEE Standards Coordinating Committee 34 – IEEE Std. P1528 D1.2 (April 2003), *Draft Recommended Practice for Determining the Peak Spatial-Average Specific Absorption Rate (SAR) in the Human Body Due to Wireless Communications Devices: Experimental Techniques*.
- [6] NCRP, National Council on Radiation Protection and Measurements, *Biological Effects and Exposure Criteria for RadioFrequency Electromagnetic Fields*, NCRP Report No. 86, 1986. Reprinted Feb. 1995.
- [7] V. Hombach, K. Meier, M. Burkhardt, E. Kuhn, N. Kuster, *The Dependence of EM Energy Absorption upon Human Head Modeling at 900 MHz*, IEEE Transaction on Microwave Theory and Techniques, vol. 44 no. 10, Oct. 1996, pp. 1865-1873.
- [8] N. Kuster and Q. Balzano, *Energy absorption mechanism by biological bodies in the near field of dipole antennas above 300MHz*, IEEE Transaction on Vehicular Technology, vol. 41, no. 1, Feb. 1992, pp. 17-23.
- [9] G. Hartsgrove, A. Kraszewski, A. Surowiec, *Simulated Biological Materials for Electromagnetic Radiation Absorption Studies*, University of Ottawa, Bioelectromagnetics, Canada: 1987, pp. 29-36.
- [10] Q. Balzano, O. Garay, T. Manning Jr., *Electromagnetic Energy Exposure of Simulated Users of Portable Cellular Telephones*, IEEE Transactions on Vehicular Technology, vol. 44, no.3, Aug. 1995.
- [11] W.H. Press, S.A. Teukolsky, W.T. Vetterling, and B.P. Flannery, *Numerical Recipes in C, The Art of Scientific Computing*, Second edition, Cambridge University Press, 1992.
- [12] Federal Communications Commission, OET Bulletin 65, Evaluating Compliance with FCC Guidelines for Human Exposure to Radiofrequency Electromagnetic Fields. Supplement C, Dec. 1997.
- [13] CENELEC CLC/SC111B, European Prestandard (prENV 50166-2), Human Exposure to Electromagnetic Fields High-frequency: 10kHz-300GHz, Jan. 1995.

PCTEST SAR TEST REPORT		FCC CERTIFICATION		Reviewed by: Quality Manager
SAR Filename: SAR.240206081-R1.ACJ	Test Dates: Feb. 19, 2003	EUT Type: Panasonic Toughbook w/ Siemens GPRS Module, Intel WLAN & Bluetooth	FCC ID: ACJ9TGCF-295	Page 16 of 25

# EXHIBIT A. SYSTEM VERIFICATION

## Tissue Verification

Table A.1 Simulated Tissue Verification

MEASURED TISSUE PARAMETERS									
Date(s)	2/19/2004	835MHz Brain		835MHz Muscle		1900MHz Brain		1900MHz Muscle	
Liquid Temperature (°C)	19.0	Target	Measured	Target	Measured	Target	Measured	Target	Measured
Dielectric Constant: $\epsilon$		41.50	41.08	55.20	53.1	40.00	40.06	53.30	51.11
Conductivity: $\sigma$		0.900	0.89	0.970	0.98	1.400	1.41	1.520	1.58

## Test System Validation

Prior to assessment, the system is verified to the  $\pm 10\%$  of the specifications at 835 MHz & 1900 MHz by using the system validation kits. (Graphic Plots Attached)

Table A.2 System Validation

System Validation TARGET & MEASURED							
Date:	Amb. Temp (°C)	Liquid Temp(°C)	Input Power (W)	Tissue	Targeted SAR <sub>1g</sub> (mW/g)	Measured SAR <sub>1g</sub> (mW/g)	Deviation (%)
02/19/04	22.6	19.3	0.250	835MHz Brain	2.375	2.247	-5.83 %
02/19/04	22.6	19.3	0.100	1900MHz Brain	3.97	4.13	3.91 %

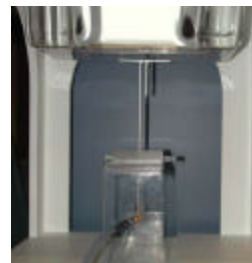



Figure A.0 Dipole Validation Test Setup

PCTEST SAR TEST REPORT		FCC CERTIFICATION		Reviewed by: Quality Manager
SAR Filename: SAR.240206081-R1.ACJ	Test Dates: Feb. 19, 2003	EUT Type: Panasonic Toughbook w/ Siemens GPRS Module, Intel WLAN & Bluetooth	FCC ID: ACJ9TGCF -295	Page 17 of 25

# EXHIBIT A. SAR DATA SUMMARY

Mixture Type: 850MHz Muscle

<b>A.1 MEASUREMENT RESULTS (GPRS Body SAR – Lap)</b>								
FREQUENCY		Modulation	POWER <sup>†</sup>			Separation Distance (cm) <sup>##</sup>	Antenna Position	SAR (W/kg)
MHz	Ch.		PCL	WLAN	Bluetooth			
824.20	128	GPRS	5 (33 dBm)	On	On	Touch	In	0.01
824.20	128	GPRS	5 (33 dBm)	On	On	Touch	Out	0.20
836.60	190	GPRS	5 (33 dBm)	On	On	Touch	In	0.01
836.60	190	GPRS	5 (33 dBm)	On	On	Touch	Out	0.15
848.80	251	GPRS	5 (33 dBm)	On	On	Touch	In	0.02
848.80	251	GPRS	5 (33 dBm)	On	On	Touch	Out	0.24
ANSI / IEEE C95.1 1992 - SAFETY LIMIT Spatial Peak Uncontrolled Exposure/General Population						Muscle <b>1.6 W/kg (mW/g)</b> averaged over 1 gram		

**NOTES:**

1. The test data reported are the worst-case SAR value with the antenna-head position set in a typical configuration. Test procedures used are according to FCC/OET Bulletin 65, Supp.C [July 2001].
2. All modes of operation were investigated, and worst-case results are reported.
3. Battery is fully charged for all readings. *Standard Batteries are the only options.*  
See Test Plots for Power Class Reference
4. SAR Measurement System                     DASY3                     IDX  
Phantom Configuration                     Left Head                     Flat Phantom                     Right Head
5. SAR Configuration                     Head                     Body                     Hand
6. Test Signal Call Mode (Dual Slot)                     Software (WLAN)                     Base Station Simulator (GPRS)  
†Power [Dual Slot]                     Max Power Level
7. Tissue parameters and temperatures are listed on the SAR plots.
8. Liquid tissue depth is 15.1 cm. ± 0.1



Alfred

---

**Alfred Cirwithian**  
Vice President Engineering



**Figure A.1 Body SAR Test Setup  
-- Lap Position --**

PCTEST SAR TEST REPORT	 <b>FCC CERTIFICATION</b>		Reviewed by: Quality Manager
SAR Filename: SAR.240206081-R1.ACJ	Test Dates: Feb. 19, 2003	EUT Type: Panasonic Toughbook w/ Siemens GPRS Module, Intel WLAN & Bluetooth	FCC ID: ACJ9TGCF-295  Page 18 of 25

# EXHIBIT A. SAR DATA SUMMARY (CONTINUED)

Mixture Type: 850MHz Muscle

A.2 MEASUREMENT RESULTS (GPRS Body SAR – Top)								
FREQUENCY		Modulation	POWER <sup>‡</sup>			Separation Distance (cm) <sup>**</sup>	Antenna Position	SAR (W/kg)
MHz	Ch.		PCL	WLAN	Bluetooth			
824.20	128	GPRS	5 (33 dBm)	On	On	1.5 cm	In	0.05
824.20	128	GPRS	5 (33 dBm)	On	On	1.5 cm	Out	0.56
836.60	190	GPRS	5 (33 dBm)	On	On	1.5 cm	In	0.06
836.60	190	GPRS	5 (33 dBm)	On	On	1.5 cm	Out	0.48
848.80	251	GPRS	5 (33 dBm)	On	On	1.5 cm	In	0.10
848.80	251	GPRS	5 (33 dBm)	On	On	1.5 cm	Out	0.63
848.80	251	GPRS	5 (33 dBm)	Off	Off	1.5 cm	In	0.08
848.80	251	GPRS	5 (33 dBm)	Off	Off	1.5 cm	Out	0.57
<b>ANSI / IEEE C95.1 1992 - SAFETY LIMIT</b> Spatial Peak Uncontrolled Exposure/General Population						<b>Muscle</b> <b>1.6 W/kg (mW/g)</b> averaged over 1 gram		



**NOTES:**

1. The test data reported are the worst-case SAR value with the antenna-head position set in a typical configuration. Test procedures used are according to FCC/OET Bulletin 65, Supp.C [July 2001].
2. All modes of operation were investigated, and worst-case results are reported.
3. Battery is fully charged for all readings. *Standard Batteries are the only options.*  
See Test Plots for Power Class Reference
4. SAR Measurement System            DASY3                    IDX  
Phantom Configuration            Left Head            Flat Phantom        Right Head
5. SAR Configuration                Head                    Body                Hand
6. Test Signal Call Mode (Dual Slot)    Software (WLAN)    Base Station Simulator (GPRS)  
‡Power [Dual Slot]                Max Power Level
7. Tissue parameters and temperatures are listed on the SAR plots.
8. Liquid tissue depth is 15.1 cm. ± 0.1

  
**Alfred Cirwithian**  
Vice President Engineering



**Figure A.2 Body SAR Test Setup  
-- Top Position --**

PCTEST SAR TEST REPORT		FCC CERTIFICATION		Reviewed by: Quality Manager
SAR Filename: SAR.240206081-R1.ACJ	Test Dates: Feb. 19, 2003	EUT Type: Panasonic Toughbook w/ Siemens GPRS Module, Intel WLAN & Bluetooth	FCC ID: ACI9TGCF-295	Page 19 of 25

# EXHIBIT A. SAR DATA SUMMARY (CONTINUED)

Mixture Type: 1900MHz Muscle

A.3 MEASUREMENT RESULTS (PCS GPRS Body SAR – Lap)								
FREQUENCY		Modulation	POWER <sup>†</sup>			Separation Distance (cm) <sup>**</sup>	Antenna Position	SAR (W/kg)
MHz	Ch.		PCL	WLAN	Bluetooth			
1850.20	512	GPRS PCS	0 (30 dBm)	On	On	Touch	In	0.01
1850.20	512	GPRS PCS	0 (30 dBm)	On	On	Touch	Out	0.02
1880.00	661	GPRS PCS	0 (30 dBm)	On	On	Touch	In	0.01
1880.00	661	GPRS PCS	0 (30 dBm)	On	On	Touch	Out	0.04
1909.80	810	GPRS PCS	0 (30 dBm)	On	On	Touch	In	0.01
1909.80	810	GPRS PCS	0 (30 dBm)	On	On	Touch	Out	0.10
<b>ANSI / IEEE C95.1 1992 - SAFETY LIMIT Spatial Peak Uncontrolled Exposure/General Population</b>						<b>Muscle 1.6 W/kg (mW/g) averaged over 1 gram</b>		

**NOTES:**

1. The test data reported are the worst-case SAR value with the antenna-head position set in a typical configuration. Test procedures used are according to FCC/OET Bulletin 65, Supp.C [July 2001].
2. All modes of operation were investigated, and worst-case results are reported.
3. Battery is fully charged for all readings. *Standard Batteries are the only options.*  
See Test Plots for Power Class Reference
4. SAR Measurement System                     DASY3                     IDX  
Phantom Configuration                     Left Head                     Flat Phantom                     Right Head
5. SAR Configuration                     Head                     Body                     Hand
6. Test Signal Call Mode (Dual Slot)     Software (WLAN)     Base Station Simulator (GPRS)  
†Power [Dual Slot]                     Max Power Level
7. Tissue parameters and temperatures are listed on the SAR plots.
8. Liquid tissue depth is 15.1 cm. ± 0.1



Alfred

---

**Alfred Cirwithian**  
Vice President Engineering



**Figure A.3 Body SAR Test Setup  
-- Lap Position --**

PCTEST SAR TEST REPORT	 <b>FCC CERTIFICATION</b>		Reviewed by: Quality Manager
SAR Filename: SAR.240206081-R1.ACJ	Test Dates: Feb. 19, 2003	EUT Type: Panasonic Toughbook w/ Siemens GPRS Module, Intel WLAN & Bluetooth	FCC ID: ACI9TGCF-295  Page 20 of 25

# EXHIBIT A. SAR DATA SUMMARY (CONTINUED)

Mixture Type: 1900MHz Muscle

A.4 MEASUREMENT RESULTS (PCS GPRS Body SAR – Top)								
FREQUENCY		Modulation	POWER <sup>‡</sup>			Separation Distance (cm) <sup>††</sup>	Antenna Position	SAR (W/kg)
MHz	Ch.		PCL	WLAN	Bluetooth			
1850.20	512	GPRS PCS	0 (30 dBm)	On	On	1.5 cm	In	0.03
1850.20	512	GPRS PCS	0 (30 dBm)	On	On	1.5 cm	Out	0.16
1880.0	661	GPRS PCS	0 (30 dBm)	On	On	1.5 cm	In	0.01
1880.00	661	GPRS PCS	0 (30 dBm)	On	On	1.5 cm	Out	0.13
1909.80	810	GPRS PCS	0 (30 dBm)	On	On	1.5 cm	In	0.01
1909.80	810	GPRS PCS	0 (30 dBm)	On	On	1.5 cm	Out	0.10
<b>ANSI / IEEE C95.1 1992 - SAFETY LIMIT</b>						<b>Muscle</b>		
<b>Spatial Peak</b>						<b>1.6 W/kg (mW/g)</b>		
<b>Uncontrolled Exposure/General Population</b>						averaged over 1 gram		



**NOTES:**

1. The test data reported are the worst-case SAR value with the antenna-head position set in a typical configuration. Test procedures used are according to FCC/OET Bulletin 65, Supp.C [July 2001].
2. All modes of operation were investigated, and worst-case results are reported.
3. Battery is fully charged for all readings. *Standard Batteries are the only options.*  
See Test Plots for Power Class Reference
4. SAR Measurement System                     DASY3                     IDX  
Phantom Configuration                     Left Head                     Flat Phantom                     Right Head
5. SAR Configuration                     Head                     Body                     Hand
6. Test Signal Call Mode (Dual Slot)     Software (WLAN)     Base Station Simulator (GPRS)  
\*Power [Dual Slot]                     Max Power Level
7. Tissue parameters and temperatures are listed on the SAR plots.
8. Liquid tissue depth is 15.1 cm. ± 0.1



  
\_\_\_\_\_  
**Alfred Cirwithian**  
Vice President Engineering



**Figure A.4 Body SAR Test Setup  
-- Top Position --**

PCTEST SAR TEST REPORT	 <b>FCC CERTIFICATION</b>		Reviewed by: Quality Manager
SAR Filename: SAR.240206081-R1.ACJ	Test Dates: Feb. 19, 2003	EUT Type: Panasonic Toughbook w/ Siemens GPRS Module, Intel WLAN & Bluetooth	FCC ID: ACJ9TGCF-295  Page 21 of 25



# EXHIBIT B. SAR TEST DATA

PCTEST SAR TEST REPORT	 <b>FCC CERTIFICATION</b>			Reviewed by: Quality Manager
SAR Filename: SAR.240206081-R1.ACJ	Test Dates: Feb. 19, 2003	EUT Type: Panasonic Toughbook w/ Siemens GPRS Module, Intel WLAN & Bluetooth	FCC ID: ACJ9TGCF -295	Page 22 of 25



# EXHIBIT C. SAR TEST SETUP PHOTOGRAPHS

PCTEST SAR TEST REPORT	 <b>FCC CERTIFICATION</b>			Reviewed by: Quality Manager
SAR Filename: SAR.240206081-R1.ACJ	Test Dates: Feb. 19, 2003	EUT Type: Panasonic Toughbook w/ Siemens GPRS Module, Intel WLAN & Bluetooth	FCC ID: ACJ9TGCF-295	Page 23 of 25

# EXHIBIT D. DIPOLE VALIDATION

PCTEST SAR TEST REPORT	 <b>FCC CERTIFICATION</b>			Reviewed by: Quality Manager
SAR Filename: SAR.240206081-R1.ACJ	Test Dates: Feb. 19, 2003	EUT Type: Panasonic Toughbook w/ Siemens GPRS Module, Intel WLAN & Bluetooth	FCC ID: ACJ9TGCF-295	Page 24 of 25

# EXHIBIT E. PROBE CALIBRATION

PCTEST SAR TEST REPORT	 <b>FCC CERTIFICATION</b>			Reviewed by: Quality Manager
SAR Filename: SAR.240206081-R1.ACJ	Test Dates: Feb. 19, 2003	EUT Type: Panasonic Toughbook w/ Siemens GPRS Module, Intel WLAN & Bluetooth	FCC ID: ACJ9TGCF-295	Page 25 of 25