



**FCC CFR47 CERTIFICATION**  
**PART 22H and 24E SPURIOUS RADIATION**

**TEST REPORT**

**FOR**

**800/1900 MHZ CDMA MODULE**

**MODEL NUMBER: SB555**

**FCC ID: N7NSB555**

**REPORT NUMBER: 02U1592-1**

**ISSUE DATE: November 21, 2002**

*Prepared for*  
**SIERRA WIRELESS, INC**  
**13811 WIRELESS WAY**  
**RICHMOND, BC V6V 3A4**  
**CANADA**

*Prepared by*  
**COMPLIANCE CERTIFICATION SERVICES**  
**561F MONTEREY ROAD, ROUTE 2**  
**MORGAN HILL, CA 95037, USA**  
**TEL: (408) 463-0885**  
**FAX: (408) 463-0888**

## TABLE OF CONTENT

<b>1. TEST RESULT CERTIFICATION .....</b>	<b>3</b>
<b>2. EUT DESCRIPTION .....</b>	<b>4</b>
<b>3. FACILITIES, LABORATORY AND ACCREDITATION .....</b>	<b>4</b>
3.1. FACILITIES .....	4
3.2. LABORATORY ACCREDITATION .....	4
3.3. LIST OF ACCREDITATIONS .....	5
<b>4. CALIBRATION, METHODOLOGY AND UNCERTAINTY .....</b>	<b>6</b>
4.1. EQUIPMENT CALIBRATION .....	6
4.2. TEST METHODOLOGY .....	6
4.3. MEASUREMENT UNCERTAINTY .....	6
4.4. TEST AND MEASUREMENT EQUIPMENT .....	7
<b>5. APPLICABLE RULES .....</b>	<b>8</b>
5.1. FIELD STRENGTH OF SPURIOUS RADIATION §2.1053 .....	8
<b>6. TEST SETUP, PROCEDURE AND RESULT .....</b>	<b>9</b>
6.1. FIELD STRENGTH OF SPURIOUS RADIATION .....	9
<b>7. EUT SETUP PHOTOS .....</b>	<b>20</b>

# 1. TEST RESULT CERTIFICATION

**COMPANY NAME:** SIERRA WIRELESS, INC.  
13811 WIRELESS WAY  
RICHMOND, BC V6V 3A4  
CANADA

**EUT DESCRIPTION:** 800/1900MHZ CDMA MODULE

**MODEL NUMBER:** SB555

**DATE TESTED:** OCTOBER 21 & NOVEMBER 19, 2002

TYPE OF EQUIPMENT	INTENTIONAL RADIATOR
EQUIPMENT TYPE	CDMA MODULE
MEASUREMENT PROCEDURE	ANSI 63.4 / 1992, TIA/EIA 603
PROCEDURE	CERTIFICATION
FCC RULE	CFR 47 PART 22 Subpart H and 24 Subpart E

Only the radiated spurious emissions are documented in this test report; other requirements (antenna port conducted measurements) are documented separately by Sierra Wireless. Subject to this scope, Compliance Certification Services, Inc. tested the above equipment for compliance with the requirement set forth in CFR 47, PART 22 Subpart H-Cellular Radiotelephone Service and 24 Subpart E-Broadband PCS. The equipment in the configuration described in this report, shows the measured emission levels emanating from the equipment do not exceed the specified limit.

**Note:** This document reports conditions under which testing was conducted and results of tests performed. This document may not be altered or revised in any way unless done so by Compliance Certification Services and all revisions are duly noted in the revisions section. Any alteration of this document not carried out by Compliance Certification Services will constitute fraud and shall nullify the document.

Tested By:



Approved and Released For CCS By:

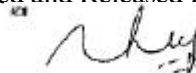

---

FRANK IBRAHIM  
EMC ENGINEER  
COMPLIANCE CERTIFICATION SERVICES

---

THU CHAN  
SENIOR EMC ENGINEER  
COMPLIANCE CERTIFICATION SERVICES

## 2. EUT DESCRIPTION

SB555 Embedded Modem is a dual-band wireless modem supporting both the 800 MHz cellular and 1900 MHz PCS bands.

## 3. FACILITIES, LABORATORY AND ACCREDITATION

### 3.1. Facilities







The open area test sites and conducted measurement facilities used to collect the radiated data are located at 561F Monterey Road, Morgan Hill, California, USA. The sites are constructed in conformance with the requirements of ANSI C63.7, ANSI C63.4 and CISPR Publication 16.

### 3.2. Laboratory Accreditation

The laboratory and associated test facilities used to perform radiated and conducted emissions tests are accredited by National Voluntary Laboratory Accreditation Program for the specific scope of accreditation under Lab Code: 200065-0 to perform Electromagnetic Interference tests according to FCC PART 15 AND CISPR 22 requirements. In addition, the test facilities are listed with Federal Communications Commission (reference no: 31040/SIT (1300B3) and 31040/SIT (1300F2)).

No part of this report may be used to claim or imply product endorsement by NVLAP or any agency of the US Government.

### 3.3. List of Accreditations

Country	Agency	Scope of Accreditation	Logo
USA	NVLAP*	FCC Part 15, CISPR 22, AS/NZS 3548, IEC 61000-4-2, IEC 61000-4-3, IEC 61000-4-4, IEC 61000-4-5, IEC 61000-4-6, IEC 61000-4-8, IEC 61000-4-11, CNS 13438	 200065-0
USA	FCC	3/10 meter Open Area Test Sites to perform FCC Part 15/18 measurements	 1300
Japan	VCCI	CISPR 22 Two OATS and one conducted Site	<b>VCCI</b> R-1014, R-619, C-640
Norway	NEMKO	EN50081-1, EN50081-2, EN50082-1, EN50082-2, IEC61000-6-1, IEC61000-6-2, EN50083-2, EN50091-2, EN50130-4, EN55011, EN55013, EN55014-1, EN55104, EN55015, EN61547, EN55022, EN55024, EN61000-3-2, EN61000-3-3, EN60945, EN61326-1	 ELA 117
Norway	NEMKO	EN60601-1-2 and IEC 60601-1-2, the Collateral Standards for Electro-Medical Products. MDD, 93/42/EEC, AIMD 90/385/EEC	 ELA-171
Taiwan	BSMI	CNS 13438	 SL2-IN-E-1012
Canada	Industry Canada	RSS210 Low Power Transmitter and Receiver	 IC2324 A,B,C, and F

\*No part of this report may be used to claim or imply product endorsement by NVLAP or any agency of the US Government.

## 4. CALIBRATION, METHODOLOGY AND UNCERTAINTY

### 4.1. Equipment Calibration

The measuring equipment, which was utilized in performing the tests documented herein, has been calibrated in accordance with the manufacturer's recommendations for utilizing calibration equipment, which is traceable to recognized national standards.

### 4.2. Test Methodology

Conducted and radiated testing were performed according to the procedures documented on chapter 13 of ANSI C63.4 and FCC CFR 47 2.1046, 2.1047, 2.1049, 2.1051, 2.1053, 2.1055 and 2.1057.

Receiving equipment (i.e., receiver, analyzer, quasi-peak adapter, pre-selector) and LISNs conform to CISPR specifications for "Radio Interference Measuring Apparatus and Measurement Methods," Publication 16.

### 4.3. Measurement Uncertainty

Where relevant, the following measurement uncertainty levels have been estimated for tests performed on the apparatus:

<b>Radiated Emission</b>	
30MHz – 200 MHz	+/- 3.3dB
200MHz – 1000MHz	+4.5/-2.9dB
1000MHz – 2000MHz	+4.6/-2.2dB
<b>Power Line Conducted Emission</b>	
150kHz – 30MHz	+/-2.9

Any results falling within the above values are deemed to be marginal.

#### 4.4. Test and Measurement Equipment

The following test and measurement equipment was utilized for the tests documented in this report:

<b>TEST EQUIPMENTS LIST</b>				
<b>Name of Equipment</b>	<b>Manufacturer</b>	<b>Model No.</b>	<b>Serial No.</b>	<b>Due Date</b>
<b>Spectrum Analyzer</b>	<b>HP</b>	<b>8593EM</b>	<b>3710A00205</b>	<b>6/11/03</b>
<b>Horn Antenna</b>	<b>EMCO</b>	<b>3115</b>	<b>6717</b>	<b>1/31/03</b>
<b>Horn Antenna</b>	<b>EMCO</b>	<b>3115</b>	<b>6739</b>	<b>1/31/03</b>
<b>Pre-Amplifier</b>	<b>Miteq</b>	<b>NSP2600-44</b>	<b>646456</b>	<b>4/26/03</b>
<b>Power Meter</b>	<b>Agilent</b>	<b>E4416A</b>	<b>GB41291160</b>	<b>8/29/03</b>
<b>Spectrum Analyzer</b>	<b>HP</b>	<b>8564E</b>	<b>06241</b>	<b>7/22/03</b>
<b>Signal Generator</b>	<b>HP</b>	<b>83732B</b>	<b>US3449059</b>	<b>3/29/03</b>
<b>Horn Antenna</b>	<b>Antenna Research Associate</b>	<b>MWH1826/B</b>	<b>1013</b>	<b>7/26/03</b>
<b>Power Sensor</b>	<b>Agilent</b>	<b>E9327A</b>	<b>US40440755</b>	<b>8/29/03</b>

## 5. APPLICABLE RULES

### 5.1. FIELD STRENGTH OF SPURIOUS RADIATION §2.1053

#### §22.917 & 24.238- EMISSION LIMITS

§22.917(e) Out of band emissions. The mean power of emissions must be attenuated below the mean power of the unmodulated carrier (P) on any frequency twice or more than twice the fundamental frequency by at least  $43+10\log P$  dB (-13dBm)

§24.238(a) The magnitude of each spurious and harmonic emission that can be detected when the equipment is operated under conditions specified in the instruction manual and/or alignment procedure, shall not be less than  $43+10 \log$  (mean output power in watts) dBc below the mean power output outside a licensee's frequency block (-13dBm).



## 6. TEST SETUP, PROCEDURE AND RESULT

### 6.1. FIELD STRENGTH OF SPURIOUS RADIATION

TEST EQUIPMENTS LIST				
Name of Equipment	Manufacturer	Model No.	Serial No.	Due Date
Spectrum Analyzer	HP	8593EM	3710A00205	6/11/03
Horn Antenna	EMCO	3115	6717	1/31/03
Horn Antenna	EMCO	3115	6739	1/31/03
Pre-Amplifier	Miteq	NSP2600-44	646456	4/26/03
Power Meter	Agilent	E4416A	GB41291160	8/29/03
Spectrum Analyzer	HP	8564E	06241	7/22/03
Signal Generator	HP	83732B	US3449059	3/29/03
Horn Antenna	Antenna Research Associate	MWH1826/B	1013	7/26/03
Power Sensor	Agilent	E9327A	US40440755	8/29/03

Detector Function Setting of Test Receiver

Frequency Range (MHz)	Detector Function	Resolution Bandwidth	Video Bandwidth
Above 1000	<input checked="" type="checkbox"/> Peak <input type="checkbox"/> Average	<input checked="" type="checkbox"/> 1 MHz <input type="checkbox"/> 1 MHz	<input checked="" type="checkbox"/> 1 MHz <input type="checkbox"/> 10 Hz

**Block Diagram for EUT setup:**

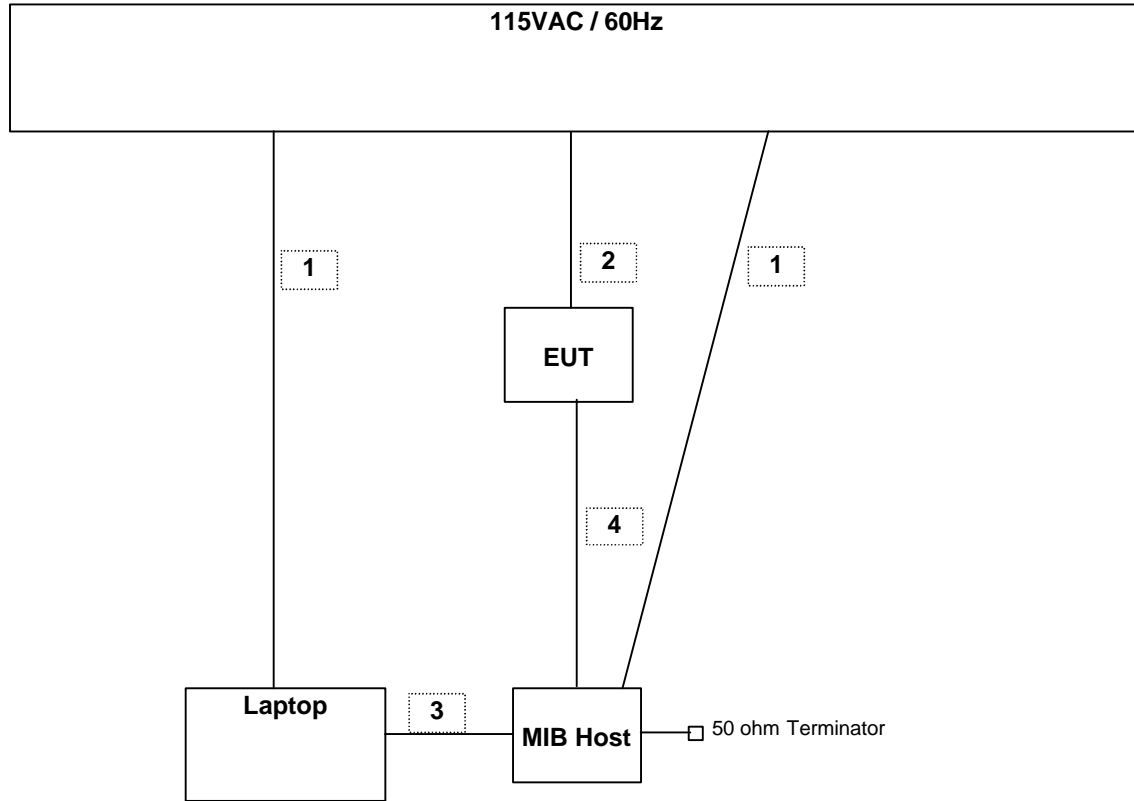

**I/O Cables :**

TEST I / O CABLES								
Cable No	I/O Port	# of I/O Port	Connector Type	Type of Cable	Cable Length	Data Traffic	Bundled	Remark
1	AC	2	US 115V	Un-shielded	2m	No	No	N/A
2	DC Power	1	Terminal Block	Un-shielded	2m	No	No	N/A
3	Serial	1	DB9	Shielded	3m	Yes	Yes	N/A
4	Interconnect	1	Snap-In	Un-shielded	0.8m	Yes	No	N/A

**Peripherals and Support Equipment List:**

<b>TEST PERIPHERALS</b>				
<b>Device Type</b>	<b>Manufacturer</b>	<b>Model Number</b>	<b>Serial Number</b>	<b>FCC ID</b>
Laptop	Toshiba	PAS206C-A	79016910	DoC
MIB Host	Sierra Wireless	1200285	N/A	N/A
DC Power Supply	Kenwood	PA36-3A	7060074	N/A
AC Adapter	Toshiba	PA2450U	0284576	N/A
MIB Power Supply	CUI Stack	DSA-0151A-06A	N/A	N/A

TEST SETUP

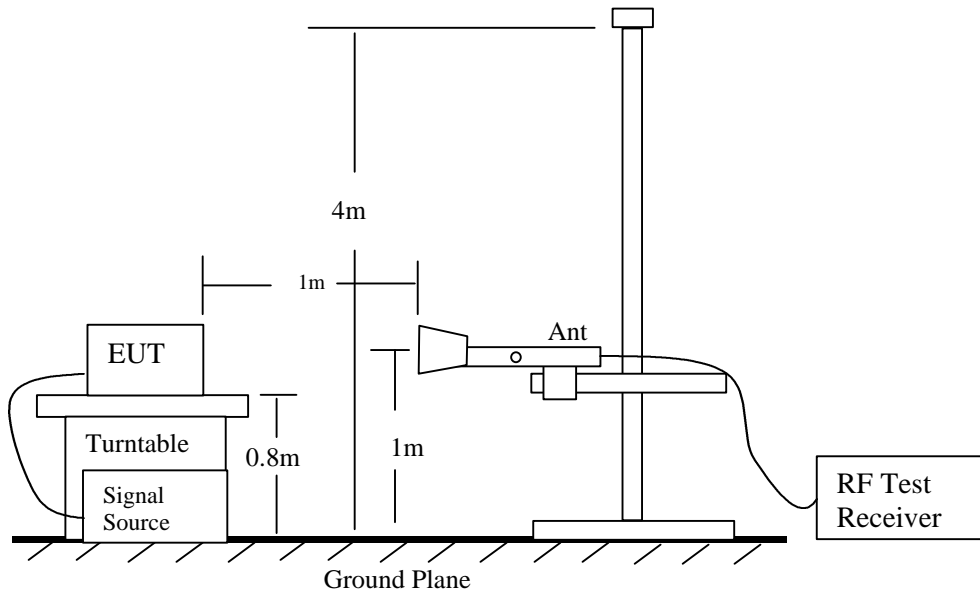

Fig 1: Radiated Emission Measurement

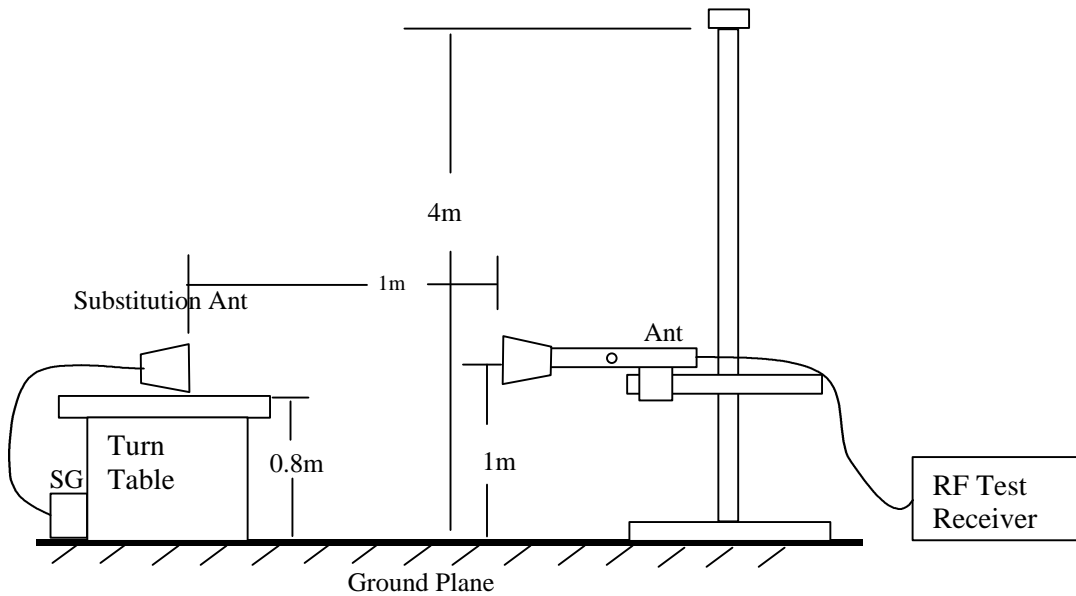

Fig 2: Radiated Emission – Substitution Method set-up

### **TEST PROCEDURE**

- 1). On a test site, the EUT shall be placed on a turntable, and in the position closest to the normal use as declared by the user.
- 2). The test antenna shall be oriented initially for vertical polarization located 1m from the EUT to correspond to the frequency of the transmitter.
- 3). The output of the test antenna shall be connected to the measuring receiver and either a peak or average detector was used for the measurement as indicated on the report. The detector selection is based on how close the emission level was approaching the limit.
- 4). The transmitter shall be switched on, if possible, without the modulation and the measurement receiver shall be tuned to the frequency of the transmitter under test.
- 5). The test antenna shall be raised and lowered through the specified range of height until a maximum signal level is detected by the measuring receiver.
- 6). The transmitter shall than be rotated through 360° in the horizontal plane, until the maximum signal level is detected by the measuring receiver.
- 7). The test antenna shall be raised and lowered again through the specified range of height until a maximum signal level is detected by the measuring receiver.
- 8). The maximum signal level detected by the measuring receiver shall be noted.
- 9). The transmitter shall be replaced by a substitution antenna.
- 10). The substitution antenna shall be oriented for vertical polarization.
- 11). The substitution antenna shall be connected to a calibrated signal generator.
- 12). If necessary, the input attenuator setting of the measuring receiver shall be adjusted in order to increase the sensitivity of the measuring receiver.
- 13). The test antenna shall be raised and lowered through the specified range of the height to ensure that the maximum signal is received.
- 14). The input signal to the substitution antenna shall be adjusted to the level that produces a level detected by the measuring receiver, that is equal to the level noted while the transmitter radiated power was measured, corrected for the change of input attenuation setting of the measuring receiver.
- 15). The input level to the substitution antenna shall be recorded as power level in dBm, corrected for any change of input attenuator setting of the measuring receiver.
- 16). The measurement shall be repeated with the test antenna and the substitution antenna oriented for horizontal polarization.
- 17). The measure of the effective radiated power is the larger of the two levels recorded, at the input to the substitution antenna, corrected for the gain of the substitution antenna if necessary.

### **RESULT**

No non-compliance noted:

11/19/02 <b>FCC Measurement</b>									
<b>Compliance Certification Services, Morgan Hill Open Field Site</b>									
<b>Test Engr:</b> Thanh Nguyen									
<b>Project #:</b> 02U1592-1									
<b>Company:</b> Sierra Wireless, Inc.									
<b>EUT Descrip.:</b> 800MHz / 1900MHz CDMA Module									
<b>EUT M/N:</b> SB555									
<b>Test Target:</b> FCC Part 24									
<b>Mode Oper:</b> 1900MHz Tx, Conducted Peak Output Power = 23.13 dBm									
Frequency	SA reading	SG reading	CL	Gain	Gain	EIRP	Limit	Margin	Notes
(GHz)	(dBuV)	(dBm)	(dB)	(dBi)	(dBd)	(dBm)	(dBm)	(dB)	
Fundamental at Low Channel									
3.703	41.33	-55.00	1.60	8.90	0.00	<b>-47.70</b>	-13.00	-34.70	V, Noise Floor
5.554	48.41	-55.00	2.10	9.70	0.00	<b>-47.40</b>	-13.00	-34.40	V, Noise Floor
7.405	41.33	-55.00	2.50	10.20	0.00	<b>-47.30</b>	-13.00	-34.30	V, Noise Floor
9.257	46.17	-55.00	2.80	11.30	0.00	<b>-46.50</b>	-13.00	-33.50	V, Noise Floor
11.108	41.33	-55.00	3.10	11.90	0.00	<b>-46.20</b>	-13.00	-33.20	V, Noise Floor
12.960	41.33	-55.00	3.40	11.80	0.00	<b>-46.60</b>	-13.00	-33.60	V, Noise Floor
14.960	49.33	-55.00	3.80	13.50	0.00	<b>-45.30</b>	-13.00	-32.30	V, Noise Floor
16.660	47.50	-55.00	4.10	11.70	0.00	<b>-47.40</b>	-13.00	-34.40	V, Noise Floor
18.513	46.33	-55.00	4.50	11.70	0.00	<b>-47.80</b>	-13.00	-34.80	V, Noise Floor
Note: Vertical is the worst polarization Scan from 30MHz to 20GHz									
RBW=VBW=1MHz									
EIPR = SG reading - CL + Gain (dBi)									
Margin = EIPR - Limit									
SA: Spectrum Analyzer, HP 8593EM, S/N: 3710A00205 CL: cable loss (3ft), FLEXCO									
SG: Signal Generator, HP 83732B, S/N: US34490599 RX Antenn Horn, EMCO 3115, S/N: 6717									
TX Antenna: Horn, EMCO 3115, S/N: 6739									

11/19/02 <b>FCC Measurement</b>									
<b>Compliance Certification Services, Morgan Hill Open Field Site</b>									
<b>Test Engr:</b> Thanh Nguyen									
<b>Project #:</b> 02U1592-1									
<b>Company:</b> Sierra Wireless, Inc.									
<b>EUT Descrip.:</b> 800MHz / 1900MHz CDMA Module									
<b>EUT M/N:</b> SB555									
<b>Test Target:</b> FCC Part 24									
<b>Mode Oper:</b> 1900MHz Tx, Conducted Peak Output Power = 23.75 dBm									
Frequency	SA reading	SG reading	CL	Gain	Gain	EIRP	Limit	Margin	Notes
(GHz)	(dBuV)	(dBm)	(dB)	(dBi)	(dBd)	(dBm)	(dBm)	(dB)	
Fundamental at Mid Channel									
3.760	41.33	-55.00	1.60	8.90	0.00	<b>-47.70</b>	-13.00	-34.70	V, Noise Floor
5.640	48.41	-55.00	2.10	9.70	0.00	<b>-47.40</b>	-13.00	-34.40	V, Noise Floor
7.520	40.23	-55.00	2.50	10.20	0.00	<b>-47.30</b>	-13.00	-34.30	V, Noise Floor
9.400	46.17	-55.00	2.80	11.30	0.00	<b>-46.50</b>	-13.00	-33.50	V, Noise Floor
11.280	41.33	-55.00	3.10	11.90	0.00	<b>-46.20</b>	-13.00	-33.20	V, Noise Floor
13.160	41.33	-55.00	3.40	11.80	0.00	<b>-46.60</b>	-13.00	-33.60	V, Noise Floor
15.040	49.33	-55.00	3.80	13.50	0.00	<b>-45.30</b>	-13.00	-32.30	V, Noise Floor
16.920	47.50	-55.00	4.10	11.70	0.00	<b>-47.40</b>	-13.00	-34.40	V, Noise Floor
18.800	46.33	-55.00	4.50	11.70	0.00	<b>-47.80</b>	-13.00	-34.80	V, Noise Floor
Note: Vertical is the worst polarization Scan from 30MHz to 20GHz RBW=VBW=1MHz EIPR = SG reading - CL + Gain (dBi) Margin = EIPR - Limit SA: Spectrum Analyzer, HP 8593EM, S/N: 3710A00205 CL: cable loss (3ft), FLEXCO SG: Signal Generator, HP 83732B, S/N: US34490599 RX Antenn Horn, EMCO 3115, S/N: 6717 TX Antenna: Horn, EMCO 3115, S/N: 6739									

Frequency (GHz)	SA reading (dBuV)	SG reading (dBm)	CL (dB)	Gain (dBi)	Gain (dBd)	EIRP (dBm)	Limit (dBm)	Margin (dB)	Notes
11/19/02 <b>FCC Measurement</b> <b>Compliance Certification Services, Morgan Hill Open Field Site</b>  <b>Test Engr:</b> Thanh Nguyen <b>Project #:</b> 02U1592-1 <b>Company:</b> Sierra Wireless, Inc. <b>EUT Descrip.:</b> 800MHz / 1900MHz CDMA Module <b>EUT M/N:</b> SB555 <b>Test Target:</b> FCC Part 24 <b>Mode Oper:</b> 1900MHz Tx, Conducted Peak Output Power = 23.76 dBm									
Fundamental at High Channel									
3.817	41.33	-55.00	1.60	8.90	0.00	<b>-47.70</b>	-13.00	-34.70	V, Noise Floor
5.726	48.41	-55.00	2.10	9.70	0.00	<b>-47.40</b>	-13.00	-34.40	V, Noise Floor
7.635	40.23	-55.00	2.50	10.20	0.00	<b>-47.30</b>	-13.00	-34.30	V, Noise Floor
9.544	47.27	-55.00	2.80	11.30	0.00	<b>-46.50</b>	-13.00	-33.50	V, Noise Floor
11.452	41.33	-55.00	3.10	11.90	0.00	<b>-46.20</b>	-13.00	-33.20	V, Noise Floor
13.360	41.33	-55.00	3.40	11.80	0.00	<b>-46.60</b>	-13.00	-33.60	V, Noise Floor
15.270	49.99	-55.00	3.80	13.50	0.00	<b>-45.30</b>	-13.00	-32.30	V, Noise Floor
17.179	47.50	-55.00	4.10	11.70	0.00	<b>-47.40</b>	-13.00	-34.40	V, Noise Floor
19.088	46.83	-55.00	4.50	11.70	0.00	<b>-47.80</b>	-13.00	-34.80	V, Noise Floor
Note: Vertical is the worst polarization Scan from 30MHz to 20GHz RBW=VBW=1MHz EIPR = SG reading - CL + Gain (dBi) Margin = EIPR - Limit  SA: Spectrum Analyzer, HP 8593EM, S/N: 3710A00205 CL: cable loss (3ft), FLEXCO SG: Signal Generator, HP 83732B, S/N: US34490599 RX Antenn Horn, EMCO 3115, S/N: 6717 TX Antenna: Horn, EMCO 3115, S/N: 6739									



Frequency (GHz)	SA reading (dBuV)	SG reading (dBm)	CL (dB)	Gain (dBi)	Gain (dBd)	ERP (dBm)	Limit (dBm)	Margin (dB)	Notes
11/19/02 <b>FCC Measurement</b> <b>Compliance Certification Services, Morgan Hill Open Field Site</b>  <b>Test Engr:</b> Thanh Nguyen <b>Project #:</b> 02U1592-1 <b>Company:</b> Sierra Wireless, Inc. <b>EUT Descrip.:</b> 800MHz / 1900MHz CDMA Module <b>EUT M/N:</b> SB555 <b>Test Target:</b> FCC Part 22 <b>Mode Oper:</b> 800MHz Tx, Conducted Peak Output Power = 23.56 dBm									
Fundamental at Low Channel									
1.649	39.44	-55.00	1.10	8.10	5.95	<b>-50.15</b>	-13.00	-37.15	V, Noise Floor
2.474	48.75	-48.42	1.30	9.00	6.85	<b>-42.87</b>	-13.00	-29.87	V, Noise Floor
3.298	33.00	-55.00	1.50	8.90	6.75	<b>-49.75</b>	-13.00	-36.75	V, Noise Floor
4.123	48.00	-42.40	1.70	8.90	6.75	<b>-37.35</b>	-13.00	-24.35	V, Noise Floor
4.948	45.34	-55.00	1.90	9.80	7.65	<b>-49.25</b>	-13.00	-36.25	V, Noise Floor
5.773	44.67	-55.00	2.10	10.30	8.15	<b>-48.95</b>	-13.00	-35.95	V, Noise Floor
6.597	46.67	-55.00	2.30	11.00	8.85	<b>-48.45</b>	-13.00	-35.45	V, Noise Floor
7.422	49.69	-55.00	2.40	10.20	8.05	<b>-49.35</b>	-13.00	-36.35	V, Noise Floor
8.246	45.83	-55.00	2.60	10.70	8.55	<b>-49.05</b>	-13.00	-36.05	V, Noise Floor
Note: Vertical is the worst polarization Scan from 30MHz to 10GHz RBW=VBW=1MHz EIPR = SG reading - CL + Gain (dBi) Margin = EIPR - Limit  SA: Spectrum Analyzer, HP 8593EM, S/N: 3710A00205 CL: cable loss (3ft), FLEXCO SG: Signal Generator, HP 83732B, S/N: US34490599 RX Antenn Horn, EMCO 3115, S/N: 6717 TX Antenna: Horn, EMCO 3115, S/N: 6739									

Frequency (GHz)	SA reading (dBuV)	SG reading (dBm)	CL (dB)	Gain (dBi)	Gain (dBd)	ERP (dBm)	Limit (dBm)	Margin (dB)	Notes
11/19/02 <b>FCC Measurement</b> <b>Compliance Certification Services, Morgan Hill Open Field Site</b>  <b>Test Engr:</b> Thanh Nguyen <b>Project #:</b> 02U1592-1 <b>Company:</b> Sierra Wireless, Inc. <b>EUT Descrip.:</b> 800MHz / 1900MHz CDMA Module <b>EUT M/N:</b> SB555 <b>Test Target:</b> FCC Part 22 <b>Mode Oper:</b> 800MHz Tx, Conducted Peak Output Power = 23.23 dBm									
Fundamental at Mid Channel									
1.668	45.00	-55.00	1.10	8.10	5.95	-50.15	-13.00	-37.15	V, Noise Floor
2.502	49.30	-48.42	1.30	9.00	6.85	-42.87	-13.00	-29.87	V, Noise Floor
3.336	39.00	-55.00	1.50	8.90	6.75	-49.75	-13.00	-36.75	V, Noise Floor
4.170	42.00	-42.40	1.70	8.90	6.75	-37.35	-13.00	-24.35	V, Noise Floor
5.007	43.00	-55.00	1.90	9.80	7.65	-49.25	-13.00	-36.25	V, Noise Floor
5.838	42.50	-55.00	2.10	10.30	8.15	-48.95	-13.00	-35.95	V, Noise Floor
6.672	46.67	-55.00	2.30	11.00	8.85	-48.45	-13.00	-35.45	V, Noise Floor
7.506	49.10	-55.00	2.40	10.20	8.05	-49.35	-13.00	-36.35	V, Noise Floor
8.340	48.87	-55.00	2.60	10.70	8.55	-49.05	-13.00	-36.05	V, Noise Floor
Note: Vertical is the worst polarization Scan from 30MHz to 10GHz RBW=VBW=1MHz EIPR = SG reading - CL + Gain (dBi) Margin = EIPR - Limit  SA: Spectrum Analyzer, HP 8593EM, S/N: 3710A00205 CL: cable loss (3ft), FLEXCO SG: Signal Generator, HP 83732B, S/N: US34490599 RX Antenn Horn, EMCO 3115, S/N: 6717 TX Antenna: Horn, EMCO 3115, S/N: 6739									

11/19/02 <b>FCC Measurement</b>									
<b>Compliance Certification Services, Morgan Hill Open Field Site</b>									
<b>Test Engr:</b> Thanh Nguyen									
<b>Project #:</b> 02U1592-1									
<b>Company:</b> Sierra Wireless, Inc.									
<b>EUT Descrip.:</b> 800MHz / 1900MHz CDMA Module									
<b>EUT M/N:</b> SB555									
<b>Test Target:</b> FCC Part 22									
<b>Mode Oper:</b> 800MHz Tx, Conducted Peak Output Power = 23.60 dBm									
Frequency	SA reading	SG reading	CL	Gain	Gain	ERP	Limit	Margin	Notes
(GHz)	(dBuV)	(dBm)	(dB)	(dBi)	(dBd)	(dBm)	(dBm)	(dB)	
Fundamental at High Channel									
1.696	45.00	-55.00	1.10	8.10	5.95	<b>-50.15</b>	-13.00	-37.15	V, Noise Floor
2.545	49.30	-48.42	1.30	9.00	6.85	<b>-42.87</b>	-13.00	-29.87	V, Noise Floor
3.393	39.00	-55.00	1.50	8.90	6.75	<b>-49.75</b>	-13.00	-36.75	V, Noise Floor
4.241	42.00	-42.40	1.70	8.90	6.75	<b>-37.35</b>	-13.00	-24.35	V, Noise Floor
5.089	43.00	-55.00	1.90	9.80	7.65	<b>-49.25</b>	-13.00	-36.25	V, Noise Floor
5.938	42.50	-55.00	2.10	10.30	8.15	<b>-48.95</b>	-13.00	-35.95	V, Noise Floor
6.786	46.67	-55.00	2.30	11.00	8.85	<b>-48.45</b>	-13.00	-35.45	V, Noise Floor
7.635	49.10	-55.00	2.40	10.20	8.05	<b>-49.35</b>	-13.00	-36.35	V, Noise Floor
8.482	48.87	-55.00	2.60	10.70	8.55	<b>-49.05</b>	-13.00	-36.05	V, Noise Floor
Note: Vertical is the worst polarization Scan from 30MHz to 10GHz RBW=VBW=1MHz <b>EIPR</b> = SG reading - CL + Gain (dBi) <b>Margin</b> = EIPR - Limit  <b>SA:</b> Spectrum Analyzer, HP 8593EM, S/N: 3710A00205 <b>CL:</b> cable loss (3ft), FLEXCO <b>SG:</b> Signal Generator, HP 83732B, S/N: US34490599 <b>RX Antenn</b> Horn, EMCO 3115, S/N: 6717 <b>TX Antenna:</b> Horn, EMCO 3115, S/N: 6739									

## 7. EUT SETUP PHOTOS

### RADIATED MEASUREMENTS



## SUBSTITUTION MEASUREMENTS

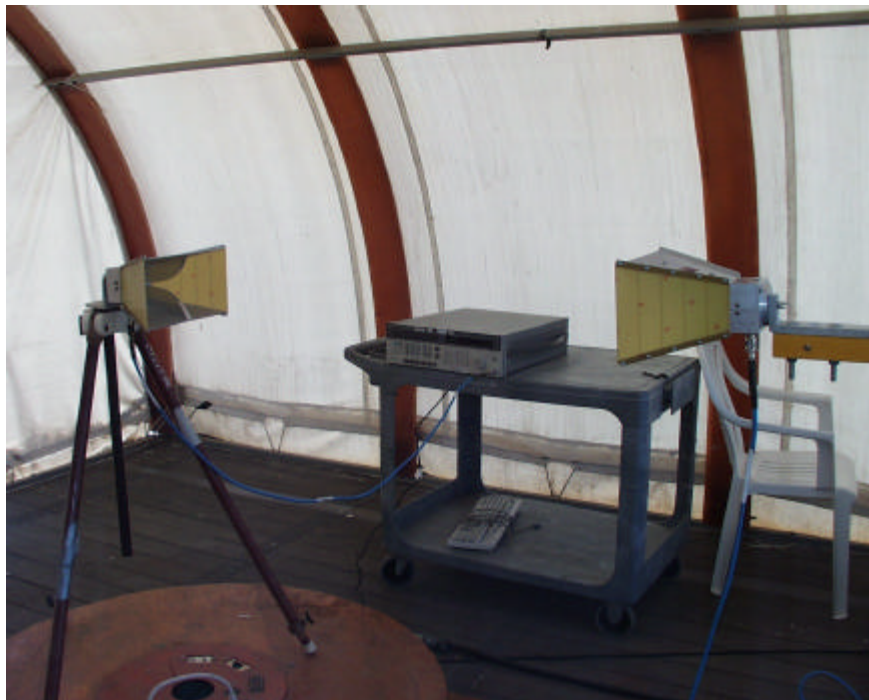
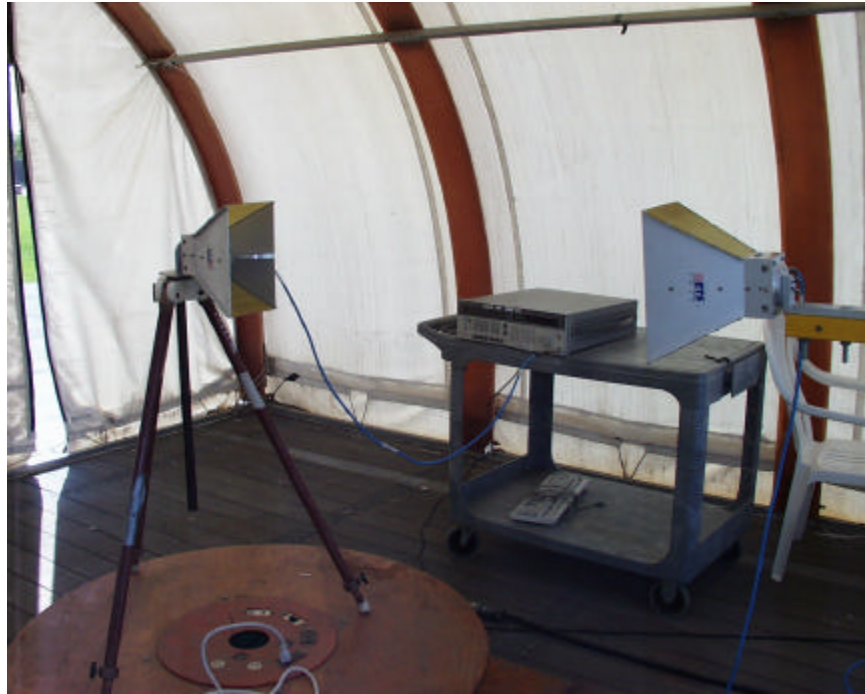

**END OF REPORT**