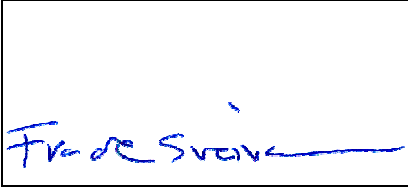
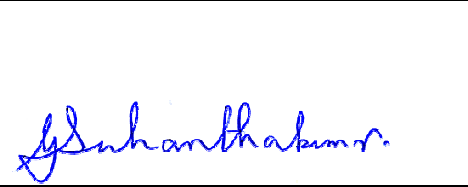

## Test Report

|  |  |  |
|--|--|--|
| <b>Product</b>   | DECT Base Station with Bluetooth   |  |
| <b>Name and address of the applicant</b>   | Panasonic Corporation of North America   |  |
| <b>Name and address of the manufacturer</b>  | Panasonic System Networks Co., Ltd.<br>1-62, 4-chome, Minoshima, Hakata-ku<br>Fukuoka 812-8531, Japan  |  |
| <b>Model</b>   | KX-TGD560  |  |
| <b>Rating</b>  | 5.5V DC (AC Adaptor, 1.5A; 100-240 V AC, 50/60 Hz, 1.2-0.6 A)  |  |
| <b>Trademark</b>   | Panasonic  |  |
| <b>Serial number</b>   | /  |  |
| <b>Additional information</b>  | DECT 6.0, Bluetooth  |  |
| <b>Tested according to</b>   | <b>FCC Part 15, subpart D</b><br>Isochronous UPCS Device, 1920 – 1930 MHz<br><b>Industry Canada RSS 213, Issue 3</b><br>2 GHz License-Exempt Personal Communications Services (LE-PCS) Devices |  |
| <b>Order number</b>  | 318949   |  |
| <b>Tested in period</b>  | 2016.10.25 to 2016.11.01   |  |
| <b>Issue date</b>  | 2016.11.15   |  |
| <b>Name and address of the testing laboratory</b>  | <br><br>Instituttveien 6<br>Kjeller, Norway   | FCC No: 994405<br>IC OATS: 2040D-1<br><br>TEL: +47 22 96 03 30<br>FAX: +47 22 96 05 50 |
|  |   |    |
|  | Prepared by [Frode Sveinsen]   | Approved by [G.Suhandhakumar]  |
| This report shall not be reproduced except in full without the written approval of Nemko. Opinions and interpretations expressed within this report are not part of the current accreditation. This report was originally distributed electronically with digital signatures. For more information please contact Nemko. |  |  |

## CONTENTS

|          |   |           |
|----------|---|-----------|
| <b>1</b> | <b>INFORMATION .....</b>                            | <b>3</b>  |
| 1.1      | Tested Item.....                                    | 3         |
| 1.2      | Description of Tested Device .....                  | 3         |
| 1.3      | Test Environment.....                               | 4         |
| 1.4      | Test Engineer(s) .....                              | 4         |
| 1.5      | Other Comments .....                                | 4         |
| <b>2</b> | <b>TEST REPORT SUMMARY .....</b>                    | <b>5</b>  |
| 2.1      | General.....  | 5         |
| 2.2      | Test Summary .....                                  | 6         |
| <b>3</b> | <b>TEST RESULTS.....</b>                            | <b>7</b>  |
| 3.1      | Power Line Conducted Emissions .....                | 7         |
| 3.2      | Digital Modulation Techniques .....                 | 9         |
| 3.3      | Labeling Requirements .....                         | 9         |
| 3.4      | Channel Frequencies.....                            | 9         |
| 3.5      | Antenna Requirement.....                            | 10        |
| 3.6      | Automatic Discontinuation of Transmission .....     | 10        |
| 3.7      | Peak Power Output.....                              | 11        |
| 3.8      | Emission Bandwidth $B$ .....                        | 14        |
| 3.9      | Power Spectral Density .....                        | 17        |
| 3.10     | In-Band Unwanted Emissions, Conducted.....          | 20        |
| 3.11     | Out-of-band Emissions, Conducted .....              | 22        |
| 3.12     | Carrier Frequency Stability .....                   | 27        |
| 3.13     | Frame Repetition Stability.....                     | 28        |
| 3.14     | Frame Period and Jitter .....                       | 28        |
| 3.15     | Monitoring Threshold, Least Interfered Channel..... | 30        |
| 3.16     | Threshold Monitoring Bandwidth.....                 | 32        |
| 3.17     | Reaction Time and Monitoring Interval .....         | 33        |
| 3.18     | Time and Spectrum Window Access Procedure.....      | 35        |
| 3.19     | Acknowledgements and Transmission Duration .....    | 38        |
| 3.20     | Dual Access Criteria Check .....                    | 39        |
| 3.21     | Alternative Monitoring Interval .....               | 40        |
| <b>4</b> | <b>MEASUREMENT UNCERTAINTY .....</b>                | <b>41</b> |
| <b>5</b> | <b>TEST SETUPS .....</b>                            | <b>42</b> |
| 5.1      | Frequency Measurements .....                        | 42        |
| 5.2      | Timing Measurements .....                           | 42        |
| 5.3      | Conducted Emission Test.....                        | 42        |
| 5.4      | Power Line Conducted Emissions Test .....           | 42        |
| 5.5      | Monitoring Tests .....                              | 43        |
| <b>6</b> | <b>TEST EQUIPMENT USED .....</b>                    | <b>44</b> |

## 1 INFORMATION

### 1.1 Tested Item

|  |   |
|--|---|
| <b>Name :</b>                              | Panasonic                                     |
| <b>Model name :</b>                        | KX-TGD560                                     |
| <b>FCC ID :</b>                            | ACJ96NKX-TGD560                               |
| <b>Industry Canada ID :</b>                | 216A-KXTGD590                                 |
| <b>Serial number :</b>                     | /   |
| <b>Hardware identity and/or version:</b>   | PNLB2666xx                                    |
| <b>Software identity and/or version :</b>  | SW200   |
| <b>Tested to IC Radio Standard (RSS) :</b> | RSS-213 Issue 3, RSS-GEN Issue 4              |
| <b>Test Site IC Reg. Number :</b>          | IC 2040D-1                                    |
| <b>Frequency Range :</b>                   | 1921.536 – 1928.448 MHz                       |
| <b>Number of Channels :</b>                | 5 RF Channels, 5x12 = 60 TDMA Duplex Channels |
| <b>Type of Modulation :</b>                | Digital (Gaussian Frequency Shift Keying)     |
| <b>Conducted Output Power :</b>            | 70 mW (Peak)                                  |
| <b>Antenna Connector :</b>                 | None  |
| <b>Number of Antennas :</b>                | 2   |
| <b>Antenna Diversity Supported :</b>       | Yes   |
| <b>Desktop Charger :</b>                   | N/A   |
| <b>Power Supply :</b>                      | PNLV226 (AC Adaptor)                          |
| <b>Interface :</b>                         | PSTN  |
| <b>Companion Device :</b>                  | KX-TGDA51                                     |

### 1.2 Description of Tested Device

The EUT is a DECT Base Station and is a responding device as described in ANSI C63.17 and is designed to operate together with a DECT Handset, which is the initiating device.

### 1.3 Test Environment

|                      |                |
|----------------------|----------------|
| Temperature:         | 21.9 – 23.5 °C |
| Relative humidity:   | 25 – 50 %      |
| Normal test voltage: | 120 V AC       |

The values are the limit registered during the test period.

### 1.4 Test Engineer(s)

Frode Sveinsen

### 1.5 Other Comments

The Monitoring and Time and Spectrum Window Access tests were performed with Test Set-Up 6 (Ref. clause 5). A clock signal from the companion device was used to synchronize the Pulse Pattern Generator and the Spectrum Analyzer to the start of the DECT time window. The EUT was limited by administrative commands to operate on only two frequency carriers. For the tests where the EUT was required to operate on only one frequency carrier, one carrier was blocked by applying a CW interfering signal from RF Generator 3. The Pulse Pattern Generator was used to apply time synchronized interference to time windows where this was required.

Since the EUT was programmed to operate on only two RF carriers, it was only necessary with two RF generators for the monitoring tests, however a third generator was applied for the tests that required specific time slots to be blocked.

This EUT supports Least Interfered Channel procedure (LIC), the Monitoring and Time and Spectrum Window Access tests were conducted as specified for EUTs that support LIC procedure.

All tests except Power-Line Conducted Emissions were performed in conducted mode with a temporary antenna connector.

The Power-Line Conducted Emissions tests was performed with all ports populated and operating.

## 2 TEST REPORT SUMMARY

### 2.1 General

All measurements are traceable to national standards.

The tests were conducted on a sample of the equipment for the purpose of demonstrating compliance with FCC CFR47 Part 15D for Isochronous UPCS Devices and Industry Canada RSS-213 Issue 3 / RSS-GEN Issue 4 / RSP-100 Issue 11.

All tests were conducted in accordance with ANSI C63.4-2014 and ANSI C63.17-2013. Antenna Gain tests were made in a 3m fully-anechoic chamber.

A description of the test facility is on file with the FCC and Industry Canada.

New Submission

Production Unit

Class II Permissive Change

Pre-production Unit

**PUB** Equipment Code

Family Listing



#### **THIS TEST REPORT APPLIES ONLY TO THE ITEM(S) AND CONFIGURATIONS TESTED.**

Deviations from, additions to, or exclusions from the test specifications are described in "Summary of Test Data".

Nemko Group authorizes the above named company to reproduce this report provided it is reproduced in its entirety and for use by the company's employees only. Any reproduction of parts of this report requires approval in writing from Nemko Group.

Any use which a third party makes of this report, or any reliance on or decisions to be made based on it, are the responsibility of such third parties. Nemko Group accepts no responsibility for damages suffered by any third party as a result of decisions made or actions based on this report.

## 2.2 Test Summary

| Name of test   | FCC CFR 47 Paragraph #              | IC RSS-213 Paragraph # | Verdict          |
|--|-------------------------------------|------------------------|------------------|
| Power Line Conducted Emission                                    | 15.107(a)<br>15.207(a)              | 5.4<br>RSS-GEN 8.8     | Complies         |
| Digital Modulation Techniques                                    | 15.319(b)                           | 5.1                    | Complies         |
| Labeling requirements  | 15.19(a)(3)                         | RSP-100 3.1            | Complies         |
| Antenna Requirement  | 15.317, 15.203                      | RSS-GEN 8.3            | Complies         |
| Channel Frequencies  | 15.303                              | 5.1                    | Complies         |
| Automatic discontinuation of transmission                        | 15.319(f)                           | 5.2 (4)                | Complies         |
| Emission Bandwidth   | 15.323(a)                           | 5.5<br>RSS-GEN 6.6     | Complies         |
| In-band emissions  | 15.323(d)                           | 5.8.2                  | Complies         |
| Out-of-band emissions  | 15.323(d)                           | 5.8.1                  | Complies         |
| Peak Transmit Power and Antenna Gain                             | 15.319(c)(e),<br>15.31(e)           | 5.6<br>RSS-GEN 8.3     | Complies         |
| Power Spectral Density   | 15.319(d)                           | 5.7                    | Complies         |
| Carrier frequency stability                                      | 15.323(f)                           | 5.3                    | Complies         |
| Frame repetition stability                                       | 15.323(e)                           | 5.2 (13)               | Complies         |
| Frame period and jitter  | 15.323(e)                           | 5.2 (13)               | Complies         |
| Monitoring threshold, Least interfered channel                   | 15.323(c)(2)(5)(9)                  | 5.2 (2)(5)(9)          | Complies         |
| Monitoring of intended transmit window and maximum reaction time | 15.323(c)(1)                        | 5.2 (1)                | Complies         |
| Threshold monitoring bandwidth                                   | 15.323(c)(7)                        | 5.2 (7)                | Complies         |
| Reaction time and monitoring interval                            | 15.323(c)(1)(5)(7)                  | 5.2 (1)(5)(7)          | Complies         |
| Access criteria test interval                                    | 15.323(c)(4)(6)                     | 5.2 (4)(6)             | Complies         |
| Access Criteria functional test                                  | 15.323(c)(4)(6)                     | 5.2 (4)(6)             | Complies         |
| Acknowledgements   | 15.323(c)(4)                        | 5.2 (4)                | Complies         |
| Transmission duration  | 15.323(c)(3)                        | 5.2 (3)                | N/A <sup>1</sup> |
| Dual access criteria   | 15.323(c)(10)                       | 5.2 (10)               | N/A <sup>1</sup> |
| Alterative monitoring interval                                   | 15.323(c)(11)(12)                   | 5.2 (11)(12)           | N/A <sup>2</sup> |
| Spurious Emissions (Radiated)                                    | 15.319(g)<br>15.109(a)<br>15.209(a) | RSS-GEN 8.9            | N/A <sup>3</sup> |

<sup>1</sup> Only applies for equipment that transmits unacknowledged control and signaling information

<sup>1</sup> Only applies for EUT that can be initiating device

<sup>2</sup> The client declares that the tested equipment does not implement this provision

<sup>3</sup> Not required if the Conducted Out-of-Band Emissions test is Passed

### 3 TEST RESULTS

#### 3.1 Power Line Conducted Emissions

FCC Part 15.207(a)

RSS-213 Clause 6.3, RSS-GEN Clause 8.8

|                                 |                          |
|---------------------------------|--------------------------|
| Test Performed By: Tore Løvlien | Date of Test: 1-Nov-2016 |
|---------------------------------|--------------------------|

Measurement procedure: ANSI C63.4-2014 using 50 µH/50 ohms LISN.

Test Results: Complies

Measurement Data: See attached graph, (Peak detector).

Highest measured value (L1 and N):

Off Hook, 120V 60Hz:

| Frequency (MHz) | QuasiPeak (dBµV) | Average (dBµV) | Limit (dBµV) | Margin (dB) | Meas. Time (ms) | Bandwidth (kHz) | Line | PE  | Corr. (dB) |
|-----------------|------------------|----------------|--------------|-------------|-----------------|-----------------|------|-----|------------|
| 0.304           | 38.25            | ---            | 60.13        | 21.88       | 1000.0          | 9.000           | L1   | GND | 10.1       |
| 4.044           | 30.08            | ---            | 56.00        | 25.92       | 1000.0          | 9.000           | N    | GND | 10.1       |
| 4.360           | 33.92            | ---            | 56.00        | 22.08       | 1000.0          | 9.000           | L1   | GND | 10.2       |
| 4.656           | 33.75            | ---            | 56.00        | 22.25       | 1000.0          | 9.000           | L1   | GND | 10.2       |
| 4.684           | 29.80            | ---            | 56.00        | 26.20       | 1000.0          | 9.000           | N    | GND | 10.1       |
| 4.688           | 33.25            | ---            | 56.00        | 22.75       | 1000.0          | 9.000           | L1   | GND | 10.2       |

On Hook, Charging, 120V 60Hz:

| Frequency (MHz) | QuasiPeak (dBµV) | Average (dBµV) | Limit (dBµV) | Margin (dB) | Meas. Time (ms) | Bandwidth (kHz) | Line | PE | Corr. (dB) |
|-----------------|------------------|----------------|--------------|-------------|-----------------|-----------------|------|----|------------|
| ---             | ---              | ---            | ---          | ---         | ---             | ---             |      |    | ---        |

Full Spectrum

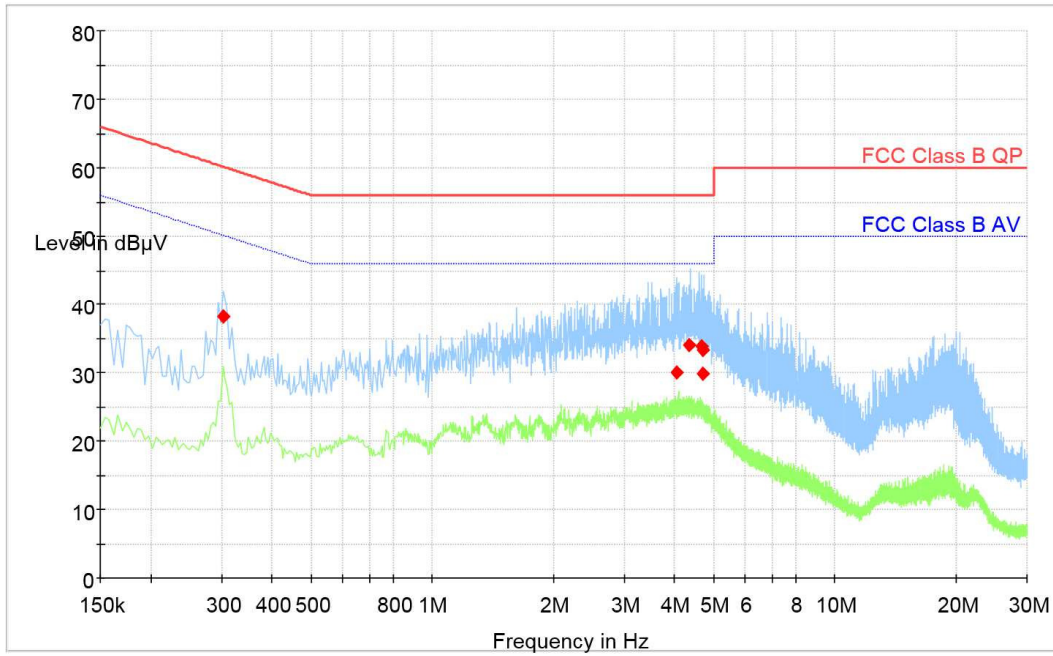

Off Hook, 120V 60Hz

Full Spectrum

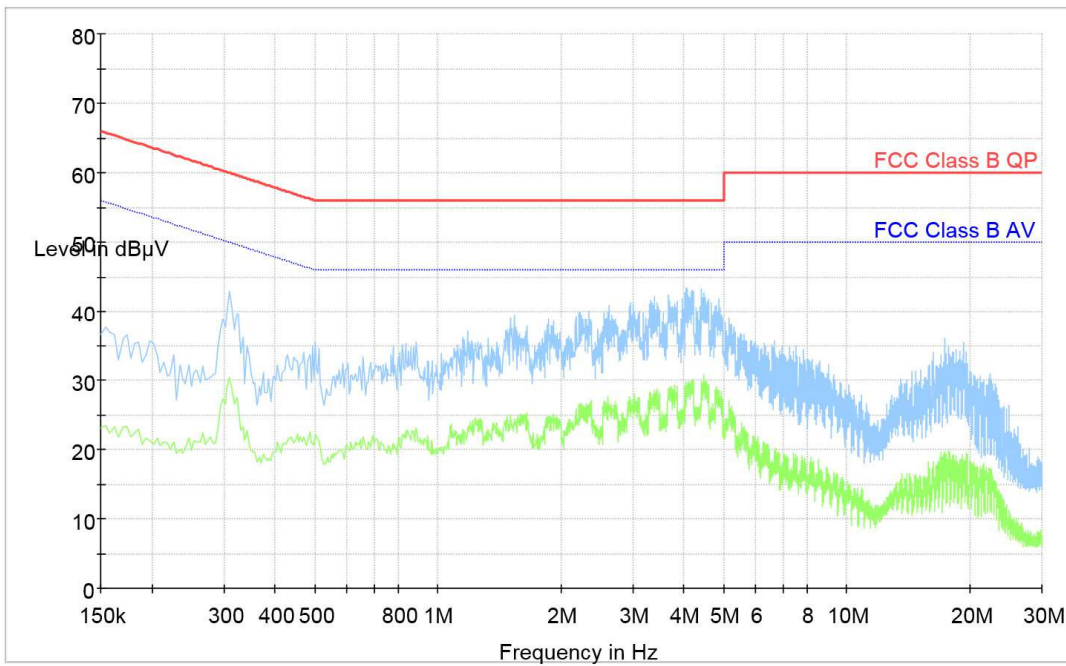

On Hook, Charging, 120V 60Hz

### 3.2 Digital Modulation Techniques

The EUT uses Multi Carrier / Time Division Multiple Access / Time Division Duplex and Digital GFSK modulation. For further details see the operational description provided by the applicant.

**Requirement, FCC 15.319(b):**

All transmissions must use only digital modulation techniques.

### 3.3 Labeling Requirements

See separate documents showing the label design and the placement of the label on the EUT.

**Requirements FCC 15.19**

The FCC Identifier shall be displayed on the label, and the device(s) shall bear the following statement in a conspicuous location on the device or in the user manual if the device is too small:

*This device complies with Part 15 of the FCC Rules. Operation is subject to the following two conditions: (1) this device may not cause harmful interference, and (2) this device must accept any interference received, including interference that may cause undesired operation.*

The label itself shall be of a permanent type, not a paper label, and shall last the lifetime of the equipment.

### 3.4 Channel Frequencies

| UPCS CHANNEL    | FREQUENCY (MHz) |
|-----------------|-----------------|
| Upper Band Edge | 1930.000        |
| 0 (Highest)     | 1928.448        |
| 1               | 1926.720        |
| 2               | 1924.992        |
| 3               | 1923.264        |
| 4 (Lowest)      | 1921.536        |
| Lower Band Edge | 1920.000        |

**Requirement: FCC 15.303**

Within 1920 -1930 MHz band for isochronous devices.

### 3.5 Antenna Requirement

|   |                              |  |
|---|------------------------------|--|
| Does the EUT have detachable antenna(s)?  | <input type="checkbox"/> YES | <input checked="" type="checkbox"/> NO |
| If detachable, is the antenna connector(s) non-standard?  | <input type="checkbox"/> YES | <input type="checkbox"/> NO            |
| The tested equipment has only integral antennas. The conducted tests were performed on a sample with a temporary antenna connector. |                              |  |

Requirement: FCC 15.203, 15.204, 15.317.

### 3.6 Automatic Discontinuation of Transmission

|  |  |   |
|--|--|---|
| Does the EUT transmit Control and Signaling Information? | <input checked="" type="checkbox"/> YES    | <input type="checkbox"/> NO                           |
| TYPE OF EUT :  | <input type="checkbox"/> INITIATING DEVICE | <input checked="" type="checkbox"/> RESPONDING DEVICE |

The following tests simulate the reaction of the EUT in case of either absence of information to transmit or operational failure after a connection with the companion device is established.

| Number | Test                                | EUT Reaction | Verdict |
|--------|-------------------------------------|--------------|---------|
| 1      | Power removed from EUT              | A            | Pass    |
| 2      | Switch Off EUT                      | N/A          | Pass    |
| 3      | Hook-On by EUT                      | N/A          | Pass    |
| 4      | Power Removed from Companion Device | B            | Pass    |
| 5      | Switch Off Companion Device         | B            | Pass    |
| 6      | Hook-On by Companion Device         | B            | Pass    |

- A - Connection breakdown, Cease of all transmissions
- B - Connection breakdown, EUT transmits control and signaling information
- C - Connection breakdown, Companion Device transmits control and signaling information
- N/A - Not Applicable (EUT does not have On/Off switch and cannot perform Hook-On)

#### Requirements, FCC 15.319(f)

The device shall automatically discontinue transmission in case of either absence of information to transmit or operational failure. These provisions are not intended to preclude transmission of control and signaling information or use of repetitive codes used by certain digital technologies to complete frame or burst intervals.

### 3.7 Peak Power Output

**Test Method:**

ANSI C63.17, clause 6.1.2.

**Test Results: Complies**

**Measurement Data:**

**Maximum Conducted Output Power**

| Channel No. | Frequency (MHz) | Maximum Conducted Output Power (dBm) | Maximum Antenna Gain (dBi) | Maximum Radiated Output Power (dBm) |
|-------------|-----------------|--------------------------------------|----------------------------|-------------------------------------|
| 4           | 1921.536        | 18.37                                | 0.0*                       | 18.37                               |
| 2           | 1924.992        | 18.44                                | 0.0*                       | 18.44                               |
| 0           | 1928.448        | 18.38                                | 0.0*                       | 18.38                               |

\*Antenna Gain is value declared by manufacturer

For this test it was also checked that input voltage variation of 85 and 115% of nominal value did not have any effect on the measured output power.

**Limit:**

Conducted:  $100 \mu\text{W} \times \text{SQRT}(B)$  where  $B$  is the measured Emission Bandwidth in Hz

FCC 15.319(c)(e) and RSS-213, Issue 3: 20.68 dBm (117 mW)

The antenna gain is below 3 dBi, no reduction in transmit power is necessary.

**Requirements, FCC 15.319(c)(e); RSS-213, Issue 3; RSS-GEN, Issue 4**

Peak transmit power shall not exceed 100 microwatts multiplied by the square root of the emission bandwidth in Hertz.

The peak transmit power shall be reduced by the amount in decibels that the maximum directional gain of the antenna exceeds 3 dBi.

### Conducted Peak Output Power

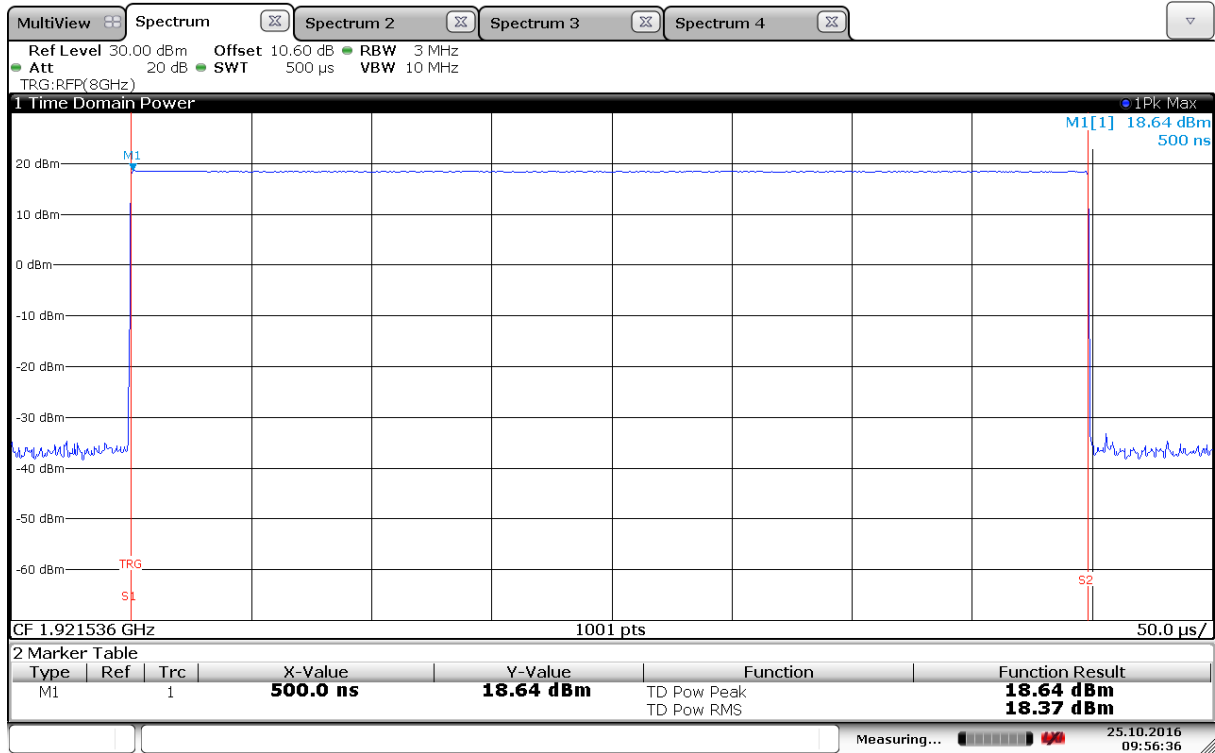

### Lower Channel

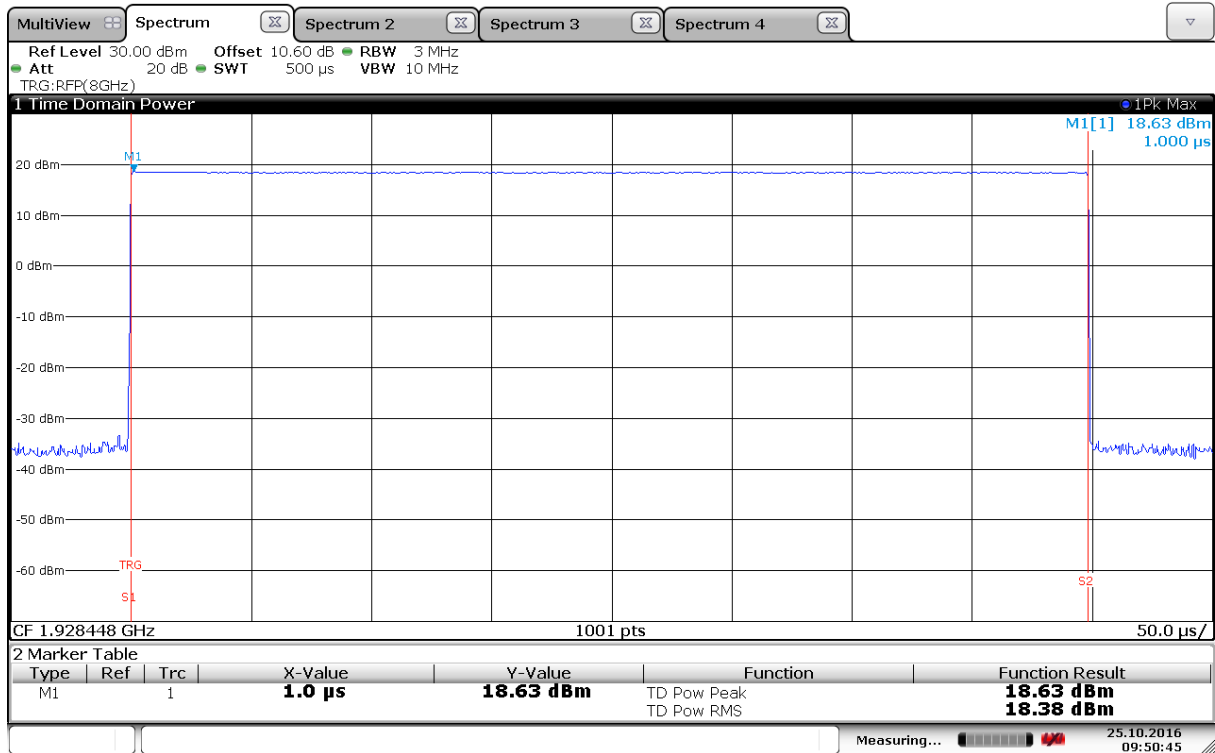

### Upper Channel

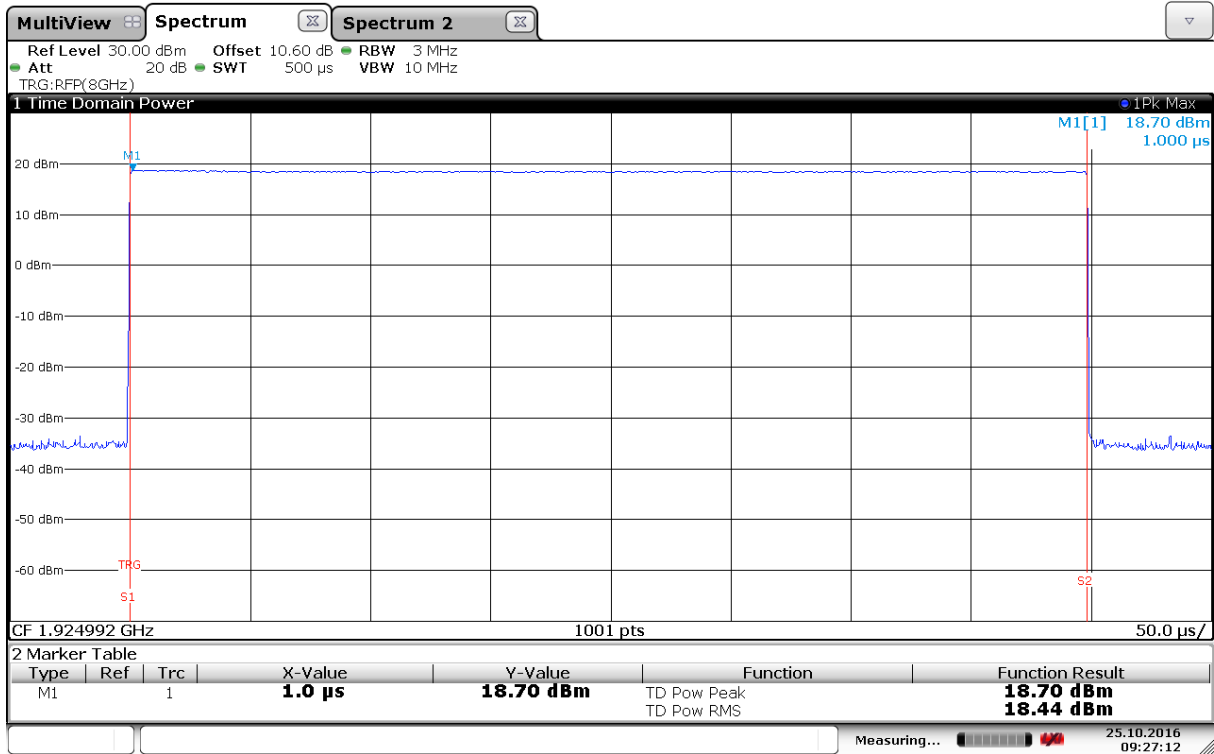

Middle Channel

### 3.8 Emission Bandwidth *B*

**Test Method:**

ANSI C63.17, clause 6.1.3.

**Test Results: Complies**

**Measurement Data:**

| Channel No. | Frequency (MHz) | Emission Bandwidth <i>B</i> (MHz) |
|-------------|-----------------|-----------------------------------|
| 4           | 1921.536        | 1.37                              |
| 2           | 1924.992        | 1.40                              |
| 0           | 1928.448        | 1.37                              |

| Channel No. | Frequency (MHz) | Occupied Bandwidth (MHz) |
|-------------|-----------------|--------------------------|
| 2           | 1924.992        | 1.24                     |

**Requirements, FCC 15.323(a), RSS-213 Issue 3, clause 5.5**

The Emission Bandwidth *B* shall be larger than 50 kHz and less than 2.5 MHz.

No requirements for 6 and 12 dB Bandwidth, these values are only used for testing Monitoring Bandwidth if the Simple Compliance test fails (ANSI C63.17, clause 7.4).

Occupied Bandwidth (99%) is measured according to RSS-GEN Issue 4, clause 6.6. This value is reported for information only.

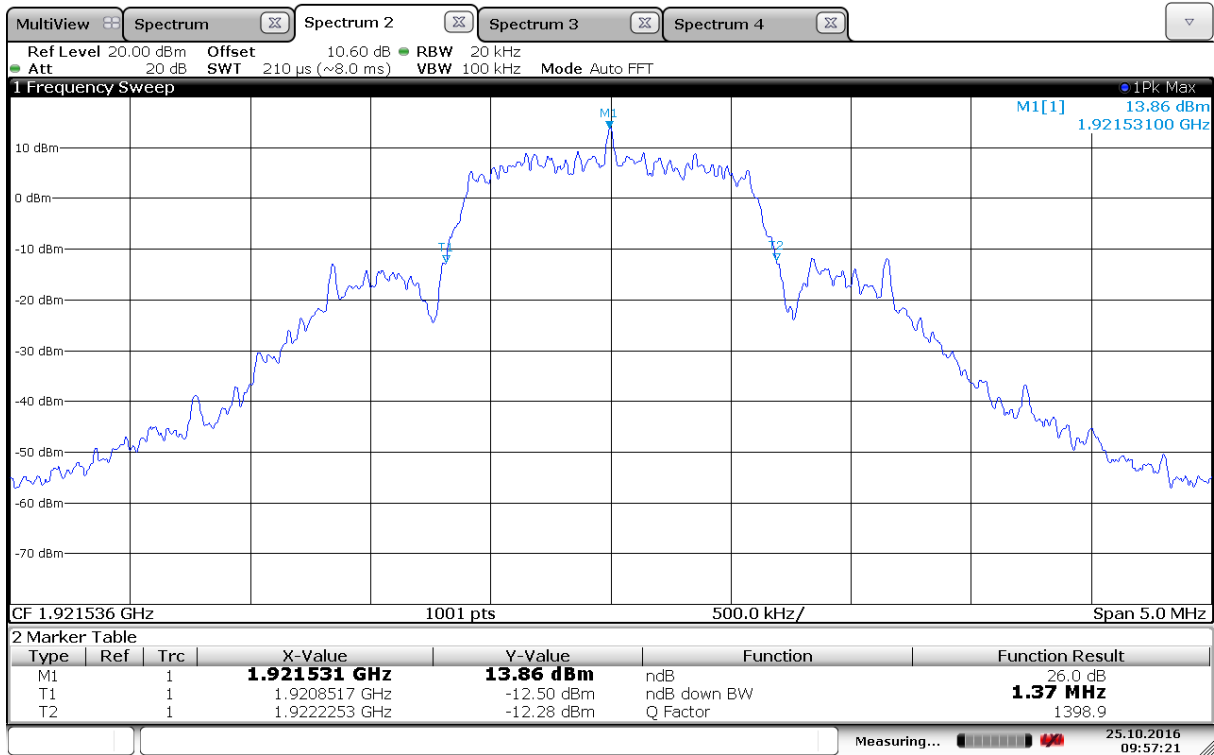

Emission Bandwidth B, Lower Channel

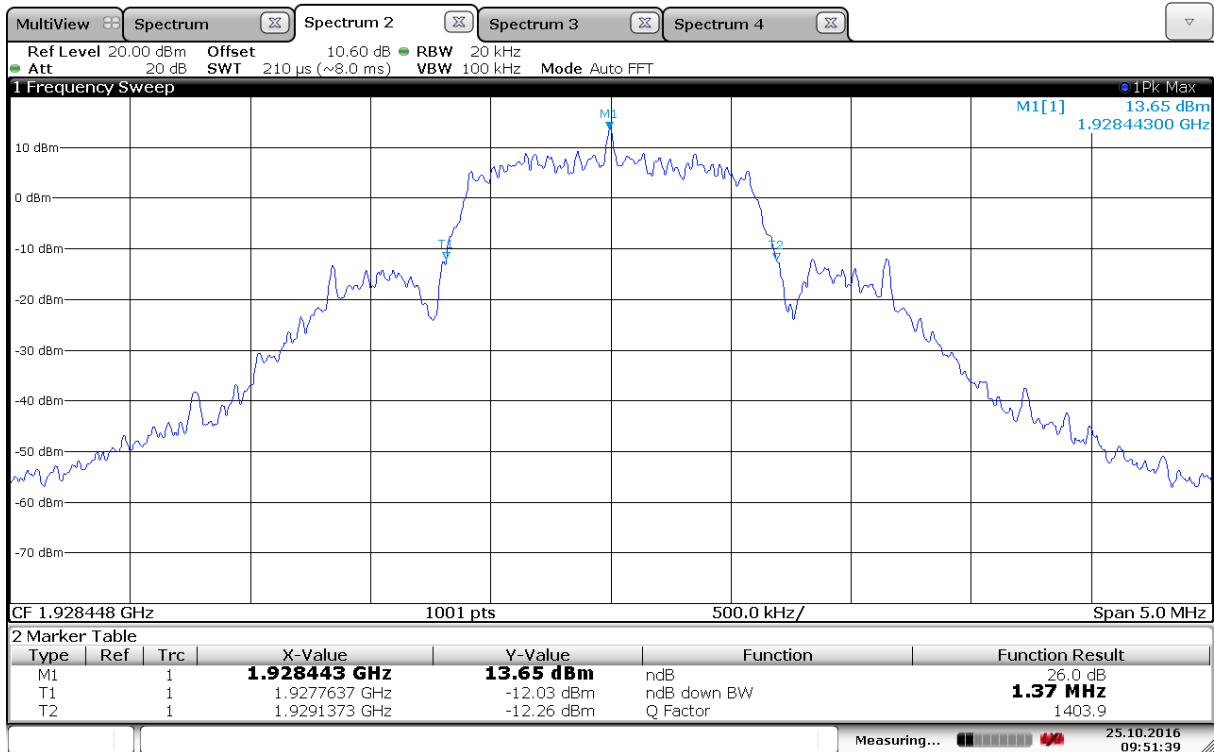

Emission Bandwidth B, Upper Channel

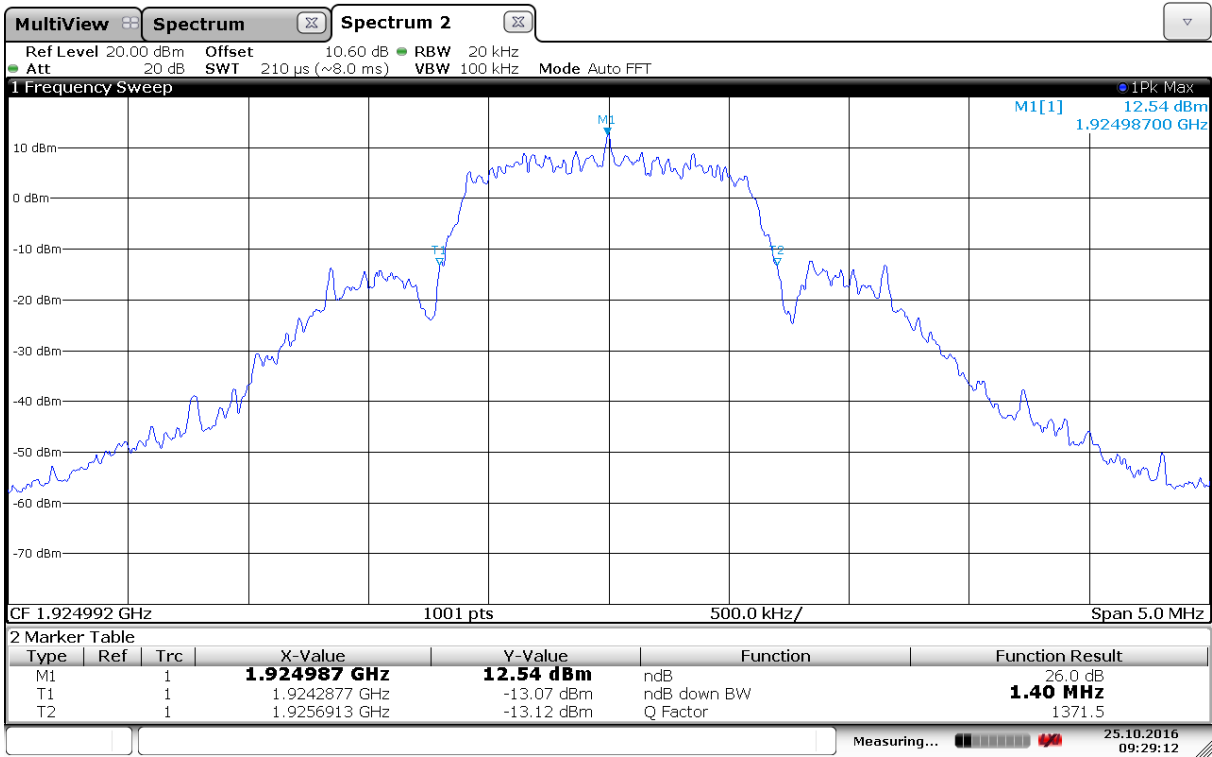

Emission Bandwidth B, Mid Channel

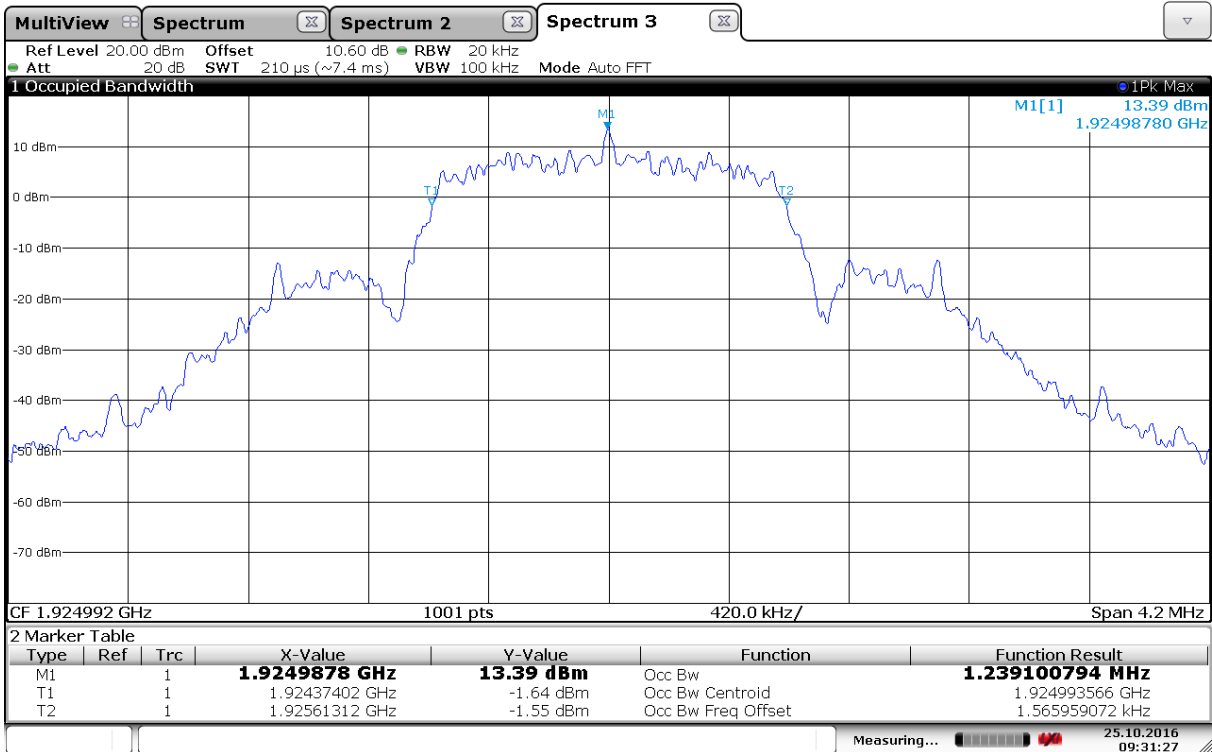

99% Bandwidth, Mid Channel

### 3.9 Power Spectral Density

**Test Method:**

ANSI C63.17, clause 6.1.5.

**Test Results: Complies**

**Measurement Data:**

| Channel No. | Frequency (MHz) | Power Spectral Density (dBm) |
|-------------|-----------------|------------------------------|
| 4           | 1921.536        | 2.7                          |
| 0           | 1928.448        | 2.6                          |

Averaged over 1000 sweeps.

**Requirements, FCC 15.319(d)**

The Power Spectral Density shall be less than 3 mW (4.77 dBm) when averaged over at least 100 sweeps.

## Power Spectral Density

### Lower Channel:

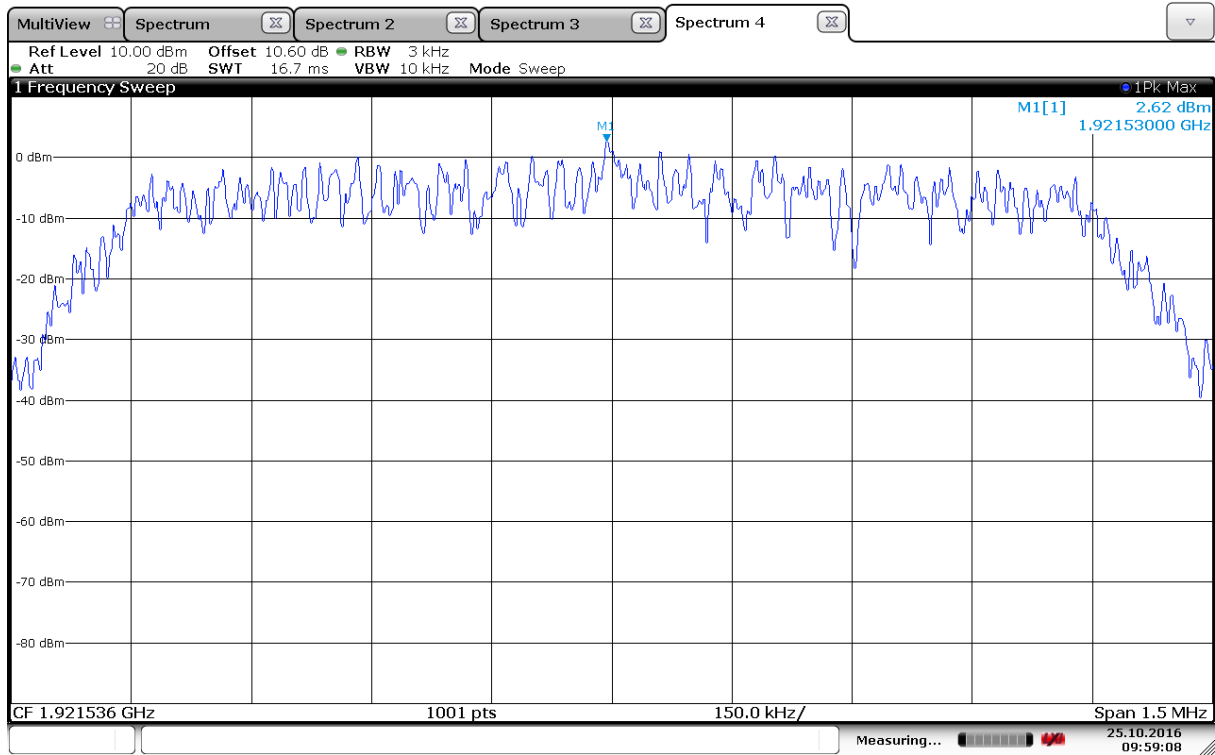

### Overview

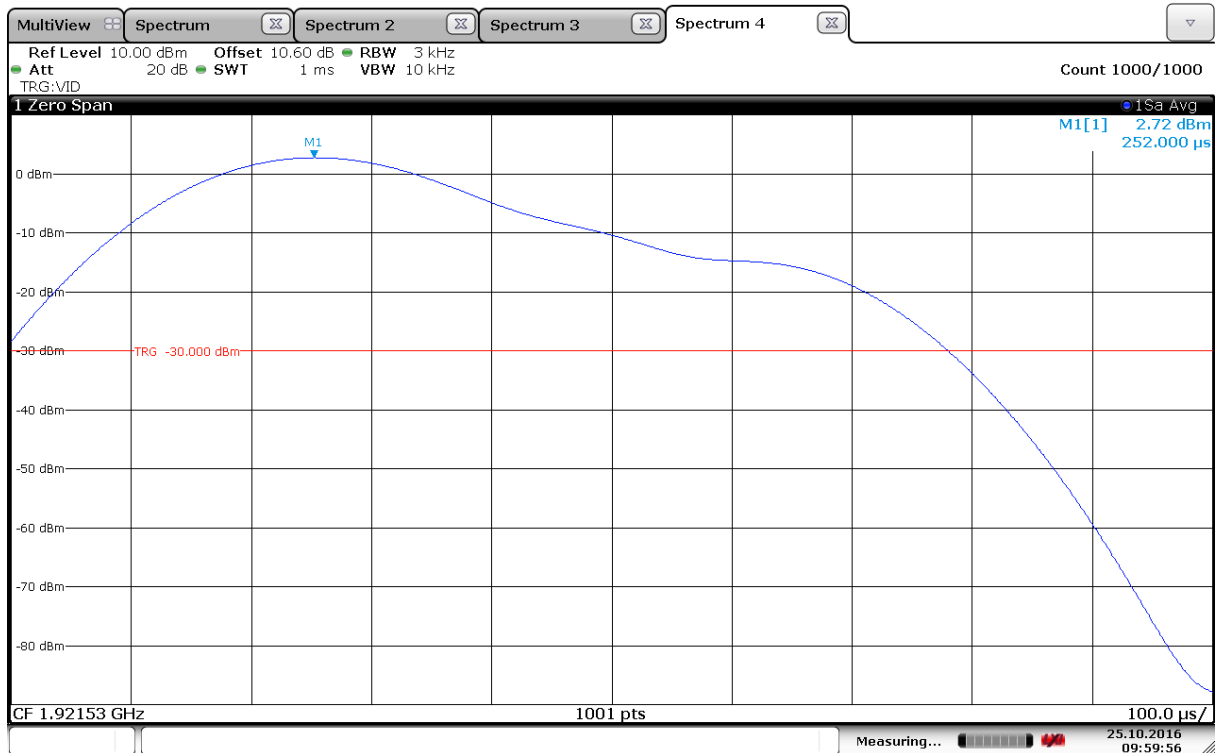

### Averaged, 1000 Sweeps

### Upper Channel:

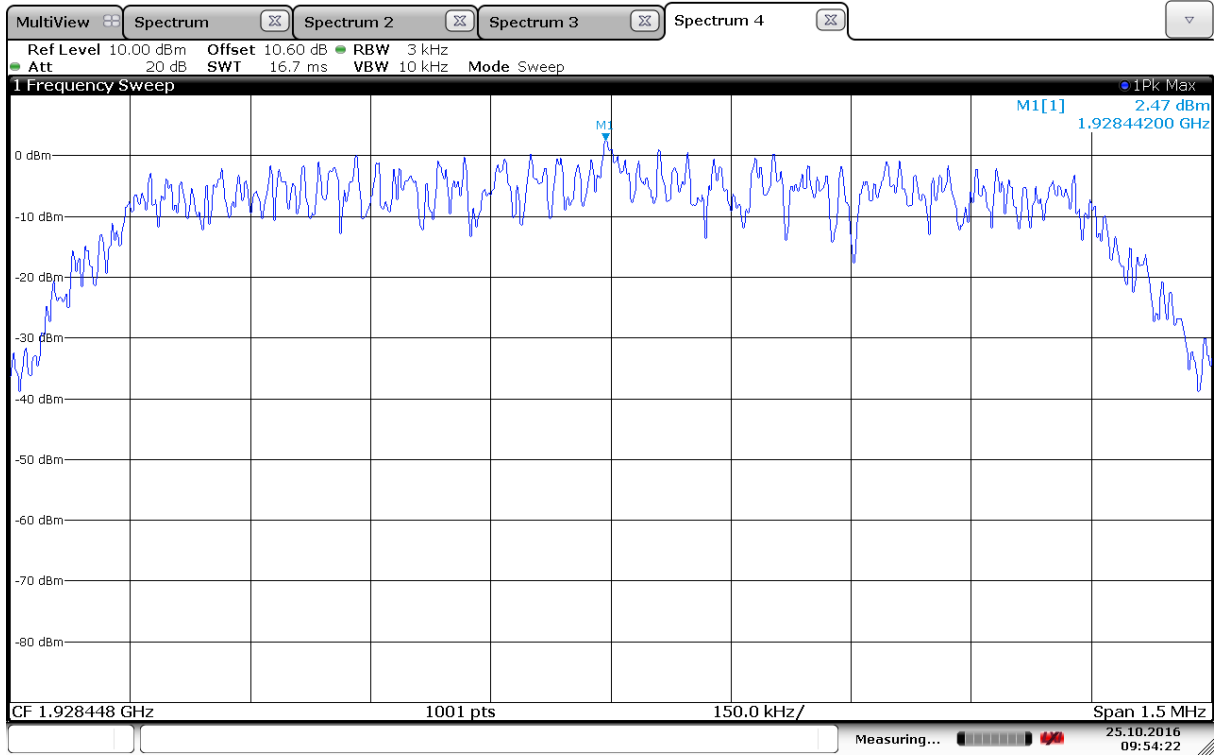

### Overview

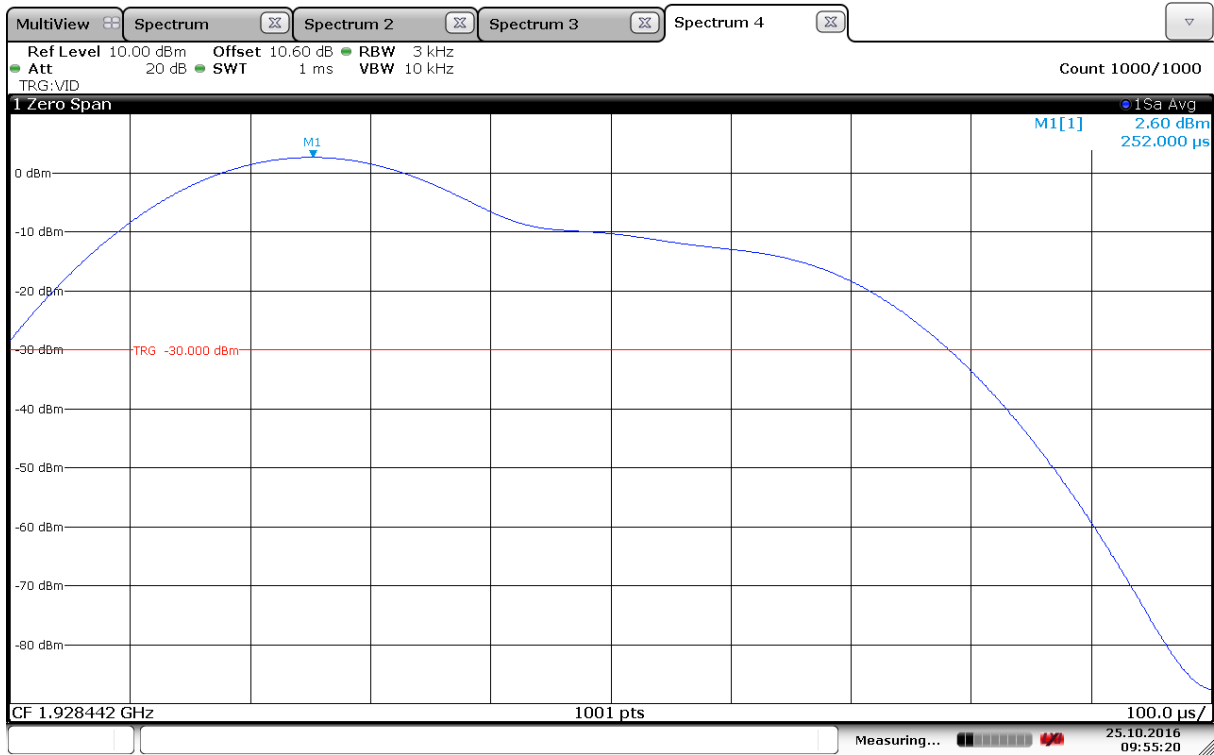

### Averaged, 1000 Sweeps

### 3.10 In-Band Unwanted Emissions, Conducted

**Test Method:**

ANSI C63.17, clause 6.1.6.1.

**Test Results: Complies**

**Measurement Data:**

See plots.

**Requirements, FCC 15.323(d):**

- $B < f \leq 2B$  : at least 30 dB below max. permitted peak power
- $2B < f \leq 3B$  : at least 50 dB below max. permitted peak power
- $3B < f \leq$  UPCS Band Edge : at least 60 dB below max. permitted peak power

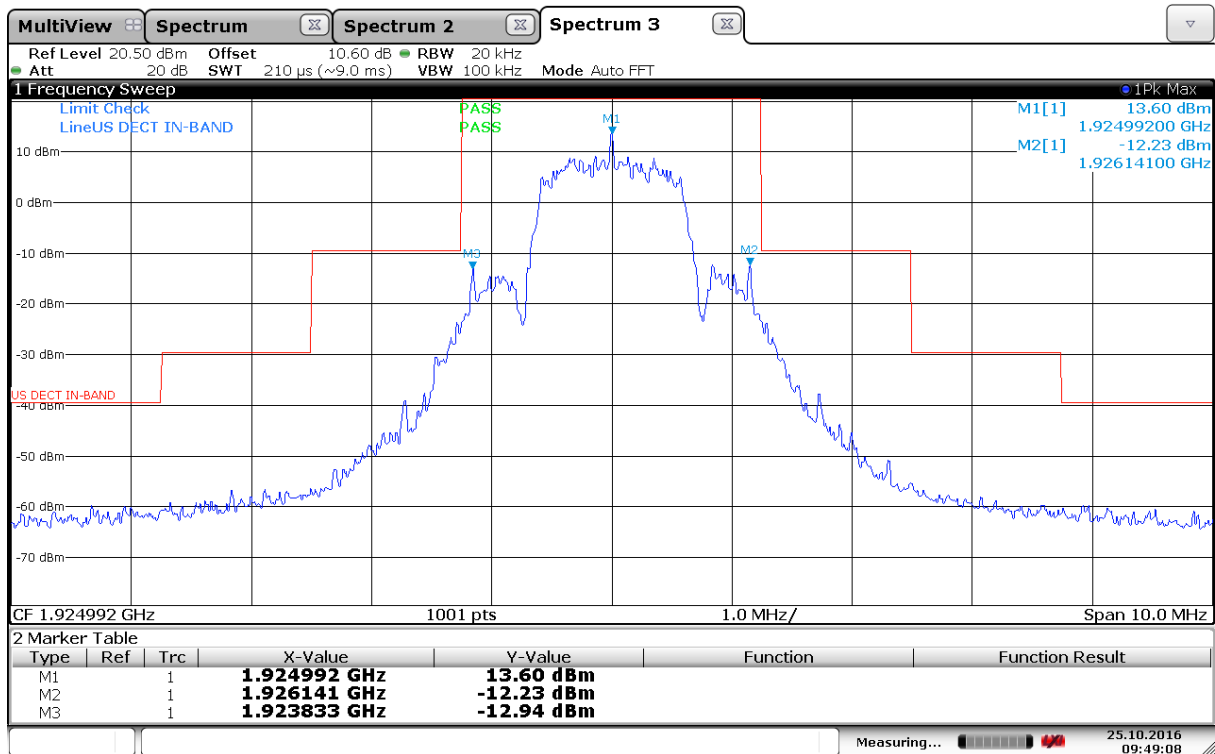

**Mid Channel**

### In-Band Unwanted Emissions, Conducted

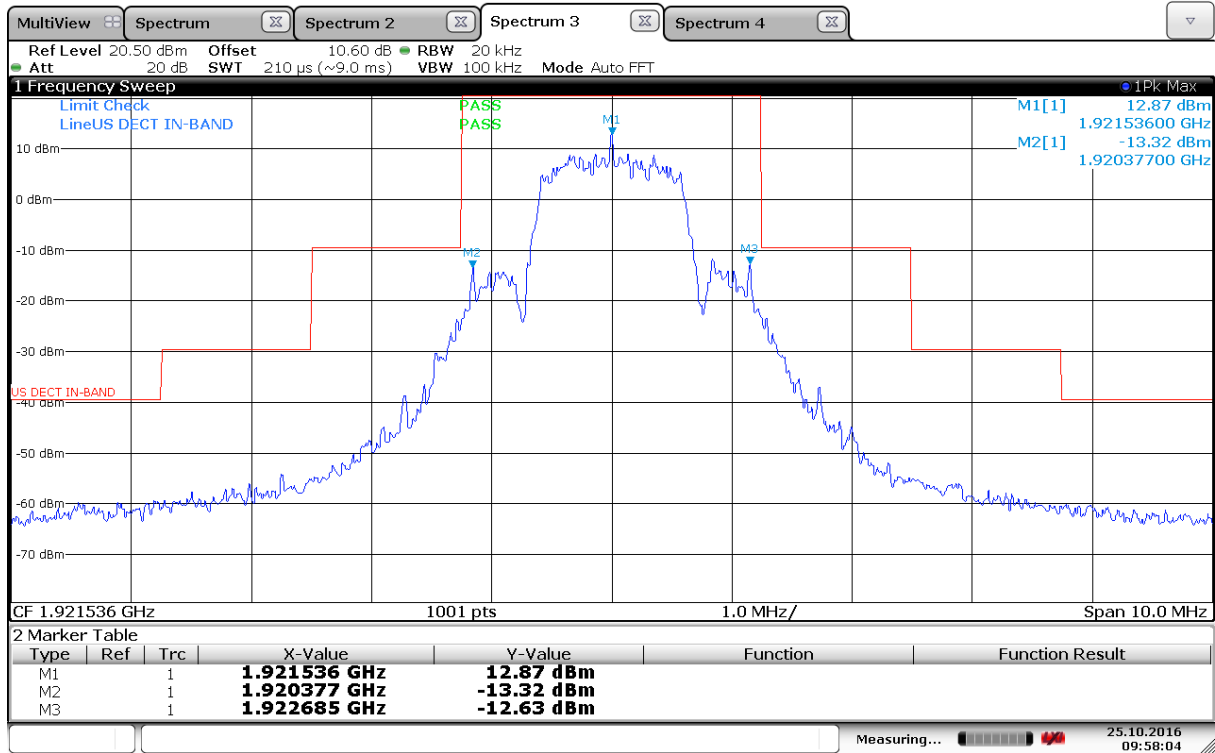

### Lower Channel

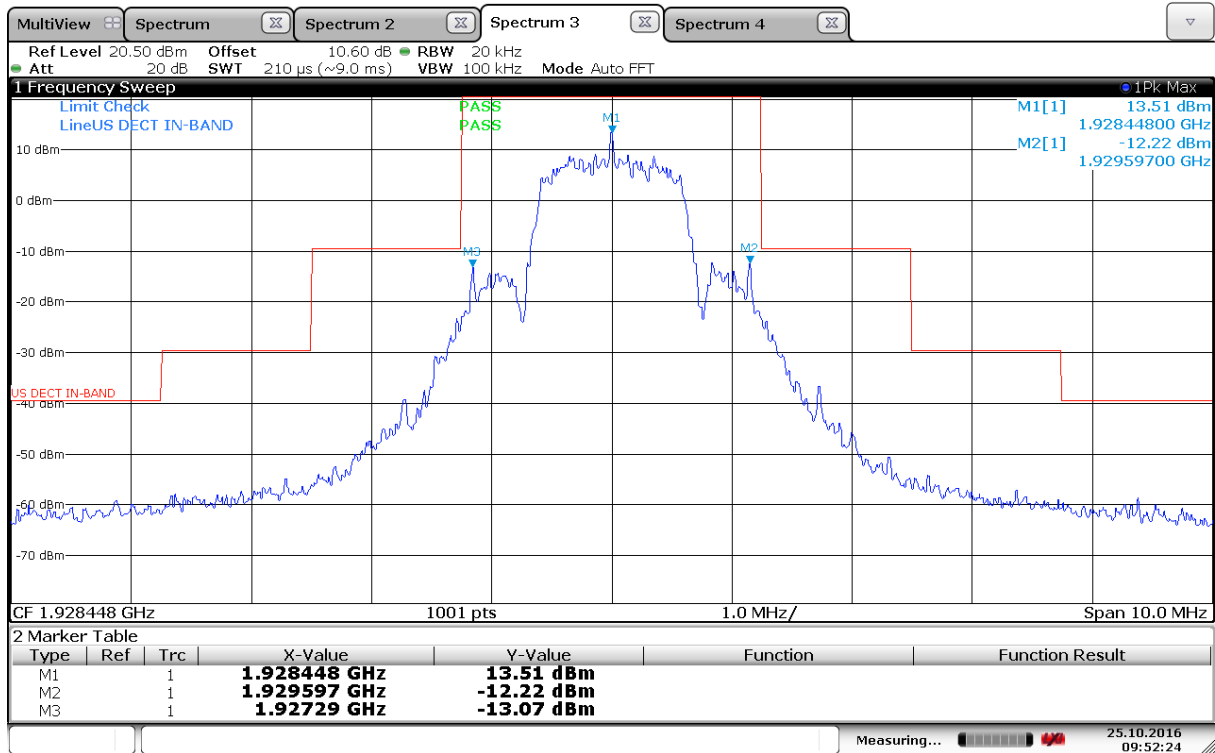

### Upper Channel

### 3.11 Out-of-band Emissions, Conducted

**Test Method:**

ANSI C63.17, clause 6.1.6.2.

**Test Results: Complies**

**Measurement Data:**

See plots.

**Requirements, FCC 15.323(d):**

- $f \leq 1.25\text{MHz}$  outside UPCS band :  $\leq -9.5\text{dBm}$
- $1.25\text{MHz} \leq f \leq 2.5\text{MHz}$  outside UPCS band :  $\leq -29.5\text{ dBm}$
- $f \geq 2.5\text{MHz}$  outside UPCS band :  $\leq -39.5\text{ dBm}$

### Out-of-Band Emissions, Conducted

**Lower Channel:**

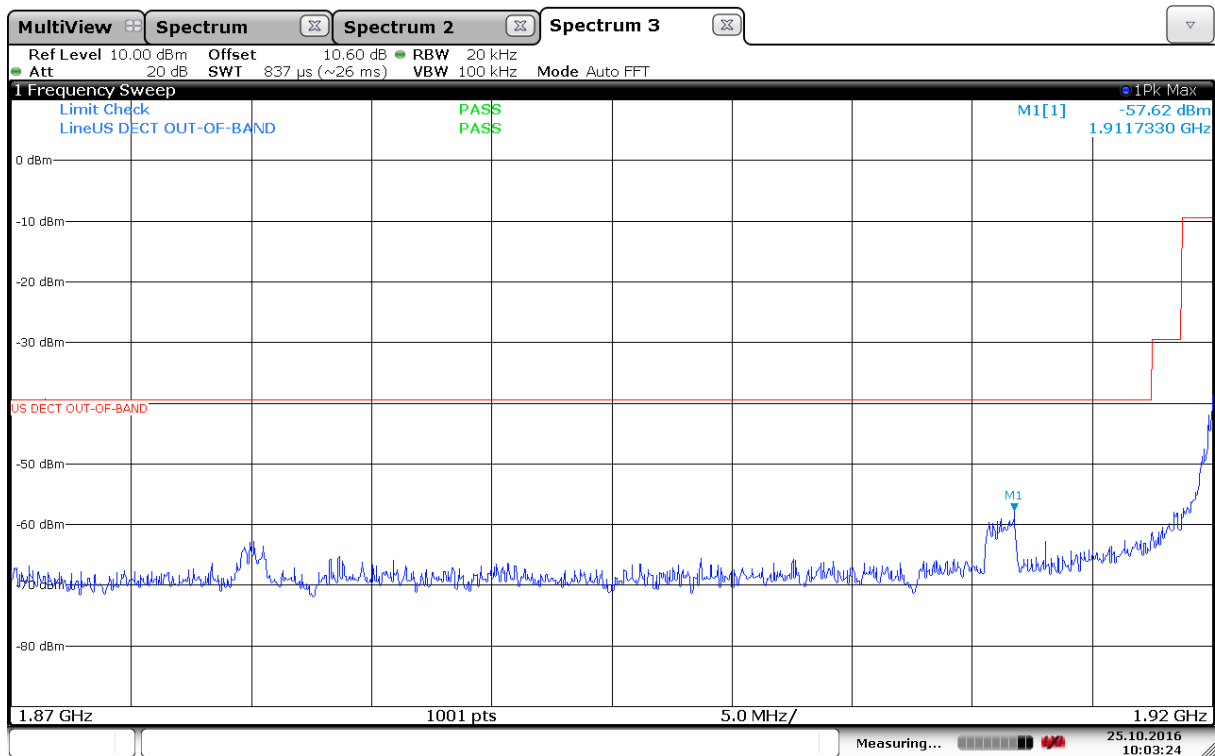

## Out-of-Band Emissions, Conducted

Lower Channel:

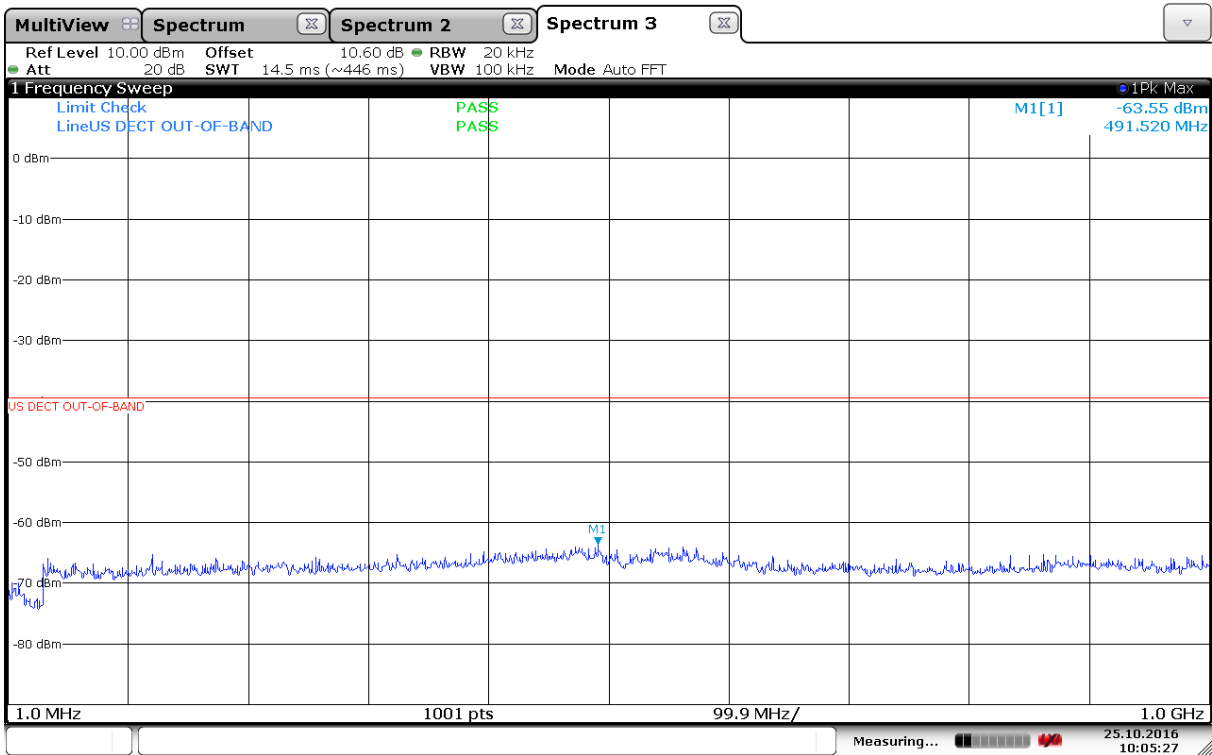
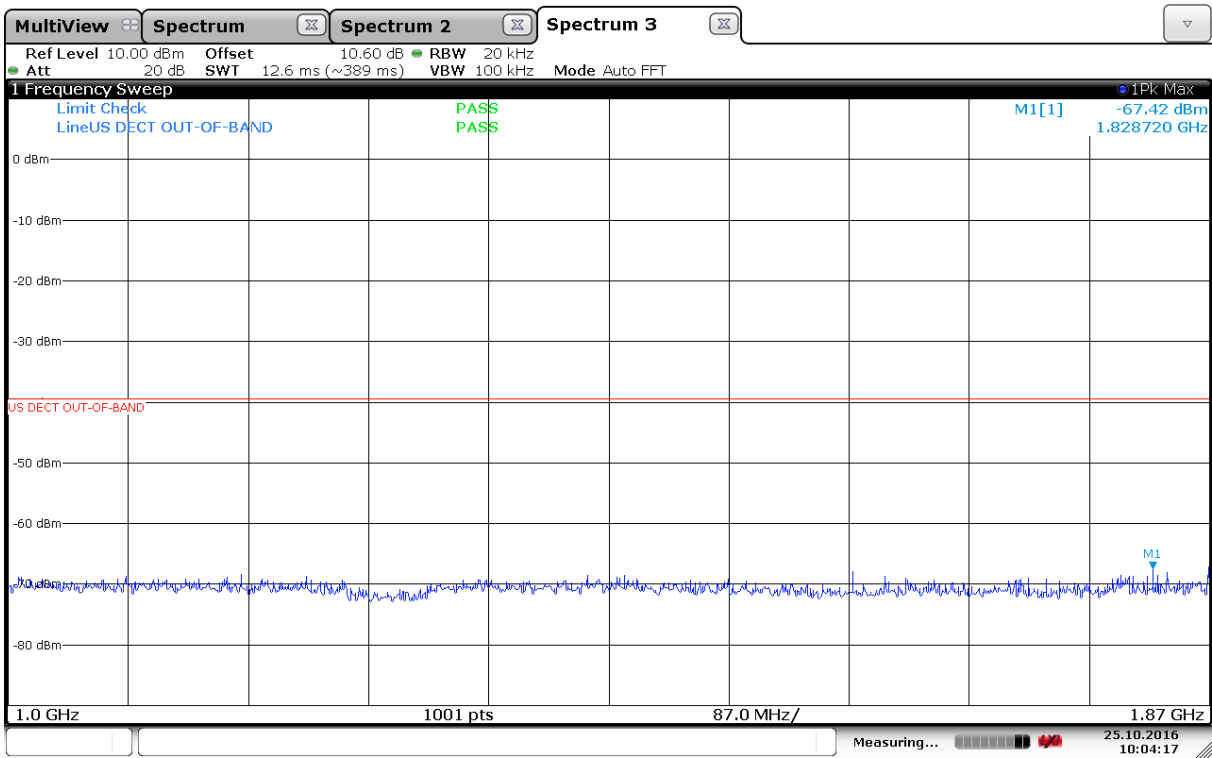

## Out-of-Band Emissions, Conducted

### Upper Channel:

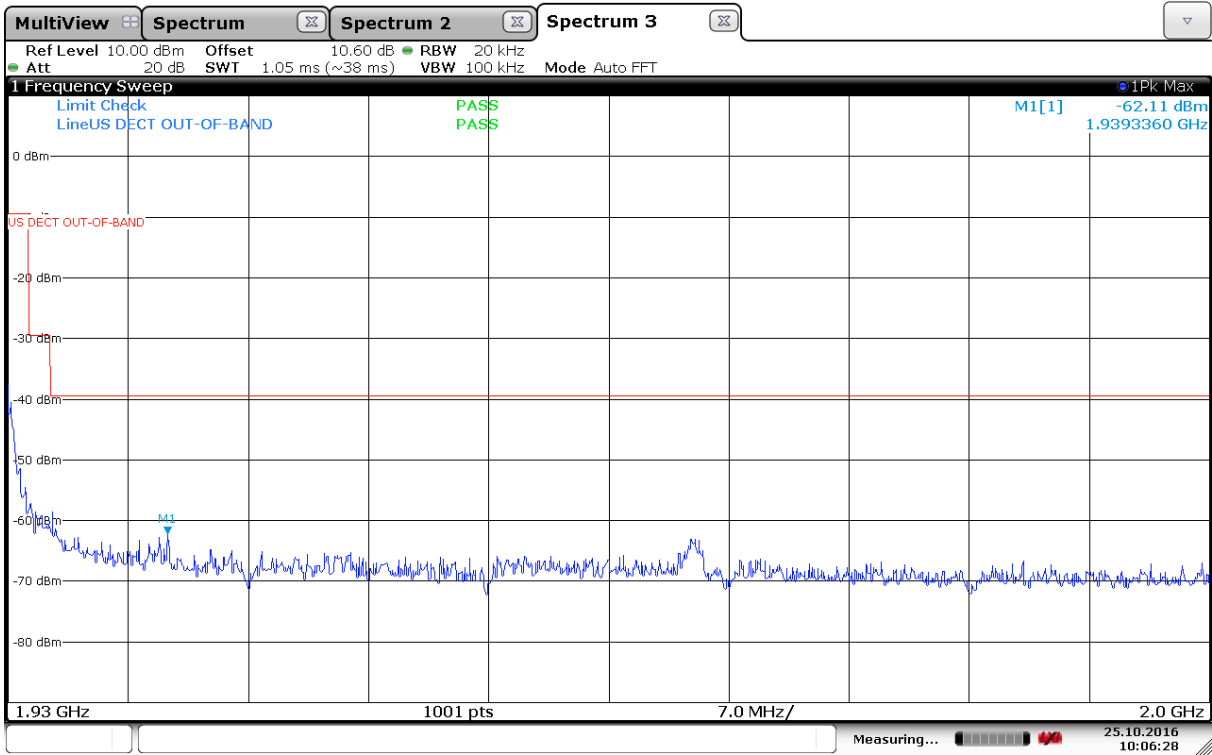

### Mid Channel:

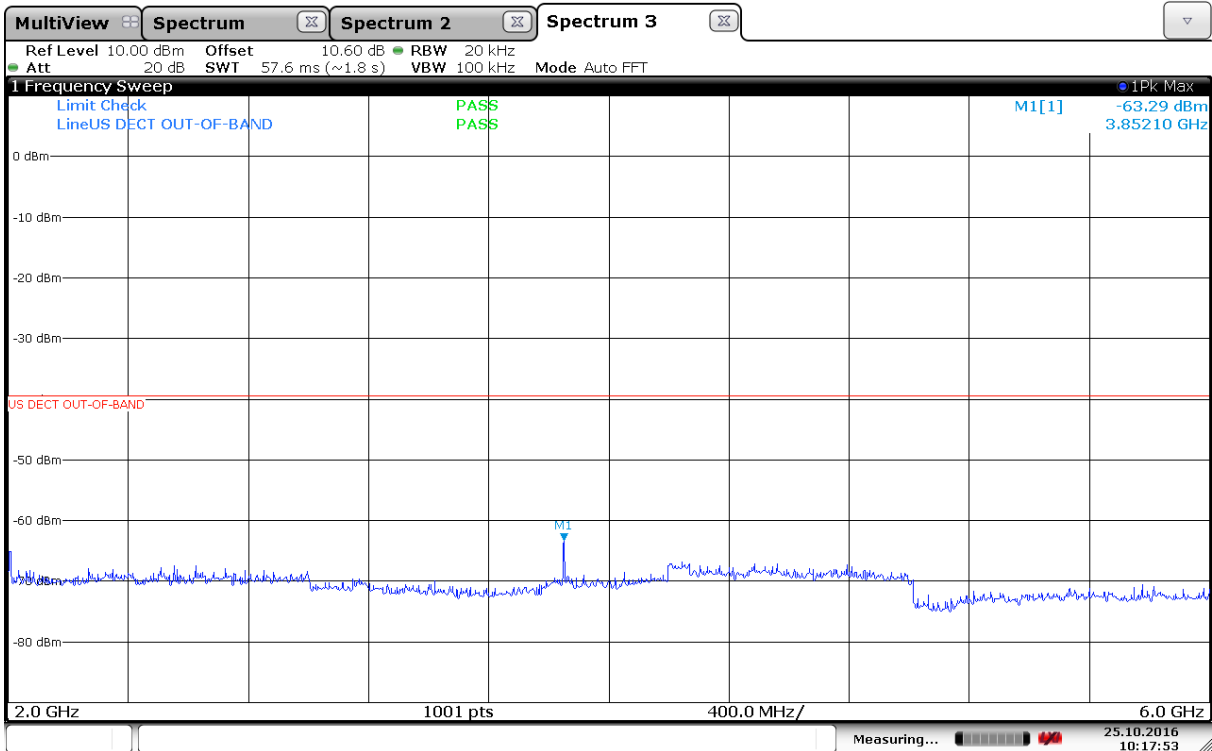

## Out-of-Band Emissions, Conducted

Mid Channel:

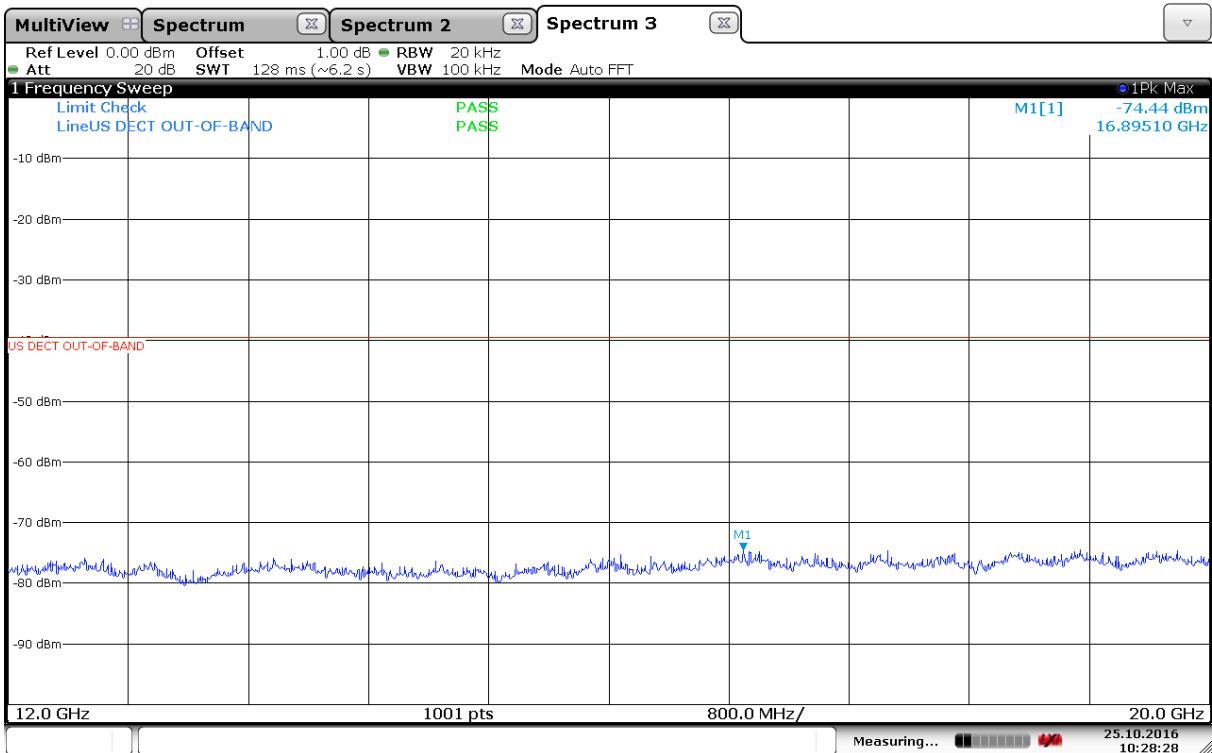
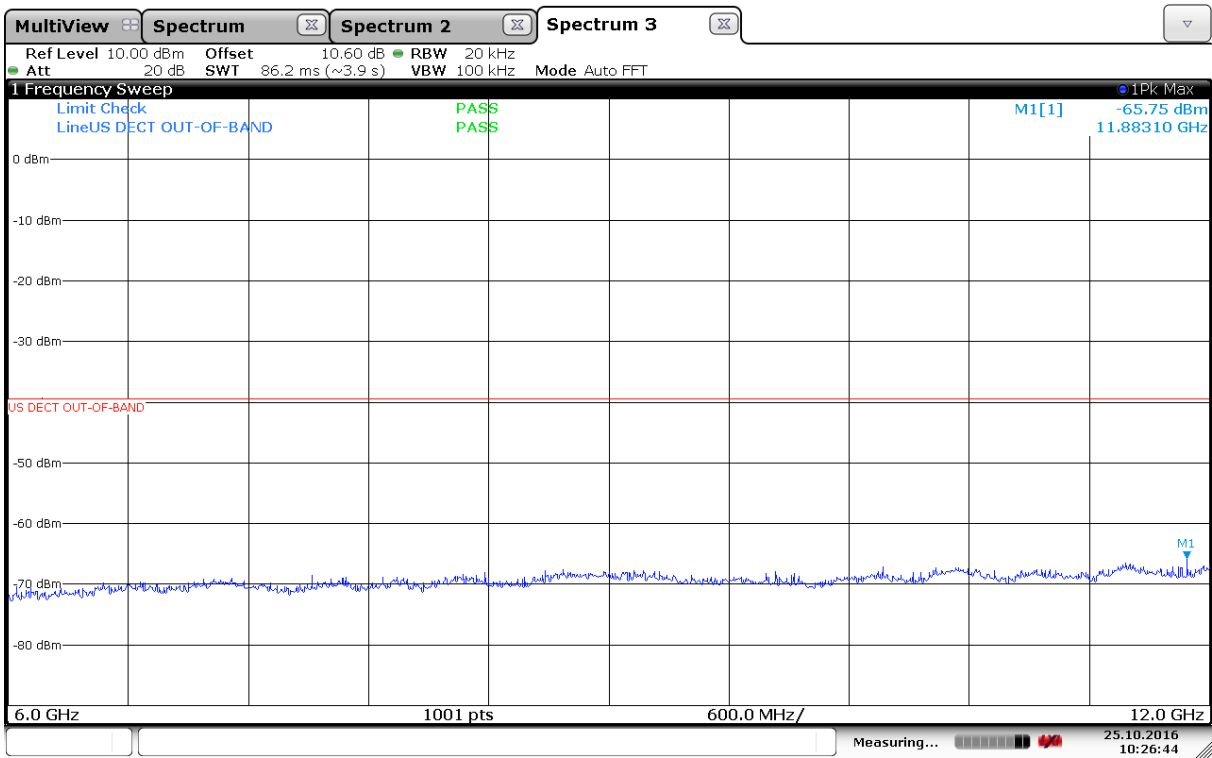

## Out-of-Band Emissions, Conducted

Mid Channel:

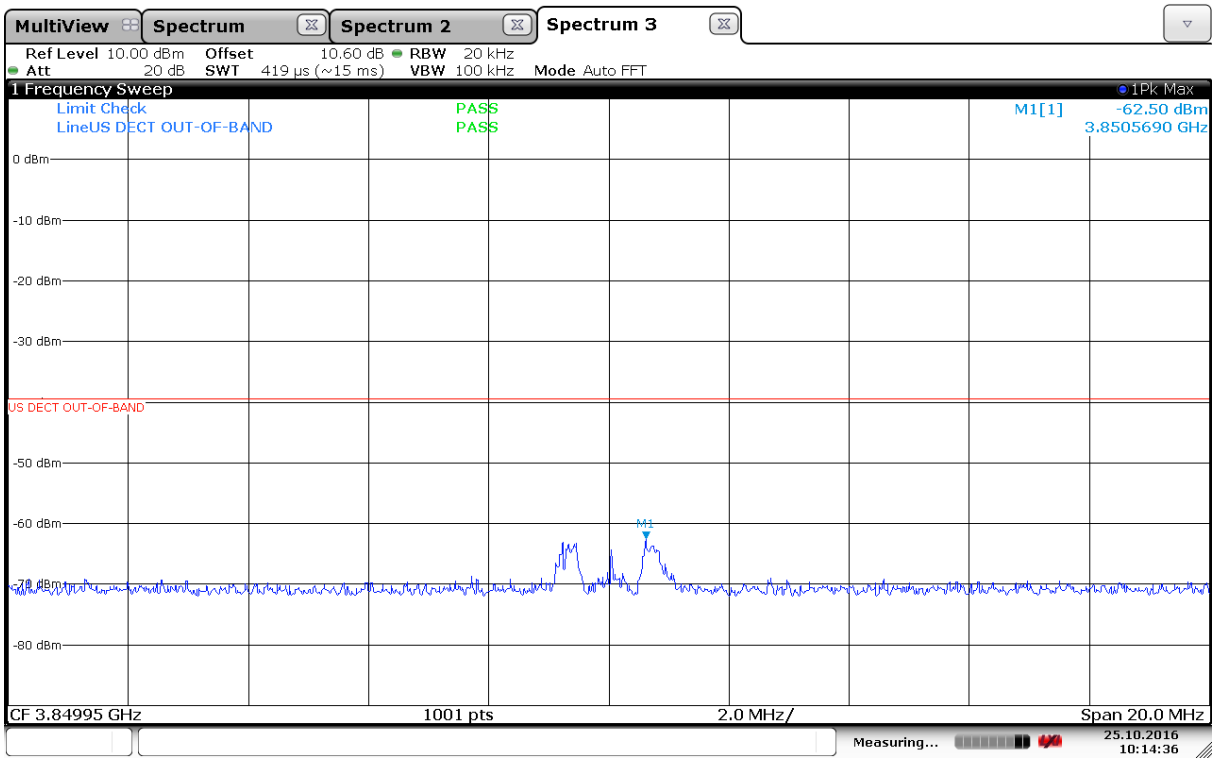

### 3.12 Carrier Frequency Stability

**Test Method:**

ANSI C63.17, clause 6.2.1.

**Test Results: Complies**

**Measurement Data:**

Long Term Frequency Stability is measured with the HP53310A Modulation Domain Analyzer. The HP53310A was logged by a computer programmed to get new readings as fast as possible (about 1 reading per second) over the noted time period or number of readings. The peak-to-peak difference was recorded and the mean value and deviation in ppm was calculated.

The Carrier Frequency Stability over Power Supply Voltage and over Temperature is measured with a Frequency Domain Analyzer in histogram mode.

**Carrier Frequency Stability over Time at Nominal Temperature**

| Average Mean Carrier Frequency (MHz) | Max. Diff. (kHz) | Min. Diff. (kHz) | Max. Dev. (ppm) | Limit   |
|--------------------------------------|------------------|------------------|-----------------|---------|
| 1924.991958                          | 2.023            | -0.863           | 1.1             | ±10 ppm |

Deviation ppm = ((Diff. - Mean Diff) / Mean Carrier Freq.) x 10<sup>6</sup>

Deviation (ppm) is calculated from 3000 readings.

**Frequency Stability over Power Supply Voltage at Nominal Temperature**

| Voltage                  | Measured Carrier Frequency (MHz) | Difference (kHz) | Deviation (ppm) | Limit   |
|--------------------------|----------------------------------|------------------|-----------------|---------|
| V <sub>nom</sub>         | 1924.9962                        | 0                | 0               | ±10 ppm |
| 85% of V <sub>nom</sub>  | 1924.9954                        | -0.8             | -0.4            |         |
| 115% of V <sub>nom</sub> | 1924.9953                        | -0.9             | -0.5            |         |

Deviation ppm = ((Mean – Measured Frequency) / Mean) x 10<sup>6</sup>

**Frequency Stability over Temperature**

| Temperature | Measured Carrier Frequency (MHz) | Difference (kHz) | Deviation (ppm) | Limit   |
|-------------|----------------------------------|------------------|-----------------|---------|
| T = +20 °C  | 1924.9962                        | 0                | 0               | ±10 ppm |
| T = -20 °C  | 1924.9862                        | -10.0            | -5.2            |         |
| T = +50 °C  | 1924.9889                        | -7.3             | -3.8            |         |

Deviation ppm = ((Mean – Measured Frequency) / Mean) x 10<sup>6</sup>

### 3.13 Frame Repetition Stability

**Test Method:**

ANSI C63.17, clause 6.2.2.

**Test Results: Complies**

**Measurement Data:**

The envelope of the RF signal from the EUT is detected with a Crystal Detector and the mean and standard deviation of the frame repetition frequency is then gated over 100 frames and measured with a Frequency Domain Analyzer. The frame repetition stability is 3 times the standard deviation.

| Carrier Frequency (MHz) | Mean (Hz) | Standard Deviation (µHz) | Frame Repetition Stability (ppm) |
|-------------------------|-----------|--------------------------|----------------------------------|
| 1924.992                | 100.000   | 0.781                    | 0.023                            |

**Limit:**

|                                   |                |
|-----------------------------------|----------------|
| <b>Frame Repetition Stability</b> | ±10 ppm (TDMA) |
|-----------------------------------|----------------|

Ref. FCC 15.323(e), ANSI C63.17, clause 6.2.2

### 3.14 Frame Period and Jitter

**Test Method:**

ANSI C63.17, clause 6.2.3.

**Test Results: Complies**

**Measurement Data:**

The envelope of the RF signal from the EUT is detected with a Crystal Detector and the frame period and jitter is measured with a Frequency Domain Analyzer over at least 100.000 frames.

| Carrier Frequency (MHz) | Frame Period (ms) | Max Jitter (µs) | 3xStandard Deviation of Jitter (µs) |
|-------------------------|-------------------|-----------------|-------------------------------------|
| 1924.992                | 10.000            | -0.022          | -0.018                              |

Max Jitter =  $(1 / (\text{Frame period} + \text{Pk-Pk}/2)) - (1/\text{Frame Period})$ , when Pk-Pk and Frame Period are in Hz

$3x\text{St.Dev.Jitter} = 3x (1/(\text{Frame Period} + \text{St.Dev}) - 1/\text{St.Dev}) \times 10^6$

**Limit:**

|                                 |             |
|---------------------------------|-------------|
| <b>Frame Period</b>             | 20 or 10 ms |
| <b>Max Jitter</b>               | 25 µs       |
| <b>3 times St.Dev of Jitter</b> | 12.5 µs     |

Ref. FCC 15.323(e), ANSI C63.17, clause 6.2.3

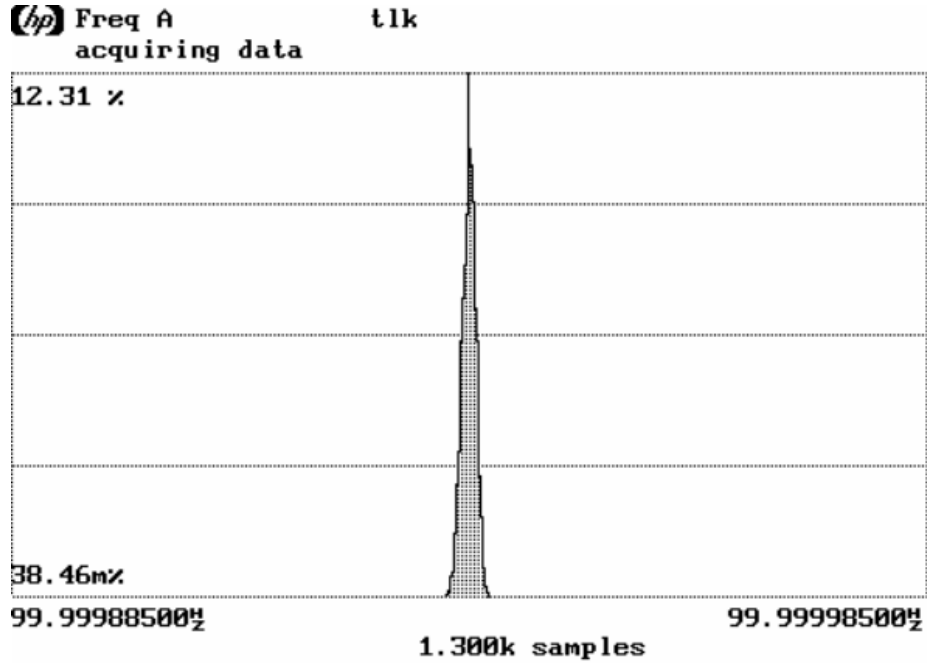

Mean 99.9999349556 MHz 1/Mean 10.000ms  
 Pk-Pk 4.90 μHz Std Dev 781.2nHz

Frame Repetition Stability, Gated over 100 Frames

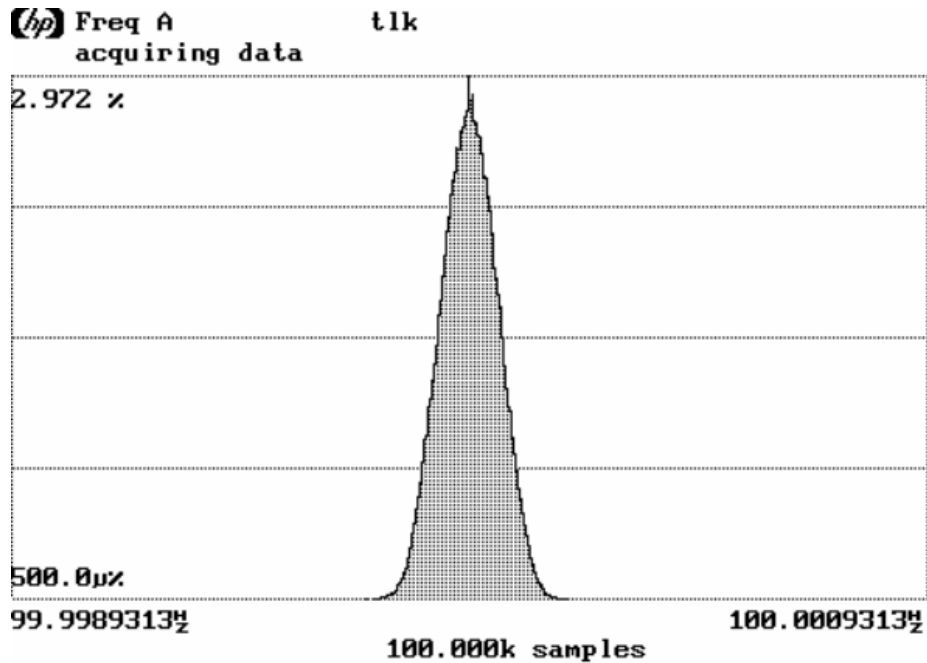

Mean 99.9999310243 MHz 1/Mean 10.000ms  
 Pk-Pk 441.0 μHz Std Dev 60.6900 μHz

Frame Period and Jitter

### 3.15 Monitoring Threshold, Least Interfered Channel

#### Monitoring Threshold Limits:

Lower Threshold:

$$T_L = 15 \log B - 184 + 30 - P_{EUT} \quad (\text{dBm})$$

Upper Threshold:

$$T_U = T_L + 20 \quad (\text{dBm})$$

$B$  is measured Emission Bandwidth in Hz  
 $P_{EUT}$  is measured Transmitter Power in dBm

#### Calculated values:

| FCC 15.323, RSS-213, Issue 3 |           |
|------------------------------|-----------|
| Lower Threshold              | -80.4 dBm |

Least Interfered Channel Procedure (LIC) may only be used by systems with more than 20 duplex system access channels. Systems with less than 20 duplex system access channels are not allowed to transmit when interferer level is above Lower Threshold.

#### Measurement Procedure:

| Least Interfered Channel Procedure NOT used: |                                     |
|--|-------------------------------------|
| Lower Threshold                              | N/A      The EUT uses LIC procedure |

#### Least Interfered Channel (LIC) Procedure Test, FCC 15.323(b), (c)(2) and (c)(5)

| ANSI C63.17 clause 7.3.2 ref.                               | Observation                  | Verdict     |
|---|------------------------------|-------------|
| b) $f_1$ at $T_L + U_M + 7$ dB, $f_2$ at $T_L + U_M$        | Transmission always on $f_2$ | <b>Pass</b> |
| c) $f_1$ at $T_L + U_M$ , $f_2$ at $T_L + U_M + 7$ dB       | Transmission always on $f_1$ | <b>Pass</b> |
| d) $f_1$ at $T_L + U_M + 1$ dB, $f_2$ at $T_L + U_M - 6$ dB | Transmission always on $f_2$ | <b>Pass</b> |
| e) $f_1$ at $T_L + U_M - 6$ dB, $f_2$ at $T_L + U_M + 1$ dB | Transmission always on $f_1$ | <b>Pass</b> |

**Selected Channel Confirmation, FCC 15.323(c)(1) and (5)**

| ANSI C63.17 clause 7.3.3              | Observation            | Verdict     |
|---------------------------------------|------------------------|-------------|
| b) Shall <b>not</b> transmit on $f_i$ | EUT transmits on $f_2$ | <b>Pass</b> |
| d) Shall <b>not</b> transmit on $f_2$ | EUT transmits on $f_i$ | <b>Pass</b> |

**Limits:**

|                               | FCC 15.323, RSS-213, Issue 3 |
|-------------------------------|------------------------------|
| Lower Threshold + 6 dB margin | -74.4 dBm                    |

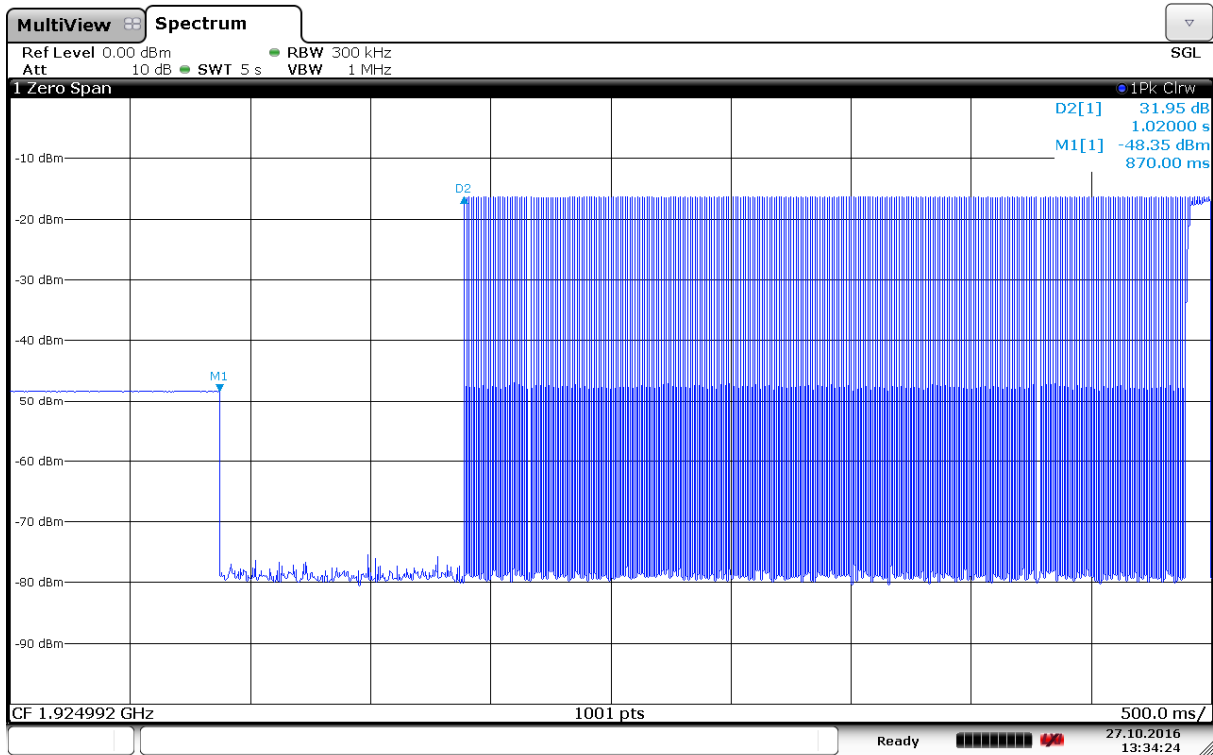

13:34:25 27.10.2016

**7.3.4 Selected Channel Confirmation, Connection 1.0s After Interferer Removed**

### 3.16 Threshold Monitoring Bandwidth

This test is only required if a dedicated monitoring receiver is used. However, if the test is not carried out the manufacturer shall declare and provide proper evidence that the monitoring is made through the radio receiver used for communication.

#### Measurement Procedure:

Simple Compliance Test, ANSI C63.17, clause 7.4.1

More Detailed Test, ANSI C63.17, clause 7.4.2

The test is passed if **either** the Simple Compliance Test or the More Detailed test is passed.

During this test the spectrum analyzer is observed visually to see if the EUT transmits or not.

#### Test Results:

| Test performed                               | Observation | Verdict    |
|--|-------------|------------|
| Simple Compliance test, at $\pm 30\%$ of $B$ | N/A         | N/A        |
| More Detailed Test, at -6 dB points          | N/A         | <b>N/A</b> |
| More Detailed Test, at -12 dB points         | N/A         | <b>N/A</b> |

The more detailed test must be pass at both the -6 and -12 dB points if the Simple Compliance test fails.

**Comment:** The manufacturer declares that the tested EUT uses the same receiver for monitoring and communication, this test is therefore not required.

#### Limits, FCC 15.323(c)(7):

The monitoring system bandwidth must be equal to or greater than the emission bandwidth of the intended transmission.

### 3.17 Reaction Time and Monitoring Interval

#### Measurement Procedure

ANSI C63.17, clause 7.5

#### Test results:

By administrative commands and out-of-operating region interference, the EUT is restricted to operate on two RF carrier frequencies.

A CW interferer signal at a level  $T_L$  is applied on  $f_1$  and time-synchronized pulsed interference at a level  $T_L + U_M$  dB is applied on  $f_2$ . The level on  $f_2$  was raised 6 dB for part d) with 35  $\mu$ s pulses.

The pulses are synchronized with the EUT timeslots and applied centered within all timeslots.

For both tests the test is passed if the EUT transmits on  $f_1$ .

| Pulse Width, ref. to ANSI C63.17 clause 7.5  | Observation            | Verdict |
|--|------------------------|---------|
| c) > largest of 50 $\mu$ s and $50 \cdot \text{SQRT}(1.25/B)$  | EUT transmits on $f_1$ | Pass    |
| d) > largest of 35 $\mu$ s and $35 \cdot \text{SQRT}(1.25/B)$ ,<br>and with interference level raised 6 dB | EUT transmits on $f_1$ | Pass    |

**Comment:** Since  $B$  is larger than 1.25 MHz the test was performed with pulse lengths of 50  $\mu$ s and 35  $\mu$ s.

#### Limits, FCC 15.323(c)(1), (5) and (7)

The maximum reaction time must be less than  $50 \cdot \text{SQRT}(1.25/\text{emission bandwidth in MHz})$  microseconds for signals at the applicable threshold level but shall not be required to be less than 50  $\mu$ s.

If a signal is detected that is 6 dB or more above the applicable threshold level, the maximum reaction time shall be  $35 \cdot \text{SQRT}(1.25/\text{emission bandwidth in MHz})$  microseconds but shall not be required to be less than 35  $\mu$ s.

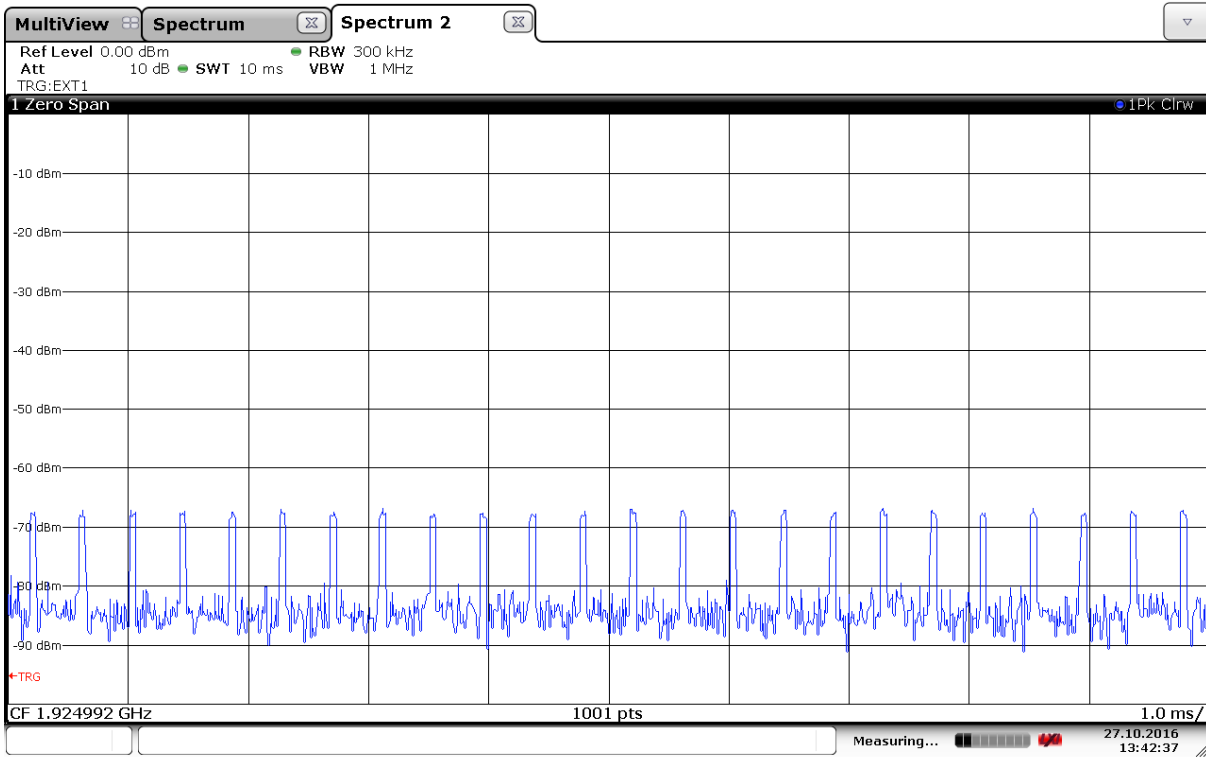

13:42:38 27.10.2016

### 50 µs Pulses

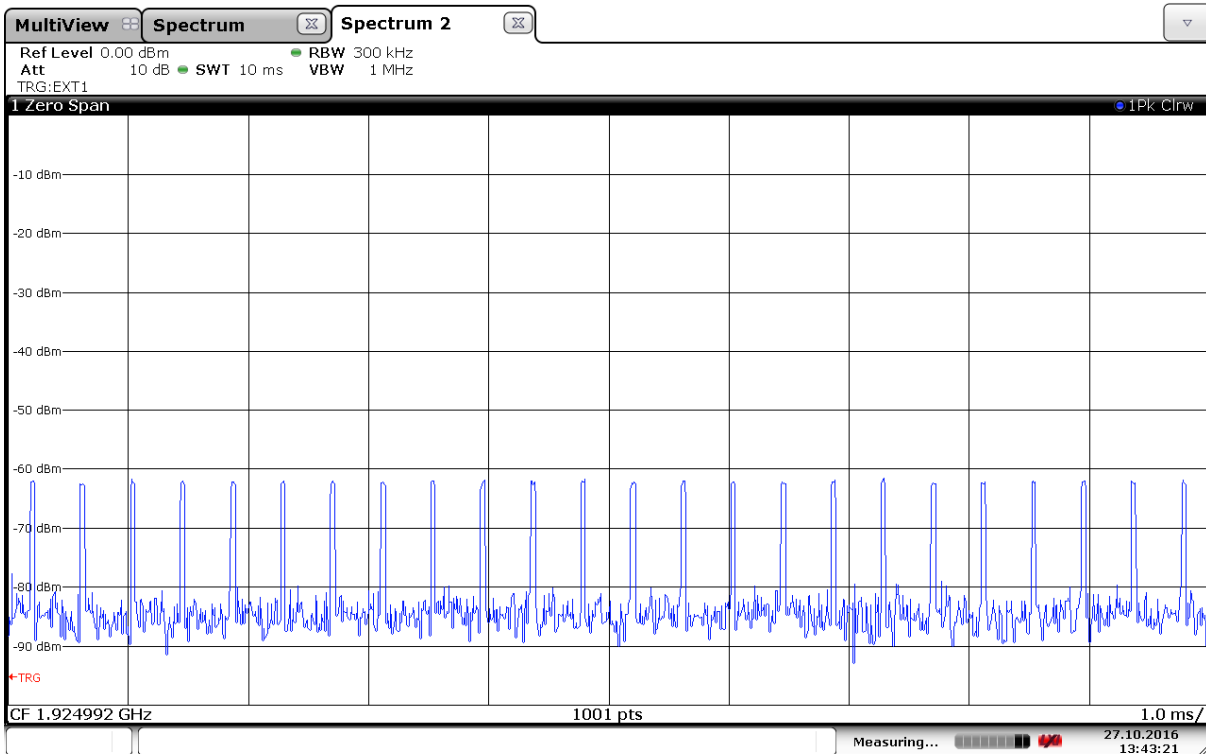

13:43:22 27.10.2016

### 35 µs Pulses

### 3.18 Time and Spectrum Window Access Procedure

This requirement is only for EUTs which transmit unacknowledged control and signaling information.

**Measurement Procedure:**

Timing for EUTs using control and signaling channel type transmissions: ANSI C63.17, clause 8.1

**Test results:**

| Access Criteria, ref. to ANSI C63.17 clause 8.1.1   | Observation                                      | Verdict |
|---|--|---------|
| b) Check that the EUT transmits on the interference free time-slot  | EUT transmits on the interference free time-slot | Pass    |
| b) The EUT must terminate or pause in its repetitive transmission of the control and signalling channel on the open channel to repeat the access criteria not less frequently than every 30 s | Transmission paused every 1.28 s                 | Pass    |

If FCC 15.323(c)(6) option, **If Random Waiting Interval is NOT implemented**

| Access Criteria, ref. to ANSI C63.17 clause 8.1.2  | Observation   | Verdict |
|--|---|---------|
| b) Check that the EUT changes to an interference-free slot when interference is introduced on the time slot in use | EUT changes to the interference-free time-slot, and stays there | Pass    |

If FCC 15.323(c)(6) option, **Only if Random Waiting Interval is implemented**

| Access Criteria, ref. to ANSI C63.17 clause 8.1.3  | Observation | Verdict |
|--|-------------|---------|
| b-d) Check that the EUT uses random waiting interval before continuing transmission on an interfered time slot | N/A         | N/A     |

Comment: The tested EUT does not support the Random Waiting Interval option.

**Limits:**

**FCC 15.323(c)(4):**

Once access to specific combined time and spectrum windows is obtained an acknowledgement from a system participant must be received by the initiating transmitter within one second or transmission must cease. Periodic acknowledgements must be received at least every 30 seconds or transmission must cease. Channels used exclusively for control and signaling information may transmit continuously for 30 seconds without receiving an acknowledgement, at which time the access criteria must be repeated.

**FCC 15.323(c)(6):**

If the selected combined time and spectrum windows are unavailable, the device may either monitor and select different windows or seek to use the same windows after waiting an amount of time, randomly chosen from a uniform random distribution between 10 and 150 milliseconds, commencing when the channel becomes available

### Access Criteria Check

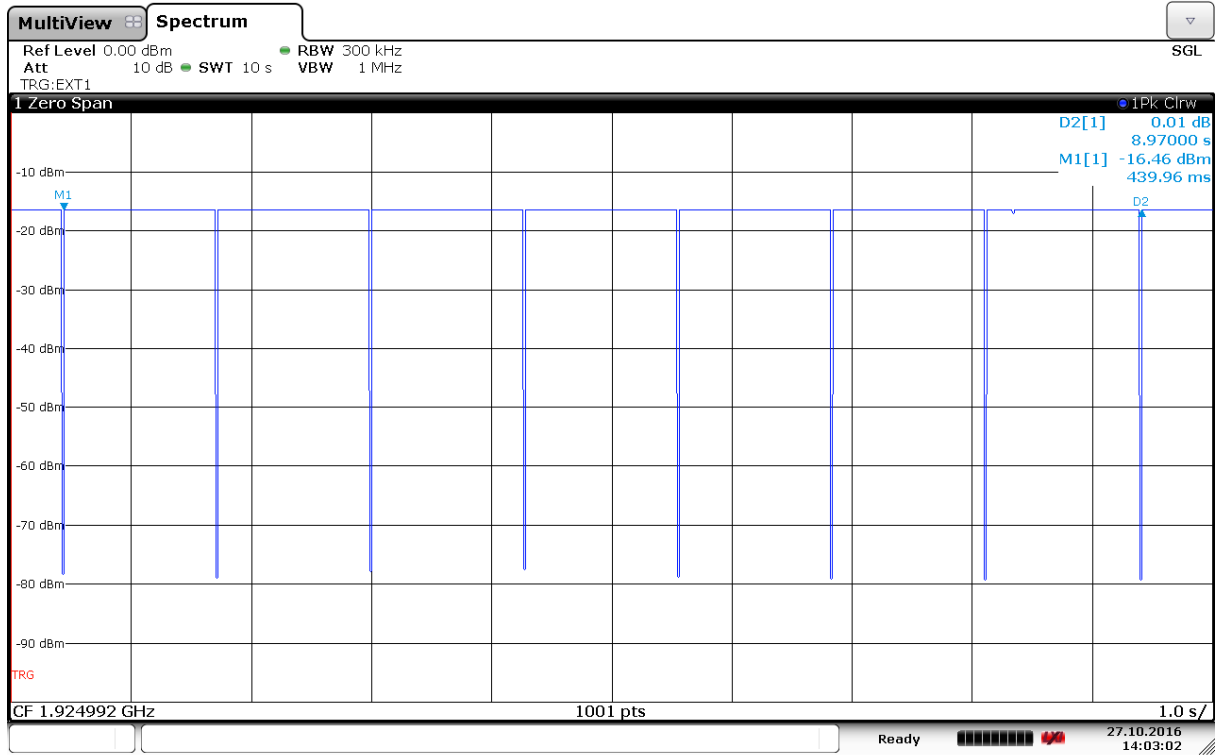

14:03:02 27.10.2016

#### 8.1.1b) Access Criteria check Interval

### Access Criteria Check

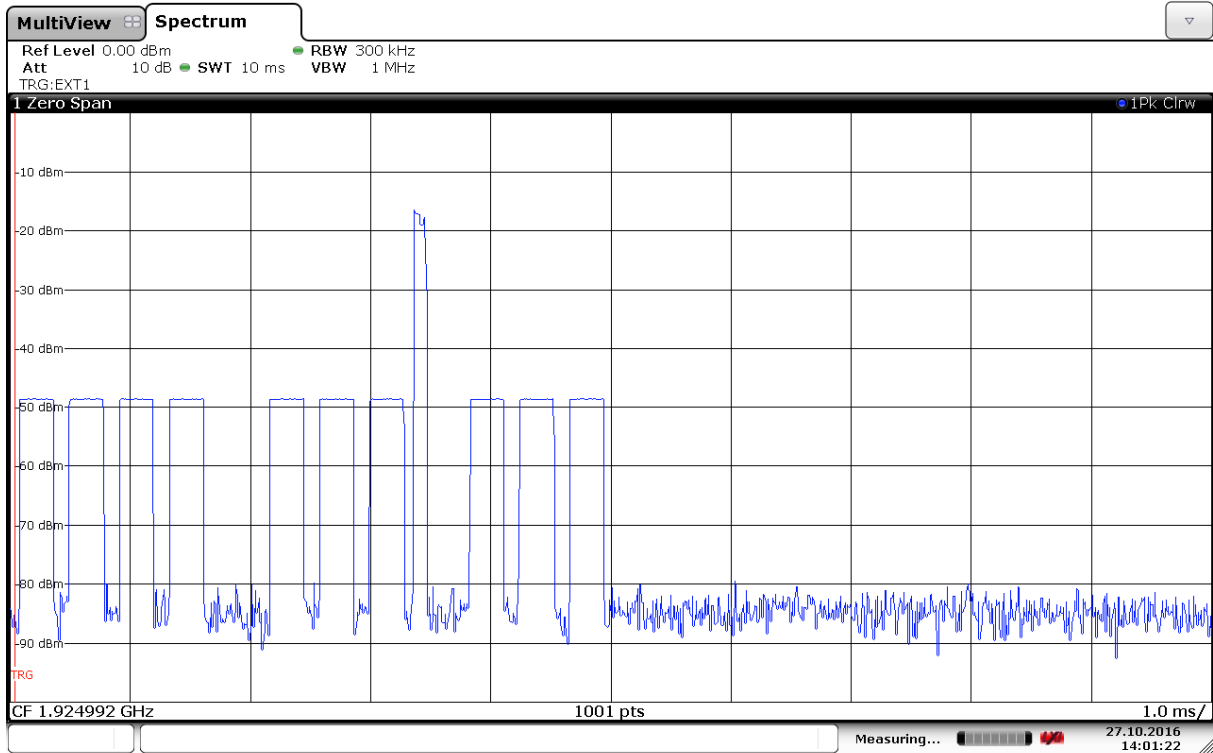

14:01:22 27.10.2016

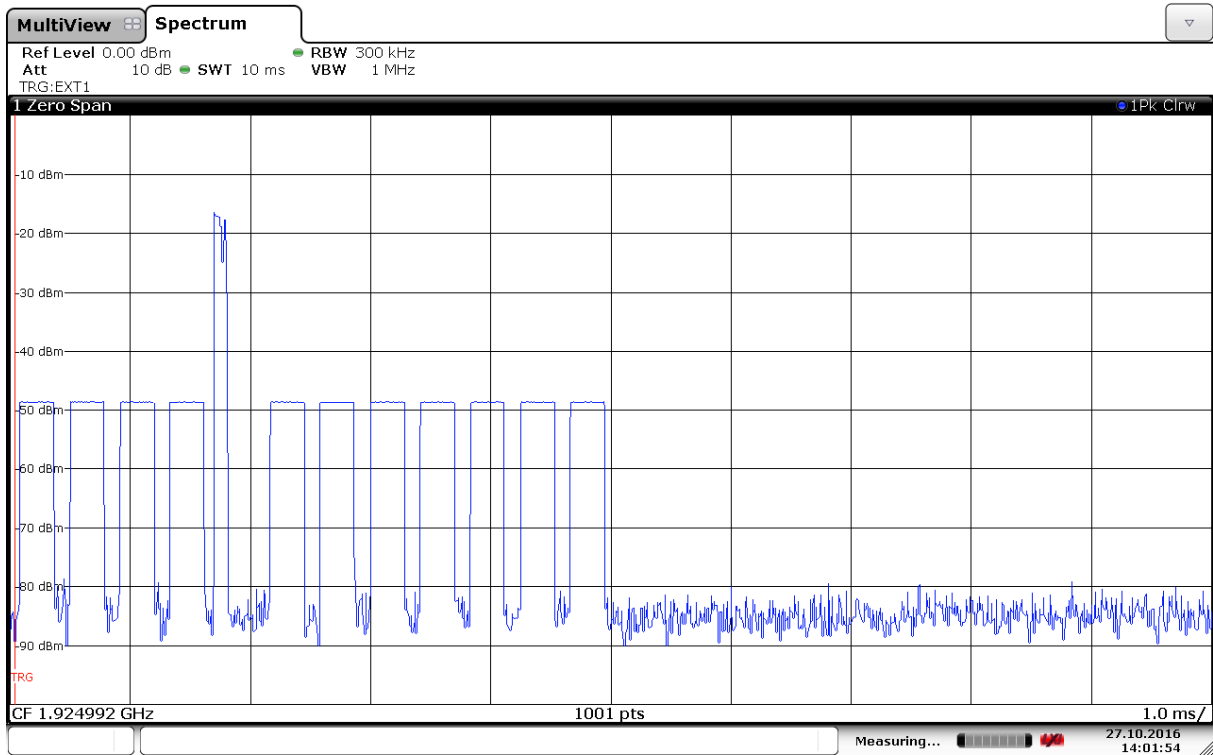

14:01:55 27.10.2016

### 8.1.2 Functional Test, Before and After

### 3.19 Acknowledgements and Transmission Duration

**Measurement Procedure:**

Acknowledgements: ANSI C63.17, clause 8.2.1

Transmission Duration: ANSI C63.17, clause 8.2.2

During the test **Initial transmission without acknowledgements** the signal from the EUT to the companion device is blocked by circulators in addition to the tunable attenuator.

The test **Transmission time after loss of acknowledgements** is performed by cutting-off the signal from the companion device by a RF switch and measuring the time until the EUT stops transmitting.

The **Transmission Duration** test is performed by monitoring the slot in use and measuring the time until the EUT changes to a different slot.

**Test Results:**

**Acknowledgements**

| Test ref. to ANSI C63.17 clause 8.2.1               | Observation   | Verdict |
|---|---|---------|
| a) Initial transmission without acknowledgements    | Not applicable for EUT that transmits control and signaling information | N/A     |
| c) Transmission time after loss of acknowledgements | 10 sec  | Pass    |

**Transmission Duration**

| Test ref. to ANSI C63.17 clause 8.2.2                      | Observation  | Verdict |
|--|--|---------|
| b) Transmission duration on same time and frequency window | Only for initiating device that controls which time slot is used | N/A     |

Comment: /

**Limits, FCC 15.323(c)(3) and (4)**

Occupation of the same combined time and spectrum windows by a device or group of cooperating devices continuously over a period of time longer than 8 hours is not permitted without repeating the access criteria.

Once access to specific combined time and spectrum windows is obtained an acknowledgement from a system participant must be received by the initiating transmitter within one second or transmission must cease.

Periodic acknowledgements must be received at least every 30 seconds or transmission must cease.

Channels used exclusively for control and signaling information may transmit continuously for 30 seconds without receiving an acknowledgement, at which time the access criteria must be repeated.

### 3.20 Dual Access Criteria Check

**Measurement Procedure:**

EUTs that does not implement the LIC procedure: ANSI C63.17, clause 8.3.1

EUTs that implement the LIC procedure: ANSI C63.17, clause 8.3.2

This test is required for equipment that uses the access criteria in FCC 15.323(c)(10).

**Test Results:**

**EUTs that do NOT implements the LIC procedure:**

| Test ref. to ANSI C63.17 clause 8.3.1   | Observation | Verdict    |
|---|-------------|------------|
| b) EUT is restricted to a single carrier $f_i$ for TDMA systems. The Test is Pass if EUT can transmit                                     | N/A         | <b>N/A</b> |
| c) d) Interference at level $T_L + U_M$ on all timeslots except one <b>receive</b> slot where interference is at least 10 dB below $T_L$  | N/A         | <b>N/A</b> |
| e) f) Interference at level $T_L + U_M$ on all timeslots except one <b>transmit</b> slot where interference is at least 10 dB below $T_L$ | N/A         | <b>N/A</b> |

**EUTs that implements the LIC procedure:**

| Test ref. to ANSI C63.17 clause 8.3.2   | Observation | Verdict    |
|---|-------------|------------|
| b) EUT is restricted to a single carrier $f_i$ for TDMA systems. The Test is Pass if EUT can transmit | N/A         | <b>N/A</b> |
| c) d) Transmission on interference-free <b>receive</b> time/spectrum window                           | N/A         | <b>N/A</b> |
| e) f) Transmission on interference-free <b>transmit</b> time/spectrum window                          | N/A         | <b>N/A</b> |

Comment: This test is only applicable for EUT that can be initiating device.

**Limits, FCC 15.323(c)(10)**

An initiating device may attempt to establish a duplex connection by monitoring both its intended transmit and receive time and spectrum windows. If both the intended transmit and receive time and spectrum windows meet the access criteria, then the initiating device can initiate a transmission in the intended transmit time and spectrum window. If the power detected by the responding device can be decoded as a duplex connection signal from the initiating device, then the responding device may immediately begin transmitting on the receive time and spectrum window monitored by the initiating device.

### **3.21 Alternative Monitoring Interval**

Test procedure described in ANSI C63.17 clause 8.4.

This test is required if the EUT implements the provisions of FCC 15.323(c)(11).

**Test result:**

Not Tested. The tested EUT does not implement this provision. See manufacturers' declaration.

## 4 Measurement Uncertainty

| Measurement Uncertainty Values                   |           |                |
|--|-----------|----------------|
| Test Item  |           | Uncertainty    |
| Output Power                                     |           | ±0.5 dB        |
| Power Spectral Density                           |           | ±0.5 dB        |
| Out of Band Emissions, Conducted (RBW < 100 kHz) | < 3.6 GHz | ±0.6 dB        |
|  | > 3.6 GHz | ±0.9 dB        |
| Spurious Emissions, Radiated                     | < 1 GHz   | ±2.5 dB        |
|  | > 1 GHz   | ±2.2 dB        |
| Emission Bandwidth                               |           | ±4 %           |
| Power Line Conducted Emissions                   |           | +2.9 / -4.1 dB |
| Spectrum Mask Measurements                       | Frequency | ±5 %           |
|  | Amplitude | ±1.0 dB        |
| Frequency Error                                  |           | ±0.6 ppm       |
| Timing and Jitter Measurements                   |           | ±2.0 ns        |
| Frame Timing Measurements                        |           | ±1.4 ppm       |
| Receiver Blocking Levels                         |           | ±1.0 dB        |
| Temperature Uncertainty                          |           | ±1 °C          |

All uncertainty values are expanded standard uncertainty to give a confidence level of 95%, based on coverage factor k=2

## 5 Test Setups

### 5.1 Frequency Measurements



*Test equipment included: 5, 9, 18*

#### Test Set-up 1

This setup is used for measuring Carrier frequency stability at normal and extreme temperatures.

### 5.2 Timing Measurements

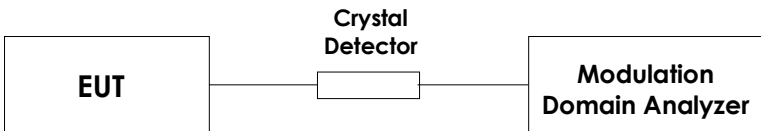

*Test equipment included: 5, 7, 9, 18*

#### Test Set-up 2

This setup is used for measuring Frame repetition stability, Frame period and Jitter.

### 5.3 Conducted Emission Test

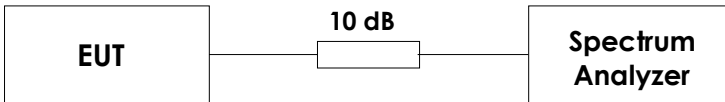

*Test equipment included: 1, 2, 9, 18*

#### Test Set-up 3

This setup is used for all conducted emission tests.

### 5.4 Power Line Conducted Emissions Test

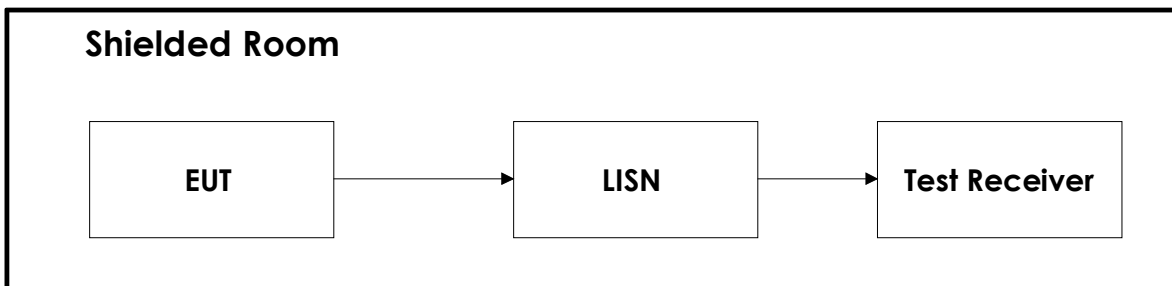

*Test equipment: 8, 16, 17, 18*

#### Test Set-Up 5

## 5.5 Monitoring Tests

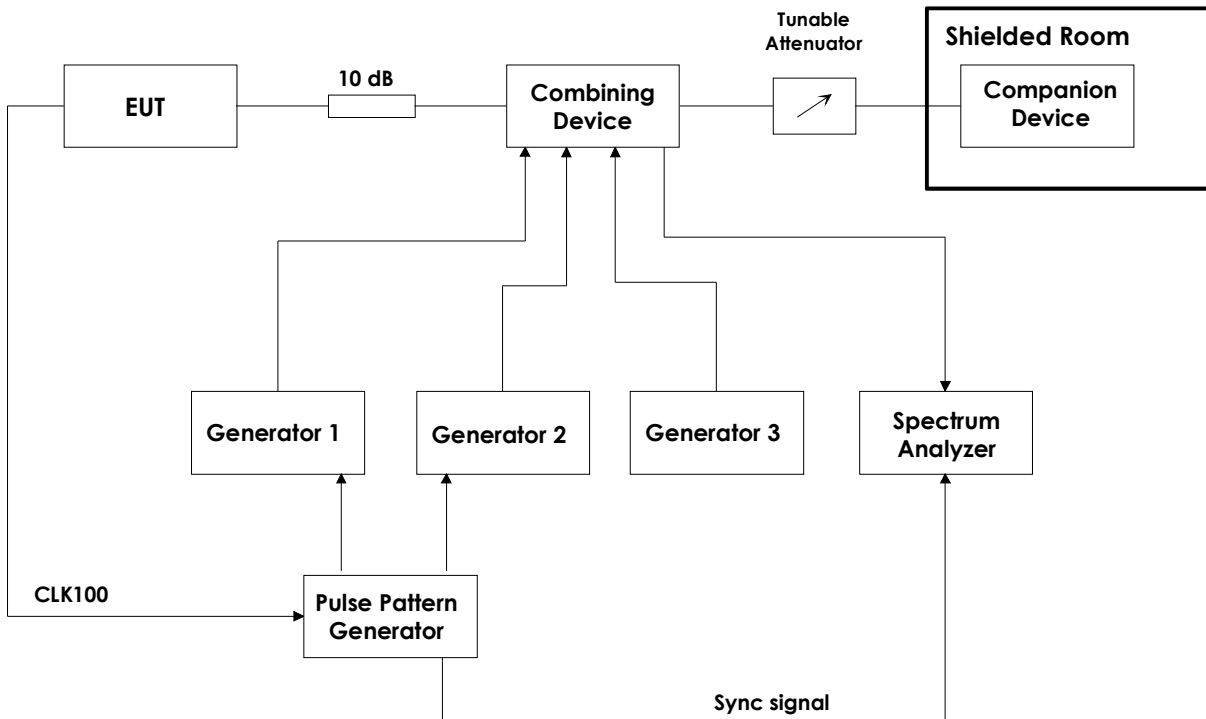

Test equipment: 1, 2, 3, 4, 6, 9, 10, 11, 12, 13, 14, 15, 18, 19, 20, 21, 22, 23

### Test Set-Up 6

This test setup is used for all Monitoring and Time and Spectrum Access Procedure tests. The path loss from the signal generators to the EUT is measured with a power meter before the testing is started.

The CLK100 is used to synchronize the Pulse-/ Pattern generator to the start of the DECT frame, this signal always comes from the base station. If the EUT is a DECT Portable Part (i.e. a handset) the CLK100 signal will come from the Companion Device.

The sync signal to the Spectrum Analyzer is the CLK100 signal that is regenerated in the Pulse-/ Pattern Generator, this is used to synchronize the Spectrum Analyzer to the DECT frame when in zero span. The Pulse-/ Pattern Generator is used for tests that require time synchronized pulses or blocking of specific time slots.

## 6 Test Equipment Used

To facilitate inclusion on each page of the test equipment used for related tests, each item of test equipment and ancillaries are identified (numbered) by the Testhouse.

| No. | Model number | Description                | Manufacturer    | Ref. no.   | Cal. date  | Cal. Due |
|-----|--------------|----------------------------|-----------------|------------|------------|----------|
| 1   | FSW43        | Spectrum Analyzer          | Rohde & Schwarz | LR 1690    | 2016.07    | 2017.07  |
| 2   | SME03        | Signal generator           | Rohde & Schwarz | LR 1238    | 2015.05    | 2017.05  |
| 3   | SMIQ03B      | Signal generator           | Rohde & Schwarz | LR 1516    | 2015.05    | 2017.05  |
| 4   | SMHU52       | Signal generator           | Rohde & Schwarz | LR 1240    | Cal b4 use |          |
| 5   | 53310A       | Modulation Domain Analyzer | Hewlett Packard | LR 1483    | 2016.01    | 2018.01  |
| 6   | 81104A       | Pulse-/ Pattern Generator  | Agilent         | LR 1502    | 2015.05    | 2017.05  |
| 7   | 8470B        | Crystal Detector           | Hewlett Packard | LR 1207    | N/A        |          |
| 8   | ESCI3        | EMI Test Receiver          | Rohde & Schwarz | N- 4259    | 2015.08    | 2017.08  |
| 9   | 6810.17B     | Attenuator                 | Suhner          | LR1669     | Cal b4 use |          |
| 10  | 745-69       | Step Attenuator            | Narda           | LR 1442    | N/A        |          |
| 11  | WE 1506A     | Power Splitter             | Weinchel        | LR 244     | Cal b4 use |          |
| 12  | WE 1506A     | Power Splitter             | Weinchel        | LR 245     | Cal b4 use |          |
| 13  | H-9          | Hybrid                     | Anzac           | LR 86      | Cal b4 use |          |
| 14  | H-9          | Hybrid                     | Anzac           | LR 257     | Cal b4 use |          |
| 15  | S212DS       | RF Switch                  | Narda           | LR 1244    | N/A        |          |
| 16  | ESH3-Z5      | Two Line V-Network         | Rohde & Schwarz | N-3403     | 2015.07    | 2017.07  |
| 17  | ESH3-Z2      | Pulse Limiter              | Rohde & Schwarz | N-3932     | 2015.03    | 2017.03  |
| 18  | 6812B        | AC Power Source            | Agilent         | LR 1515    | 2015.12    | 2016.12  |
| 19  | Model 87 V   | Multimeter                 | Fluke           | N-4669     | 2016.10    | 2017.10  |
| 20  | 87H35-1      | Circulator                 | Racal-MESL      | s.no.: 140 | N/A        |          |
| 21  | 87H35-1      | Circulator                 | Racal-MESL      | s.no.: 141 | N/A        |          |
| 22  | 87H35-1      | Circulator                 | Racal-MESL      | s.no.: 142 | N/A        |          |
| 23  | NRP-Z81      | Wideband Power Sensor      | Rohde Schwarz   | LR 1644    | 2015.11    | 2016.11  |
| 24  | VMT 08/64    | Climatic chamber           | Vötsch          | LR 323     | 2016.03    | 2017.03  |

The software listed below has been used for one or more tests.

| No. | Manufacturer    | Name                    | Version | Comment                                      |
|-----|-----------------|-------------------------|---------|--|
| 1   | Rohde & Schwarz | EMC32                   | 9.26.00 | Power-Line Conducted Emissions test software |
| 2   | Agilent         | Intuitlink Data Capture | 2.1.0   | Screenshots from HP 53310A                   |

### Revision history

| Version | Date       | Comment       | Sign |
|---------|------------|---------------|------|
| 1.0     | 2016.11.15 | First edition | FS   |
|         |            |               |      |