

Test Report

Product	DECT Base Station		
Name and address of the applicant	Panasonic Corporation of North America Two Riverfront Plaza, 9 th Floor Newark, 07102-5490, NJ, USA		
Name and address of the manufacturer	Panasonic Corporation 1-62, 4-chome, Minoshima, Hakata-ku Fukuoka, 812-8531, Japan		
Model	KX-TGD830 KX-TGD850C		
Rating	120V 60Hz (Input: 120V ~60Hz 0.1A; Output: 5.5V 0.5A, 2.75W)		
Trademark	Panasonic		
Serial number	See page 3		
Additional information	DECT 6.0		
Tested according to	Parts of FCC Part 15, subpart D Isochronous UPCS Device, 1920 – 1930 MHz Parts of Industry Canada RSS 213, Issue 3 2 GHz License-Exempt Personal Communications Services (LE-PCS) Devices		
Order number	408178		
Tested in period	2020-10-15 to 2020-10-28		
Issue date	2020-11-17		
Name and address of the testing laboratory	 Instituttveien 6 Kjeller, Norway www.nemko.com	CAB Number: FCC: NO0001 ISED: NO0470 TEL: +47 22 96 03 30 FAX: +47 22 96 05 50	 
An accredited technical test executed under the Norwegian accreditation scheme			
 Prepared by [Frode Sveisen]		 Approved by [G.Suhanthakumar]	
This report shall not be reproduced except in full without the written approval of Nemko. Opinions and interpretations expressed within this report are not part of the current accreditation. This report was originally distributed electronically with digital signatures. For more information please contact Nemko.			

CONTENTS

1	INFORMATION	3
1.1	Tested Item.....	3
1.2	Description of Tested Device.....	3
1.3	Normal Test Conditions	4
1.4	Test Engineer(s)	4
1.5	Digital Modulation Techniques.....	4
1.6	Labeling Requirements.....	4
1.7	Antenna Requirement.....	4
1.8	Channel Frequencies.....	5
1.9	Other Comments	5
2	TEST REPORT SUMMARY	6
2.1	General.....	6
2.2	Test Summary	7
3	TEST RESULTS.....	8
3.1	Power Line Conducted Emissions	8
3.2	Automatic Discontinuation of Transmission	10
3.3	Peak Power Output.....	11
3.4	Emission Bandwidth <i>B</i>	13
3.5	Power Spectral Density	15
3.6	In-Band Unwanted Emissions, Conducted	17
3.7	Out-of-band Emissions, Conducted.....	19
4	MEASUREMENT UNCERTAINTY	22
5	TEST SETUPS	23
5.1	Conducted Emission Test.....	23
5.2	Power Line Conducted Emissions Test	23
6	TEST EQUIPMENT USED	24

1 INFORMATION

1.1 Tested Item

Name	Panasonic
Model name	KX-TGD830 (US Models) KX-TGD850C (Canadian Models)
FCC ID	ACJ96NKX-TGD830
ISED ID	216A-KXTGD850
Serial number	Conducted Sample: 1081780001 Radiated Sample: 4081780002
Hardware identity and/or version	PNLB2909
Software identity and/or version	SW200
Frequency Range	1921.536 – 1928.448 MHz
Number of Channels	5 RF Channels, 5x12 = 60 TDMA Duplex Channels
Type of Modulation	Digital (Gaussian Frequency Shift Keying)
Conducted Output Power	66 mW (Peak)
Antenna Connector	None
Number of Antennas	2
Antenna Diversity	Yes
Power Supply	AC Adaptor PNLV226(UC) / PNLV226(ZZ) / PNLV226(ZC) (Input: 120V ~60Hz 0.1A, Output: 5.5V _{DC} 0.5A, 2.75W)
Interfaces	PSTN

1.2 Description of Tested Device

The EUT is a DECT Base Station and is a responding device as described in ANSI C63.17 and is designed to operate together with a DECT Handset, which is the initiating device.

This model is identical to the models KX-TGD560 and KX-TGD860 (FCC ID: ACJ96NKX-TGD560), but the Bluetooth Part is removed on this model.

The AC adaptor PNLV226(ZC) is new.

This report contains only spot-check results, all other tests for the DECT Part are covered by Nemko Test Report No. 318949-02-R02.

All results in this report were tested on the fully populated model KX-TGD860.

1.3 Normal Test Conditions

Temperature:	20 – 23 °C
Relative humidity:	30 – 50 %
Normal test voltage:	120 V AC

The values are the limit registered during the test period.

1.4 Test Engineer(s)

Frode Sveinsen

1.5 Digital Modulation Techniques

The EUT uses Multi Carrier / Time Division Multiple Access / Time Division Duplex and Digital GFSK modulation. For further details see the operational description provided by the applicant.

Requirement, FCC 15.319(b), RSS-213 Issue 3, clause 5.1:

All transmissions must use only digital modulation techniques.

1.6 Labeling Requirements

See separate documents showing the label design and the placement of the label on the EUT.

Requirements FCC 15.19

The FCC Identifier shall be displayed on the label, and the device(s) shall bear the following statement in a conspicuous location on the device or in the user manual if the device is too small:

This device complies with Part 15 of the FCC Rules. Operation is subject to the following two conditions: (1) this device may not cause harmful interference, and (2) this device must accept any interference received, including interference that may cause undesired operation.

The label itself shall be of a permanent type, not a paper label, and shall last the lifetime of the equipment.

1.7 Antenna Requirement

Does the EUT have detachable antenna(s)?	<input type="checkbox"/> YES	<input checked="" type="checkbox"/> NO
If detachable, is the antenna connector(s) non-standard?	<input type="checkbox"/> YES	<input type="checkbox"/> NO
The tested equipment has only integral antennas. The conducted tests were performed on a sample with a temporary antenna connector.		

Requirement: FCC 15.203, 15.204, 15.317, RSS-GEN Issue 5, clause 6.8

1.8 Channel Frequencies

UPCS CHANNEL	FREQUENCY (MHz)
Upper Band Edge	1930.000
0 (Highest)	1928.448
1	1926.720
2	1924.992
3	1923.264
4 (Lowest)	1921.536
Lower Band Edge	1920.000

Requirement: FCC 15.303, RSS-213 Issue 3, clause 5.1:

Within 1920 -1930 MHz band for isochronous devices.

1.9 Other Comments

The Monitoring and Time and Spectrum Window Access tests were performed with Test Set-Up 6 (Ref. clause 5). A clock signal from the Base Station was used to synchronize the Pulse Pattern Generator and the Spectrum Analyzer to the start of the DECT time window. The EUT was limited by administrative commands to operate on only two frequency carriers. For the tests where the EUT was required to operate on only one frequency carrier, one carrier was blocked by applying a CW interfering signal from RF Generator 3. The Pulse Pattern Generator was used to apply time synchronized interference to time windows where this was required.

Since the EUT was programmed to operate on only two RF carriers, it was only necessary with two RF generators for the monitoring tests, however a third generator was applied for the tests that required specific time slots to be blocked.

This EUT supports Least Interfered Channel procedure (LIC), the Monitoring and Time and Spectrum Window Access tests were conducted as specified for EUTs that support LIC procedure.

All tests except Power-Line Conducted Emissions were performed in conducted mode with a temporary antenna connector.

The Radiated Emissions tests were performed with all ports populated and operating.

2 TEST REPORT SUMMARY

2.1 General

All measurements are traceable to national standards.

The tests were conducted on a sample of the equipment for the purpose of demonstrating compliance with FCC CFR47 Part 15D for Isochronous UPCS Devices and Industry Canada RSS-213 Issue 3 / RSS-GEN Issue 5 / RSP-100 Issue 11.

All tests were conducted in accordance with ANSI C63.4-2014 and ANSI C63.17-2013.

Antenna Gain tests were made in a 3m fully-anechoic chamber.

A description of the test facility is on file with FCC and ISED.

- | | |
|---|---|
| <input checked="" type="checkbox"/> New Submission | <input checked="" type="checkbox"/> Production Unit |
| <input type="checkbox"/> Class II Permissive Change | <input type="checkbox"/> Pre-production Unit |
| PUB Equipment Code | <input type="checkbox"/> Family Listing |



THIS TEST REPORT APPLIES ONLY TO THE ITEM(S) AND CONFIGURATIONS TESTED.

Deviations from, additions to, or exclusions from the test specifications are described in "Summary of Test Data".

Nemko Group authorizes the above named entity to reproduce this report provided it is reproduced in its entirety and for use by the entity's employees only. Any reproduction of parts of this report requires approval in writing from Nemko Group.

Any use that a third party makes of this report, or any reliance on or decisions to be made based on it, are the responsibility of such third parties. Nemko Group accepts no responsibility for damages suffered by any third party caused by decisions made or actions based on this report.

2.2 Test Summary

Name of test	FCC CFR 47 Paragraph #	IC RSS-213 Paragraph #	Verdict
Power Line Conducted Emission	15.107(a) 15.207(a)	5.4 RSS-GEN 7.2 / 8.8	Complies
Digital Modulation Techniques	15.319(b)	5.1	Complies
Labeling requirements	15.19(a)(3)	RSP-100 3.1	Complies
Antenna Requirement	15.317, 15.203	RSS-GEN 6.8	Complies
Channel Frequencies	15.303	5.1	Complies
Automatic discontinuation of transmission	15.319(f)	5.2	Complies
Emission Bandwidth	15.323(a)	5.5	Complies
Occupied Bandwidth	N/A	RSS-GEN 6.7	Complies
In-band emissions	15.323(d)	5.8.2	Complies
Out-of-band emissions	15.323(d)	5.8.1	Complies
Peak Transmit Power and Antenna Gain	15.319(c)(e), 15.31(e)	5.6 RSS-GEN 8.3	Complies
Power Spectral Density	15.319(d)	5.7	Complies
Carrier frequency stability	15.323(f)	5.3	Complies ⁴
Frame repetition stability	15.323(e)	5.2 (13)	Complies ⁴
Frame period and jitter	15.323(e)	5.2 (13)	Complies ⁴
Monitoring threshold, Least interfered channel	15.323(c)(2)(5)(9)	5.2 (2)(5)(9)	Complies ⁴
Monitoring of intended transmit window and maximum reaction time	15.323(c)(1)	5.2 (1)	Complies ⁴
Threshold monitoring bandwidth	15.323(c)(7)	5.2 (7)	Complies ⁴
Reaction time and monitoring interval	15.323(c)(1)(5)(7)	5.2 (1)(5)(7)	Complies ⁴
Access criteria test interval	15.323(c)(4)(6)	5.2 (4)(6)	Complies ⁴
Access Criteria functional test	15.323(c)(4)(6)	5.2 (4)(6)	Complies ¹
Acknowledgements	15.323(c)(4)	5.2 (4)	Complies ⁴
Transmission duration	15.323(c)(3)	5.2 (3)	N/A ¹
Dual access criteria	15.323(c)(10)	5.2 (10)	N/A ¹
Alternative monitoring interval	15.323(c)(11)(12)	5.2 (11)(12)	N/A ²
Spurious Emissions (Radiated)	15.319(g) 15.109(a) 15.209(a)	RSS-GEN 7.3 / 8.9	N/A ³

¹ Only applies for EUT that can be initiating device

² The client declares that the tested equipment does not implement this provision

³ Not required if the Conducted Out-of-Band Emissions test is Passed

⁴ See Nemko Test Report No. 318849-02-R01

3 TEST RESULTS

3.1 Power Line Conducted Emissions

FCC Part 15.207

ISED RSS-213 Issue 3, Clause 6.3

RSS-GEN Issue 5, Clause 7.2 / 8.8

Measurement procedure: ANSI C63.4-2014 using 50 μ H/50 ohms LISN

Test Results: Complies

Measurement Data: See attached plots

Highest measured value (L1 and N):

PNLV226 (ZC), On-Hook, Handset Charging, 120V 60Hz

Frequency (MHz)	QuasiPeak (dB μ V)	Average (dB μ V)	Limit (dB μ V)	Margin (dB)	Meas. Time (ms)	Bandwidth (kHz)	Line	Filter
0.288	33.42	---	60.58	27.16	1000	9	N	OFF
0.300	---	34.06	50.24	16.19	1000	9	L1	OFF
1.912	41.40	---	56.00	14.60	1000	9	L1	OFF
1.916	41.60	---	56.00	14.40	1000	9	L1	OFF
1.936	41.30	---	56.00	14.70	1000	9	L1	OFF
1.944	41.47	---	56.00	14.53	1000	9	L1	OFF
1.960	41.53	---	56.00	14.47	1000	9	L1	OFF
2.108	42.52	---	56.00	13.48	1000	9	L1	OFF
2.392	40.03	---	56.00	15.97	1000	9	L1	OFF

PNLV226 (ZC), Off-Hook, 120V 60Hz

Frequency (MHz)	QuasiPeak (dB μ V)	Average (dB μ V)	Limit (dB μ V)	Margin (dB)	Meas. Time (ms)	Bandwidth (kHz)	Line	Filter
0.292	32.27	---	60.47	28.20	1000	9	N	OFF
0.296	36.58	---	60.35	23.78	1000	9	L1	OFF
1.868	39.64	---	56.00	16.36	1000	9	L1	OFF
1.940	39.11	---	56.00	16.89	1000	9	L1	OFF
1.988	40.46	---	56.00	15.54	1000	9	L1	OFF
2.048	35.41	---	56.00	20.59	1000	9	N	OFF
2.112	40.17	---	56.00	15.83	1000	9	L1	OFF
2.128	35.58	---	56.00	20.42	1000	9	N	OFF
2.136	39.29	---	56.00	16.71	1000	9	L1	OFF
2.212	34.67	---	56.00	21.33	1000	9	N	OFF
2.364	33.31	---	56.00	22.69	1000	9	N	OFF

PNLV226 (ZC), On-Hook, Handset Charging, 120V 60Hz

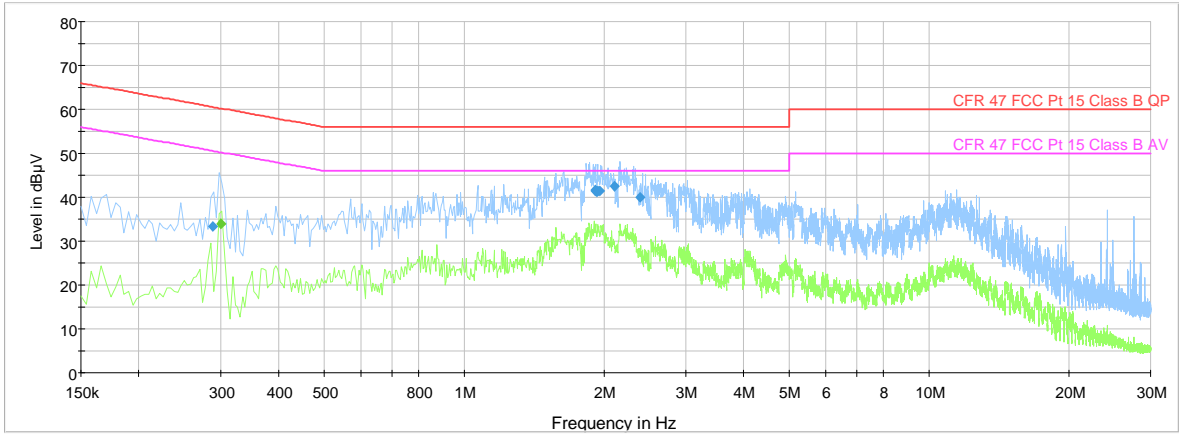

PNLV226 (ZC), Off-Hook, 120V 60Hz

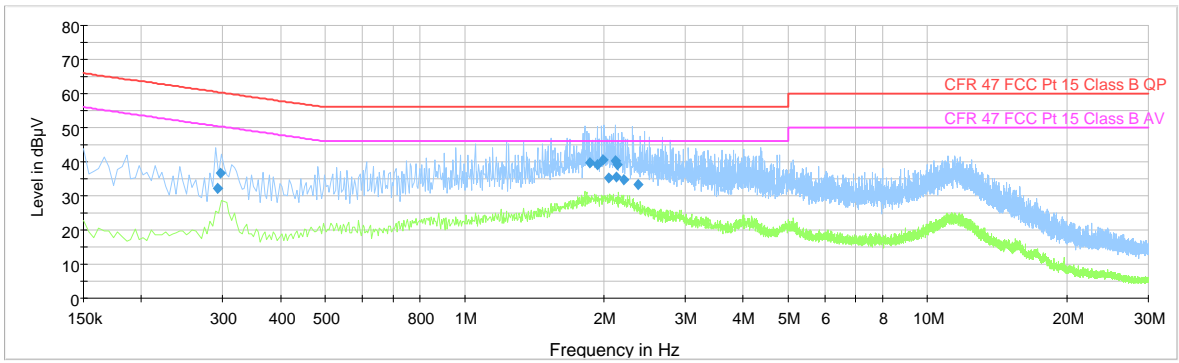

3.2 Automatic Discontinuation of Transmission

Does the EUT transmit Control and Signaling Information?	<input checked="" type="checkbox"/> YES	<input type="checkbox"/> NO
TYPE OF EUT :	<input type="checkbox"/> INITIATING DEVICE	<input checked="" type="checkbox"/> RESPONDING DEVICE

The following tests simulate the reaction of the EUT in case of either absence of information to transmit or operational failure after a connection with the companion device is established.

Number	Test	EUT Reaction	Verdict
1	Power removed from EUT	A	Pass
2	Switch Off EUT	N/A	Pass
3	Hook-On by EUT	N/A	Pass
4	Power Removed from Companion Device	B	Pass
5	Switch Off Companion Device	B	Pass
6	Hook-On by Companion Device	B	Pass

- A - Connection breakdown, Cease of all transmissions
- B - Connection breakdown, EUT transmits control and signaling information
- C - Connection breakdown, Companion Device transmits control and signaling information
- N/A - Not Applicable (EUT does not have On/Off switch and cannot perform Hook-On)

Requirements, FCC 15.319(f), RSS-213 Issue 3, Clause 5.2:

The device shall automatically discontinue transmission in case of either absence of information to transmit or operational failure. These provisions are not intended to preclude transmission of control and signaling information or use of repetitive codes used by certain digital technologies to complete frame or burst intervals.

3.3 Peak Power Output

Test Method:

ANSI C63.17, clause 6.1.2.

Test Results: Complies

Measurement Data:

Maximum Conducted Output Power

Channel No.	Frequency (MHz)	Maximum Conducted Output Power (dBm)	Maximum Antenna Gain (dBi)	Maximum Radiated Output Power (dBm)
4	1921.536	18.2	0.0*	18.2
2	1924.992	18.2	0.0*	18.2
0	1928.448	18.2	0.0*	18.2

*Antenna Gain is value declared by manufacturer

Values above are RMS value measured in RF burst with Max Hold function of Spectrum Analyzer.

BASE: For this test it was also checked that input voltage variation of 85 and 115% of nominal value did not have any effect on the measured output power.

Limit:

Conducted: $100 \mu W \times \text{SQRT}(B)$ where B is the measured Emission Bandwidth in Hz

FCC 15.319(c)(e): 20.72 dBm (118 mW)

ISED RSS-213, Issue 3: 20.45 dBm (111 mW)

The antenna gain is below 3 dBi, no reduction in transmit power is necessary.

Requirements,

FCC 15.319(c)(e):

Peak transmit power shall not exceed 100 microwatts multiplied by the square root of the emission bandwidth in Hertz.

RSS-213 Issue 3, clause 5.6:

Peak transmit power shall not exceed 100 microwatts multiplied by the square root of the occupied bandwidth in Hertz.

FCC 15.319(c)(e); RSS-213 Issue 3, clause 5.6:

The peak transmit power shall be reduced by the amount in decibels that the maximum directional gain of the antenna exceeds 3 dBi.

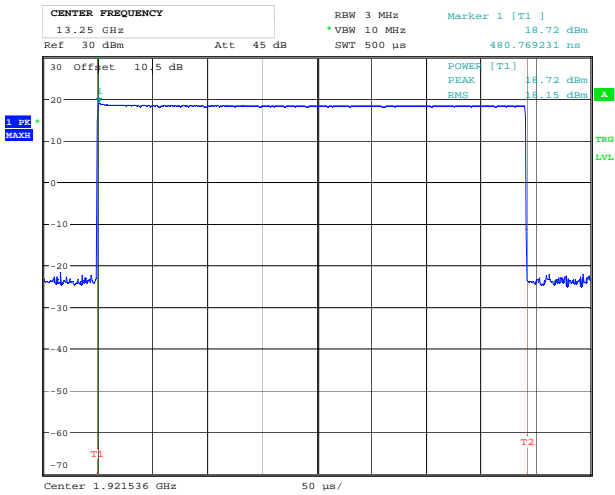

Date: 15.OCT.2020 15:55:06

Conducted Peak Output Power, Lower Channel

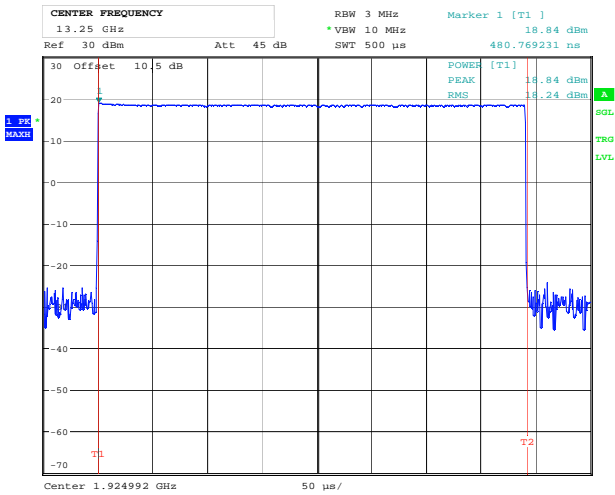

Date: 15.OCT.2020 14:33:36

Conducted Peak Output Power, Middle Channel

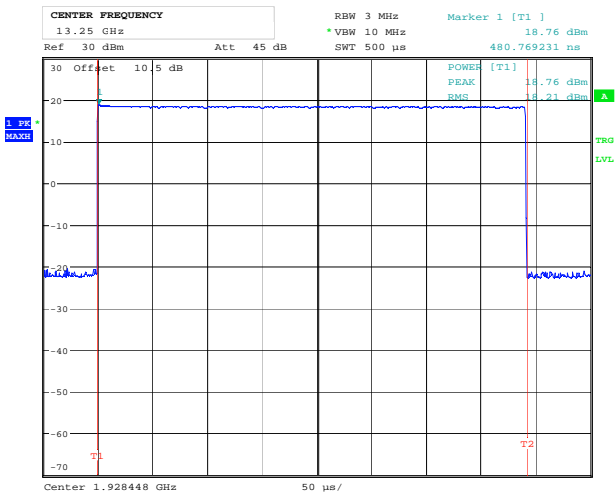

Date: 15.OCT.2020 15:41:56

Conducted Peak Output Power, Upper Channel

3.4 Emission Bandwidth *B*

Test Method:

ANSI C63.17, clause 6.1.3.

Test Results: Complies

Measurement Data:

Channel No.	Frequency (MHz)	Emission Bandwidth <i>B</i> (MHz)
4	1921.536	1.37
2	1924.992	1.37
0	1928.448	1.39

Channel No.	Frequency (MHz)	Occupied Bandwidth (MHz)
2	1924.992	1.23

Requirements, FCC 15.323(a), RSS-213 Issue 3, clause 5.5:

The Emission Bandwidth *B* shall be larger than 50 kHz and less than 2.5 MHz.

No requirements for 6 and 12 dB Bandwidth, these values are only used for testing Monitoring Bandwidth if the Simple Compliance test fails (ANSI C63.17, clause 7.4).

RSS-GEN Issue 5, clause 6.7:

Occupied Bandwidth (99%) is measured according to RSS-GEN Issue 5, clause 6.7. No requirement specified.

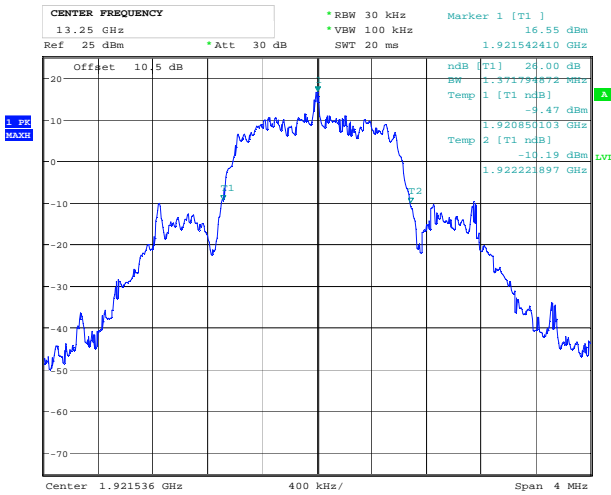

Date: 9.OCT.2020 10:10:03

Emission Bandwidth B, Lower Channel

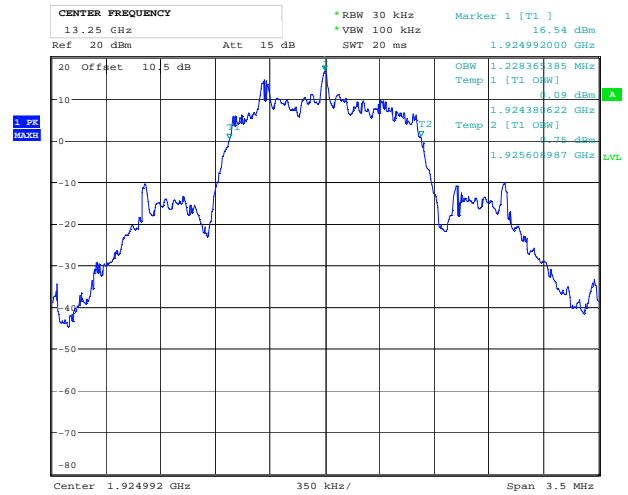

Date: 8.OCT.2020 17:29:39

99% Bandwidth, Middle Channel

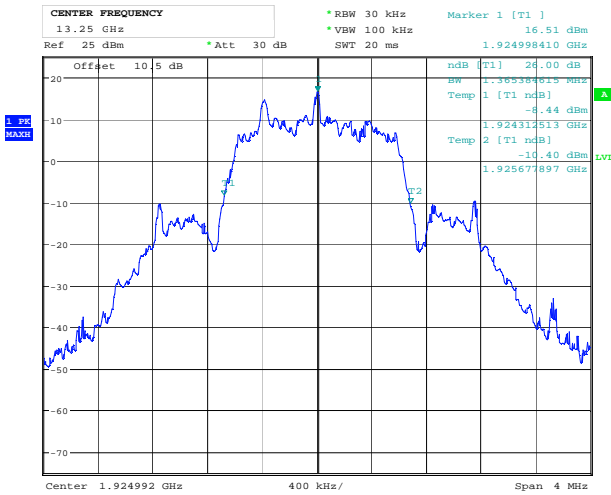

Date: 8.OCT.2020 17:22:24

Emission Bandwidth B, Middle Channel

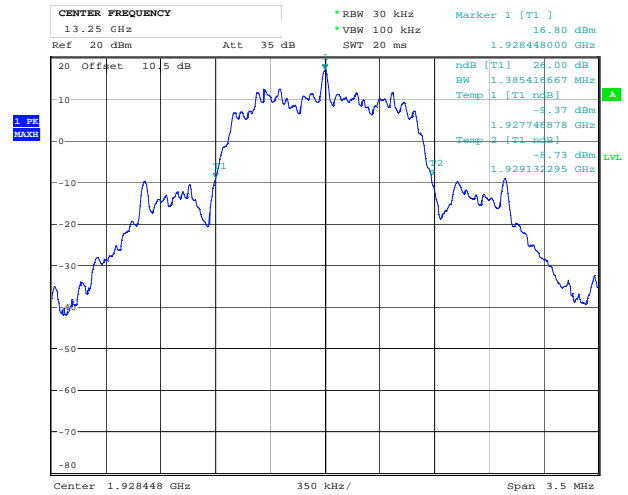

Date: 26.OCT.2020 12:01:12

Emission Bandwidth B, Upper Channel

3.5 Power Spectral Density

Test Method:

ANSI C63.17, clause 6.1.5.

Test Results: Complies

Measurement Data:

Channel No.	Frequency (MHz)	Power Spectral Density (dBm)
4	1921.536	-3.5
0	1928.448	-3.6

Values above is the RMS value of the sweep that is within 30 dB of the peak.

Measured with Sample Detector and Averaged over 1000 sweeps.

Requirements, FCC 15.319(d), RSS-213 Issue 3, clause 5.7

The Power Spectral Density shall be less than 3 mW (4.77 dBm) when averaged over at least 100 sweeps.

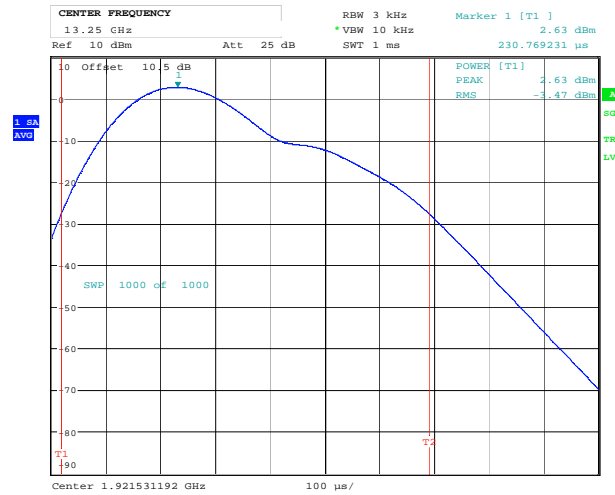
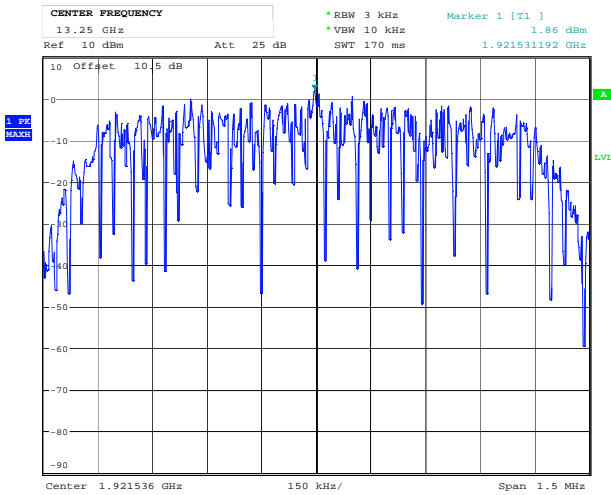

Date: 26.OCT.2020 15:00:25

Date: 26.OCT.2020 15:01:20

PSD Overview, Lower Channel

PSD Averaged, 1000 Sweeps, Lower Channel

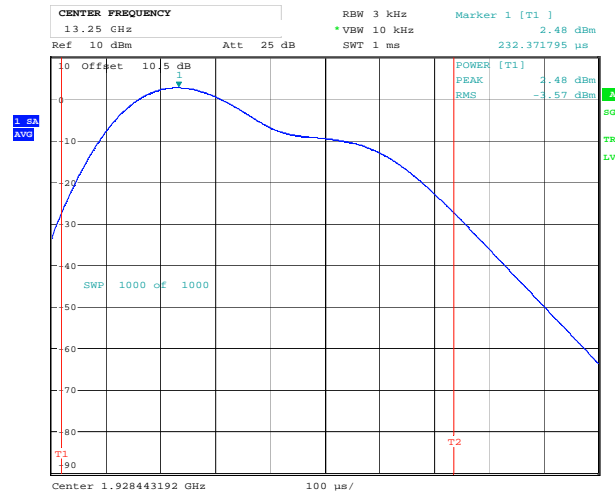
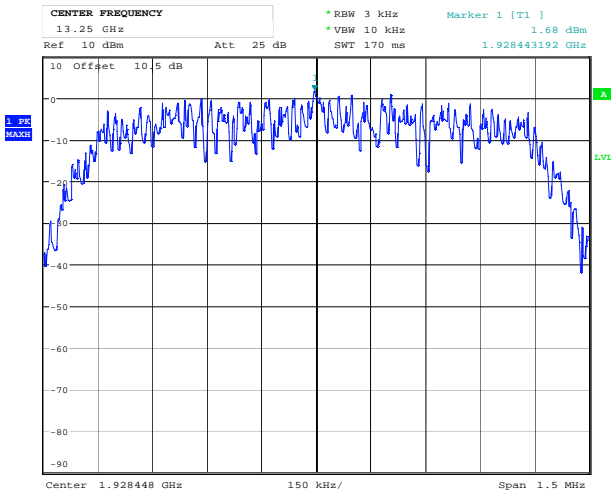

Date: 26.OCT.2020 15:12:46

Date: 26.OCT.2020 15:13:37

PSD Overview, Upper Channel

PSD Averaged, 1000 Sweeps, Upper Channel

3.6 In-Band Unwanted Emissions, Conducted

Test Method:

ANSI C63.17, clause 6.1.6.1.

Test Results: Complies

Measurement Data:

See plots.

Requirements, FCC 15.323(d), RSS-213 Issue 3, clause 5.8.2:

$B < f \leq 2B$: at least 30 dB below max. permitted peak power

$2B < f \leq 3B$: at least 50 dB below max. permitted peak power

$3B < f \leq$ UPCS Band Edge : at least 60 dB below max. permitted peak power

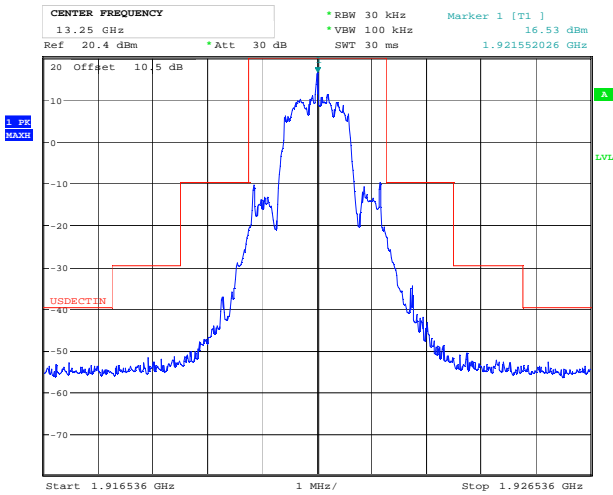

Date: 15.OCT.2020 15:56:50

In-Band Unwanted Emissions, Lower Channel

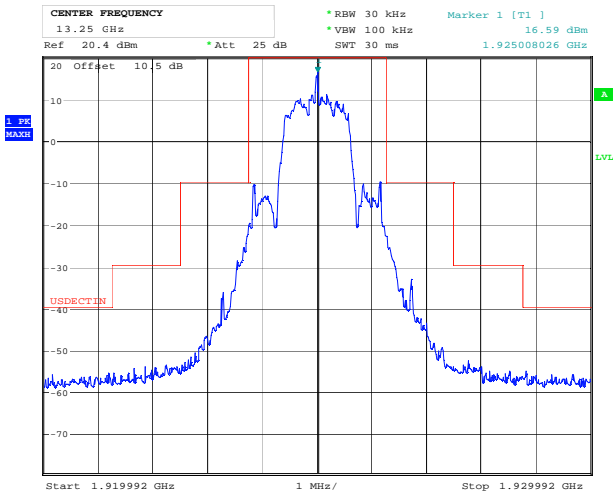

Date: 15.OCT.2020 14:49:34

In-Band Unwanted Emissions, Middle Channel

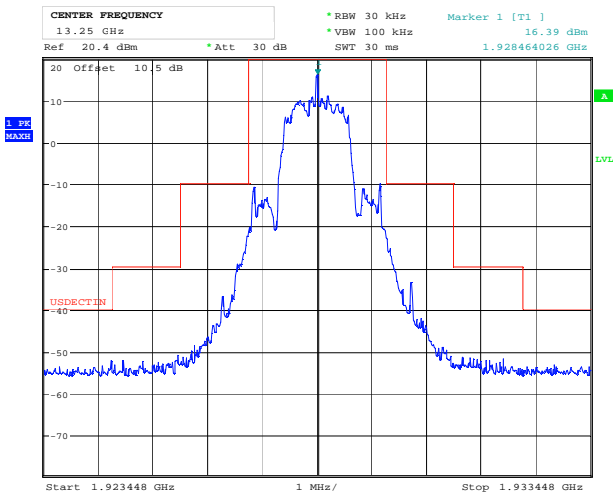

Date: 15.OCT.2020 15:59:26

In-Band Unwanted Emissions, Upper Channel

3.7 Out-of-band Emissions, Conducted

Test Method:

ANSI C63.17, clause 6.1.6.2.

Test Results: Complies

Measurement Data:

All Emissions are below the limit.

Requirements, FCC 15.323(d), RSS-213 Issue 3, clause 5.8.1:

$f \leq 1.25\text{MHz}$ outside UPCS band :	$\leq -9.5\text{dBm}$
$1.25\text{MHz} \leq f \leq 2.5\text{MHz}$ outside UPCS band :	$\leq -29.5 \text{ dBm}$
$f \geq 2.5\text{MHz}$ outside UPCS band :	$\leq -39.5 \text{ dBm}$

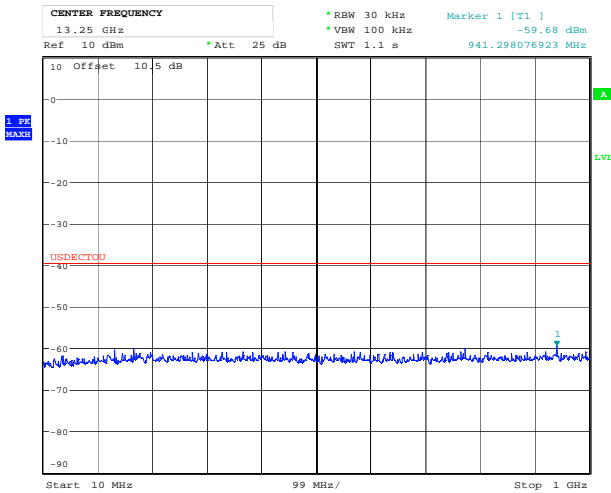

Date: 23.OCT.2020 15:32:37

Out-of-Band Emissions, Lower Channel

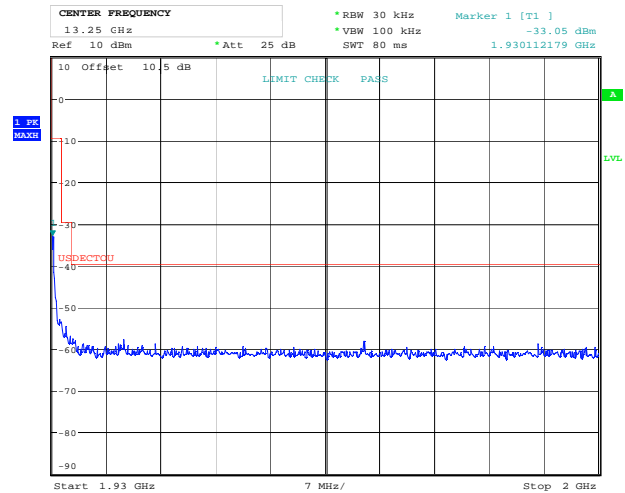

Date: 26.OCT.2020 16:15:19

Out-of-Band Emissions, Upper Channel

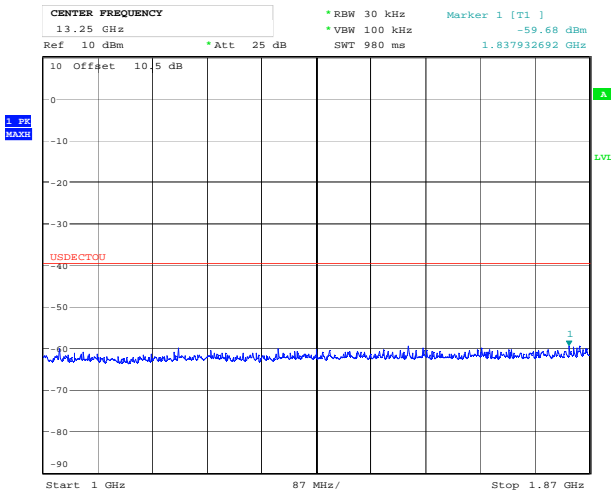

Date: 23.OCT.2020 15:33:24

Out-of-Band Emissions, Lower Channel

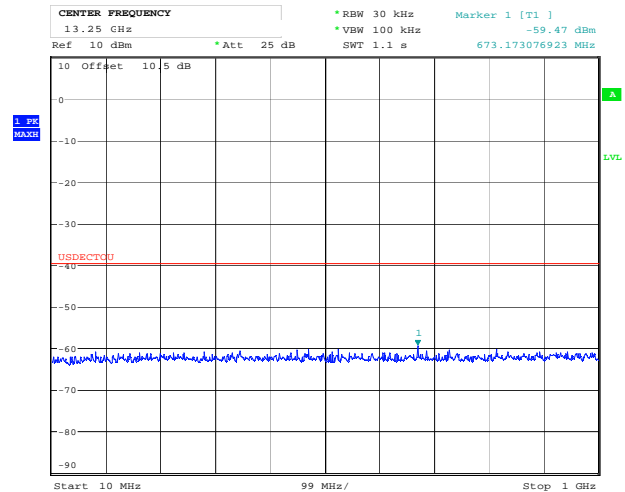

Date: 23.OCT.2020 15:24:09

Out-of-Band Emissions, Middle Channel

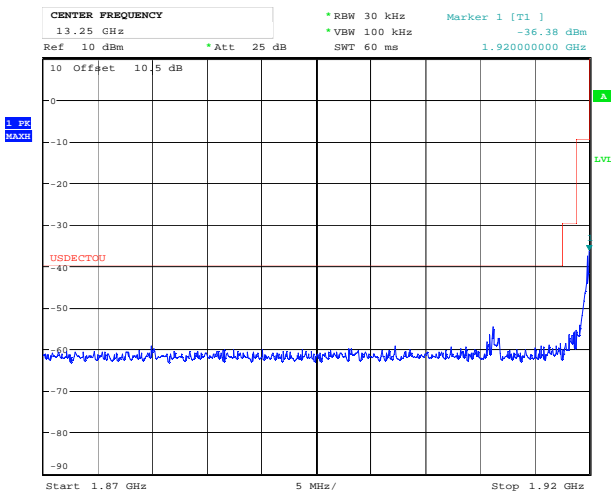

Date: 23.OCT.2020 15:34:01

Out-of-Band Emissions, Lower Channel

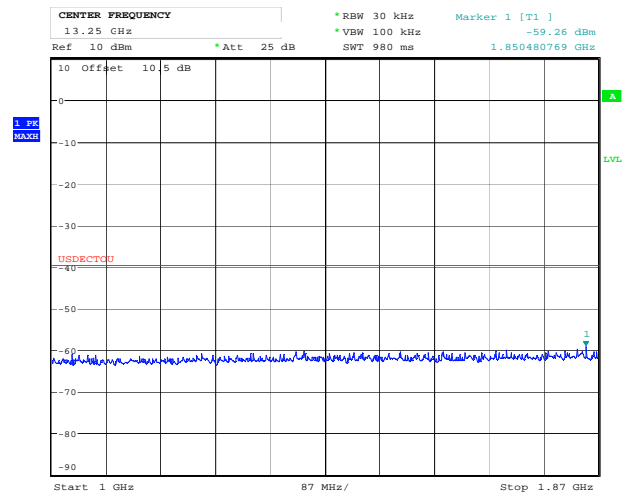

Date: 23.OCT.2020 15:25:33

Out-of-Band Emissions, Middle Channel

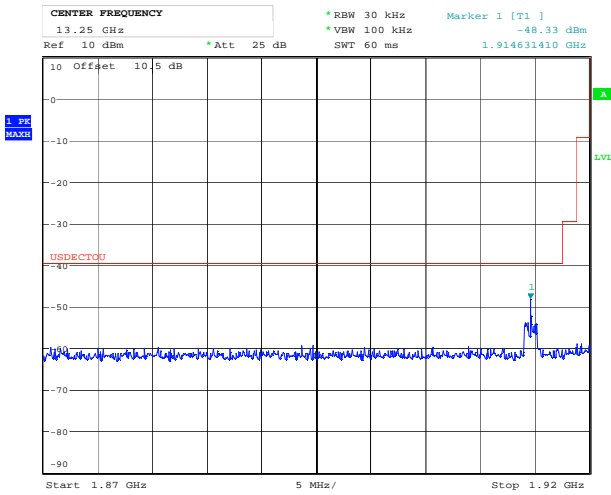

Date: 23.OCT.2020 15:26:14

Out-of-Band Emissions, Middle Channel

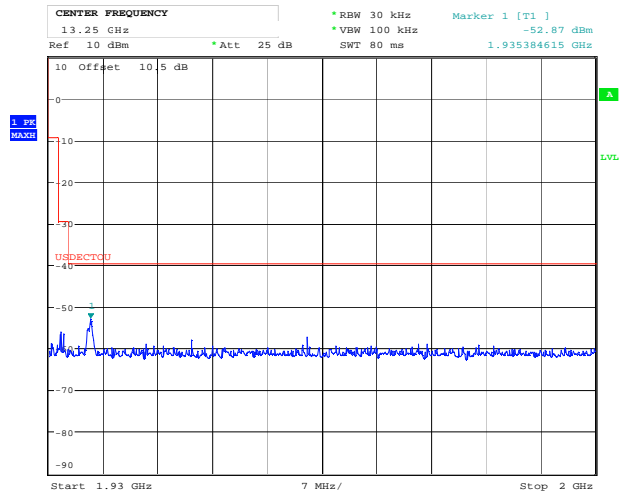

Date: 23.OCT.2020 15:26:53

Out-of-Band Emissions, Middle Channel

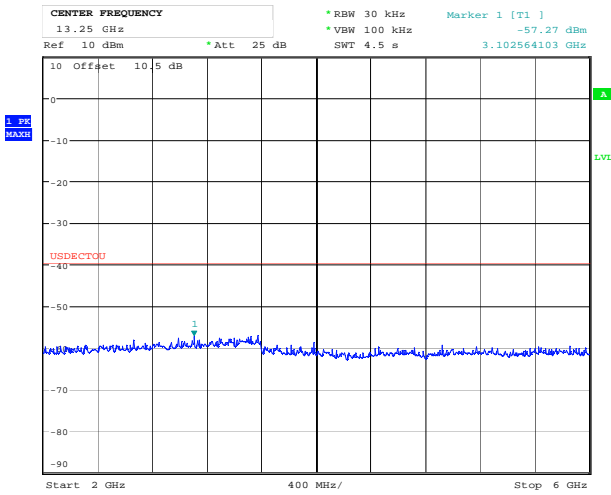

Date: 23.OCT.2020 15:27:55

Out-of-Band Emissions, Middle Channel

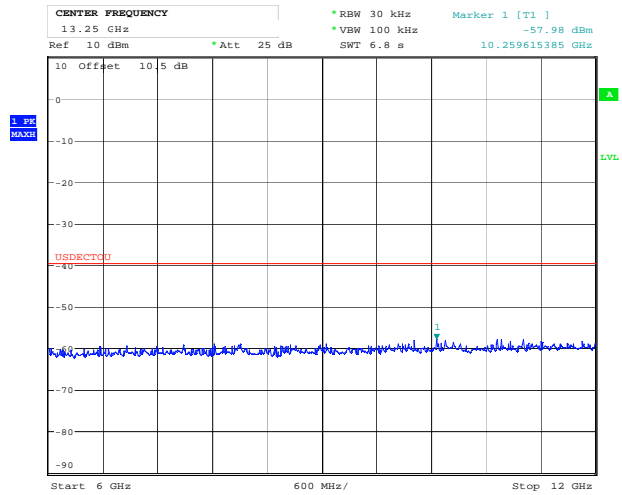

Date: 23.OCT.2020 15:29:46

Out-of-Band Emissions, Middle Channel

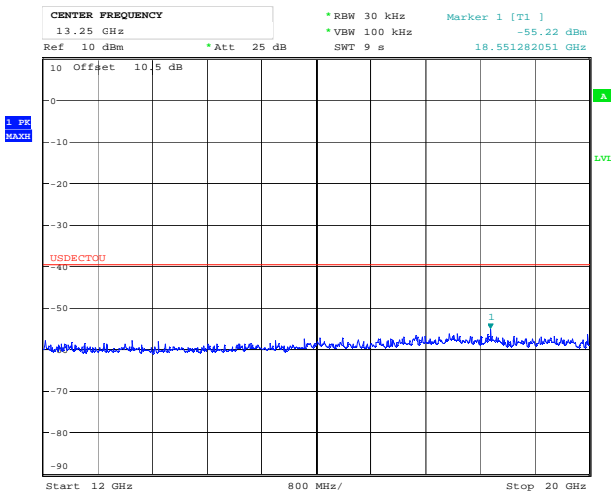

Date: 23.OCT.2020 15:30:43

Out-of-Band Emissions, Middle Channel

4 Measurement Uncertainty

Measurement Uncertainty Values		
Test Item		Uncertainty
Output Power		±0.5 dB
Power Spectral Density		±0.5 dB
Out of Band Emissions, Conducted (RBW < 100 kHz)	< 3.6 GHz	±0.6 dB
	> 3.6 GHz	±0.9 dB
Spurious Emissions, Radiated	< 1 GHz	±2.5 dB
	> 1 GHz	±2.2 dB
Emission Bandwidth		±4 %
Power Line Conducted Emissions		+2.9 / -4.1 dB
Spectrum Mask Measurements	Frequency	±5 %
	Amplitude	±1.0 dB
Frequency Error		±0.6 ppm
Timing and Jitter Measurements		±2.0 ns
Frame Timing Measurements		±1.4 ppm
Receiver Blocking Levels		±1.0 dB
Temperature Uncertainty		±1 °C

All uncertainty values are expanded standard uncertainty to give a confidence level of 95%, based on coverage factor k=2

5 Test Setups

5.1 Conducted Emission Test

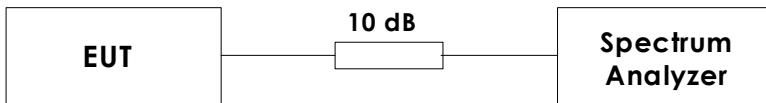

Test Set-up 3

This setup is used for all conducted emission tests.

5.2 Power Line Conducted Emissions Test

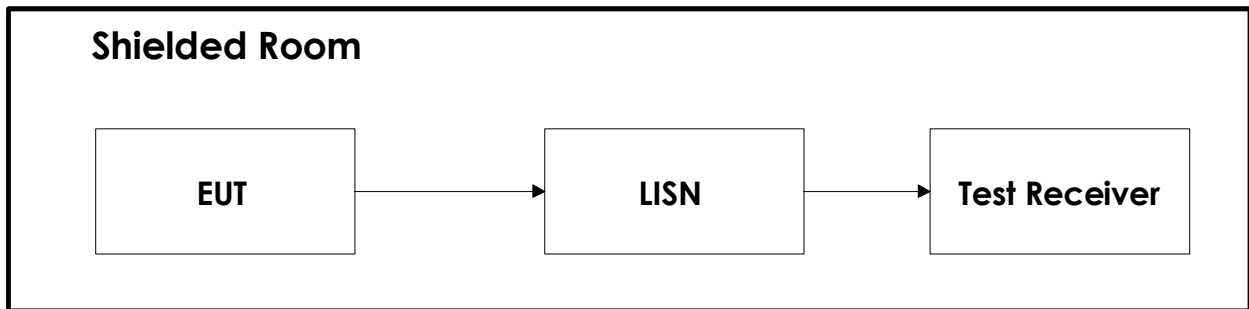

Test Set-Up 5

6 Test Equipment Used

To facilitate inclusion on each page of the test equipment used for related tests, each item of test equipment and ancillaries are identified (numbered) by the Testhouse.

No.	Model number	Description	Manufacturer	Ref. no.	Cal. date	Cal. Due
1	FSU26	Spectrum Analyzer	Rohde & Schwarz	LR 1504	2020-01	2022-01
2	6810.17B	Attenuator	Suhner	LR 1669	2020-08	2021-08
3	ESCI3	Measuring Receiver	Rohde & Schwarz	N-4259	2019.10	2021.10
4	ENV216	Two Line V-Network	Rohde & Schwarz	LR 1665	2019-11	2021-11
5	6812B	AC Power Source	Agilent	LR 1515	2020-04	2021-04
6	ST18/SMA/N/36	RF Cable	Suhner	LR 1627	COU	

COU = Cal on use

The software listed below has been used for one or more tests.

No.	Manufacturer	Name	Version	Comment
1	Rohde & Schwarz	EMC32	10.50.10	Power Line Conducted test software
2	Nemko AS	RSPlot	1.0.8.0	Screenshots from R&S Spectrum Analyzers
3				

Revision history

Revision	Date	Comment	Sign
00	2020-11-17	First edition	FS