

Test Report

Product	DECT Handset		
Name and address of the applicant	Panasonic Corporation of North America Two Riverfront Plaza, 9 th Floor Newark, 07102-5490, NJ, USA		
Name and address of the manufacturer	Panasonic Corporation 1-62, 4-chome, Minoshima, Hakata-ku Fukuoka, 812-8531, Japan		
Model	KX-TGCA35, KX-TGCA36, KX-TGCA38AC		
Rating	2.4V _{DC} (2x AAA NiMH cells)		
Trademark	Panasonic		
Serial number	See clause 1.1		
Additional information	DECT 6.0		
Tested according to	FCC Part 15, subpart B Other Class B Digital Device Industry Canada ICES-003, Issue 7 Information Technology Equipment (ITE)		
Order number	458842		
Tested in period	2022-01-21 to 2022-02-14		
Issue date	2022-02-23		
Name and address of the testing laboratory	<div style="display: flex; justify-content: space-between; align-items: flex-start;"> <div style="text-align: center;">  Instituttveien 6 Kjeller, Norway www.nemko.com </div> <div style="text-align: center;"> CAB Number: FCC: NO0001 ISED: NO0470 </div> <div style="text-align: center;">   </div> </div> <p style="text-align: center; color: red; font-weight: bold;">An accredited technical test executed under the Norwegian accreditation scheme</p>		
	 Prepared by [Frode Sveinsen]	 Approved by [G.Suhanthakumar]	
<p style="font-size: small;">This report shall not be reproduced except in full without the written approval of Nemko. Opinions and interpretations expressed within this report are not part of the current accreditation. This report was originally distributed electronically with digital signatures. For more information contact Nemko.</p>			

Revision history

Revision	Date	Comment	Sign
00	2022-02-23	First edition	FS

CONTENTS

1	INFORMATION	4
1.1	Tested Item	4
1.2	Test Environment	4
1.3	Test Engineer(s)	4
1.4	Test Equipment	4
1.5	Test Configurations	4
1.6	Other Comments	4
2	TEST REPORT SUMMARY	5
2.1	General	5
2.2	Test Summary	5
3	TEST RESULTS.....	6
3.1	Power Line Conducted Emissions	6
3.2	Spurious Emissions (Radiated).....	10
4	MEASUREMENT UNCERTAINTY	12
5	TEST SETUPS	13
5.1	Radiated Emissions Test	13
5.2	Power Line Conducted Emissions Test.....	13
6	TEST EQUIPMENT USED	14

1 INFORMATION

1.1 Tested Item

Name	Panasonic
Model name	KX-TGCA35 KX-TGCA36 KX-TGCA38AC
FCC ID	ACJ96NKX-TGCA35A
FCC / IC Class	B
Serial number	Sample with 50 Ohm connectors: 4588420001 Sample with Integral Antennas: 4588420006
Hardware identity and/or version	S1
Software identity and/or version	SW300
Desktop Charger	PNLC1073 with AC Adaptors PNLV233 (UC), PNLV233 (VJ) , PNLV233 (2A)
Power Supply	Secondary Batteries (2x AAA cells, 1.2V, 400mAh)

Description of Tested Device(s)

The tested equipment is a DECT Handset with Desktop Charger.
 All (handset) model variants listed above are identical.

1.2 Test Environment

Temperature:	20 – 23 °C
Relative humidity:	30 – 50 %
Normal test voltage:	2.4 V _{DC} (Nominal Voltage)

The values are the limit registered during the test period.

1.3 Test Engineer(s)

Frode Sveinsen

1.4 Test Equipment

See list of test equipment in clause 6.

1.5 Test Configurations

Test Configuration	EUT Standby in charger and charging.
--------------------	--------------------------------------

1.6 Other Comments

All tests were performed with the EUT in charger and charging.

2 TEST REPORT SUMMARY

2.1 General

All measurements are traceable to national standards.

All tests were performed in accordance with ANSI C63.4-2014 where applicable. Radiated emissions are made in a 10m semi-anechoic chamber. A description of the test facility is on file with FCC and Industry Canada.



THIS TEST REPORT APPLIES ONLY TO THE ITEM(S) AND CONFIGURATIONS TESTED.

Deviations from, additions to, or exclusions from the test specifications are described in "Summary of Test Data".

Nemko Group authorizes the above named entity to reproduce this report provided it is reproduced in its entirety and for use by the entity's employees only. Any reproduction of parts of this report requires approval in writing from Nemko Group.

Any use that a third party makes of this report, or any reliance on or decisions to be made based on it, are the responsibility of such third parties. Nemko Group accepts no responsibility for damages suffered by any third party caused by decisions made or actions based on this report.

2.2 Test Summary

Name of test	FCC CFR 47, Paragraph #	ISED RSS-GEN, Issue 5, Paragraph #	ISED ICES-003, Issue 7, Paragraph #	Verdict
Power Line Conducted Emission	15.107(a) 15.207(a)	7.2	3.2.1	Complies
Spurious Emissions (Radiated)	15.109	7.3	3.2.2	Complies

3 TEST RESULTS

3.1 Power Line Conducted Emissions

FCC Part 15.107 (a)

ISED RSS-Gen Issue 5, Clause 7.2

ISED ICES-003 Issue 7, Clause 3.2.1

Measurement procedure: ANSI C63.4-2014 using 50 μ H/50 ohms LISN.

Test Results: Complies

Measurement Data: See attached plots.

All tests were performed with 120V 60Hz AC

Highest measured value (L1 and N):

Charging, PNLV233 (UC):

Frequency (MHz)	QuasiPeak (dB μ V)	Average (dB μ V)	Limit (dB μ V)	Margin (dB)	Meas. Time (ms)	Bandwidth (kHz)	Line	Filter
0.158	43.45	---	65.57	22.12	1000	9	N	OFF
0.184	42.43	---	64.30	21.87	1000	9	L1	OFF
0.208	---	34.65	53.29	18.64	1000	9	N	OFF
0.214	---	26.29	53.05	26.76	1000	9	N	OFF
1.820	36.77	---	56.00	19.23	1000	9	L1	OFF
2.184	34.49	---	56.00	21.51	1000	9	N	OFF
2.328	35.95	---	56.00	20.05	1000	9	N	OFF
2.336	---	27.20	46.00	18.80	1000	9	L1	OFF
2.512	39.83	---	56.00	16.17	1000	9	L1	OFF
2.520	35.91	---	56.00	20.09	1000	9	N	OFF
2.636	---	28.81	46.00	17.19	1000	9	L1	OFF
2.672	---	28.70	46.00	17.30	1000	9	L1	OFF
2.708	40.07	---	56.00	15.93	1000	9	L1	OFF
2.748	40.54	---	56.00	15.46	1000	9	L1	OFF
2.792	---	28.68	46.00	17.32	1000	9	L1	OFF
2.796	---	26.14	46.00	19.86	1000	9	N	OFF
2.868	35.91	---	56.00	20.09	1000	9	N	OFF
2.932	39.24	---	56.00	16.76	1000	9	L1	OFF
2.976	39.31	---	56.00	16.69	1000	9	L1	OFF

Charging, PNLV233 (VJ):

Frequency (MHz)	QuasiPeak (dBµV)	Average (dBµV)	Limit (dBµV)	Margin (dB)	Meas. Time (ms)	Bandwidth (kHz)	Line	Filter
0.162	---	26.40	55.36	28.96	1000	9	L1	OFF
0.182	41.80	---	64.39	22.60	1000	9	N	OFF
0.194	---	23.81	53.86	30.06	1000	9	N	OFF
1.056	23.08	---	56.00	32.92	1000	9	L1	OFF
1.404	23.71	---	56.00	32.29	1000	9	N	OFF
2.164	---	21.24	46.00	24.76	1000	9	L1	OFF
2.204	32.03	---	56.00	23.97	1000	9	L1	OFF
2.272	32.27	---	56.00	23.73	1000	9	L1	OFF
2.364	---	20.94	46.00	25.06	1000	9	L1	OFF
2.392	31.37	---	56.00	24.63	1000	9	L1	OFF
2.936	28.25	---	56.00	27.75	1000	9	N	OFF
3.264	30.37	---	56.00	25.63	1000	9	L1	OFF
3.648	---	20.94	46.00	25.06	1000	9	L1	OFF
3.764	---	20.13	46.00	25.87	1000	9	N	OFF
21.404	21.16	---	60.00	38.84	1000	9	L1	OFF
21.724	21.02	---	60.00	38.98	1000	9	L1	OFF
21.848	---	9.64	50.00	40.36	1000	9	L1	OFF

Charging, PNLV233 (2A):

Frequency (MHz)	QuasiPeak (dBµV)	Average (dBµV)	Limit (dBµV)	Margin (dB)	Meas. Time (ms)	Bandwidth (kHz)	Line	Filter
0.190	---	25.45	54.04	28.59	1000	9	L1	OFF
0.192	44.35	---	63.95	19.60	1000	9	N	OFF
0.196	---	24.09	53.78	29.69	1000	9	N	OFF
0.244	38.06	---	61.96	23.90	1000	9	N	OFF
0.254	38.84	---	61.63	22.78	1000	9	L1	OFF
0.256	38.23	---	61.56	23.33	1000	9	N	OFF
0.260	---	18.39	51.43	33.04	1000	9	L1	OFF
0.372	31.52	---	58.46	26.93	1000	9	N	OFF
0.452	---	21.98	46.84	24.86	1000	9	L1	OFF
0.456	34.05	---	56.77	22.72	1000	9	L1	OFF
2.984	28.60	---	56.00	27.40	1000	9	L1	OFF
3.464	28.91	---	56.00	27.09	1000	9	L1	OFF
3.520	---	15.08	46.00	30.92	1000	9	L1	OFF
3.724	28.12	---	56.00	27.88	1000	9	L1	OFF

All emissions were below the Average Limit, even when measured with Peak Detector.

Full Spectrum

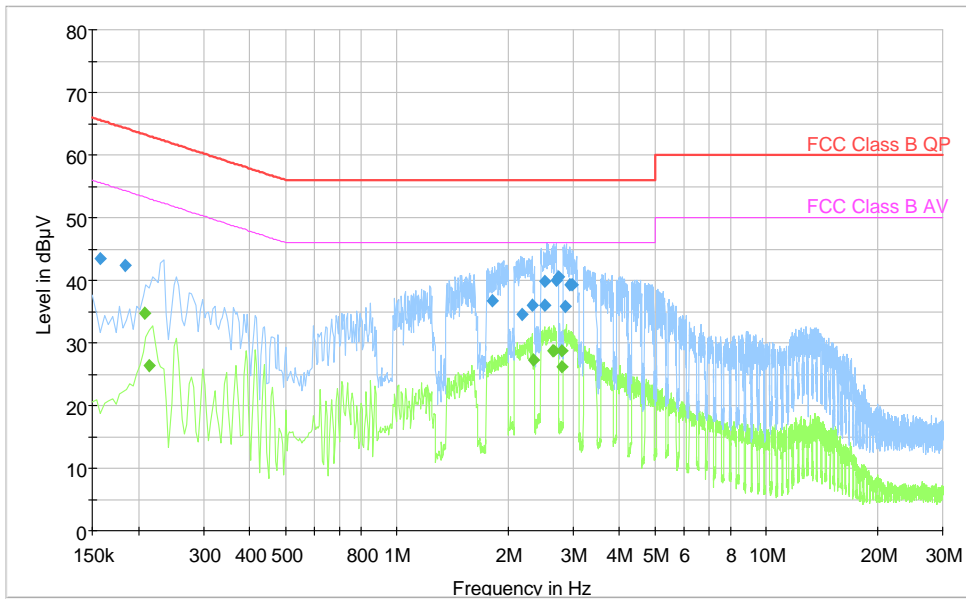

Charging, 120V 60Hz, PNLV233 (UC)

Blue is Peak Det
 Green is Average Det

Full Spectrum

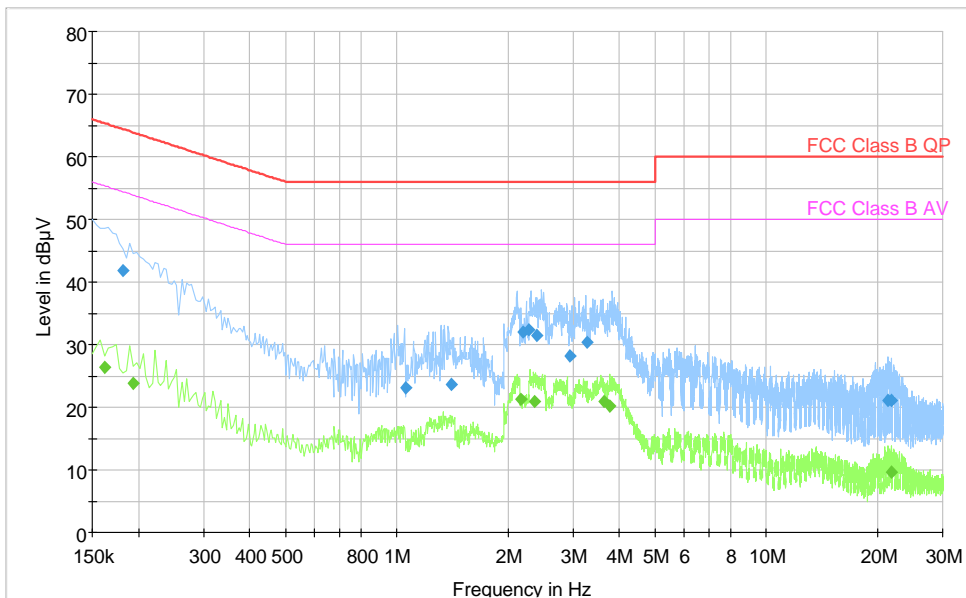

Charging, 120V 60Hz, PNLV233 (VJ)

Blue is Peak Det
 Green is Average Det

Full Spectrum

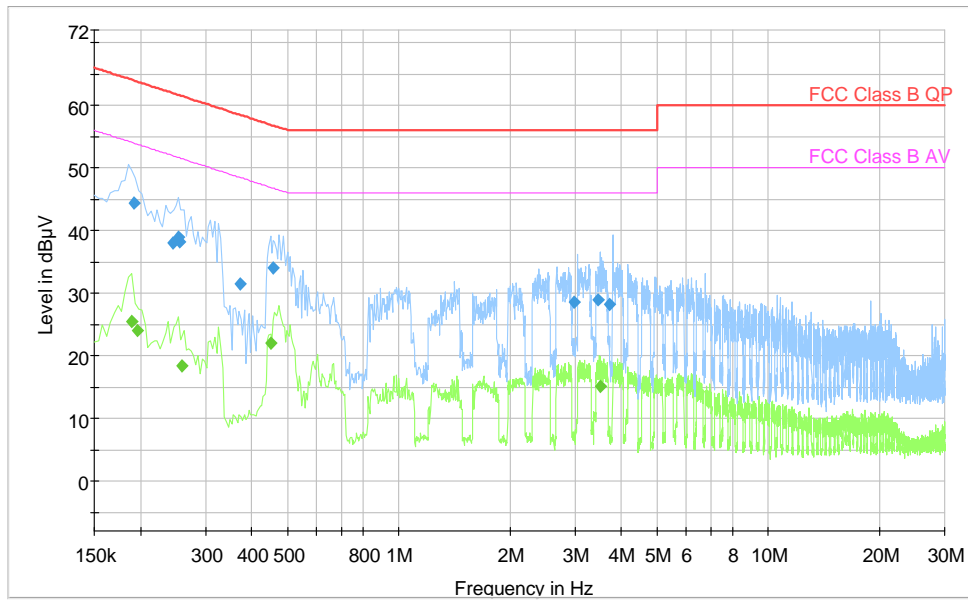

Charging, 120V 60Hz, PNLV233 (2A)

Blue is Peak Det

Green is Average Det

3.2 Spurious Emissions (Radiated)

FCC Part 15.109

ISED RSS-Gen Issue 5, Clause 7.3

ISED ICES-003 Issue 7, Clause 3.2.2

Test Results:

Radiated Emissions 30 - 1000 MHz

Detector: Peak

Measuring distance 3m

The EUT were rotated 360 degrees and the antenna height varied between 1 and 4 m.

PNLV233 (UC) / PNLV233 (VJ) / PNLV233 (2A):

Measured Frequency (MHz)	Measured Emission (dBµV/m)	Limit (dBµV/m)	Margin (dB)
30 – 88	< 30	40.0	>10
88 – 216	< 23.5	43.5	>20
216 – 960	< 30	46.0	>16
960 – 1000	< 36	54.0	>18

Requirements/Limit

FCC	Part 15.209 @ frequencies defined in §15.205	
ISED	RSS-GEN Issue 4, Clause 8.9 @ frequencies defined in clause 8.10	
	Radiated emission limit @3 meters	
Frequency (MHz)	Quasi Peak (µV/m)	Quasi Peak (dBµV/m)
30 – 88	100	40.0
88 – 216	150	43.5
216 – 960	200	46.0
Above 960	500	54.0

¹ The limit above 1000 MHz is specified for Average Detector, when the measurement is performed with a Peak Detector a Duty-Cycle Correction Factor has to be calculated to find the corresponding Average Detector value.

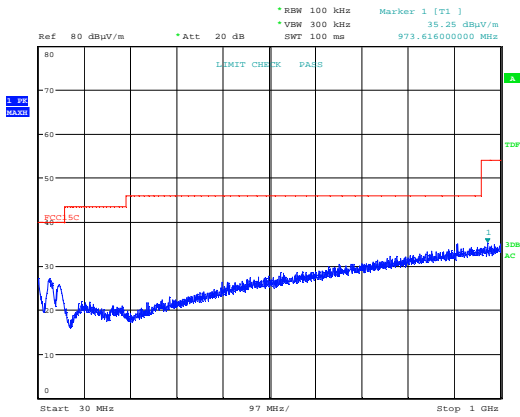

Date: 26.JAN.2022 13:03:54

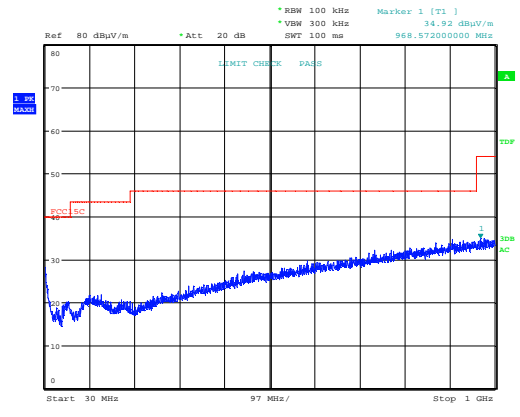

Date: 26.JAN.2022 13:06:06

Radiated Emissions 30 – 1000 MHz, AC Adaptor PNLV223 (UC), VP HP

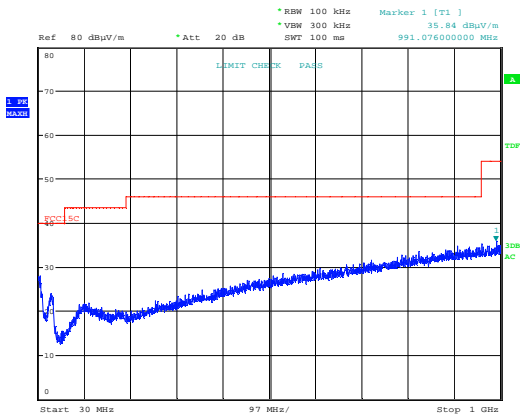

Date: 26.JAN.2022 13:26:33

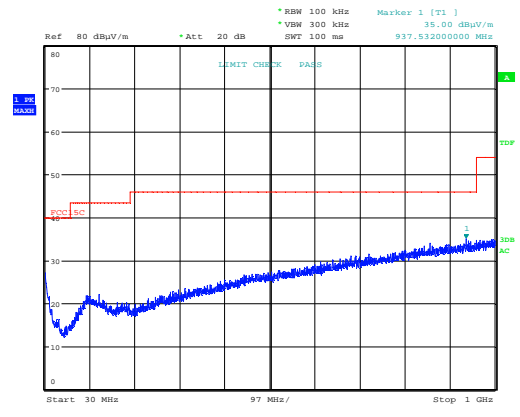

Date: 26.JAN.2022 13:28:46

Radiated Emissions 30 – 1000 MHz, AC Adaptor PNLV223 (VJ), VP HP

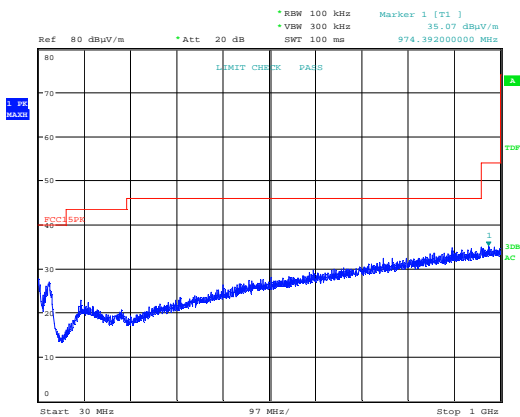

Date: 26.JAN.2022 13:39:57

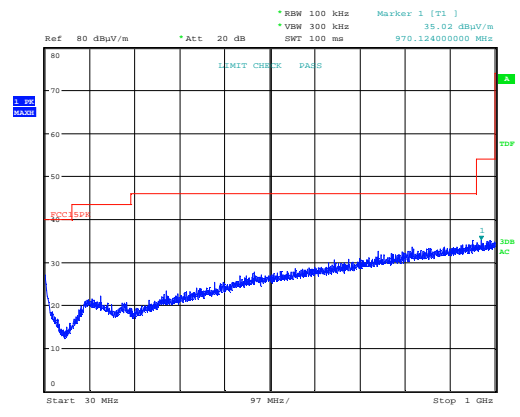

Date: 26.JAN.2022 13:42:09

Radiated Emissions 30 – 1000 MHz, AC Adaptor PNLV223 (2A), VP HP

4 Measurement Uncertainty

Measurement Uncertainty Values		
Test Item		Uncertainty
Spurious Emissions, Radiated	< 1 GHz	±2.5 dB
	> 1 GHz	±2.2 dB
Power Line Conducted Emissions		+2.9 / -4.1 dB
Temperature Uncertainty		±1 °C

All uncertainty values are expanded standard uncertainty to give a confidence level of 95%, based on coverage factor $k=2$

5 Test Setups

5.1 Radiated Emissions Test

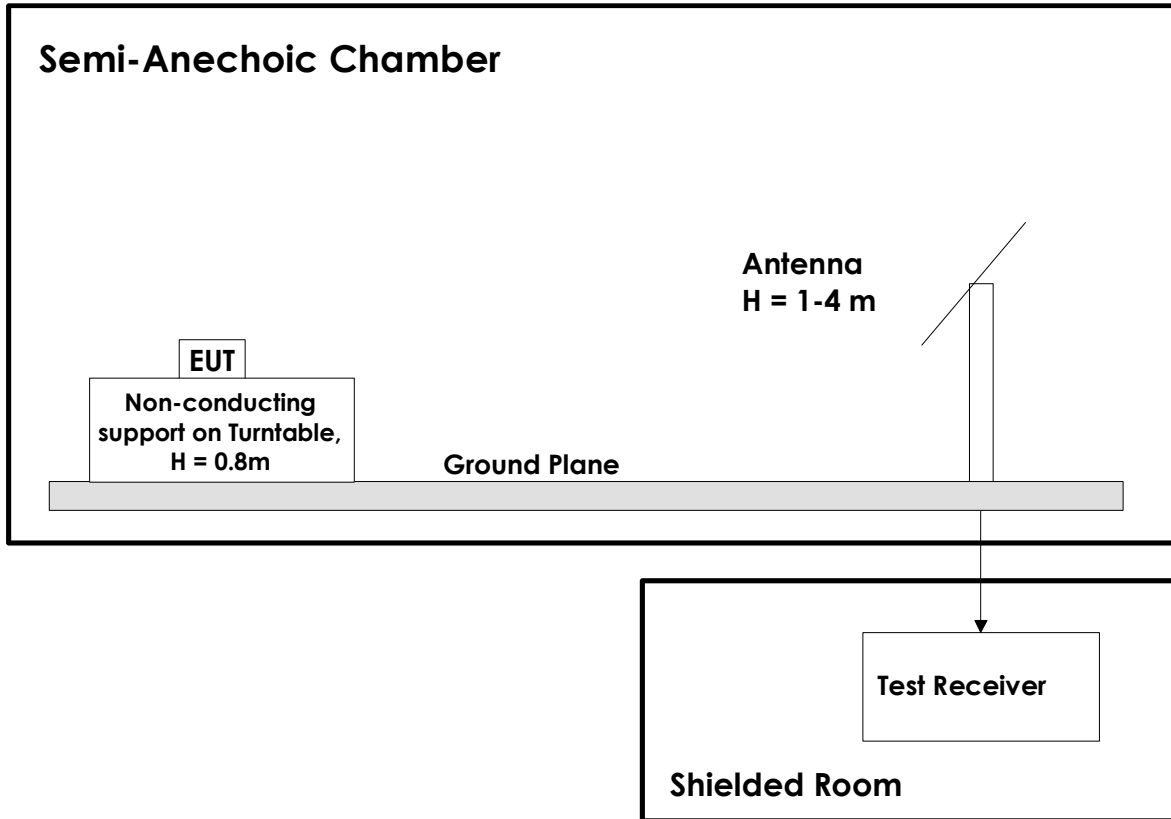

This test setup is used for all radiated emissions tests. For frequencies below 30 MHz the measuring distance is 10m, for all other frequencies it is 3m or 1m. Emissions above 1 GHz are measured with a Spectrum Analyzer and Horn Antenna. For measurements above 18 GHz the test receiver is moved inside the anechoic chamber and located next to the antenna to minimize the cable loss. All measurements at 1GHz and above were performed with turntable height 1.5m and with the ground plane covered by absorbers. A pre-amplifier is used for all measurements above 30 MHz.

5.2 Power Line Conducted Emissions Test

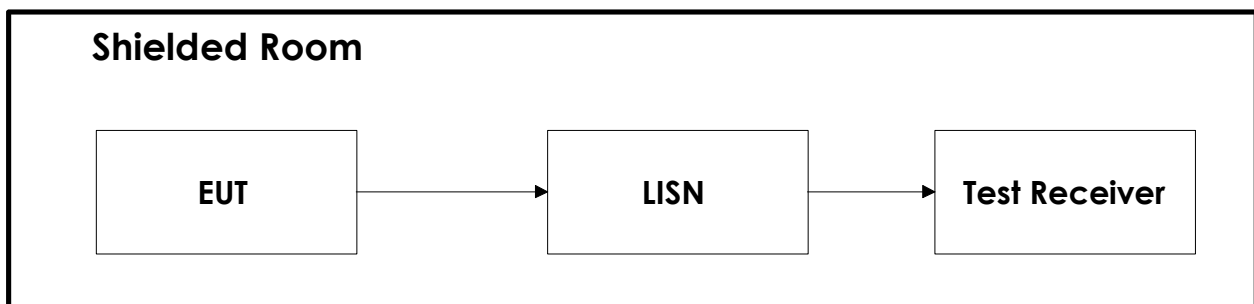

6 Test Equipment Used

To facilitate inclusion on each page of the test equipment used for related tests, each item of test equipment and ancillaries are identified (numbered) by the Testhouse.

No.	Model number	Description	Manufacturer	Ref. no.	Cal. date	Cal. Due
1	ESU40	Measuring Receiver	Rohde & Schwarz	LR 1639	2022-01	2023-01
2	L01G18G1	Low Pass Filter (1 GHz)	Microwave Circuits	LR 1768	2021-08	2022-08
3	JB3	BiLog Antenna	Sunol	N-4525	2020-03	2023-03
4	310	Preamplifier	Sonoma Inst.	LR 1686	2021-08	2022-08
5	6812B	AC Power Source	Agilent	LR 1515	2020-04	2022-04
6	ESCI3	Measuring Receiver	Rohde & Schwarz	N-4259	2021.10	2023.10
7	ENV216	Two Line V-Network	Rohde & Schwarz	LR 1665	2021-12	2023-12

COU = Calibrate on Use

The software listed below has been used for one or more tests.

No.	Manufacturer	Name	Version	Comment
1	Rohde & Schwarz	EMC32	10.50.10	EMC test software
3	Nemko AS	RSPlot	1.0.8.0	Screenshots from R&S Spectrum Analyzers