



**CONFORMANCE TEST REPORT
 FOR
 FCC Part 15, subpart D**

Report No.: 17-10-MAS-010-01

Client: Panasonic Corporation of North America
 Product: Baby Monitor
 Model: KX-HNC300
 FCC ID: ACJ96NKX-HNC300

Manufacturer/supplier: Panasonic Corporation

Date test item received: 2017/10/02
 Date test campaign completed: 2017/12/20
 Date of issue: 2017/12/20

The test result only corresponds to the tested sample. It is not permitted to copy this report, in part or in full, without the permission of the test laboratory.
Total number of pages of this test report: 85 pages
Total number of pages of photos: External photos 5 pages
Internal photos 8 pages
Setup photos 2 pages

Test Engineer	Checked By	Approved By
John Li	Falcon Shi	Jerry Huang

Table of Contents Page

- 1 GENERAL INFORMATION 4**
- 1.1 Testing Laboratory 4
- 1.2 Client Information 4
- 1.3 Manufacturer 4
- 2 TEST INFORMATION..... 5**
- 2.1 Description of Tested Device(s)..... 5
- 2.2 Test Environment 5
- 3 TEST REPORT SUMMARY 6**
- 3.1 Test Summary 6
- 3.2 Other Comments 7
- 4 TEST SETUP..... 8**
- 4.1 Frequency and Timing Measurements 8
- 4.2 Conducted Emission Tests 8
- 4.3 Radiated Emission Tests 9
- 4.4 Power line Conducted Tests 9
- 4.5 Monitoring Tests 10
- 5 TEST EQUIPMENT LIST..... 11**
- 6 TEST RESULT 12**
- 6.1 Cross Reference 12
- 6.2 Field Strength Calculation..... 17
- 6.3 Labeling Requirements 18
- 6.4 Power line Conducted Emissions 19
- 6.5 Result Data Calculation..... 22
- 6.6 Antenna Requirement 23
- 6.7 Digital Modulation Techniques 23
- 6.8 Peak Transmit Power 24
- 6.9 Power Spectral Density..... 28
- 6.10 Antenna Gain..... 32
- 6.11 Automatic discontinuation of transmission..... 32
- 6.12 Safety exposure levels 33
- 6.13 Emission Bandwidth B 35
- 6.14 Monitoring time 39
- 6.15 Monitoring threshold 40

6.16 Maximum transmit period	41
6.17 System Acknowledgement	43
6.18 Least Interfered Channel, LIC	48
6.19 Random waiting	55
6.20 Monitoring bandwidth and reaction time	56
6.21 Monitoring antenna	63
6.22 Monitoring threshold relaxation	64
6.23 Duplex system LBT	65
6.24 Co-located device LBT	66
6.25 Fair Access	67
6.26 Emissions inside and outside the subband	68
6.27 Frame period and jitter	81
6.28 Carrier frequency stability	84

1 GENERAL INFORMATION

1.1 Testing Laboratory

Name: Electronic Testing Center, Taiwan
Address: No.8, Lane 29, Wenming Rd. Guishan Dist.
Taoyuan City 33383, Taiwan, R.O.C.
Telephone: 886-3-3280026
Fax: 886-3-3276188
NVLAP lab registration #: 200133-0
FCC Registration Number: TW0371, TW1112
Industry Canada Site IC 2949A-2
Registration Number:

1.2 Client Information

Name: Panasonic Corporation of North America
Address: Two Riverfront Plaza, 9th Floor, Newark, NJ
Telephone: 201-348-7760
Contact person: Ben, Botros

1.3 Manufacturer

Name: Panasonic Corporation
Address: 1006, OazaKadoma, Kadoma-shi, Osaka, Japan

2 TEST INFORMATION

2.1 Description of Tested Device(s)

The tested equipment is Baby unit that complies with ETSI EN 300175. The frequencies have been reprogrammed to comply with the FCC and IC requirements to an Isochronous UPCS device after FCC Part 15D and Industry Canada RSS-213 Issue 3.

The EUT is a responding device as described in ANSI C63.17-2013 and is designed to operate together with a DECT base station, which is then the initiating device.

Frequency Channel	Frequency	Test Frequency
CH4	1921.536 MHz	F _L
CH3	1923.264 MHz	-
CH2	1924.992 MHz	F _M
CH1	1926.720 MHz	-
CH0	1928.448 MHz	F _H

2.2 Test Environment

Normal test condition

Temperature:	20 - 25 °C
Relative humidity:	55 - 75%

Extreme test condition (declared by manufacturer)

Please see the manufacturer declaration form.

3 TEST REPORT SUMMARY

3.1 Test Summary

Requirement	FCC Paragraph #	Required	Customer Declaration	Test Pass
Cross Reference	15.33 (a), 15.309(b)	<input checked="" type="checkbox"/>	<input type="checkbox"/>	<input checked="" type="checkbox"/>
Labeling requirements	15.311,15.19(a)(3)	<input checked="" type="checkbox"/>	<input checked="" type="checkbox"/>	<input type="checkbox"/>
Power line Conducted Emission	15.315,15.207	<input checked="" type="checkbox"/>	<input checked="" type="checkbox"/>	<input checked="" type="checkbox"/>
Antenna Requirement	15.317, 15.203	<input checked="" type="checkbox"/>	<input checked="" type="checkbox"/>	<input type="checkbox"/>
Digital Modulation Techniques	15.319(b)	<input checked="" type="checkbox"/>	<input checked="" type="checkbox"/>	<input type="checkbox"/>
Peak transmit Power	15.319(c)	<input checked="" type="checkbox"/>	<input type="checkbox"/>	<input checked="" type="checkbox"/>
Power Spectral Density	15.319(d)	<input checked="" type="checkbox"/>	<input type="checkbox"/>	<input checked="" type="checkbox"/>
Antenna gain	15.319(e)	<input checked="" type="checkbox"/>	<input checked="" type="checkbox"/>	<input type="checkbox"/>
Automatic discontinuation of transmission	15.319(f)	<input checked="" type="checkbox"/>	<input checked="" type="checkbox"/>	<input type="checkbox"/>
Safety exposure levels	15.319(i)	<input checked="" type="checkbox"/>	<input type="checkbox"/>	<input checked="" type="checkbox"/>
Emission Bandwidth	15.323(a)	<input checked="" type="checkbox"/>	<input type="checkbox"/>	<input checked="" type="checkbox"/>
Monitoring time	15.323(c)(1)	<input checked="" type="checkbox"/>	<input type="checkbox"/>	<input checked="" type="checkbox"/>
Monitoring threshold	15.323(c)(2)	<input checked="" type="checkbox"/>	<input checked="" type="checkbox"/>	<input type="checkbox"/>
Maximum transmit period	15.323(c)(3)	<input checked="" type="checkbox"/>	<input type="checkbox"/>	<input checked="" type="checkbox"/>
System acknowledgement	15.323(c)(4)	<input checked="" type="checkbox"/>	<input type="checkbox"/>	<input checked="" type="checkbox"/>
Least Interfered Channel, LIC	15.323(c)(5)	<input checked="" type="checkbox"/>	<input type="checkbox"/>	<input checked="" type="checkbox"/>
Random waiting	15.323(c)(6)	<input checked="" type="checkbox"/>	<input checked="" type="checkbox"/>	<input type="checkbox"/>
Monitoring bandwidth and reKX-HNC300ion time	15.323(c)(7)	<input checked="" type="checkbox"/>	<input type="checkbox"/>	<input checked="" type="checkbox"/>
Monitoring antenna	15.323(c)(8)	<input checked="" type="checkbox"/>	<input checked="" type="checkbox"/>	<input type="checkbox"/>
Monitoring threshold relaxation	15.323(c)(9)	<input checked="" type="checkbox"/>	<input type="checkbox"/>	<input checked="" type="checkbox"/>
Duplex system LBT	15.323(c)(10)	<input checked="" type="checkbox"/>	<input checked="" type="checkbox"/>	<input type="checkbox"/>
Co-located device LBT	15.323(c)(11)	<input checked="" type="checkbox"/>	<input checked="" type="checkbox"/>	<input type="checkbox"/>
Fair access	15.323(c)(12)	<input checked="" type="checkbox"/>	<input checked="" type="checkbox"/>	<input type="checkbox"/>
Emissions inside and outside the subband	15.323(d)	<input checked="" type="checkbox"/>	<input type="checkbox"/>	<input checked="" type="checkbox"/>
Frame period and jitter	15.323(e)	<input checked="" type="checkbox"/>	<input type="checkbox"/>	<input checked="" type="checkbox"/>
Carrier frequency stability	15.323(f)	<input checked="" type="checkbox"/>	<input type="checkbox"/>	<input checked="" type="checkbox"/>

Note: The final test data was worst-case data in this report, the worst-case mode from all possible combinations between available modulations, data rates and antenna ports (if EUT with antenna diversity architecture).

3.2 Other Comments

All measurements are traceable to national standards.

The tests were conducted on a sample of the equipment for the purpose of demonstrating compliance with FCC CFR47 Part 15, Paragraph 15.323 for Isochronous UPCS Devices and Industry Canada RSS-213 Issue 3.

The conducted test methods have been in accordance with ANSI C63.17-2013 where applicable. Radiated tests were conducted in accordance with ANSI C63.4-2014.

Where a test method specified in this Standard cannot be followed, a test method given in ANSI C63.17-2013 may be used by quoting the test section number. An equivalent alternative method may also be used provided that it is fully described in the test report.

Where a test is not practicable (e.g. the test for an access protocol of Section 4.3.4), the certification applicant may submit to Industry Canada the manufacturer's declaration that the access protocol has nevertheless been met in the design and prototype tests. Full justification as to why testing is not practicable should be given for Industry Canada's consideration.

A mid-band carrier frequency should normally be used for tests.

When an antenna conducted measurement is used to determine the RF output power of the device, the effective gain of the antenna intended for the device must be stated, based on measurement or on data from the antenna manufacturer. Any antenna gain in excess of 3 dBi (3 dB above isotropic gain) shall be added to the measured RF output power before using the power limits specified in this standard.

Accessories and peripheral equipment that are normally required to be connected to the device in actual use, shall be so connected with representative cable lengths for the tests. Only one test using representative peripherals and accessories is required. The emission tests shall be performed with the device and accessories configured in a manner which tends to produce the maximum level of emissions within the range of variations that can be expected under normal operating conditions.

4 TEST SETUP

4.1 Frequency and Timing Measurements

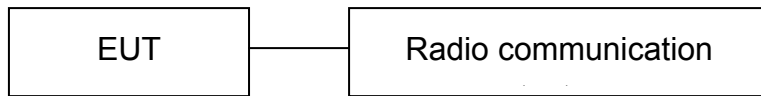

Test Set-up 1

This setup is used for measuring Frame repetition stability, Jitter, Carrier frequency stability at normal and extreme temperatures.

4.2 Conducted Emission Tests

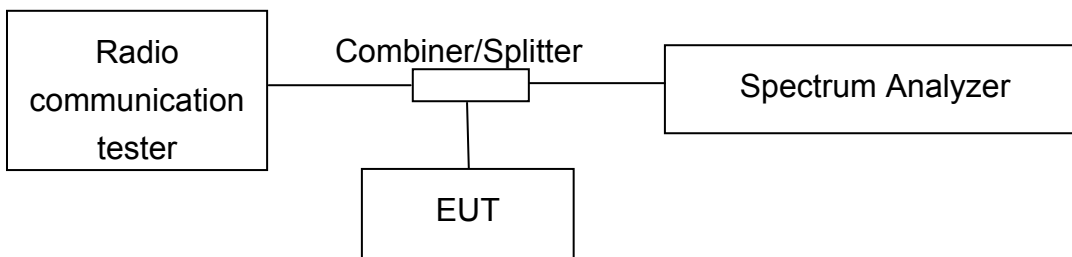

Test Set-up 2

This setup is used for all conducted emission tests.

4.3 Radiated Emission Tests

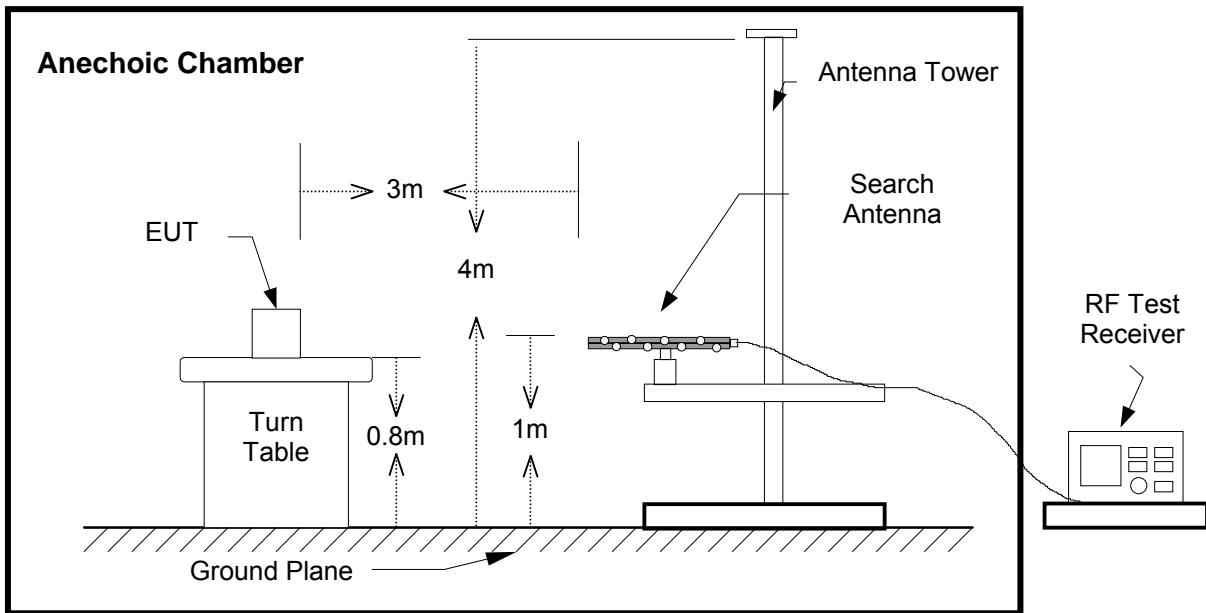

Test Set-Up 3

This test setup is used for all radiated emissions tests. For frequencies below 30 MHz the measuring distance is 10 m, for all other frequencies it is 3 m. Emissions above 1 GHz were measured with the Spectrum Analyzer, Horn Antenna and the preamplifier after the antenna.

4.4 Power line Conducted Tests

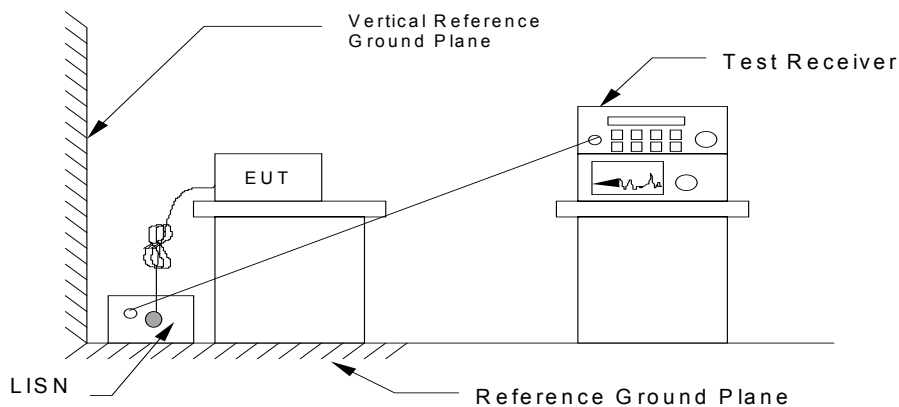

Test Set-Up 4

4.5 Monitoring Tests

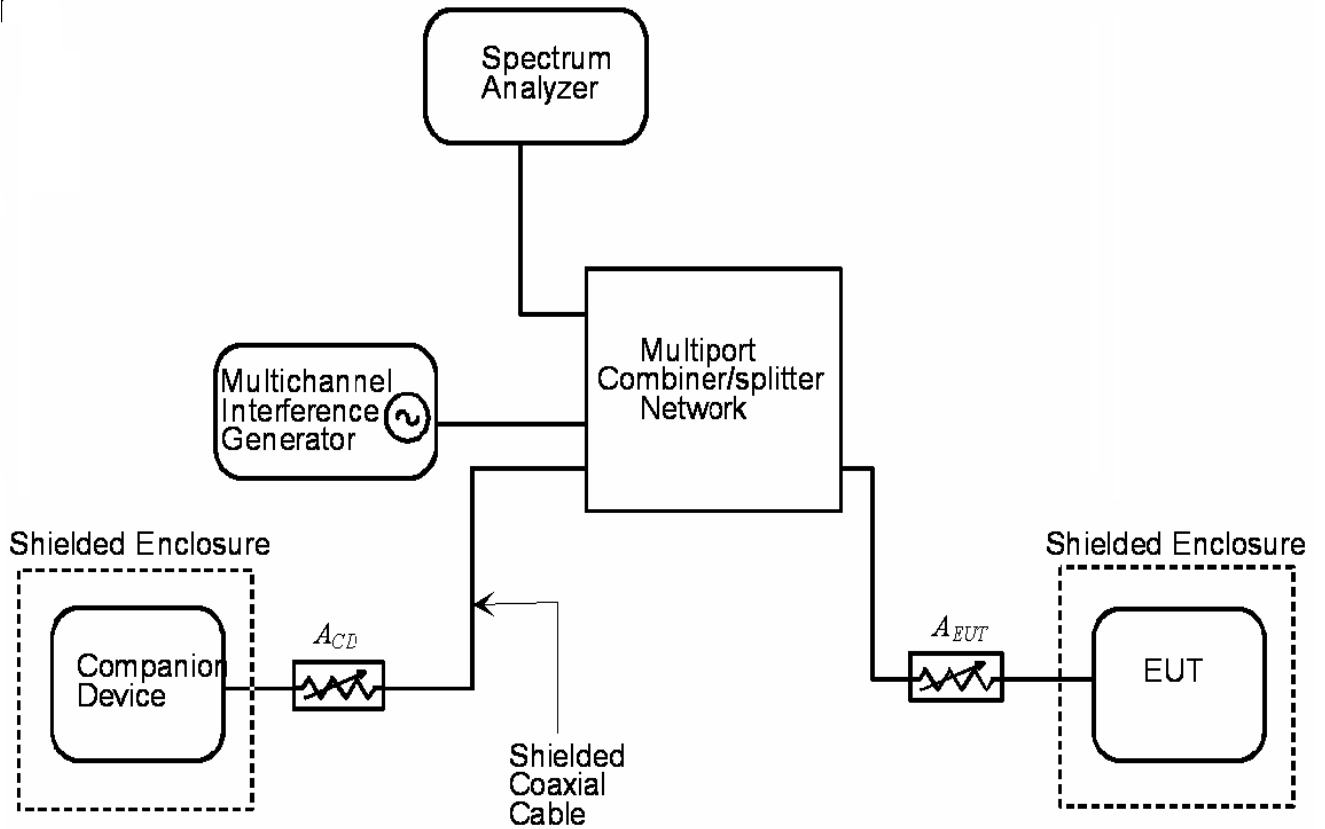

Test Set-Up 5

This test setup is used for all Monitoring and Time and Spectrum Access Procedure tests.

Companion Device	A _{CD} (dB)	EUT	A _{EUT} (dB)
Base	50	Handset	0
Handset	30	Base	0

5 TEST EQUIPMENT LIST

To facilitate inclusion on each page of the test equipment used for related tests, each item of test equipment and ancillaries are identified (numbered) by the Test Laboratory.

Equipment	ManufKX- HNC300urer	Model No.	S/N	Calibration Date (MM/DD/YY)	Next Calibration Date (MM/DD/YY)
EMI Test Receiver	R&S	ESCI	13054418-001	01/16/2017	01/15/2018
BiLog Antenna	ETC	MCTD 2786B	BLB17F04016	02/15/2017	02/14/2018
Horn Antenna	EMCO	3115	13059201-001	11/29/2017	11/28/2018
Horn Antenna	EMCO	3116	13059202-001	11/04/2017	11/03/2018
PRE-Amplifier	Agilent	8449B	13040709-001	01/10/2017	01/09/2018
Spectrum Analyzer	Agilent	E4446A	13052013-001	01/24/2017	01/23/2018
Spectrum Analyzer	R&S	FSU46	13040904-001	01/10/2017	01/09/2018
Radio Communication Tester	Rohde & Schwarz	CTS60	13046802-002	10/09/2017	10/08/2018
RF Downconverter	National Instruments	PXI-5600	E35372	05/08/2017	05/07/2018
RF Downconverter	National Instruments	PXI-5600	E224BD	05/08/2017	05/07/2018
64 MS/s Digitizer	National Instruments	PXI-5620	E34BOB	05/08/2017	05/07/2018
64 MS/s Digitizer	National Instruments	PXI-5620	E22946	05/08/2017	05/07/2018
100 MS/s AWG OSP	National Instruments	PXI-5441	E32987	05/08/2017	05/07/2018
8-Bit 250 MS/s Digitizer	National Instruments	PXI-5114	E41FBC	05/08/2017	05/07/2018
8-Bit 250 MS/s Digitizer	National Instruments	PXI-5114	E41FBE	05/08/2017	05/07/2018
RF Upconverter	National Instruments	PXI-5610	E35372	05/08/2017	05/07/2018
Loop Antenna	EMCO	6512	13054104-001	01/18/2017	01/17/2018

6 TEST RESULT

6.1 Cross Reference

6.1.1 Standard Applicable:

15.309(b)

The requirements of Subpart D apply only to the radio transmitter contained in the PCS device. Other aspects of the operation of a PCS device may be subject to requirements contained elsewhere in this Chapter. In particular, a PCS device that includes digital circuitry not directly associated with the radio transmitter also is subject to the requirements for unintentional radiators in Subpart B.

15.109(a)

For unintentional device, according to **FCC §15.109(a)**, the field strength of radiated emissions from unintentional except for class A digital device radiators at a distance of 3 meters shall not exceed the following values:

Frequency MHz	Distance Meters	Radiated μ V/m	Radiated dB μ V/m
30 - 88	3	100	40.0
88 - 216	3	150	43.5
216 - 960	3	200	46.0
above 960	3	500	54.0

For intentional radiator device, according to §15.209(a), the emissions from an intentional radiator shall not exceed the field strength levels specified in the following table:

Frequency (MHz)	Field Strength (microvolts/meter)	Measurement Distance (meters)
0.009 - 0.490	2400/F(kHz)	300
0.490 - 1.705	24000/F(kHz)	30
1.705 - 30.0	30	30
30 - 88	100 **	3
88 - 216	150 **	3
216 - 960	200 **	3
Above 960	500	3

** Except as provided in paragraph (g), fundamental emissions from intentional radiators operating under this Section shall not be located in the frequency bands 54-72 MHz, 76-88 MHz, 174-216 MHz or 470-806 MHz. However, operation within these frequency bands is permitted under other sections of this Part, e.g., Sections 15.231 and 15.241.

6.1.2 Test Results:

This requirement is not applicable because test sample do not include digital circuitry which is not direct associated with the radio transmitter	<input type="checkbox"/>
For test results according to FCC part 15 subpart B, see the EMC report as attached	<input type="checkbox"/>
For test results according to FCC part 15 subpart B, see the measurement data as follow	<input checked="" type="checkbox"/>
This requirement is covered by results of power line conducted emission test according to FCC 15.315	<input checked="" type="checkbox"/>

Note: For radiated test, if EUT is a handset, rotate the EUT in turns with three orthogonal axes to determine the axis of maximum emission as a worse case.

B. Above 1GHz

Frequency (MHz)	Ant Pol H/V	Reading (dBuV/m)@3m		Factor (dBuV)	Result (dBuV/m)@3m		Limit (dBuV/m)@3m		Margin (dB)
		Peak	(dB)		Peak	AVG	Peak	AVG	
1532.2436	V	73.8	42.5	-10.50	63.3	32.0	74	54	-10.7
1538.8141	H	52.9	---	-10.50	42.4	---	74	54	-11.6
1670.8333	V	59.2	37.2	-9.60	49.6	27.6	74	54	-24.4
1729.8077	V	53.9	39.1	-9.30	44.6	29.8	74	54	-24.2
1731.2821	H	50.5	---	-9.30	41.2	---	74	54	-12.8
1745.5000	V	54.4	38.7	-9.20	45.2	29.5	74	54	-24.5
1768.1410	V	58.2	39.8	-9.00	49.2	30.8	74	54	-23.2
1807.9487	V	53.9	38.5	-8.80	45.1	29.7	74	54	-24.3
1900.8333	V	54.1	36.3	-8.20	45.9	28.1	74	54	-25.9
1930.5834	V	58.5	38	-8.00	50.5	30.0	74	54	-23.5
1937.5481	V	57.5	41.4	-7.90	49.6	33.5	74	54	-20.5
1977.8045	H	50	---	-7.70	42.3	---	74	54	-11.7
2020.5769	H	50.6	---	-7.50	43.1	---	74	54	-10.9
2113.6699	V	53.2	38.8	-7.30	45.9	31.5	74	54	-22.5
2455.8494	V	51.6	37.0	-6.40	45.2	30.6	74	54	-23.4
2458.3654	H	50.1	---	-6.40	43.7	---	74	54	-10.3
3842.9808	H	48.3	---	-1.60	46.7	---	74	54	-7.3
3848.5577	V	50.1	33.9	-1.50	48.6	32.4	74	54	-21.6
4778.0450	H	48.0	---	-0.10	47.9	---	74	54	-6.1
5724.0064	H	46.0	32.8	1.60	47.6	34.4	74	54	-19.6
5763.7500	V	55.5	32.3	1.60	57.1	33.9	74	54	-16.9
7682.6823	H	55.6	35.9	4.20	59.8	40.1	74	54	-13.9
7682.6923	V	56.6	35.8	4.20	60.8	40.0	74	54	-13.2
9611.3782	H	58.7	36.3	5.40	64.1	41.7	74	54	-9.9
9611.3782	V	55.9	35.8	5.40	61.3	41.2	74	54	-12.7
11540.064	H	48.5	34.8	8.00	56.5	42.8	74	54	-11.2

C. below 30MHz

Frequency (MHz)	Reading (dBuV/m)	Duty (dB)	Factor (dB)	Result @3m (dBuV/m)			Limit @3m (dBuV/m)	
	Peak			Peak	QP	(MHz)	Peak	(dB)
Radiated emission frequencies from 9 kHz to 30 MHz were too low to be measured.								

- Note:
- Place of Measurement: Measuring site of the ETC.
 - The measurements of radiated emission frequencies from 9kHz to 30MHz were greater than 20dB below the limit.
 - The estimated measurement uncertainty of the result measurement is
 - ±4.2dB (9kHz ≤ f ≤ 30MHz).
 - ±4.6dB (30MHz ≤ f < 300MHz).
 - ±4.4dB (300MHz ≤ f < 1000MHz).
 - ±4.1dB (1GHz ≤ f < 18GHz).
 - ±4.4dB (18GHz ≤ f ≤ 40GHz).
 - Remark “---” means that the emissions level is too low to be measured.

6.2 Field Strength Calculation

The field strength is calculated by adding the Antenna Factor, High Pass Filter Loss(if used) and Cable Loss, and subtracting the Amplifier Gain (if any) from the measured reading. The basic equation calculation is as follows:

$$\mathbf{Result = Reading + Corrected Factor}$$

where

$$\text{Corrected Factor} = \text{Antenna Factor} + \text{Cable Loss} + \text{High Pass Filter Loss} - \text{Amplifier Gain}$$

6.3 Labeling Requirements

6.3.1 Standard Applicable: FCC 15.19

The FCC Identifier shall be displayed on the label, and the device(s) shall bear the following statement in a conspicuous location on the device or in the user manual if the device is too small:

Operation is subject to the following two conditions: (1) this device may not cause harmful interference, and (2) this device must accept any interference received, including interference that may cause undesired operation.

The label itself shall be of a permanent type, not a paper label, and shall last the lifetime of the equipment.

6.3.2 Result

See separate documents showing the label design and the placement of the label on the EUT.

6.4 Power line Conducted Emissions

6.4.1 Standard Applicable:

15.315

An unlicensed PCS device that is designed to be connected to the public utility (AC) power line must meet the limits specified in Section 15.207.

15.207(a)

For an intentional radiator that is designed to be connected to the public utility (AC) power line, the radio frequency voltage that is conducted back onto the AC power line on any frequency or frequencies within the band 150 kHz to 30 MHz shall not exceed the limits in the following table, as measured using a 50 μ H/50 ohms line impedance stabilization network (LISN). Compliance with the provisions of this paragraph shall be based on the measurement of the radio frequency voltage between each power line and ground at the power terminal. The lower limit applies at the boundary between the frequency ranges.

Frequency MHz	Quasi Peak dB μ V	Average dB μ V
0.15 - 0.5	66-56*	56-46*
0.5 - 5.0	56	46
5.0 - 30.0	60	50

*Decreases with the logarithm of the frequency.

6.4.2 Measurement Procedure

ANSI C63.4-2014 using 50 μ H/50 ohms LISN.

6.4.3 Test Results: Complies

Measurement Data: See attached graph, (Peak detector).

Highest measured value (L1 and N):

All emissions were below the QP and Average limits when measured with Peak detector.

The test was performed with the EUT in standby charging and repeated with the EUT transmitting in speakerphone mode and charging.

Conducted Emission Test

File: c

Data: #3

Date: 2017/12/7

Temperature: 20 °C

Time: PM 01:41:39

Humidity: 58 %

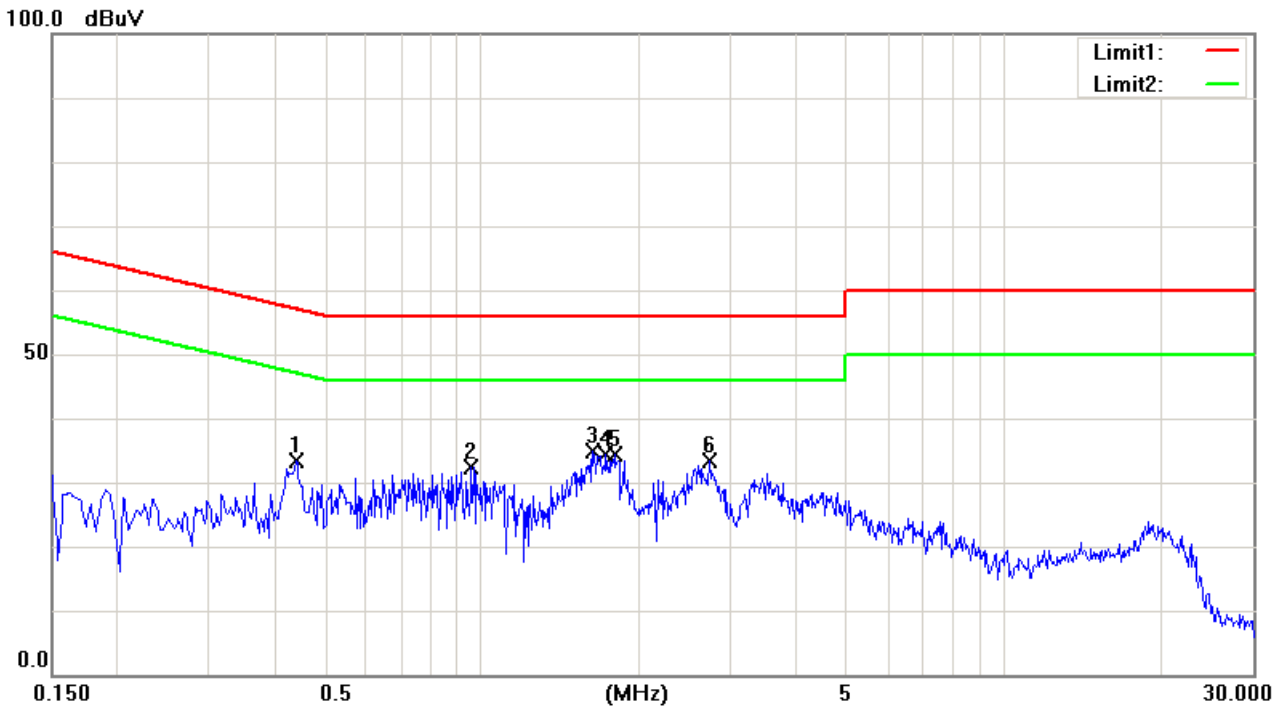

Condition:

Phase:

N

EUT:

Model:

Test Mode: c

No.	Frequency (MHz)	Reading (dBuV)	Detector	Corrected dB	Result (dBuV)	Limit (dBuV)	Margin (dB)
1	0.4420	33.23	peak	0.04	33.27	57.02	-23.75
2	0.9580	32.36	peak	0.05	32.41	56.00	-23.59
3	1.6300	34.71	peak	0.06	34.77	56.00	-21.23
4	1.7300	34.34	peak	0.06	34.40	56.00	-21.60
5	1.7980	34.30	peak	0.07	34.37	56.00	-21.63
6	2.7300	33.18	peak	0.08	33.26	56.00	-22.74

Note: 1. "****" means the value was too low to be measured.

2. If the data table appeared symbol of "----" means the Q.P. value is under the limit of AVG. so, the AVG. value doesn't need to be measured.

3. The estimated measurement uncertainty of the result measurement is ±2.5dB.

6.5 Result Data Calculation

The result data is calculated by adding the LISN Factor to the measured reading. The basic equation with a sample calculation is as follows:

$$\mathbf{RESULT = READING + LISN FACTOR (Included Cable Loss)}$$

6.6 Antenna Requirement

6.6.1 Standard Applicable: FCC 15.317, 15.203

Does the EUT have detachable antenna?

Yes

No

If detachable, is the antenna connector non-standard.

Yes

No

The tested equipment has integral antennas. The conducted tests were performed on a sample with a temporary antenna connector.

The EUT antennas are soldered on the circuit board (fixed, meet the requirements of FCC 15.203.)

6.7 Digital Modulation Techniques

6.7.1 Standard Applicable: FCC 15.319(b)

All transmissions must use only digital modulation techniques.

6.7.2 Result: Meets the requirement

Please see the declaration provided by applicant.

6.8 Peak Transmit Power

6.8.1 Standard Applicable: FCC 15.319(c) & (e)

(c) Peak transmit power shall not exceed 100 microwatts multiplied by the square root of the emission bandwidth in hertz. Peak transmit power must be measured over any interval of continuous transmission using instrumentation calibrated in terms of an rms-equivalent voltage. The measurement results shall be properly adjusted for any instrument limitations, such as detector response times, limited resolution bandwidth capability when compared to the emission bandwidth, sensitivity, etc., so as to obtain a true peak measurement for the emission in question over the full bandwidth of the channel.

(e) The peak transmit power shall be reduced by the amount in decibels that the maximum directional gain of the antenna exceeds 3 dBi.

6.8.2 Measurement procedure

Measurement method according to ANSI C63.17-2013 paragraph 6.1.2

6.8.3 Test Results: Complies

Measurement Data:

Test Date : Dec. 11, 2017

Temperature : 20 °C

Humidity : 58%

Channel	Frequency (MHz)	Maximum Peak Output Power (dBm)	Limit (dBm)
F _L	1921.536	16.37	21.84
F _M	1924.992	16.53	21.84
F _H	1928.448	16.65	21.84

Limit:

Conducted: $5 \text{ Log (B)} - 10 = 21.84 \text{ dBm}$

Where B is the emission bandwidth in Hz measured at 26 dBm.

Maximum Peak Output Power: CH FL

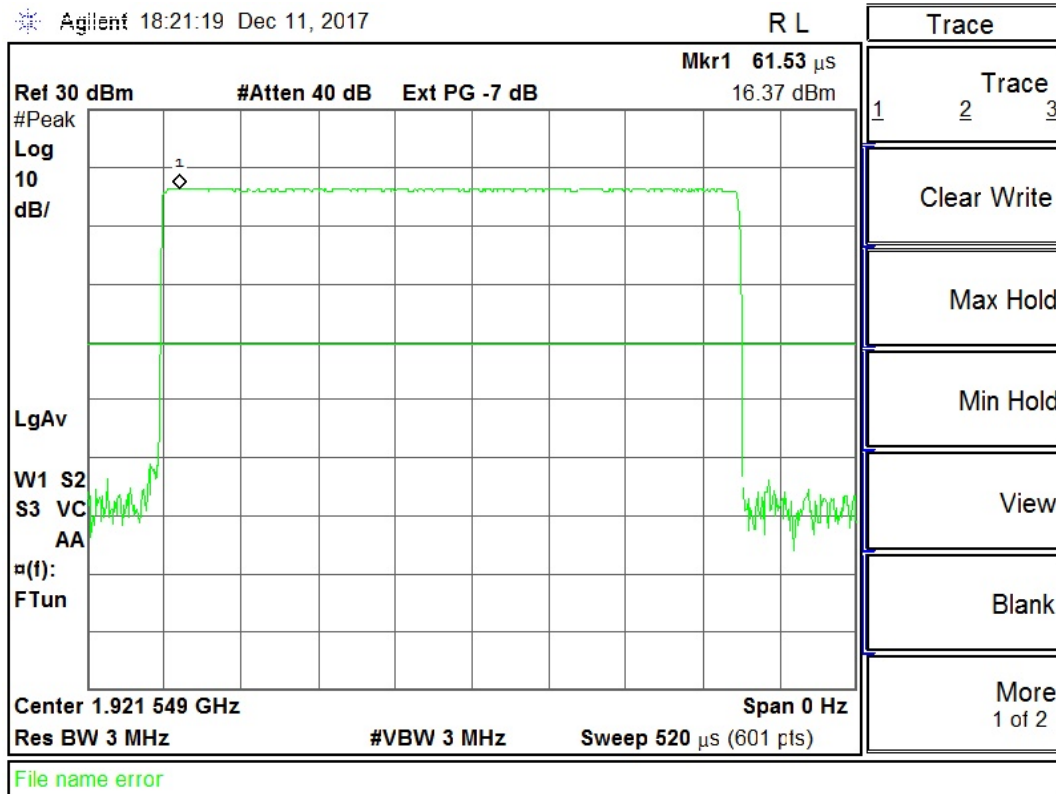

Maximum Peak Output Power: CH Fm

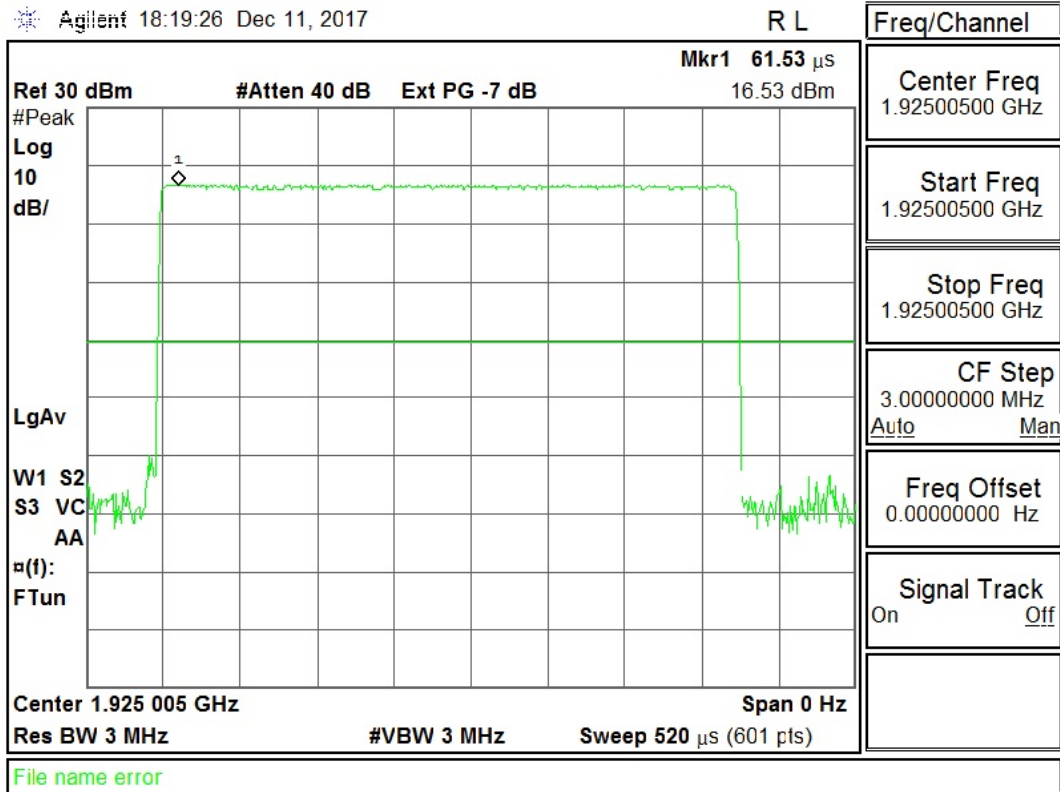

Maximum Peak Output Power: CH FH

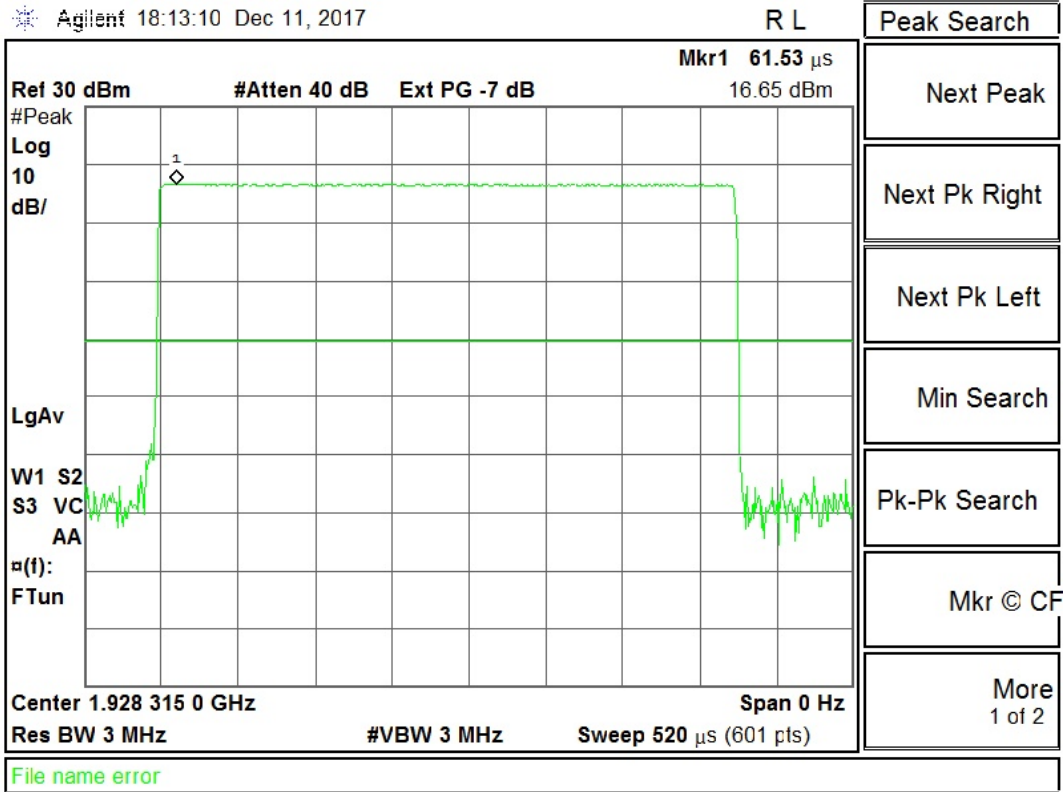

6.9 Power Spectral Density

6.9.1 Standard Applicable: FCC 15.319(d)

Power spectral density shall not exceed 3 milliwatts in any 3 kHz bandwidth as measured with a spectrum analyzer having a resolution bandwidth of 3 kHz.

6.9.2 Measurement procedure

Measurement method according to ANSI C63.17-2013 paragraph 6.1.5

6.9.3 Test Results: Complies

Measurement Data:

Test Date : Dec. 11, 2017

Temperature : 20 °C

Humidity : 58%

Channel	Frequency (MHz)	Power Spectral Density (dBm)	Limit (dBm)
FL	1921.524	-5.14	4.77
F _M	1924.998	-4.61	4.77
FH	1928.454	-11.32	4.77

Power Spectral Density: CH FL

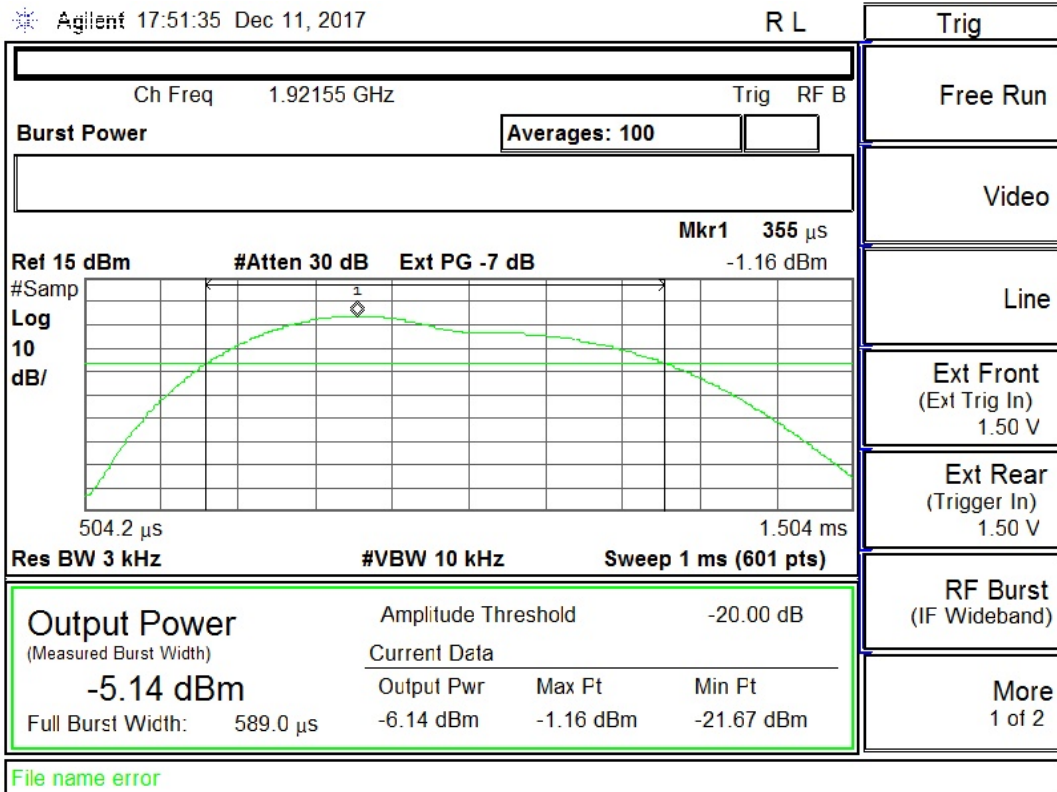

Power Spectral Density: CH Fm

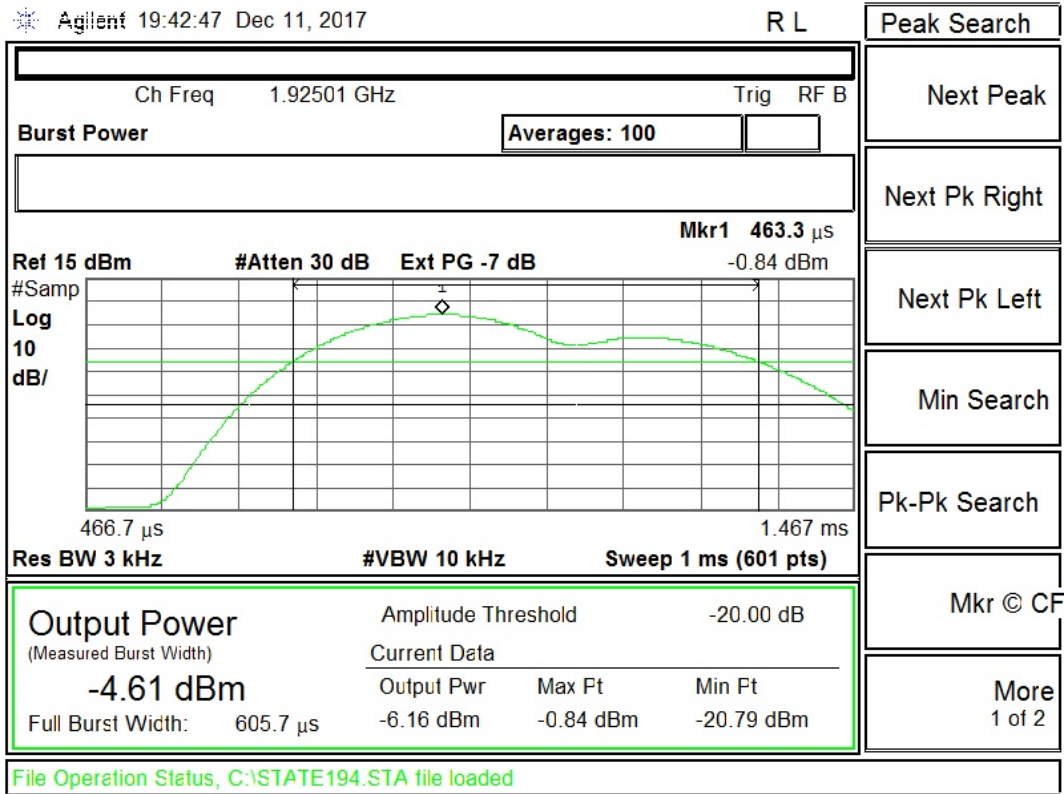

Power Spectral Density: CH F1

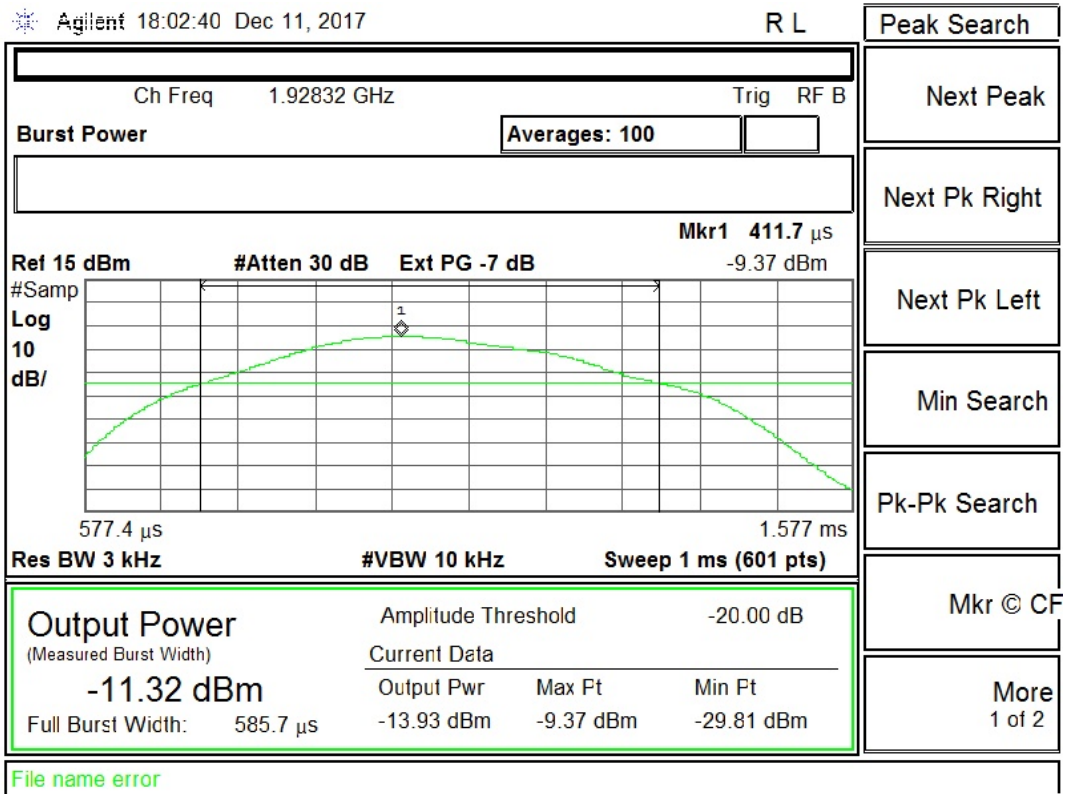

6.10 Antenna Gain

6.10.1 Standard Applicable: FCC 15.323(e)

The peak transmit power shall be reduced by the amount in decibels that the maximum directional gain of the antenna exceeds 3 dBi.

6.10.2 Results: Meets the requirement

The antenna gain value provided by manufacturer is 2.14 dBi.

6.11 Automatic discontinuation of transmission

6.11.1 Standard Applicable: FCC 15.319(f)

The device shall automatically discontinue transmission in case of either absence of information to transmit or operational failure. These provisions are not intended to preclude transmission of control and signaling information or use of repetitive codes used by certain digital technologies to complete frame or burst intervals.

6.11.2 Procedure

Please see the declaration provided by applicant.

6.11.3 Results: Meets the requirement

6.12 Safety exposure levels

6.12.1 Standard Applicable: FCC 15.319(i)

UPCS devices are subject to the radio frequency radiation exposure requirements specified in FCC parts 1.1307 (b), 2.1091 and 2.1093, as appropriate. All equipment shall be considered to operate in a “general population / uncontrolled environment. For portable devices tests according to IEEE Std.1528 & KDB447498 are requested, if applicable.

6.12.2 Measurement procedure

Consideration of radio frequency radiation exposure for EUT is done as

SAR test according to IEEE Std.1528 & KDB447498	<input type="checkbox"/>
MPE calculation as below	<input checked="" type="checkbox"/>

MPE calculation:

The limit of Power density for General Population / Umcontrolled Exposure is 1.0 mW/cm².

Formula:

$$S = \text{EIRP} / 4\pi R^2$$

Calculation:

EIRP	Radiated Power (dBm)	18.79
EIRP	Radiated Power (mW)	75.68
R	Distance (cm)	20
S	Power Density (mW/cm ²)	0.01506

Simultaneous Evaluation:

The formula of calculated MPE is:

$$\text{CPD1/LPD1} + \text{CPD2/LPD2} + \dots \text{etc.} < 1$$

CPD=Calculated Power Density

LPD=Limit of Power Density

Radio Technology	Worse CPD (mW/cm ²)
DECT	0.01506

The MPE evaluation is $0.01506/1 = 0.01506 < 1$, which confirm the device comply the MPE limit.

6.13.3 Results : Complies

6.13 Emission Bandwidth B

6.13.1 Standard Applicable: FCC 15.323(a)

The 26 dB Bandwidth B shall be larger than 50 kHz and less than 2.5 MHz.

6.13.2 Measurement procedure

Measurement method according to ANSI C63.17-2013 paragraph 6.1.3

6.13.3 Results: Complies

Measurement Data:

Test Date : Dec. 11, 2017

Temperature : 20 °C

Humidity : 58%

Channel	Frequency (MHz)	26 dB Bandwidth (MHz)
FL	1921.536	2.33
F _M	1924.992	2.34
FH	1928.448	2.34

26 dB Bandwidth B: CH FL

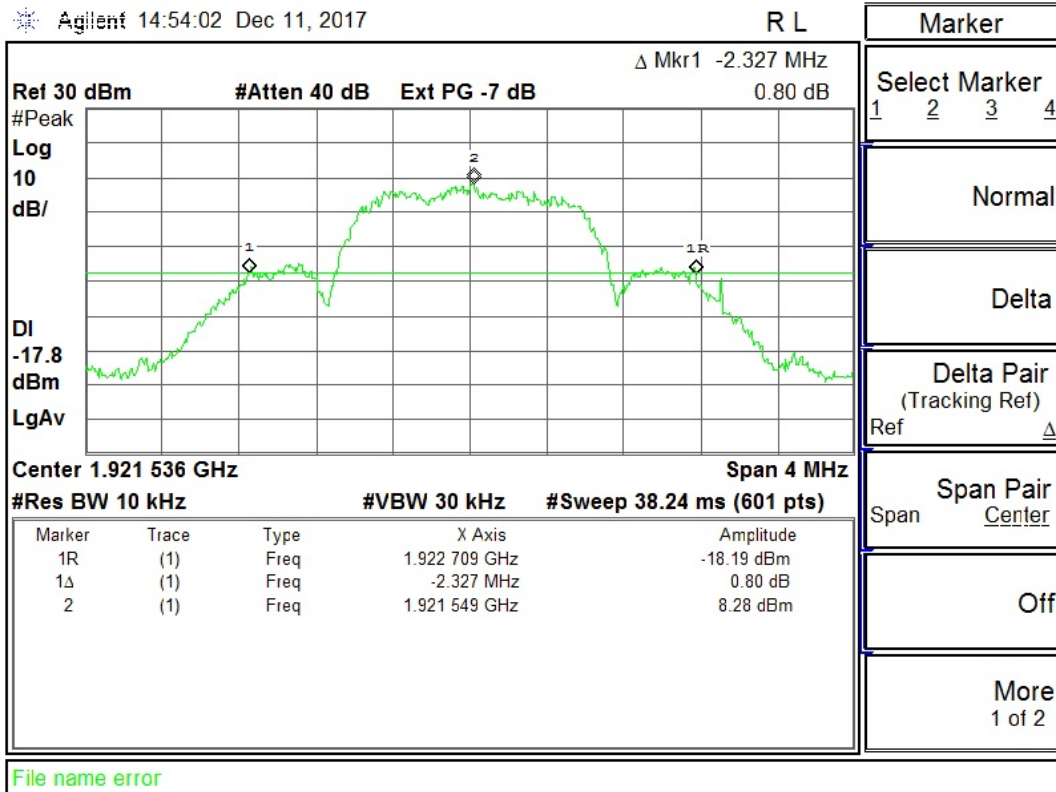

26 dB Bandwidth B: CH Fm

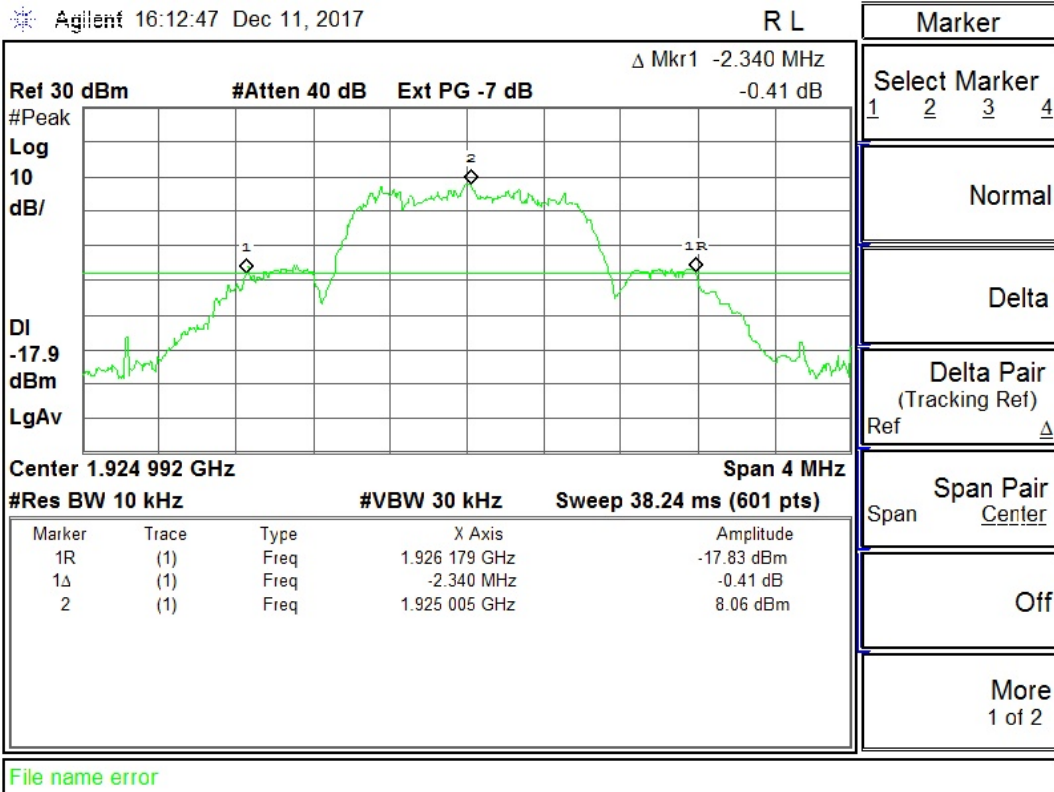

26 dB Bandwidth B: CH FH

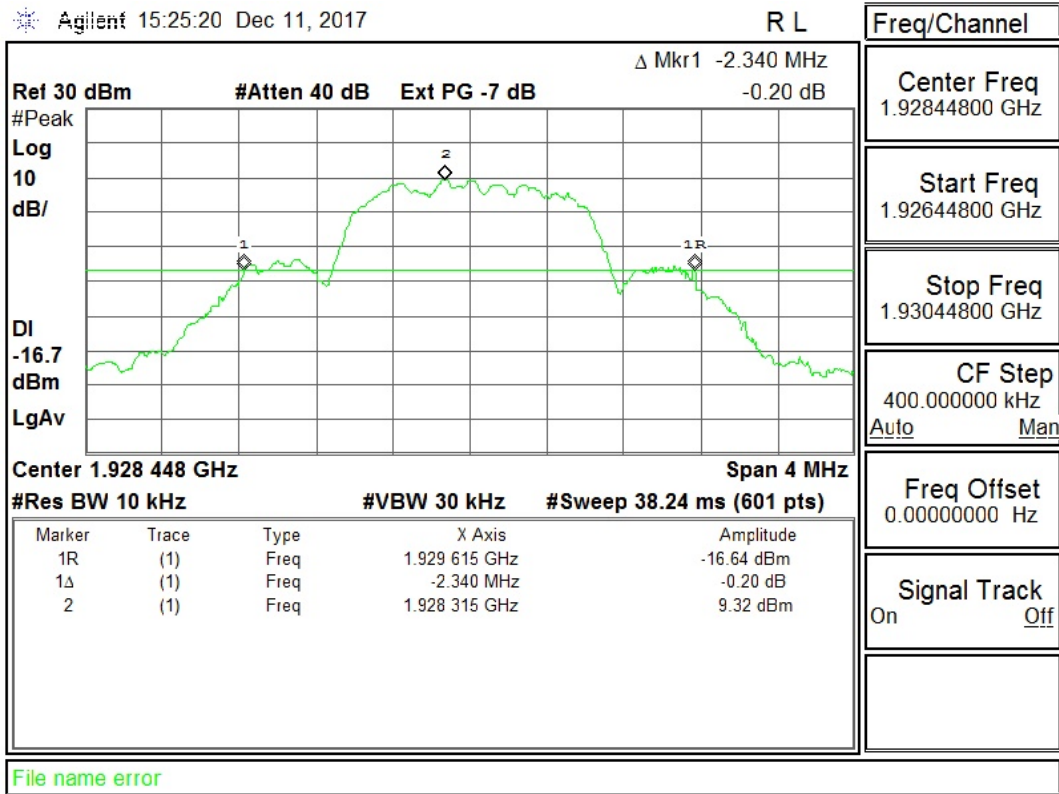

6.14 Monitoring time

6.14.1 Standard Applicable: FCC 15.323(c)(1)

Immediately prior to initiating transmission, devices must monitor the combined time and spectrum window in which they intend to transmit. For a period of at least 10 milliseconds for systems designed to use a 10 millisecond or shorter frame period or at least 20 milliseconds for systems designed to use a 20 millisecond frame period.

6.14.2 Measurement procedure

Measurement method according to ANSI C63.17-2013 paragraph 7.3.3

6.14.3 Results: Complies

EUT monitors the combined time and spectrum window prior to initiation of transmission.

Measurement Data:

This requirement is covered by results of Least Interfered Channel (LIC) test according to FCC 15.323(c) (5)	<input checked="" type="checkbox"/>
--	-------------------------------------

6.15 Monitoring threshold

6.15.1 Standard Applicable: FCC 15.323(c)(2)

The monitoring threshold must not be more than 30 dB above the thermal noise power for a bandwidth equivalent to the emission bandwidth of the device.

6.15.2 Measurement procedure

Measurement method according to ANSI C63.17-2013 paragraph 7.3.1

6.15.3 Result: Not apply

Note: For EUT which support LIC there is no need to measure lower threshold because it is automatically met by LIC Procedure.

6.16 Maximum transmit period

6.16.1 Standard Applicable: FCC 15.323(C) (3)

Occupation of the same combined time and spectrum windows by a device or group of cooperating devices continuously over a period of time longer than 8 hours is not permitted without repeating the access criteria.

6.16.2 Measurement procedure

Measurement method according to ANSI C63.17-2013 paragraph 8.2.2

6.16.3 Test Results: Complies

Measurement Data:

Test Date : Dec. 18, 2017

Temperature : 20 °C

Humidity : 58%

	Observation	Limit
Maximum transmission time	1 hours 4 minutes	8 hours

Start to transmission time and Cease of transmission time:

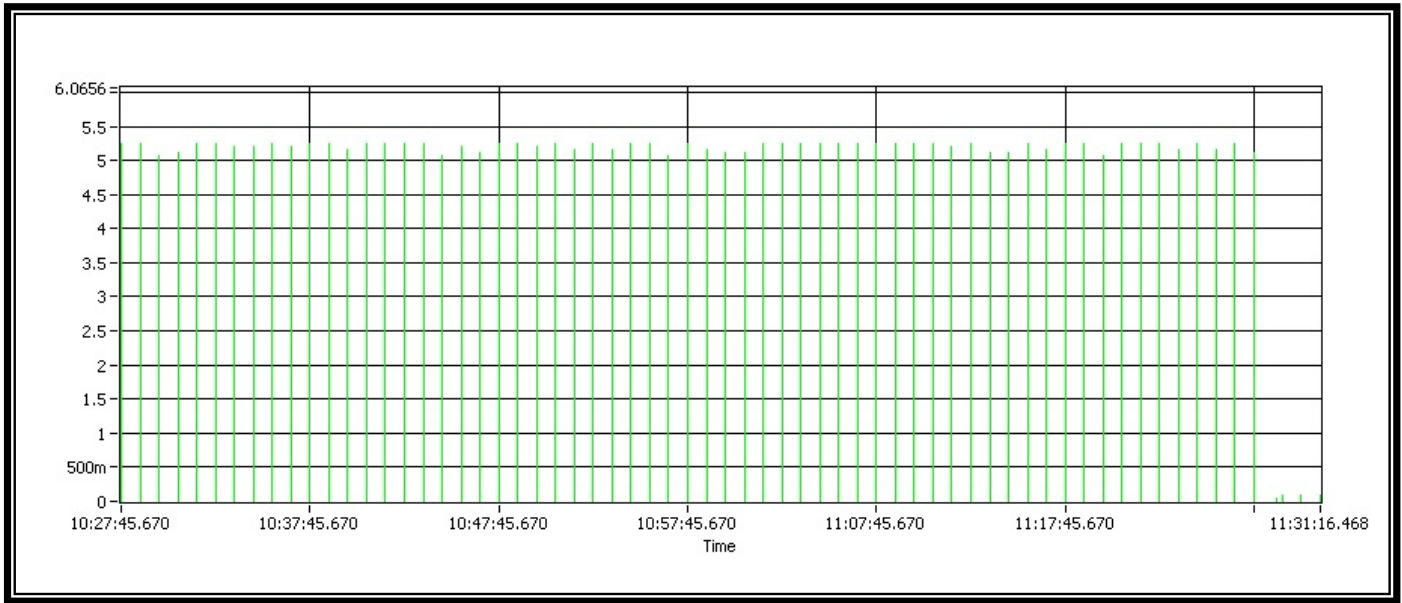

6.17 System Acknowledgement

6.17.1 Standard Applicable: FCC 15.323 (c)(4)

Once access to specific combined time and spectrum windows is obtained an acknowledgement from a system participant must be received by the initiating transmitter within one second or transmission must cease. Periodic acknowledgements must be received at least every 30 seconds or transmission must cease. Channels used exclusively for control and signaling information may transmit continuously for 30 seconds without receiving an acknowledgement, at which time the access criteria must be repeated.

6.17.2 Measurement procedure

Measurement method according to ANSI C63.17-2013 paragraph 8

6.17.3 Results: Complies

Measurement Data

Unacknowledged transmission:

Limit:

Requirement	Value
Change of access criteria for control information	30 s
Pause length	> 10 ms
Change of access channel	mandatory

Result:

Test Date : Dec. 18, 2017

Temperature : 20 °C

Humidity : 58%

Requirement	Time	Verdict
Change of access criteria for control information	----	n.a.
Pause length	----	n.a.
Change of access channel	----	n.a.

Connection acknowledgement:

Limit:

Requirement	Value
Connection acknowledgement	1 s
Termination of transmission	30 s

Result:

Test Date : Dec. 11, 2017Temperature : 20 °CHumidity : 58%

Requirement	Time observed	Verdict
Connection acknowledgement	5 ms	Pass
Termination of transmission	5.01s	Pass

Comment: Connection acknowledgement

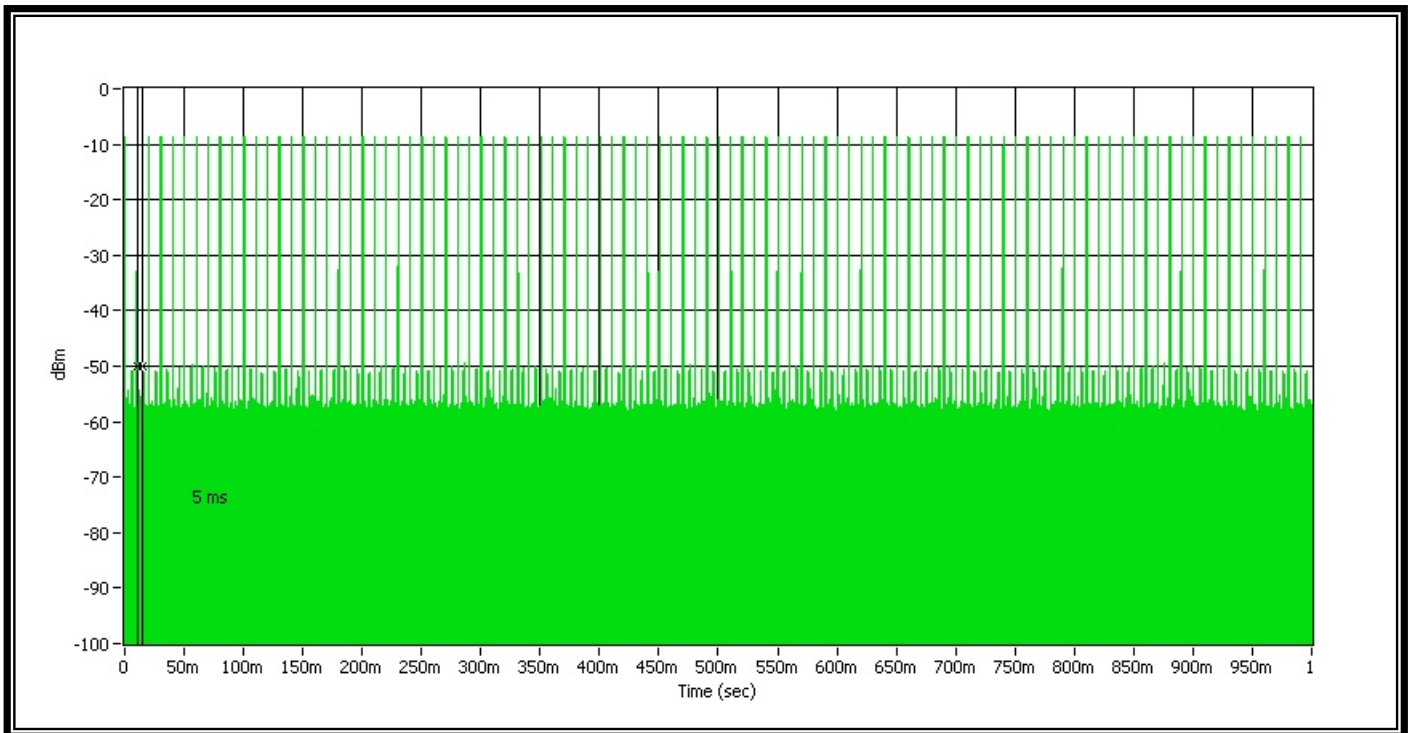
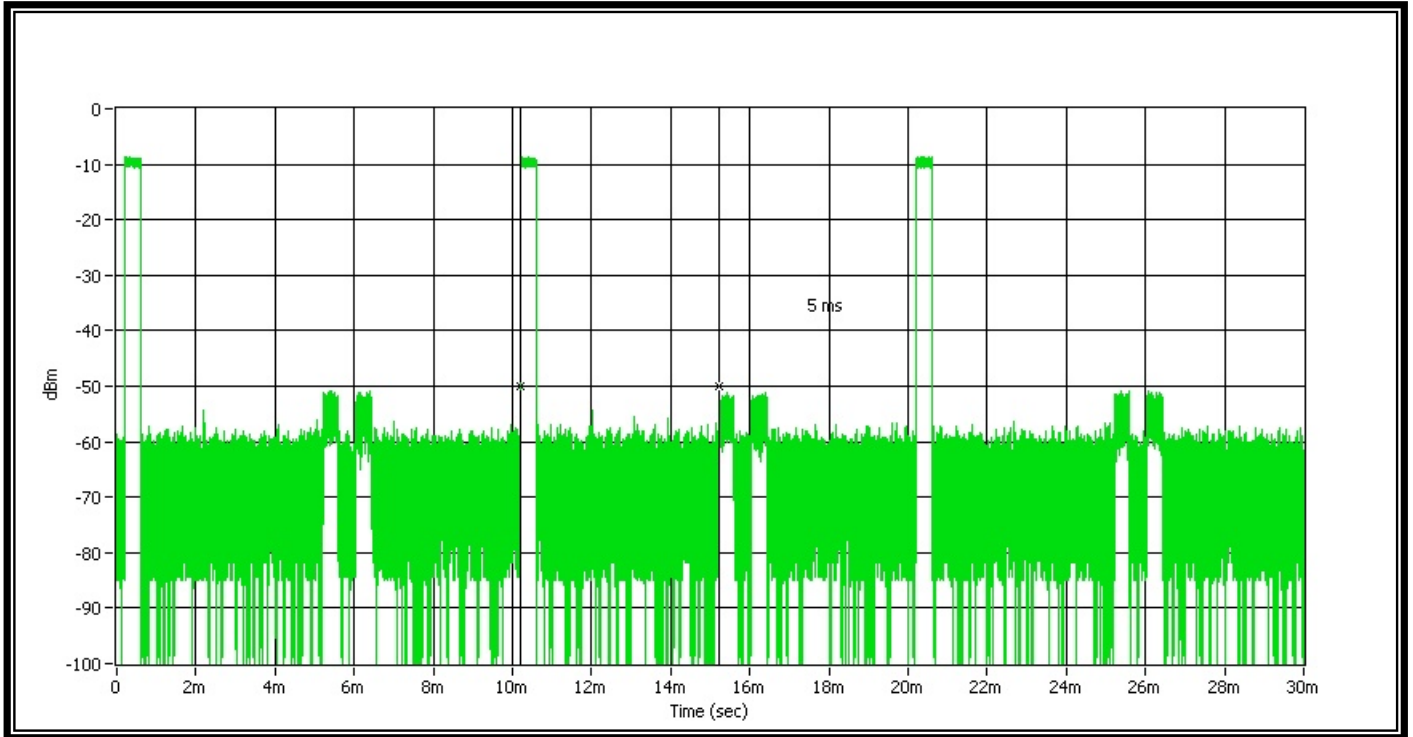

Comment: Termination of transmission

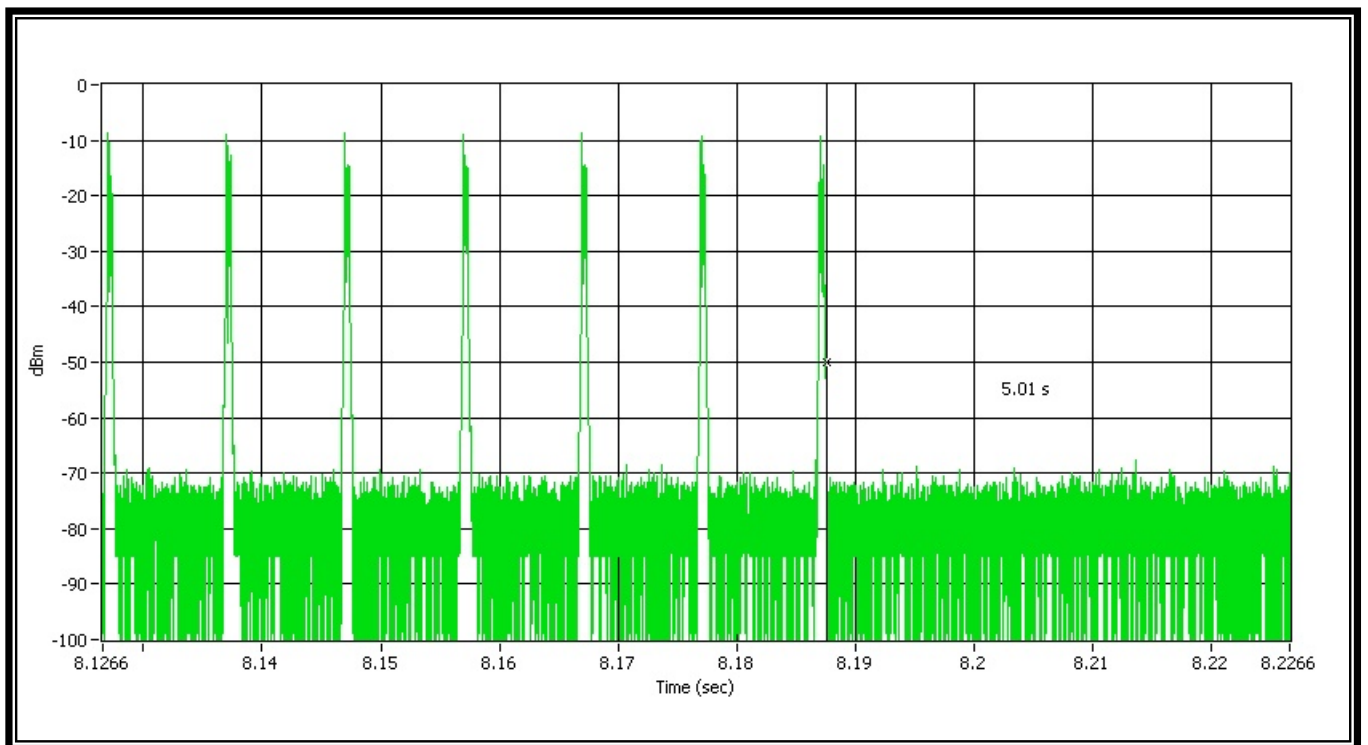
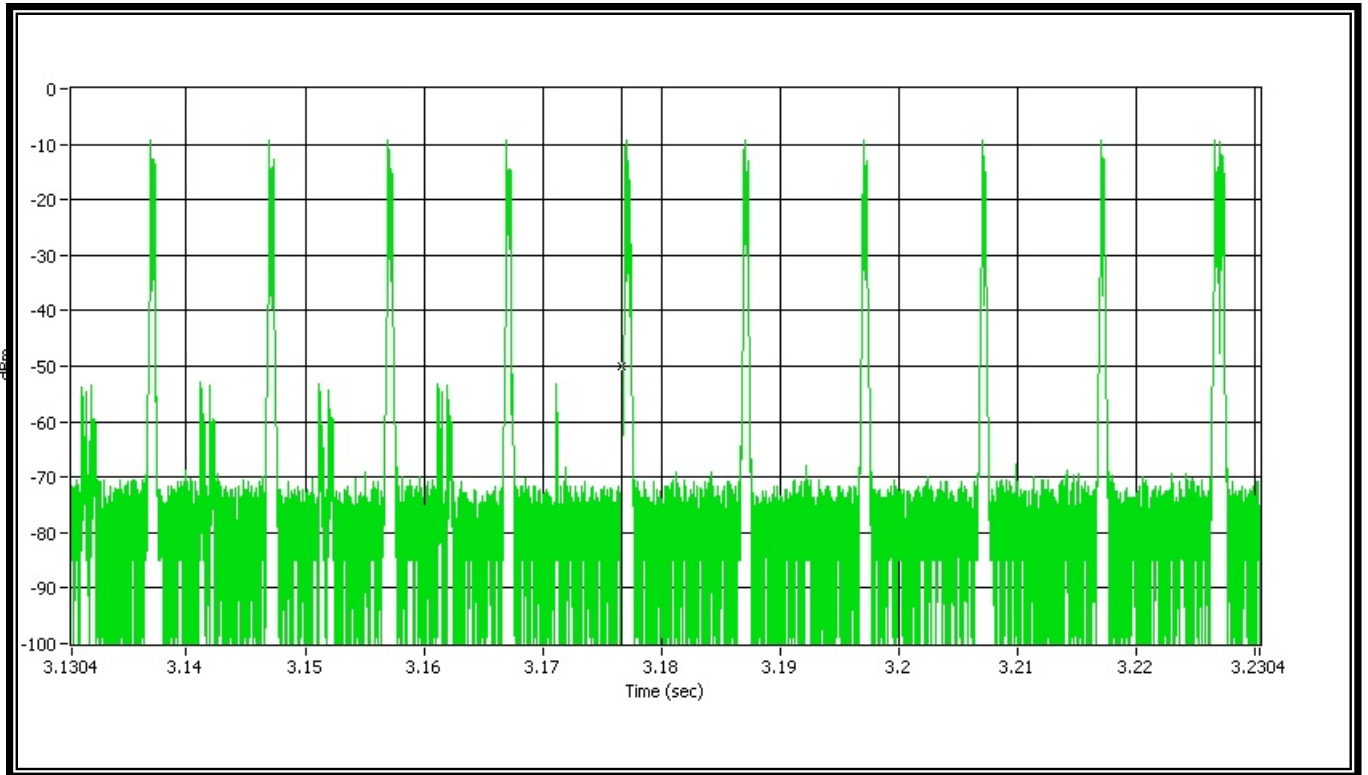

Comment: Termination of transmission

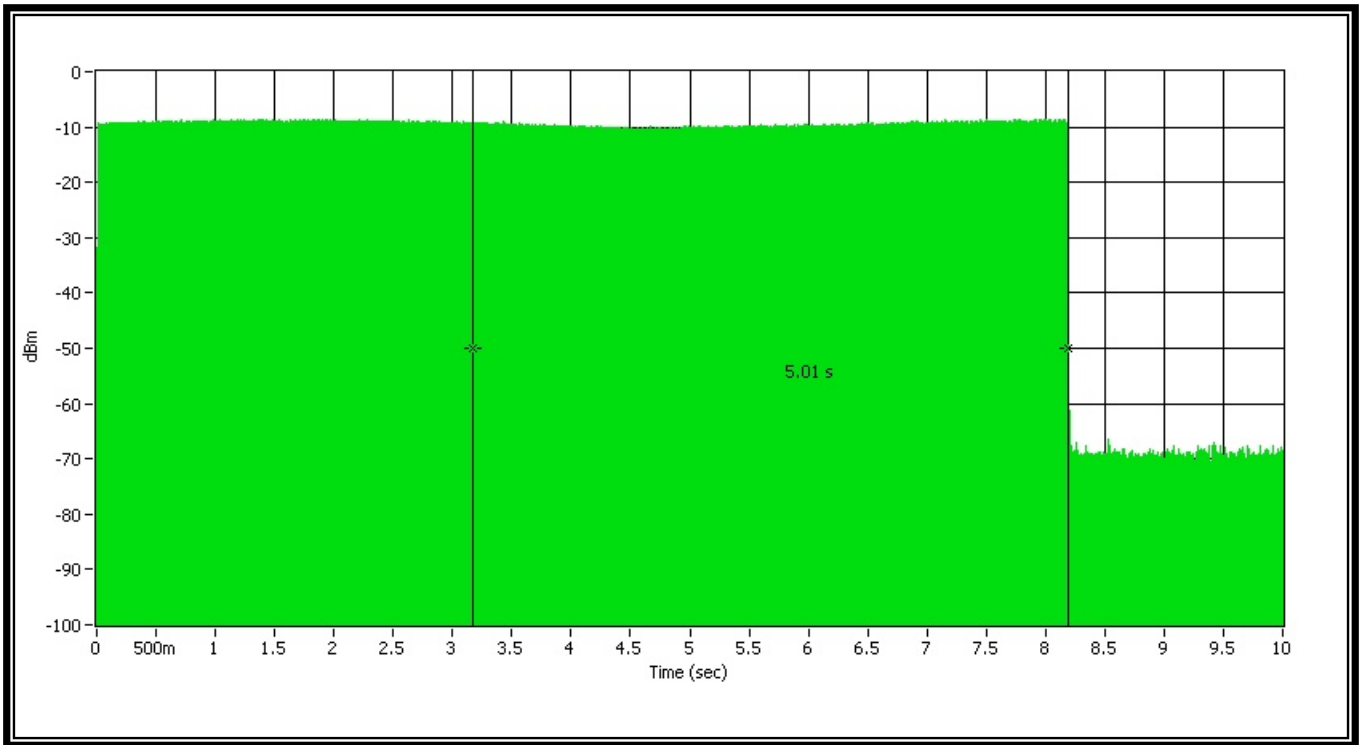

6.18 Least Interfered Channel, LIC

6.18.1 Standard Applicable: FCC 15.323(c) (5)

If access to spectrum is not available as determined by the above, and a minimum of 20 duplex system access channels are defined for the system, the time and spectrum windows with the lowest power level may be accessed. A device utilizing the provisions of this paragraph must have monitored all access channels defined for its system within the last 10 seconds and must verify, within the 20 milliseconds (40 milliseconds for devices designed to use a 20 milliseconds frame period) immediately preceding actual channel access that the detected power of the selected time and spectrum windows is no higher than the previously detected value. The power measurement resolution for this comparison must be accurate to within 6 dB. No device or group of co-operating devices located within 1 meter of each other shall during any frame period occupy more than 6 MHz of aggregate bandwidth, or alternatively, more than one third of the time and spectrum windows defined by the system.

6.18.2 Measurement procedure

Measurement method according to ANSI C63.17-2013 paragraph 7.3.2, 7.3.3, 7.3.4

6.18.3 Results: Complies

Measurement Data

Test Date : Dec. 18, 2017

Temperature : 20 °C

Humidity : 58%

Calculation of monitoring threshold limits:

Threshold: $T = 15 \log B - 184 + 30 - P$ (dBm)
 B = emission bandwidth (Hz)
 P = peak transmit power (dBm)

Calculated thresholds:

TL: Lower threshold (dBm)	-75.1
---------------------------	-------

Limit:

Used results	Emission bandwidth (MHz)	2.33
	Peak transmit power (dBm)	16.65
$T_L + U_M = -75.1 + 6 = -69.6$ (dBm)		

Result:

Least interfered channel	Pass
--------------------------	------

Note 1: The Threshold is applicable for systems which have defined a minimum of 40 duplex system access channels.

Note 2: f1=1921.536 MHz, f2=1928.448MHz

Comment: 7.3.2b

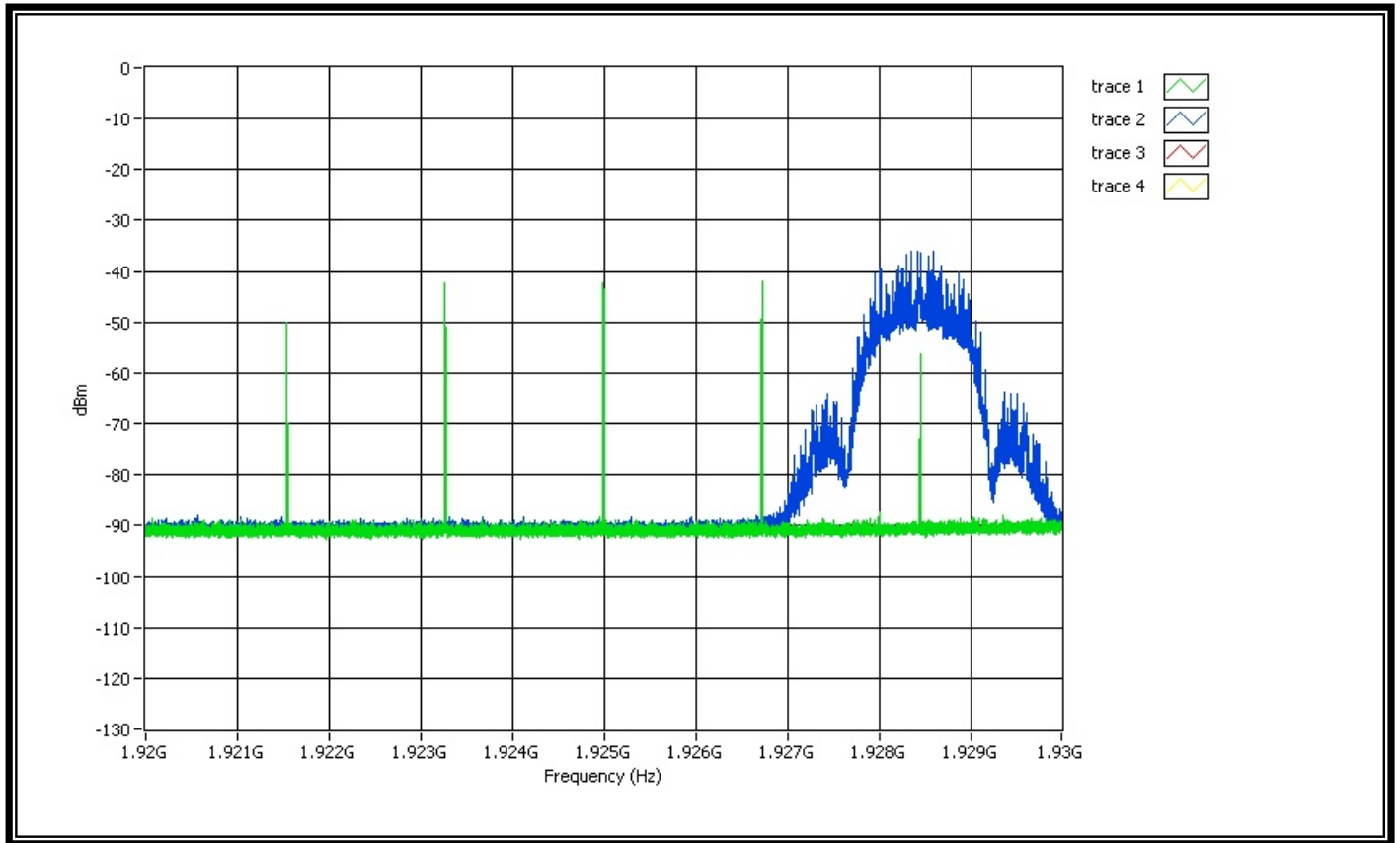

Comment1: Trace1 (green) shows the interference profile.

Comment2: Trace2 (blue) shows the EUT transmissions are occurring.

Comment3: The EUT always transmits on f2 (the carrier with the lower interference level) and so meets the requirement.

Comment: 7.3.2c

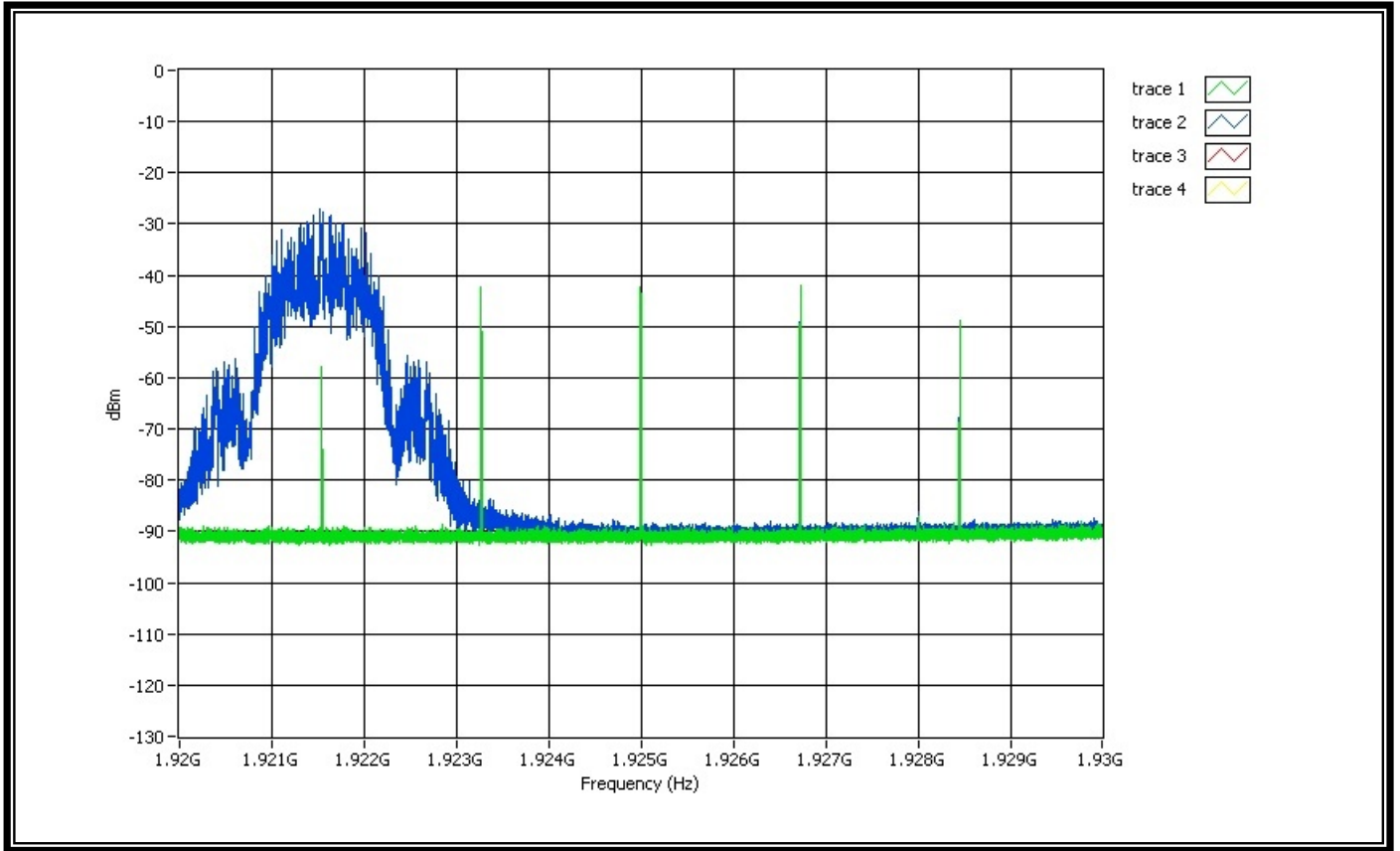

Comment1: Trace1 (green) shows the interference profile.

Comment2: Trace2 (blue) shows the EUT transmissions are occurring.

Comment3: The EUT always transmits on f1 (the carrier with the lower interference level) and so meets the requirement.

Comment: 7.3.2d

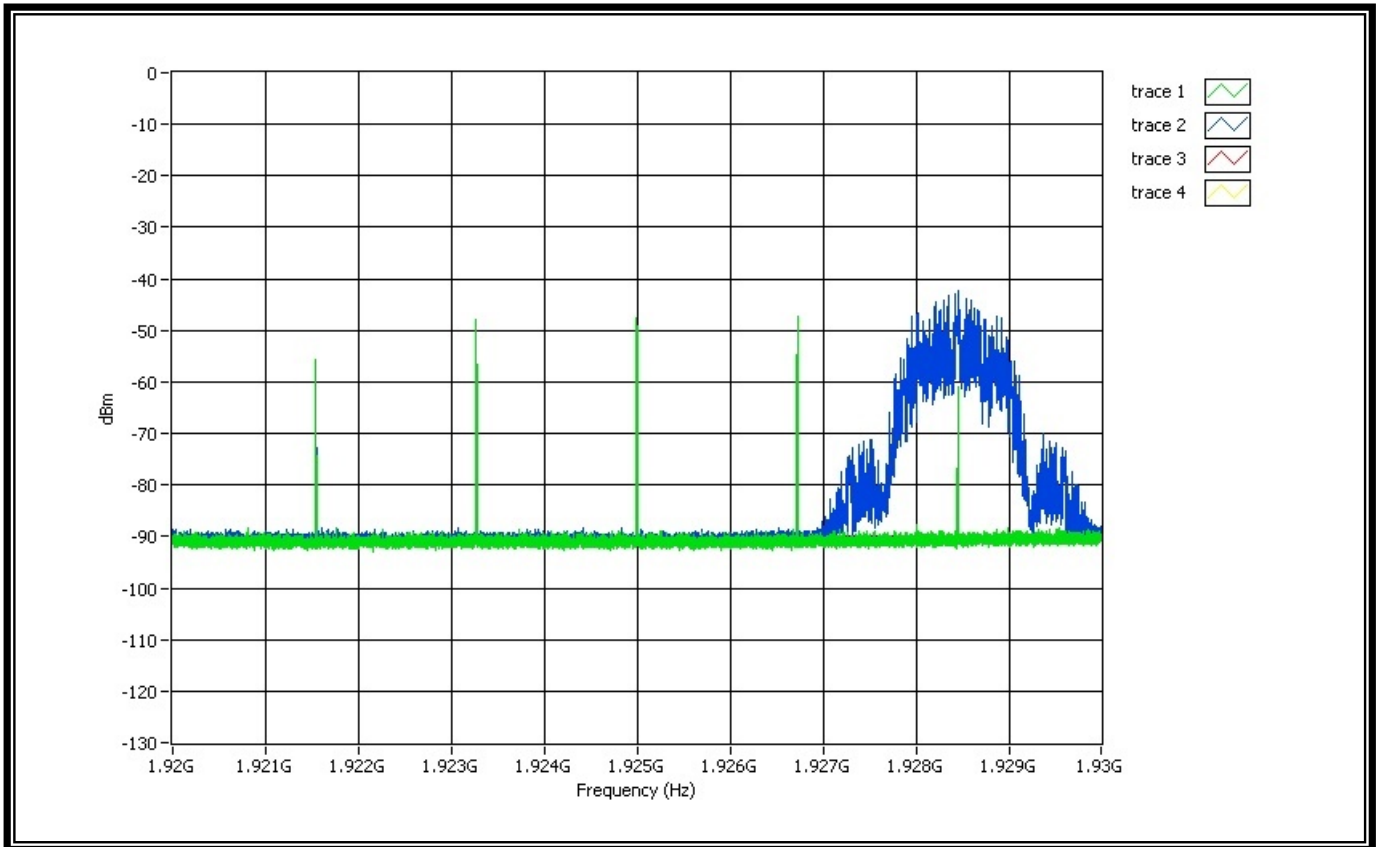

Comment1: Trace1 (green) shows the interference profile.

Comment2: Trace2 (blue) shows the EUT transmissions are occurring.

Comment3: The EUT always transmits on f2 (the carrier with the lower interference level) and so meets the requirement.

Comment: 7.3.2e

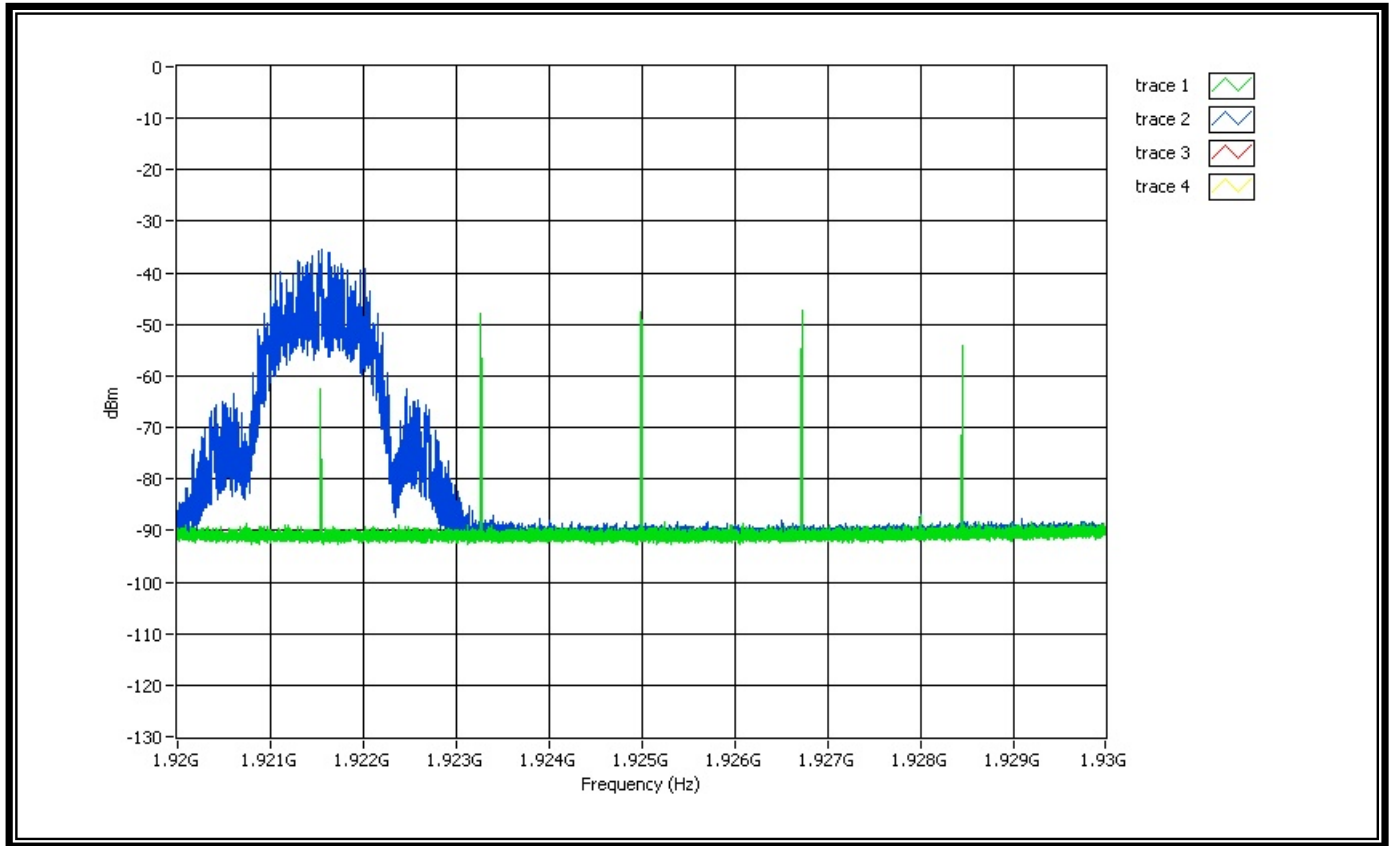

Comment1: Trace1 (green) shows the interference profile.

Comment2: Trace2 (blue) shows the EUT transmissions are occurring.

Comment3: The EUT always transmits on f1 (the carrier with the lower interference level) and so meets the requirement.

Comment: 7.3.3

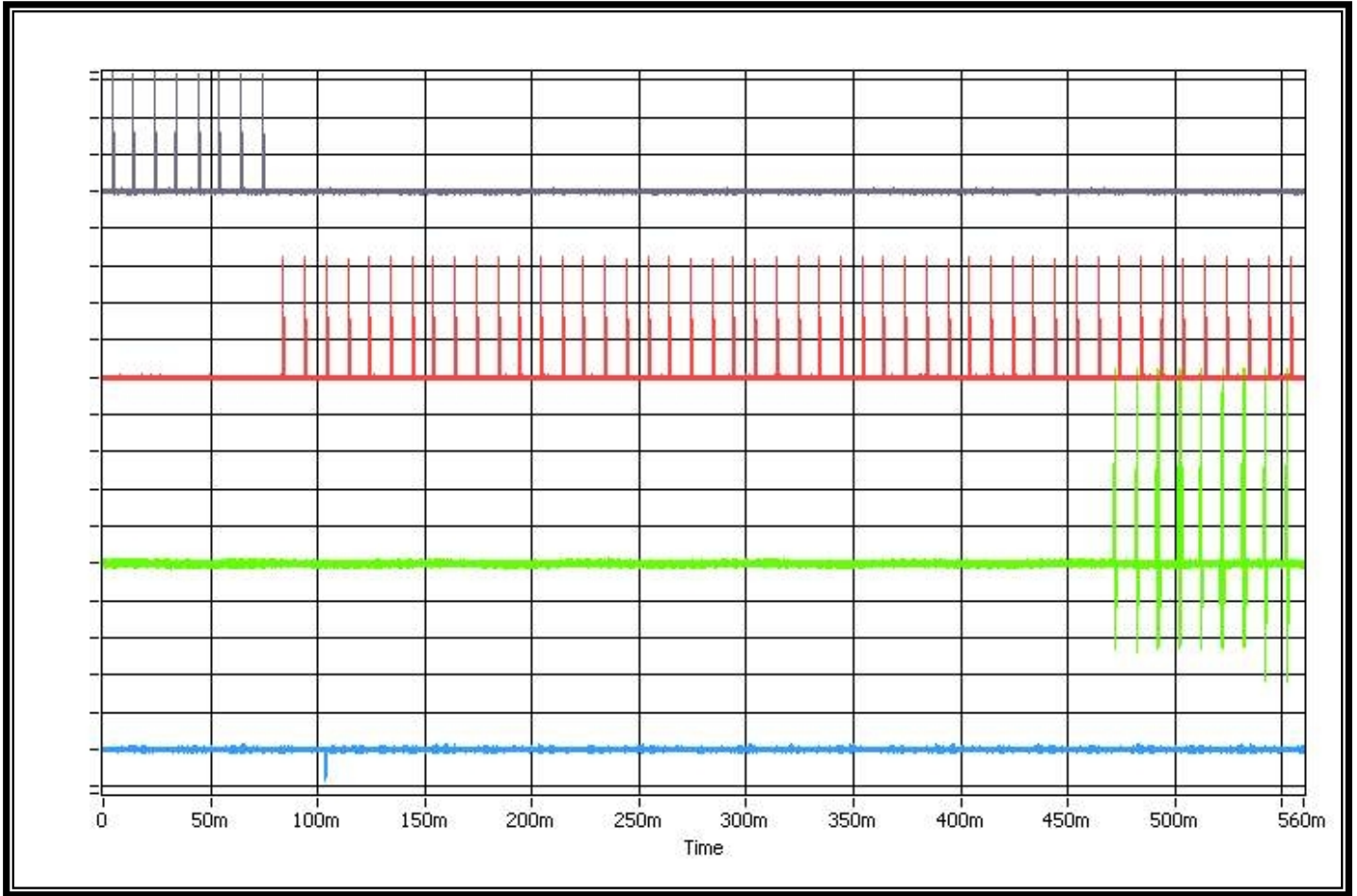

- Comment1: Trace1 (deep blue, top) shows interference on f1.
- Comment2: Trace2 (red, 2nd from top) shows the interference on f2.
- Comment3: Trace3 (green, 3rd from top) shows EUT transmissions on f1.
- Comment4: Trace4 (light blue, 4th from top) shows the signal to the handset to trigger the transmissions.
- Comment5: Set interference on all system carriers except f2, at a level of T_L+U_M , in-band per carrier.
- Comment6: Apply interference on f2 at a level of T_L+U_M+20 , in-band, and immediately remove all interference from f1 and immediately (but not sooner than 20 ms after the interference on f2 is applied) cause the EUT to attempt transmission.
- Comment7: The EUT transmits on f1 and so meets the requirement.

Comment: 7.3.4 (Zoom in)

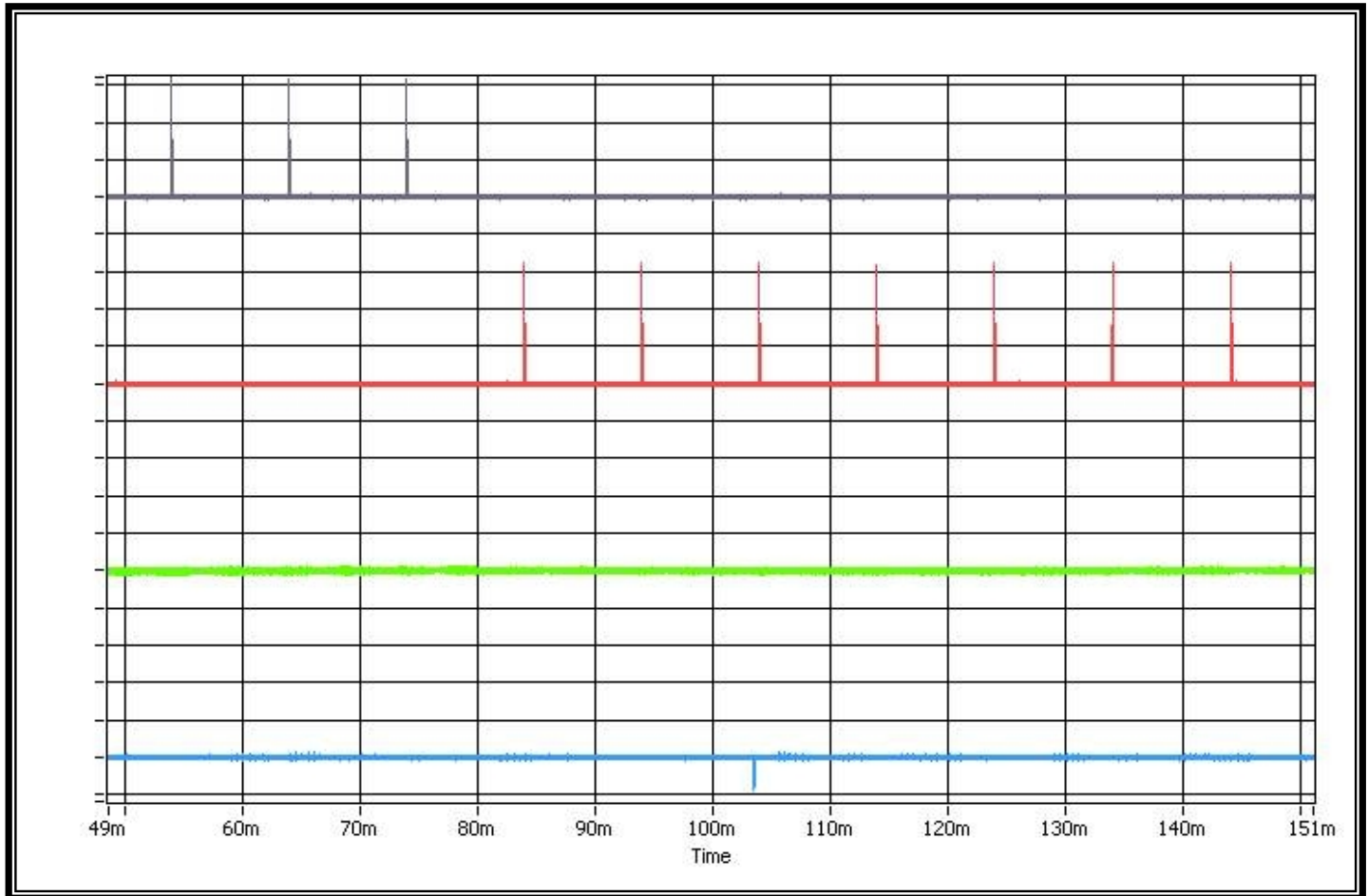

Comment1: Trace1 (deep blue, top) shows interference on f1.

Comment2: Trace2 (red, 2nd from top) shows the interference on f2.

Comment3: Trace3 (green, 3rd from top) shows EUT transmissions on f1.

Comment4: Trace4 (light blue, 4th from top) shows the signal to the handset to trigger the transmissions.
The signal is not sooner than 20 ms after the interference on f2 is applied.

6.19 Random waiting

6.19.1 Standard Applicable: FCC 15.323 (c)(6)

If the selected combined time and spectrum windows are unavailable, the device may either monitor and select different windows or seek to use the same window after waiting an amount of time, randomly chosen from a uniform random distribution between 10 and 150 milliseconds, commencing when the channel becomes available.

6.19.2 Measurement procedure

Measurement method according to ANSI C63.17-2013 paragraph 8.1.3

6.19.3 Results:

The manufacturer declares that this provision is not utilized by the EUT.

6.20 Monitoring bandwidth and reaction time

6.20.1 Standard Applicable: FCC 15.323(c)(7)

The monitoring system band width must be equal to or greater than the emission band width of the intended transmission and have a maximum reaction time less than $50 \times \text{SQRT}(1.25/\text{emission band width in MHz})$ microseconds for signals at the applicable threshold level but shall not be required to be less than 50 microsecond. If a signal is detected that is 6 dB or more above the applicable threshold level, the maximum reaction time shall be $35 \times \text{SQRT}(1.25/\text{emission band width in MHz})$ microseconds but shall not be required to be less than 35 microseconds.

6.20.2 Measurement procedure

Measurement method according to ANSI C63.17-2013 paragraph 7.5

6.20.3 Results: Meets the requirement

Measurement Data

Calculation of applied pulse width and maximum reaction time:

For emission bandwidth > 1.25MHz, the pulse width is always 35us and 50us.

Used results	Emission bandwidth B (MHz)	2.33 MHz
Maximum reaction time and pulse width	$50\sqrt{1.25/B}$ (μs)	36.6 μs
	$35\sqrt{1.25/B}$ (μs)	25.6 μs

Result:

Test Date : Dec. 18, 2017

Temperature : 20 °C

Humidity : 58%

Pulse width (μs)	Connection
$50 \mu\text{s}$ or $50\sqrt{(1.25/B)}$	no
$35 \mu\text{s}$ or $35\sqrt{(1.25/B)}$	no

Comment: 50us

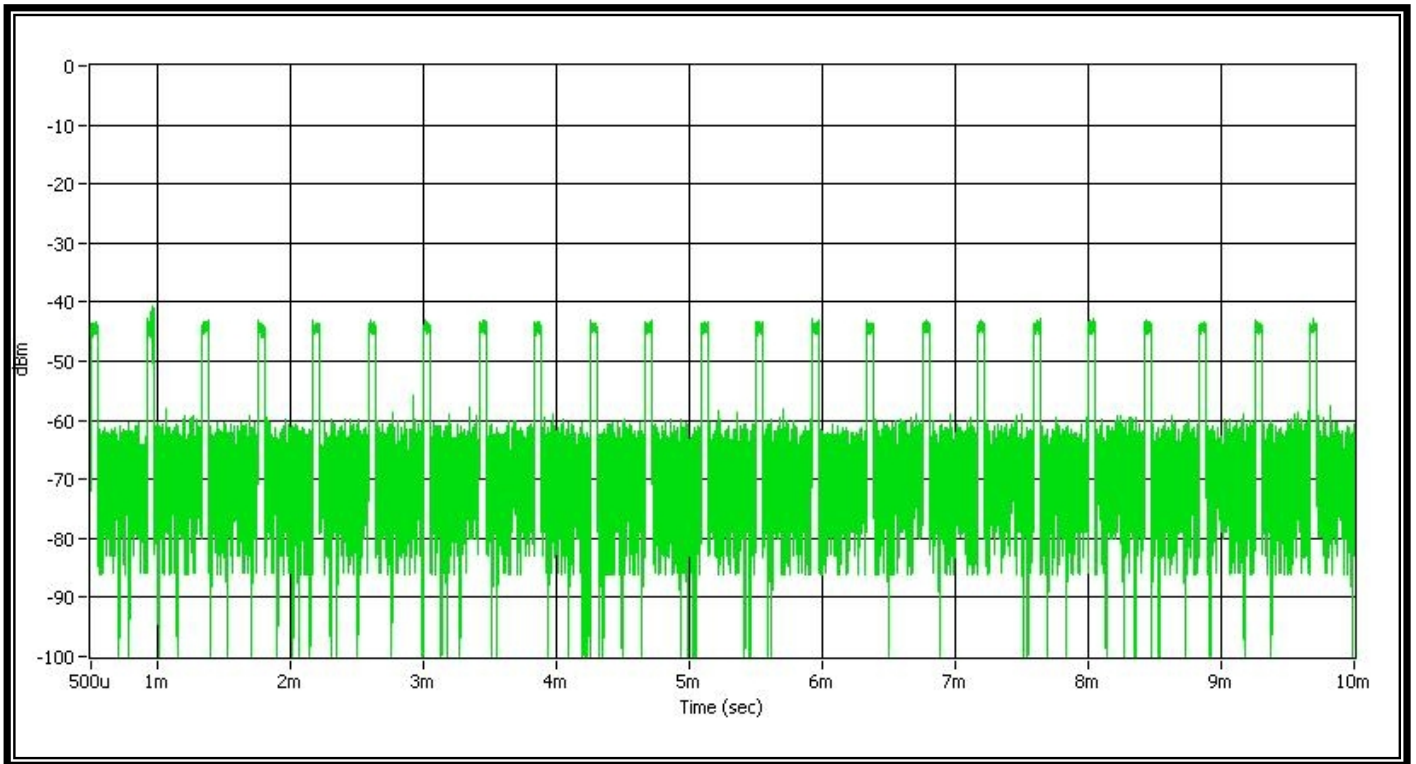

Comment: 50us (Zoom in)

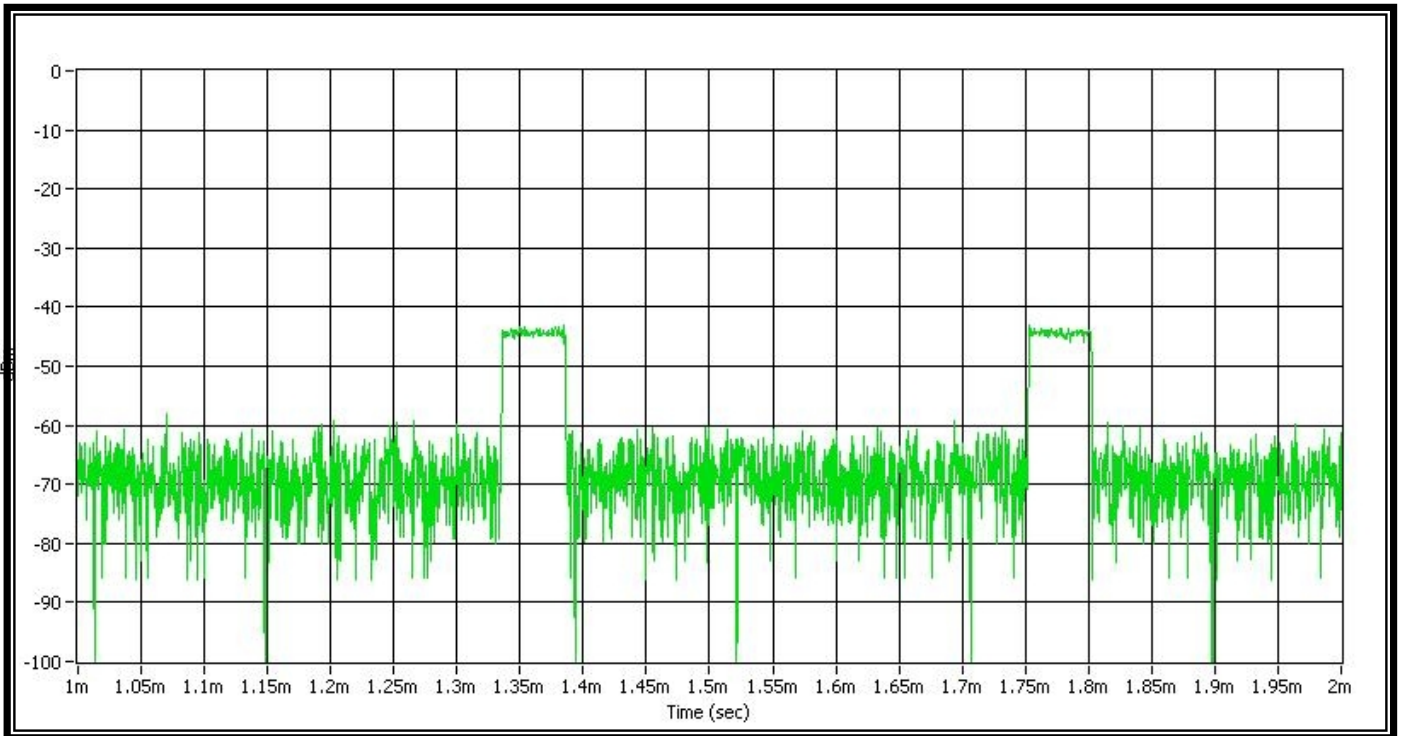

Comment: 50us (5 carriers)

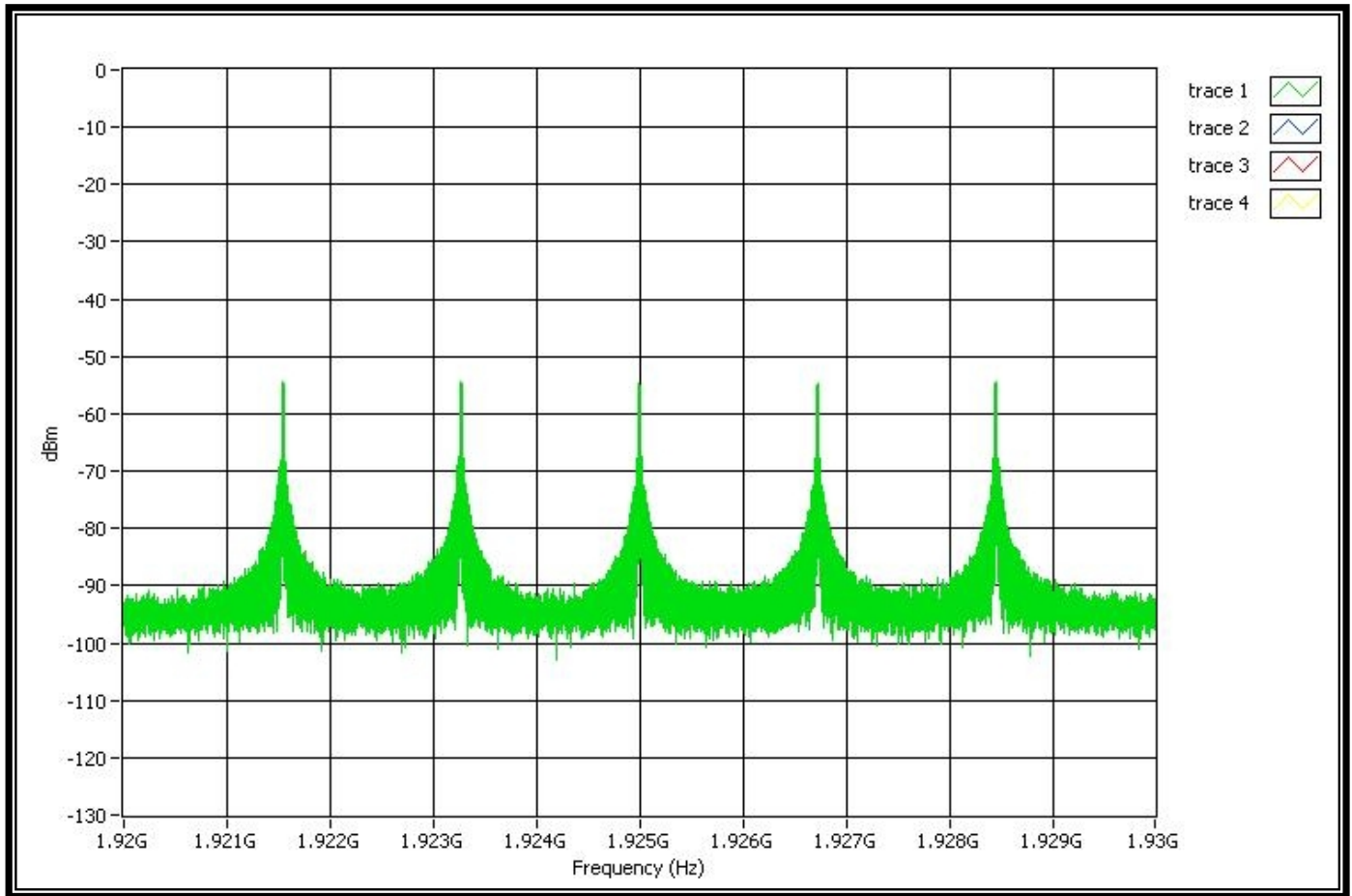

Comment: 35us

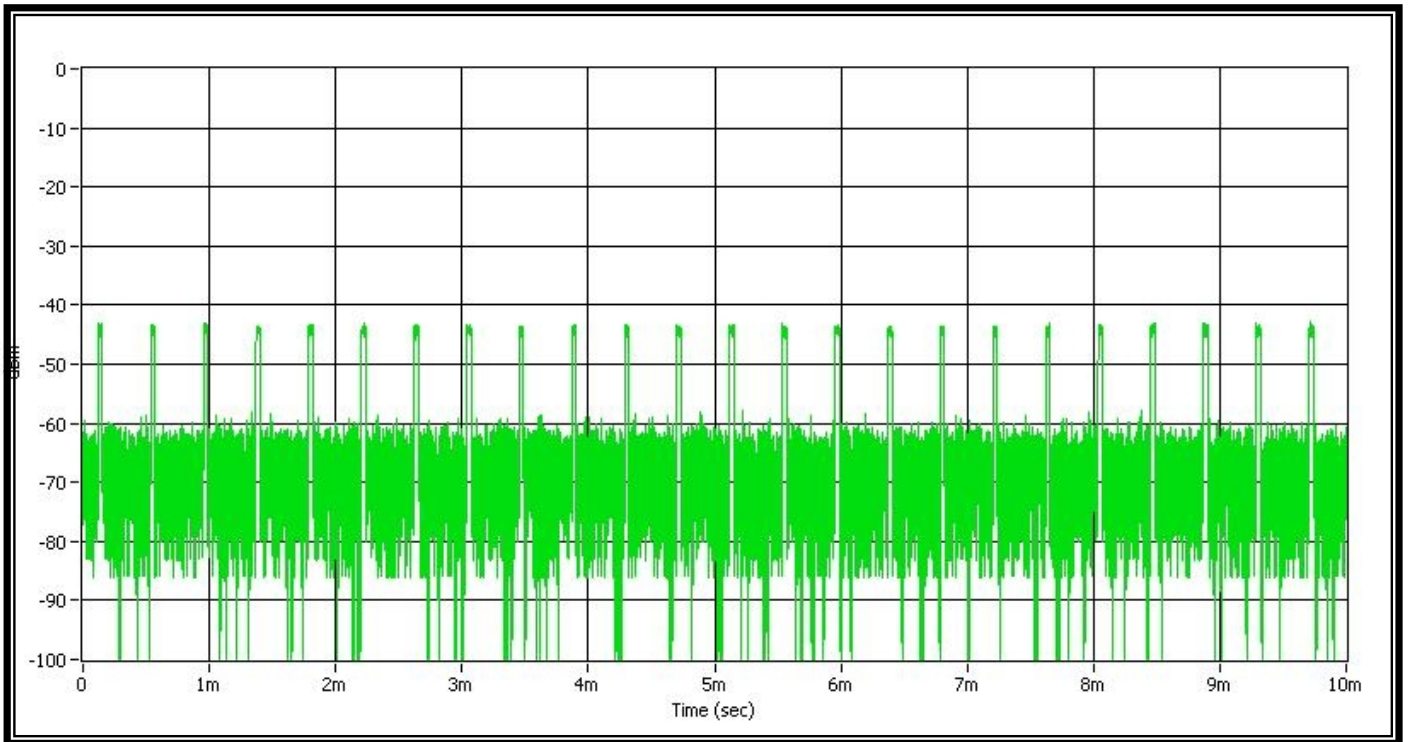

Comment: 35us (Zoom in)

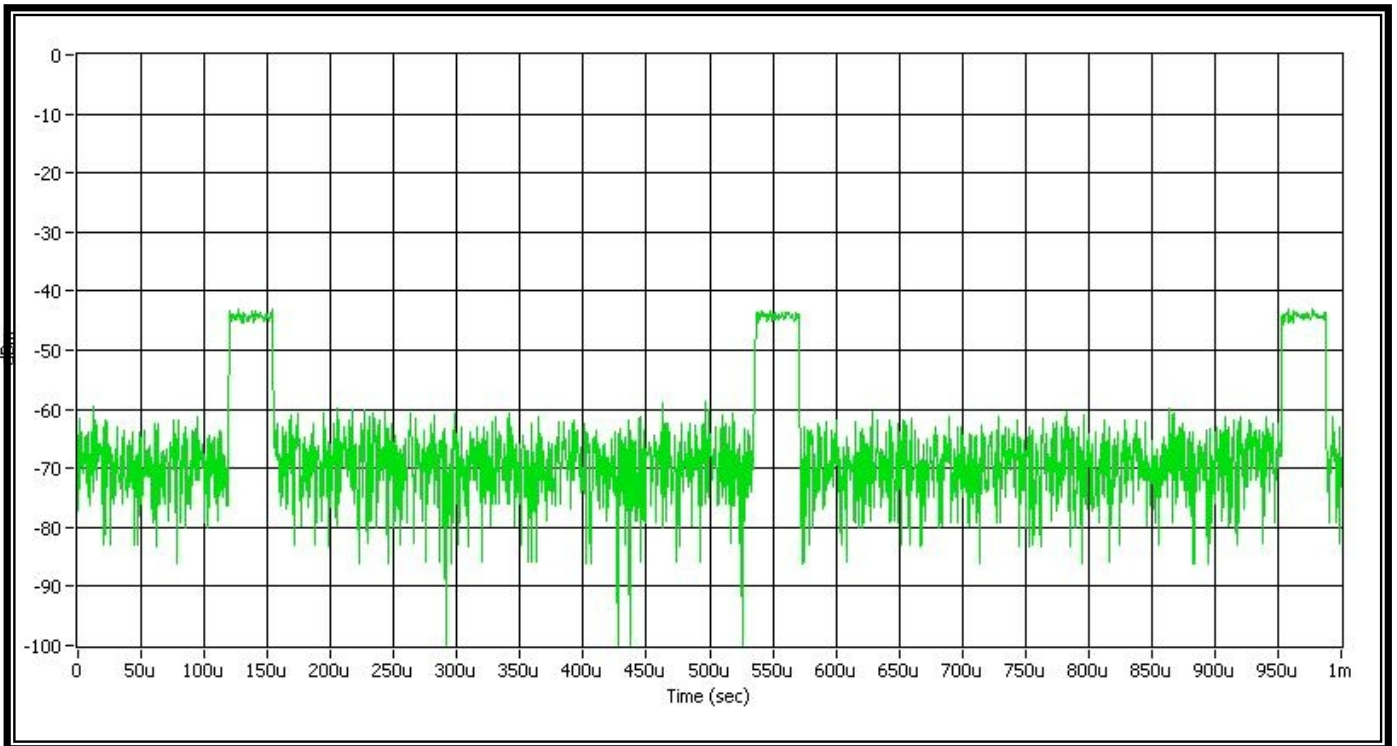

Comment: 35us (5 carriers)

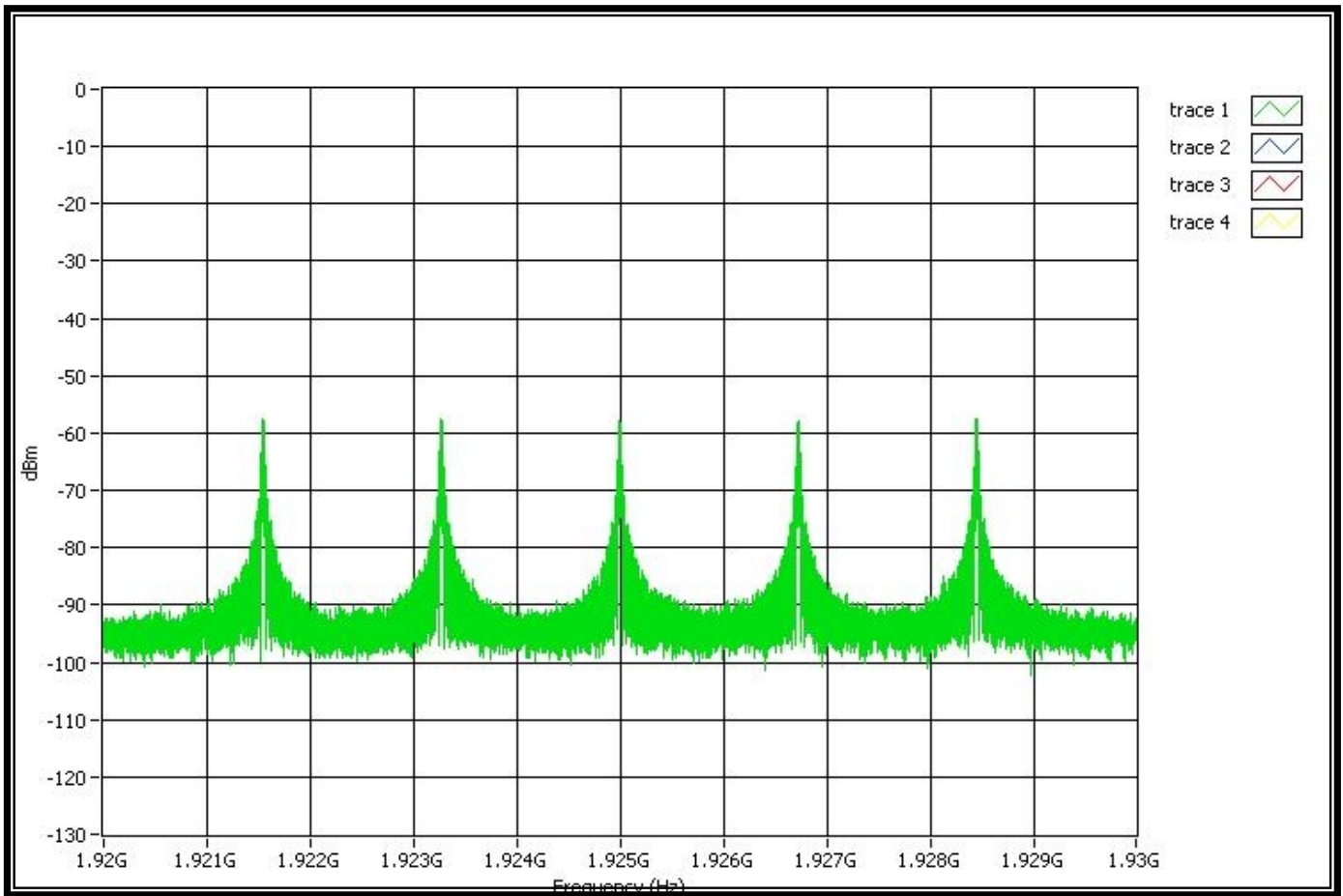

6.21 Monitoring antenna

6.21.1 Standard Applicable: FCC 15.323(c) (8)

The monitoring system shall use the same antenna used for transmission, or an antenna that yields equivalent reception at that location.

6.21.2 Measurement procedure

Measurement method according to ANSI C63.17-2013 paragraph 4

6.21.3 Results: Complies

The EUT uses the same antennas for transmission and reception as for monitoring.

6.22 Monitoring threshold relaxation

6.22.1 Standard Applicable: FCC 15.323(c)(9)

Devices that have a power output lower than the maximum permitted under the rules can increase their monitoring detection threshold by one decibel for each one decibel that the transmitter power is below the maximum permitted.

6.22.2 Measurement procedure

Measurement method according to ANSI C63.17-2013 paragraph 4

6.22.3 Results: Complies

Measurement Data:

This requirement is covered by results of Least Interfered Channel (LIC) test according to FCC 15.323(c) (5)	<input checked="" type="checkbox"/>
--	-------------------------------------

6.23 Duplex system LBT

6.23.1 Standard Applicable: FCC 15.323(c) (10)

An initiating device may attempt to establish a duplex connection by monitoring both its intended transmit and receive time and spectrum windows. If both the intended transmit and receive time and spectrum windows meet the access criteria, then the initiating device can initiate a transmission in the intended transmit time and spectrum window. If the power detected by the responding device can be decoded as a duplex connection signal from the initiating device, then the responding device may immediately begin transmitting on the receive time and spectrum window monitored by the initiating device.

6.23.2 Measurement procedure

Measurement method according to ANSI C63.17-2013, clause 8.3

This test is required for equipment that uses the access criteria in FCC 15.323(c)(10).

6.23.3 Test Results:

The manufacturer declares that this provision is not utilized by the EUT.

6.24 Co-located device LBT

6.24.1 Standard Applicable: FCC 15.323 (c)(11)

An initiating device that is prevented from monitoring during its intended transmit window due to monitoring system blocking from the transmissions of a co-located (within one meter) transmitter of the same system, may monitor the portions of the time and spectrum windows in which they intend to receive over a period of at least 10 milliseconds. The monitored time and spectrum window must total at least 50 percent of the 10 millisecond frame interval and the monitored spectrum must be within 1.25 MHz of the center frequency of channel(s) already occupied by that device or co-located co-operating device. If the access criteria is met for the intended receive time and spectrum window under the above conditions, then transmission in the intended transmit window by the initiating device may commence.

6.24.2 Measurement procedure

Measurement method according to ANSI C63.17-2013 paragraph 8.4

6.24.3 Results:

The manufacturer declares that this provision is not utilized by the EUT.

6.25 Fair Access

6.25.1 Standard Applicable: FCC 15.323 (c)(12)

The provisions of (c) (10) or (c) (11) shall not be used to extend the range of spectrum occupied over space or time for the purpose of denying fair access to spectrum for other devices.

6.25.2 Results:

The manufacturer declares that EUT does not work in a mode which denies fair access to spectrum for other devices.

6.26 Emissions inside and outside the subband

6.26.1 Standard Applicable: FCC 15.323(d)

Emissions outside the band shall be attenuated below a reference power of 112 milliwatts as follows: 30 dB between the band and 1.25 MHz above or below the band; 50 dB between 1.25 and 2.5 MHz above or below the band; and 60 dB at 2.5 MHz or greater above or below the band. Emissions inside the band must comply with the following emission mask: In the bands between 1B and 2B measured from the center of the emission bandwidth the total power emitted by the device shall be at least 30 dB below the transmit power permitted for that device; in the bands between 2B and 3B measured from the center of the emission bandwidth the total power emitted by an intentional radiator shall be at least 50 dB below the transmit power permitted for that radiator; in the bands between 3B and the band edge the total power emitted by an intentional radiator in the measurement bandwidth shall be at least 60 dB below the transmit power permitted for that radiator. B” is defined as the emission bandwidth of the device in hertz. Compliance with the emission limits is based on the use of measurement instrumentation employing peak detector function with an instrument resolution bandwidth approximately equal to 1.0 percent of the emission bandwidth of the device under measurement.

6.26.2 Measurement procedure

Measurement method according to ANSI C63.17-2013 paragraph 6.1.6

6.26.3 Results: Complies

Measurement Data:

See plots.

Note: Photos of worst-case display follow:

In-band Unwanted Emissions: CH FL

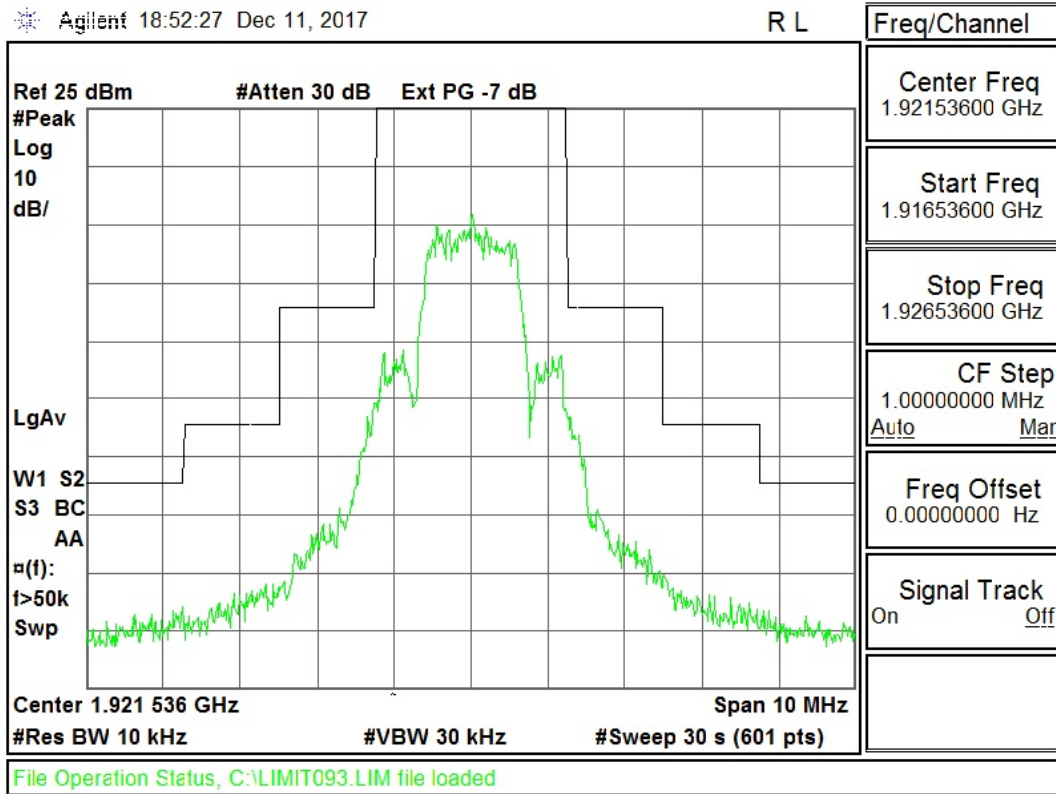

In-band Unwanted Emissions: CH Fm

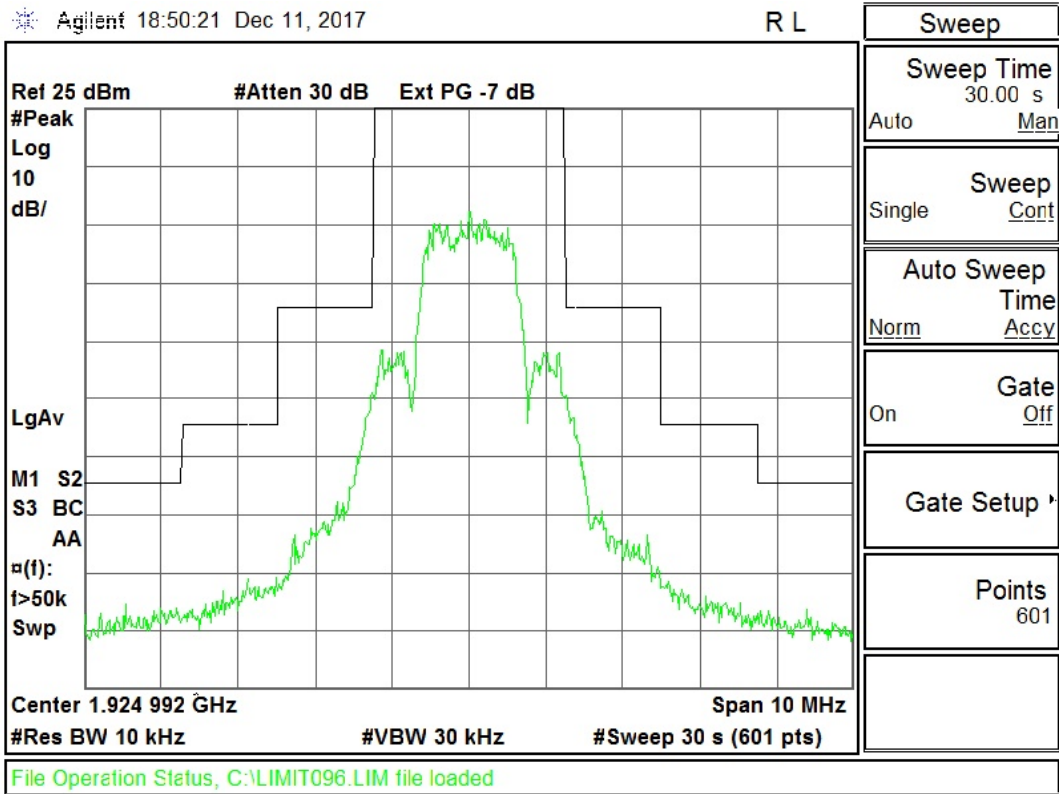

In-band Unwanted Emissions: CH F_H

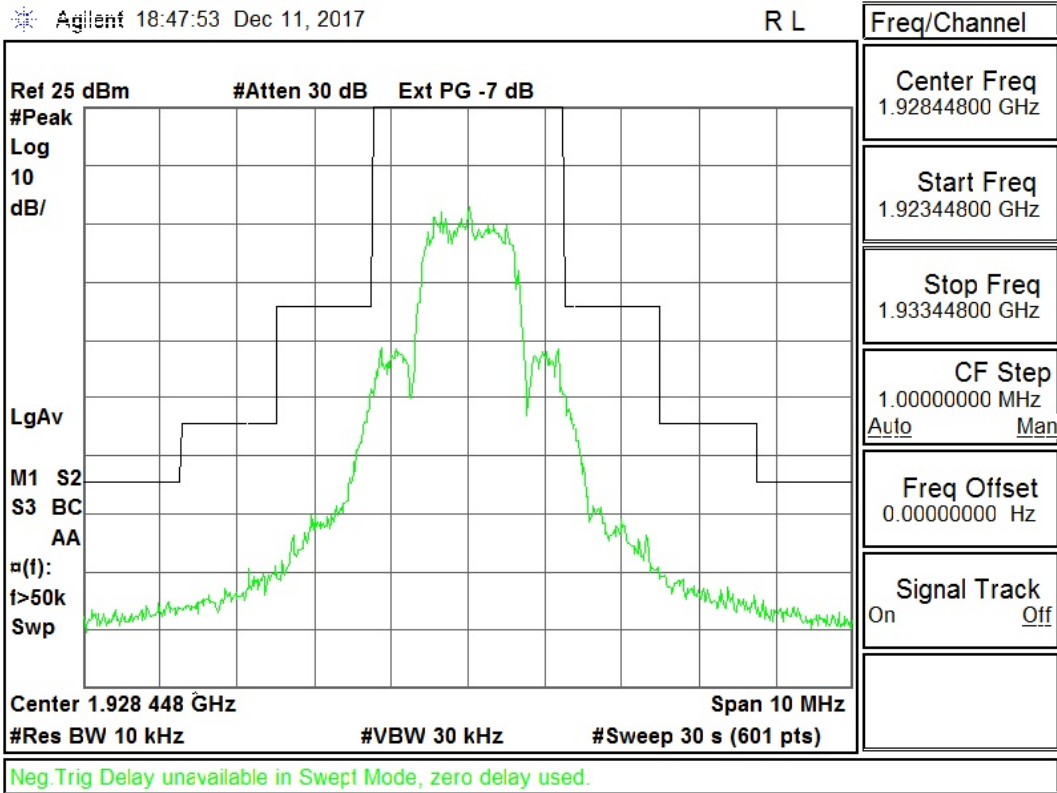

Out-of-band Unwanted Emissions: CH FL

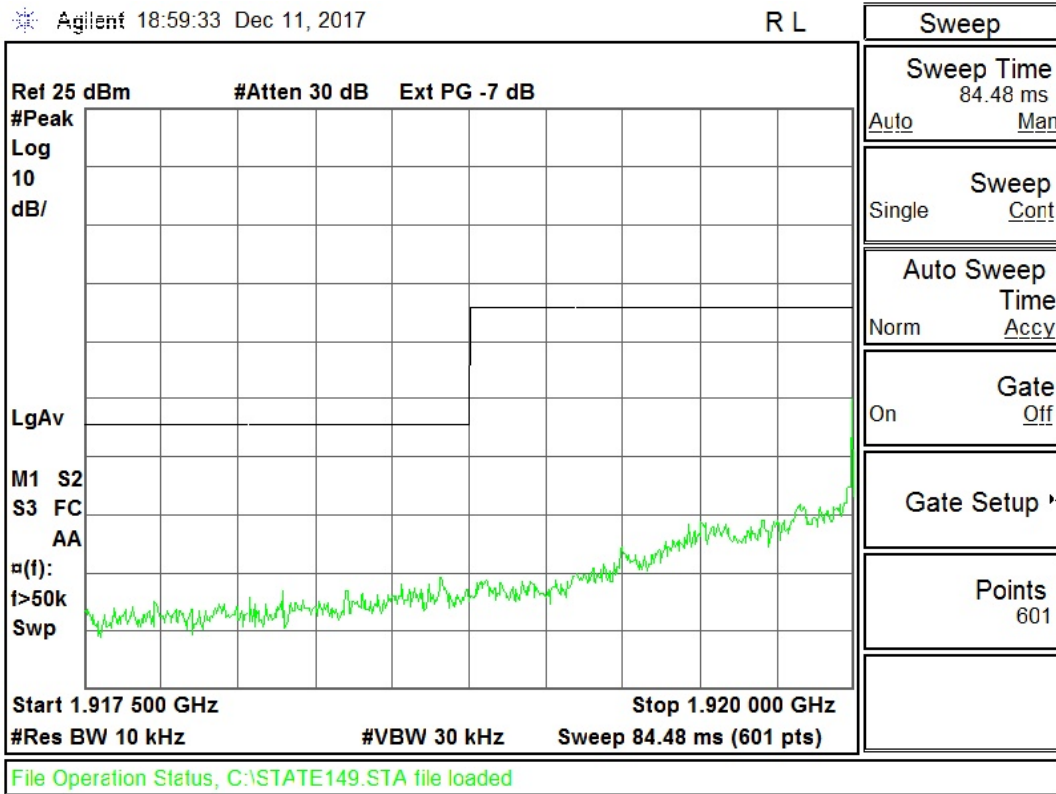

Out-of-band Unwanted Emissions: CH FL

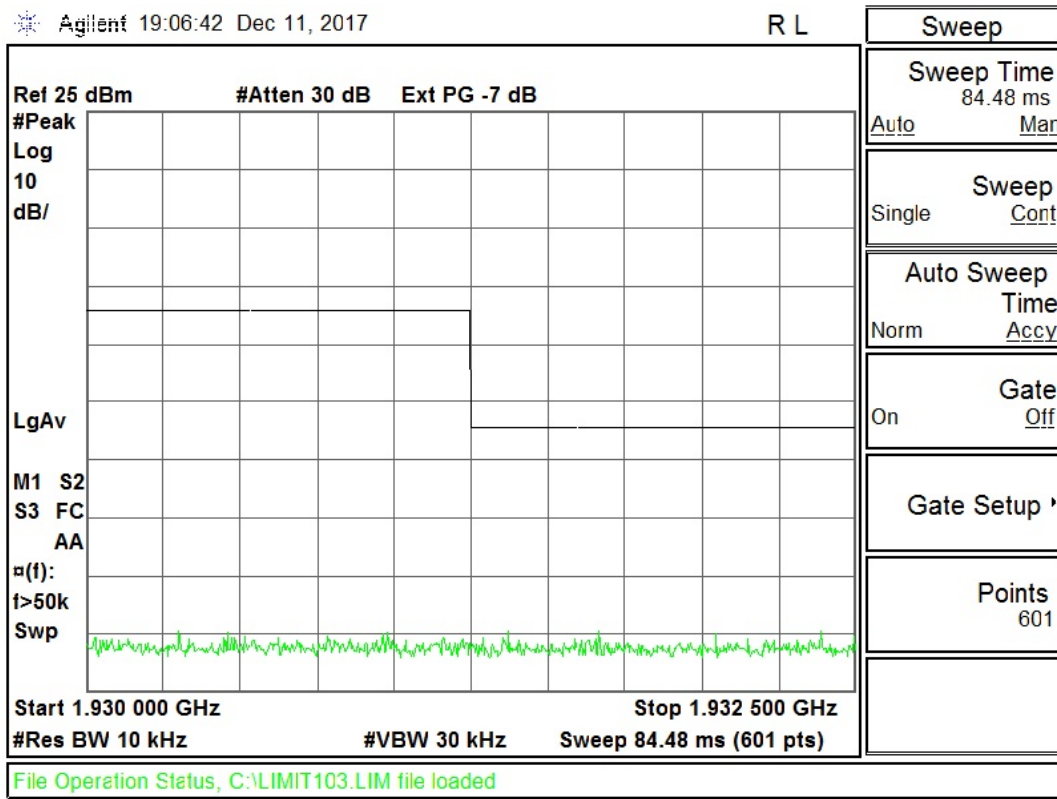

Out-of-band Unwanted Emissions: CH FL

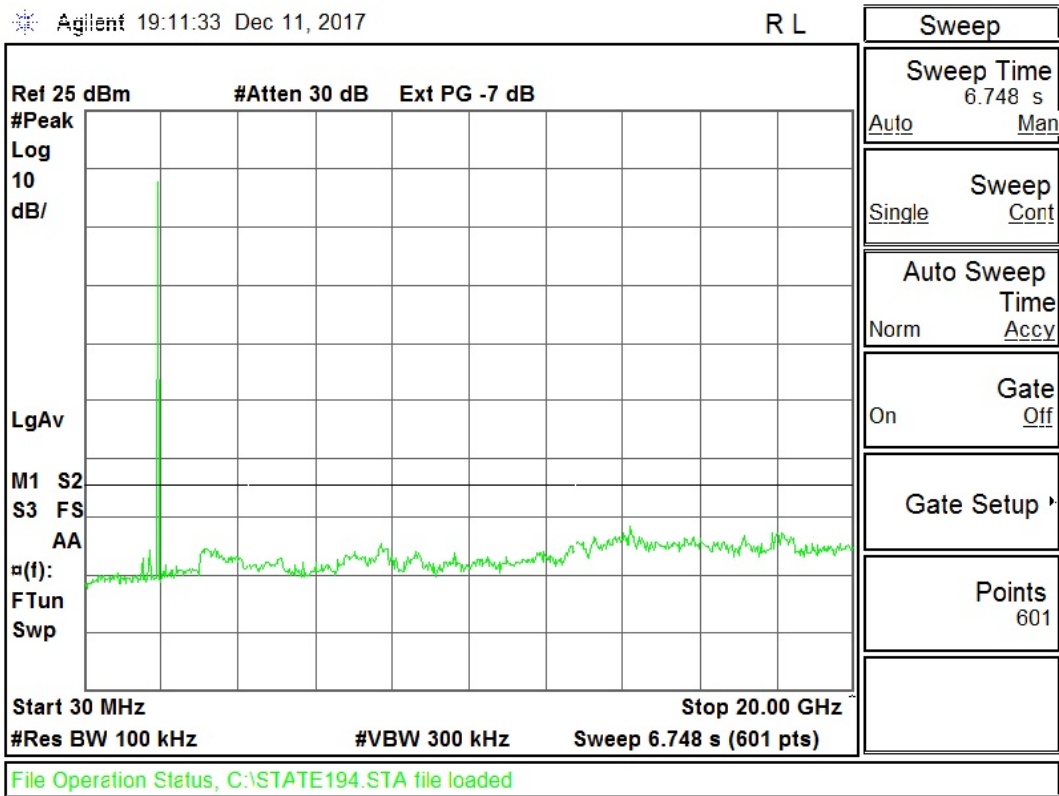

Out-of-band Unwanted Emissions: CH Fm

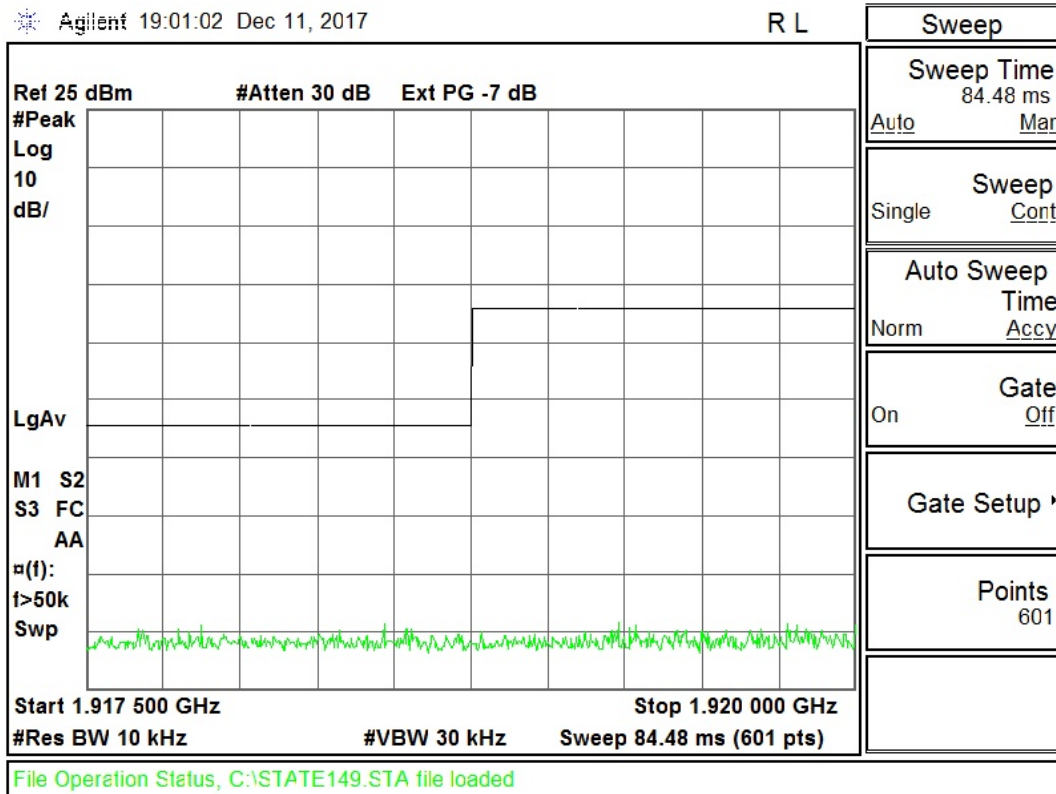

Out-of-band Unwanted Emissions: CH Fm

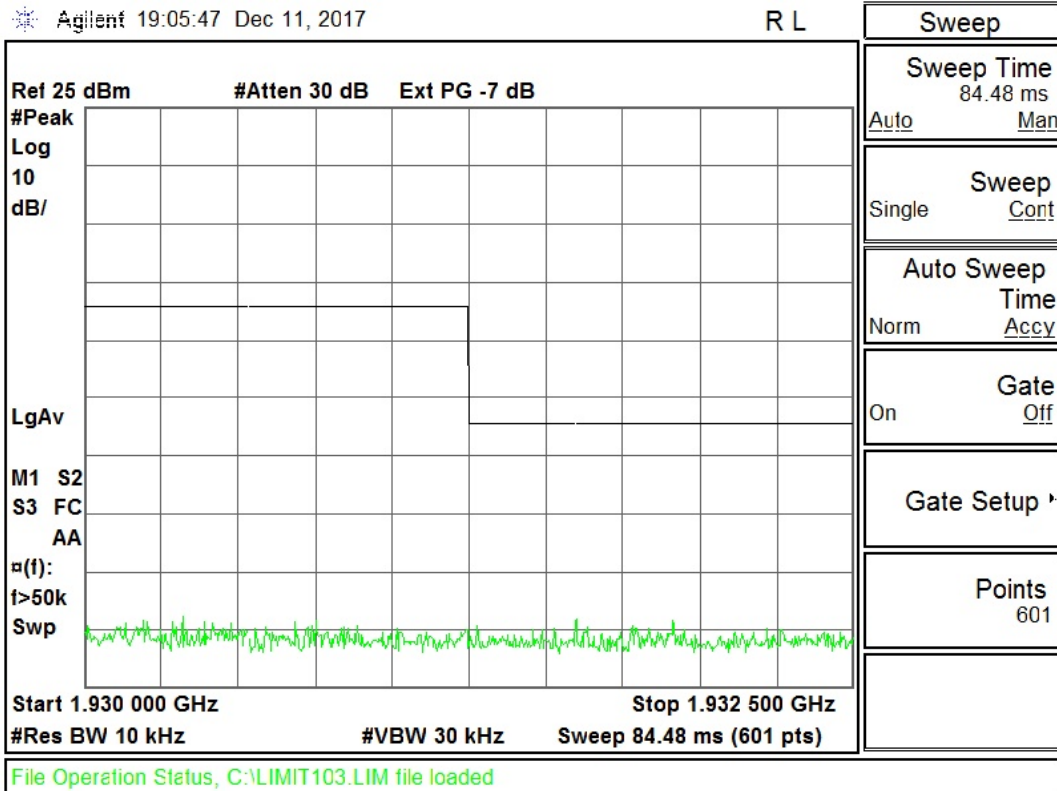

Out-of-band Unwanted Emissions: CH Fm

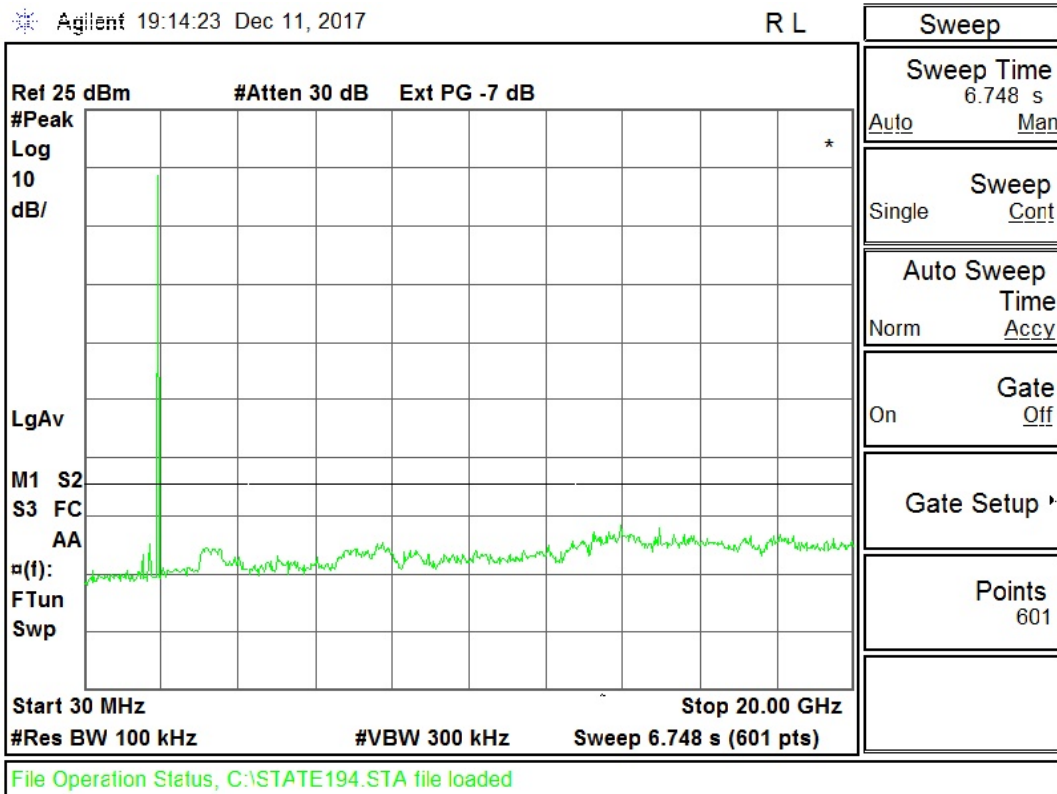

Out-of-band Unwanted Emissions: CH FH

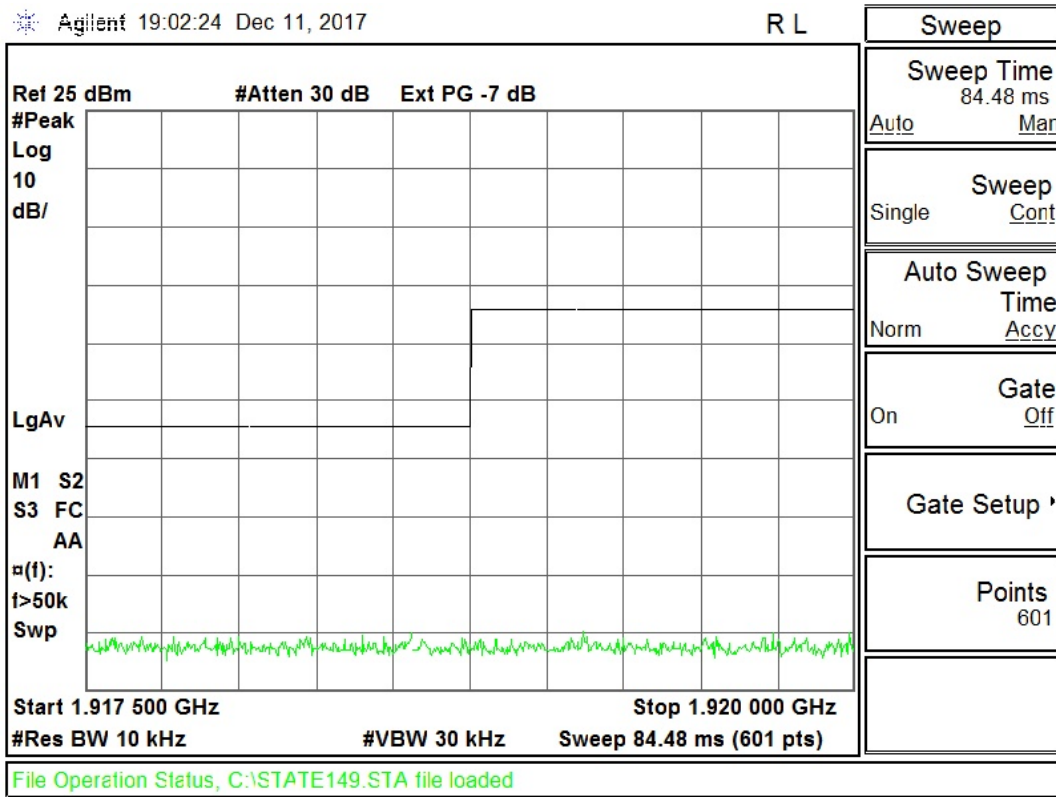

Out-of-band Unwanted Emissions: CH FH

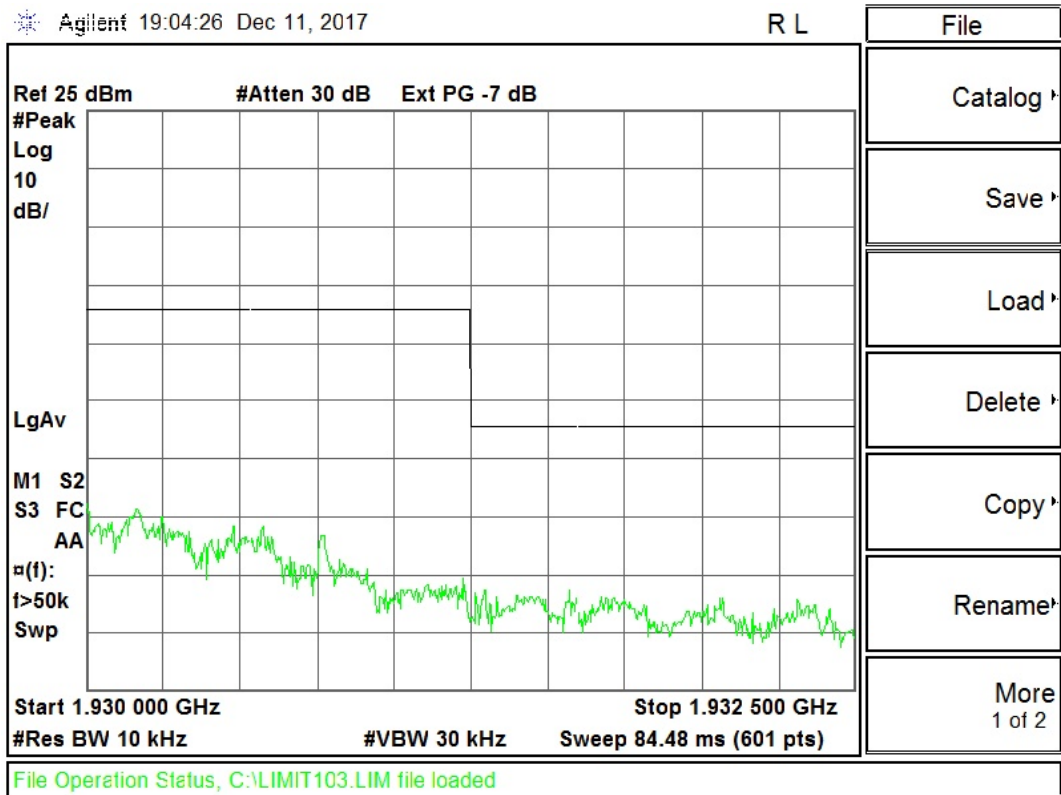

Out-of-band Unwanted Emissions: CH FH

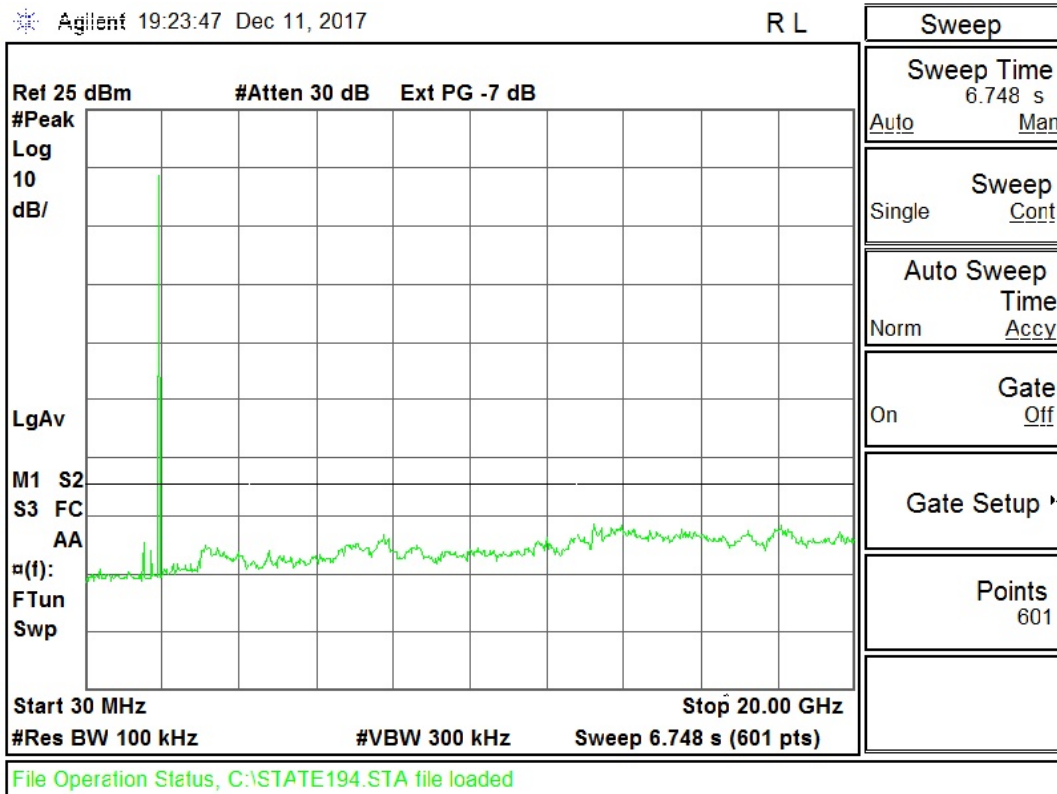

6.27 Frame period and jitter

6.27.1 Standard Applicable: FCC 15.323(e)

The frame period (a set of consecutive time slots in which the position of each time slot can be identified by reference to a synchronizing source) of an intentional radiator operating in these subbands shall be 20 milliseconds/X where X is a positive whole number. Each device that implements time division for the purposes of maintaining a duplex connection on a given frequency carrier shall maintain a frame repetition rate with a frequency stability of at least 50 parts per millions (ppm). Each device which further divides access in time in order to support multiple communication links on a given frequency carrier shall maintain a frame repetition rate with a frequency stability of at least 10 ppm. The jitter (time-related, abrupt, spurious variations in the duration of the frame interval) introduced at the two ends of such a communication link shall not exceed 25 microseconds for any two consecutive transmissions. Transmissions shall be continuous in every time and spectrum window during the frame period defined for the device.

6.27.2 Measurement Requirement:

- Frame frequency stability ≤ 50 ppm
- TDMA frame frequency stability ≤ 10 ppm (That translates to frequency drift of 19.2 kHz/slot for 1920 MHz carrier)
- Frame jitter ≤ 25 μ s

6.27.3 Test Results: Complies

Measurement Data:

Test Date : Dec. 08, 2017

Temperature : 20 °C

Humidity : 58%

a) TDMA frame frequency stability (frequency drift)

Channel No.	Frequency Drift (KHz/ slot)					Limit of Δ (KHz/ slot)
	min	mean	max	Δ min	Δ max	
F _M	-3	2	10	-5	8	± 19.2

Δ min = min - Avg of mean

$\Delta \text{max} = \text{max} - \text{Avg of mean}$

Photo of worst-case of Frequency Drift display follows:

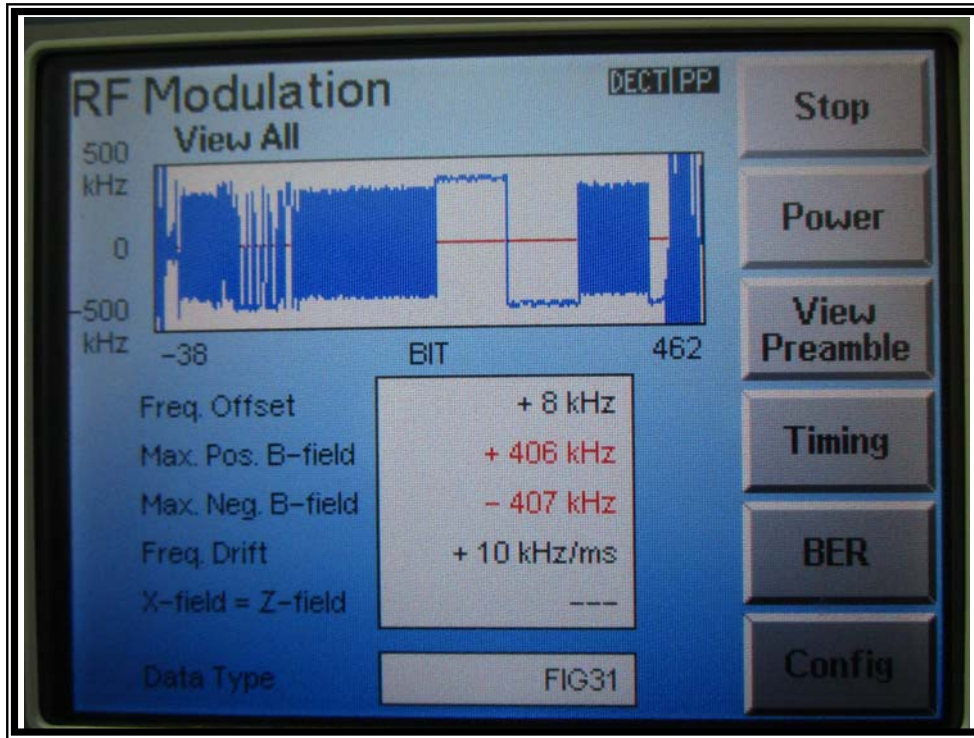

b) Frame jitter

Test Date : Dec. 08, 2017

Temperature : 20 °C

Humidity : 58%

Channel No.	Frame Jitter (uS)					Limit of Δ (uS)
	min	mean	max	Δ min	Δ max	
F _M	-0.08	0	0.08	-0.08	0.08	<u>±25</u>

$\Delta \text{min} = \text{min} - \text{Avg of mean}$

$\Delta \text{max} = \text{max} - \text{Avg of mean}$

Photo of worst-case of TDMA Frame Jitter display follows:

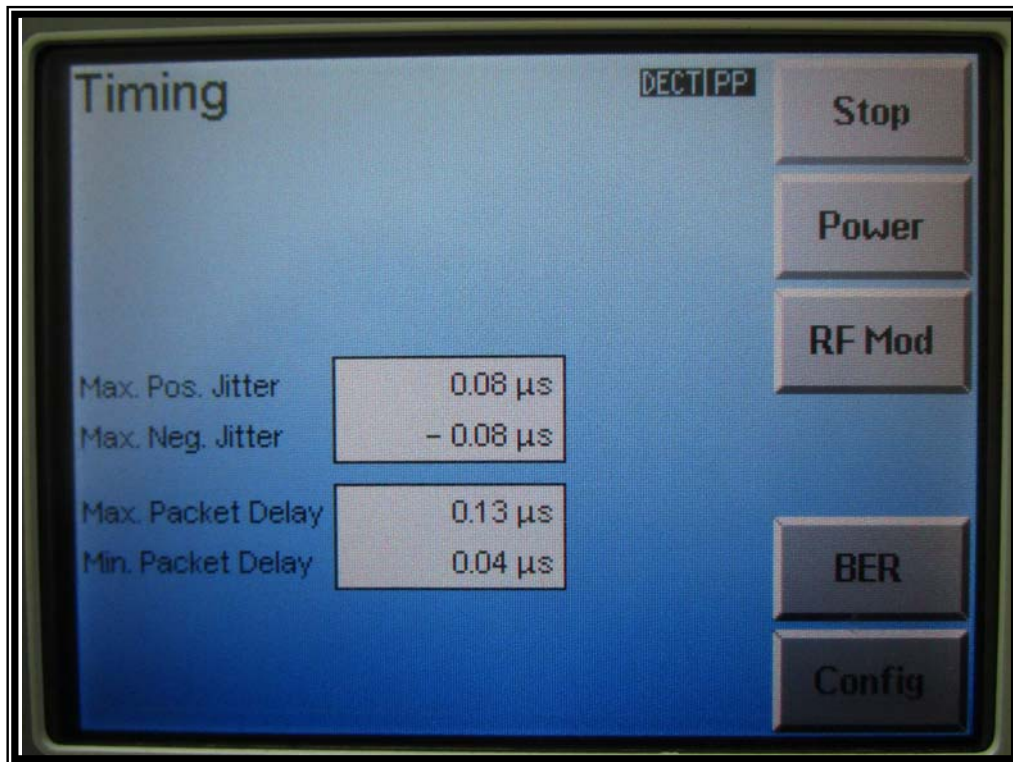

6.28 Carrier frequency stability

6.28.1 Standard Applicable: FCC 15.323(f)

The frequency stability of the carrier frequency of the intentional radiator shall be maintained within ± 10 ppm over 1 hour or the interval between channel access monitoring, whichever is shorter. The frequency stability shall be maintained over a temperature variation of -0°C to $+50^{\circ}\text{C}$ at normal supply voltage, and over a variation in the primary supply voltage of 85 percent to 115 percent of the rated supply voltage at a temperature of 20°C . For equipment that is capable only of operating from a battery, the frequency stability tests shall be performed using a new battery without any further requirement to vary supply voltage.

6.28.3 Test Results: Complies

Measurement Data:

Test Date : Dec. 08, 2017 Temperature : 20 °C Humidity : 58%

a) Carrier Frequency Stability over time

Channel No.	Frequency Offset (kHz)					Limit of Δ (kHz)
	min	mean	max	Δ min	Δ max	
F _M	7	8	8	-1	0	± 19.2

Δ min = min - Avg of mean

Δ max = max - Avg of mean

Test was conducted for duration longer than 1 hour. Photo of worst-case of Frequency offset display follows:

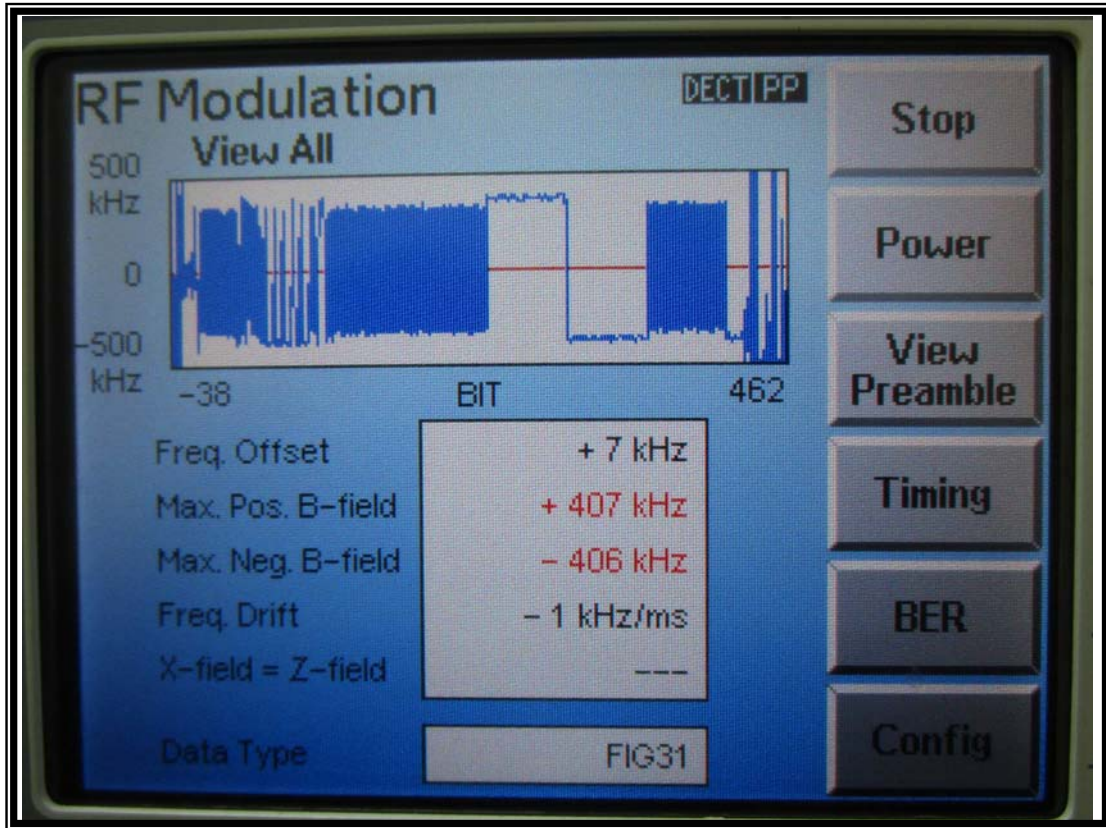

b) Carrier Frequency Stability over temperature

Channel No.	Frequency Offset (kHz)					Limit of Δ (kHz)
	Mean of low temp. (0°C)	Mean of normal temp. (20°C)	Mean of high temp. (40°C)	Δ low	Δ high	
FM	7	8	8	-1	0	± 19.2

Δ low = Mean of low temp. - Mean of normal temp.

Δ high = Mean of high temp. - Mean of normal temp.