

OTHER CONTROLS AND EQUIPMENT

Installation of radio frequency transmitters

We recommend that you always ask a SUZUKI dealer or a qualified workshop about frequency band, max output power, antenna position at vehicle and specific conditions for installation and/or use before installing a radio transmitter in your vehicle. Such equipments may cause the electronic control system to malfunction if they are incorrectly installed or they are not suited for the vehicle.

Audio system (if equipped)

Safety information

WARNING

If you pay too much attention to operating the audio system or viewing the audio system display while driving, an accident can occur. If you set the sound volume too loud, it could prevent you from being aware of road and traffic conditions.

- **Keep your eyes on the road and your mind on the drive. Avoid paying too much attention to operating the audio system or viewing the audio system display.**
- **Familiarize yourself with the audio system controls and operation of the audio system before driving.**
- **Preset your favorite radio stations before driving so that you can quickly tune to them using the presets.**
- **Set the sound volume to a level that will allow you to continue to be aware of road and traffic conditions while driving.**
- **Set the smartphone dock on to the Audio system at a comfortable viewing angle and familize yourself with the smartphone application controls.**

Open source definition

This Product includes following open source software.
mbedtls version 2.5.1

Copyright © 2006–2015, ARM Limited,
All Rights Reserved
SPDX-License-Identifier: Apache-2.0

Licensed under the Apache License, Version 2.0 (the "License"); you may not use this file except in compliance with the License.

You may obtain a copy of the License at <http://www.apache.org/licenses/LICENSE-2.0>

Unless required by applicable law or agreed to in writing, software distributed under the License is on an "AS IS" BASIS, WITHOUT WARRANTIES OR CONDITIONS OF ANY KIND, either express or implied.

See the License for specific language governing permissions and limitations under the License.

This file is part of mbed TLS (<https://tls.mbed.org>)

Please be noted that a portion of this software is made by changing or modifying original source files.

OTHER CONTROLS AND EQUIPMENT

Basic operations

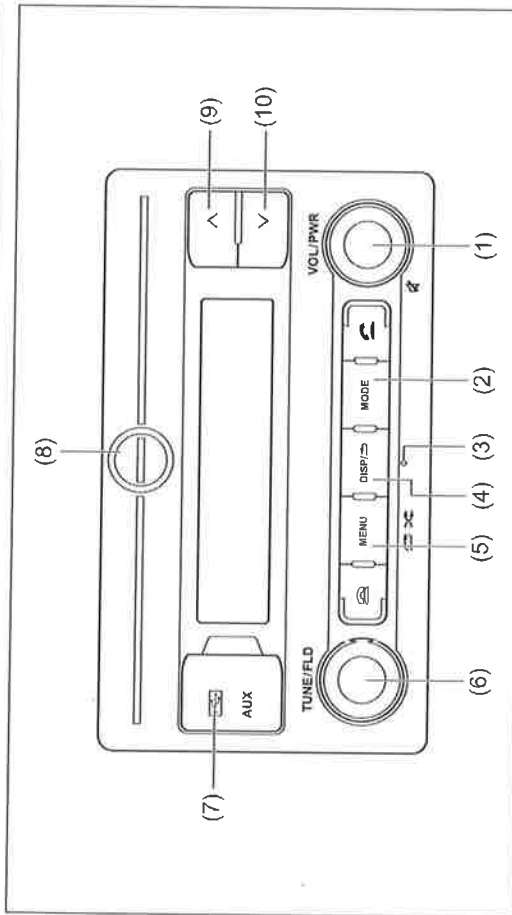

- (1) "VOL/PWR" knob
- (2) "MODE" button
- (3) MICROPHONE (for handsfree)
- (4) "DISP/BACK" button
- (5) "MENU" button
- (6) "TUNE/FLD" knob
- (7) USB/AUX
- (8) SMARTPHONE DOCK CAP
- (9) "SEEK UP" button
- (10) "SEEK DOWN" button

Turning on/off power

Press "VOL/PWR" knob (1) to turn on the power. The unit starts to operate in the previous mode that the power was turned off.

- To turn off the power, press "VOL/PWR" knob (1) for about 1 second.

Adjusting the volume

Turn "VOL/PWR" knob (1).

- Turning it clockwise increases the volume.
- Turning it counterclockwise decreases the volume.

Mute

- Press "VOL/PWR" knob(1) to mute the sound.
- To cancel mute, press any button.

NOTE:

For the purpose of safe driving, adjust the audio volume to a level that allows you to hear sounds outside of the vehicle including car horns and particularly emergency vehicle sirens.

OTHER CONTROLS AND EQUIPMENT

Sound settings

- 1) Press "MENU" button (5). Setup menu will be displayed.
- 2) Turn "TUNE/FLD" knob (6) to select "Sound Settings", and press the knob (6) to determine the selection.
- 3) Turn "TUNE/FLD" knob (6) to select one of the settings as follows, and press the knob (6) to determine the selection.

Equalizer
↕
Bass
↕
Treble
↕
Balance
↕
Fader
↕
AVC
↕
Speaker Configuration

Equalizer

The equalizer can set various types of sounds depending on the type of music.

- 1) Turn "TUNE/FLD" knob (6) to select "Equalizer", and press the knob (6) to determine the selection.
- 2) Turn "TUNE/FLD" knob (6) to select one of the settings as follows, and press the knob (6) to determine the selection.

Fiat
↕
Classic
↕
Jazz
↕
Rock
↕
Hip-Hop
↕
Pop
↕
Custom

NOTE:

- When you select "Custom", the sound curve can be adjusted as your preference. Turn "TUNE/FLD" knob (6) to adjust values of sound, and press the knob (6) to determine the selection.
- ">>" "<<" mark appears at both left and right ends of the currently selected equalizer.

Adjusting bass/treble/balance/fader

- 1) Turn "TUNE/FLD" knob (6) to select "Bass", "Treble", "Balance" or "Fader", and press the knob (6) to determine the selection.
- 2) Turn "TUNE/FLD" knob (6) to adjust the sound, and press the knob (6) to determine the selection.
 - "Bass" / "Treble":
 - Can be adjusted in levels -6 to 0 to +6.
 - Turn "TUNE/FLD" knob (6) clockwise to adjust the low or high frequency and turn the knob (6) counterclockwise to quiet.
 - "Balance":
 - Can be adjusted in 9 level left to right.
 - Turn "TUNE/FLD" knob (6) clockwise to emphasize the right speaker, and turn the knob (6) counterclockwise to emphasize the left speaker.
 - "Fader":
 - Can be adjusted in 9 level back to front.
 - Turn "TUNE/FLD" knob (6) clockwise to emphasize the front speaker, and turn the knob (6) counterclockwise to emphasize the rear speaker (if equipped).

NOTE:

When you adjust to emphasize the rear speakers, sound output may fade out completely in case vehicle is not equipped with rear speakers.

OTHER CONTROLS AND EQUIPMENT

Adjusting the AVC (Auto volume control)

The Auto Volume Control (AVC) function automatically adjusts (increases/decreases) the sound volume in accordance with vehicle speed. The AVC control is provided with four selectable levels (LEVEL OFF, 1, 2, 3). The level of volume adjustment increases together with the LEVEL number.

- 1) Turn "TUNE/FLD" knob (6) to select "AVC", and press the knob (6) to determine the selection.
- 2) Turn "TUNE/FLD" knob (6) to adjust the level, and press the knob (6) to determine the selection.

Adjusting the sound parameters as per speaker configuration

- 1) Turn "TUNE/FLD" knob (6) to select "Speaker Configuration", and press the knob (6) to determine the selection.
- 2) Turn "TUNE/FLD" knob (6) to select "2SPK" or "4SPK", and press the knob (6) to determine the selection.

- "2SPK":
Sound is generated from the front speakers.
- "4SPK" (if equipped):
Sound is generated from the all speakers.

NOTE:

For optimal sound experience, ensure that speaker configuration is selected as per the actual speakers present in the vehicle.

System settings

- 1) Press "MENU" button (5). Setup menu will be displayed.
- 2) Turn "TUNE/FLD" knob (6) to select "System Settings", and press the knob (6) to determine the selection.
- 3) Turn "TUNE/FLD" knob (6) to select one of the settings as follows, and press the knob (6) to determine the selection.

Beep
↓
Security
↓
Initialize
↓
Vehicle Alerts
↓
Reverse Warning Priority
↓
Auto Scroll
↓
RDS
↓
SmartPhone APP

Beep on/off

Beep sound is activated when error message is displayed or during operations of few button.

Beep setting can be turned on or off through the following steps:

- 1) Turn "TUNE/FLD" knob (6) to select "Beep"
- 2) Press "TUNE/FLD" knob (6) to select "ON" or "OFF".

Security setting

Refer to "Anti-theft feature" later in this section.

Initialize setting

You can delete the registered Bluetooth® device information.

- 1) Turn "TUNE/FLD" knob (6) to select "Initialize", and press the knob (6) to determine the selection.
- 2) Turn "TUNE/FLD" knob (6) to select "Reset BT", and press the knob (6) to determine the selection.
- 3) Turn "TUNE/FLD" knob (6) to select "YES", and press the knob (6) to determine the selection.

OTHER CONTROLS AND EQUIPMENT

Vehicle alerts setting

You can turn on or off the warning, indications related to vehicle system using this setting. By default, this setting is ON for all alerts.

- 1) Turn "TUNE/FLD" knob (6) to select "Vehicle Alerts", and press the knob (6) to determine the selection.
- 2) Turn "TUNE/FLD" knob (6) to select one of the settings as follows, and press the knob (6) to determine the selection.

Parking Brake Engaged ↓ Seat Belt Open ↓ Door Open ↓ Low Fuel

- 3) Press "TUNE/FLD" knob (6) to select "ON" or "OFF".
- 4) Following are the warning display related to vehicle system:
 - "Parking Brake Engaged": Parking brake is engaged.
 - "Seat Belt Open": Seat belt(s) is (are) remaining unbuckled.
 - "Door Open": Doors are not completely closed.
 - "Low Fuel": Fuel is low.

NOTE:

If you push "DISP/BACK" button (4) while the warning and indicator messages is displayed, the indication will disappear.

Reverse warning priority setting

On applying reverse, volume of audio system gets lowered. By default, this setting is ON. This setting can be turned on or off through the following steps:

- 1) Turn "TUNE/FLD" knob (6) to select "Reverse Warning Priority", and press the knob (6) to determine the selection.
- 2) Turn "TUNE/FLD" knob (6) to select "No" or "Yes", and press the knob (6) to determine the selection.

Auto scroll setting

Auto scroll setting is ON by default.

If the text contains more characters, ">" mark will appear at the right end and the display changes to the next set of characters automatically.

- 1) Turn "TUNE/FLD" knob (6) to select "Auto Scroll".
- 2) Press "TUNE/FLD" knob (6) to select "ON" or "OFF".

RDS (Radio Data System) setting

Enabling this setting displays the messages transmitted by FM station. This setting is ON by default. You can choose to turn ON/OFF this setting through the following steps:

- 1) Turn "TUNE/FLD" knob (6) to select "RDS".
- 2) Press "TUNE/FLD" knob (6) to select "ON" or "OFF".

NOTE:

- Messages are displayed only when RDS signal is included in FM radio waves.
- The messages are displayed program service name only.

Smartphone app setting

Refer to section 5-52 for details about smartphone application.

Smartphone app can be used only when app setting is enabled as ON.

Refer to "Suzuki Smartplay Dock application" later in this section for details.

- 1) Turn "TUNE/FLD" knob (6) to select "SmartPhone APP".
- 2) Press "TUNE/FLD" knob (6) to select "ON" or "OFF".

NOTE:

An Apple device can be connected in either Bluetooth® or iPod mode. Bluetooth® mode has higher priority over iPod Mode. In case, you want to connect the Apple device on iPod mode instead, use the above setting and change Smartphone app setting to "OFF".

OTHER CONTROLS AND EQUIPMENT

Listening to the radio

- (1) UP button
 - (2) DOWN button
 - (3) "MODE" button
 - (4) "TUNE/FLD" knob
- (A) Frequency
 - (B) Band
 - (C) Auto store mode indication
 - (D) RDS data

NOTE:

Radio Reception
Radio reception can be affected by environment, atmospheric conditions, or radio signal's power and distance from the station.

Nearby mountains and buildings may interfere or deflect radio reception, causing poor reception. Poor reception or radio static can also be caused by electric current from overhead wires or high voltage power lines.

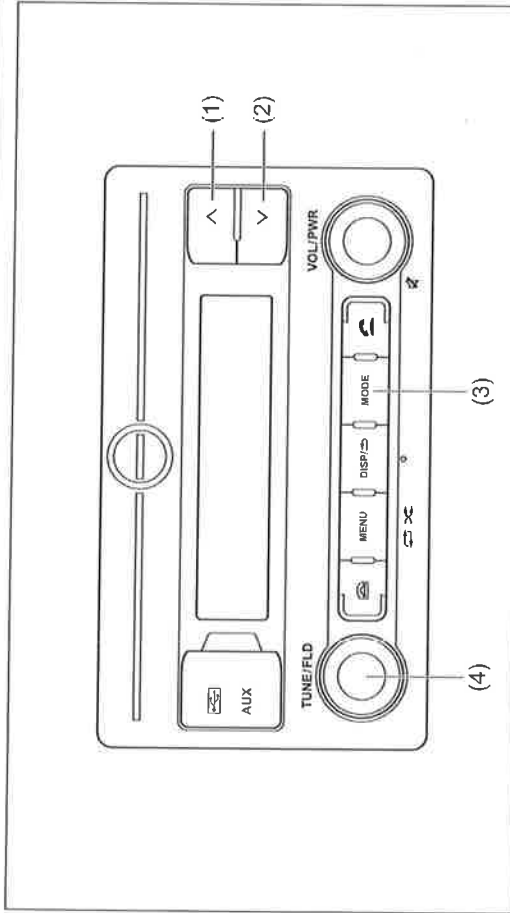

Display

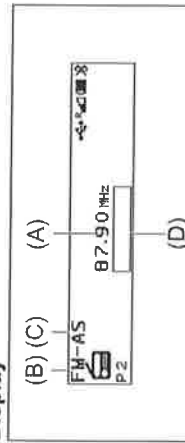

OTHER CONTROLS AND EQUIPMENT

Selecting the band

- 1) Press and hold "MODE" button (3) to change to the list of available modes.
- 2) Turn "TUNE/FLD" knob (4) to select "FM" or "AM", and press the knob (4) to determine the selection.

NOTE:

You can also switch the display in sequence by short pressing the "MODE" button (3).

Seek tuning

Press and hold UP button (1) or DOWN button (2) to start searching. The unit stops searching for a station at a frequency where a broadcast station is available.

Manual tuning

Turn "TUNE/FLD" knob (4). The frequency being received is displayed.

Preset memory

- 1) Tune to the desired station.
 - 2) Press "TUNE/FLD" knob (4) to change the display to the preset channel list.
 - 3) To store the station, turn "TUNE/FLD" knob (4) to select one of the channels, and press and hold the knob (4) to determine the selection.
 - 4) To select station from the preset channel list, press "TUNE/FLD" knob (4) to change the display to the preset channel list.
- Turn "TUNE/FLD" knob (4) to select one of the channels, and press the knob (4) to determine the selection.

NOTE:

12 stations can be stored for FM, and 6 stations can be stored for AM.

In case a station is stored over an existing preset station, previous data will be overridden.

Auto store

- 1) Press and hold "TUNE/FLD" knob (4) to start searching when in FM/AM mode. Some stations in good reception will automatically be stored to preset channel list in order, starting from a station whose frequency is the lowest.
- 2) To select station from the preset channel list, press "TUNE/FLD" knob (4) to change the display to the preset channel list while auto store mode indication (C) is displayed.

NOTE:

- *Auto Store can be cancelled by pressing the "DISP/BACK" button.*
- *When the auto store is performed, the station previously stored in the memory at the position is overwritten.*
- *6 stations can be preset for FM-AS, and 6 stations can be preset for AM-AS in auto store mode.*

OTHER CONTROLS AND EQUIPMENT

Listening to files stored in a USB device

- (1) "UP" button
- (2) "DOWN" button
- (3) "MODE" button
- (4) "DISP/BACK" button
- (5) "MENU" button
- (6) "TUNE/FLD" knob

- (A) Track number
- (B) Play time
- (C) Current Active track information
(if supported by audio device)
- (D) Repeat/Random status Indication

NOTICE

Do not connect any USB device other than a USB memory or a USB audio player. Do not connect multiple USB devices to the USB connector using a USB hub, etc. Supplying power to multiple USB devices from the connector could cause overheating, smoke and permanent damage to audio system.

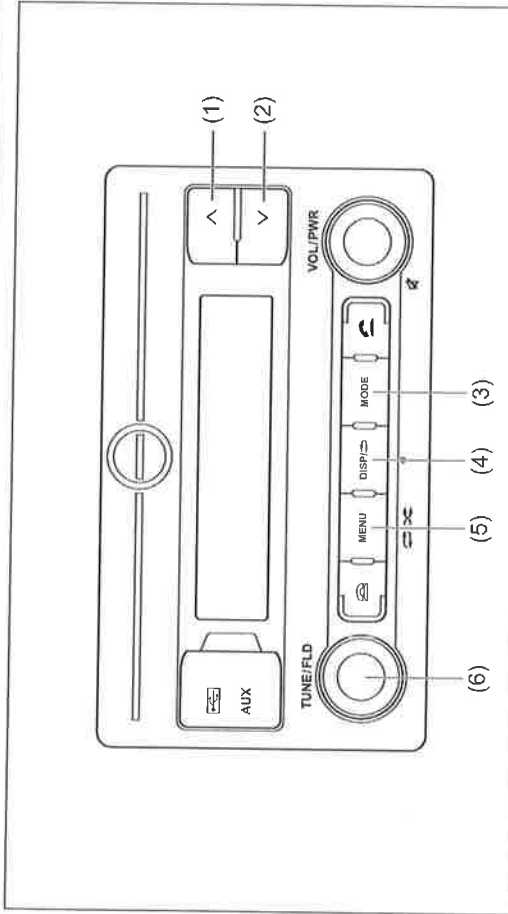

69RH146

Display

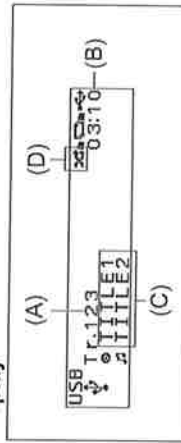

69RM05003

OTHER CONTROLS AND EQUIPMENT

Selecting a USB device mode

- 1) Press and hold "MODE" button (3) to change the display.
- 2) Turn "TUNE/FLD" knob (6) to select "USB", and press the knob (6) to determine the selection.

NOTE:

You can also switch the display in sequence by short pressing the "MODE" button (3).

Selecting a folder

Turn "TUNE/FLD" knob (6) to select the desired folder.

Selecting a track

- Press UP button (1) to listen to the next track.
 - Press DOWN button (2) twice to listen to the previous track.
- When DOWN button (2) is pressed once, the track currently being played will start from the beginning again.

Fast forwarding/rewinding a track

- Press and hold UP button (1) to fast forward the track.
- Press and hold DOWN button (2) to fast rewind the track.
- Releasing the button can stop the fast forwarding/rewinding.

Repeat playback

- 1) Press and hold "MENU" button (5) to change the display.
- 2) Turn "TUNE/FLD" knob (6) to select "Repeat".
- 3) Press "TUNE/FLD" knob (6) to select one of the settings as follows.



- FILE

The track currently being played will be played repeatedly.

- FOLDER

All the tracks in the folder currently selected will be played repeatedly.

Random playback

- 1) Press and hold "MENU" button (5) to change the display.
- 2) Turn "TUNE/FLD" knob (6) to select "Random".
- 3) Press "TUNE/FLD" knob (6) to select one of the settings as follows.



- FOLDER

The tracks in the currently selected folder will be played in random order.

- ALL

The tracks in the connected USB device will be played in random order.

OTHER CONTROLS AND EQUIPMENT

Display change

Press "DISP/BACK" button (4). Each time the button is pressed, display will change as follows:

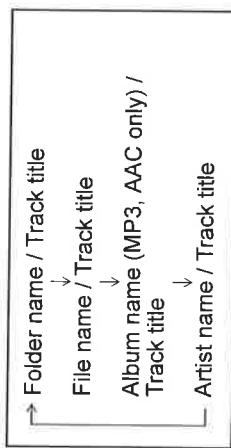

NOTE:

- "NO TITLE" will be displayed when there is no text information in the file currently being played.
- If text data contains more characters than the display area, ">" mark will appear at the right end.

Notes on USB device

Compatible USB devices

- USB mass storage class
- For details as to whether your USB memory/USB audio is compatible with USB mass storage class, please contact the USB memory/USB audio manufacturer.

- Audio file
MP3 (.mp3) / WMA (.wma) / AAC (.m4a) / AAC (.aac)
- File system
FAT 16/32, VFAT (supporting long file name)
- USB standard compatibility
1.1/2.0 full speed

- If a USB hub or extension cable is connected to the audio system, it may not be recognized. In this case, directly connect the USB device to the audio system.

- Devices such as MP3 players/mobile phones/digital cameras may not be recognized as audio systems for playing music.

USB device connection

- When connecting a USB device, make sure that the connector is pushed all the way into the port present on audio system.
- Depending on the USB flash drive that you are using, (non-brand product, USB flash drive that has been externally damaged) it may disable connection or cause unstable operation.
- Do not leave the USB device for long periods of time in places inside the vehicle where the temperature can rise too high.
- Back up any important data beforehand. We cannot accept responsibility for any lost data.
- It is recommended not to connect a USB device that contains data files other than MP3/WMA format.

Playing MP3/WMA/AAC files on a USB device

- Playback or display may not be possible depending on the type of USB device in use or the condition of the recording.
- Depending on the connected USB memory, the files may be played in different order from the order that the files were stored.
- The DRM (Digital Rights Management) file cannot be played.

OTHER CONTROLS AND EQUIPMENT

Compatible compression formats

- MP3
 - Bit rate
 - MPEG1 Audio Layer III: 32 up to 320 kbps
 - MPEG2 Audio Layer III: 8 up to 160 kbps
 - MPEG2.5 Audio Layer III: 8 up to 160 kbps
 - VBR: up to 384 kbps (MAX.)
 - Sampling frequency
 - MPEG1 Audio Layer III: 32/44.1/48 kHz
 - MPEG2 Audio Layer III: 16/22.05/24 kHz
 - MPEG2.5 Audio Layer III: 8/11.025/12 kHz
 - Channel
 - Stereo/Joint stereo/Dual channel/
 - Monaural
 - ID3 tag
 - ID3v1.x/ID3v2.x

WMA

- Windows Media Audio Ver.7/Ver.8/Ver.9
- Standard compliant
- Bit rate: 32 up to 320 kbps
- VBR: up to 384 kbps (MAX.)
- Sampling frequency: 32/44.1/48 kHz
- WMA tag: Ver.8.0
- Channel: 2 Channels

AAC

- Bit rate: 16 up to 320 kbps
- VBR: up to 320 Kbps (MAX.)
- Sampling frequency: 32/44.1/48 kHz
- AAC tag: iTunes m4a metadata

Maximum number of files/folders

- Maximum number of files: 2500
- Maximum number of files in a folder: 255
- Maximum number of folders: 255
 - Root folder and empty folder are included.
- Maximum depth of tree structure: 8

NOTICE

Never use “.mp3”, “.wma” or “.m4a” as a file name extension if it is not in the MP3/WMA/AAC format file. Failure to observe this may result in damage to the speaker due to noise production.

OTHER CONTROLS AND EQUIPMENT

Listening to an iPod

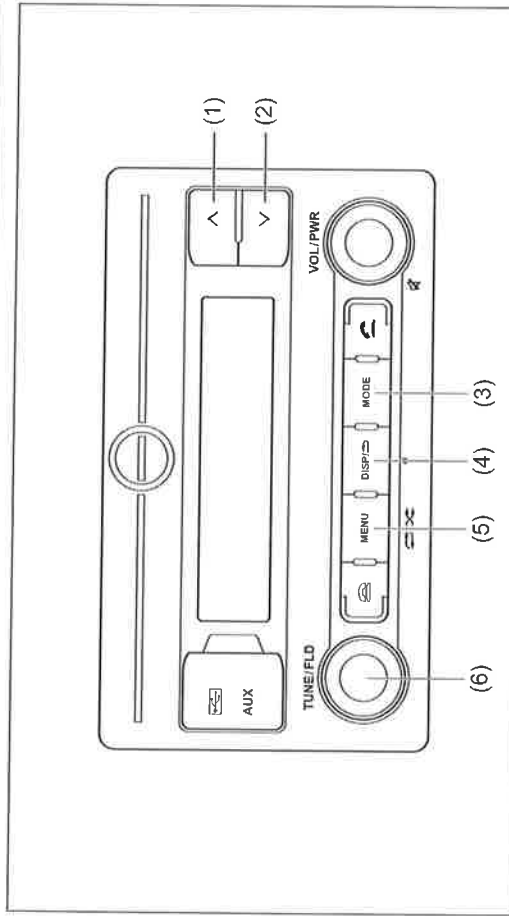

- (1) UP button
- (2) DOWN button
- (3) "MODE" button
- (4) "DISP/BACK" button
- (5) "MENU" button
- (6) "TUNE/FLD" knob

- (A) Track number
- (B) Play time
- (C) Current Active track information (if supported by audio device)

Selecting an iPod mode

- 1) Press and hold "MODE" button (3) to change the display.
- 2) Turn "TUNE/FLD" knob (6) to select "iPod", and press the knob (6) to determine the selection.

NOTE:

You can also switch the display in sequence by short pressing the "MODE" button (3).

69RH146

Display

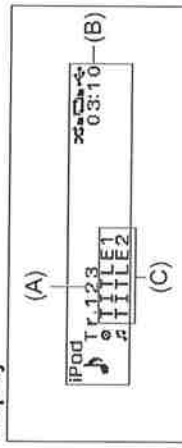

Selecting a track

- Press UP button (1) to listen to the next track.
 - Press DOWN button (2) twice to listen to the previous track.
- When DOWN button (2) is pressed once, the track currently being played will start from the beginning again.

OTHER CONTROLS AND EQUIPMENT

Fast forwarding/rewinding a track

- Press and hold UP button (1) to fast forward the track.
- Press and hold DOWN button (2) to fast rewind the track.
- Releasing the button can stop the fast forwarding/rewinding.

Repeat playback

- 1) Press and hold "MENU" button (5) to change the display.
- 2) Turn "TUNE/FLD" knob (6) to select "Repeat".
- 3) Press "TUNE/FLD" knob (6) to select one of the settings as follows.



- FOLDER
All the tracks in the folder currently selected will be played repeatedly.
- SONG
The track currently being played will be played repeatedly.

NOTE:

Settings may be displayed depending on the model of iPod.

Random playback

- 1) Press and hold "MENU" button (5) to change the display.
- 2) Turn "TUNE/FLD" knob (6) to select "Random".
- 3) Press "TUNE/FLD" knob (6) to select one of the settings as follows.



- SONG
The tracks in the iPod will be played in random order.

NOTE:

Settings may be displayed depending on the model of iPod.

Display change

Press "DISP/BACK" button (4). Each time the button is pressed, display will change as follows:

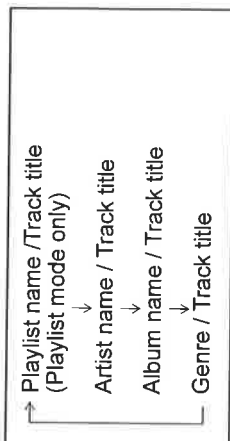

NOTE:

- "NO TITLE" will be displayed when there is no text information in the file currently being played.
- If text data contains more characters than the display area, ">" mark will appear at the right end.

Selecting a category

Categories such as Artist, Album, Podcast, Genre, Audiobook, Playlist, Song may be displayed depending on the model of iPod.

- 1) Press and hold "TUNE/FLD" knob (6) to change the display.
- 2) Turn "TUNE/FLD" knob (6) to select one of the categories, and press the knob (6) to determine the selection.

OTHER CONTROLS AND EQUIPMENT

iPod

Notes on iPod

Made for iPod

- iPod touch (6th generation)
- iPod touch (5th generation)
- iPod nano (7th generation)
- iPhone 8 Plus
- iPhone 8
- iPhone 7 Plus
- iPhone 7
- iPhone SE
- iPhone 6s Plus
- iPhone 6s
- iPhone 6 Plus
- iPhone 6
- iPhone 5s
- iPhone 5c
- iPhone 5

* Some functions may not be available depending on the model of iPod.



69RH201

- Use of the Made for Apple badge means that an accessory has been designed to connect specifically to the Apple product(s) identified in the badge, and has been certified by the developer to meet Apple performance standards. Apple is not responsible for the operation of this device or its compliance with safety and regulatory standards.
- Please note that the use of this accessory with an Apple product may affect wireless performance.
- Apple, iPod touch, iPod nano, iPhone, and Lightning are trademarks of Apple Inc., registered in the U.S. and other countries.

NOTE:

Please do not connect iPod accessory such as iPod remote control or headphones while connecting the iPod with the unit. Unit may not operate correctly.

OTHER CONTROLS AND EQUIPMENT

AUX function

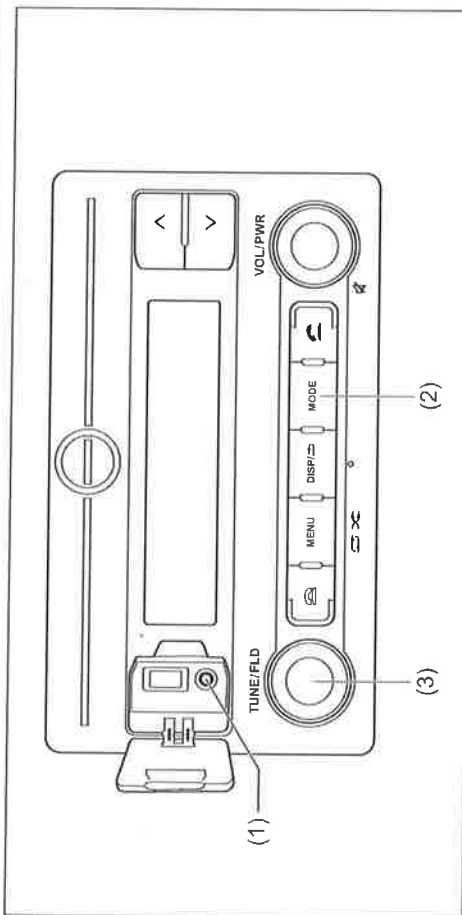

- (1) AUX socket
- (2) "MODE" button
- (3) "TUNE/FLD" knob

Display

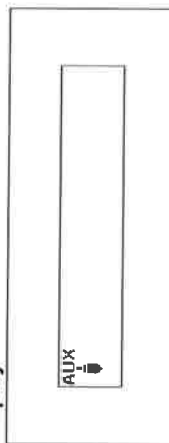

AUX connection

To listen to auxiliary audio sources (sold separately) through the unit, follow the instruction below.

- 1) Connect the auxiliary audio source to the AUX socket (1) with an AUX cable.
- 2) Press and hold "MODE" button (2) to change the display.
- 3) Turn "TUNE/FLD" knob (3) to select "AUX", and press the knob (3) to determine the selection.

NOTE:

You can also switch the display in sequence by short pressing the "MODE" button (2).

▲ CAUTION

- Before connection, mute the unit, and also keep the volume of the auxiliary audio source within a range that will not cause distortion.
- When the audio source is turned off, noise may be emitted. Be sure to turn off the unit or switch to another mode before turning off the audio source.

NOTE:

Please consult your place of purchase for details about whether a given auxiliary audio source can be connected and the proper auxiliary cord to use.

OTHER CONTROLS AND EQUIPMENT

Setting of Bluetooth® devices

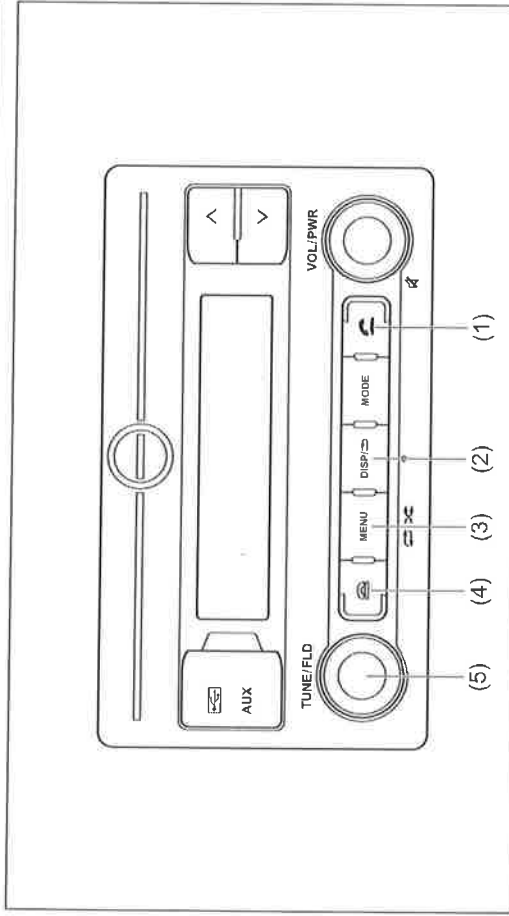

69RH185

Steering switch (if equipped)

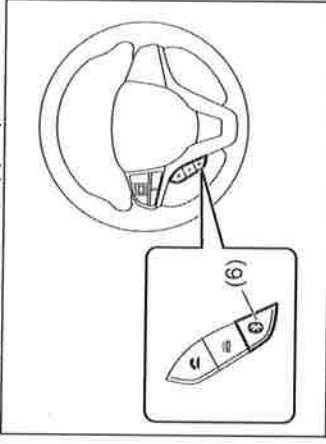

69RH186

- (1) OFF HOOK button
- (2) "DISP/BACK" button
- (3) "MENU" button
- (4) ON HOOK button
- (5) "TUNE/FLD" knob
- (6) Bluetooth® setting button

⚠ WARNING

Do not register or set the Bluetooth® device while driving. Stop your vehicle in a safe area before registering the device.

Bluetooth® related settings can be entered only when the vehicle is in stationary condition.

OTHER CONTROLS AND EQUIPMENT

Registration of Bluetooth® devices

To use Bluetooth® devices (Bluetooth® audio or mobile phone) on the audio system, it is required to register the Bluetooth® devices to the audio system. Up to 5 Bluetooth® devices can be registered.

NOTE:

- Certain functions cannot be used depending on the Bluetooth® device.
- Refer to the user manual included with your device regarding the operation method of Bluetooth® devices.
- If the pairing cannot be established, the connection operation is canceled. For the Bluetooth® device pairing method, refer to the user manual included with your device or try pairing again.

- 1) Press "MENU" button (3). Setup menu will be displayed.
- 2) Turn "TUNE/FLD" knob (5) to select "Bluetooth Settings", and press the knob (5) to determine the selection.
- 3) Turn "TUNE/FLD" knob (5) to select "Pairing", and press the knob (5) to determine the selection.
- 4) Turn "TUNE/FLD" knob (5) to select "Name & Passkey", and press the knob (5) to determine the selection.

NOTE:

If you have no Bluetooth® device to be registered, you can also switch the display to "Pairing Name" and "Passkey" at once by pressing the Bluetooth® setting button (6), OFF HOOK button (1) or ON HOOK button (4).

- 5) Operate and register the Bluetooth® device.

Secure Simple Pairing (SSP) incompatible Bluetooth® device:

Enter the passkey into the Bluetooth® device.

Secure Simple Pairing (SSP) compatible Bluetooth® device:

Select "Yes" to register the Bluetooth® device.

It is possible to automatically register devices depending on the type of Bluetooth® device.

NOTE:

If the Bluetooth® device contains music player and mobile phone function, both functions will be registered simultaneously. When deleting a Bluetooth® device, both functions will be deleted simultaneously.

Set from the list of mobile phones

The list of paired mobile phones is displayed and the various settings can be changed.

- 1) Press "MENU" button (3). Setup menu will be displayed.
- 2) Turn "TUNE/FLD" knob (5) to select "Bluetooth Settings", and press the knob (5) to determine the selection.
- 3) Turn "TUNE/FLD" knob (5) to select "Pairing", and press the knob (5) to determine the selection.

NOTE:

If you have the mobile phone which currently connected, you can also switch the display to "Pairing" at once by pressing the Bluetooth® setting button (6).

- 4) Turn "TUNE/FLD" knob (5) to select "Pairing Phone List", and press the knob (5) to determine the selection.
- 5) Turn "TUNE/FLD" knob (5) to select one of the registered mobile phones, and press the knob (5) to determine the selection.

NOTE:

">" mark appears at the left end of the currently connected mobile phone.

OTHER CONTROLS AND EQUIPMENT

- 6) Turn "TUNE/FLD" knob (5) to select one of the settings as follows, and press the knob (5) to determine the selection.

- "Connect": Connect a registered mobile phone.
- "Disconnect": Disconnect a registered mobile phone.
- "Delete": Delete a registered mobile phone.

Selection from the Bluetooth® audio list

The list of paired Bluetooth® audio is displayed and the various settings can be changed.

- 1) Press "MENU" button (3). Setup menu will be displayed.
- 2) Turn "TUNE/FLD" knob (5) to select "Bluetooth Settings", and press the knob (5) to determine the selection.
- 3) Turn "TUNE/FLD" knob (5) to select "Pairing", and press the knob (5) to determine the selection.

NOTE:

If you have the Bluetooth® audio which currently connected, you can also switch the display to "Pairing" at once by pressing the Bluetooth® setting button (6).

- 4) Turn "TUNE/FLD" knob (5) to select "Pairing Audio List", and press the knob (5) to determine the selection.

- 5) Turn "TUNE/FLD" knob (5) to select one of the registered Bluetooth® audio devices, and press the knob (5) to determine the selection.

NOTE:

">>" mark appears at the left end of the currently connected Bluetooth® audio.

- 6) Turn "TUNE/FLD" knob (5) to select one of the settings as follows, and press the knob (5) to determine the selection.

- "Connect": Connect a registered Bluetooth® audio.
- "Disconnect": Disconnect a registered Bluetooth® audio.
- "Delete": Delete a registered Bluetooth® audio.

Change of passkey

- 1) Press "MENU" button (3). Setup menu will be displayed.
- 2) Turn "TUNE/FLD" knob (5) to select "Bluetooth Settings", and press the knob (5) to determine the selection.
- 3) Turn "TUNE/FLD" knob (5) to select "Pairing", and press the knob (5) to determine the selection.

NOTE:

If you have the Bluetooth® device which currently connected, you can also switch the display to "Pairing" at once by pressing the Bluetooth® setting button (6).

- 4) Turn "TUNE/FLD" knob (5) to select "Edit Passkey", and press the knob (5) to determine the selection.

- 5) Turn "TUNE/FLD" knob (5) to select a number for the first digit, and press the knob (5) to determine the selection. Select and determine numbers for from the second to fourth digits in order in the same manner.

- 6) Press "TUNE/FLD" knob (5) to determine the passkey setting.

Automatic connection with the Bluetooth® device

If the "BT Power" is set to "ON", turning the ignition switch to "ON" position will automatically connect the registered Bluetooth® device.

- With the automatic connection, the Bluetooth® device that was connected last will be prioritized.

- 1) Press "MENU" button (3). Setup menu will be displayed.
- 2) Turn "TUNE/FLD" knob (5) to select "Bluetooth Settings", and press the knob (5) to determine the selection.
- 3) Turn "TUNE/FLD" knob (5) to select "Initial Settings", and press the knob (5) to determine the selection.
- 4) Turn "TUNE/FLD" knob (5) to select "BT Power".
- 5) Press "TUNE/FLD" knob (5) to select "ON" or "OFF".

OTHER CONTROLS AND EQUIPMENT

NOTE:

- When "BT Power" is set to "OFF", the audio system disconnects from the registered Bluetooth® device.
- If "BT Power" is set to "OFF", the audio system will not automatically reconnect the next time the ignition is switched on.

The device status will be displayed

- 1) Press "MENU" button (3). Setup menu will be displayed.
- 2) Turn "TUNE/FLD" knob (5) to select "Bluetooth Settings", and press the knob (5) to determine the selection.
- 3) Turn "TUNE/FLD" knob (5) to select "Pairing", and press the knob (5) to determine the selection.

NOTE:

If you have the Bluetooth® device which currently connected, you can also switch the display to "Pairing" at once by pressing the Bluetooth® setting button (6).

- 4) Turn "TUNE/FLD" knob (5) to select "Device Information", and press the knob (5) to determine the selection. The device name and address will be displayed.

Initialize Bluetooth® settings
It is possible to initialize the Bluetooth® settings.

▲ CAUTION

- Do not initialize the settings while driving. Stop your vehicle in a safe area before initializing the device.
- Initialize with caution. Initialized settings cannot be restored.

- 1) Press "MENU" button (3). Setup menu will be displayed.
- 2) Turn "TUNE/FLD" knob (5) to select "Bluetooth Settings", and press the knob (5) to determine the selection.
- 3) Turn "TUNE/FLD" knob (5) to select "Initial Settings", and press the knob (5) to determine the selection.
- 4) Turn "TUNE/FLD" knob (5) to select "Initialize BT", and press the knob (5) to determine the selection.
- 5) Turn "TUNE/FLD" knob (5) to select "YES", and press the knob (5) to determine the selection.

- Items to be initialized:
 - BT Power
 - Talk Volume
 - Ring Volume

Notes on Bluetooth®



73R0209

- The Bluetooth® word mark and logos are registered trademarks owned by Bluetooth SIG, Inc. and any use of such marks by Panasonic Corporation is under license. Other trademarks and trade names are those of their respective owners.

This telecommunication equipment conforms to the requirements of the National Telecommunications Commission.

- Stop using this unit and a Bluetooth® ready device whenever requested. This unit shares the communication frequency with other private or public wireless communication equipment such as a wireless LAN and other wireless communication radios. You should stop using this unit immediately whenever you are notified that your unit disturbs other wireless communication.

OTHER CONTROLS AND EQUIPMENT

Profile

- SSP (Secure Simple Pairing)
- PBAP (Phone Book Access Profile)
- OPP (Object Push Profile)
- HFP (Hand-Free Profile)
- A2DP (Advanced Audio Distribution Profile)
- AVRCP (Audio/Video Remote Control Profile)
- SPP (Serial Port Profile)

NOTE:

After the Audio system is turned ON, it takes a few seconds to detect and set up Bluetooth® related settings.

OTHER CONTROLS AND EQUIPMENT

Bluetooth® hands-free

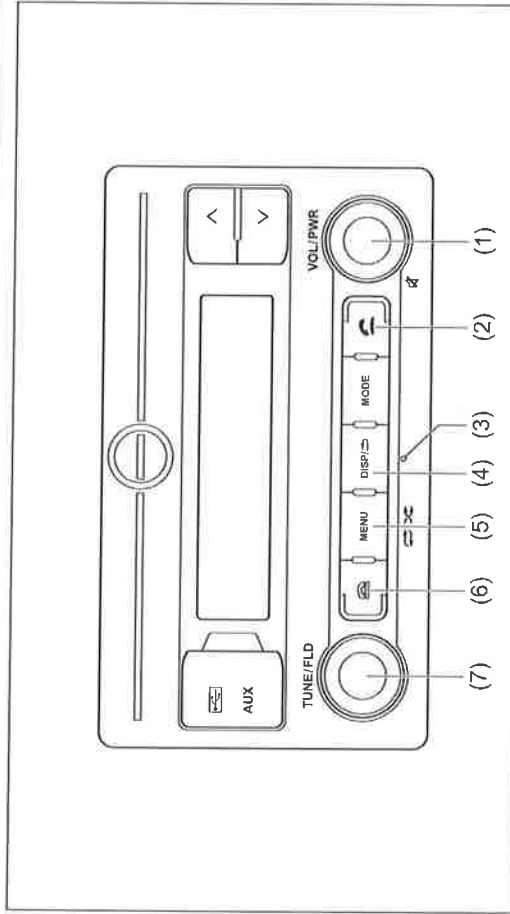

Steering switch (if equipped)

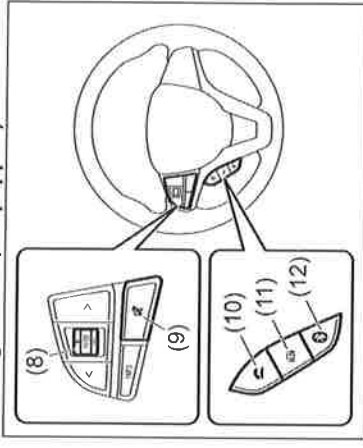

- (1) "VOL/PWR" knob
- (2) OFF HOOK button (on audio)
- (3) Microphone
- (4) "DISP/BACK" button
- (5) "MENU" button
- (6) ON HOOK button (on audio)
- (7) "TUNE/FLD" knob
- (8) Volume button
- (9) Mute button
- (10) OFF HOOK button (on steering wheel)
- (11) ON HOOK button (on steering wheel)
- (12) Bluetooth® setting button

OTHER CONTROLS AND EQUIPMENT

NOTICE

- Do not leave your mobile phone inside your vehicle. If the temperature inside the vehicle increases, it may damage your mobile phone.
- When disposing your vehicle, make sure to delete all personal information saved to the audio system.
- The following hands-free data must be deleted from the audio system.
 - Speed dial
 - Reception history/Incoming call history
 - Bluetooth® phonebook data

NOTE:

- Please keep your phone volume low. The person's voice who you are talking to may be heard outside of the vehicle and increase the voice echo. When talking on the phone, speak clearly towards the microphone.
- In the following cases, your voice may not be heard clearly by the person on the other line:
 - When driving on unpaved roads. (If there is loud traffic noise.)
 - When driving at high speeds.
 - When driving with the window open.
 - If the air conditioner is blowing directly towards the microphone.
 - When the sound of the air conditioner fan is loud.

- When there is an adverse effect to the sound quality of the phone or network that you are using.
- The audio system may not function under the following conditions.
 - When the phone power is not turned on.
 - When the mobile phone is out of service.
 - When the mobile phone is not connected.
 - When the mobile phone battery is low
- The Bluetooth®'s hands-free operation is dependent upon the mobile phone's compatibility.
 - The Bluetooth®'s hands-free performance is affected by the driving conditions of mobile phone networks, handsets and vehicles.
- The audio system's performance may be restricted due to the model of your mobile phone.

- It is possible to register a mobile phone and register the phone number to the audio system as follows:
- Up to 1,000 phone numbers can be saved for every registered mobile phone.
 - Up to 30 phone numbers can be saved to the call history menu (missed calls/incoming/outgoing calls.)
 - When the call history exceeds 30 calls, they are deleted from the oldest one first, and the latest call history

- information is displayed in descending order.
- Up to 6 phone numbers can be saved to the speed dial list.

Answer the phone

- Press OFF HOOK button (2) or (10).
- When you press the ON HOOK button (6) or (11) during an incoming call, you can block the call. (Only for compatible phone units)

NOTE:

- If you receive a call from a registered phone, the caller's name will appear on the screen.
- If you receive a call from an unregistered phone, only the caller's phone number will appear on the screen.

Hang up the phone

- When the call is finished, press the ON HOOK button (6) or (11).

Move call to Private mode

- If you wish to move a call to private mode, press the "DISP/BACK" button (4). To move the call back to Handsfree mode, press the OFF/ON hook button.

Mute the transmission volume

- Press "VOL/PWR" knob (1) or mute button (9).
- To deactivate the mute volume, press "VOL/PWR" knob (1) or mute button (9) again.

OTHER CONTROLS AND EQUIPMENT

Adjust the reception volume

- Turn "VOL/PWR" knob (1) during a call. Turning it clockwise increases the volume; turning it counterclockwise decreases the volume.
- Press volume button (8) during a call. Pressing the button up increases the volume; pressing the button down decreases the volume.

NOTE:

The volume and microphone sensitivity settings vary depending on the specifications of each mobile phone.

Adjust the ringtone volume

- Turn "VOL/PWR" knob (1) during an incoming call. Turning it clockwise increases the volume; turning it counterclockwise decreases the volume.
- Press volume button (8) during an incoming call. Pressing the button up increases the volume; pressing the button down decreases the volume.

Adjust the volume with the Bluetooth® settings

- 1) Press "MENU" button (5). Setup menu will be displayed.
- 2) Turn "TUNE/FLD" knob (7) to select "Bluetooth Settings", and press the knob (7) to determine the selection.
- 3) Turn "TUNE/FLD" knob (7) to select "Initial Settings", and press the knob (7) to determine the selection.

- 4) Turn "TUNE/FLD" knob (7) to select "Talk volume" or "Ring volume", and press the knob (7) to determine the selection.
- 5) Turn "TUNE/FLD" knob (7) to adjust the volume, and press the knob (7) to determine the selection.

Make a call

Press the OFF HOOK button (2) or (10) to enter the telephone mode.

Use the phonebook

- 1) Turn "TUNE/FLD" knob (7) to select "Contacts", and press the knob (7) to determine the selection.
- 2) Turn "TUNE/FLD" knob (7) to select the desired initials, and press the knob (7) to determine the selection.
- 3) Turn "TUNE/FLD" knob (7) to select the desired name, and press the knob (7) to determine the selection.
- 4) Turn "TUNE/FLD" knob (7) to select the desired phone number, and press the knob (7) or OFF HOOK button (2) or (10).

Use the call history

- 1) Turn "TUNE/FLD" knob (7) to select "Call Log", and press the knob (7) to determine the selection.
- 2) Turn "TUNE/FLD" knob (7) to select "All", "Missed", "Dialed" or "Received", and press the knob (7) to determine the selection.

- 3) Turn "TUNE/FLD" knob (7) to select the desired name or phone number, and press the knob (7) or OFF HOOK button (2) or (10).

Use the speed dial

- 1) Turn "TUNE/FLD" knob (7) to select "Speed Dial", and press the knob (7) to determine the selection.
- 2) Turn "TUNE/FLD" knob (7) to select the desired name or phone number, and press the knob (7) or OFF HOOK button (2) or (10).

NOTE:

Speed dial numbers must be registered before this function can be used.

Transfer all contacts from your mobile phone

- 1) Press "MENU" button (5). Setup menu will be displayed.
- 2) Turn "TUNE/FLD" knob (7) to select "Bluetooth Settings", and press the knob (7) to determine the selection.
- 3) Turn "TUNE/FLD" knob (7) to select "Dial", and press the knob (7) to determine the selection.
- 4) Turn "TUNE/FLD" knob (7) to select "Setup Contacts", and press the knob (7) to determine the selection.
- 5) Turn "TUNE/FLD" knob (7) to select "Overwrite", and press the knob (7) to determine the selection.

OTHER CONTROLS AND EQUIPMENT

- 6) Turn "TUNE/FLD" knob (7) to select "YES", and press the knob (7) to determine the selection.
- Delete the registered phonebook**
- 1) Press "MENU" button (5). Setup menu will be displayed.
 - 2) Turn "TUNE/FLD" knob (7) to select "Bluetooth Settings", and press the knob (7) to determine the selection.
 - 3) Turn "TUNE/FLD" knob (7) to select "Dial", and press the knob (7) to determine the selection.
 - 4) Turn "TUNE/FLD" knob (7) to select "Setup Contacts", and press the knob (7) to determine the selection.
 - 5) Turn "TUNE/FLD" knob (7) to select "Delete Contacts", and press the knob (7) to determine the selection.
 - 6) Turn "TUNE/FLD" knob (7) to select "YES", and press the knob (7) to determine the selection.
- Delete the call history**
- 1) Press "MENU" button (5). Setup menu will be displayed.
 - 2) Turn "TUNE/FLD" knob (7) to select "Bluetooth Settings", and press the knob (7) to determine the selection.
 - 3) Turn "TUNE/FLD" knob (7) to select "Dial", and press the knob (7) to determine the selection.
 - 4) Turn "TUNE/FLD" knob (7) to select "Setup Contacts", and press the knob (7) to determine the selection.
- 5) Turn "TUNE/FLD" knob (7) to select "Delete Call Log", and press the knob (7) to determine the selection.
 - 6) Turn "TUNE/FLD" knob (7) to select "YES", and press the knob (7) to determine the selection.
- Registration in speed dial**
- 1) Press "MENU" button (5). Setup menu will be displayed.
 - 2) Turn "TUNE/FLD" knob (7) to select "Bluetooth Settings", and press the knob (7) to determine the selection.
 - 3) Turn "TUNE/FLD" knob (7) to select "Dial", and press the knob (7) to determine the selection.
 - 4) Turn "TUNE/FLD" knob (7) to select "Add Speed Dial", and press the knob (7) to determine the selection.
 - 5) Turn "TUNE/FLD" knob (7) to select "Add/Modify", and press the knob (7) to determine the selection.
 - 6) Turn "TUNE/FLD" knob (7) to select the desired speed dial number, and press the knob (7) to determine the selection.
 - 7) Turn "TUNE/FLD" knob (7) to select the desired initials, and press the knob (7) to determine the selection.
 - 8) Turn "TUNE/FLD" knob (7) to select the desired name, and press the knob (7) to determine the selection.
 - 9) Turn "TUNE/FLD" knob (7) to select the desired Phone number, and press the knob (7) to determine the selection.
- Deletion of speed dial**
- 1) Press "MENU" button (5). Setup menu will be displayed.
 - 2) Turn "TUNE/FLD" knob (7) to select "Bluetooth Settings", and press the knob (7) to determine the selection.
 - 3) Turn "TUNE/FLD" knob (7) to select "Dial", and press the knob (7) to determine the selection.
 - 4) Turn "TUNE/FLD" knob (7) to select "Add Speed Dial", and press the knob (7) to determine the selection.
 - 5) Turn "TUNE/FLD" knob (7) to select "Delete", and press the knob (7) to determine the selection.
 - 6) Turn "TUNE/FLD" knob (7) to select "Delete All" or "Delete Contact", and press the knob (7) to determine the selection.
 - If you select "Delete Contact", select the name for delete.
 - 7) Turn "TUNE/FLD" knob (7) to select "YES", and press the knob (7) to determine the selection.

OTHER CONTROLS AND EQUIPMENT

Automatic transfer of the phonebook/ call history

When registering the mobile phone, you can select to automatically transfer the phonebook and call history from your device. Select according to the following steps.

- 1) Press "MENU" button (5). Setup menu will be displayed.
- 2) Turn "TUNE/FLD" knob (7) to select "Bluetooth Settings", and press the knob (7) to determine the selection.
- 3) Turn "TUNE/FLD" knob (7) to select "Dial", and press the knob (7) to determine the selection.
- 4) Turn "TUNE/FLD" knob (7) to select "Auto Transfer".
- 5) Press "TUNE/FLD" knob (7) to select "ON" or "OFF".

OTHER CONTROLS AND EQUIPMENT

Bluetooth® audio

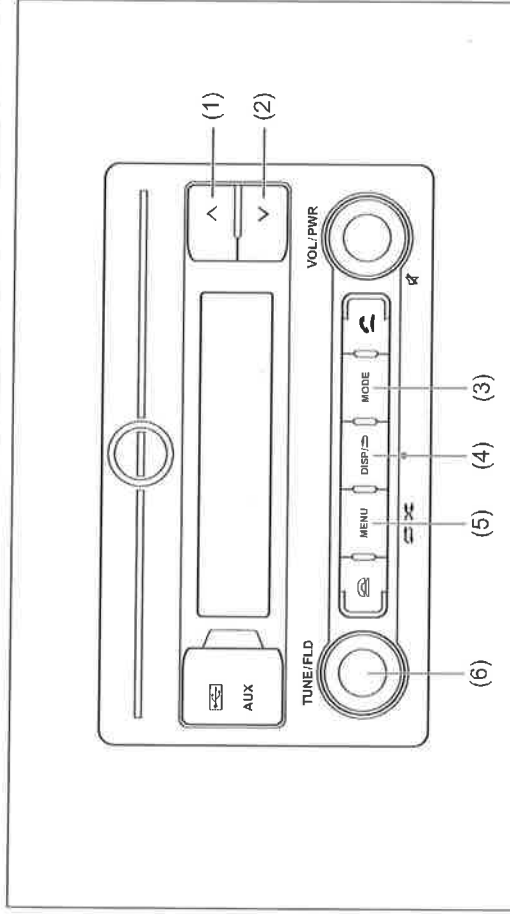

69RH146

Display

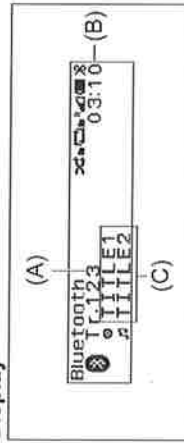

69RH161

- (1) UP button
- (2) DOWN button
- (3) "MODE" button
- (4) "DISP/BACK" button
- (5) "MENU" button
- (6) "TUNE/FLD" knob

- (A) Track number
- (B) Play time
- (C) Text information display

NOTE:
Some functions may not be usable on some Bluetooth® devices.

Selecting Bluetooth® audio mode

- 1) Press and hold "MODE" button (3) to change the display.
- 2) Turn "TUNE/FLD" knob (6) to select "Bluetooth", and press the knob (6) to determine the selection.

NOTE:
You can also switch the display in sequence by short pressing the "MODE" button (3).

Selecting a group (only for supported models)

- Turn "TUNE/FLD" knob (6) to select a group.

OTHER CONTROLS AND EQUIPMENT

Selecting a track

- Press UP button (1) to listen to the next track.
 - Press DOWN button (2) twice to listen to the previous track.
- When DOWN button (2) is pressed once, the track currently being played will start from the beginning again.

Fast forwarding/rewinding a track

- Press and hold UP button (1) to fast forward the track.
- Press and hold DOWN button (2) to fast rewind the track.
- Releasing the button can stop the fast forwarding/rewinding.

Repeat playback

(if supported by device)

- 1) Press and hold "MENU" button (5) to change the display.
- 2) Turn "TUNE/FLD" knob (6) to select "Repeat".
- 3) Press "TUNE/FLD" knob (6) to select one of the settings as follows.



- SONG

The track currently being played will be played repeatedly.

- GROUP

All the tracks in the group currently selected will be played repeatedly.

NOTE:

Settings may be displayed depending on the Bluetooth® device.

Random playback

(if supported by device)

- 1) Press and hold "MENU" button (5) to change the display.
- 2) Turn "TUNE/FLD" knob (6) to select "Random".
- 3) Press "TUNE/FLD" knob (6) to select one of the settings as follows.



- GROUP

The tracks in the currently selected group will be played in random order.

- ALL

The tracks in the connected device will be played in random order.

NOTE:

Settings may be displayed depending on the Bluetooth® device.

Display change

Press "DISP/BACK" button (4). Each time the button is pressed, display will change as follows:

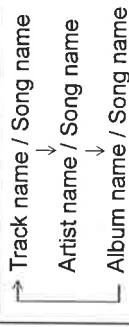

NOTE:

- "NO TITLE" will be displayed when there is no text information in the device currently being played.
- If text data contains more characters than the display area, ">" mark will appear at the right end.

OTHER CONTROLS AND EQUIPMENT

Disclaimer for Bluetooth® function

- Depending on the mobile phone models, some phones may not be compatible fully or partially (some function may be restricted).
 - Media playback through third-party applications may have limited support.
 - Playback, display contents, connectivity or voice quality etc. may get affected depending on circumstances.
- After the ignition switch is turned to "ON" position the audio system takes few seconds to detect and connect to the Bluetooth® device (if already paired).

Steering switch (if equipped)

Use the steering wheel button to operate the basic functions of the audio system.

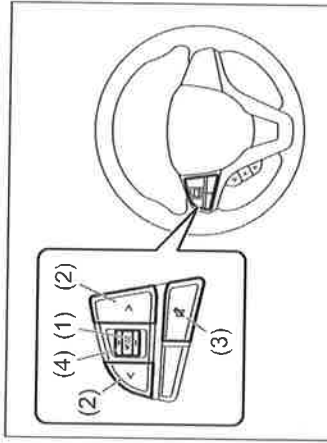

- (1) "MODE" button
- (2) Selection button
 - Selecting the radio station
 - Selecting the track (USB (iPod), Bluetooth® audio mode)
- (3) Mute button
- (4) Volume button

"MODE" button (1)

Each time the button is pressed, the mode will change as follows:



Selection button (2)

- FM, AM mode:
 - Press ">" to transfer to the next preset channel.
 - Press "<" to transfer to the previous preset channel.
 - Press ">" for 1 second or longer, it will search for receivable stations at a high frequency.
 - Press "<" for 1 second or longer, it will search for receivable stations at a low frequency.
- USB (iPod), Bluetooth® audio mode:
 - Press ">" to transfer to the next song.
 - With the folder operation mode, it will transfer to the next folder.

OTHER CONTROLS AND EQUIPMENT

- Press “<” to return to the beginning of the currently playing song. Pressing it twice consecutively will return to the previous song.
With the folder operation mode, it will return to the previous folder.
- Press “>” for 1 second or longer to fast-forward the song.
When the button is released, it will stop fast-forwarding.
- Press “<” for 1 second or longer to rewind the song.
Releasing the button can stop rewinding.
- Radio, USB (iPod), Bluetooth® audio, AUX mode:
 - Press “+”, the volume will increase.
 - Press “-”, the volume will decrease.

Mute button (3)

- Hands-free/iPod mode:
Each time you press the button the mute will switch from ON/OFF.
- USB mode:
Press the button during playback to temporarily stop the playback.

Volume button (4)

- Hands-free mode:
 - Press “+” during an outgoing or incoming call, the reception/ringtone sound will increase.
 - Press “-” during an outgoing or incoming call, the reception/ringtone sound will decrease.
 - Press “+” during an outgoing call, the ringtone sound will increase.
 - Press “-” during an outgoing call, the ringtone sound will decrease.

OTHER CONTROLS AND EQUIPMENT

Anti-theft feature

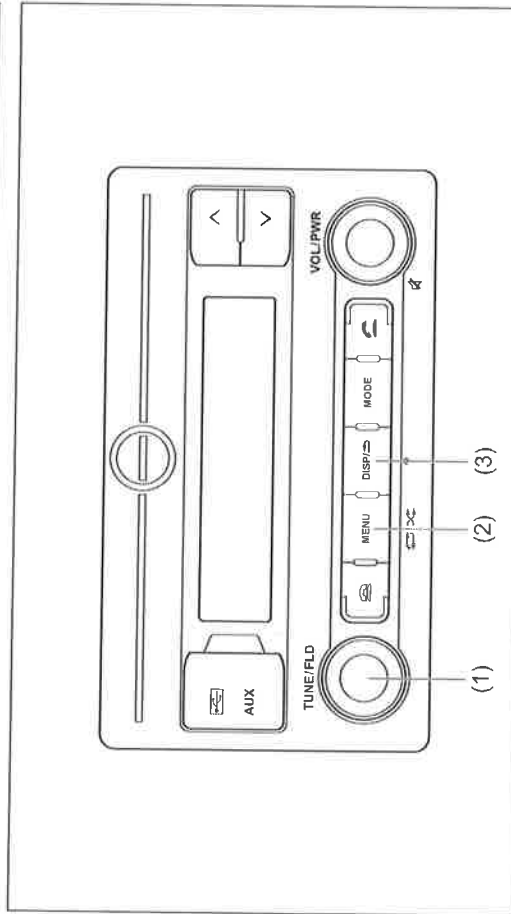

- (1) "TUNE/FLD" knob
- (2) "MENU" button
- (3) "DISP/BACK" button

The anti-theft function is intended to discourage thefts, such as that the audio system becomes inoperable when it is installed on other vehicles. This function works by entering a Personal Identification Number (PIN). When the unit is disconnected from its power source, such as when the audio system is removed or the battery is disconnected, the unit will become inoperable until the PIN is reentered.

Display

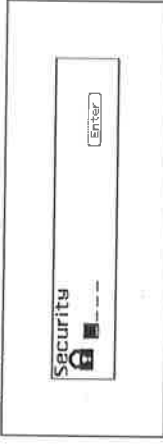

Setting the anti-theft function

- 1) Press "MENU" button (2). Setup menu will be displayed.
- 2) Turn "TUNE/FLD" knob (1) to select "System Settings", and press the knob (1) to determine the selection.
- 3) Turn "TUNE/FLD" knob (1) to select "Security", and press the knob (1) to determine the selection.
- 4) Turn "TUNE/FLD" knob (1) to select "ON", and press the knob (1). "----" will be displayed.
- 5) Enter a 4-digit number to be registered as PIN by turning and pressing the "TUNE/FLD" knob (1).
- 6) After entering 4-digit number, press "TUNE/FLD" knob (1) on "Enter" indication. "Do you want to set XXXX as password" will be displayed.
- 7) Turn "TUNE/FLD" knob (1) to select "YES", and press the knob (1). "XXXX is set as password" will be displayed and the anti-theft function will be set.

NOTE:

Take a note of the registered PIN and keep it for the future use.

OTHER CONTROLS AND EQUIPMENT

Canceling the anti-theft feature

To cancel the anti-theft function, delete the registered PIN.

- 1) Press "MENU" button (2). Setup menu will be displayed.
- 2) Turn "TUNE/FLD" knob (1) to select "System Settings", and press the knob (1) to determine the selection.
- 3) Turn "TUNE/FLD" knob (1) to select "Security", and press the knob (1) to determine the selection.
- 4) Turn "TUNE/FLD" knob (1) to select "OFF", and press the knob (1). "----" will be displayed.
- 5) Enter a 4-digit number to be registered as PIN by turning and pressing the "TUNE/FLD" knob (1).
- 6) After entering 4-digit number, press "TUNE/FLD" knob (1) on "Enter" indication. The anti-theft function will be canceled.

NOTE:

To change your PIN, first delete your current PIN, and then set a new one.

Confirming the Personal Identification Number (PIN)

When the main power source is disconnected such as when the battery is replaced, etc. it is required to enter the PIN to make the unit operable again.

- 1) Set the ignition switch to "ACC" position.
- 2) "SECURITY" will be displayed.
- 3) Press "TUNE/FLD" knob (1). "----" will be displayed.
- 4) Enter a 4-digit number to be registered as PIN by turning and pressing the "TUNE/FLD" knob (1).
- 5) Press and hold "TUNE/FLD" knob (1) for a while.

When the same PIN as registered is entered, the power of the audio system will be turned off automatically and it will become operable again.

NOTE:

If an incorrect PIN is entered, "ERROR" and the total number of incorrect entry attempts will be displayed.

If an incorrect PIN is entered 10 times or more, "Contact Dealer" will be displayed and the audio system will become inoperable.

Using smartphone dock

You can mount smartphone on the audio system using the smartphone dock (1).

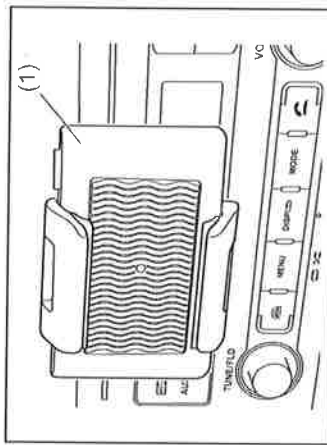

69RH202

Attaching the smartphone dock

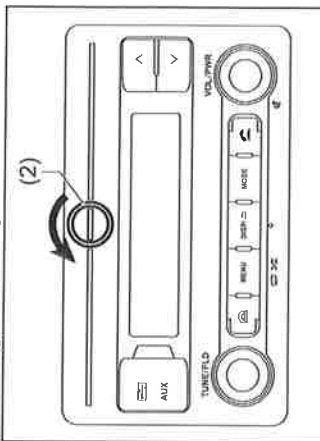

69RH190

OTHER CONTROLS AND EQUIPMENT

NOTE:

To avoid accumulation of dust inside the audio, ensure cap is fixed when smartphone dock is not in use.

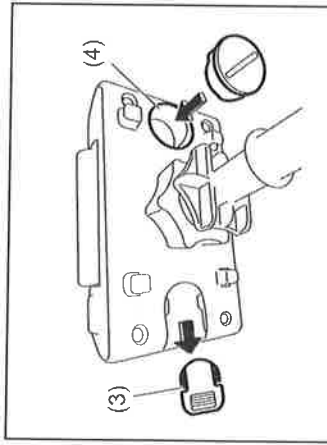

- 1) Turn dock cap (2) counterclockwise using cap opener (3) which is located behind smartphone dock (1), and remove it.
- 2) After removal of dock cap (2), install it into the hole (4) which is located behind smartphone dock (1), and turn it clockwise.

NOTICE

Do not use any sharp or metal object like a coin while opening dock cap (2) of the audio system.

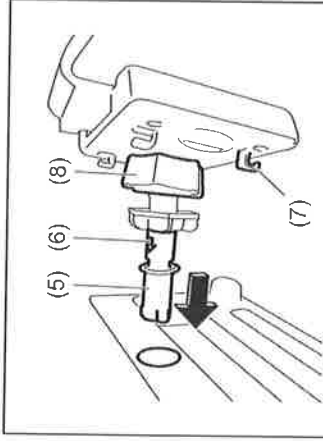

- 3) Insert shaft (5) of the smartphone dock into the mounted hole.
An arrow mark (6) is provided on shaft for guidance to insert the smartphone dock correctly.
- 4) Push and then turn it clockwise to lock smartphone dock (1) to the audio system.

NOTICE

Do not turn the shaft forcibly. It can damage the smartphone dock.

NOTE:

- Provision is also given for charging cable routing (7).
- Smartphone dock (1) can be rotated after nut (8) is loosened. You can adjust the angle of the dock by rotating in 360 degree.

After setting the angle as per the desired viewability, tighten the nut (8).

NOTE:

Ensure the nut is tightened properly to avoid phone from falling.

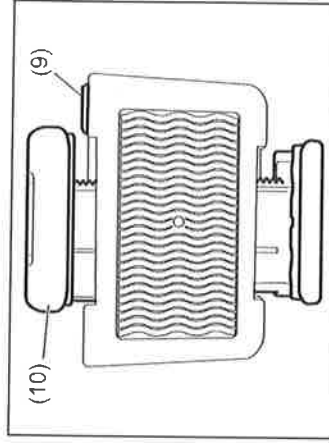

- 5) Press release button (9). Place your mobile phone in smartphone dock (1) and adjust arms (10) as per the mobile phone size.

NOTE:

Applying excessive pressure on the smartphone dock may cause damage. This dock supports phone upto max. weight of 200gm, length-160mm, width-85mm & height 12.5mm (including mobile cover).

OTHER CONTROLS AND EQUIPMENT

NOTE:

It is recommended to use the smartphone on smartphone dock (1) with "Suzuki Smartplay Dock" application. Refer to "Suzuki Smartplay Dock" application in this section for details.

Removing the smartphone dock

- 1) Remove the mobile phone from smartphone dock (1) by pressing release button (9).
- 2) Push smartphone dock (1) and then turn it counterclockwise to release it from audio system.
- 3) Replace dock cap (2) by turning it clockwise using cap opener (3).

"Suzuki Smartplay Dock" application

"Suzuki Smartplay Dock" is an application that allows user to use smartphone features such as calling and audio system controls safely with minimal driver distraction.

This application can be downloaded on smartphone through Google Play store or Apple App Store.

A WARNING

While driving, ensure adherence to all traffic regulations. Insufficient attention to the road and traffic may cause an accident. It is recommended to familiarize with the tutorial section of application before actual usage.

In vehicle running condition, the application can be used in landscape mode only.

NOTE:

- For further information on compatible phones and application download process, please refer to MARUTI SUZUKI website
- Application is compatible with smartphones supporting iOS version 9.0, Android OS 5.0 and above.

- Since this audio allows pairing of 2 devices on Bluetooth® simultaneously, application is supported on the phone which is paired through handsfree profile.
- Information about compatible smartphones with application is available on MARUTI SUZUKI website.
- Application services are subject to change. It is recommended to install the latest updates for optimal experience.
- Application functioning is dependent on mobile data carrier and smartphone hardware, OS performance.

OTHER CONTROLS AND EQUIPMENT

Troubleshooting

When encountering a problem, check and follow the instructions below. If the described suggestions do not solve the problem, it is recommended to take the unit to a SUZUKI dealer or a qualified workshop.

Problem	Possible cause	Possible solution
Common		
Unable to operate	The security function is on.	When "SECURITY" is displayed, enter the PIN. When "Contact Dealer" is displayed, contact a SUZUKI dealer or a qualified workshop.
Unable to turn on the power (No sound is produced)	Fuse is blown.	Contact a SUZUKI dealer or a qualified workshop.
Radio		
Much noise	It may not be exactly tuned in to the station.	Tune it in exactly to the station.
Unable to receive by auto tuning	There may be no station emitting signals powerful enough.	Pick up a station by manual tuning.
USB		
Playback does not start when the USB device is connected	There is no supported format file to play on this unit. The current consumption of the USB device exceeds 2.1 A.	Check the file format. Use a USB device with a current consumption lower than 2.1 A.
Sound skips or noise produced	Sound skipping may occur when playing VBR (Variable Bit Rate) files.	It is not recommended to play VBR files.

OTHER CONTROLS AND EQUIPMENT

Problem	Possible cause	Possible solution
Bluetooth®		
Pairing failed	The distance between this unit and the Bluetooth® ready device is too far, or a metallic object may be located between the Bluetooth® ready device and this unit.	Change the location of the Bluetooth® ready device.
Unable to receive a call	The Bluetooth® function of the Bluetooth® ready device is off. Your current location may be out of service area.	Refer to the manual of the Bluetooth® ready device. (Some devices have the power saving function that automatically activates after a certain time.) Drive your vehicle to the service area of the phone.
The voice quality of hands-free is low (Distortion, noise etc.)	Another wireless device may be located near the unit.	Switch off the wireless device or keep it away from the unit. Check the microphone opening for obstruction on audio device.

OTHER CONTROLS AND EQUIPMENT

Error display messages

The following messages (flashing) will be displayed onto the screen depending on the condition of the audio system.

Display	Possible solution
USB READ ERROR	When the USB device or iPod's reading error occurs, this message will be displayed. Reconnect the USB device or iPod's connection cable. When the Bluetooth® audio playback malfunction occurs, this message will be displayed. Check the Bluetooth® audio body.
ERROR 1	When the USB device or iPod's communication error occurs, this message will be displayed. Reconnect the USB device or iPod's connection cable.
iPod ERROR 1	
ERROR 2	When the USB device or iPod mechanical error occurs, this message will be displayed. Remove the USB device or iPod, and check the USB device or the iPod body.
ERROR 3	If the USB device or iPod does not operate due to an over current, this message will be displayed. Remove the USB device or iPod, and check the USB device or the iPod body.
HUB NOT SUPPORTED	When the USB hub is connected, this message will be displayed. Disconnect the USB hub.
UNSUPPORTED	When an unsupported iPod is connected, this message will be displayed. Connect the supported iPod.
MEDIA NOT SUPPORTED	When an unsupported USB device is connected, this message will be displayed. Connect the supported USB device. When the Bluetooth® audio playback malfunction occurs, this message will be displayed. Check the Bluetooth® audio body.
NO MUSIC	When an empty USB device or iPod is connected, this message will be displayed. Connect the USB device or iPod containing files with the playable extension.
VEHICLE DATA NOT AVAILABLE	Contact your nearest SUZUKI dealer or a qualified workshop for troubleshooting.

Federal Communication Commission Interference Statement

This device complies with Part 15 of the FCC Rules. Operation is subject to the following two conditions: (1) This device may not cause harmful interference, and (2) this device must accept any interference received, including interference that may cause undesired operation.

This equipment has been tested and found to comply with the limits for a Class B digital device, pursuant to Part 15 of the FCC Rules. These limits are designed to provide reasonable protection against harmful interference in a residential installation. This equipment generates, uses and can radiate radio frequency energy and, if not installed and used in accordance with the instructions, may cause harmful interference to radio communications. However, there is no guarantee that interference will not occur in a particular installation. If this equipment does cause harmful interference to radio or television reception, which can be determined by turning the equipment off and on, the user is encouraged to try to correct the interference by one of the following measures:

- Reorient or relocate the receiving antenna.
- Increase the separation between the equipment and receiver.
- Connect the equipment into an outlet on a circuit different from that to which the receiver is connected.
- Consult the dealer or an experienced radio/TV technician for help.

FCC Caution:

- Any changes or modifications not expressly approved by the party responsible for compliance could void the user's authority to operate this equipment.
- This transmitter must not be co-located or operating in conjunction with any other antenna or transmitter.

FOR MOBILE DEVICE USAGE (>20cm)

Radiation Exposure Statement:

This equipment complies with FCC radiation exposure limits set forth for an uncontrolled environment. This equipment should be installed and operated with minimum distance 20cm between the radiator & your body.

FOR COUNTRY CODE SELECTION USAGE (WLAN DEVICES)

Note: The country code selection is for non-US model only and is not available to all US model. Per FCC regulation, all WiFi product marketed in US must fixed to US operation channels only.