

# TEST REPORT

## CERTIFICATE OF CONFORMITY

**Standard:** 47 CFR FCC Part 15, Subpart C (Section 15.247)  
**Report No.:** RFBHJR-WTW-P22080863-1  
**FCC ID:** ACJ932A-TA220  
**Product:** Toyota Trailer Camera ECU  
**Brand:** Panasonic  
**Model No.:** TA-220-TUND-MI  
**Received Date:** 2022/8/25  
**Test Date:** 2022/9/16 ~ 2022/9/21  
**Issued Date:** 2022/12/9

**Applicant:** Panasonic Corporation of North America

**Address:** Two Riverfront Plaza, 9th Floor Newark New Jersey United States 07102-5490

**Issued By:** Bureau Veritas Consumer Products Services (H.K.) Ltd., Taoyuan Branch  
Lin Kou Laboratories

**Lab Address:** No. 47-2, 14th Ling, Chia Pau Vil., Lin Kou Dist., New Taipei City, Taiwan

**Test Location:** No. 47-2, 14th Ling, Chia Pau Vil., Lin Kou Dist., New Taipei City, Taiwan

**FCC Registration /** 198487 / TW2021

**Designation Number:**

**Approved by:** Jeremy Lin, **Date:** 2022/12/9  
Jeremy Lin / Project Engineer

This test report consists of 31 pages in total. It may be duplicated completely for legal use with the approval of the applicant. It should not be reproduced except in full, without the written approval of our laboratory. The test results in the report only apply to the tested sample. The test results in this report are traceable to the national or international standards.



Prepared by : Annie Chang / Senior Specialist

This report is governed by, and incorporates by reference, the Conditions of Testing as posted at the date of issuance of this report at <http://www.bureauveritas.com/home/about-us/our-business/cps/about-us/terms-conditions/> and is intended for your exclusive use. Any copying or replication of this report to or for any other person or entity, or use of our name or trademark, is permitted only with our prior written permission. This report sets forth our findings solely with respect to the test samples identified herein. The results set forth in this report are not indicative or representative of the quality or characteristics of the lot from which a test sample was taken or any similar or identical product unless specifically and expressly noted. Our report includes all of the tests requested by you and the results thereof based upon the information that you provided to us. Measurement uncertainty is only provided upon request for accredited tests. Statements of conformity are based on simple acceptance criteria without taking measurement uncertainty into account, unless otherwise requested in writing. You have 60 days from date of issuance of this report to notify us of any material error or omission caused by our negligence or if you require measurement uncertainty; provided, however, that such notice shall be in writing and shall specifically address the issue you wish to raise. A failure to raise such issue within the prescribed time shall constitute your unqualified acceptance of the completeness of this report, the tests conducted and the correctness of the report contents.

## Table of Contents

<b>Release Control Record</b> .....	<b>4</b>
<b>1 Certificate</b> .....	<b>5</b>
<b>2 Summary of Test Results</b> .....	<b>6</b>
2.1 Measurement Uncertainty .....	6
2.2 Supplementary Information .....	6
<b>3 General Information</b> .....	<b>7</b>
3.1 General Description .....	7
3.2 Antenna Description of EUT .....	7
3.3 Channel List .....	8
3.4 Test Mode Applicability and Tested Channel Detail .....	9
3.5 Duty Cycle of Test Signal .....	9
3.6 Test Program Used and Operation Descriptions .....	10
3.7 Connection Diagram of EUT and Peripheral Devices .....	10
3.8 Configuration of Peripheral Devices and Cable Connections .....	10
<b>4 Test Instruments</b> .....	<b>11</b>
4.1 RF Output Power .....	11
4.2 Power Spectral Density .....	11
4.3 6 dB Bandwidth .....	11
4.4 Conducted Out of Band Emissions .....	11
4.5 Unwanted Emissions below 1 GHz .....	12
4.6 Unwanted Emissions above 1 GHz .....	13
<b>5 Limits of Test Items</b> .....	<b>14</b>
5.1 RF Output Power .....	14
5.2 Power Spectral Density .....	14
5.3 6 dB Bandwidth .....	14
5.4 Conducted Out of Band Emissions .....	14
5.5 Unwanted Emissions below 1 GHz .....	14
5.6 Unwanted Emissions above 1 GHz .....	14
<b>6 Test Arrangements</b> .....	<b>15</b>
6.1 RF Output Power .....	15
6.1.1 Test Setup .....	15
6.1.2 Test Procedure .....	15
6.2 Power Spectral Density .....	15
6.2.1 Test Setup .....	15
6.2.2 Test Procedure .....	15
6.3 6 dB Bandwidth .....	16
6.3.1 Test Setup .....	16
6.3.2 Test Procedure .....	16
6.4 Conducted Out of Band Emissions .....	16
6.4.1 Test Setup .....	16
6.4.2 Test Procedure .....	16
6.5 Unwanted Emissions below 1 GHz .....	17
6.5.1 Test Setup .....	17
6.5.2 Test Procedure .....	18
6.6 Unwanted Emissions above 1 GHz .....	19
6.6.1 Test Setup .....	19
6.6.2 Test Procedure .....	19
<b>7 Test Results of Test Item</b> .....	<b>20</b>
7.1 RF Output Power .....	20
7.2 Power Spectral Density .....	21
7.3 6 dB Bandwidth .....	22
7.4 Conducted Out of Band Emissions .....	23
7.5 Unwanted Emissions below 1 GHz .....	24

7.6	Unwanted Emissions above 1 GHz.....	26
8	<b>Pictures of Test Arrangements .....</b>	<b>30</b>
9	<b>Information of the Testing Laboratories .....</b>	<b>31</b>



## Release Control Record

Issue No.	Description	Date Issued
RFBHJR-WTW-P22080863-1	Original release.	2022/12/9

## 1 Certificate

**Product:** Toyota Trailer Camera ECU

**Brand:** Panasonic

**Test Model:** TA-220-TUND-MI

**Sample Status:** Engineering sample

**Applicant:** Panasonic Corporation of North America

**Test Date:** 2022/9/16 ~ 2022/9/21

**Standard:** 47 CFR FCC Part 15, Subpart C (Section 15.247)

**Measurement** ANSI C63.10-2013

**procedure:** KDB 558074 D01 15.247 Meas Guidance v05r02

The above equipment has been tested by **Bureau Veritas Consumer Products Services (H.K.) Ltd., Taoyuan Branch**, and found compliance with the requirement of the above standards. The test record, data evaluation & Equipment Under Test (EUT) configurations represented herein are true and accurate accounts of the measurements of the sample's RF characteristics under the conditions specified in this report.

## 2 Summary of Test Results

47 CFR FCC Part 15, Subpart C (Section 15.247)			
Standard / Clause	Test Item	Result	Remark
15.247(b)	RF Output Power	Pass	Meet the requirement of limit.
15.247(e)	Power Spectral Density	Pass	Meet the requirement of limit.
15.247(a)(2)	6 dB Bandwidth	Pass	Meet the requirement of limit.
15.247(d)	Conducted Out of Band Emissions	Pass	Meet the requirement of limit.
15.205 / 15.209 / 15.247(d)	Unwanted Emissions below 1 GHz	Pass	Minimum passing margin is -10.7 dB at 30.58 MHz
15.205 / 15.209 / 15.247(d)	Unwanted Emissions above 1 GHz	Pass	Minimum passing margin is -1.2 dB at 7320.00 MHz
15.203	Antenna Requirement	Pass	No antenna connector is used.

Note: Determining compliance based on the results of the compliance measurement, not taking into account measurement instrumentation uncertainty.

### 2.1 Measurement Uncertainty

Where relevant, the following measurement uncertainty levels have been estimated for tests performed on the EUT as specified in CISPR 16-4-2:

Measurement	Specification	Expanded Uncertainty (k=2) (±)
Conducted Out of Band Emissions	9 kHz ~ 40 GHz	2.63 dB
Unwanted Emissions below 1 GHz	9 kHz ~ 30 MHz	2.38 dB
	30 MHz ~ 1 GHz	5.62 dB
Unwanted Emissions above 1 GHz	1 GHz ~ 6 GHz	4.61 dB
	6 GHz ~ 18 GHz	5.41 dB
	18 GHz ~ 40 GHz	5.14 dB

The other instruments specified are routine verified to remain within the calibrated levels, no measurement uncertainty is required to be calculated.

### 2.2 Supplementary Information

There is not any deviation from the test standards for the test method, and no modifications required for compliance.

### 3 General Information

#### 3.1 General Description

Product	Toyota Trailer Camera ECU
Brand	Panasonic
Test Model	TA-220-TUND-MI
Status of EUT	Engineering sample
Power Supply Rating	12Vdc
Modulation Type	GFSK
Modulation Technology	DTS
Transfer Rate	Up to 1 Mbps
Operating Frequency	2.402 GHz ~ 2.48 GHz
Number of Channel	40
Output Power	52.845 mW (17.23 dBm)

Note:

1. There are Bluetooth and WLAN 2.4 GHz technology used for the EUT.
2. Bluetooth and WLAN 2.4 GHz technology can transmit at same time.
3. The above EUT information is declared by manufacturer and for more detailed features description, please refer to the manufacturer's specifications or User's Manual.

#### 3.2 Antenna Description of EUT

The antenna information is listed as below.

Gain (dBi)	Antenna Type	Connector Type
3.86	Sharkfin	Coaxial

\* Detail antenna specification please refer to antenna datasheet and/or antenna measurement report.

### 3.3 Channel List

40 channels are provided for BT-LE:

Channel	Frequency (MHz)	Channel	Frequency (MHz)	Channel	Frequency (MHz)	Channel	Frequency (MHz)
0	2402	10	2422	20	2442	30	2462
1	2404	11	2424	21	2444	31	2464
2	2406	12	2426	22	2446	32	2466
3	2408	13	2428	23	2448	33	2468
4	2410	14	2430	24	2450	34	2470
5	2412	15	2432	25	2452	35	2472
6	2414	16	2434	26	2454	36	2474
7	2416	17	2436	27	2456	37	2476
8	2418	18	2438	28	2458	38	2478
9	2420	19	2440	29	2460	39	2480



### 3.4 Test Mode Applicability and Tested Channel Detail

Following channel(s) was (were) selected for the final test as listed below:

Test Item	Mode	Tested Channel	Modulation	Data Rate Parameter
RF Output Power / Power Spectral Density	BT-LE 1M	0, 19, 39	GFSK	1Mb/s
6 dB Bandwidth / Conducted Out of Band Emissions	BT-LE 1M	0, 19, 39	GFSK	1Mb/s
Unwanted Emissions below 1 GHz	BT-LE 1M	19	GFSK	1Mb/s
Unwanted Emissions above 1 GHz	BT-LE 1M	0, 19, 39	GFSK	1Mb/s

### 3.5 Duty Cycle of Test Signal

**BT-LE 1M:** Duty cycle =  $0.391 \text{ ms} / 0.625 \text{ ms} \times 100\% = 62.6\%$ , duty factor =  $10 * \log (1/\text{Duty cycle}) = 2.04 \text{ dB}$

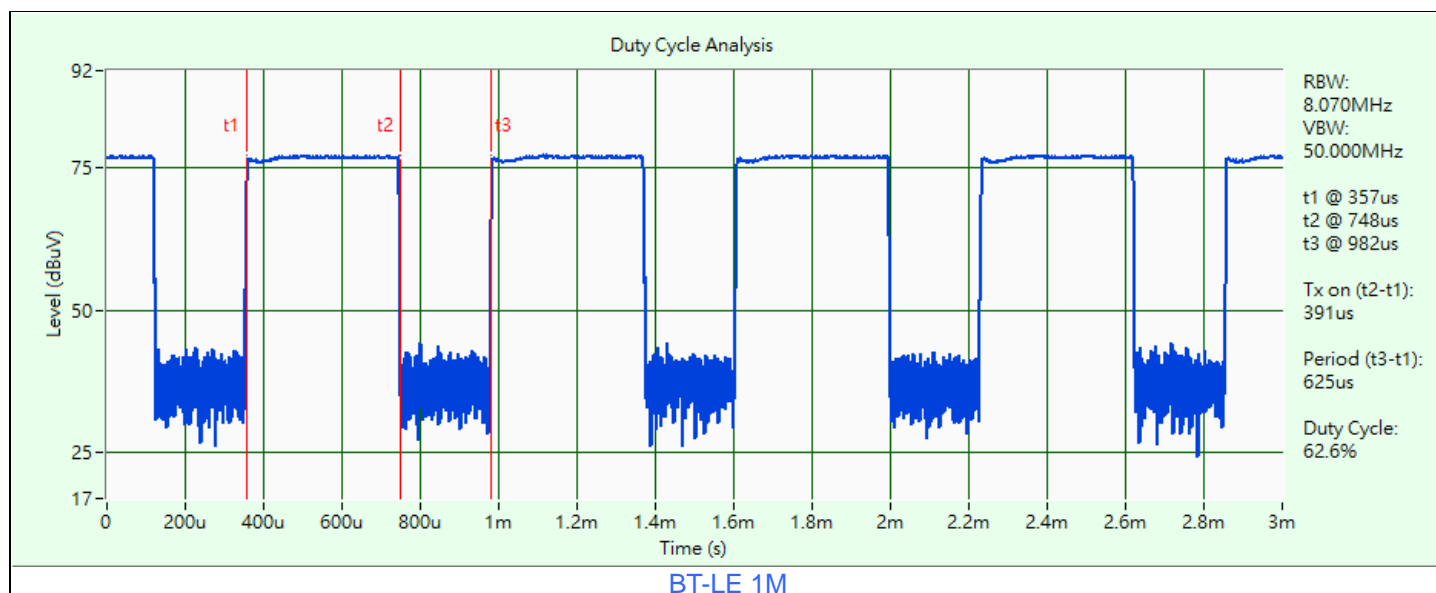

### 3.6 Test Program Used and Operation Descriptions

Controlling software (DutApiMimoApApp) has been activated to set the EUT under transmission condition continuously at specific channel frequency.

### 3.7 Connection Diagram of EUT and Peripheral Devices

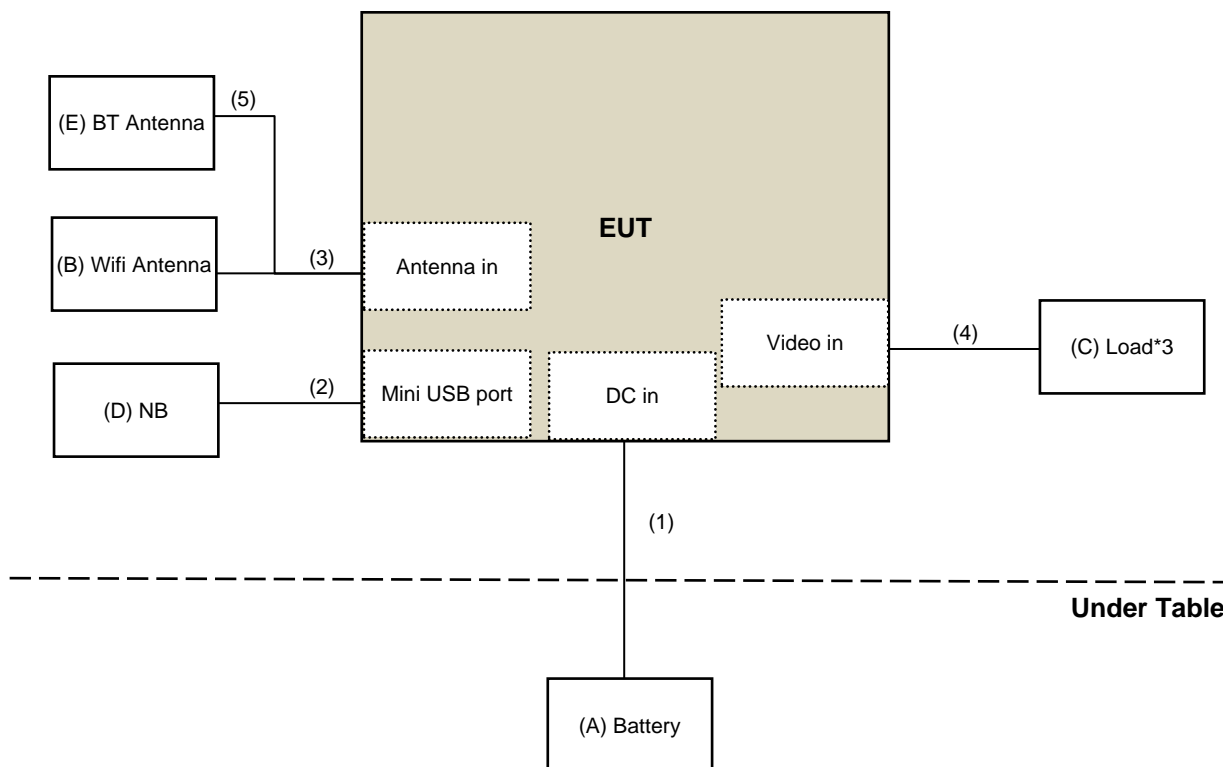

### 3.8 Configuration of Peripheral Devices and Cable Connections

ID	Product	Brand	Model No.	Serial No.	FCC ID	Remarks
A	Battery	GS	60044-MFZ	N/A	N/A	Provided by Lab
B	Wifi Antenna	Yokowo	VZ-003900	N/A	N/A	Supplied by applicant
C	Load*3	N/A	N/A	N/A	N/A	Supplied by applicant
D	NB	Lenovo	IdeaPad 5 15ITL05	N/A	N/A	Provided by Lab
E	BT Antenna	Yokowo	VZ-003902	N/A	N/A	Supplied by applicant

ID	Cable Descriptions	Qty.	Length (m)	Shielding (Yes/No)	Cores (Qty.)	Remarks
1	DC Cable	1	2.1	N	0	Supplied by applicant
2	Mini to USB to A cable	1	1	Y	0	Provided by Lab
3	WIFI Antenna Cable	2	2.2	Y	0	Supplied by applicant
4	Video Cable	3	1	N	0	Supplied by applicant
5	BT Antenna Cable	1	3.2	Y	0	Supplied by applicant

## 4 Test Instruments

The calibration interval of the all test instruments are 12 months and the calibrations are traceable to NML/ROC and NIST/USA.

### 4.1 RF Output Power

Description Manufacturer	Model No.	Serial No.	Calibrated Date	Calibrated Until
MIMO Powermeasurement Test set (4X4) KEYSIGHT	U2021XA	U2021XA_001	2022/6/13	2023/6/12
MXG Vector Signal Generator KEYSIGHT	N5182B	MY53052658	2022/5/9	2023/5/8
Power Meter Anritsu	ML2495A	1232003	2022/1/9	2023/1/8
Power Sensor Anritsu	MA2411B	1207333	2022/1/9	2023/1/8
Spectrum Analyzer KEYSIGHT	N9030A	MY54490260	2022/7/14	2023/7/13
Spectrum Analyzer R&S	FSV40	101042	2022/9/5	2023/9/4
		101544	2022/5/9	2023/5/8
Temperature & Humidity Chamber TERCHY	MHU-225AU	920409	2022/6/27	2023/6/26

Notes:

1. The test was performed in LK - Oven
2. Tested Date: 2022/9/19

### 4.2 Power Spectral Density

Refer to section 4.1 to get information of the instruments.

### 4.3 6 dB Bandwidth

Refer to section 4.1 to get information of the instruments.

### 4.4 Conducted Out of Band Emissions

Refer to section 4.1 to get information of the instruments.

#### 4.5 Unwanted Emissions below 1 GHz

Description Manufacturer	Model No.	Serial No.	Calibrated Date	Calibrated Until
* LOOP ANTENNA EMCI	LPA600	270	2021/9/2	2023/9/1
Bi_Log Antenna Schwarzbeck	VULB 9168	137	2021/10/27	2022/10/26
Coupling/Dcoupling Network Schwarzbeck	CDNE-M2	00097	2022/6/1	2023/5/31
	CDNE-M3	00091	2022/6/1	2023/5/31
Pre_Amplifier EMCI	EMC001340	980269	2022/6/28	2023/6/27
Pre_Amplifier HP	8447D	2432A03504	2022/2/17	2023/2/16
RF Coaxial Cable Pacific	8D-FB	Cable-CH6-02	2022/6/30	2023/6/29
Software BVADT	Radiated_V8.7.08	N/A	N/A	N/A
Spectrum Analyzer R&S	FSV40	101544	2022/5/9	2023/5/8
Test Receiver Agilent	N9038A	MY51210129	2022/4/8	2023/4/7
		MY51210137	2022/6/9	2023/6/8
Tower ADT	AT100	0306	N/A	N/A
Turn Table ADT	TT100	0306	N/A	N/A

Notes:

- \* The calibration interval of the above test instruments is 24 months and the calibrations are traceable to NML/ROC and NIST/USA
- The test was performed in Linkou 966 Chamber 6 (CH 6).
- Tested Date: 2022/9/21

#### 4.6 Unwanted Emissions above 1 GHz

Description Manufacturer	Model No.	Serial No.	Calibrated Date	Calibrated Until
Band Pass Filter MICRO-TRONICS	BRM17690	005	2022/5/26	2023/5/25
Boresight antenna tower fixture BV	BAF-02	6	N/A	N/A
High Pass Filter Wainwright Instruments	WHK 3.1/18G-10SS	SN 8	2022/5/26	2023/5/25
Horn Antenna EMCO	3115	00027024	2021/11/14	2022/11/13
		00028257	2021/11/14	2022/11/13
Horn Antenna ETS-Lindgren	3117-PA	00215857	2021/11/14	2022/11/13
Horn Antenna Schwarzbeck	BBHA 9170	212	2021/10/13	2022/10/12
Notch Filter MICRO-TRONICS	BRC50703-01	010	2022/5/26	2023/5/25
Pre-amplifier HP	8449B	3008A01201	2022/2/17	2023/2/16
Pre-amplifier (18GHz-40GHz) EMCI	EMC184045B	980175	2022/9/3	2023/9/2
Pre_Amplifier EMCI	EMC0126545	980076	2022/2/17	2023/2/16
	EMC184045B	980235	2022/2/17	2023/2/16
RF Coaxial Cable EM	EM102-KMKM-3.5+1M	EM102-KMKM-3.5+1M-01	2022/7/7	2023/7/6
RF Coaxial Cable HUBER SUHNER	SF-104	Cable-CH6-01	2022/7/7	2023/7/6
Software BVADT	Radiated_V8.7.08	N/A	N/A	N/A
Spectrum Analyzer Agilent	E4446A	MY51100009	2022/6/27	2023/6/26
Spectrum Analyzer KEYSIGHT	N9030A	MY54490260	2022/7/14	2023/7/13
Spectrum Analyzer R&S	FSV40	101042	2022/9/5	2023/9/4
		101544	2022/5/9	2023/5/8
Test Receiver Agilent	N9038A	MY51210129	2022/4/8	2023/4/7
		MY51210137	2022/6/9	2023/6/8
Tower ADT	AT100	0306	N/A	N/A
Turn Table ADT	TT100	0306	N/A	N/A

Notes:

1. The test was performed in Linkou 966 Chamber 6 (CH 6).
2. Tested Date: 2022/9/16

## 5 Limits of Test Items

### 5.1 RF Output Power

For systems using digital modulation in the 2400–2483.5 MHz bands: 1 Watt (30 dBm)

### 5.2 Power Spectral Density

The Maximum of Power Spectral Density Measurement is 8 dBm in any 3 kHz.

### 5.3 6 dB Bandwidth

The minimum of 6 dB Bandwidth Measurement is 0.5 MHz.

### 5.4 Conducted Out of Band Emissions

Below 20 dB of the highest emission level of operating band (in 100 kHz Resolution Bandwidth).

### 5.5 Unwanted Emissions below 1 GHz

Radiated emissions up to 1 GHz which fall in the restricted bands must comply with the radiated emission limits specified as below table. Other emissions shall be at least 20 dB below the highest level of the desired power:

Frequencies (MHz)	Field Strength (microvolts/meter)	Measurement Distance (meters)
0.009 ~ 0.490	2400/F(kHz)	300
0.490 ~ 1.705	24000/F(kHz)	30
1.705 ~ 30.0	30	30
30 ~ 88	100	3
88 ~ 216	150	3
216 ~ 960	200	3
Above 960	500	3

Notes:

1. The lower limit shall apply at the transition frequencies.
2. Emission level (dBuV/m) = 20 log Emission level (uV/m).

### 5.6 Unwanted Emissions above 1 GHz

Radiated emissions above 1 GHz which fall in the restricted bands must comply with the radiated emission limits specified as below table. Other emissions shall be at least 20 dB below the highest level of the desired power:

Frequencies (MHz)	Field Strength (microvolts/meter)	Measurement Distance (meters)
Above 960	500	3

Notes:

1. The lower limit shall apply at the transition frequencies.
2. Emission level (dBuV/m) = 20 log Emission level (uV/m).
3. For frequencies above 1000 MHz, the field strength limits are based on average detector, however, the peak field strength of any emission shall not exceed the maximum permitted average limits, specified above by more than 20 dB under any condition of modulation.

## 6 Test Arrangements

### 6.1 RF Output Power

#### 6.1.1 Test Setup

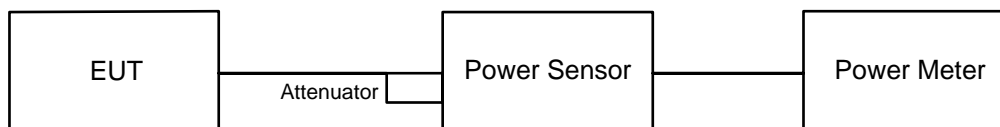

#### 6.1.2 Test Procedure

##### Peak Power:

A peak power sensor was used on the output port of the EUT. A power meter was used to read the response of the peak power sensor. Record the power level.

##### Average Power:

Average power sensor was used to perform output power measurement, trigger and gating function of wide band power meter is enabled to measure max output power of TX on burst. Duty factor is not added to measured value.

### 6.2 Power Spectral Density

#### 6.2.1 Test Setup

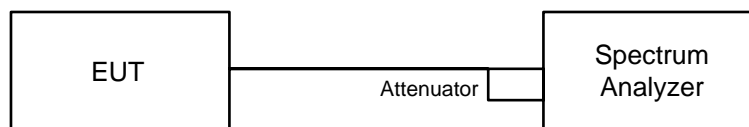

#### 6.2.2 Test Procedure

- a. Set analyzer center frequency to DTS channel center frequency.
- b. Set the span to 1.5 times the DTS bandwidth.
- c. Set the RBW to: 3 kHz.
- d. Set the VBW  $\geq 3 \times$  RBW.
- e. Detector = peak.
- f. Sweep time = auto couple.
- g. Trace mode = max hold.
- h. Allow trace to fully stabilize.
- i. Use the peak marker function to determine the maximum amplitude level within the RBW.

### 6.3 6 dB Bandwidth

#### 6.3.1 Test Setup

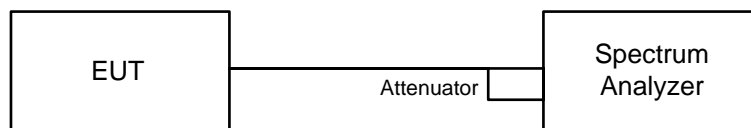

#### 6.3.2 Test Procedure

- Set resolution bandwidth (RBW) = 100 kHz.
- Set the video bandwidth (VBW)  $\geq 3 \times$  RBW, Detector = Peak.
- Trace mode = max hold.
- Sweep = auto couple.
- Measure the maximum width of the emission that is constrained by the frequencies associated with the two amplitude points (upper and lower) that are attenuated by 6 dB relative to the maximum level measured in the fundamental emission.

### 6.4 Conducted Out of Band Emissions

#### 6.4.1 Test Setup

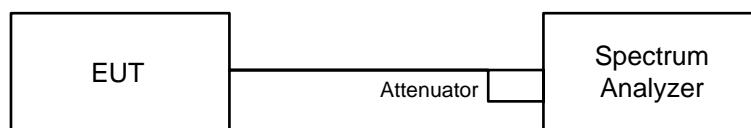

#### 6.4.2 Test Procedure

##### MEASUREMENT PROCEDURE REF

- Set the RBW = 100 kHz.
- Set the VBW  $\geq 300$  kHz.
- Detector = peak.
- Sweep time = auto couple.
- Trace mode = max hold.
- Allow trace to fully stabilize.
- Use the peak marker function to determine the maximum power level in any 100 kHz band segment within the fundamental EBW.

##### MEASUREMENT PROCEDURE OOB

- Set RBW = 100 kHz.
- Set VBW  $\geq 300$  kHz.
- Detector = peak.
- Sweep = auto couple.
- Trace Mode = max hold.
- Allow trace to fully stabilize.
- Use the peak marker function to determine the maximum amplitude level.



## 6.5 Unwanted Emissions below 1 GHz

### 6.5.1 Test Setup

#### For Radiated emission below 30 MHz

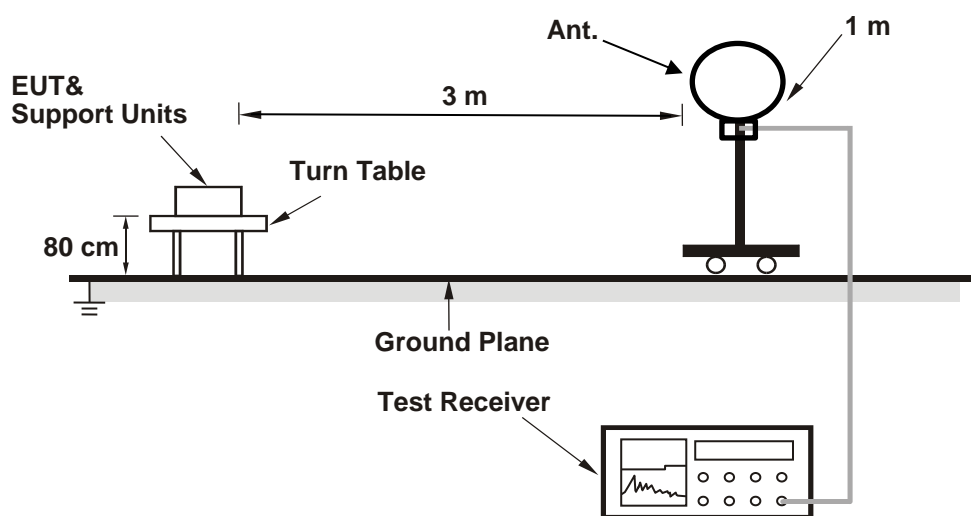

#### For Radiated emission above 30 MHz

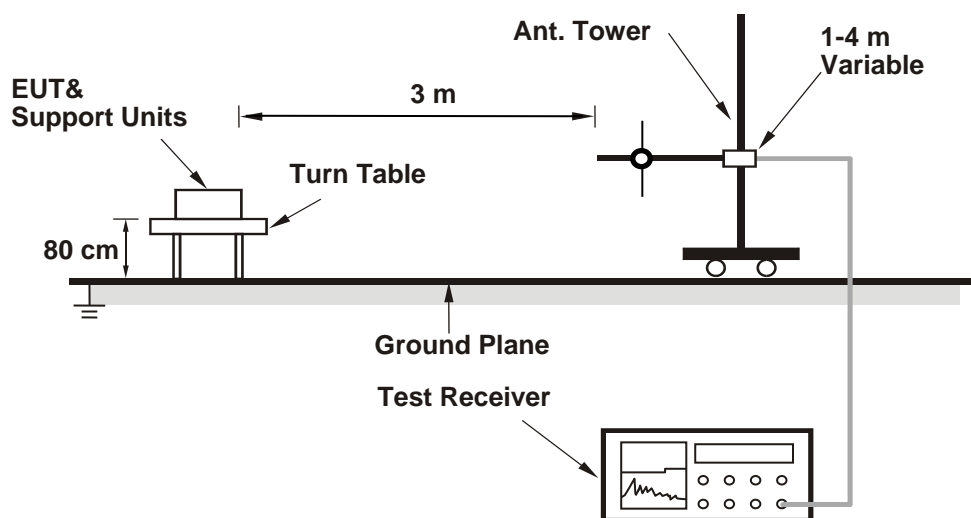

For the actual test configuration, please refer to the attached file (Test Setup Photo).

## 6.5.2 Test Procedure

### For Radiated emission below 30 MHz

- a. The EUT was placed on the top of a rotating table 0.8 meters above the ground at 3 meter chamber room for test. The table was rotated 360 degrees to determine the position of the highest radiation.
- b. The EUT was set 3 meters away from the interference-receiving antenna, which was mounted on the top of a variable-height antenna tower.
- c. Parallel, perpendicular, and ground-parallel orientations of the antenna are set to make the measurement.
- d. For each suspected emission, the EUT was arranged to its worst case and the rotatable table was turned from 0 degrees to 360 degrees to find the maximum reading.
- e. The test-receiver system was set to Quasi-Peak Detect Function and Specified Bandwidth with Maximum Hold Mode, except for the frequency band (9 kHz to 90 kHz and 110 kHz to 490 kHz) set to average detect function and peak detect function.

#### Notes:

1. The resolution bandwidth and video bandwidth of test receiver/spectrum analyzer is 200 Hz at frequency below 150 kHz.
2. The resolution bandwidth and video bandwidth of test receiver/spectrum analyzer is 9 kHz or 10 kHz at frequency (150 kHz to 30 MHz).
3. All modes of operation were investigated and the worst-case emissions are reported.

### For Radiated emission above 30 MHz

- a. The EUT was placed on the top of a rotating table 0.8 meters above the ground at 3 meter chamber room for test. The table was rotated 360 degrees to determine the position of the highest radiation.
- b. The EUT was set 3 meters away from the interference-receiving antenna, which was mounted on the top of a variable-height antenna tower.
- c. The height of antenna is varied from one meter to four meters above the ground to determine the maximum value of the field strength. Both horizontal and vertical polarizations of the antenna are set to make the measurement.
- d. For each suspected emission, the EUT was arranged to its worst case and then the antenna was tuned to heights from 1 meter to 4 meters and the rotatable table was turned from 0 degrees to 360 degrees to find the maximum reading.
- e. The test-receiver system was set to quasi-peak detect function and specified bandwidth with maximum hold mode when the test frequency is below 1 GHz.

#### Notes:

1. The resolution bandwidth and video bandwidth of test receiver/spectrum analyzer is 120 kHz for Quasi-peak detection (QP) at frequency below 1 GHz.
2. All modes of operation were investigated and the worst-case emissions are reported.

## 6.6 Unwanted Emissions above 1 GHz

### 6.6.1 Test Setup

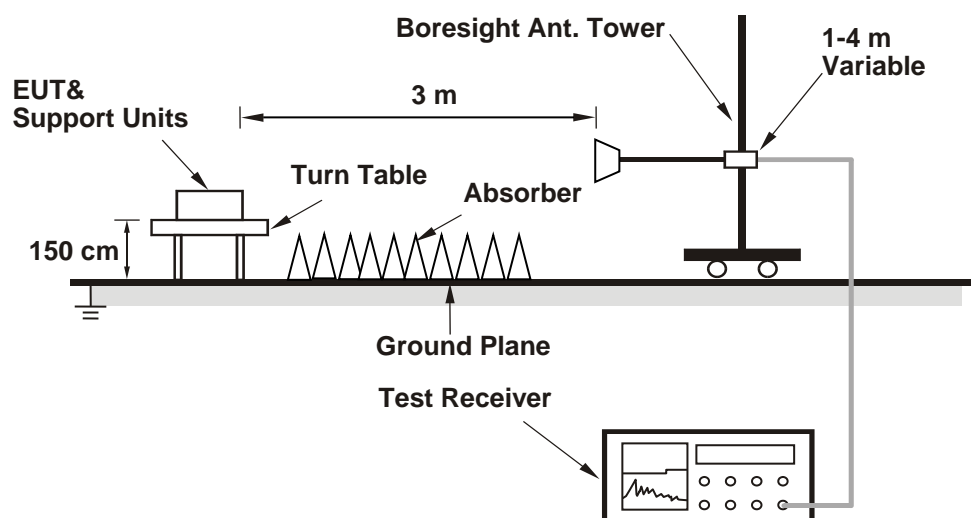

For the actual test configuration, please refer to the attached file (Test Setup Photo).

### 6.6.2 Test Procedure

- The EUT was placed on the top of a rotating table 1.5 meters above the ground at 3 meter chamber room for test. The table was rotated 360 degrees to determine the position of the highest radiation.
- The EUT was set 3 meters away from the interference-receiving antenna, which was mounted on the top of a variable-height antenna tower.
- The height of antenna is varied from one meter to four meters above the ground to determine the maximum value of the field strength. Both horizontal and vertical polarizations of the antenna are set to make the measurement.
- For each suspected emission, the EUT was arranged to its worst case and then the antenna was tuned to heights from 1 meter to 4 meters and the rotatable table was turned from 0 degrees to 360 degrees to find the maximum reading.
- The test-receiver system was set to peak and average detects function and specified bandwidth with maximum hold mode when the test frequency is above 1 GHz. If the peak reading value also meets average limit, measurement with the average detector is unnecessary.

#### Notes:

- The resolution bandwidth of test receiver/spectrum analyzer is 1 MHz and the video bandwidth is 3 MHz for Peak detection (PK) and Average detection (AV) at frequency above 1 GHz.
- For fundamental and harmonic signal measurement, the resolution bandwidth of test receiver/spectrum analyzer is 1 MHz and the video bandwidth is  $\geq 1/T$  (Duty cycle  $< 98\%$ ) or 10 Hz (Duty cycle  $\geq 98\%$ ) for Average detection (AV) at frequency above 1 GHz.
- All modes of operation were investigated and the worst-case emissions are reported.

## 7 Test Results of Test Item

### 7.1 RF Output Power

Input Power:	12 Vdc	Environmental Conditions:	25°C, 76% RH	Tested By:	Dalen Dai
--------------	--------	---------------------------	--------------	------------	-----------

#### For Peak Power

##### BT-LE 1M

Chan.	Chan. Freq. (MHz)	Peak Power (mW)	Peak Power (dBm)	Power Limit (dBm)	Test Result
0	2402	52.119	17.17	30	Pass
19	2440	52.845	17.23	30	Pass
39	2480	30.339	14.82	30	Pass

Note: The antenna gain is 3.86 dBi < 6 dBi, so the output power limit shall not be reduced.

#### For Average Power

##### BT-LE 1M

Chan.	Chan. Freq. (MHz)	Average Power (mW)	Average Power (dBm)
0	2402	48.529	16.86
19	2440	48.865	16.89
39	2480	28.708	14.58

## 7.2 Power Spectral Density

Input Power:	12 Vdc	Environmental Conditions:	25°C, 76% RH	Tested By:	Dalen Dai
--------------	--------	---------------------------	--------------	------------	-----------

### BT-LE 1M

Channel	Freq. (MHz)	PSD (dBm/3kHz)	PSD Limit (dBm/3kHz)	Pass / Fail
0	2402	1.24	8	Pass
19	2440	1.05	8	Pass
39	2480	-1.45	8	Pass

Note: The antenna gain is 3.86 dBi < 6 dBi, so the power density limit shall not be reduced.

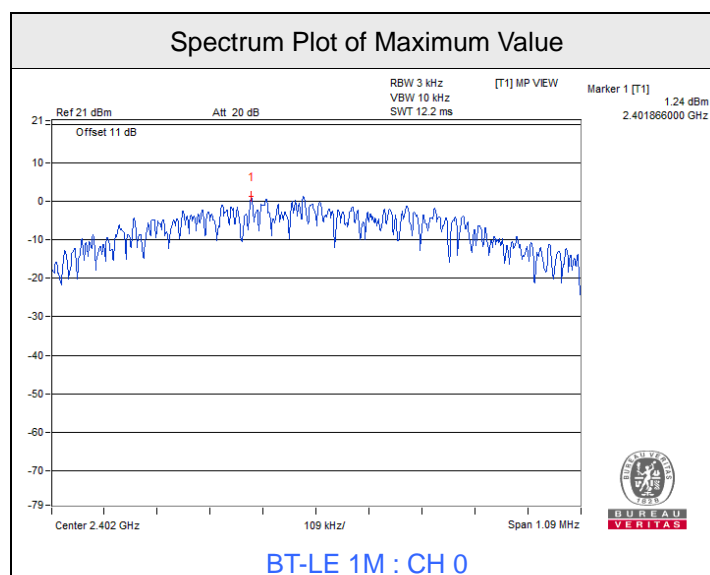

### 7.3 6 dB Bandwidth

Input Power:	12 Vdc	Environmental Conditions:	25°C, 76% RH	Tested By:	Dalen Dai
--------------	--------	---------------------------	--------------	------------	-----------

#### BT-LE 1M

Channel	Frequency (MHz)	6dB Bandwidth (MHz)	Minimum Limit (MHz)	Test Result
0	2402	0.73	0.5	Pass
19	2440	0.73	0.5	Pass
39	2480	0.73	0.5	Pass

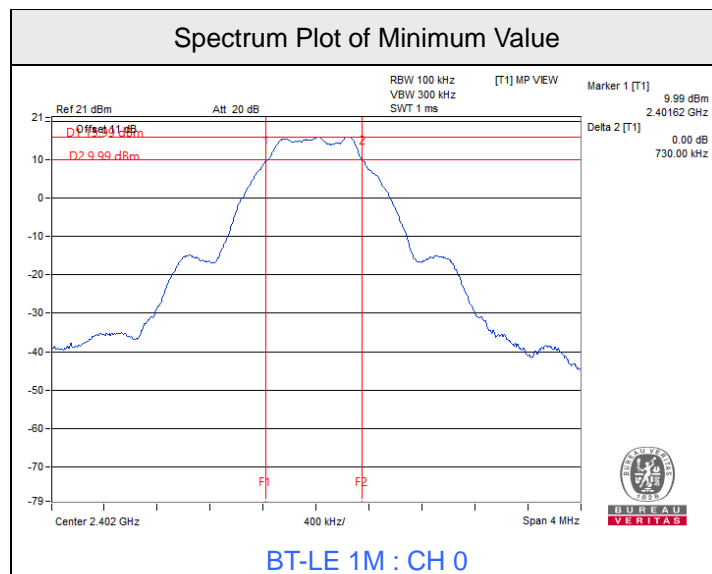

### 7.4 Conducted Out of Band Emissions

Input Power:	12 Vdc	Environmental Conditions:	25°C, 76% RH	Tested By:	Dalen Dai
--------------	--------	---------------------------	--------------	------------	-----------

#### BT-LE 1M

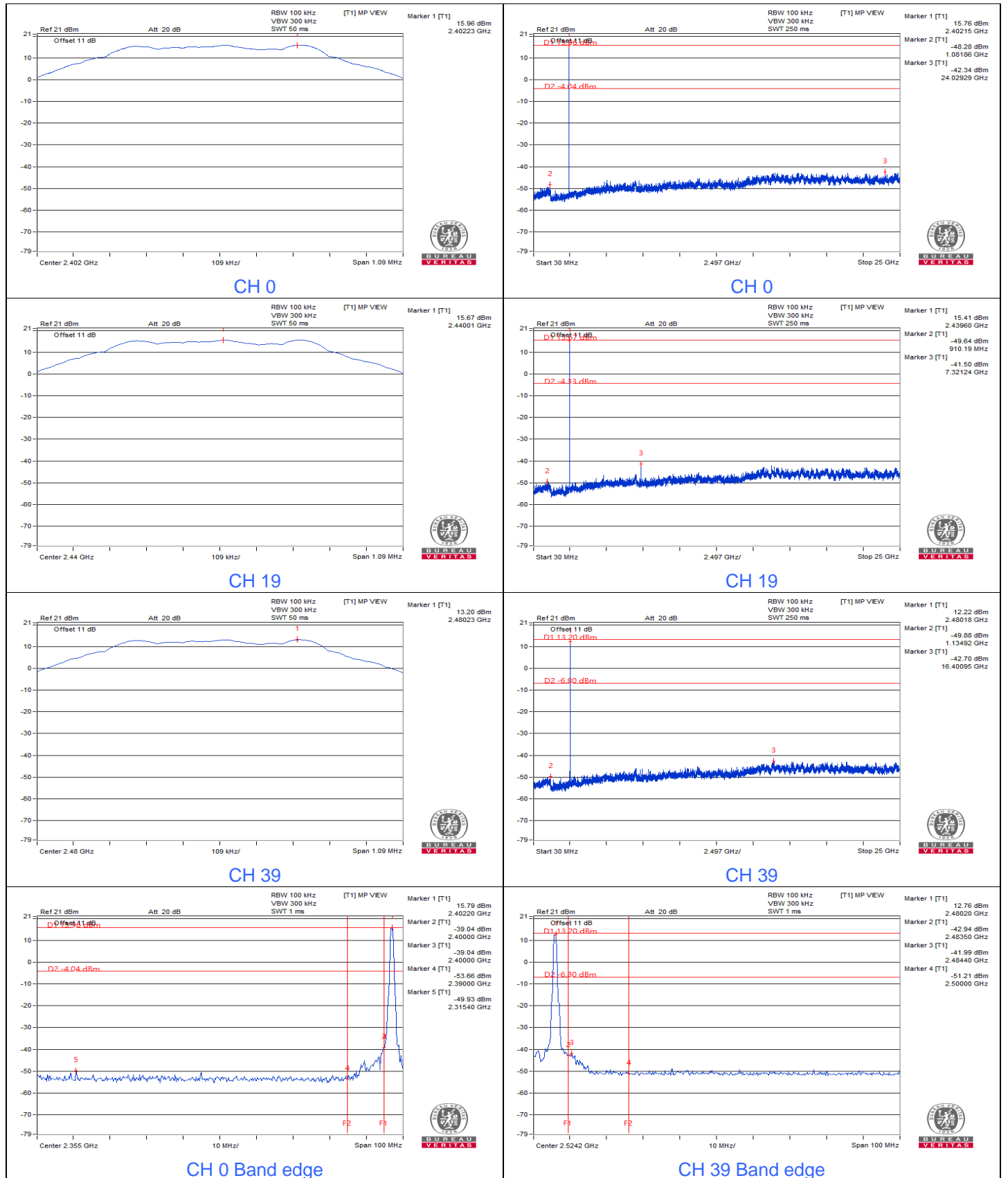

## 7.5 Unwanted Emissions below 1 GHz

RF Mode	BT-LE 1M	Channel	CH 19 : 2440 MHz
Frequency Range	9 kHz ~ 1 GHz	Detector Function & Bandwidth	(QP) RB = 120kHz
Input Power	12 Vdc	Environmental Conditions	20°C, 70% RH
Tested By	Jed Wu		

Antenna Polarity & Test Distance : Horizontal at 3 m								
No	Frequency (MHz)	Emission Level (dBuV/m)	Limit (dBuV/m)	Margin (dB)	Antenna Height (m)	Table Angle (Degree)	Raw Value (dBuV)	Correction Factor (dB/m)
1	33.54	22.0 QP	40.0	-18.0	1.85 H	63	37.4	-15.4
2	162.79	22.8 QP	43.5	-20.7	1.96 H	241	36.0	-13.2
3	244.32	32.1 QP	46.0	-13.9	1.74 H	253	45.6	-13.5
4	316.63	29.4 QP	46.0	-16.6	1.14 H	159	39.8	-10.4
5	402.24	35.2 QP	46.0	-10.8	1.25 H	130	43.9	-8.7
6	485.22	31.5 QP	46.0	-14.5	1.36 H	135	38.3	-6.8

### Remarks:

1. Emission Level(dBuV/m) = Raw Value(dBuV) + Correction Factor(dB/m)
2. Correction Factor(dB/m) = Antenna Factor(dB/m) + Cable Factor(dB) – Pre-Amplifier Factor(dB)
3. Margin value = Emission Level – Limit value
4. The other emission levels were very low against the limit of frequency range 30 MHz ~ 1 GHz.
5. The emission levels were very low against the limit of frequency range 9 kHz ~ 30 MHz: the amplitude of spurious emissions attenuated more than 20 dB below the permissible value to be report.

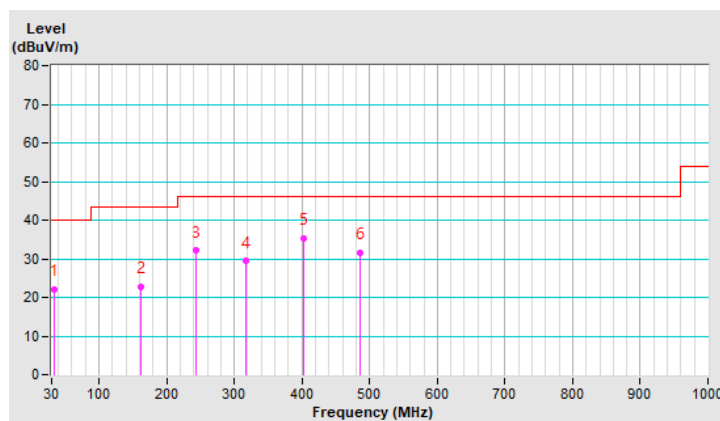



<b>RF Mode</b>	BT-LE 1M	<b>Channel</b>	CH 19 : 2440 MHz
<b>Frequency Range</b>	9 kHz ~ 1 GHz	<b>Detector Function &amp; Bandwidth</b>	(QP) RB = 120kHz
<b>Input Power</b>	12 Vdc	<b>Environmental Conditions</b>	20°C, 70% RH
<b>Tested By</b>	Jed Wu		

Antenna Polarity & Test Distance : Vertical at 3 m								
No	Frequency (MHz)	Emission Level (dBuV/m)	Limit (dBuV/m)	Margin (dB)	Antenna Height (m)	Table Angle (Degree)	Raw Value (dBuV)	Correction Factor (dB/m)
1	30.58	29.3 QP	40.0	-10.7	1.38 V	188	45.0	-15.7
2	127.53	25.2 QP	43.5	-18.3	1.19 V	198	40.2	-15.0
3	233.85	21.9 QP	46.0	-24.1	1.27 V	116	36.6	-14.7
4	316.83	28.2 QP	46.0	-17.8	1.75 V	242	38.6	-10.4
5	401.95	32.9 QP	46.0	-13.1	1.86 V	188	41.7	-8.8
6	638.09	32.6 QP	46.0	-13.4	1.94 V	96	35.8	-3.2

**Remarks:**

1. Emission Level(dBuV/m) = Raw Value(dBuV) + Correction Factor(dB/m)
2. Correction Factor(dB/m) = Antenna Factor(dB/m) + Cable Factor(dB) – Pre-Amplifier Factor(dB)
3. Margin value = Emission Level – Limit value
4. The other emission levels were very low against the limit of frequency range 30 MHz ~ 1 GHz.
5. The emission levels were very low against the limit of frequency range 9 kHz ~ 30 MHz: the amplitude of spurious emissions attenuated more than 20 dB below the permissible value to be report.

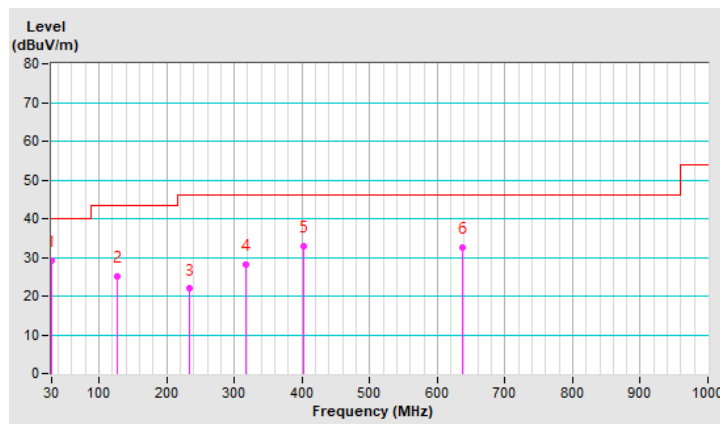

## 7.6 Unwanted Emissions above 1 GHz

<b>RF Mode</b>	BT-LE 1M	<b>Channel</b>	CH 0 : 2402 MHz
<b>Frequency Range</b>	1 GHz ~ 25 GHz	<b>Detector Function &amp; Bandwidth</b>	(PK) RB = 1 MHz, VB = 3 MHz (AV) RB = 1 MHz, VB = 3 kHz
<b>Input Power</b>	12 Vdc	<b>Environmental Conditions</b>	25°C, 68% RH
<b>Tested By</b>	Jed Wu		

Antenna Polarity & Test Distance : Horizontal at 3 m								
No	Frequency (MHz)	Emission Level (dBuV/m)	Limit (dBuV/m)	Margin (dB)	Antenna Height (m)	Table Angle (Degree)	Raw Value (dBuV)	Correction Factor (dB/m)
1	2390.00	54.8 PK	74.0	-19.2	3.11 H	148	56.6	-1.8
2	2390.00	43.6 AV	54.0	-10.4	3.11 H	148	45.4	-1.8
3	*2402.00	112.3 PK			3.11 H	148	114.2	-1.9
4	*2402.00	111.4 AV			3.11 H	148	113.3	-1.9
5	4804.00	48.5 PK	74.0	-25.5	2.07 H	66	42.7	5.8
6	4804.00	41.3 AV	54.0	-12.7	2.07 H	66	35.5	5.8
7	#7206.00	55.7 PK			1.12 H	143	45.4	10.3
8	#7206.00	51.0 AV			1.12 H	143	40.7	10.3

Antenna Polarity & Test Distance : Vertical at 3 m								
No	Frequency (MHz)	Emission Level (dBuV/m)	Limit (dBuV/m)	Margin (dB)	Antenna Height (m)	Table Angle (Degree)	Raw Value (dBuV)	Correction Factor (dB/m)
1	2390.00	56.2 PK	74.0	-17.8	1.75 V	176	58.0	-1.8
2	2390.00	45.3 AV	54.0	-8.7	1.75 V	176	47.1	-1.8
3	*2402.00	114.8 PK			1.75 V	176	116.7	-1.9
4	*2402.00	114.2 AV			1.75 V	176	116.1	-1.9
5	4804.00	49.4 PK	74.0	-24.6	1.25 V	124	43.6	5.8
6	4804.00	41.7 AV	54.0	-12.3	1.25 V	124	35.9	5.8
7	#7206.00	58.0 PK			1.08 V	154	47.7	10.3
8	#7206.00	52.7 AV			1.08 V	154	42.4	10.3

### Remarks:

1. Emission Level(dBuV/m) = Raw Value(dBuV) + Correction Factor(dB/m)
2. Correction Factor(dB/m) = Antenna Factor(dB/m) + Cable Factor(dB) – Pre-Amplifier Factor(dB)
3. Margin value = Emission Level – Limit value
4. The other emission levels were very low against the limit.
5. " \* ": Fundamental frequency, the limit was restricted at the RF Output Power.
6. " # ": The radiated frequency is out of the restricted band, the limit was restricted at the Conducted Out of Band Emissions.



<b>RF Mode</b>	BT-LE 1M	<b>Channel</b>	CH 19 : 2440 MHz
<b>Frequency Range</b>	1 GHz ~ 25 GHz	<b>Detector Function &amp; Bandwidth</b>	(PK) RB = 1 MHz, VB = 3 MHz (AV) RB = 1 MHz, VB = 3 kHz
<b>Input Power</b>	12 Vdc	<b>Environmental Conditions</b>	25°C, 68% RH
<b>Tested By</b>	Jed Wu		

**Antenna Polarity & Test Distance : Horizontal at 3 m**

No	Frequency (MHz)	Emission Level (dBuV/m)	Limit (dBuV/m)	Margin (dB)	Antenna Height (m)	Table Angle (Degree)	Raw Value (dBuV)	Correction Factor (dB/m)
1	*2440.00	111.2 PK			3.32 H	147	113.0	-1.8
2	*2440.00	110.3 AV			3.32 H	147	112.1	-1.8
3	4880.00	46.5 PK	74.0	-27.5	2.28 H	67	40.5	6.0
4	4880.00	39.3 AV	54.0	-14.7	2.28 H	67	33.3	6.0
5	7320.00	56.6 PK	74.0	-17.4	1.11 H	124	45.5	11.1
6	7320.00	50.5 AV	54.0	-3.5	1.11 H	124	39.4	11.1

**Antenna Polarity & Test Distance : Vertical at 3 m**

No	Frequency (MHz)	Emission Level (dBuV/m)	Limit (dBuV/m)	Margin (dB)	Antenna Height (m)	Table Angle (Degree)	Raw Value (dBuV)	Correction Factor (dB/m)
1	*2440.00	113.7 PK			1.96 V	175	115.5	-1.8
2	*2440.00	113.1 AV			1.96 V	175	114.9	-1.8
3	4880.00	47.4 PK	74.0	-26.6	1.46 V	125	41.4	6.0
4	4880.00	39.7 AV	54.0	-14.3	1.46 V	125	33.7	6.0
5	7320.00	58.9 PK	74.0	-15.1	1.07 V	135	47.8	11.1
<b>6</b>	<b>7320.00</b>	<b>52.8 AV</b>	<b>54.0</b>	<b>-1.2</b>	<b>1.07 V</b>	<b>135</b>	<b>41.7</b>	<b>11.1</b>

**Remarks:**

1. Emission Level(dBuV/m) = Raw Value(dBuV) + Correction Factor(dB/m)
2. Correction Factor(dB/m) = Antenna Factor(dB/m) + Cable Factor(dB) – Pre-Amplifier Factor(dB)
3. Margin value = Emission Level – Limit value
4. The other emission levels were very low against the limit.
5. " \* ": Fundamental frequency, the limit was restricted at the RF Output Power.



<b>RF Mode</b>	BT-LE 1M	<b>Channel</b>	CH 39 : 2480 MHz
<b>Frequency Range</b>	1 GHz ~ 25 GHz	<b>Detector Function &amp; Bandwidth</b>	(PK) RB = 1 MHz, VB = 3 MHz (AV) RB = 1 MHz, VB = 3 kHz
<b>Input Power</b>	12 Vdc	<b>Environmental Conditions</b>	25°C, 68% RH
<b>Tested By</b>	Jed Wu		

**Antenna Polarity & Test Distance : Horizontal at 3 m**

No	Frequency (MHz)	Emission Level (dBuV/m)	Limit (dBuV/m)	Margin (dB)	Antenna Height (m)	Table Angle (Degree)	Raw Value (dBuV)	Correction Factor (dB/m)
1	*2480.00	108.7 PK			3.08 H	149	110.4	-1.7
2	*2480.00	106.9 AV			3.08 H	149	108.6	-1.7
3	2483.50	59.8 PK	74.0	-14.2	3.08 H	149	61.5	-1.7
4	2483.50	47.9 AV	54.0	-6.1	3.08 H	149	49.6	-1.7
5	4960.00	45.6 PK	74.0	-28.4	2.04 H	65	39.5	6.1
6	4960.00	37.9 AV	54.0	-16.1	2.04 H	65	31.8	6.1
7	7440.00	53.8 PK	74.0	-20.2	1.13 H	144	42.2	11.6
8	7440.00	46.6 AV	54.0	-7.4	1.13 H	144	35.0	11.6

**Antenna Polarity & Test Distance : Vertical at 3 m**

No	Frequency (MHz)	Emission Level (dBuV/m)	Limit (dBuV/m)	Margin (dB)	Antenna Height (m)	Table Angle (Degree)	Raw Value (dBuV)	Correction Factor (dB/m)
1	*2480.00	111.8 PK			1.72 V	176	113.5	-1.7
2	*2480.00	110.7 AV			1.72 V	176	112.4	-1.7
3	2483.50	60.8 PK	74.0	-13.2	1.72 V	176	62.5	-1.7
4	2483.50	48.3 AV	54.0	-5.7	1.72 V	176	50.0	-1.7
5	4960.00	46.5 PK	74.0	-27.5	1.28 V	123	40.4	6.1
6	4960.00	38.8 AV	54.0	-15.2	1.28 V	123	32.7	6.1
7	7440.00	56.1 PK	74.0	-17.9	1.15 V	148	44.5	11.6
8	7440.00	48.9 AV	54.0	-5.1	1.15 V	148	37.3	11.6

**Remarks:**

1. Emission Level(dBuV/m) = Raw Value(dBuV) + Correction Factor(dB/m)
2. Correction Factor(dB/m) = Antenna Factor(dB/m) + Cable Factor(dB) – Pre-Amplifier Factor(dB)
3. Margin value = Emission Level – Limit value
4. The other emission levels were very low against the limit.
5. " \* " : Fundamental frequency, the limit was restricted at the RF Output Power.

Plot of Band Edge

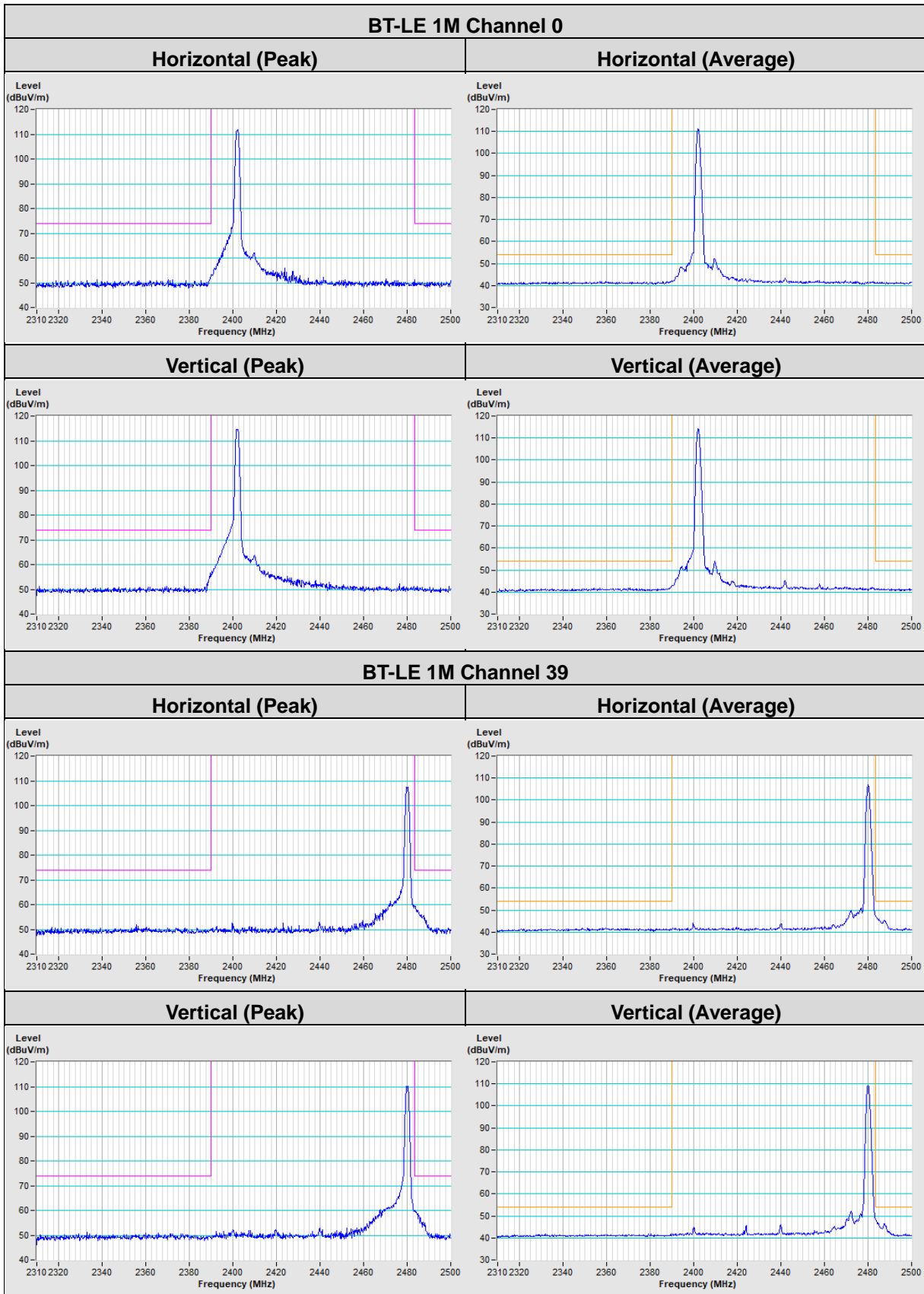

## 8 Pictures of Test Arrangements

Please refer to the attached file (Test Setup Photo)

## 9 Information of the Testing Laboratories

We, Bureau Veritas Consumer Products Services (H.K.) Ltd., Taoyuan Branch, were founded in 1988 to provide our best service in EMC, Radio, Telecom and Safety consultation. Our laboratories are FCC recognized accredited test firms and accredited according to ISO/IEC 17025.

If you have any comments, please feel free to contact us at the following:

**Lin Kou EMC/RF Lab**

Tel: 886-2-26052180

Fax: 886-2-26051924

**Hsin Chu EMC/RF/Telecom Lab**

Tel: 886-3-6668565

Fax: 886-3-6668323

**Hwa Ya EMC/RF/Safety Lab**

Tel: 886-3-3183232

Fax: 886-3-3270892

**Email:** [service.adt@bureauveritas.com](mailto:service.adt@bureauveritas.com)

**Web Site:** <http://ee.bureauveritas.com.tw>

The address and road map of all our labs can be found in our web site also.

--- END ---