

Toyota Trailer Camera ECU
Model: TA-220-TUND-MI
FCC ID: ACJ932A-TA220
IC : 216A-TA220

PANASONIC AUTOMOTIVE

Panasonic®

Panasonic Automotive Systems Company of America

W-LAN receiver and camera system User Manual

Version 1.0

10/28/2022

Author

Sanjeev Rao

Toyota Trailer Camera ECU
Model: TA-220-TUND-MI
FCC ID: ACJ932A-TA220
IC : 216A-TA220

Table of Contents

INTRODUCTION

GETTING STARTED WITH W-LAN RECEIVER

W-LAN RECEIVER OPERATION

SYSTEM SETTINGS

PAIRING OF W-LAN RECEIVER WITH CAMERA

Toyota Trailer Camera ECU

Model: TA-220-TUND-MI

FCC ID: ACJ932A-TA220

IC : 216A-TA220

PRIVACY WARNING

- The W-LAN receiver video camera module is built into this WCS but no video is recorded or stored in the system.

FCC/ISED Regulatory Notices

Modification Statement

Panasonic Automotive Systems of America has not approved any changes or modifications to this device by the user. Any changes or modifications could void the user's authority to operate the equipment.

Panasonic Automotive Systems of America n'approuve aucune modification apportée à l'appareil par l'utilisateur, quelle qu'en soit la nature. Tout changement ou modification peuvent annuler le droit d'utilisation de l'appareil par l'utilisateur.

Interference statement

This device complies with Part 15 of the FCC Rules and ISED's licence-exempt RSS standard(s). Operation is subject to the following two conditions: (1) this device may not cause interference, and (2) this device must accept any interference, including interference that may cause undesired operation of the device.

The antenna should be installed and operated with minimum distance of 20 cm between the radiator and your body.

Le présent appareil est conforme aux CNR d'ISED applicables aux appareils radio exempts de licence. L'exploitation est autorisée aux deux conditions suivantes : (1) le dispositif ne doit pas produire de brouillage préjudiciable, et (2) ce dispositif doit accepter tout brouillage reçu, y compris un brouillage susceptible de provoquer un fonctionnement indésirable.

L'antenne doit être installée de façon à garder une distance minimale de 20 centimètres entre la source de rayonnements et votre corps.

Radiation Exposure Statement:

This equipment complies with FCC/ISED radiation exposure limits set forth for an uncontrolled environment. This equipment should be installed and operated with minimum distance 20cm between the radiator & your body.

This transmitter must not be co-located or operating in conjunction with any other antenna or transmitter.

Déclaration d'exposition aux radiations:

Cet équipement est conforme aux limites d'exposition aux rayonnements ISED établies pour un environnement non contrôlé. Cet équipement doit être installé et utilisé à plus de 20cm entre le radiateur et votre corps.

Toyota Trailer Camera ECU

Model: TA-220-TUND-MI

FCC ID: ACJ932A-TA220

IC : 216A-TA220

FCC Class B digital device notice

This equipment has been tested and found to comply with the limits for a Class B digital device, pursuant to part 15 of the FCC Rules. These limits are designed to provide reasonable protection against harmful interference in a residential installation. This equipment generates, uses and can radiate radio frequency energy and, if not installed and used in accordance with the instructions, may cause harmful interference to radio communications. However, there is no guarantee that interference will not occur in a particular installation. If this equipment does cause harmful interference to radio or television reception, which can be determined by turning the equipment off and on, the user is encouraged to try to correct the interference by one or more of the following measures:

- Reorient or relocate the receiving antenna.
- Increase the separation between the equipment and receiver.
- Connect the equipment into an outlet on a circuit different from that to which the receiver is connected.
- Consult the dealer or an experienced radio/TV technician for help.

FCC Caution: Any changes or modifications not expressly approved by the party responsible for compliance could void the user's authority to operate this equipment.

CAN ICES-3 (B) / NMB-3 (B)

This Class B digital apparatus complies with Canadian ICES-003.

Cet appareil numérique de classe B est conforme a la norme canadienne ICES-003.

Professional installation instruction

1. Installation personal

This product is designed for specific application and needs to be installed by a qualified personal who has RF and related rule knowledge. The general user shall not attempt to install or change the setting.

2. Installation location

The product shall be installed at a location where the radiating antenna can be kept 20cm from nearby person in normal operation condition to meet regulatory RF exposure requirement.

3. External antenna

Use only the antennas which have been approved by the applicant. The non-approved antenna(s) may produce unwanted spurious or excessive RF transmitting power which may lead to the violation of FCC/IC limit and is prohibited.

4. Installation procedure

Please refer to user's manual for the detail.

5. Warning

Please carefully select the installation position and make sure that the final output power does not exceed the limit set force in relevant rules. The violation of the rule could lead to serious federal penalty.

Instructions d'installation professionnelle

1. Installation

Ce produit est destine a un usage specifique et doit etre installe par un personnel qualifie maitrisant les radiofrequences et les regles s'y rapportant. L'installation et les reglages ne doivent pas etre modifies par l'utilisateur final.

2. Emplacement d'installation

En usage normal, afin de respecter les exigences reglementaires concernant l'exposition aux radiofrequences, ce produit doit etre installe de facon a respecter une distance de 20cm entre l'antenne emettrice et les personnes.

3. Antenn externe.

Utiliser uniiquement les antennes approuvees par le fabricant. L'utilisation d'autres antennes peut conduire a un niveau de rayonnement essentiel ou non essentiel depassant les niveaux limites definis par FCC/IC, ce qui est interdit.

4. Procedure d'installation

Consulter le manuel d'utilisation.

5. Avertissement

Choisir avec soin la position d'installation et s'assurer que la puissance de sortie ne depasse pas les limites en vigueur. La violation de cette regle peut conduire a de serieuses penalites federales.

Toyota Trailer Camera ECU

Model: TA-220-TUND-MI

FCC ID: ACJ932A-TA220

IC : 216A-TA220

Introduction

W-LAN receiver is a part of Wireless Camera System (WCS) which includes wireless camera, display and a W-LAN receiver. The camera streams video over W-LAN to the multiple display in the vehicle via the W-LAN receiver. The wireless camera will come paired with the system from the manufacturer. The user will have the ability to add remove cameras (see *WCS Pairing*). Video can be streamed consciously or on-demand on each display.

DETACHABLE ANTENNA USAGE

This radio transmitter [IC: 216A-TA220] has been approved by Innovation, Science and Economic Development Canada to operate with the antenna types listed below, with the maximum permissible gain indicated. Antenna types not included in this list that have a gain greater than the maximum gain indicated for any type listed are strictly prohibited for use with this device.

Le présent émetteur radio [IC: 216A-TA220] a été approuvé par Innovation, Sciences et Développement économique Canada pour fonctionner avec les types d'antenne énumérés ci-dessous et ayant un gain admissible maximal. Les types d'antenne non inclus dans cette liste, et dont le gain est supérieur au gain maximal indiqué pour tout type figurant sur la liste, sont strictement interdits pour l'exploitation de l'émetteur.

Operational Frequency ⁺	Antenna no. ⁺	Manufacturer ⁺	Model ⁺	Antenna Type ⁺	Max Gain (dBi) ⁺	Impedance (Ω) ⁺
WIFI+BLE ⁺	Chain 1 ⁺	[YOKOWO] ⁺	[VZ-003902] ⁺	[Sharkfin] ⁺	[4.20dBi] ⁺	[50±10 Ω] ⁺
WIFI ⁺	Chain 2 ⁺	[YOKOWO] ⁺	[VZ-003900] ⁺	[Sharkfin] ⁺	[4.61dBi] ⁺	[50±10 Ω] ⁺

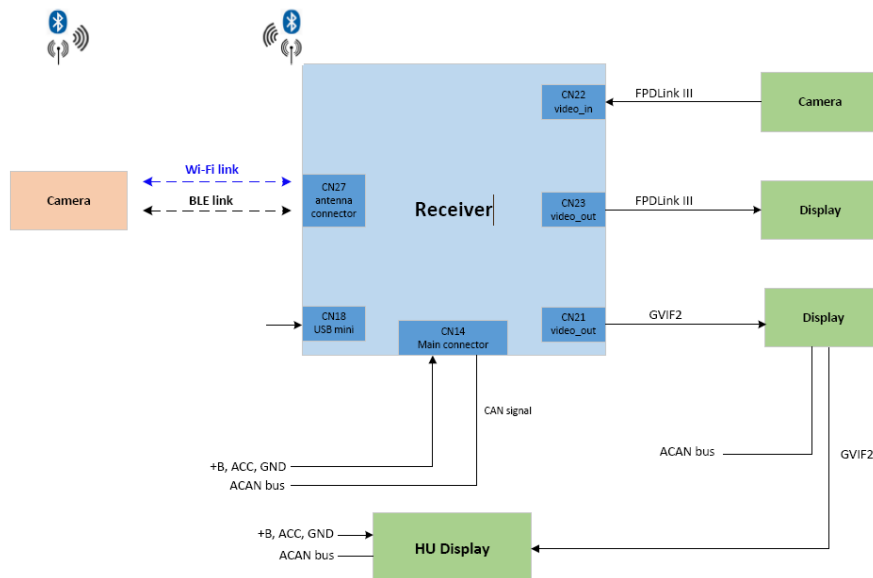

Wireless Camera System Diagram

Toyota Trailer Camera ECU

Model: TA-220-TUND-MI

FCC ID: ACJ932A-TA220

IC : 216A-TA220



W-LAN receiver Electrical specification:

Operational voltage	9 V - 16 V
Operational current	0.65 A
Operational frequency	2.4 GHz W-LAN and BT
Operational power consumption	9 Watt
W –Lan transmit power	29.94 dBm
BTLE transmit power	18 dBm
Storage Temperature	-40 deg C to + 85 deg C
Operating temperature	-30 deg C to +70 deg C
802.11g sensitivity 54Mbps	-74 dBm
BT receiver sensitivity	-80 dBm

GETTING STARTED WITH WIRELESS CAMERA SYSTEM

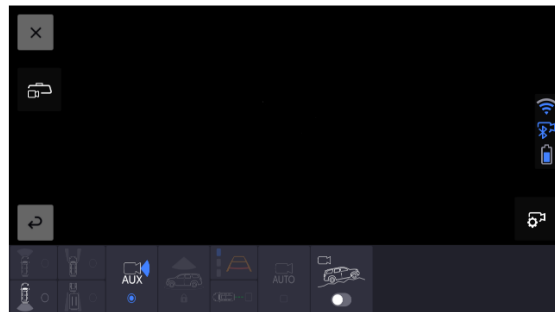
1. Make sure camera battery is fully charged before using camera with W_LAN receiver
2. Wake up wireless camera by Plugging the USB-C cable to wireless camera and computer USB port
3. Power on W-LAN receiver by suppling 12V via power harness.
4. The wireless camera status indicator should come on after a few seconds.
5. Wait for the wireless camera status indicator to become solid green, indicating video is streaming.
6. Press AUX () on the display window to display wireless camera video on the main display.



7. Press () on the main display window to show the same wireless camera video on the second display
8. Press t() to change video from wireless camera to wired video
9. Turn off 12V to turn receiver off.

WIRELESS CAMERA SYSTEM OPERATION

1. Waking up the Wireless Camera

To conserve battery the wireless camera will be in sleep state when shipped from factory. To wake the camera, you may perform one of the following actions:

- Supply 12V
- Connect a USB-C cable to a USB power

2. Main display and operation

- a. Turn on receiver by applying 12V
- b. Press () to access the wireless camera video.

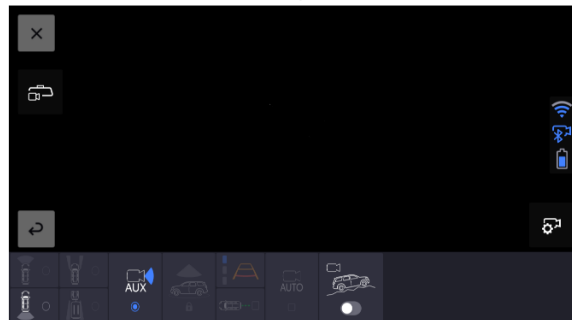
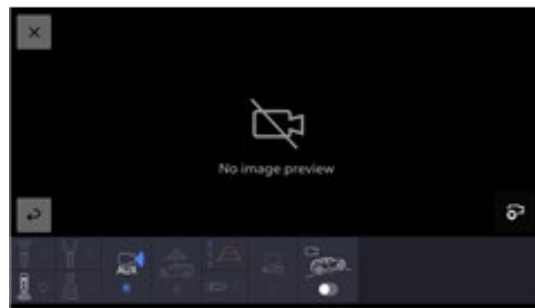

- c. Press  to enter settings menu, select "Camera Device Management".



- d. To connect to a previously paired camera select the camera to view Connect button and press the Connect button on the screen.

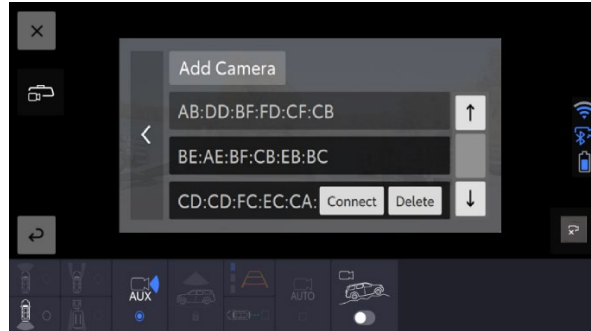

- f. After the camera connected to the W-LAN receiver you will see the camera stream on the multimedia display.

3. Second display operation

- a. Wired camera view Only Mode (default)

Wired camera is always displayed on the second display in this mode.



Toyota Trailer Camera ECU

Model: TA-220-TUND-MI

FCC ID: ACJ932A-TA220

IC : 216A-TA220

b. AUTO Mode

In AUTO mode, if the left or right turn signals are engaged the **wireless camera** video is shown on the second display. If turn signal is off, then **wired camera** video is displayed on the second display. This feature helps in conserving the wireless camera battery when it is not connected to the 12V vehicle power supply by switching the video to cargo and turning off the video streaming in the wireless camera.



c. ON Mode

Wireless camera video is always displayed on the second display in this mode.



WIRELESS CAMERA SYSTEM SETTINGS

Wireless camera settings allow flipping an image, pairing more wireless cameras, run diagnostics, reset settings, and perform software updates.

1. Turn receiver on
2. Press the Aux () button in the screen to see wireless camera landing page.

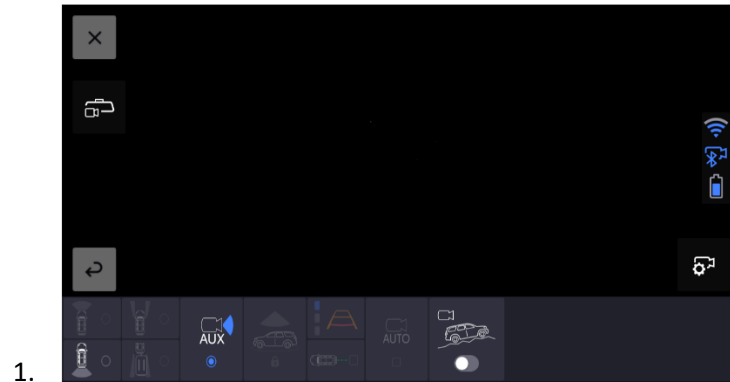

3. Wireless camera setting menu is only accessible while vehicle is parked. Select  icon from the main display.



4. To exit the wireless camera settings, select  icon.

5. Wireless Camera Settings Menu

- **Camera Device Management**

Camera Device Management menu lists all currently paired wireless cameras to the system and allows you to add/delete/turn off your wireless cameras.

- **Diagnostics**

Provides you with wireless camera and W-LAN receiver (WiFi Receiver) diagnostics.

Reset Settings restores the factory default settings.

- Second display will be set up (default) **ON** mode
- Second display will be set up (default) wired camera view
- Flip WiFi Camera Image option will be set to (default) **ON**

- Delete all paired wireless cameras
- **Flip Image**
This is a toggle button to flip the camera image vertically.

WIRELESS CAMERA PAIRING

1. Enter to wireless CAM screen.



2. Press  to enter settings menu, select "Camera Device Management", and click "Add Camera".

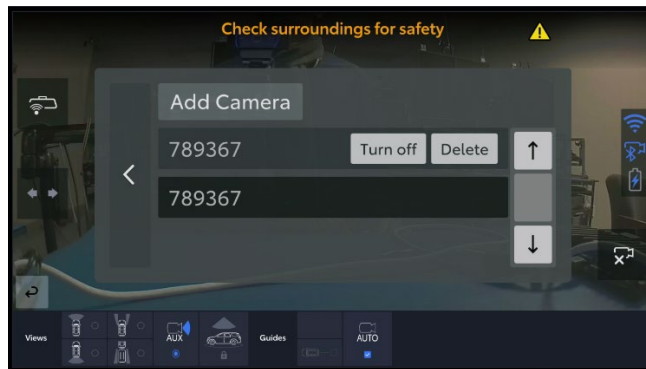

2. The main display shows below message.

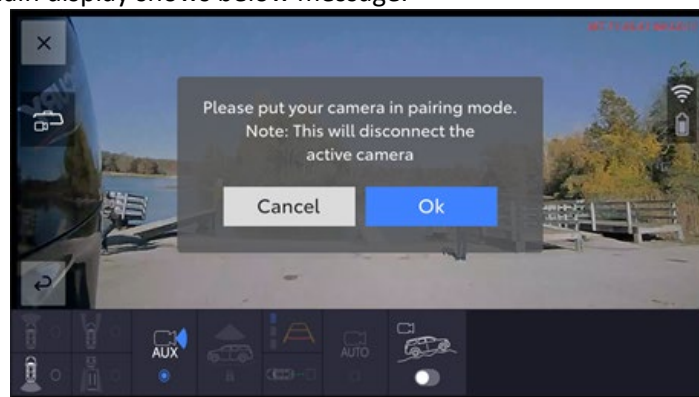

Toyota Trailer Camera ECU

Model: TA-220-TUND-MI

FCC ID: ACJ932A-TA220

IC : 216A-TA220

3. Move the Trailer CAM following the sequence below in order to put the camera in pairing mode.

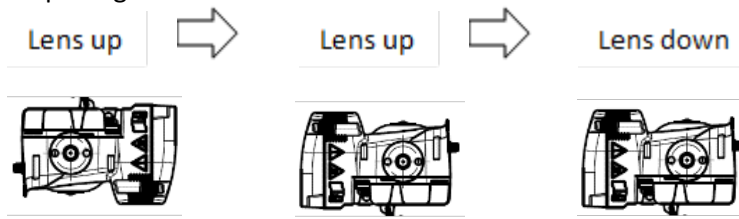

- 1) In lens up position for 5 seconds
- 2) In lens down position for 5 seconds
- 3) In lens up position again

Once the wireless CAM enters Pairing mode, the wireless CAM LED will blinking orange

4. Select "OK" button and QR code will be shown on the radio display.

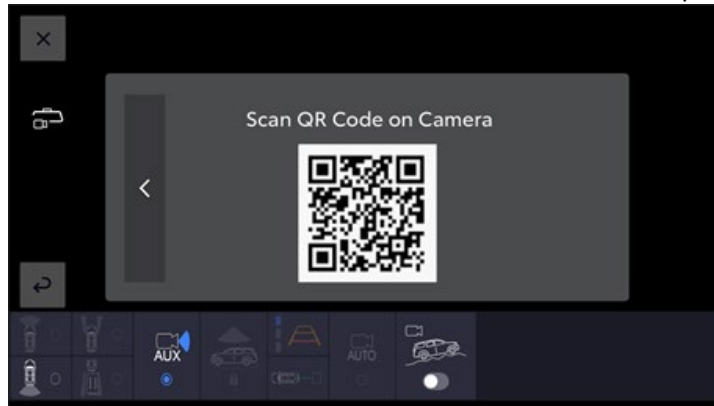

5. Aim the wireless CAM to the radio display to scan the QR code.

6. Once QR code scan and pairing is completed, "WiFi Camera was added successfully" will be displayed.

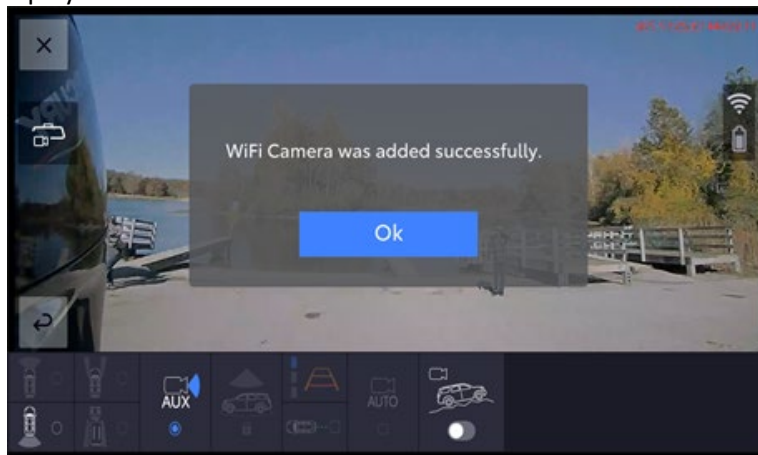

Toyota Trailer Camera ECU

Model: TA-220-TUND-MI

FCC ID: ACJ932A-TA220

IC : 216A-TA220

7. If QR scan or pairing failed, a failed message is displayed. Please try previous steps again.

