

TEST REPORT

CERTIFICATE OF CONFORMITY

Standard: 47 CFR FCC Part 15, Subpart C (Section 15.247)

Report No.: RFBHJR-WTW-P22080862

FCC ID: ACJ932A-PT230

Product: Trailer Camera

Brand: Panasonic

Model No.: PT-230-COMN-CU

Received Date: 2023/3/27

Test Date: 2023/4/20 ~ 2023/4/27

Issued Date: 2023/6/8

Applicant: Panasonic Corporation of North America

Address: Two Riverfront Plaza, 9th Floor Newark New Jersey United States 07102-5490

Issued By: Bureau Veritas Consumer Products Services (H.K.) Ltd., Taoyuan Branch
Lin Kou Laboratories

Lab Address: No. 47-2, 14th Ling, Chia Pau Vil., Lin Kou Dist., New Taipei City, Taiwan

Test Location: No. 47-2, 14th Ling, Chia Pau Vil., Lin Kou Dist., New Taipei City, Taiwan

FCC Registration / 198487 / TW2021

Designation Number:

Approved by: Jeremy Lin , **Date:** 2023/6/8
Jeremy Lin / Project Engineer

This test report consists of 47 pages in total. It may be duplicated completely for legal use with the approval of the applicant. It should not be reproduced except in full, without the written approval of our laboratory. The test results in the report only apply to the tested sample. The test results in this report are traceable to the national or international standards.



Prepared by : Annie Chang / Senior Specialist

This report is governed by, and incorporates by reference, the Conditions of Testing as posted at the date of issuance of this report at <http://www.bureauveritas.com/home/about-us/our-business/cps/about-us/terms-conditions/> and is intended for your exclusive use. Any copying or replication of this report to or for any other person or entity, or use of our name or trademark, is permitted only with our prior written permission. This report sets forth our findings solely with respect to the test samples identified herein. The results set forth in this report are not indicative or representative of the quality or characteristics of the lot from which a test sample was taken or any similar or identical product unless specifically and expressly noted. Our report includes all of the tests requested by you and the results thereof based upon the information that you provided to us. Measurement uncertainty is only provided upon request for accredited tests. Statements of conformity are based on simple acceptance criteria without taking measurement uncertainty into account, unless otherwise requested in writing. You have 60 days from date of issuance of this report to notify us of any material error or omission caused by our negligence or if you require measurement uncertainty; provided, however, that such notice shall be in writing and shall specifically address the issue you wish to raise. A failure to raise such issue within the prescribed time shall constitute your unqualified acceptance of the completeness of this report, the tests conducted and the correctness of the report contents.

Table of Contents

Release Control Record	4
1 Certificate.....	5
2 Summary of Test Results	6
2.1 Measurement Uncertainty	6
2.2 Supplementary Information	6
3 General Information	7
3.1 General Description	7
3.2 Antenna Description of EUT	7
3.3 Channel List.....	8
3.4 Test Mode Applicability and Tested Channel Detail.....	9
3.5 Duty Cycle of Test Signal.....	10
3.6 Test Program Used and Operation Descriptions	11
3.7 Connection Diagram of EUT and Peripheral Devices	11
3.8 Configuration of Peripheral Devices and Cable Connections	12
4 Test Instruments	13
4.1 RF Output Power.....	13
4.2 Power Spectral Density	13
4.3 6 dB Bandwidth	13
4.4 Conducted Out of Band Emissions	13
4.5 AC Power Conducted Emissions	14
4.6 Unwanted Emissions below 1 GHz	15
4.7 Unwanted Emissions above 1 GHz.....	16
5 Limits of Test Items.....	17
5.1 RF Output Power.....	17
5.2 Power Spectral Density	17
5.3 6 dB Bandwidth	17
5.4 Conducted Out of Band Emissions	17
5.5 AC Power Conducted Emissions	17
5.6 Unwanted Emissions below 1 GHz	17
5.7 Unwanted Emissions above 1 GHz.....	18
6 Test Arrangements.....	19
6.1 RF Output Power.....	19
6.1.1 Test Setup	19
6.1.2 Test Procedure.....	19
6.2 Power Spectral Density	19
6.2.1 Test Setup	19
6.2.2 Test Procedure.....	19
6.3 6 dB Bandwidth	20
6.3.1 Test Setup	20
6.3.2 Test Procedure.....	20
6.4 Conducted Out of Band Emissions	20
6.4.1 Test Setup	20
6.4.2 Test Procedure.....	20
6.5 AC Power Conducted Emissions	21
6.5.1 Test Setup	21
6.5.2 Test Procedure.....	21
6.6 Unwanted Emissions below 1 GHz	22
6.6.1 Test Setup	22
6.6.2 Test Procedure.....	23
6.7 Unwanted Emissions above 1 GHz.....	24
6.7.1 Test Setup	24
6.7.2 Test Procedure.....	24
7 Test Results of Test Item	25



7.1	RF Output Power	25
7.2	Power Spectral Density	26
7.3	6 dB Bandwidth	27
7.4	Conducted Out of Band Emissions	28
7.5	AC Power Conducted Emissions	30
7.6	Unwanted Emissions below 1 GHz	34
7.7	Unwanted Emissions above 1 GHz	38
8	Pictures of Test Arrangements	46
9	Information of the Testing Laboratories	47



Release Control Record

Issue No.	Description	Date Issued
RFBHJR-WTW-P22080862	Original release.	2023/6/8

1 Certificate

Product: Trailer Camera

Brand: Panasonic

Test Model: PT-230-COMN-CU

Sample Status: Engineering sample

Applicant: Panasonic Corporation of North America

Test Date: 2023/4/20 ~ 2023/4/27

Standard: 47 CFR FCC Part 15, Subpart C (Section 15.247)

Measurement ANSI C63.10-2013

procedure: KDB 558074 D01 15.247 Meas Guidance v05r02

The above equipment has been tested by **Bureau Veritas Consumer Products Services (H.K.) Ltd., Taoyuan Branch**, and found compliance with the requirement of the above standards. The test record, data evaluation & Equipment Under Test (EUT) configurations represented herein are true and accurate accounts of the measurements of the sample's RF characteristics under the conditions specified in this report.

2 Summary of Test Results

47 CFR FCC Part 15, Subpart C (Section 15.247)			
Standard / Clause	Test Item	Result	Remark
15.247(b)	RF Output Power	Pass	Meet the requirement of limit.
15.247(e)	Power Spectral Density	Pass	Meet the requirement of limit.
15.247(a)(2)	6 dB Bandwidth	Pass	Meet the requirement of limit.
15.247(d)	Conducted Out of Band Emissions	Pass	Meet the requirement of limit.
15.207	AC Power Conducted Emissions	Pass	Minimum passing margin is -8.65 dB at 0.15225 MHz
15.205 / 15.209 / 15.247(d)	Unwanted Emissions below 1 GHz	Pass	Minimum passing margin is -7.1 dB at 60.94 MHz
15.205 / 15.209 / 15.247(d)	Unwanted Emissions above 1 GHz	Pass	Minimum passing margin is -0.4 dB at 2390.00 MHz
15.203	Antenna Requirement	Pass	Antenna connector is RP-SMA not a standard connector.

Note: Determining compliance based on the results of the compliance measurement, not taking into account measurement instrumentation uncertainty.

2.1 Measurement Uncertainty

Where relevant, the following measurement uncertainty levels have been estimated for tests performed on the EUT as specified in CISPR 16-4-2:

Measurement	Specification	Expanded Uncertainty (k=2) (±)
Conducted Out of Band Emissions	9 kHz ~ 40 GHz	2.63 dB
AC Power Conducted Emissions	150 kHz ~ 30 MHz	3.00 dB
Unwanted Emissions below 1 GHz	9 kHz ~ 30 MHz	2.38 dB
	30 MHz ~ 1 GHz	5.7 dB
Unwanted Emissions above 1 GHz	1 GHz ~ 6 GHz	4.83 dB
	6 GHz ~ 18 GHz	5.37 dB
	18 GHz ~ 40 GHz	5.24 dB

The other instruments specified are routine verified to remain within the calibrated levels, no measurement uncertainty is required to be calculated.

2.2 Supplementary Information

There is not any deviation from the test standards for the test method, and no modifications required for compliance.

3 General Information

3.1 General Description

Product	Trailer Camera
Brand	Panasonic
Test Model	PT-230-COMN-CU
Status of EUT	Engineering sample
Power Supply Rating	3.2Vdc from, internal Battery or 12Vdc from Car Battery or 5Vdc from Type C interface for charging mode
Modulation Type	CCK, DQPSK, DBPSK for DSSS 64QAM, 16QAM, QPSK, BPSK for OFDM
Modulation Technology	DSSS, OFDM
Transfer Rate	Up to 54 Mbps
Operating Frequency	2.412 GHz ~ 2.462 GHz
Number of Channel	802.11b, 802.11g:11
Output Power	760.326 mW (28.81 dBm)

Note:

1. The EUT uses following accessories.

Item	Specification
Type C to USB cable	Shielded 1.0m

2. There are Bluetooth and WLAN (2.4 GHz) technology used for the EUT.
3. Bluetooth and WLAN (2.4 GHz) technology cannot transmission at the same time.
4. The above EUT information is declared by manufacturer and for more detailed features description, please refer to the manufacturer's specifications or user's manual.

3.2 Antenna Description of EUT

1. The antenna information is listed as below.

Antenna No.	Gain (dBi)	Antenna Type	Connector Type
1	5.9	Dipole	RP-SMA
2	5.7	Dipole	RP-SMA

* Detail antenna specification please refer to antenna datasheet and/or antenna measurement report.

2. The EUT incorporates a SISO function:

Modulation Mode	TX & RX Configuration	
802.11b	1TX Diversity	1RX
802.11g	1TX Diversity	1RX

3.3 Channel List

11 channels are provided for 802.11b, 802.11g:

Channel	Frequency	Channel	Frequency
1	2412 MHz	7	2442 MHz
2	2417 MHz	8	2447 MHz
3	2422 MHz	9	2452 MHz
4	2427 MHz	10	2457 MHz
5	2432 MHz	11	2462 MHz
6	2437 MHz		

3.4 Test Mode Applicability and Tested Channel Detail

Pre-Scan:	<p>1. EUT can be used in the following ways: XYZ 3-axis. Pre-scan in these ways and find the worst case as a representative test condition.</p> <p>2. For 802.11b / 802.11g module's setting is Diversity. Pre-scan Chain0/ Chain1 and find the worst case as a representative test condition.</p> <p>3. For Unwanted Emission above 1 GHz has EUT only/ EUT+12V Battery mode of power supply. Pre-scan and find the worst case as a representative test condition.</p> <p>4. For Unwanted Emission below 1 GHz has Charging with NB/ Charging with Adapter mode of power supply. Pre-scan and find the worst charging case as a representative test condition.</p>
Worst Case:	<p>1. X/ Y/ Z Worst Condition: Z Axis for Unwanted Emission above 1GHz and Unwanted Emission below 1GHz.</p> <p>2. Chain0/ Chain1 Worst Condition: Chain0.</p> <p>3. For Unwanted Emission above 1 GHz Worst Condition: EUT+12V Battery.</p> <p>4. For Unwanted Emission below 1 GHz Worst Charging Condition: Charging with NB.</p>

Following channel(s) was (were) selected for the final test as listed below:

Test Item	EUT Configure Mode	Mode	Signal Mode	Tested Channel	Modulation	Data Rate Parameter
RF Output Power / Power Spectral Density	A	802.11b	CDD	1, 6, 11	DBPSK	1Mb/s
		802.11g	CDD	1, 6, 11	BPSK	6Mb/s
6 dB Bandwidth / Conducted Out of Band Emissions	A	802.11b	CDD	1, 6, 11	DBPSK	1Mb/s
		802.11g	CDD	1, 6, 11	BPSK	6Mb/s
AC Power Conducted Emissions	B	-	-	-	-	-
	C	-	-	-	-	-
Unwanted Emissions below 1 GHz	A	802.11g	CDD	6	BPSK	6Mb/s
	B	-	-	-	-	-
Unwanted Emissions above 1 GHz	A	802.11b	CDD	1, 6, 11	DBPSK	1Mb/s
		802.11g	CDD	1, 6, 11	BPSK	6Mb/s
EUT Configure Mode:	A	EUT+12V Battery				
	B	Charging with NB				
	C	Charging with Adapter				

3.5 Duty Cycle of Test Signal

Mode A

802.11b: Duty cycle = 0.959 ms / 0.969 ms x 100% = 99.0%

802.11g: Duty cycle = 0.181 ms / 0.197 ms x 100% = 91.9%, duty factor = 10 * log (1/Duty cycle) = 0.37 dB

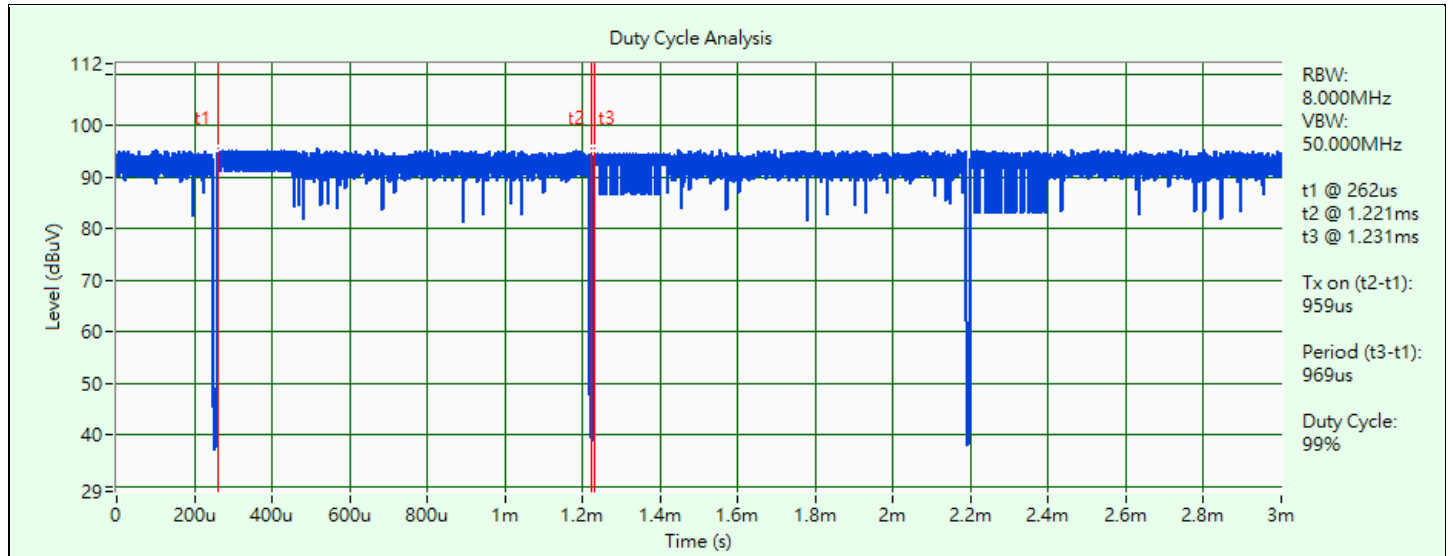

802.11b

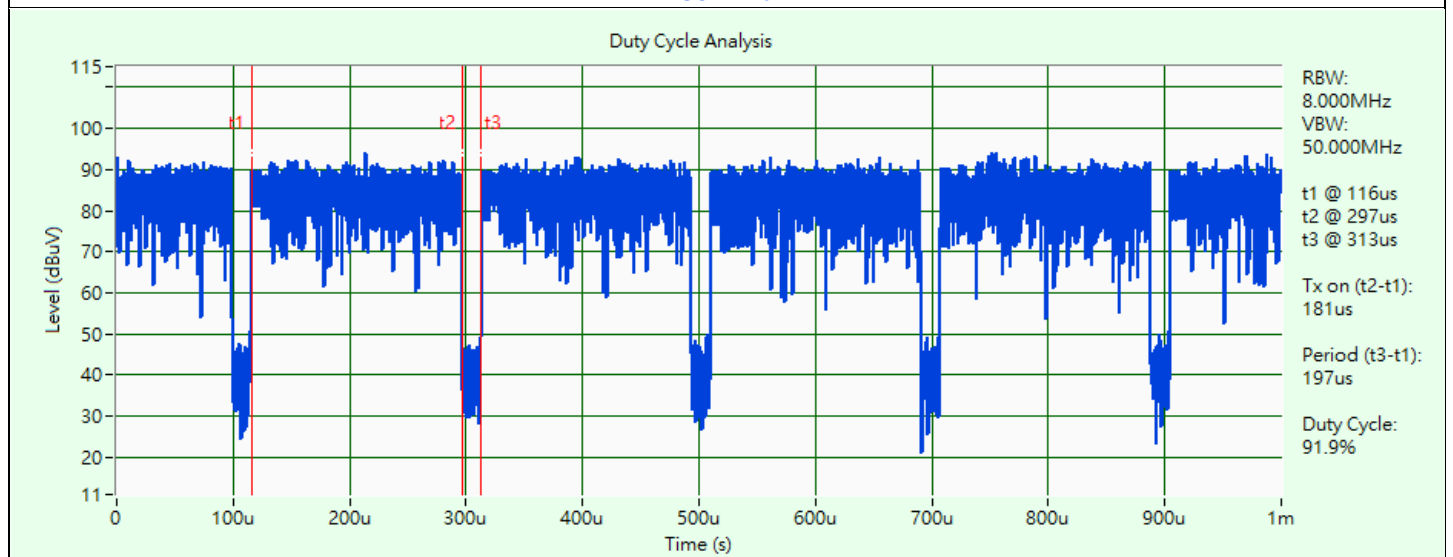

802.11g

3.6 Test Program Used and Operation Descriptions

Controlling software (Labtool 2.0.0.88) has been activated to set the EUT under transmission condition continuously at specific channel frequency.

3.7 Connection Diagram of EUT and Peripheral Devices

Mode A

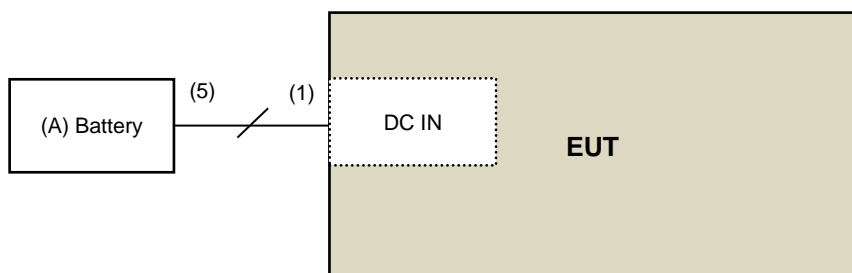

Mode B

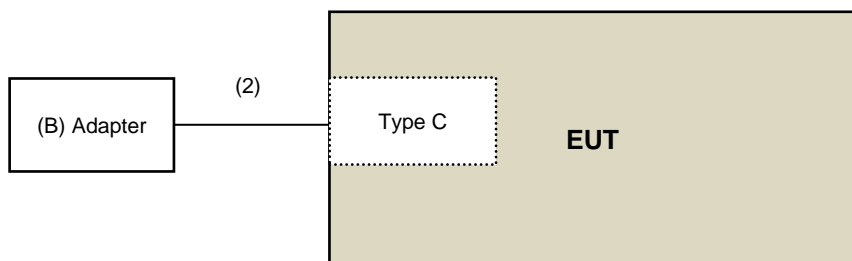

Mode C

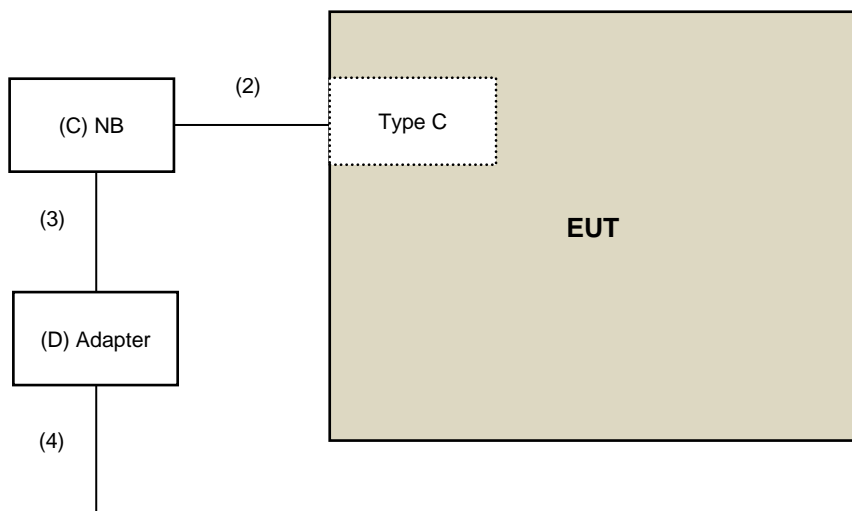

3.8 Configuration of Peripheral Devices and Cable Connections

ID	Product	Brand	Model No.	Serial No.	FCC ID	Remarks
A	Battery	GS	GG03FH1	N/A	N/A	Provided by Lab
B	Adapter	AMAZON	B0773JCTR5	N/A	N/A	Supplied by applicant
C	NB	DELL	P135G	N/A	N/A	Supplied by applicant
D	Adapter	DELL	HA65NM190	N/A	N/A	Supplied by applicant

ID	Cable Descriptions	Qty.	Length (m)	Shielding (Yes/No)	Cores (Qty.)	Remarks
1	DC cable	1	1.7	N	0	Supplied by applicant
2	Type C to USB cable	1	1	Y	0	Supplied by applicant
3	DC cable	1	1.8	Y	0	Supplied by applicant
4	AC cable	1	0.9	N	0	Supplied by applicant
5	DC cable	1	1	N	0	Provided by Lab

4 Test Instruments

The calibration interval of the all test instruments are 12 months and the calibrations are traceable to NML/ROC and NIST/USA.

4.1 RF Output Power

Description Manufacturer	Model No.	Serial No.	Calibrated Date	Calibrated Until
MIMO Power measurement Test set (4X4) KEYSIGHT	U2021XA	U2021XA_001	2022/6/13	2023/6/12
MXG Vector Signal Generator KEYSIGHT	N5182B	MY53052658	2022/5/9	2023/5/8
Power Meter Anritsu	ML2495A	1529002	2022/6/22	2023/6/21
Pulse Power Sensor Anritsu	MA2411B	1339443	2022/5/29	2023/5/28
Spectrum Analyzer KEYSIGHT	N9030A	MY54490260	2022/7/14	2023/7/13
Spectrum Analyzer R&S	FSV40	101042	2022/9/5	2023/9/4
		101544	2022/5/9	2023/5/8
Temperature & Humidity Chamber TERCHY	MHU-225AU	920409	2022/6/27	2023/6/26
Voltage Meter FLUKE	179	89610322	2022/10/3	2023/10/2

Notes:

1. The test was performed in LK - Oven
2. Tested Date: 2023/4/27

4.2 Power Spectral Density

Refer to section 4.1 to get information of the instruments.

4.3 6 dB Bandwidth

Refer to section 4.1 to get information of the instruments.

4.4 Conducted Out of Band Emissions

Refer to section 4.1 to get information of the instruments.

4.5 AC Power Conducted Emissions

Description Manufacturer	Model No.	Serial No.	Calibrated Date	Calibrated Until
50 ohm terminal LYNICS	0900510	E1-011285	2022/9/19	2023/9/18
		E1-011286	2022/9/19	2023/9/18
50 Ohms Terminator LYNICS	0900510	E1-01-305	2023/2/13	2024/2/12
Attenuator STI	STI02-2200-10	NO.4	2022/9/2	2023/9/1
DC LISN R&S	ESH3-Z6	100219	2022/8/2	2023/8/1
		844950/018	2022/8/2	2023/8/1
DC LISN Schwarzbeck	NNLK 8121	8121-808	2022/4/29	2023/4/28
High Voltage Probe Schwarzbeck	TK9420	00982	2022/12/14	2023/12/13
Isolation Transformer Erika Fiedler	D-65396	017	2022/9/8	2023/9/7
LISN R&S	ENV216	101196	2022/5/24	2023/5/23
LISN Schwarzbeck	NNLK 8121	8121-731	2022/5/26	2023/5/25
		8121-00759	2022/8/18	2023/8/17
	NNLK8129	8129229	2022/6/8	2023/6/7
	NSLK 8128	8128-244	2022/11/8	2023/11/7
RF Coaxial Cable Commate	5D-FB	Cable-CO5-01	2023/1/19	2024/1/18
Software BVADT	Cond_V7.3.7.4	N/A	N/A	N/A
Test Receiver R&S	ESR3	102412	2022/12/21	2023/12/20

Notes:

1. The test was performed in Linkou Conduction 5.
2. Tested Date: 2023/4/25

4.6 Unwanted Emissions below 1 GHz

Description Manufacturer	Model No.	Serial No.	Calibrated Date	Calibrated Until
* LOOP ANTENNA EMCI	LPA600	270	2021/9/2	2023/9/1
Bi_Log Antenna Schwarzbeck	VULB 9168	137	2022/10/21	2023/10/20
Coupling/Dcoupling Network Schwarzbeck	CDNE-M2	00097	2022/6/1	2023/5/31
	CDNE-M3	00091	2022/6/1	2023/5/31
Pre_Amplifier EMCI	EMC001340	980269	2022/6/28	2023/6/27
Pre_Amplifier HP	8447D	2432A03504	2023/2/16	2024/2/15
RF Coaxial Cable Pacific	8D-FB	Cable-CH6-02	2022/6/30	2023/6/29
Software BVADT	Radiated_V7.7.1.1.1	N/A	N/A	N/A
	Radiated_V8.7.08	N/A	N/A	N/A
Spectrum Analyzer R&S	FSV40	101544	2022/5/9	2023/5/8
Test Receiver Agilent	N9038A	MY51210129	2023/3/24	2024/3/23
		MY51210137	2022/6/9	2023/6/8
Tower ADT	AT100	0306	N/A	N/A
Turn Table ADT	TT100	0306	N/A	N/A

Notes:

- * The calibration interval of the above test instruments is 24 months and the calibrations are traceable to NML/ROC and NIST/USA
- The test was performed in Linkou 966 Chamber 6 (CH 6).
- Tested Date: 2023/4/24 ~ 2023/4/25

4.7 Unwanted Emissions above 1 GHz

Description Manufacturer	Model No.	Serial No.	Calibrated Date	Calibrated Until
Band Pass Filter MICRO-TRONICS	BRM17690	005	2022/5/26	2023/5/25
Boresight antenna tower fixture BV	BAF-02	6	N/A	N/A
High Pass Filter Wainwright Instruments	WHK 3.1/18G-10SS	SN 8	2022/5/26	2023/5/25
Horn Antenna EMCO	3115	00028257	2022/11/13	2023/11/12
Horn Antenna ETS-Lindgren	3117-PA	00215857	2023/2/3	2024/2/2
Horn Antenna Schwarzbeck	BBHA 9170	212	2022/10/20	2023/10/19
Notch Filter MICRO-TRONICS	BRC50703-01	010	2022/5/26	2023/5/25
Pre-amplifier HP	8449B	3008A01201	2023/2/16	2024/2/15
Pre-amplifier (18GHz-40GHz) EMCI	EMC184045B	980175	2022/9/3	2023/9/2
Pre_Amplifier EMCI	EMC0126545	980076	2023/2/16	2024/2/15
	EMC184045B	980235	2023/2/16	2024/2/15
RF Coaxial Cable EM	EM102-KMKM-3.5+1M	EM102-KMKM-3.5+1M-01	2022/7/7	2023/7/6
RF Coaxial Cable EMCI	EMC104	190801	2022/9/20	2023/9/19
		190804	2022/9/20	2023/9/19
RF Coaxial Cable HUBER SUHNER	SF-104	Cable-CH6-01	2022/9/20	2023/9/19
Software BVADT	Radiated_V7.7.1.1.1	N/A	N/A	N/A
	Radiated_V8.7.08	N/A	N/A	N/A
Spectrum Analyzer R&S	FSV40	101042	2022/9/5	2023/9/4
		101544	2022/5/9	2023/5/8
Test Receiver Agilent	N9038A	MY51210129	2023/3/24	2024/3/23
Tower ADT	AT100	0306	N/A	N/A
Turn Table ADT	TT100	0306	N/A	N/A

Notes:

1. The test was performed in Linkou 966 Chamber 6 (CH 6).
2. Tested Date: 2023/4/20 ~ 2023/4/21

5 Limits of Test Items

5.1 RF Output Power

For systems using digital modulation in the 2400–2483.5 MHz bands: 1 Watt (30 dBm)

5.2 Power Spectral Density

The Maximum of Power Spectral Density Measurement is 8 dBm in any 3 kHz.

5.3 6 dB Bandwidth

The minimum of 6 dB Bandwidth Measurement is 0.5 MHz.

5.4 Conducted Out of Band Emissions

Below 20 dB of the highest emission level of operating band (in 100 kHz Resolution Bandwidth).

5.5 AC Power Conducted Emissions

Frequency (MHz)	Conducted Limit (dBuV)	
	Quasi-peak	Average
0.15 - 0.5	66 - 56	56 - 46
0.50 - 5.0	56	46
5.0 - 30.0	60	50

Notes:

1. The lower limit shall apply at the transition frequencies.
2. The limit decreases in line with the logarithm of the frequency in the range of 0.15 to 0.50 MHz.

5.6 Unwanted Emissions below 1 GHz

Radiated emissions up to 1 GHz which fall in the restricted bands must comply with the radiated emission limits specified as below table. Other emissions shall be at least 20 dB below the highest level of the desired power:

Frequencies (MHz)	Field Strength (microvolts/meter)	Measurement Distance (meters)
0.009 ~ 0.490	2400/F(kHz)	300
0.490 ~ 1.705	24000/F(kHz)	30
1.705 ~ 30.0	30	30
30 ~ 88	100	3
88 ~ 216	150	3
216 ~ 960	200	3
Above 960	500	3

Notes:

1. The lower limit shall apply at the transition frequencies.
2. Emission level (dBuV/m) = 20 log Emission level (uV/m).

5.7 Unwanted Emissions above 1 GHz

Radiated emissions above 1 GHz which fall in the restricted bands must comply with the radiated emission limits specified as below table. Other emissions shall be at least 20 dB below the highest level of the desired power:

Frequencies (MHz)	Field Strength (microvolts/meter)	Measurement Distance (meters)
Above 960	500	3

Notes:

1. The lower limit shall apply at the transition frequencies.
2. Emission level (dBuV/m) = 20 log Emission level (uV/m).
3. For frequencies above 1000 MHz, the field strength limits are based on average detector, however, the peak field strength of any emission shall not exceed the maximum permitted average limits, specified above by more than 20 dB under any condition of modulation.

6 Test Arrangements

6.1 RF Output Power

6.1.1 Test Setup

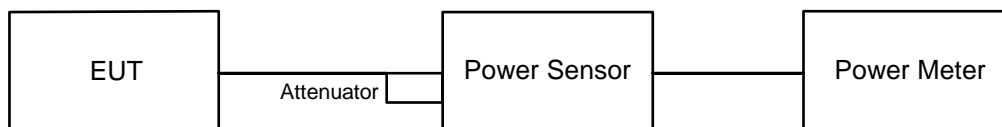

6.1.2 Test Procedure

Peak Power:

A peak power sensor was used on the output port of the EUT. A power meter was used to read the response of the peak power sensor. Record the power level.

Average Power:

Average power sensor was used to perform output power measurement, trigger and gating function of wide band power meter is enabled to measure max output power of TX on burst. Duty factor is not added to measured value.

6.2 Power Spectral Density

6.2.1 Test Setup

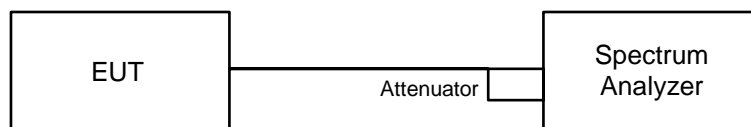

6.2.2 Test Procedure

- a. Set analyzer center frequency to DTS channel center frequency.
- b. Set the span to 1.5 times the DTS bandwidth.
- c. Set the RBW to: 3 kHz.
- d. Set the VBW $\geq 3 \times$ RBW.
- e. Detector = peak.
- f. Sweep time = auto couple.
- g. Trace mode = max hold.
- h. Allow trace to fully stabilize.
- i. Use the peak marker function to determine the maximum amplitude level within the RBW.

6.3 6 dB Bandwidth

6.3.1 Test Setup



6.3.2 Test Procedure

- Set resolution bandwidth (RBW) = 100 kHz.
- Set the video bandwidth (VBW) $\geq 3 \times$ RBW, Detector = Peak.
- Trace mode = max hold.
- Sweep = auto couple.
- Measure the maximum width of the emission that is constrained by the frequencies associated with the two amplitude points (upper and lower) that are attenuated by 6 dB relative to the maximum level measured in the fundamental emission.

6.4 Conducted Out of Band Emissions

6.4.1 Test Setup

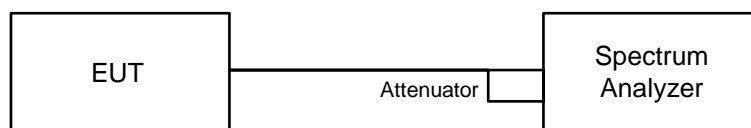

6.4.2 Test Procedure

MEASUREMENT PROCEDURE REF

- Set the RBW = 100 kHz.
- Set the VBW ≥ 300 kHz.
- Detector = peak.
- Sweep time = auto couple.
- Trace mode = max hold.
- Allow trace to fully stabilize.
- Use the peak marker function to determine the maximum power level in any 100 kHz band segment within the fundamental EBW.

MEASUREMENT PROCEDURE OOB

- Set RBW = 100 kHz.
- Set VBW ≥ 300 kHz.
- Detector = peak.
- Sweep = auto couple.
- Trace Mode = max hold.
- Allow trace to fully stabilize.
- Use the peak marker function to determine the maximum amplitude level.

6.5 AC Power Conducted Emissions

6.5.1 Test Setup

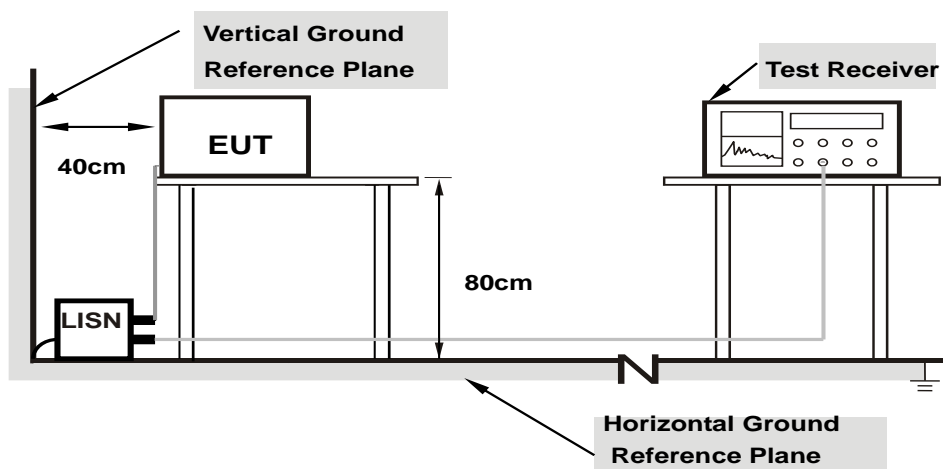

Note: 1.Support units were connected to second LISN.

For the actual test configuration, please refer to the attached file (Test Setup Photo).

6.5.2 Test Procedure

- The EUT was placed on a 0.8 meter to the top of table and placed 0.4 meters from the conducting wall of the shielded room with EUT being connected to the power mains through a line impedance stabilization network (LISN). Other support units were connected to the power mains through another LISN. The two LISNs provide 50 ohm/ 50 uH of coupling impedance for the measuring instrument.
- Both lines of the power mains connected to the EUT were checked for maximum conducted interference.
- The frequency range from 150 kHz to 30 MHz was searched. Emission levels under (Limit – 20 dB) was not recorded.

Note: The resolution bandwidth and video bandwidth of test receiver is 9 kHz for quasi-peak detection (QP) and average detection (AV) at frequency 0.15 MHz-30 MHz.

6.6 Unwanted Emissions below 1 GHz

6.6.1 Test Setup

For Radiated emission below 30 MHz

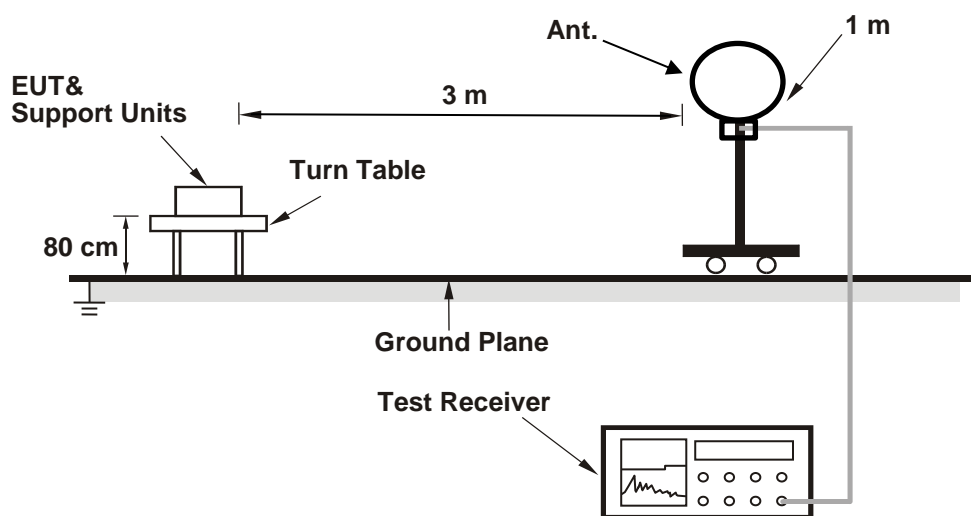

For Radiated emission above 30 MHz

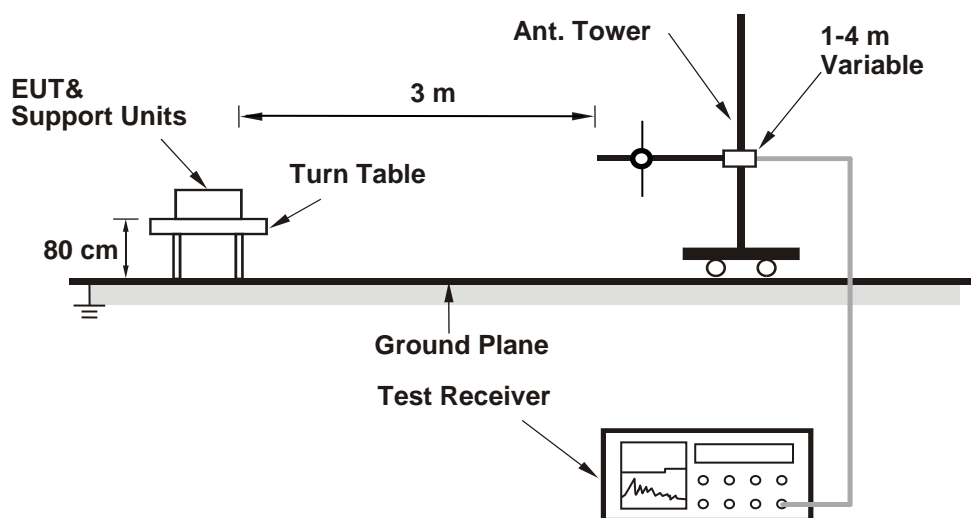

For the actual test configuration, please refer to the attached file (Test Setup Photo).

6.6.2 Test Procedure

For Radiated emission below 30 MHz

- a. The EUT was placed on the top of a rotating table 0.8 meters above the ground at 3 meter chamber room for test. The table was rotated 360 degrees to determine the position of the highest radiation.
- b. The EUT was set 3 meters away from the interference-receiving antenna, which was mounted on the top of a variable-height antenna tower.
- c. Parallel, perpendicular, and ground-parallel orientations of the antenna are set to make the measurement.
- d. For each suspected emission, the EUT was arranged to its worst case and the rotatable table was turned from 0 degrees to 360 degrees to find the maximum reading.
- e. The test-receiver system was set to Quasi-Peak Detect Function and Specified Bandwidth with Maximum Hold Mode, except for the frequency band (9 kHz to 90 kHz and 110 kHz to 490 kHz) set to average detect function and peak detect function.

Notes:

1. The resolution bandwidth and video bandwidth of test receiver/spectrum analyzer is 200 Hz at frequency below 150 kHz.
2. The resolution bandwidth and video bandwidth of test receiver/spectrum analyzer is 9 kHz or 10 kHz at frequency (150 kHz to 30 MHz).
3. All modes of operation were investigated and the worst-case emissions are reported.

For Radiated emission above 30 MHz

- a. The EUT was placed on the top of a rotating table 0.8 meters above the ground at 3 meter chamber room for test. The table was rotated 360 degrees to determine the position of the highest radiation.
- b. The EUT was set 3 meters away from the interference-receiving antenna, which was mounted on the top of a variable-height antenna tower.
- c. The height of antenna is varied from one meter to four meters above the ground to determine the maximum value of the field strength. Both horizontal and vertical polarizations of the antenna are set to make the measurement.
- d. For each suspected emission, the EUT was arranged to its worst case and then the antenna was tuned to heights from 1 meter to 4 meters and the rotatable table was turned from 0 degrees to 360 degrees to find the maximum reading.
- e. The test-receiver system was set to quasi-peak detect function and specified bandwidth with maximum hold mode when the test frequency is below 1 GHz.

Notes:

1. The resolution bandwidth and video bandwidth of test receiver/spectrum analyzer is 120 kHz for Quasi-peak detection (QP) at frequency below 1 GHz.
2. All modes of operation were investigated and the worst-case emissions are reported.

6.7 Unwanted Emissions above 1 GHz

6.7.1 Test Setup

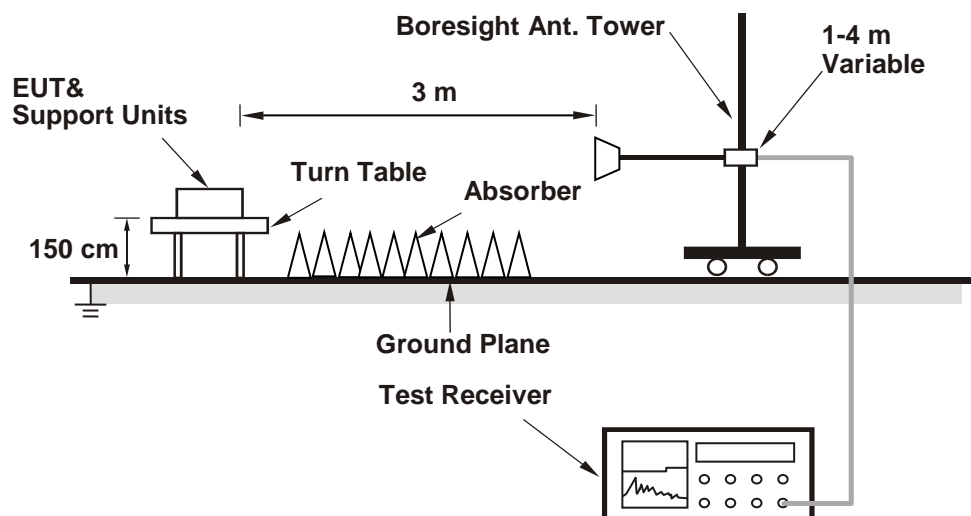

For the actual test configuration, please refer to the attached file (Test Setup Photo).

6.7.2 Test Procedure

- The EUT was placed on the top of a rotating table 1.5 meters above the ground at 3 meter chamber room for test. The table was rotated 360 degrees to determine the position of the highest radiation.
- The EUT was set 3 meters away from the interference-receiving antenna, which was mounted on the top of a variable-height antenna tower.
- The height of antenna is varied from one meter to four meters above the ground to determine the maximum value of the field strength. Both horizontal and vertical polarizations of the antenna are set to make the measurement.
- For each suspected emission, the EUT was arranged to its worst case and then the antenna was tuned to heights from 1 meter to 4 meters and the rotatable table was turned from 0 degrees to 360 degrees to find the maximum reading.
- The test-receiver system was set to peak and average detects function and specified bandwidth with maximum hold mode when the test frequency is above 1 GHz. If the peak reading value also meets average limit, measurement with the average detector is unnecessary.

Notes:

- The resolution bandwidth of test receiver/spectrum analyzer is 1 MHz and the video bandwidth is 3 MHz for Peak detection (PK) and Average detection (AV) at frequency above 1 GHz.
- For fundamental and harmonic signal measurement, the resolution bandwidth of test receiver/spectrum analyzer is 1 MHz and the video bandwidth is $\geq 1/T$ (Duty cycle $< 98\%$) or 10 Hz (Duty cycle $\geq 98\%$) for Average detection (AV) at frequency above 1 GHz.
- All modes of operation were investigated and the worst-case emissions are reported.

7 Test Results of Test Item

7.1 RF Output Power

Input Power:	12 Vdc	Environmental Conditions:	25°C, 76% RH	Tested By:	Waydi Tuan
--------------	--------	---------------------------	--------------	------------	------------

Mode A

For Peak Power

802.11b

Chan.	Chan. Freq. (MHz)	Peak Power (mW)	Peak Power (dBm)	Power Limit (dBm)	Test Result
1	2412	603.949	27.81	30	Pass
6	2437	549.541	27.40	30	Pass
11	2462	304.089	24.83	30	Pass

Note: The antenna gain is 5.9 dBi < 6 dBi, so the output power limit shall not be reduced.

802.11g

Chan.	Chan. Freq. (MHz)	Peak Power (mW)	Peak Power (dBm)	Power Limit (dBm)	Test Result
1	2412	203.704	23.09	30	Pass
6	2437	760.326	28.81	30	Pass
11	2462	204.644	23.11	30	Pass

Note: The antenna gain is 5.9 dBi < 6 dBi, so the output power limit shall not be reduced.

For Average Power

802.11b

Chan.	Chan. Freq. (MHz)	Average Power (mW)	Average Power (dBm)
1	2412	331.131	25.20
6	2437	300.608	24.78
11	2462	167.88	22.25

802.11g

Chan.	Chan. Freq. (MHz)	Average Power (mW)	Average Power (dBm)
1	2412	19.588	12.92
6	2437	85.114	19.30
11	2462	24.66	13.92

7.2 Power Spectral Density

Input Power:	12 Vdc	Environmental Conditions:	25°C, 76% RH	Tested By:	Waydi Tuan
--------------	--------	---------------------------	--------------	------------	------------

Mode A

802.11b

TX chain	Channel	Freq. (MHz)	PSD (dBm/3kHz)	PSD Limit (dBm/3kHz)	Pass / Fail
Chain 0	1	2412	5.25	8	Pass
	6	2437	4.72	8	Pass
	11	2462	2.23	8	Pass

Note: The antenna gain is 5.9 dBi < 6 dBi, so the power density limit shall not be reduced.

802.11g

TX chain	Channel	Freq. (MHz)	PSD (dBm/3kHz)	PSD Limit (dBm/3kHz)	Pass / Fail
Chain 0	1	2412	-15.05	8	Pass
	6	2437	-7.93	8	Pass
	11	2462	-12.44	8	Pass

Note: The antenna gain is 5.9 dBi < 6 dBi, so the power density limit shall not be reduced.

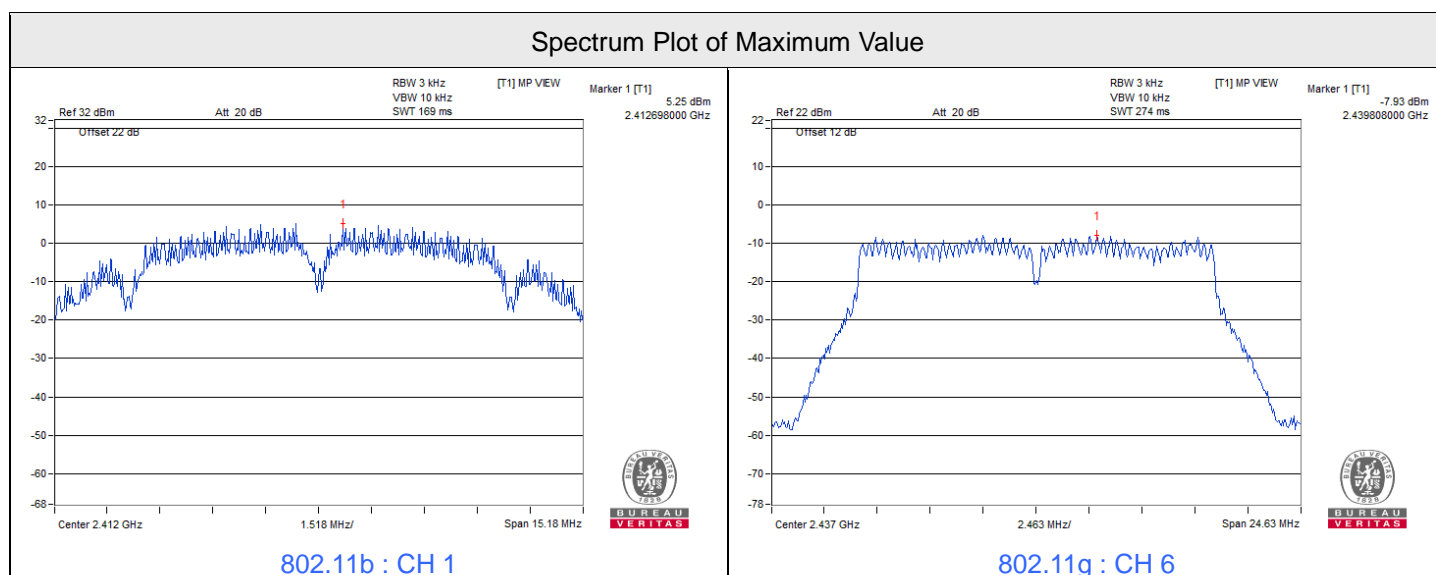

7.3 6 dB Bandwidth

Input Power:	12 Vdc	Environmental Conditions:	25°C, 76% RH	Tested By:	Waydi Tuan
--------------	--------	---------------------------	--------------	------------	------------

Mode A

802.11b

Channel	Frequency (MHz)	6dB Bandwidth (MHz)	Minimum Limit (MHz)	Test Result
1	2412	10.12	0.5	Pass
6	2437	10.1	0.5	Pass
11	2462	10.12	0.5	Pass

802.11g

Channel	Frequency (MHz)	6dB Bandwidth (MHz)	Minimum Limit (MHz)	Test Result
1	2412	16.42	0.5	Pass
6	2437	16.42	0.5	Pass
11	2462	16.42	0.5	Pass

Spectrum Plot of Minimum Value

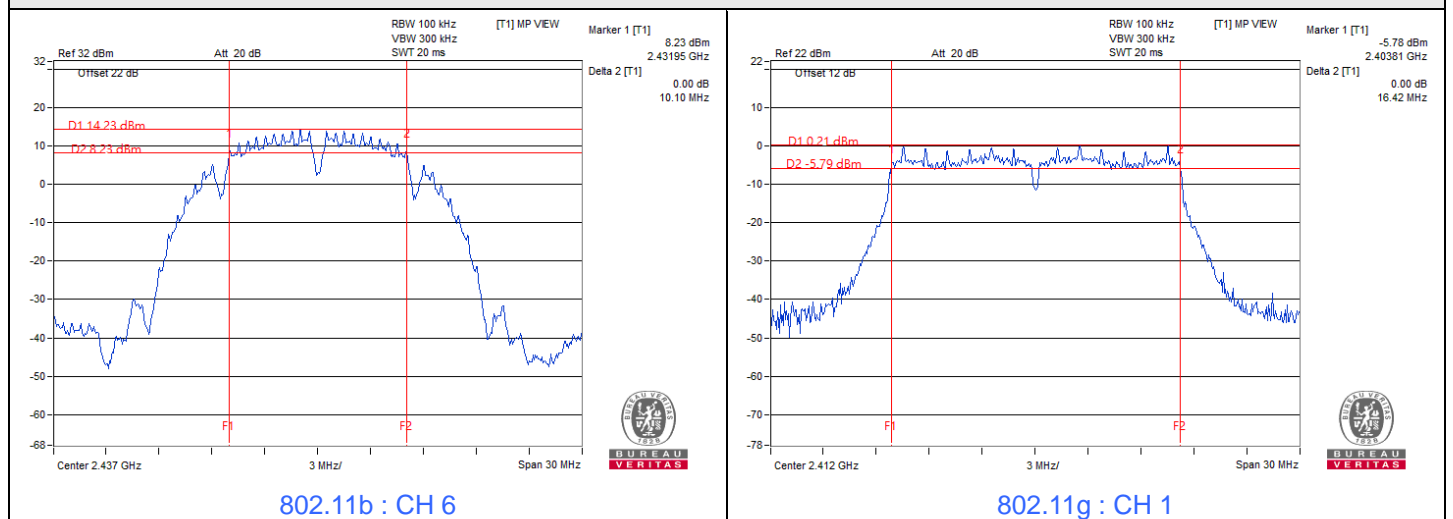



BUREAU VERITAS

7.4 Conducted Out of Band Emissions

Input Power:	12 Vdc	Environmental Conditions:	25°C, 76% RH	Tested By:	Waydi Tuan
--------------	--------	---------------------------	--------------	------------	------------

Mode A

802.11b

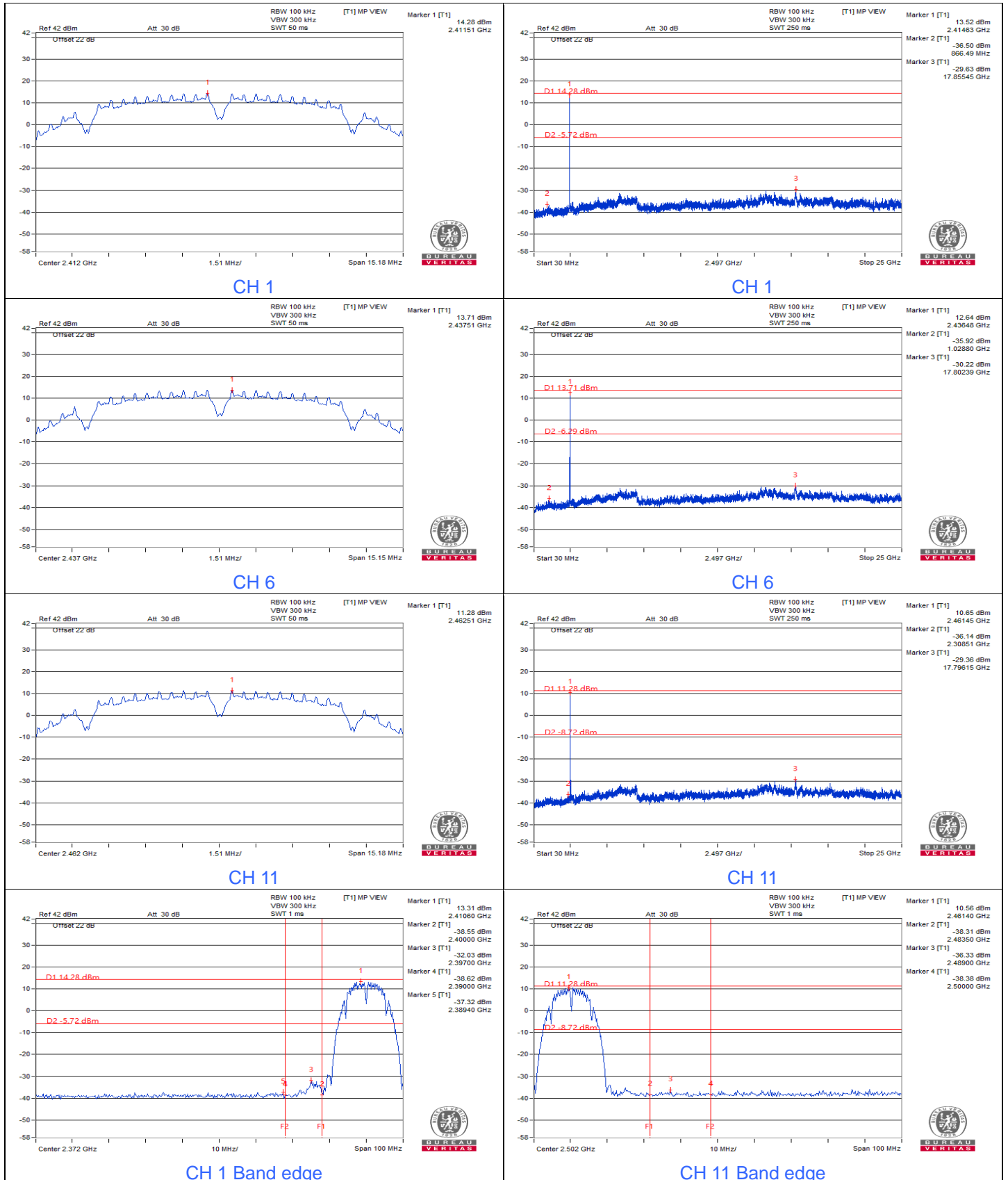

802.11g

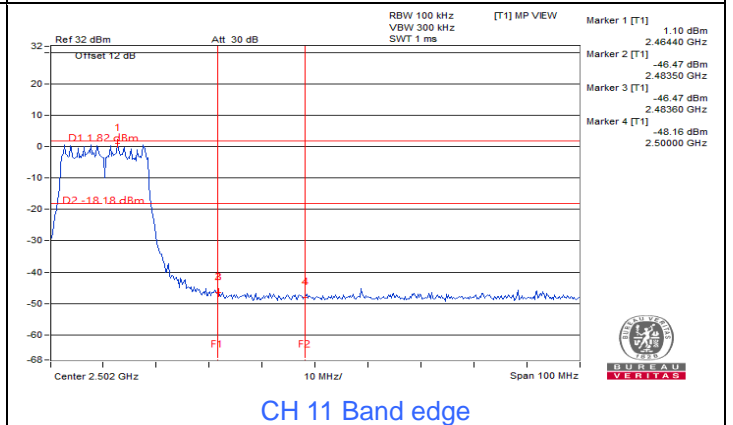
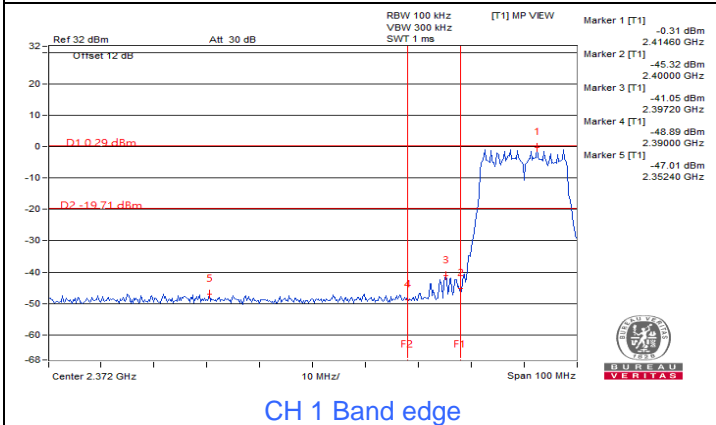
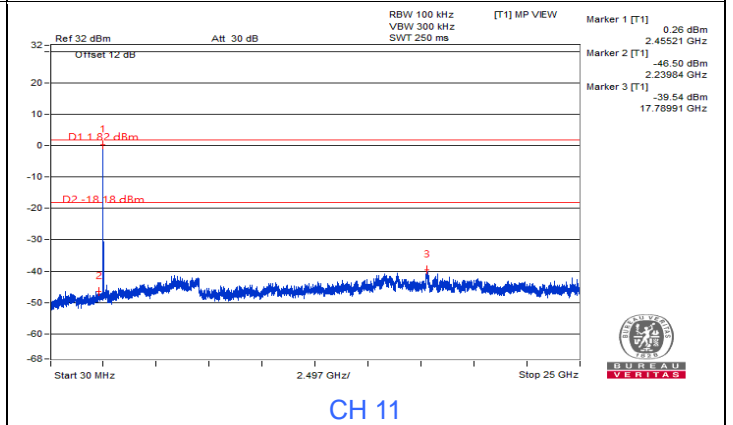
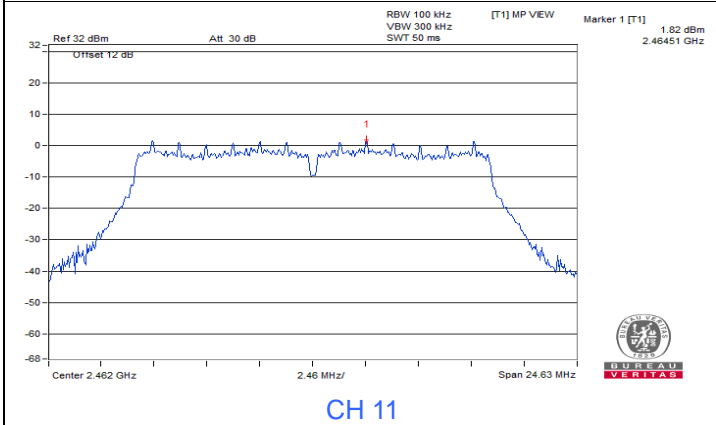
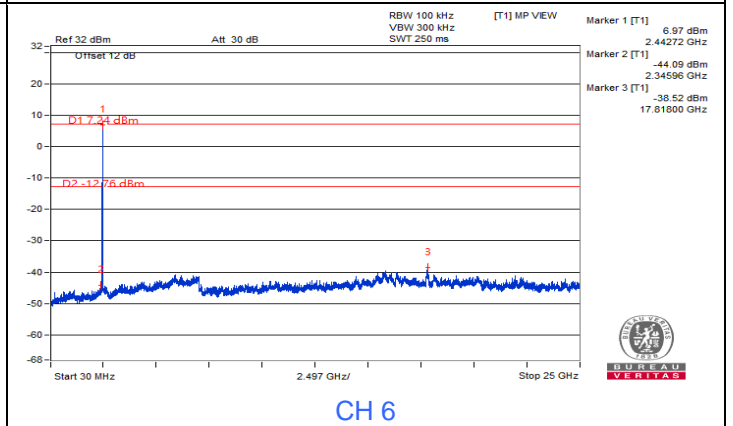
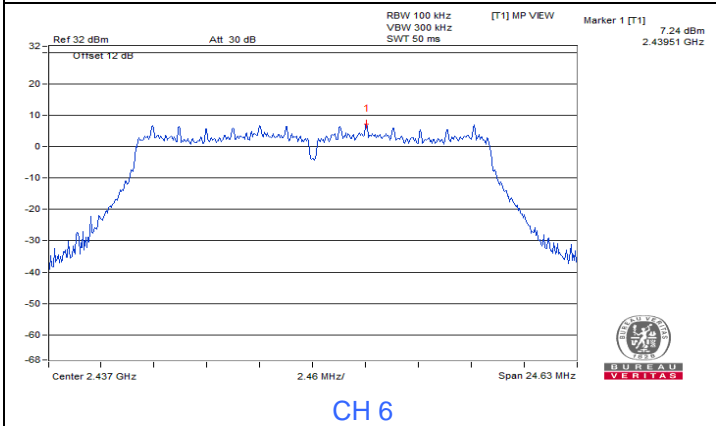
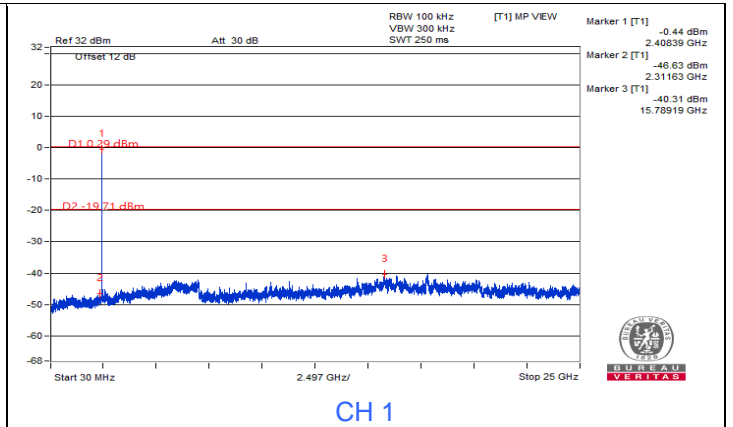
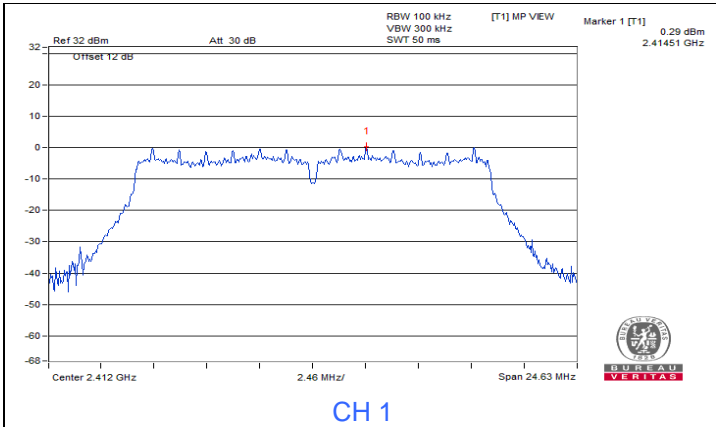

7.5 AC Power Conducted Emissions

Mode B

RF Mode	802.11g	Channel	CH 6 : 2437 MHz
Frequency Range	150kHz ~ 30MHz	Detector Function & Resolution Bandwidth	Quasi-Peak (QP) / Average (AV), 9 kHz
Input Power	120 Vac, 60 Hz	Environmental Conditions	25°C, 75% RH
Tested By	Jed Wu		

Phase Of Power : Line (L)										
No	Frequency (MHz)	Correction Factor (dB)	Reading Value (dBUV)		Emission Level (dBUV)		Limit (dBUV)		Margin (dB)	
			Q.P.	AV.	Q.P.	AV.	Q.P.	AV.	Q.P.	AV.
1	0.15225	10.04	47.19	27.02	57.23	37.06	65.88	55.88	-8.65	-18.82
2	0.29616	10.16	32.94	15.80	43.10	25.96	60.35	50.35	-17.25	-24.39
3	1.32225	10.37	20.81	14.56	31.18	24.93	56.00	46.00	-24.82	-21.07
4	3.88275	10.49	30.55	23.32	41.04	33.81	56.00	46.00	-14.96	-12.19
5	7.49850	10.59	24.93	19.65	35.52	30.24	60.00	50.00	-24.48	-19.76
6	13.18425	10.74	31.00	25.20	41.74	35.94	60.00	50.00	-18.26	-14.06

Remarks:

1. Q.P. and AV. are abbreviations of quasi-peak and average individually.
2. The emission levels of other frequencies were very low against the limit.
3. Margin value = Emission level – Limit value
4. Correction factor = Insertion loss + Cable loss
5. Emission Level = Correction Factor + Reading Value

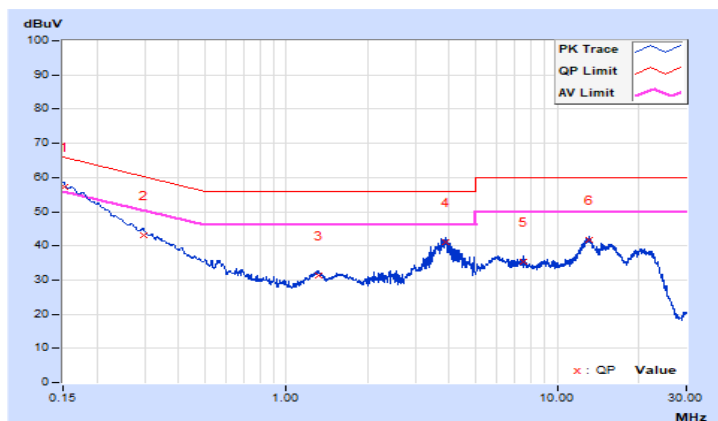

RF Mode	802.11g	Channel	CH 6 : 2437 MHz
Frequency Range	150kHz ~ 30MHz	Detector Function & Resolution Bandwidth	Quasi-Peak (QP) / Average (AV), 9 kHz
Input Power	120 Vac, 60 Hz	Environmental Conditions	25°C, 75% RH
Tested By	Jed Wu		

Phase Of Power : Neutral (N)										
No	Frequency (MHz)	Correction Factor (dB)	Reading Value (dBuV)		Emission Level (dBuV)		Limit (dBuV)		Margin (dB)	
			Q.P.	AV.	Q.P.	AV.	Q.P.	AV.	Q.P.	AV.
1	0.15000	10.06	46.72	30.89	56.78	40.95	66.00	56.00	-9.22	-15.05
2	0.44700	10.20	25.24	14.35	35.44	24.55	56.93	46.93	-21.49	-22.38
3	1.26825	10.27	20.81	15.11	31.08	25.38	56.00	46.00	-24.92	-20.62
4	3.78375	10.41	28.68	18.18	39.09	28.59	56.00	46.00	-16.91	-17.41
5	6.23850	10.52	25.23	19.56	35.75	30.08	60.00	50.00	-24.25	-19.92
6	12.91875	10.73	29.45	23.43	40.18	34.16	60.00	50.00	-19.82	-15.84

Remarks:

1. Q.P. and AV. are abbreviations of quasi-peak and average individually.
2. The emission levels of other frequencies were very low against the limit.
3. Margin value = Emission level – Limit value
4. Correction factor = Insertion loss + Cable loss
5. Emission Level = Correction Factor + Reading Value

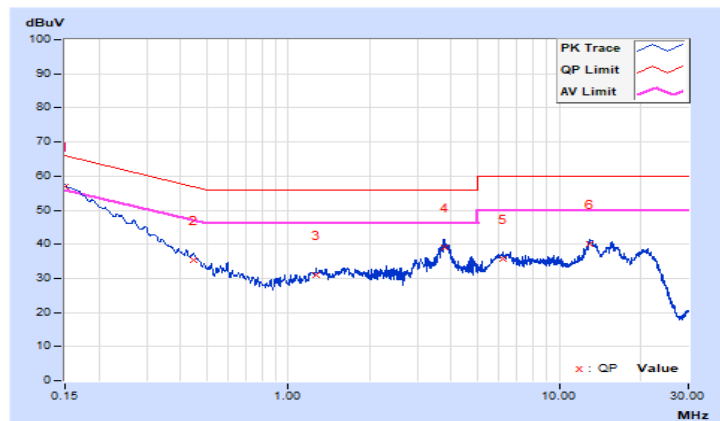

Mode C

Frequency Range	150kHz ~ 30MHz	Detector Function & Resolution Bandwidth	Quasi-Peak (QP) / Average (AV), 9 kHz
Input Power	120 Vac, 60 Hz	Environmental Conditions	25°C, 75% RH
Tested By	Jed Wu		

Phase Of Power : Line (L)										
No	Frequency (MHz)	Correction Factor (dB)	Reading Value (dBuV)		Emission Level (dBuV)		Limit (dBuV)		Margin (dB)	
			Q.P.	AV.	Q.P.	AV.	Q.P.	AV.	Q.P.	AV.
1	0.16125	10.05	27.02	13.78	37.07	23.83	65.40	55.40	-28.33	-31.57
2	0.39300	10.21	26.35	7.54	36.56	17.75	58.00	48.00	-21.44	-30.25
3	0.58839	10.26	33.42	12.30	43.68	22.56	56.00	46.00	-12.32	-23.44
4	4.39998	10.51	20.84	5.64	31.35	16.15	56.00	46.00	-24.65	-29.85
5	9.73725	10.65	24.85	4.85	35.50	15.50	60.00	50.00	-24.50	-34.50
6	15.02475	10.78	24.32	11.58	35.10	22.36	60.00	50.00	-24.90	-27.64

Remarks:

1. Q.P. and AV. are abbreviations of quasi-peak and average individually.
2. The emission levels of other frequencies were very low against the limit.
3. Margin value = Emission level – Limit value
4. Correction factor = Insertion loss + Cable loss
5. Emission Level = Correction Factor + Reading Value

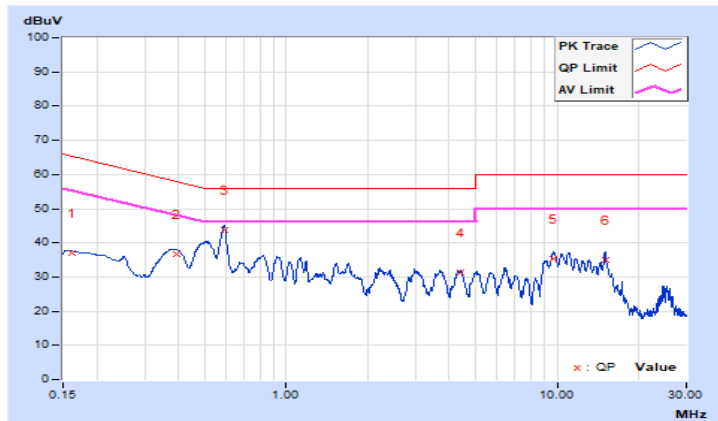

Frequency Range	150kHz ~ 30MHz	Detector Function & Resolution Bandwidth	Quasi-Peak (QP) / Average (AV), 9 kHz
Input Power	120 Vac, 60 Hz	Environmental Conditions	25°C, 75% RH
Tested By	Jed Wu		

Phase Of Power : Neutral (N)										
No	Frequency (MHz)	Correction Factor (dB)	Reading Value (dBuV)		Emission Level (dBuV)		Limit (dBuV)		Margin (dB)	
			Q.P.	AV.	Q.P.	AV.	Q.P.	AV.	Q.P.	AV.
1	0.16125	10.09	28.12	14.52	38.21	24.61	65.40	55.40	-27.19	-30.79
2	0.38362	10.19	24.75	10.16	34.94	20.35	58.20	48.20	-23.26	-27.85
3	0.59100	10.22	28.06	14.87	38.28	25.09	56.00	46.00	-17.72	-20.91
4	4.27402	10.44	17.32	7.37	27.76	17.81	56.00	46.00	-28.24	-28.19
5	10.24221	10.67	22.15	5.81	32.82	16.48	60.00	50.00	-27.18	-33.52
6	14.96850	10.78	25.37	12.16	36.15	22.94	60.00	50.00	-23.85	-27.06

Remarks:

1. Q.P. and AV. are abbreviations of quasi-peak and average individually.
2. The emission levels of other frequencies were very low against the limit.
3. Margin value = Emission level – Limit value
4. Correction factor = Insertion loss + Cable loss
5. Emission Level = Correction Factor + Reading Value

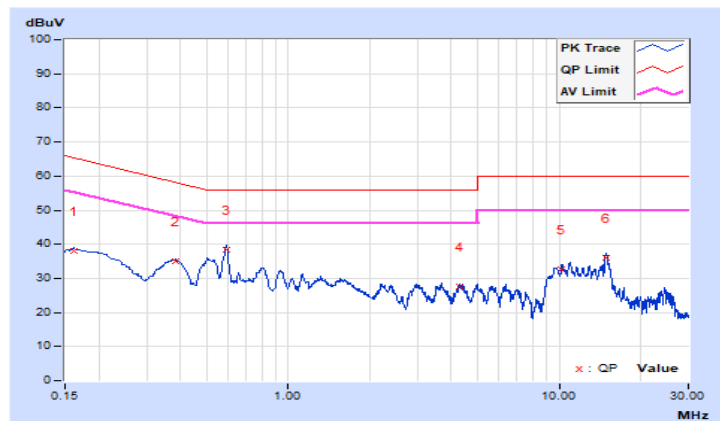

7.6 Unwanted Emissions below 1 GHz

Mode A

RF Mode	802.11g	Channel	CH 6 : 2437 MHz
Frequency Range	30 MHz ~ 1 GHz	Detector Function & Bandwidth	(QP) RB = 120kHz
Input Power	12 Vdc	Environmental Conditions	19°C, 62% RH
Tested By	Jed Wu		

Antenna Polarity & Test Distance : Horizontal at 3 m

No	Frequency (MHz)	Emission Level (dBuV/m)	Limit (dBuV/m)	Margin (dB)	Antenna Height (m)	Table Angle (Degree)	Raw Value (dBuV)	Correction Factor (dB/m)
1	48.40	19.8 QP	40.0	-20.2	1.47 H	113	28.4	-8.6
2	107.50	22.2 QP	43.5	-21.3	1.23 H	84	34.2	-12.0
3	240.00	31.7 QP	46.0	-14.3	1.75 H	228	40.5	-8.8
4	282.20	30.3 QP	46.0	-15.7	1.36 H	249	36.9	-6.6
5	330.10	27.5 QP	46.0	-18.5	1.82 H	223	32.6	-5.1
6	432.00	29.4 QP	46.0	-16.6	1.64 H	221	32.2	-2.8

Remarks:

1. Emission Level(dBuV/m) = Raw Value(dBuV) + Correction Factor(dB/m)
2. Correction Factor(dB/m) = Antenna Factor(dB/m) + Cable Factor(dB) – Pre-Amplifier Factor(dB)
3. Margin value = Emission Level – Limit value
4. The other emission levels were very low against the limit of frequency range 30 MHz ~ 1 GHz.
5. The emission levels were very low against the limit of frequency range 9 kHz ~ 30 MHz: the amplitude of spurious emissions attenuated more than 20 dB below the permissible value to be report.

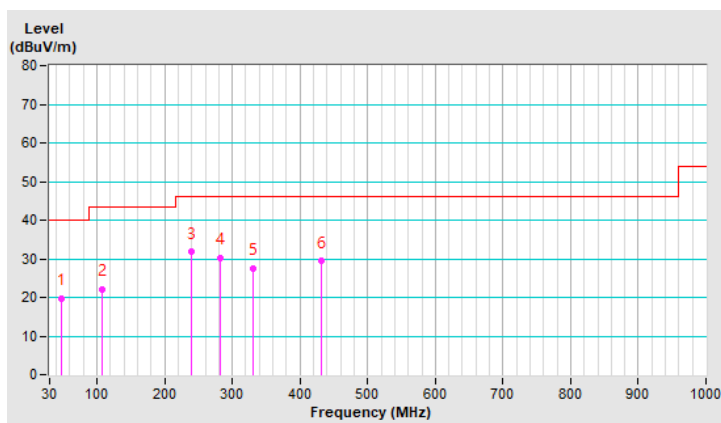

RF Mode	802.11g	Channel	CH 6 : 2437 MHz
Frequency Range	30 MHz ~ 1 GHz	Detector Function & Bandwidth	(QP) RB = 120kHz
Input Power	12 Vdc	Environmental Conditions	19°C, 62% RH
Tested By	Jed Wu		

Antenna Polarity & Test Distance : Vertical at 3 m								
No	Frequency (MHz)	Emission Level (dBuV/m)	Limit (dBuV/m)	Margin (dB)	Antenna Height (m)	Table Angle (Degree)	Raw Value (dBuV)	Correction Factor (dB/m)
1	35.60	28.7 QP	40.0	-11.3	1.57 V	31	38.9	-10.2
2	106.00	23.2 QP	43.5	-20.3	1.24 V	169	35.5	-12.3
3	240.00	32.3 QP	46.0	-13.7	1.39 V	307	41.1	-8.8
4	283.00	30.1 QP	46.0	-15.9	1.86 V	120	36.7	-6.6
5	376.40	25.9 QP	46.0	-20.1	1.02 V	106	30.3	-4.4
6	480.00	32.9 QP	46.0	-13.1	1.18 V	19	34.9	-2.0

Remarks:

1. Emission Level(dBuV/m) = Raw Value(dBuV) + Correction Factor(dB/m)
2. Correction Factor(dB/m) = Antenna Factor(dB/m) + Cable Factor(dB) – Pre-Amplifier Factor(dB)
3. Margin value = Emission Level – Limit value
4. The other emission levels were very low against the limit of frequency range 30 MHz ~ 1 GHz.
5. The emission levels were very low against the limit of frequency range 9 kHz ~ 30 MHz: the amplitude of spurious emissions attenuated more than 20 dB below the permissible value to be report.

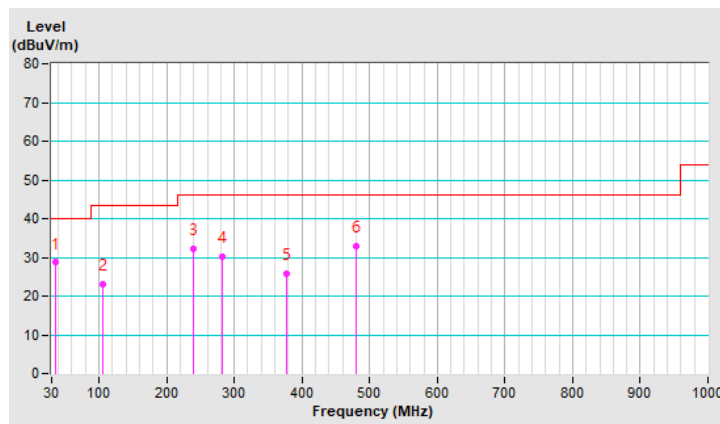

Mode B

Frequency Range	30 MHz ~ 1 GHz	Detector Function & Bandwidth	(QP) RB = 120kHz
Input Power	120 Vac, 60 Hz	Environmental Conditions	19°C, 62% RH
Tested By	Jed Wu		

Antenna Polarity & Test Distance : Horizontal at 3 m								
No	Frequency (MHz)	Emission Level (dBuV/m)	Limit (dBuV/m)	Margin (dB)	Antenna Height (m)	Table Angle (Degree)	Raw Value (dBuV)	Correction Factor (dB/m)
1	60.99	24.2 QP	40.0	-15.8	1.93 H	148	33.8	-9.6
2	103.09	22.5 QP	43.5	-21.0	1.45 H	138	35.1	-12.6
3	212.84	29.1 QP	43.5	-14.4	1.75 H	66	39.8	-10.7
4	288.02	38.3 QP	46.0	-7.7	1.62 H	227	44.8	-6.5
5	336.04	37.4 QP	46.0	-8.6	1.28 H	239	42.6	-5.2
6	432.06	31.2 QP	46.0	-14.8	1.03 H	242	34.0	-2.8

Remarks:

1. Emission Level(dBuV/m) = Raw Value(dBuV) + Correction Factor(dB/m)
2. Correction Factor(dB/m) = Antenna Factor(dB/m) + Cable Factor(dB) – Pre-Amplifier Factor(dB)
3. Margin value = Emission Level – Limit value
4. The other emission levels were very low against the limit of frequency range 30 MHz ~ 1 GHz.
5. The emission levels were very low against the limit of frequency range 9 kHz ~ 30 MHz: the amplitude of spurious emissions attenuated more than 20 dB below the permissible value to be report.

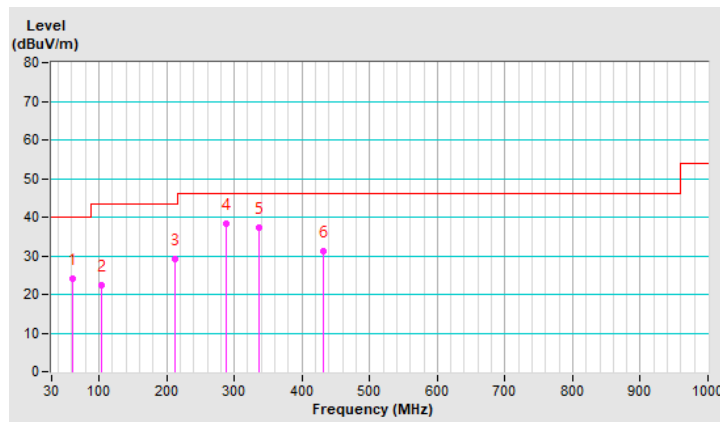

Frequency Range	30 MHz ~ 1 GHz	Detector Function & Bandwidth	(QP) RB = 120kHz
Input Power	120 Vac, 60 Hz	Environmental Conditions	19°C, 62% RH
Tested By	Jed Wu		

Antenna Polarity & Test Distance : Vertical at 3 m								
No	Frequency (MHz)	Emission Level (dBuV/m)	Limit (dBuV/m)	Margin (dB)	Antenna Height (m)	Table Angle (Degree)	Raw Value (dBuV)	Correction Factor (dB/m)
1	60.94	32.9 QP	40.0	-7.1	1.28 V	29	42.5	-9.6
2	100.23	25.9 QP	43.5	-17.6	1.34 V	126	38.9	-13.0
3	161.68	27.3 QP	43.5	-16.2	1.07 V	114	35.6	-8.3
4	240.00	32.5 QP	46.0	-13.5	1.86 V	304	41.3	-8.8
5	283.12	31.0 QP	46.0	-15.0	1.88 V	360	37.6	-6.6
6	335.99	31.9 QP	46.0	-14.1	1.94 V	251	37.1	-5.2

Remarks:

1. Emission Level(dBuV/m) = Raw Value(dBuV) + Correction Factor(dB/m)
2. Correction Factor(dB/m) = Antenna Factor(dB/m) + Cable Factor(dB) – Pre-Amplifier Factor(dB)
3. Margin value = Emission Level – Limit value
4. The other emission levels were very low against the limit of frequency range 30 MHz ~ 1 GHz.
5. The emission levels were very low against the limit of frequency range 9 kHz ~ 30 MHz: the amplitude of spurious emissions attenuated more than 20 dB below the permissible value to be report.

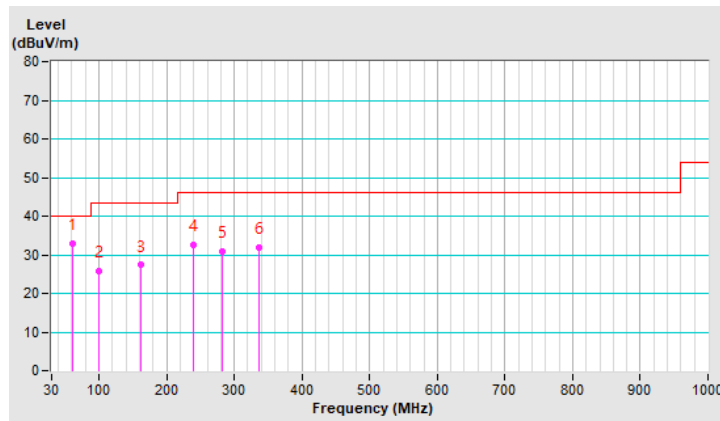

7.7 Unwanted Emissions above 1 GHz

Mode A

RF Mode	802.11b	Channel	CH 1 : 2412 MHz
Frequency Range	1 GHz ~ 25 GHz	Detector Function & Bandwidth	(PK) RB = 1 MHz, VB = 3 MHz (AV) RB = 1 MHz, VB = 2 kHz
Input Power	12 Vdc	Environmental Conditions	19.1°C, 63.7% RH
Tested By	Jed Wu		

Antenna Polarity & Test Distance : Horizontal at 3 m

No	Frequency (MHz)	Emission Level (dBuV/m)	Limit (dBuV/m)	Margin (dB)	Antenna Height (m)	Table Angle (Degree)	Raw Value (dBuV)	Correction Factor (dB/m)
1	2390.00	59.1 PK	74.0	-14.9	2.77 H	64	46.4	12.7
2	2390.00	45.8 AV	54.0	-8.2	2.77 H	64	33.1	12.7
3	*2412.00	108.6 PK			2.77 H	64	95.7	12.9
4	*2412.00	100.9 AV			2.77 H	64	88.0	12.9
5	4824.00	56.6 PK	74.0	-17.4	3.01 H	286	43.3	13.3
6	4824.00	42.8 AV	54.0	-11.2	3.01 H	286	29.5	13.3

Antenna Polarity & Test Distance : Vertical at 3 m

No	Frequency (MHz)	Emission Level (dBuV/m)	Limit (dBuV/m)	Margin (dB)	Antenna Height (m)	Table Angle (Degree)	Raw Value (dBuV)	Correction Factor (dB/m)
1	2390.00	65.4 PK	74.0	-8.6	2.04 V	341	52.7	12.7
2	2390.00	53.6 AV	54.0	-0.4	2.04 V	341	40.9	12.7
3	*2412.00	122.9 PK			2.04 V	341	110.0	12.9
4	*2412.00	114.2 AV			2.04 V	341	101.3	12.9
5	4824.00	57.3 PK	74.0	-16.7	2.91 V	351	44.0	13.3
6	4824.00	43.7 AV	54.0	-10.3	2.91 V	351	30.4	13.3

Remarks:

1. Emission Level(dBuV/m) = Raw Value(dBuV) + Correction Factor(dB/m)
2. Correction Factor(dB/m) = Antenna Factor(dB/m) + Cable Factor(dB) – Pre-Amplifier Factor(dB)
3. Margin value = Emission Level – Limit value
4. The other emission levels were very low against the limit.
5. " * ": Fundamental frequency, the limit was restricted at the RF Output Power.



RF Mode	802.11b	Channel	CH 6 : 2437 MHz
Frequency Range	1 GHz ~ 25 GHz	Detector Function & Bandwidth	(PK) RB = 1 MHz, VB = 3 MHz (AV) RB = 1 MHz, VB = 2 kHz
Input Power	12 Vdc	Environmental Conditions	19.1°C, 63.7% RH
Tested By	Jed Wu		

Antenna Polarity & Test Distance : Horizontal at 3 m								
No	Frequency (MHz)	Emission Level (dBuV/m)	Limit (dBuV/m)	Margin (dB)	Antenna Height (m)	Table Angle (Degree)	Raw Value (dBuV)	Correction Factor (dB/m)
1	*2437.00	107.9 PK			2.60 H	61	94.9	13.0
2	*2437.00	100.2 AV			2.60 H	61	87.2	13.0
3	4874.00	56.1 PK	74.0	-17.9	2.84 H	289	42.5	13.6
4	4874.00	42.3 AV	54.0	-11.7	2.84 H	289	28.7	13.6

Antenna Polarity & Test Distance : Vertical at 3 m								
No	Frequency (MHz)	Emission Level (dBuV/m)	Limit (dBuV/m)	Margin (dB)	Antenna Height (m)	Table Angle (Degree)	Raw Value (dBuV)	Correction Factor (dB/m)
1	*2437.00	122.0 PK			1.87 V	344	109.0	13.0
2	*2437.00	113.4 AV			1.87 V	344	100.4	13.0
3	4874.00	56.6 PK	74.0	-17.4	2.74 V	347	43.0	13.6
4	4874.00	43.1 AV	54.0	-10.9	2.74 V	347	29.5	13.6

Remarks:

1. Emission Level(dBuV/m) = Raw Value(dBuV) + Correction Factor(dB/m)
2. Correction Factor(dB/m) = Antenna Factor(dB/m) + Cable Factor(dB) – Pre-Amplifier Factor(dB)
3. Margin value = Emission Level – Limit value
4. The other emission levels were very low against the limit.
5. " * " : Fundamental frequency, the limit was restricted at the RF Output Power.



RF Mode	802.11b	Channel	CH 11 : 2462 MHz
Frequency Range	1 GHz ~ 25 GHz	Detector Function & Bandwidth	(PK) RB = 1 MHz, VB = 3 MHz (AV) RB = 1 MHz, VB = 2 kHz
Input Power	12 Vdc	Environmental Conditions	19.1°C, 63.7% RH
Tested By	Jed Wu		

Antenna Polarity & Test Distance : Horizontal at 3 m

No	Frequency (MHz)	Emission Level (dBuV/m)	Limit (dBuV/m)	Margin (dB)	Antenna Height (m)	Table Angle (Degree)	Raw Value (dBuV)	Correction Factor (dB/m)
1	*2462.00	103.4 PK			2.42 H	20	90.3	13.1
2	*2462.00	94.9 AV			2.42 H	20	81.8	13.1
3	2483.50	59.8 PK	74.0	-14.2	2.42 H	20	46.7	13.1
4	2483.50	46.3 AV	54.0	-7.7	2.42 H	20	33.2	13.1
5	4924.00	56.5 PK	74.0	-17.5	2.66 H	242	42.8	13.7
6	4924.00	42.7 AV	54.0	-11.3	2.66 H	242	29.0	13.7

Antenna Polarity & Test Distance : Vertical at 3 m

No	Frequency (MHz)	Emission Level (dBuV/m)	Limit (dBuV/m)	Margin (dB)	Antenna Height (m)	Table Angle (Degree)	Raw Value (dBuV)	Correction Factor (dB/m)
1	*2462.00	119.6 PK			1.85 V	358	106.5	13.1
2	*2462.00	111.1 AV			1.85 V	358	98.0	13.1
3	2483.50	65.1 PK	74.0	-8.9	1.85 V	358	52.0	13.1
4	2483.50	53.1 AV	54.0	-0.9	1.85 V	358	40.0	13.1
5	4924.00	57.2 PK	74.0	-16.8	2.72 V	334	43.5	13.7
6	4924.00	43.6 AV	54.0	-10.4	2.72 V	334	29.9	13.7

Remarks:

1. Emission Level(dBuV/m) = Raw Value(dBuV) + Correction Factor(dB/m)
2. Correction Factor(dB/m) = Antenna Factor(dB/m) + Cable Factor(dB) – Pre-Amplifier Factor(dB)
3. Margin value = Emission Level – Limit value
4. The other emission levels were very low against the limit.
5. " * ": Fundamental frequency, the limit was restricted at the RF Output Power.



RF Mode	802.11g	Channel	CH 1 : 2412 MHz
Frequency Range	1 GHz ~ 25 GHz	Detector Function & Bandwidth	(PK) RB = 1 MHz, VB = 3 MHz (AV) RB = 1 MHz, VB = 10 kHz
Input Power	12 Vdc	Environmental Conditions	19.1°C, 63.7% RH
Tested By	Jed Wu		

Antenna Polarity & Test Distance : Horizontal at 3 m

No	Frequency (MHz)	Emission Level (dBuV/m)	Limit (dBuV/m)	Margin (dB)	Antenna Height (m)	Table Angle (Degree)	Raw Value (dBuV)	Correction Factor (dB/m)
1	2390.00	60.5 PK	74.0	-13.5	1.90 H	332	47.8	12.7
2	2390.00	49.5 AV	54.0	-4.5	1.90 H	332	36.8	12.7
3	*2412.00	96.7 PK			1.90 H	332	83.8	12.9
4	*2412.00	87.0 AV			1.90 H	332	74.1	12.9
5	4824.00	53.3 PK	74.0	-20.7	2.14 H	194	40.0	13.3
6	4824.00	41.6 AV	54.0	-12.4	2.14 H	194	28.3	13.3

Antenna Polarity & Test Distance : Vertical at 3 m

No	Frequency (MHz)	Emission Level (dBuV/m)	Limit (dBuV/m)	Margin (dB)	Antenna Height (m)	Table Angle (Degree)	Raw Value (dBuV)	Correction Factor (dB/m)
1	2390.00	73.1 PK	74.0	-0.9	2.05 V	348	60.4	12.7
2	2390.00	50.4 AV	54.0	-3.6	2.05 V	348	37.7	12.7
3	*2412.00	112.9 PK			2.05 V	348	100.0	12.9
4	*2412.00	103.4 AV			2.05 V	348	90.5	12.9
5	4824.00	53.6 PK	74.0	-20.4	2.92 V	344	40.3	13.3
6	4824.00	41.9 AV	54.0	-12.1	2.92 V	344	28.6	13.3

Remarks:

1. Emission Level(dBuV/m) = Raw Value(dBuV) + Correction Factor(dB/m)
2. Correction Factor(dB/m) = Antenna Factor(dB/m) + Cable Factor(dB) – Pre-Amplifier Factor(dB)
3. Margin value = Emission Level – Limit value
4. The other emission levels were very low against the limit.
5. " * ": Fundamental frequency, the limit was restricted at the RF Output Power.



RF Mode	802.11g	Channel	CH 6 : 2437 MHz
Frequency Range	1 GHz ~ 25 GHz	Detector Function & Bandwidth	(PK) RB = 1 MHz, VB = 3 MHz (AV) RB = 1 MHz, VB = 10 kHz
Input Power	12 Vdc	Environmental Conditions	19.1°C, 63.7% RH
Tested By	Jed Wu		

Antenna Polarity & Test Distance : Horizontal at 3 m								
No	Frequency (MHz)	Emission Level (dBuV/m)	Limit (dBuV/m)	Margin (dB)	Antenna Height (m)	Table Angle (Degree)	Raw Value (dBuV)	Correction Factor (dB/m)
1	*2437.00	103.0 PK			1.54 H	333	90.0	13.0
2	*2437.00	93.3 AV			1.54 H	333	80.3	13.0
3	4874.00	53.8 PK	74.0	-20.2	1.78 H	195	40.2	13.6
4	4874.00	42.1 AV	54.0	-11.9	1.78 H	195	28.5	13.6
Antenna Polarity & Test Distance : Vertical at 3 m								
No	Frequency (MHz)	Emission Level (dBuV/m)	Limit (dBuV/m)	Margin (dB)	Antenna Height (m)	Table Angle (Degree)	Raw Value (dBuV)	Correction Factor (dB/m)
1	*2437.00	119.2 PK			1.69 V	347	106.2	13.0
2	*2437.00	109.7 AV			1.69 V	347	96.7	13.0
3	4874.00	54.1 PK	74.0	-19.9	2.56 V	343	40.5	13.6
4	4874.00	42.4 AV	54.0	-11.6	2.56 V	343	28.8	13.6

Remarks:

1. Emission Level(dBuV/m) = Raw Value(dBuV) + Correction Factor(dB/m)
2. Correction Factor(dB/m) = Antenna Factor(dB/m) + Cable Factor(dB) – Pre-Amplifier Factor(dB)
3. Margin value = Emission Level – Limit value
4. The other emission levels were very low against the limit.
5. " * " : Fundamental frequency, the limit was restricted at the RF Output Power.



RF Mode	802.11g	Channel	CH 11 : 2462 MHz
Frequency Range	1 GHz ~ 25 GHz	Detector Function & Bandwidth	(PK) RB = 1 MHz, VB = 3 MHz (AV) RB = 1 MHz, VB = 10 kHz
Input Power	12 Vdc	Environmental Conditions	19.1°C, 63.7% RH
Tested By	Jed Wu		

Antenna Polarity & Test Distance : Horizontal at 3 m

No	Frequency (MHz)	Emission Level (dBuV/m)	Limit (dBuV/m)	Margin (dB)	Antenna Height (m)	Table Angle (Degree)	Raw Value (dBuV)	Correction Factor (dB/m)
1	*2462.00	98.2 PK			2.04 H	285	85.1	13.1
2	*2462.00	88.5 AV			2.04 H	285	75.4	13.1
3	2483.50	62.6 PK	74.0	-11.4	2.04 H	285	49.5	13.1
4	2483.50	49.5 AV	54.0	-4.5	2.04 H	285	36.4	13.1
5	4924.00	53.5 PK	74.0	-20.5	2.28 H	147	39.8	13.7
6	4924.00	41.8 AV	54.0	-12.2	2.28 H	147	28.1	13.7

Antenna Polarity & Test Distance : Vertical at 3 m

No	Frequency (MHz)	Emission Level (dBuV/m)	Limit (dBuV/m)	Margin (dB)	Antenna Height (m)	Table Angle (Degree)	Raw Value (dBuV)	Correction Factor (dB/m)
1	*2462.00	112.1 PK			2.19 V	35	99.0	13.1
2	*2462.00	101.5 AV			2.19 V	35	88.4	13.1
3	2483.50	72.3 PK	74.0	-1.7	2.19 V	35	59.2	13.1
4	2483.50	50.9 AV	54.0	-3.1	2.19 V	35	37.8	13.1
5	4924.00	53.8 PK	74.0	-20.2	2.78 V	297	40.1	13.7
6	4924.00	42.1 AV	54.0	-11.9	2.78 V	297	28.4	13.7

Remarks:

1. Emission Level(dBuV/m) = Raw Value(dBuV) + Correction Factor(dB/m)
2. Correction Factor(dB/m) = Antenna Factor(dB/m) + Cable Factor(dB) – Pre-Amplifier Factor(dB)
3. Margin value = Emission Level – Limit value
4. The other emission levels were very low against the limit.
5. " * ": Fundamental frequency, the limit was restricted at the RF Output Power.

Plot of Band Edge_Mode A

802.11b Channel 1

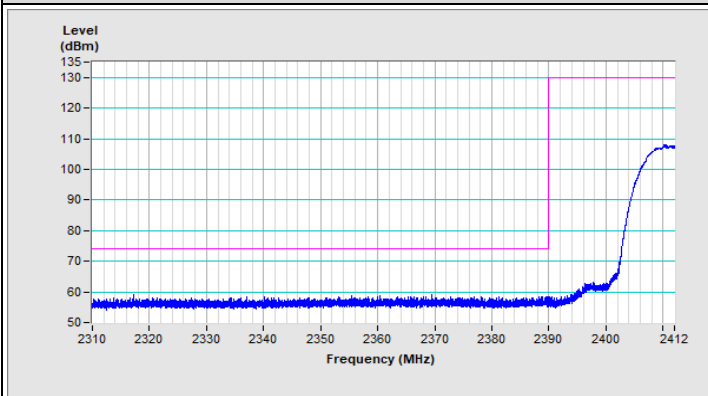

Horizontal (Peak)

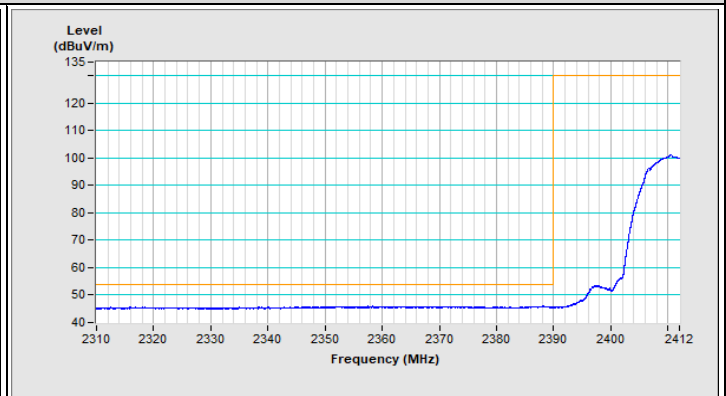

Horizontal (Average)

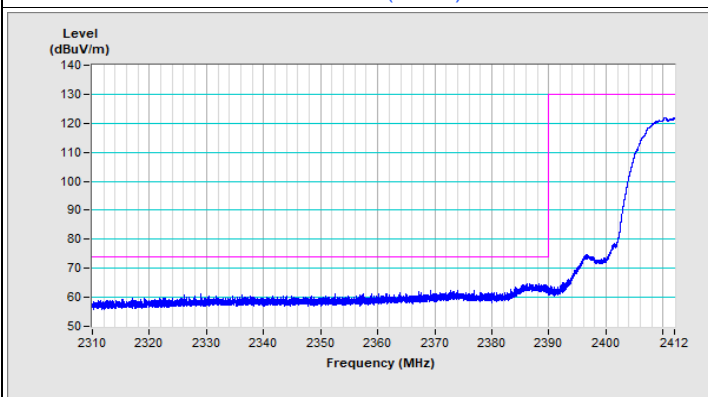

Vertical (Peak)

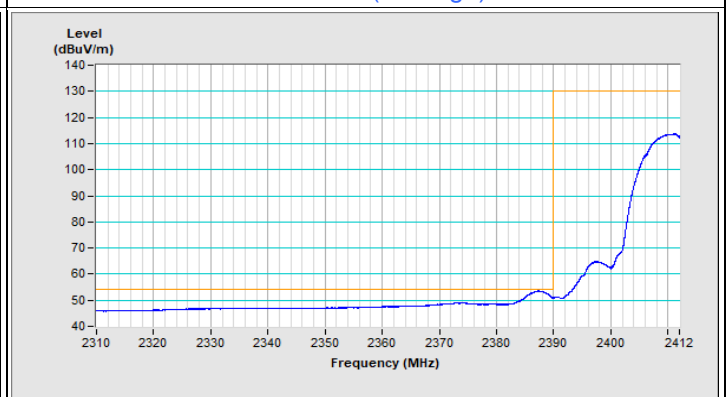

Vertical (Average)

802.11b Channel 11

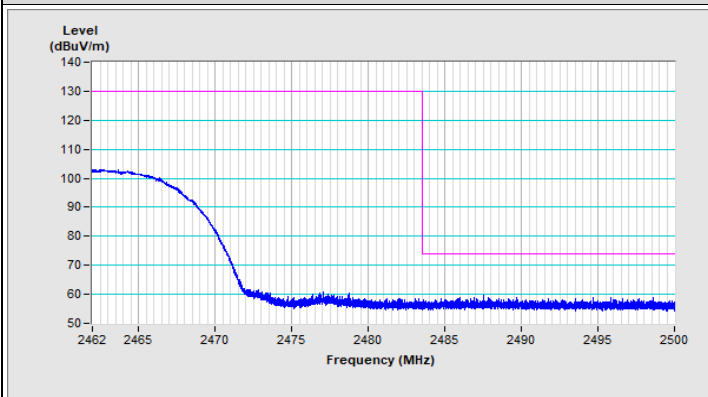

Horizontal (Peak)

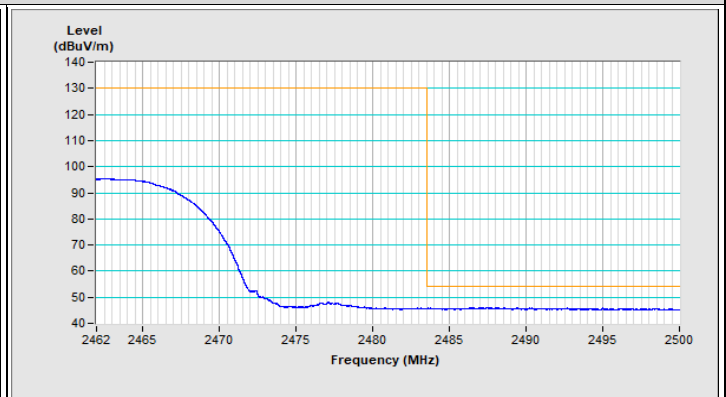

Horizontal (Average)

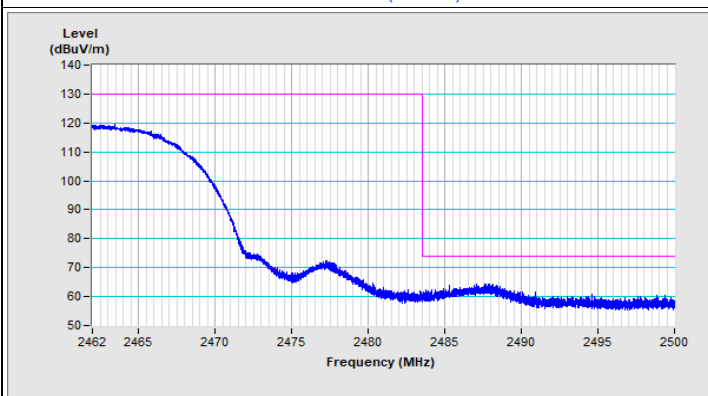

Vertical (Peak)

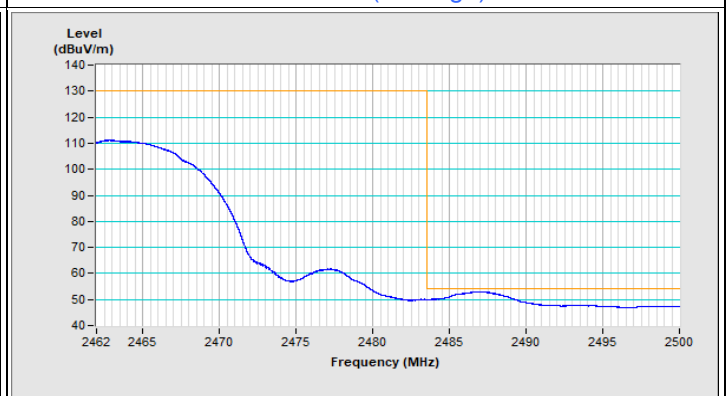

Vertical (Average)

802.11g Channel 1

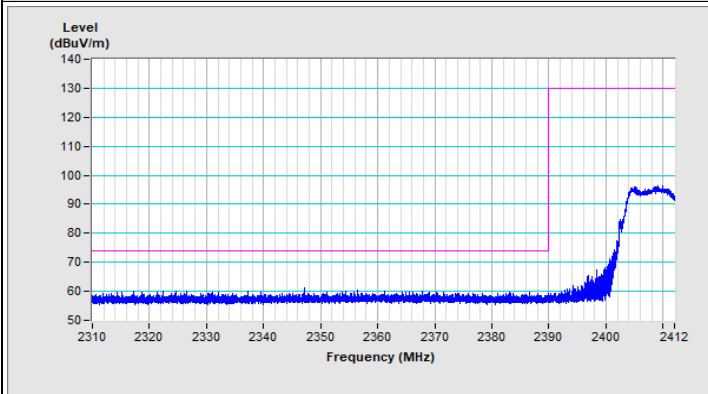

Horizontal (Peak)

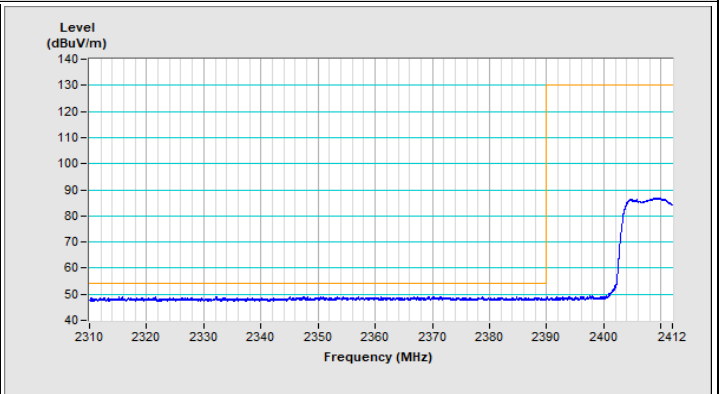

Horizontal (Average)

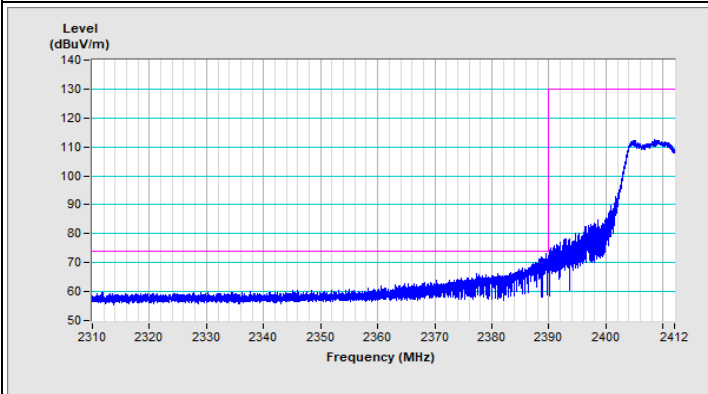

Vertical (Peak)

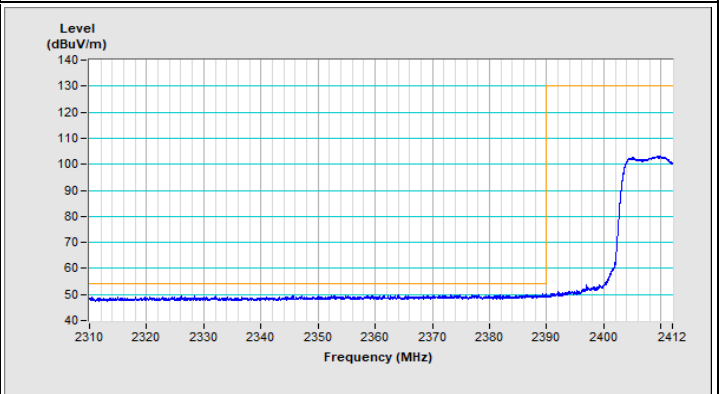

Vertical (Average)

802.11g Channel 11

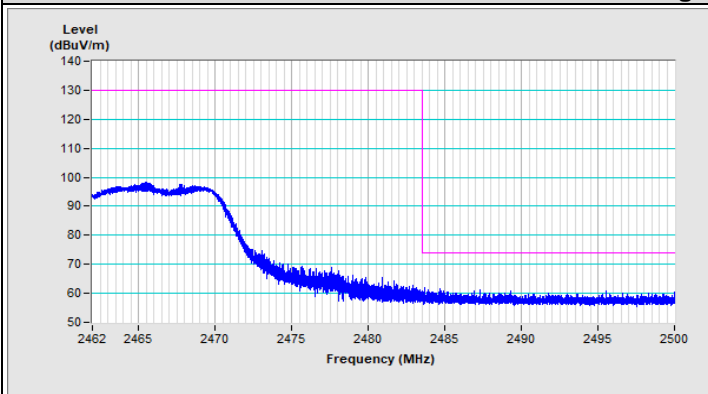

Horizontal (Peak)

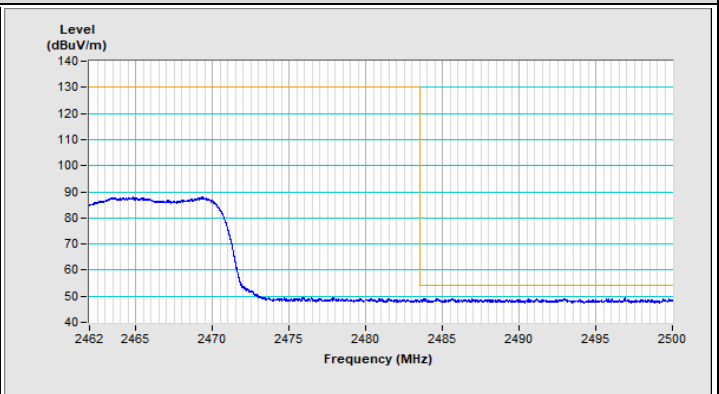

Horizontal (Average)

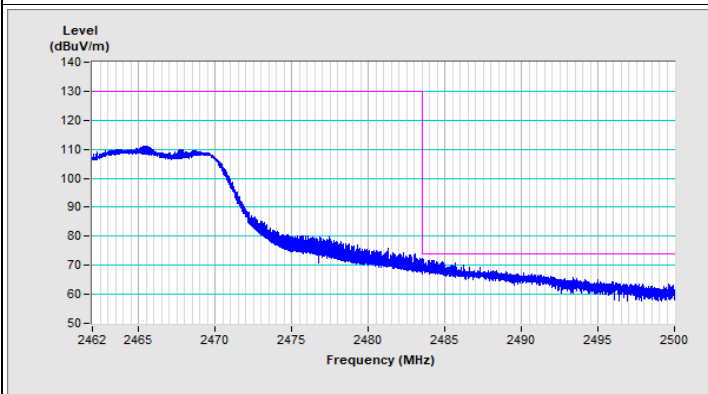

Vertical (Peak)

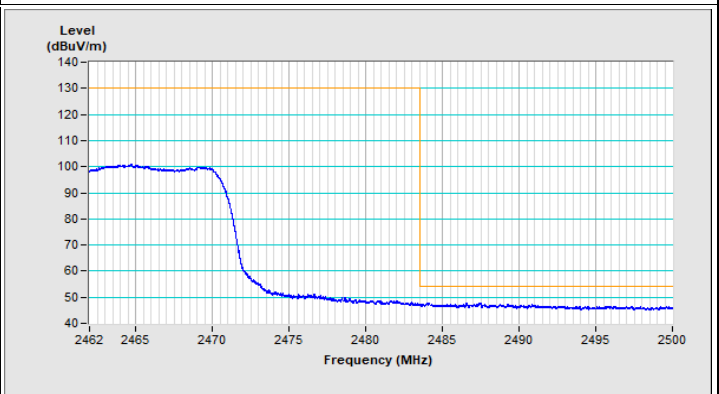

Vertical (Average)

8 Pictures of Test Arrangements

Please refer to the attached file (Test Setup Photo)

9 Information of the Testing Laboratories

We, Bureau Veritas Consumer Products Services (H.K.) Ltd., Taoyuan Branch, were founded in 1988 to provide our best service in EMC, Radio, Telecom and Safety consultation. Our laboratories are FCC recognized accredited test firms and accredited according to ISO/IEC 17025.

If you have any comments, please feel free to contact us at the following:

Lin Kou EMC/RF Lab

Tel: 886-2-26052180

Fax: 886-2-26051924

Hsin Chu EMC/RF/Telecom Lab

Tel: 886-3-6668565

Fax: 886-3-6668323

Hwa Ya EMC/RF/Safety Lab

Tel: 886-3-3183232

Fax: 886-3-3270892

Email: service.adt@bureauveritas.com

Web Site: <http://ee.bureauveritas.com.tw>

The address and road map of all our labs can be found in our web site also.

--- END ---