



FCC LISTED, REGISTRATION
 NUMBER: 720267

Informe de ensayo nº:
 Test report No:

IC LISTED REGISTRATION
 NUMBER IC 4621A-1

NIE: 48278RRF.001

Test report

USA FCC Part 15.247, 15.209

CANADA RSS-247, RSS-Gen

Radio Frequency Devices. Operation within the bands 902 - 928 MHz, 2400 -2483.5 MHz, and 5725 - 5850 MHz.

Digital Transmission Systems (DTSs), Frequency Hopping Systems (FHSs) and Licence-Exempt Local Area Network (LE-LAN) Devices.

General Requirements and Information for the Certification of Radio Apparatus.

Identificación del objeto ensayado.....: Identification of item tested	Radio with Navigation
Marca Trademark	Panasonic
Modelo y/o referencia tipo Model and /or type reference	VP4R-A
Other identification of the product	S/N: T M9 0 1 3700322 & T M9 0 1 3700321 FCC ID: ACJ-VP4RA ISED: 216A-VP4RA
Final HW version	VP4RA
Final SW version	VP4RA US SW
Características Features	Navigation, Tuner, DAB, Class D Amp, Modem, BT, Wi-Fi
Solicitante Applicant	For FCC: Panasonic Corporation of North America Two Riverfront Plaza, 9th Floor, 07102-5490 Newark, New Jersey, USA For ISED: Panasonic Canada Inc. 5770 Ambler Drive, Mississauga ON L4W 2T3 Canada
Método de ensayo solicitado, norma.....: Test method requested, standard	USA FCC Part 15.247 10-1-15 Edition: Operation within the bands 902 - 928 MHz, 2400 -2483.5 MHz, and 5725 - 5850 MHz. USA FCC Part 15.209 10-1-15 Edition: Radiated emission limits; general requirements. CANADA RSS-247 Issue 1 (May 2015). CANADA RSS-Gen Issue 4 (November 2014). ANSI C63.10-2013: American National Standard for Testing Unlicensed Wireless Devices.
Resultado.....: Summary	IN COMPLIANCE

Aprobado por (nombre / cargo y firma) Approved by (name / position & signature)	A. Llamas RF Lab. Manager
Fecha de realización Date of issue	2017-04-21
Formato de informe No. Report template No	FDT08_19

Index

Competences and guarantees.....	4
General conditions.....	4
Uncertainty	4
Usage of samples.....	4
Test sample description	6
Identification of the client	6
Testing period.....	6
Environmental conditions.....	6
Testing verdicts	8
Appendix A – Test result (Bluetooth EDR)	9

Competences and guarantees

DEKRA Testing and Certification is a testing laboratory accredited by the National Accreditation Body (ENAC - Entidad Nacional de Acreditación), to perform the tests indicated in the Certificate No. 51/LE 147.

DEKRA Testing and Certification is a laboratory with a measurement facility in compliance with the requirements of Section 2.948 of the FCC rules and has been added to the list of facilities whose measurements data will be accepted in conjunction with applications for Certification under Parts 15 or 18 of the Commission's Rules. Registration Number: 720267.

DEKRA Testing and Certification is a laboratory with a measurement site in compliance with the requirements of RSS 212, Issue 1 (Provisional) and has been added to the list of filed sites of the Canadian Certification and Engineering Bureau. Reference File Number: IC 4621A-1.

In order to assure the traceability to other national and international laboratories, DEKRA Testing and Certification has a calibration and maintenance program for its measurement equipment.

the measurements and the tests performed to the item under test on the date and under the conditions stated on the report and, it is based on the knowledge and technical facilities available at DEKRA Testing and Certification at the time of performance of the test.

DEKRA Testing and Certification is liable to the client for the maintenance of the confidentiality of all information related to the item under test and the results of the test.

The results presented in this Test Report apply only to the particular item under test established in this document.

IMPORTANT: No parts of this report may be reproduced or quoted out of context, in any form or by any means, except in full, without the previous written permission of DEKRA Testing and Certification.

General conditions

1. This report is only referred to the item that has undergone the test.
2. This report does not constitute or imply on its own an approval of the product by the Certification Bodies or competent Authorities.
3. This document is only valid if complete; no partial reproduction can be made without previous written permission of DEKRA Testing and Certification.
4. This test report cannot be used partially or in full for publicity and/or promotional purposes without previous written permission of DEKRA Testing and Certification and the Accreditation Bodies.

Uncertainty

Uncertainty (factor $k=2$) was calculated according to the DEKRA Testing and Certification internal document PODT000.

Usage of samples

Samples undergoing test have been selected by: **the client**

Sample S/01 is composed of the following elements:

Control N°	Description	Model	Serial N°	Date of reception
48278D/006	Power DC cable	---	---	2017-03-15
48278D/079	Antenna	---	---	2017-04-04
48278D/080	Amphenal cable	---	---	2017-04-04
48278D/013	FM Antenna	---	---	2017-03-28
48278D/106	Radio with Navigation	VP4R-A	T M9 0 1 3700322	2017-04-17
48278D/104	Faceplate	---	---	2017-04-10

Auxiliary elements used with the sample S/01:

Control N°	Description	Model	Serial N°	Date of reception
48193E/050	USB HUB	DUB-H7	DL481E3002717	2016-05-17
48193E/015	AC/DC HUB	CF1805-B	---	2016-04-18
48193E/051	USB cable	---	---	2016-05-17
48193E/053	USB cable	---	---	2016-05-17
48193E/022	USB – Ethernet adapter	---	---	2016-04-18
48278D/007	ValueCAN3 cable	ValueCAN3	134184	2017-03-15
48193E/055	Pendrive	---	---	2016-05-17

1. Sample S/01 has undergone following test(s).
All radiated tests indicated in appendix A.

Sample S/02 is composed of the following elements:

Control N°	Description	Model	Serial N°	Date of reception
48278D/006	Power DC cable	---	---	2017-03-15
48278D/105	Radio with Navigation with temporary antenna connector	VP4R-A	T M9 0 1 3700321	2017-04-17

Auxiliary elements used with the sample S/02:

Control N°	Description	Model	Serial N°	Date of reception
48193E/050	USB HUB	DUB-H7	DL481E3002717	2016-05-17
48193E/015	AC/DC HUB	CF1805-B	---	2016-04-18
48193E/051	USB cable	---	---	2016-05-17
48193E/053	USB cable	---	---	2016-05-17
48193E/022	USB – Ethernet adapter	---	---	2016-04-18
48278D/007	ValueCAN3 cable	ValueCAN3	134184	2017-03-15
48193E/055	Pendrive	---	---	2016-05-17

1. Sample S/02 has undergone following test(s).
All conducted tests indicated in appendix A.

Test sample description

The test sample consists of a 8.4" Integrated Display Radio (TI J6, QNX6.6) with Navigation, Tuner, DAB, Class D Amp, Modem, BT, Wi-Fi.

Identification of the client

For FCC:

Panasonic Corporation of North America

Two Riverfront Plaza, 9th Floor, 07102-5490 Newark, New Jersey, USA

For ISED:

Panasonic Canada Inc.

5770 Ambler Drive, Mississauga ON L4W 2T3 Canada

Testing period

The performed test started on 2017-04-19 and finished on 2017-04-20.

The tests have been performed at DEKRA Testing and Certification.

Environmental conditions

In the control chamber, the following limits were not exceeded during the test:

Temperature	Min. = 15 °C Max. = 35 °C
Relative humidity	Min. = 20 % Max. = 75 %
Shielding effectiveness	> 100 dB
Electric insulation	> 10 kΩ
Reference resistance to earth	< 1 Ω

In the semianechoic chamber, the following limits were not exceeded during the test.

Temperature	Min. = 15 °C Max. = 35 °C
Relative humidity	Min. = 20 % Max. = 75 %
Air pressure	Min. = 860 mbar Max. = 1060 mbar
Shielding effectiveness	> 100 dB
Electric insulation	> 10 kΩ
Reference resistance to earth	< 1 Ω
Normal site attenuation (NSA)	< ±4 dB at 10 m distance between item under test and receiver antenna, (30 MHz to 1000 MHz)
Field homogeneity	More than 75% of illuminated surface is between 0 and 6 dB (26 MHz to 1000 MHz).

In the chamber for conducted measurements, the following limits were not exceeded during the test:

Temperature	Min. = 15 °C Max. = 35 °C
Relative humidity	Min. = 20 % Max. = 75 %
Air pressure	Min. = 860 mbar Max. = 1060 mbar
Shielding effectiveness	> 100 dB
Electric insulation	> 10 kΩ
Reference resistance to earth	< 1 Ω

Remarks and comments

1: Used instrumentation:

Conducted Measurements

	Last Cal. date	Cal. due date
1. Spectrum analyser Agilent E4440A	2015/10	2017/10
2. DC power supply R&S NGPE 40/40	2014/11	2017/11
3. RF Bluetooth Test Set Anritsu MT8852B	N.A.	N.A.

Radiated Measurements

	Last Cal. date	Cal. due date
1. Semianechoic Absorber Lined Chamber ETS FACT3 200STP	N.A.	N.A.
2. BiconicalLog antenna ETS LINDGREN 3142E	2017/07	2020/04
3. Multi Device Controller EMCO 2090	N.A.	N.A.
4. Double-ridge Guide Horn antenna 1-18 GHz SCHWARZBECK BBHA 9120 D	2016/11	2019/11
5. Broadband Horn antenna 18-40 GHz SCHWARZBECK BBHA 9170	2017/03	2020/03
6. EMI Test Receiver R&S ESU 40	2016/03	2018/03
7. Spectrum analyser Rohde & Schwarz FSW50	2015/12	2017/12
8. RF pre-amplifier 20 MHz-7 GHz PAM-0207	2016/09	2017/09
9. RF pre-amplifier 1-18 GHz Bonn Elektronik BLMA 0118-1M	2016/02	2018/02
10. RF pre-amplifier 18-40 GHz BONN ELEKTRONIK BLMA 1840-1M	2015/12	2017/12
11. RF Bluetooth Test Set Anritsu MT8852B	N.A.	N.A.

Testing verdicts

Not applicable	N/A
Pass	P
Fail	F
Not measured	N/M

1. - BT EDR

FCC PART 15 PARAGRAPH / RSS-247		VERDICT			
		NA	P	F	NM
FCC 15.247 Subclause (a) (1) / RSS-247 Clause 5.1 (2)	20 dB Bandwidth and Carrier frequency separation		P		
FCC 15.247 Subclause (a)(1)(iii) / RSS-247 Clause 5.1 (4)	Number of hopping channels		P		
FCC 15.247 Subclause (a)(1)(iii) / RSS-247 Clause 5.1 (4)	Time of occupancy (Dwell Time)		P		
FCC 15.247 Subclause (b) / RSS-247 Clause 5.4 (2)	Maximum peak output power and antenna gain		P		
FCC 15.247 Subclause (d) / RSS-247 Clause 5.5	Emission limitations conducted (Transmitter)		P		
FCC 15.247 Subclause (d) / RSS-247 Clause 5.5	Emission limitations radiated (Transmitter)		P		

Appendix A – Test result (Bluetooth EDR)

INDEX

TEST CONDITIONS	11
FCC Section 15.247 Subclause (a) (1) / RSS-247 Clause 5.1 (2). 20 dB Bandwidth and Carrier frequency separation	14
FCC Section 15.247 Subclause (a) (1) (iii) / RSS-247 Clause 5.1 (4). Number of hopping channels	21
FCC Section 15.247 Subclause (a) (1) (iii) / RSS-247 Clause 5.1 (4). Time of occupancy (Dwell Time).....	27
FCC Section 15.247 Subclause (b) / RSS-247 Clause 5.4 (2). Maximum peak output power and antenna gain ..	37
FCC Section 15.247 Subclause (d) / RSS-247 Clause 5.5. Band-edge compliance of conducted emissions (Transmitter)	43
FCC Section 15.247 Subclause (d) / RSS-247 Clause 5.5. Emission limitations conducted (Transmitter).....	50
FCC Section 15.247 Subclause (d) / RSS-247 Clause 5.5 Emission limitations radiated (Transmitter)	56

TEST CONDITIONS

Power supply (V):

$$V_{\text{nominal}} = 12.9 \text{ Vdc}$$

Type of power supply = External power supply (Battery).

Type of antenna: Integral antenna

Declared Gain for antenna (maximum) = +4 dBi

TEST FREQUENCIES:

Lowest channel: 2402 MHz

Middle channel: 2441 MHz

Highest channel: 2480 MHz

CONDUCTED MEASUREMENTS

The equipment under test was set up in a shielded room and it is connected to a Bluetooth signalling unit (Bluetooth test set) and to the spectrum analyzer using a 6 dB power splitter. The reading in the spectrum analyzer is corrected taking into account the power splitter loss.

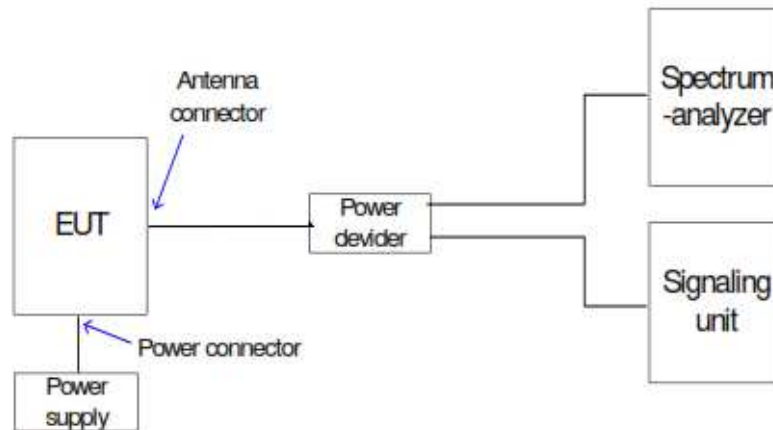

The DC supply voltage is applied using an external calibrated power supply.

RADIATED MEASUREMENTS

All radiated tests were performed in a semi-anechoic chamber. The measurement antenna is situated at a distance of 3 m for the frequency range 30 MHz-1000 MHz (30 MHz-1000 MHz Bilog antenna) and at a distance of 1m for the frequency range 1 GHz-25 GHz (1 GHz-18 GHz Double ridge horn antenna and 18 GHz-40 GHz horn antenna).

For radiated emissions in the range 1 GHz-25 GHz that is performed at a distance closer than the specified distance, an inverse proportionality factor of 20 dB per decade is used to normalize the measured data for determining compliance.

The equipment under test was set up on a non-conductive platform above the ground plane and the situation and orientation was varied to find the maximum radiated emission.

It was also rotated 360° and the antenna height was varied from 1 to 4 meters to find the maximum radiated emission.

Measurements were made in both horizontal and vertical planes of polarization.

An additional horn antenna is used to control the equipment under test with the Bluetooth signalling unit (Bluetooth test set).

Radiated measurements setup $f < 1$ GHz

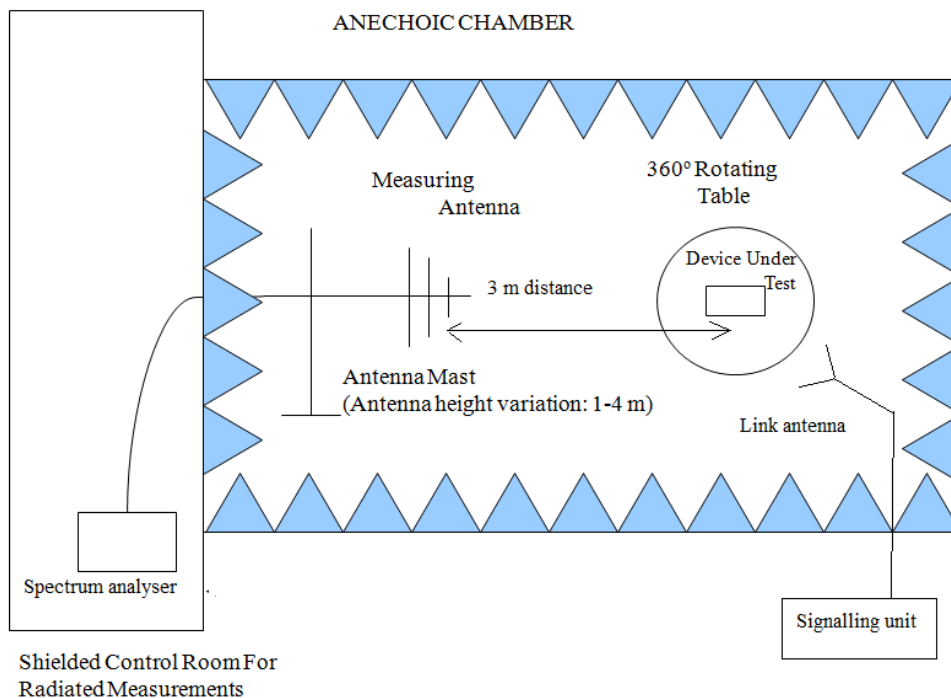

Radiated measurements setup $f > 1$ GHz

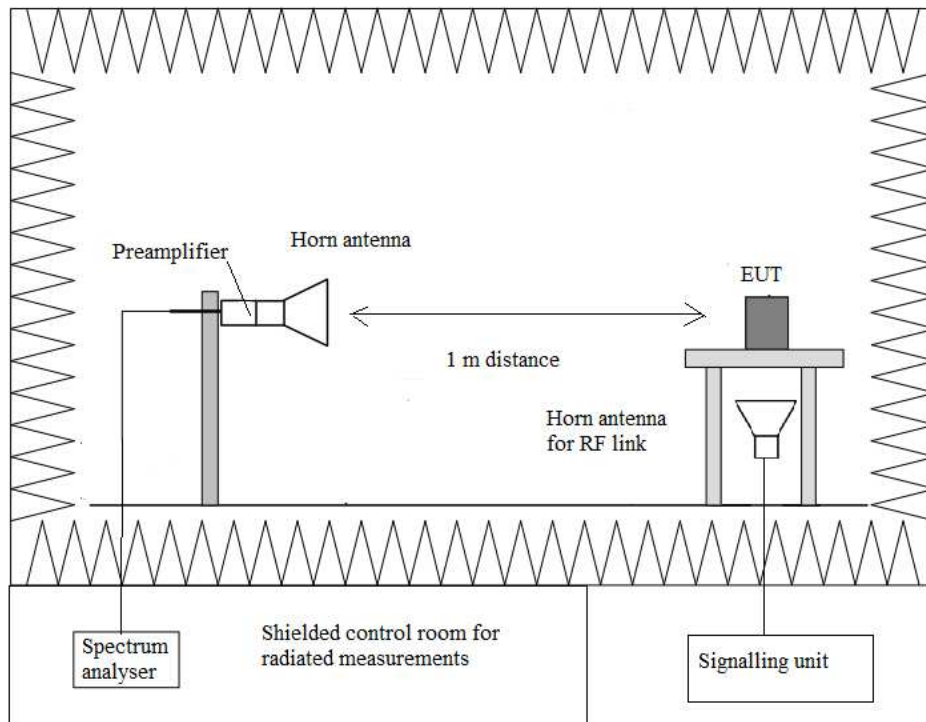

FCC Section 15.247 Subclause (a) (1) / RSS-247 Clause 5.1 (2). 20 dB Bandwidth and Carrier frequency separation

SPECIFICATION

Frequency hopping systems shall have hopping channel carrier frequencies separated by a minimum of 25 kHz or the 20 dB bandwidth of the hopping channel, whichever is greater. Alternatively, frequency hopping systems operating in the 2400-2483.5 MHz band may have hopping channel carrier frequencies that are separated by 25 kHz or two-thirds of the 20 dB bandwidth of the hopping channel, whichever is greater, provided the systems operate with an output power no greater than 125 mW.

RESULTS

(See next plots)

Modulation: GFSK

	Lowest frequency 2402 MHz	Middle frequency 2441 MHz	Highest frequency 2480 MHz
20 dB Spectrum bandwidth (kHz)	1030	1029	1023
Measurement uncertainty (kHz)	<±5.00		

Modulation: Π/4-DQPSK (2Mbps)

	Lowest frequency 2402 MHz	Middle frequency 2441 MHz	Highest frequency 2480 MHz
20 dB Spectrum bandwidth (kHz)	1289	1290	1304
Measurement uncertainty (kHz)	<±5.00		

Modulation: 8-DPSK (3Mbps)

	Lowest frequency 2402 MHz	Middle frequency 2441 MHz	Highest frequency 2480 MHz
20 dB Spectrum bandwidth (kHz)	1308	1305	1302
Measurement uncertainty (kHz)	<±5.00		

Modulation: GFSK

20 dB BANDWIDTH.

Lowest Channel: 2402 MHz.

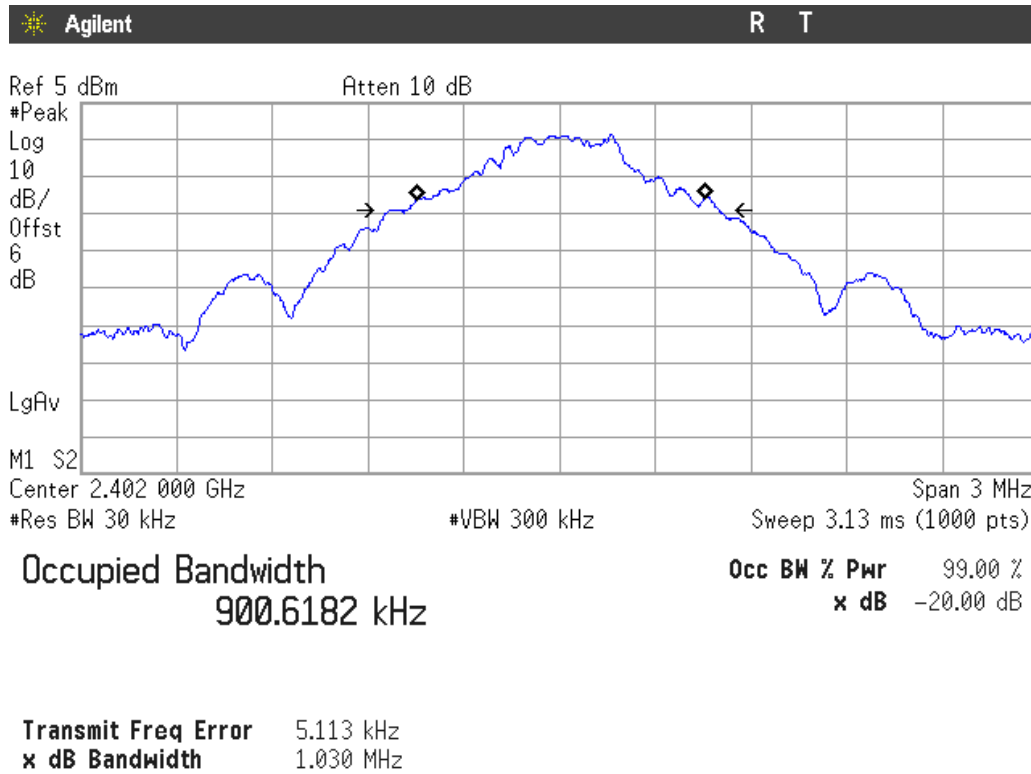

20 dB BANDWIDTH

Middle Channel: 2441 MHz.

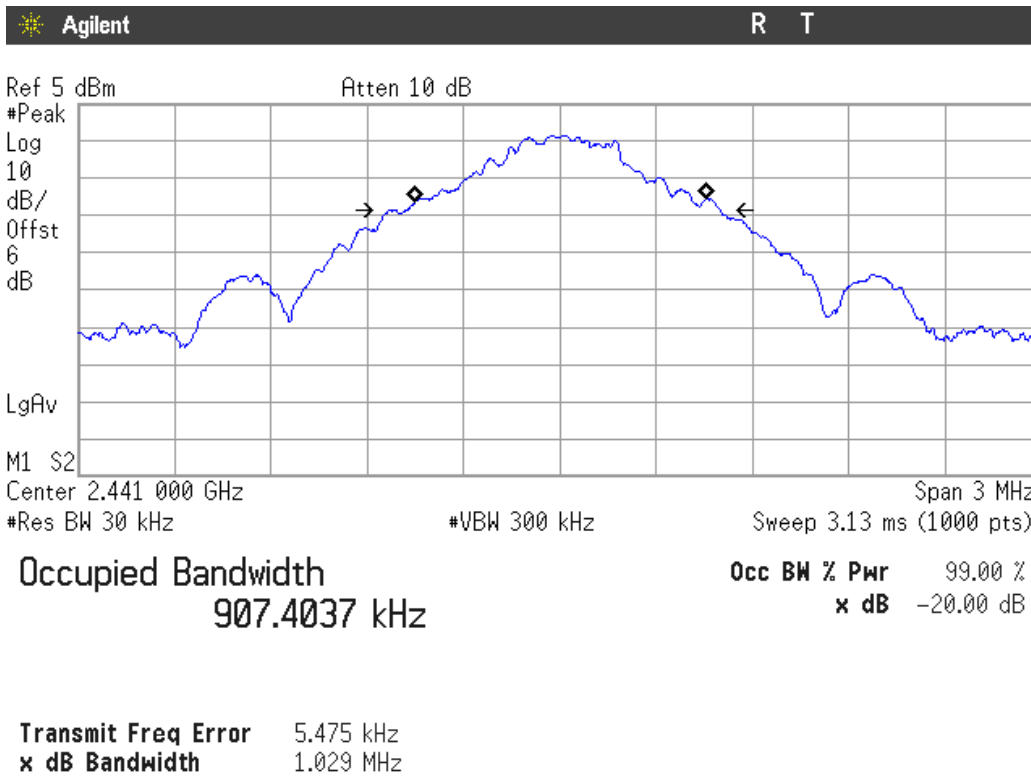

20 dB BANDWIDTH

Highest Channel: 2480 MHz.

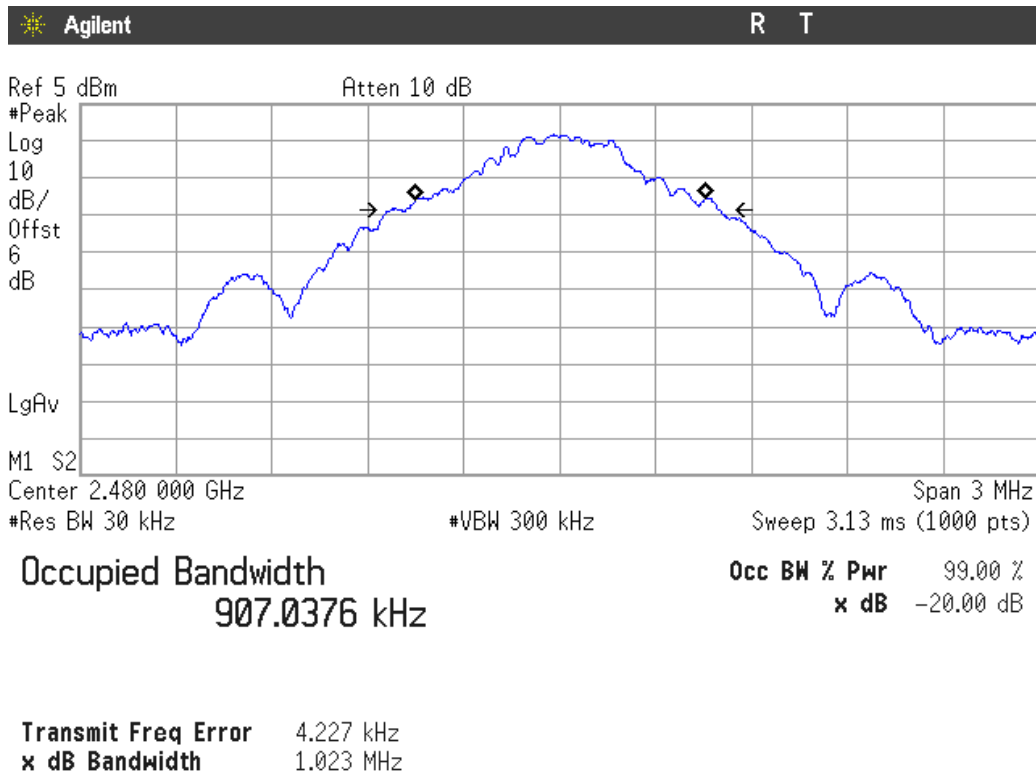

Carrier frequency separation

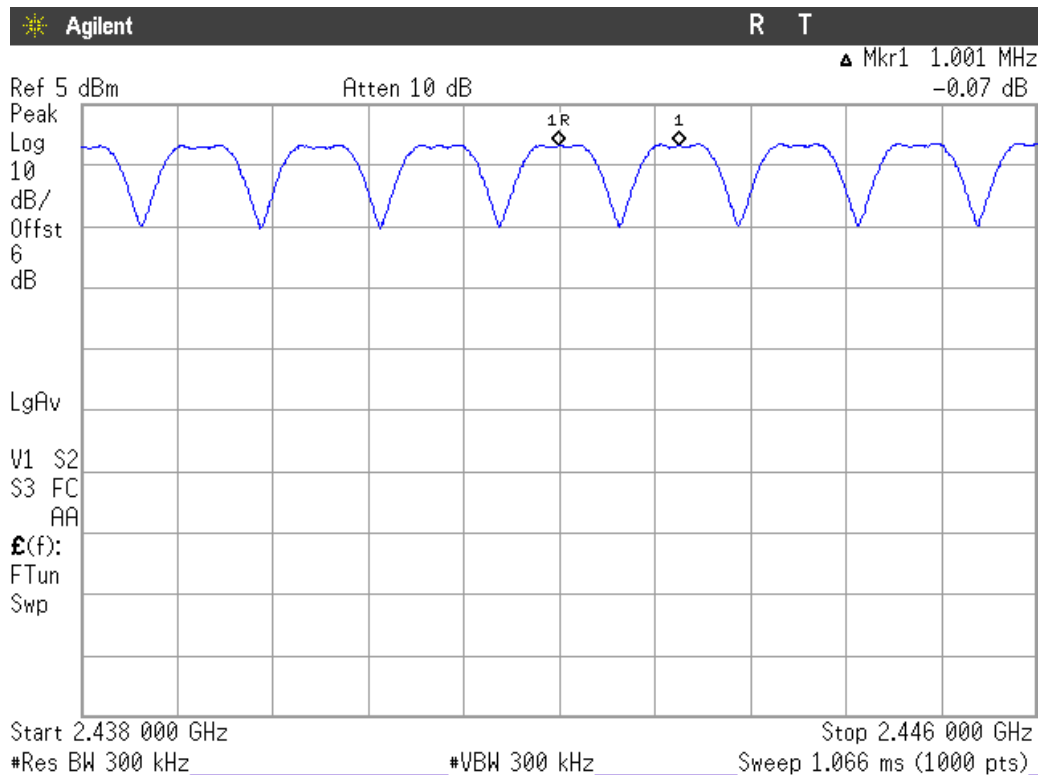

The hopping channel carrier frequencies are separated by a minimum of the two-thirds of the 20 dB bandwidth of the hopping channel.

Verdict: PASS

Modulation: $\Pi/4$ -DQPSK

20 dB BANDWIDTH.

Lowest Channel: 2402 MHz.

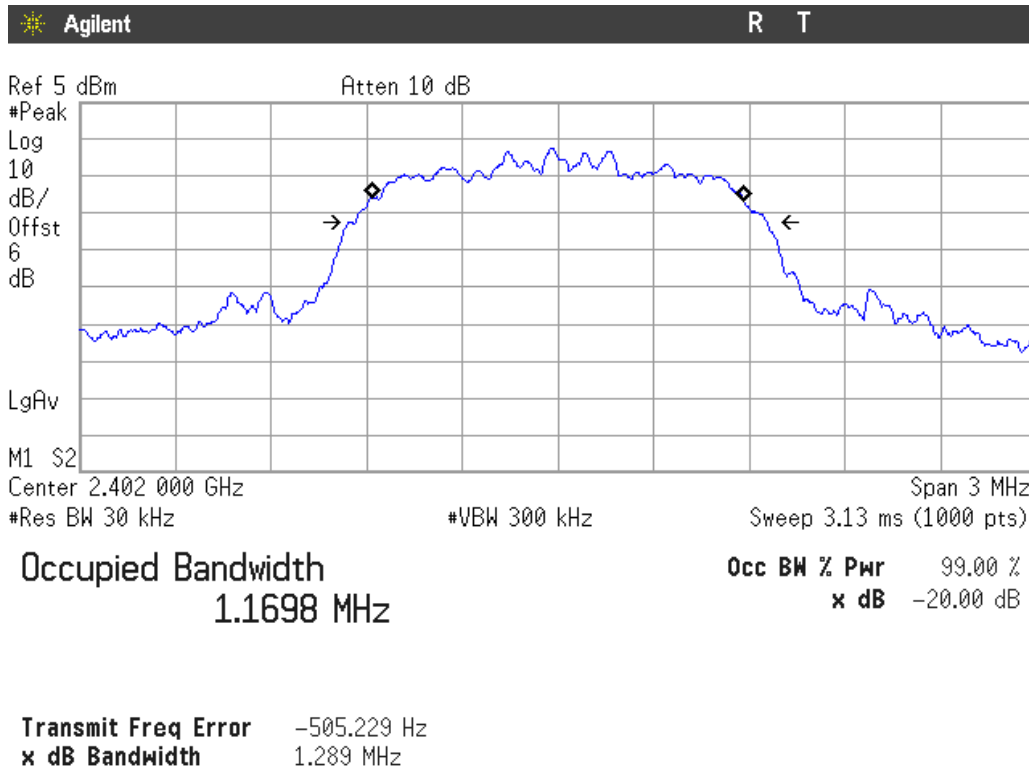

20 dB BANDWIDTH

Middle Channel: 2441 MHz.

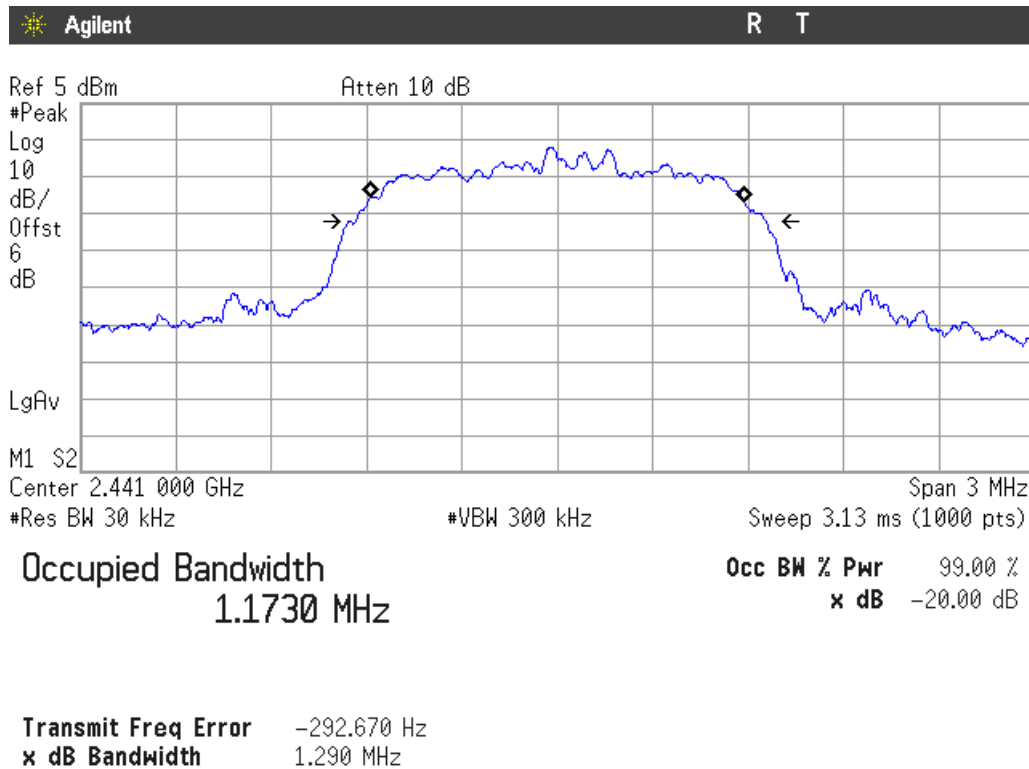

20 dB BANDWIDTH

Highest Channel: 2480 MHz.

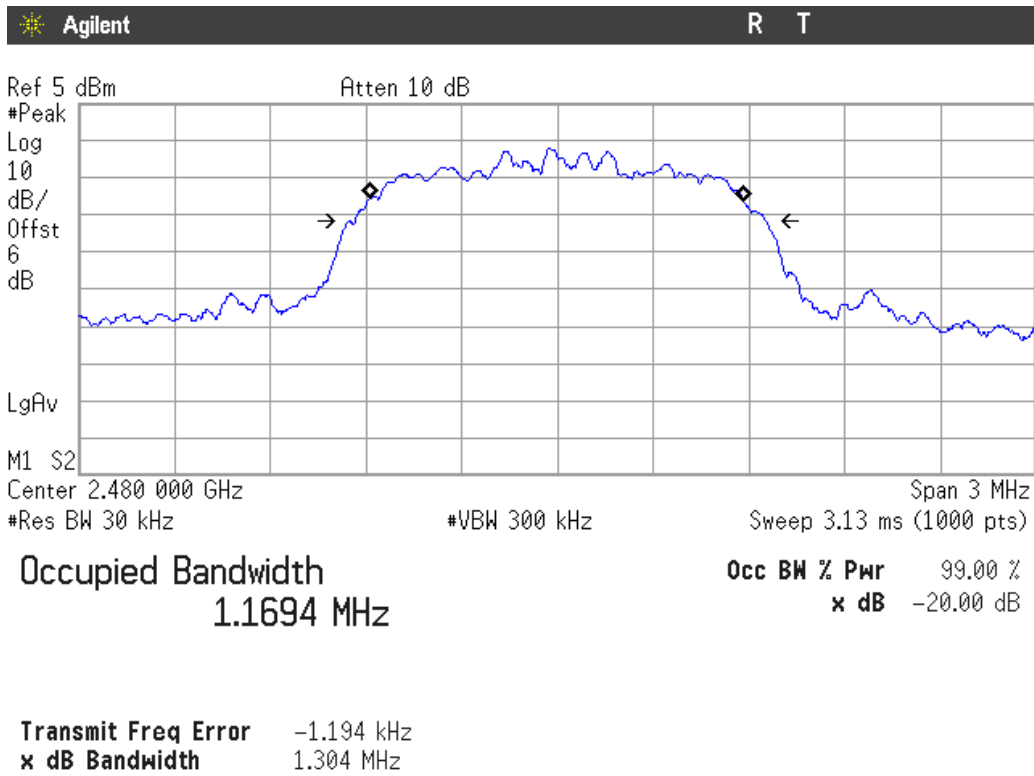

Carrier frequency separation

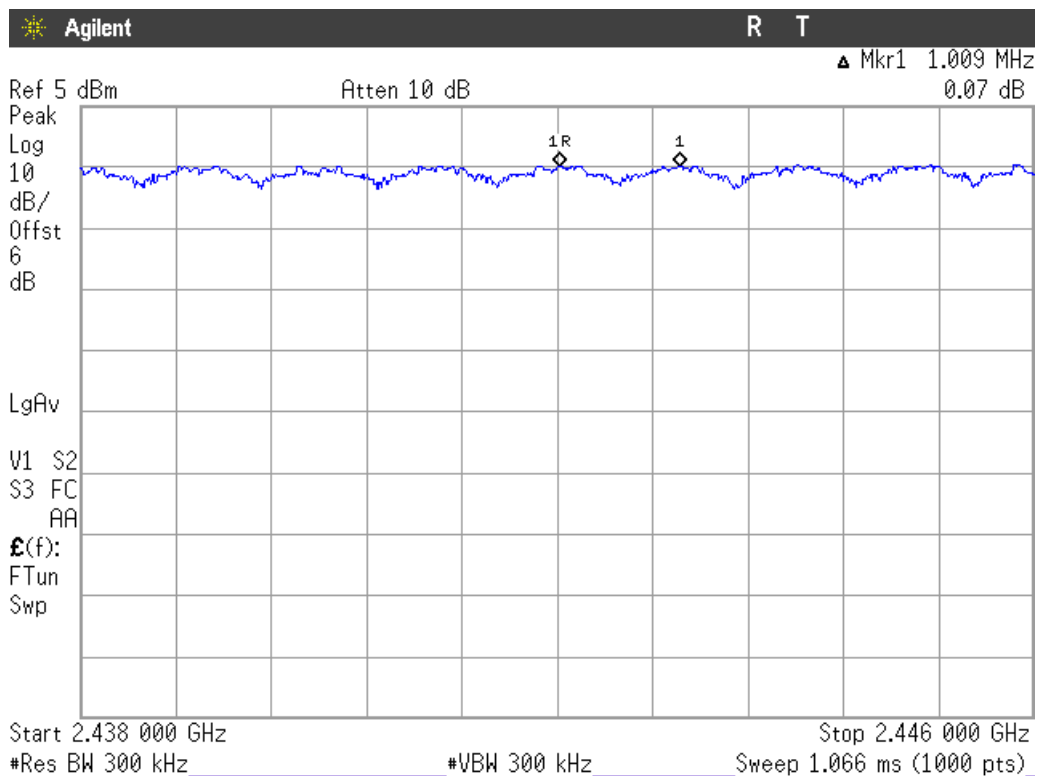

The hopping channel carrier frequencies are separated by a minimum of the two-thirds of the 20 dB bandwidth of the hopping channel

Verdict: PASS

Modulation: 8-DPSK

20 dB BANDWIDTH

Lowest Channel: 2402 MHz.

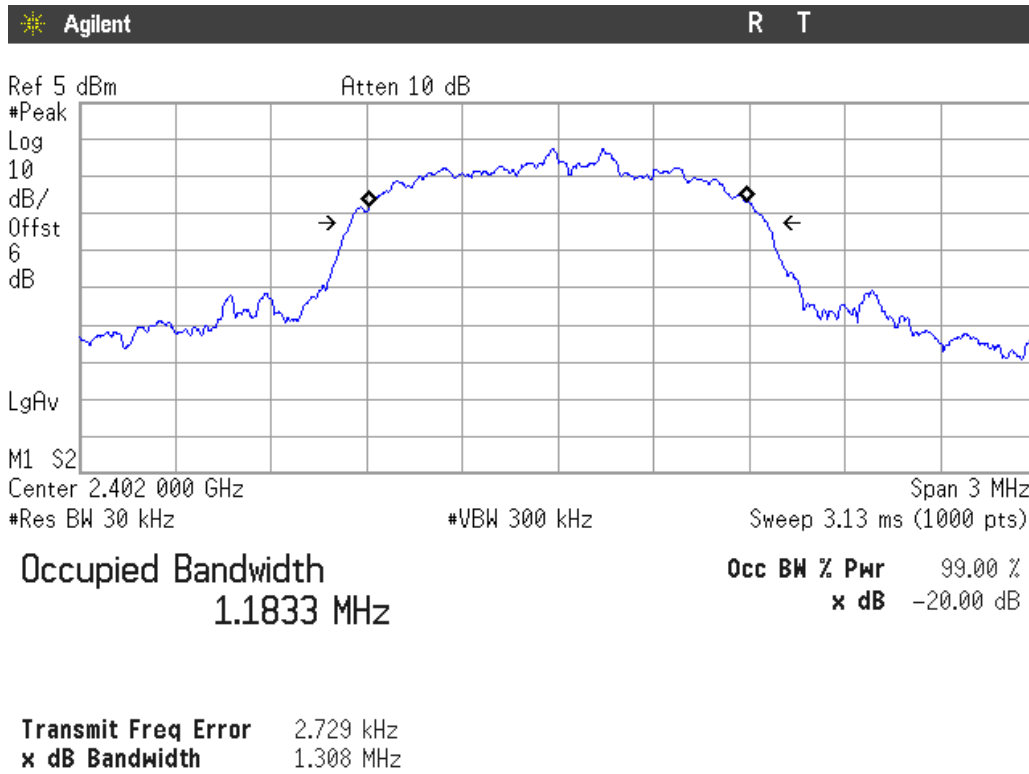

20 dB BANDWIDTH

Middle Channel: 2441 MHz.

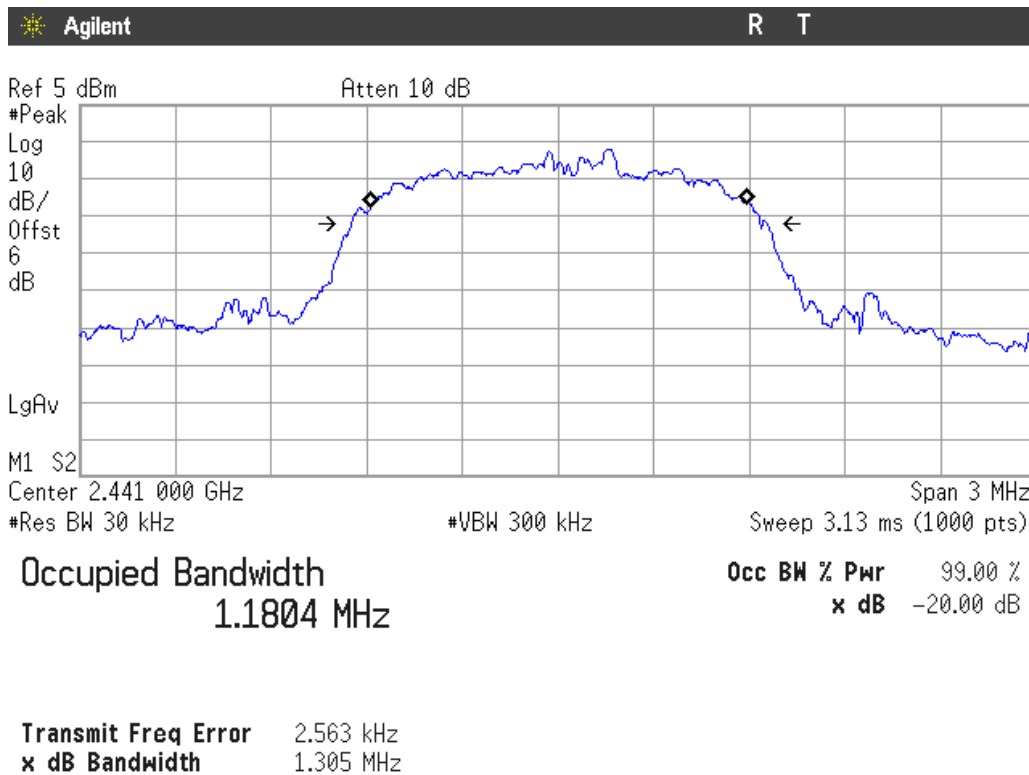

20 dB BANDWIDTH

Highest Channel: 2480 MHz.

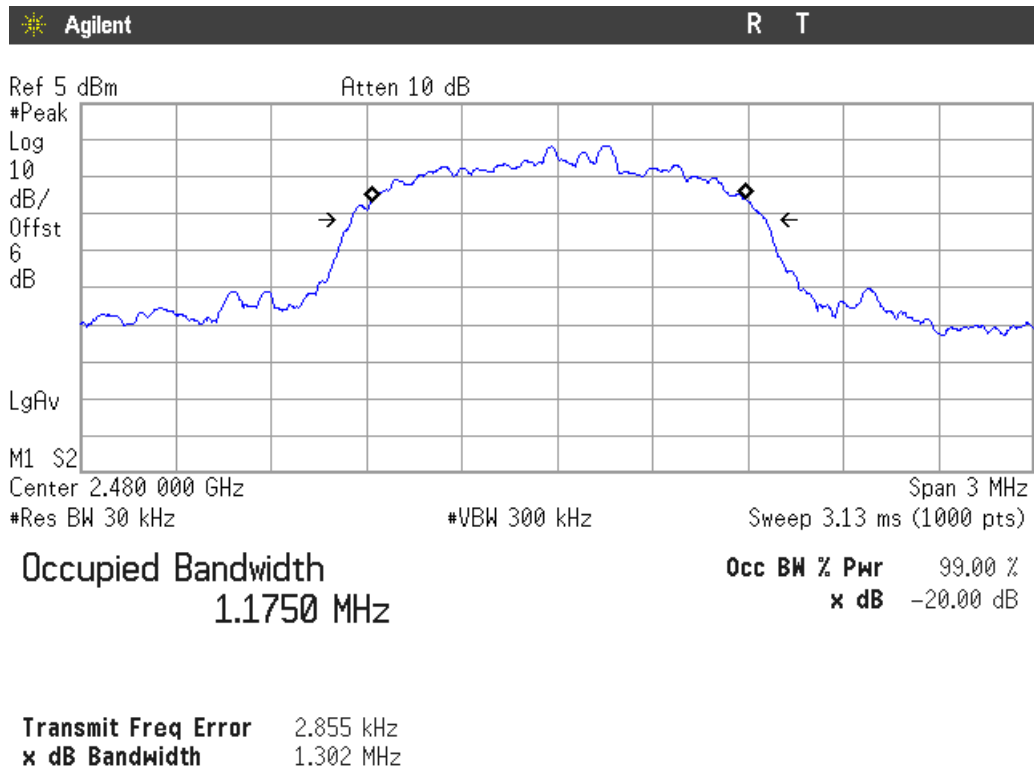

Carrier frequency separation

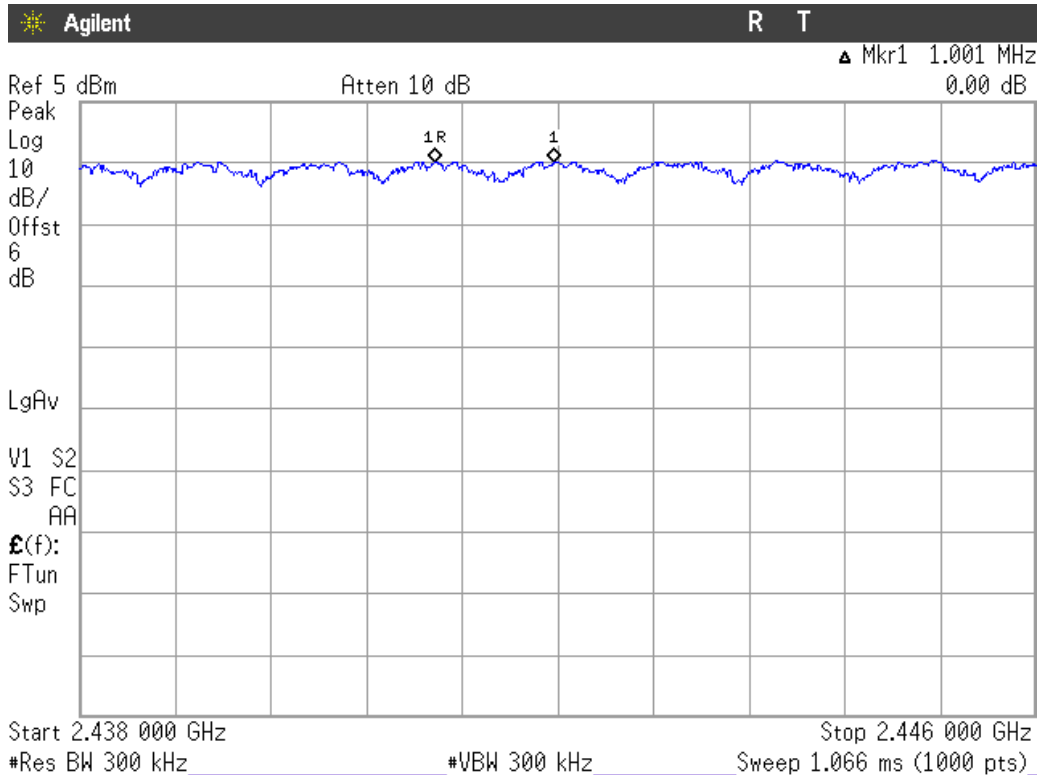

The hopping channel carrier frequencies are separated by a minimum of the two-thirds of the 20 dB bandwidth of the hopping channel.

Verdict: PASS

FCC Section 15.247 Subclause (a) (1) (iii) / RSS-247 Clause 5.1 (4). Number of hopping channels

SPECIFICATION

Frequency hopping system in the 2400-2483.5 MHz band shall use at least 15 channels.

RESULTS

The number of hopping channels is 79 for all three modes (see next plots).

Modulation: GFSK

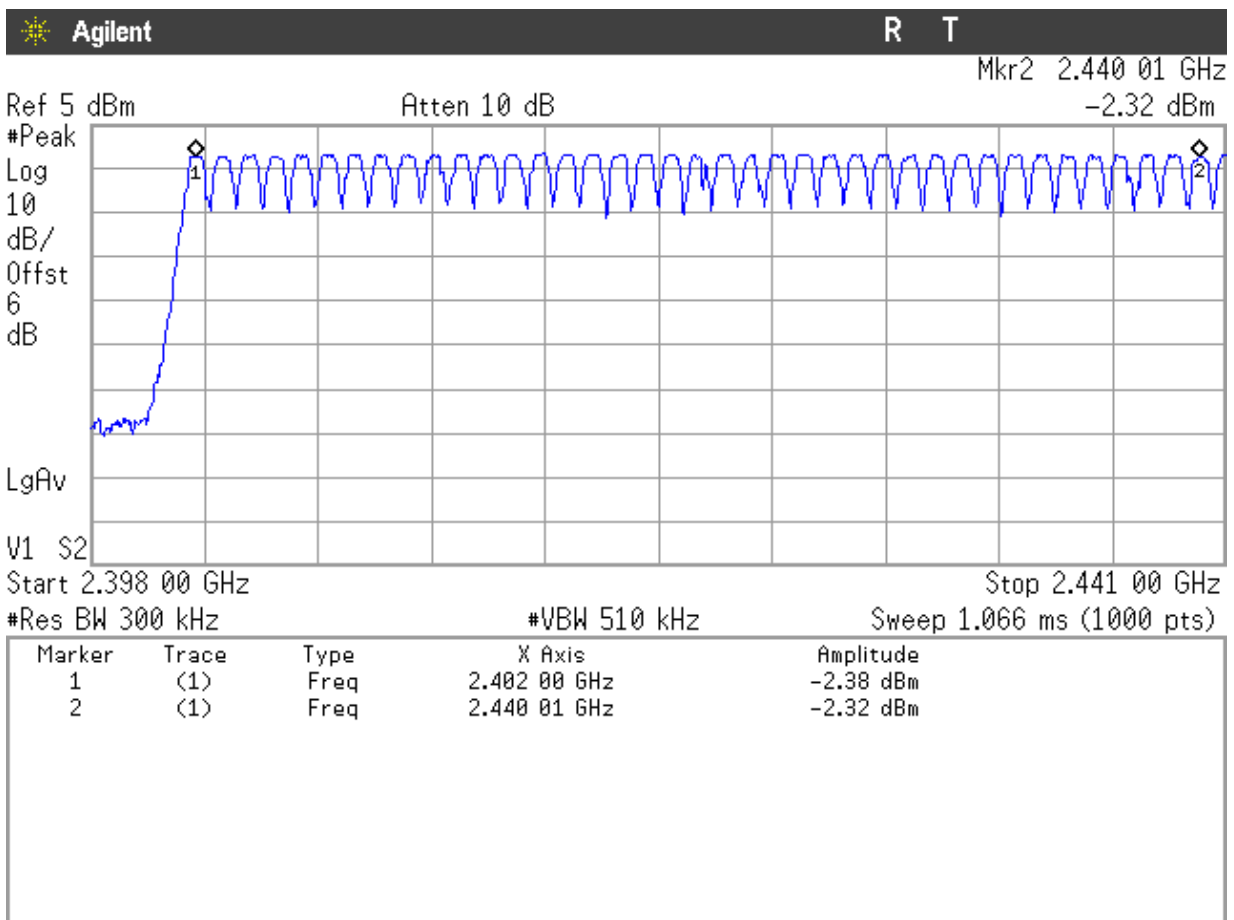

Number of hopping frequencies: 39

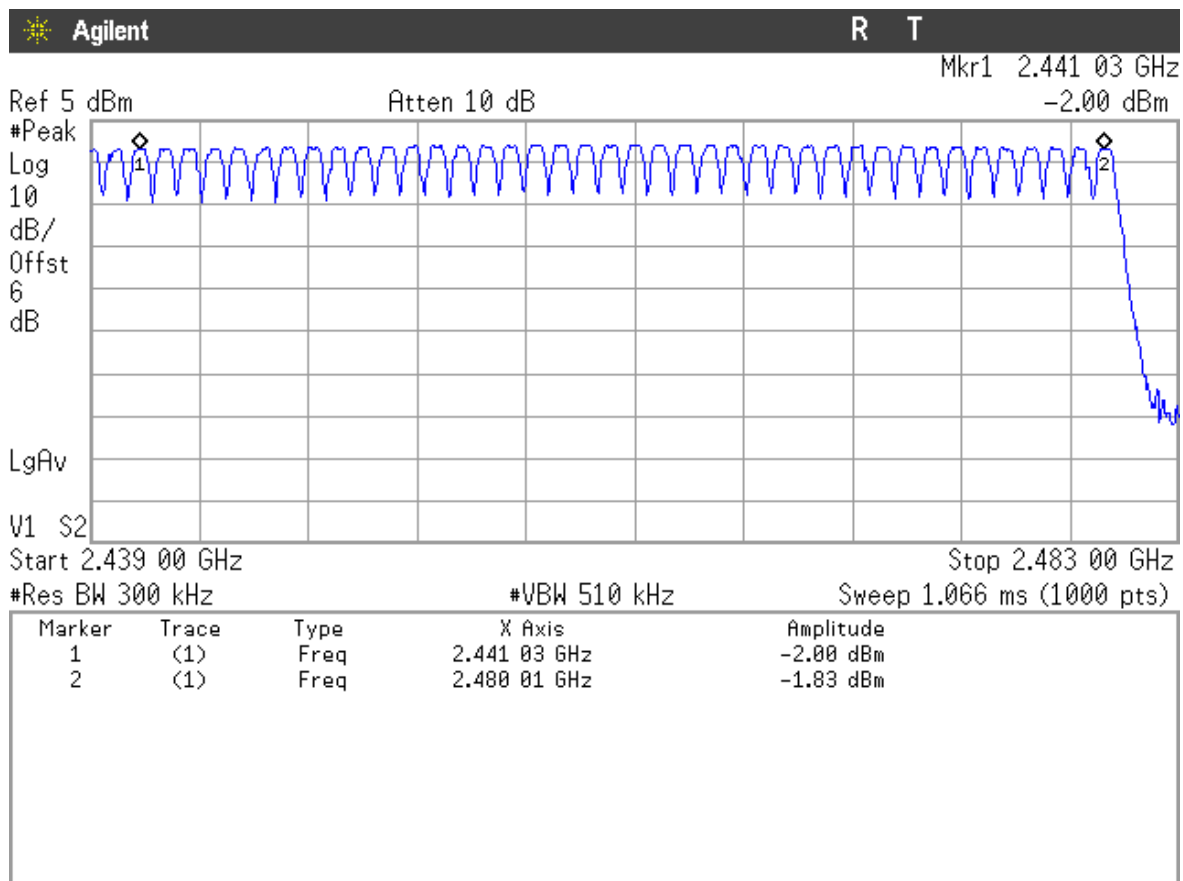

Number of hopping frequencies: 40

Total number of hopping frequencies: 79

Verdict: PASS

Modulation: $\Pi/4$ -DQPSK

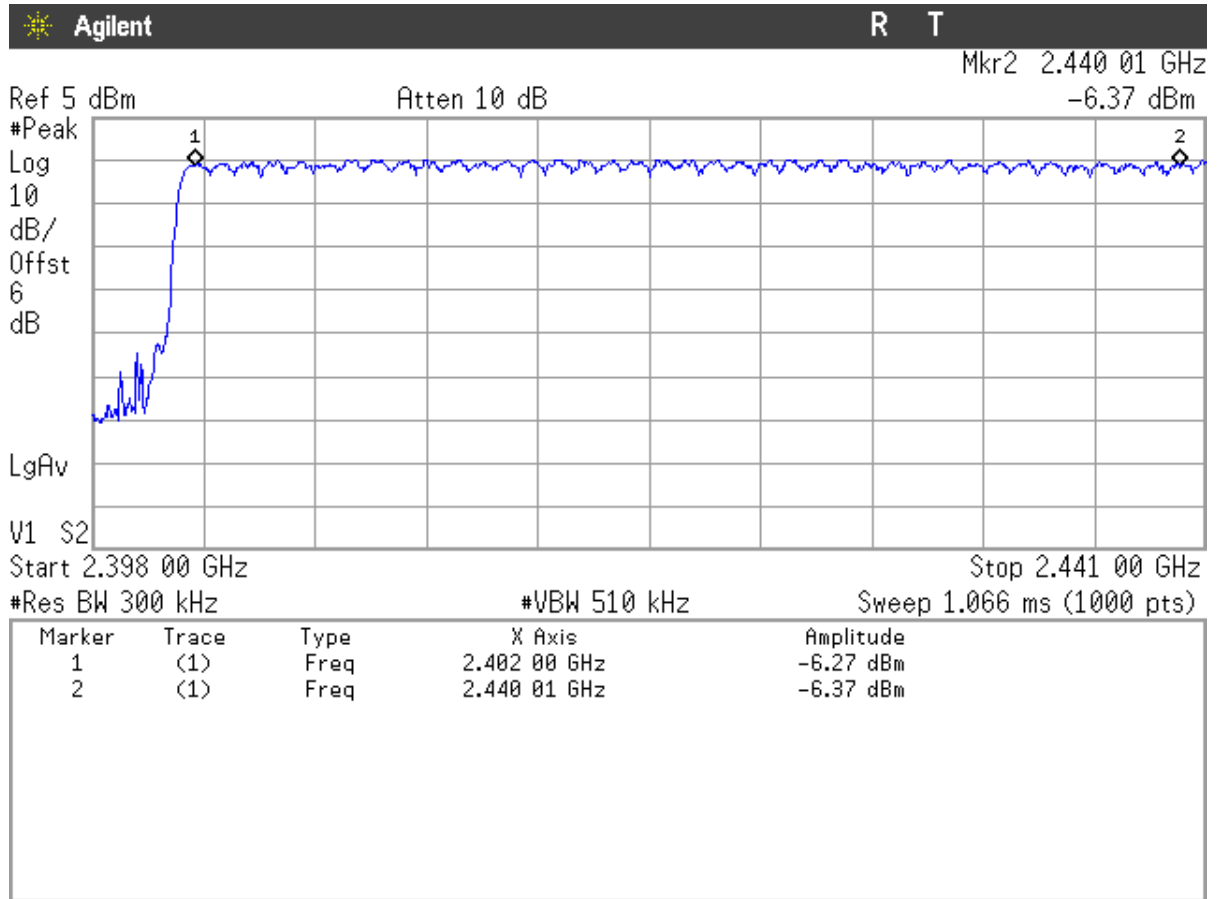

Number of hopping frequencies: 39

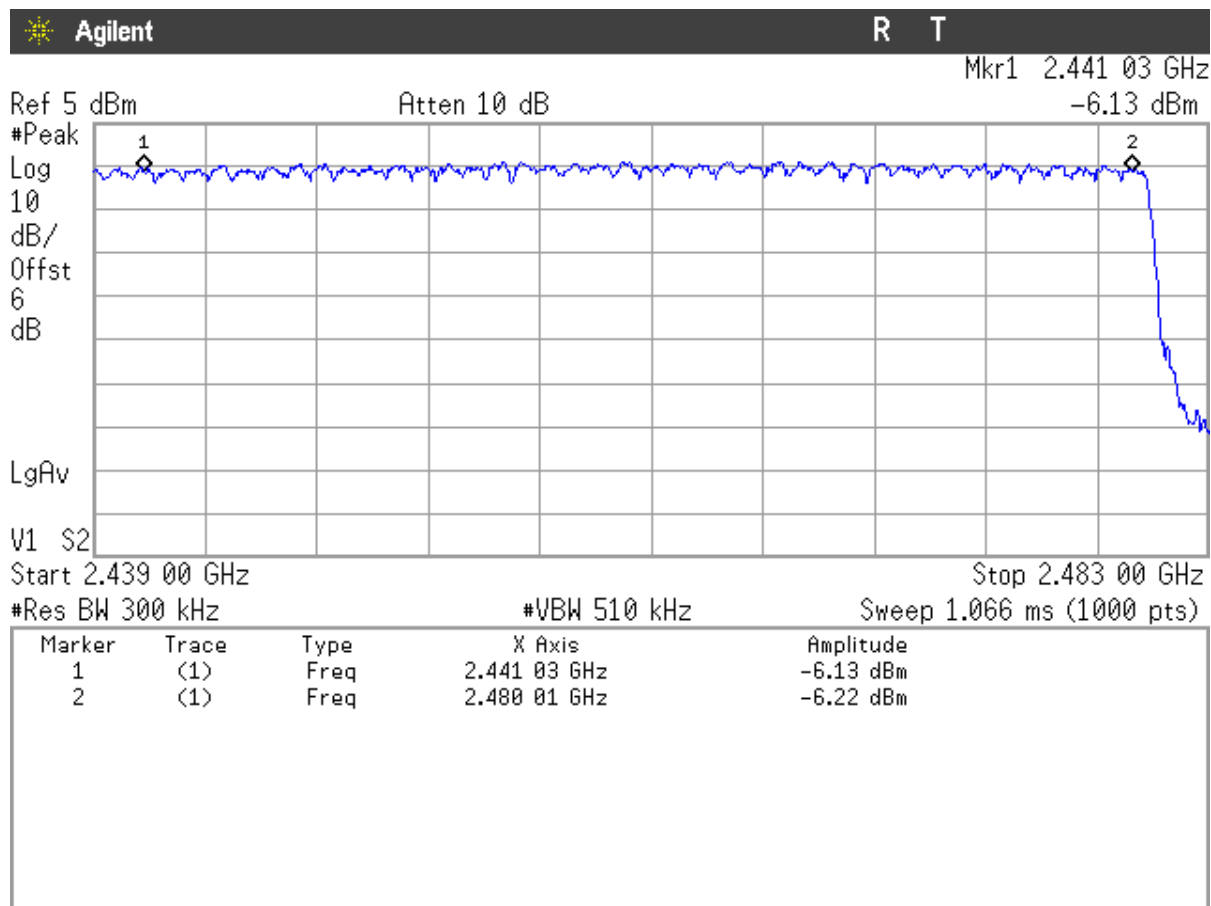

Number of hopping frequencies: 40

Total number of hopping frequencies: 79

Verdict: PASS

Modulation: 8-DPSK

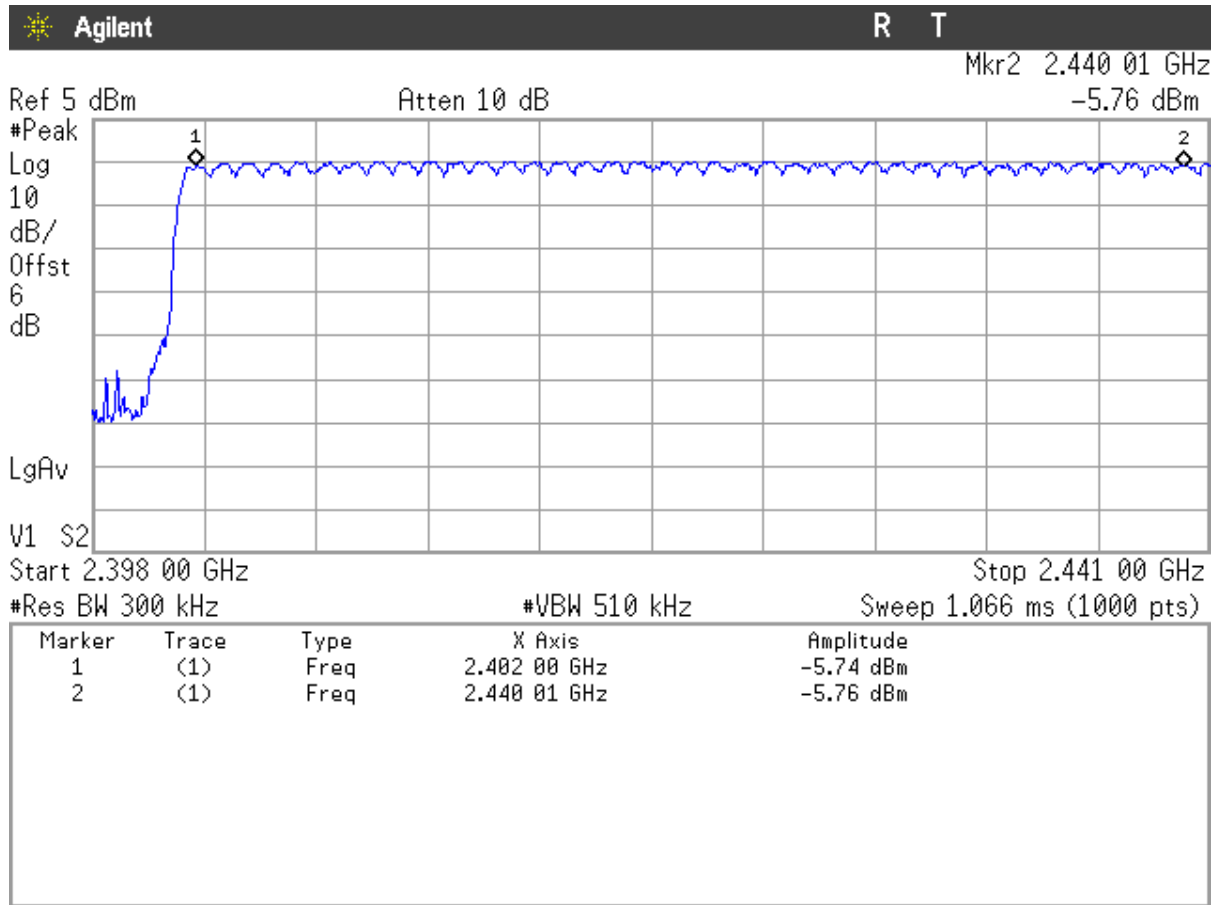

Number of hopping frequencies: 39

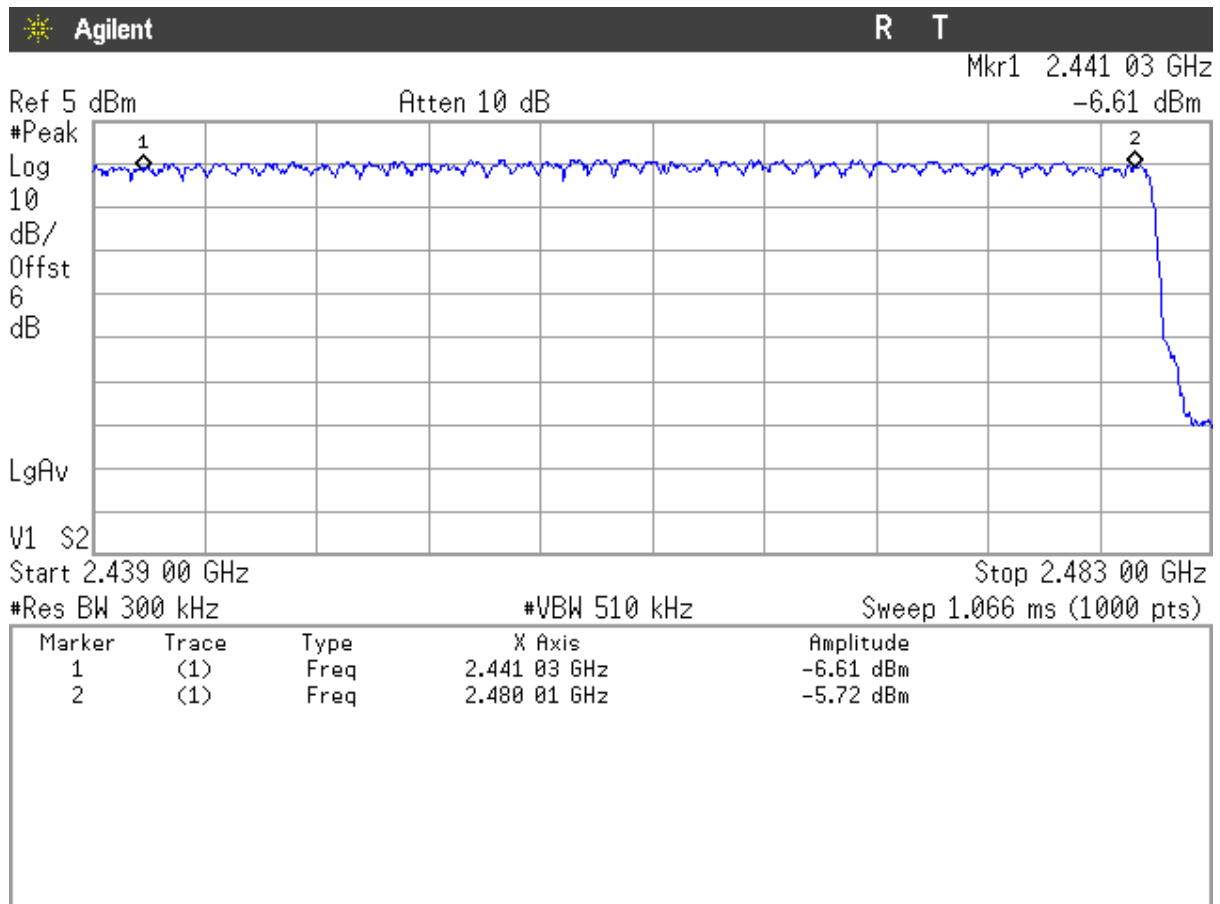

Number of hopping frequencies: 40

Total number of hopping frequencies: 79

Verdict: PASS

FCC Section 15.247 Subclause (a) (1) (iii) / RSS-247 Clause 5.1 (4). Time of occupancy (Dwell Time)

SPECIFICATION

The average time of occupancy on any channel shall not be greater than 0.4 seconds (400 ms) within a period of 0.4 seconds multiplied by the number of hopping channels employed = $0.4 \times 79 = 31.6$ seconds.

RESULTS

Modulation: GFSK

1. TIME OF OCCUPANCY (DWELL TIME) FOR PACKET TYPE DH1.

- Tx-time per hop = 377.7 μ s (see next plot).

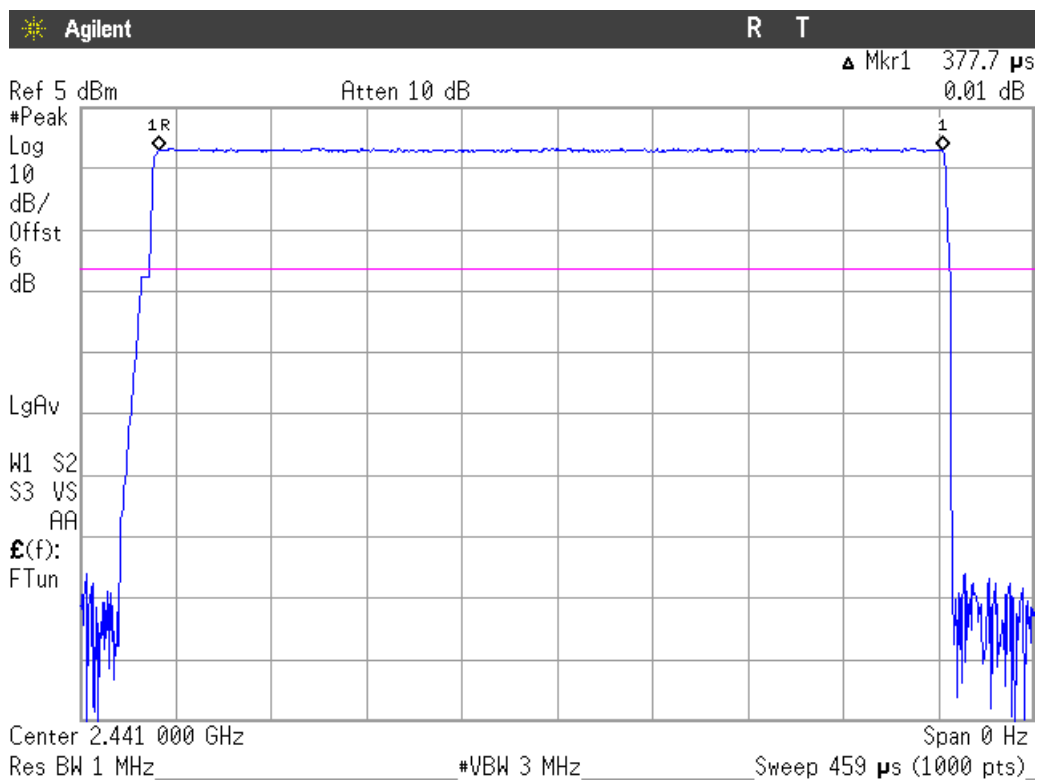

- Number of hops over a period of 1 seconds = 10 (see next plot).

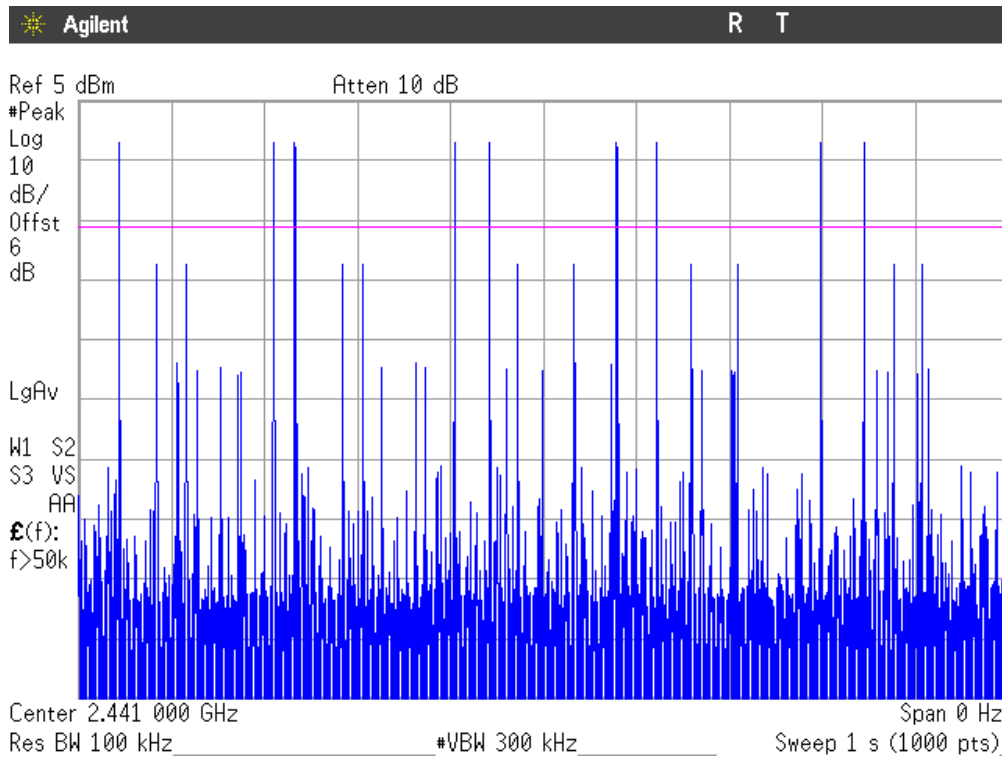

Number of hops in the period specified in the requirements = (10 hops) x (31.6 s / 1 s) = 316 hops.

Averaging time of occupancy = 377.7 μ s x 316 hops = 106.71 ms per 31.6 seconds.

Measurement uncertainty (%)	< \pm 0.01
-----------------------------	--------------

Verdict: PASS

2. TIME OF OCCUPANCY (DWELL TIME) FOR PACKET TYPE DH3.

- Tx-time per hop = 1.633 ms (see next plot).

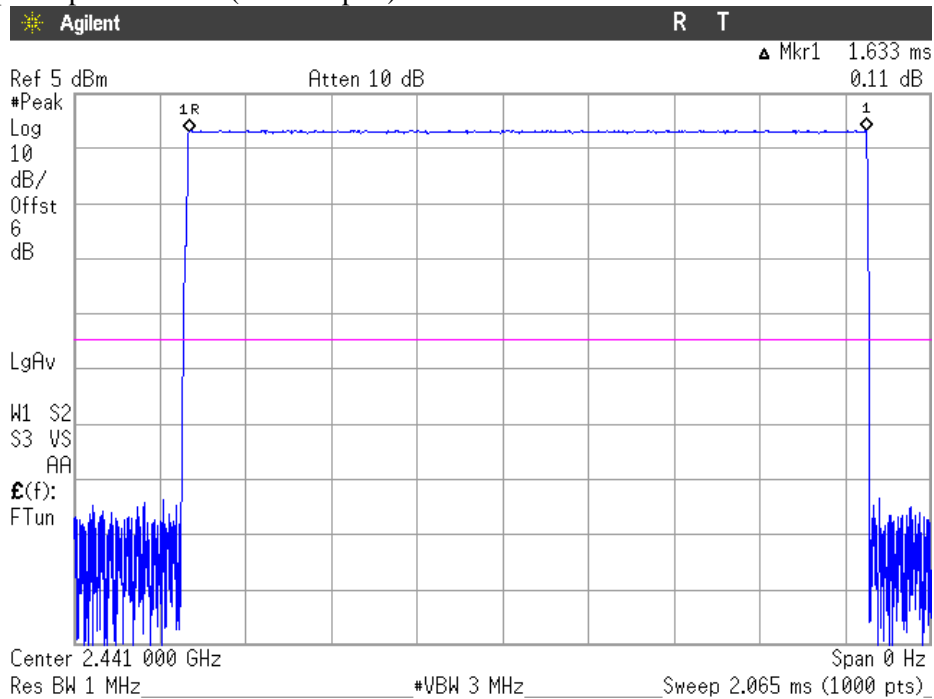

- Number of hops over a period of 3 seconds = 11 (see next plot).

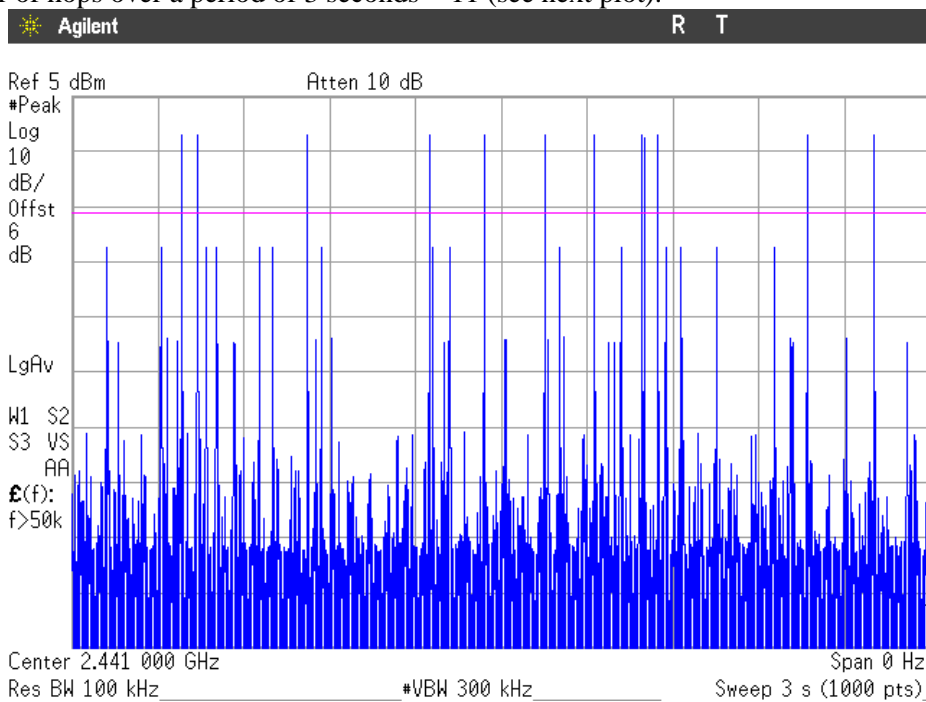

Number of hops in the period specified in the requirements = (11 hops) x (31.6 s / 3 s) = 115.87 hops.
 Averaging time of occupancy = 1.633 ms x 115.87 hops = 189.21 ms per 31.6 seconds.

Measurement uncertainty (%)	<±0.01
-----------------------------	--------

Verdict: PASS

3. TIME OF OCCUPANCY (DWELL TIME) FOR PACKET TYPE DH5.

- Tx- time per hop = 2.880 ms (see next plot).

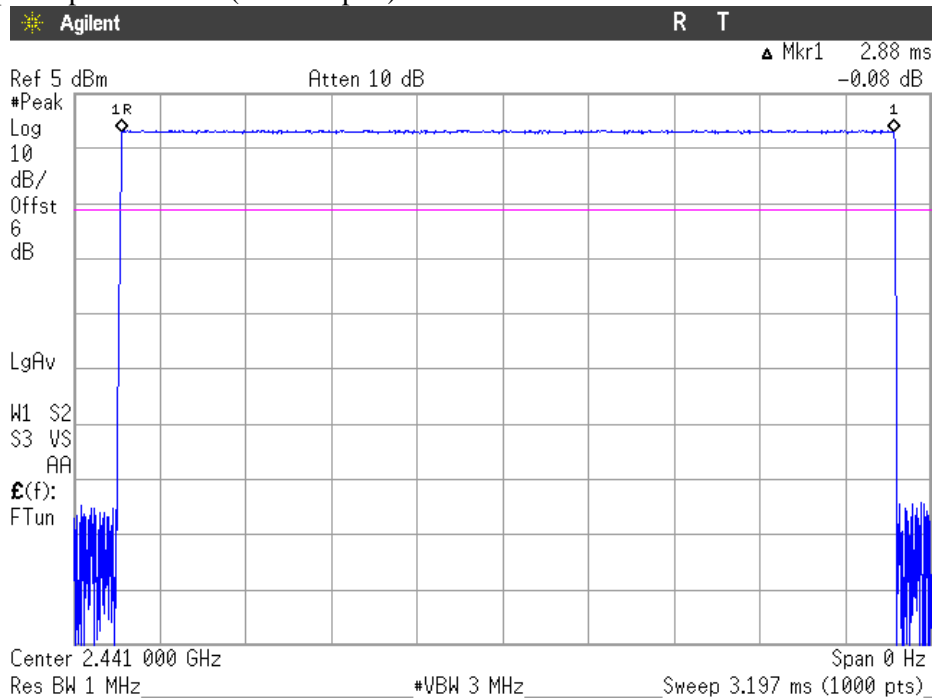

- Number of hops over a period of 3 seconds = 11 (see next plot).

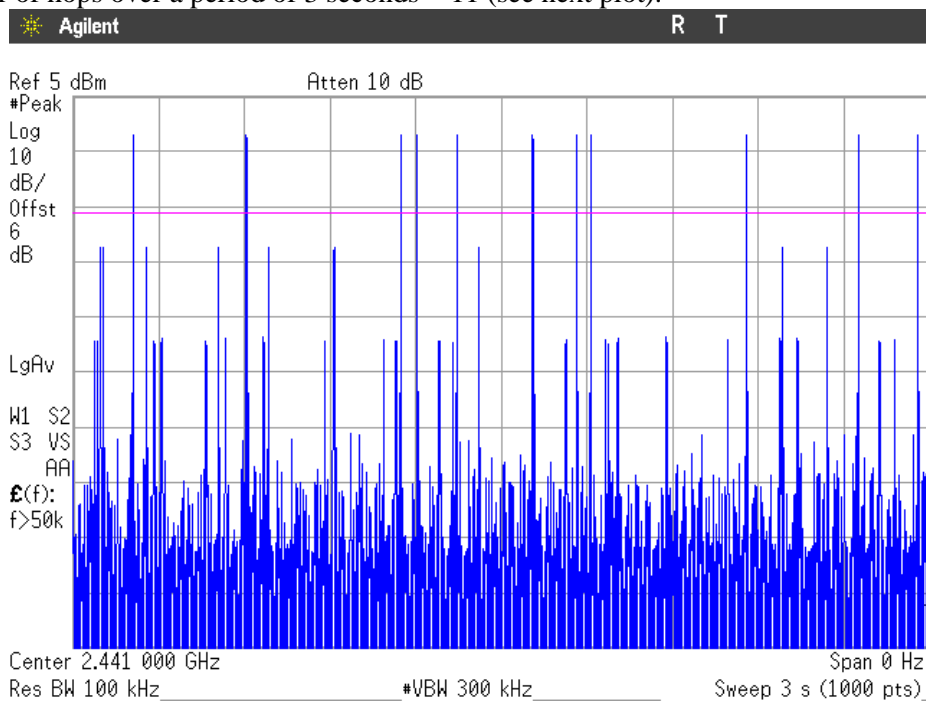

Number of hops in the period specified in the requirements = (11 hops) x (31.6 s / 3 s) = 115.87 hops.
 Averaging time of occupancy = 2.880 ms x 115.87 hops = 333.70 ms per 31.6 seconds.

Measurement uncertainty (%)	<±0.01
-----------------------------	--------

Verdict: PASS

Modulation: Π/4-DQPSK

1. TIME OF OCCUPANCY (DWELL TIME) FOR PACKET TYPE DH1.

- Tx- time per hop = 385.5 μs (see next plot).

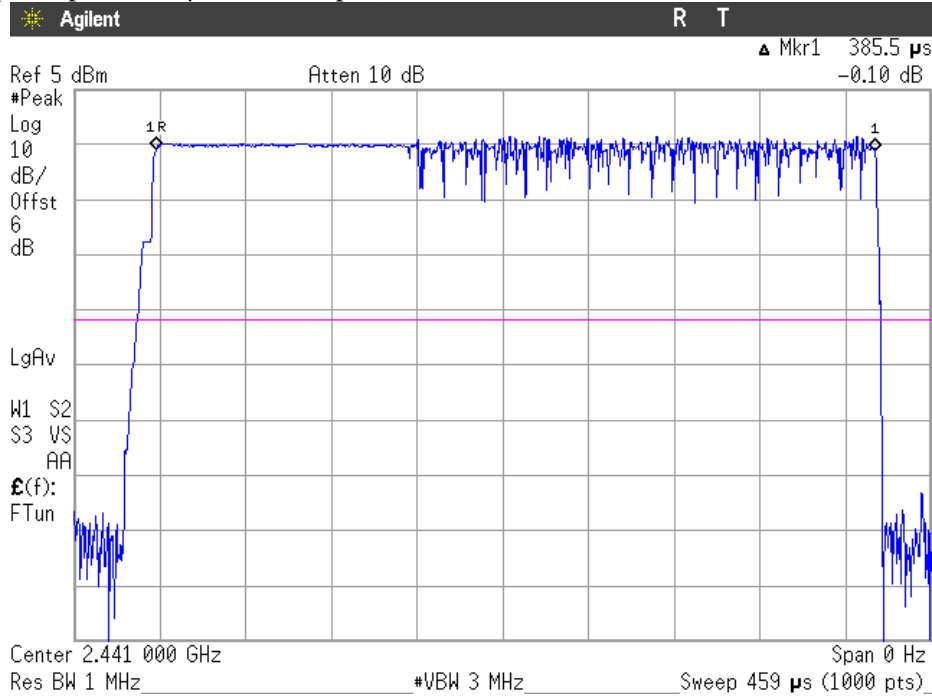

- Number of hops over a period of 1 second = 11 (see next plot).

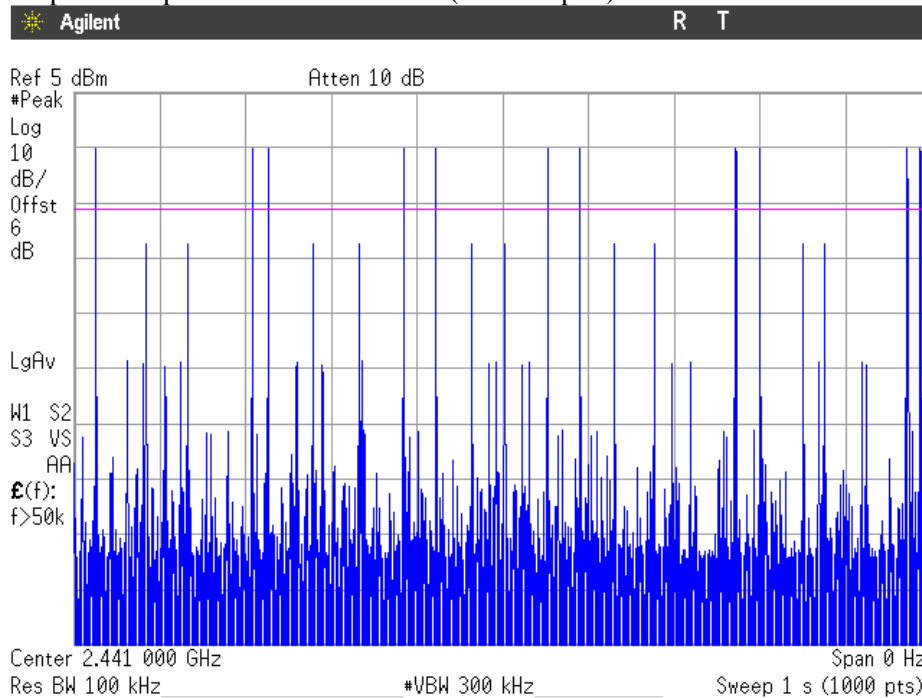

Number of hops in the period specified in the requirements = (11 hops) x (31.6 s / 1 s) = 347.6 hops.
 Averaging time of occupancy = 385.5 μs x 347.6 hops = 134 ms per 31.6 seconds.

Measurement uncertainty (%)	<±0.01
-----------------------------	--------

Verdict: PASS

2. TIME OF OCCUPANCY (DWELL TIME) FOR PACKET TYPE DH3.

- Tx- time per hop = 1.637 ms (see next plot).

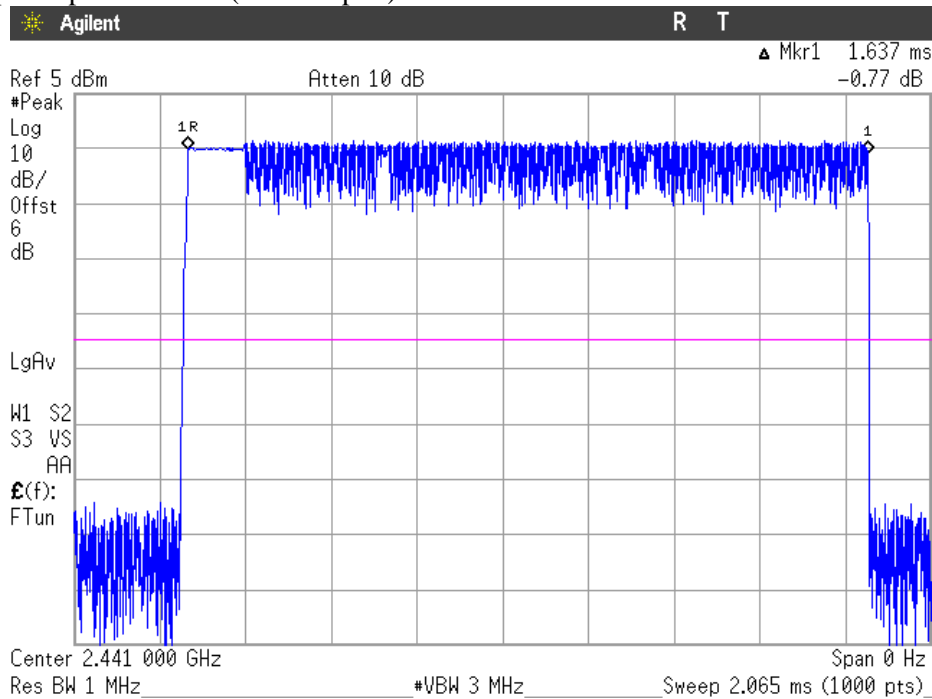

- Number of hops over a period of 3 seconds = 11 (see next plot).

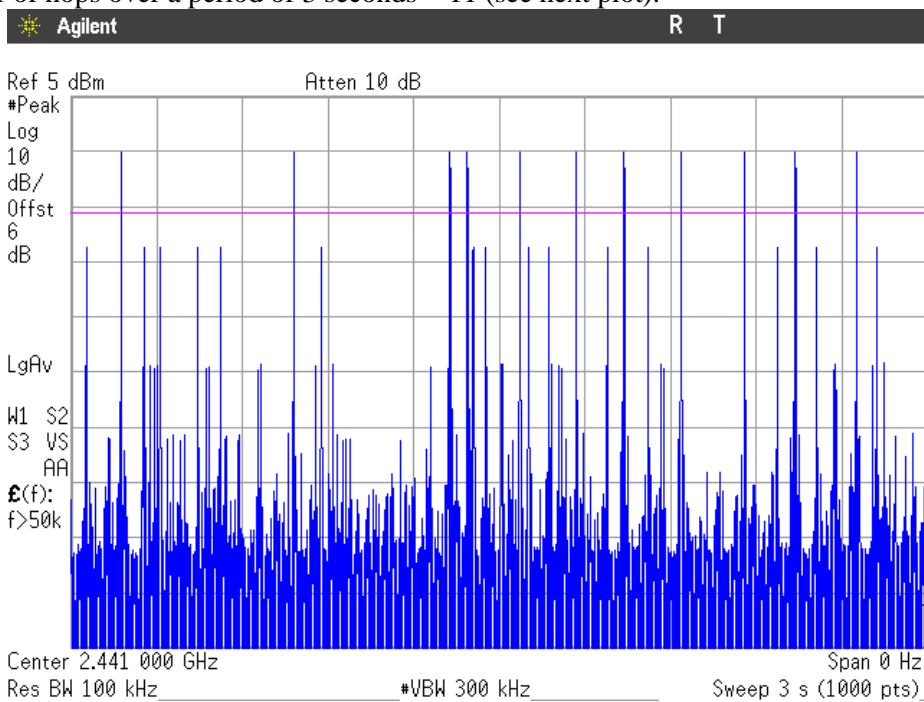

Number of hops in the period specified in the requirements = (11 hops) x (31.6 s / 3 s) = 115.87 hops.
 Averaging time of occupancy = 1.637 ms x 115.87 hops = 189.68 ms per seconds.

Measurement uncertainty (%)	<±0.01
-----------------------------	--------

Verdict: PASS

3. TIME OF OCCUPANCY (DWELL TIME) FOR PACKET TYPE DH5.

- Tx-time per hop = 2.886 ms (see next plot).

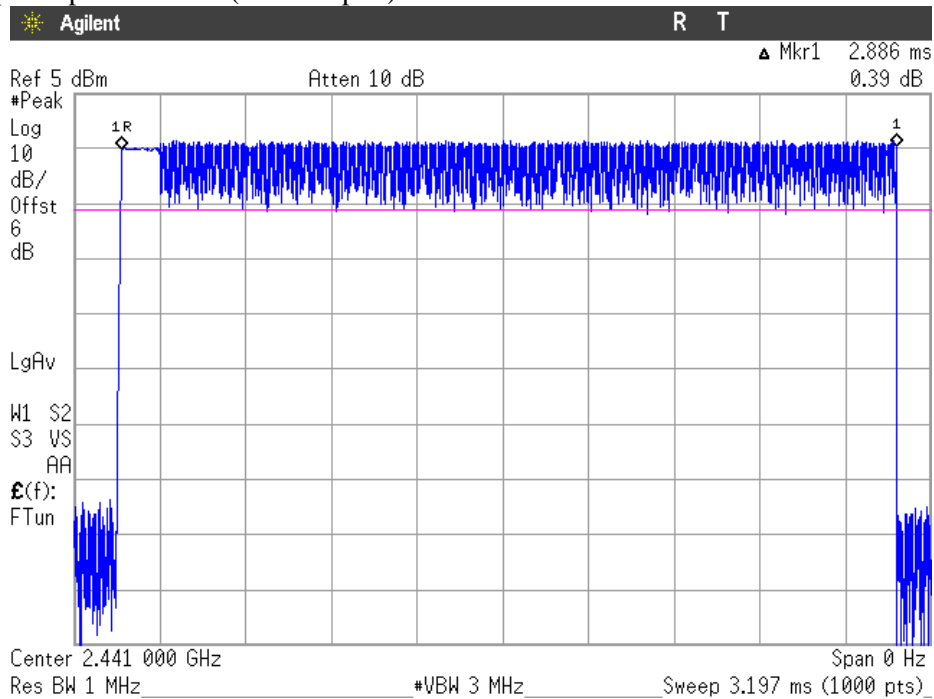

- Number of hops over a period of 3 seconds = 11 (see next plot).

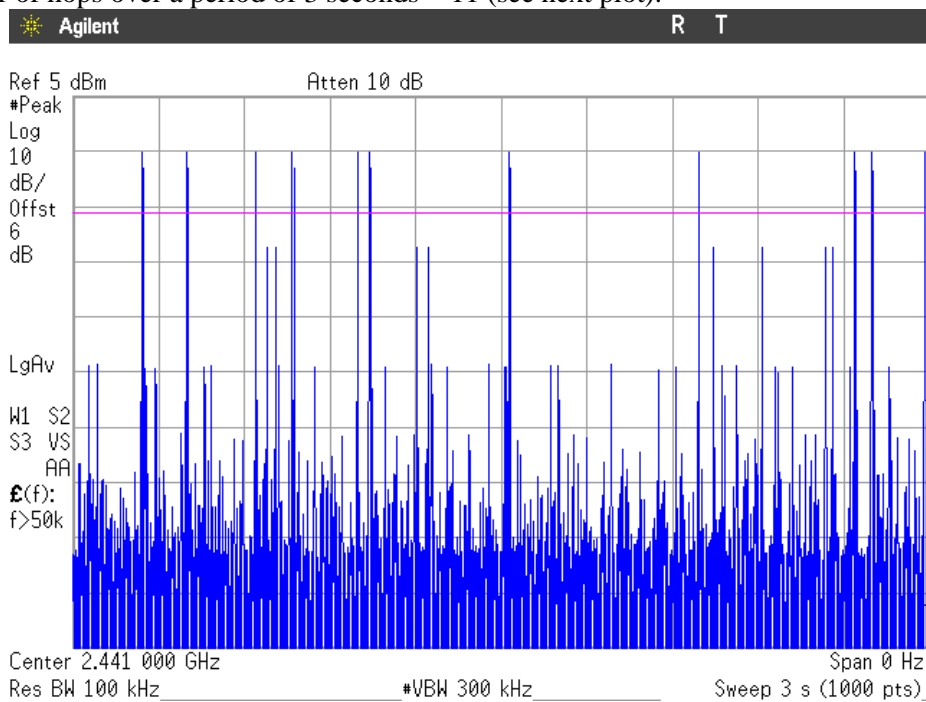

Number of hops in the period specified in the requirements = (11 hops) x (31.6 s / 3 s) = 115.87 hops.
 Averaging time of occupancy = 2.886 ms x 115.87 hops = 334.39 ms per 31.6 seconds.

Measurement uncertainty (%)	<±0.01
-----------------------------	--------

Verdict: PASS

Modulation: 8-DPSK

1. TIME OF OCCUPANCY (DWELL TIME) FOR PACKET TYPE DH1.

- Tx- time per hop = 383.2 μs (see next plot).

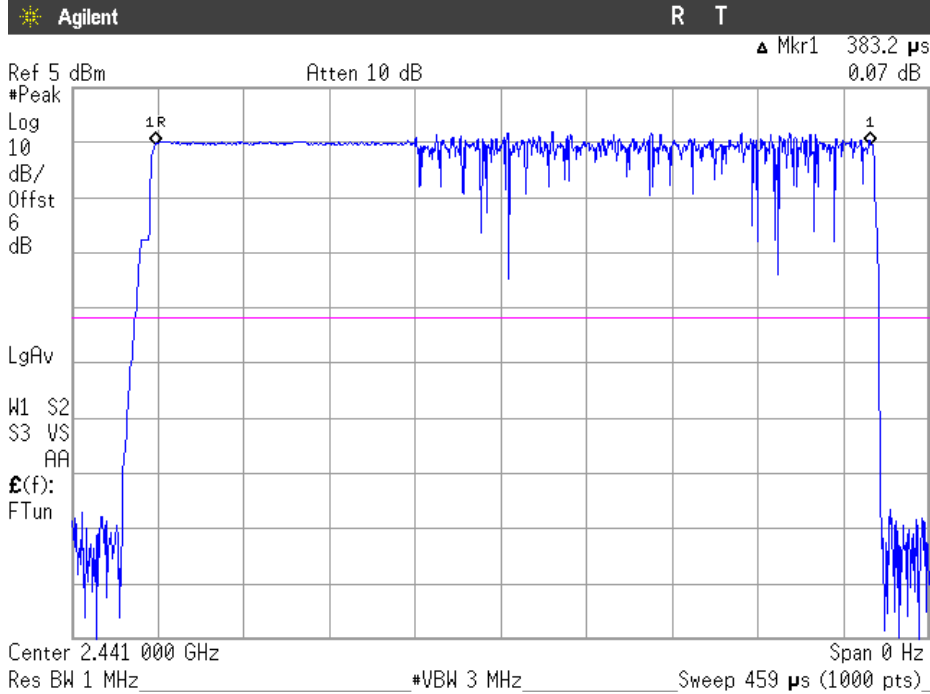

- Number of hops over a period of 1 second = 9 (see next plot).

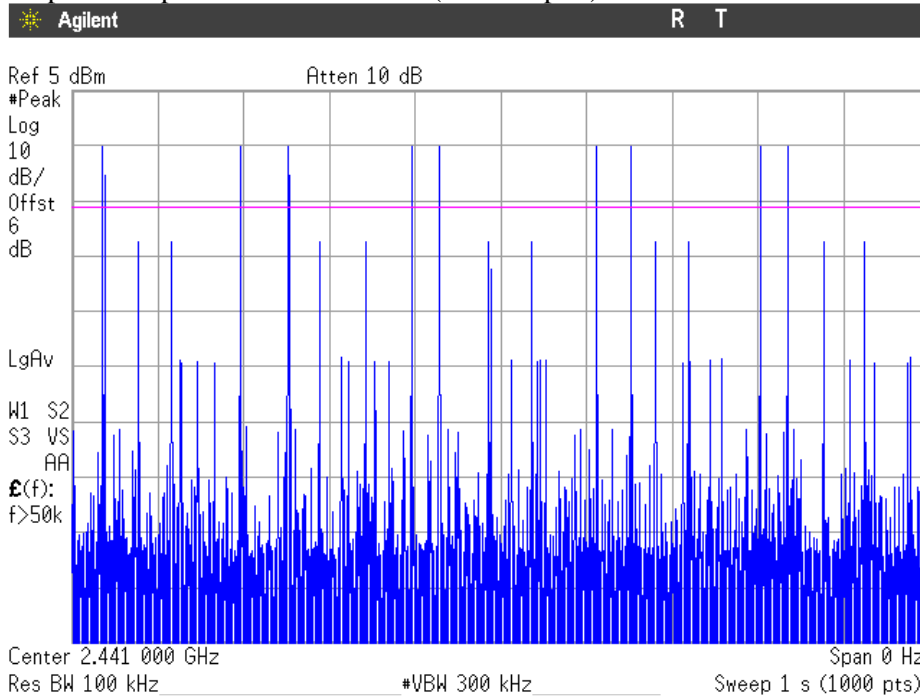

Number of hops in the period specified in the requirements = (9 hops) x (31.6 s / 1 s) = 284.4 hops.
 Averaging time of occupancy = 383.2 μs x 284.4 hops = 108.98 ms per seconds.

Measurement uncertainty (%)	<±0.01
-----------------------------	--------

Verdict: PASS

2. TIME OF OCCUPANCY (DWELL TIME) FOR PACKET TYPE DH3.

- Tx- time per hop = 1.635 ms (see next plot).

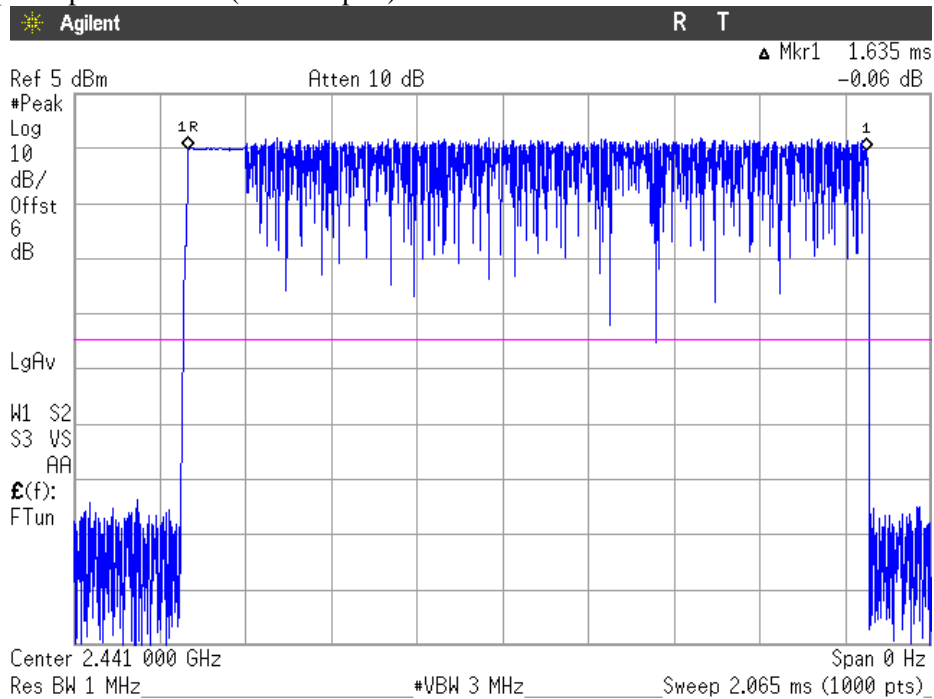

- Number of hops over a period of 3 seconds = 14 (see next plot).

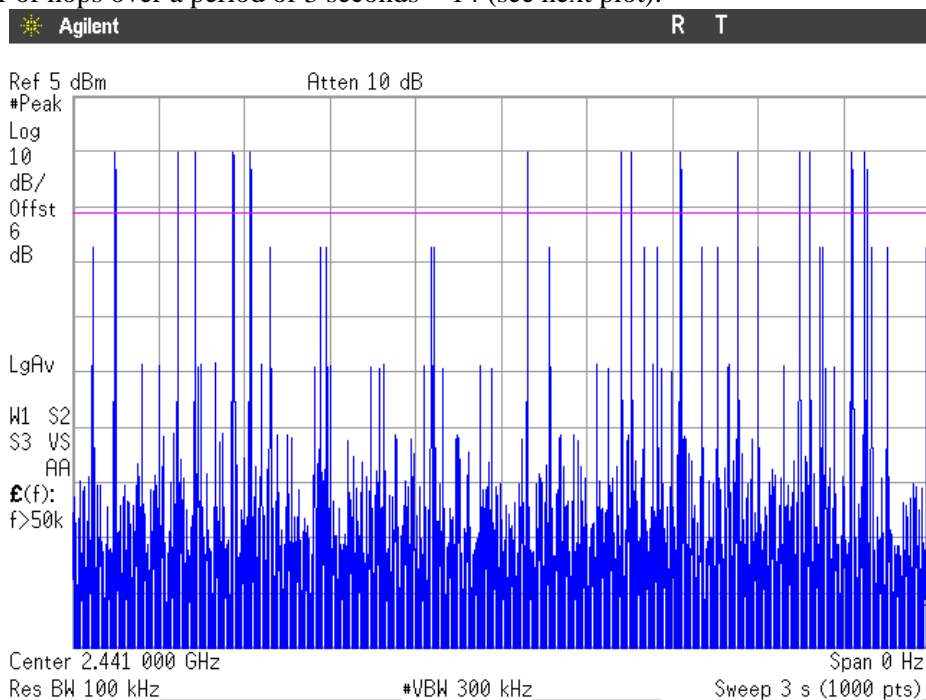

Number of hops in the period specified in the requirements = (14 hops) x (31.6 s / 3 s) = 147.47 hops.
 Averaging time of occupancy = 1.635 ms x 147.47 hops = 241.11 ms per 31.6 seconds.

Measurement uncertainty (%)	<±0.01
-----------------------------	--------

Verdict: PASS

3. TIME OF OCCUPANCY (DWELL TIME) FOR PACKET TYPE DH5.

- Tx-time per hop = 2.877 ms (see next plot).

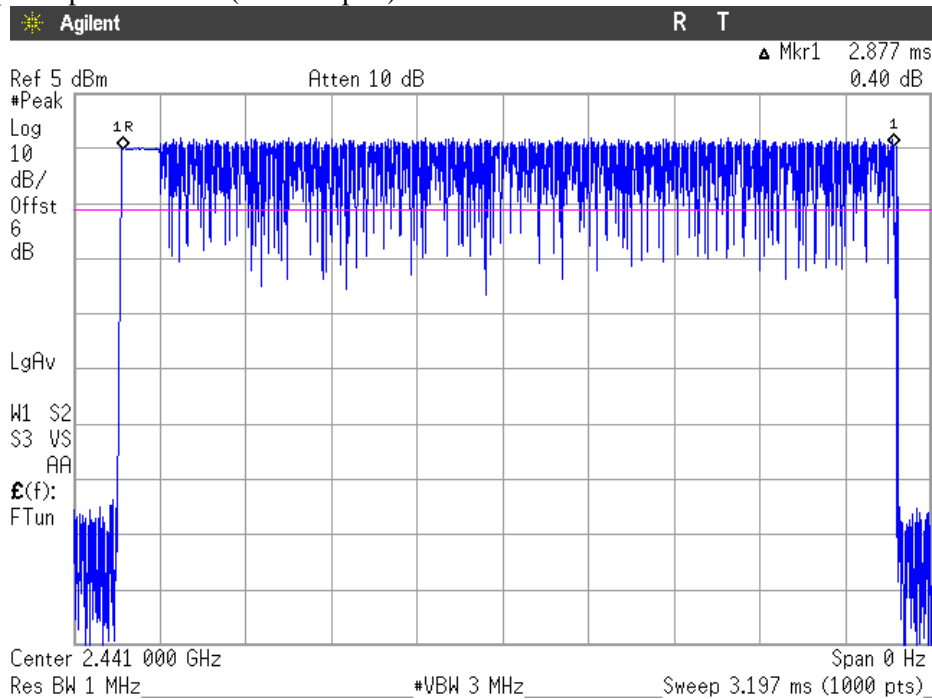

- Number of hops over a period of 3 seconds = 13 (see next plot).

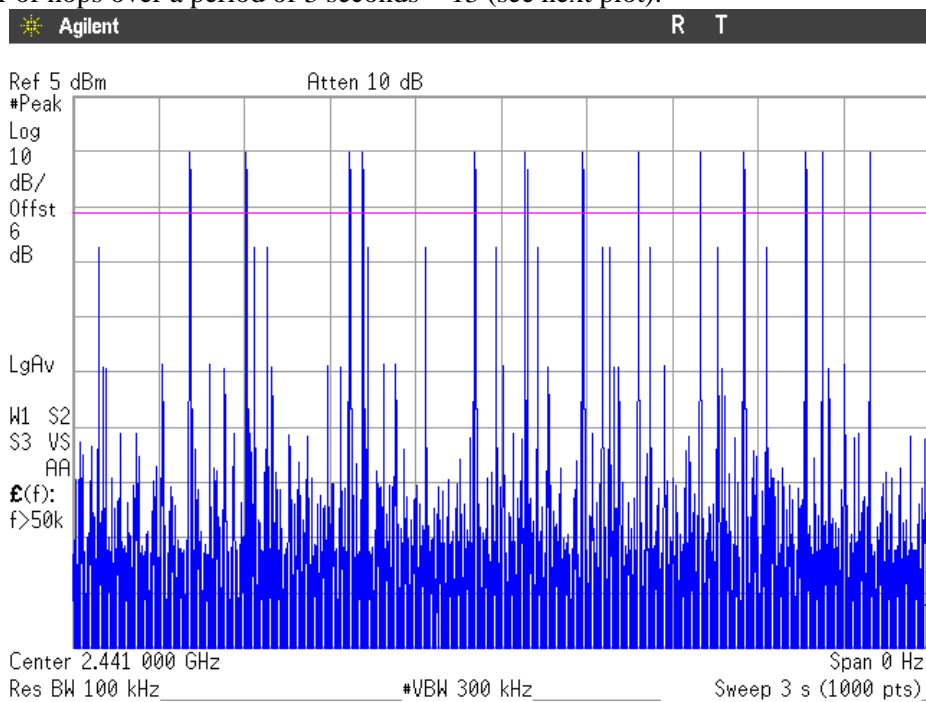

Number of hops in the period specified in the requirements = (13 hops) x (31.6 s / 3 s) = 136.93 hops.
 Averaging time of occupancy = 2.877 ms x 136.93 hops = 393.96 ms per 31.6 seconds.

Measurement uncertainty (%)	<±0.01
-----------------------------	--------

Verdict: PASS

FCC Section 15.247 Subclause (b) / RSS-247 Clause 5.4 (2). Maximum peak output power and antenna gain

SPECIFICATION

For frequency hopping systems operating in the 2400-2483.5 MHz band employing at least 75 hopping channels: 1 watt (30 dBm). The e.i.r.p. shall not exceed 4 W (RSS-247).

MAXIMUM OUTPUT POWER. See next plots.

Declared maximum antenna gain: +4 dBi.

The EIRP power (dBm) is calculated by adding the declared maximum antenna gain to the measured conducted power.

Modulation: GFSK

	Lowest frequency 2402 MHz	Middle frequency 2441 MHz	Highest frequency 2480 MHz
Maximum peak power (dBm)	-2.13	-1.78	-1.60
Maximum EIRP power (dBm)	1.87	2.22	2.40
Measurement uncertainty (dB)	<±0.78		

Modulation: Π/4-DQPSK (2Mbps)

	Lowest frequency 2402 MHz	Middle frequency 2441 MHz	Highest frequency 2480 MHz
Maximum peak power (dBm)	-3.27	-2.93	-2.79
Maximum EIRP power (dBm)	0.73	1.07	1.21
Measurement uncertainty (dB)	<±0.78		

Modulation: 8-DPSK (3Mbps)

	Lowest frequency 2402 MHz	Middle frequency 2441 MHz	Highest frequency 2480 MHz
Maximum peak power (dBm)	-2.88	-2.56	-2.39
Maximum EIRP power (dBm)	1.12	1.44	1.61
Measurement uncertainty (dB)	<±0.78		

The maximum directional gain of the antenna is less than 6 dBi and therefore the maximum output power is not required to be reduced from the stated values.

Verdict: PASS

PEAK OUTPUT POWER (CONDUCTED).

Modulation: GFSK

Lowest Channel: 2402 MHz.

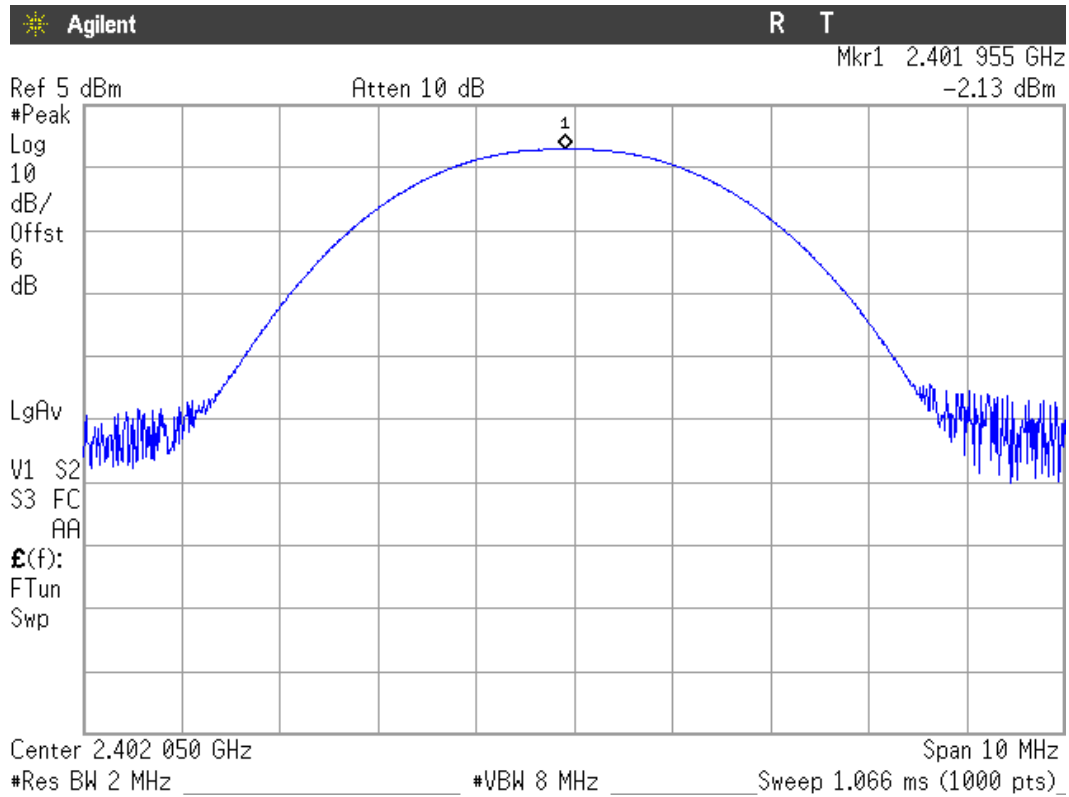

Modulation: GFSK

Middle Channel: 2441 MHz.

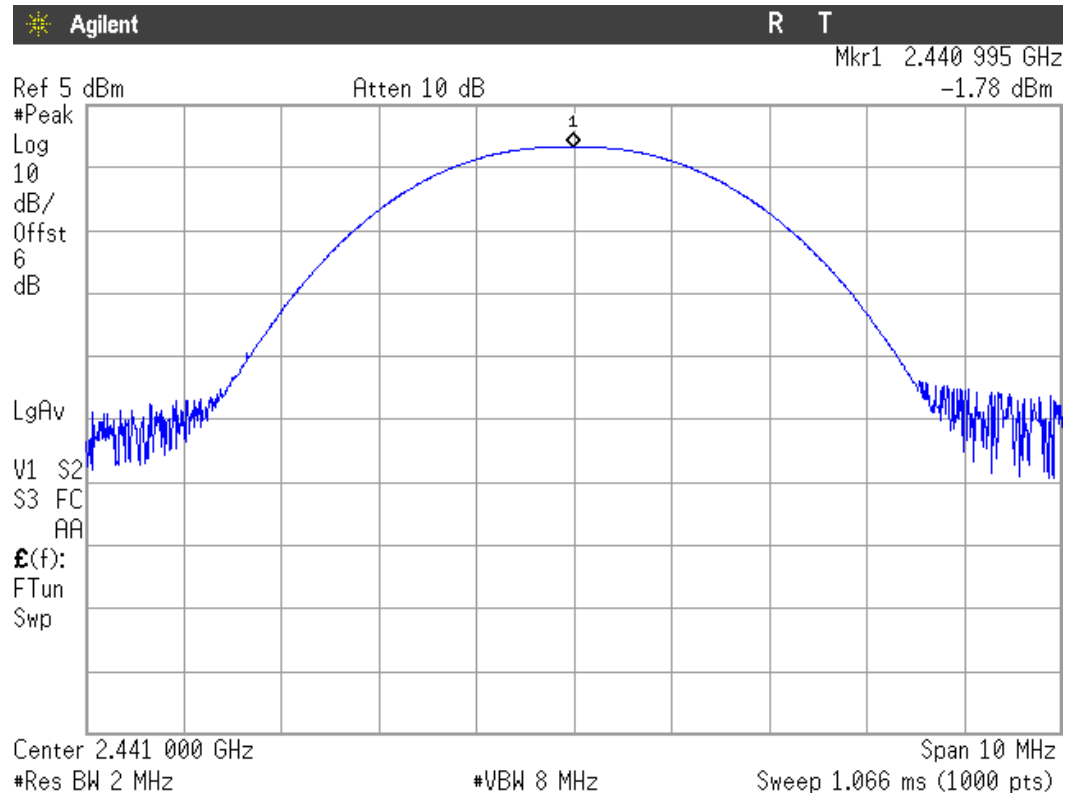

PEAK OUTPUT POWER (CONDUCTED).

Modulation: GFSK

Highest Channel: 2480 MHz.

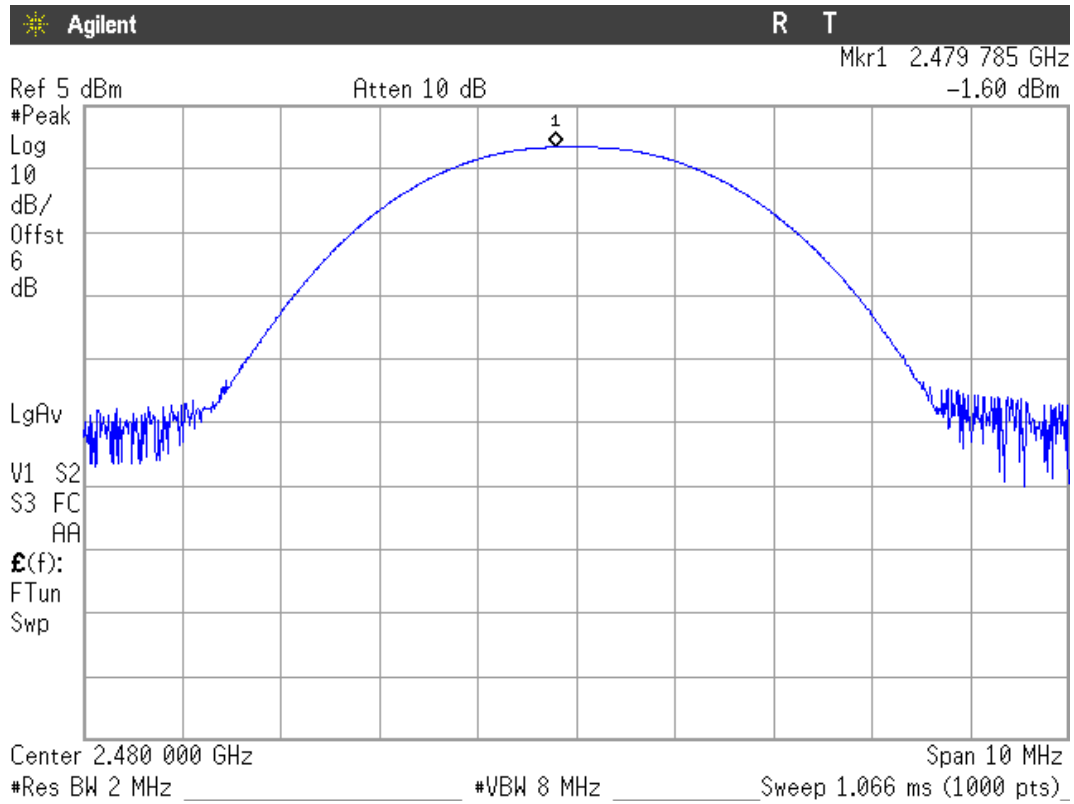

Modulation: $\Pi/4$ -DQPSK

Lowest Channel: 2402 MHz

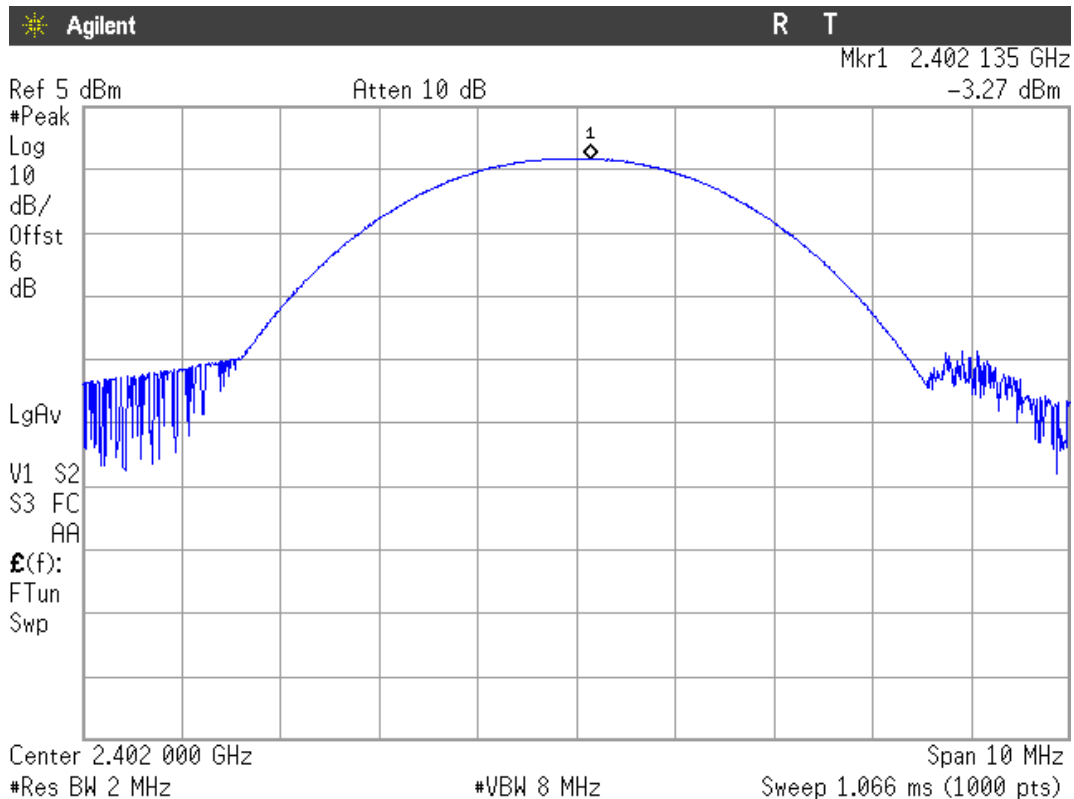

PEAK OUTPUT POWER (CONDUCTED)

Modulation: $\Pi/4$ -DQPSK

Middle Channel: 2441 MHz.

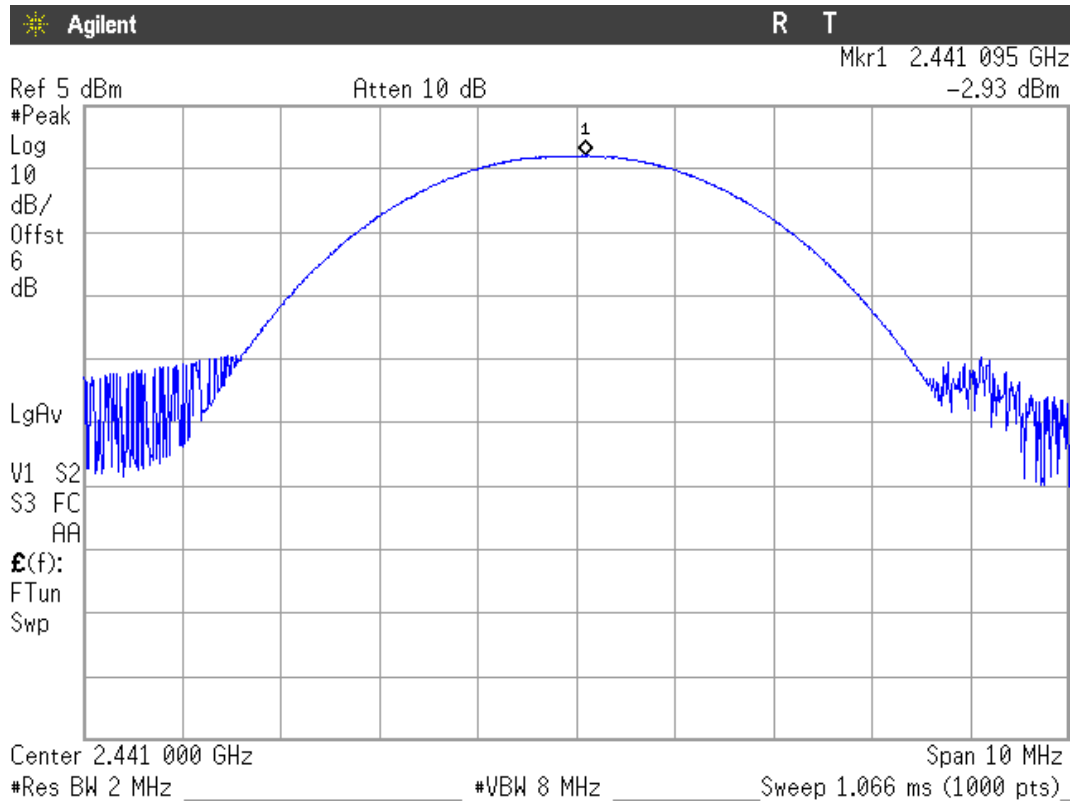

Modulation: $\Pi/4$ -DQPSK

Highest Channel: 2480 MHz.

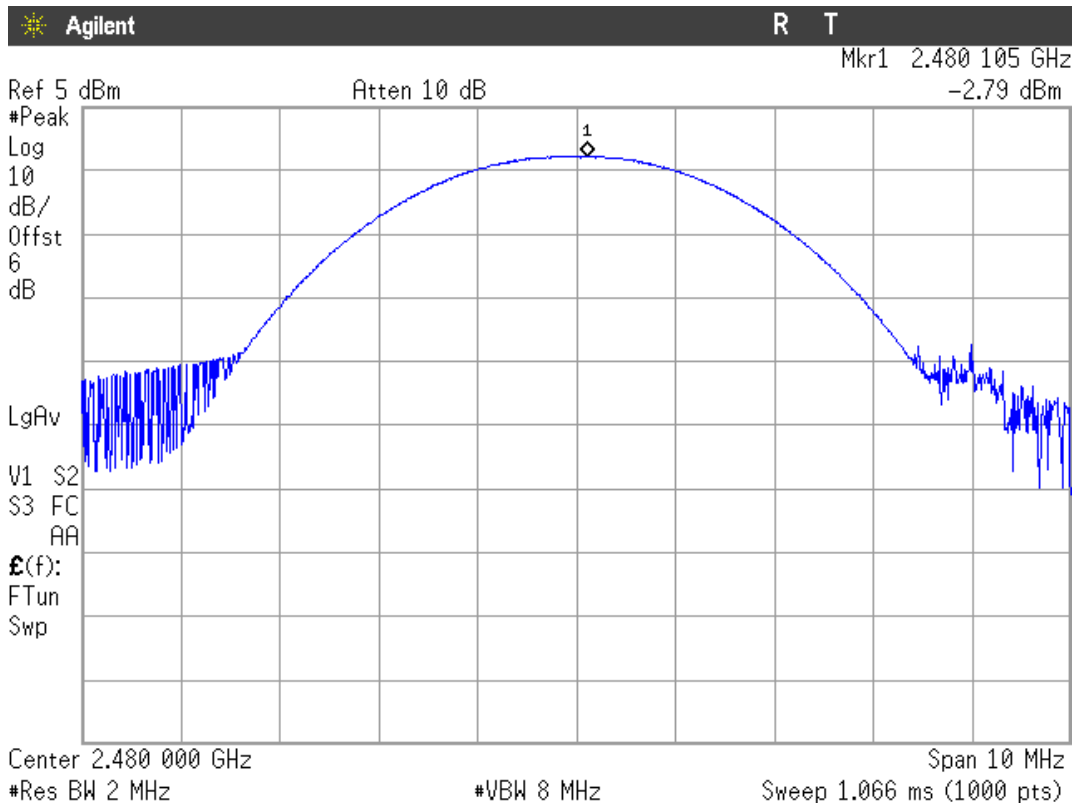

PEAK OUTPUT POWER (CONDUCTED).

Modulation: 8-DPSK

Lowest Channel: 2402 MHz

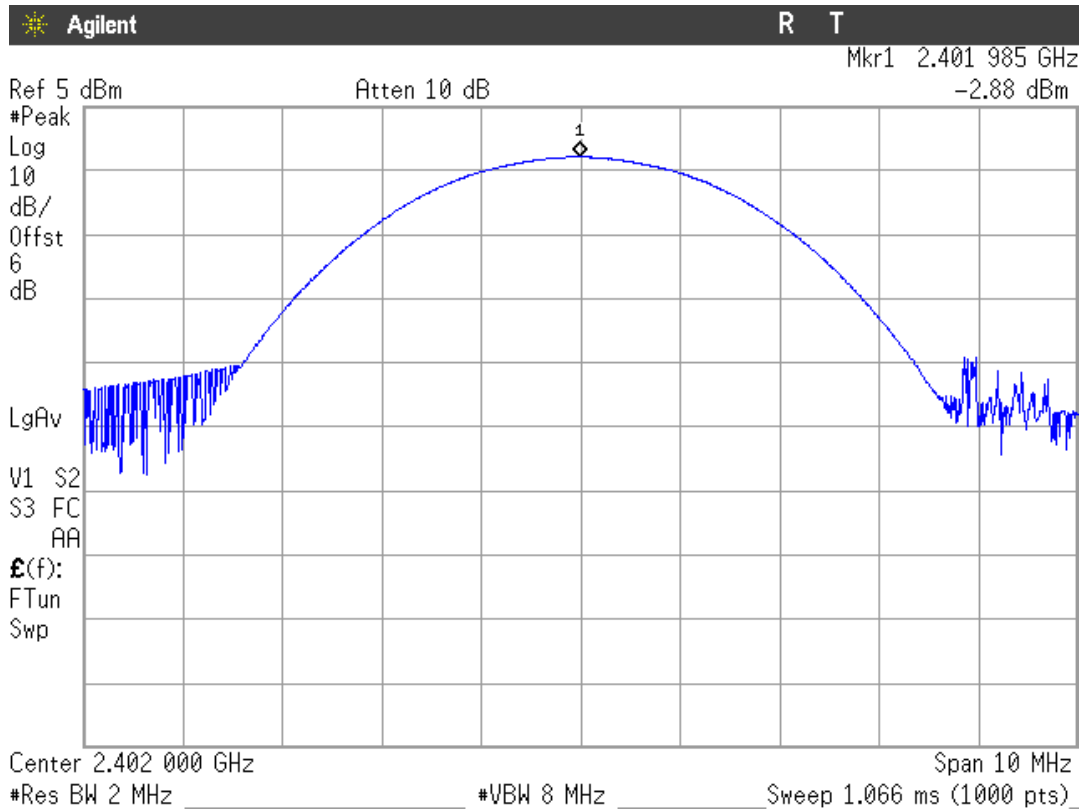

Modulation: 8-DPSK

Middle Channel: 2441 MHz.

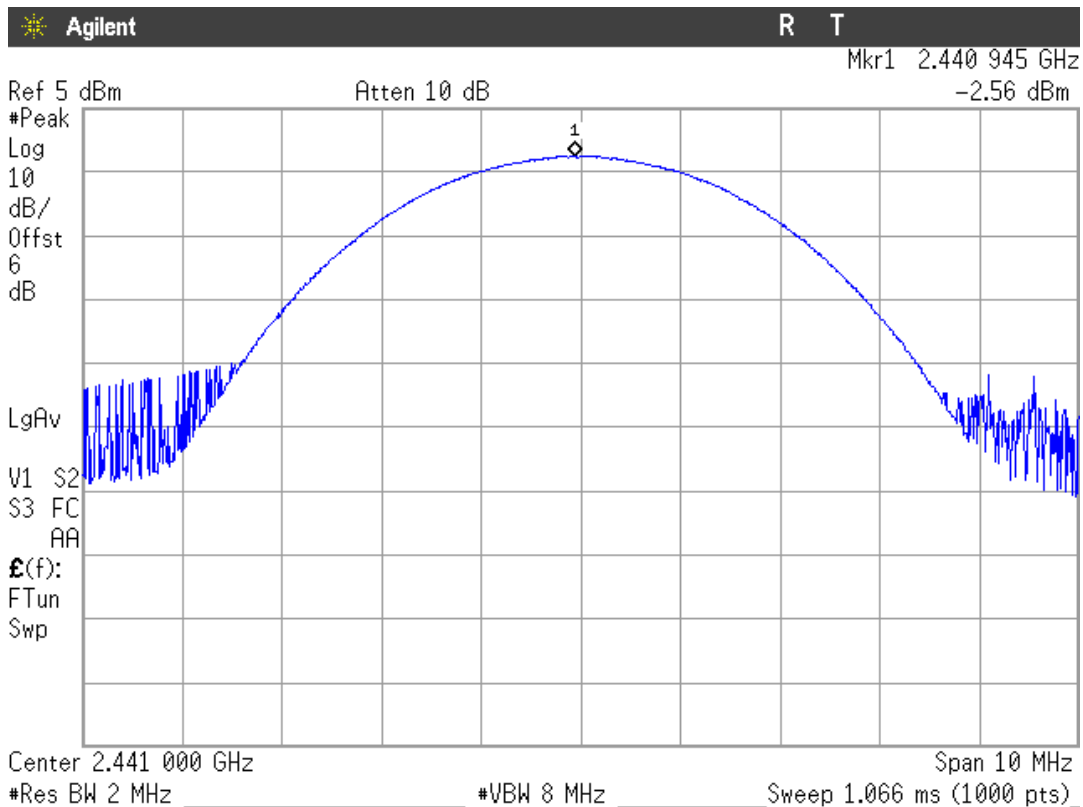

PEAK OUTPUT POWER (CONDUCTED).

Modulation: 8-DPSK

Highest Channel: 2480 MHz.

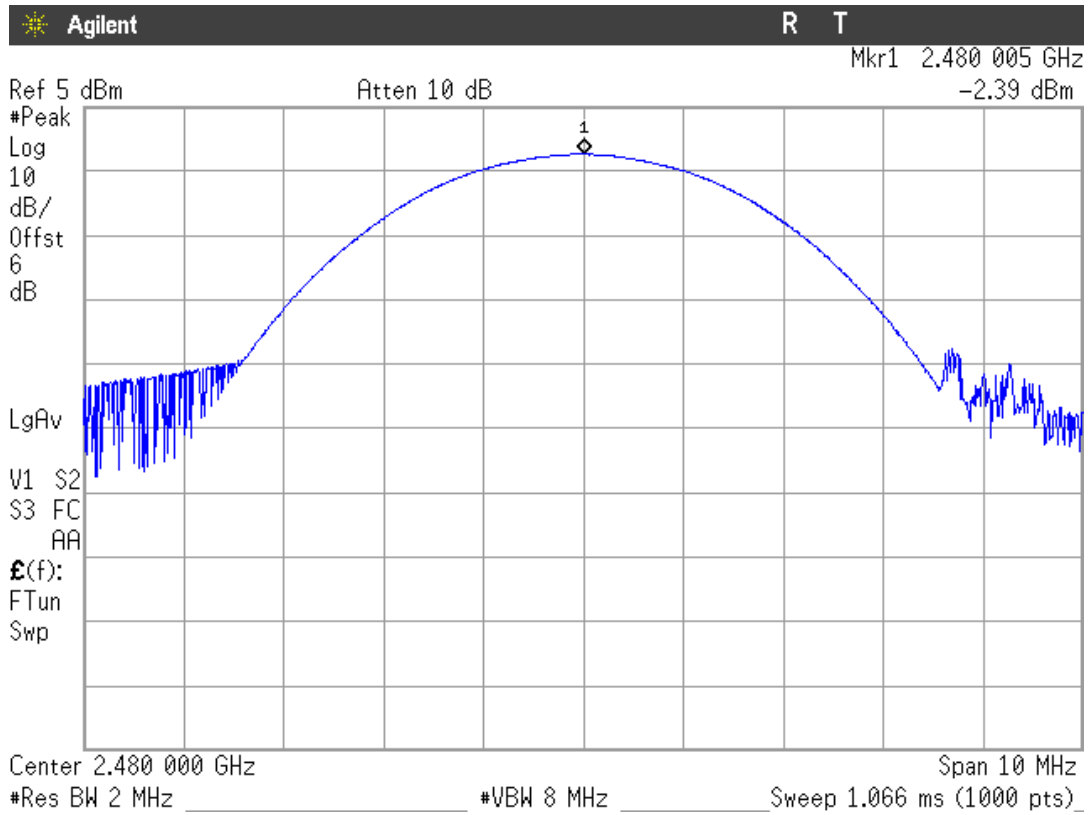

FCC Section 15.247 Subclause (d) / RSS-247 Clause 5.5. Band-edge compliance of conducted emissions (Transmitter)

SPECIFICATION

Emissions outside the frequency band in which the intentional radiator is operating shall be at least 20dB below the highest level of the desired power.

RESULTS:

Modulation: GFSK

1. LOW FREQUENCY SECTION 2402 MHz (HOPPING OFF). See next plot.

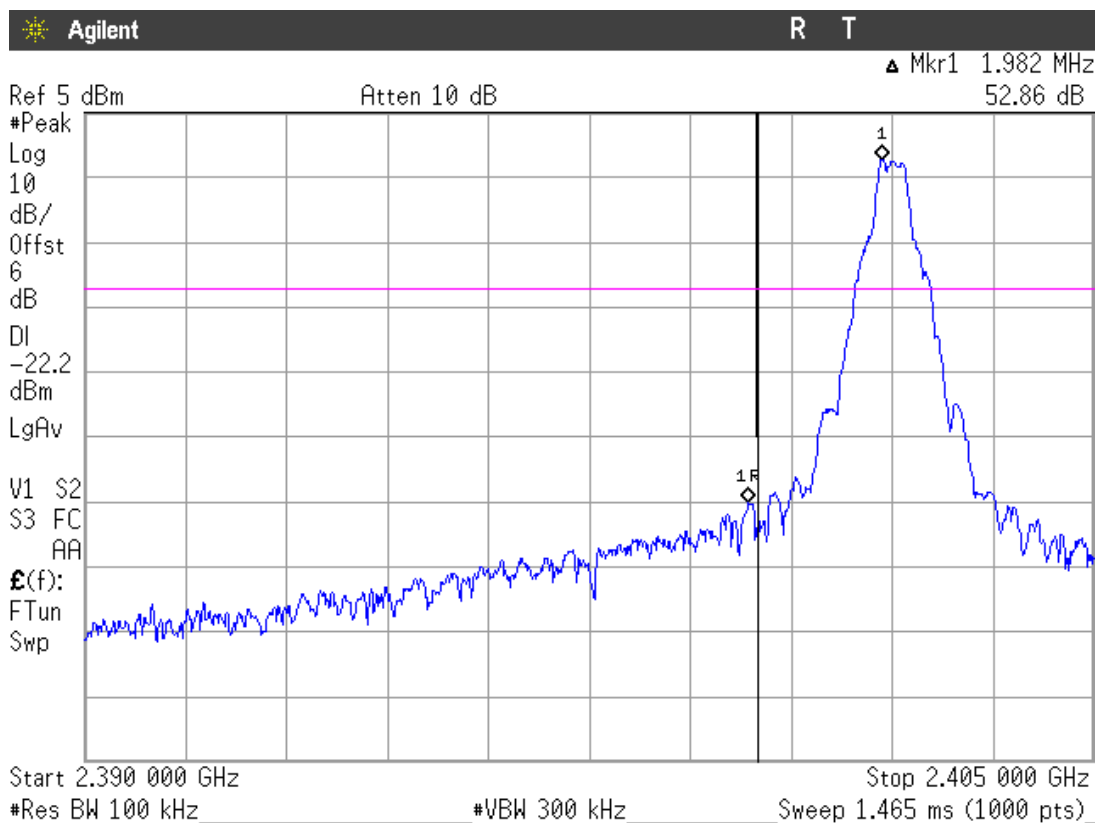

Verdict: PASS

2. HIGH FREQUENCY SECTION 2480 MHz (HOPPING OFF). See next plot.

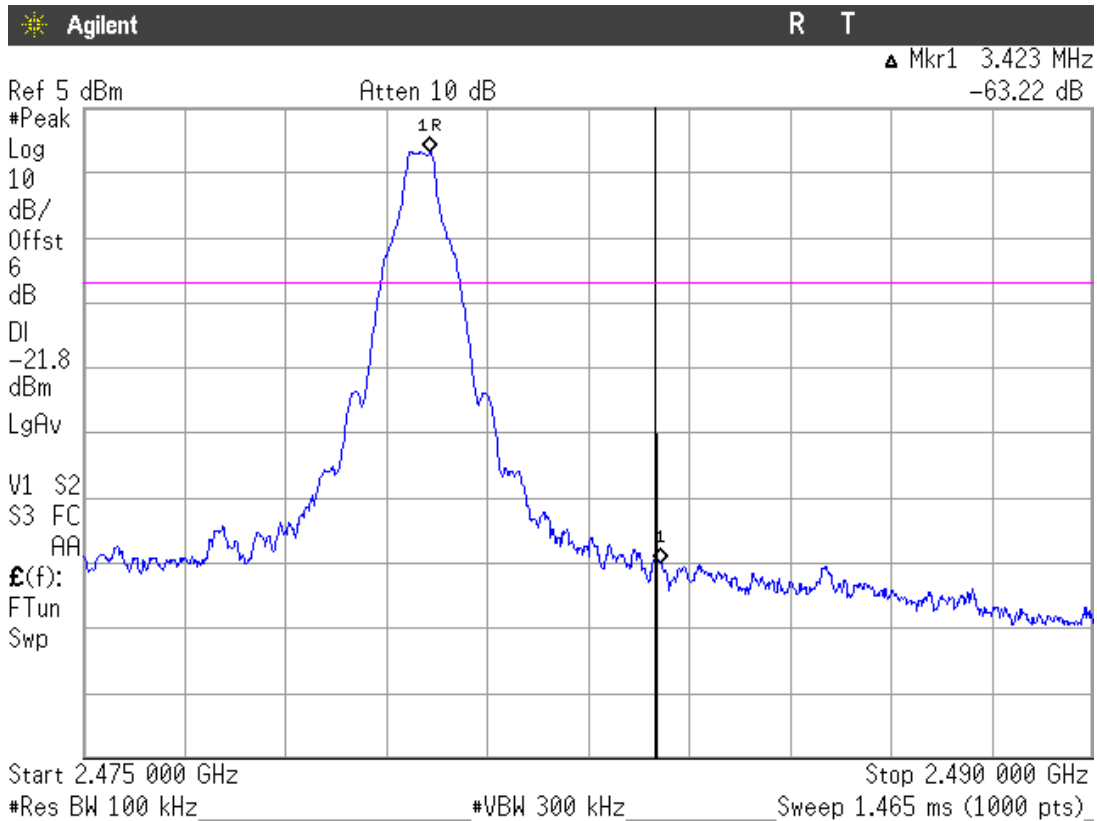

Verdict: PASS

3. LOW FREQUENCY SECTION (HOPPING ON). See next plot.

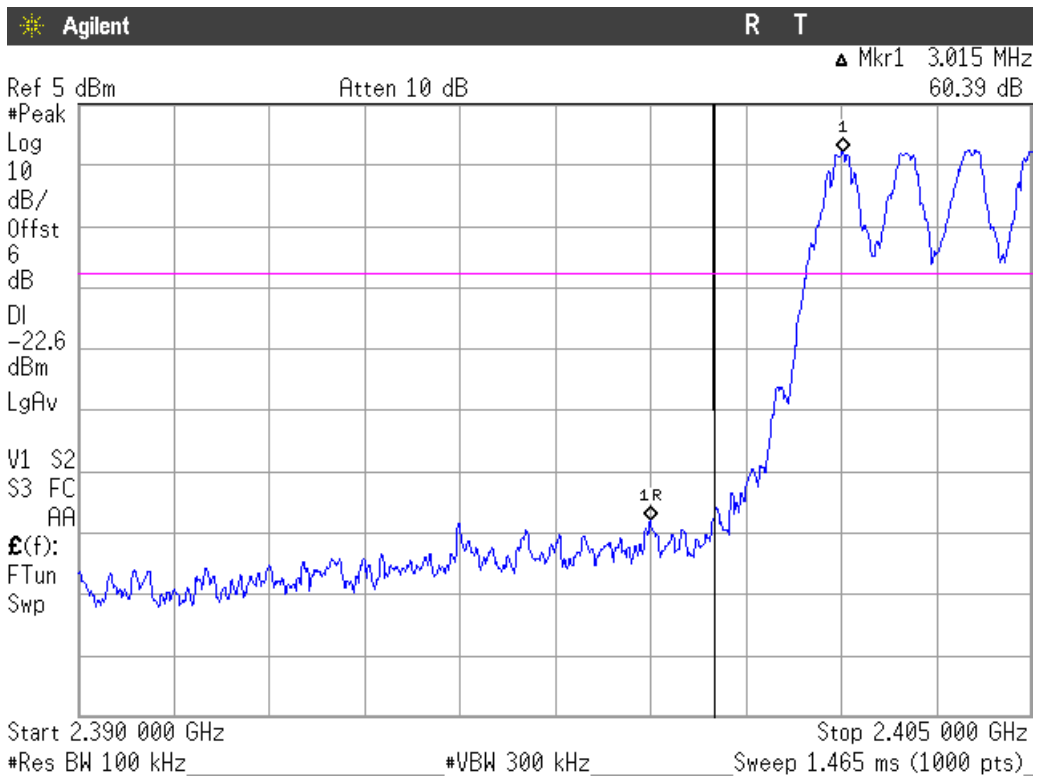

Verdict: PASS

4. HIGH FREQUENCY SECTION (HOPPING ON). See next plot.

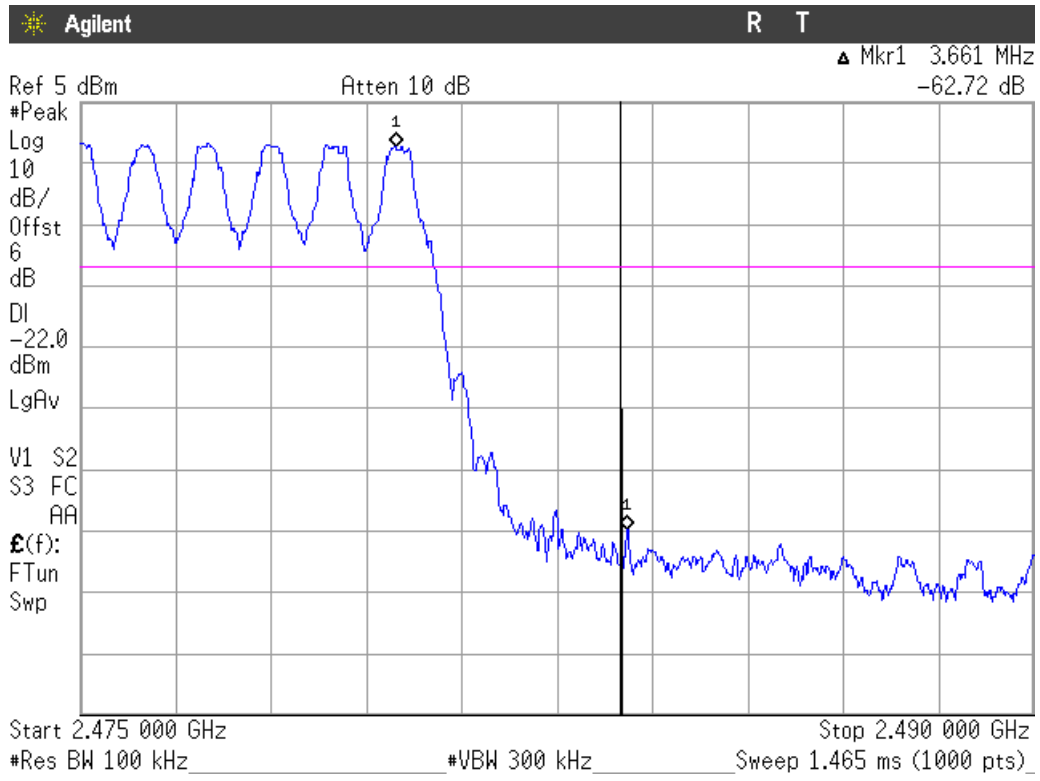

Verdict: PASS

Measurement uncertainty (dB)	<±2.03
------------------------------	--------

Modulation: $\Pi/4$ -DQPSK

1. LOW FREQUENCY SECTION 2402 MHz (HOPPING OFF). See next plot.

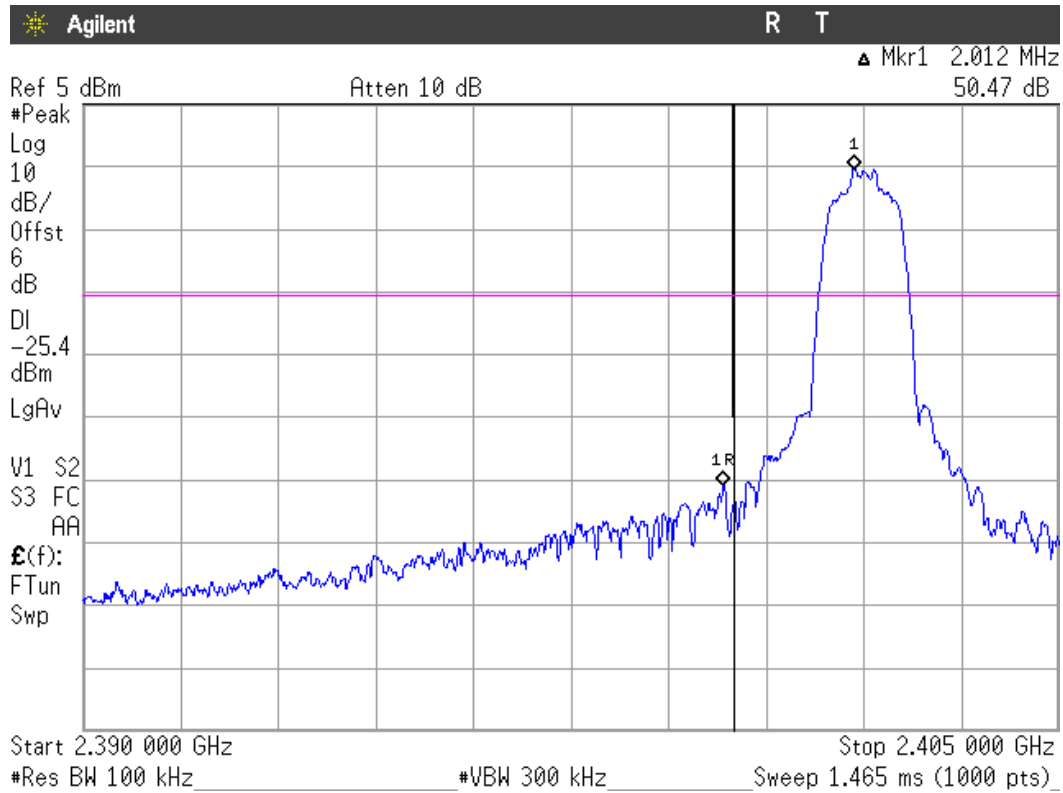

Verdict: PASS

2. HIGH FREQUENCY SECTION 2480 MHz (HOPPING OFF). See next plot.

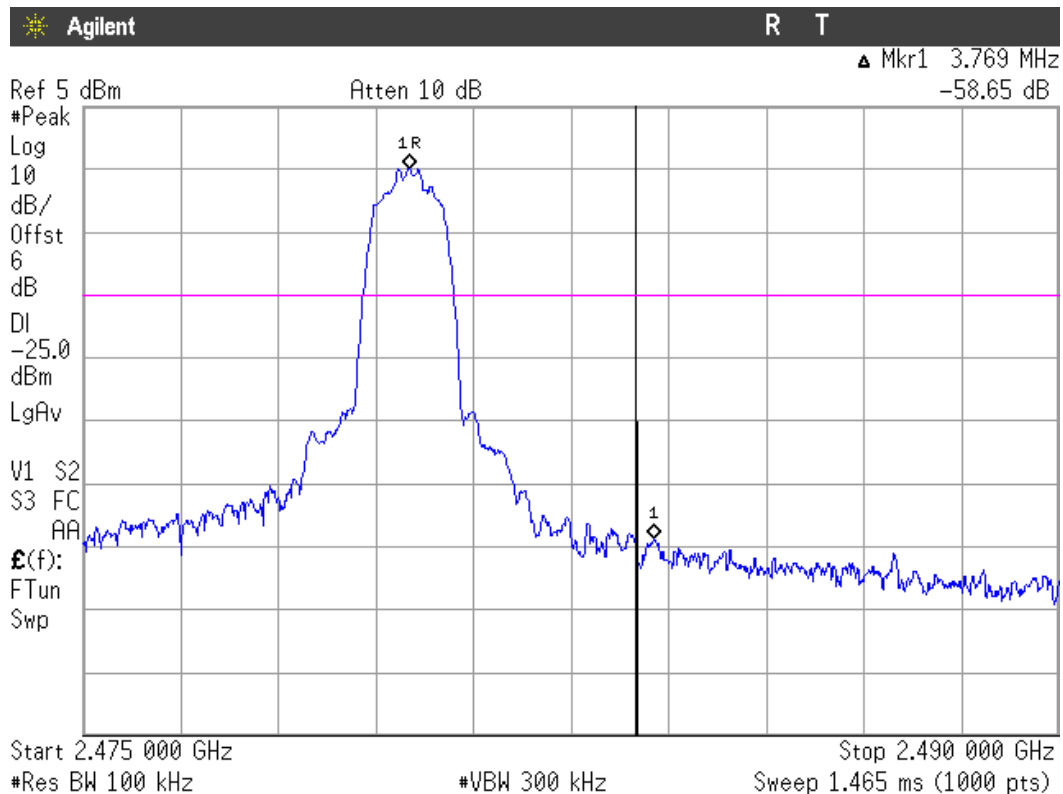

Verdict: PASS

3. LOW FREQUENCY SECTION (HOPPING ON). See next plot.

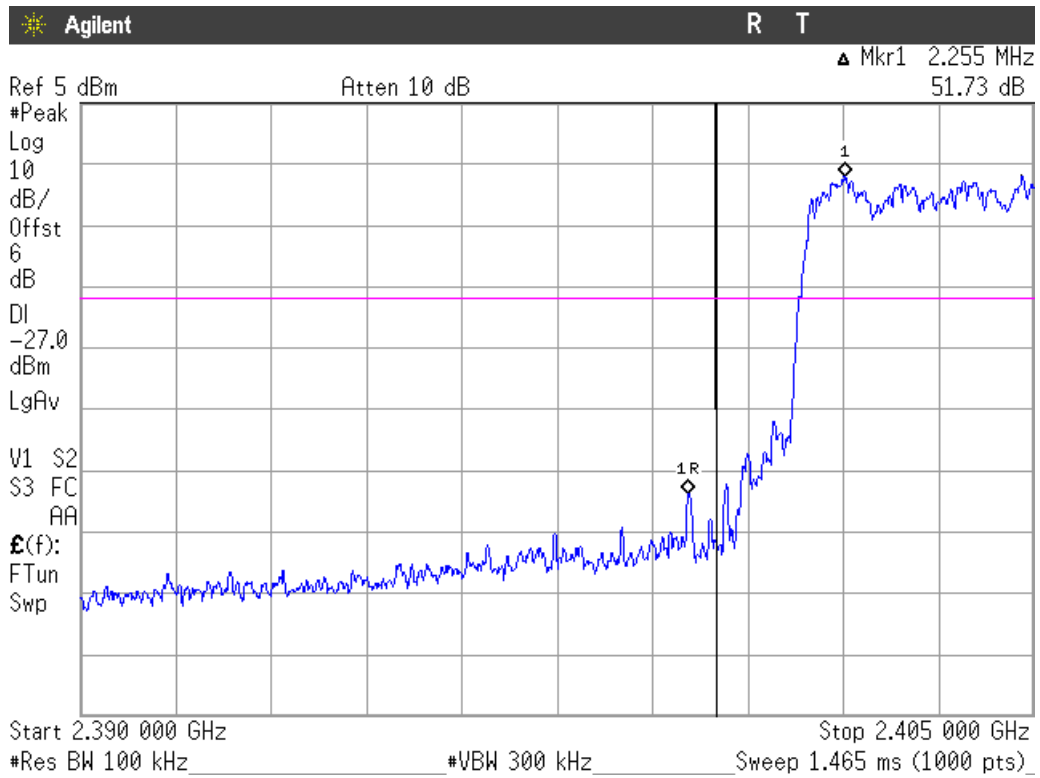

Verdict: PASS

4. HIGH FREQUENCY SECTION (HOPPING ON). See next plot.

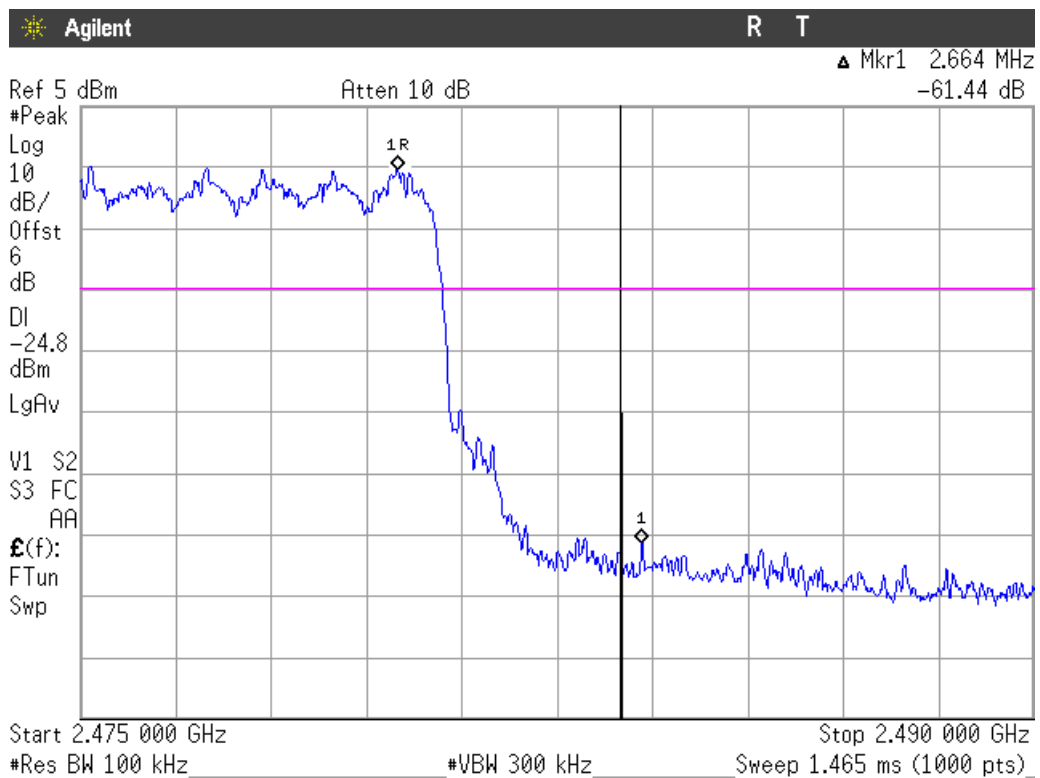

Verdict: PASS

Measurement uncertainty (dB)	<±2.03
------------------------------	--------

Modulation: 8-DPSK

1. LOW FREQUENCY SECTION 2402 MHz (HOPPING OFF). See next plot.

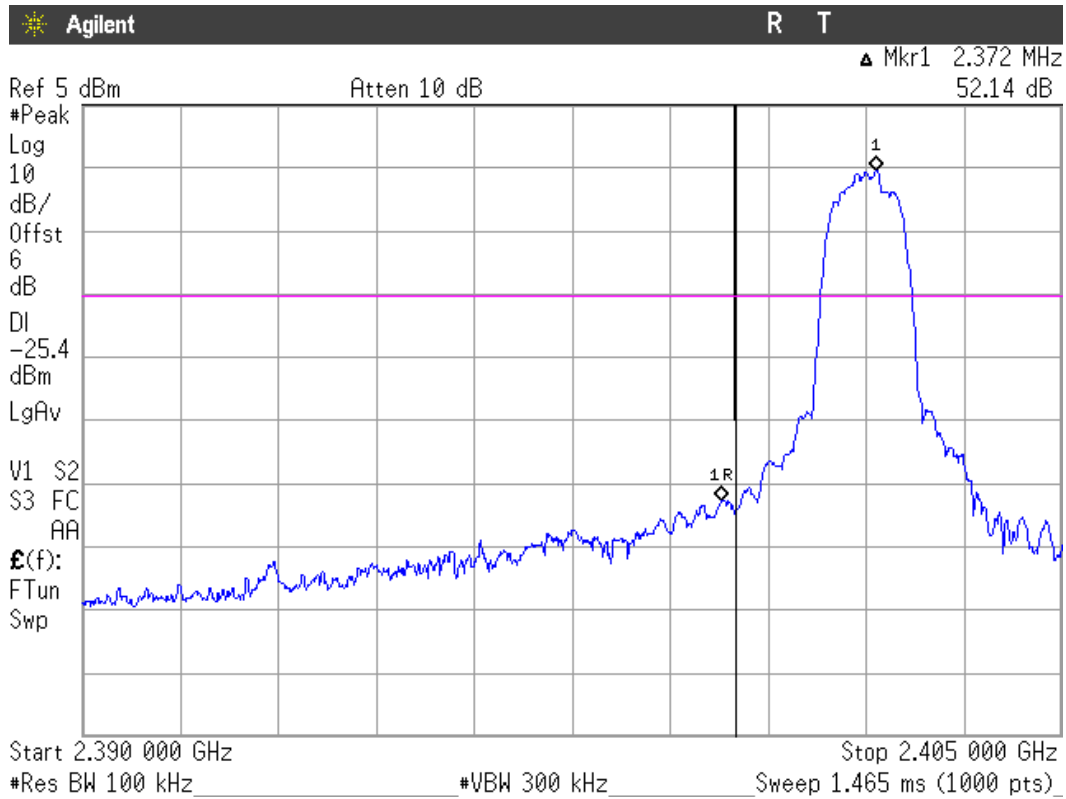

Verdict: PASS

2. HIGH FREQUENCY SECTION 2480 MHz (HOPPING OFF). See next plot.

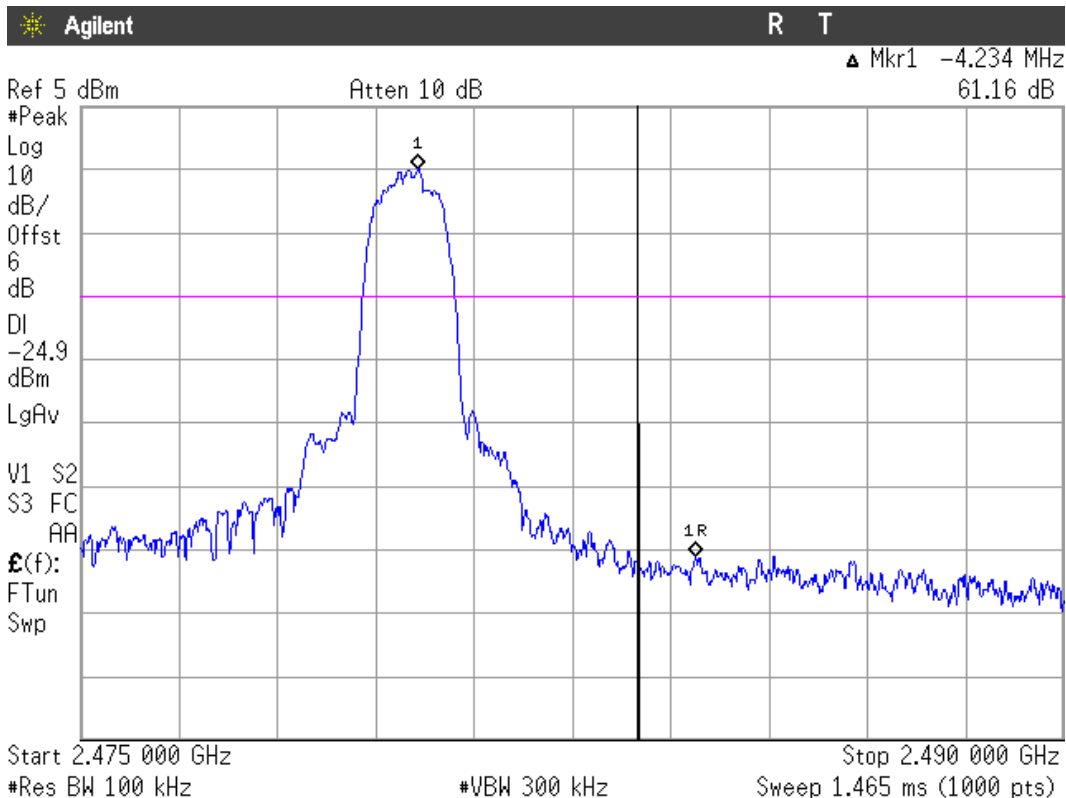

Verdict: PASS

3. LOW FREQUENCY SECTION (HOPPING ON). See next plot.

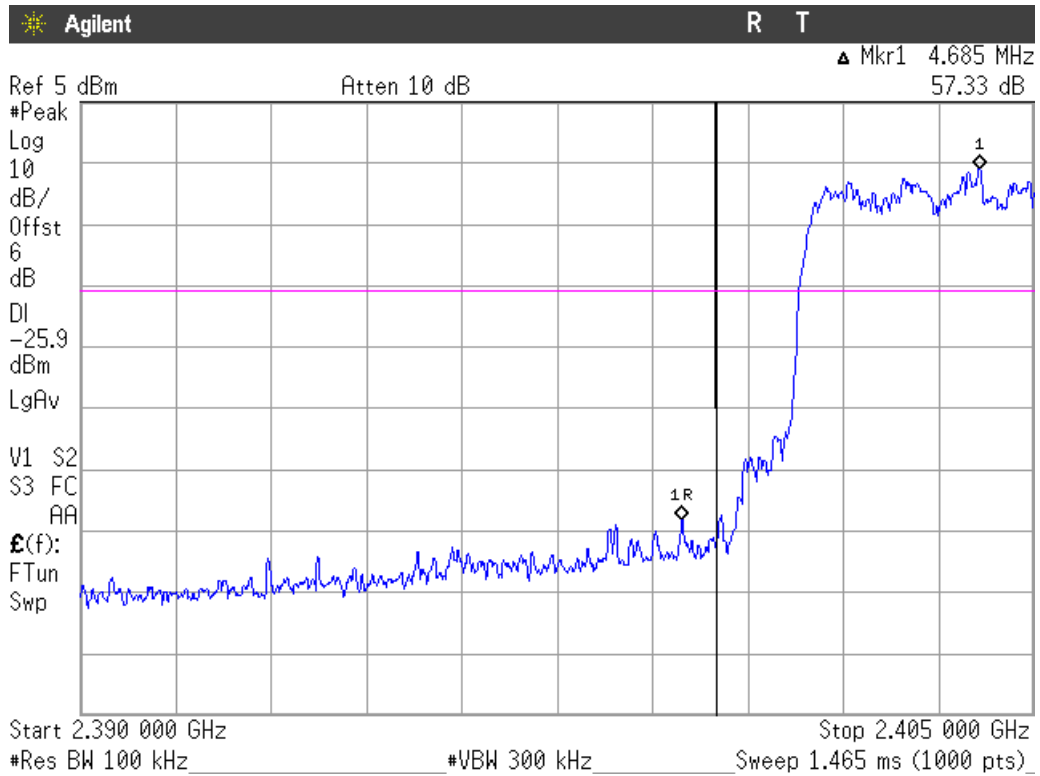

Verdict: PASS

4. HIGH FREQUENCY SECTION (HOPPING ON). See next plot.

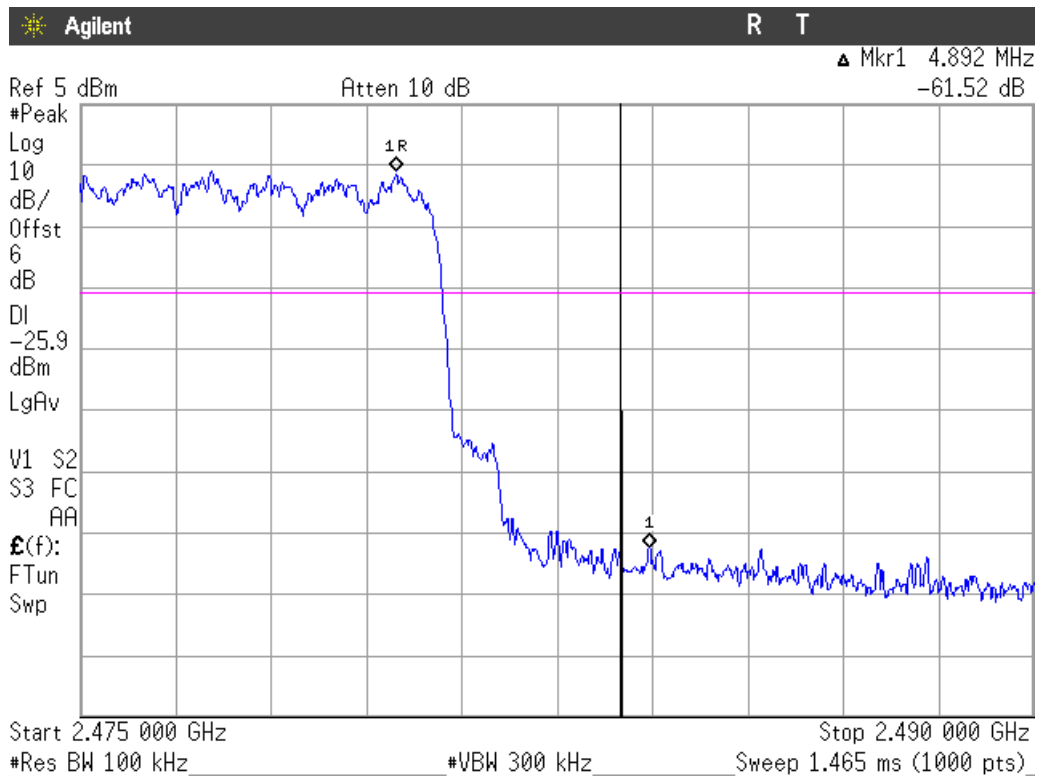

Verdict: PASS

Measurement uncertainty (dB)	<±2.03
------------------------------	--------

FCC Section 15.247 Subclause (d) / RSS-247 Clause 5.5. Emission limitations conducted (Transmitter)

SPECIFICATION

In any 100 kHz bandwidths outside the frequency band in which the intentional radiator is operating, the radio frequency power that is produced by the intentional radiator shall be at least 20dB below that in the 100 kHz bandwidth within the band that contains the highest level of the desired power.

RESULTS:

Modulation: GFSK

1. LOWEST CHANNEL (2402 MHz): 30 MHz-25 GHz (see next plot).

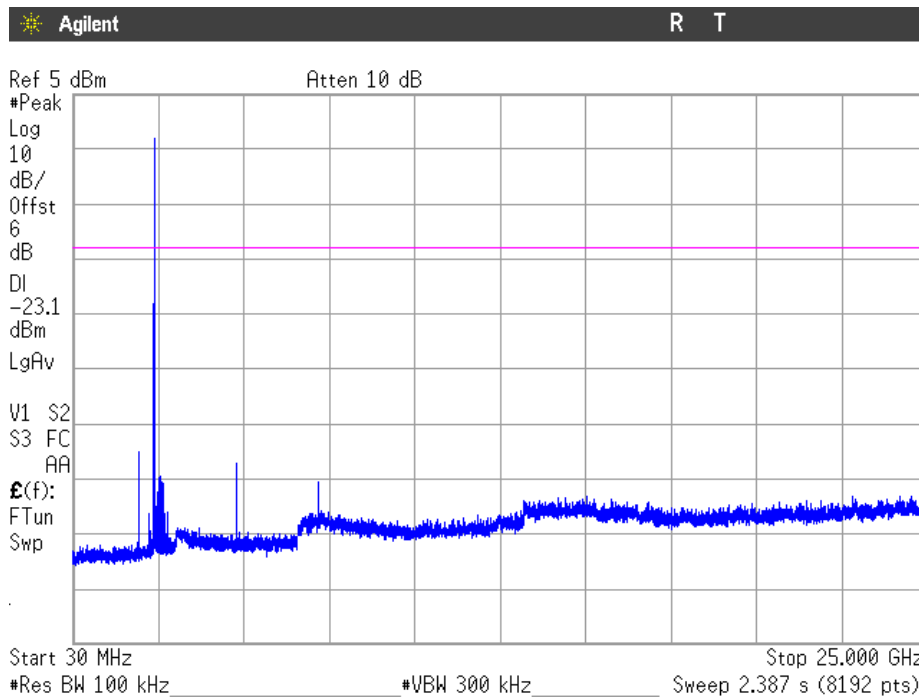

Note: The peak above the limit is the carrier frequency.

Verdict: PASS

2. MIDDLE CHANNEL (2441 MHz): 30 MHz-25 GHz (see next plot).

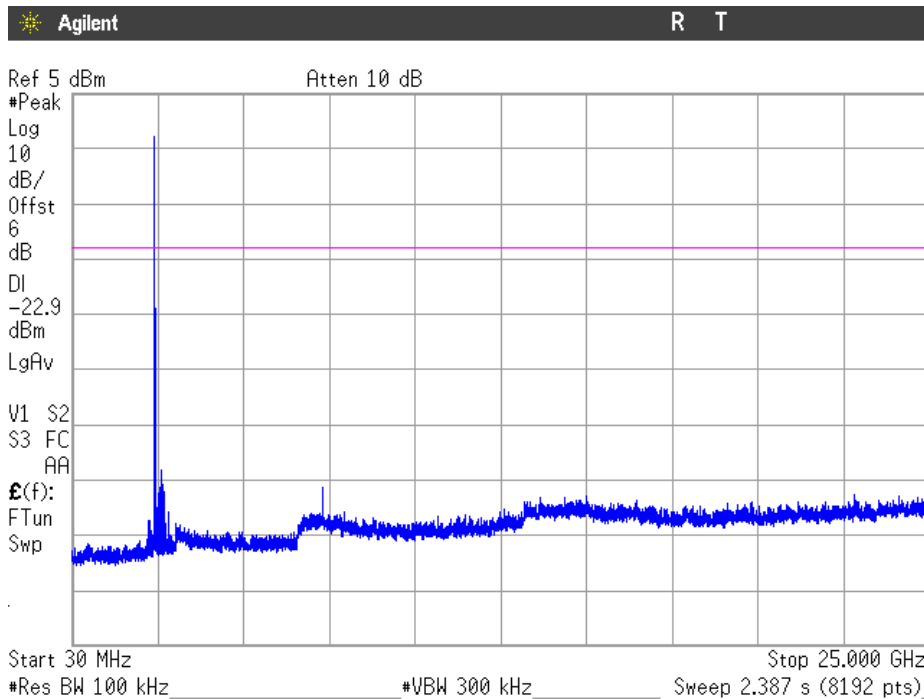

Note: The peak above the limits is the carrier frequency.

Verdict: PASS

3. HIGH CHANNEL (2480 MHz): 30 MHz-25 GHz (see next plot).

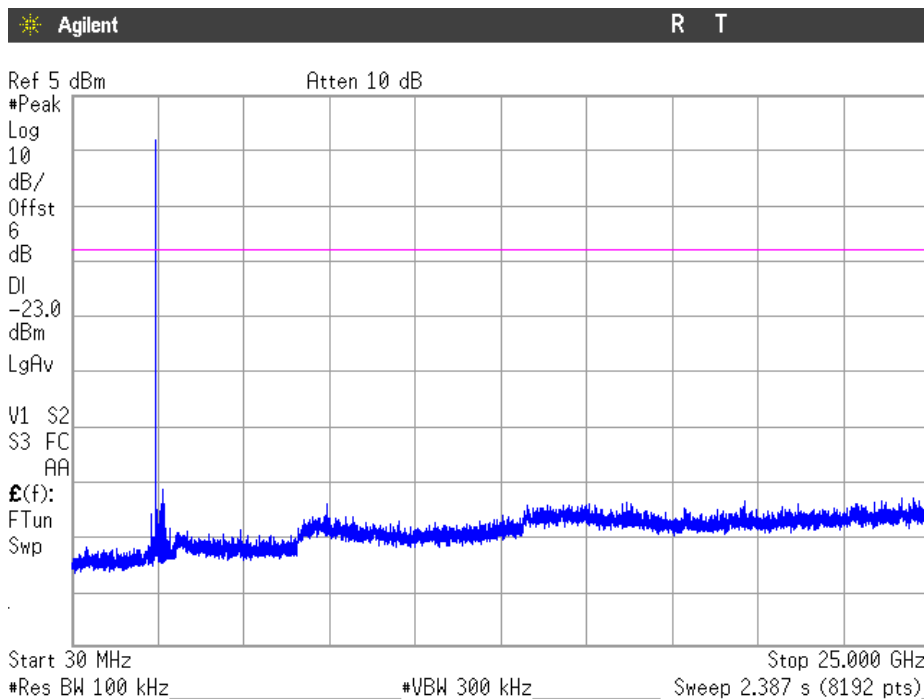

Note: The peak above the limits is the carrier frequency.

Verdict: PASS

Measurement uncertainty (dB)	<±2.03
------------------------------	--------

Modulation: $\Pi/4$ -DQPSK

1. LOWEST CHANNEL (2402 MHz): 30 MHz-25 GHz (see next plot).

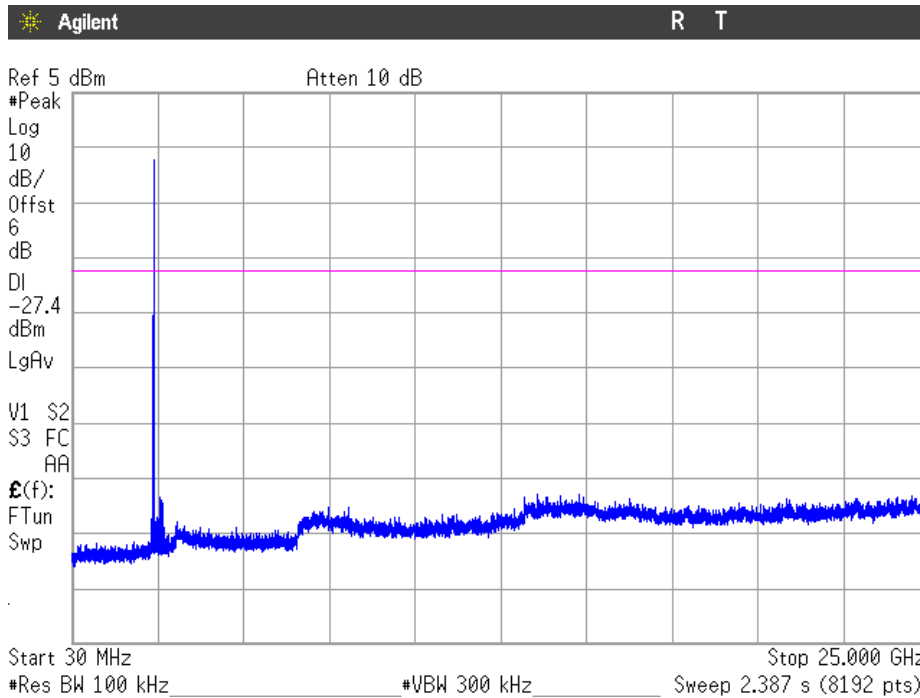

Note: The peak above the limits is the carrier frequency.

Verdict: PASS

2. MIDDLE CHANNEL (2441 MHz): 30 MHz-25 GHz (see next plot).

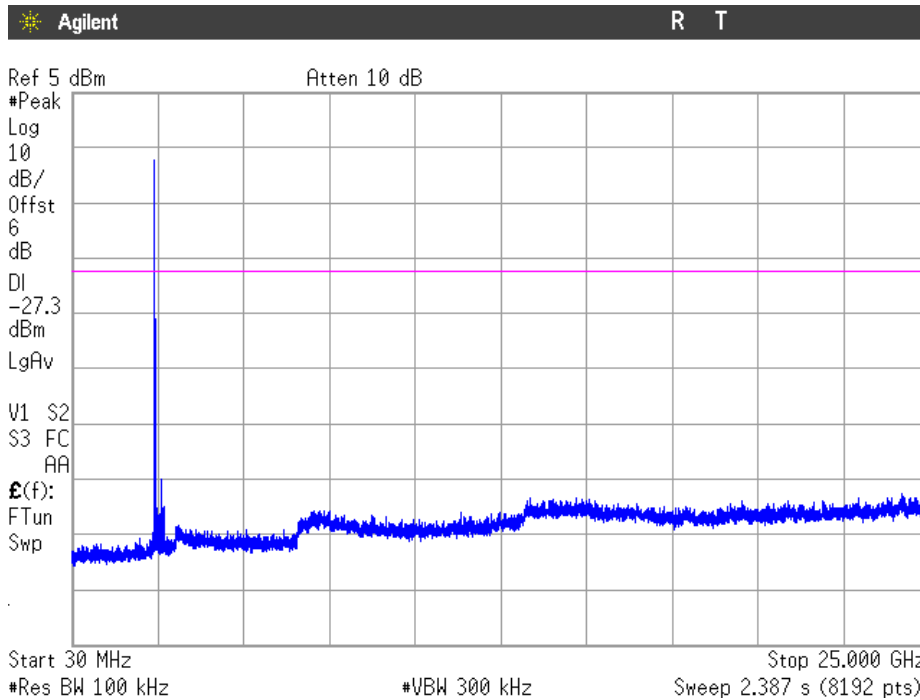

Note: The peaks above the limits are the carrier frequencies.

Verdict: PASS

3. HIGH CHANNEL (2480 MHz): 30 MHz-25 GHz (see next plot).

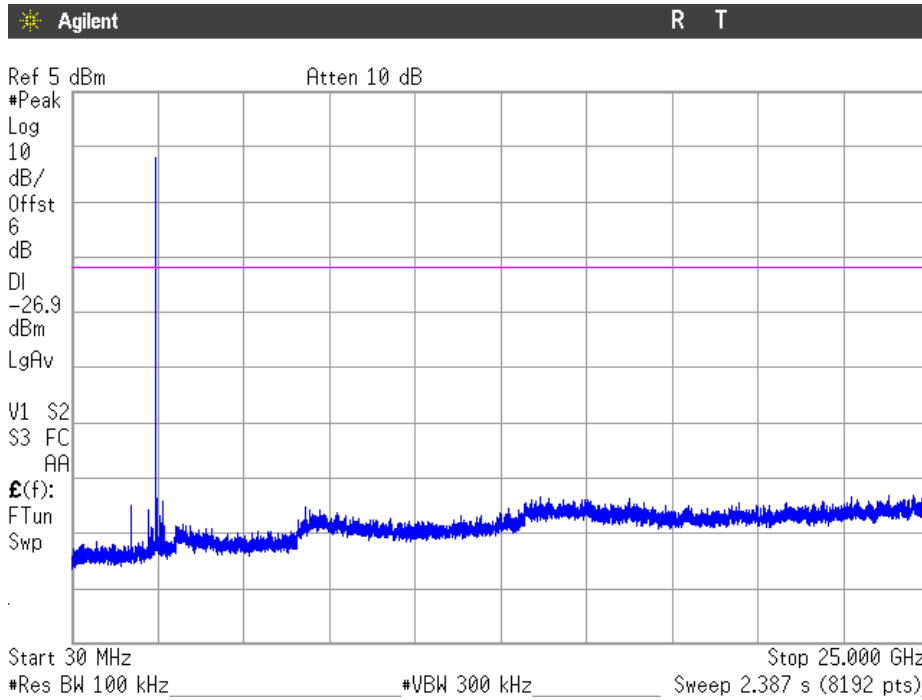

Note: The peak above the limit is the carrier frequency.

Verdict: PASS

Measurement uncertainty (dB)	<±2.03
------------------------------	--------

Modulation: 8-DPSK

1. LOWEST CHANNEL (2402 MHz): 30 MHz-25 GHz (see next plot).

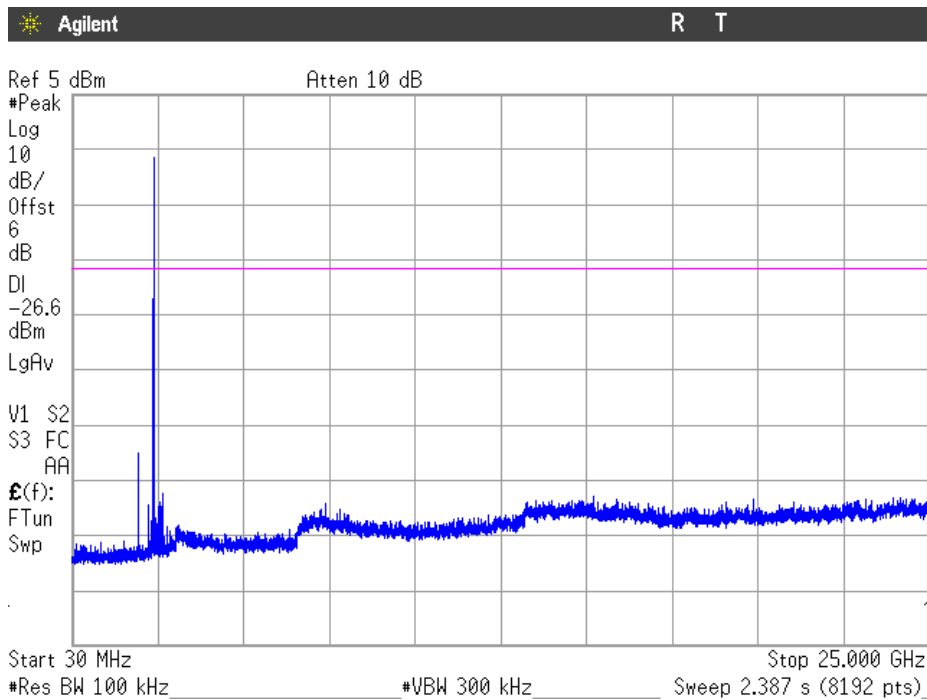

Note: The peak above the limits is the carrier frequency.

Verdict: PASS

2. MIDDLE CHANNEL (2441 MHz): 30 MHz-25 GHz (see next plot).

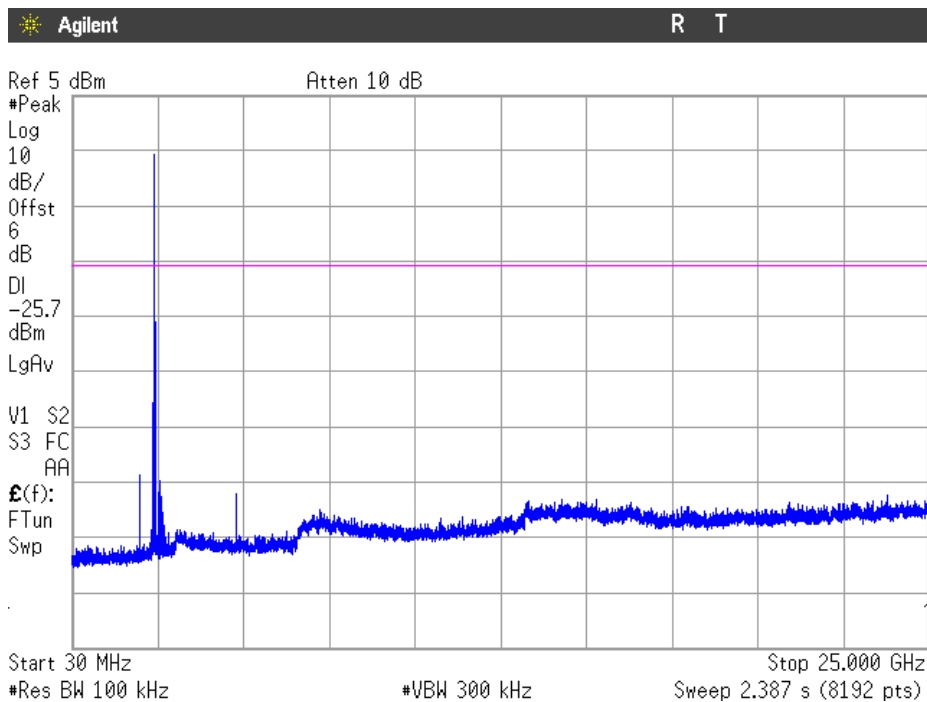

Note: The peaks above the limit are the carrier frequencies.

Verdict: PASS

3. HIGH CHANNEL (2480 MHz): 30 MHz-25 GHz (see next plot).

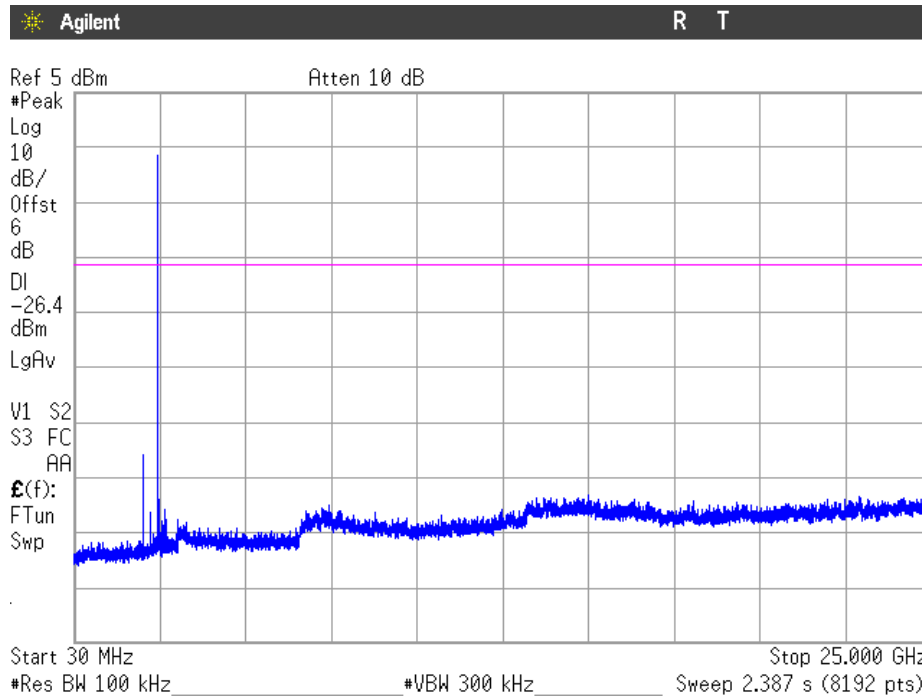

Note: The peak above the limit is the carrier frequency.

Verdict: PASS

Measurement uncertainty (dB)	<±2.03
------------------------------	--------

FCC Section 15.247 Subclause (d) / RSS-247 Clause 5.5 Emission limitations radiated (Transmitter)

SPECIFICATION

Radiated emissions which fall in the restricted bands, as defined in §15.205(a), must also comply with the radiated emission limits specified in §15.209(a) (see §15.205(c)/RSS-Gen):

Frequency Range (MHz)	Field strength ($\mu\text{V/m}$)	Field strength ($\text{dB}\mu\text{V/m}$)	Measurement distance (m)
0.009-0.490	2400/F(kHz)	-	300
0.490-1.705	24000/F(kHz)	-	30
1.705 - 30.0	30	-	30
30 - 88	100	40	3
88 - 216	150	43.5	3
216 - 960	200	46	3
960 - 25000	500	54	3

The emission limits shown in the above table are based on measurements employing CISPR quasi-peak detector except for the frequency bands 9-90 kHz, 110-490 kHz and above 1000 MHz. Radiated emission limits in these three bands are based on measurements employing an average detector.

For average radiated emission measurements above 1000 MHz, there is also a limit corresponding to 20 dB above the indicated values in the table is specified when measuring with peak detector function.

RSS-247. Attenuation below the general field strength limits specified in RSS-Gen is not required.

RESULTS:

The situation and orientation was varied to find the maximum radiated emission. It was also rotated 360° and the antenna height was varied from 1 to 4 meters to find the maximum radiated emission.

Measurements were made in both horizontal and vertical planes of polarization.

All tests were performed in a semi-anechoic chamber at a distance of 3 m for the frequency range 30 MHz-1000 MHz and at distance of 1m for the frequency range 1 GHz-25 GHz.

The field strength is calculated by adding correction factor to the measured level from the spectrum analyzer. This correction factor includes antenna factor, cable loss and pre-amplifiers gain.

Frequency range 30 MHz-1000 MHz.

Note: The spurious emissions below 1 GHz do not depend on either the operating channel or the modulation mode selected in the EUT.

Spurious levels operating (radiated) closest to limit.

Spurious frequency (MHz)	Polarization	Detector	Emission Level (dB μ V/m)	Measurement Uncertainty (dB)
30.7275	V	Quasi-Peak	32.62	± 3.88
109.9765	V	Quasi-Peak	35.12	± 3.88
224.0014	H	Quasi-Peak	34.65	± 3.88
227.9770	H	Quasi-Peak	35.41	± 3.88
400.0065	H	Quasi-Peak	34.65	± 3.88
665.5925	H	Quasi-Peak	37.51	± 3.88
752.5045	V	Quasi-Peak	36.54	± 3.88
755.2205	H	Quasi-Peak	40.97	± 3.88
767.2485	H	Quasi-Peak	41.21	± 3.88
799.3555	H	Quasi-Peak	36.56	± 3.88
832.0445	H	Quasi-Peak	32.10	± 3.88
910.0810	V	Quasi-Peak	35.10	± 3.88

Frequency range 1 GHz-25 GHz

The results in the next tables show the maximum measured levels in the 1-25 GHz range including the restricted bands 2.31-2.39 GHz and 2.4835-2.5 GHz (see next plots).

Modulation: GFSK

1. CHANNEL: LOWEST (2402 MHz).

Spurious frequency (GHz)	Polarization	Detector	Emission Level (dB μ V/m)	Measurement Uncertainty (dB)
1.06670	V	Peak	44.69	± 4.87
1.40343	V	Peak	44.62	± 4.87
1.51563	V	Peak	48.22	± 4.87
1.57170	V	Peak	47.47	± 4.87
1.72783	H	Peak	44.79	± 4.87
2.34901	H	Peak	48.18	± 4.87
3.11825	H	Peak	37.64	± 4.87
4.80375	H	Peak	40.20	± 4.87

2. CHANNEL: MIDDLE (2441 MHz).

Spurious frequency (GHz)	Polarization	Detector	Emission Level (dB μ V/m)	Measurement Uncertainty (dB)
1.06700	V	Peak	43.98	± 4.87
1.40357	V	Peak	44.54	± 4.87
1.51657	V	Peak	47.72	± 4.87
1.51600	H	Peak	45.70	± 4.87
2.24457	H	Peak	47.68	± 4.87
2.38812	H	Peak	48.33	± 4.87
2.49397	H	Peak	49.66	± 4.87
3.11825	H	Peak	38.37	± 4.87
7.32325	H	Peak	41.90	± 4.87

3. CHANNEL: HIGHEST (2480 MHz).

Spurious frequency (GHz)	Polarization	Detector	Emission Level (dB μ V/m)	Measurement Uncertainty (dB)
1.06700	V	Peak	44.80	± 4.87
1.40360	V	Peak	45.87	± 4.87
1.50010	H	Peak	46.17	± 4.87
1.51600	H	Peak	45.63	± 4.87
1.57070	V	Peak	46.73	± 4.87
2.26617	H	Peak	48.63	± 4.87
2.37415	H	Peak	45.70	± 4.87
2.48351	H	Peak	61.07	± 4.87
		Average	38.17	± 4.87
3.11825	H	Peak	38.21	± 4.87
4.95975	V	Peak	42.74	± 4.87

Verdict: PASS

Modulation: $\Pi/4$ -DQPSK

1. CHANNEL: LOWEST (2402 MHz).

Spurious frequency (GHz)	Polarization	Detector	Emission Level (dB μ V/m)	Measurement Uncertainty (dB)
1.40370	V	Peak	44.99	± 4.87
1.49957	V	Peak	46.52	± 4.87
1.51517	V	Peak	47.22	± 4.87
1.95300	V	Peak	46.49	± 4.87
2.34902	V	Peak	50.28	± 4.87
2.55903	V	Peak	52.27	± 4.87
3.11825	H	Peak	39.02	± 4.87

2. CHANNEL: MIDDLE (2441 MHz).

Spurious frequency (GHz)	Polarization	Detector	Emission Level (dB μ V/m)	Measurement Uncertainty (dB)
1.40363	V	Peak	45.68	± 4.87
1.50050	H	Peak	44.31	± 4.87
1.51577	V	Peak	47.03	± 4.87
1.99177	V	Peak	47.60	± 4.87
2.24537	H	Peak	49.93	± 4.87
2.38786	V	Peak	50.50	± 4.87
2.49412	V	Peak	51.59	± 4.87
2.63683	V	Peak	50.53	± 4.87
3.11825	H	Peak	39.23	± 4.87
4.86775	V	Peak	39.18	± 4.87

3. CHANNEL: HIGHEST (2480 MHz).

Spurious frequency (GHz)	Polarization	Detector	Emission Level (dB μ V/m)	Measurement Uncertainty (dB)
1.49983	H	Peak	46.29	± 4.87
1.51650	V	Peak	47.87	± 4.87
1.77617	V	Peak	44.94	± 4.87
2.03083	V	Peak	54.48	± 4.87
		Average	51.48	± 4.87
2.24523	V	Peak	48.85	± 4.87
2.26597	H	Peak	47.53	± 4.87
2.37429	V	Peak	49.10	± 4.87
2.48350	V	Peak	67.10	± 4.87
		Average	39.72	± 4.87
3.11825	H	Peak	39.54	± 4.87
4.06225	V	Peak	39.15	± 4.87
4.96025	V	Peak	42.49	± 4.87

Verdict: PASS

Modulation: 8-DPSK

1. CHANNEL: LOWEST (2402 MHz).

Spurious frequency (GHz)	Polarization	Detector	Emission Level (dB μ V/m)	Measurement Uncertainty (dB)
1.06663	V	Peak	44.75	± 4.87
1.40377	V	Peak	45.90	± 4.87
1.50050	H	Peak	42.45	± 4.87
1.51583	V	Peak	46.91	± 4.87
1.57150	V	Peak	46.27	± 4.87
2.24530	V	Peak	50.44	± 4.87
2.34895	V	Peak	50.40	± 4.87
2.55937	V	Peak	50.37	± 4.87
3.11825	H	Peak	39.99	± 4.87

2. CHANNEL: MIDDLE (2441 MHz).

Spurious frequency (GHz)	Polarization	Detector	Emission Level (dB μ V/m)	Measurement Uncertainty (dB)
1.06633	V	Peak	45.24	± 4.87
1.40443	V	Peak	46.46	± 4.87
1.49970	H	Peak	46.61	± 4.87
1.51550	V	Peak	47.88	± 4.87
1.99210	V	Peak	49.54	± 4.87
2.24477	V	Peak	50.16	± 4.87
2.38802	V	Peak	50.16	± 4.87
2.49403	V	Peak	51.46	± 4.87
2.63697	V	Peak	50.43	± 4.87
3.11825	H	Peak	39.42	± 4.87
4.43275	V	Peak	38.26	± 4.87
4.86825	V	Peak	40.09	± 4.87

3. CHANNEL: HIGHEST (2480 MHz).

Spurious frequency (GHz)	Polarization	Detector	Emission Level (dB μ V/m)	Measurement Uncertainty (dB)
1.06677	V	Peak	44.88	± 4.87
1.51663	V	Peak	47.58	± 4.87
2.03103	V	Peak	52.02	± 4.87
2.24523	V	Peak	47.87	± 4.87
2.26590	V	Peak	49.77	± 4.87
2.37399	V	Peak	49.55	± 4.87
2.48351	V	Peak	66.69	± 4.87
		Average	39.84	± 4.87
3.11825	H	Peak	39.44	± 4.87
4.06175	V	Peak	38.60	± 4.87
4.95975	H	Peak	42.57	± 4.87

Verdict: PASS

FREQUENCY RANGE 30 MHz-1000 MHz.

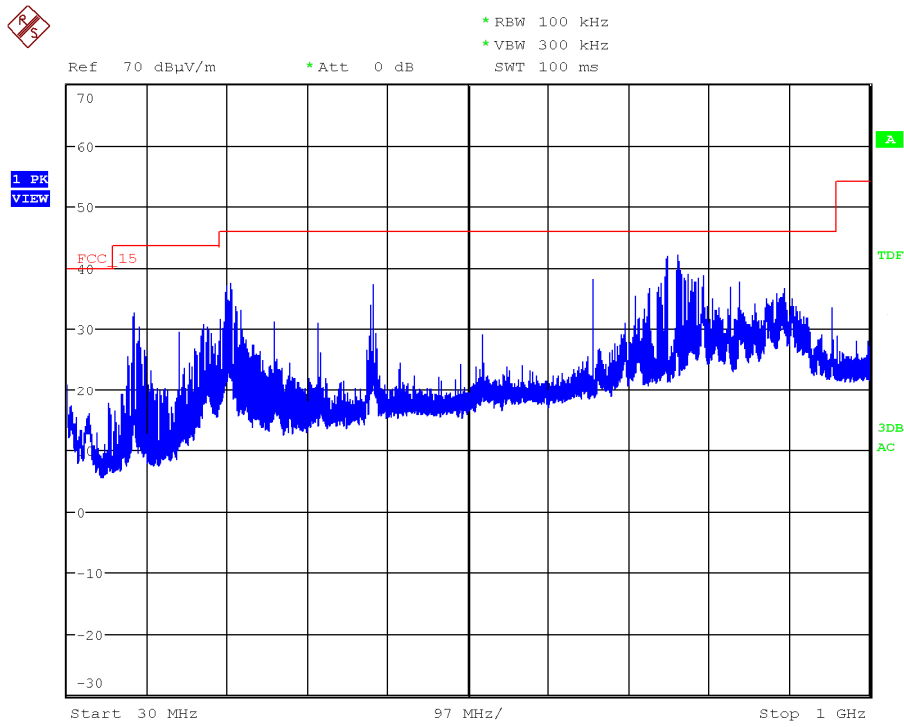

(This plot is valid for all three channels and all modulation modes).

FREQUENCY RANGE 1 GHz to 3 GHz.

Modulation: GFSK

CHANNEL: Lowest (2402 MHz).

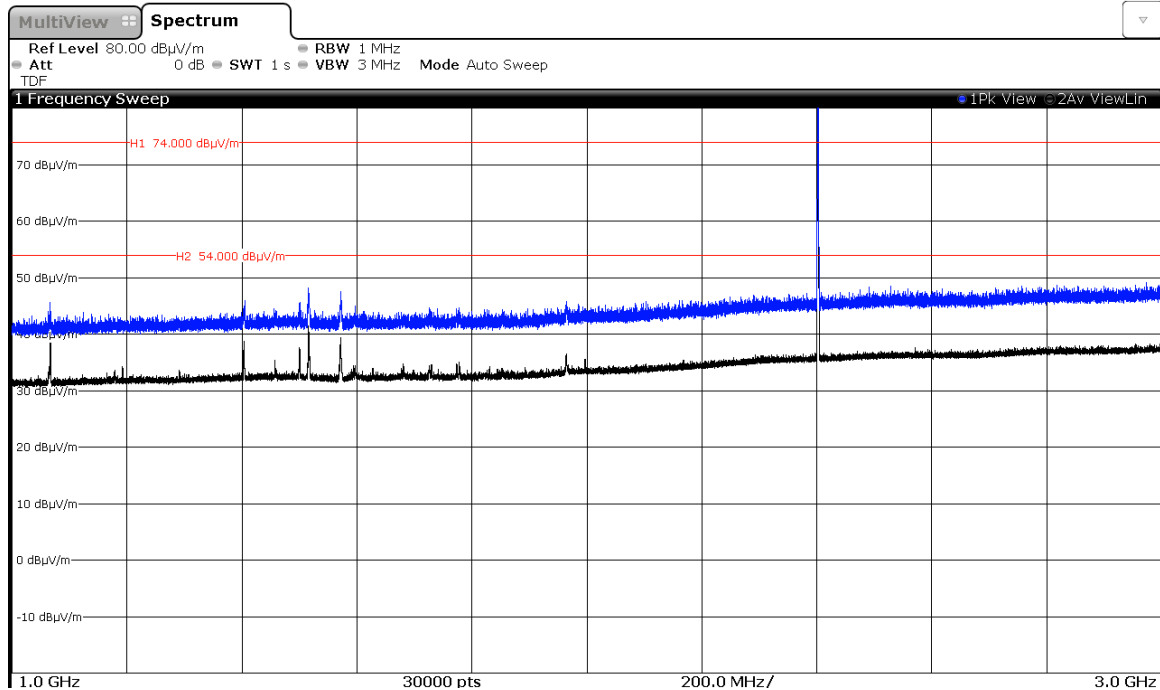

Note: The peak shown in the plot above the limits is the carrier frequency.

CHANNEL: Middle (2441 MHz).

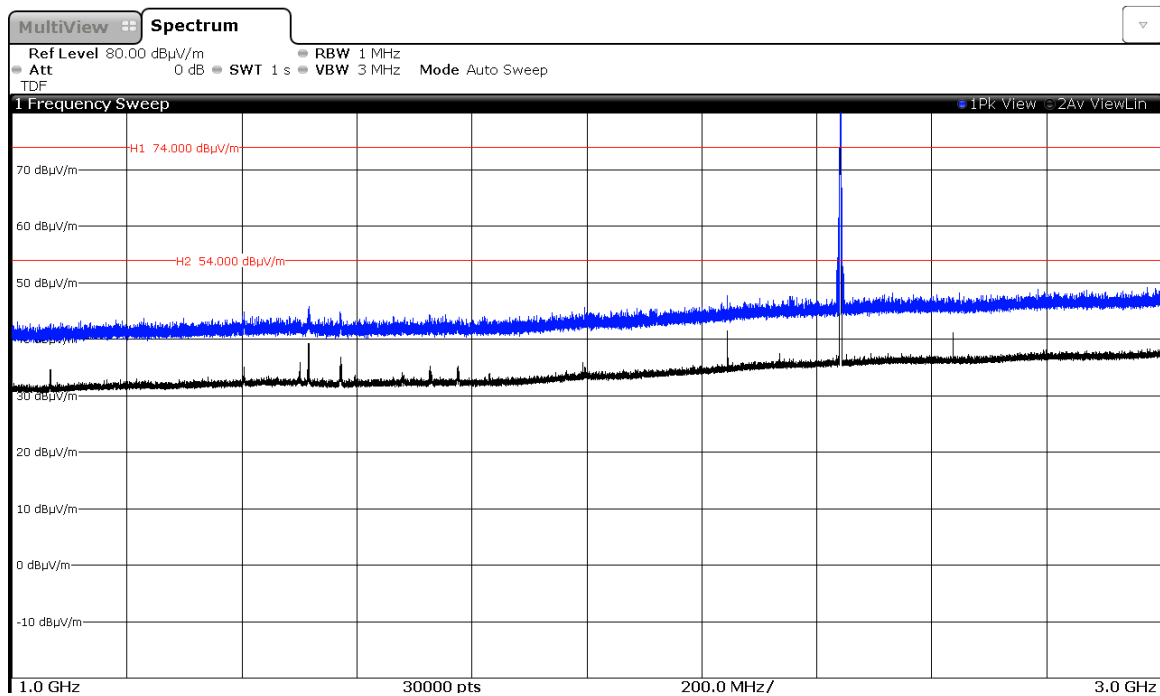

Note: The peak shown in the plot above the limits is the carrier frequency.

CHANNEL: Highest (2480 MHz).

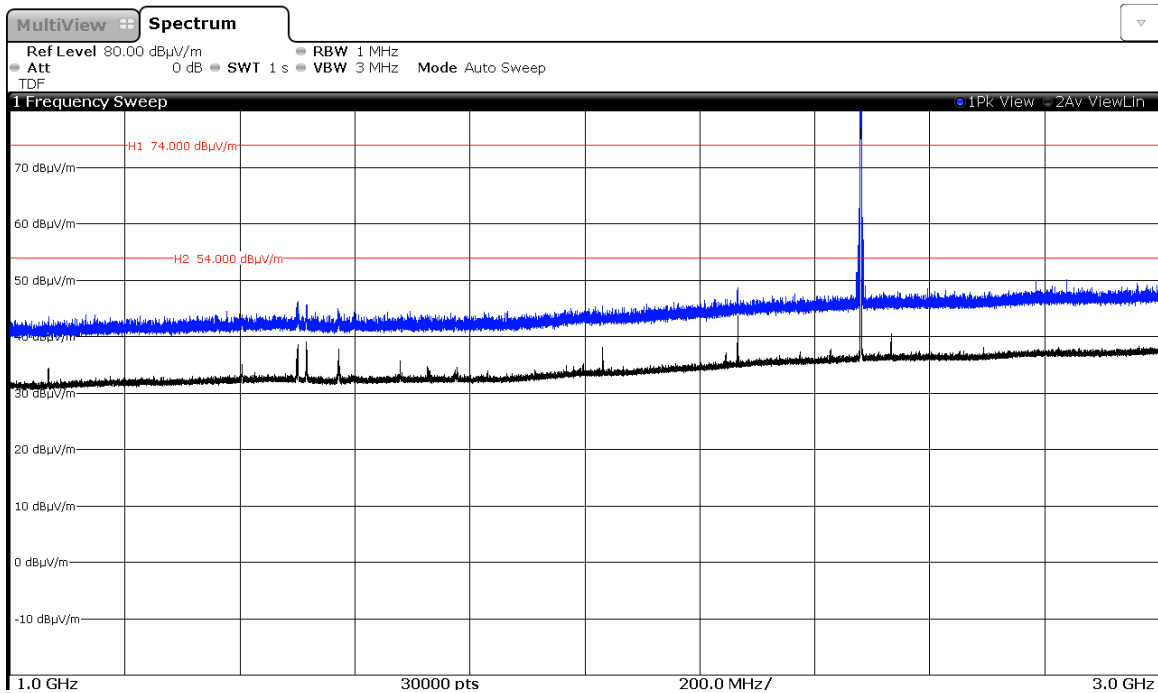

Note: The peak shown in the plot above the limits is the carrier frequency.

Modulation: $\pi/4$ -DQPSK

CHANNEL: Lowest (2402 MHz).

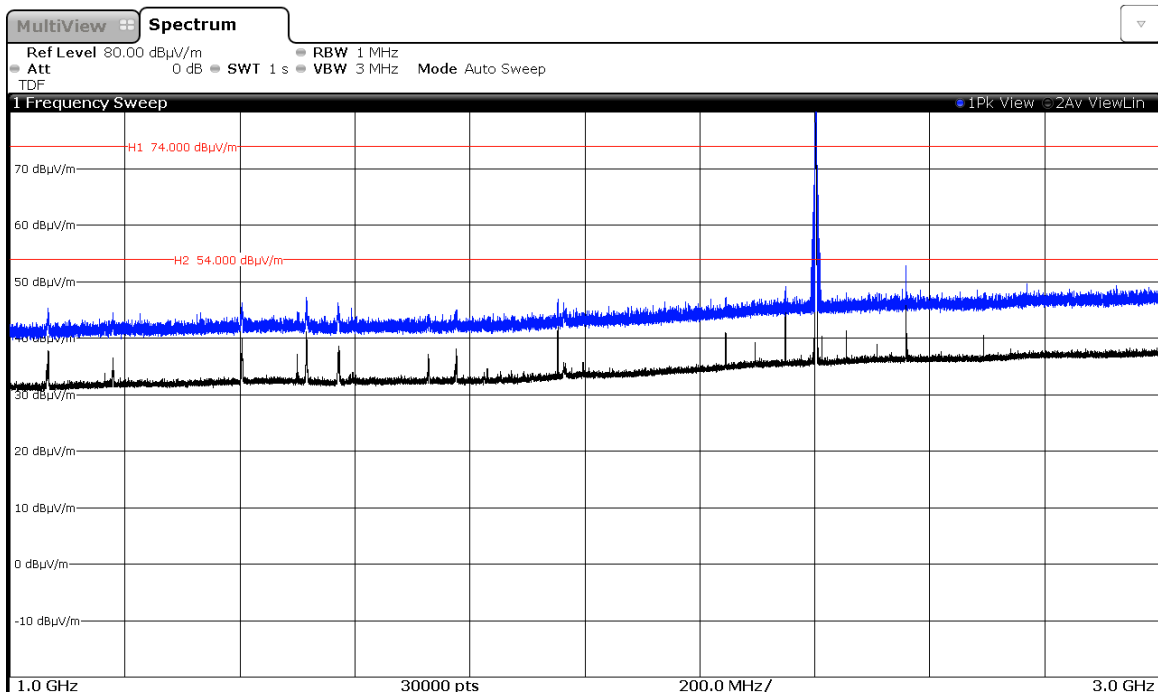

Note: The peak shown in the plot above the limits is the carrier frequency.

CHANNEL: Middle (2441 MHz).

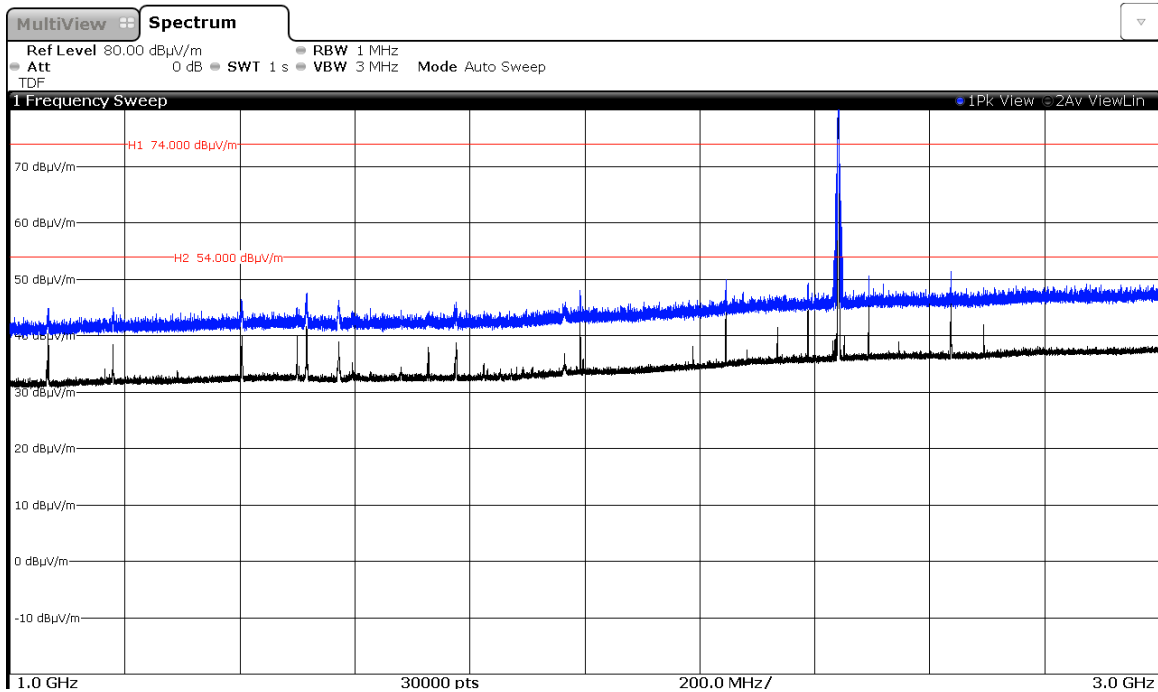

Note: The peak shown in the plot above the limits is the carrier frequency.

CHANNEL: Highest (2480 MHz).

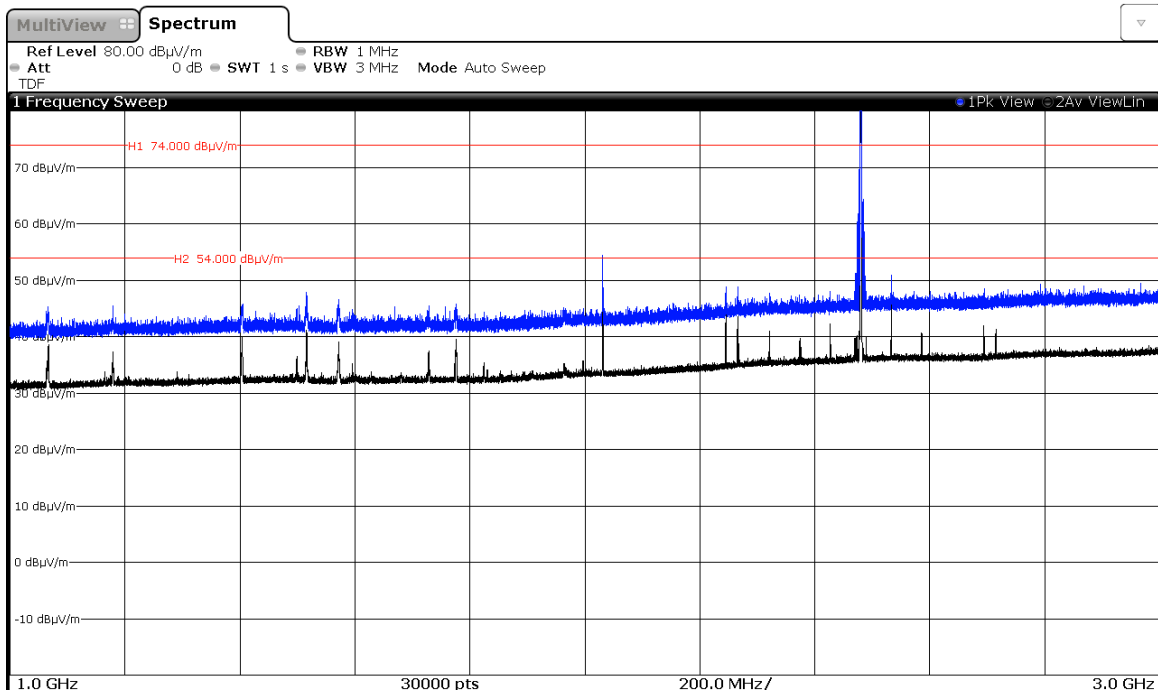

Note: The peak shown in the plot above the limits is the carrier frequency.

Modulation: 8-DPSK

CHANNEL: Lowest (2402 MHz).

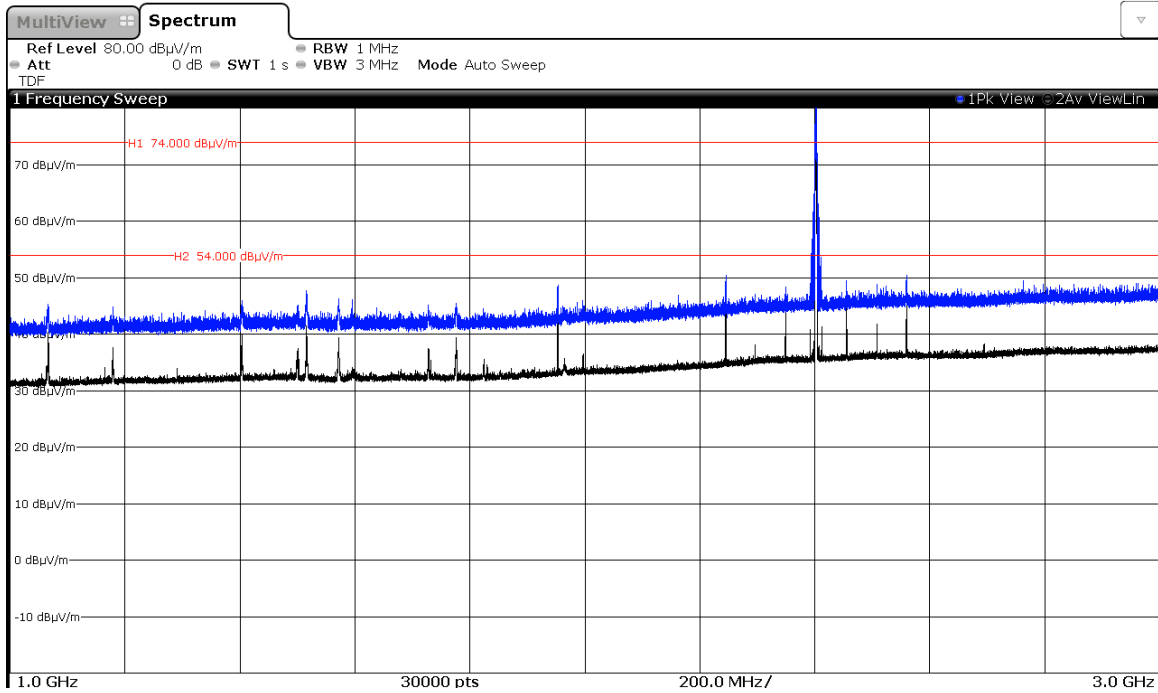

Note: The peak shown in the plot above the limits is the carrier frequency.

CHANNEL: Middle (2441 MHz).

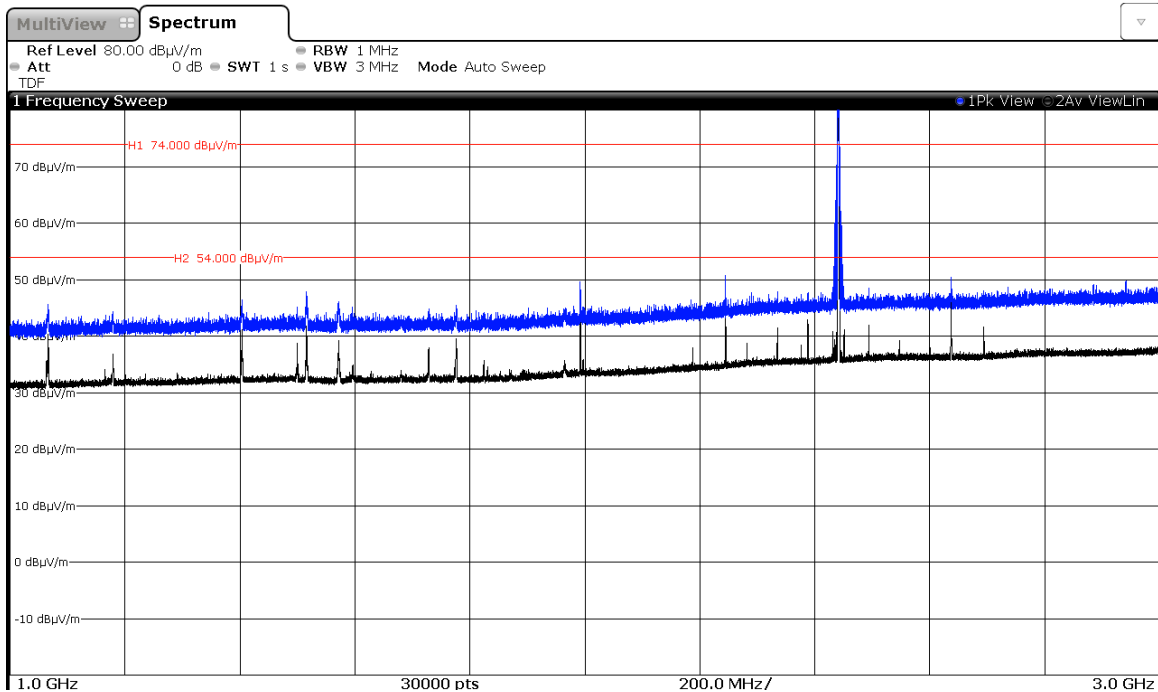

Note: The peak shown in the plot above the limits is the carrier frequency.

CHANNEL: Highest (2480 MHz).

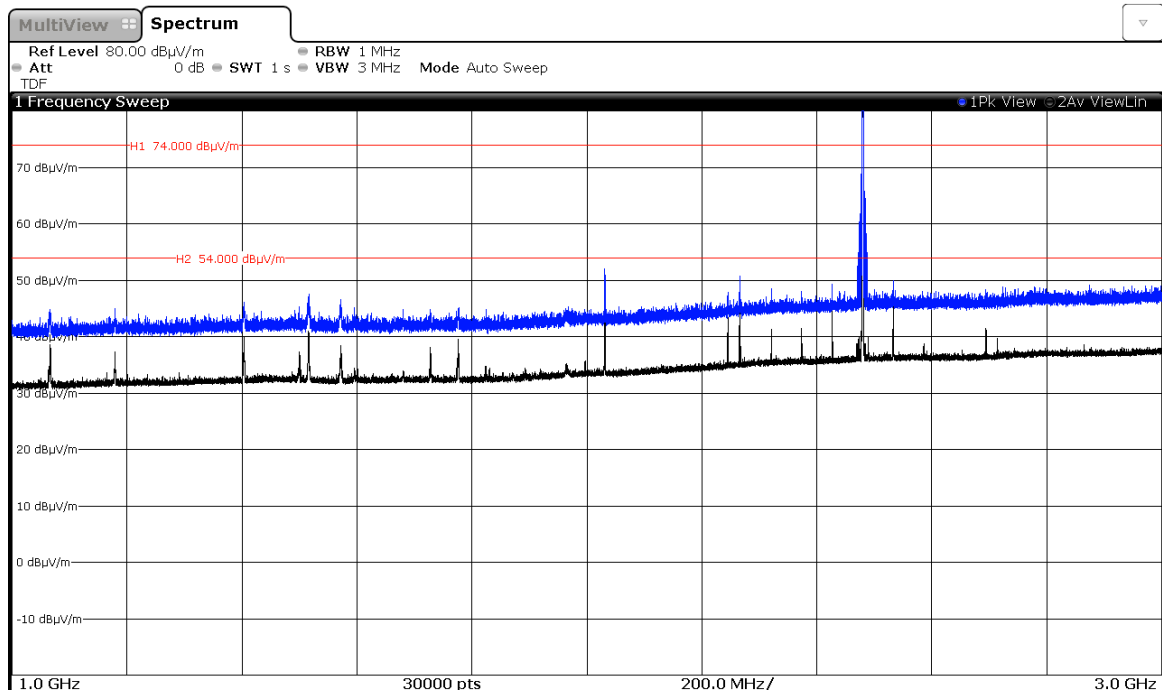

Note: The peak shown in the plot above the limits is the carrier frequency.

FREQUENCY RANGE 3 GHz to 18 GHz.

Modulation: GFSK

CHANNEL: Lowest (2402 MHz).

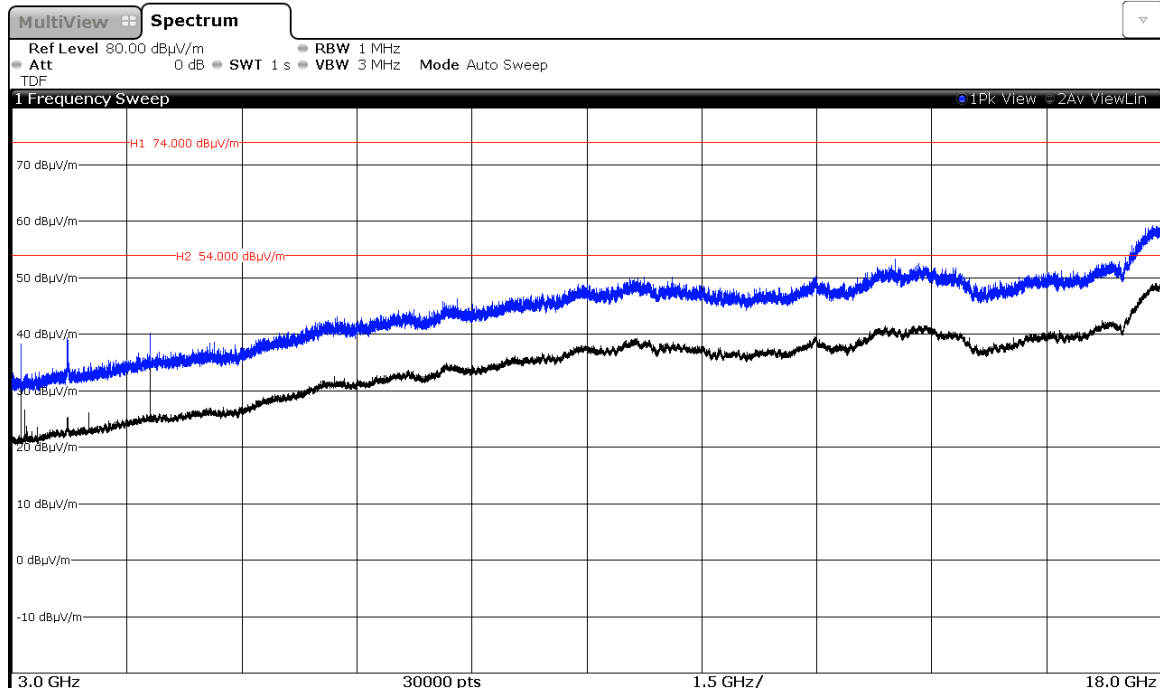

CHANNEL: Middle (2441 MHz).

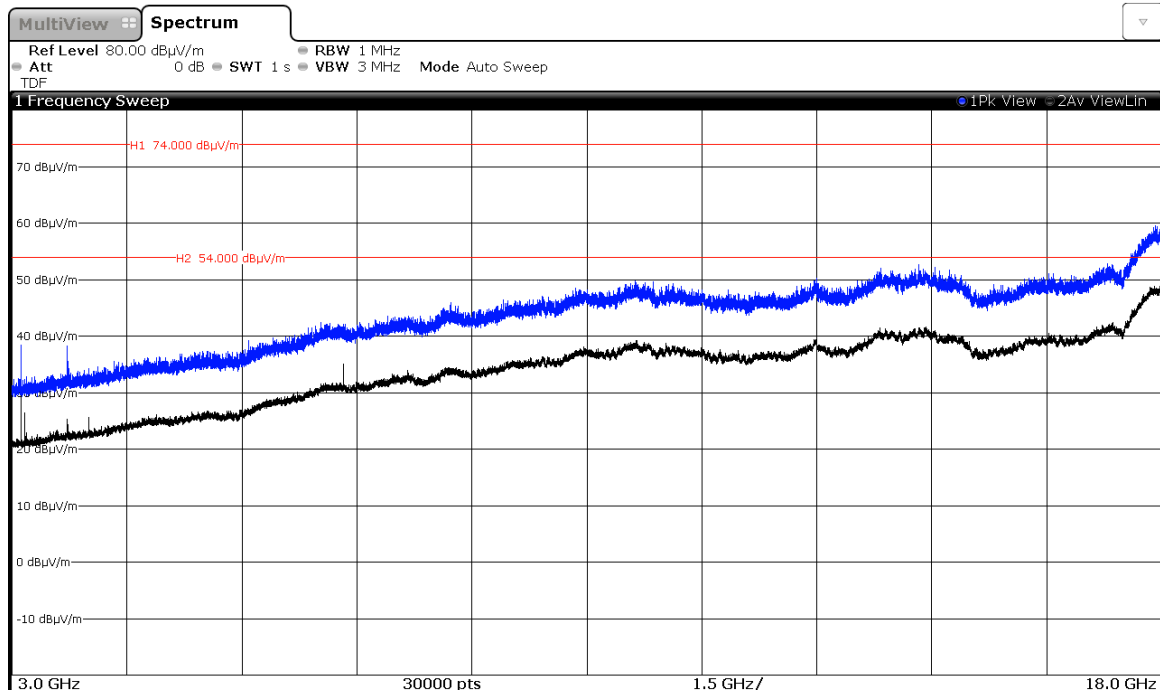

CHANNEL: Highest (2480 MHz).

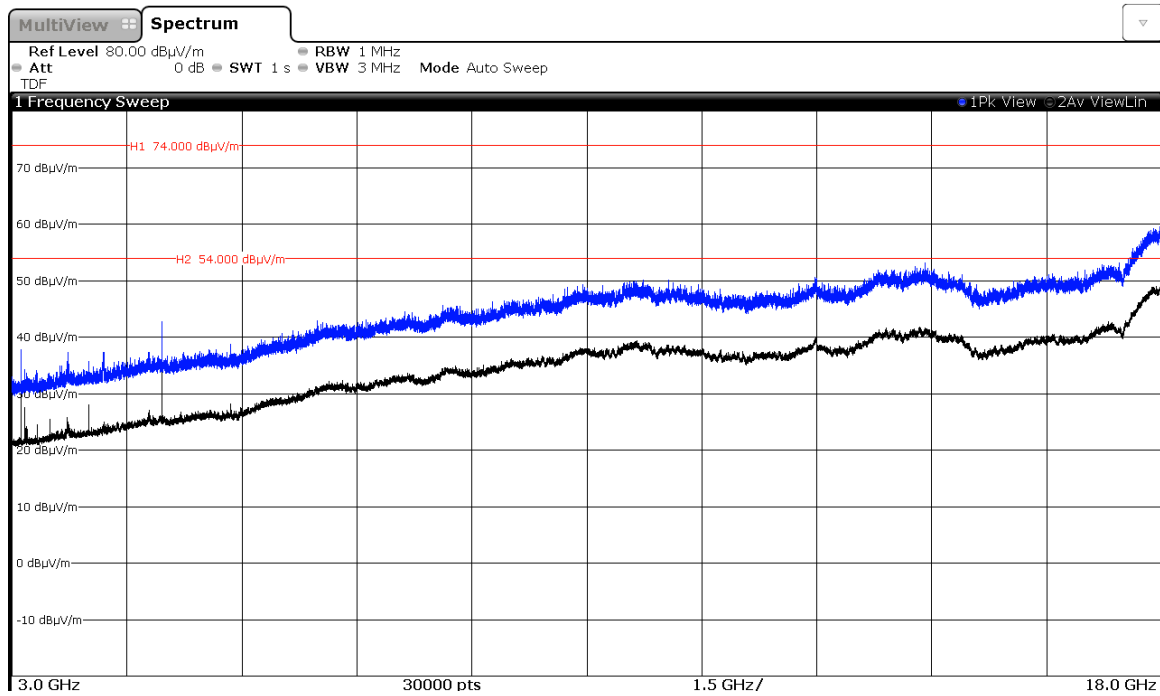

Modulation: $\Pi/4$ -DQPSK

CHANNEL: Lowest (2402 MHz).

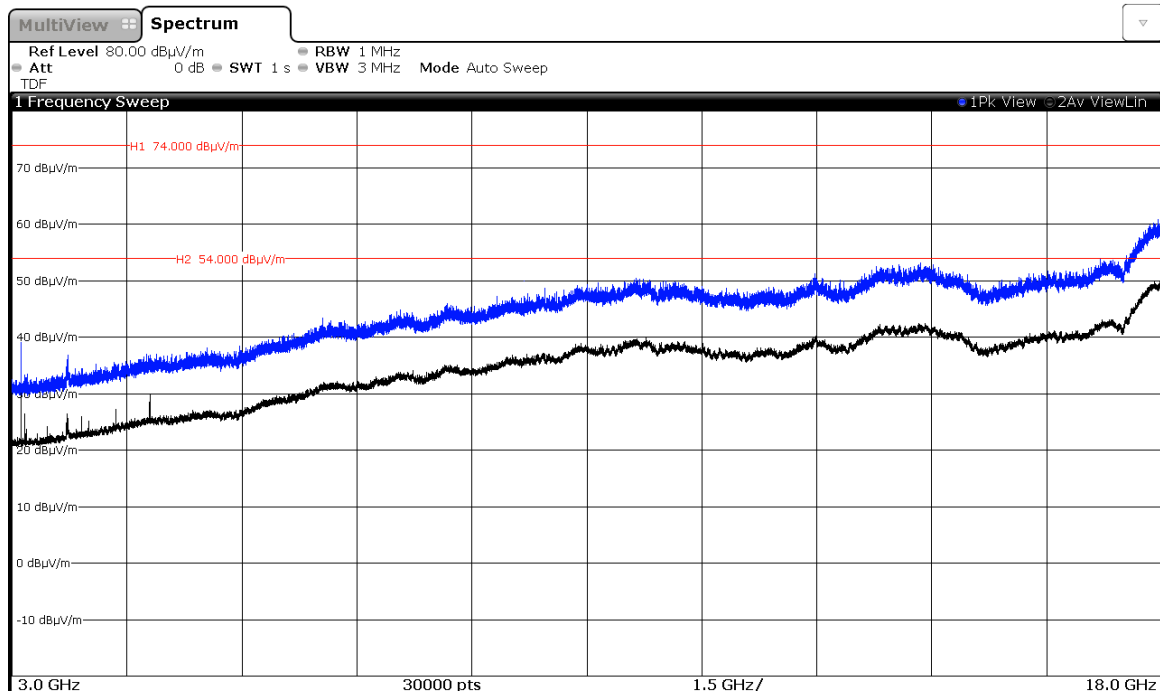

CHANNEL: Middle (2441 MHz).

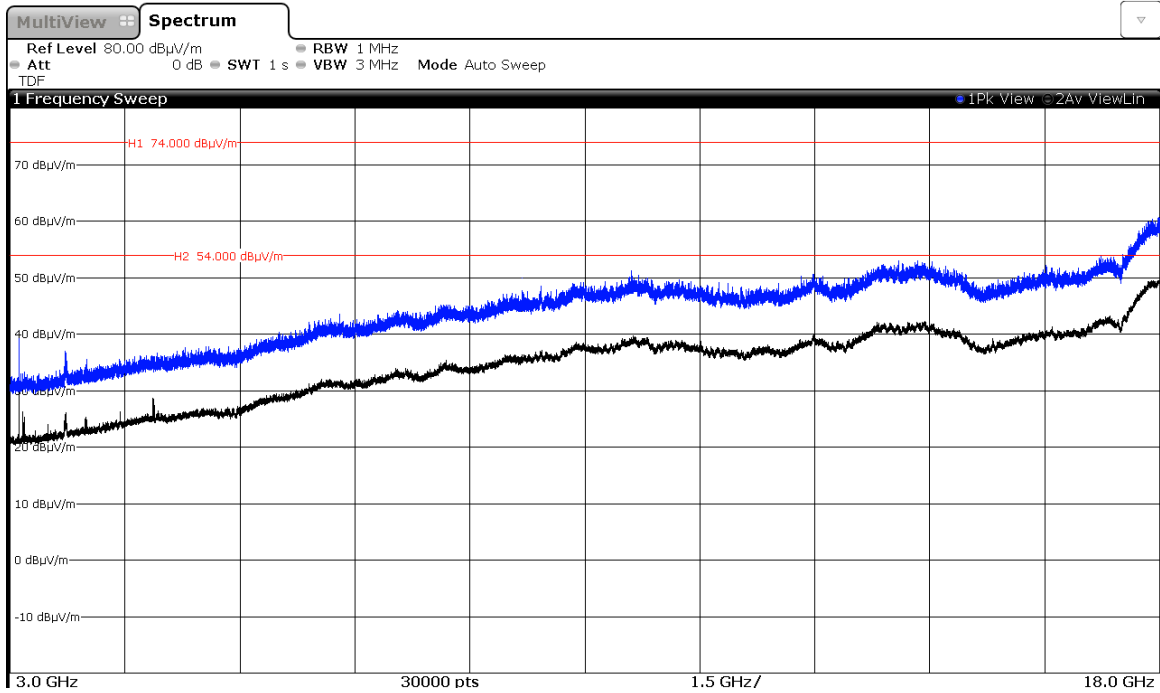

CHANNEL: Highest (2480 MHz).

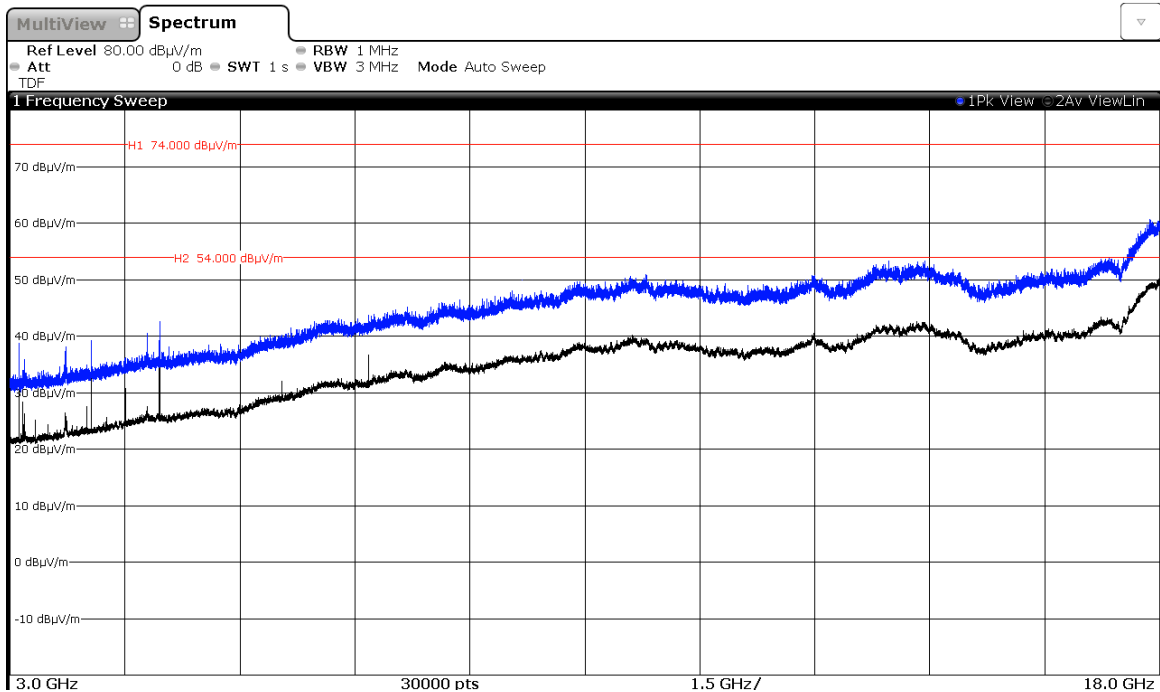

Modulation: 8-DPSK

CHANNEL: Lowest (2402 MHz).

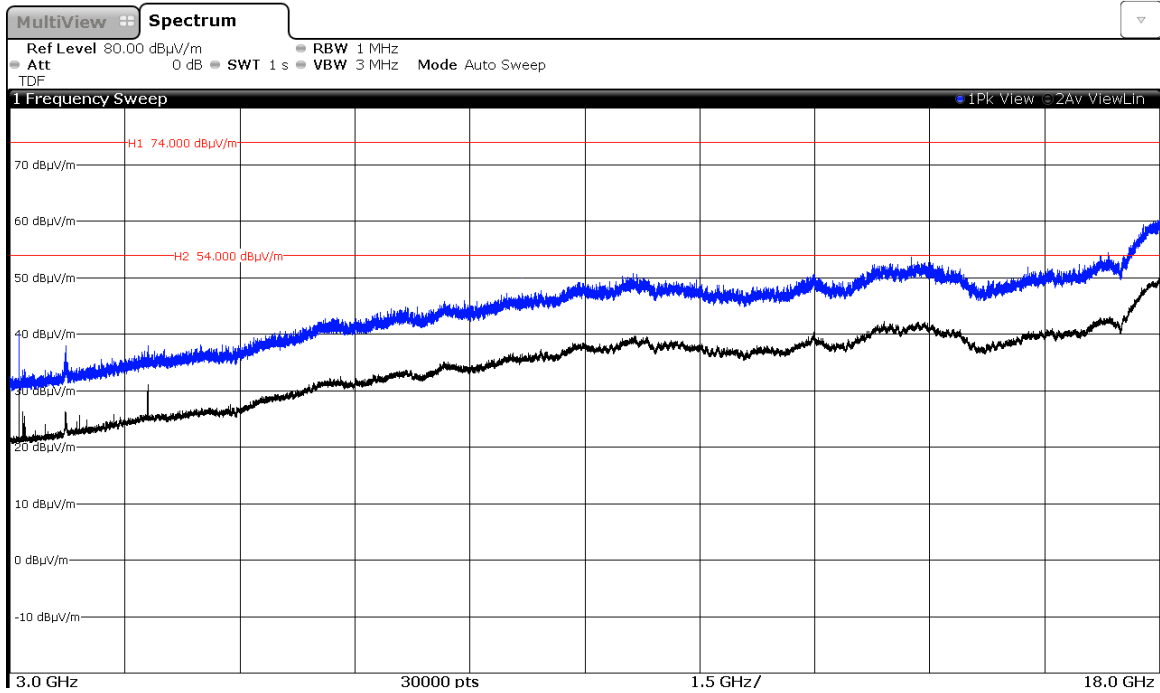

CHANNEL: Middle (2441 MHz).

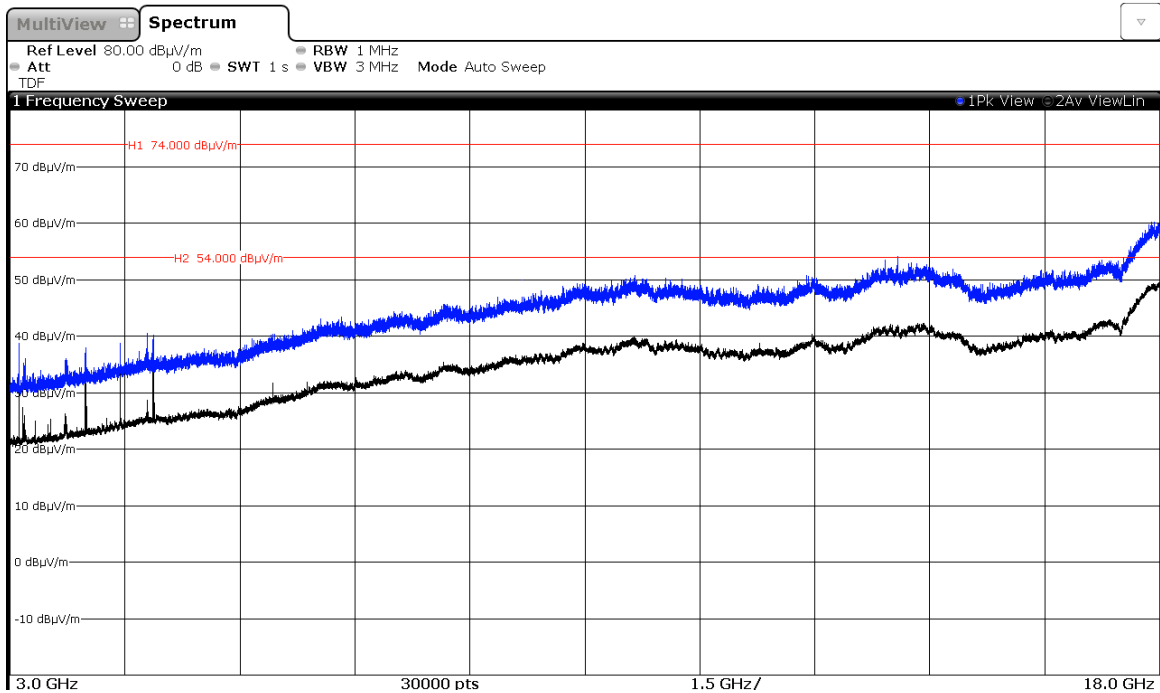

CHANNEL: Highest (2480 MHz).

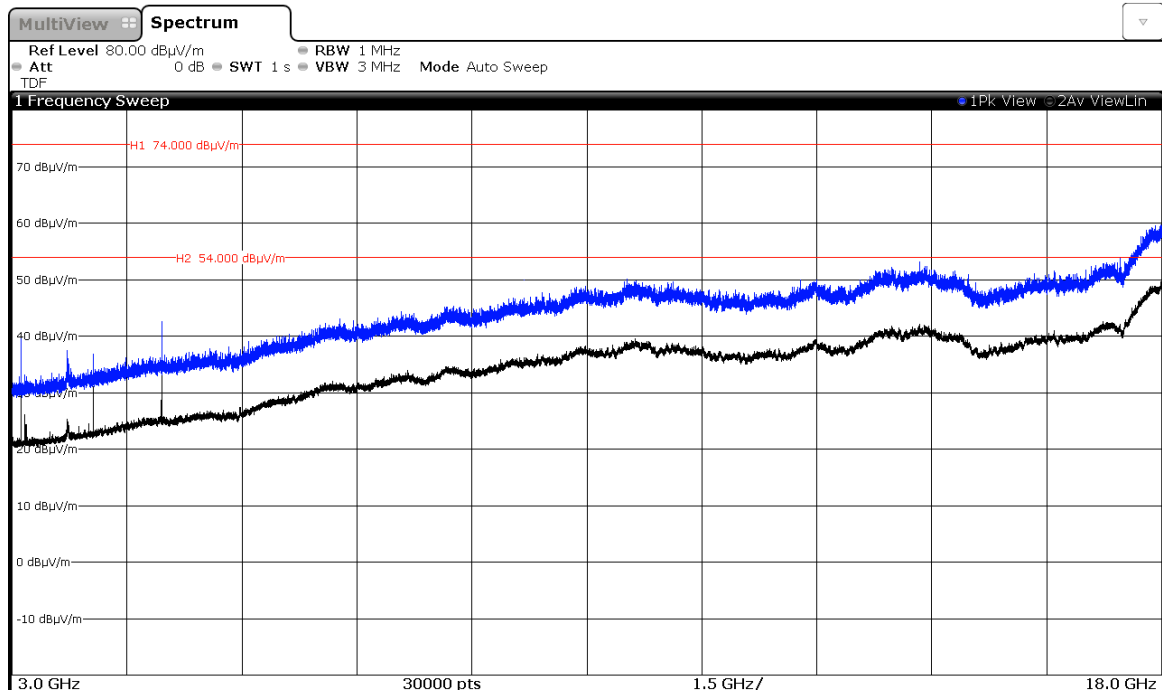

FREQUENCY RANGE 18 GHz to 26 GHz.

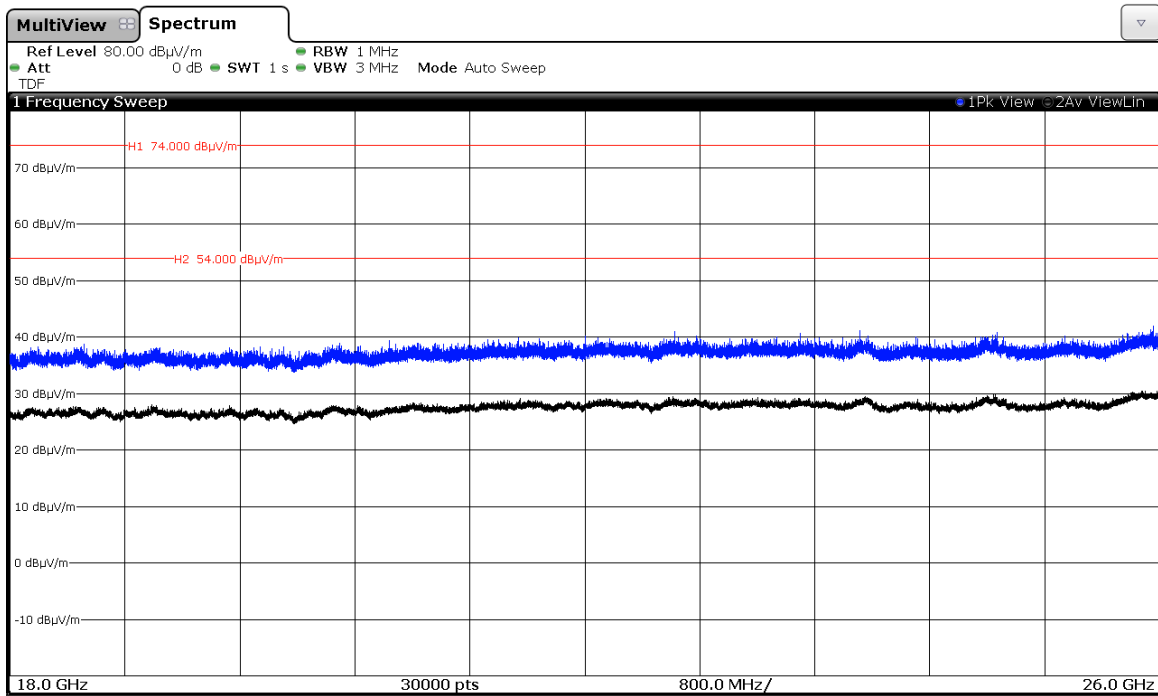

(This plot is valid for all three channels and all modulation modes).

FREQUENCY RANGE 2.31 GHz to 2.39 GHz. (RESTRICTED BAND)

CHANNEL: Lowest

Modulation: GFSK

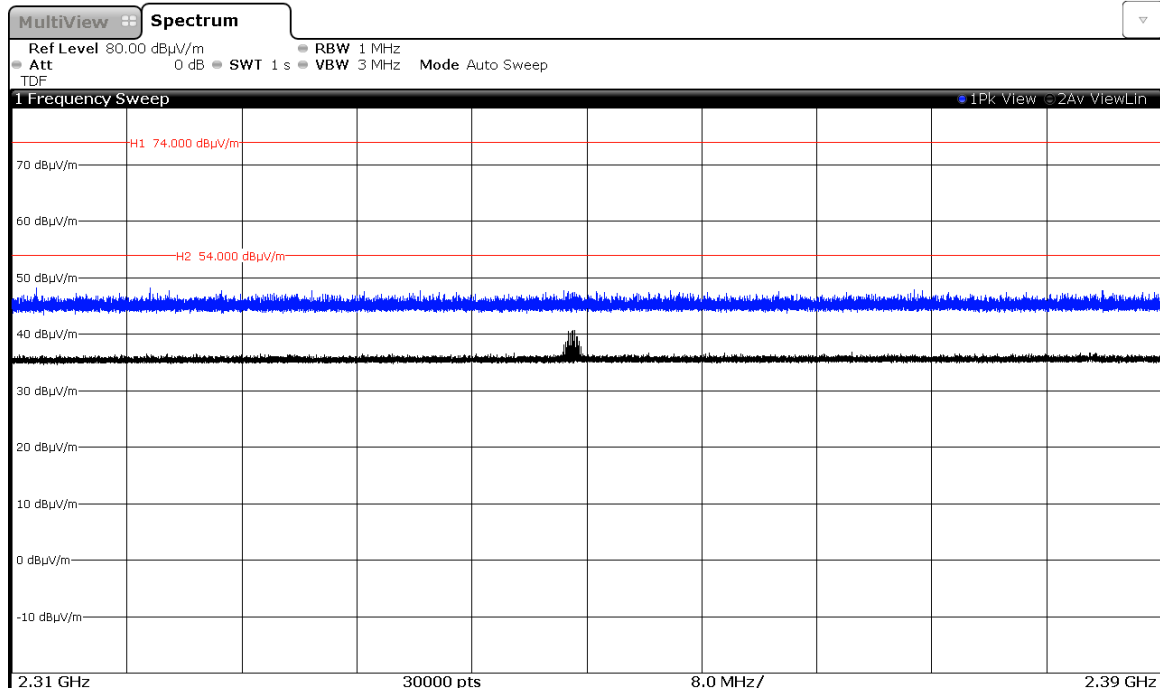

Modulation: $\Pi/4$ -DQPSK

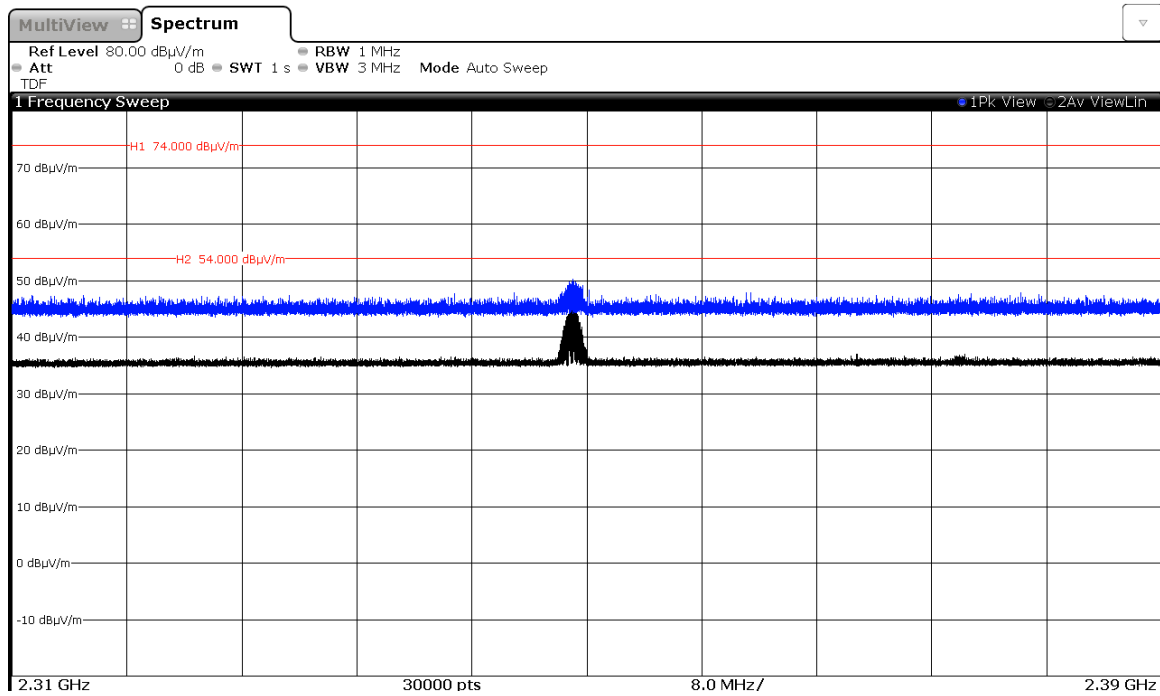

Modulation: 8-DPSK

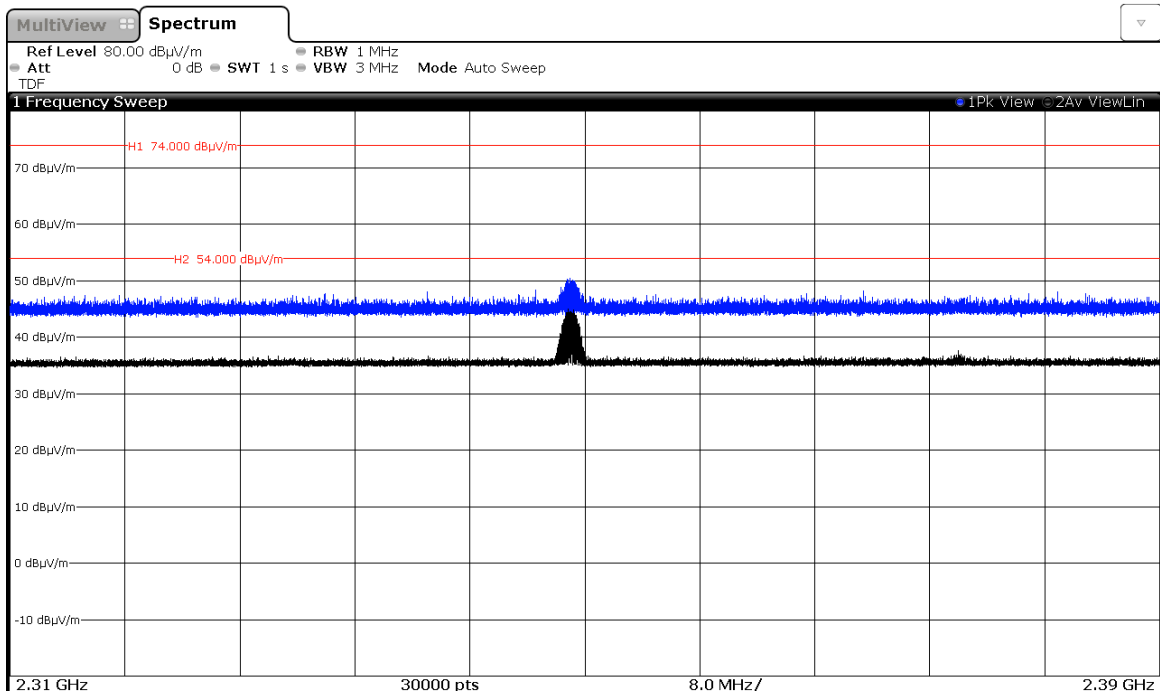

CHANNEL: Middle

Modulation: GFSK

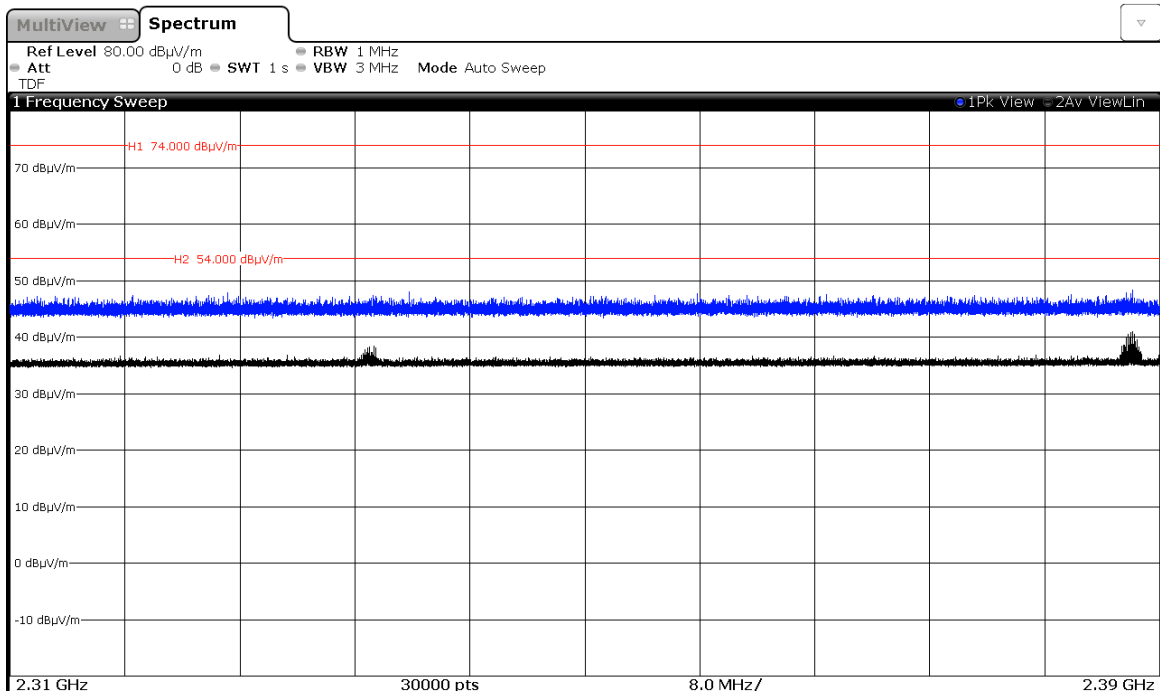

Modulation: $\Pi/4$ -DQPSK

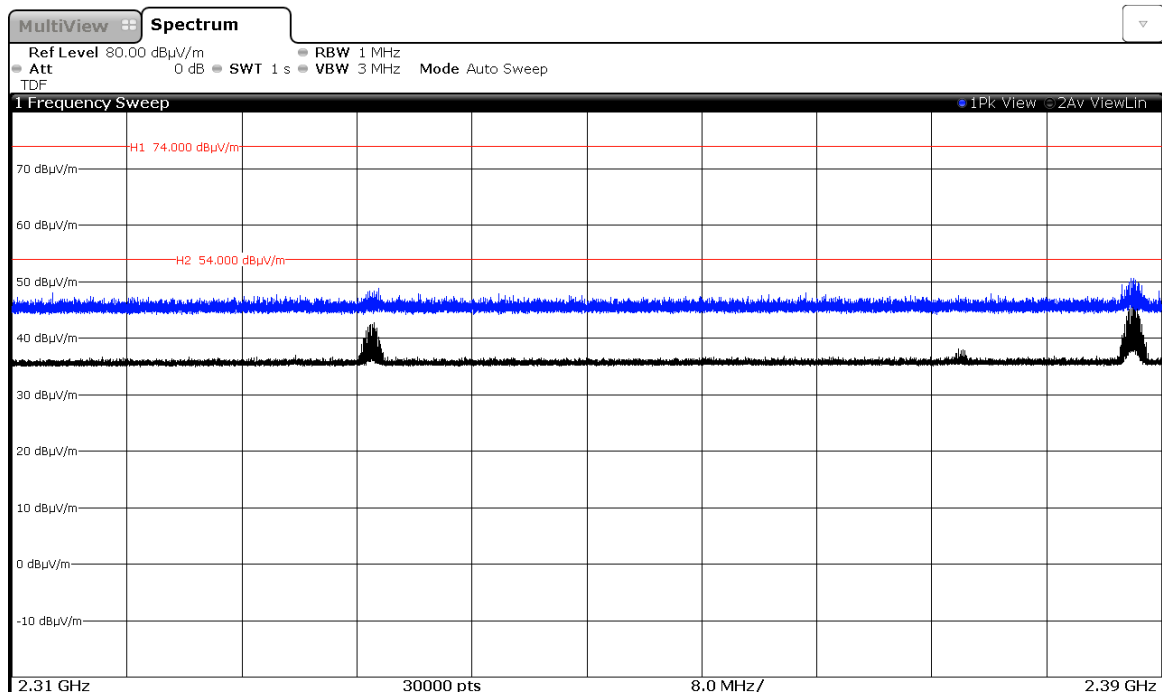

Modulation: 8-DPSK

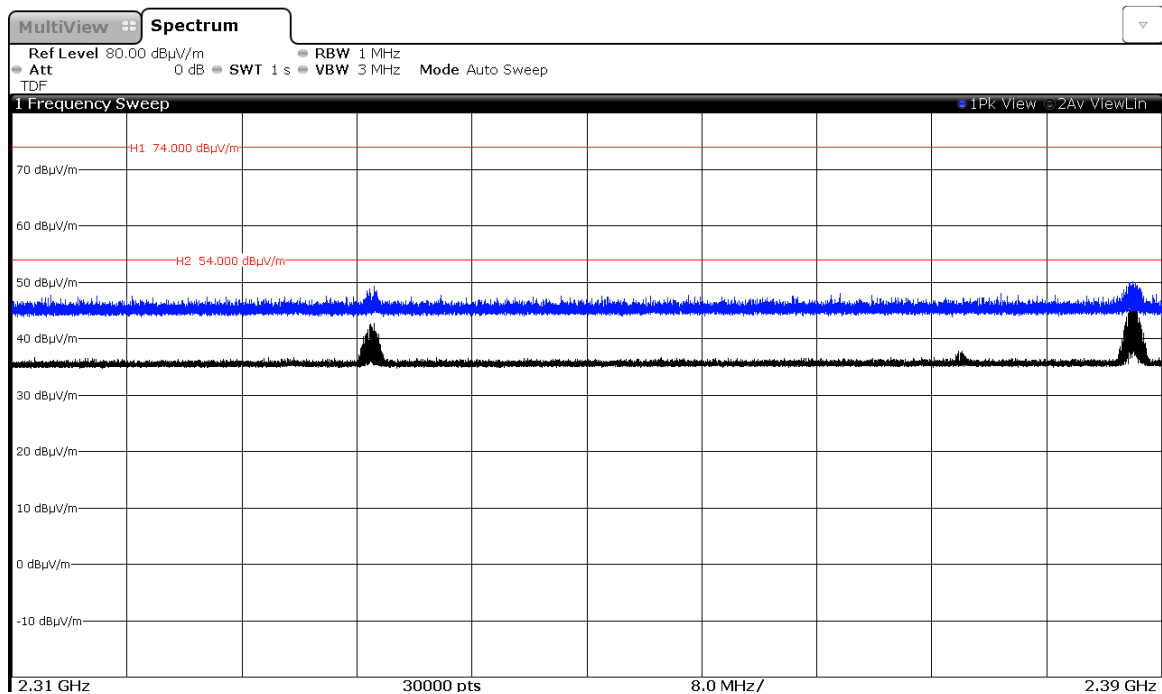

CHANNEL: Highest

Modulation: GFSK

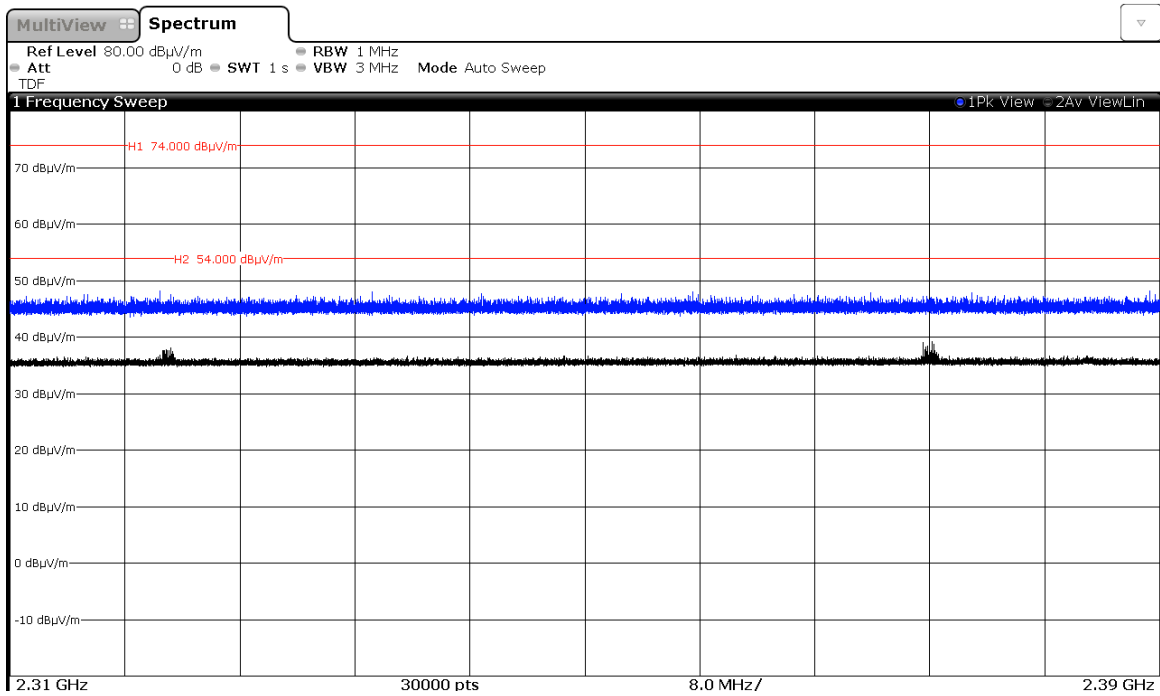

Modulation: $\Pi/4$ -DQPSK

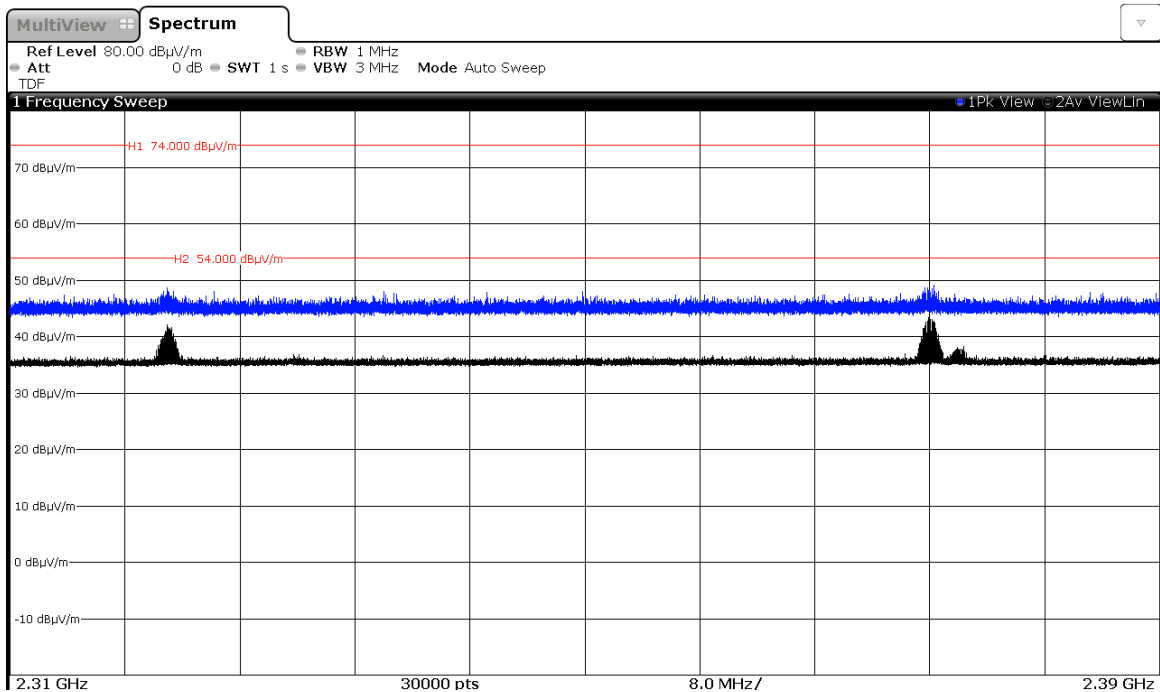

Modulation: 8-DPSK

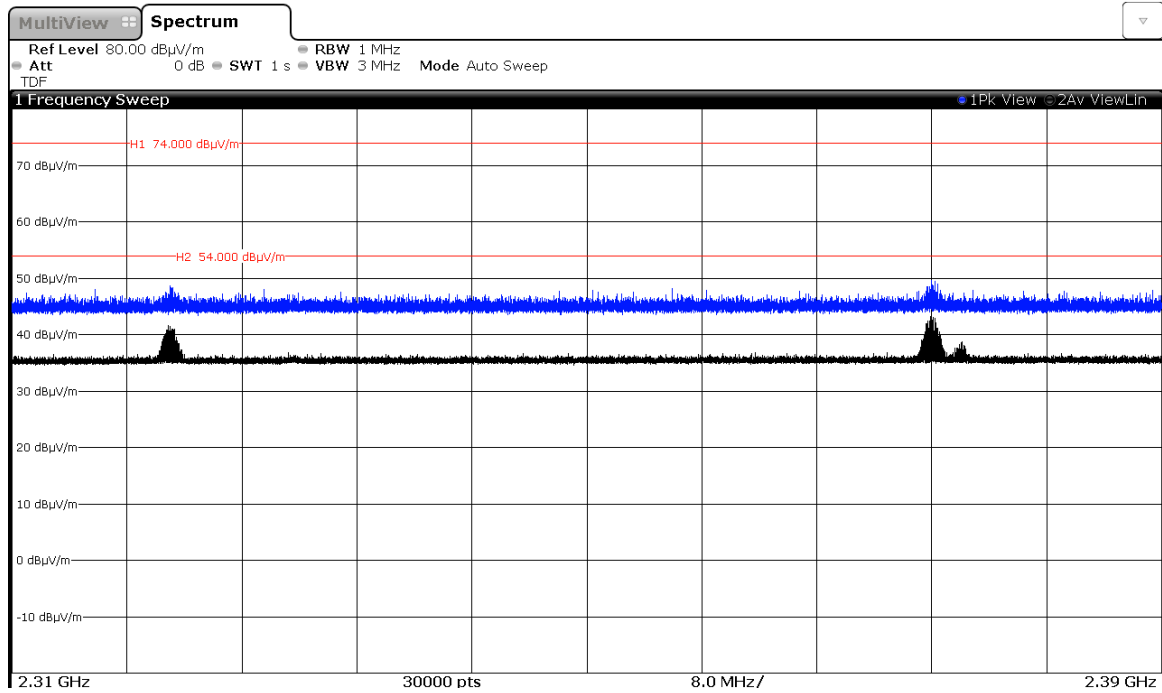

FREQUENCY RANGE 2.4835 GHz to 2.5 GHz. (RESTRICTED BAND)

CHANNEL: Lowest

Modulation: GFSK

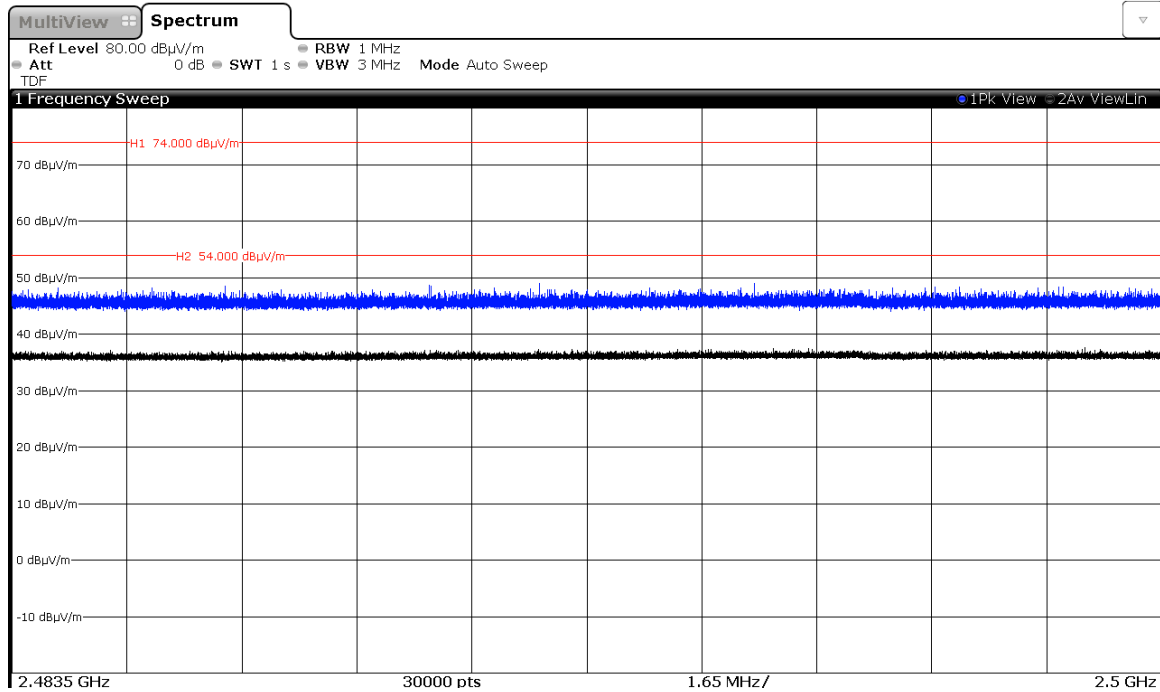

Modulation: $\Pi/4$ -DQPSK

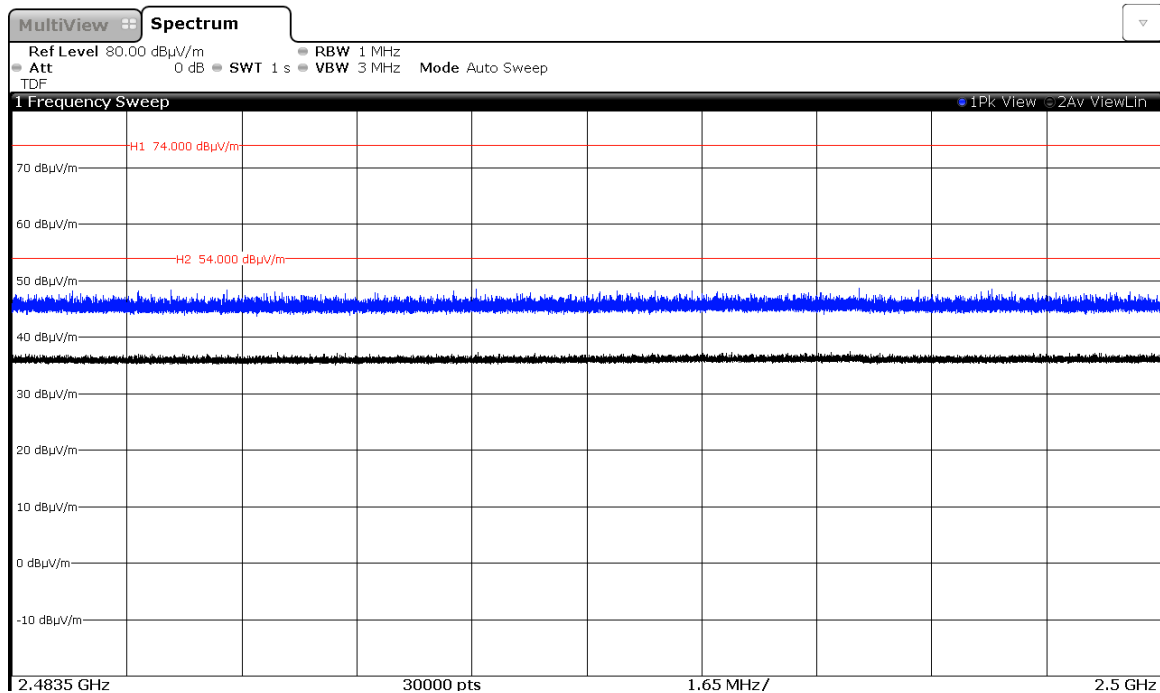

Modulation: 8-DPSK

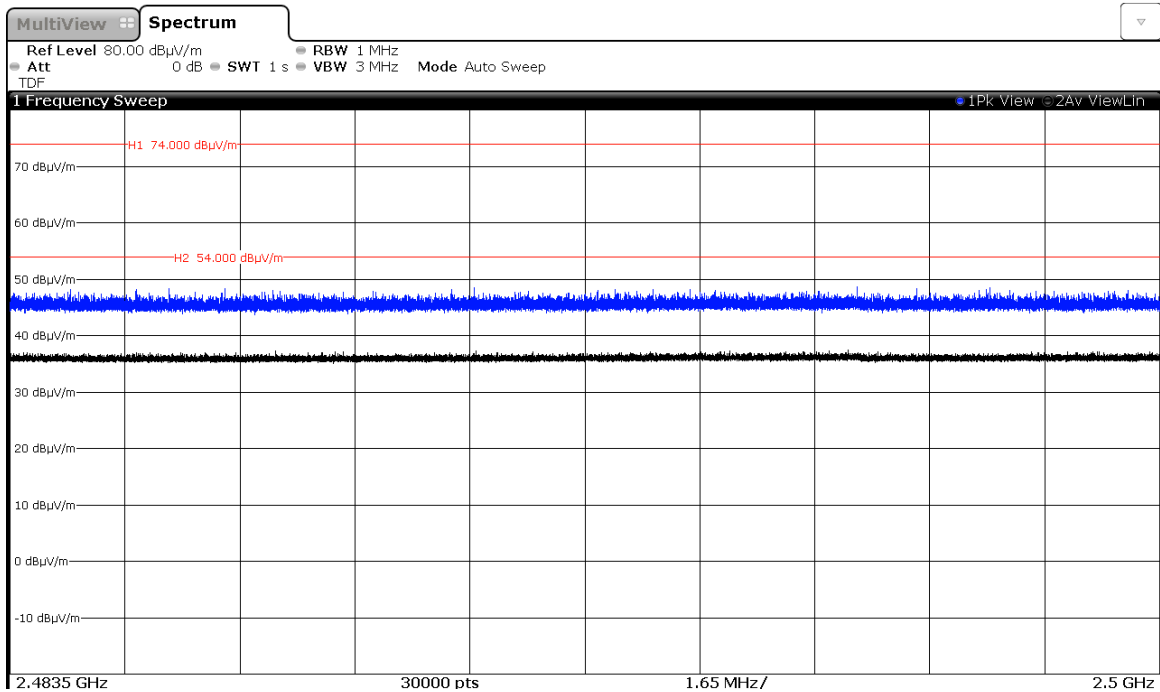

CHANNEL: Middle

Modulation: GFSK

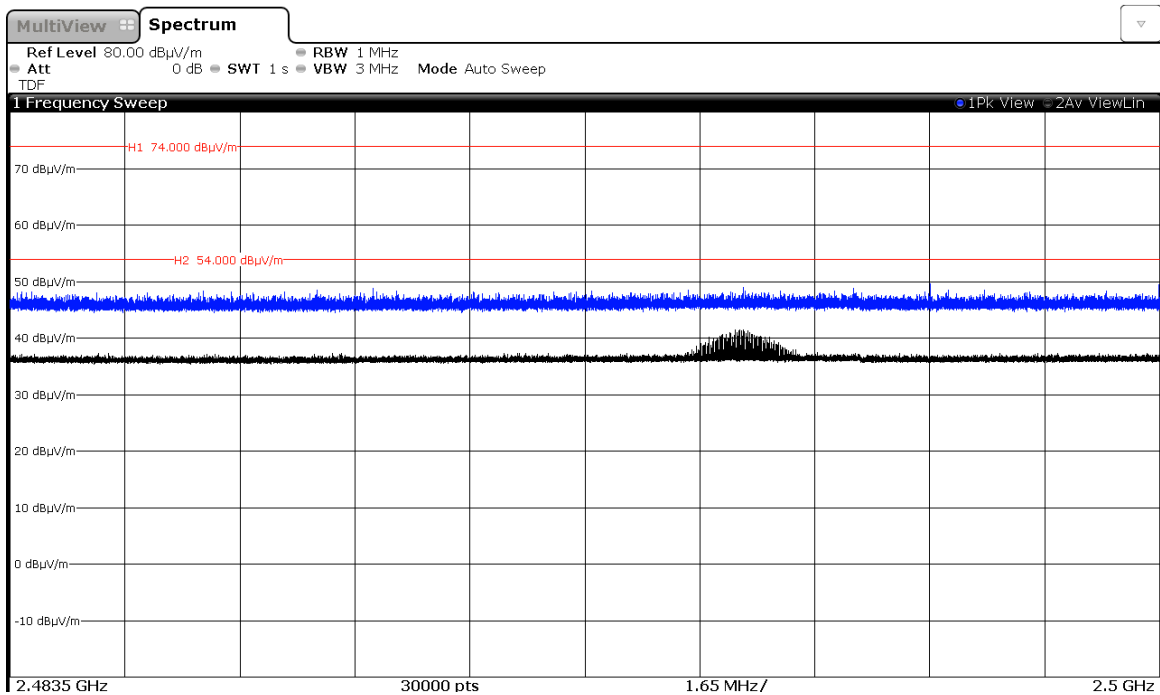

Modulation: $\Pi/4$ -DQPSK

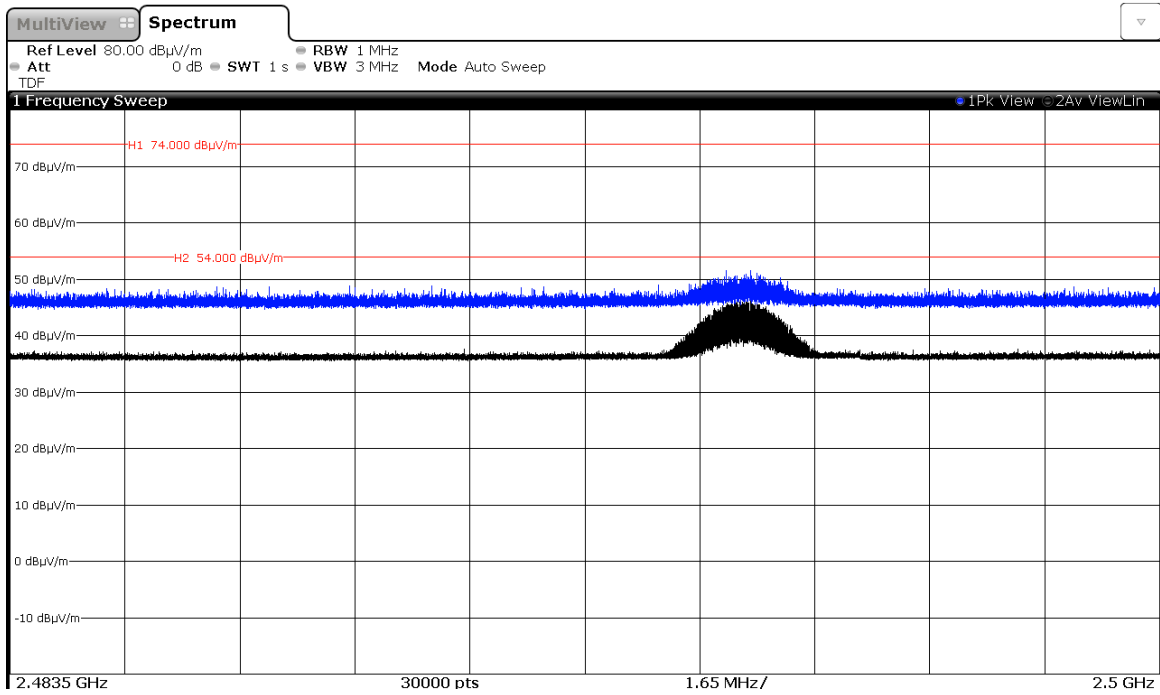

Modulation: 8-DPSK

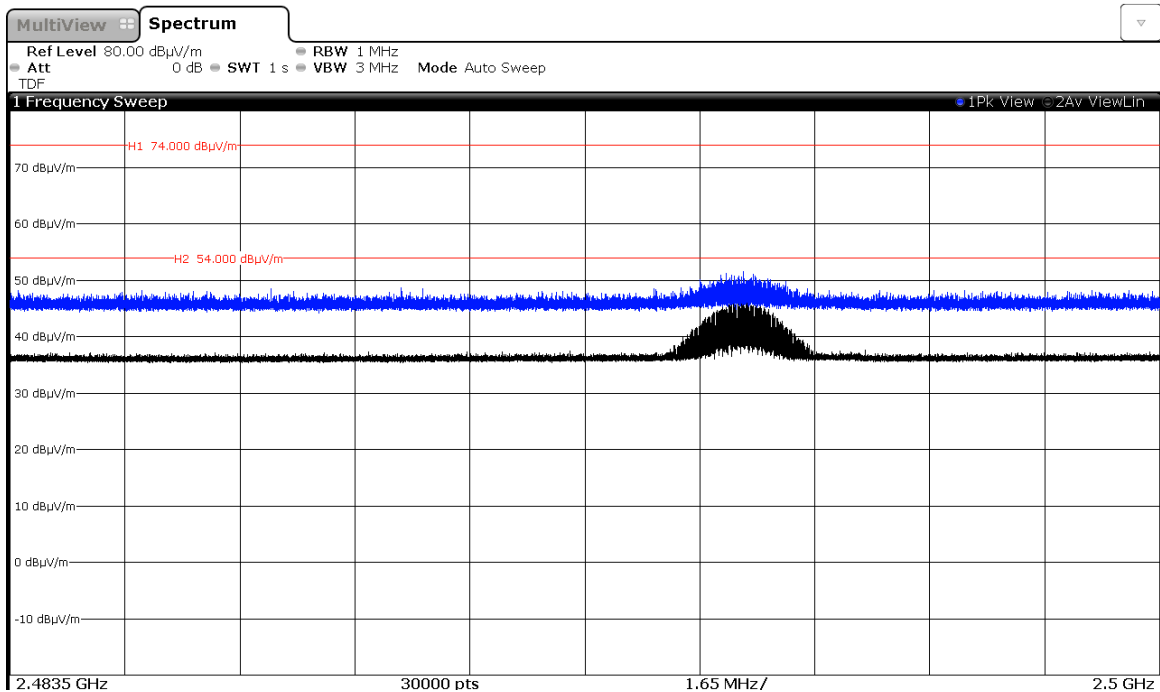

CHANNEL: Highest

Modulation: GFSK

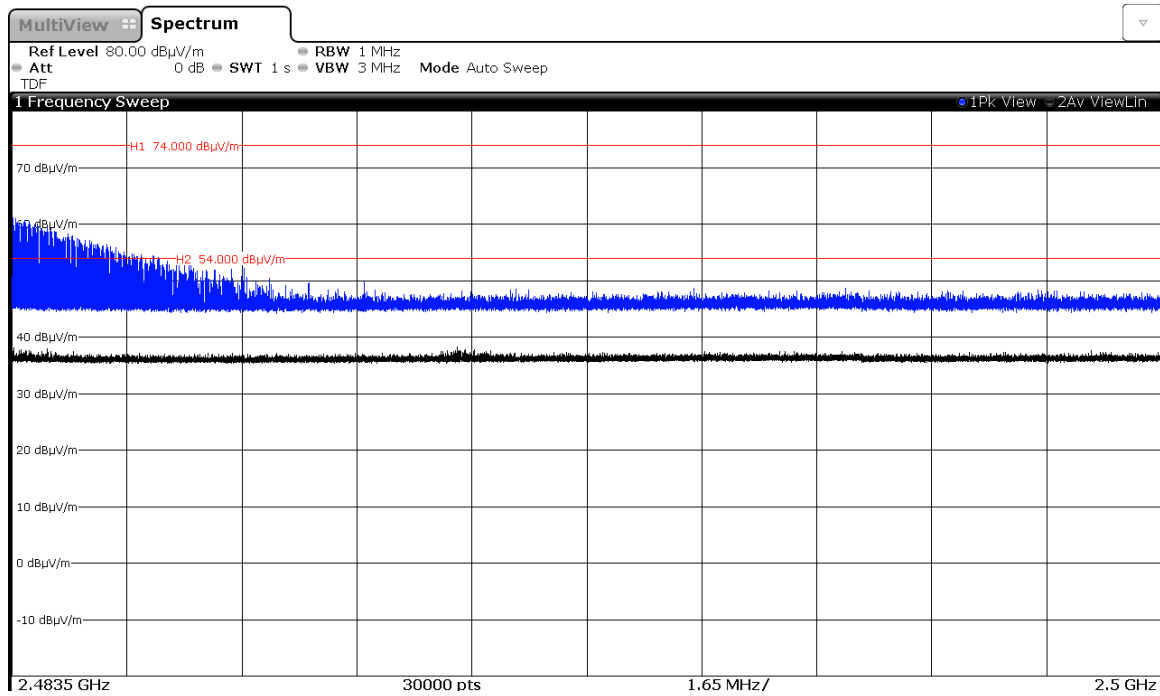

Modulation: $\pi/4$ -DQPSK

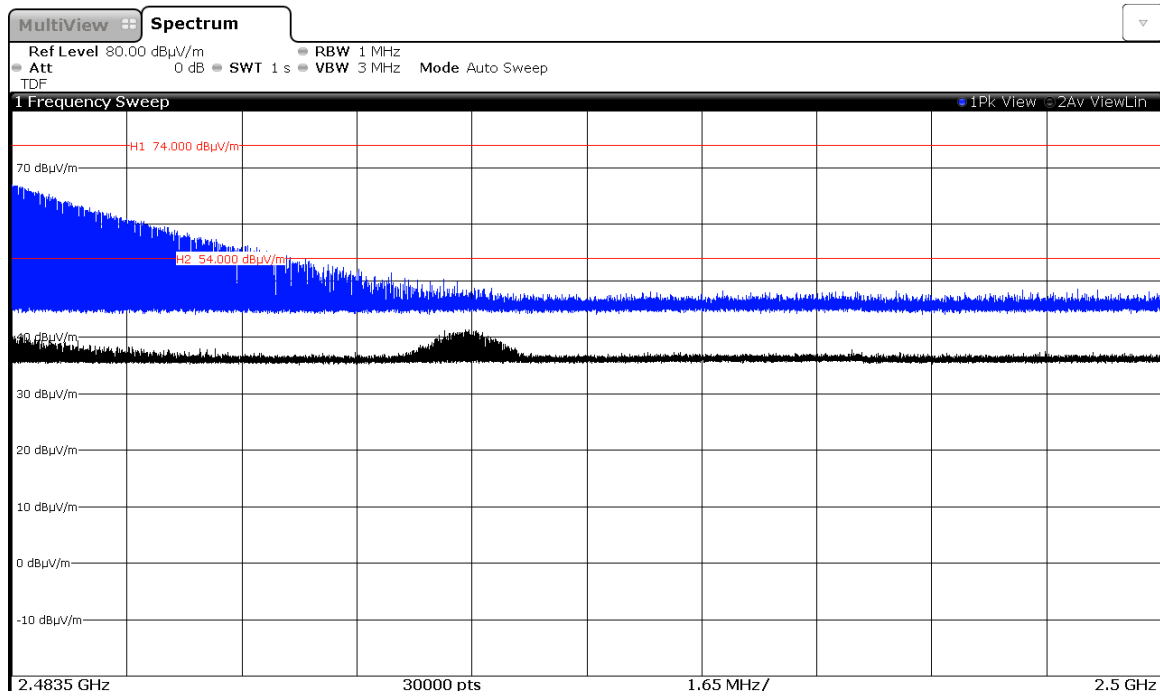

Modulation: 8-DPSK

