

**MEASUREMENT REPORT
 LTE**

Applicant Name: Panasonic Automotive Systems Company of America 776 Highway 74 South Peachtree City, Georgia, 30269, USA Attn: Benjamin Onambele	Date of Testing: 11/13-11/18/2017 Test Site/Location: PCTEST Lab. Columbia, MD, USA Test Report Serial No.: 1M1711020284-02.ACJ
---	---

FCC ID:	ACJ-VP4RAC
IC:	216A-VP4RAC
APPLICANT:	Panasonic Automotive Systems Company of America

Application Type:	Certification
Model:	VP4R-A
EUT Type:	Automotive Radio with Navigation
FCC Classification:	PCS Licensed Transmitter (PCB)
FCC Rule Part(s):	22, 24, & 27
Test Procedure(s):	ANSI C63.26-2015, ANSI/TIA-603-E-2016, KDB 971168 D01 v03

This equipment has been shown to be capable of compliance with the applicable technical standards as indicated in the measurement report and was tested in accordance with the measurement procedures specified in §2.947. Test results reported herein relate only to the item(s) tested.

I attest to the accuracy of data. All measurements reported herein were performed by me or were made under my supervision and are correct to the best of my knowledge and belief. I assume full responsibility for the completeness of these measurements and vouch for the qualifications of all persons taking them.

 Randy Ortanez
 President



FCC ID: ACJ-VP4RAC		MEASUREMENT REPORT (CERTIFICATION)		Approved by: Quality Manager
Test Report S/N: 1M1711020284-02.ACJ	Test Dates: 11/13-11/18/2017	EUT Type: Automotive Radio with Navigation		Page 1 of 25

TABLE OF CONTENTS

1.0	INTRODUCTION	3
1.1	Scope	3
1.2	PCTEST Test Location	3
1.3	Test Facility / Accreditations	3
2.0	PRODUCT INFORMATION	4
2.1	Equipment Description	4
2.2	Device Capabilities	4
2.3	Test Configuration	4
2.4	EMI Suppression Device(s)/Modifications	4
3.0	DESCRIPTION OF TESTS	5
3.1	Measurement Procedure	5
3.2	Block A Frequency Range	5
3.3	Cellular - Base Frequency Blocks	5
3.4	Cellular - Mobile Frequency Blocks	5
3.5	PCS - Base Frequency Blocks	6
3.6	PCS - Mobile Frequency Blocks	6
3.7	AWS - Base Frequency Blocks	6
3.8	AWS - Mobile Frequency Blocks	6
3.9	BRS/EBS Frequency Block	7
3.10	Radiated Power and Radiated Spurious Emissions	7
4.0	MEASUREMENT UNCERTAINTY	9
5.0	TEST EQUIPMENT CALIBRATION DATA	10
6.0	SAMPLE CALCULATIONS	11
7.0	TEST RESULTS	12
7.1	Summary	12
7.2	Radiated Spurious Emissions Measurements	13
8.0	CONCLUSION	25

FCC ID: ACJ-VP4RAC		MEASUREMENT REPORT (CERTIFICATION)		Approved by: Quality Manager
Test Report S/N: 1M1711020284-02.ACJ	Test Dates: 11/13-11/18/2017	EUT Type: Automotive Radio with Navigation		Page 2 of 25

1.0 INTRODUCTION

1.1 Scope

Measurement and determination of electromagnetic emissions (EMC) of radio frequency devices including intentional and/or unintentional radiators for compliance with the technical rules and regulations of the Federal Communications Commission and the Innovation, Science and Economic Development Canada.

1.2 PCTEST Test Location

These measurement tests were conducted at the PCTEST Engineering Laboratory, Inc. facility located at 7185 Oakland Mills Road, Columbia, MD 21046. The facility is 0.4 miles North of the FCC laboratory, and the ambient signal and ambient signal strength are approximately equal to those of the FCC laboratory. The measurement facility is compliant with the test site requirements specified in ANSI C63.4-2014.

1.3 Test Facility / Accreditations

Measurements were performed at PCTEST Engineering Lab located in Columbia, MD 21046, U.S.A.

- PCTEST is an ISO 17025-2005 accredited test facility under the American Association for Laboratory Accreditation (A2LA) with Certificate number 2041.01 for Specific Absorption Rate (SAR), Hearing Aid Compatibility (HAC) testing, where applicable, and Electromagnetic Compatibility (EMC) testing for FCC and Innovation, Science, and Economic Development Canada rules.
- PCTEST TCB is a Telecommunication Certification Body (TCB) accredited to ISO/IEC 17065-2012 by A2LA (Certificate number 2041.03) in all scopes of FCC Rules and ISED Standards (RSS).
- PCTEST facility is a registered (22831) test laboratory with the site description on file with ISED.

FCC ID: ACJ-VP4RAC	 <small>ENGINEERING LABORATORY, INC.</small>	MEASUREMENT REPORT (CERTIFICATION)		Approved by: Quality Manager
Test Report S/N: 1M1711020284-02.ACJ	Test Dates: 11/13-11/18/2017	EUT Type: Automotive Radio with Navigation		Page 3 of 25

2.0 PRODUCT INFORMATION

2.1 Equipment Description

The Equipment Under Test (EUT) is the **Panasonic Automotive Radio with Navigation FCC ID: ACJ-VP4RAC**. The EUT is a 8.4" Integrated Display Radio (TI J6, QNX6.6) with Navigation, Tuner, Class D Amp, GPS/GLONASS, SXM, HD Radio, Bluetooth, Wi-Fi, and Cellular capabilities.

The test data contained in this report pertains only to the emissions due to the EUT's LTE function.

Test Device Serial No.: 1010

2.2 Device Capabilities

This device contains the following capabilities:

850/1900 WCDMA/UMTS, LTE Bands 2, 4, 5, 7, 17

2.3 Test Configuration

The EUT was tested per the guidance of ANSI/TIA-603-E-2016 and KDB 971168 D01 v03. See Section 7.0 of this test report for a description of the radiated emissions tests.

2.4 EMI Suppression Device(s)/Modifications

No EMI suppression device(s) were added and no modifications were made during testing.

FCC ID: ACJ-VP4RAC		MEASUREMENT REPORT (CERTIFICATION)		Approved by: Quality Manager
Test Report S/N: 1M1711020284-02.ACJ	Test Dates: 11/13-11/18/2017	EUT Type: Automotive Radio with Navigation		Page 4 of 25

3.0 DESCRIPTION OF TESTS

3.1 Measurement Procedure

The measurement procedures described in the document titled “Land Mobile FM or PM – Communications Equipment – Measurements and Performance Standards” (ANSI/TIA-603-E-2016) and “Procedures for Compliance Measurement of the Fundamental Emission Power of Licensed Wideband (> 1 MHz) Digital Transmission Systems” (KDB 971168 D01 v03) were used in the measurement of the EUT.

3.2 Block A Frequency Range

§27.5(c)

698-746 MHz band. The following frequencies are available for licensing pursuant to this part in the 698-746 MHz band: (1) Three paired channel blocks of 12 megahertz each are available for assignment as follows:

Block A: 698-704 MHz and 728-734 MHz;
 Block B: 704-710 MHz and 734-740 MHz; and
 Block C: 710-716 MHz and 740-746 MHz.

3.3 Cellular - Base Frequency Blocks

§22.905

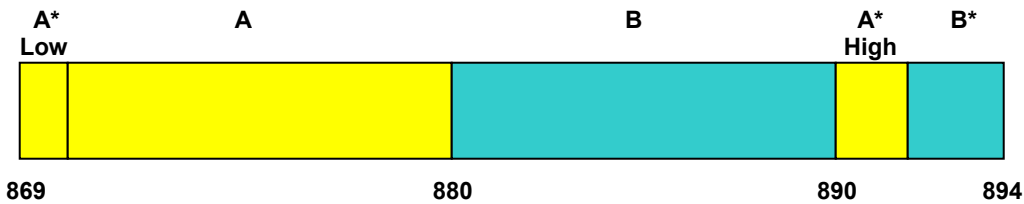

BLOCK 1: 869 – 880 MHz (A* Low + A)
BLOCK 2: 880 – 890 MHz (B)

BLOCK 3: 890 – 891.5 MHz (A* High)
BLOCK 4: 891.5 – 894 MHz (B*)

3.4 Cellular - Mobile Frequency Blocks

§22.905

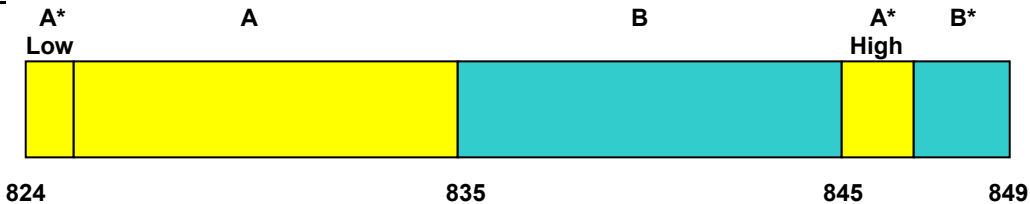

BLOCK 1: 824 – 835 MHz (A* Low + A)
BLOCK 2: 835 – 845 MHz (B)

BLOCK 3: 845 – 846.5 MHz (A* High)
BLOCK 4: 846.5 – 849 MHz (B*)

FCC ID: ACJ-VP4RAC	 MEASUREMENT REPORT (CERTIFICATION)			Approved by: Quality Manager
Test Report S/N: 1M1711020284-02.ACJ	Test Dates: 11/13-11/18/2017	EUT Type: Automotive Radio with Navigation		Page 5 of 25

3.5 PCS - Base Frequency Blocks

§24.229

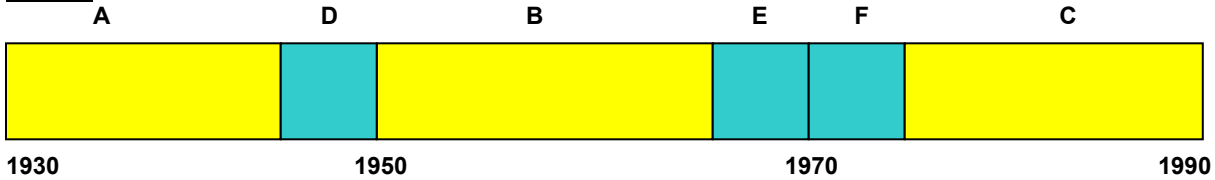

- BLOCK 1: 1930 – 1945 MHz (A)
- BLOCK 2: 1945 – 1950 MHz (D)
- BLOCK 3: 1950 – 1965 MHz (B)
- BLOCK 4: 1965 – 1970 MHz (E)
- BLOCK 5: 1970 – 1975 MHz (F)
- BLOCK 6: 1975 – 1990 MHz (C)

3.6 PCS - Mobile Frequency Blocks

§24.229

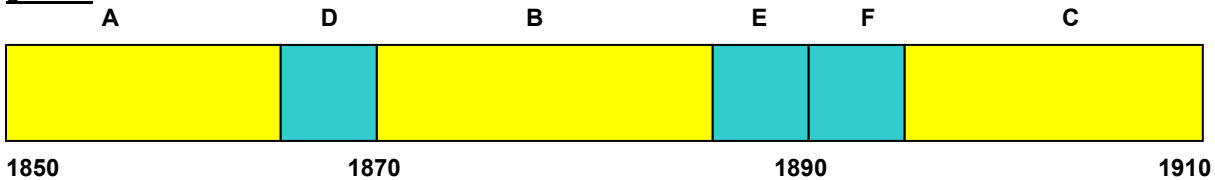

- BLOCK 1: 1850 – 1865 MHz (A)
- BLOCK 2: 1865 – 1870 MHz (D)
- BLOCK 3: 1870 – 1885 MHz (B)
- BLOCK 4: 1885 – 1890 MHz (E)
- BLOCK 5: 1890 – 1895 MHz (F)
- BLOCK 6: 1895 – 1910 MHz (C)

3.7 AWS - Base Frequency Blocks

§27.5(h)

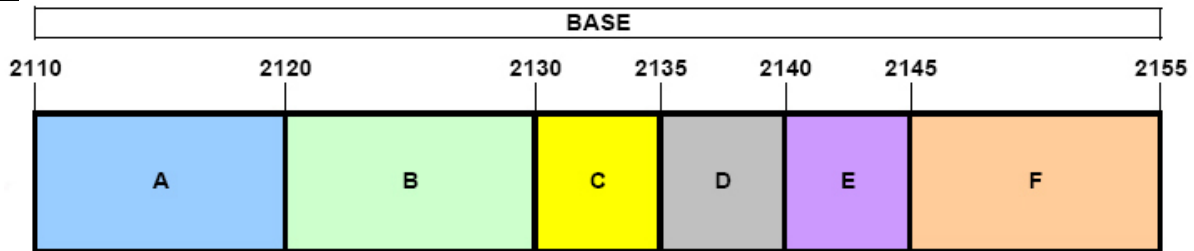

- BLOCK 1: 2110 – 2120 MHz (A)
- BLOCK 2: 2120 – 2130 MHz (B)
- BLOCK 3: 2130 – 2135 MHz (C)
- BLOCK 4: 2135 – 2140 MHz (D)
- BLOCK 5: 2140 – 2145 MHz (E)
- BLOCK 6: 2145 – 2155 MHz (F)

3.8 AWS - Mobile Frequency Blocks

§27.5(h)

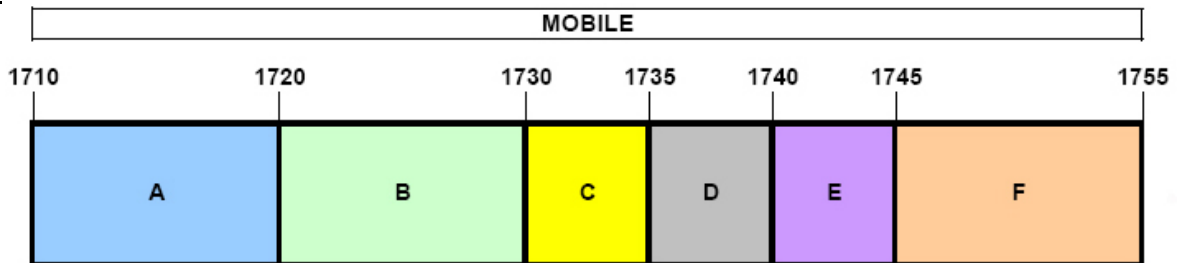

- BLOCK 1: 1710 – 1720 MHz (A)
- BLOCK 2: 1720 – 1730 MHz (B)
- BLOCK 3: 1730 – 1735 MHz (C)
- BLOCK 4: 1735 – 1740 MHz (D)
- BLOCK 5: 1740 – 1745 MHz (E)
- BLOCK 6: 1745 – 1755 MHz (F)

FCC ID: ACJ-VP4RAC		MEASUREMENT REPORT (CERTIFICATION)		Approved by: Quality Manager
Test Report S/N: 1M1711020284-02.ACJ	Test Dates: 11/13-11/18/2017	EUT Type: Automotive Radio with Navigation	Page 6 of 25	

3.9 BRS/EBS Frequency Block

§27.5

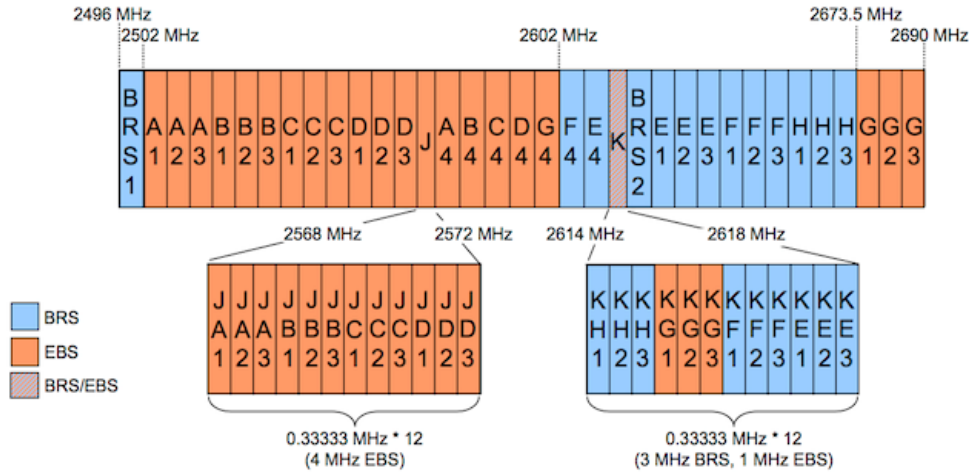

3.10 Radiated Power and Radiated Spurious Emissions

§2.1053 §22.913(a)(2) §22.917(a) §24.232(c) §24.238(a) §27.50(c)(10) §27.50(d)(4) §27.53(g) §27.53(h) §27.53(m) RSS-130(4.4) RSS-132(5.4) RSS-132(5.5) RSS-133(6.4) RSS-133(6.5) RSS-139(6.5) RSS-139(6.6) RSS-199(4.4) RSS-199(4.5)

The radiated test facilities consisted of an indoor 3 meter semi-anechoic chamber used for final measurements and exploratory measurements, when necessary. The measurement area is contained within the semi-anechoic chamber which is shielded from any ambient interference. The test site inside the chamber is a 6m x 5.2m elliptical, obstruction-free area in accordance with Figure 5.7 of Clause 5 in ANSI C63.4-2014. Absorbers are arranged on the floor between the turn table and the antenna mast in such a way so as to maximize the reduction of reflections for measurements above 1GHz. For measurements below 1GHz, the absorbers are removed. A raised turntable is used for radiated measurement. The turn table is a continuously rotatable, remote-controlled, metallic turntable and 2 meters (6.56 ft.) in diameter. The turn table is flush with the raised floor of the chamber in order to maintain its function as a ground plane. An 80cm tall test table made of Styrodur is placed on top of the turn table. A Styrodur pedestal is placed on top of the test table to bring the total table height to 1.5m.

The equipment under test was transmitting while connected to its integral antenna and is placed on a turntable 3 meters from the receive antenna. The receive antenna height is adjusted between 1 and 4 meter height, the turntable is rotated through 360 degrees, and the EUT is manipulated through all orthogonal planes representative of its typical use to achieve the highest reading on the receive spectrum analyzer. Radiated power levels are also investigated with the receive antenna horizontally and vertically polarized. The maximized power level is recorded using the spectrum analyzer "Channel Power" function with the integration band set to the emissions' occupied bandwidth, a RMS detector, RBW = 100kHz, VBW = 300kHz, and a 1 second sweep time over a minimum of 10 sweeps, per the guidelines of KDB 971168 D01 v03.

Per the guidance of ANSI/TIA-603-E-2016, a half-wave dipole is then substituted in place of the EUT. For emissions above 1GHz, a horn antenna is substituted in place of the EUT. The substitute antenna is driven by a signal generator with the level of the signal generator being adjusted to obtain the same receive spectrum analyzer level previously recorded from the spurious emission from the EUT. The power of the emission is calculated using the following formula:

$$P_d \text{ [dBm]} = P_g \text{ [dBm]} - \text{cable loss [dB]} + \text{antenna gain [dBd/dBi]}$$

FCC ID: ACJ-VP4RAC	 MEASUREMENT REPORT (CERTIFICATION) 		Approved by: Quality Manager
Test Report S/N: 1M1711020284-02.ACJ	Test Dates: 11/13-11/18/2017	EUT Type: Automotive Radio with Navigation	Page 7 of 25

Where, P_d is the dipole equivalent power, P_g is the generator output into the substitution antenna, and the antenna gain is the gain of the substitute antenna used relative to either a half-wave dipole (dBd) or an isotropic source (dBi). The substitute level is equal to P_g [dBm] – cable loss [dB].

The calculated P_d levels are then compared to the absolute spurious emission limit of -13dBm which is equivalent to the required minimum attenuation of $43 + 10\log_{10}(\text{Power}_{\text{[Watts]}})$. For Band 7, the calculated P_d levels are compared to the absolute spurious emission limit of -25dBm which is equivalent to the required minimum attenuation of $55 + 10\log_{10}(\text{Power}_{\text{[Watts]}})$.

FCC ID: ACJ-VP4RAC	 MEASUREMENT REPORT (CERTIFICATION) 		Approved by: Quality Manager
Test Report S/N: 1M1711020284-02.ACJ	Test Dates: 11/13-11/18/2017	EUT Type: Automotive Radio with Navigation	Page 8 of 25

4.0 MEASUREMENT UNCERTAINTY

The measurement uncertainties shown below were calculated in accordance with the requirements of ANSI C63.4-2014. All measurement uncertainty values are shown with a coverage factor of $k = 2$ to indicate a 95% level of confidence. The measurement uncertainty shown below meets or exceeds the U_{CISPR} measurement uncertainty values specified in CISPR 16-4-2 and, thus, can be compared directly to specified limits to determine compliance.

Contribution	Expanded Uncertainty (\pm dB)
Conducted Bench Top Measurements	1.13
Radiated Disturbance (<1GHz)	4.98
Radiated Disturbance (>1GHz)	5.07
Radiated Disturbance (>18GHz)	5.09

FCC ID: ACJ-VP4RAC		MEASUREMENT REPORT (CERTIFICATION)		Approved by: Quality Manager
Test Report S/N: 1M1711020284-02.ACJ	Test Dates: 11/13-11/18/2017	EUT Type: Automotive Radio with Navigation	Page 9 of 25	

5.0 TEST EQUIPMENT CALIBRATION DATA

Test Equipment Calibration is traceable to the National Institute of Standards and Technology (NIST). Measurements antennas used during testing were calibrated in accordance to the requirements of ANSI C63.5-2017.

Manufacturer	Model	Description	Cal Date	Cal Interval	Cal Due	Serial Number
-	RE1	Radiated Emissions Cable Set (UHF/EHF)	6/21/2017	Annual	6/21/2018	RE1
Com-Power	AL-130	9kHz - 30MHz Loop Antenna	10/10/2017	Biennial	10/10/2019	121034
EMCO	3160-09	Small Horn (18 - 26.5GHz)	8/23/2016	Biennial	8/23/2018	135427
Rohde & Schwarz	TS-PR26	18-26.5 GHz Pre-Amplifier	5/11/2017	Annual	5/11/2018	100040
Rohde & Schwarz	CMW500	Radio Communication Tester	10/13/2017	Annual	10/13/2018	102060
Rohde & Schwarz	ESU40	EMI Test Receiver (40GHz)	7/31/2017	Annual	7/31/2018	100348
Rohde & Schwarz	FSW67	Signal / Spectrum Analyzer	8/11/2017	Annual	8/11/2018	103200
Rohde & Schwarz	SFUNIT-Rx	Shielded Filter Unit	7/3/2017	Annual	7/3/2018	102134
Sunol	DRH-118	Horn Antenna (1-18GHz)	8/11/2017	Biennial	8/11/2019	A050307
Sunol	JB5	Bi-Log Antenna (30M - 5GHz)	3/14/2016	Biennial	3/14/2018	A051107

Table 5-1. Test Equipment

FCC ID: ACJ-VP4RAC	 MEASUREMENT REPORT (CERTIFICATION)			Approved by: Quality Manager
Test Report S/N: 1M1711020284-02.ACJ	Test Dates: 11/13-11/18/2017	EUT Type: Automotive Radio with Navigation		Page 10 of 25

6.0 SAMPLE CALCULATIONS

Emission Designator

QPSK Modulation

Emission Designator = 8M62G7D

- LTE BW = 8.62 MHz
- G = Phase Modulation
- 7 = Quantized/Digital Info
- D = Data transmission, telemetry, telecommand

QAM Modulation

Emission Designator = 8M45W7D

- LTE BW = 8.45 MHz
- W = Amplitude/Angle Modulated
- 7 = Quantized/Digital Info
- D = Data transmission, telemetry, telecommand

Spurious Radiated Emission – LTE Band

Example: Middle Channel LTE Mode 2nd Harmonic (1564 MHz)

The average spectrum analyzer reading at 3 meters with the EUT on the turntable was -81.0 dBm. The gain of the substituted antenna is 8.1 dBi. The signal generator connected to the substituted antenna terminals is adjusted to produce a reading of -81.0 dBm on the spectrum analyzer. The loss of the cable between the signal generator and the terminals of the substituted antenna is 2.0 dB at 1564 MHz. So 6.1 dB is added to the signal generator reading of -30.9 dBm yielding -24.80 dBm. The fundamental EIRP was 25.501 dBm so this harmonic was 25.501 dBm - (-24.80).

FCC ID: ACJ-VP4RAC		MEASUREMENT REPORT (CERTIFICATION)		Approved by: Quality Manager
Test Report S/N: 1M1711020284-02.ACJ	Test Dates: 11/13-11/18/2017	EUT Type: Automotive Radio with Navigation		Page 11 of 25

7.0 TEST RESULTS

7.1 Summary

Company Name: Panasonic Automotive Systems Company of America
 FCC ID: ACJ-VP4RAC
 FCC Classification: PCS Licensed Transmitter (PCB)
 Mode(s): LTE

FCC Part Section(s)	RSS Section(s)	Test Description	Test Limit	Test Condition	Test Result	Reference
2.1053 22.917(a) 24.238(a) 27.53(g) 27.53(h)	RSS-130(4.6) RSS-132(5.5) RSS-133(6.5) RSS-139(6.6)	Undesirable Emissions (Band 2, 4, 5, 17)	$> 43 + 10\log_{10}(P[\text{Watts}])$ for all out-of-band emissions	RADIATED	PASS	Section 7.2
27.53(m)	RSS-199(4.5)	Undesirable Emissions (Band 7)	Undesirable emissions must meet the limits detailed in 27.53(m) (RSS-199 [6.4])		PASS	Section 7.2

Table 7-1. Summary of Radiated Test Results

Notes:

- 1) All modes of operation and data rates were investigated. The test results shown in the following sections represent the worst case emissions.
- 2) The EUT's output port was terminated in 50Ω (i.e. into a base station simulator) for evaluation of radiated spurious emissions.

FCC ID: ACJ-VP4RAC	 MEASUREMENT REPORT (CERTIFICATION) 		Approved by: Quality Manager
Test Report S/N: 1M1711020284-02.ACJ	Test Dates: 11/13-11/18/2017	EUT Type: Automotive Radio with Navigation	Page 12 of 25

7.2 Radiated Spurious Emissions Measurements

§2.1053 §22.917(a) §24.238(a) §27.53(g) §27.53(h) §27.53(m) RSS-130(4.6) RSS-132(5.5) RSS-133(6.5) RSS-139(6.6) RSS-199(4.5)

Test Overview

Radiated spurious emissions measurements are performed using the substitution method described in ANSI/TIA-603-E-2016 with the EUT terminated in 50Ω. Measurements on signals operating below 1GHz are performed using vertically and horizontally polarized tuned dipole antennas. Measurements on signals operating above 1GHz are performed using vertically and horizontally polarized broadband horn antennas.

Test Procedures Used

KDB 971168 D01 v03 – Section 5.8

ANSI/TIA-603-E-2016 – Section 2.2.12

Test Settings

1. RBW = 100kHz for emissions below 1GHz and 1MHz for emissions above 1GHz
2. VBW $\geq 3 \times$ RBW
3. Span = 1.5 times the OBW
4. No. of sweep points $\geq 2 \times$ span / RBW
5. Detector = RMS
6. Trace mode = Average (Max Hold for pulsed emissions)
7. The trace was allowed to stabilize

FCC ID: ACJ-VP4RAC			MEASUREMENT REPORT (CERTIFICATION)		Approved by: Quality Manager
Test Report S/N: 1M1711020284-02.ACJ	Test Dates: 11/13-11/18/2017	EUT Type: Automotive Radio with Navigation			Page 13 of 25

Test Setup

The EUT and measurement equipment were set up as shown in the diagram below.

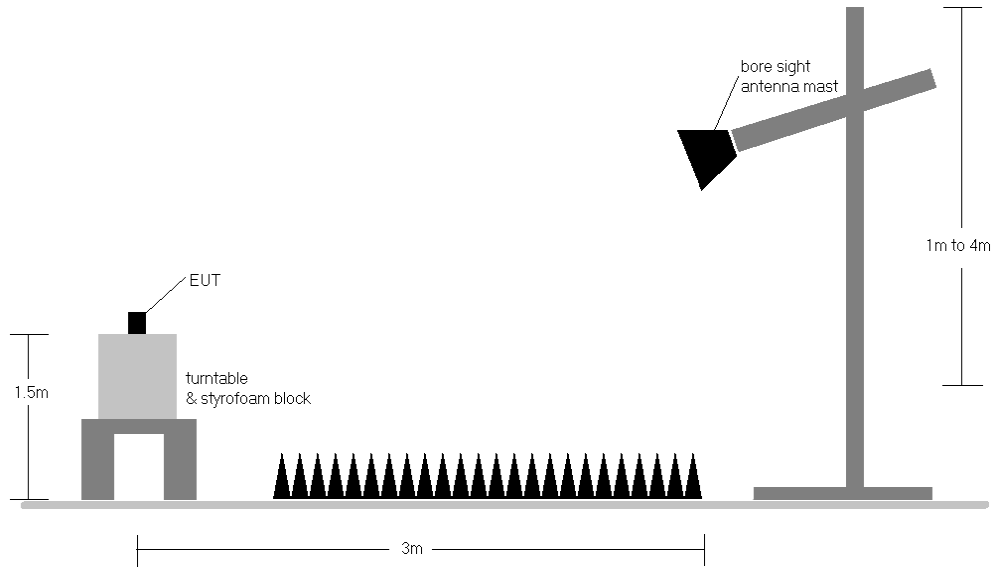

Figure 7-1. Test Instrument & Measurement Setup

Test Notes

- 1) The EUT was tested in three orthogonal planes and in all possible test configurations and positioning. The worst case emissions are reported with the EUT positioning, modulations, RB sizes and offsets, and channel bandwidth configurations shown in the tables below.
- 2) This unit was tested while powered with a 12Vdc power supply.
- 3) The spectrum is measured from 9kHz to the 10th harmonic of the fundamental frequency of the transmitter. The worst-case emissions are reported.
- 4) Emissions below 18GHz were measured at a 3 meter test distance while emissions above 18GHz were measured at a 1 meter test distance with the application of a distance correction factor.
- 5) The "-" shown in the following RSE tables are used to denote a noise floor measurement.

FCC ID: ACJ-VP4RAC	 MEASUREMENT REPORT (CERTIFICATION) 		Approved by: Quality Manager
Test Report S/N: 1M1711020284-02.ACJ	Test Dates: 11/13-11/18/2017	EUT Type: Automotive Radio with Navigation	Page 14 of 25

Band 17

OPERATING FREQUENCY: 709.00 MHz
 CHANNEL: 23780
 MODULATION SIGNAL: QPSK
 BANDWIDTH: 10.0 MHz
 DISTANCE: 3 meters
 LIMIT: -13 dBm

Frequency [MHz]	Ant. Pol. [H/V]	Antenna Height [cm]	Turntable Azimuth [degree]	Level at Antenna Terminals [dBm]	Substitute Antenna Gain [dBi]	Spurious Emission Level [dBm]	Margin [dB]
1418.00	H	205	70	-65.66	8.12	-57.54	-44.5
2127.00	H	341	78	-69.34	8.87	-60.47	-47.5
2836.00	H	355	140	-70.22	10.14	-60.07	-47.1
3545.00	H	-	-	-67.94	9.70	-58.25	-45.2

Table 7-2. Radiated Spurious Data (Band 17 – Low Channel)

OPERATING FREQUENCY: 710.00 MHz
 CHANNEL: 23790
 MODULATION SIGNAL: QPSK
 BANDWIDTH: 10.0 MHz
 DISTANCE: 3 meters
 LIMIT: -13 dBm

Frequency [MHz]	Ant. Pol. [H/V]	Antenna Height [cm]	Turntable Azimuth [degree]	Level at Antenna Terminals [dBm]	Substitute Antenna Gain [dBi]	Spurious Emission Level [dBm]	Margin [dB]
1420.00	H	384	78	-71.50	8.15	-63.36	-50.4
2130.00	H	-	-	-72.10	8.87	-63.23	-50.2

Table 7-3. Radiated Spurious Data (Band 17 – Mid Channel)

FCC ID: ACJ-VP4RAC	 MEASUREMENT REPORT (CERTIFICATION) 		Approved by: Quality Manager
Test Report S/N: 1M1711020284-02.ACJ	Test Dates: 11/13-11/18/2017	EUT Type: Automotive Radio with Navigation	Page 15 of 25

OPERATING FREQUENCY: 711.00 MHz
 CHANNEL: 23800
 MODULATION SIGNAL: QPSK
 BANDWIDTH: 10.0 MHz
 DISTANCE: 3 meters
 LIMIT: -13 dBm

Frequency [MHz]	Ant. Pol. [H/V]	Antenna Height [cm]	Turntable Azimuth [degree]	Level at Antenna Terminals [dBm]	Substitute Antenna Gain [dBi]	Spurious Emission Level [dBm]	Margin [dB]
1422.00	H	372	208	-63.95	8.17	-55.78	-42.8
2133.00	H	-	-	-72.02	8.87	-63.15	-50.1

Table 7-4. Radiated Spurious Data (Band 17 – High Channel)

FCC ID: ACJ-VP4RAC			MEASUREMENT REPORT (CERTIFICATION)		Approved by: Quality Manager
Test Report S/N: 1M1711020284-02.ACJ	Test Dates: 11/13-11/18/2017	EUT Type: Automotive Radio with Navigation			Page 16 of 25

Band 5

OPERATING FREQUENCY: 829.00 MHz
 CHANNEL: 20450
 MODULATION SIGNAL: QPSK
 BANDWIDTH: 10.0 MHz
 DISTANCE: 3 meters
 LIMIT: -13 dBm

Frequency [MHz]	Ant. Pol. [H/V]	Antenna Height [cm]	Turntable Azimuth [degree]	Level at Antenna Terminals [dBm]	Substitute Antenna Gain [dBi]	Spurious Emission Level [dBm]	Margin [dB]
1658.00	V	134	143	-66.47	8.96	-57.51	-44.5
2487.00	V	193	141	-64.90	9.13	-55.77	-42.8
3316.00	V	134	27	-65.28	9.36	-55.91	-42.9
4145.00	V	-	-	-70.49	9.95	-60.54	-47.5

Table 7-5. Radiated Spurious Data (Band 5 – Low Channel)

OPERATING FREQUENCY: 836.50 MHz
 CHANNEL: 20525
 MODULATION SIGNAL: QPSK
 BANDWIDTH: 10.0 MHz
 DISTANCE: 3 meters
 LIMIT: -13 dBm

Frequency [MHz]	Ant. Pol. [H/V]	Antenna Height [cm]	Turntable Azimuth [degree]	Level at Antenna Terminals [dBm]	Substitute Antenna Gain [dBi]	Spurious Emission Level [dBm]	Margin [dB]
1673.00	V	142	38	-64.67	8.85	-55.82	-42.8
2509.50	V	111	30	-51.99	9.17	-42.82	-29.8
3346.00	V	400	124	-65.64	9.36	-56.28	-43.3
4182.50	V	-	-	-70.36	10.19	-60.17	-47.2

Table 7-6. Radiated Spurious Data (Band 5 – Mid Channel)

FCC ID: ACJ-VP4RAC		MEASUREMENT REPORT (CERTIFICATION)		Approved by: Quality Manager
Test Report S/N: 1M1711020284-02.ACJ	Test Dates: 11/13-11/18/2017	EUT Type: Automotive Radio with Navigation		Page 17 of 25

OPERATING FREQUENCY: 844.00 MHz
 CHANNEL: 20600
 MODULATION SIGNAL: QPSK
 BANDWIDTH: 10.0 MHz
 DISTANCE: 3 meters
 LIMIT: -13 dBm

Frequency [MHz]	Ant. Pol. [H/V]	Antenna Height [cm]	Turntable Azimuth [degree]	Level at Antenna Terminals [dBm]	Substitute Antenna Gain [dBi]	Spurious Emission Level [dBm]	Margin [dB]
1688.00	V	317	148	-64.11	8.74	-55.37	-42.4
2532.00	V	203	136	-68.36	9.24	-59.13	-46.1
3376.00	V	387	91	-67.70	9.42	-58.28	-45.3
4220.00	V	-	-	-71.02	10.38	-60.64	-47.6

Table 7-7. Radiated Spurious Data (Band 5 – High Channel)

FCC ID: ACJ-VP4RAC		MEASUREMENT REPORT (CERTIFICATION)			Approved by: Quality Manager
Test Report S/N: 1M1711020284-02.ACJ	Test Dates: 11/13-11/18/2017	EUT Type: Automotive Radio with Navigation			Page 18 of 25

Band 4

OPERATING FREQUENCY: 1720.00 MHz
 CHANNEL: 20050
 MODULATION SIGNAL: QPSK
 BANDWIDTH: 20.0 MHz
 DISTANCE: 3 meters
 LIMIT: -13 dBm

Frequency [MHz]	Ant. Pol. [H/V]	Antenna Height [cm]	Turntable Azimuth [degree]	Level at Antenna Terminals [dBm]	Substitute Antenna Gain [dBi]	Spurious Emission Level [dBm]	Margin [dB]
3440.00	H	-	-	-69.15	9.54	-59.61	-46.6
5160.00	H	312	172	-60.91	10.79	-50.11	-37.1
6880.00	H	-	-	-65.94	10.86	-55.09	-42.1

Table 7-8. Radiated Spurious Data (Band 4 – Low Channel)

OPERATING FREQUENCY: 1732.50 MHz
 CHANNEL: 20175
 MODULATION SIGNAL: QPSK
 BANDWIDTH: 20.0 MHz
 DISTANCE: 3 meters
 LIMIT: -13 dBm

Frequency [MHz]	Ant. Pol. [H/V]	Antenna Height [cm]	Turntable Azimuth [degree]	Level at Antenna Terminals [dBm]	Substitute Antenna Gain [dBi]	Spurious Emission Level [dBm]	Margin [dB]
3465.00	H	150	24	-68.93	9.59	-59.33	-46.3
5197.50	H	-	-	-70.38	10.83	-59.55	-46.5

Table 7-9. Radiated Spurious Data (Band 4 – Mid Channel)

FCC ID: ACJ-VP4RAC		MEASUREMENT REPORT (CERTIFICATION)		Approved by: Quality Manager
Test Report S/N: 1M1711020284-02.ACJ	Test Dates: 11/13-11/18/2017	EUT Type: Automotive Radio with Navigation		Page 19 of 25

OPERATING FREQUENCY: 1745.00 MHz
 CHANNEL: 20300
 MODULATION SIGNAL: QPSK
 BANDWIDTH: 20.0 MHz
 DISTANCE: 3 meters
 LIMIT: -13 dBm

Frequency [MHz]	Ant. Pol. [H/V]	Antenna Height [cm]	Turntable Azimuth [degree]	Level at Antenna Terminals [dBm]	Substitute Antenna Gain [dBi]	Spurious Emission Level [dBm]	Margin [dB]
3490.00	H	-	-	-68.65	9.65	-59.00	-46.0
5235.00	H	131	131	-68.88	10.93	-57.95	-45.0
6980.00	H	-	-	-65.79	10.96	-54.83	-41.8

Table 7-10. Radiated Spurious Data (Band 4 – High Channel)

FCC ID: ACJ-VP4RAC		MEASUREMENT REPORT (CERTIFICATION)		Approved by: Quality Manager
Test Report S/N: 1M1711020284-02.ACJ	Test Dates: 11/13-11/18/2017	EUT Type: Automotive Radio with Navigation		Page 20 of 25

Band 2

OPERATING FREQUENCY: 1850.70 MHz
 CHANNEL: 18607
 MODULATION SIGNAL: QPSK
 BANDWIDTH: 1.4 MHz
 DISTANCE: 3 meters
 LIMIT: -13 dBm

Frequency [MHz]	Ant. Pol. [H/V]	Antenna Height [cm]	Turntable Azimuth [degree]	Level at Antenna Terminals [dBm]	Substitute Antenna Gain [dBi]	Spurious Emission Level [dBm]	Margin [dB]
3701.40	V	211	136	-59.66	9.74	-49.92	-36.9
5552.10	V	194	138	-65.07	10.98	-54.09	-41.1
7402.80	V	-	-	-65.44	10.77	-54.66	-41.7

Table 7-11. Radiated Spurious Data (Band 2 – Low Channel)

OPERATING FREQUENCY: 1880.00 MHz
 CHANNEL: _____
 MODULATION SIGNAL: QPSK
 BANDWIDTH: 1.4 MHz
 DISTANCE: 3 meters
 LIMIT: -13 dBm

Frequency [MHz]	Ant. Pol. [H/V]	Antenna Height [cm]	Turntable Azimuth [degree]	Level at Antenna Terminals [dBm]	Substitute Antenna Gain [dBi]	Spurious Emission Level [dBm]	Margin [dB]
3760.00	V	314	127	-57.16	9.50	-47.66	-34.7
5640.00	V	144	147	-62.01	11.16	-50.85	-37.9
7520.00	V	-	-	-65.98	11.03	-54.95	-42.0

Table 7-12. Radiated Spurious Data (Band 2 – Mid Channel)

FCC ID: ACJ-VP4RAC		MEASUREMENT REPORT (CERTIFICATION)		Approved by: Quality Manager
Test Report S/N: 1M1711020284-02.ACJ	Test Dates: 11/13-11/18/2017	EUT Type: Automotive Radio with Navigation		Page 21 of 25

OPERATING FREQUENCY: 1909.30 MHz
 CHANNEL: 19193
 MODULATION SIGNAL: QPSK
 BANDWIDTH: 1.4 MHz
 DISTANCE: 3 meters
 LIMIT: -13 dBm

Frequency [MHz]	Ant. Pol. [H/V]	Antenna Height [cm]	Turntable Azimuth [degree]	Level at Antenna Terminals [dBm]	Substitute Antenna Gain [dBi]	Spurious Emission Level [dBm]	Margin [dB]
3818.60	V	358	314	-63.57	9.29	-54.28	-41.3
5727.90	V	132	234	-64.66	11.33	-53.32	-40.3
7637.20	V	-	-	-66.24	11.27	-54.97	-42.0

Table 7-13. Radiated Spurious Data (Band 2 – High Channel)

FCC ID: ACJ-VP4RAC		MEASUREMENT REPORT (CERTIFICATION)		Approved by: Quality Manager
Test Report S/N: 1M1711020284-02.ACJ	Test Dates: 11/13-11/18/2017	EUT Type: Automotive Radio with Navigation		Page 22 of 25

Band 7

OPERATING FREQUENCY: 2510.00 MHz
 CHANNEL: 20850
 MODULATION SIGNAL: QPSK
 BANDWIDTH: 20.0 MHz
 DISTANCE: 3 meters
 LIMIT: -25 dBm

Frequency [MHz]	Ant. Pol. [H/V]	Antenna Height [cm]	Turntable Azimuth [degree]	Level at Antenna Terminals [dBm]	Substitute Antenna Gain [dBi]	Spurious Emission Level [dBm]	Margin [dB]
5020.00	V	152	147	-42.86	10.87	-31.99	-7.0
7530.00	V	233	156	-57.44	11.13	-46.30	-21.3
10040.00	V	-	-	-64.02	12.07	-51.95	-26.9

Table 7-14. Radiated Spurious Data (Band 7 – Low Channel)

OPERATING FREQUENCY: 2535.00 MHz
 CHANNEL: 21100
 MODULATION SIGNAL: QPSK
 BANDWIDTH: 20.0 MHz
 DISTANCE: 3 meters
 LIMIT: -25 dBm

Frequency [MHz]	Ant. Pol. [H/V]	Antenna Height [cm]	Turntable Azimuth [degree]	Level at Antenna Terminals [dBm]	Substitute Antenna Gain [dBi]	Spurious Emission Level [dBm]	Margin [dB]
5070.00	V	349	151	-46.26	10.81	-35.45	-10.4
7605.00	V	202	118	-60.97	11.30	-49.67	-24.7
10140.00	V	-	-	-62.12	12.17	-49.95	-25.0

Table 7-15. Radiated Spurious Data (Band 7 – Mid Channel)

FCC ID: ACJ-VP4RAC		MEASUREMENT REPORT (CERTIFICATION)		Approved by: Quality Manager
Test Report S/N: 1M1711020284-02.ACJ	Test Dates: 11/13-11/18/2017	EUT Type: Automotive Radio with Navigation	Page 23 of 25	

OPERATING FREQUENCY: 2560.00 MHz
 CHANNEL: 21350
 MODULATION SIGNAL: QPSK
 BANDWIDTH: 20.0 MHz
 DISTANCE: 3 meters
 LIMIT: -25 dBm

Frequency [MHz]	Ant. Pol. [H/V]	Antenna Height [cm]	Turntable Azimuth [degree]	Level at Antenna Terminals [dBm]	Substitute Antenna Gain [dBi]	Spurious Emission Level [dBm]	Margin [dB]
5120.00	V	300	69	-57.49	10.76	-46.74	-21.7
7680.00	V	328	140	-58.66	11.37	-47.28	-22.3
10240.00	V	-	-	-62.60	12.30	-50.30	-25.3

Table 7-16. Radiated Spurious Data (Band 7 – High Channel)

FCC ID: ACJ-VP4RAC		MEASUREMENT REPORT (CERTIFICATION)		Approved by: Quality Manager
Test Report S/N: 1M1711020284-02.ACJ	Test Dates: 11/13-11/18/2017	EUT Type: Automotive Radio with Navigation	Page 24 of 25	

8.0 CONCLUSION

The data collected relate only to the item(s) tested and show that the **Panasonic Automotive Radio with Navigation FCC ID: ACJ-VP4RAC** complies with all the requirements of Part 22, 24, & 27 of the FCC Rules and RSS-130, RSS-132, RSS-133, RSS-139, and RSS-199 of the Innovation, Science, and Economic Development Rules for LTE operation only.

FCC ID: ACJ-VP4RAC		MEASUREMENT REPORT (CERTIFICATION)		Approved by: Quality Manager
Test Report S/N: 1M1711020284-02.ACJ	Test Dates: 11/13-11/18/2017	EUT Type: Automotive Radio with Navigation	Page 25 of 25	