

## FCC

### RF Test Report

Product Type : Module  
Applicant : Sierra Wireless Inc.  
Address : 13811 Wireless Way Richmond, British Columbia V6V 3A4  
Model Number : AR7552  
Test Specification : FCC 47 CFR PART 22H: Oct, 2014  
FCC 47 CFR PART 24E: Oct, 2014  
FCC 47 CFR PART 27: Oct. 2014  
Canada RSS-130 ISSUE 1: Oct. 2013  
CANADA RSS-132 ISSUE 3: Jan. 2013  
CANADA RSS-133 ISSUE 6: Jan. 2013  
Canada RSS-139 ISSUE 2: Feb. 2009  
Canada RSS-199 ISSUE 2: Oct. 2014  
Canada RSS-Gen ISSUE 4: Nov., 2014  
ANSI/TIA/EIA-603-C  
Application Purpose : Original  
Receive Date : Apr. 29, 2015  
Test Period : Apr. 29 ~ May 05, 2015  
Issue Date : May 27, 2015

#### Issue by

A Test Lab Techno Corp.  
No. 140-1, Changan Street, Bade City,  
Taoyuan County 334, Taiwan R.O.C.  
Tel : +886-3-2710188 / Fax : +886-3-2710190



Taiwan Accreditation Foundation accreditation number: 1330

**Note:** This report shall not be reproduced except in full, without the written approval of A Test Lab Techno Corp. This document may be altered or revised by A Test Lab Techno Corp. personnel only, and shall be noted in the revision section of the document. The client should not use it to claim product endorsement by TAF, or any government agencies. The test results in the report only apply to the tested sample.

**Revision History**

Rev.	Issue Date	Revisions	Revised By
00	May 08, 2015	Initial Issue	
01	May 14, 2015	Revised report information.	Peggy Chang
02	May 18, 2015	Revised report information.	Snow Wang
03	May 25, 2015	Revised report information.	Peggy Chang
04	May 27, 2015	Revised report information.	Peggy Chang

## Verification of Compliance

Issued Date: 05/27/2015

Product Type : Module  
Applicant : Sierra Wireless Inc.  
Address : 13811 Wireless Way Richmond, British Columbia V6V 3A4  
Model Number : AR7552  
EUT Rated Voltage : DC 3.4V / 3.7V / 4.2V  
Test Voltage : DC 3.7V  
Applicable Standard : FCC 47 CFR PART 22H: Oct, 2014  
FCC 47 CFR PART 24E: Oct, 2014  
FCC 47 CFR PART 27: Oct. 2014  
Canada RSS-130 ISSUE 1: Oct. 2013  
CANADA RSS-132 ISSUE 3: Jan. 2013  
CANADA RSS-133 ISSUE 6: Jan. 2013  
Canada RSS-139 ISSUE 2: Feb. 2009  
Canada RSS-199 ISSUE 2: Oct. 2014  
Canada RSS-Gen ISSUE 4: Nov., 2014  
ANSI/TIA/EIA-603-C

Test Result : Complied

Application Purpose : Original

Performing Lab. : A Test Lab Techno Corp.  
No. 140-1, Changan Street, Bade City,  
Taoyuan County 334, Taiwan R.O.C.  
Tel : +886-3-2710188 / Fax : +886-3-2710190



Taiwan Accreditation Foundation accreditation number: 1330

<http://www.atl-lab.com.tw/e-index.htm>

The above equipment was tested by A Test Lab Techno Corp. The test data, data evaluation, test procedures, and equipment configurations shown in this report were made in accordance with the procedures given in ANSI/TIA/EIA-603-C and the energy emitted by the sample tested as described in this report is in compliance with the requirements of FCC Rules Part 27L. The test results of this report relate only to the tested sample identified in this report.

Approved By : Fly Lu Reviewed By : Eric Ou Yang  
(Manager) (Fly Lu) (Testing Engineer) (Eric Ou Yang)

## TABLE OF CONTENTS

<b>1</b>	<b>General Information.....</b>	<b>6</b>
1.1.	EUT Description .....	6
1.2.	Mode of Operation.....	9
1.3.	EUT Exercise Software .....	15
1.4.	Configuration of Test System Details .....	15
1.5.	Test Site Environment .....	15
1.6.	Summary of Test Result .....	16
<b>2</b>	<b>Conducted Output Average Power Test.....</b>	<b>17</b>
2.1.	Limit .....	17
2.2.	Test Instruments .....	17
2.3.	Test Setup.....	17
2.4.	Test Procedure .....	17
2.5.	Uncertainty .....	17
2.6.	Test Result.....	18
<b>3</b>	<b>Effective Radiated Power / Equivalent Isotropic Radiated Power Test.....</b>	<b>40</b>
3.1.	Limit .....	40
3.2.	Test Instruments .....	40
3.3.	Test Setup.....	40
3.4.	Test Procedure .....	42
3.5.	Uncertainty .....	42
3.6.	Test Result.....	43
<b>4</b>	<b>Frequency Stability Test .....</b>	<b>45</b>
4.1.	Limit .....	45
4.2.	Test Instruments .....	45
4.3.	Setup .....	45
4.4.	Test Procedure .....	46
4.5.	Uncertainty .....	46
4.6.	Test Result.....	47
<b>5</b>	<b>Emission Bandwidth &amp; Occupied Bandwidth Test .....</b>	<b>50</b>
5.1.	Limit .....	50
5.2.	Test Instruments .....	50
5.3.	Setup .....	50
5.4.	Test Procedure .....	51
5.5.	Uncertainty .....	51
5.6.	Test Result.....	52
5.7.	Test Graphs .....	56

<b>6</b>	<b>Peak to Average Ratio Test .....</b>	<b>100</b>
6.1.	Limit .....	100
6.2.	Test Instruments .....	100
6.3.	Setup .....	100
6.4.	Test Procedure .....	101
6.5.	Uncertainty .....	101
6.6.	Test Result.....	102
6.7.	Test Graphs .....	104
<b>7</b>	<b>Band Edge Test.....</b>	<b>126</b>
7.1.	Limit .....	126
7.2.	Test Instruments .....	126
7.3.	Setup .....	127
7.4.	Test Procedure .....	127
7.5.	Uncertainty .....	127
7.6.	Test Result.....	128
<b>8</b>	<b>Conducted Spurious Emission and Radiation Emission Test.....</b>	<b>154</b>
8.1.	Limit .....	154
8.2.	Test Instruments .....	154
8.3.	Setup .....	154
8.4.	Test Procedure .....	155
8.5.	Uncertainty .....	155
8.6.	Test Graphs .....	156
8.7.	Test Result.....	222
<b>9</b>	<b>Radiated Emission Test .....</b>	<b>228</b>
9.1.	Limit .....	228
9.2.	Test Instruments .....	228
9.3.	Setup .....	228
9.4.	Test Procedure .....	230
9.5.	Uncertainty .....	230
9.6.	Test Result.....	231

# 1 General Information

## 1.1. EUT Description

Applicant		Sierra Wireless Inc.			
Applicant Address		13811 Wireless Way Richmond, British Columbia V6V 3A4			
Manufacturer		Sierra Wireless Inc.			
Manufacturer Address		13811 Wireless Way Richmond, British Columbia V6V 3A4			
Product Type		Module			
Model Number		AR7552			
IMEI No.		IMEI 1:352767050012507, IMEI 2:352767050012515			
FCC ID		N7NAR7552			
IC		2417C-AR7552			
Mode	LTE	Band	UL Frequency (MHz)	DL Frequency (MHz)	Modulation
		2	1850.7 ~ 1909.3	1930.7 ~ 1989.3	QPSK, 16QAM
		4	1710.7 ~ 1754.3	2110.7 ~ 2154.3	QPSK, 16QAM
		5	824.7 ~ 848.3	869.7 ~ 893.3	QPSK, 16QAM
		7	2500 ~ 2570	2620 ~ 2690	QPSK, 16QAM
		17	704.0 ~ 715.9	734.0 ~ 745.9	QPSK, 16QAM
Channel Bandwidth		LTE Band 2	1.4M, 3M, 5MHz, 10MHz, 15MHz, 20MHz		
		LTE Band 4	1.4M, 3M, 5MHz, 10MHz, 15MHz, 20MHz		
		LTE Band 5	1.4M, 3M, 5MHz, 10MHz		
		LTE Band 7	5MHz, 10MHz, 15MHz, 20MHz		
		LTE Band 17	5MHz, 10MHz		
Antenna Gain		LTE Band 2	5 dBi		
		LTE Band 4	5 dBi		
		LTE Band 5	5 dBi		
		LTE Band 7	7 dBi		
		LTE Band 17	5 dBi		

Max. Conducted Output	LTE Band 2 (Channel Bandwidth 1.4MHz)	0.218	W
Average Power	LTE Band 2 (Channel Bandwidth 3MHz)	0.218	W
	LTE Band 2 (Channel Bandwidth 5MHz)	0.219	W
	LTE Band 2 (Channel Bandwidth 10MHz)	0.214	W
	LTE Band 2 (Channel Bandwidth 15MHz)	0.220	W
	LTE Band 2 (Channel Bandwidth 20MHz)	0.219	W
	LTE Band 4 (Channel Bandwidth 1.4MHz)	0.205	W
	LTE Band 4 (Channel Bandwidth 3MHz)	0.199	W
	LTE Band 4 (Channel Bandwidth 5MHz)	0.200	W
	LTE Band 4 (Channel Bandwidth 10MHz)	0.203	W
	LTE Band 4 (Channel Bandwidth 15MHz)	0.205	W
	LTE Band 4 (Channel Bandwidth 20MHz)	0.203	W
	LTE Band 5 (Channel Bandwidth 1.4MHz)	0.191	W
	LTE Band 5 (Channel Bandwidth 3MHz)	0.195	W
	LTE Band 5 (Channel Bandwidth 5MHz)	0.189	W
	LTE Band 5 (Channel Bandwidth 10MHz)	0.190	W
	LTE Band 7 (Channel Bandwidth 5MHz)	0.184	W
	LTE Band 7 (Channel Bandwidth 10MHz)	0.179	W
	LTE Band 7 (Channel Bandwidth 15MHz)	0.179	W
	LTE Band 7 (Channel Bandwidth 20MHz)	0.180	W
	LTE Band 17 (Channel Bandwidth 5MHz)	0.195	W
LTE Band 17 (Channel Bandwidth 10MHz)	0.197	W	

Max. E.R.P. / E.I.R.P.	LTE Band 2 (Channel Bandwidth 1.4MHz)	0.689 W (E.I.R.P.)
	LTE Band 2 (Channel Bandwidth 3MHz)	0.690 W (E.I.R.P.)
	LTE Band 2 (Channel Bandwidth 5MHz)	0.692 W (E.I.R.P.)
	LTE Band 2 (Channel Bandwidth 10MHz)	0.676 W (E.I.R.P.)
	LTE Band 2 (Channel Bandwidth 15MHz)	0.697 W (E.I.R.P.)
	LTE Band 2 (Channel Bandwidth 20MHz)	0.693 W (E.I.R.P.)
	LTE Band 4 (Channel Bandwidth 1.4MHz)	0.649 W (E.I.R.P.)
	LTE Band 4 (Channel Bandwidth 3MHz)	0.630 W (E.I.R.P.)
	LTE Band 4 (Channel Bandwidth 5MHz)	0.632 W (E.I.R.P.)
	LTE Band 4 (Channel Bandwidth 10MHz)	0.641 W (E.I.R.P.)
	LTE Band 4 (Channel Bandwidth 15MHz)	0.647 W (E.I.R.P.)
	LTE Band 4 (Channel Bandwidth 20MHz)	0.643 W (E.I.R.P.)
	LTE Band 5 (Channel Bandwidth 1.4MHz)	0.368 W (E.R.P.)
	LTE Band 5 (Channel Bandwidth 3MHz)	0.376 W (E.R.P.)
	LTE Band 5 (Channel Bandwidth 5MHz)	0.365 W (E.R.P.)
	LTE Band 5 (Channel Bandwidth 10MHz)	0.366 W (E.R.P.)
	LTE Band 7 (Channel Bandwidth 5MHz)	0.923 W (E.I.R.P.)
	LTE Band 7 (Channel Bandwidth 10MHz)	0.899 W (E.I.R.P.)
	LTE Band 7 (Channel Bandwidth 15MHz)	0.899 W (E.I.R.P.)
	LTE Band 7 (Channel Bandwidth 20MHz)	0.902 W (E.I.R.P.)
	LTE Band 17 (Channel Bandwidth 5MHz)	0.376 W (E.R.P.)
	LTE Band 17 (Channel Bandwidth 10MHz)	0.380 W (E.R.P.)



## 1.2. Mode of Operation

Three channels had been tested for each channel bandwidth.

LTE Band 2						
Channel Bandwidth	1.4MHz		3MHz		5MHz	
	Channel	Frequency (MHz)	Channel	Frequency (MHz)	Channel	Frequency (MHz)
Low CH	18607	1850.7	18615	1851.5	18625	1852.5
Middle CH	18900	1880.0	18900	1880.0	18900	1880.0
High CH	19193	1909.3	19185	1908.5	19175	1907.5
Channel Bandwidth	10MHz		15MHz		20MHz	
	Channel	Frequency (MHz)	Channel	Frequency (MHz)	Channel	Frequency (MHz)
Low CH	18650	1855.0	18675	1857.5	18700	1860.0
Middle CH	18900	1880.0	18900	1880.0	18900	1880.0
High CH	19150	1905.0	19125	1902.5	19100	1900.0

LTE Band 4						
Channel Bandwidth	1.4MHz		3MHz		5MHz	
	Channel	Frequency (MHz)	Channel	Frequency (MHz)	Channel	Frequency (MHz)
Low CH	19957	1710.7	19965	1711.5	19975	1712.5
Middle CH	20175	1732.5	20175	1732.5	20175	1732.5
High CH	20393	1754.3	20385	1753.5	20375	1752.5
Channel Bandwidth	10MHz		15MHz		20MHz	
	Channel	Frequency (MHz)	Channel	Frequency (MHz)	Channel	Frequency (MHz)
Low CH	20000	1715.0	20025	1717.5	20050	1720.0
Middle CH	20175	1732.5	20175	1732.5	20175	1732.5
High CH	20350	1750.0	20325	1747.5	20300	1745.0

LTE Band 5				
Channel Bandwidth	1.4MHz		3MHz	
	Channel	Frequency (MHz)	Channel	Frequency (MHz)
Low CH	20407	824.7	20415	825.5
Middle CH	20525	836.5	20525	836.5
High CH	20643	848.3	20635	847.5
Channel Bandwidth	5MHz		10MHz	
	Channel	Frequency (MHz)	Channel	Frequency (MHz)
Low CH	20425	826.5	20450	829.0
Middle CH	20525	836.5	20525	836.5
High CH	20625	846.5	20600	844.0

LTE Band 7				
Channel Bandwidth	5MHz		10MHz	
	Channel	Frequency (MHz)	Channel	Frequency (MHz)
Low CH	20775	2502.5	20800	2505.0
Middle CH	21100	2535.0	21100	2535.0
High CH	21425	2567.5	21400	2565.0
Channel Bandwidth	15MHz		20MHz	
	Channel	Frequency (MHz)	Channel	Frequency (MHz)
Low CH	20825	2507.5	20850	2510.0
Middle CH	21100	2535.0	21100	2535.0
High CH	21375	2562.5	21350	2560.0

LTE Band 17				
Channel Bandwidth	5MHz		10MHz	
	Channel	Frequency (MHz)	Channel	Frequency (MHz)
Low CH	23755	706.5	23780	709.0
Middle CH	23790	710.0	23790	710.0
High CH	23825	713.5	23800	711.0

Note: Regards to the frequency band operation: the lowest, middle and highest frequency of channel were selected to perform the test, then shown on this report.

During all testing, EUT is in link mode with base station emulator at maximum power level. The spurious emission measurements were carried out in semi-anechoic chamber with 3-meter test range, and EUT is rotated on three test planes to find out the worst emission.

Frequency range investigated for radiated emission: 30MHz to 19000 MHz.

Band	Channel Bandwidth	Test Modes	
LTE Band 2	1.4 MHz	<input checked="" type="checkbox"/> LTE(RB Size 1, RB Offset 0) Link <input type="checkbox"/> LTE(RB Size 1, RB Offset 2) Link <input type="checkbox"/> LTE(RB Size 1, RB Offset 5) Link <input type="checkbox"/> LTE(RB Size 3, RB Offset 0) Link <input type="checkbox"/> LTE(RB Size 3, RB Offset 1) Link <input type="checkbox"/> LTE(RB Size 3, RB Offset 3) Link <input type="checkbox"/> LTE(RB Size 6, RB Offset 0) Link	QPSK
	3 MHz	<input checked="" type="checkbox"/> LTE(RB Size 1, RB Offset 0) Link <input type="checkbox"/> LTE(RB Size 1, RB Offset 8) Link <input type="checkbox"/> LTE(RB Size 1, RB Offset 14) Link <input type="checkbox"/> LTE(RB Size 8, RB Offset 0) Link <input type="checkbox"/> LTE(RB Size 8, RB Offset 4) Link <input type="checkbox"/> LTE(RB Size 8, RB Offset 7) Link <input type="checkbox"/> LTE(RB Size 15, RB Offset 0) Link	QPSK
	5 MHz	<input checked="" type="checkbox"/> LTE(RB Size 1, RB Offset 0) Link <input type="checkbox"/> LTE(RB Size 1, RB Offset 12) Link <input type="checkbox"/> LTE(RB Size 1, RB Offset 24) Link <input type="checkbox"/> LTE(RB Size 12, RB Offset 0) Link <input type="checkbox"/> LTE(RB Size 12, RB Offset 6) Link <input type="checkbox"/> LTE(RB Size 12, RB Offset 13) Link <input type="checkbox"/> LTE(RB Size 25, RB Offset 0) Link	QPSK
	10 MHz	<input checked="" type="checkbox"/> LTE(RB Size 1, RB Offset 0) Link <input type="checkbox"/> LTE(RB Size 1, RB Offset 24) Link <input type="checkbox"/> LTE(RB Size 1, RB Offset 49) Link <input type="checkbox"/> LTE(RB Size 25, RB Offset 0) Link <input type="checkbox"/> LTE(RB Size 25, RB Offset 12) Link <input type="checkbox"/> LTE(RB Size 25, RB Offset 25) Link <input type="checkbox"/> LTE(RB Size 50, RB Offset 0) Link	QPSK
	15 MHz	<input checked="" type="checkbox"/> LTE(RB Size 1, RB Offset 0) Link <input type="checkbox"/> LTE(RB Size 1, RB Offset 38) Link <input type="checkbox"/> LTE(RB Size 1, RB Offset 74) Link <input type="checkbox"/> LTE(RB Size 38, RB Offset 0) Link <input type="checkbox"/> LTE(RB Size 38, RB Offset 18) Link <input type="checkbox"/> LTE(RB Size 38, RB Offset 37) Link <input type="checkbox"/> LTE(RB Size 75, RB Offset 0) Link	QPSK
	20 MHz	<input checked="" type="checkbox"/> LTE(RB Size 1, RB Offset 0) Link <input type="checkbox"/> LTE(RB Size 1, RB Offset 49) Link <input type="checkbox"/> LTE(RB Size 1, RB Offset 99) Link <input type="checkbox"/> LTE(RB Size 50, RB Offset 0) Link <input type="checkbox"/> LTE(RB Size 50, RB Offset 25) Link <input type="checkbox"/> LTE(RB Size 50, RB Offset 50) Link <input type="checkbox"/> LTE(RB Size 100, RB Offset 0) Link	QPSK

Band	Channel Bandwidth	Test Modes	
LTE Band 4	1.4 MHz	<input checked="" type="checkbox"/> LTE(RB Size 1, RB Offset 0) Link <input type="checkbox"/> LTE(RB Size 1, RB Offset 2) Link <input type="checkbox"/> LTE(RB Size 1, RB Offset 5) Link <input type="checkbox"/> LTE(RB Size 3, RB Offset 0) Link <input type="checkbox"/> LTE(RB Size 3, RB Offset 1) Link <input type="checkbox"/> LTE(RB Size 3, RB Offset 3) Link <input type="checkbox"/> LTE(RB Size 6, RB Offset 0) Link	QPSK
	3 MHz	<input checked="" type="checkbox"/> LTE(RB Size 1, RB Offset 0) Link <input type="checkbox"/> LTE(RB Size 1, RB Offset 8) Link <input type="checkbox"/> LTE(RB Size 1, RB Offset 14) Link <input type="checkbox"/> LTE(RB Size 8, RB Offset 0) Link <input type="checkbox"/> LTE(RB Size 8, RB Offset 4) Link <input type="checkbox"/> LTE(RB Size 8, RB Offset 7) Link <input type="checkbox"/> LTE(RB Size 15, RB Offset 0) Link	QPSK
	5 MHz	<input checked="" type="checkbox"/> LTE(RB Size 1, RB Offset 0) Link <input type="checkbox"/> LTE(RB Size 1, RB Offset 12) Link <input type="checkbox"/> LTE(RB Size 1, RB Offset 24) Link <input type="checkbox"/> LTE(RB Size 12, RB Offset 0) Link <input type="checkbox"/> LTE(RB Size 12, RB Offset 6) Link <input type="checkbox"/> LTE(RB Size 12, RB Offset 13) Link <input type="checkbox"/> LTE(RB Size 25, RB Offset 0) Link	QPSK
	10 MHz	<input checked="" type="checkbox"/> LTE(RB Size 1, RB Offset 0) Link <input type="checkbox"/> LTE(RB Size 1, RB Offset 24) Link <input type="checkbox"/> LTE(RB Size 1, RB Offset 49) Link <input type="checkbox"/> LTE(RB Size 25, RB Offset 0) Link <input type="checkbox"/> LTE(RB Size 25, RB Offset 12) Link <input type="checkbox"/> LTE(RB Size 25, RB Offset 25) Link <input type="checkbox"/> LTE(RB Size 50, RB Offset 0) Link	QPSK
	15 MHz	<input checked="" type="checkbox"/> LTE(RB Size 1, RB Offset 0) Link <input type="checkbox"/> LTE(RB Size 1, RB Offset 38) Link <input type="checkbox"/> LTE(RB Size 1, RB Offset 74) Link <input type="checkbox"/> LTE(RB Size 38, RB Offset 0) Link <input type="checkbox"/> LTE(RB Size 38, RB Offset 18) Link <input type="checkbox"/> LTE(RB Size 38, RB Offset 37) Link <input type="checkbox"/> LTE(RB Size 75, RB Offset 0) Link	QPSK
	20 MHz	<input checked="" type="checkbox"/> LTE(RB Size 1, RB Offset 0) Link <input type="checkbox"/> LTE(RB Size 1, RB Offset 49) Link <input type="checkbox"/> LTE(RB Size 1, RB Offset 99) Link <input type="checkbox"/> LTE(RB Size 50, RB Offset 0) Link <input type="checkbox"/> LTE(RB Size 50, RB Offset 25) Link <input type="checkbox"/> LTE(RB Size 50, RB Offset 50) Link <input type="checkbox"/> LTE(RB Size 100, RB Offset 0) Link	QPSK

Band	Channel Bandwidth	Test Modes	
LTE Band 5	1.4 MHz	<input checked="" type="checkbox"/> LTE(RB Size 1, RB Offset 0) Link <input type="checkbox"/> LTE(RB Size 1, RB Offset 2) Link <input type="checkbox"/> LTE(RB Size 1, RB Offset 5) Link <input type="checkbox"/> LTE(RB Size 3, RB Offset 0) Link <input type="checkbox"/> LTE(RB Size 3, RB Offset 1) Link <input type="checkbox"/> LTE(RB Size 3, RB Offset 3) Link <input type="checkbox"/> LTE(RB Size 6, RB Offset 0) Link	QPSK
	3 MHz	<input checked="" type="checkbox"/> LTE(RB Size 1, RB Offset 0) Link <input type="checkbox"/> LTE(RB Size 1, RB Offset 8) Link <input type="checkbox"/> LTE(RB Size 1, RB Offset 14) Link <input type="checkbox"/> LTE(RB Size 8, RB Offset 0) Link <input type="checkbox"/> LTE(RB Size 8, RB Offset 4) Link <input type="checkbox"/> LTE(RB Size 8, RB Offset 8) Link <input type="checkbox"/> LTE(RB Size 15, RB Offset 0) Link	QPSK
	5 MHz	<input checked="" type="checkbox"/> LTE(RB Size 1, RB Offset 0) Link <input type="checkbox"/> LTE(RB Size 1, RB Offset 12) Link <input type="checkbox"/> LTE(RB Size 1, RB Offset 24) Link <input type="checkbox"/> LTE(RB Size 12, RB Offset 0) Link <input type="checkbox"/> LTE(RB Size 12, RB Offset 6) Link <input type="checkbox"/> LTE(RB Size 12, RB Offset 13) Link <input type="checkbox"/> LTE(RB Size 25, RB Offset 0) Link	QPSK
	10 MHz	<input checked="" type="checkbox"/> LTE(RB Size 1, RB Offset 0) Link <input type="checkbox"/> LTE(RB Size 1, RB Offset 24) Link <input type="checkbox"/> LTE(RB Size 1, RB Offset 49) Link <input type="checkbox"/> LTE(RB Size 25, RB Offset 0) Link <input type="checkbox"/> LTE(RB Size 25, RB Offset 12) Link <input type="checkbox"/> LTE(RB Size 25, RB Offset 25) Link <input type="checkbox"/> LTE(RB Size 50, RB Offset 0) Link	QPSK

Band	Channel Bandwidth	Test Modes	
LTE Band 7	5 MHz	<input checked="" type="checkbox"/> LTE(RB Size 1, RB Offset 0) Link <input type="checkbox"/> LTE(RB Size 1, RB Offset 12) Link <input type="checkbox"/> LTE(RB Size 1, RB Offset 24) Link <input type="checkbox"/> LTE(RB Size 12, RB Offset 0) Link <input type="checkbox"/> LTE(RB Size 12, RB Offset 6) Link <input type="checkbox"/> LTE(RB Size 12, RB Offset 13) Link <input type="checkbox"/> LTE(RB Size 25, RB Offset 0) Link	QPSK
	10 MHz	<input checked="" type="checkbox"/> LTE(RB Size 1, RB Offset 0) Link <input type="checkbox"/> LTE(RB Size 1, RB Offset 24) Link <input type="checkbox"/> LTE(RB Size 1, RB Offset 49) Link <input type="checkbox"/> LTE(RB Size 25, RB Offset 0) Link <input type="checkbox"/> LTE(RB Size 25, RB Offset 12) Link <input type="checkbox"/> LTE(RB Size 25, RB Offset 25) Link <input type="checkbox"/> LTE(RB Size 50, RB Offset 0) Link	QPSK
	15 MHz	<input checked="" type="checkbox"/> LTE(RB Size 1, RB Offset 0) Link <input type="checkbox"/> LTE(RB Size 1, RB Offset 38) Link <input type="checkbox"/> LTE(RB Size 1, RB Offset 74) Link <input type="checkbox"/> LTE(RB Size 36, RB Offset 0) Link <input type="checkbox"/> LTE(RB Size 36, RB Offset 18) Link <input type="checkbox"/> LTE(RB Size 36, RB Offset 39) Link <input type="checkbox"/> LTE(RB Size 75, RB Offset 0) Link	QPSK
	20 MHz	<input checked="" type="checkbox"/> LTE(RB Size 1, RB Offset 0) Link <input type="checkbox"/> LTE(RB Size 1, RB Offset 49) Link <input type="checkbox"/> LTE(RB Size 1, RB Offset 99) Link <input type="checkbox"/> LTE(RB Size 50, RB Offset 0) Link <input type="checkbox"/> LTE(RB Size 50, RB Offset 25) Link <input type="checkbox"/> LTE(RB Size 50, RB Offset 50) Link <input type="checkbox"/> LTE(RB Size 100, RB Offset 0) Link	QPSK

Band	Channel Bandwidth	Test Modes	
LTE Band 17	5 MHz	<input checked="" type="checkbox"/> LTE(RB Size 1, RB Offset 0) Link <input type="checkbox"/> LTE(RB Size 1, RB Offset 12) Link <input type="checkbox"/> LTE(RB Size 1, RB Offset 24) Link <input type="checkbox"/> LTE(RB Size 12, RB Offset 0) Link <input type="checkbox"/> LTE(RB Size 12, RB Offset 6) Link <input type="checkbox"/> LTE(RB Size 12, RB Offset 13) Link <input type="checkbox"/> LTE(RB Size 25, RB Offset 0) Link	QPSK
	10 MHz	<input checked="" type="checkbox"/> LTE(RB Size 1, RB Offset 0) Link <input type="checkbox"/> LTE(RB Size 1, RB Offset 25) Link <input type="checkbox"/> LTE(RB Size 1, RB Offset 49) Link <input type="checkbox"/> LTE(RB Size 25, RB Offset 0) Link <input type="checkbox"/> LTE(RB Size 25, RB Offset 12) Link <input type="checkbox"/> LTE(RB Size 25, RB Offset 25) Link <input type="checkbox"/> LTE(RB Size 50, RB Offset 0) Link	QPSK

### 1.3. EUT Exercise Software

1	Setup the EUT and Base Station (CMW500) as shown on 1.4.
2	Turn on the power of all equipment.
3	EUT run test program test.

### 1.4. Configuration of Test System Details

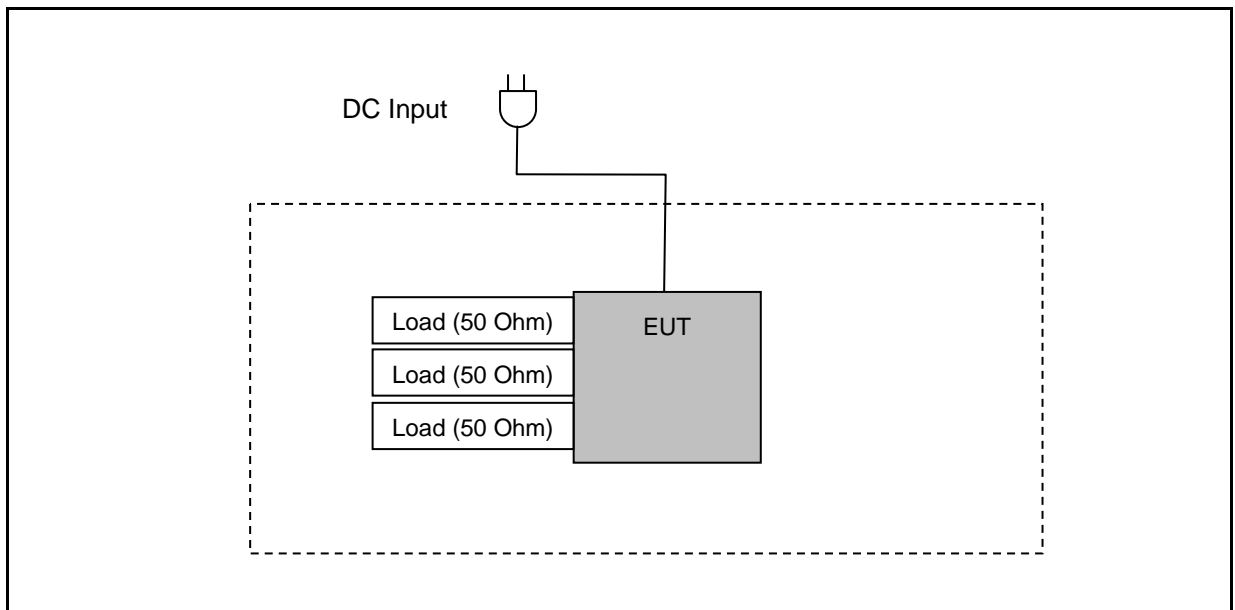

### 1.5. Test Site Environment

Items	Required (IEC 68-1)	Actual
Temperature (°C)	15-35	26
Humidity (%RH)	25-75	60
Barometric pressure (mbar)	860-1060	950

**1.6. Summary of Test Result**

FCC Rule	IC Standards	Description	Result
§2.1046	---	Conducted Output Average Power	Pass
§22.913 §24.232 §27.50	RSS-130, 4.4 RSS-132, 5.4 RSS-133, 6.4 RSS-139, 6.4 RSS-199, 4.4	Equivalent Isotropic Radiated Power / Equivalent Radiated Power	Pass
§2.1055 §22.355 §24.235 §27.54	RSS-130, 4.3 RSS-132, 4.3 RSS-133, 6.3 RSS-139, 6.3 RSS-199, 4.3	Frequency Stability	Pass
§2.1049	RSS-Gen, 6.6	Emission Bandwidth & Occupied Bandwidth	Pass
§24.232 §27.50	RSS-130, 4.4 RSS-132, 5.4 RSS-133, 6.4 RSS-139, 6.4	Peak to average ratio	Pass
§22.917 §24.238 §27.53	RSS-130, 4.6 RSS-132, 5.5 RSS-133, 6.5 RSS-139, 6.5 RSS-199, 4.6	Band Edge	Pass
§2.1051 §22.917 §24.238 §27.53	RSS-130, 4.6 RSS-132, 5.5 RSS-133, 6.5 RSS-139, 6.5 RSS-199, 4.6	Conducted Spurious Emissions	Pass
§2.1053 §22.917 §24.238 §27.53	RSS-130, 4.6 RSS-132, 5.5 RSS-133, 6.5 RSS-139, 6.5 RSS-199, 4.6	Radiated Spurious Emissions	Pass



## 2 Conducted Output Average Power Test

### 2.1. Limit

N/A

### 2.2. Test Instruments

Equipment	Manufacturer	Model No.	Serial No.	Cal. Date	Remark
Wideband Radio Communication Tester	R & S	CMW500	103168	11/05/2014	(1)
Wideband Power Sensor	Agilent	N1921A	MY45241957	12/15/2014	(1)
Single Channel PK Power Meter	Agilent	N1911A	MY45101619	12/15/2014	(1)
Test Site	ATL	TE05	TE05	N.C.R.	-----

Remark: <sup>(1)</sup> Calibration period 1 year. <sup>(2)</sup> Calibration period 2 years.

Note: N.C.R. = No Calibration Request.

### 2.3. Test Setup

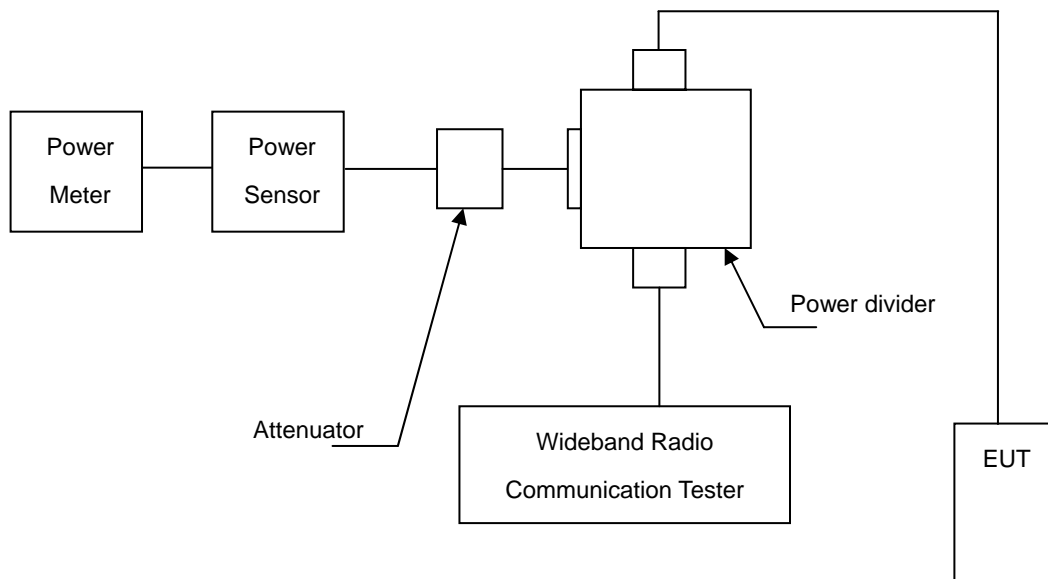

### 2.4. Test Procedure

- The EUT was set up for the maximum power with LTE link data modulation and link up with simulator.
- Set the EUT to transmit under low, middle and high channel and record the power level shown on simulator.

### 2.5. Uncertainty

The measurement uncertainty is defined as for Conducted Power measurement is 1.2 dB.

**2.6. Test Result**

Model Number	AR7552		
Test Item	Conducted Output Average Power		
Date of Test	04/29/2015	Test Site	TE05

Band	Channel Bandwidth	Modulation	Channel	Frequency (MHz)	RB Configuration		Average Power	
					Size	Offset	(dBm)	(W)
LTE Band 2	1.4 MHz	QPSK	18607	1850.7	1	0	23.25	0.211
					1	2	23.21	0.209
					1	5	23.17	0.207
					3	0	23.14	0.206
					3	1	23.09	0.204
					3	3	23.07	0.203
			6	0	22.39	0.173		
			1	0	<b>23.38</b>	<b>0.218</b>		
			1	2	23.37	0.217		
			1	5	23.35	0.216		
			3	0	23.31	0.214		
			3	1	23.29	0.213		
			3	3	23.25	0.211		
			6	0	22.42	0.175		
			1	0	23.09	0.204		
			1	2	23.08	0.203		
			1	5	23.05	0.202		
			3	0	23.04	0.201		
		3	1	23.01	0.200			
		3	3	22.99	0.199			
		6	0	22.22	0.167			
		1	0	22.61	0.182			
		1	2	22.35	0.172			
		1	5	22.33	0.171			
		3	0	22.21	0.166			
		3	1	22.20	0.166			
		3	3	22.18	0.165			
		6	0	21.43	0.139			
		1	0	22.66	0.185			
		1	2	22.64	0.184			
		1	5	22.50	0.178			
		3	0	22.49	0.177			
		3	1	22.48	0.177			
		3	3	22.17	0.165			
		6	0	21.50	0.141			
		1	0	22.26	0.168			
1	2	22.12	0.163					
1	5	22.10	0.162					
3	0	22.09	0.162					
3	1	22.06	0.161					
3	3	22.05	0.160					
6	0	21.47	0.140					

Band	Channel Bandwidth	Modulation	Channel	Frequency (MHz)	RB Configuration		Average Power	
					Size	Offset	(dBm)	(W)
LTE Band 2	3 MHz	QPSK	18615	1851.5	1	0	23.23	0.210
					1	8	23.21	0.209
					1	14	23.15	0.207
					8	0	22.34	0.171
					8	4	22.32	0.171
					8	7	22.22	0.167
			15	0	22.19	0.166		
			1	0	<b>23.39</b>	<b>0.218</b>		
			1	8	23.30	0.214		
			1	14	23.26	0.212		
			8	0	22.41	0.174		
			8	4	22.40	0.174		
			8	7	22.39	0.173		
			15	0	22.37	0.173		
			1	0	23.21	0.209		
			1	8	23.10	0.204		
			1	14	22.96	0.198		
			8	0	22.35	0.172		
			8	4	22.32	0.171		
			8	7	22.27	0.169		
			15	0	22.22	0.167		
			1	0	22.47	0.177		
			1	8	22.26	0.168		
			1	14	22.09	0.162		
		8	0	21.40	0.138			
		8	4	21.39	0.138			
		8	7	21.37	0.137			
		15	0	21.29	0.135			
		1	0	22.56	0.180			
		1	8	22.22	0.167			
		1	14	22.12	0.163			
		8	0	21.46	0.140			
		8	4	21.43	0.139			
		8	7	21.42	0.139			
		15	0	21.41	0.138			
		1	0	22.37	0.173			
		1	8	22.34	0.171			
		1	14	21.79	0.151			
		8	0	21.38	0.137			
		8	4	21.33	0.136			
		8	7	21.32	0.136			
		15	0	21.29	0.135			

Band	Channel Bandwidth	Modulation	Channel	Frequency (MHz)	RB Configuration		Average Power			
					Size	Offset	(dBm)	(W)		
LTE Band 2	5 MHz	QPSK	18625	1852.5	1	0	23.22	0.210		
					1	12	23.16	0.207		
					1	24	22.95	0.197		
					12	0	22.36	0.172		
					12	6	22.26	0.168		
					12	13	22.25	0.168		
			25	0	22.18	0.165				
			1	0	<b>23.40</b>	<b>0.219</b>				
			1	12	23.36	0.217				
			1	24	23.21	0.209				
			12	0	22.46	0.176				
			12	6	22.46	0.176				
			12	13	22.44	0.175				
			25	0	22.32	0.171				
			1	0	23.24	0.211				
			1	12	23.17	0.207				
			1	24	22.98	0.199				
			12	0	22.35	0.172				
		12	6	22.34	0.171					
		12	13	22.31	0.170					
		25	0	22.29	0.169					
		1	0	22.46	0.176					
		1	12	22.21	0.166					
		1	24	22.02	0.159					
		12	0	21.44	0.139					
		12	6	21.43	0.139					
		12	13	21.34	0.136					
		25	0	21.24	0.133					
		1	0	22.67	0.185					
		1	12	22.28	0.169					
		1	24	22.07	0.161					
		12	0	21.44	0.139					
		12	6	21.41	0.138					
		12	13	21.38	0.137					
		25	0	21.37	0.137					
		1	0	22.49	0.177					
		1	12	22.22	0.167					
		1	24	21.76	0.150					
		12	0	21.53	0.142					
		12	6	21.50	0.141					
		12	11	21.43	0.139					
		25	0	21.34	0.136					
		16QAM	18625	1852.5	18625	1852.5	1	0	22.46	0.176
							1	12	22.21	0.166
							1	24	22.02	0.159
							12	0	21.44	0.139
							12	6	21.43	0.139
							12	13	21.34	0.136
25	0		21.24	0.133						
1	0		22.67	0.185						
1	12		22.28	0.169						
1	24		22.07	0.161						
12	0		21.44	0.139						
12	6		21.41	0.138						
12	13		21.38	0.137						
25	0		21.37	0.137						
1	0		22.49	0.177						
1	12		22.22	0.167						
1	24		21.76	0.150						
12	0		21.53	0.142						
12	6	21.50	0.141							
12	11	21.43	0.139							
25	0	21.34	0.136							

Band	Channel Bandwidth	Modulation	Channel	Frequency (MHz)	RB Configuration		Average Power	
					Size	Offset	(dBm)	(W)
LTE Band 2	10 MHz	QPSK	18650	1855.0	1	0	<b>23.30</b>	<b>0.214</b>
					1	24	23.20	0.209
					1	49	23.00	0.200
					25	0	22.33	0.171
					25	12	22.30	0.170
					25	25	22.25	0.168
			50	0	22.23	0.167		
			18900	1880.0	1	0	23.29	0.213
					1	24	23.28	0.213
					1	49	23.24	0.211
					25	0	22.41	0.174
					25	12	22.41	0.174
					25	25	22.38	0.173
			50	0	22.36	0.172		
			19150	1905.0	1	0	23.25	0.211
					1	24	23.17	0.207
					1	49	22.89	0.195
					25	0	22.43	0.175
		25			12	22.29	0.169	
		25			25	22.29	0.169	
		50	0	22.22	0.167			
		16QAM	18650	1855.0	1	0	22.32	0.171
					1	24	22.19	0.166
					1	49	22.08	0.161
					25	0	21.51	0.142
					25	12	21.51	0.142
					25	25	21.31	0.135
			50	0	21.27	0.134		
			18900	1880.0	1	0	22.54	0.179
					1	24	22.51	0.178
					1	49	22.15	0.164
					25	0	21.57	0.144
					25	12	21.48	0.141
					25	25	21.44	0.139
			50	0	21.42	0.139		
			19150	1905.0	1	0	22.42	0.175
					1	24	22.23	0.167
					1	49	21.79	0.151
					25	0	21.43	0.139
		25			12	21.41	0.138	
		25			25	21.39	0.138	
		50	0	21.38	0.137			

Band	Channel Bandwidth	Modulation	Channel	Frequency (MHz)	RB Configuration		Average Power	
					Size	Offset	(dBm)	(W)
LTE Band 2	15 MHz	QPSK	18675	1857.5	1	0	23.33	0.215
					1	38	23.29	0.213
					1	74	23.22	0.210
					38	0	22.34	0.171
					38	18	22.32	0.171
					38	37	22.32	0.171
			75	0	22.30	0.170		
			1	0	<b>23.43</b>	<b>0.220</b>		
			1	38	23.32	0.215		
			1	74	23.28	0.213		
			38	0	22.48	0.177		
			38	18	22.43	0.175		
			38	37	22.40	0.174		
			75	0	22.39	0.173		
			1	0	23.38	0.218		
			1	38	23.14	0.206		
			1	74	23.02	0.200		
			38	0	22.32	0.171		
		38	18	22.31	0.170			
		38	37	22.29	0.169			
		75	0	22.27	0.169			
		1	0	22.25	0.168			
		1	38	22.23	0.167			
		1	74	22.00	0.158			
		38	0	21.52	0.142			
		38	18	21.51	0.142			
		38	37	21.37	0.137			
		75	0	21.29	0.135			
		1	0	22.59	0.182			
		1	38	22.49	0.177			
		1	74	22.29	0.169			
		38	0	21.53	0.142			
		38	18	21.51	0.142			
		38	37	21.48	0.141			
		75	0	21.47	0.140			
		1	0	22.20	0.166			
1	38	22.13	0.163					
1	74	22.09	0.162					
38	0	21.51	0.142					
38	18	21.48	0.141					
38	37	21.46	0.140					
75	0	21.45	0.140					

Band	Channel Bandwidth	Modulation	Channel	Frequency (MHz)	RB Configuration		Average Power		
					Size	Offset	(dBm)	(W)	
LTE Band 2	20 MHz	QPSK	18700	1860.0	1	0	23.31	0.214	
					1	49	23.27	0.212	
					1	99	23.22	0.210	
					50	0	22.32	0.171	
					50	25	22.19	0.166	
					50	50	22.19	0.166	
					100	0	22.17	0.165	
					1	0	<b>23.41</b>	<b>0.219</b>	
			1	49	23.38	0.218			
			1	99	23.24	0.211			
			50	0	22.44	0.175			
			50	25	22.39	0.173			
			50	50	22.33	0.171			
			100	0	22.32	0.171			
			1	0	23.26	0.212			
			1	49	23.15	0.207			
			1	99	23.02	0.200			
			50	0	22.34	0.171			
			50	25	22.32	0.171			
			50	50	22.28	0.169			
			100	0	22.27	0.169			
			1	0	22.37	0.173			
			1	49	22.22	0.167			
			1	99	22.17	0.165			
		50	0	21.41	0.138				
		50	25	21.35	0.136				
		50	50	21.34	0.136				
		100	0	21.33	0.136				
		1	0	22.38	0.173				
		1	49	22.37	0.173				
		1	99	22.28	0.169				
		50	0	21.49	0.141				
		50	25	21.46	0.140				
		50	50	21.43	0.139				
		100	0	21.35	0.136				
		1	0	22.77	0.189				
		1	49	22.17	0.165				
		1	99	22.12	0.163				
		50	0	21.44	0.139				
		50	25	21.42	0.139				
		50	50	21.37	0.137				
		100	0	21.35	0.136				
		16QAM	18700	1860.0	1860.0	1	0	22.37	0.173
						1	49	22.22	0.167
						1	99	22.17	0.165
						50	0	21.41	0.138
						50	25	21.35	0.136
						50	50	21.34	0.136
100	0					21.33	0.136		
1	0					22.38	0.173		
1	49		22.37	0.173					
1	99		22.28	0.169					
50	0		21.49	0.141					
50	25		21.46	0.140					
50	50		21.43	0.139					
100	0		21.35	0.136					
1	0		22.77	0.189					
1	49		22.17	0.165					
1	99		22.12	0.163					
50	0		21.44	0.139					
50	25		21.42	0.139					
50	50		21.37	0.137					
100	0		21.35	0.136					
18900	1880.0		1880.0	1880.0	1	0	22.37	0.173	
					1	49	22.22	0.167	
					1	99	22.17	0.165	
		50			0	21.41	0.138		
		50			25	21.35	0.136		
		50			50	21.34	0.136		
		100			0	21.33	0.136		
		1			0	22.38	0.173		
1	49	22.37	0.173						
1	99	22.28	0.169						
50	0	21.49	0.141						
50	25	21.46	0.140						
50	50	21.43	0.139						
100	0	21.35	0.136						
19100	1900.0	1900.0	1900.0	1	0	22.77	0.189		
				1	49	22.17	0.165		
				1	99	22.12	0.163		
				50	0	21.44	0.139		
				50	25	21.42	0.139		
				50	50	21.37	0.137		
				100	0	21.35	0.136		
				1	0	22.37	0.173		
1	49	22.22	0.167						
1	99	22.17	0.165						
50	0	21.41	0.138						
50	25	21.35	0.136						
50	50	21.34	0.136						
100	0	21.33	0.136						

Band	Channel Bandwidth	Modulation	Channel	Frequency (MHz)	RB Configuration		Average Power	
					Size	Offset	(dBm)	(W)
LTE Band 4	1.4 MHz	QPSK	19957	1710.7	1	0	<b>23.12</b>	<b>0.205</b>
					1	2	23.09	0.204
					1	5	23.07	0.203
					3	0	23.05	0.202
					3	1	23.01	0.200
					3	3	22.99	0.199
			6	0	22.13	0.163		
			20175	1732.5	1	0	22.92	0.196
					1	2	22.89	0.195
					1	5	22.87	0.194
					3	0	22.84	0.192
					3	1	22.81	0.191
					3	3	22.82	0.191
			6	0	22.01	0.159		
			20393	1754.3	1	0	22.99	0.199
					1	2	22.90	0.195
					1	5	22.89	0.195
					3	0	22.87	0.194
		3			1	22.86	0.193	
		3			3	22.83	0.192	
		6	0	21.94	0.156			
		16QAM	19957	1710.7	1	0	22.42	0.175
					1	2	22.16	0.164
					1	5	22.11	0.163
					3	0	22.04	0.160
					3	1	21.99	0.158
					3	3	21.93	0.156
			6	0	21.06	0.128		
			20175	1732.5	1	0	22.22	0.167
					1	2	22.14	0.164
					1	5	22.11	0.163
					3	0	22.08	0.161
					3	1	21.97	0.157
					3	3	21.75	0.150
			6	0	21.07	0.128		
			20393	1754.3	1	0	21.94	0.156
					1	2	21.92	0.156
					1	5	21.92	0.156
					3	0	21.81	0.152
		3			1	21.77	0.150	
		3			3	21.73	0.149	
		6	0	20.96	0.125			



Band	Channel Bandwidth	Modulation	Channel	Frequency (MHz)	RB Configuration		Average Power	
					Size	Offset	(dBm)	(W)
LTE Band 4	3 MHz	QPSK	19965	1711.5	1	0	<b>22.99</b>	<b>0.199</b>
					1	8	22.97	0.198
					1	14	22.92	0.196
					8	0	22.15	0.164
					8	4	22.14	0.164
					8	7	22.13	0.163
			15	0	22.01	0.159		
			1	0	22.89	0.195		
			1	8	22.86	0.193		
			1	14	22.84	0.192		
			8	0	22.04	0.160		
			8	4	21.97	0.157		
			8	7	21.93	0.156		
			15	0	21.90	0.155		
			1	0	22.87	0.194		
			1	8	22.86	0.193		
			1	14	22.84	0.192		
			8	0	21.96	0.157		
		8	4	21.91	0.155			
		8	7	21.87	0.154			
		15	0	21.84	0.153			
		1	0	22.41	0.174			
		1	8	21.90	0.155			
		1	14	21.73	0.149			
		8	0	21.17	0.131			
		8	4	21.10	0.129			
		8	7	21.00	0.126			
		15	0	20.94	0.124			
		1	0	22.22	0.167			
		1	8	22.05	0.160			
		1	14	21.80	0.151			
		8	0	21.00	0.126			
		8	4	20.94	0.124			
		8	7	20.90	0.123			
		15	0	20.87	0.122			
		1	0	21.96	0.157			
		1	8	21.86	0.153			
		1	14	21.61	0.145			
		8	0	20.92	0.124			
		8	4	20.88	0.122			
		8	7	20.88	0.122			
		15	0	20.83	0.121			

Band	Channel Bandwidth	Modulation	Channel	Frequency (MHz)	RB Configuration		Average Power	
					Size	Offset	(dBm)	(W)
LTE Band 4	5 MHz	QPSK	19975	1712.5	1	0	<b>23.01</b>	<b>0.200</b>
					1	12	22.97	0.198
					1	24	22.95	0.197
					12	0	22.08	0.161
					12	6	22.04	0.160
					12	13	21.99	0.158
			25	0	21.98	0.158		
			1	0	22.89	0.195		
			1	12	22.86	0.193		
			1	24	22.79	0.190		
			12	0	22.03	0.160		
			12	6	22.01	0.159		
			12	13	22.00	0.158		
			25	0	21.92	0.156		
			1	0	22.88	0.194		
			1	12	22.85	0.193		
			1	24	22.82	0.191		
			12	0	22.02	0.159		
		12	6	21.96	0.157			
		12	13	21.94	0.156			
		25	0	21.89	0.155			
		1	0	22.30	0.170			
		1	12	22.05	0.160			
		1	24	21.85	0.153			
		12	0	21.11	0.129			
		12	6	21.09	0.129			
		12	13	21.04	0.127			
		25	0	20.97	0.125			
		1	0	22.17	0.165			
		1	12	22.06	0.161			
		1	24	21.70	0.148			
		12	0	21.07	0.128			
		12	6	21.01	0.126			
		12	13	20.99	0.126			
		25	0	20.98	0.125			
		1	0	21.86	0.153			
1	12	21.83	0.152					
1	24	21.57	0.144					
12	0	20.98	0.125					
12	6	20.95	0.124					
12	11	20.84	0.121					
25	0	20.77	0.119					

Band	Channel Bandwidth	Modulation	Channel	Frequency (MHz)	RB Configuration		Average Power	
					Size	Offset	(dBm)	(W)
LTE Band 4	10 MHz	QPSK	2000	1715.0	1	0	<b>23.07</b>	<b>0.203</b>
					1	24	22.93	0.196
					1	49	22.88	0.194
					25	0	22.15	0.164
					25	12	22.06	0.161
					25	25	22.05	0.160
			50	0	22.00	0.158		
			20175	1732.5	1	0	22.88	0.194
					1	24	22.86	0.193
					1	49	22.84	0.192
					25	0	21.96	0.157
					25	12	21.96	0.157
					25	25	21.93	0.156
			50	0	21.92	0.156		
			20350	1750.0	1	0	22.96	0.198
					1	24	22.86	0.193
					1	49	22.84	0.192
					25	0	21.94	0.156
		25			12	21.91	0.155	
		25			25	21.89	0.155	
		50	0	21.87	0.154			
		16QAM	2000	1715.0	1	0	22.02	0.159
					1	24	21.88	0.154
					1	49	21.71	0.148
					25	0	21.09	0.129
					25	12	21.07	0.128
					25	25	21.06	0.128
			50	0	21.03	0.127		
			20175	1732.5	1	0	22.21	0.166
					1	24	22.05	0.160
					1	49	21.80	0.151
					25	0	21.03	0.127
					25	12	21.02	0.126
					25	25	20.95	0.124
			50	0	20.91	0.123		
			20350	1750.0	1	0	22.27	0.169
					1	24	22.19	0.166
					1	49	21.82	0.152
					25	0	20.96	0.125
		25			12	20.84	0.121	
		25			25	20.83	0.121	
		50	0	20.77	0.119			

Band	Channel Bandwidth	Modulation	Channel	Frequency (MHz)	RB Configuration		Average Power	
					Size	Offset	(dBm)	(W)
LTE Band 4	15 MHz	QPSK	20025	1717.5	1	0	<b>23.11</b>	<b>0.205</b>
					1	38	23.03	0.201
					1	74	22.90	0.195
					38	0	22.06	0.161
					38	18	22.04	0.160
					38	37	21.99	0.158
					75	0	21.96	0.157
					1	0	23.01	0.200
			20175	1732.5	1	38	22.98	0.199
					1	74	22.86	0.193
					38	0	22.04	0.160
					38	18	22.03	0.160
					38	37	22.02	0.159
					75	0	21.95	0.157
					1	0	23.07	0.203
					1	38	23.00	0.200
			20325	1747.5	1	74	22.95	0.197
					38	0	22.03	0.160
					38	18	21.99	0.158
					38	37	21.94	0.156
					75	0	21.84	0.153
					1	0	22.37	0.173
					1	38	22.27	0.169
					1	74	21.91	0.155
		16QAM	20025	1717.5	38	0	21.08	0.128
					38	18	21.01	0.126
					38	37	21.01	0.126
					75	0	20.92	0.124
					1	0	21.91	0.155
					1	38	21.72	0.149
					1	74	21.70	0.148
					38	0	21.11	0.129
			20175	1732.5	38	18	21.06	0.128
					38	37	20.95	0.124
					75	0	20.92	0.124
					1	0	22.35	0.172
					1	38	22.17	0.165
					1	74	22.14	0.164
					38	0	21.02	0.126
					38	18	20.92	0.124
			20325	1747.5	38	37	20.90	0.123
					75	0	20.75	0.119

Band	Channel Bandwidth	Modulation	Channel	Frequency (MHz)	RB Configuration		Average Power	
					Size	Offset	(dBm)	(W)
LTE Band 4	20 MHz	QPSK	20050	1720.0	1	0	<b>23.08</b>	<b>0.203</b>
					1	49	22.95	0.197
					1	99	22.83	0.192
					50	0	22.08	0.161
					50	25	22.03	0.160
					50	50	22.03	0.160
			100	0	22.02	0.159		
			20175	1732.5	1	0	23.02	0.200
					1	49	22.91	0.195
					1	99	22.73	0.187
					50	0	22.04	0.160
					50	25	21.92	0.156
					50	50	21.91	0.155
			100	0	21.91	0.155		
			20300	1745.0	1	0	22.99	0.199
					1	49	22.90	0.195
					1	99	22.88	0.194
					50	0	21.96	0.157
		50			25	21.85	0.153	
		50			50	21.83	0.152	
		100	0	21.82	0.152			
		16QAM	20050	1720.0	1	0	22.38	0.173
					1	49	22.31	0.170
					1	99	21.54	0.143
					50	0	21.02	0.126
					50	25	20.97	0.125
					50	50	20.95	0.124
			100	0	20.93	0.124		
			20175	1732.5	1	0	22.26	0.168
					1	49	21.96	0.157
					1	99	21.62	0.145
					50	0	21.02	0.126
					50	25	20.99	0.126
					50	50	20.93	0.124
			100	0	20.84	0.121		
			20300	1745.0	1	0	22.33	0.171
					1	49	22.23	0.167
					1	99	21.78	0.151
					50	0	20.88	0.122
		50			25	20.87	0.122	
		50			50	20.86	0.122	
		100	0	20.83	0.121			

Band	Channel Bandwidth	Modulation	Channel	Frequency (MHz)	RB Configuration		Average Power	
					Size	Offset	(dBm)	(W)
LTE Band 5	1.4 MHz	QPSK	20407	824.7	1	0	22.74	0.188
					1	2	22.72	0.187
					1	5	22.71	0.187
					3	0	22.70	0.186
					3	1	22.69	0.186
					3	3	22.68	0.185
			20525	836.5	6	0	21.73	0.149
					1	0	22.76	0.189
					1	2	22.72	0.187
					1	5	22.69	0.186
					3	0	22.67	0.185
					3	1	22.66	0.185
			20643	848.3	3	3	22.60	0.182
					6	0	21.83	0.152
					1	0	<b>22.81</b>	<b>0.191</b>
					1	2	22.80	0.191
					1	5	22.77	0.189
					3	0	22.76	0.189
		16QAM	20407	824.7	3	1	22.67	0.185
					3	3	22.64	0.184
					6	0	21.81	0.152
					1	0	21.77	0.150
					1	2	21.71	0.148
					1	5	21.65	0.146
			20525	836.5	3	0	21.63	0.146
					3	1	21.55	0.143
					3	3	21.31	0.135
					6	0	20.71	0.118
					1	0	21.86	0.153
					1	2	21.83	0.152
			20643	848.3	1	5	21.80	0.151
					3	0	21.68	0.147
					3	1	21.50	0.141
					3	3	21.42	0.139
					6	0	20.64	0.116
					1	0	21.94	0.156
20407	824.7	1	2	21.93	0.156			
		1	5	21.85	0.153			
		3	0	21.69	0.148			
		3	1	21.63	0.146			
		3	3	21.60	0.145			
		6	0	20.69	0.117			

Band	Channel Bandwidth	Modulation	Channel	Frequency (MHz)	RB Configuration		Average Power	
					Size	Offset	(dBm)	(W)
LTE Band 5	3 MHz	QPSK	20415	825.5	1	0	22.71	0.187
					1	8	22.68	0.185
					1	14	22.64	0.184
					8	0	21.74	0.149
					8	4	21.70	0.148
					8	7	21.64	0.146
			15	0	21.62	0.145		
			1	0	22.71	0.187		
			1	8	22.71	0.187		
			1	14	22.63	0.183		
			8	0	21.77	0.150		
			8	4	21.76	0.150		
			8	7	21.71	0.148		
			15	0	21.68	0.147		
			1	0	<b>22.90</b>	<b>0.195</b>		
			1	8	22.78	0.190		
			1	14	22.71	0.187		
			8	0	21.84	0.153		
		8	4	21.82	0.152			
		8	7	21.76	0.150			
		15	0	21.71	0.148			
		1	0	21.97	0.157			
		1	8	21.52	0.142			
		1	14	21.34	0.136			
		8	0	20.71	0.118			
		8	4	20.57	0.114			
		8	7	20.55	0.114			
		15	0	20.54	0.113			
		1	0	21.95	0.157			
		1	8	21.70	0.148			
		1	14	21.29	0.135			
		8	0	20.74	0.119			
		8	4	20.68	0.117			
		8	7	20.59	0.115			
		15	0	20.38	0.109			
		1	0	21.70	0.148			
1	8	21.61	0.145					
1	14	21.59	0.144					
8	0	20.80	0.120					
8	4	20.69	0.117					
8	7	20.67	0.117					
15	0	20.61	0.115					

Band	Channel Bandwidth	Modulation	Channel	Frequency (MHz)	RB Configuration		Average Power	
					Size	Offset	(dBm)	(W)
LTE Band 5	5 MHz	QPSK	20425	826.5	1	0	22.74	0.188
					1	12	22.74	0.188
					1	24	22.65	0.184
					12	0	21.80	0.151
					12	6	21.79	0.151
					12	13	21.69	0.148
			20525	836.5	25	0	21.68	0.147
					1	0	22.61	0.182
					1	12	22.61	0.182
					1	24	22.56	0.180
					12	0	21.78	0.151
					12	6	21.74	0.149
			20625	846.5	12	13	21.71	0.148
					25	0	21.70	0.148
					1	0	<b>22.77</b>	<b>0.189</b>
					1	12	22.63	0.183
					1	24	22.61	0.182
					12	0	21.84	0.153
		16QAM	20425	826.5	12	6	21.77	0.150
					12	13	21.70	0.148
					25	0	21.65	0.146
					1	0	21.93	0.156
					1	12	21.81	0.152
					1	24	21.59	0.144
			20525	836.5	12	0	20.71	0.118
					12	6	20.64	0.116
					12	13	20.59	0.115
					25	0	20.58	0.114
					1	0	21.90	0.155
					1	12	21.65	0.146
			20625	846.5	1	24	21.48	0.141
					12	0	20.63	0.116
					12	6	20.61	0.115
					12	13	20.60	0.115
					25	0	20.53	0.113
					1	0	21.95	0.157
20425	826.5	1	12	21.70	0.148			
		1	24	21.58	0.144			
		12	0	20.92	0.124			
		12	6	20.86	0.122			
		12	11	20.74	0.119			
		25	0	20.61	0.115			



Band	Channel Bandwidth	Modulation	Channel	Frequency (MHz)	RB Configuration		Average Power	
					Size	Offset	(dBm)	(W)
LTE Band 5	10 MHz	QPSK	20450	829.0	1	0	22.77	0.189
					1	24	22.60	0.182
					1	49	22.57	0.181
					25	0	21.72	0.149
					25	12	21.70	0.148
					25	25	21.67	0.147
			50	0	21.62	0.145		
			1	0	22.76	0.189		
			1	24	22.72	0.187		
			1	49	22.59	0.182		
			25	0	21.73	0.149		
			25	12	21.70	0.148		
			25	25	21.66	0.147		
			50	0	21.61	0.145		
			1	0	<b>22.79</b>	<b>0.190</b>		
			1	24	22.76	0.189		
			1	49	22.64	0.184		
			25	0	21.72	0.149		
		25	12	21.71	0.148			
		25	25	21.71	0.148			
		50	0	21.68	0.147			
		1	0	21.59	0.144			
		1	24	21.54	0.143			
		1	49	21.49	0.141			
		25	0	20.63	0.116			
		25	12	20.61	0.115			
		25	25	20.58	0.114			
		50	0	20.54	0.113			
		1	0	21.92	0.156			
		1	24	21.81	0.152			
		1	49	21.33	0.136			
		25	0	20.64	0.116			
		25	12	20.64	0.116			
		25	25	20.61	0.115			
		50	0	20.57	0.114			
		1	0	21.93	0.156			
1	24	21.80	0.151					
1	49	21.64	0.146					
25	0	20.68	0.117					
25	12	20.67	0.117					
25	25	20.64	0.116					
50	0	20.56	0.114					

Band	Channel Bandwidth	Modulation	Channel	Frequency (MHz)	RB Configuration		Average Power	
					Size	Offset	(dBm)	(W)
LTE Band 7	5 MHz	QPSK	20775	2502.5	1	0	<b>22.65</b>	<b>0.184</b>
					1	12	22.58	0.181
					1	24	22.49	0.177
					12	0	21.62	0.145
					12	6	21.61	0.145
					12	13	21.58	0.144
			25	0	21.50	0.141		
			1	0	22.28	0.169		
			1	12	22.26	0.168		
			1	24	22.20	0.166		
			12	0	21.40	0.138		
			12	6	21.38	0.137		
			12	13	21.30	0.135		
			25	0	21.30	0.135		
			1	0	22.14	0.164		
			1	12	22.12	0.163		
			1	24	22.00	0.158		
			12	0	21.30	0.135		
		12	6	21.28	0.134			
		12	13	21.28	0.134			
		25	0	21.25	0.133			
		1	0	21.73	0.149			
		1	12	21.58	0.144			
		1	24	21.16	0.131			
		12	0	20.59	0.115			
		12	6	20.59	0.115			
		12	13	20.58	0.114			
		25	0	20.48	0.112			
		1	0	21.58	0.144			
		1	12	21.54	0.143			
		1	24	21.22	0.132			
		12	0	20.42	0.110			
		12	6	20.40	0.110			
		12	13	20.37	0.109			
		25	0	20.20	0.105			
		1	0	21.38	0.137			
1	12	21.27	0.134					
1	24	21.07	0.128					
12	0	20.45	0.111					
12	6	20.39	0.109					
12	13	20.35	0.108					
25	0	20.20	0.105					

Band	Channel Bandwidth	Modulation	Channel	Frequency (MHz)	RB Configuration		Average Power	
					Size	Offset	(dBm)	(W)
LTE Band 7	10 MHz	QPSK	20800	2505.0	1	0	<b>22.54</b>	<b>0.179</b>
					1	24	22.43	0.175
					1	49	22.42	0.175
					25	0	21.54	0.143
					25	12	21.50	0.141
					25	25	21.50	0.141
			50	0	21.47	0.140		
			21100	2535.0	1	0	22.45	0.176
					1	24	22.39	0.173
					1	49	22.22	0.167
					25	0	21.38	0.137
					25	12	21.31	0.135
					25	25	21.26	0.134
			50	0	21.24	0.133		
			21400	2565.0	1	0	22.24	0.167
					1	24	22.12	0.163
					1	49	22.05	0.160
					25	0	21.30	0.135
		25			12	21.28	0.134	
		25			25	21.28	0.134	
		50	0	21.26	0.134			
		16QAM	20800	2505.0	1	0	21.89	0.155
					1	24	21.83	0.152
					1	49	21.42	0.139
					25	0	20.47	0.111
					25	12	20.45	0.111
					25	25	20.44	0.111
			50	0	20.42	0.110		
			21100	2535.0	1	0	21.62	0.145
					1	24	21.22	0.132
					1	49	21.05	0.127
					25	0	20.40	0.110
					25	12	20.27	0.106
					25	25	20.18	0.104
			50	0	20.17	0.104		
			21400	2565.0	1	0	21.56	0.143
					1	24	21.17	0.131
					1	49	21.09	0.129
					25	0	20.38	0.109
		25			12	20.30	0.107	
		25			25	20.20	0.105	
		50	0	20.20	0.105			

Band	Channel Bandwidth	Modulation	Channel	Frequency (MHz)	RB Configuration		Average Power	
					Size	Offset	(dBm)	(W)
LTE Band 7	15 MHz	QPSK	20825	2507.5	1	0	<b>22.54</b>	<b>0.179</b>
					1	38	22.52	0.179
					1	74	22.47	0.177
					36	0	21.48	0.141
					36	18	21.48	0.141
					36	39	21.44	0.139
			75	0	21.39	0.138		
			1	0	22.40	0.174		
			1	38	22.37	0.173		
			1	74	22.20	0.166		
			36	0	21.45	0.140		
			36	18	21.38	0.137		
			36	39	21.35	0.136		
			75	0	21.32	0.136		
			1	0	22.23	0.167		
			1	38	22.19	0.166		
			1	74	22.17	0.165		
			36	0	21.31	0.135		
		36	18	21.26	0.134			
		36	39	21.20	0.132			
		75	0	21.19	0.132			
		1	0	21.82	0.152			
		1	38	21.69	0.148			
		1	74	21.50	0.141			
		36	0	20.56	0.114			
		36	18	20.44	0.111			
		36	39	20.43	0.110			
		75	0	20.41	0.110			
		1	0	21.55	0.143			
		1	38	21.32	0.136			
		1	74	21.30	0.135			
		36	0	20.37	0.109			
		36	18	20.33	0.108			
		36	39	20.32	0.108			
		75	0	20.27	0.106			
		1	0	21.30	0.135			
1	38	21.27	0.134					
1	74	20.92	0.124					
36	0	20.30	0.107					
36	18	20.23	0.105					
36	39	20.21	0.105					
75	0	20.16	0.104					

Band	Channel Bandwidth	Modulation	Channel	Frequency (MHz)	RB Configuration		Average Power	
					Size	Offset	(dBm)	(W)
LTE Band 7	20 MHz	QPSK	20850	2510.0	1	0	<b>22.55</b>	<b>0.180</b>
					1	49	22.37	0.173
					1	99	22.36	0.172
					50	0	21.47	0.140
					50	25	21.41	0.138
					50	50	21.37	0.137
			100	0	21.30	0.135		
			21100	2535.0	1	0	22.34	0.171
					1	49	22.22	0.167
					1	99	22.17	0.165
					50	0	21.33	0.136
					50	25	21.30	0.135
					50	50	21.30	0.135
			100	0	21.25	0.133		
			21350	2560.0	1	0	22.19	0.166
					1	49	22.17	0.165
					1	99	22.11	0.163
					50	0	21.30	0.135
		50			25	21.23	0.133	
		50			50	21.21	0.132	
		100	0	21.14	0.130			
		16QAM	20850	2510.0	1	0	21.75	0.150
					1	49	21.32	0.136
					1	99	21.09	0.129
					50	0	20.45	0.111
					50	25	20.45	0.111
					50	50	20.38	0.109
			100	0	20.38	0.109		
			21100	2535.0	1	0	21.30	0.135
					1	49	21.21	0.132
					1	99	20.89	0.123
					50	0	20.36	0.109
					50	25	20.35	0.108
					50	50	20.33	0.108
			100	0	20.29	0.107		
			21350	2560.0	1	0	21.54	0.143
					1	49	21.22	0.132
					1	99	21.04	0.127
					50	0	20.32	0.108
		50			25	20.19	0.104	
		50			50	20.15	0.104	
		100	0	20.12	0.103			

Band	Channel Bandwidth	Modulation	Channel	Frequency (MHz)	RB Configuration		Average Power	
					Size	Offset	(dBm)	(W)
LTE Band 17	5 MHz	QPSK	23755	706.5	1	0	<b>22.90</b>	<b>0.195</b>
					1	12	22.84	0.192
					1	24	22.77	0.189
					12	0	21.86	0.153
					12	6	21.79	0.151
					12	13	21.76	0.150
			23790	710.0	25	0	21.72	0.149
					1	0	22.83	0.192
					1	12	22.82	0.191
					1	24	22.62	0.183
					12	0	21.88	0.154
					12	6	21.84	0.153
			23825	713.5	12	13	21.83	0.152
					25	0	21.82	0.152
					1	0	22.90	0.195
					1	12	22.72	0.187
					1	24	22.53	0.179
					12	0	21.85	0.153
		16QAM	23755	706.5	12	6	21.84	0.153
					12	13	21.80	0.151
					25	0	21.76	0.150
					1	0	22.08	0.161
					1	12	22.02	0.159
					1	24	21.69	0.148
			23790	710.0	12	0	20.82	0.121
					12	6	20.78	0.120
					12	13	20.75	0.119
					25	0	20.74	0.119
					1	0	21.78	0.151
					1	12	21.72	0.149
			23825	713.5	1	24	21.44	0.139
					12	0	20.94	0.124
					12	6	20.83	0.121
					12	13	20.65	0.116
					25	0	20.61	0.115
					1	0	21.97	0.157
		23755	706.5	1	12	21.68	0.147	
				1	24	21.48	0.141	
				12	0	20.96	0.125	
				12	6	20.96	0.125	
				12	13	20.82	0.121	
				25	0	20.78	0.120	

Band	Channel Bandwidth	Modulation	Channel	Frequency (MHz)	RB Configuration		Average Power	
					Size	Offset	(dBm)	(W)
LTE Band 17	10 MHz	QPSK	23780	709.0	1	0	<b>22.95</b>	<b>0.197</b>
					1	24	22.76	0.189
					1	49	22.65	0.184
					25	0	21.88	0.154
					25	12	21.83	0.152
					25	25	21.82	0.152
			50	0	21.78	0.151		
			23790	710.0	1	0	22.92	0.196
					1	24	22.82	0.191
					1	49	22.64	0.184
					25	0	21.82	0.152
					25	12	21.80	0.151
					25	25	21.80	0.151
			50	0	21.76	0.150		
			23800	711.0	1	0	22.76	0.189
					1	24	22.65	0.184
					1	49	22.63	0.183
					25	0	21.79	0.151
		25			12	21.77	0.150	
		25			25	21.76	0.150	
		50	0	21.69	0.148			
		16QAM	23780	709.0	1	0	21.83	0.152
					1	24	21.70	0.148
					1	49	21.45	0.140
					25	0	20.85	0.122
					25	12	20.77	0.119
					25	25	20.72	0.118
			50	0	20.72	0.118		
			23790	710.0	1	0	22.14	0.164
					1	24	21.96	0.157
					1	49	21.66	0.147
					25	0	20.82	0.121
					25	12	20.81	0.121
					25	25	20.75	0.119
			50	0	20.72	0.118		
			23800	711.0	1	0	21.97	0.157
					1	24	21.64	0.146
					1	49	21.52	0.142
					25	0	20.79	0.120
		25			12	20.78	0.120	
		25			25	20.73	0.118	
		50	0	20.67	0.117			

### 3 Effective Radiated Power / Equivalent Isotropic Radiated Power Test

#### 3.1. Limit

For FCC Part 27: The EIRP of mobile transmitters and auxiliary test transmitters must not exceed 1 Watts.

For FCC Part 27.50(c)(10): Portable stations in the 698-746 MHz band are limited to 3 watts ERP.

For FCC Part 27.50(h)(2): Mobile stations are limited to 2.0 watts EIRP.

For FCC Part 22.913(a)(2): The ERP of mobile transmitters and auxiliary test transmitters must not exceed 7 Watts.

For FCC Part 24.232(b): The EIRP of mobile transmitters and auxiliary test transmitters must not exceed 2 Watts.

#### 3.2. Test Instruments

3 Meter Chamber					
Equipment	Manufacturer	Model Number	Serial Number	Cal. Date	Remark
RF Pre-selector	Agilent	N9039A	MY46520256	01/06/2015	(1)
Spectrum Analyzer	Agilent	E4446A	MY46180578	01/06/2015	(1)
Pre Amplifier	Agilent	8449B	3008A02237	02/24/2015	(1)
Pre Amplifier	Agilent	8447D	2944A10961	02/24/2015	(1)
Broadband Antenna (30MHz~1GHz)	SCHWARZBECK MESS-ELEKTRONIK	VULB9163	9163-270	07/22/2014	(1)
Horn Antenna (1~18GHz)	SCHWARZBECK MESS-ELEKTRONIK	BBHA9120D	9120D-550	06/11/2014	(1)
Horn Antenna (18~40GHz)	SCHWARZBECK MESS-ELEKTRONIK	BBHA9170	9170-320	07/02/2014	(1)
Test Site	ATL	TE01	888001	08/28/2014	(1)

Remark: <sup>(1)</sup> Calibration period 1 year. <sup>(2)</sup> Calibration period 2 years.

Note: N.C.R. = No Calibration Request.

#### 3.3. Test Setup

##### Below 1 GHz

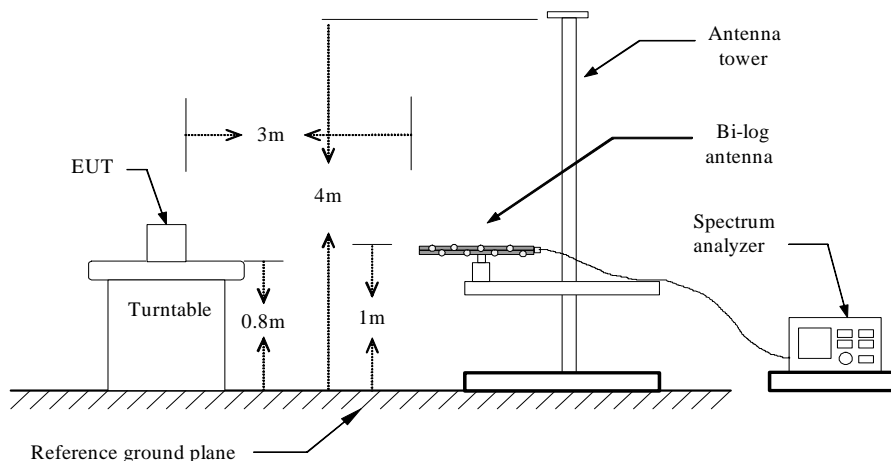



**Above 1 GHz**

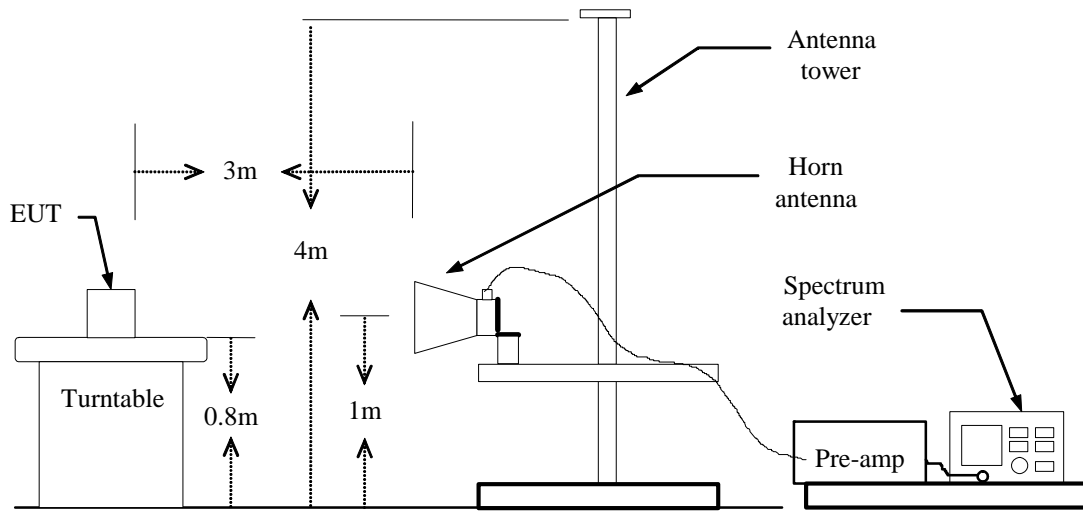

**For Substituted Method Test Set-UP**

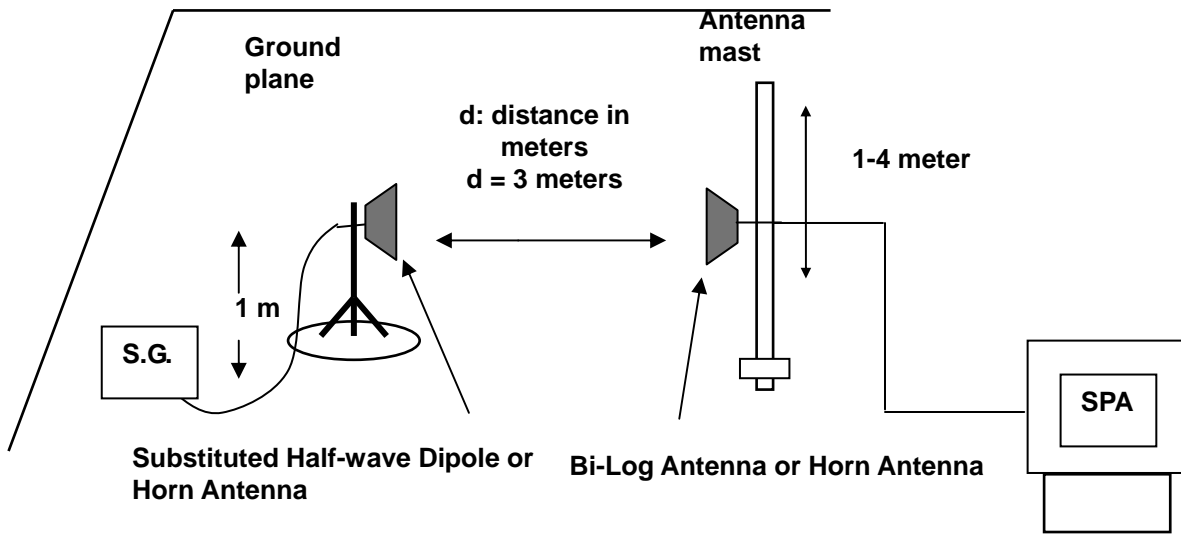

### 3.4. Test Procedure

- a. The EUT was set up for the maximum power with LTE link data modulation. The power was measured with R&S Spectrum Analyzer. All measurements were done at 3 channels (low, middle and high operational frequency range). RWB and VBW is 10MHz for LTE and 5MHz for WCDMA mode.
- b. E.I.R.P power measurement. In the semi-anechoic chamber, EUT placed on the 0.8m height of Turn Table, rotated the table around 360 degrees to search the maximum radiation power and receiver antenna shall be rotated vertical and horizontal polarization and moved height from 1m to 4m to find the maximum polar radiated power. The "Read Value" is the spectrum reading the maximum power value.
- c. The substitution horn antenna is substituted for EUT at the same position and signals generator export the CW signal to the substitution antenna via a TX cable. Rotated the Turn Table and moved receiving antenna to find the maximum radiation power. Adjust output power level of S.G to get a Value of spectrum reading equal to "Read Value" of step a. Record the power level of S.G.
- d.  $E.I.R.P. = \text{Output power level of S.G} - \text{TX cable loss} + \text{Antenna gain of substitution horn}$
- e.  $E.R.P. = E.I.R.P. - 2.15 \text{ dB}$

### 3.5. Uncertainty

The measurement uncertainty is defined as for Field Strength of Spurious Radiation measurement is  $\pm 3.072 \text{ dB}$ .

**3.6. Test Result**

Model Number	AR7552		
Test Item	E.I.R.P. / E.R.P.		
Date of Test	05/05/2015	Test Site	TC03

LTE Band 2										
Channel Bandwidth	Modulation	CH	Frequency (MHz)	RB Configuration		Average Power (dBm)	Antenna Gain (dBi)	E.I.R.P.		Limit (W)
				Size	Offset			(dBm)	(W)	
1.4 M	QPSK	18900	1880.0	1	0	23.38	5	28.38	0.689	< 2
3 MHz	QPSK	18900	1880.0	1	0	23.39	5	28.39	0.690	< 2
5 MHz	QPSK	18900	1880.0	1	0	23.40	5	28.40	0.692	< 2
10 MHz	QPSK	18650	1855.0	1	0	23.30	5	28.30	0.676	< 2
15 MHz	QPSK	18900	1880.0	1	0	23.43	5	28.43	0.697	< 2
20 MHz	QPSK	18900	1880.0	1	0	23.41	5	28.41	0.693	< 2

LTE Band 4										
Channel Bandwidth	Modulation	CH	Frequency (MHz)	RB Configuration		Average Power (dBm)	Antenna Gain (dBi)	E.I.R.P.		Limit (W)
				Size	Offset			(dBm)	(W)	
1.4 M	QPSK	19957	1710.7	1	0	23.12	5	28.12	0.649	< 1
3 MHz	QPSK	19965	1711.5	1	0	22.99	5	27.99	0.630	< 1
5 MHz	QPSK	19975	1712.5	1	0	23.01	5	28.01	0.632	< 1
10 MHz	QPSK	20000	1715.0	1	0	23.07	5	28.07	0.641	< 1
15 MHz	QPSK	20025	1717.5	1	0	23.11	5	28.11	0.647	< 1
20 MHz	QPSK	20050	1720.0	1	0	23.08	5	28.08	0.643	< 1

LTE Band 5										
Channel Bandwidth	Modulation	CH	Frequency (MHz)	RB Configuration		Average Power (dBm)	Antenna Gain (dBi)	E.R.P.		Limit (W)
				Size	Offset			(dBm)	(W)	
1.4 M	QPSK	20643	848.3	1	0	22.81	5	25.66	0.368	< 7
3 MHz	QPSK	20635	847.5	1	0	22.90	5	25.75	0.376	< 7
5 MHz	QPSK	20625	846.5	1	0	22.77	5	25.62	0.365	< 7
10 MHz	QPSK	20600	844.0	1	0	22.79	5	25.64	0.366	< 7

LTE Band 7										
Channel Bandwidth	Modulation	CH	Frequency (MHz)	RB Configuration		Average Power (dBm)	Antenna Gain (dBi)	E.I.R.P.		Limit (W)
				Size	Offset			(dBm)	(W)	
5 MHz	QPSK	20775	2502.5	1	0	22.65	7	29.65	0.923	< 2
10 MHz	QPSK	20800	2505.0	1	0	22.54	7	29.54	0.899	< 2
15 MHz	QPSK	20825	2507.5	1	0	22.54	7	29.54	0.899	< 2
20 MHz	QPSK	20850	2510.0	1	0	22.55	7	29.55	0.902	< 2

LTE Band 17										
Channel Bandwidth	Modulation	CH	Frequency (MHz)	RB Configuration		Average Power (dBm)	Antenna Gain (dBi)	E.R.P.		Limit (W)
				Size	Offset			(dBm)	(W)	
5 MHz	QPSK	23755	706.5	1	0	22.90	5	25.75	0.376	< 3
10 MHz	QPSK	23780	709.0	1	0	22.95	5	25.80	0.380	< 3

## 4 Frequency Stability Test

### 4.1. Limit

According to the FCC rule shall be tested the frequency stability. The rule is defined that” The frequency stability shall be sufficient to ensure that the fundamental emissions stay within the authorized bands of operation. The test extreme voltage is according to the 2.1055(d)(1) Vary primary supply voltage from 85 to 115 percent of the nominal value for other than hand carried battery equipment and the extreme temperature rule is comply with the 2.1055(a)(1) -30°C ~ 50°C.

### 4.2. Test Instruments

Equipment	Manufacturer	Model No.	Serial No.	Cal. Date	Remark
Wideband Radio Communication Test	R & S	CMW500	103168	11/05/2014	(1)
Temperature & Humidity Chamber	TAICHY	MHU-225LA	980729	08/14/2014	(1)
Test Site	ATL	TE05	TE05	N.C.R.	-----

Remark: <sup>(1)</sup> Calibration period 1 year. <sup>(2)</sup> Calibration period 2 years.

Note: N.C.R. = No Calibration Request.

### 4.3. Setup

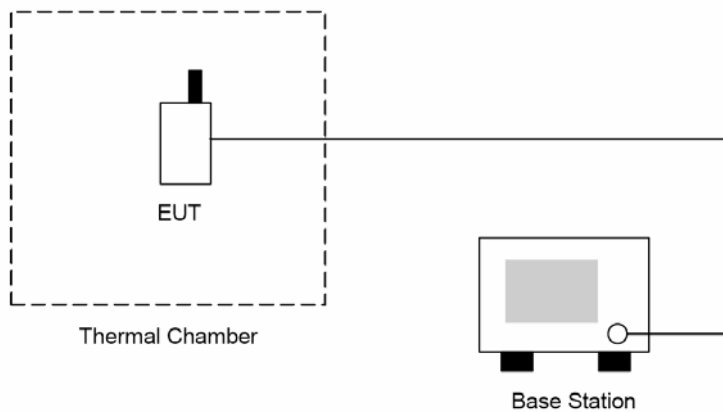

#### 4.4. Test Procedure

The measurement is made according to FCC rules:

1. The EUT and test equipment were set up as shown on the following section.
2. With all power removed, the temperature was decreased to  $-30^{\circ}\text{C}$  and permitted to stabilize for three hours. Power was applied and the maximum change in frequency was note within one minute.
3. With power OFF, the temperature was raised in  $10^{\circ}\text{C}$  steps. The sample was permitted to stabilize at each step for at least one-half hour. Power was applied and the maximum frequency change was noted within one minute.
4. The EUT was placed in a temperature chamber at  $25 \pm 5^{\circ}\text{C}$  and connected as the following section.
5. The power supply voltage to the EUT was varied from BEP to 115% of the nominal value measured at the input to the EUT.
6. The temperature tests were performed for the worst case.
7. Test data was recorded.

#### 4.5. Uncertainty

The measurement uncertainty is defined as for Frequency Stability measurement is  $\pm 10\text{Hz}$ .

**4.6. Test Result**

Model Number	AR7552		
Test Item	Frequency Stability		
Date of Test	05/05/2015	Test Site	TE05

LTE Band 2 _ QPSK						
Voltage						
Channel Bandwidth	Frequency (MHz)	Voltage [Vdc]	Temperature (°C)	Deviation (Hz)	Deviation (ppm)	Limit (ppm)
20 MHz	1880.0	4.20	20	-3.93	-0.002	± 2.5
		3.70	20	-9.90	-0.005	± 2.5
		3.40	20	-10.05	-0.005	± 2.5
Temperature						
Channel Bandwidth	Frequency (MHz)	Voltage [Vdc]	Temperature (°C)	Deviation (Hz)	Deviation (ppm)	Limit (ppm)
20 MHz	1880.0	3.70	-30	-9.66	-0.005	± 2.5
		3.70	-20	0.25	0.000	± 2.5
		3.70	-10	2.43	0.001	± 2.5
		3.70	0	1.95	0.001	± 2.5
		3.70	10	-5.11	-0.003	± 2.5
		3.70	20	0.89	0.000	± 2.5
		3.70	30	-3.56	-0.002	± 2.5
		3.70	40	0.13	0.000	± 2.5
		3.70	50	5.62	0.003	± 2.5
		3.70	60	-14.98	-0.008	± 2.5
3.70	70	-12.61	-0.007	± 2.5		

LTE Band 4 _ QPSK						
Voltage						
Channel Bandwidth	Frequency (MHz)	Voltage [Vdc]	Temperature (°C)	Deviation (Hz)	Deviation (ppm)	Limit (ppm)
20 MHz	1732.5	4.20	20	13.83	0.008	± 2.5
		3.70	20	-12.27	-0.007	± 2.5
		3.40	20	5.24	0.003	± 2.5
Temperature						
Channel Bandwidth	Frequency (MHz)	Voltage [Vdc]	Temperature (°C)	Deviation (Hz)	Deviation (ppm)	Limit (ppm)
20 MHz	1732.5	3.70	-30	-13.92	-0.008	± 2.5
		3.70	-20	-5.35	-0.003	± 2.5
		3.70	-10	-2.10	-0.001	± 2.5
		3.70	0	-4.63	-0.003	± 2.5
		3.70	10	-16.32	-0.009	± 2.5
		3.70	20	-0.86	0.000	± 2.5
		3.70	30	0.45	0.000	± 2.5
		3.70	40	5.32	0.003	± 2.5
		3.70	50	2.04	0.001	± 2.5
		3.70	60	0.11	0.000	± 2.5
3.70	70	-4.64	-0.003	± 2.5		

LTE Band 5 _ QPSK						
Voltage						
Channel Bandwidth	Frequency (MHz)	Voltage [Vdc]	Temperature (°C)	Deviation (Hz)	Deviation (ppm)	Limit (ppm)
10 MHz	836.5	4.20	20	6.27	0.007	± 2.5
		3.70	20	4.50	0.005	± 2.5
		3.40	20	6.46	0.008	± 2.5
Temperature						
Channel Bandwidth	Frequency (MHz)	Voltage [Vdc]	Temperature (°C)	Deviation (Hz)	Deviation (ppm)	Limit (ppm)
10 MHz	836.5	3.70	-30	-11.46	-0.014	± 2.5
		3.70	-20	11.72	0.014	± 2.5
		3.70	-10	-12.81	-0.015	± 2.5
		3.70	0	-1.31	-0.002	± 2.5
		3.70	10	-5.56	-0.007	± 2.5
		3.70	20	-4.01	-0.005	± 2.5
		3.70	30	-2.07	-0.002	± 2.5
		3.70	40	1.15	0.001	± 2.5
		3.70	50	3.58	0.004	± 2.5
		3.70	60	-13.91	-0.017	± 2.5
3.70	70	-13.76	-0.016	± 2.5		



LTE Band 7 _ QPSK						
Voltage						
Channel Bandwidth	Frequency (MHz)	Voltage [Vdc]	Temperature (°C)	Deviation (Hz)	Deviation (ppm)	Limit (ppm)
20 MHz	2535.0	4.20	20	6.14	0.002	± 2.5
		3.70	20	-4.57	-0.002	± 2.5
		3.40	20	-6.80	-0.003	± 2.5
Temperature						
Channel Bandwidth	Frequency (MHz)	Voltage [Vdc]	Temperature (°C)	Deviation (Hz)	Deviation (ppm)	Limit (ppm)
20 MHz	2535.0	3.70	-30	-7.62	-0.003	± 2.5
		3.70	-20	18.76	0.007	± 2.5
		3.70	-10	-0.24	0.000	± 2.5
		3.70	0	-3.22	-0.001	± 2.5
		3.70	10	-3.10	-0.001	± 2.5
		3.70	20	-9.27	-0.004	± 2.5
		3.70	30	-3.92	-0.002	± 2.5
		3.70	40	-4.23	-0.002	± 2.5
		3.70	50	8.73	0.003	± 2.5
		3.70	60	-12.96	-0.005	± 2.5
3.70	70	-11.72	-0.005	± 2.5		

LTE Band 17 _ QPSK						
Voltage						
Channel Bandwidth	Frequency (MHz)	Voltage [Vdc]	Temperature (°C)	Deviation (Hz)	Deviation (ppm)	Limit (ppm)
10 MHz	710.0	4.20	20	1.06	0.001	± 2.5
		3.70	20	-2.59	-0.004	± 2.5
		3.40	20	7.92	0.011	± 2.5
Temperature						
Channel Bandwidth	Frequency (MHz)	Voltage [Vdc]	Temperature (°C)	Deviation (Hz)	Deviation (ppm)	Limit (ppm)
10 MHz	710.0	3.70	-30	-15.68	-0.022	± 2.5
		3.70	-20	3.52	0.005	± 2.5
		3.70	-10	3.32	0.005	± 2.5
		3.70	0	-8.87	-0.012	± 2.5
		3.70	10	-9.71	-0.014	± 2.5
		3.70	20	-10.47	-0.015	± 2.5
		3.70	30	6.46	0.009	± 2.5
		3.70	40	-12.68	-0.018	± 2.5
		3.70	50	0.09	0.000	± 2.5
		3.70	60	-4.79	-0.007	± 2.5
3.70	70	-5.53	-0.008	± 2.5		

## 5 Emission Bandwidth & Occupied Bandwidth Test

### 5.1. Limit

The width of a frequency band such that, below the lower and above the upper frequency limits, the mean powers emitted are each equal to a specified percentage 0.5 %of the total mean power of a given emission.

The emission bandwidth is defined as the width of the signal between two points, located at the 2 sides of the carrier frequency, outside of which all emissions are attenuated at least 26 dB below the transmitter power.

### 5.2. Test Instruments

Equipment	Manufacturer	Model No.	Serial No.	Cal. Date	Remark
Spectrum Analyzer	Agilent	E4445A	MY46181986	05/10/2014	(1)
Wideband Radio Communication Test	R & S	CMW500	103168	11/05/2014	(1)
Attenuator	RADIALL	R41572000	0603033073	N.C.R.	-----
Power divider	Agilent	87302C	3239A00760	N.C.R.	-----
Test Site	ATL	TE05	TE05	N.C.R.	-----

Remark: <sup>(1)</sup> Calibration period 1 year. <sup>(2)</sup> Calibration period 2 years.

Note: N.C.R. = No Calibration Request.

### 5.3. Setup

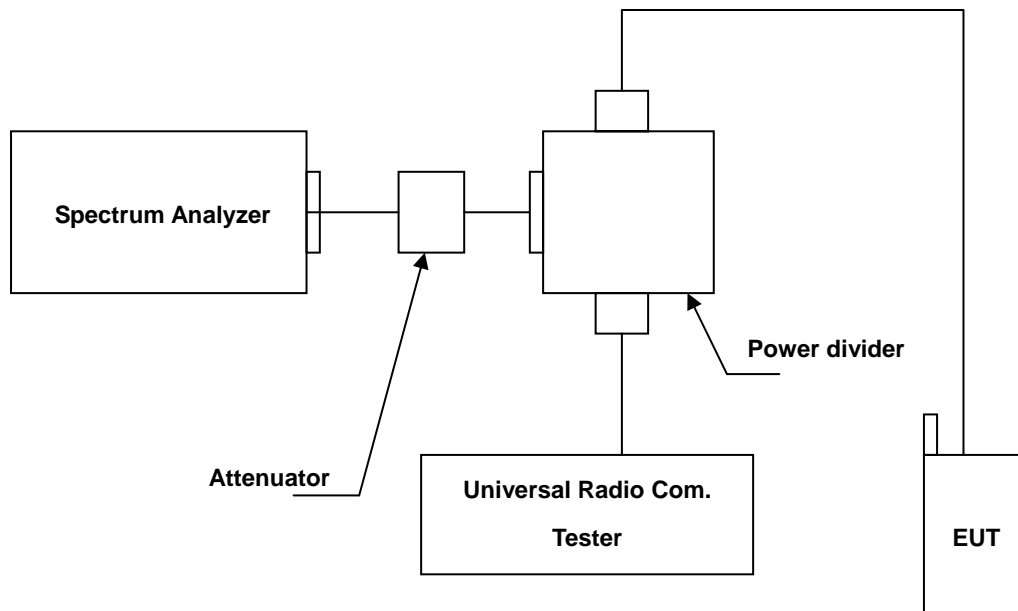

#### **5.4. Test Procedure**

The measurement is made according to FCC rules:

- a. The EUT makes a phone call to the communication simulator. The power was measured with R&S Spectrum Analyzer. All measurements were done at 3 channels. (low, middle and high operational frequency range.)
- b. The conducted occupied bandwidth used the power splitter via EUT RF power connector between simulation base station and spectrum analyzer.
- c. The communication simulator station system controlled a EUT to export maximum output power under transmission mode and specific channel frequency. Use OBW measurement function of Spectrum analyzer to measure 99 % occupied bandwidth.

#### **5.5. Uncertainty**

The measurement uncertainty is defined as  $\pm 10\text{Hz}$

**5.6. Test Result**

Model Number	AR7552		
Test Item	Emission Bandwidth & Occupied Bandwidth		
Date of Test	04/29/2015	Test Site	TE05

LTE Band 2				
Modulation	Channel Bandwidth	Frequency (MHz)	26dB Bandwidth (MHz)	Occupied Bandwidth (MHz)
QPSK	1.4 MHz	1850.7	1.282	1.0817
		1880.0	1.323	1.0905
		1909.3	1.322	1.0830
	3 MHz	1851.5	2.987	2.6837
		1880.0	2.977	2.6904
		1908.5	3.023	2.6868
	5 MHz	1852.5	4.938	4.4694
		1880.0	4.925	4.4648
		1907.5	4.897	4.4651
	10 MHz	1855.0	9.764	8.9497
		1880.0	9.708	8.9558
		1905.0	9.736	8.9535
	15 MHz	1857.5	14.365	13.3763
		1880.0	14.384	13.4391
		1902.5	14.588	13.4164
	20 MHz	1860.0	19.173	17.8356
		1880.0	19.272	17.8655
		1900.0	19.381	17.8813
16QAM	1.4 MHz	1850.7	1.283	1.0819
		1880.0	1.287	1.0899
		1909.3	1.318	1.0840
	3 MHz	1851.5	2.987	2.6835
		1880.0	2.994	2.6886
		1908.5	3.078	2.6788
	5 MHz	1852.5	4.935	4.4642
		1880.0	4.994	4.4727
		1907.5	4.893	4.4603
	10 MHz	1855.0	9.770	8.9478
		1880.0	9.752	8.9572
		1905.0	9.592	8.9533
	15 MHz	1857.5	14.284	13.4040
		1880.0	14.438	13.4245
		1902.5	14.370	13.4076
	20 MHz	1860.0	19.166	17.8451
		1880.0	19.247	17.8493
		1900.0	19.531	17.8914

LTE Band 4				
Modulation	Channel Bandwidth	Frequency (MHz)	26dB Bandwidth (MHz)	Occupied Bandwidth (MHz)
QPSK	1.4 MHz	1710.7	1.253	1.0800
		1732.5	1.244	1.0818
		1754.3	1.228	1.0779
	3 MHz	1711.5	2.966	2.6913
		1732.5	2.959	2.6877
		1753.5	2.935	2.6808
	5 MHz	1712.5	4.912	4.4772
		1732.5	4.920	4.4773
		1752.5	4.933	4.4640
	10 MHz	1715.0	9.655	8.9296
		1732.5	9.630	8.9419
		1750.0	9.693	8.9405
	15 MHz	1717.5	14.556	13.3738
		1732.5	14.483	13.4362
		1747.5	14.555	13.4184
	20 MHz	1720.0	19.100	17.7683
		1732.5	19.358	17.9432
		1745.0	18.989	17.8662
16QAM	1.4 MHz	1710.7	1.252	1.0801
		1732.5	1.244	1.0831
		1754.3	1.211	1.0778
	3 MHz	1711.5	2.953	2.6869
		1732.5	2.972	2.6879
		1753.5	2.926	2.6797
	5 MHz	1712.5	4.870	4.4631
		1732.5	4.914	4.4844
		1752.5	4.895	4.4585
	10 MHz	1715.0	9.651	8.9271
		1732.5	9.695	8.9410
		1750.0	9.632	8.9131
	15 MHz	1717.5	14.600	13.3779
		1732.5	14.555	13.4286
		1747.5	14.554	13.3749
	20 MHz	1720.0	19.100	17.7555
		1732.5	19.533	17.9297
		1745.0	18.989	17.8441

LTE Band 5				
Modulation	Channel Bandwidth	Frequency (MHz)	26dB Bandwidth (MHz)	Occupied Bandwidth (MHz)
QPSK	1.4 MHz	824.7	1.244	1.0796
		836.5	1.213	1.0777
		848.3	1.271	1.0790
	3 MHz	825.5	2.968	2.6887
		836.5	2.937	2.6779
		847.5	2.977	2.6881
	5 MHz	826.5	4.891	4.4721
		836.5	4.839	4.4731
		846.5	4.920	4.4661
	10 MHz	829.0	9.679	8.9533
		836.5	9.597	8.9377
		844.0	9.703	8.9370
16QAM	1.4 MHz	824.7	1.244	1.0795
		836.5	1.215	1.0772
		848.3	1.253	1.0787
	3 MHz	825.5	2.970	2.6904
		836.5	2.958	2.6786
		847.5	2.961	2.6872
	5 MHz	826.5	4.888	4.4735
		836.5	4.928	4.4737
		846.5	4.877	4.4621
	10 MHz	829.0	9.650	8.9647
		836.5	9.729	8.9403
		844.0	9.666	8.9395

LTE Band 7				
Modulation	Channel Bandwidth	Frequency (MHz)	26dB Bandwidth (MHz)	Occupied Bandwidth (MHz)
QPSK	5 MHz	2502.5	4.967	4.4739
		2535.0	4.928	4.4739
		2567.5	4.888	4.4799
	10 MHz	2505.0	9.726	8.9530
		2535.0	9.620	8.9425
		2565.0	9.664	8.9588
	15 MHz	2507.5	14.574	13.4406
		2535.0	14.418	13.3814
		2562.5	14.397	13.3792
	20 MHz	2510.0	18.967	17.8502
		2535.0	19.215	17.8831
		2560.0	19.066	17.8134
16QAM	5 MHz	2502.5	4.967	4.4697
		2535.0	4.928	4.4728
		2567.5	4.864	4.4641
	10 MHz	2505.0	9.722	8.9421
		2535.0	9.631	8.9414
		2565.0	9.595	8.9494
	15 MHz	2507.5	14.464	13.4479
		2535.0	14.559	13.3704
		2562.5	14.312	13.3982
	20 MHz	2510.0	19.088	17.8452
		2535.0	19.417	17.8887
		2560.0	19.042	17.8208

LTE Band 17				
Channel Bandwidth	Modulation	Frequency (MHz)	-26dB Bandwidth (MHz)	Occupied Bandwidth (MHz)
5 MHz	QPSK	706.5	5.012	4.4803
		710.0	4.904	4.4811
		713.5	5.018	4.4799
	16QAM	709.0	4.900	4.4795
		710.0	4.918	4.4847
		711.0	4.959	4.4764
10 MHz	QPSK	706.5	9.802	8.9567
		710.0	9.600	8.9502
		713.5	9.683	8.9539
	16QAM	709.0	9.730	8.9562
		710.0	9.608	8.9509
		711.0	9.627	8.9574

**5.7. Test Graphs**

LTE Band 2 (Channel Bandwidth: 1.4 MHz) _ QPSK	
1850.7 MHz	<p><b>Agilent</b> R T Freq/Channel</p> <p>Ch Freq 1.8507 GHz Trig Free</p> <p>Center Freq 1.85070000 GHz</p> <p>Start Freq 1.84920000 GHz</p> <p>Stop Freq 1.85220000 GHz</p> <p>CF Step 300.000000 kHz Auto Man</p> <p>Freq Offset 0.00000000 Hz</p> <p>Signal Track On Off</p> <p>Ref 20 dBm Atten 30 dB</p> <p>#Peak Log 10 dB/Offst 4.3 dB</p> <p>Center 1.850 700 GHz Span 3 MHz</p> <p>#Res BW 15 kHz #VBW 15 kHz Sweep 16.08 ms (601 pts)</p> <p><b>Occupied Bandwidth</b> Occ BW % Pwr 99.00 %</p> <p><b>1.0817 MHz</b> x dB -26.00 dB</p> <p>Transmit Freq Error 190,299 Hz</p> <p>x dB Bandwidth 1.282 MHz</p> <p>Copyright 2000-2006 Agilent Technologies</p>
1880.0 MHz	<p><b>Agilent</b> R T Freq/Channel</p> <p>Ch Freq 1.88 GHz Trig Free</p> <p>Center Freq 1.88000000 GHz</p> <p>Start Freq 1.87850000 GHz</p> <p>Stop Freq 1.88150000 GHz</p> <p>CF Step 300.000000 kHz Auto Man</p> <p>Freq Offset 0.00000000 Hz</p> <p>Signal Track On Off</p> <p>Ref 20 dBm Atten 30 dB</p> <p>#Peak Log 10 dB/Offst 4.3 dB</p> <p>Center 1.880 000 GHz Span 3 MHz</p> <p>#Res BW 15 kHz #VBW 15 kHz Sweep 16.08 ms (601 pts)</p> <p><b>Occupied Bandwidth</b> Occ BW % Pwr 99.00 %</p> <p><b>1.0905 MHz</b> x dB -26.00 dB</p> <p>Transmit Freq Error 378,326 Hz</p> <p>x dB Bandwidth 1.323 MHz</p> <p>Copyright 2000-2006 Agilent Technologies</p>
1909.3 MHz	<p><b>Agilent</b> R T Freq/Channel</p> <p>Ch Freq 1.9093 GHz Trig Free</p> <p>Center Freq 1.90930000 GHz</p> <p>Start Freq 1.90780000 GHz</p> <p>Stop Freq 1.91080000 GHz</p> <p>CF Step 300.000000 kHz Auto Man</p> <p>Freq Offset 0.00000000 Hz</p> <p>Signal Track On Off</p> <p>Ref 20 dBm Atten 30 dB</p> <p>#Peak Log 10 dB/Offst 4.3 dB</p> <p>Center 1.909 300 GHz Span 3 MHz</p> <p>#Res BW 15 kHz #VBW 15 kHz Sweep 16.08 ms (601 pts)</p> <p><b>Occupied Bandwidth</b> Occ BW % Pwr 99.00 %</p> <p><b>1.0830 MHz</b> x dB -26.00 dB</p> <p>Transmit Freq Error 667,473 Hz</p> <p>x dB Bandwidth 1.322 MHz</p> <p>Copyright 2000-2006 Agilent Technologies</p>



LTE Band 2 (Channel Bandwidth: 3 MHz) _ QPSK	
1851.5 MHz	<p>Agilent R T Freq/Channel</p> <p>Ch Freq 1.8515 GHz Trig Free</p> <p>Center Freq 1.85150000 GHz</p> <p>Start Freq 1.84850000 GHz</p> <p>Stop Freq 1.85450000 GHz</p> <p>CF Step 600.000000 kHz Auto Man</p> <p>Freq Offset 0.00000000 Hz</p> <p>Signal Track On Off</p> <p>Ref 20 dBm Atten 30 dB</p> <p>#Peak Log 10 dB/Offst 4.3 dB</p> <p>Center 1.851 500 GHz Span 6 MHz</p> <p>#Res BW 33 kHz #VBW 33 kHz Sweep 6.68 ms (601 pts)</p> <p><b>Occupied Bandwidth 2.6837 MHz</b></p> <p>Occ BW % Pwr 99.00 %</p> <p>x dB -26.00 dB</p> <p>Transmit Freq Error 1.814 kHz</p> <p>x dB Bandwidth 2.987 MHz</p> <p>Copyright 2000-2006 Agilent Technologies</p>
1880.0 MHz	<p>Agilent R T Freq/Channel</p> <p>Ch Freq 1.88 GHz Trig Free</p> <p>Center Freq 1.88000000 GHz</p> <p>Start Freq 1.87700000 GHz</p> <p>Stop Freq 1.88300000 GHz</p> <p>CF Step 600.000000 kHz Auto Man</p> <p>Freq Offset 0.00000000 Hz</p> <p>Signal Track On Off</p> <p>Ref 20 dBm Atten 30 dB</p> <p>#Peak Log 10 dB/Offst 4.3 dB</p> <p>Center 1.880 000 GHz Span 6 MHz</p> <p>#Res BW 33 kHz #VBW 33 kHz Sweep 6.68 ms (601 pts)</p> <p><b>Occupied Bandwidth 2.6904 MHz</b></p> <p>Occ BW % Pwr 99.00 %</p> <p>x dB -26.00 dB</p> <p>Transmit Freq Error 1.145 kHz</p> <p>x dB Bandwidth 2.977 MHz</p> <p>Copyright 2000-2006 Agilent Technologies</p>
1908.5 MHz	<p>Agilent R T Freq/Channel</p> <p>Ch Freq 1.9085 GHz Trig Free</p> <p>Center Freq 1.90850000 GHz</p> <p>Start Freq 1.90550000 GHz</p> <p>Stop Freq 1.91150000 GHz</p> <p>CF Step 600.000000 kHz Auto Man</p> <p>Freq Offset 0.00000000 Hz</p> <p>Signal Track On Off</p> <p>Ref 20 dBm Atten 30 dB</p> <p>#Peak Log 10 dB/Offst 4.3 dB</p> <p>Center 1.908 500 GHz Span 6 MHz</p> <p>#Res BW 33 kHz #VBW 33 kHz Sweep 6.68 ms (601 pts)</p> <p><b>Occupied Bandwidth 2.6868 MHz</b></p> <p>Occ BW % Pwr 99.00 %</p> <p>x dB -26.00 dB</p> <p>Transmit Freq Error 3.385 kHz</p> <p>x dB Bandwidth 3.023 MHz</p> <p>Copyright 2000-2006 Agilent Technologies</p>

LTE Band 2 (Channel Bandwidth: 5 MHz) _ QPSK	
1852.5 MHz	<p>Agilent R T Freq/Channel</p> <p>Ch Freq 1.8525 GHz Trig Free</p> <p>Center Freq 1.85250000 GHz</p> <p>Start Freq 1.84750000 GHz</p> <p>Stop Freq 1.85750000 GHz</p> <p>CF Step 1.00000000 MHz</p> <p>Freq Offset 0.00000000 Hz</p> <p>Signal Track On Off</p> <p>Ref 20 dBm Atten 30 dB</p> <p>#Peak Log 10 dB/Offst 4.3 dB</p> <p>Center 1.852 50 GHz Span 10 MHz</p> <p>#Res BW 51 kHz #VBW 51 kHz Sweep 4.64 ms (601 pts)</p> <p><b>Occupied Bandwidth 4.4694 MHz</b></p> <p>Occ BW % Pwr 99.00 %</p> <p>x dB -26.00 dB</p> <p>Transmit Freq Error 8.642 kHz</p> <p>x dB Bandwidth 4.938 MHz</p> <p>Copyright 2000-2006 Agilent Technologies</p>
1880.0 MHz	<p>Agilent R T Freq/Channel</p> <p>Ch Freq 1.88 GHz Trig Free</p> <p>Center Freq 1.88000000 GHz</p> <p>Start Freq 1.87500000 GHz</p> <p>Stop Freq 1.88500000 GHz</p> <p>CF Step 1.00000000 MHz</p> <p>Freq Offset 0.00000000 Hz</p> <p>Signal Track On Off</p> <p>Ref 20 dBm Atten 30 dB</p> <p>#Peak Log 10 dB/Offst 4.3 dB</p> <p>Center 1.880 00 GHz Span 10 MHz</p> <p>#Res BW 51 kHz #VBW 51 kHz Sweep 4.64 ms (601 pts)</p> <p><b>Occupied Bandwidth 4.4648 MHz</b></p> <p>Occ BW % Pwr 99.00 %</p> <p>x dB -26.00 dB</p> <p>Transmit Freq Error -64.368 Hz</p> <p>x dB Bandwidth 4.925 MHz</p> <p>Copyright 2000-2006 Agilent Technologies</p>
1907.5 MHz	<p>Agilent R T Freq/Channel</p> <p>Ch Freq 1.9075 GHz Trig Free</p> <p>Center Freq 1.90750000 GHz</p> <p>Start Freq 1.90250000 GHz</p> <p>Stop Freq 1.91250000 GHz</p> <p>CF Step 1.00000000 MHz</p> <p>Freq Offset 0.00000000 Hz</p> <p>Signal Track On Off</p> <p>Ref 20 dBm Atten 30 dB</p> <p>#Peak Log 10 dB/Offst 4.3 dB</p> <p>Center 1.907 50 GHz Span 10 MHz</p> <p>#Res BW 51 kHz #VBW 51 kHz Sweep 4.64 ms (601 pts)</p> <p><b>Occupied Bandwidth 4.4651 MHz</b></p> <p>Occ BW % Pwr 99.00 %</p> <p>x dB -26.00 dB</p> <p>Transmit Freq Error 5.709 kHz</p> <p>x dB Bandwidth 4.897 MHz</p> <p>Copyright 2000-2006 Agilent Technologies</p>

LTE Band 2 (Channel Bandwidth: 10 MHz) _ QPSK	
1855.0 MHz	<p>Agilent R T Freq/Channel</p> <p>Ch Freq 1.855 GHz Trig Free</p> <p>Center Freq 1.85500000 GHz</p> <p>Start Freq 1.84500000 GHz</p> <p>Stop Freq 1.86500000 GHz</p> <p>CF Step 2.00000000 MHz</p> <p>Freq Offset 0.00000000 Hz</p> <p>Signal Track On Off</p> <p>Ref 20 dBm Atten 30 dB</p> <p>#Peak Log 10 dB/Offst 4.3 dB</p> <p>Center 1.855 00 GHz Span 20 MHz</p> <p>#Res BW 110 kHz #VBW 110 kHz Sweep 2 ms (601 pts)</p> <p><b>Occupied Bandwidth 8.9497 MHz</b></p> <p>Occ BW % Pwr 99.00 %</p> <p>x dB -26.00 dB</p> <p>Transmit Freq Error 3.346 kHz</p> <p>x dB Bandwidth 9.764 MHz</p> <p>Copyright 2000-2006 Agilent Technologies</p>
1880.0 MHz	<p>Agilent R T Freq/Channel</p> <p>Ch Freq 1.88 GHz Trig Free</p> <p>Center Freq 1.88000000 GHz</p> <p>Start Freq 1.87000000 GHz</p> <p>Stop Freq 1.89000000 GHz</p> <p>CF Step 2.00000000 MHz</p> <p>Freq Offset 0.00000000 Hz</p> <p>Signal Track On Off</p> <p>Ref 20 dBm Atten 30 dB</p> <p>#Peak Log 10 dB/Offst 4.3 dB</p> <p>Center 1.880 00 GHz Span 20 MHz</p> <p>#Res BW 110 kHz #VBW 110 kHz Sweep 2 ms (601 pts)</p> <p><b>Occupied Bandwidth 8.9558 MHz</b></p> <p>Occ BW % Pwr 99.00 %</p> <p>x dB -26.00 dB</p> <p>Transmit Freq Error 3.399 kHz</p> <p>x dB Bandwidth 9.708 MHz</p> <p>Copyright 2000-2006 Agilent Technologies</p>
1905.0 MHz	<p>Agilent R T Freq/Channel</p> <p>Ch Freq 1.905 GHz Trig Free</p> <p>Center Freq 1.90500000 GHz</p> <p>Start Freq 1.89500000 GHz</p> <p>Stop Freq 1.91500000 GHz</p> <p>CF Step 2.00000000 MHz</p> <p>Freq Offset 0.00000000 Hz</p> <p>Signal Track On Off</p> <p>Ref 20 dBm Atten 30 dB</p> <p>#Peak Log 10 dB/Offst 4.3 dB</p> <p>Center 1.905 00 GHz Span 20 MHz</p> <p>#Res BW 110 kHz #VBW 110 kHz Sweep 2 ms (601 pts)</p> <p><b>Occupied Bandwidth 8.9535 MHz</b></p> <p>Occ BW % Pwr 99.00 %</p> <p>x dB -26.00 dB</p> <p>Transmit Freq Error 57.003 Hz</p> <p>x dB Bandwidth 9.736 MHz</p> <p>Copyright 2000-2006 Agilent Technologies</p>

LTE Band 2 (Channel Bandwidth: 15 MHz) _ QPSK	
1857.5 MHz	<p>Agilent R T Freq/Channel</p> <p>Ch Freq 1.8575 GHz Trig Free</p> <p>Center Freq 1.85750000 GHz</p> <p>Start Freq 1.84250000 GHz</p> <p>Stop Freq 1.87250000 GHz</p> <p>CF Step 3.00000000 MHz Auto Man</p> <p>Freq Offset 0.00000000 Hz</p> <p>Signal Track On Off</p> <p>Ref 20 dBm Atten 30 dB</p> <p>#Peak Log 10 dB/Offst 4.3 dB</p> <p>Center 1.857 50 GHz Span 30 MHz</p> <p>#Res BW 160 kHz #VBW 160 kHz Sweep 1.44 ms (601 pts)</p> <p><b>Occupied Bandwidth 13.3763 MHz</b></p> <p>Occ BW % Pwr 99.00 % x dB -26.00 dB</p> <p>Transmit Freq Error 2.284 kHz</p> <p>x dB Bandwidth 14.365 MHz</p> <p>Copyright 2000-2006 Agilent Technologies</p>
1880.0 MHz	<p>Agilent R T Freq/Channel</p> <p>Ch Freq 1.88 GHz Trig Free</p> <p>Center Freq 1.88000000 GHz</p> <p>Start Freq 1.86500000 GHz</p> <p>Stop Freq 1.89500000 GHz</p> <p>CF Step 3.00000000 MHz Auto Man</p> <p>Freq Offset 0.00000000 Hz</p> <p>Signal Track On Off</p> <p>Ref 20 dBm Atten 30 dB</p> <p>#Peak Log 10 dB/Offst 4.3 dB</p> <p>Center 1.880 00 GHz Span 30 MHz</p> <p>#Res BW 160 kHz #VBW 160 kHz Sweep 1.44 ms (601 pts)</p> <p><b>Occupied Bandwidth 13.4391 MHz</b></p> <p>Occ BW % Pwr 99.00 % x dB -26.00 dB</p> <p>Transmit Freq Error 37.414 kHz</p> <p>x dB Bandwidth 14.384 MHz</p> <p>Copyright 2000-2006 Agilent Technologies</p>
1902.5 MHz	<p>Agilent R T Freq/Channel</p> <p>Ch Freq 1.9025 GHz Trig Free</p> <p>Center Freq 1.90250000 GHz</p> <p>Start Freq 1.88750000 GHz</p> <p>Stop Freq 1.91750000 GHz</p> <p>CF Step 3.00000000 MHz Auto Man</p> <p>Freq Offset 0.00000000 Hz</p> <p>Signal Track On Off</p> <p>Ref 20 dBm Atten 30 dB</p> <p>#Peak Log 10 dB/Offst 4.3 dB</p> <p>Center 1.902 50 GHz Span 30 MHz</p> <p>#Res BW 160 kHz #VBW 160 kHz Sweep 1.44 ms (601 pts)</p> <p><b>Occupied Bandwidth 13.4164 MHz</b></p> <p>Occ BW % Pwr 99.00 % x dB -26.00 dB</p> <p>Transmit Freq Error -3.038 kHz</p> <p>x dB Bandwidth 14.588 MHz</p> <p>Copyright 2000-2006 Agilent Technologies</p>

LTE Band 2 (Channel Bandwidth: 20 MHz) _ QPSK	
1860.0 MHz	<p>Agilent R T Freq/Channel</p> <p>Ch Freq 1.86 GHz Trig Free</p> <p>Center Freq 1.8600000 GHz</p> <p>Start Freq 1.8400000 GHz</p> <p>Stop Freq 1.8800000 GHz</p> <p>CF Step 4.0000000 MHz Auto Man</p> <p>Freq Offset 0.0000000 Hz</p> <p>Signal Track On Off</p> <p>Ref 20 dBm Atten 30 dB</p> <p>#Peak Log 10 dB/Offst 4.3 dB</p> <p>Center 1.860 00 GHz Span 40 MHz</p> <p>#Res BW 220 kHz #VBW 220 kHz Sweep 1 ms (601 pts)</p> <p><b>Occupied Bandwidth 17.8356 MHz</b></p> <p>Occ BW % Pwr 99.00 % x dB -26.00 dB</p> <p>Transmit Freq Error -4.434 kHz</p> <p>x dB Bandwidth 19.173 MHz</p> <p>Copyright 2000-2006 Agilent Technologies</p>
1880.0 MHz	<p>Agilent R T Freq/Channel</p> <p>Ch Freq 1.88 GHz Trig Free</p> <p>Center Freq 1.8800000 GHz</p> <p>Start Freq 1.8600000 GHz</p> <p>Stop Freq 1.9000000 GHz</p> <p>CF Step 4.0000000 MHz Auto Man</p> <p>Freq Offset 0.0000000 Hz</p> <p>Signal Track On Off</p> <p>Ref 20 dBm Atten 30 dB</p> <p>#Peak Log 10 dB/Offst 4.3 dB</p> <p>Center 1.880 00 GHz Span 40 MHz</p> <p>#Res BW 220 kHz #VBW 220 kHz Sweep 1 ms (601 pts)</p> <p><b>Occupied Bandwidth 17.8655 MHz</b></p> <p>Occ BW % Pwr 99.00 % x dB -26.00 dB</p> <p>Transmit Freq Error 35.147 kHz</p> <p>x dB Bandwidth 19.272 MHz</p> <p>Copyright 2000-2006 Agilent Technologies</p>
1900.0 MHz	<p>Agilent R T Freq/Channel</p> <p>Ch Freq 1.9 GHz Trig Free</p> <p>Center Freq 1.9000000 GHz</p> <p>Start Freq 1.8800000 GHz</p> <p>Stop Freq 1.9200000 GHz</p> <p>CF Step 4.0000000 MHz Auto Man</p> <p>Freq Offset 0.0000000 Hz</p> <p>Signal Track On Off</p> <p>Ref 20 dBm Atten 30 dB</p> <p>#Peak Log 10 dB/Offst 4.3 dB</p> <p>Center 1.900 00 GHz Span 40 MHz</p> <p>#Res BW 220 kHz #VBW 220 kHz Sweep 1 ms (601 pts)</p> <p><b>Occupied Bandwidth 17.8813 MHz</b></p> <p>Occ BW % Pwr 99.00 % x dB -26.00 dB</p> <p>Transmit Freq Error -4.209 kHz</p> <p>x dB Bandwidth 19.381 MHz</p> <p>Copyright 2000-2006 Agilent Technologies</p>

LTE Band 2 (Channel Bandwidth: 1.4 MHz) _ 16QAM	
1850.7 MHz	<p>Agilent R T Freq/Channel</p> <p>Ch Freq 1.8507 GHz Trig Free</p> <p>Center Freq 1.85070000 GHz</p> <p>Start Freq 1.84920000 GHz</p> <p>Stop Freq 1.85220000 GHz</p> <p>CF Step 300.000000 kHz Auto Man</p> <p>Freq Offset 0.00000000 Hz</p> <p>Signal Track On Off</p> <p>Ref 20 dBm Atten 30 dB</p> <p>#Peak Log 10 dB/Offst 4.3 dB</p> <p>Center 1.850 700 GHz Span 3 MHz</p> <p>#Res BW 15 kHz #VBW 15 kHz Sweep 16.08 ms (601 pts)</p> <p><b>Occupied Bandwidth 1.0819 MHz</b></p> <p>Occ BW % Pwr 99.00 %</p> <p>x dB -26.00 dB</p> <p>Transmit Freq Error 223.314 Hz</p> <p>x dB Bandwidth 1.283 MHz</p> <p>Copyright 2000-2006 Agilent Technologies</p>
1880.0 MHz	<p>Agilent R T Freq/Channel</p> <p>Ch Freq 1.88 GHz Trig Free</p> <p>Center Freq 1.88000000 GHz</p> <p>Start Freq 1.87850000 GHz</p> <p>Stop Freq 1.88150000 GHz</p> <p>CF Step 300.000000 kHz Auto Man</p> <p>Freq Offset 0.00000000 Hz</p> <p>Signal Track On Off</p> <p>Ref 20 dBm Atten 30 dB</p> <p>#Peak Log 10 dB/Offst 4.3 dB</p> <p>Center 1.880 000 GHz Span 3 MHz</p> <p>#Res BW 15 kHz #VBW 15 kHz Sweep 16.08 ms (601 pts)</p> <p><b>Occupied Bandwidth 1.0899 MHz</b></p> <p>Occ BW % Pwr 99.00 %</p> <p>x dB -26.00 dB</p> <p>Transmit Freq Error 320.824 Hz</p> <p>x dB Bandwidth 1.287 MHz</p> <p>Copyright 2000-2006 Agilent Technologies</p>
1909.3 MHz	<p>Agilent R T Freq/Channel</p> <p>Ch Freq 1.9093 GHz Trig Free</p> <p>Center Freq 1.90930000 GHz</p> <p>Start Freq 1.90780000 GHz</p> <p>Stop Freq 1.91080000 GHz</p> <p>CF Step 300.000000 kHz Auto Man</p> <p>Freq Offset 0.00000000 Hz</p> <p>Signal Track On Off</p> <p>Ref 20 dBm Atten 30 dB</p> <p>#Peak Log 10 dB/Offst 4.3 dB</p> <p>Center 1.909 300 GHz Span 3 MHz</p> <p>#Res BW 15 kHz #VBW 15 kHz Sweep 16.08 ms (601 pts)</p> <p><b>Occupied Bandwidth 1.0840 MHz</b></p> <p>Occ BW % Pwr 99.00 %</p> <p>x dB -26.00 dB</p> <p>Transmit Freq Error 763.667 Hz</p> <p>x dB Bandwidth 1.318 MHz</p> <p>Copyright 2000-2006 Agilent Technologies</p>

LTE Band 2 (Channel Bandwidth: 3 MHz) _ 16QAM	
<p>1851.5 MHz</p>	<p>Agilent R T Freq/Channel</p> <p>Ch Freq 1.8515 GHz Trig Free</p> <p>Center Freq 1.85150000 GHz</p> <p>Start Freq 1.84850000 GHz</p> <p>Stop Freq 1.85450000 GHz</p> <p>CF Step 600.000000 kHz Auto Man</p> <p>Freq Offset 0.00000000 Hz</p> <p>Signal Track On Off</p> <p>Ref 20 dBm Atten 30 dB</p> <p>#Peak Log 10 dB/Offst 4.3 dB</p> <p>Center 1.851 500 GHz Span 6 MHz</p> <p>#Res BW 33 kHz #VBW 33 kHz Sweep 6.68 ms (601 pts)</p> <p><b>Occupied Bandwidth 2.6835 MHz</b></p> <p>Occ BW % Pwr 99.00 %</p> <p>x dB -26.00 dB</p> <p>Transmit Freq Error 2.389 kHz</p> <p>x dB Bandwidth 2.987 MHz</p> <p>Copyright 2000-2006 Agilent Technologies</p>
<p>1880.0 MHz</p>	<p>Agilent R T Freq/Channel</p> <p>Ch Freq 1.88 GHz Trig Free</p> <p>Center Freq 1.88000000 GHz</p> <p>Start Freq 1.87700000 GHz</p> <p>Stop Freq 1.88300000 GHz</p> <p>CF Step 600.000000 kHz Auto Man</p> <p>Freq Offset 0.00000000 Hz</p> <p>Signal Track On Off</p> <p>Ref 20 dBm Atten 30 dB</p> <p>#Peak Log 10 dB/Offst 4.3 dB</p> <p>Center 1.880 000 GHz Span 6 MHz</p> <p>#Res BW 33 kHz #VBW 33 kHz Sweep 6.68 ms (601 pts)</p> <p><b>Occupied Bandwidth 2.6886 MHz</b></p> <p>Occ BW % Pwr 99.00 %</p> <p>x dB -26.00 dB</p> <p>Transmit Freq Error 1.142 kHz</p> <p>x dB Bandwidth 2.994 MHz</p> <p>Copyright 2000-2006 Agilent Technologies</p>
<p>1908.5 MHz</p>	<p>Agilent R T Freq/Channel</p> <p>Ch Freq 1.9085 GHz Trig Free</p> <p>Center Freq 1.90850000 GHz</p> <p>Start Freq 1.90550000 GHz</p> <p>Stop Freq 1.91150000 GHz</p> <p>CF Step 600.000000 kHz Auto Man</p> <p>Freq Offset 0.00000000 Hz</p> <p>Signal Track On Off</p> <p>Ref 20 dBm Atten 30 dB</p> <p>#Peak Log 10 dB/Offst 4.3 dB</p> <p>Center 1.908 500 GHz Span 6 MHz</p> <p>#Res BW 33 kHz #VBW 33 kHz Sweep 6.68 ms (601 pts)</p> <p><b>Occupied Bandwidth 2.6788 MHz</b></p> <p>Occ BW % Pwr 99.00 %</p> <p>x dB -26.00 dB</p> <p>Transmit Freq Error 1.176 kHz</p> <p>x dB Bandwidth 3.078 MHz</p> <p>Copyright 2000-2006 Agilent Technologies</p>

LTE Band 2 (Channel Bandwidth: 5 MHz) _ 16QAM	
<p>1852.5 MHz</p>	<p>Agilent R T Freq/Channel</p> <p>Ch Freq 1.8525 GHz Trig Free</p> <p>Center Freq 1.85250000 GHz</p> <p>Start Freq 1.84750000 GHz</p> <p>Stop Freq 1.85750000 GHz</p> <p>CF Step 1.00000000 MHz</p> <p>Freq Offset 0.00000000 Hz</p> <p>Signal Track On Off</p> <p>Ref 20 dBm Atten 30 dB</p> <p>#Peak Log 10 dB/Offst 4.3 dB</p> <p>Center 1.852 50 GHz Span 10 MHz</p> <p>#Res BW 51 kHz #VBW 51 kHz Sweep 4.64 ms (601 pts)</p> <p><b>Occupied Bandwidth 4.4642 MHz</b></p> <p>Occ BW % Pwr 99.00 %</p> <p>x dB -26.00 dB</p> <p>Transmit Freq Error 5.539 kHz</p> <p>x dB Bandwidth 4.935 MHz</p> <p>Copyright 2000-2006 Agilent Technologies</p>
<p>1880.0 MHz</p>	<p>Agilent R T Freq/Channel</p> <p>Ch Freq 1.88 GHz Trig Free</p> <p>Center Freq 1.88000000 GHz</p> <p>Start Freq 1.87500000 GHz</p> <p>Stop Freq 1.88500000 GHz</p> <p>CF Step 1.00000000 MHz</p> <p>Freq Offset 0.00000000 Hz</p> <p>Signal Track On Off</p> <p>Ref 20 dBm Atten 30 dB</p> <p>#Peak Log 10 dB/Offst 4.3 dB</p> <p>Center 1.880 00 GHz Span 10 MHz</p> <p>#Res BW 51 kHz #VBW 51 kHz Sweep 4.64 ms (601 pts)</p> <p><b>Occupied Bandwidth 4.4727 MHz</b></p> <p>Occ BW % Pwr 99.00 %</p> <p>x dB -26.00 dB</p> <p>Transmit Freq Error 3.819 kHz</p> <p>x dB Bandwidth 4.994 MHz</p> <p>Copyright 2000-2006 Agilent Technologies</p>
<p>1907.5 MHz</p>	<p>Agilent R T Freq/Channel</p> <p>Ch Freq 1.9075 GHz Trig Free</p> <p>Center Freq 1.90750000 GHz</p> <p>Start Freq 1.90250000 GHz</p> <p>Stop Freq 1.91250000 GHz</p> <p>CF Step 1.00000000 MHz</p> <p>Freq Offset 0.00000000 Hz</p> <p>Signal Track On Off</p> <p>Ref 20 dBm Atten 30 dB</p> <p>#Peak Log 10 dB/Offst 4.3 dB</p> <p>Center 1.907 50 GHz Span 10 MHz</p> <p>#Res BW 51 kHz #VBW 51 kHz Sweep 4.64 ms (601 pts)</p> <p><b>Occupied Bandwidth 4.4603 MHz</b></p> <p>Occ BW % Pwr 99.00 %</p> <p>x dB -26.00 dB</p> <p>Transmit Freq Error 7.286 kHz</p> <p>x dB Bandwidth 4.893 MHz</p> <p>Copyright 2000-2006 Agilent Technologies</p>



LTE Band 2 (Channel Bandwidth: 10 MHz) _ 16QAM	
1855.0 MHz	<p>Agilent R T Freq/Channel</p> <p>Ch Freq 1.855 GHz Trig Free</p> <p>Center Freq 1.8550000 GHz</p> <p>Start Freq 1.8450000 GHz</p> <p>Stop Freq 1.8650000 GHz</p> <p>CF Step 2.0000000 MHz</p> <p>Freq Offset 0.0000000 Hz</p> <p>Signal Track On Off</p> <p>Ref 20 dBm Atten 30 dB</p> <p>#Peak Log 10 dB/Offst 4.3 dB</p> <p>Center 1.855 00 GHz Span 20 MHz</p> <p>#Res BW 110 kHz #VBW 110 kHz Sweep 2 ms (601 pts)</p> <p><b>Occupied Bandwidth 8.9478 MHz</b></p> <p>Occ BW % Pwr 99.00 %</p> <p>x dB -26.00 dB</p> <p>Transmit Freq Error 1.500 kHz</p> <p>x dB Bandwidth 9.770 MHz</p> <p>Copyright 2000-2006 Agilent Technologies</p>
1880.0 MHz	<p>Agilent R T Freq/Channel</p> <p>Ch Freq 1.88 GHz Trig Free</p> <p>Center Freq 1.8800000 GHz</p> <p>Start Freq 1.8700000 GHz</p> <p>Stop Freq 1.8900000 GHz</p> <p>CF Step 2.0000000 MHz</p> <p>Freq Offset 0.0000000 Hz</p> <p>Signal Track On Off</p> <p>Ref 20 dBm Atten 30 dB</p> <p>#Peak Log 10 dB/Offst 4.3 dB</p> <p>Center 1.880 00 GHz Span 20 MHz</p> <p>#Res BW 110 kHz #VBW 110 kHz Sweep 2 ms (601 pts)</p> <p><b>Occupied Bandwidth 8.9572 MHz</b></p> <p>Occ BW % Pwr 99.00 %</p> <p>x dB -26.00 dB</p> <p>Transmit Freq Error 5.782 kHz</p> <p>x dB Bandwidth 9.752 MHz</p> <p>Copyright 2000-2006 Agilent Technologies</p>
1905.0 MHz	<p>Agilent R T Freq/Channel</p> <p>Ch Freq 1.905 GHz Trig Free</p> <p>Center Freq 1.9050000 GHz</p> <p>Start Freq 1.8950000 GHz</p> <p>Stop Freq 1.9150000 GHz</p> <p>CF Step 2.0000000 MHz</p> <p>Freq Offset 0.0000000 Hz</p> <p>Signal Track On Off</p> <p>Ref 20 dBm Atten 30 dB</p> <p>#Peak Log 10 dB/Offst 4.3 dB</p> <p>Center 1.905 00 GHz Span 20 MHz</p> <p>#Res BW 110 kHz #VBW 110 kHz Sweep 2 ms (601 pts)</p> <p><b>Occupied Bandwidth 8.9533 MHz</b></p> <p>Occ BW % Pwr 99.00 %</p> <p>x dB -26.00 dB</p> <p>Transmit Freq Error -2.191 kHz</p> <p>x dB Bandwidth 9.592 MHz</p> <p>Copyright 2000-2006 Agilent Technologies</p>

LTE Band 2 (Channel Bandwidth: 15 MHz) _ 16QAM	
1857.5 MHz	<p>Agilent R T Freq/Channel</p> <p>Ch Freq 1.8575 GHz Trig Free</p> <p>Center Freq 1.85750000 GHz</p> <p>Start Freq 1.84250000 GHz</p> <p>Stop Freq 1.87250000 GHz</p> <p>CF Step 3.00000000 MHz Auto Man</p> <p>Freq Offset 0.00000000 Hz</p> <p>Signal Track On Off</p> <p>Ref 20 dBm Atten 30 dB</p> <p>#Peak Log 10 dB/Offst 4.3 dB</p> <p>Center 1.857 50 GHz Span 30 MHz</p> <p>#Res BW 160 kHz #VBW 160 kHz Sweep 1.44 ms (601 pts)</p> <p><b>Occupied Bandwidth 13.4040 MHz</b></p> <p>Occ BW % Pwr 99.00 %</p> <p>x dB -26.00 dB</p> <p>Transmit Freq Error 1.924 kHz</p> <p>x dB Bandwidth 14.284 MHz</p> <p>Copyright 2000-2006 Agilent Technologies</p>
1880.0 MHz	<p>Agilent R T Freq/Channel</p> <p>Ch Freq 1.88 GHz Trig Free</p> <p>Center Freq 1.88000000 GHz</p> <p>Start Freq 1.86500000 GHz</p> <p>Stop Freq 1.89500000 GHz</p> <p>CF Step 3.00000000 MHz Auto Man</p> <p>Freq Offset 0.00000000 Hz</p> <p>Signal Track On Off</p> <p>Ref 20 dBm Atten 30 dB</p> <p>#Peak Log 10 dB/Offst 4.3 dB</p> <p>Center 1.880 00 GHz Span 30 MHz</p> <p>#Res BW 160 kHz #VBW 160 kHz Sweep 1.44 ms (601 pts)</p> <p><b>Occupied Bandwidth 13.4245 MHz</b></p> <p>Occ BW % Pwr 99.00 %</p> <p>x dB -26.00 dB</p> <p>Transmit Freq Error 37.239 kHz</p> <p>x dB Bandwidth 14.438 MHz</p> <p>Copyright 2000-2006 Agilent Technologies</p>
1902.5 MHz	<p>Agilent R T Freq/Channel</p> <p>Ch Freq 1.9025 GHz Trig Free</p> <p>Center Freq 1.90250000 GHz</p> <p>Start Freq 1.88750000 GHz</p> <p>Stop Freq 1.91750000 GHz</p> <p>CF Step 3.00000000 MHz Auto Man</p> <p>Freq Offset 0.00000000 Hz</p> <p>Signal Track On Off</p> <p>Ref 20 dBm Atten 30 dB</p> <p>#Peak Log 10 dB/Offst 4.3 dB</p> <p>Center 1.902 50 GHz Span 30 MHz</p> <p>#Res BW 160 kHz #VBW 160 kHz Sweep 1.44 ms (601 pts)</p> <p><b>Occupied Bandwidth 13.4076 MHz</b></p> <p>Occ BW % Pwr 99.00 %</p> <p>x dB -26.00 dB</p> <p>Transmit Freq Error 4.610 kHz</p> <p>x dB Bandwidth 14.370 MHz</p> <p>Copyright 2000-2006 Agilent Technologies</p>

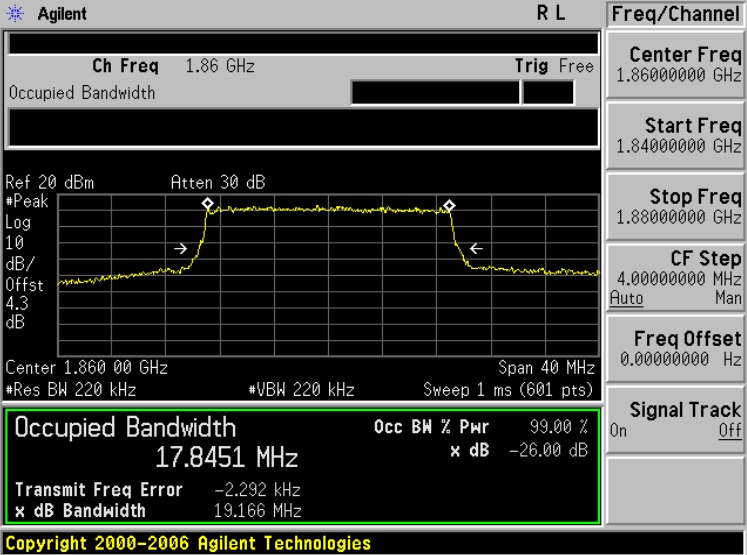
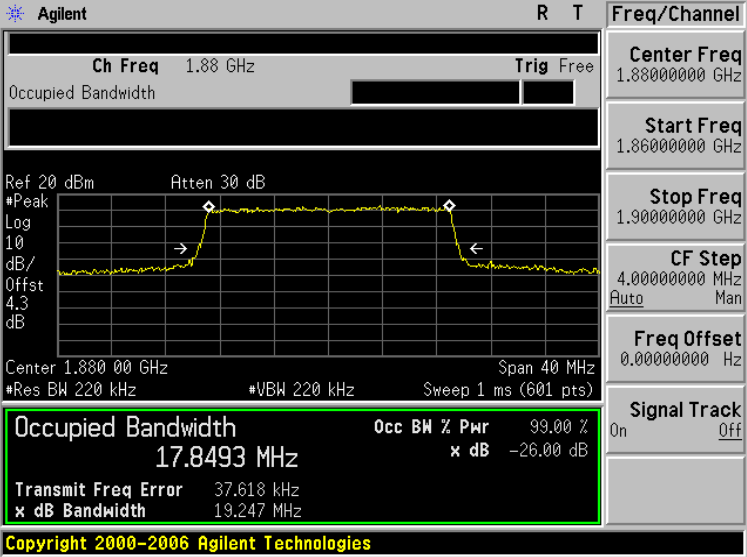
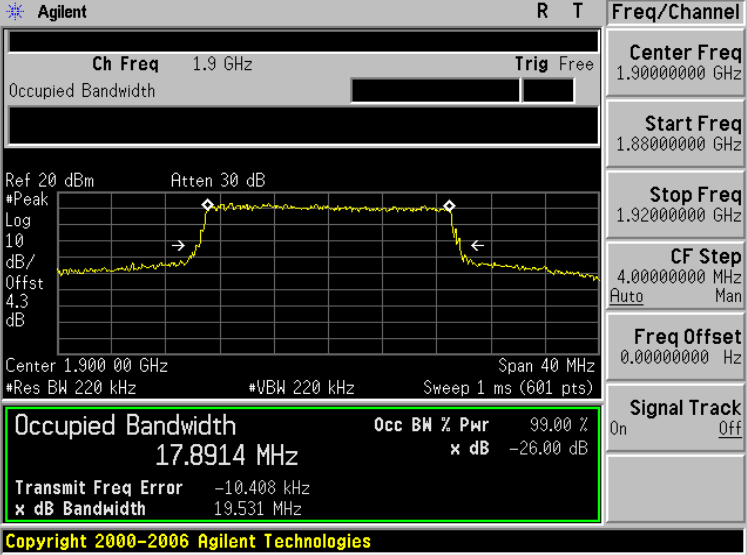
LTE Band 2 (Channel Bandwidth: 20 MHz) _ 16QAM	
1860.0 MHz	 <p>Agilent R L Freq/Channel</p> <p>Ch Freq 1.86 GHz Trig Free</p> <p>Center Freq 1.8600000 GHz</p> <p>Start Freq 1.8400000 GHz</p> <p>Stop Freq 1.8800000 GHz</p> <p>CF Step 4.0000000 MHz</p> <p>Freq Offset 0.0000000 Hz</p> <p>Signal Track On Off</p> <p>Ref 20 dBm Atten 30 dB</p> <p>#Peak Log 10 dB/Offst 4.3 dB</p> <p>Center 1.860 00 GHz Span 40 MHz</p> <p>#Res BW 220 kHz #VBW 220 kHz Sweep 1 ms (601 pts)</p> <p><b>Occupied Bandwidth 17.8451 MHz</b></p> <p>Occ BW % Pwr 99.00 %</p> <p>x dB -26.00 dB</p> <p>Transmit Freq Error -2.292 kHz</p> <p>x dB Bandwidth 19.166 MHz</p> <p>Copyright 2000-2006 Agilent Technologies</p>
1880.0 MHz	 <p>Agilent R T Freq/Channel</p> <p>Ch Freq 1.88 GHz Trig Free</p> <p>Center Freq 1.8800000 GHz</p> <p>Start Freq 1.8600000 GHz</p> <p>Stop Freq 1.9000000 GHz</p> <p>CF Step 4.0000000 MHz</p> <p>Freq Offset 0.0000000 Hz</p> <p>Signal Track On Off</p> <p>Ref 20 dBm Atten 30 dB</p> <p>#Peak Log 10 dB/Offst 4.3 dB</p> <p>Center 1.880 00 GHz Span 40 MHz</p> <p>#Res BW 220 kHz #VBW 220 kHz Sweep 1 ms (601 pts)</p> <p><b>Occupied Bandwidth 17.8493 MHz</b></p> <p>Occ BW % Pwr 99.00 %</p> <p>x dB -26.00 dB</p> <p>Transmit Freq Error 37.618 kHz</p> <p>x dB Bandwidth 19.247 MHz</p> <p>Copyright 2000-2006 Agilent Technologies</p>
1900.0 MHz	 <p>Agilent R T Freq/Channel</p> <p>Ch Freq 1.9 GHz Trig Free</p> <p>Center Freq 1.9000000 GHz</p> <p>Start Freq 1.8800000 GHz</p> <p>Stop Freq 1.9200000 GHz</p> <p>CF Step 4.0000000 MHz</p> <p>Freq Offset 0.0000000 Hz</p> <p>Signal Track On Off</p> <p>Ref 20 dBm Atten 30 dB</p> <p>#Peak Log 10 dB/Offst 4.3 dB</p> <p>Center 1.900 00 GHz Span 40 MHz</p> <p>#Res BW 220 kHz #VBW 220 kHz Sweep 1 ms (601 pts)</p> <p><b>Occupied Bandwidth 17.8914 MHz</b></p> <p>Occ BW % Pwr 99.00 %</p> <p>x dB -26.00 dB</p> <p>Transmit Freq Error -10.408 kHz</p> <p>x dB Bandwidth 19.531 MHz</p> <p>Copyright 2000-2006 Agilent Technologies</p>

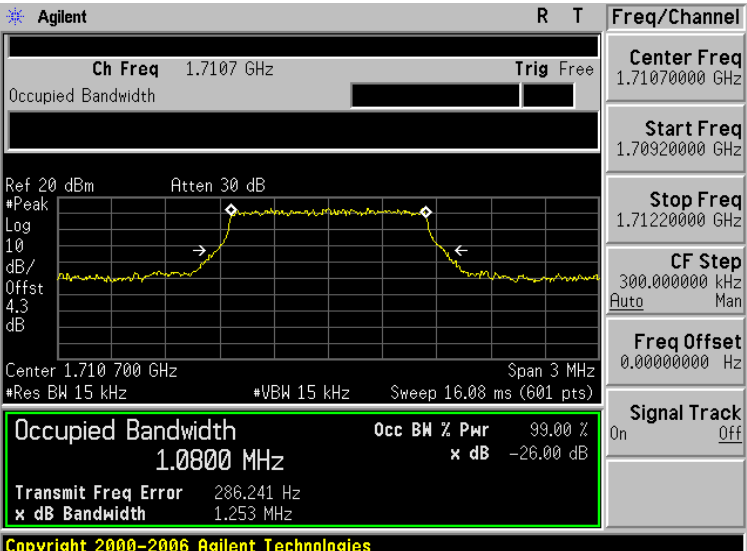
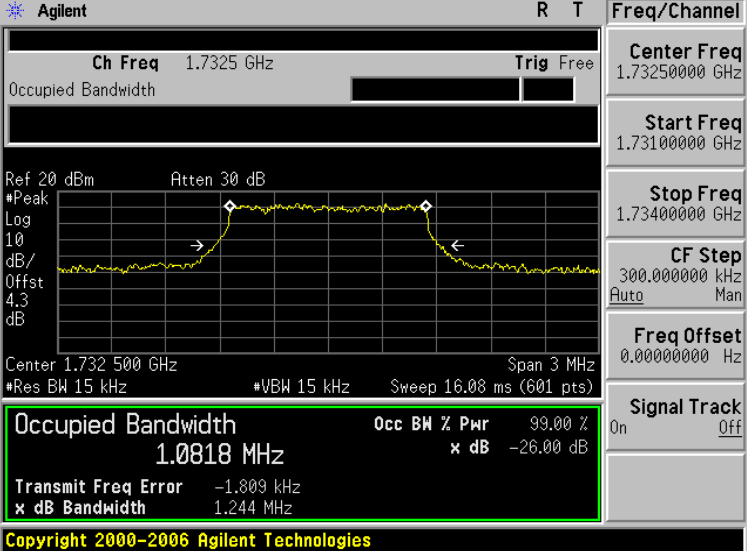
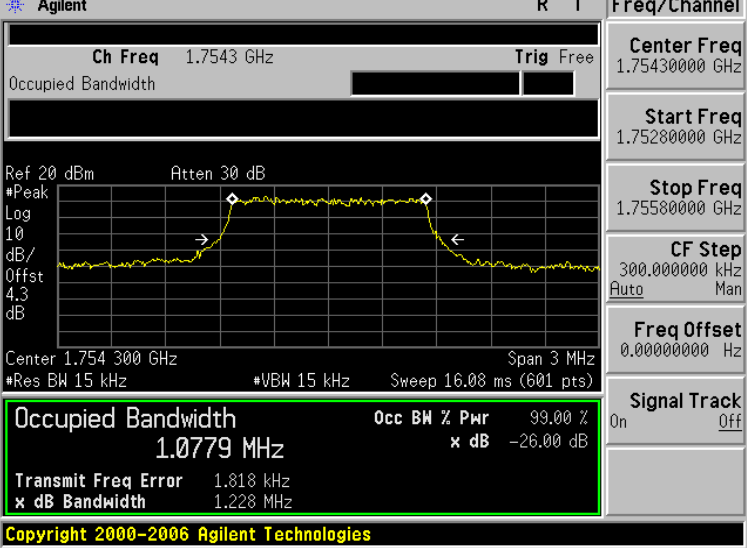
LTE Band 4 (Channel Bandwidth: 1.4 MHz) _ QPSK	
1710.7 MHz	 <p>Agilent R T Freq/Channel</p> <p>Ch Freq 1.7107 GHz Trig Free</p> <p>Center Freq 1.71070000 GHz</p> <p>Start Freq 1.70920000 GHz</p> <p>Stop Freq 1.71220000 GHz</p> <p>CF Step 300.000000 kHz Auto Man</p> <p>Freq Offset 0.00000000 Hz</p> <p>Signal Track On Off</p> <p>Ref 20 dBm Atten 30 dB</p> <p>#Peak Log 10 dB/Offst 4.3 dB</p> <p>Center 1.710 700 GHz Span 3 MHz</p> <p>#Res BW 15 kHz #VBW 15 kHz Sweep 16.08 ms (601 pts)</p> <p><b>Occupied Bandwidth 1.0800 MHz</b></p> <p>Occ BW % Pwr 99.00 %</p> <p>x dB -26.00 dB</p> <p>Transmit Freq Error 286.241 Hz</p> <p>x dB Bandwidth 1.253 MHz</p> <p>Copyright 2000-2006 Agilent Technologies</p>
1732.5 MHz	 <p>Agilent R T Freq/Channel</p> <p>Ch Freq 1.7325 GHz Trig Free</p> <p>Center Freq 1.73250000 GHz</p> <p>Start Freq 1.73100000 GHz</p> <p>Stop Freq 1.73400000 GHz</p> <p>CF Step 300.000000 kHz Auto Man</p> <p>Freq Offset 0.00000000 Hz</p> <p>Signal Track On Off</p> <p>Ref 20 dBm Atten 30 dB</p> <p>#Peak Log 10 dB/Offst 4.3 dB</p> <p>Center 1.732 500 GHz Span 3 MHz</p> <p>#Res BW 15 kHz #VBW 15 kHz Sweep 16.08 ms (601 pts)</p> <p><b>Occupied Bandwidth 1.0818 MHz</b></p> <p>Occ BW % Pwr 99.00 %</p> <p>x dB -26.00 dB</p> <p>Transmit Freq Error -1.809 kHz</p> <p>x dB Bandwidth 1.244 MHz</p> <p>Copyright 2000-2006 Agilent Technologies</p>
1754.3 MHz	 <p>Agilent R T Freq/Channel</p> <p>Ch Freq 1.7543 GHz Trig Free</p> <p>Center Freq 1.75430000 GHz</p> <p>Start Freq 1.75280000 GHz</p> <p>Stop Freq 1.75580000 GHz</p> <p>CF Step 300.000000 kHz Auto Man</p> <p>Freq Offset 0.00000000 Hz</p> <p>Signal Track On Off</p> <p>Ref 20 dBm Atten 30 dB</p> <p>#Peak Log 10 dB/Offst 4.3 dB</p> <p>Center 1.754 300 GHz Span 3 MHz</p> <p>#Res BW 15 kHz #VBW 15 kHz Sweep 16.08 ms (601 pts)</p> <p><b>Occupied Bandwidth 1.0779 MHz</b></p> <p>Occ BW % Pwr 99.00 %</p> <p>x dB -26.00 dB</p> <p>Transmit Freq Error 1.818 kHz</p> <p>x dB Bandwidth 1.228 MHz</p> <p>Copyright 2000-2006 Agilent Technologies</p>

LTE Band 4 (Channel Bandwidth: 3 MHz) _ QPSK	
1711.5 MHz	<p>Agilent R T Freq/Channel</p> <p>Ch Freq 1.7115 GHz Trig Free</p> <p>Center Freq 1.71150000 GHz</p> <p>Start Freq 1.70850000 GHz</p> <p>Stop Freq 1.71450000 GHz</p> <p>CF Step 600.000000 kHz Auto Man</p> <p>Freq Offset 0.00000000 Hz</p> <p>Signal Track On Off</p> <p>Ref 20 dBm Atten 30 dB</p> <p>#Peak Log 10 dB/Offst 4.3 dB</p> <p>Center 1.711 500 GHz Span 6 MHz</p> <p>#Res BW 33 kHz #VBW 33 kHz Sweep 6.68 ms (601 pts)</p> <p><b>Occupied Bandwidth 2.6913 MHz</b></p> <p>Occ BW % Pwr 99.00 %</p> <p>x dB -26.00 dB</p> <p>Transmit Freq Error 5.667 kHz</p> <p>x dB Bandwidth 2.966 MHz</p> <p>Copyright 2000-2006 Agilent Technologies</p>
1732.5 MHz	<p>Agilent R T Freq/Channel</p> <p>Ch Freq 1.7325 GHz Trig Free</p> <p>Center Freq 1.73250000 GHz</p> <p>Start Freq 1.72950000 GHz</p> <p>Stop Freq 1.73550000 GHz</p> <p>CF Step 600.000000 kHz Auto Man</p> <p>Freq Offset 0.00000000 Hz</p> <p>Signal Track On Off</p> <p>Ref 20 dBm Atten 30 dB</p> <p>#Peak Log 10 dB/Offst 4.3 dB</p> <p>Center 1.732 500 GHz Span 6 MHz</p> <p>#Res BW 33 kHz #VBW 33 kHz Sweep 6.68 ms (601 pts)</p> <p><b>Occupied Bandwidth 2.6877 MHz</b></p> <p>Occ BW % Pwr 99.00 %</p> <p>x dB -26.00 dB</p> <p>Transmit Freq Error -147.525 Hz</p> <p>x dB Bandwidth 2.959 MHz</p> <p>Copyright 2000-2006 Agilent Technologies</p>
1753.5 MHz	<p>Agilent R T Freq/Channel</p> <p>Ch Freq 1.7535 GHz Trig Free</p> <p>Center Freq 1.75350000 GHz</p> <p>Start Freq 1.75050000 GHz</p> <p>Stop Freq 1.75650000 GHz</p> <p>CF Step 600.000000 kHz Auto Man</p> <p>Freq Offset 0.00000000 Hz</p> <p>Signal Track On Off</p> <p>Ref 20 dBm Atten 30 dB</p> <p>#Peak Log 10 dB/Offst 4.3 dB</p> <p>Center 1.753 500 GHz Span 6 MHz</p> <p>#Res BW 33 kHz #VBW 33 kHz Sweep 6.68 ms (601 pts)</p> <p><b>Occupied Bandwidth 2.6808 MHz</b></p> <p>Occ BW % Pwr 99.00 %</p> <p>x dB -26.00 dB</p> <p>Transmit Freq Error 1.516 kHz</p> <p>x dB Bandwidth 2.935 MHz</p> <p>Copyright 2000-2006 Agilent Technologies</p>

LTE Band 4 (Channel Bandwidth: 5 MHz) _ QPSK	
1712.5 MHz	<p>Agilent R T Freq/Channel</p> <p>Ch Freq 1.7125 GHz Trig Free</p> <p>Center Freq 1.71250000 GHz</p> <p>Start Freq 1.70750000 GHz</p> <p>Stop Freq 1.71750000 GHz</p> <p>CF Step 1.00000000 MHz Auto Man</p> <p>Freq Offset 0.00000000 Hz</p> <p>Signal Track On Off</p> <p>Ref 20 dBm Atten 30 dB</p> <p>#Peak Log 10 dB/Offst 4.3 dB</p> <p>Center 1.712 50 GHz Span 10 MHz</p> <p>#Res BW 51 kHz #VBW 51 kHz Sweep 4.64 ms (601 pts)</p> <p><b>Occupied Bandwidth 4.4772 MHz</b></p> <p>Occ BW % Pwr 99.00 %</p> <p>x dB -26.00 dB</p> <p>Transmit Freq Error 2.100 kHz</p> <p>x dB Bandwidth 4.912 MHz</p> <p>Copyright 2000-2006 Agilent Technologies</p>
1732.5 MHz	<p>Agilent R T Freq/Channel</p> <p>Ch Freq 1.7325 GHz Trig Free</p> <p>Center Freq 1.73250000 GHz</p> <p>Start Freq 1.72750000 GHz</p> <p>Stop Freq 1.73750000 GHz</p> <p>CF Step 1.00000000 MHz Auto Man</p> <p>Freq Offset 0.00000000 Hz</p> <p>Signal Track On Off</p> <p>Ref 20 dBm Atten 30 dB</p> <p>#Peak Log 10 dB/Offst 4.3 dB</p> <p>Center 1.732 50 GHz Span 10 MHz</p> <p>#Res BW 51 kHz #VBW 51 kHz Sweep 4.64 ms (601 pts)</p> <p><b>Occupied Bandwidth 4.4773 MHz</b></p> <p>Occ BW % Pwr 99.00 %</p> <p>x dB -26.00 dB</p> <p>Transmit Freq Error 3.438 kHz</p> <p>x dB Bandwidth 4.920 MHz</p> <p>Copyright 2000-2006 Agilent Technologies</p>
1752.5 MHz	<p>Agilent R T Freq/Channel</p> <p>Ch Freq 1.7525 GHz Trig Free</p> <p>Center Freq 1.75250000 GHz</p> <p>Start Freq 1.74750000 GHz</p> <p>Stop Freq 1.75750000 GHz</p> <p>CF Step 1.00000000 MHz Auto Man</p> <p>Freq Offset 0.00000000 Hz</p> <p>Signal Track On Off</p> <p>Ref 20 dBm Atten 30 dB</p> <p>#Peak Log 10 dB/Offst 4.3 dB</p> <p>Center 1.752 50 GHz Span 10 MHz</p> <p>#Res BW 51 kHz #VBW 51 kHz Sweep 4.64 ms (601 pts)</p> <p><b>Occupied Bandwidth 4.4640 MHz</b></p> <p>Occ BW % Pwr 99.00 %</p> <p>x dB -26.00 dB</p> <p>Transmit Freq Error -4.288 kHz</p> <p>x dB Bandwidth 4.933 MHz</p> <p>Copyright 2000-2006 Agilent Technologies</p>

LTE Band 4 (Channel Bandwidth: 10 MHz) _ QPSK	
1715.0 MHz	<p>Agilent R T Freq/Channel</p> <p>Ch Freq 1.715 GHz Trig Free</p> <p>Center Freq 1.71500000 GHz</p> <p>Start Freq 1.70500000 GHz</p> <p>Stop Freq 1.72500000 GHz</p> <p>CF Step 2.00000000 MHz</p> <p>Freq Offset 0.00000000 Hz</p> <p>Signal Track On Off</p> <p>Ref 20 dBm Atten 30 dB</p> <p>#Peak Log 10 dB/Offst 4.3 dB</p> <p>Center 1.715 00 GHz Span 20 MHz</p> <p>#Res BW 110 kHz #VBW 110 kHz Sweep 2 ms (601 pts)</p> <p><b>Occupied Bandwidth 8.9296 MHz</b></p> <p>Occ BW % Pwr 99.00 %</p> <p>x dB -26.00 dB</p> <p>Transmit Freq Error -5.947 kHz</p> <p>x dB Bandwidth 9.655 MHz</p> <p>Copyright 2000-2006 Agilent Technologies</p>
1732.5 MHz	<p>Agilent R T Freq/Channel</p> <p>Ch Freq 1.7325 GHz Trig Free</p> <p>Center Freq 1.73250000 GHz</p> <p>Start Freq 1.72250000 GHz</p> <p>Stop Freq 1.74250000 GHz</p> <p>CF Step 2.00000000 MHz</p> <p>Freq Offset 0.00000000 Hz</p> <p>Signal Track On Off</p> <p>Ref 20 dBm Atten 30 dB</p> <p>#Peak Log 10 dB/Offst 4.3 dB</p> <p>Center 1.732 50 GHz Span 20 MHz</p> <p>#Res BW 110 kHz #VBW 110 kHz Sweep 2 ms (601 pts)</p> <p><b>Occupied Bandwidth 8.9419 MHz</b></p> <p>Occ BW % Pwr 99.00 %</p> <p>x dB -26.00 dB</p> <p>Transmit Freq Error 253.515 Hz</p> <p>x dB Bandwidth 9.630 MHz</p> <p>Copyright 2000-2006 Agilent Technologies</p>
1750.0 MHz	<p>Agilent R T Freq/Channel</p> <p>Ch Freq 1.75 GHz Trig Free</p> <p>Center Freq 1.75000000 GHz</p> <p>Start Freq 1.74000000 GHz</p> <p>Stop Freq 1.76000000 GHz</p> <p>CF Step 2.00000000 MHz</p> <p>Freq Offset 0.00000000 Hz</p> <p>Signal Track On Off</p> <p>Ref 20 dBm Atten 30 dB</p> <p>#Peak Log 10 dB/Offst 4.3 dB</p> <p>Center 1.750 00 GHz Span 20 MHz</p> <p>#Res BW 110 kHz #VBW 110 kHz Sweep 2 ms (601 pts)</p> <p><b>Occupied Bandwidth 8.9405 MHz</b></p> <p>Occ BW % Pwr 99.00 %</p> <p>x dB -26.00 dB</p> <p>Transmit Freq Error 1.456 kHz</p> <p>x dB Bandwidth 9.693 MHz</p> <p>Copyright 2000-2006 Agilent Technologies</p>

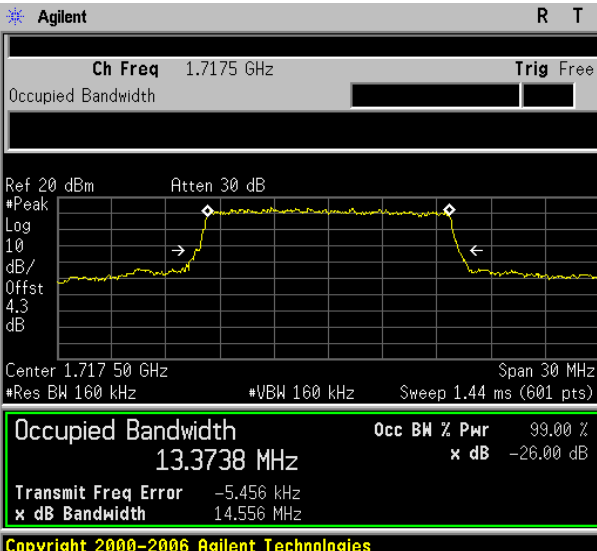
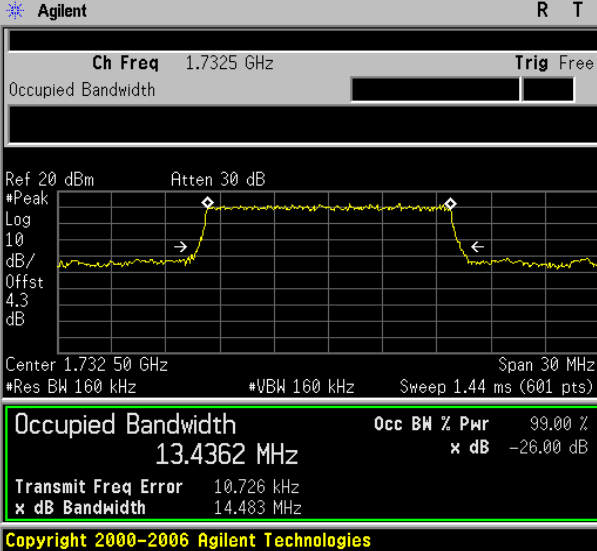
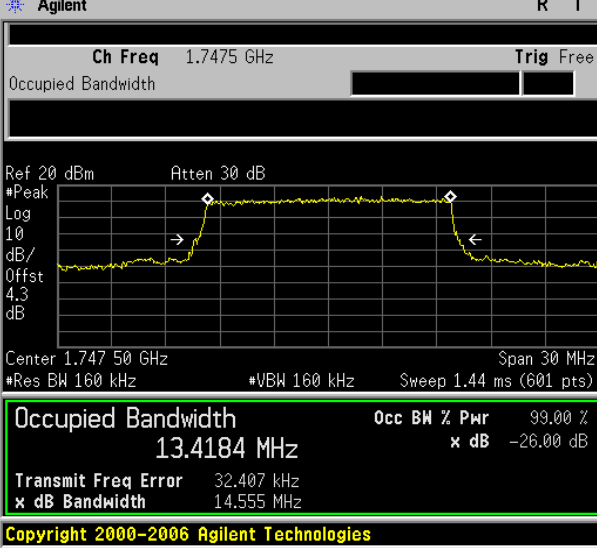
LTE Band 4 (Channel Bandwidth: 15 MHz) _ QPSK	
1717.5 MHz	 <p> <b>Agilent</b> R T Freq/Channel                  Ch Freq 1.7175 GHz Trig Free                  Occupied Bandwidth                  Ref 20 dBm Atten 30 dB                  #Peak                  Log                  10                  dB/                  Offst                  4.3                  dB                  Center 1.717 50 GHz Span 30 MHz                  #Res BW 160 kHz #VBW 160 kHz Sweep 1.44 ms (601 pts)  <b>Occupied Bandwidth</b> Occ BW % Pwr 99.00 %  <b>13.3738 MHz</b> x dB -26.00 dB                  Transmit Freq Error -5.456 kHz                  x dB Bandwidth 14.556 MHz                  Copyright 2000-2006 Agilent Technologies             </p>
1732.5 MHz	 <p> <b>Agilent</b> R T Freq/Channel                  Ch Freq 1.7325 GHz Trig Free                  Occupied Bandwidth                  Ref 20 dBm Atten 30 dB                  #Peak                  Log                  10                  dB/                  Offst                  4.3                  dB                  Center 1.732 50 GHz Span 30 MHz                  #Res BW 160 kHz #VBW 160 kHz Sweep 1.44 ms (601 pts)  <b>Occupied Bandwidth</b> Occ BW % Pwr 99.00 %  <b>13.4362 MHz</b> x dB -26.00 dB                  Transmit Freq Error 10.726 kHz                  x dB Bandwidth 14.483 MHz                  Copyright 2000-2006 Agilent Technologies             </p>
1747.5 MHz	 <p> <b>Agilent</b> R T Freq/Channel                  Ch Freq 1.7475 GHz Trig Free                  Occupied Bandwidth                  Ref 20 dBm Atten 30 dB                  #Peak                  Log                  10                  dB/                  Offst                  4.3                  dB                  Center 1.747 50 GHz Span 30 MHz                  #Res BW 160 kHz #VBW 160 kHz Sweep 1.44 ms (601 pts)  <b>Occupied Bandwidth</b> Occ BW % Pwr 99.00 %  <b>13.4184 MHz</b> x dB -26.00 dB                  Transmit Freq Error 32.407 kHz                  x dB Bandwidth 14.555 MHz                  Copyright 2000-2006 Agilent Technologies             </p>

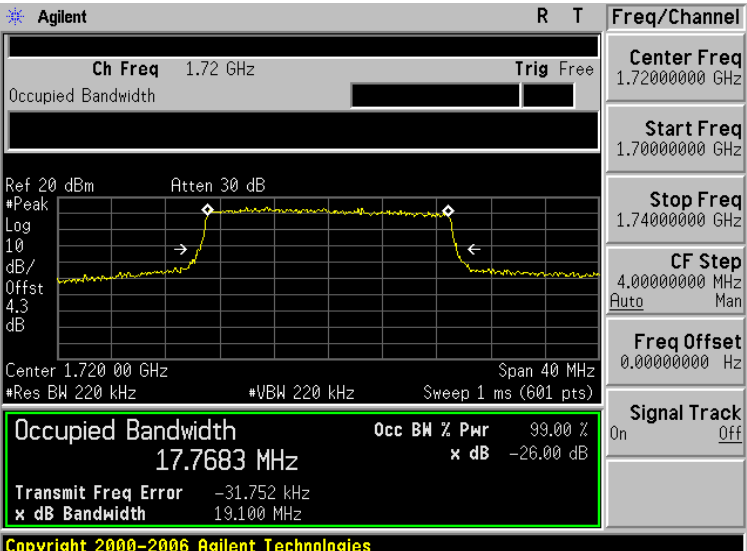
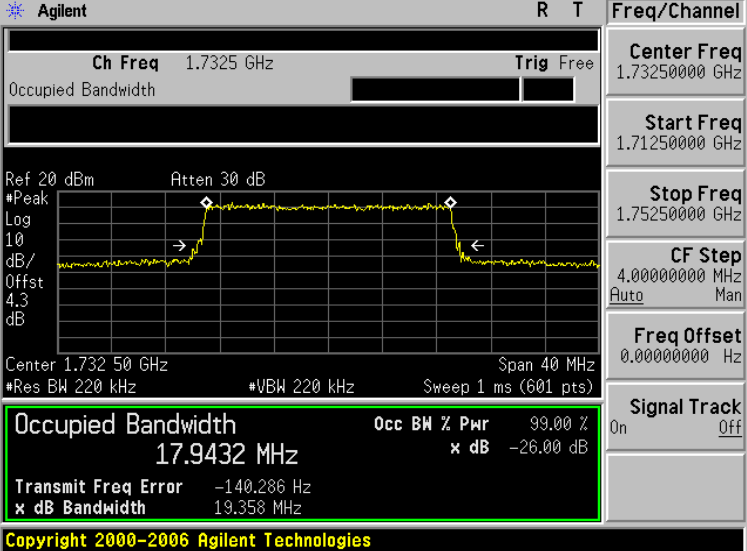
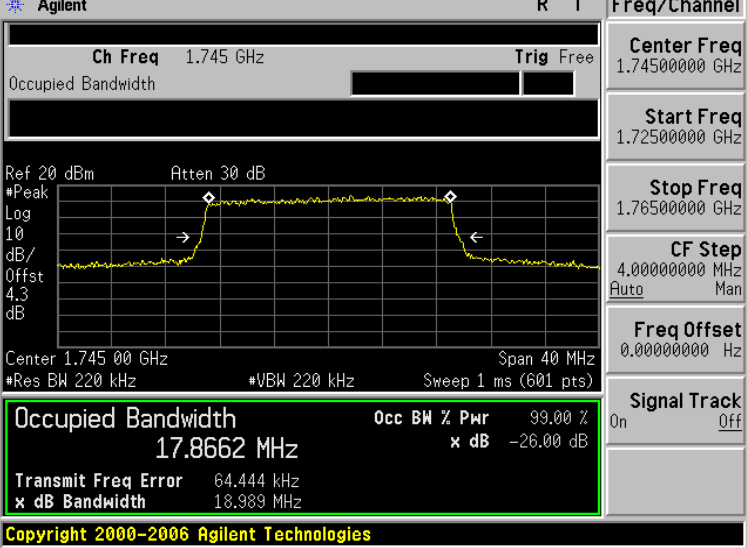

LTE Band 4 (Channel Bandwidth: 20 MHz) _ QPSK	
1720.0 MHz	 <p><b>Agilent</b> R T Freq/Channel</p> <p>Ch Freq 1.72 GHz Trig Free</p> <p>Center Freq 1.7200000 GHz</p> <p>Start Freq 1.7400000 GHz</p> <p>Stop Freq 1.7400000 GHz</p> <p>CF Step 4.0000000 MHz Auto Man</p> <p>Freq Offset 0.0000000 Hz</p> <p>Signal Track On Off</p> <p>Ref 20 dBm Atten 30 dB</p> <p>#Peak Log 10 dB/Offst 4.3 dB</p> <p>Center 1.720 00 GHz Span 40 MHz</p> <p>#Res BW 220 kHz #VBW 220 kHz Sweep 1 ms (601 pts)</p> <p><b>Occupied Bandwidth 17.7683 MHz</b></p> <p>Occ BW % Pwr 99.00 %</p> <p>x dB -26.00 dB</p> <p>Transmit Freq Error -31.752 kHz</p> <p>x dB Bandwidth 19.100 MHz</p> <p>Copyright 2000-2006 Agilent Technologies</p>
1732.5 MHz	 <p><b>Agilent</b> R T Freq/Channel</p> <p>Ch Freq 1.7325 GHz Trig Free</p> <p>Center Freq 1.7325000 GHz</p> <p>Start Freq 1.7125000 GHz</p> <p>Stop Freq 1.7525000 GHz</p> <p>CF Step 4.0000000 MHz Auto Man</p> <p>Freq Offset 0.0000000 Hz</p> <p>Signal Track On Off</p> <p>Ref 20 dBm Atten 30 dB</p> <p>#Peak Log 10 dB/Offst 4.3 dB</p> <p>Center 1.732 50 GHz Span 40 MHz</p> <p>#Res BW 220 kHz #VBW 220 kHz Sweep 1 ms (601 pts)</p> <p><b>Occupied Bandwidth 17.9432 MHz</b></p> <p>Occ BW % Pwr 99.00 %</p> <p>x dB -26.00 dB</p> <p>Transmit Freq Error -140.286 Hz</p> <p>x dB Bandwidth 19.358 MHz</p> <p>Copyright 2000-2006 Agilent Technologies</p>
1745.0 MHz	 <p><b>Agilent</b> R T Freq/Channel</p> <p>Ch Freq 1.745 GHz Trig Free</p> <p>Center Freq 1.7450000 GHz</p> <p>Start Freq 1.7250000 GHz</p> <p>Stop Freq 1.7650000 GHz</p> <p>CF Step 4.0000000 MHz Auto Man</p> <p>Freq Offset 0.0000000 Hz</p> <p>Signal Track On Off</p> <p>Ref 20 dBm Atten 30 dB</p> <p>#Peak Log 10 dB/Offst 4.3 dB</p> <p>Center 1.745 00 GHz Span 40 MHz</p> <p>#Res BW 220 kHz #VBW 220 kHz Sweep 1 ms (601 pts)</p> <p><b>Occupied Bandwidth 17.8662 MHz</b></p> <p>Occ BW % Pwr 99.00 %</p> <p>x dB -26.00 dB</p> <p>Transmit Freq Error 64.444 kHz</p> <p>x dB Bandwidth 18.989 MHz</p> <p>Copyright 2000-2006 Agilent Technologies</p>

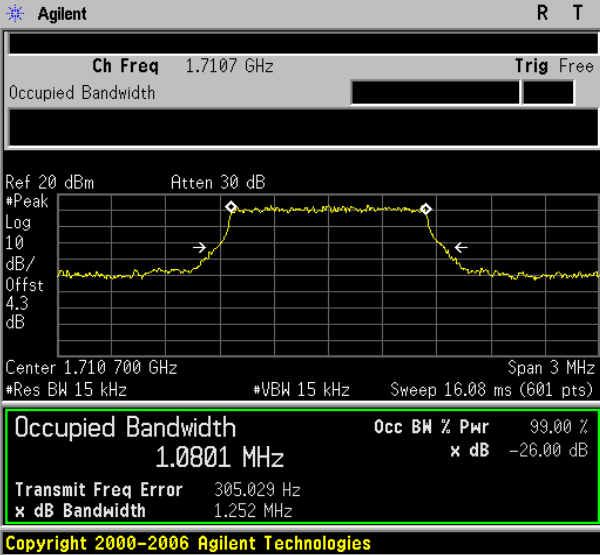
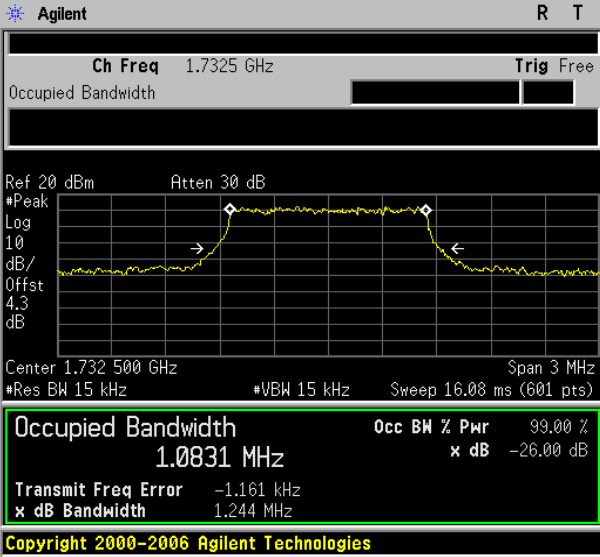
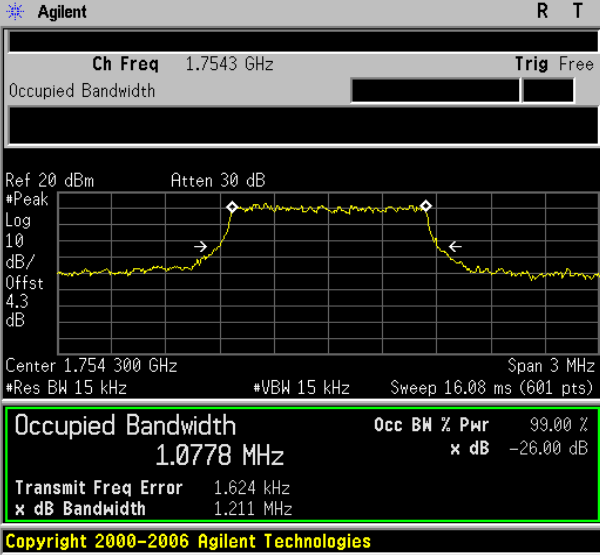
LTE Band 4 (Channel Bandwidth: 1.4 MHz) _ 16QAM	
1710.7 MHz	 <p><b>Agilent</b> R T Freq/Channel</p> <p>Ch Freq 1.7107 GHz Trig Free</p> <p>Center Freq 1.71070000 GHz</p> <p>Start Freq 1.70920000 GHz</p> <p>Stop Freq 1.71220000 GHz</p> <p>CF Step 300.000000 kHz Auto Man</p> <p>Freq Offset 0.00000000 Hz</p> <p>Signal Track On Off</p> <p>Ref 20 dBm Atten 30 dB</p> <p>#Peak Log 10 dB/Offst 4.3 dB</p> <p>Center 1.710 700 GHz Span 3 MHz</p> <p>#Res BW 15 kHz #VBW 15 kHz Sweep 16.08 ms (601 pts)</p> <p><b>Occupied Bandwidth</b> Occ BW % Pwr 99.00 %</p> <p>1.0801 MHz x dB -26.00 dB</p> <p>Transmit Freq Error 305.029 Hz</p> <p>x dB Bandwidth 1.252 MHz</p> <p>Copyright 2000-2006 Agilent Technologies</p>
1732.5 MHz	 <p><b>Agilent</b> R T Freq/Channel</p> <p>Ch Freq 1.7325 GHz Trig Free</p> <p>Center Freq 1.73250000 GHz</p> <p>Start Freq 1.73100000 GHz</p> <p>Stop Freq 1.73400000 GHz</p> <p>CF Step 300.000000 kHz Auto Man</p> <p>Freq Offset 0.00000000 Hz</p> <p>Signal Track On Off</p> <p>Ref 20 dBm Atten 30 dB</p> <p>#Peak Log 10 dB/Offst 4.3 dB</p> <p>Center 1.732 500 GHz Span 3 MHz</p> <p>#Res BW 15 kHz #VBW 15 kHz Sweep 16.08 ms (601 pts)</p> <p><b>Occupied Bandwidth</b> Occ BW % Pwr 99.00 %</p> <p>1.0831 MHz x dB -26.00 dB</p> <p>Transmit Freq Error -1.161 kHz</p> <p>x dB Bandwidth 1.244 MHz</p> <p>Copyright 2000-2006 Agilent Technologies</p>
1754.3 MHz	 <p><b>Agilent</b> R T Freq/Channel</p> <p>Ch Freq 1.7543 GHz Trig Free</p> <p>Center Freq 1.75430000 GHz</p> <p>Start Freq 1.75280000 GHz</p> <p>Stop Freq 1.75580000 GHz</p> <p>CF Step 300.000000 kHz Auto Man</p> <p>Freq Offset 0.00000000 Hz</p> <p>Signal Track On Off</p> <p>Ref 20 dBm Atten 30 dB</p> <p>#Peak Log 10 dB/Offst 4.3 dB</p> <p>Center 1.754 300 GHz Span 3 MHz</p> <p>#Res BW 15 kHz #VBW 15 kHz Sweep 16.08 ms (601 pts)</p> <p><b>Occupied Bandwidth</b> Occ BW % Pwr 99.00 %</p> <p>1.0778 MHz x dB -26.00 dB</p> <p>Transmit Freq Error 1.624 kHz</p> <p>x dB Bandwidth 1.211 MHz</p> <p>Copyright 2000-2006 Agilent Technologies</p>

LTE Band 4 (Channel Bandwidth: 3 MHz) _ 16QAM	
1711.5 MHz	<p>Agilent R T Freq/Channel</p> <p>Ch Freq 1.7115 GHz Trig Free</p> <p>Center Freq 1.71150000 GHz</p> <p>Start Freq 1.70850000 GHz</p> <p>Stop Freq 1.71450000 GHz</p> <p>CF Step 600.000000 kHz Auto Man</p> <p>Freq Offset 0.00000000 Hz</p> <p>Signal Track On Off</p> <p>Ref 20 dBm Atten 30 dB</p> <p>#Peak Log 10 dB/Offst 4.3 dB</p> <p>Center 1.711 500 GHz Span 6 MHz</p> <p>#Res BW 33 kHz #VBW 33 kHz Sweep 6.68 ms (601 pts)</p> <p><b>Occupied Bandwidth 2.6869 MHz</b></p> <p>Occ BW % Pwr 99.00 % x dB -26.00 dB</p> <p>Transmit Freq Error 2.680 kHz x dB Bandwidth 2.953 MHz</p> <p>Copyright 2000-2006 Agilent Technologies</p>
1732.5 MHz	<p>Agilent R T Freq/Channel</p> <p>Ch Freq 1.7325 GHz Trig Free</p> <p>Center Freq 1.73250000 GHz</p> <p>Start Freq 1.72950000 GHz</p> <p>Stop Freq 1.73550000 GHz</p> <p>CF Step 600.000000 kHz Auto Man</p> <p>Freq Offset 0.00000000 Hz</p> <p>Signal Track On Off</p> <p>Ref 20 dBm Atten 30 dB</p> <p>#Peak Log 10 dB/Offst 4.3 dB</p> <p>Center 1.732 500 GHz Span 6 MHz</p> <p>#Res BW 33 kHz #VBW 33 kHz Sweep 6.68 ms (601 pts)</p> <p><b>Occupied Bandwidth 2.6879 MHz</b></p> <p>Occ BW % Pwr 99.00 % x dB -26.00 dB</p> <p>Transmit Freq Error 1.396 kHz x dB Bandwidth 2.972 MHz</p> <p>Copyright 2000-2006 Agilent Technologies</p>
1753.5 MHz	<p>Agilent R T Freq/Channel</p> <p>Ch Freq 1.7535 GHz Trig Free</p> <p>Center Freq 1.75350000 GHz</p> <p>Start Freq 1.75050000 GHz</p> <p>Stop Freq 1.75650000 GHz</p> <p>CF Step 600.000000 kHz Auto Man</p> <p>Freq Offset 0.00000000 Hz</p> <p>Signal Track On Off</p> <p>Ref 20 dBm Atten 30 dB</p> <p>#Peak Log 10 dB/Offst 4.3 dB</p> <p>Center 1.753 500 GHz Span 6 MHz</p> <p>#Res BW 33 kHz #VBW 33 kHz Sweep 6.68 ms (601 pts)</p> <p><b>Occupied Bandwidth 2.6797 MHz</b></p> <p>Occ BW % Pwr 99.00 % x dB -26.00 dB</p> <p>Transmit Freq Error 640.903 Hz x dB Bandwidth 2.926 MHz</p> <p>Copyright 2000-2006 Agilent Technologies</p>

LTE Band 4 (Channel Bandwidth: 5 MHz) _ 16QAM	
1712.5 MHz	<p>Agilent R T Freq/Channel</p> <p>Ch Freq 1.7125 GHz Trig Free</p> <p>Center Freq 1.71250000 GHz</p> <p>Start Freq 1.70750000 GHz</p> <p>Stop Freq 1.71750000 GHz</p> <p>CF Step 1.00000000 MHz</p> <p>Freq Offset 0.00000000 Hz</p> <p>Signal Track On Off</p> <p>Ref 20 dBm Atten 30 dB</p> <p>#Peak Log 10 dB/Offst 4.3 dB</p> <p>Center 1.712 50 GHz Span 10 MHz</p> <p>#Res BW 51 kHz #VBW 51 kHz Sweep 4.64 ms (601 pts)</p> <p><b>Occupied Bandwidth 4.4631 MHz</b></p> <p>Occ BW % Pwr 99.00 %</p> <p>x dB -26.00 dB</p> <p>Transmit Freq Error 5.611 kHz</p> <p>x dB Bandwidth 4.870 MHz</p> <p>Copyright 2000-2006 Agilent Technologies</p>
1732.5 MHz	<p>Agilent R T Freq/Channel</p> <p>Ch Freq 1.7325 GHz Trig Free</p> <p>Center Freq 1.73250000 GHz</p> <p>Start Freq 1.72750000 GHz</p> <p>Stop Freq 1.73750000 GHz</p> <p>CF Step 1.00000000 MHz</p> <p>Freq Offset 0.00000000 Hz</p> <p>Signal Track On Off</p> <p>Ref 20 dBm Atten 30 dB</p> <p>#Peak Log 10 dB/Offst 4.3 dB</p> <p>Center 1.732 50 GHz Span 10 MHz</p> <p>#Res BW 51 kHz #VBW 51 kHz Sweep 4.64 ms (601 pts)</p> <p><b>Occupied Bandwidth 4.4844 MHz</b></p> <p>Occ BW % Pwr 99.00 %</p> <p>x dB -26.00 dB</p> <p>Transmit Freq Error 5.587 kHz</p> <p>x dB Bandwidth 4.914 MHz</p> <p>Copyright 2000-2006 Agilent Technologies</p>
1752.5 MHz	<p>Agilent R T Freq/Channel</p> <p>Ch Freq 1.7525 GHz Trig Free</p> <p>Center Freq 1.75250000 GHz</p> <p>Start Freq 1.74750000 GHz</p> <p>Stop Freq 1.75750000 GHz</p> <p>CF Step 1.00000000 MHz</p> <p>Freq Offset 0.00000000 Hz</p> <p>Signal Track On Off</p> <p>Ref 20 dBm Atten 30 dB</p> <p>#Peak Log 10 dB/Offst 4.3 dB</p> <p>Center 1.752 50 GHz Span 10 MHz</p> <p>#Res BW 51 kHz #VBW 51 kHz Sweep 4.64 ms (601 pts)</p> <p><b>Occupied Bandwidth 4.4585 MHz</b></p> <p>Occ BW % Pwr 99.00 %</p> <p>x dB -26.00 dB</p> <p>Transmit Freq Error -4.544 kHz</p> <p>x dB Bandwidth 4.895 MHz</p> <p>Copyright 2000-2006 Agilent Technologies</p>

LTE Band 4 (Channel Bandwidth: 10 MHz) _ 16QAM	
1715.0 MHz	<p>Agilent R T Freq/Channel</p> <p>Ch Freq 1.715 GHz Trig Free</p> <p>Center Freq 1.71500000 GHz</p> <p>Start Freq 1.70500000 GHz</p> <p>Stop Freq 1.72500000 GHz</p> <p>CF Step 2.00000000 MHz Auto Man</p> <p>Freq Offset 0.00000000 Hz</p> <p>Signal Track On Off</p> <p>Ref 20 dBm Atten 30 dB</p> <p>#Peak Log 10 dB/Offst 4.3 dB</p> <p>Center 1.715 00 GHz Span 20 MHz</p> <p>#Res BW 110 kHz #VBW 110 kHz Sweep 2 ms (601 pts)</p> <p><b>Occupied Bandwidth 8.9271 MHz</b></p> <p>Occ BW % Pwr 99.00 %</p> <p>x dB -26.00 dB</p> <p>Transmit Freq Error -8.787 kHz</p> <p>x dB Bandwidth 9.651 MHz</p> <p>Copyright 2000-2006 Agilent Technologies</p>
1732.5 MHz	<p>Agilent R T Freq/Channel</p> <p>Ch Freq 1.7325 GHz Trig Free</p> <p>Center Freq 1.73250000 GHz</p> <p>Start Freq 1.72250000 GHz</p> <p>Stop Freq 1.74250000 GHz</p> <p>CF Step 2.00000000 MHz Auto Man</p> <p>Freq Offset 0.00000000 Hz</p> <p>Signal Track On Off</p> <p>Ref 20 dBm Atten 30 dB</p> <p>#Peak Log 10 dB/Offst 4.3 dB</p> <p>Center 1.732 50 GHz Span 20 MHz</p> <p>#Res BW 110 kHz #VBW 110 kHz Sweep 2 ms (601 pts)</p> <p><b>Occupied Bandwidth 8.9410 MHz</b></p> <p>Occ BW % Pwr 99.00 %</p> <p>x dB -26.00 dB</p> <p>Transmit Freq Error 345.102 Hz</p> <p>x dB Bandwidth 9.695 MHz</p> <p>Copyright 2000-2006 Agilent Technologies</p>
1750.0 MHz	<p>Agilent R T Freq/Channel</p> <p>Ch Freq 1.75 GHz Trig Free</p> <p>Center Freq 1.75000000 GHz</p> <p>Start Freq 1.74000000 GHz</p> <p>Stop Freq 1.76000000 GHz</p> <p>CF Step 2.00000000 MHz Auto Man</p> <p>Freq Offset 0.00000000 Hz</p> <p>Signal Track On Off</p> <p>Ref 20 dBm Atten 30 dB</p> <p>#Peak Log 10 dB/Offst 4.3 dB</p> <p>Center 1.750 00 GHz Span 20 MHz</p> <p>#Res BW 110 kHz #VBW 110 kHz Sweep 2 ms (601 pts)</p> <p><b>Occupied Bandwidth 8.9131 MHz</b></p> <p>Occ BW % Pwr 99.00 %</p> <p>x dB -26.00 dB</p> <p>Transmit Freq Error 5.617 kHz</p> <p>x dB Bandwidth 9.632 MHz</p> <p>Copyright 2000-2006 Agilent Technologies</p>

LTE Band 4 (Channel Bandwidth: 15 MHz) _ 16QAM	
1717.5 MHz	<p>Agilent R T Freq/Channel</p> <p>Ch Freq 1.7175 GHz Trig Free</p> <p>Center Freq 1.71750000 GHz</p> <p>Start Freq 1.70250000 GHz</p> <p>Stop Freq 1.73250000 GHz</p> <p>CF Step 3.00000000 MHz Auto Man</p> <p>Freq Offset 0.00000000 Hz</p> <p>Signal Track On Off</p> <p>Ref 20 dBm Atten 30 dB</p> <p>#Peak Log 10 dB/Offst 4.3 dB</p> <p>Center 1.717 50 GHz Span 30 MHz</p> <p>#Res BW 160 kHz #VBW 160 kHz Sweep 1.44 ms (601 pts)</p> <p><b>Occupied Bandwidth 13.3779 MHz</b></p> <p>Occ BW % Pwr 99.00 %</p> <p>x dB -26.00 dB</p> <p>Transmit Freq Error -2.113 kHz</p> <p>x dB Bandwidth 14.600 MHz</p> <p>Copyright 2000-2006 Agilent Technologies</p>
1732.5 MHz	<p>Agilent R T Freq/Channel</p> <p>Ch Freq 1.7325 GHz Trig Free</p> <p>Center Freq 1.73250000 GHz</p> <p>Start Freq 1.71750000 GHz</p> <p>Stop Freq 1.74750000 GHz</p> <p>CF Step 3.00000000 MHz Auto Man</p> <p>Freq Offset 0.00000000 Hz</p> <p>Signal Track On Off</p> <p>Ref 20 dBm Atten 30 dB</p> <p>#Peak Log 10 dB/Offst 4.3 dB</p> <p>Center 1.732 50 GHz Span 30 MHz</p> <p>#Res BW 160 kHz #VBW 160 kHz Sweep 1.44 ms (601 pts)</p> <p><b>Occupied Bandwidth 13.4286 MHz</b></p> <p>Occ BW % Pwr 99.00 %</p> <p>x dB -26.00 dB</p> <p>Transmit Freq Error 8.564 kHz</p> <p>x dB Bandwidth 14.555 MHz</p> <p>Copyright 2000-2006 Agilent Technologies</p>
1747.5 MHz	<p>Agilent R T Freq/Channel</p> <p>Ch Freq 1.7475 GHz Trig Free</p> <p>Center Freq 1.74750000 GHz</p> <p>Start Freq 1.73250000 GHz</p> <p>Stop Freq 1.76250000 GHz</p> <p>CF Step 3.00000000 MHz Auto Man</p> <p>Freq Offset 0.00000000 Hz</p> <p>Signal Track On Off</p> <p>Ref 20 dBm Atten 30 dB</p> <p>#Peak Log 10 dB/Offst 4.3 dB</p> <p>Center 1.747 50 GHz Span 30 MHz</p> <p>#Res BW 160 kHz #VBW 160 kHz Sweep 1.44 ms (601 pts)</p> <p><b>Occupied Bandwidth 13.3749 MHz</b></p> <p>Occ BW % Pwr 99.00 %</p> <p>x dB -26.00 dB</p> <p>Transmit Freq Error 30.224 kHz</p> <p>x dB Bandwidth 14.554 MHz</p> <p>Copyright 2000-2006 Agilent Technologies</p>

LTE Band 4 (Channel Bandwidth: 20 MHz) _ 16QAM	
1720.0 MHz	<p>Agilent R T Freq/Channel</p> <p>Ch Freq 1.72 GHz Trig Free</p> <p>Center Freq 1.72000000 GHz</p> <p>Start Freq 1.74000000 GHz</p> <p>Stop Freq 1.74000000 GHz</p> <p>CF Step 4.00000000 MHz Auto Man</p> <p>Freq Offset 0.00000000 Hz</p> <p>Signal Track On Off</p> <p>Ref 20 dBm Atten 30 dB</p> <p>#Peak Log 10 dB/Offst 4.3 dB</p> <p>Center 1.720 00 GHz Span 40 MHz</p> <p>#Res BW 220 kHz #VBW 220 kHz Sweep 1 ms (601 pts)</p> <p><b>Occupied Bandwidth 17.7555 MHz</b></p> <p>Occ BW % Pwr 99.00 %</p> <p>x dB -26.00 dB</p> <p>Transmit Freq Error -34.080 kHz</p> <p>x dB Bandwidth 19.100 MHz</p> <p>Copyright 2000-2006 Agilent Technologies</p>
1732.5 MHz	<p>Agilent R T Freq/Channel</p> <p>Ch Freq 1.7325 GHz Trig Free</p> <p>Center Freq 1.73250000 GHz</p> <p>Start Freq 1.71250000 GHz</p> <p>Stop Freq 1.75250000 GHz</p> <p>CF Step 4.00000000 MHz Auto Man</p> <p>Freq Offset 0.00000000 Hz</p> <p>Signal Track On Off</p> <p>Ref 20 dBm Atten 30 dB</p> <p>#Peak Log 10 dB/Offst 4.3 dB</p> <p>Center 1.732 50 GHz Span 40 MHz</p> <p>#Res BW 220 kHz #VBW 220 kHz Sweep 1 ms (601 pts)</p> <p><b>Occupied Bandwidth 17.9297 MHz</b></p> <p>Occ BW % Pwr 99.00 %</p> <p>x dB -26.00 dB</p> <p>Transmit Freq Error 885.832 Hz</p> <p>x dB Bandwidth 19.533 MHz</p> <p>Copyright 2000-2006 Agilent Technologies</p>
1745.0 MHz	<p>Agilent R T Freq/Channel</p> <p>Ch Freq 1.745 GHz Trig Free</p> <p>Center Freq 1.74500000 GHz</p> <p>Start Freq 1.72500000 GHz</p> <p>Stop Freq 1.76500000 GHz</p> <p>CF Step 4.00000000 MHz Auto Man</p> <p>Freq Offset 0.00000000 Hz</p> <p>Signal Track On Off</p> <p>Ref 20 dBm Atten 30 dB</p> <p>#Peak Log 10 dB/Offst 4.3 dB</p> <p>Center 1.745 00 GHz Span 40 MHz</p> <p>#Res BW 220 kHz #VBW 220 kHz Sweep 1 ms (601 pts)</p> <p><b>Occupied Bandwidth 17.8441 MHz</b></p> <p>Occ BW % Pwr 99.00 %</p> <p>x dB -26.00 dB</p> <p>Transmit Freq Error 84.608 kHz</p> <p>x dB Bandwidth 18.989 MHz</p> <p>Copyright 2000-2006 Agilent Technologies</p>

LTE Band 5 (Channel Bandwidth: 1.4 MHz) _ QPSK	
824.7 MHz	<div style="border: 1px solid black; padding: 5px;"> <p style="text-align: right;">Agilent <span style="float: right;">R T</span></p> <hr/> <p style="text-align: center;"><b>Ch Freq</b> 824.7 MHz <span style="float: right;"><b>Trig</b> Free</span></p> <p>Occupied Bandwidth <span style="float: right;">█</span></p> <hr/> <p>Ref 20 dBm <span style="margin-left: 100px;">Atten 30 dB</span></p> <p>#Peak <span style="float: right;">█</span></p> <p>Log <span style="float: right;">█</span></p> <p>dB/ <span style="float: right;">█</span></p> <p>Offst 3.9 <span style="float: right;">█</span></p> <p>dB <span style="float: right;">█</span></p> <p style="text-align: center;">Center 824.700 MHz <span style="float: right;">Span 3 MHz</span></p> <p>#Res BW 15 kHz <span style="margin-left: 100px;">#VBW 15 kHz</span> <span style="float: right;">Sweep 16.08 ms (601 pts)</span></p> <div style="border: 2px solid green; padding: 2px; margin-top: 5px;"> <p><b>Occupied Bandwidth</b> <span style="float: right;"><b>Occ BW % Pwr</b> 99.00 %</span></p> <p style="text-align: center; font-size: 1.2em;">1.0796 MHz <span style="float: right;"><b>x dB</b> -26.00 dB</span></p> <p><b>Transmit Freq Error</b> -2.807 kHz</p> <p><b>x dB Bandwidth</b> 1.244 MHz</p> </div> <p style="font-size: 0.8em; color: yellow; text-align: center;">Copyright 2000-2006 Agilent Technologies</p> </div> <div style="border: 1px solid black; padding: 5px; margin-top: 5px;"> <p style="text-align: right;">Agilent <span style="float: right;">R T</span></p> <hr/> <p style="text-align: center;"><b>Ch Freq</b> 824.7 MHz <span style="float: right;"><b>Trig</b> Free</span></p> <p>Occupied Bandwidth <span style="float: right;">█</span></p> <hr/> <p>Ref 20 dBm <span style="margin-left: 100px;">Atten 30 dB</span></p> <p>#Peak <span style="float: right;">█</span></p> <p>Log <span style="float: right;">█</span></p> <p>dB/ <span style="float: right;">█</span></p> <p>Offst 3.9 <span style="float: right;">█</span></p> <p>dB <span style="float: right;">█</span></p> <p style="text-align: center;">Center 824.700 MHz <span style="float: right;">Span 3 MHz</span></p> <p>#Res BW 15 kHz <span style="margin-left: 100px;">#VBW 15 kHz</span> <span style="float: right;">Sweep 16.08 ms (601 pts)</span></p> <div style="border: 2px solid green; padding: 2px; margin-top: 5px;"> <p><b>Occupied Bandwidth</b> <span style="float: right;"><b>Occ BW % Pwr</b> 99.00 %</span></p> <p style="text-align: center; font-size: 1.2em;">1.0796 MHz <span style="float: right;"><b>x dB</b> -26.00 dB</span></p> <p><b>Transmit Freq Error</b> -2.807 kHz</p> <p><b>x dB Bandwidth</b> 1.244 MHz</p> </div> <p style="font-size: 0.8em; color: yellow; text-align: center;">Copyright 2000-2006 Agilent Technologies</p> </div>
836.5 MHz	<div style="border: 1px solid black; padding: 5px;"> <p style="text-align: right;">Agilent <span style="float: right;">R T</span></p> <hr/> <p style="text-align: center;"><b>Ch Freq</b> 836.5 MHz <span style="float: right;"><b>Trig</b> Free</span></p> <p>Occupied Bandwidth <span style="float: right;">█</span></p> <hr/> <p>Ref 20 dBm <span style="margin-left: 100px;">Atten 30 dB</span></p> <p>#Peak <span style="float: right;">█</span></p> <p>Log <span style="float: right;">█</span></p> <p>dB/ <span style="float: right;">█</span></p> <p>Offst 3.9 <span style="float: right;">█</span></p> <p>dB <span style="float: right;">█</span></p> <p style="text-align: center;">Center 836.500 MHz <span style="float: right;">Span 3 MHz</span></p> <p>#Res BW 15 kHz <span style="margin-left: 100px;">#VBW 15 kHz</span> <span style="float: right;">Sweep 16.08 ms (601 pts)</span></p> <div style="border: 2px solid green; padding: 2px; margin-top: 5px;"> <p><b>Occupied Bandwidth</b> <span style="float: right;"><b>Occ BW % Pwr</b> 99.00 %</span></p> <p style="text-align: center; font-size: 1.2em;">1.0777 MHz <span style="float: right;"><b>x dB</b> -26.00 dB</span></p> <p><b>Transmit Freq Error</b> 1.533 kHz</p> <p><b>x dB Bandwidth</b> 1.213 MHz</p> </div> <p style="font-size: 0.8em; color: yellow; text-align: center;">Copyright 2000-2006 Agilent Technologies</p> </div> <div style="border: 1px solid black; padding: 5px; margin-top: 5px;"> <p style="text-align: right;">Agilent <span style="float: right;">R T</span></p> <hr/> <p style="text-align: center;"><b>Ch Freq</b> 836.5 MHz <span style="float: right;"><b>Trig</b> Free</span></p> <p>Occupied Bandwidth <span style="float: right;">█</span></p> <hr/> <p>Ref 20 dBm <span style="margin-left: 100px;">Atten 30 dB</span></p> <p>#Peak <span style="float: right;">█</span></p> <p>Log <span style="float: right;">█</span></p> <p>dB/ <span style="float: right;">█</span></p> <p>Offst 3.9 <span style="float: right;">█</span></p> <p>dB <span style="float: right;">█</span></p> <p style="text-align: center;">Center 836.500 MHz <span style="float: right;">Span 3 MHz</span></p> <p>#Res BW 15 kHz <span style="margin-left: 100px;">#VBW 15 kHz</span> <span style="float: right;">Sweep 16.08 ms (601 pts)</span></p> <div style="border: 2px solid green; padding: 2px; margin-top: 5px;"> <p><b>Occupied Bandwidth</b> <span style="float: right;"><b>Occ BW % Pwr</b> 99.00 %</span></p> <p style="text-align: center; font-size: 1.2em;">1.0777 MHz <span style="float: right;"><b>x dB</b> -26.00 dB</span></p> <p><b>Transmit Freq Error</b> 1.533 kHz</p> <p><b>x dB Bandwidth</b> 1.213 MHz</p> </div> <p style="font-size: 0.8em; color: yellow; text-align: center;">Copyright 2000-2006 Agilent Technologies</p> </div>
848.3 MHz	<div style="border: 1px solid black; padding: 5px;"> <p style="text-align: right;">Agilent <span style="float: right;">R T</span></p> <hr/> <p style="text-align: center;"><b>Ch Freq</b> 848.3 MHz <span style="float: right;"><b>Trig</b> Free</span></p> <p>Occupied Bandwidth <span style="float: right;">█</span></p> <hr/> <p>Ref 20 dBm <span style="margin-left: 100px;">Atten 30 dB</span></p> <p>#Peak <span style="float: right;">█</span></p> <p>Log <span style="float: right;">█</span></p> <p>dB/ <span style="float: right;">█</span></p> <p>Offst 3.9 <span style="float: right;">█</span></p> <p>dB <span style="float: right;">█</span></p> <p style="text-align: center;">Center 848.300 MHz <span style="float: right;">Span 3 MHz</span></p> <p>#Res BW 15 kHz <span style="margin-left: 100px;">#VBW 15 kHz</span> <span style="float: right;">Sweep 16.08 ms (601 pts)</span></p> <div style="border: 2px solid green; padding: 2px; margin-top: 5px;"> <p><b>Occupied Bandwidth</b> <span style="float: right;"><b>Occ BW % Pwr</b> 99.00 %</span></p> <p style="text-align: center; font-size: 1.2em;">1.0790 MHz <span style="float: right;"><b>x dB</b> -26.00 dB</span></p> <p><b>Transmit Freq Error</b> -1.097 kHz</p> <p><b>x dB Bandwidth</b> 1.271 MHz</p> </div> <p style="font-size: 0.8em; color: yellow; text-align: center;">Copyright 2000-2006 Agilent Technologies</p> </div> <div style="border: 1px solid black; padding: 5px; margin-top: 5px;"> <p style="text-align: right;">Agilent <span style="float: right;">R T</span></p> <hr/> <p style="text-align: center;"><b>Ch Freq</b> 848.3 MHz <span style="float: right;"><b>Trig</b> Free</span></p> <p>Occupied Bandwidth <span style="float: right;">█</span></p> <hr/> <p>Ref 20 dBm <span style="margin-left: 100px;">Atten 30 dB</span></p> <p>#Peak <span style="float: right;">█</span></p> <p>Log <span style="float: right;">█</span></p> <p>dB/ <span style="float: right;">█</span></p> <p>Offst 3.9 <span style="float: right;">█</span></p> <p>dB <span style="float: right;">█</span></p> <p style="text-align: center;">Center 848.300 MHz <span style="float: right;">Span 3 MHz</span></p> <p>#Res BW 15 kHz <span style="margin-left: 100px;">#VBW 15 kHz</span> <span style="float: right;">Sweep 16.08 ms (601 pts)</span></p> <div style="border: 2px solid green; padding: 2px; margin-top: 5px;"> <p><b>Occupied Bandwidth</b> <span style="float: right;"><b>Occ BW % Pwr</b> 99.00 %</span></p> <p style="text-align: center; font-size: 1.2em;">1.0790 MHz <span style="float: right;"><b>x dB</b> -26.00 dB</span></p> <p><b>Transmit Freq Error</b> -1.097 kHz</p> <p><b>x dB Bandwidth</b> 1.271 MHz</p> </div> <p style="font-size: 0.8em; color: yellow; text-align: center;">Copyright 2000-2006 Agilent Technologies</p> </div>

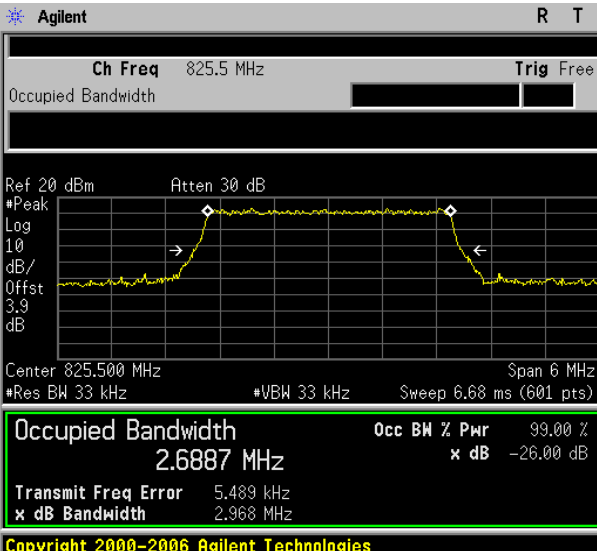
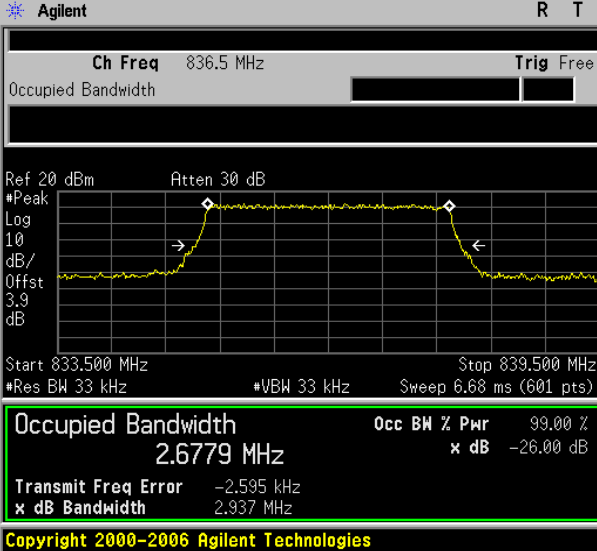
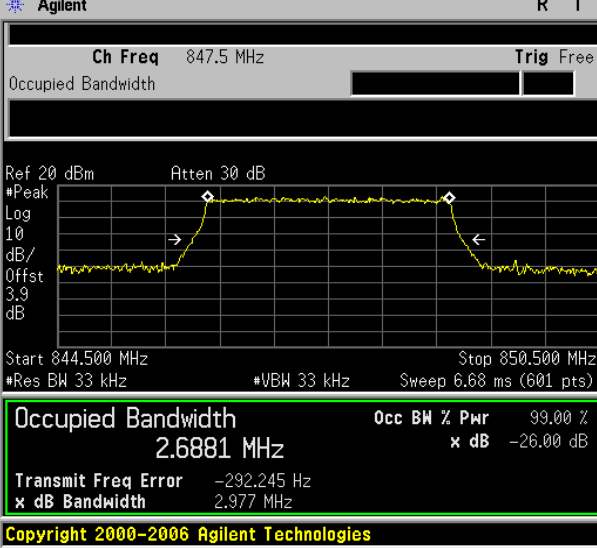

LTE Band 5 (Channel Bandwidth: 3 MHz) _ QPSK	
825.5 MHz	 <p> <b>Agilent</b> R T Freq/Channel  <b>Ch Freq</b> 825.5 MHz <b>Trig</b> Free                  Occupied Bandwidth                  Ref 20 dBm <b>Atten</b> 30 dB                  #Peak                  Log                  dB/                  Offst                  3.9                  dB                  Center 825.500 MHz Span 6 MHz                  #Res BW 33 kHz #VBW 33 kHz Sweep 6.68 ms (601 pts)  <b>Occupied Bandwidth</b> <b>Occ BW % Pwr</b> 99.00 %                  2.6887 MHz <b>x dB</b> -26.00 dB  <b>Transmit Freq Error</b> 5.489 kHz  <b>x dB Bandwidth</b> 2.968 MHz                  Copyright 2000-2006 Agilent Technologies             </p>
836.5 MHz	 <p> <b>Agilent</b> R T Freq/Channel  <b>Ch Freq</b> 836.5 MHz <b>Trig</b> Free                  Occupied Bandwidth                  Ref 20 dBm <b>Atten</b> 30 dB                  #Peak                  Log                  dB/                  Offst                  3.9                  dB                  Start 833.500 MHz Stop 839.500 MHz                  #Res BW 33 kHz #VBW 33 kHz Sweep 6.68 ms (601 pts)  <b>Occupied Bandwidth</b> <b>Occ BW % Pwr</b> 99.00 %                  2.6779 MHz <b>x dB</b> -26.00 dB  <b>Transmit Freq Error</b> -2.595 kHz  <b>x dB Bandwidth</b> 2.937 MHz                  Copyright 2000-2006 Agilent Technologies             </p>
847.5 MHz	 <p> <b>Agilent</b> R T Freq/Channel  <b>Ch Freq</b> 847.5 MHz <b>Trig</b> Free                  Occupied Bandwidth                  Ref 20 dBm <b>Atten</b> 30 dB                  #Peak                  Log                  dB/                  Offst                  3.9                  dB                  Start 844.500 MHz Stop 850.500 MHz                  #Res BW 33 kHz #VBW 33 kHz Sweep 6.68 ms (601 pts)  <b>Occupied Bandwidth</b> <b>Occ BW % Pwr</b> 99.00 %                  2.6881 MHz <b>x dB</b> -26.00 dB  <b>Transmit Freq Error</b> -292.245 Hz  <b>x dB Bandwidth</b> 2.977 MHz                  Copyright 2000-2006 Agilent Technologies             </p>

LTE Band 5 (Channel Bandwidth: 5 MHz) _ QPSK	
826.5 MHz	<p>Agilent R T Freq/Channel</p> <p>Ch Freq 826.5 MHz Trig Free</p> <p>Center Freq 826.500000 MHz</p> <p>Start Freq 821.500000 MHz</p> <p>Stop Freq 831.500000 MHz</p> <p>CF Step 1.00000000 MHz Auto Man</p> <p>Freq Offset 0.00000000 Hz</p> <p>Signal Track On Off</p> <p>Ref 20 dBm Atten 30 dB</p> <p>#Peak Log 10 dB/Offst 3.9 dB</p> <p>Center 826.50 MHz Span 10 MHz</p> <p>#Res BW 51 kHz #VBW 51 kHz Sweep 4.64 ms (601 pts)</p> <p><b>Occupied Bandwidth 4.4721 MHz</b></p> <p>Occ BW % Pwr 99.00 %</p> <p>x dB -26.00 dB</p> <p>Transmit Freq Error -2.050 kHz</p> <p>x dB Bandwidth 4.891 MHz</p> <p>Copyright 2000-2006 Agilent Technologies</p>
836.5 MHz	<p>Agilent R T Freq/Channel</p> <p>Ch Freq 836.5 MHz Trig Free</p> <p>Center Freq 836.500000 MHz</p> <p>Start Freq 831.500000 MHz</p> <p>Stop Freq 841.500000 MHz</p> <p>CF Step 1.00000000 MHz Auto Man</p> <p>Freq Offset 0.00000000 Hz</p> <p>Signal Track On Off</p> <p>Ref 20 dBm Atten 30 dB</p> <p>#Peak Log 10 dB/Offst 3.9 dB</p> <p>Center 836.50 MHz Span 10 MHz</p> <p>#Res BW 51 kHz #VBW 51 kHz Sweep 4.64 ms (601 pts)</p> <p><b>Occupied Bandwidth 4.4731 MHz</b></p> <p>Occ BW % Pwr 99.00 %</p> <p>x dB -26.00 dB</p> <p>Transmit Freq Error 4.839 kHz</p> <p>x dB Bandwidth 4.839 MHz</p> <p>Copyright 2000-2006 Agilent Technologies</p>
846.5 MHz	<p>Agilent R T Freq/Channel</p> <p>Ch Freq 846.5 MHz Trig Free</p> <p>Center Freq 846.500000 MHz</p> <p>Start Freq 841.500000 MHz</p> <p>Stop Freq 851.500000 MHz</p> <p>CF Step 1.00000000 MHz Auto Man</p> <p>Freq Offset 0.00000000 Hz</p> <p>Signal Track On Off</p> <p>Ref 20 dBm Atten 30 dB</p> <p>#Peak Log 10 dB/Offst 3.9 dB</p> <p>Center 846.50 MHz Span 10 MHz</p> <p>#Res BW 51 kHz #VBW 51 kHz Sweep 4.64 ms (601 pts)</p> <p><b>Occupied Bandwidth 4.4661 MHz</b></p> <p>Occ BW % Pwr 99.00 %</p> <p>x dB -26.00 dB</p> <p>Transmit Freq Error -451.840 Hz</p> <p>x dB Bandwidth 4.920 MHz</p> <p>Copyright 2000-2006 Agilent Technologies</p>

LTE Band 5 (Channel Bandwidth: 10 MHz) _ QPSK	
829.0 MHz	<p>Agilent R T Freq/Channel</p> <p>Ch Freq 829 MHz Trig Free</p> <p>Center Freq 829.000000 MHz</p> <p>Start Freq 819.000000 MHz</p> <p>Stop Freq 839.000000 MHz</p> <p>CF Step 2.00000000 MHz Auto Man</p> <p>Freq Offset 0.00000000 Hz</p> <p>Signal Track On Off</p> <p>Ref 20 dBm Atten 30 dB</p> <p>#Peak Log 10 dB/Offst 3.9 dB</p> <p>Center 829.00 MHz Span 20 MHz</p> <p>#Res BW 110 kHz #VBW 110 kHz Sweep 2 ms (601 pts)</p> <p><b>Occupied Bandwidth 8.9533 MHz</b></p> <p>Occ BW % Pwr 99.00 %</p> <p>x dB -26.00 dB</p> <p>Transmit Freq Error 2.845 kHz</p> <p>x dB Bandwidth 9.679 MHz</p> <p>Copyright 2000-2006 Agilent Technologies</p>
836.5 MHz	<p>Agilent R T Freq/Channel</p> <p>Ch Freq 836.5 MHz Trig Free</p> <p>Center Freq 836.500000 MHz</p> <p>Start Freq 826.500000 MHz</p> <p>Stop Freq 846.500000 MHz</p> <p>CF Step 2.00000000 MHz Auto Man</p> <p>Freq Offset 0.00000000 Hz</p> <p>Signal Track On Off</p> <p>Ref 20 dBm Atten 30 dB</p> <p>#Peak Log 10 dB/Offst 3.9 dB</p> <p>Center 836.50 MHz Span 20 MHz</p> <p>#Res BW 110 kHz #VBW 110 kHz Sweep 2 ms (601 pts)</p> <p><b>Occupied Bandwidth 8.9377 MHz</b></p> <p>Occ BW % Pwr 99.00 %</p> <p>x dB -26.00 dB</p> <p>Transmit Freq Error 1.199 kHz</p> <p>x dB Bandwidth 9.597 MHz</p> <p>Copyright 2000-2006 Agilent Technologies</p>
844.0 MHz	<p>Agilent R T Freq/Channel</p> <p>Ch Freq 844 MHz Trig Free</p> <p>Center Freq 844.000000 MHz</p> <p>Start Freq 834.000000 MHz</p> <p>Stop Freq 854.000000 MHz</p> <p>CF Step 2.00000000 MHz Auto Man</p> <p>Freq Offset 0.00000000 Hz</p> <p>Signal Track On Off</p> <p>Ref 20 dBm Atten 30 dB</p> <p>#Peak Log 10 dB/Offst 3.9 dB</p> <p>Center 844.00 MHz Span 20 MHz</p> <p>#Res BW 110 kHz #VBW 110 kHz Sweep 2 ms (601 pts)</p> <p><b>Occupied Bandwidth 8.9370 MHz</b></p> <p>Occ BW % Pwr 99.00 %</p> <p>x dB -26.00 dB</p> <p>Transmit Freq Error -4.064 kHz</p> <p>x dB Bandwidth 9.703 MHz</p> <p>Copyright 2000-2006 Agilent Technologies</p>

LTE Band 5 (Channel Bandwidth: 1.4 MHz) _ 16QAM	
824.7 MHz	<div style="border: 1px solid black; padding: 5px;"> <p style="text-align: right;">Agilent <span style="float: right;">R T</span></p> <hr/> <p style="text-align: center;"><b>Ch Freq</b> 824.7 MHz <span style="float: right;"><b>Trig</b> Free</span></p> <p>Occupied Bandwidth <span style="float: right;">█</span></p> <hr/> <p>Ref 20 dBm <span style="margin-left: 100px;">Atten 30 dB</span></p> <p style="text-align: center;">Center 824.700 MHz <span style="float: right;">Span 3 MHz</span></p> <p>#Res BW 15 kHz <span style="margin-left: 100px;">#VBW 15 kHz</span> <span style="float: right;">Sweep 16.08 ms (601 pts)</span></p> <div style="border: 2px solid green; padding: 2px; margin-top: 5px;"> <p><b>Occupied Bandwidth</b> <span style="float: right;"><b>Occ BW % Pwr</b> 99.00 %</span></p> <p style="text-align: center; font-size: 1.2em;">1.0795 MHz <span style="float: right;"><b>x dB</b> -26.00 dB</span></p> <p><b>Transmit Freq Error</b> -3.133 kHz</p> <p><b>x dB Bandwidth</b> 1.244 MHz</p> </div> <p style="font-size: 0.8em; color: yellow;">Copyright 2000-2006 Agilent Technologies</p> </div>
836.5 MHz	<div style="border: 1px solid black; padding: 5px;"> <p style="text-align: right;">Agilent <span style="float: right;">R T</span></p> <hr/> <p style="text-align: center;"><b>Ch Freq</b> 836.5 MHz <span style="float: right;"><b>Trig</b> Free</span></p> <p>Occupied Bandwidth <span style="float: right;">█</span></p> <hr/> <p>Ref 20 dBm <span style="margin-left: 100px;">Atten 30 dB</span></p> <p style="text-align: center;">Center 836.500 MHz <span style="float: right;">Span 3 MHz</span></p> <p>#Res BW 15 kHz <span style="margin-left: 100px;">#VBW 15 kHz</span> <span style="float: right;">Sweep 16.08 ms (601 pts)</span></p> <div style="border: 2px solid green; padding: 2px; margin-top: 5px;"> <p><b>Occupied Bandwidth</b> <span style="float: right;"><b>Occ BW % Pwr</b> 99.00 %</span></p> <p style="text-align: center; font-size: 1.2em;">1.0771 MHz <span style="float: right;"><b>x dB</b> -26.00 dB</span></p> <p><b>Transmit Freq Error</b> 1.402 kHz</p> <p><b>x dB Bandwidth</b> 1.215 MHz</p> </div> <p style="font-size: 0.8em; color: yellow;">Copyright 2000-2006 Agilent Technologies</p> </div>
848.3 MHz	<div style="border: 1px solid black; padding: 5px;"> <p style="text-align: right;">Agilent <span style="float: right;">R T</span></p> <hr/> <p style="text-align: center;"><b>Ch Freq</b> 848.3 MHz <span style="float: right;"><b>Trig</b> Free</span></p> <p>Occupied Bandwidth <span style="float: right;">█</span></p> <hr/> <p>Ref 20 dBm <span style="margin-left: 100px;">Atten 30 dB</span></p> <p style="text-align: center;">Center 848.300 MHz <span style="float: right;">Span 3 MHz</span></p> <p>#Res BW 15 kHz <span style="margin-left: 100px;">#VBW 15 kHz</span> <span style="float: right;">Sweep 16.08 ms (601 pts)</span></p> <div style="border: 2px solid green; padding: 2px; margin-top: 5px;"> <p><b>Occupied Bandwidth</b> <span style="float: right;"><b>Occ BW % Pwr</b> 99.00 %</span></p> <p style="text-align: center; font-size: 1.2em;">1.0787 MHz <span style="float: right;"><b>x dB</b> -26.00 dB</span></p> <p><b>Transmit Freq Error</b> -1.493 kHz</p> <p><b>x dB Bandwidth</b> 1.253 MHz</p> </div> <p style="font-size: 0.8em; color: yellow;">Copyright 2000-2006 Agilent Technologies</p> </div>

LTE Band 5 (Channel Bandwidth: 3 MHz) _ 16QAM	
825.5 MHz	<p><b>Agilent</b> R T Freq/Channel</p> <p>Ch Freq 825.5 MHz Trig Free</p> <p>Center Freq 825.500000 MHz</p> <p>Start Freq 822.500000 MHz</p> <p>Stop Freq 828.500000 MHz</p> <p>CF Step 600.000000 kHz Auto Man</p> <p>Freq Offset 0.00000000 Hz</p> <p>Signal Track On Off</p> <p>Ref 20 dBm Atten 30 dB</p> <p>#Peak Log 10 dB/Offst 3.9 dB</p> <p>Center 825.500 MHz Span 6 MHz</p> <p>#Res BW 33 kHz #VBW 33 kHz Sweep 6.68 ms (601 pts)</p> <p><b>Occupied Bandwidth 2.6904 MHz</b> Occ BW % Pwr 99.00 % x dB -26.00 dB</p> <p>Transmit Freq Error 5.031 kHz x dB Bandwidth 2.970 MHz</p> <p>Copyright 2000-2006 Agilent Technologies</p>
836.5 MHz	<p><b>Agilent</b> R T Freq/Channel</p> <p>Ch Freq 836.5 MHz Trig Free</p> <p>Center Freq 836.500000 MHz</p> <p>Start Freq 833.500000 MHz</p> <p>Stop Freq 839.500000 MHz</p> <p>CF Step 600.000000 kHz Auto Man</p> <p>Freq Offset 0.00000000 Hz</p> <p>Signal Track On Off</p> <p>Ref 20 dBm Atten 30 dB</p> <p>#Peak Log 10 dB/Offst 3.9 dB</p> <p>Start 833.500 MHz Stop 839.500 MHz</p> <p>#Res BW 33 kHz #VBW 33 kHz Sweep 6.68 ms (601 pts)</p> <p><b>Occupied Bandwidth 2.6786 MHz</b> Occ BW % Pwr 99.00 % x dB -26.00 dB</p> <p>Transmit Freq Error -1.785 kHz x dB Bandwidth 2.958 MHz</p> <p>Copyright 2000-2006 Agilent Technologies</p>
847.5 MHz	<p><b>Agilent</b> R T Freq/Channel</p> <p>Ch Freq 847.5 MHz Trig Free</p> <p>Center Freq 847.500000 MHz</p> <p>Start Freq 844.500000 MHz</p> <p>Stop Freq 850.500000 MHz</p> <p>CF Step 600.000000 kHz Auto Man</p> <p>Freq Offset 0.00000000 Hz</p> <p>Signal Track On Off</p> <p>Ref 20 dBm Atten 30 dB</p> <p>#Peak Log 10 dB/Offst 3.9 dB</p> <p>Start 844.500 MHz Stop 850.500 MHz</p> <p>#Res BW 33 kHz #VBW 33 kHz Sweep 6.68 ms (601 pts)</p> <p><b>Occupied Bandwidth 2.6872 MHz</b> Occ BW % Pwr 99.00 % x dB -26.00 dB</p> <p>Transmit Freq Error 875.773 Hz x dB Bandwidth 2.961 MHz</p> <p>Copyright 2000-2006 Agilent Technologies</p>

LTE Band 5 (Channel Bandwidth: 5 MHz) _ 16QAM	
826.5 MHz	<p>Agilent R T Freq/Channel</p> <p>Ch Freq 826.5 MHz Trig Free</p> <p>Center Freq 826.500000 MHz</p> <p>Start Freq 821.500000 MHz</p> <p>Stop Freq 831.500000 MHz</p> <p>CF Step 1.00000000 MHz Auto Man</p> <p>Freq Offset 0.00000000 Hz</p> <p>Signal Track On Off</p> <p>Ref 20 dBm Atten 30 dB</p> <p>#Peak Log 10 dB/Offst 3.9 dB</p> <p>Center 826.50 MHz Span 10 MHz</p> <p>#Res BW 51 kHz #VBW 51 kHz Sweep 4.64 ms (601 pts)</p> <p><b>Occupied Bandwidth 4.4735 MHz</b></p> <p>Occ BW % Pwr 99.00 %</p> <p>x dB -26.00 dB</p> <p>Transmit Freq Error -1.425 kHz</p> <p>x dB Bandwidth 4.888 MHz</p> <p>Copyright 2000-2006 Agilent Technologies</p>
836.5 MHz	<p>Agilent R T Freq/Channel</p> <p>Ch Freq 836.5 MHz Trig Free</p> <p>Center Freq 836.500000 MHz</p> <p>Start Freq 831.500000 MHz</p> <p>Stop Freq 841.500000 MHz</p> <p>CF Step 1.00000000 MHz Auto Man</p> <p>Freq Offset 0.00000000 Hz</p> <p>Signal Track On Off</p> <p>Ref 20 dBm Atten 30 dB</p> <p>#Peak Log 10 dB/Offst 3.9 dB</p> <p>Center 836.50 MHz Span 10 MHz</p> <p>#Res BW 51 kHz #VBW 51 kHz Sweep 4.64 ms (601 pts)</p> <p><b>Occupied Bandwidth 4.4737 MHz</b></p> <p>Occ BW % Pwr 99.00 %</p> <p>x dB -26.00 dB</p> <p>Transmit Freq Error 3.345 kHz</p> <p>x dB Bandwidth 4.928 MHz</p> <p>Copyright 2000-2006 Agilent Technologies</p>
846.5 MHz	<p>Agilent R T Freq/Channel</p> <p>Ch Freq 846.5 MHz Trig Free</p> <p>Center Freq 846.500000 MHz</p> <p>Start Freq 841.500000 MHz</p> <p>Stop Freq 851.500000 MHz</p> <p>CF Step 1.00000000 MHz Auto Man</p> <p>Freq Offset 0.00000000 Hz</p> <p>Signal Track On Off</p> <p>Ref 20 dBm Atten 30 dB</p> <p>#Peak Log 10 dB/Offst 3.9 dB</p> <p>Center 846.50 MHz Span 10 MHz</p> <p>#Res BW 51 kHz #VBW 51 kHz Sweep 4.64 ms (601 pts)</p> <p><b>Occupied Bandwidth 4.4621 MHz</b></p> <p>Occ BW % Pwr 99.00 %</p> <p>x dB -26.00 dB</p> <p>Transmit Freq Error 3.056 kHz</p> <p>x dB Bandwidth 4.877 MHz</p> <p>Copyright 2000-2006 Agilent Technologies</p>

LTE Band 5 (Channel Bandwidth: 10 MHz) _ 16QAM	
829.0 MHz	<p>Agilent R T Freq/Channel</p> <p>Ch Freq 829 MHz Trig Free</p> <p>Center Freq 829.000000 MHz</p> <p>Start Freq 819.000000 MHz</p> <p>Stop Freq 839.000000 MHz</p> <p>CF Step 2.00000000 MHz Auto Man</p> <p>Freq Offset 0.00000000 Hz</p> <p>Signal Track On Off</p> <p>Ref 20 dBm Atten 30 dB</p> <p>#Peak Log 10 dB/Offst 3.9 dB</p> <p>Center 829.00 MHz Span 20 MHz</p> <p>#Res BW 110 kHz #VBW 110 kHz Sweep 2 ms (601 pts)</p> <p><b>Occupied Bandwidth 8.9647 MHz</b></p> <p>Occ BW % Pwr 99.00 %</p> <p>x dB -26.00 dB</p> <p>Transmit Freq Error 3.020 kHz</p> <p>x dB Bandwidth 9.650 MHz</p> <p>Copyright 2000-2006 Agilent Technologies</p>
836.5 MHz	<p>Agilent R T Freq/Channel</p> <p>Ch Freq 836.5 MHz Trig Free</p> <p>Center Freq 836.500000 MHz</p> <p>Start Freq 826.500000 MHz</p> <p>Stop Freq 846.500000 MHz</p> <p>CF Step 2.00000000 MHz Auto Man</p> <p>Freq Offset 0.00000000 Hz</p> <p>Signal Track On Off</p> <p>Ref 20 dBm Atten 30 dB</p> <p>#Peak Log 10 dB/Offst 3.9 dB</p> <p>Center 836.50 MHz Span 20 MHz</p> <p>#Res BW 110 kHz #VBW 110 kHz Sweep 2 ms (601 pts)</p> <p><b>Occupied Bandwidth 8.9403 MHz</b></p> <p>Occ BW % Pwr 99.00 %</p> <p>x dB -26.00 dB</p> <p>Transmit Freq Error 686.075 Hz</p> <p>x dB Bandwidth 9.729 MHz</p> <p>Copyright 2000-2006 Agilent Technologies</p>
844.0 MHz	<p>Agilent R T Freq/Channel</p> <p>Ch Freq 844 MHz Trig Free</p> <p>Center Freq 844.000000 MHz</p> <p>Start Freq 834.000000 MHz</p> <p>Stop Freq 854.000000 MHz</p> <p>CF Step 2.00000000 MHz Auto Man</p> <p>Freq Offset 0.00000000 Hz</p> <p>Signal Track On Off</p> <p>Ref 20 dBm Atten 30 dB</p> <p>#Peak Log 10 dB/Offst 3.9 dB</p> <p>Center 844.00 MHz Span 20 MHz</p> <p>#Res BW 110 kHz #VBW 110 kHz Sweep 2 ms (601 pts)</p> <p><b>Occupied Bandwidth 8.9395 MHz</b></p> <p>Occ BW % Pwr 99.00 %</p> <p>x dB -26.00 dB</p> <p>Transmit Freq Error -1.417 kHz</p> <p>x dB Bandwidth 9.666 MHz</p> <p>Copyright 2000-2006 Agilent Technologies</p>

LTE Band 7 (Channel Bandwidth: 5 MHz) _ QPSK	
2502.5 MHz	<p>Agilent R T Freq/Channel</p> <p>Ch Freq 2.5025 GHz Trig Free</p> <p>Center Freq 2.50250000 GHz</p> <p>Start Freq 2.49750000 GHz</p> <p>Stop Freq 2.50750000 GHz</p> <p>CF Step 1.00000000 MHz Auto Man</p> <p>Freq Offset 0.00000000 Hz</p> <p>Signal Track On Off</p> <p>Ref 20 dBm Atten 30 dB</p> <p>#Peak Log 10 dB/Offst 4.3 dB</p> <p>Center 2.502 50 GHz Span 10 MHz</p> <p>#Res BW 51 kHz #VBW 51 kHz Sweep 4.64 ms (601 pts)</p> <p><b>Occupied Bandwidth 4.4739 MHz</b></p> <p>Occ BW % Pwr 99.00 %</p> <p>x dB -26.00 dB</p> <p>Transmit Freq Error 344.000 Hz</p> <p>x dB Bandwidth 4.967 MHz</p> <p>Copyright 2000-2006 Agilent Technologies</p>
2535.0 MHz	<p>Agilent R T Freq/Channel</p> <p>Ch Freq 2.535 GHz Trig Free</p> <p>Center Freq 2.53500000 GHz</p> <p>Start Freq 2.53000000 GHz</p> <p>Stop Freq 2.54000000 GHz</p> <p>CF Step 1.00000000 MHz Auto Man</p> <p>Freq Offset 0.00000000 Hz</p> <p>Signal Track On Off</p> <p>Ref 20 dBm Atten 30 dB</p> <p>#Peak Log 10 dB/Offst 4.3 dB</p> <p>Center 2.535 00 GHz Span 10 MHz</p> <p>#Res BW 51 kHz #VBW 51 kHz Sweep 4.64 ms (601 pts)</p> <p><b>Occupied Bandwidth 4.4739 MHz</b></p> <p>Occ BW % Pwr 99.00 %</p> <p>x dB -26.00 dB</p> <p>Transmit Freq Error 4.730 kHz</p> <p>x dB Bandwidth 4.928 MHz</p> <p>Copyright 2000-2006 Agilent Technologies</p>
2567.5 MHz	<p>Agilent R T Freq/Channel</p> <p>Ch Freq 2.5675 GHz Trig Free</p> <p>Center Freq 2.56750000 GHz</p> <p>Start Freq 2.56250000 GHz</p> <p>Stop Freq 2.57250000 GHz</p> <p>CF Step 1.00000000 MHz Auto Man</p> <p>Freq Offset 0.00000000 Hz</p> <p>Signal Track On Off</p> <p>Ref 20 dBm Atten 30 dB</p> <p>#Peak Log 10 dB/Offst 4.3 dB</p> <p>Center 2.567 50 GHz Span 10 MHz</p> <p>#Res BW 51 kHz #VBW 51 kHz Sweep 4.64 ms (601 pts)</p> <p><b>Occupied Bandwidth 4.4799 MHz</b></p> <p>Occ BW % Pwr 99.00 %</p> <p>x dB -26.00 dB</p> <p>Transmit Freq Error -3.743 kHz</p> <p>x dB Bandwidth 4.888 MHz</p> <p>Copyright 2000-2006 Agilent Technologies</p>

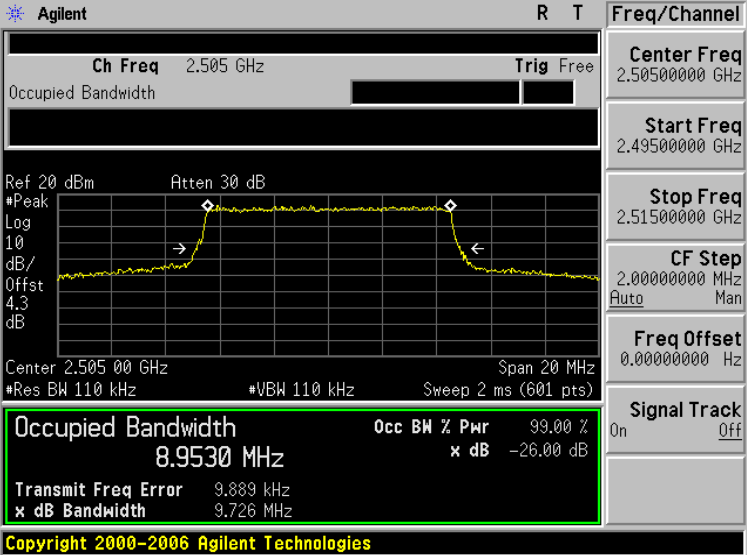
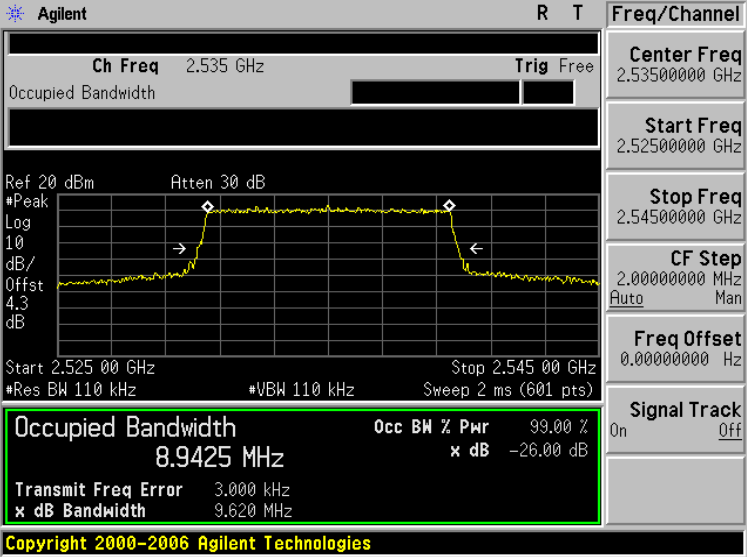
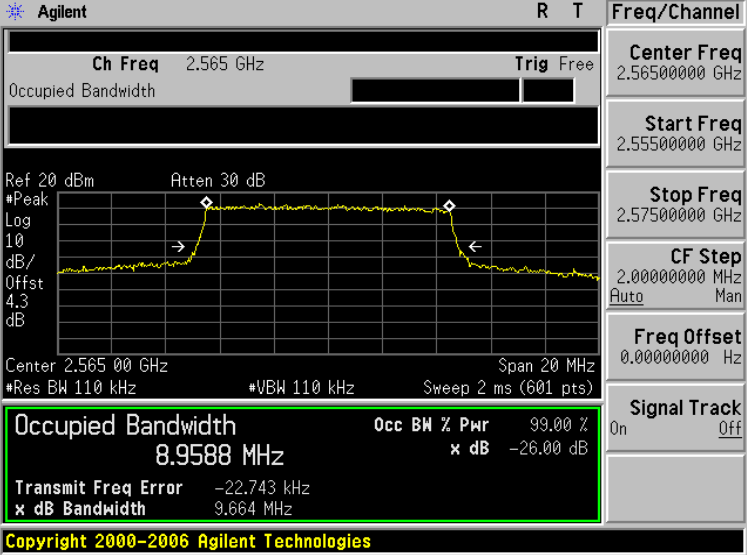

LTE Band 7 (Channel Bandwidth: 10 MHz) _ QPSK	
2505.0 MHz	 <p>Agilent R T Freq/Channel</p> <p>Ch Freq 2.505 GHz Trig Free</p> <p>Center Freq 2.50500000 GHz</p> <p>Start Freq 2.49500000 GHz</p> <p>Stop Freq 2.51500000 GHz</p> <p>CF Step 2.00000000 MHz Auto Man</p> <p>Freq Offset 0.00000000 Hz</p> <p>Signal Track On Off</p> <p>Ref 20 dBm Atten 30 dB</p> <p>#Peak Log 10 dB/Offst 4.3 dB</p> <p>Center 2.505 00 GHz Span 20 MHz</p> <p>#Res BW 110 kHz #VBW 110 kHz Sweep 2 ms (601 pts)</p> <p><b>Occupied Bandwidth 8.9530 MHz</b></p> <p>Occ BW % Pwr 99.00 %</p> <p>x dB -26.00 dB</p> <p>Transmit Freq Error 9.889 kHz</p> <p>x dB Bandwidth 9.726 MHz</p> <p>Copyright 2000-2006 Agilent Technologies</p>
2535.0 MHz	 <p>Agilent R T Freq/Channel</p> <p>Ch Freq 2.535 GHz Trig Free</p> <p>Center Freq 2.53500000 GHz</p> <p>Start Freq 2.52500000 GHz</p> <p>Stop Freq 2.54500000 GHz</p> <p>CF Step 2.00000000 MHz Auto Man</p> <p>Freq Offset 0.00000000 Hz</p> <p>Signal Track On Off</p> <p>Ref 20 dBm Atten 30 dB</p> <p>#Peak Log 10 dB/Offst 4.3 dB</p> <p>Start 2.525 00 GHz Stop 2.545 00 GHz</p> <p>#Res BW 110 kHz #VBW 110 kHz Sweep 2 ms (601 pts)</p> <p><b>Occupied Bandwidth 8.9425 MHz</b></p> <p>Occ BW % Pwr 99.00 %</p> <p>x dB -26.00 dB</p> <p>Transmit Freq Error 3.000 kHz</p> <p>x dB Bandwidth 9.620 MHz</p> <p>Copyright 2000-2006 Agilent Technologies</p>
2565.0 MHz	 <p>Agilent R T Freq/Channel</p> <p>Ch Freq 2.565 GHz Trig Free</p> <p>Center Freq 2.56500000 GHz</p> <p>Start Freq 2.55500000 GHz</p> <p>Stop Freq 2.57500000 GHz</p> <p>CF Step 2.00000000 MHz Auto Man</p> <p>Freq Offset 0.00000000 Hz</p> <p>Signal Track On Off</p> <p>Ref 20 dBm Atten 30 dB</p> <p>#Peak Log 10 dB/Offst 4.3 dB</p> <p>Center 2.565 00 GHz Span 20 MHz</p> <p>#Res BW 110 kHz #VBW 110 kHz Sweep 2 ms (601 pts)</p> <p><b>Occupied Bandwidth 8.9588 MHz</b></p> <p>Occ BW % Pwr 99.00 %</p> <p>x dB -26.00 dB</p> <p>Transmit Freq Error -22.743 kHz</p> <p>x dB Bandwidth 9.664 MHz</p> <p>Copyright 2000-2006 Agilent Technologies</p>

LTE Band 7 (Channel Bandwidth: 15 MHz) _ QPSK	
2507.5 MHz	<p>Agilent R T Freq/Channel</p> <p>Ch Freq 2.5075 GHz Trig Free</p> <p>Center Freq 2.50750000 GHz</p> <p>Start Freq 2.49250000 GHz</p> <p>Stop Freq 2.52250000 GHz</p> <p>CF Step 3.00000000 MHz Auto Man</p> <p>Freq Offset 0.00000000 Hz</p> <p>Signal Track On Off</p> <p>Ref 20 dBm Atten 30 dB</p> <p>#Peak Log 10 dB/Offst 4.3 dB</p> <p>Center 2.507 50 GHz Span 30 MHz</p> <p>#Res BW 160 kHz #VBW 160 kHz Sweep 1.44 ms (601 pts)</p> <p><b>Occupied Bandwidth 13.4406 MHz</b></p> <p>Occ BW % Pwr 99.00 % x dB -26.00 dB</p> <p>Transmit Freq Error 22.908 kHz</p> <p>x dB Bandwidth 14.574 MHz</p> <p>Copyright 2000-2006 Agilent Technologies</p>
2535.0 MHz	<p>Agilent R T Freq/Channel</p> <p>Ch Freq 2.535 GHz Trig Free</p> <p>Center Freq 2.53500000 GHz</p> <p>Start Freq 2.52000000 GHz</p> <p>Stop Freq 2.55000000 GHz</p> <p>CF Step 3.00000000 MHz Auto Man</p> <p>Freq Offset 0.00000000 Hz</p> <p>Signal Track On Off</p> <p>Ref 20 dBm Atten 30 dB</p> <p>#Peak Log 10 dB/Offst 4.3 dB</p> <p>Center 2.535 00 GHz Span 30 MHz</p> <p>#Res BW 160 kHz #VBW 160 kHz Sweep 1.44 ms (601 pts)</p> <p><b>Occupied Bandwidth 13.3814 MHz</b></p> <p>Occ BW % Pwr 99.00 % x dB -26.00 dB</p> <p>Transmit Freq Error 7.528 kHz</p> <p>x dB Bandwidth 14.418 MHz</p> <p>Copyright 2000-2006 Agilent Technologies</p>
2562.5 MHz	<p>Agilent R T Freq/Channel</p> <p>Ch Freq 2.5625 GHz Trig Free</p> <p>Center Freq 2.56250000 GHz</p> <p>Start Freq 2.54750000 GHz</p> <p>Stop Freq 2.57750000 GHz</p> <p>CF Step 3.00000000 MHz Auto Man</p> <p>Freq Offset 0.00000000 Hz</p> <p>Signal Track On Off</p> <p>Ref 20 dBm Atten 30 dB</p> <p>#Peak Log 10 dB/Offst 4.3 dB</p> <p>Center 2.562 50 GHz Span 30 MHz</p> <p>#Res BW 160 kHz #VBW 160 kHz Sweep 1.44 ms (601 pts)</p> <p><b>Occupied Bandwidth 13.3792 MHz</b></p> <p>Occ BW % Pwr 99.00 % x dB -26.00 dB</p> <p>Transmit Freq Error -24.699 kHz</p> <p>x dB Bandwidth 14.397 MHz</p> <p>Copyright 2000-2006 Agilent Technologies</p>

LTE Band 7 (Channel Bandwidth: 20 MHz) _ QPSK	
2510.0 MHz	<p>Agilent R T Freq/Channel</p> <p>Ch Freq 2.51 GHz Trig Free</p> <p>Center Freq 2.51000000 GHz</p> <p>Start Freq 2.49000000 GHz</p> <p>Stop Freq 2.53000000 GHz</p> <p>CF Step 4.00000000 MHz Auto Man</p> <p>Freq Offset 0.00000000 Hz</p> <p>Signal Track On Off</p> <p>Ref 20 dBm Atten 30 dB</p> <p>#Peak Log 10 dB/Offst 4.3 dB</p> <p>Center 2.510 00 GHz Span 40 MHz</p> <p>#Res BW 220 kHz #VBW 220 kHz Sweep 1 ms (601 pts)</p> <p><b>Occupied Bandwidth 17.8502 MHz</b></p> <p>Occ BW % Pwr 99.00 % x dB -26.00 dB</p> <p>Transmit Freq Error 17.376 kHz</p> <p>x dB Bandwidth 18.967 MHz</p> <p>Copyright 2000-2006 Agilent Technologies</p>
2535.0 MHz	<p>Agilent R T Freq/Channel</p> <p>Ch Freq 2.535 GHz Trig Free</p> <p>Center Freq 2.53500000 GHz</p> <p>Start Freq 2.51500000 GHz</p> <p>Stop Freq 2.55500000 GHz</p> <p>CF Step 4.00000000 MHz Auto Man</p> <p>Freq Offset 0.00000000 Hz</p> <p>Signal Track On Off</p> <p>Ref 20 dBm Atten 30 dB</p> <p>#Peak Log 10 dB/Offst 4.3 dB</p> <p>Center 2.535 00 GHz Span 40 MHz</p> <p>#Res BW 220 kHz #VBW 220 kHz Sweep 1 ms (601 pts)</p> <p><b>Occupied Bandwidth 17.8831 MHz</b></p> <p>Occ BW % Pwr 99.00 % x dB -26.00 dB</p> <p>Transmit Freq Error 26.083 kHz</p> <p>x dB Bandwidth 19.215 MHz</p> <p>Copyright 2000-2006 Agilent Technologies</p>
2560.0 MHz	<p>Agilent R T Freq/Channel</p> <p>Ch Freq 2.56 GHz Trig Free</p> <p>Center Freq 2.56000000 GHz</p> <p>Start Freq 2.54000000 GHz</p> <p>Stop Freq 2.58000000 GHz</p> <p>CF Step 4.00000000 MHz Auto Man</p> <p>Freq Offset 0.00000000 Hz</p> <p>Signal Track On Off</p> <p>Ref 20 dBm Atten 30 dB</p> <p>#Peak Log 10 dB/Offst 4.3 dB</p> <p>Center 2.560 00 GHz Span 40 MHz</p> <p>#Res BW 220 kHz #VBW 220 kHz Sweep 1 ms (601 pts)</p> <p><b>Occupied Bandwidth 17.8134 MHz</b></p> <p>Occ BW % Pwr 99.00 % x dB -26.00 dB</p> <p>Transmit Freq Error -18.224 kHz</p> <p>x dB Bandwidth 19.066 MHz</p> <p>Copyright 2000-2006 Agilent Technologies</p>

LTE Band 7 (Channel Bandwidth: 5 MHz) _ 16QAM	
2502.5 MHz	<p>Agilent R T Freq/Channel</p> <p>Ch Freq 2.5025 GHz Trig Free</p> <p>Center Freq 2.50250000 GHz</p> <p>Start Freq 2.49750000 GHz</p> <p>Stop Freq 2.50750000 GHz</p> <p>CF Step 1.00000000 MHz</p> <p>Freq Offset 0.00000000 Hz</p> <p>Signal Track On Off</p> <p>Ref 20 dBm Atten 30 dB</p> <p>#Peak Log 10 dB/Offst 4.3 dB</p> <p>Center 2.502 50 GHz Span 10 MHz</p> <p>#Res BW 51 kHz #VBW 51 kHz Sweep 4.64 ms (601 pts)</p> <p><b>Occupied Bandwidth 4.4697 MHz</b></p> <p>Occ BW % Pwr 99.00 %</p> <p>x dB -26.00 dB</p> <p>Transmit Freq Error -2.210 kHz</p> <p>x dB Bandwidth 4.967 MHz</p> <p>Copyright 2000-2006 Agilent Technologies</p>
2535.0 MHz	<p>Agilent R T Freq/Channel</p> <p>Ch Freq 2.535 GHz Trig Free</p> <p>Center Freq 2.53500000 GHz</p> <p>Start Freq 2.53000000 GHz</p> <p>Stop Freq 2.54000000 GHz</p> <p>CF Step 1.00000000 MHz</p> <p>Freq Offset 0.00000000 Hz</p> <p>Signal Track On Off</p> <p>Ref 20 dBm Atten 30 dB</p> <p>#Peak Log 10 dB/Offst 4.3 dB</p> <p>Center 2.535 00 GHz Span 10 MHz</p> <p>#Res BW 51 kHz #VBW 51 kHz Sweep 4.64 ms (601 pts)</p> <p><b>Occupied Bandwidth 4.4728 MHz</b></p> <p>Occ BW % Pwr 99.00 %</p> <p>x dB -26.00 dB</p> <p>Transmit Freq Error 3.977 kHz</p> <p>x dB Bandwidth 4.928 MHz</p> <p>Copyright 2000-2006 Agilent Technologies</p>
2567.5 MHz	<p>Agilent R T Freq/Channel</p> <p>Ch Freq 2.5675 GHz Trig Free</p> <p>Center Freq 2.56750000 GHz</p> <p>Start Freq 2.56250000 GHz</p> <p>Stop Freq 2.57250000 GHz</p> <p>CF Step 1.00000000 MHz</p> <p>Freq Offset 0.00000000 Hz</p> <p>Signal Track On Off</p> <p>Ref 20 dBm Atten 30 dB</p> <p>#Peak Log 10 dB/Offst 4.3 dB</p> <p>Center 2.567 50 GHz Span 10 MHz</p> <p>#Res BW 51 kHz #VBW 51 kHz Sweep 4.64 ms (601 pts)</p> <p><b>Occupied Bandwidth 4.4641 MHz</b></p> <p>Occ BW % Pwr 99.00 %</p> <p>x dB -26.00 dB</p> <p>Transmit Freq Error 2.524 kHz</p> <p>x dB Bandwidth 4.864 MHz</p> <p>Copyright 2000-2006 Agilent Technologies</p>

LTE Band 7 (Channel Bandwidth: 10 MHz) _16QAM	
2505.0 MHz	<p>Agilent R T Freq/Channel</p> <p>Ch Freq 2.505 GHz Trig Free</p> <p>Center Freq 2.50500000 GHz</p> <p>Start Freq 2.49500000 GHz</p> <p>Stop Freq 2.51500000 GHz</p> <p>CF Step 2.00000000 MHz Auto Man</p> <p>Freq Offset 0.00000000 Hz</p> <p>Signal Track On Off</p> <p>Ref 20 dBm Atten 30 dB</p> <p>#Peak Log 10 dB/Offst 4.3 dB</p> <p>Center 2.505 00 GHz Span 20 MHz</p> <p>#Res BW 110 kHz #VBW 110 kHz Sweep 2 ms (601 pts)</p> <p><b>Occupied Bandwidth 8.9421 MHz</b></p> <p>Occ BW % Pwr 99.00 %</p> <p>x dB -26.00 dB</p> <p>Transmit Freq Error 1.884 kHz</p> <p>x dB Bandwidth 9.722 MHz</p> <p>Copyright 2000-2006 Agilent Technologies</p>
2535.0 MHz	<p>Agilent R T Freq/Channel</p> <p>Ch Freq 2.535 GHz Trig Free</p> <p>Center Freq 2.53500000 GHz</p> <p>Start Freq 2.52500000 GHz</p> <p>Stop Freq 2.54500000 GHz</p> <p>CF Step 2.00000000 MHz Auto Man</p> <p>Freq Offset 0.00000000 Hz</p> <p>Signal Track On Off</p> <p>Ref 20 dBm Atten 30 dB</p> <p>#Peak Log 10 dB/Offst 4.3 dB</p> <p>Start 2.525 00 GHz Stop 2.545 00 GHz</p> <p>#Res BW 110 kHz #VBW 110 kHz Sweep 2 ms (601 pts)</p> <p><b>Occupied Bandwidth 8.9414 MHz</b></p> <p>Occ BW % Pwr 99.00 %</p> <p>x dB -26.00 dB</p> <p>Transmit Freq Error 2.038 kHz</p> <p>x dB Bandwidth 9.631 MHz</p> <p>Copyright 2000-2006 Agilent Technologies</p>
2565.0 MHz	<p>Agilent R T Freq/Channel</p> <p>Ch Freq 2.565 GHz Trig Free</p> <p>Center Freq 2.56500000 GHz</p> <p>Start Freq 2.55500000 GHz</p> <p>Stop Freq 2.57500000 GHz</p> <p>CF Step 2.00000000 MHz Auto Man</p> <p>Freq Offset 0.00000000 Hz</p> <p>Signal Track On Off</p> <p>Ref 20 dBm Atten 30 dB</p> <p>#Peak Log 10 dB/Offst 4.3 dB</p> <p>Center 2.565 00 GHz Span 20 MHz</p> <p>#Res BW 110 kHz #VBW 110 kHz Sweep 2 ms (601 pts)</p> <p><b>Occupied Bandwidth 8.9494 MHz</b></p> <p>Occ BW % Pwr 99.00 %</p> <p>x dB -26.00 dB</p> <p>Transmit Freq Error -28.054 kHz</p> <p>x dB Bandwidth 9.595 MHz</p> <p>Copyright 2000-2006 Agilent Technologies</p>

LTE Band 7 (Channel Bandwidth: 15 MHz) _ 16QAM	
2507.5 MHz	<p>Agilent R T Freq/Channel</p> <p>Ch Freq 2.5075 GHz Trig Free</p> <p>Center Freq 2.50750000 GHz</p> <p>Start Freq 2.49250000 GHz</p> <p>Stop Freq 2.52250000 GHz</p> <p>CF Step 3.00000000 MHz</p> <p>Freq Offset 0.00000000 Hz</p> <p>Signal Track On Off</p> <p>Ref 20 dBm Atten 30 dB</p> <p>#Peak Log 10 dB/Offst 4.3 dB</p> <p>Center 2.507 50 GHz Span 30 MHz</p> <p>#Res BW 160 kHz #VBW 160 kHz Sweep 1.44 ms (601 pts)</p> <p><b>Occupied Bandwidth 13.4479 MHz</b></p> <p>Occ BW % Pwr 99.00 %</p> <p>x dB -26.00 dB</p> <p>Transmit Freq Error 22.000 kHz</p> <p>x dB Bandwidth 14.464 MHz</p> <p>Copyright 2000-2006 Agilent Technologies</p>
2535.0 MHz	<p>Agilent R T Freq/Channel</p> <p>Ch Freq 2.535 GHz Trig Free</p> <p>Center Freq 2.53500000 GHz</p> <p>Start Freq 2.52000000 GHz</p> <p>Stop Freq 2.55000000 GHz</p> <p>CF Step 3.00000000 MHz</p> <p>Freq Offset 0.00000000 Hz</p> <p>Signal Track On Off</p> <p>Ref 20 dBm Atten 30 dB</p> <p>#Peak Log 10 dB/Offst 4.3 dB</p> <p>Center 2.535 00 GHz Span 30 MHz</p> <p>#Res BW 160 kHz #VBW 160 kHz Sweep 1.44 ms (601 pts)</p> <p><b>Occupied Bandwidth 13.3704 MHz</b></p> <p>Occ BW % Pwr 99.00 %</p> <p>x dB -26.00 dB</p> <p>Transmit Freq Error 13.028 kHz</p> <p>x dB Bandwidth 14.559 MHz</p> <p>Copyright 2000-2006 Agilent Technologies</p>
2562.5 MHz	<p>Agilent R T Freq/Channel</p> <p>Ch Freq 2.5625 GHz Trig Free</p> <p>Center Freq 2.56250000 GHz</p> <p>Start Freq 2.54750000 GHz</p> <p>Stop Freq 2.57750000 GHz</p> <p>CF Step 3.00000000 MHz</p> <p>Freq Offset 0.00000000 Hz</p> <p>Signal Track On Off</p> <p>Ref 20 dBm Atten 30 dB</p> <p>#Peak Log 10 dB/Offst 4.3 dB</p> <p>Center 2.562 50 GHz Span 30 MHz</p> <p>#Res BW 160 kHz #VBW 160 kHz Sweep 1.44 ms (601 pts)</p> <p><b>Occupied Bandwidth 13.3982 MHz</b></p> <p>Occ BW % Pwr 99.00 %</p> <p>x dB -26.00 dB</p> <p>Transmit Freq Error -23.984 kHz</p> <p>x dB Bandwidth 14.312 MHz</p> <p>Copyright 2000-2006 Agilent Technologies</p>

LTE Band 7 (Channel Bandwidth: 20 MHz) _ 16QAM	
2510.0 MHz	<p>Agilent R T Freq/Channel</p> <p>Ch Freq 2.51 GHz Trig Free</p> <p>Center Freq 2.51000000 GHz</p> <p>Start Freq 2.49000000 GHz</p> <p>Stop Freq 2.53000000 GHz</p> <p>CF Step 4.00000000 MHz</p> <p>Freq Offset 0.00000000 Hz</p> <p>Signal Track On Off</p> <p>Ref 20 dBm Atten 30 dB</p> <p>#Peak Log 10 dB/Offst 4.3 dB</p> <p>Center 2.510 00 GHz Span 40 MHz</p> <p>#Res BW 220 kHz #VBW 220 kHz Sweep 1 ms (601 pts)</p> <p><b>Occupied Bandwidth 17.8452 MHz</b></p> <p>Occ BW % Pwr 99.00 %</p> <p>x dB -26.00 dB</p> <p>Transmit Freq Error 12.788 kHz</p> <p>x dB Bandwidth 19.088 MHz</p> <p>Copyright 2000-2006 Agilent Technologies</p>
2535.0 MHz	<p>Agilent R T Freq/Channel</p> <p>Ch Freq 2.535 GHz Trig Free</p> <p>Center Freq 2.53500000 GHz</p> <p>Start Freq 2.51500000 GHz</p> <p>Stop Freq 2.55500000 GHz</p> <p>CF Step 4.00000000 MHz</p> <p>Freq Offset 0.00000000 Hz</p> <p>Signal Track On Off</p> <p>Ref 20 dBm Atten 30 dB</p> <p>#Peak Log 10 dB/Offst 4.3 dB</p> <p>Center 2.535 00 GHz Span 40 MHz</p> <p>#Res BW 220 kHz #VBW 220 kHz Sweep 1 ms (601 pts)</p> <p><b>Occupied Bandwidth 17.8887 MHz</b></p> <p>Occ BW % Pwr 99.00 %</p> <p>x dB -26.00 dB</p> <p>Transmit Freq Error 7.427 kHz</p> <p>x dB Bandwidth 19.417 MHz</p> <p>Copyright 2000-2006 Agilent Technologies</p>
2560.0 MHz	<p>Agilent R T Freq/Channel</p> <p>Ch Freq 2.56 GHz Trig Free</p> <p>Center Freq 2.56000000 GHz</p> <p>Start Freq 2.54000000 GHz</p> <p>Stop Freq 2.58000000 GHz</p> <p>CF Step 4.00000000 MHz</p> <p>Freq Offset 0.00000000 Hz</p> <p>Signal Track On Off</p> <p>Ref 20 dBm Atten 30 dB</p> <p>#Peak Log 10 dB/Offst 4.3 dB</p> <p>Center 2.560 00 GHz Span 40 MHz</p> <p>#Res BW 220 kHz #VBW 220 kHz Sweep 1 ms (601 pts)</p> <p><b>Occupied Bandwidth 17.8208 MHz</b></p> <p>Occ BW % Pwr 99.00 %</p> <p>x dB -26.00 dB</p> <p>Transmit Freq Error -31.434 kHz</p> <p>x dB Bandwidth 19.042 MHz</p> <p>Copyright 2000-2006 Agilent Technologies</p>

LTE Band 17 (Channel Bandwidth: 5 MHz) _ QPSK	
706.5 MHz	<p>Agilent R T Freq/Channel</p> <p>Ch Freq 706.5 MHz Trig Free</p> <p>Center Freq 706.500000 MHz</p> <p>Start Freq 701.500000 MHz</p> <p>Stop Freq 711.500000 MHz</p> <p>CF Step 1.00000000 MHz Auto Man</p> <p>Freq Offset 0.00000000 Hz</p> <p>Signal Track On Off</p> <p>Ref 20 dBm Atten 30 dB</p> <p>#Peak Log 10 dB/Offst 3.9 dB</p> <p>Center 706.50 MHz Span 10 MHz</p> <p>#Res BW 51 kHz #VBW 51 kHz Sweep 4.64 ms (601 pts)</p> <p><b>Occupied Bandwidth 4.4803 MHz</b></p> <p>Occ BW % Pwr 99.00 %</p> <p>x dB -26.00 dB</p> <p>Transmit Freq Error 4.276 kHz</p> <p>x dB Bandwidth 5.012 MHz</p> <p>Copyright 2000-2006 Agilent Technologies</p>
710.0 MHz	<p>Agilent R T Freq/Channel</p> <p>Ch Freq 710 MHz Trig Free</p> <p>Center Freq 710.000000 MHz</p> <p>Start Freq 705.000000 MHz</p> <p>Stop Freq 715.000000 MHz</p> <p>CF Step 1.00000000 MHz Auto Man</p> <p>Freq Offset 0.00000000 Hz</p> <p>Signal Track On Off</p> <p>Ref 20 dBm Atten 30 dB</p> <p>#Peak Log 10 dB/Offst 3.9 dB</p> <p>Center 710.00 MHz Span 10 MHz</p> <p>#Res BW 51 kHz #VBW 51 kHz Sweep 4.64 ms (601 pts)</p> <p><b>Occupied Bandwidth 4.4811 MHz</b></p> <p>Occ BW % Pwr 99.00 %</p> <p>x dB -26.00 dB</p> <p>Transmit Freq Error -4.151 kHz</p> <p>x dB Bandwidth 4.904 MHz</p> <p>Copyright 2000-2006 Agilent Technologies</p>
713.5 MHz	<p>Agilent R T Freq/Channel</p> <p>Ch Freq 713.5 MHz Trig Free</p> <p>Center Freq 713.500000 MHz</p> <p>Start Freq 708.500000 MHz</p> <p>Stop Freq 718.500000 MHz</p> <p>CF Step 1.00000000 MHz Auto Man</p> <p>Freq Offset 0.00000000 Hz</p> <p>Signal Track On Off</p> <p>Ref 20 dBm Atten 30 dB</p> <p>#Peak Log 10 dB/Offst 3.9 dB</p> <p>Center 713.50 MHz Span 10 MHz</p> <p>#Res BW 51 kHz #VBW 51 kHz Sweep 4.64 ms (601 pts)</p> <p><b>Occupied Bandwidth 4.4799 MHz</b></p> <p>Occ BW % Pwr 99.00 %</p> <p>x dB -26.00 dB</p> <p>Transmit Freq Error 2.969 kHz</p> <p>x dB Bandwidth 5.018 MHz</p> <p>Copyright 2000-2006 Agilent Technologies</p>



LTE Band 17 (Channel Bandwidth: 10 MHz) _ QPSK	
709.0 MHz	<p>Agilent R T Freq/Channel</p> <p>Ch Freq 709 MHz Trig Free</p> <p>Center Freq 709.000000 MHz</p> <p>Start Freq 699.000000 MHz</p> <p>Stop Freq 719.000000 MHz</p> <p>CF Step 2.00000000 MHz Auto Man</p> <p>Freq Offset 0.00000000 Hz</p> <p>Signal Track On Off</p> <p>Ref 20 dBm Atten 30 dB</p> <p>#Peak Log 10 dB/Offst 3.9 dB</p> <p>Center 709.00 MHz Span 20 MHz</p> <p>#Res BW 110 kHz #VBW 110 kHz Sweep 2 ms (601 pts)</p> <p><b>Occupied Bandwidth 8.9567 MHz</b></p> <p>Occ BW % Pwr 99.00 % x dB -26.00 dB</p> <p>Transmit Freq Error -8.533 kHz x dB Bandwidth 9.802 MHz</p> <p>Copyright 2000-2006 Agilent Technologies</p>
710.0 MHz	<p>Agilent R T Freq/Channel</p> <p>Ch Freq 710 MHz Trig Free</p> <p>Center Freq 710.000000 MHz</p> <p>Start Freq 700.000000 MHz</p> <p>Stop Freq 720.000000 MHz</p> <p>CF Step 2.00000000 MHz Auto Man</p> <p>Freq Offset 0.00000000 Hz</p> <p>Signal Track On Off</p> <p>Ref 20 dBm Atten 30 dB</p> <p>#Peak Log 10 dB/Offst 3.9 dB</p> <p>Center 710.00 MHz Span 20 MHz</p> <p>#Res BW 110 kHz #VBW 110 kHz Sweep 2 ms (601 pts)</p> <p><b>Occupied Bandwidth 8.9502 MHz</b></p> <p>Occ BW % Pwr 99.00 % x dB -26.00 dB</p> <p>Transmit Freq Error -6.070 kHz x dB Bandwidth 9.600 MHz</p> <p>Copyright 2000-2006 Agilent Technologies</p>
711.0 MHz	<p>Agilent R T Freq/Channel</p> <p>Ch Freq 711 MHz Trig Free</p> <p>Center Freq 711.000000 MHz</p> <p>Start Freq 701.000000 MHz</p> <p>Stop Freq 721.000000 MHz</p> <p>CF Step 2.00000000 MHz Auto Man</p> <p>Freq Offset 0.00000000 Hz</p> <p>Signal Track On Off</p> <p>Ref 20 dBm Atten 30 dB</p> <p>#Peak Log 10 dB/Offst 3.9 dB</p> <p>Center 711.00 MHz Span 20 MHz</p> <p>#Res BW 110 kHz #VBW 110 kHz Sweep 2 ms (601 pts)</p> <p><b>Occupied Bandwidth 8.9539 MHz</b></p> <p>Occ BW % Pwr 99.00 % x dB -26.00 dB</p> <p>Transmit Freq Error -6.930 kHz x dB Bandwidth 9.683 MHz</p> <p>Copyright 2000-2006 Agilent Technologies</p>

LTE Band 17 (Channel Bandwidth: 5 MHz) _ 16QAM	
706.5 MHz	<p>Agilent R T Freq/Channel</p> <p>Ch Freq 706.5 MHz Trig Free</p> <p>Center Freq 706.500000 MHz</p> <p>Start Freq 701.500000 MHz</p> <p>Stop Freq 711.500000 MHz</p> <p>CF Step 1.00000000 MHz Auto Man</p> <p>Freq Offset 0.00000000 Hz</p> <p>Signal Track On Off</p> <p>Ref 20 dBm Atten 30 dB</p> <p>#Peak Log 10 dB/Offst 3.9 dB</p> <p>Center 706.50 MHz Span 10 MHz</p> <p>#Res BW 51 kHz #VBW 51 kHz Sweep 4.64 ms (601 pts)</p> <p><b>Occupied Bandwidth 4.4795 MHz</b></p> <p>Occ BW % Pwr 99.00 %</p> <p>x dB -26.00 dB</p> <p>Transmit Freq Error 3.220 kHz</p> <p>x dB Bandwidth 4.900 MHz</p> <p>Copyright 2000-2006 Agilent Technologies</p>
710.0 MHz	<p>Agilent R T Freq/Channel</p> <p>Ch Freq 710 MHz Trig Free</p> <p>Center Freq 710.000000 MHz</p> <p>Start Freq 705.000000 MHz</p> <p>Stop Freq 715.000000 MHz</p> <p>CF Step 1.00000000 MHz Auto Man</p> <p>Freq Offset 0.00000000 Hz</p> <p>Signal Track On Off</p> <p>Ref 20 dBm Atten 30 dB</p> <p>#Peak Log 10 dB/Offst 3.9 dB</p> <p>Center 710.00 MHz Span 10 MHz</p> <p>#Res BW 51 kHz #VBW 51 kHz Sweep 4.64 ms (601 pts)</p> <p><b>Occupied Bandwidth 4.4847 MHz</b></p> <p>Occ BW % Pwr 99.00 %</p> <p>x dB -26.00 dB</p> <p>Transmit Freq Error -6.259 kHz</p> <p>x dB Bandwidth 4.918 MHz</p> <p>Copyright 2000-2006 Agilent Technologies</p>
713.5 MHz	<p>Agilent R T Freq/Channel</p> <p>Ch Freq 713.5 MHz Trig Free</p> <p>Center Freq 713.500000 MHz</p> <p>Start Freq 708.500000 MHz</p> <p>Stop Freq 718.500000 MHz</p> <p>CF Step 1.00000000 MHz Auto Man</p> <p>Freq Offset 0.00000000 Hz</p> <p>Signal Track On Off</p> <p>Ref 20 dBm Atten 30 dB</p> <p>#Peak Log 10 dB/Offst 3.9 dB</p> <p>Center 713.50 MHz Span 10 MHz</p> <p>#Res BW 51 kHz #VBW 51 kHz Sweep 4.64 ms (601 pts)</p> <p><b>Occupied Bandwidth 4.4764 MHz</b></p> <p>Occ BW % Pwr 99.00 %</p> <p>x dB -26.00 dB</p> <p>Transmit Freq Error 2.375 kHz</p> <p>x dB Bandwidth 4.959 MHz</p> <p>Copyright 2000-2006 Agilent Technologies</p>

LTE Band 17 (Channel Bandwidth: 10 MHz) _ 16QAM	
709.0 MHz	<p>Agilent R T Freq/Channel</p> <p>Ch Freq 709 MHz Trig Free</p> <p>Center Freq 709.000000 MHz</p> <p>Start Freq 699.000000 MHz</p> <p>Stop Freq 719.000000 MHz</p> <p>CF Step 2.00000000 MHz Auto Man</p> <p>Freq Offset 0.00000000 Hz</p> <p>Signal Track On Off</p> <p>Ref 20 dBm Atten 30 dB</p> <p>#Peak Log 10 dB/Offst 3.9 dB</p> <p>Center 709.00 MHz Span 20 MHz</p> <p>#Res BW 110 kHz #VBW 110 kHz Sweep 2 ms (601 pts)</p> <p><b>Occupied Bandwidth 8.9562 MHz</b></p> <p>Occ BW % Pwr 99.00 % x dB -26.00 dB</p> <p>Transmit Freq Error -12.690 kHz</p> <p>x dB Bandwidth 9.730 MHz</p> <p>Copyright 2000-2006 Agilent Technologies</p>
710.0 MHz	<p>Agilent R T Freq/Channel</p> <p>Ch Freq 710 MHz Trig Free</p> <p>Center Freq 710.000000 MHz</p> <p>Start Freq 700.000000 MHz</p> <p>Stop Freq 720.000000 MHz</p> <p>CF Step 2.00000000 MHz Auto Man</p> <p>Freq Offset 0.00000000 Hz</p> <p>Signal Track On Off</p> <p>Ref 20 dBm Atten 30 dB</p> <p>#Peak Log 10 dB/Offst 3.9 dB</p> <p>Center 710.00 MHz Span 20 MHz</p> <p>#Res BW 110 kHz #VBW 110 kHz Sweep 2 ms (601 pts)</p> <p><b>Occupied Bandwidth 8.9509 MHz</b></p> <p>Occ BW % Pwr 99.00 % x dB -26.00 dB</p> <p>Transmit Freq Error -4.034 kHz</p> <p>x dB Bandwidth 9.608 MHz</p> <p>Copyright 2000-2006 Agilent Technologies</p>
711.0 MHz	<p>Agilent R T Freq/Channel</p> <p>Ch Freq 711 MHz Trig Free</p> <p>Center Freq 711.000000 MHz</p> <p>Start Freq 701.000000 MHz</p> <p>Stop Freq 721.000000 MHz</p> <p>CF Step 2.00000000 MHz Auto Man</p> <p>Freq Offset 0.00000000 Hz</p> <p>Signal Track On Off</p> <p>Ref 20 dBm Atten 30 dB</p> <p>#Peak Log 10 dB/Offst 3.9 dB</p> <p>Center 711.00 MHz Span 20 MHz</p> <p>#Res BW 110 kHz #VBW 110 kHz Sweep 2 ms (601 pts)</p> <p><b>Occupied Bandwidth 8.9574 MHz</b></p> <p>Occ BW % Pwr 99.00 % x dB -26.00 dB</p> <p>Transmit Freq Error -7.013 kHz</p> <p>x dB Bandwidth 9.627 MHz</p> <p>Copyright 2000-2006 Agilent Technologies</p>

## 6 Peak to Average Ratio Test

### 6.1. Limit

In measuring transmissions in this band using an average power technique, the peak to-average ratio (PAR) of the transmission may not exceed 13 dB.

### 6.2. Test Instruments

Equipment	Manufacturer	Model No.	Serial No.	Cal. Date	Remark
Spectrum Analyzer	Agilent	E4445A	MY46181986	05/10/2014	(1)
Wideband Radio Communication Test	R & S	CMW500	103168	11/05/2014	(1)
Attenuator	RADIALL	R41572000	0603033073	N.C.R.	-----
Power divider	Agilent	87302C	3239A00760	N.C.R.	-----
Test Site	ATL	TE05	TE05	N.C.R.	-----

Remark: <sup>(1)</sup> Calibration period 1 year. <sup>(2)</sup> Calibration period 2 years.

Note: N.C.R. = No Calibration Request.

### 6.3. Setup

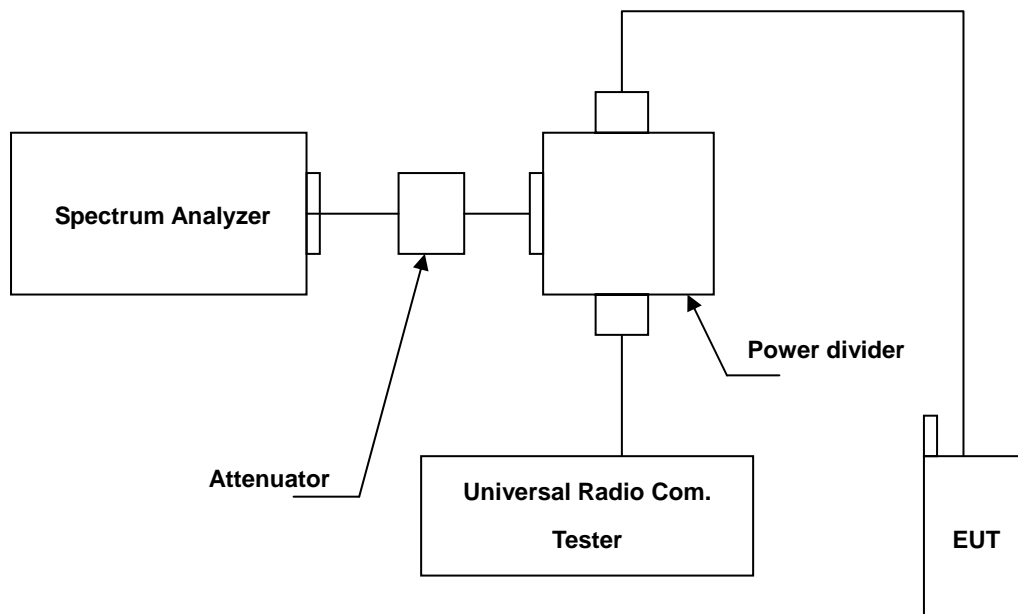

#### **6.4. Test Procedure**

The measurement is made according to FCC rules:

- a. Set resolution/measurement bandwidth = signal's occupied bandwidth;
- b. Set the number of counts to a value that stabilizes the measured CCDF curve;
- c. Record the maximum PAPR level associated with a probability of 0.1%.

#### **6.5. Uncertainty**

The measurement uncertainty is defined as for Conducted Power measurement is 1.2 dB.

**6.6. Test Result**

Model Number	AR7552		
Test Item	Peak to Average Ratio		
Date of Test	04/29/2015	Test Site	TE05

LTE Band 2				
Modulation	Channel Bandwidth	Frequency (MHz)	Peak to Average Ratio (dB)	Limit (dB)
QPSK	1.4 MHz	1880.0	5.70	< 13
	3 MHz	1880.0	5.64	< 13
	5 MHz	1880.0	5.36	< 13
	10 MHz	1880.0	5.69	< 13
	15 MHz	1880.0	5.58	< 13
	20 MHz	1880.0	5.44	< 13
16QAM	1.4 MHz	1880.0	6.56	< 13
	3 MHz	1880.0	6.51	< 13
	5 MHz	1880.0	6.07	< 13
	10 MHz	1880.0	6.55	< 13
	15 MHz	1880.0	6.56	< 13
	20 MHz	1880.0	5.98	< 13

LTE Band 4				
Modulation	Channel Bandwidth	Frequency (MHz)	Peak to Average Ratio (dB)	Limit (dB)
QPSK	1.4 MHz	1732.5	5.47	< 13
	3 MHz	1732.5	5.43	< 13
	5 MHz	1732.5	5.19	< 13
	10 MHz	1732.5	5.41	< 13
	15 MHz	1732.5	5.53	< 13
	20 MHz	1732.5	5.44	< 13
16QAM	1.4 MHz	1732.5	6.38	< 13
	3 MHz	1732.5	6.30	< 13
	5 MHz	1732.5	5.94	< 13
	10 MHz	1732.5	6.29	< 13
	15 MHz	1732.5	6.49	< 13
	20 MHz	1732.5	6.03	< 13

LTE Band 5				
Modulation	Channel Bandwidth	Frequency (MHz)	Peak to Average Ratio (dB)	Limit (dB)
QPSK	1.4 MHz	836.5	5.27	< 13
	3 MHz	836.5	5.12	< 13
	5 MHz	836.5	4.88	< 13
	10 MHz	836.5	4.95	< 13
16QAM	1.4 MHz	836.5	6.29	< 13
	3 MHz	836.5	6.00	< 13
	5 MHz	836.5	5.76	< 13
	10 MHz	836.5	5.80	< 13

LTE Band 7				
Modulation	Channel Bandwidth	Frequency (MHz)	Peak to Average Ratio (dB)	Limit (dB)
QPSK	5 MHz	2535.0	5.03	< 13
	10 MHz	2535.0	5.27	< 13
	15 MHz	2535.0	5.20	< 13
	20 MHz	2535.0	5.11	< 13
16QAM	5 MHz	2535.0	5.81	< 13
	10 MHz	2535.0	6.15	< 13
	15 MHz	2535.0	6.15	< 13
	20 MHz	2535.0	5.77	< 13

LTE Band 17				
Modulation	Channel Bandwidth	Frequency (MHz)	Peak to Average Ratio (dB)	Limit (dB)
QPSK	5 MHz	710.0	5.65	< 13
	10 MHz	710.0	5.86	< 13
16QAM	5 MHz	710.0	6.24	< 13
	10 MHz	710.0	6.72	< 13

**6.7. Test Graphs**

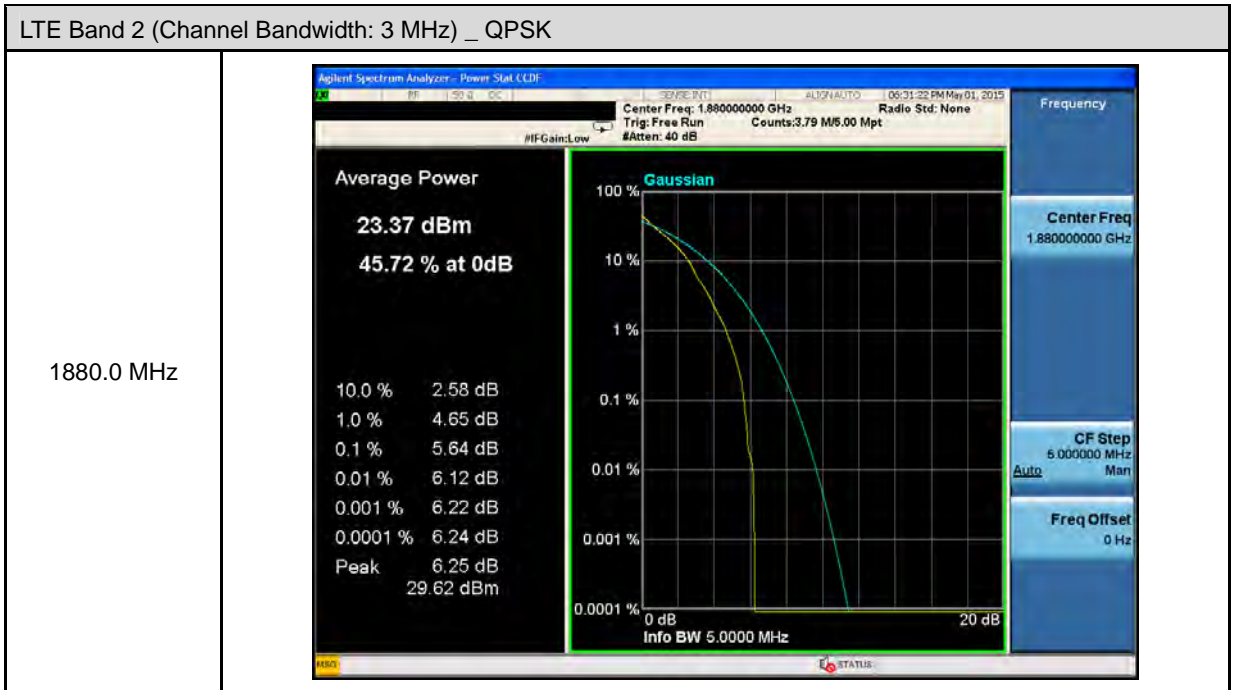
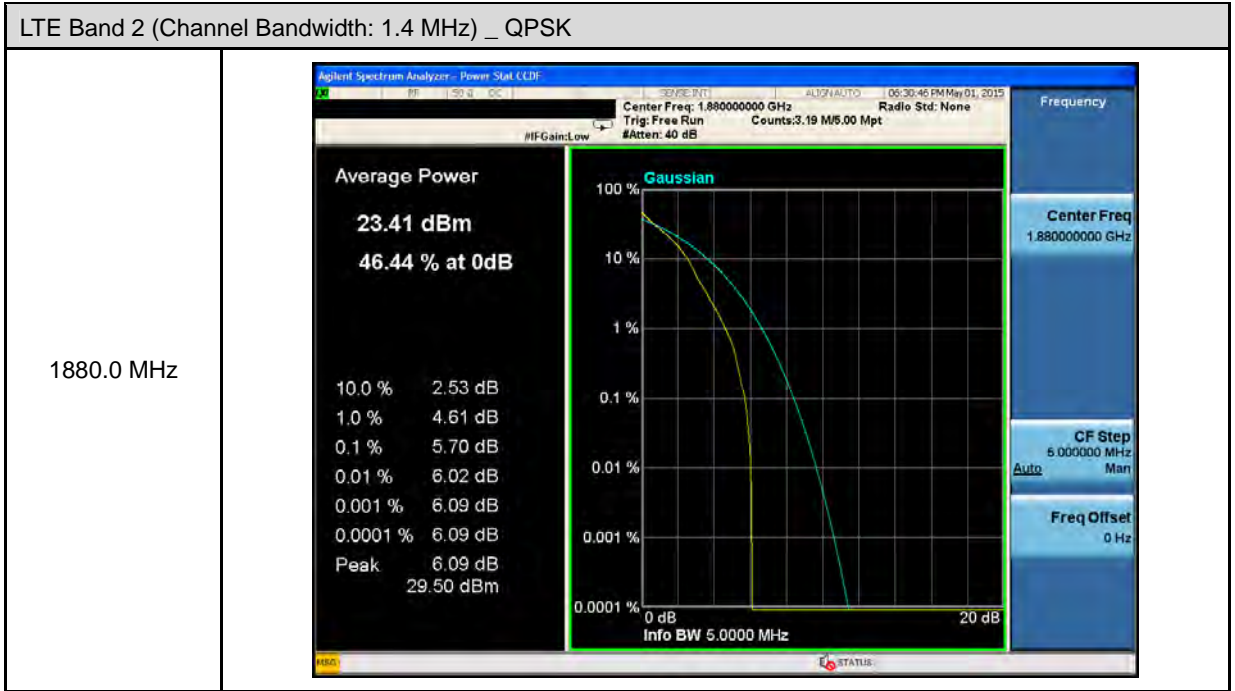



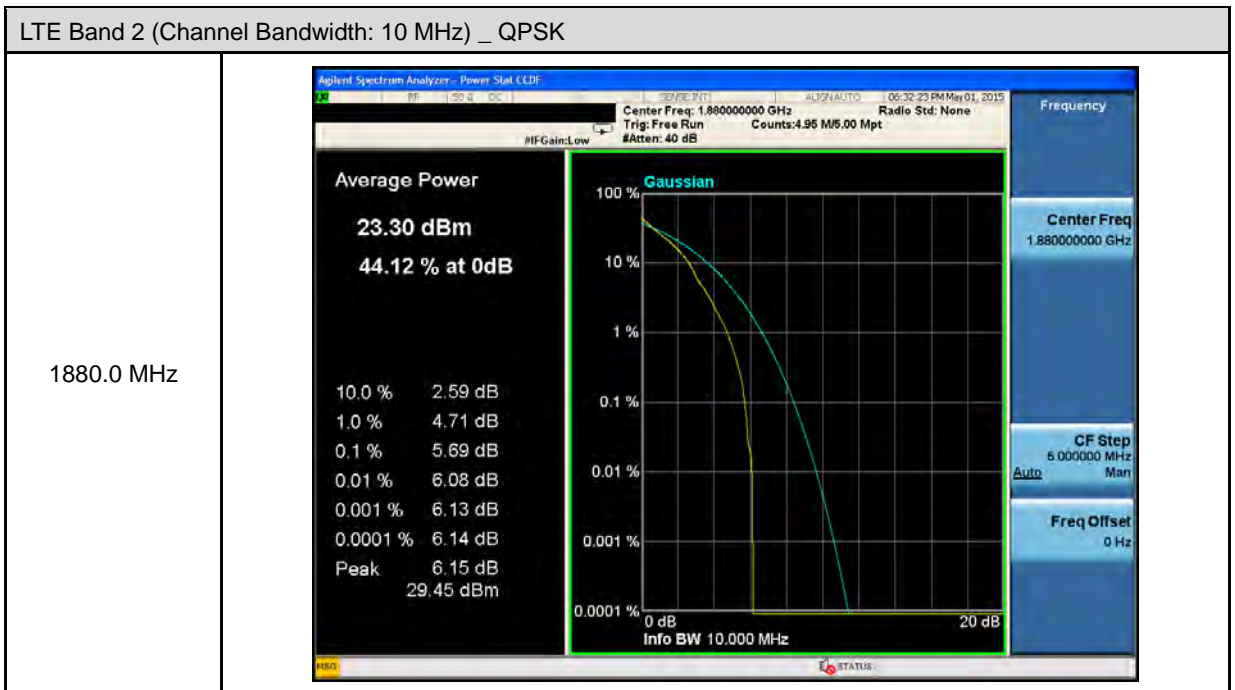
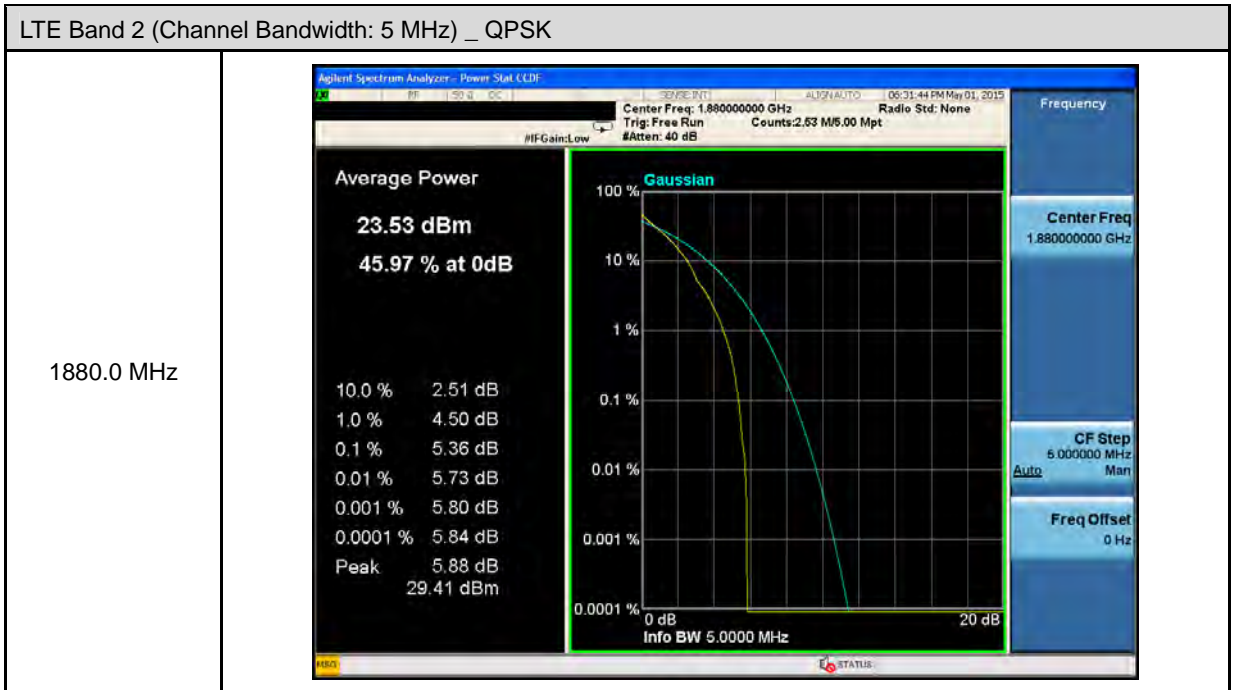

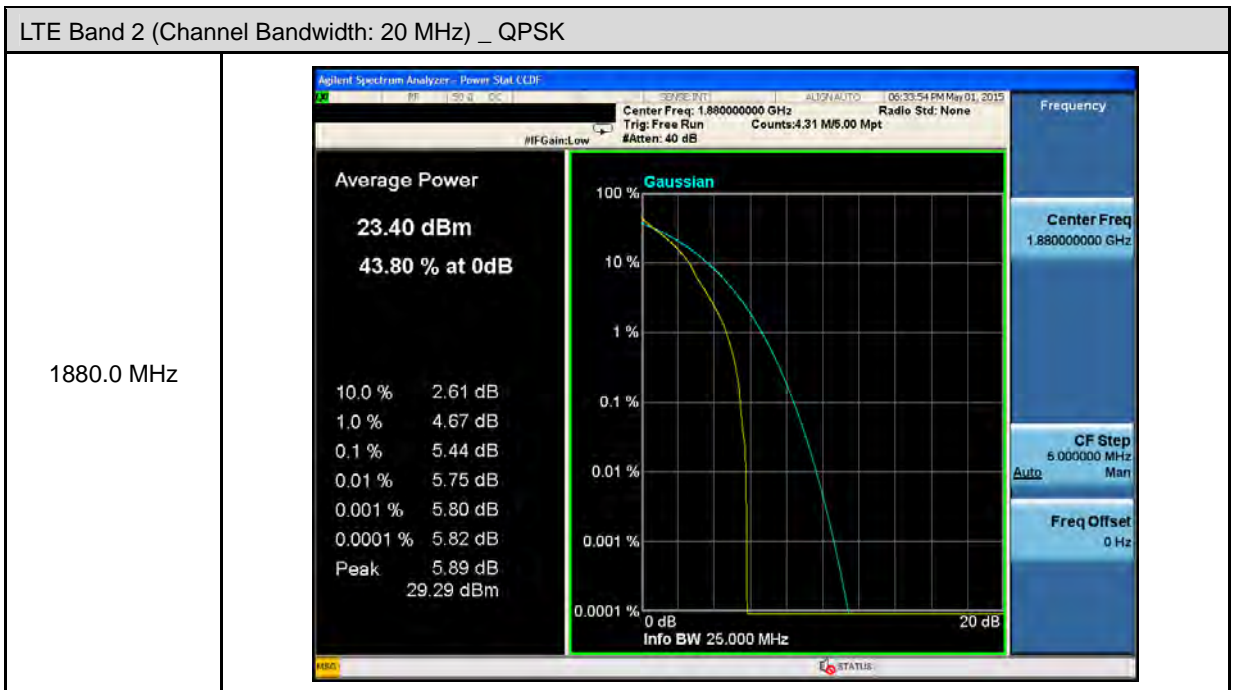
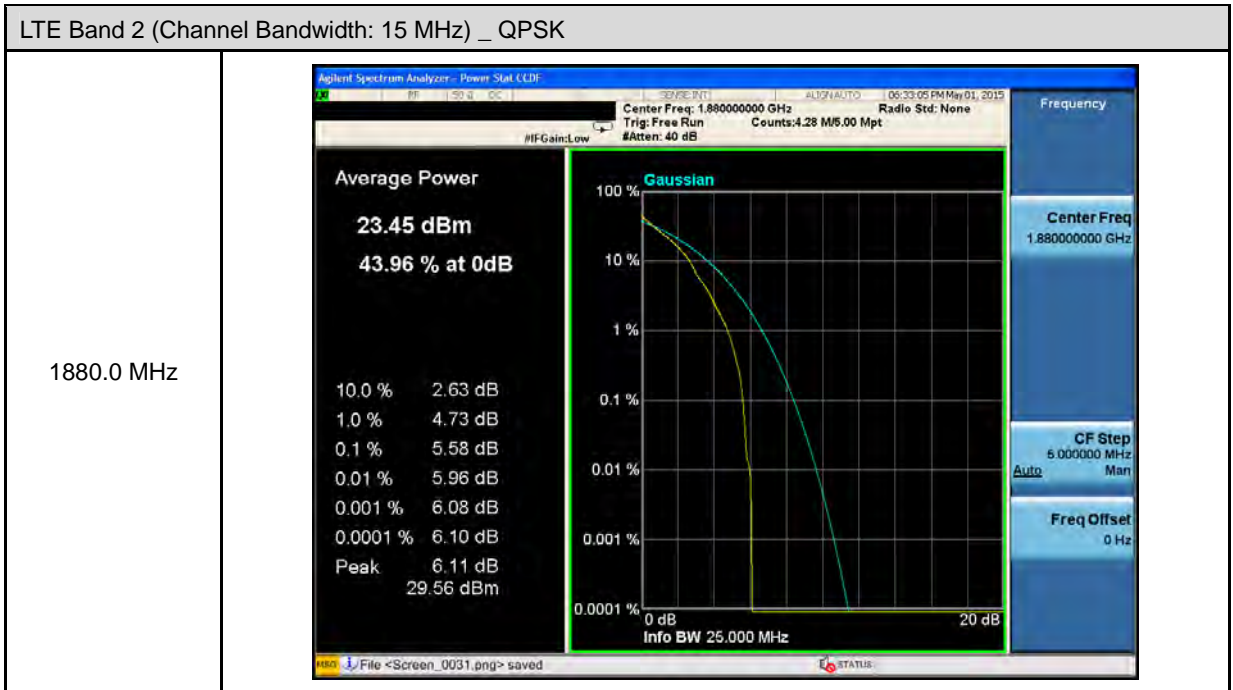

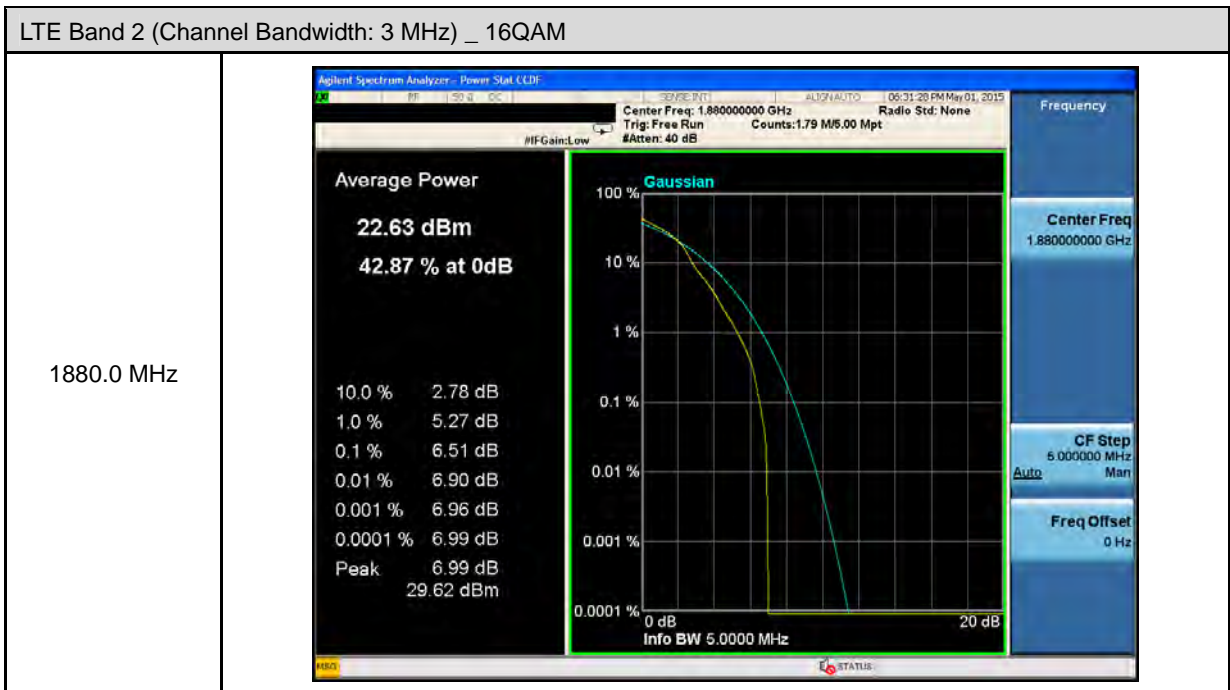
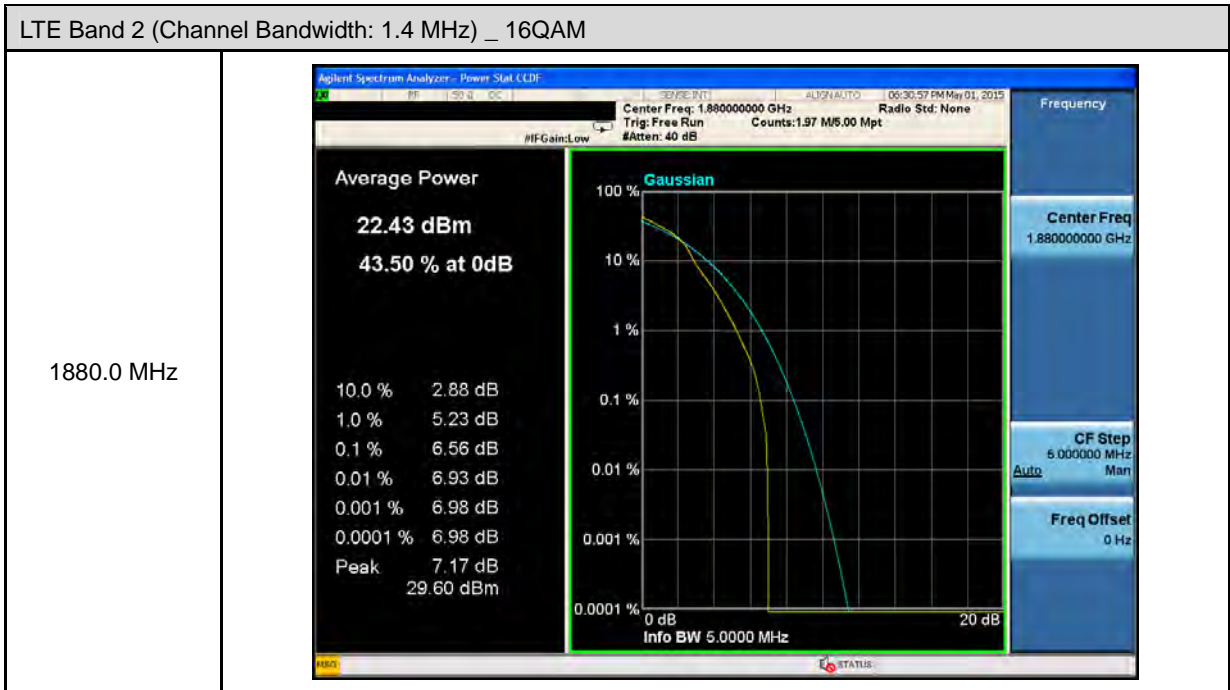

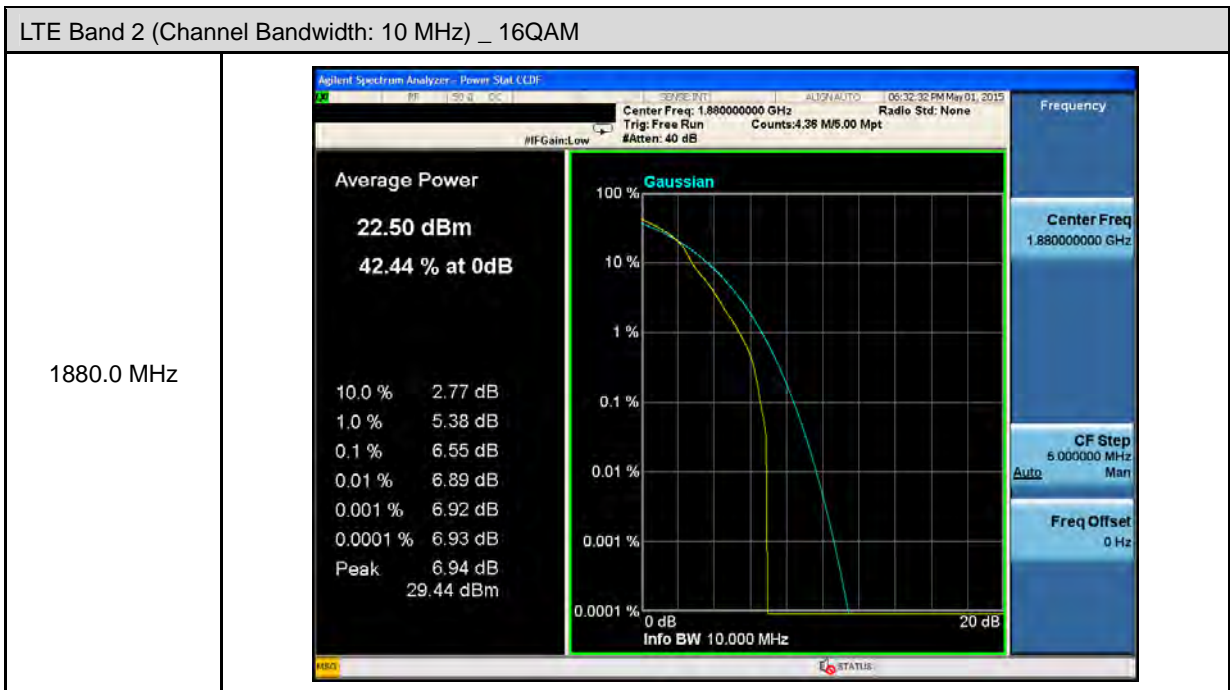
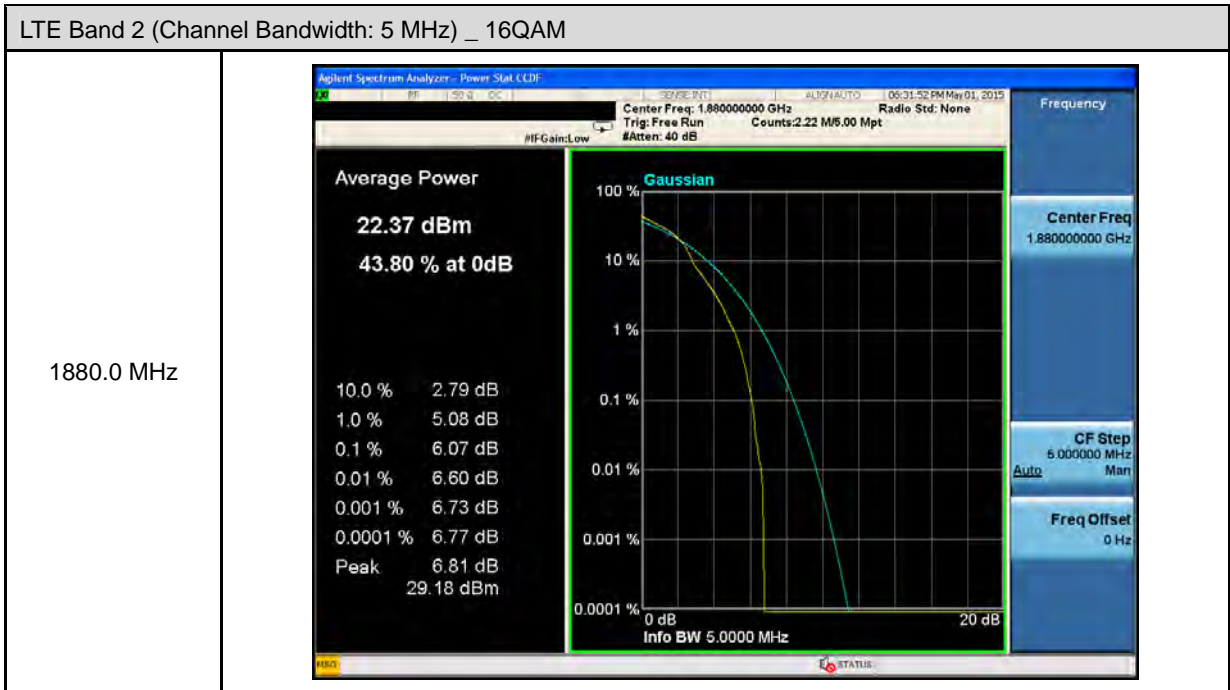

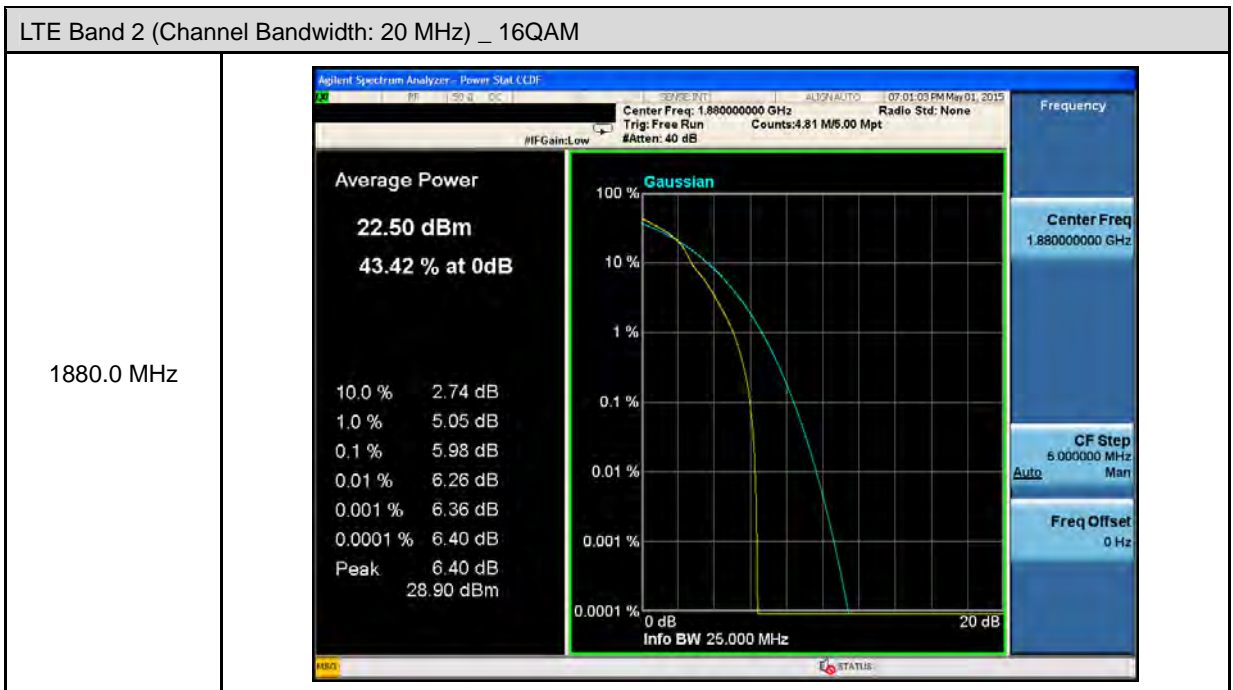
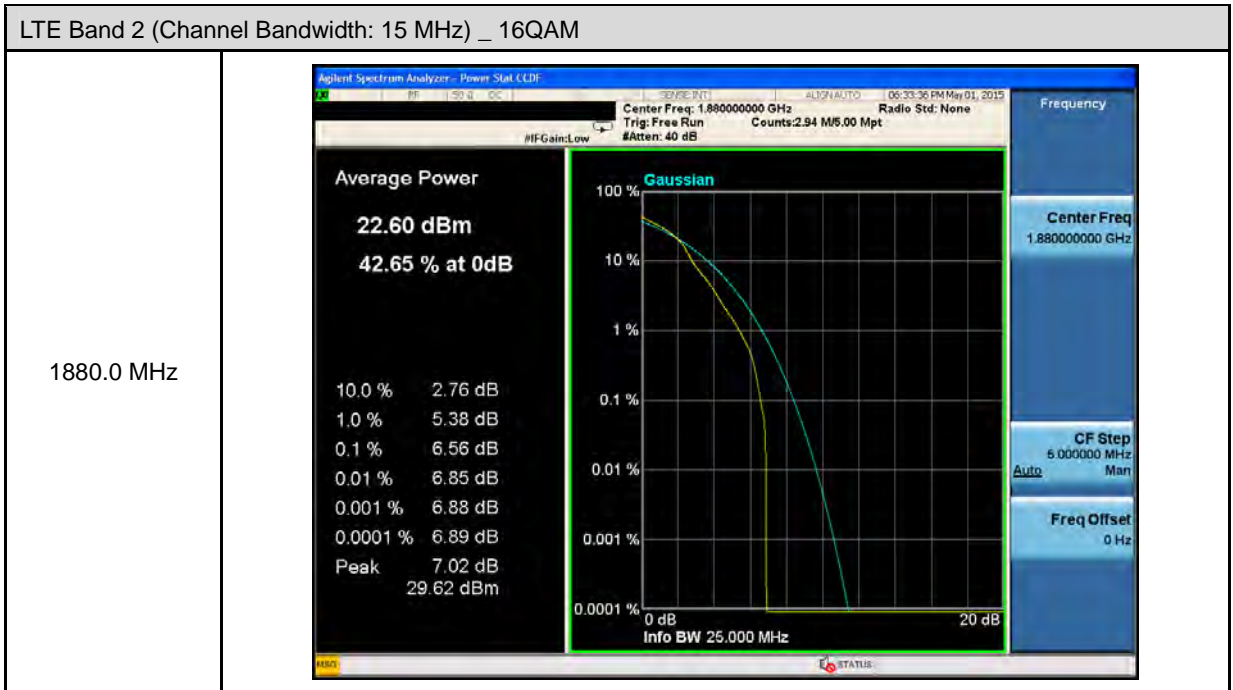

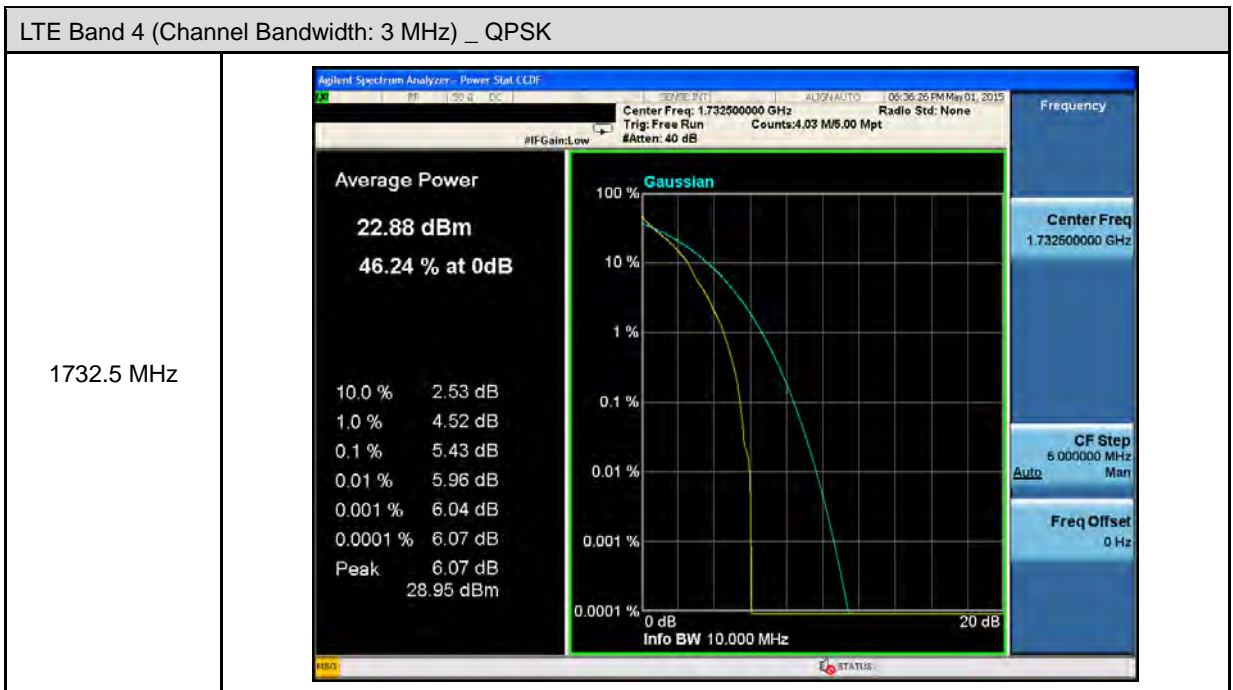
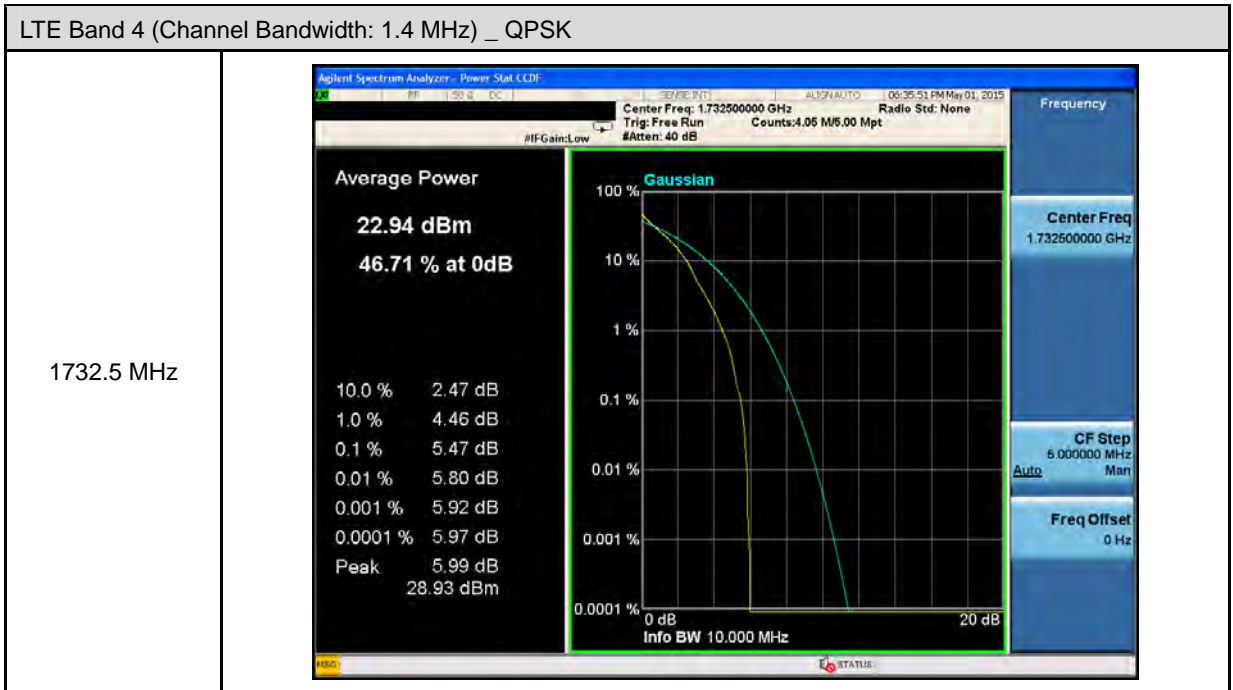

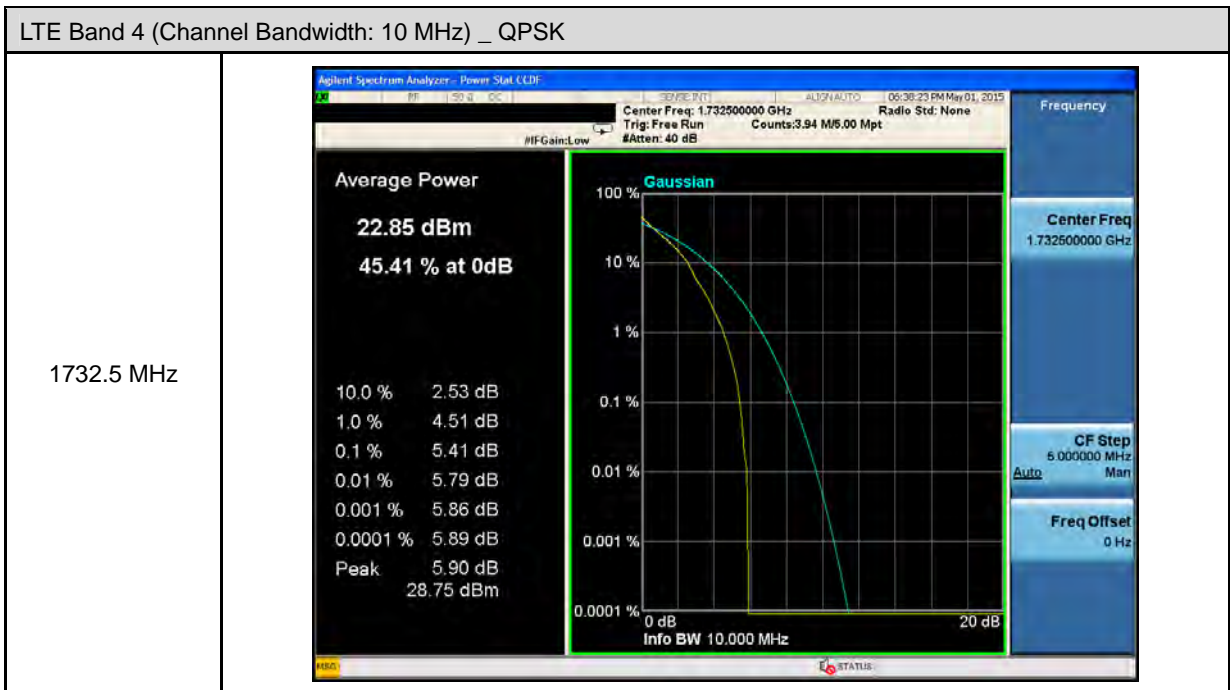
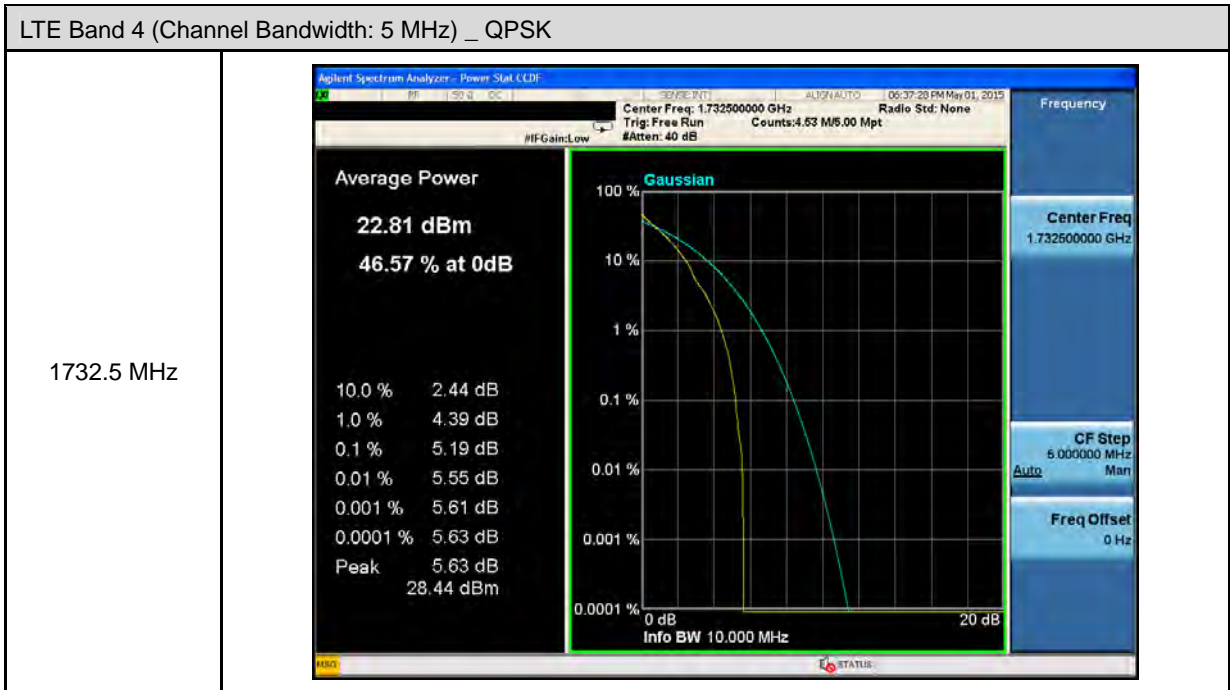

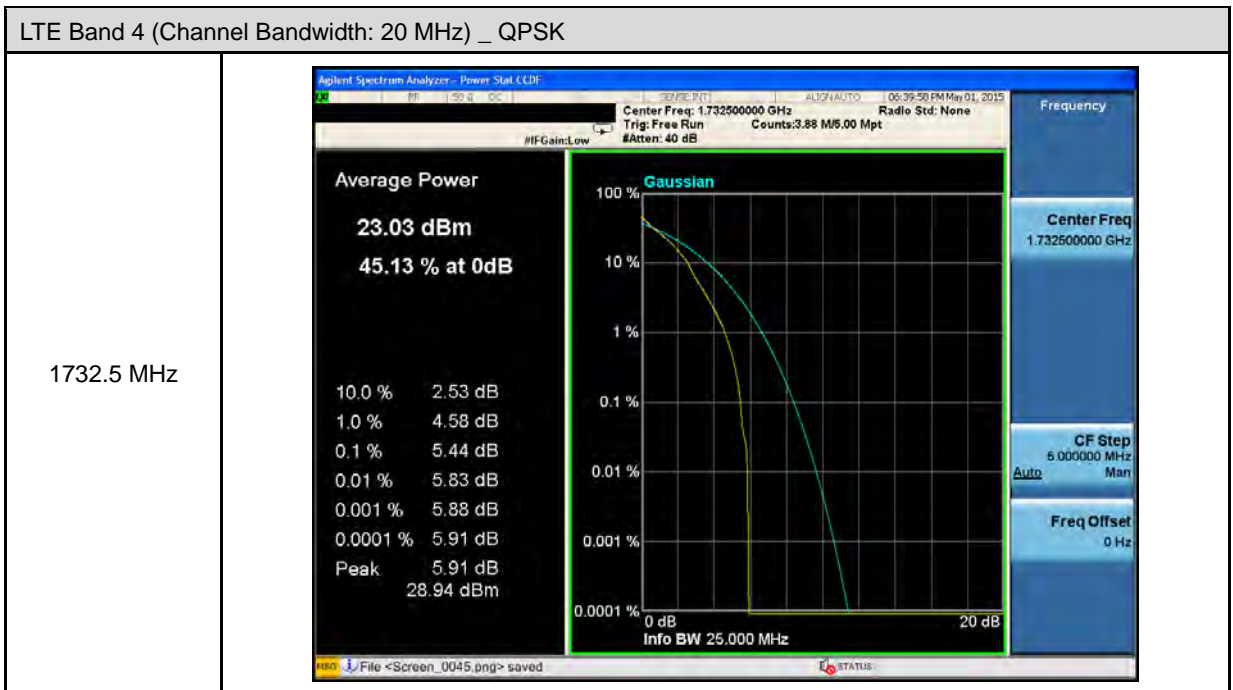
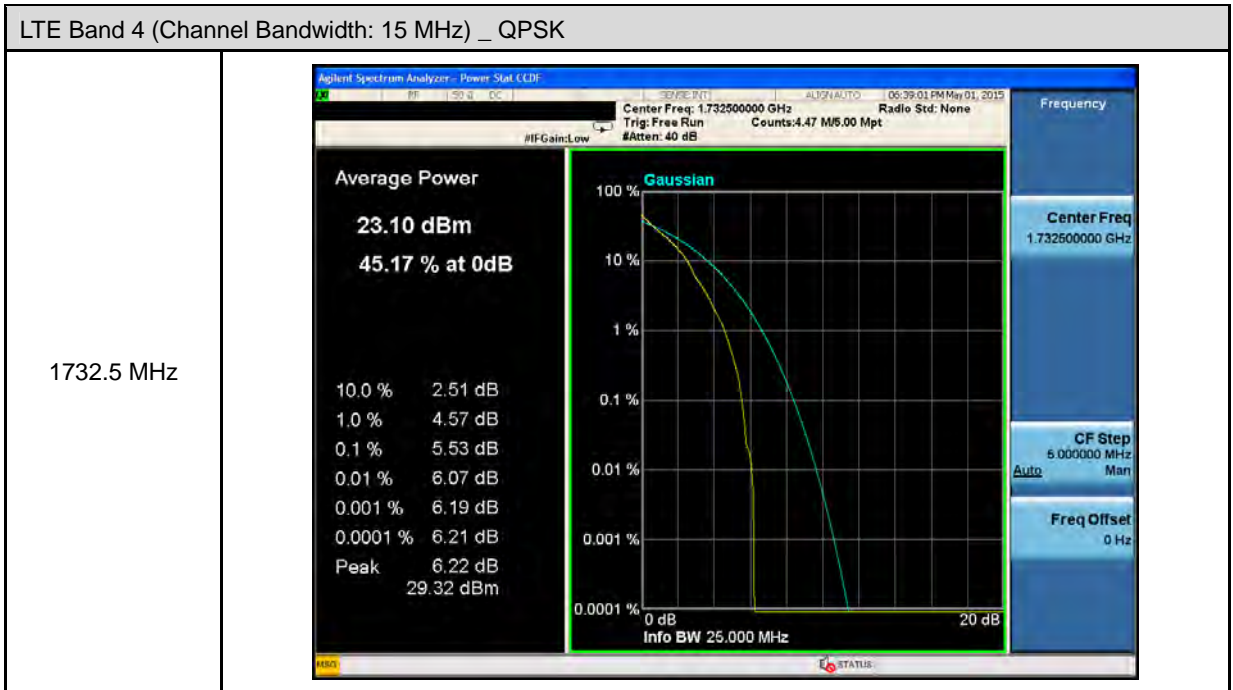



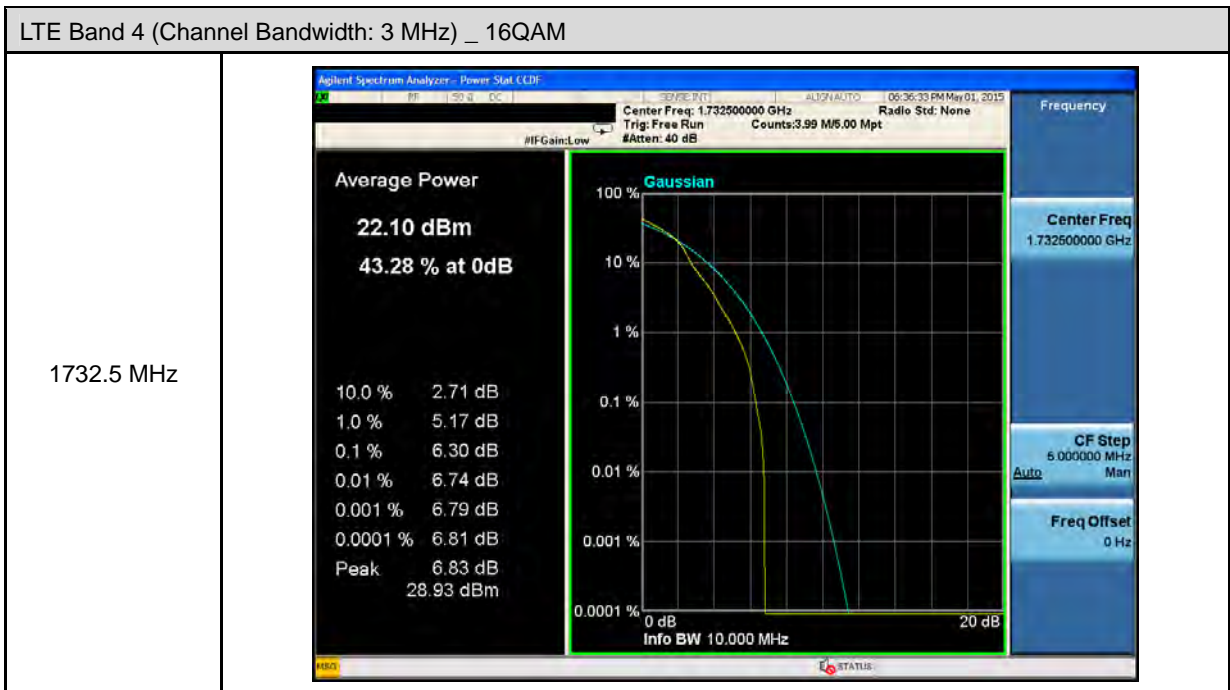
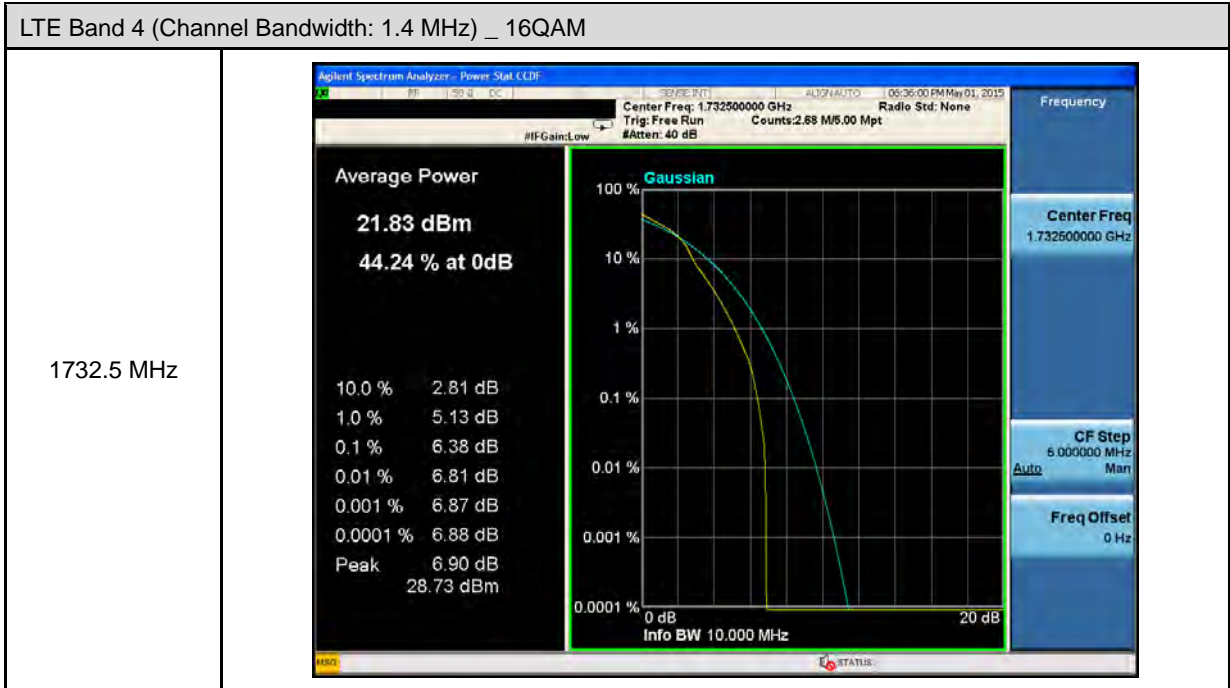

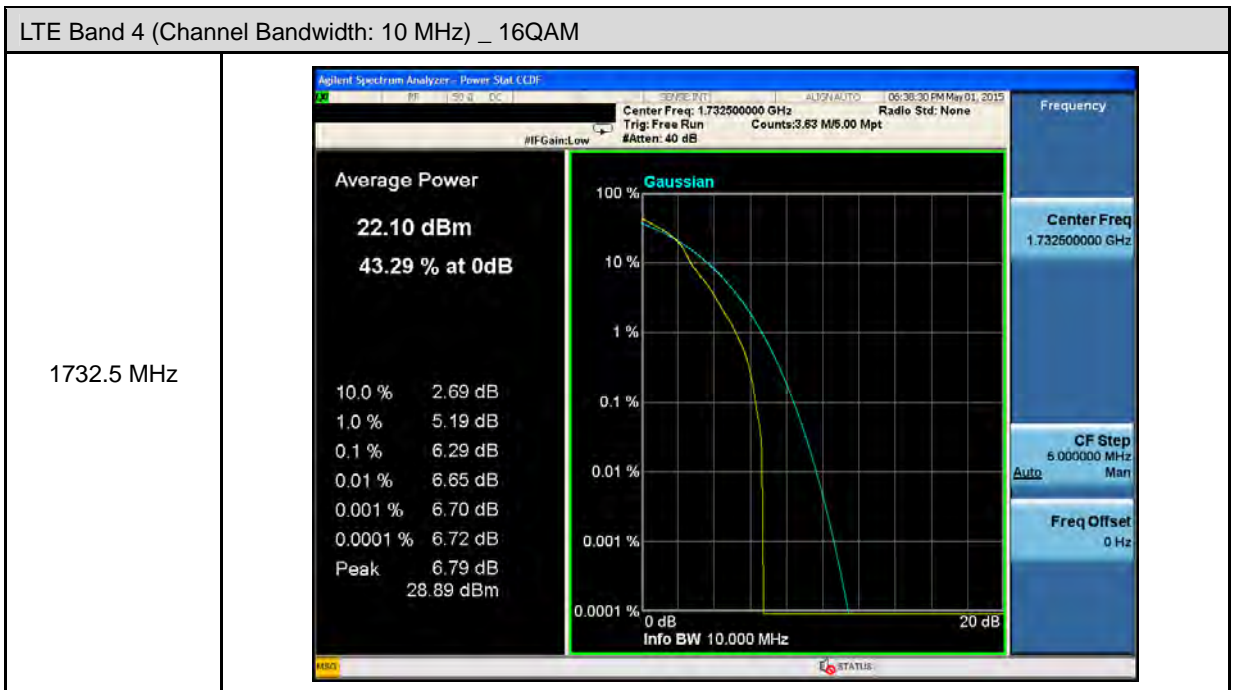
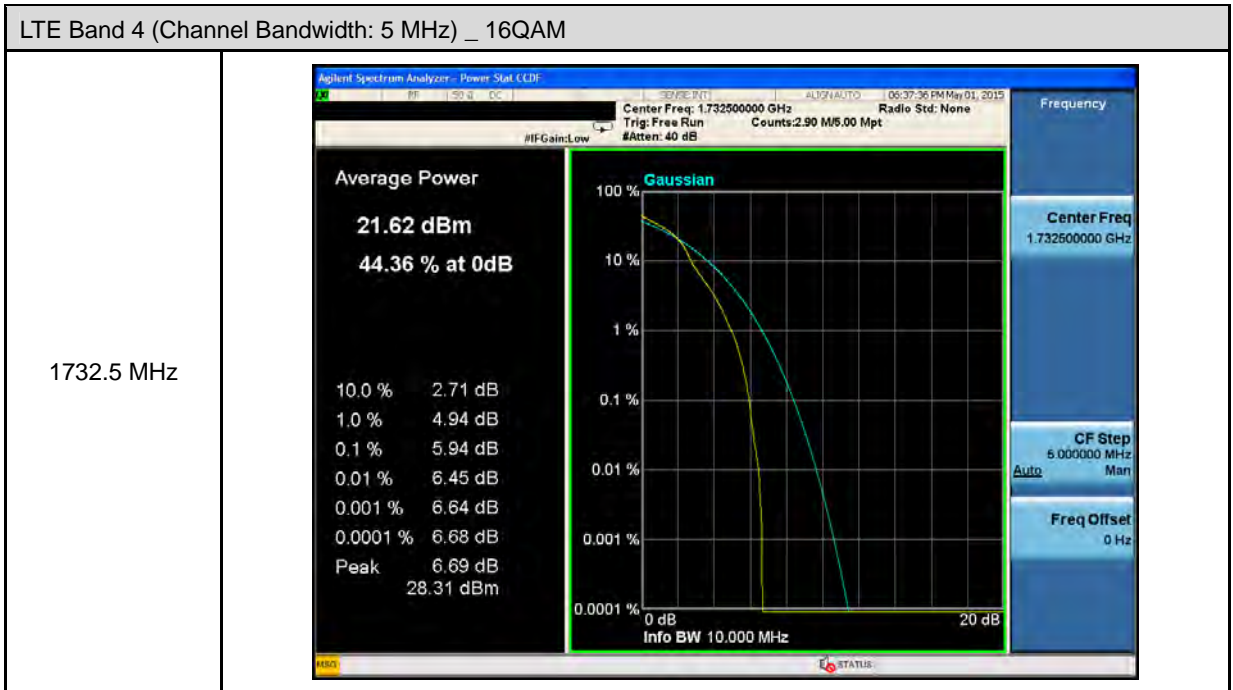

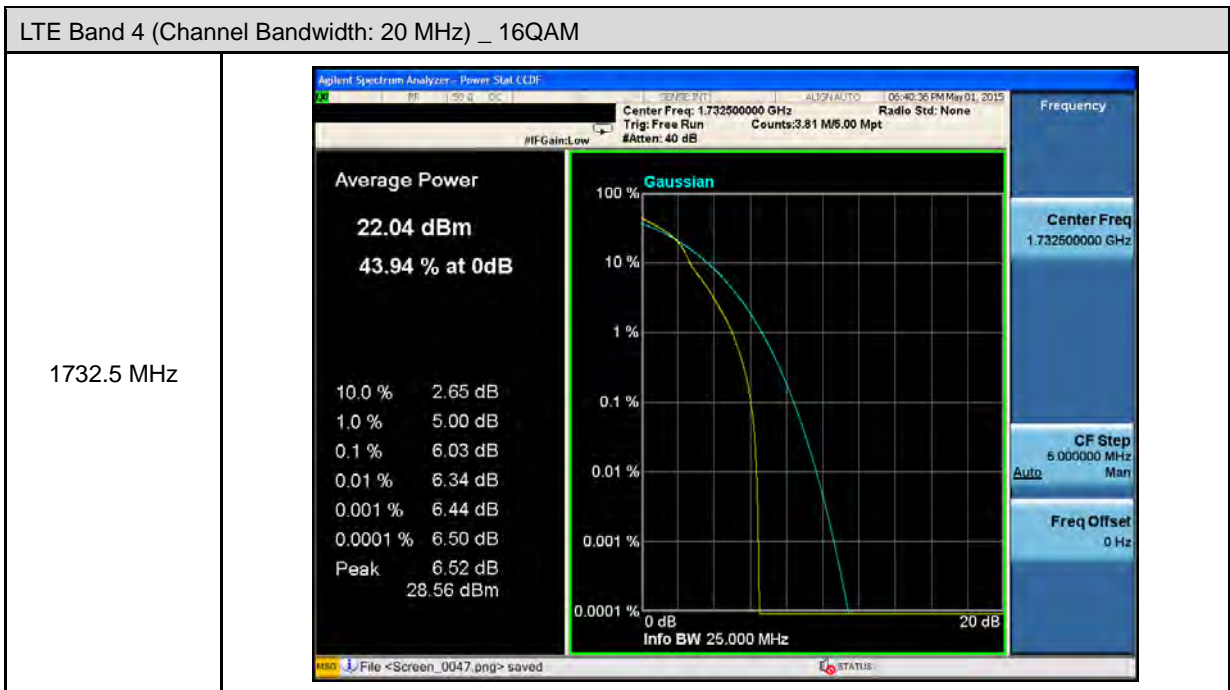
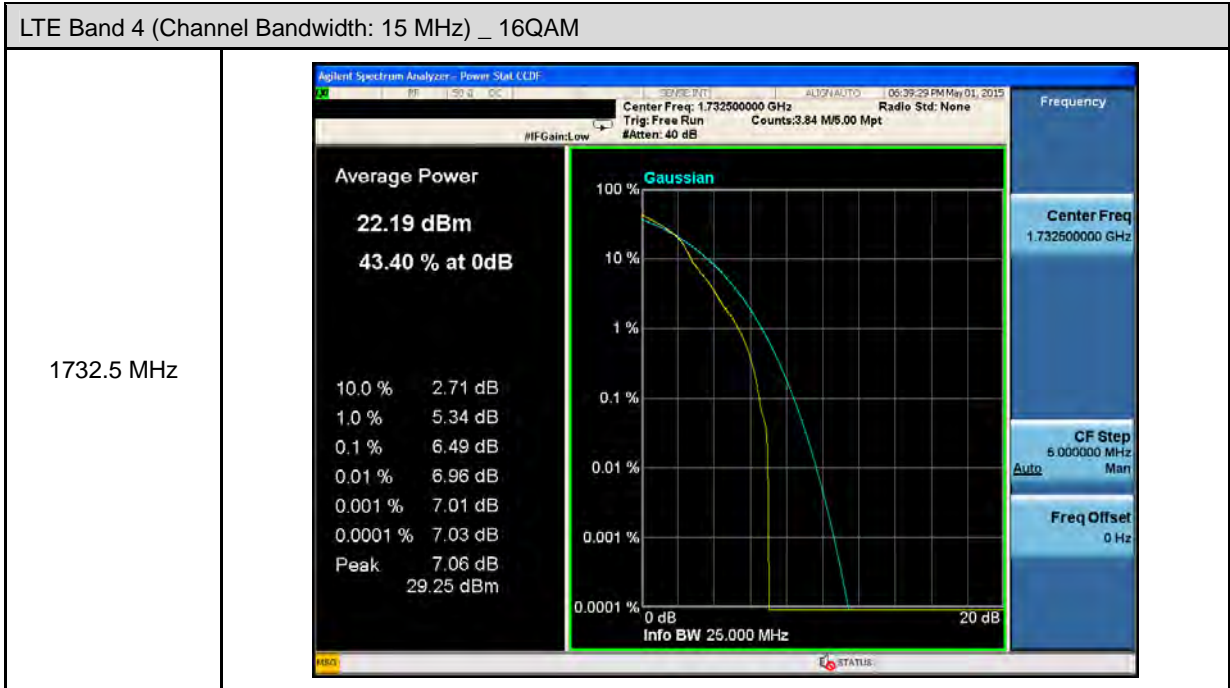

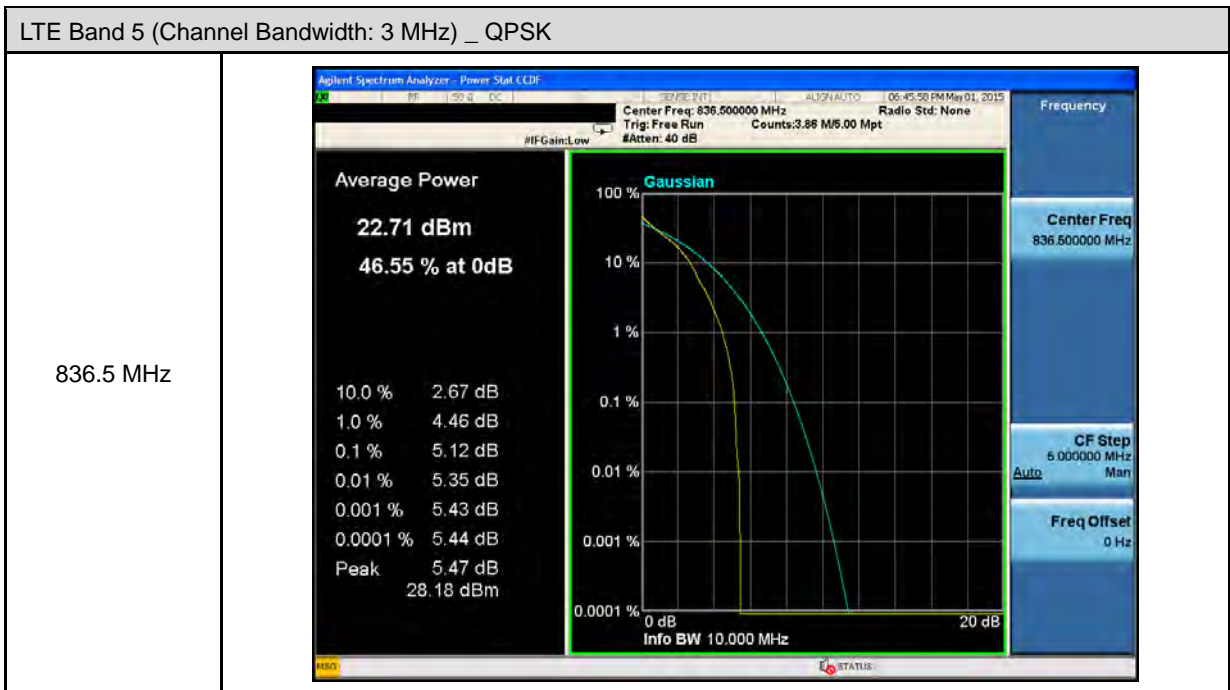
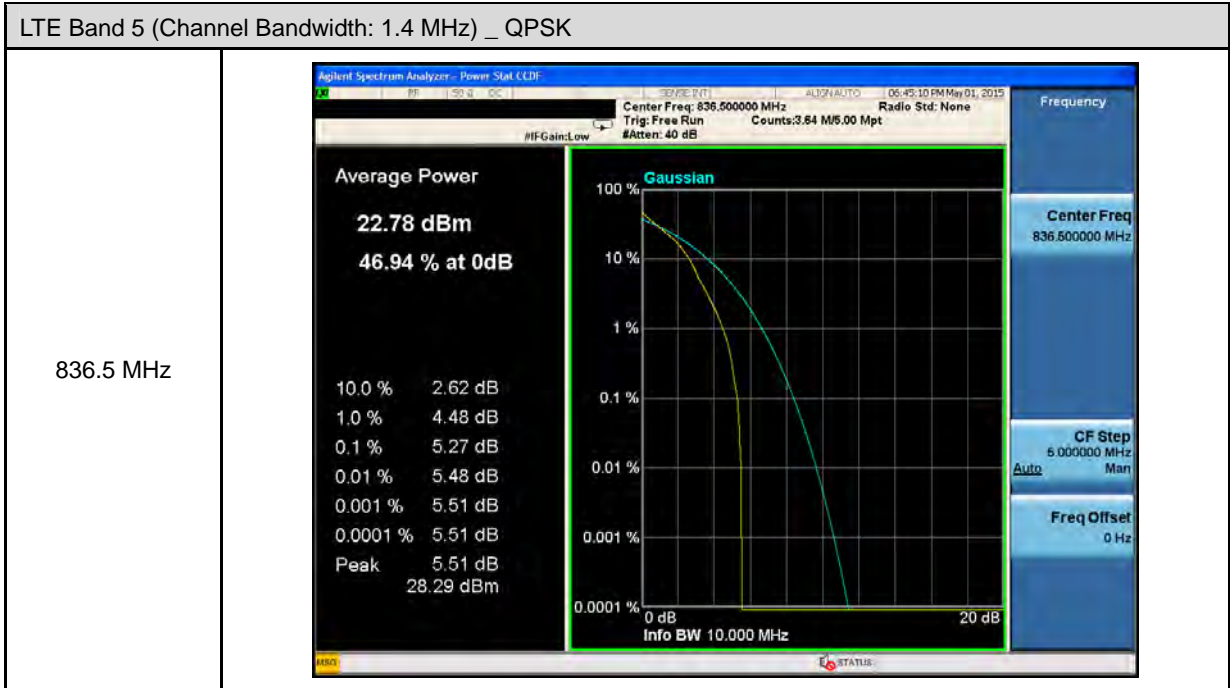

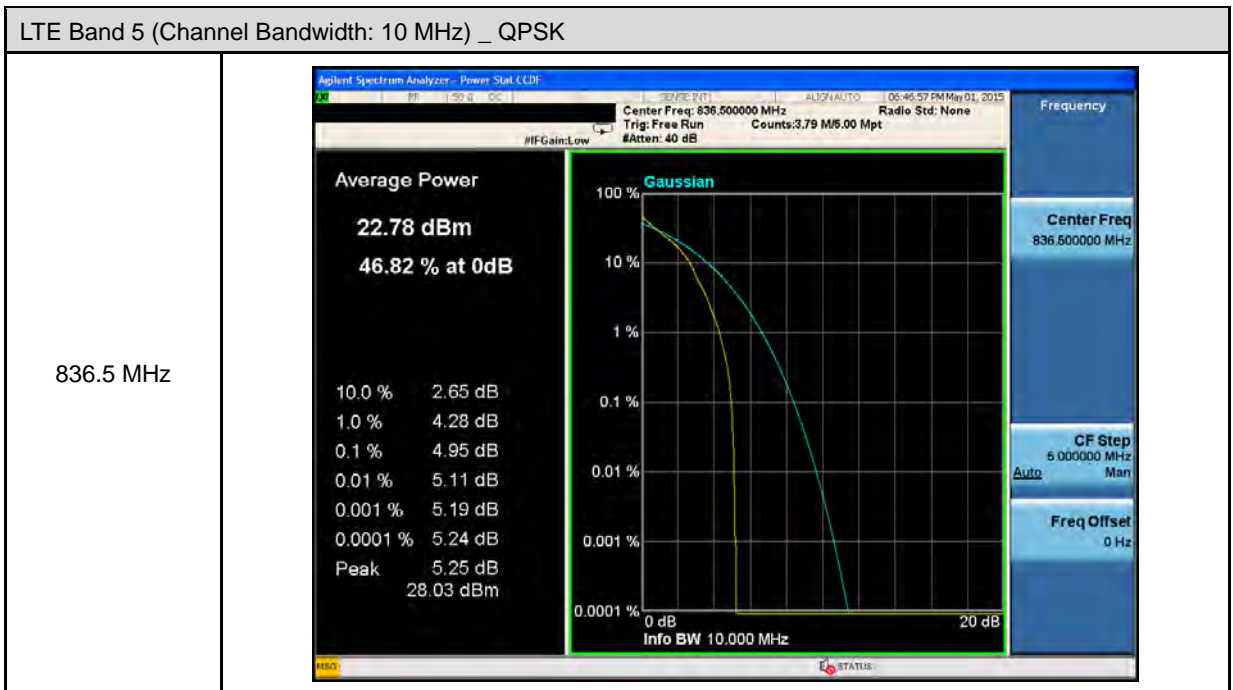
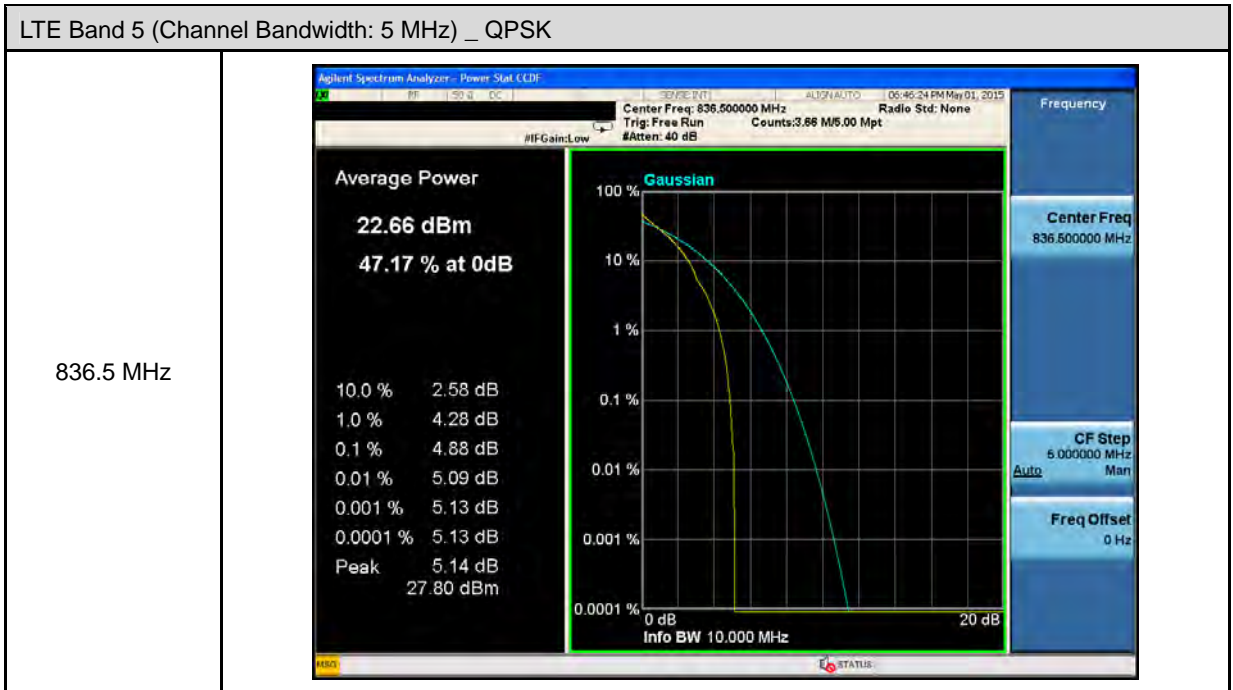

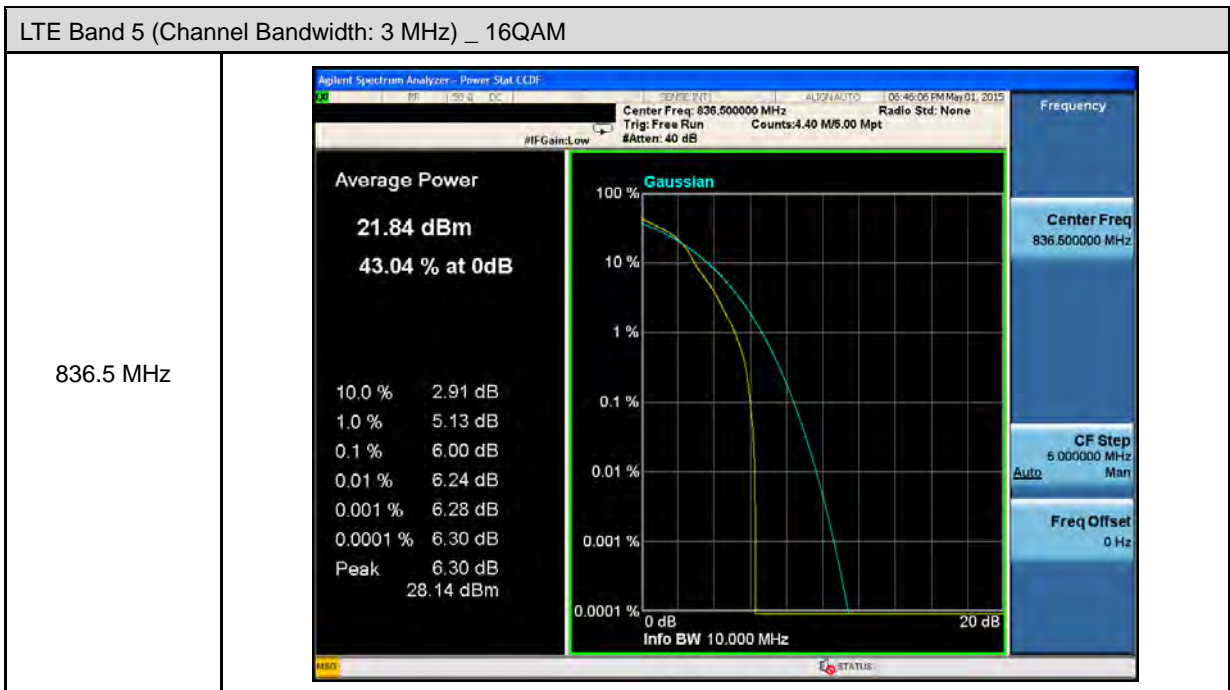
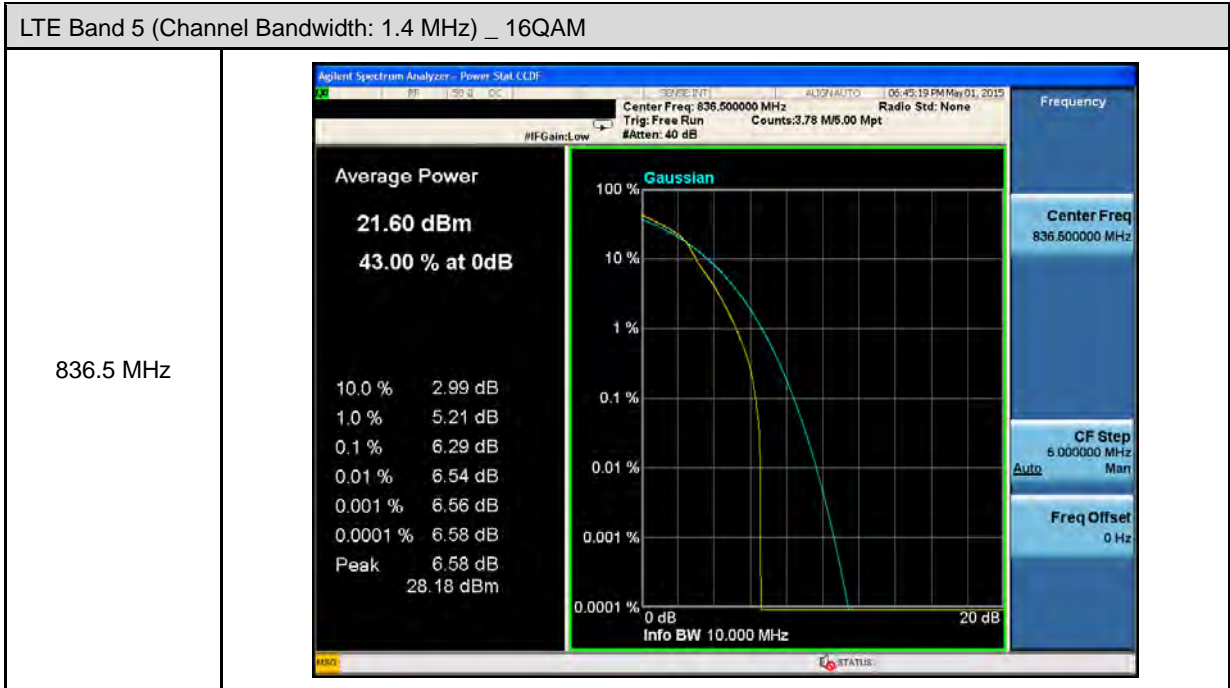

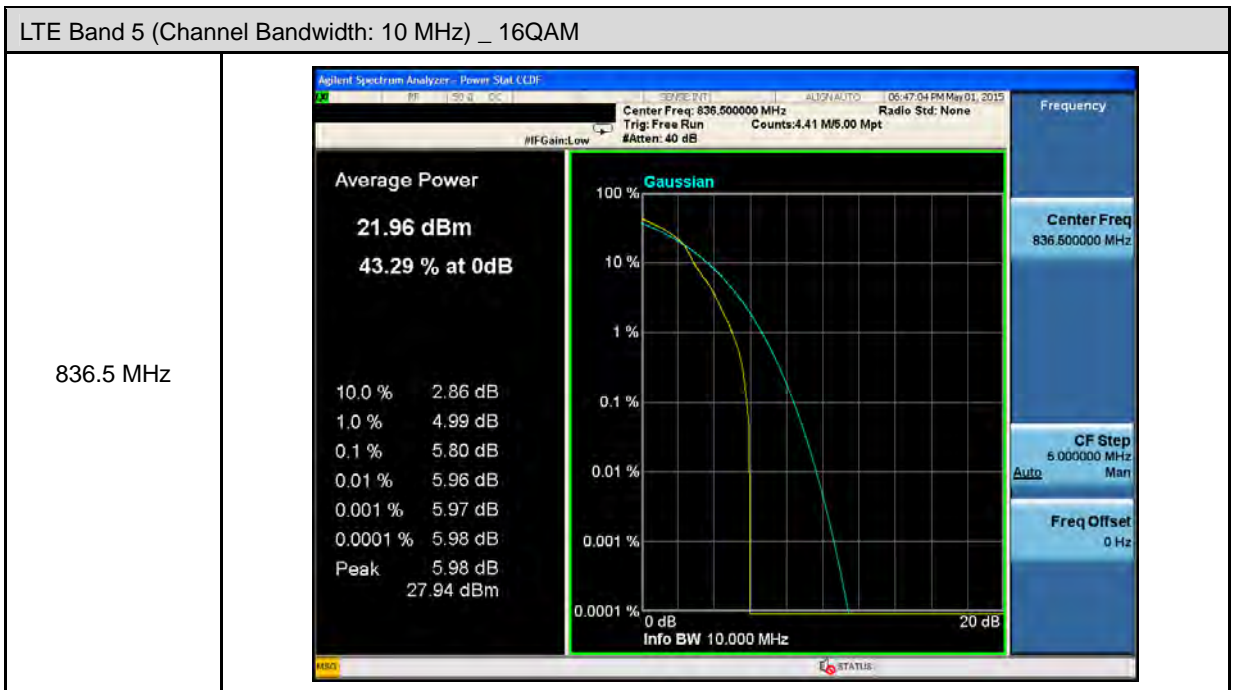
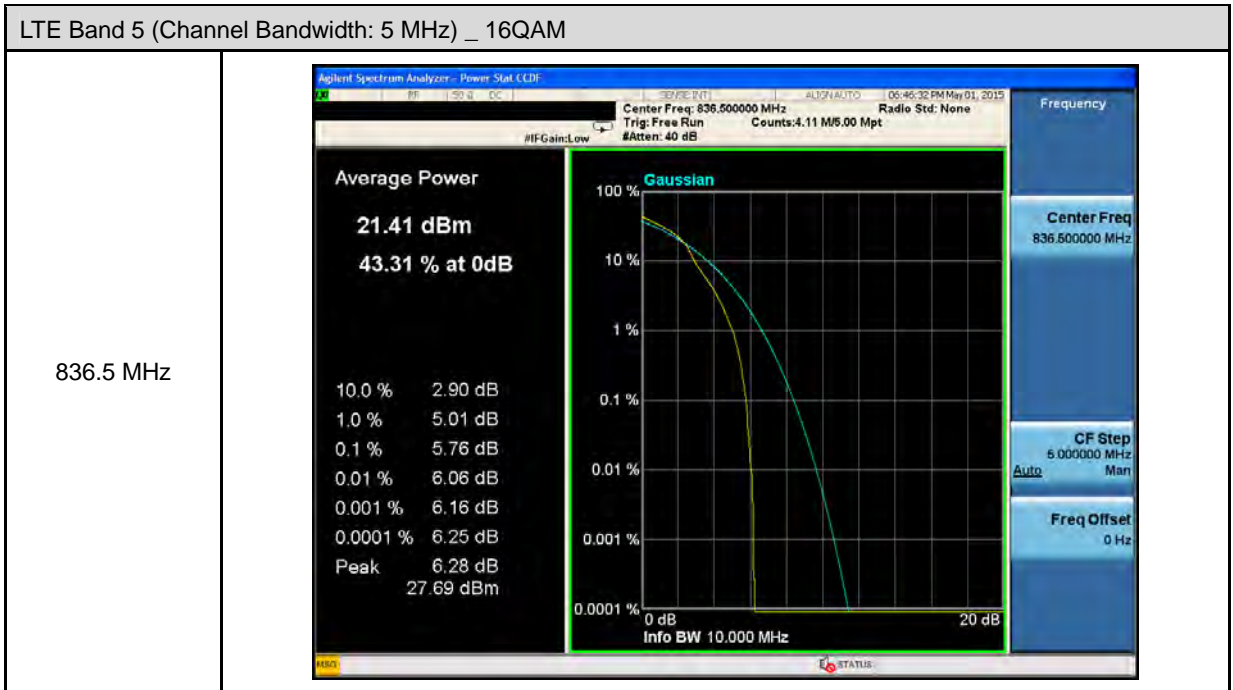

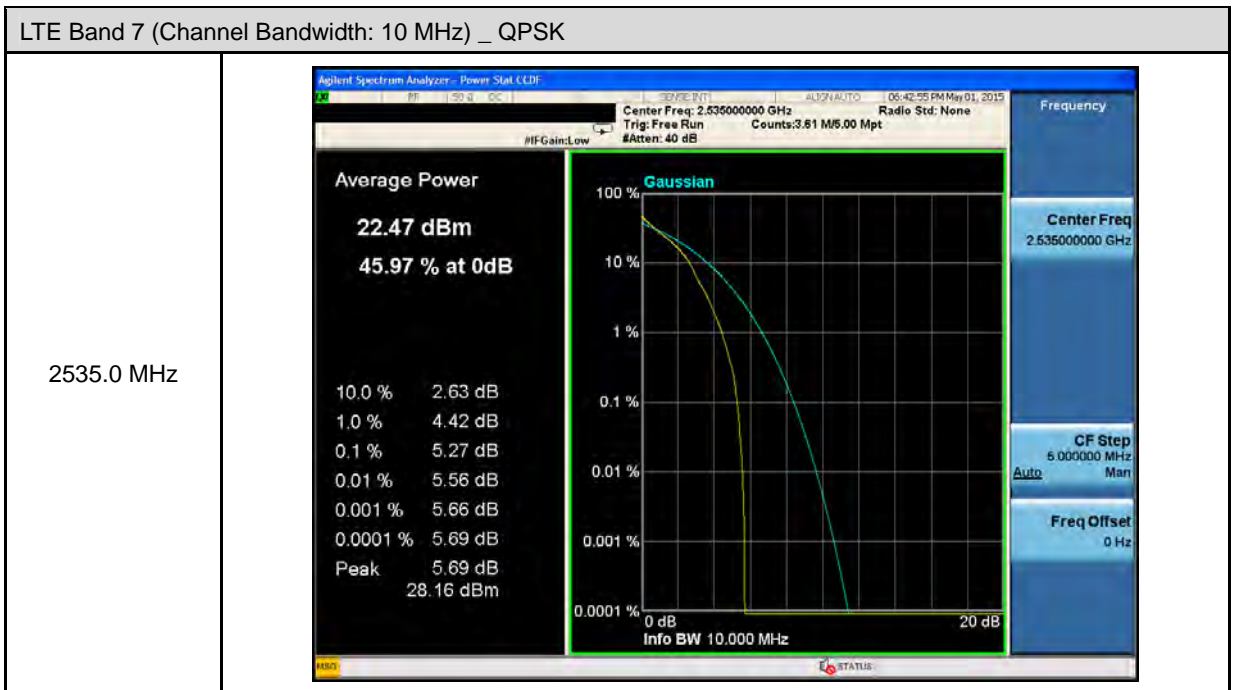
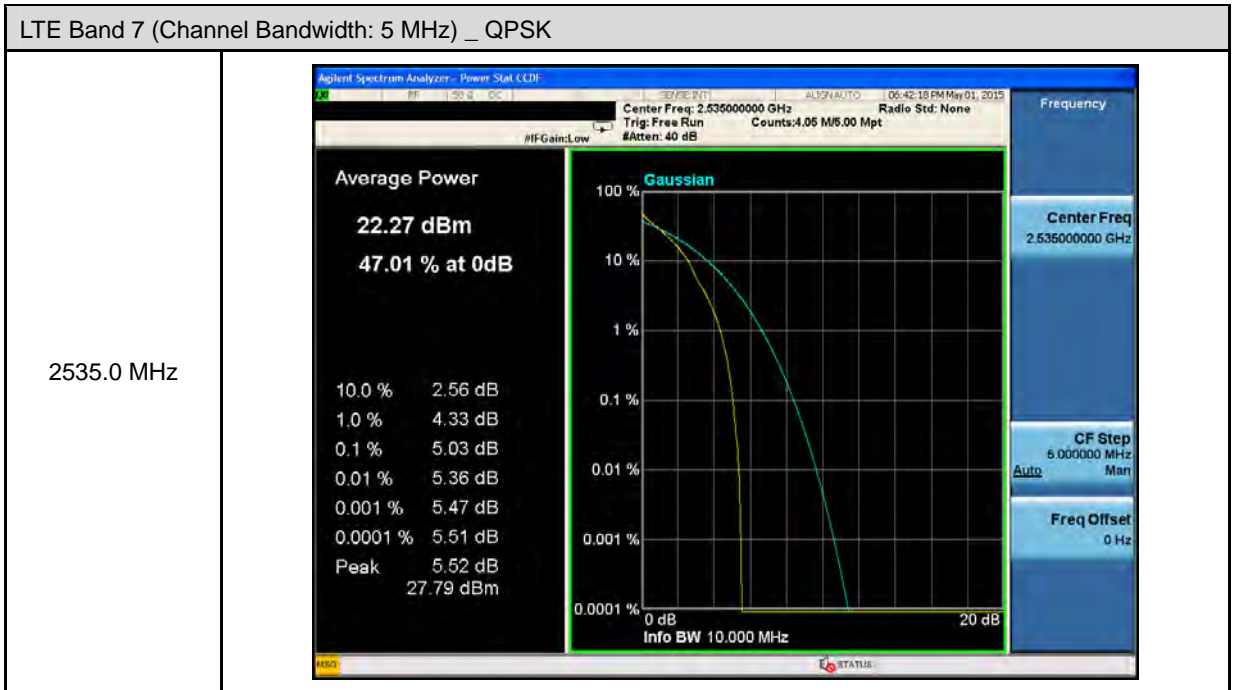



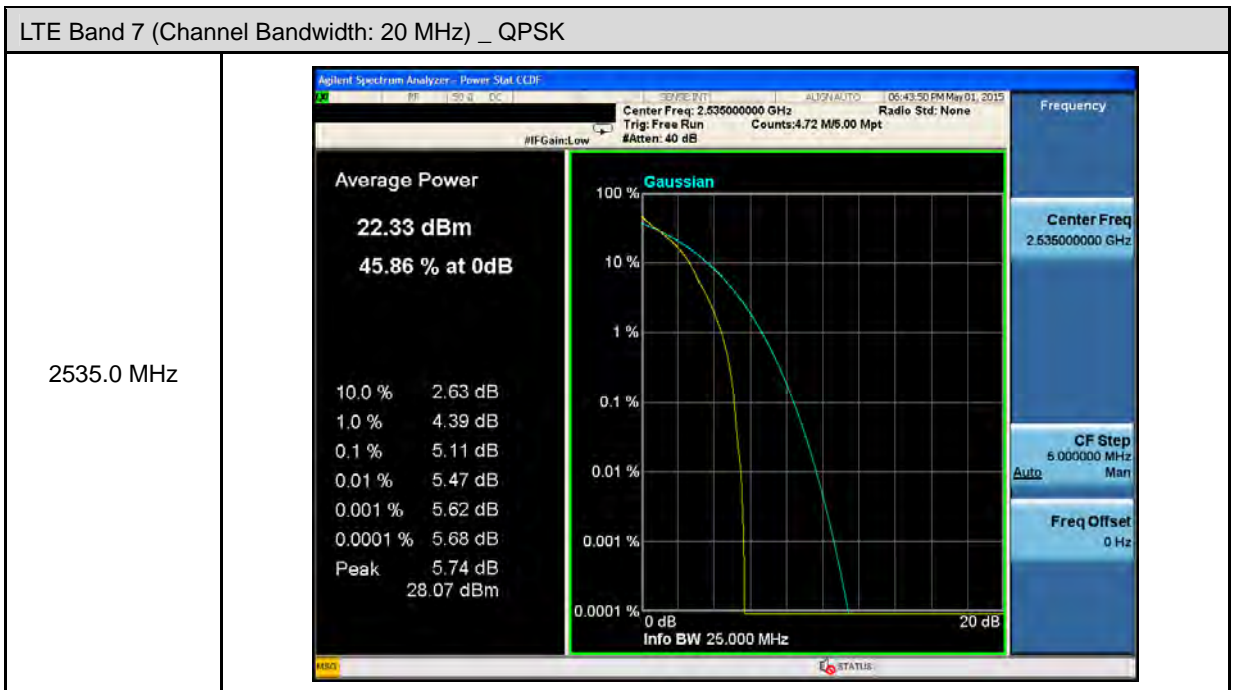
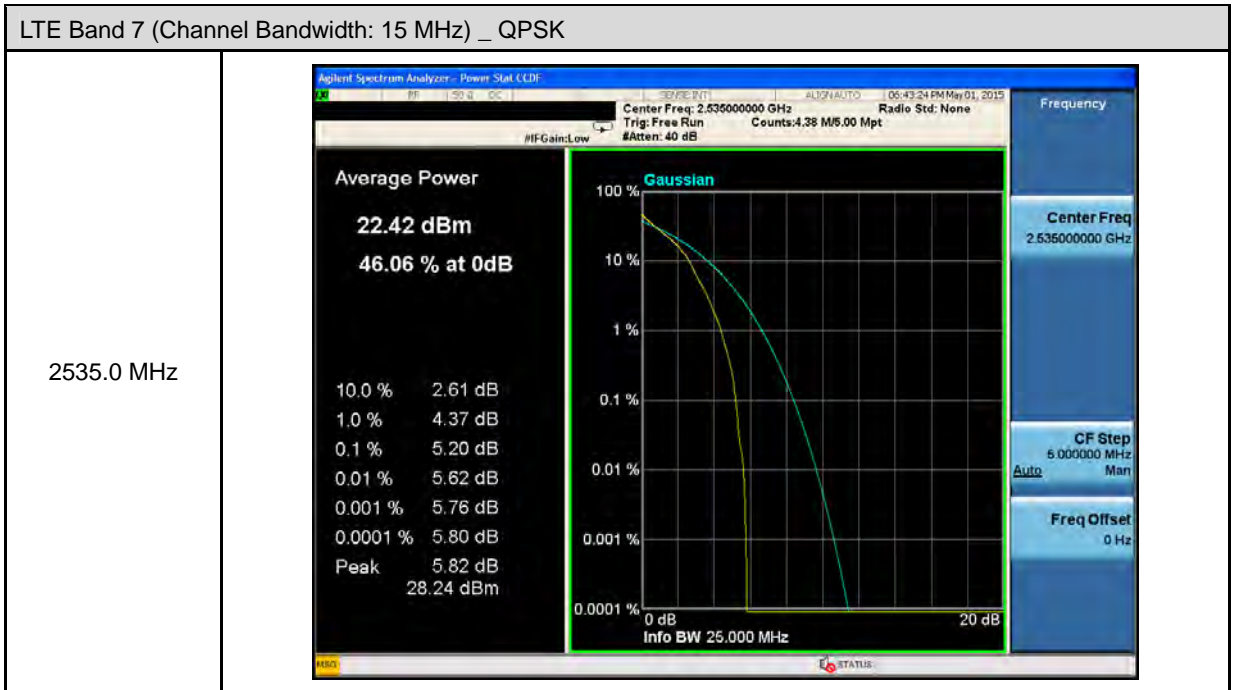

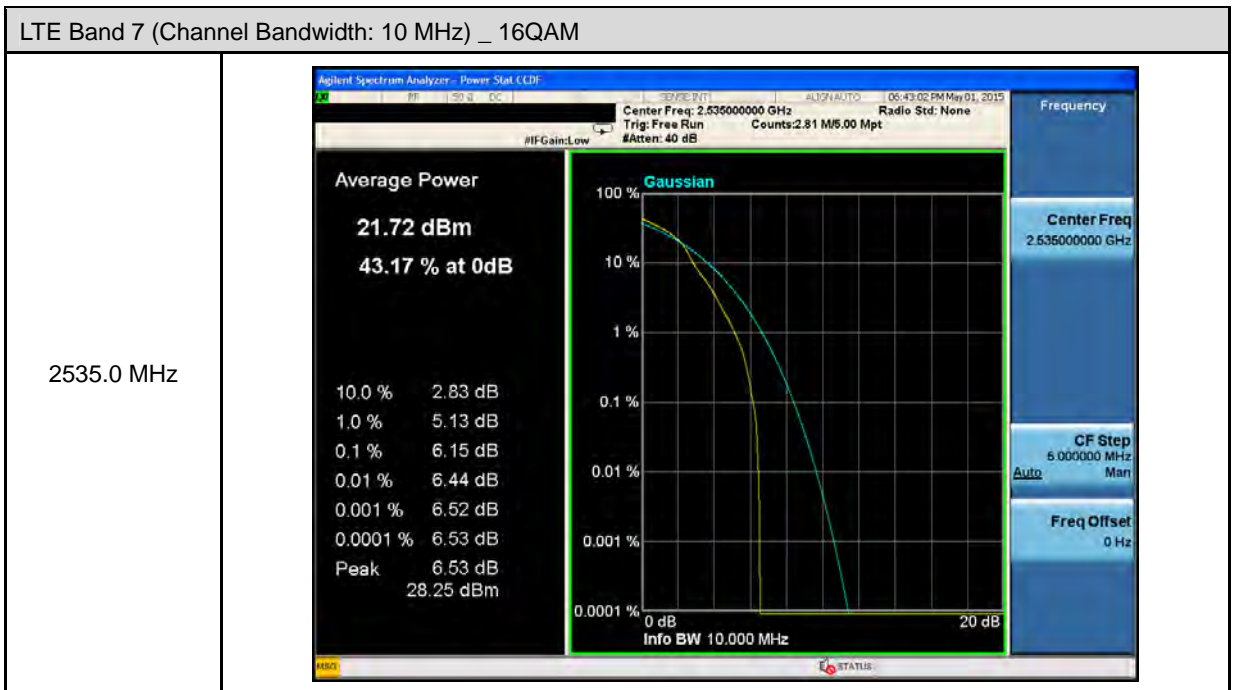
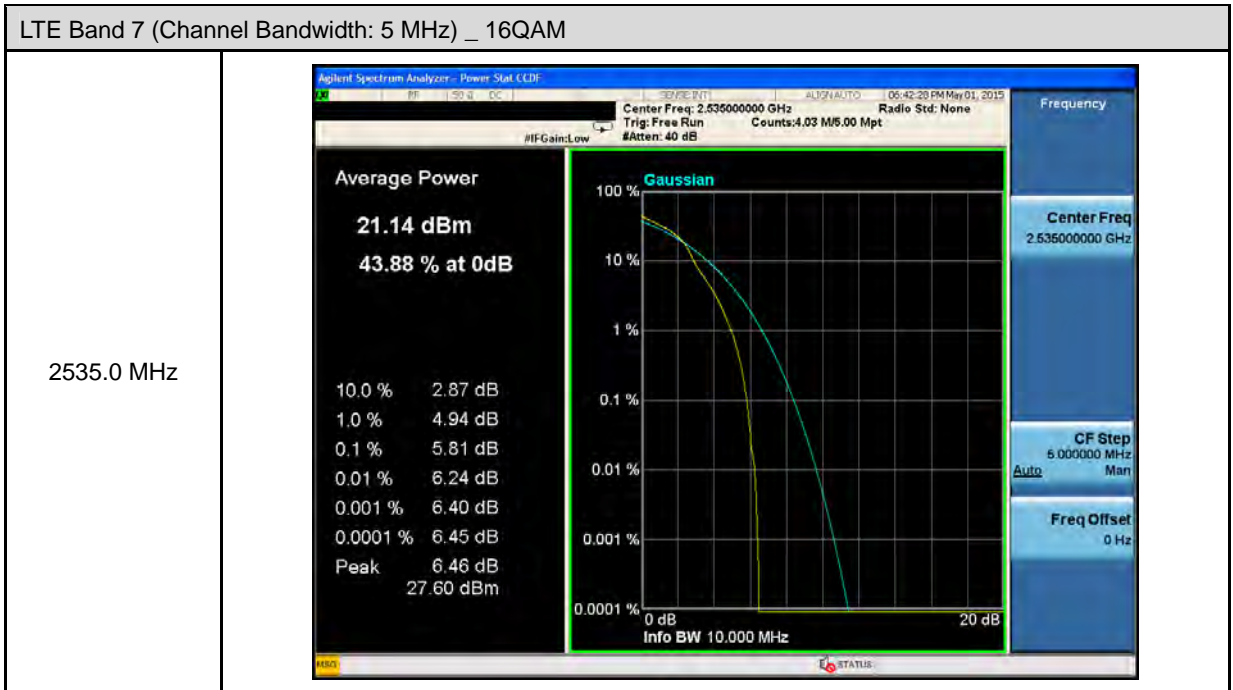

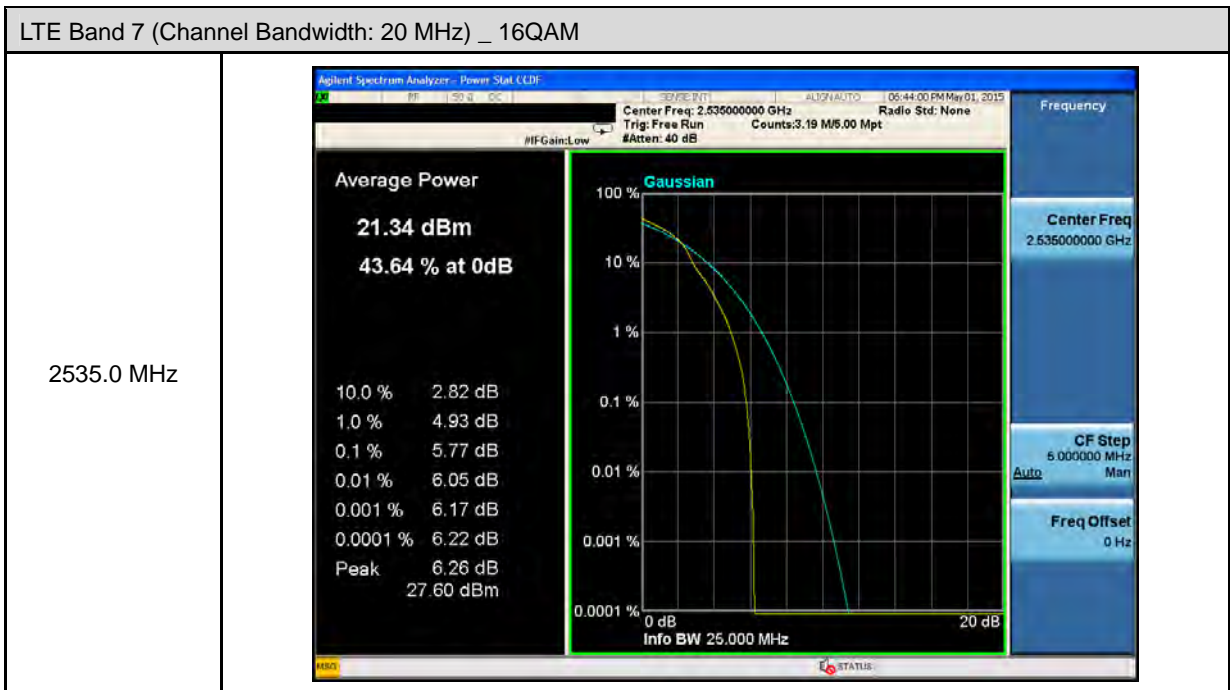
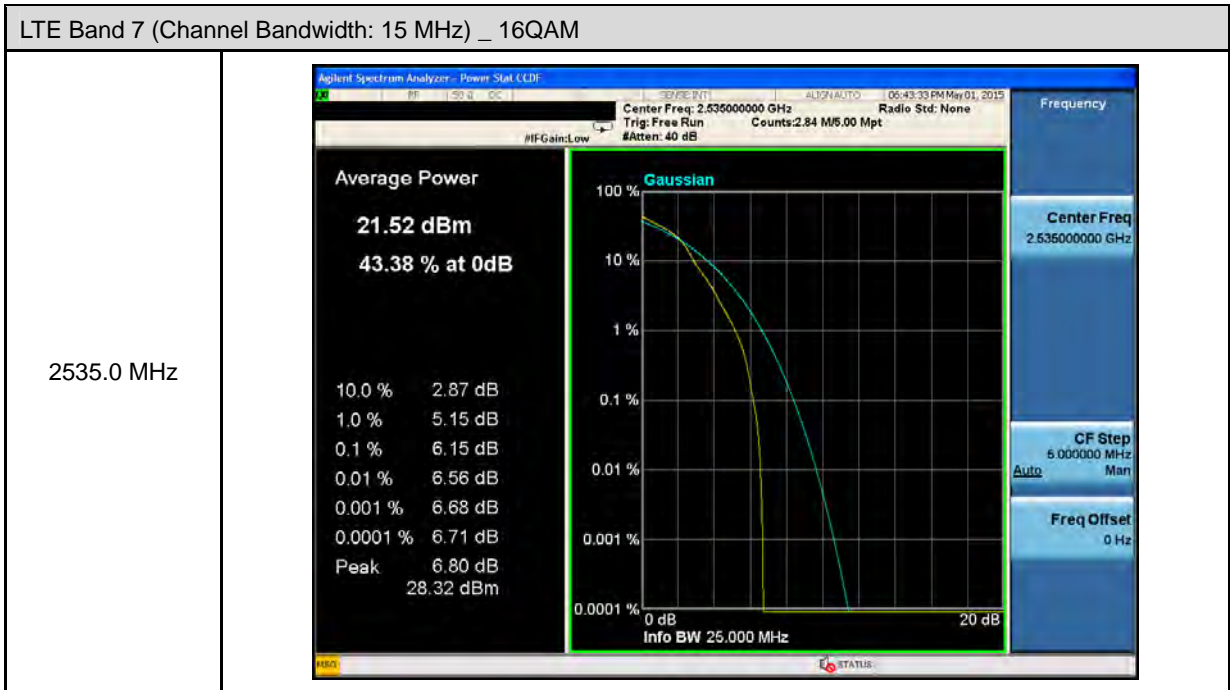

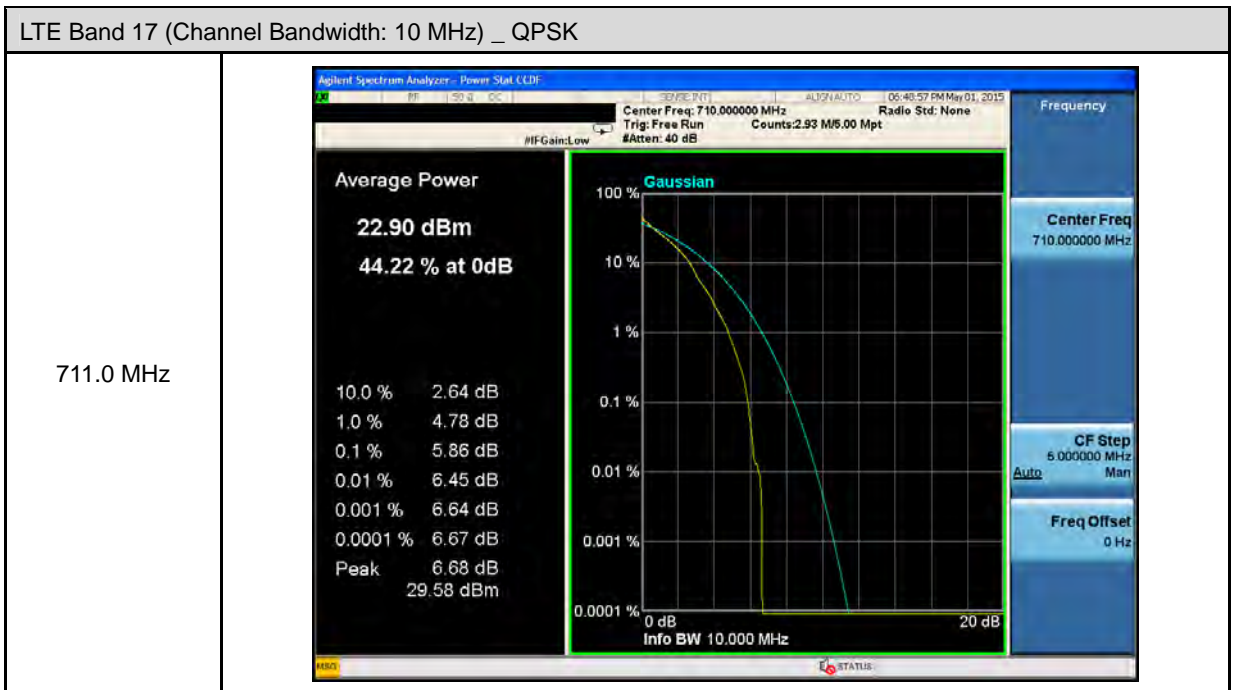
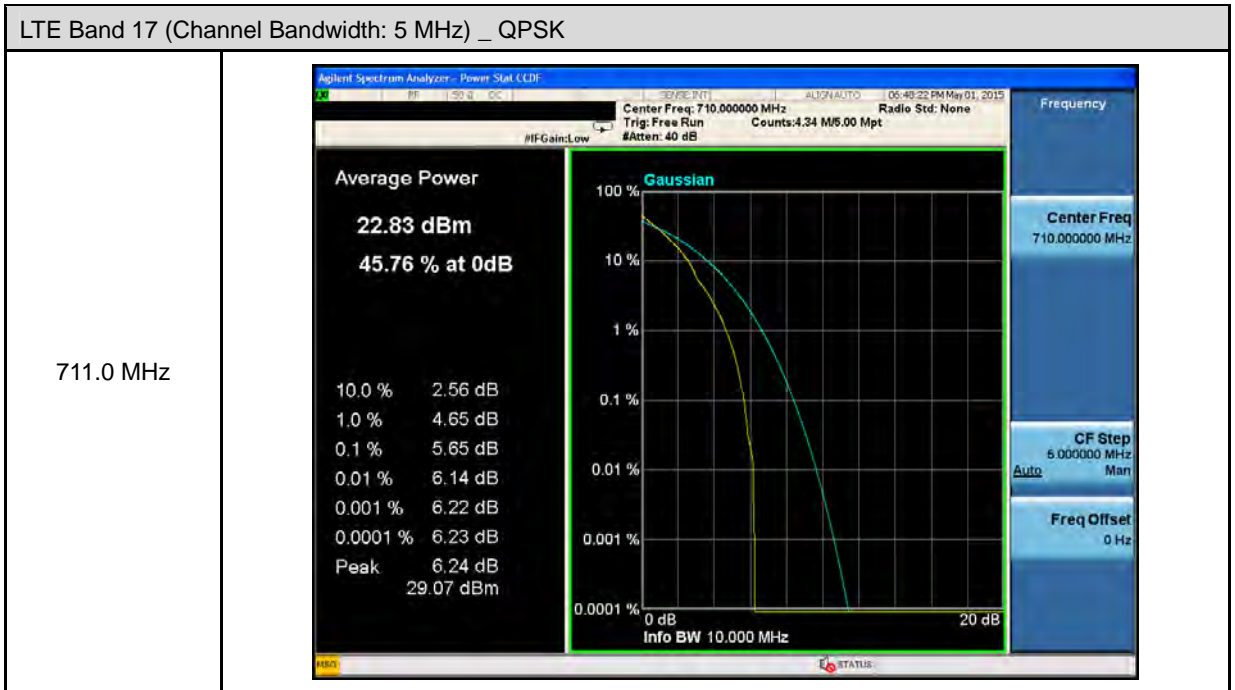

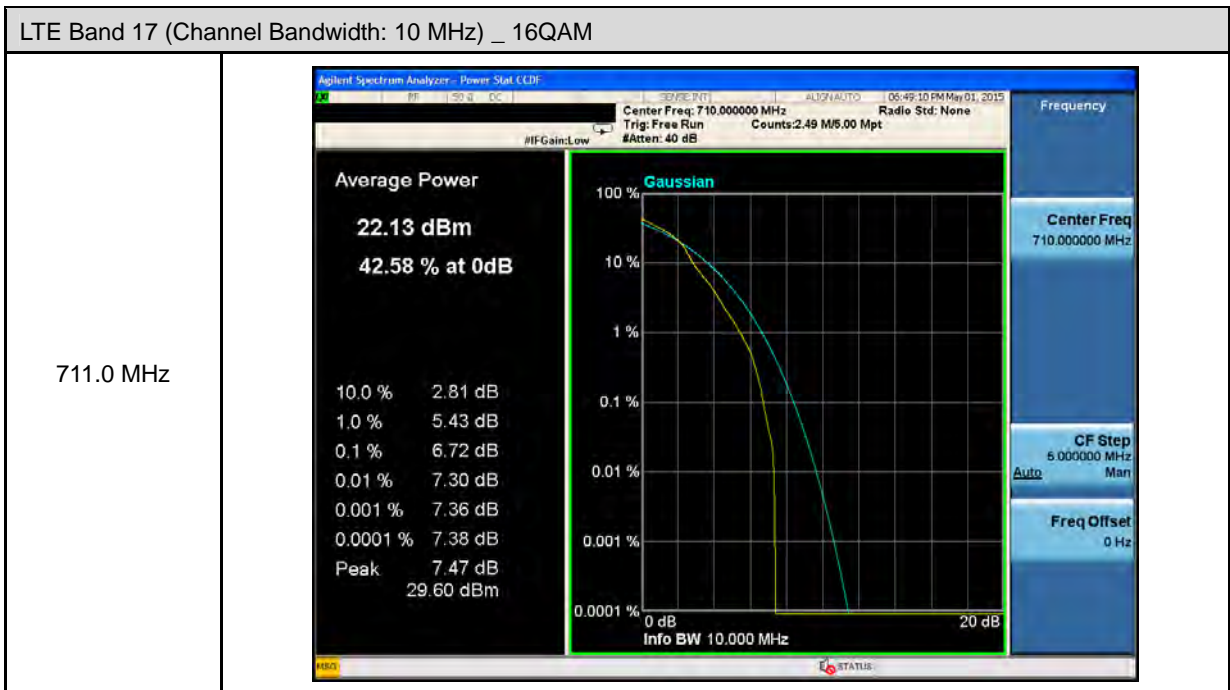
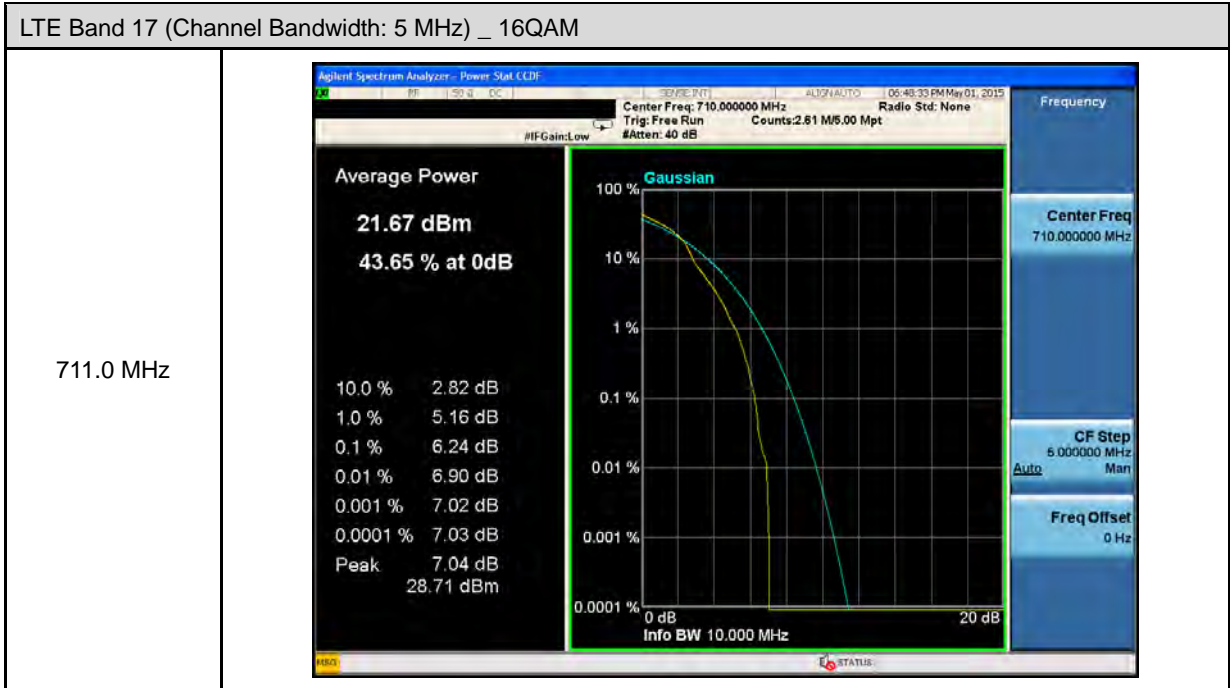

## 7 Band Edge Test

### 7.1. Limit

The Band Edge Limit:

§22.917(a), §24.238(a)

The power of any emission outside of the authorized operating frequency ranges must be attenuated below the transmitting power (P) by a factor of at least  $43 + 10\log(P)$  dB.

§27.53(m)

For mobile digital stations, the attenuation factor shall be not less than  $43+10 \log(p)$  dB at the channel edge and  $55+10 \log(P)$  dB at 5.5 megahertz from the channel edges.

### 7.2. Test Instruments

Equipment	Manufacturer	Model No.	Serial No.	Cal. Date	Remark
Spectrum Analyzer	Agilent	E4445A	MY46181986	05/10/2014	(1)
Wideband Radio Communication Test	R & S	CMW500	103168	11/05/2014	(1)
Attenuator	RADIALL	R41572000	0603033073	N.C.R.	-----
Power divider	Agilent	87302C	3239A00760	N.C.R.	-----
Test Site	ATL	TE05	TE05	N.C.R.	-----

Remark: <sup>(1)</sup> Calibration period 1 year. <sup>(2)</sup> Calibration period 2 years.

Note: N.C.R. = No Calibration Request.

### 7.3. Setup

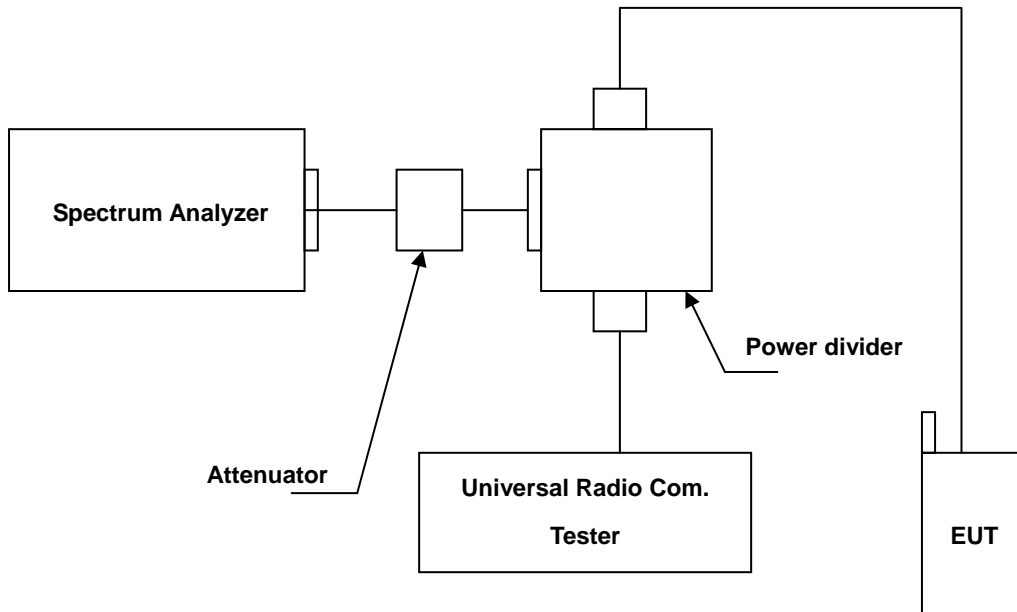

### 7.4. Test Procedure

The measurement is made according to FCC rules:

- The EUT was set up for the maximum peak power with LTE/WCDMA link data modulation. The power was measured with R&S Spectrum Analyzer. All measurements were done at 2 channels (low and high operational frequency range.)
- The band edge measurement used the power splitter via EUT RF power connector between simulation base station and spectrum analyzer. This splitter loss and cable loss are the worst loss 7.2 dB in the transmitted path track.
- The center frequency of spectrum is the band edge frequency and span is 10 MHz. RB of the resolution bandwidth of at least one percent of the emission bandwidth.
- Record the max trace plot into the test report.

### 7.5. Uncertainty

The measurement uncertainty is defined as for Conducted Power measurement is 1.2 dB.

**7.6. Test Result**

Frequency	LTE Band 2	Channel Bandwidth	1.4 MHz	RB Allocated	6
Lower Band Edge					
Higher Band Edge					



Frequency	LTE Band 2	Channel Bandwidth	3 MHz	RB Allocated	15
Lower Band Edge	<p>Agilent R T Freq/Channel  Mkr1 1.850 00 GHz  Ref 20 dBm Atten 30 dB  #Aveg 10  Log  dB/Offst 4.3 dB  DI -13.0 dBm  PAvg 100  W1 S2  S3 FS  AA  E(f): f&gt;50k  Swp  Center 1.850 00 GHz Span 10 MHz  #Res BW 100 kHz #VBW 300 kHz Sweep 3.04 ms (601 pts)  Copyright 2000-2006 Agilent Technologies</p>				
Higher Band Edge	<p>Agilent R T Freq/Channel  Mkr1 1.910 00 GHz  Ref 20 dBm Atten 30 dB  #Aveg 10  Log  dB/Offst 4.3 dB  DI -13.0 dBm  PAvg 100  W1 S2  S3 FS  AA  E(f): f&gt;50k  Swp  Center 1.910 00 GHz Span 10 MHz  #Res BW 100 kHz #VBW 300 kHz Sweep 3.04 ms (601 pts)  Copyright 2000-2006 Agilent Technologies</p>				

Frequency	LTE Band 2	Channel Bandwidth	5 MHz	RB Allocated	25
Lower Band Edge	<p>Agilent R T Freq/Channel  Mkr1 1.850 00 GHz  Ref 20 dBm Atten 30 dB  #Ave 10  Log  dB/Offst 4.3 dB  DI -13.0 dBm  PAvg 100  W1 S2  S3 FS  AA  f(f):  f&gt;50k  Swp  Center 1.850 00 GHz Span 10 MHz  #Res BW 100 kHz #VBW 300 kHz Sweep 3.04 ms (601 pts)  Copyright 2000-2006 Agilent Technologies</p> <p>Center Freq 1.85000000 GHz  Start Freq 1.84500000 GHz  Stop Freq 1.85500000 GHz  CF Step 1.00000000 MHz  Auto Man  Freq Offset 0.00000000 Hz  Signal Track On Off</p>				
Higher Band Edge	<p>Agilent R T Freq/Channel  Mkr1 1.910 00 GHz  Ref 20 dBm Atten 30 dB  #Ave 10  Log  dB/Offst 4.3 dB  DI -13.0 dBm  PAvg 100  W1 S2  S3 FS  AA  f(f):  f&gt;50k  Swp  Center 1.910 00 GHz Span 10 MHz  #Res BW 100 kHz #VBW 300 kHz Sweep 3.04 ms (601 pts)  Copyright 2000-2006 Agilent Technologies</p> <p>Center Freq 1.91000000 GHz  Start Freq 1.90500000 GHz  Stop Freq 1.91500000 GHz  CF Step 1.00000000 MHz  Auto Man  Freq Offset 0.00000000 Hz  Signal Track On Off</p>				

Frequency	LTE Band 2	Channel Bandwidth	10 MHz	RB Allocated	50
Lower Band Edge					
Higher Band Edge					

Frequency	LTE Band 2	Channel Bandwidth	15 MHz	RB Allocated	75												
Lower Band Edge	<p>Agilent R T Freq/Channel  Mkr1 1.850 00 GHz  Ref 20 dBm Atten 30 dB  #Avg Log  10 dB/ Offst 4.3 dB  DI -13.0 dBm  PAvg 100  W1 S2  S3 FS  AA  E(f):  FTun  Swp  Center 1.850 00 GHz Span 30 MHz  #Res BW 100 kHz #VBW 300 kHz Sweep 9.08 ms (601 pts)  Copyright 2000-2006 Agilent Technologies</p> <table border="1"> <tr><td>Center Freq</td><td>1.85000000 GHz</td></tr> <tr><td>Start Freq</td><td>1.83500000 GHz</td></tr> <tr><td>Stop Freq</td><td>1.86500000 GHz</td></tr> <tr><td>CF Step</td><td>3.00000000 MHz Auto Man</td></tr> <tr><td>Freq Offset</td><td>0.00000000 Hz</td></tr> <tr><td>Signal Track</td><td>On Off</td></tr> </table>					Center Freq	1.85000000 GHz	Start Freq	1.83500000 GHz	Stop Freq	1.86500000 GHz	CF Step	3.00000000 MHz Auto Man	Freq Offset	0.00000000 Hz	Signal Track	On Off
Center Freq	1.85000000 GHz																
Start Freq	1.83500000 GHz																
Stop Freq	1.86500000 GHz																
CF Step	3.00000000 MHz Auto Man																
Freq Offset	0.00000000 Hz																
Signal Track	On Off																
Higher Band Edge	<p>Agilent R T Freq/Channel  Mkr1 1.910 00 GHz  Ref 20 dBm Atten 30 dB  #Avg Log  10 dB/ Offst 4.3 dB  DI -13.0 dBm  PAvg 100  W1 S2  S3 FS  AA  E(f):  FTun  Swp  Center 1.910 00 GHz Span 30 MHz  #Res BW 100 kHz #VBW 300 kHz Sweep 9.08 ms (601 pts)  Copyright 2000-2006 Agilent Technologies</p> <table border="1"> <tr><td>Center Freq</td><td>1.91000000 GHz</td></tr> <tr><td>Start Freq</td><td>1.89500000 GHz</td></tr> <tr><td>Stop Freq</td><td>1.92500000 GHz</td></tr> <tr><td>CF Step</td><td>3.00000000 MHz Auto Man</td></tr> <tr><td>Freq Offset</td><td>0.00000000 Hz</td></tr> <tr><td>Signal Track</td><td>On Off</td></tr> </table>					Center Freq	1.91000000 GHz	Start Freq	1.89500000 GHz	Stop Freq	1.92500000 GHz	CF Step	3.00000000 MHz Auto Man	Freq Offset	0.00000000 Hz	Signal Track	On Off
Center Freq	1.91000000 GHz																
Start Freq	1.89500000 GHz																
Stop Freq	1.92500000 GHz																
CF Step	3.00000000 MHz Auto Man																
Freq Offset	0.00000000 Hz																
Signal Track	On Off																

Frequency	LTE Band 2	Channel Bandwidth	20 MHz	RB Allocated	100
Lower Band Edge	<p>Agilent R T Freq/Channel  Mkr1 1.850 00 GHz  Ref 20 dBm Atten 30 dB  Center 1.850 00 GHz Span 40 MHz  #Res BW 100 kHz #VBW 300 kHz Sweep 12.12 ms (601 pts)  Copyright 2000-2006 Agilent Technologies</p>				
Higher Band Edge	<p>Agilent R T Freq/Channel  Mkr1 1.910 00 GHz  Ref 20 dBm Atten 30 dB  Center 1.910 00 GHz Span 40 MHz  #Res BW 100 kHz #VBW 300 kHz Sweep 12.12 ms (601 pts)  Copyright 2000-2006 Agilent Technologies</p>				

Frequency	LTE Band 4	Channel Bandwidth	1.4 MHz	RB Allocated	6
Lower Band Edge	<p>Agilent R T Freq/Channel Mkr1 1.710 00 GHz Ref 20 dBm Atten 30 dB Center Freq 1.71000000 GHz dB/ Start Freq 1.70500000 GHz Offst 4.3 dB Stop Freq 1.71500000 GHz DI -13.0 dB CF Step 1.00000000 MHz dBm PAvg Auto Man 100 Freq Offset 0.00000000 Hz W1 S2 Signal Track On Off S3 FS AA E(f): f&gt;50k Swp Center 1.710 00 GHz Span 10 MHz #Res BW 100 kHz #VBW 300 kHz Sweep 3.04 ms (601 pts) Copyright 2000-2006 Agilent Technologies</p>				
Higher Band Edge	<p>Agilent R T Freq/Channel Mkr1 1.755 00 GHz Ref 20 dBm Atten 30 dB Center Freq 1.75500000 GHz dB/ Start Freq 1.75000000 GHz Offst 4.3 dB Stop Freq 1.76000000 GHz DI -13.0 dB CF Step 1.00000000 MHz dBm PAvg Auto Man 100 Freq Offset 0.00000000 Hz W1 S2 Signal Track On Off S3 FS AA E(f): f&gt;50k Swp Center 1.755 00 GHz Span 10 MHz #Res BW 100 kHz #VBW 300 kHz Sweep 3.04 ms (601 pts) Copyright 2000-2006 Agilent Technologies</p>				

Frequency	LTE Band 4	Channel Bandwidth	3 MHz	RB Allocated	15
Lower Band Edge	<p>Agilent R T Freq/Channel  Mkr1 1.710 00 GHz  Center Freq 1.71000000 GHz  Start Freq 1.70500000 GHz  Stop Freq 1.71500000 GHz  CF Step 1.00000000 MHz  Freq Offset 0.00000000 Hz  Signal Track On Off  Ref 20 dBm Atten 30 dB  #Avg 10  Log dB/Offst 4.3 dB  DI -13.0 dBm  PAvg 100  W1 S2  S3 FS  AA  E(f): f&gt;50k Swp  Center 1.710 00 GHz Span 10 MHz  #Res BW 100 kHz #VBW 300 kHz Sweep 3.04 ms (601 pts)  Copyright 2000-2006 Agilent Technologies</p>				
Higher Band Edge	<p>Agilent R T Freq/Channel  Mkr1 1.755 00 GHz  Center Freq 1.75500000 GHz  Start Freq 1.75000000 GHz  Stop Freq 1.76000000 GHz  CF Step 1.00000000 MHz  Freq Offset 0.00000000 Hz  Signal Track On Off  Ref 20 dBm Atten 30 dB  #Avg 10  Log dB/Offst 4.3 dB  DI -13.0 dBm  PAvg 100  W1 S2  S3 FS  AA  E(f): f&gt;50k Swp  Center 1.755 00 GHz Span 10 MHz  #Res BW 100 kHz #VBW 300 kHz Sweep 3.04 ms (601 pts)  Copyright 2000-2006 Agilent Technologies</p>				

Frequency	LTE Band 4	Channel Bandwidth	5 MHz	RB Allocated	25
Lower Band Edge	<p>Agilent R T Freq/Channel</p> <p>Mkr1 1.710 00 GHz -26.463 dBm</p> <p>Center Freq 1.7100000 GHz</p> <p>Start Freq 1.7050000 GHz</p> <p>Stop Freq 1.7150000 GHz</p> <p>CF Step 1.0000000 MHz Auto Man</p> <p>Freq Offset 0.0000000 Hz</p> <p>Signal Track On Off</p> <p>Ref 20 dBm Atten 30 dB</p> <p>#Ave 10 Log dB/Offst 4.3 dB DI -13.0 dBm PAvg 100 W1 S2 S3 FS AA</p> <p>Ⓔ(f): f&gt;50k Swp</p> <p>Center 1.710 00 GHz Span 10 MHz #Res BW 100 kHz #VBW 300 kHz Sweep 3.04 ms (601 pts)</p> <p>Copyright 2000-2006 Agilent Technologies</p>				
Higher Band Edge	<p>Agilent R T Freq/Channel</p> <p>Mkr1 1.755 00 GHz -24.382 dBm</p> <p>Center Freq 1.7550000 GHz</p> <p>Start Freq 1.7500000 GHz</p> <p>Stop Freq 1.7600000 GHz</p> <p>CF Step 1.0000000 MHz Auto Man</p> <p>Freq Offset 0.0000000 Hz</p> <p>Signal Track On Off</p> <p>Ref 20 dBm Atten 30 dB</p> <p>#Ave 10 Log dB/Offst 4.3 dB DI -13.0 dBm PAvg 100 W1 S2 S3 FS AA</p> <p>Ⓔ(f): f&gt;50k Swp</p> <p>Center 1.755 00 GHz Span 10 MHz #Res BW 100 kHz #VBW 300 kHz Sweep 3.04 ms (601 pts)</p> <p>Copyright 2000-2006 Agilent Technologies</p>				



Frequency	LTE Band 4	Channel Bandwidth	10 MHz	RB Allocated	50
Lower Band Edge	<p>Agilent R T Freq/Channel  Mkr1 1.710 00 GHz  Ref 20 dBm Atten 30 dB -31.670 dBm  Center Freq 1.71000000 GHz  Start Freq 1.70000000 GHz  Stop Freq 1.72000000 GHz  CF Step 2.00000000 MHz  Freq Offset 0.00000000 Hz  Signal Track On Off  Center 1.710 00 GHz Span 20 MHz  #Res BW 100 kHz #VBW 300 kHz Sweep 6.08 ms (601 pts)  Copyright 2000-2006 Agilent Technologies</p>				
Higher Band Edge	<p>Agilent R T Freq/Channel  Mkr1 1.755 00 GHz  Ref 20 dBm Atten 30 dB -32.604 dBm  Center Freq 1.75500000 GHz  Start Freq 1.74500000 GHz  Stop Freq 1.76500000 GHz  CF Step 2.00000000 MHz  Freq Offset 0.00000000 Hz  Signal Track On Off  Center 1.755 00 GHz Span 20 MHz  #Res BW 100 kHz #VBW 300 kHz Sweep 6.08 ms (601 pts)  Copyright 2000-2006 Agilent Technologies</p>				

Frequency	LTE Band 5	Channel Bandwidth	15 MHz	RB Allocated	75
Lower Band Edge	<p>Agilent R T Freq/Channel  Mkr1 1.710 00 GHz  Center Freq 1.71000000 GHz  Start Freq 1.69500000 GHz  Stop Freq 1.72500000 GHz  CF Step 3.00000000 MHz  Auto Man  Freq Offset 0.00000000 Hz  Signal Track On Off</p> <p>Ref 20 dBm Atten 30 dB  #Ave 10  Log  dB/Offst 4.3  DI -13.0  dBrn  PAvg 100  W1 S2  S3 FS  AA  E(f):  FTun  Swp</p> <p>Center 1.710 00 GHz Span 30 MHz  #Res BW 100 kHz #VBW 300 kHz Sweep 9.08 ms (601 pts)</p> <p>Copyright 2000-2006 Agilent Technologies</p>				
Higher Band Edge	<p>Agilent R T Freq/Channel  Mkr1 1.755 00 GHz  Center Freq 1.75500000 GHz  Start Freq 1.74000000 GHz  Stop Freq 1.77000000 GHz  CF Step 3.00000000 MHz  Auto Man  Freq Offset 0.00000000 Hz  Signal Track On Off</p> <p>Ref 20 dBm Atten 30 dB  #Ave 10  Log  dB/Offst 4.3  DI -13.0  dBrn  PAvg 100  W1 S2  S3 FS  AA  E(f):  FTun  Swp</p> <p>Center 1.755 00 GHz Span 30 MHz  #Res BW 100 kHz #VBW 300 kHz Sweep 9.08 ms (601 pts)</p> <p>Copyright 2000-2006 Agilent Technologies</p>				

Frequency	LTE Band 4	Channel Bandwidth	20 MHz	RB Allocated	100
Lower Band Edge					
Higher Band Edge					

Frequency	LTE Band 5	Channel Bandwidth	1.4 MHz	RB Allocated	6
Lower Band Edge	<p>Agilent R T Freq/Channel  Mkr1 824.00 MHz  Center Freq 824.000000 MHz  Start Freq 819.000000 MHz  Stop Freq 829.000000 MHz  CF Step 1.00000000 MHz  Auto Man  Freq Offset 0.00000000 Hz  Signal Track On Off  Ref 20 dBm Atten 30 dB  #Ave 10 Log dB/Offst 3.9 dB  DI -13.0 dBm  PAvg 100  W1 S2 S3 FS AA  f &gt; 50k Swp  Mkr1 824.00 MHz  -20.782 dBm  Center 824.00 MHz Span 10 MHz  #Res BW 100 kHz #VBW 300 kHz Sweep 3.04 ms (601 pts)  Copyright 2000-2006 Agilent Technologies</p>				
Higher Band Edge	<p>Agilent R T Freq/Channel  Mkr1 849.00 MHz  Center Freq 849.000000 MHz  Start Freq 844.000000 MHz  Stop Freq 854.000000 MHz  CF Step 1.00000000 MHz  Auto Man  Freq Offset 0.00000000 Hz  Signal Track On Off  Ref 20 dBm Atten 30 dB  #Ave 10 Log dB/Offst 3.9 dB  DI -13.0 dBm  PAvg 100  W1 S2 S3 FS AA  f &gt; 50k Swp  Mkr1 849.00 MHz  -21.582 dBm  Center 849.00 MHz Span 10 MHz  #Res BW 100 kHz #VBW 300 kHz Sweep 3.04 ms (601 pts)  Copyright 2000-2006 Agilent Technologies</p>				

Frequency	LTE Band 5	Channel Bandwidth	3 MHz	RB Allocated	15
Lower Band Edge					
Higher Band Edge					

Frequency	LTE Band 5	Channel Bandwidth	5 MHz	RB Allocated	25
Lower Band Edge					
Higher Band Edge					

Frequency	LTE Band 5	Channel Bandwidth	10 MHz	RB Allocated	50
Lower Band Edge					
Higher Band Edge					

Frequency	LTE Band 7	Channel Bandwidth	5 MHz	RB Allocated	25
Res BW	100kHz				
Lower Band Edge					
Higher Band Edge					



Frequency	LTE Band 7	Channel Bandwidth	5 MHz	RB Allocated	25
Res BW	1MHz				
Lower Band Edge					
Higher Band Edge					

Frequency	LTE Band 7	Channel Bandwidth	10 MHz	RB Allocated	50
Res BW	100kHz				
Lower Band Edge					
Higher Band Edge					

Frequency	LTE Band 7	Channel Bandwidth	10 MHz	RB Allocated	50												
Res BW	1MHz																
Lower Band Edge	<p>Agilent R T Freq/Channel            Ref 20 dBm Atten 30 dB Mkr1 2.494 50 GHz            -40.011 dBm            #Avg            Log            10            dB/            Offst            4.3            dB            DI            -25.0            dBm            PAvg            100            W1 S2            S3 FS            AA            £(f):            FTun            Swp            Center 2.494 50 GHz Span 20 MHz            #Res BW 1 MHz #VBW 3 MHz Sweep 1 ms (601 pts)  <b>Copyright 2000-2006 Agilent Technologies</b></p> <table border="1"> <tr><th>Center Freq</th><td>2.49450000 GHz</td></tr> <tr><th>Start Freq</th><td>2.48450000 GHz</td></tr> <tr><th>Stop Freq</th><td>2.50450000 GHz</td></tr> <tr><th>CF Step</th><td>2.00000000 MHz Auto Man</td></tr> <tr><th>Freq Offset</th><td>0.00000000 Hz</td></tr> <tr><th>Signal Track</th><td>On Off</td></tr> </table>					Center Freq	2.49450000 GHz	Start Freq	2.48450000 GHz	Stop Freq	2.50450000 GHz	CF Step	2.00000000 MHz Auto Man	Freq Offset	0.00000000 Hz	Signal Track	On Off
Center Freq	2.49450000 GHz																
Start Freq	2.48450000 GHz																
Stop Freq	2.50450000 GHz																
CF Step	2.00000000 MHz Auto Man																
Freq Offset	0.00000000 Hz																
Signal Track	On Off																
Higher Band Edge	<p>Agilent R T Freq/Channel            Ref 20 dBm Atten 30 dB Mkr1 2.575 50 GHz            -39.051 dBm            #Avg            Log            10            dB/            Offst            4.3            dB            DI            -25.0            dBm            PAvg            100            W1 S2            S3 FS            AA            £(f):            FTun            Swp            Center 2.575 50 GHz Span 20 MHz            #Res BW 1 MHz #VBW 3 MHz Sweep 1 ms (601 pts)  <b>Copyright 2000-2006 Agilent Technologies</b></p> <table border="1"> <tr><th>Center Freq</th><td>2.57550000 GHz</td></tr> <tr><th>Start Freq</th><td>2.56550000 GHz</td></tr> <tr><th>Stop Freq</th><td>2.58550000 GHz</td></tr> <tr><th>CF Step</th><td>2.00000000 MHz Auto Man</td></tr> <tr><th>Freq Offset</th><td>0.00000000 Hz</td></tr> <tr><th>Signal Track</th><td>On Off</td></tr> </table>					Center Freq	2.57550000 GHz	Start Freq	2.56550000 GHz	Stop Freq	2.58550000 GHz	CF Step	2.00000000 MHz Auto Man	Freq Offset	0.00000000 Hz	Signal Track	On Off
Center Freq	2.57550000 GHz																
Start Freq	2.56550000 GHz																
Stop Freq	2.58550000 GHz																
CF Step	2.00000000 MHz Auto Man																
Freq Offset	0.00000000 Hz																
Signal Track	On Off																

Frequency	LTE Band 7	Channel Bandwidth	15 MHz	RB Allocated	75
Res BW	100kHz				
Lower Band Edge	<p>Agilent R T Freq/Channel            Ref 20 dBm Atten 30 dB Mkr1 2.500 00 GHz            -33.066 dBm            #Avg Log 10 dB/Offst 4.3 dB DI -13.0 dBm PAVg 100 W1 S2 S3 FS AA            £(f): FTun Swp            Center 2.500 00 GHz Span 30 MHz            #Res BW 100 kHz #VBW 300 kHz Sweep 9.08 ms (601 pts)  <b>Copyright 2000-2006 Agilent Technologies</b></p> <p>Center Freq 2.50000000 GHz            Start Freq 2.48500000 GHz            Stop Freq 2.51500000 GHz            CF Step 3.00000000 MHz Auto Man            Freq Offset 0.00000000 Hz            Signal Track On Off</p>				
Higher Band Edge	<p>Agilent R T Freq/Channel            Ref 20 dBm Atten 30 dB Mkr1 2.570 00 GHz            -34.710 dBm            #Avg Log 10 dB/Offst 4.3 dB DI -13.0 dBm PAVg 100 W1 S2 S3 FS AA            £(f): FTun Swp            Center 2.570 00 GHz Span 30 MHz            #Res BW 100 kHz #VBW 300 kHz Sweep 9.08 ms (601 pts)  <b>Copyright 2000-2006 Agilent Technologies</b></p> <p>Center Freq 2.57000000 GHz            Start Freq 2.55500000 GHz            Stop Freq 2.58500000 GHz            CF Step 3.00000000 MHz Auto Man            Freq Offset 0.00000000 Hz            Signal Track On Off</p>				

Frequency	LTE Band 7	Channel Bandwidth	15 MHz	RB Allocated	75
Res BW	1MHz				
Lower Band Edge	<p>Agilent R T Freq/Channel            Ref 20 dBm Atten 30 dB Mkr1 2.494 50 GHz            -40.429 dBm            #Avg            Log            10            dB/            Offst            4.3            dB            DI            -25.0            dBm            PAvg            100            W1 S2            S3 FS            AA            £(f):            FTun            Swp            Center 2.494 50 GHz Span 20 MHz            #Res BW 1 MHz #VBW 3 MHz Sweep 1 ms (601 pts)  <b>Copyright 2000-2006 Agilent Technologies</b></p>				
Higher Band Edge	<p>Agilent R T Freq/Channel            Ref 20 dBm Atten 30 dB Mkr1 2.575 50 GHz            -40.222 dBm            #Avg            Log            10            dB/            Offst            4.3            dB            DI            -25.0            dBm            PAvg            100            W1 S2            S3 FS            AA            £(f):            FTun            Swp            Center 2.575 50 GHz Span 20 MHz            #Res BW 1 MHz #VBW 3 MHz Sweep 1 ms (601 pts)  <b>Copyright 2000-2006 Agilent Technologies</b></p>				

Frequency	LTE Band 7	Channel Bandwidth	20 MHz	RB Allocated	100
Res BW	100kHz				
Lower Band Edge	<p>Agilent R T Freq/Channel            Ref 20 dBm Atten 30 dB Mkr1 2.500 00 GHz Center Freq 2.50000000 GHz            #Avg Log dB/ Offst 4.3 dB Stop Freq 2.48000000 GHz            DI -13.0 dBm CF Step 4.00000000 MHz Auto Man            PAVg 100 W1 S2 Freq Offset 0.00000000 Hz            S3 FS Signal Track On Off            AA £(f): FTun Swp            Center 2.500 00 GHz Span 40 MHz            #Res BW 100 kHz #VBW 300 kHz Sweep 12.12 ms (601 pts)  <b>Copyright 2000-2006 Agilent Technologies</b></p>				
Higher Band Edge	<p>Agilent R T Freq/Channel            Ref 20 dBm Atten 30 dB Mkr1 2.570 00 GHz Center Freq 2.57000000 GHz            #Avg Log dB/ Offst 4.3 dB Stop Freq 2.55000000 GHz            DI -13.0 dBm CF Step 4.00000000 MHz Auto Man            PAVg 100 W1 S2 Freq Offset 0.00000000 Hz            S3 FS Signal Track On Off            AA £(f): FTun Swp            Center 2.570 00 GHz Span 40 MHz            #Res BW 100 kHz #VBW 300 kHz Sweep 12.12 ms (601 pts)  <b>Copyright 2000-2006 Agilent Technologies</b></p>				

Frequency	LTE Band 7	Channel Bandwidth	20MHz	RB Allocated	100
Res BW	1MHz				
Lower Band Edge	<p>Agilent R T Freq/Channel</p> <p>Ref 20 dBm Atten 30 dB Mkr1 2.494 50 GHz -40.247 dBm</p> <p>#Avg Log 10 dB/Offst 4.3 dB DI -25.0 dBm PAvg 100 W1 S2 W3 FS AA</p> <p>Center 2.494 50 GHz Span 20 MHz #Res BW 1 MHz #VBW 3 MHz Sweep 1 ms (601 pts)</p> <p>Copyright 2000-2006 Agilent Technologies</p> <p>Center Freq 2.49450000 GHz Start Freq 2.48450000 GHz Stop Freq 2.50450000 GHz CF Step 2.00000000 MHz Auto Man Freq Offset 0.00000000 Hz Signal Track On Off</p>				
Higher Band Edge	<p>Agilent R T Freq/Channel</p> <p>Ref 20 dBm Atten 30 dB Mkr1 2.575 50 GHz -40.620 dBm</p> <p>#Avg Log 10 dB/Offst 4.3 dB DI -25.0 dBm PAvg 100 W1 S2 W3 FS AA</p> <p>Center 2.575 50 GHz Span 20 MHz #Res BW 1 MHz #VBW 3 MHz Sweep 1 ms (601 pts)</p> <p>Copyright 2000-2006 Agilent Technologies</p> <p>Center Freq 2.57550000 GHz Start Freq 2.56550000 GHz Stop Freq 2.58550000 GHz CF Step 2.00000000 MHz Auto Man Freq Offset 0.00000000 Hz Signal Track On Off</p>				

Frequency	LTE Band 17	Channel Bandwidth	5 MHz	RB Allocated	25
Lower Band Edge	<p>Agilent R T Freq/Channel            Mkr1 704.00 MHz            Ref 20 dBm Atten 30 dB -26.063 dBm            Center Freq 704.000000 MHz            Start Freq 699.000000 MHz            Stop Freq 709.000000 MHz            CF Step 1.00000000 MHz            Freq Offset 0.00000000 Hz            Signal Track On Off            Center 704.00 MHz Span 10 MHz            #Res BW 100 kHz #VBW 300 kHz Sweep 3.04 ms (601 pts)            Copyright 2000-2006 Agilent Technologies</p>				
Higher Band Edge	<p>Agilent R T Freq/Channel            Mkr1 716.00 MHz            Ref 20 dBm Atten 30 dB -25.415 dBm            Center Freq 716.000000 MHz            Start Freq 711.000000 MHz            Stop Freq 721.000000 MHz            CF Step 1.00000000 MHz            Freq Offset 0.00000000 Hz            Signal Track On Off            Center 716.00 MHz Span 10 MHz            #Res BW 100 kHz #VBW 300 kHz Sweep 3.04 ms (601 pts)            Copyright 2000-2006 Agilent Technologies</p>				



Frequency	LTE Band 17	Channel Bandwidth	10 MHz	RB Allocated	50
Lower Band Edge					
Higher Band Edge					