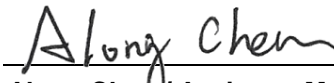

FCC Test Report

FCC ID : ACJ-V2WA
Equipment : Wireless Module
Model No. : PIOT-V2(WA)
Brand Name : Panasonic
Applicant : Panasonic Corporation of North America
Address : Two Riverfront Plaza, 9th Floor Newark New Jersey United States 07102-5490
Standard : 47 CFR FCC Part 15.247
Received Date : Sep. 23, 2020
Tested Date : Sep. 30 ~ Oct. 13, 2020

We, International Certification Corp., would like to declare that the tested sample has been evaluated and in compliance with the requirement of the above standards. The test results contained in this report refer exclusively to the product. It may be duplicated completely for legal use with the approval of the applicant. It shall not be reproduced except in full without the written approval of our laboratory.

Reviewed by:

Along Chen / Assistant Manager

Approved by:

Gary Chang / Manager



Table of Contents

1	GENERAL DESCRIPTION	5
1.1	Information.....	5
1.2	Local Support Equipment List	7
1.3	Test Setup Chart	7
1.4	Test Equipment List and Calibration Data.....	8
1.5	Test Standards	9
1.6	Reference Guidance	9
1.7	Deviation from Test Standard and Measurement Procedure.....	9
1.8	Measurement Uncertainty	9
2	TEST CONFIGURATION	10
2.1	Testing Facility.....	10
2.2	The Worst Test Modes and Channel Details	10
3	TRANSMITTER TEST RESULTS.....	11
3.1	Conducted Emissions.....	11
3.2	6dB and Occupied Bandwidth	14
3.3	RF Output Power	17
3.4	Power Spectral Density	19
3.5	Emissions in Restricted Frequency Bands.....	22
3.6	Emissions in non-restricted Frequency Bands.....	32
4	TEST LABORATORY INFORMATION	35

Release Record

Report No.	Version	Description	Issued Date
FR092302AE	Rev. 01	Initial issue	Oct. 28, 2020

Summary of Test Results

FCC Rules	Test Items	Measured	Result
15.207	AC Power Line Conducted Emissions	[dBuV]: 0.529MHz 29.82 (Margin -16.18dB) - AV	Pass
15.247(d) 15.209	Radiated Emissions	[dBuV/m at 3m]: 54.46MHz 33.95 (Margin -6.05dB) - PK	Pass
15.247(b)(3)	Maximum Output Power	Power [dBm]: 9.03	Pass
15.247(a)(2)	6dB Bandwidth	Meet the requirement of limit	Pass
15.247(e)	Power Spectral Density	Meet the requirement of limit	Pass
15.203	Antenna Requirement	Meet the requirement of limit	Pass

Declaration of Conformity:

The test results with all measurement uncertainty excluded are presented in accordance with the regulation limits or requirements declared by manufacturers.

Comments and Explanations:

The declared of product specification for EUT presented in the report are provided by the manufacturer, and the manufacturer takes all the responsibilities for the accuracy of product specification.

1 General Description

1.1 Information

1.1.1 Specification of the Equipment under Test (EUT)

RF General Information				
Frequency Range (MHz)	Bluetooth Mode	Ch. Freq. (MHz)	Channel Number	Data Rate
2400-2483.5	V4.2 LE	2402-2480	0-39 [40]	1 Mbps
Note 1: Bluetooth LE (Low energy) uses GFSK modulation.				

1.1.2 Antenna Details

Ant. No.	Brand	Model	Type	Connector	Gain (dBi)	Remarks
1	WNC	ANT-0	Printed	N/A	2.66	---
2	WNC	ANT-1	Printed	N/A	1.28	---

1.1.3 Power Supply Type of Equipment under Test (EUT)

Power Supply Type	5Vdc from host
--------------------------	----------------

1.1.4 Accessories

N/A

1.1.5 Channel List

Frequency band (MHz)				2400~2483.5			
Channel	Frequency (MHz)	Channel	Frequency (MHz)	Channel	Frequency (MHz)	Channel	Frequency (MHz)
37	2402	9	2422	18	2442	28	2462
0	2404	10	2424	19	2444	29	2464
1	2406	38	2426	20	2446	30	2466
2	2408	11	2428	21	2448	31	2468
3	2410	12	2430	22	2450	32	2470
4	2412	13	2432	23	2452	33	2472
5	2414	14	2434	24	2454	34	2474
6	2416	15	2436	25	2456	35	2476
7	2418	16	2438	26	2458	36	2478
8	2420	17	2440	27	2460	39	2480

1.1.6 Test Tool and Duty Cycle

Test Tool	RTLBTAPP, Version: V5.2.2.59	
Duty Cycle and Duty Factor	Duty Cycle (%)	Duty Factor (dB)
	66.20	1.79

1.1.7 Power Index of Test Tool

Modulation Mode	Test Frequency (MHz)		
	2402	2440	2480
BT LE	0X0F	0X0F	0X0F

1.2 Local Support Equipment List

Support Equipment List					
No.	Equipment	Brand	Model	FCC ID	Remarks
1	Notebook	DELL	Latitude E6430	DoC	---
2	USB Cable	ICC	extension	---	
3	Fixture	WNC	F5DNSK32.DG1	---	Provided by applicant.

1.3 Test Setup Chart

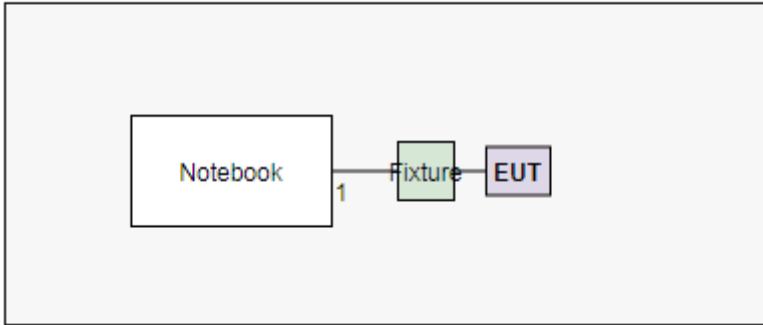
Test Setup Diagram	
 <pre> graph LR Notebook[Notebook] --- 1 Fixture[Fixture] Fixture --- EUT[EUT] </pre>	
No.	Signal cable / Length (m)
1	USB Cable (extension), 1m shielded.

1.4 Test Equipment List and Calibration Data

Test Item	Conducted Emission				
Test Site	Conduction room 1 / (CO01-WS)				
Test Date	Oct. 13, 2020				
Instrument	Manufacturer	Model No.	Serial No.	Calibration Date	Calibration Until
Receiver	R&S	ESR3	101658	Dec. 12, 2019	Dec. 11, 2020
LISN	R&S	ENV216	101579	Mar. 12, 2020	Mar. 11, 2021
RF Cable-CON	Woken	CFD200-NL	CFD200-NL-001	Oct. 22, 2019	Oct. 21, 2020
Measurement Software	AUDIX	e3	6.120210k	NA	NA
Note: Calibration Interval of instruments listed above is one year.					

Test Item	Radiated Emission				
Test Site	966 chamber 3 / (03CH03-WS)				
Test Date	Sep. 30, 2020				
Instrument	Manufacturer	Model No.	Serial No.	Calibration Date	Calibration Until
Spectrum Analyzer	R&S	FSV40	101499	Jan. 09, 2020	Jan. 08, 2021
Receiver	R&S	ESR3	101657	Feb. 14, 2020	Feb. 13, 2021
Bilog Antenna	SCHWARZBECK	VULB9168	VULB9168-685	Apr. 29, 2020	Apr. 28, 2021
Horn Antenna 1G-18G	SCHWARZBECK	BBHA 9120 D	BBHA 9120 D 1206	Dec. 27, 2019	Dec. 26, 2020
Horn Antenna 18G-40G	SCHWARZBECK	BBHA 9170	BBHA 9170517	Nov. 15, 2019	Nov. 14, 2020
Loop Antenna	R&S	HFH2-Z2	100330	Nov. 13, 2019	Nov. 12, 2020
Loop Antenna Cable	KOAX KABEL	101354-BW	101354-BW	Oct. 07, 2019	Oct. 06, 2020
Preamplifier	EMC	EMC02325	980187	Aug. 05, 2020	Aug. 04, 2021
Preamplifier	Agilent	83017A	MY39501309	Sep. 02, 2020	Sep. 01, 2021
Preamplifier	EMC	EMC184045B	980192	Jul. 21, 2020	Jul. 20, 2021
RF cable-3M	HUBER+SUHNER	SUCOFLEX104	MY22620/4	Sep. 26, 2020	Sep. 25, 2021
RF cable-8M	EMC	EMC104-SM-SM-8000	181107	Sep. 26, 2020	Sep. 25, 2021
RF cable-1M	HUBER+SUHNER	SUCOFLEX104	MY22624/4	Sep. 26, 2020	Sep. 25, 2021
LF cable-0.8M	EMC	EMC8D-NM-NM-800	EMC8D-NM-NM-800-001	Sep. 26, 2020	Sep. 25, 2021
LF cable-3M	EMC	EMC8D-NM-NM-3000	131103	Sep. 26, 2020	Sep. 25, 2021
LF cable-13M	EMC	EMC8D-NM-NM-13000	131104	Sep. 26, 2020	Sep. 25, 2021
Measurement Software	AUDIX	e3	6.120210g	NA	NA
Note: Calibration Interval of instruments listed above is one year.					

Test Item	RF Conducted				
Test Site	(TH01-WS)				
Test Date	Oct. 08, 2020				
Instrument	Manufacturer	Model No.	Serial No.	Calibration Date	Calibration Until
Spectrum Analyzer	R&S	FSV40	101063	Apr. 30, 2020	Apr. 29, 2021
Spectrum Analyzer	R&S	FSV40	101499	Jan. 09, 2020	Jan. 08, 2021
Power Meter	Anritsu	ML2495A	1241002	Oct. 23, 2019	Oct. 22, 2020
Power Sensor	Anritsu	MA2411B	1207366	Oct. 23, 2019	Oct. 22, 2020
AC POWER SOURCE	APC	AFC-500W	F312060012	Dec. 02, 2019	Dec. 01, 2020
Measurement Software	Sporton	Sporton_1	1.3.30	NA	NA
Note: Calibration Interval of instruments listed above is one year.					

1.5 Test Standards

47 CFR FCC Part 15.247
ANSI C63.10-2013

1.6 Reference Guidance

FCC KDB 558074 D01 15.247 Meas Guidance v05r02

1.7 Deviation from Test Standard and Measurement Procedure

None

1.8 Measurement Uncertainty

The measurement uncertainties given below are based on a 95% confidence level (based on a coverage factor ($k=2$)).

Measurement Uncertainty	
Parameters	Uncertainty
Bandwidth	± 34.130 Hz
Conducted power	± 0.808 dB
Power density	± 0.583 dB
Conducted emission	± 2.715 dB
AC conducted emission	± 2.92 dB
Radiated emission ≤ 1 GHz	± 3.96 dB
Radiated emission > 1 GHz	± 4.51 dB

2 Test Configuration

2.1 Testing Facility

Test Laboratory	International Certification Corp.
Test Site	CO01-WS, TH01-WS
Address of Test Site	No. 3-1, Lane 6, Wen San 3rd St., Kwei Shan District, Tao Yuan City 333, Taiwan, R.O.C.
Test Site	03CH03-WS
Address of Test Site	No. 14-1, Lane 19, Wen San 3rd St., Kwei Shan District, Tao Yuan City 333, Taiwan, R.O.C.

- FCC Designation No.: TW0009
- FCC site registration No.: 207696
- ISED#: 10807A
- CAB identifier: TW2732

2.2 The Worst Test Modes and Channel Details

Test item	Mode	Test Frequency (MHz)	Data Rate	Test Configuration
AC Power Line Conducted Emissions Radiated Emissions \leq 1GHz	BT LE	2402	1Mbps	---
Maximum Output Power 6dB bandwidth Power spectral density Radiated Emissions > 1GHz	BT LE	2402, 2440, 2480	1Mbps	---
NOTE:				
1. The EUT was pretested with 3 orientations placed on the table for the radiated emission measurement – X, Y, and Z-plane. The X-plane results were found as the worst case and were shown in this report.				

3 Transmitter Test Results

3.1 Conducted Emissions

3.1.1 Limit of Conducted Emissions

Conducted Emissions Limit		
Frequency Emission (MHz)	Quasi-Peak	Average
0.15-0.5	66 - 56 *	56 - 46 *
0.5-5	56	46
5-30	60	50

Note 1: * Decreases with the logarithm of the frequency.

3.1.2 Test Procedures

1. The device is placed on a test table, raised 80 cm above the reference ground plane. The vertical conducting plane is located 40 cm to the rear of the device.
2. The device is connected to line impedance stabilization network (LISN) and other accessories are connected to other LISN. Measured levels of AC power line conducted emission are across the 50 Ω LISN port.
3. AC conducted emission measurements is made over frequency range from 150 kHz to 30 MHz.
4. This measurement was performed with AC 120V/60Hz

3.1.3 Test Setup

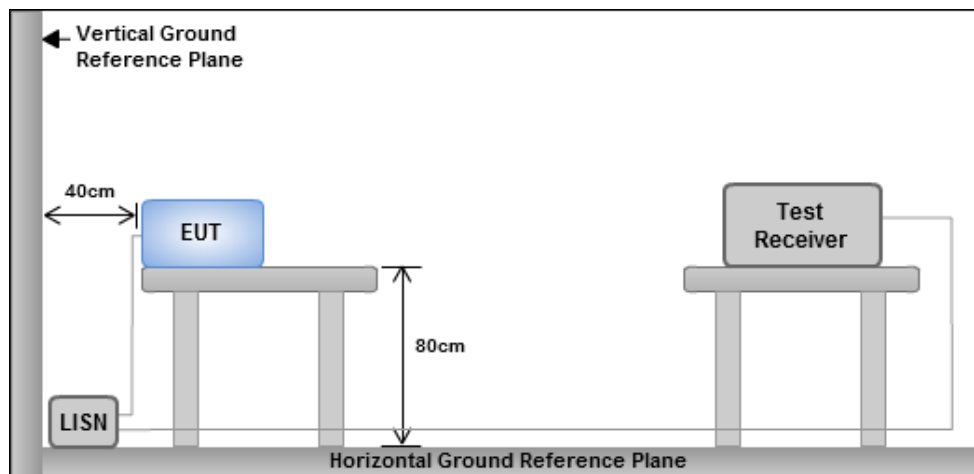

- Note: 1. Support units were connected to second LISN.
 2. Both of LISNs (AMN) are 80 cm from EUT and at least 80 cm from other units and other metal planes

3.1.4 Test Result of Conducted Emissions

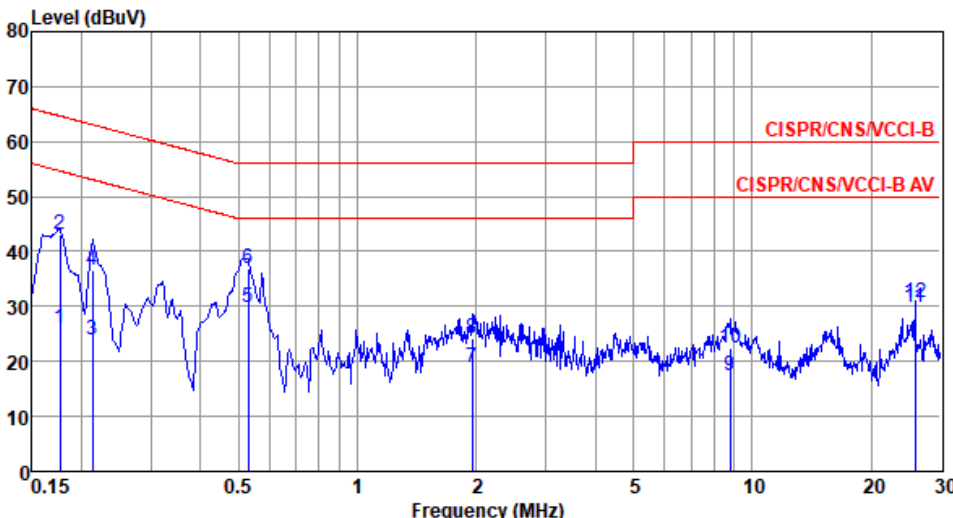
Modulation Mode	BT LE	Test Freq. (MHz)	2402																																																																																																																					
Power Phase	Line																																																																																																																							
Test by : Alex Tsai Temperature: 23°C Humidity: 57%																																																																																																																								
																																																																																																																								
<table border="1"> <thead> <tr> <th></th> <th>Freq MHz</th> <th>Level dBuV</th> <th>Limit Line dBuV</th> <th>Over Limit dB</th> <th>Read Level dBuV</th> <th>LISN factor dB</th> <th>cable loss dB</th> <th>Remark</th> </tr> </thead> <tbody> <tr><td>1</td><td>0.177</td><td>25.87</td><td>54.64</td><td>-28.77</td><td>16.18</td><td>9.63</td><td>0.06</td><td>Average</td></tr> <tr><td>2</td><td>0.177</td><td>43.13</td><td>64.64</td><td>-21.51</td><td>33.44</td><td>9.63</td><td>0.06</td><td>QP</td></tr> <tr><td>3</td><td>0.213</td><td>23.79</td><td>53.10</td><td>-29.31</td><td>14.10</td><td>9.63</td><td>0.06</td><td>Average</td></tr> <tr><td>4</td><td>0.213</td><td>36.58</td><td>63.10</td><td>-26.52</td><td>26.89</td><td>9.63</td><td>0.06</td><td>QP</td></tr> <tr><td>5*</td><td>0.529</td><td>29.82</td><td>46.00</td><td>-16.18</td><td>20.10</td><td>9.63</td><td>0.09</td><td>Average</td></tr> <tr><td>6</td><td>0.529</td><td>36.89</td><td>56.00</td><td>-19.11</td><td>27.17</td><td>9.63</td><td>0.09</td><td>QP</td></tr> <tr><td>7</td><td>1.949</td><td>19.00</td><td>46.00</td><td>-27.00</td><td>9.18</td><td>9.64</td><td>0.18</td><td>Average</td></tr> <tr><td>8</td><td>1.949</td><td>24.35</td><td>56.00</td><td>-31.65</td><td>14.53</td><td>9.64</td><td>0.18</td><td>QP</td></tr> <tr><td>9</td><td>8.776</td><td>17.42</td><td>50.00</td><td>-32.58</td><td>7.37</td><td>9.68</td><td>0.37</td><td>Average</td></tr> <tr><td>10</td><td>8.776</td><td>22.41</td><td>60.00</td><td>-37.59</td><td>12.36</td><td>9.68</td><td>0.37</td><td>QP</td></tr> <tr><td>11</td><td>25.873</td><td>29.91</td><td>50.00</td><td>-20.09</td><td>19.53</td><td>9.66</td><td>0.72</td><td>Average</td></tr> <tr><td>12</td><td>25.873</td><td>30.61</td><td>60.00</td><td>-29.39</td><td>20.23</td><td>9.66</td><td>0.72</td><td>QP</td></tr> </tbody> </table>					Freq MHz	Level dBuV	Limit Line dBuV	Over Limit dB	Read Level dBuV	LISN factor dB	cable loss dB	Remark	1	0.177	25.87	54.64	-28.77	16.18	9.63	0.06	Average	2	0.177	43.13	64.64	-21.51	33.44	9.63	0.06	QP	3	0.213	23.79	53.10	-29.31	14.10	9.63	0.06	Average	4	0.213	36.58	63.10	-26.52	26.89	9.63	0.06	QP	5*	0.529	29.82	46.00	-16.18	20.10	9.63	0.09	Average	6	0.529	36.89	56.00	-19.11	27.17	9.63	0.09	QP	7	1.949	19.00	46.00	-27.00	9.18	9.64	0.18	Average	8	1.949	24.35	56.00	-31.65	14.53	9.64	0.18	QP	9	8.776	17.42	50.00	-32.58	7.37	9.68	0.37	Average	10	8.776	22.41	60.00	-37.59	12.36	9.68	0.37	QP	11	25.873	29.91	50.00	-20.09	19.53	9.66	0.72	Average	12	25.873	30.61	60.00	-29.39	20.23	9.66	0.72	QP
	Freq MHz	Level dBuV	Limit Line dBuV	Over Limit dB	Read Level dBuV	LISN factor dB	cable loss dB	Remark																																																																																																																
1	0.177	25.87	54.64	-28.77	16.18	9.63	0.06	Average																																																																																																																
2	0.177	43.13	64.64	-21.51	33.44	9.63	0.06	QP																																																																																																																
3	0.213	23.79	53.10	-29.31	14.10	9.63	0.06	Average																																																																																																																
4	0.213	36.58	63.10	-26.52	26.89	9.63	0.06	QP																																																																																																																
5*	0.529	29.82	46.00	-16.18	20.10	9.63	0.09	Average																																																																																																																
6	0.529	36.89	56.00	-19.11	27.17	9.63	0.09	QP																																																																																																																
7	1.949	19.00	46.00	-27.00	9.18	9.64	0.18	Average																																																																																																																
8	1.949	24.35	56.00	-31.65	14.53	9.64	0.18	QP																																																																																																																
9	8.776	17.42	50.00	-32.58	7.37	9.68	0.37	Average																																																																																																																
10	8.776	22.41	60.00	-37.59	12.36	9.68	0.37	QP																																																																																																																
11	25.873	29.91	50.00	-20.09	19.53	9.66	0.72	Average																																																																																																																
12	25.873	30.61	60.00	-29.39	20.23	9.66	0.72	QP																																																																																																																
Note 1: Level (dBuV) = Read Level (dBuV) + LISN Factor (dB) + Cable Loss (dB). Note 2: Over Limit (dB) = Level (dBuV) – Limit Line (dBuV).																																																																																																																								

Modulation Mode	BT LE	Test Freq. (MHz)	2402
Power Phase	Neutral		

Test by : Alex Tsai Temperature: 23°C Humidity: 57%

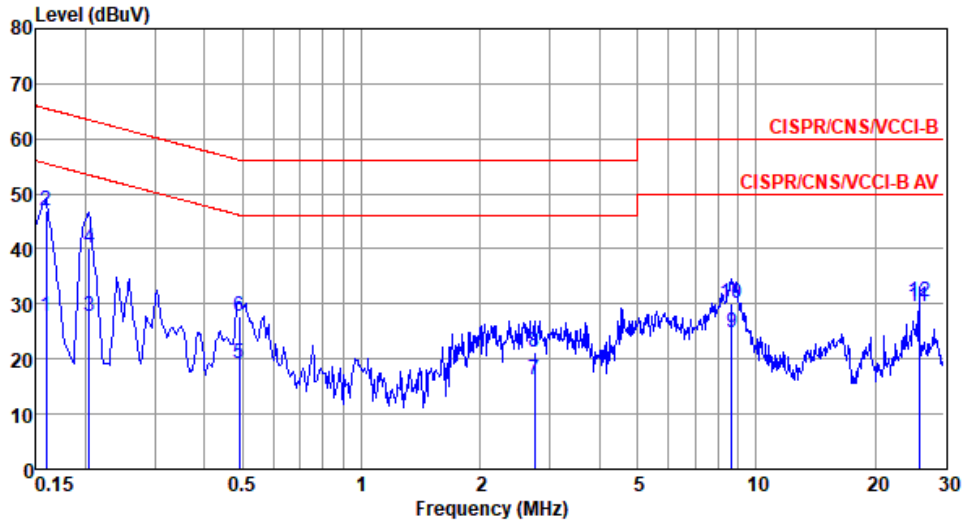

	Freq MHz	Level dBuV	Limit Line dBuV	Over Limit dB	Read Level dBuV	LISN factor dB	cable loss dB	Remark
1	0.159	27.82	55.52	-27.70	18.11	9.66	0.05	Average
2*	0.159	46.85	65.52	-18.67	37.14	9.66	0.05	QP
3	0.204	27.73	53.45	-25.72	18.02	9.65	0.06	Average
4	0.204	40.21	63.45	-23.24	30.50	9.65	0.06	QP
5	0.491	19.20	46.14	-26.94	9.46	9.65	0.09	Average
6	0.491	27.78	56.14	-28.36	18.04	9.65	0.09	QP
7	2.750	16.29	46.00	-29.71	6.40	9.66	0.23	Average
8	2.750	21.40	56.00	-34.60	11.51	9.66	0.23	QP
9	8.683	24.76	50.00	-25.24	14.67	9.72	0.37	Average
10	8.683	30.13	60.00	-29.87	20.04	9.72	0.37	QP
11	25.871	29.60	50.00	-20.40	19.08	9.80	0.72	Average
12	25.871	30.30	60.00	-29.70	19.78	9.80	0.72	QP

Note 1: Level (dBuV) = Read Level (dBuV) + LISN Factor (dB) + Cable Loss (dB).
 Note 2: Over Limit (dB) = Level (dBuV) – Limit Line (dBuV).

3.2 6dB and Occupied Bandwidth

3.2.1 Limit of 6dB Bandwidth

The minimum 6dB bandwidth shall be at least 500 kHz.

3.2.2 Test Procedures

6dB Bandwidth

1. Set resolution bandwidth (RBW) = 100 kHz, Video bandwidth = 300 kHz.
2. Detector = Peak, Trace mode = max hold.
3. Sweep = auto couple, Allow the trace to stabilize.
4. Measure the maximum width of the emission that is constrained by the frequencies associated with the two outermost amplitude points (upper and lower) that are attenuated by 6dB relative to the maximum level measured in the fundamental emission.

Occupied Bandwidth

1. Set resolution bandwidth (RBW) = 1% ~ 5 % of OBW, Video bandwidth = 3 x RBW
2. Detector = Sample, Trace mode = max hold.
3. Sweep = auto couple, Allow the trace to stabilize.
4. Use the OBW measurement function of spectrum analyzer to measure the occupied bandwidth.

3.2.3 Test Setup

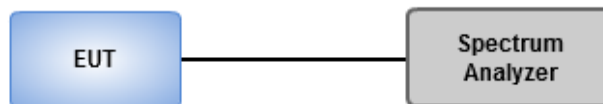

3.2.4 Test Result of 6dB and Occupied Bandwidth

Ambient Condition	22°C / 66%	Tested By	Aska Huang
--------------------------	------------	------------------	------------

Summary

Mode	Max-N dB (Hz)	Max-OBW (Hz)	ITU-Code	Min-N dB (Hz)	Min-OBW (Hz)
2.4-2.4835GHz	-	-	-	-	-
BT-LE(1Mbps)	652.174k	1.039M	1M04F1D	644.928k	1.019M

Max-N dB = Maximum 6dB down bandwidth; **Max-OBW** = Maximum 99% occupied bandwidth;

Min-N dB = Minimum 6dB down bandwidth; **Min-OBW** = Minimum 99% occupied bandwidth;

Result

Mode	Result	Limit (Hz)	Port 1-N dB (Hz)	Port 1-OBW (Hz)
BT-LE(1Mbps)	-	-	-	-
2402MHz	Pass	500k	652.174k	1.027M
2440MHz	Pass	500k	648.551k	1.019M
2480MHz	Pass	500k	644.928k	1.039M

Port X-N dB = Port X 6dB down bandwidth; **Port X-OBW** = Port X 99% occupied bandwidth;

BT-LE(1Mbps)

EBW-DTS

2402MHz

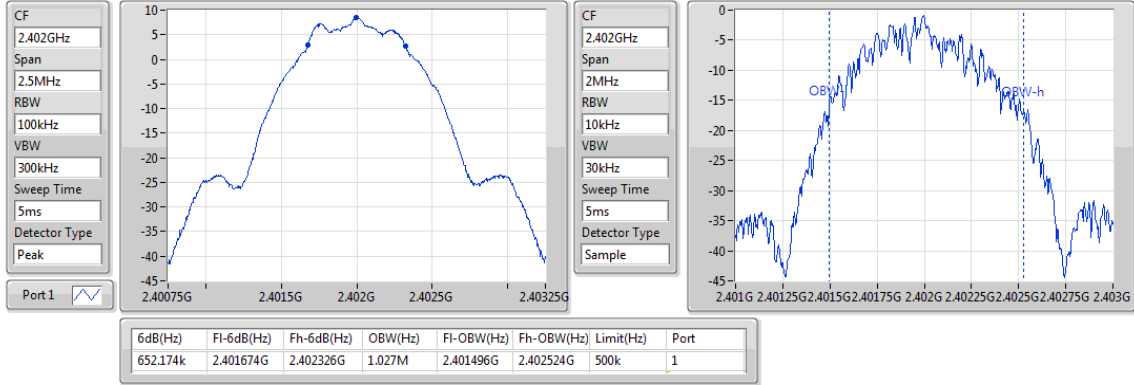

BT-LE(1Mbps)

EBW-DTS

2440MHz

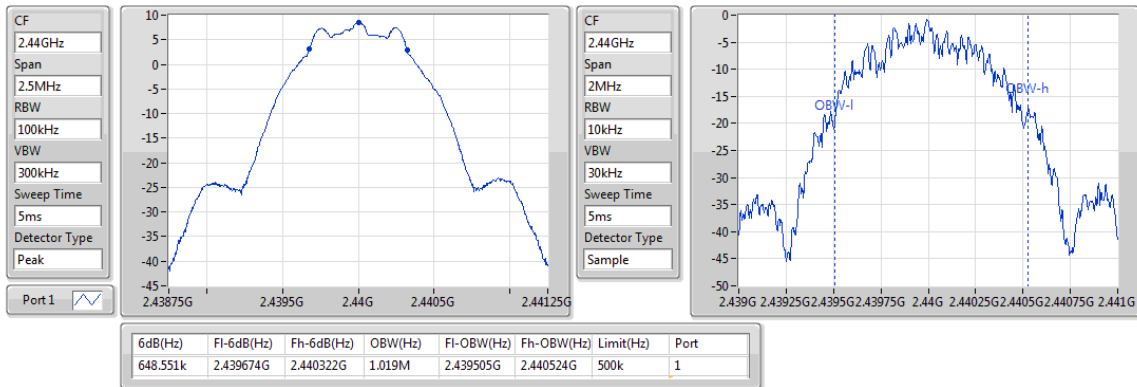

BT-LE(1Mbps)

EBW-DTS

2480MHz

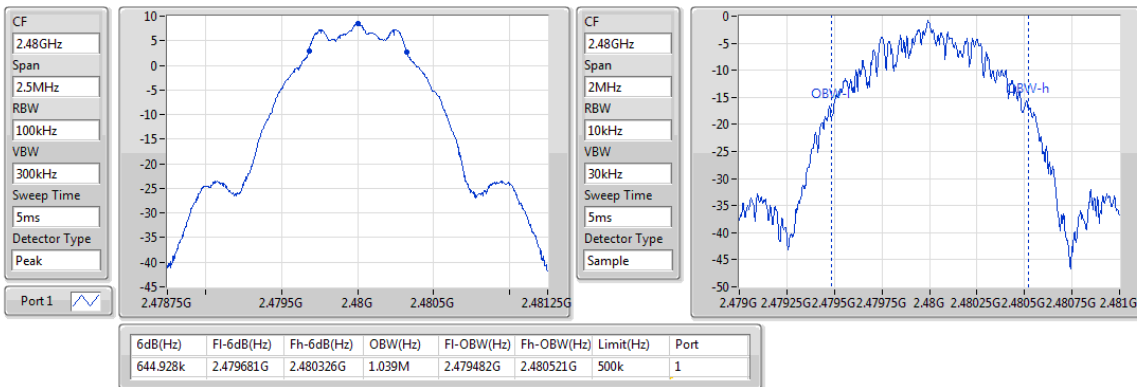

3.3 RF Output Power

3.3.1 Limit of RF Output Power

Conducted power shall not exceed 1Watt.

Antenna gain $\leq 6\text{dBi}$, no any corresponding reduction is in output power limit.

3.3.2 Test Procedures

A broadband RF power meter is used for output power measurement. The video bandwidth of power meter is greater than DTS bandwidth of EUT. If duty cycle of test signal is not 100 %, trigger and gating function of power meter will be enabled to capture transmission burst for measuring output power.

3.3.3 Test Setup

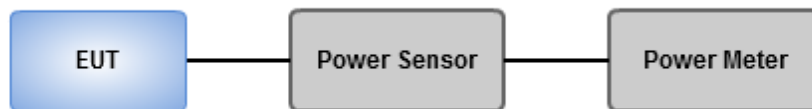

3.3.4 Test Result of Maximum Output Power

Ambient Condition	22°C / 66%	Tested By	Aska Huang
--------------------------	------------	------------------	------------

Summary of Peak Conducted Output Power

Mode	Power (dBm)	Power (W)
2.4-2.4835GHz	-	-
BT-LE(1Mbps)	9.03	0.00800

Result

Mode	Result	Gain (dBi)	Power (dBm)	Power Limit (dBm)
BT-LE(1Mbps)	-	-	-	-
2402MHz	Pass	2.66	9.03	30.00
2440MHz	Pass	2.66	9.02	30.00
2480MHz	Pass	2.66	8.94	30.00

Summary of Conducted (Average) Output Power

Mode	Power (dBm)	Power (W)
2.4-2.4835GHz	-	-
BT-LE(1Mbps)	8.71	0.00743

Result

Mode	Result	Gain (dBi)	Power (dBm)	Power Limit (dBm)
BT-LE(1Mbps)	-	-	-	-
2402MHz	Pass	2.66	8.71	-
2440MHz	Pass	2.66	8.68	-
2480MHz	Pass	2.66	8.61	-

Note: Average power is for reference only.

3.4 Power Spectral Density

3.4.1 Limit of Power Spectral Density

Power spectral density shall not be greater than 8 dBm in any 3 kHz band.

3.4.2 Test Procedures

1. Set the RBW = 3 kHz, VBW = 10 kHz.
2. Detector = Peak, Sweep time = auto couple.
3. Trace mode = max hold, allow trace to fully stabilize.
4. Use the peak marker function to determine the maximum amplitude level.

3.4.3 Test Setup

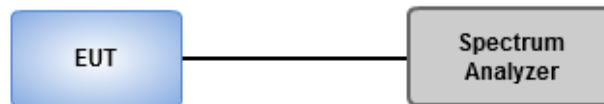

3.4.4 Test Result of Power Spectral Density

Ambient Condition	22°C / 66%	Tested By	Aska Huang
--------------------------	------------	------------------	------------

Summary

Mode	PD (dBm/3kHz)
2.4-2.4835GHz	-
BT-LE(1Mbps)	-6.36

Result

Mode	Result	Gain (dBi)	PD (dBm/3kHz)	PD Limit (dBm/3kHz)
BT-LE(1Mbps)	-	-	-	-
2402MHz	Pass	2.66	-6.89	8.00
2440MHz	Pass	2.66	-6.36	8.00
2480MHz	Pass	2.66	-7.33	8.00

BT-LE(1Mbps)

PSD

2402MHz

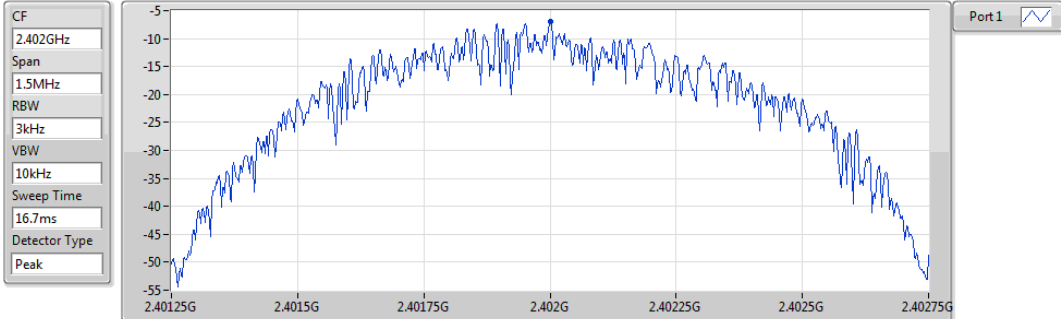

Sum	PD	Port 1
(dBm/RBW)	(dBm/RBW)	(dBm/RBW)
-6.89	-6.89	-6.89

BT-LE(1Mbps)

PSD

2440MHz

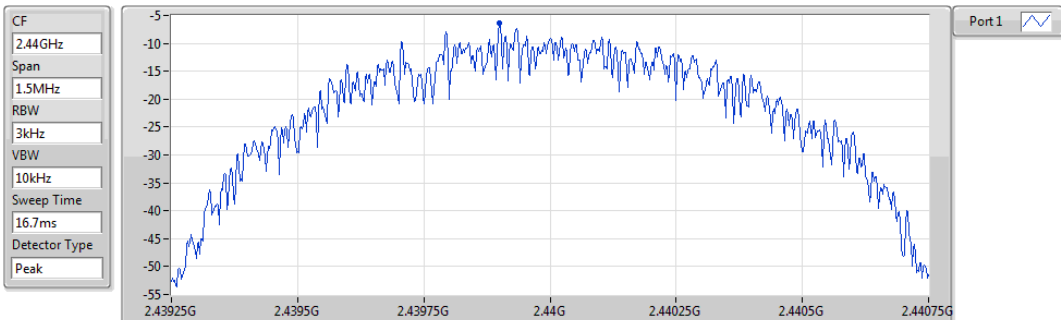

Sum	PD	Port 1
(dBm/RBW)	(dBm/RBW)	(dBm/RBW)
-6.36	-6.36	-6.36

BT-LE(1Mbps)

PSD

2480MHz

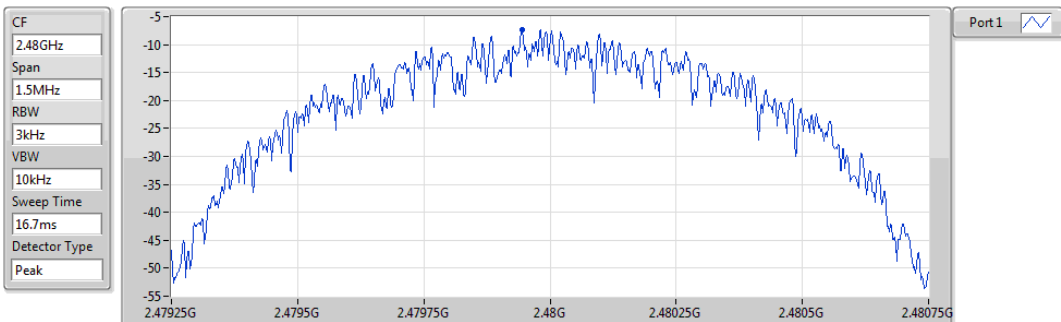

Sum	PD	Port 1
(dBm/RBW)	(dBm/RBW)	(dBm/RBW)
-7.33	-7.33	-7.33

3.5 Emissions in Restricted Frequency Bands

3.5.1 Limit of Emissions in Restricted Frequency Bands

Restricted Band Emissions Limit			
Frequency Range (MHz)	Field Strength (uV/m)	Field Strength (dBuV/m)	Measure Distance (m)
0.009~0.490	2400/F(kHz)	48.5 - 13.8	300
0.490~1.705	24000/F(kHz)	33.8 - 23	30
1.705~30.0	30	29	30
30~88	100	40	3
88~216	150	43.5	3
216~960	200	46	3
Above 960	500	54	3

Note 1:
Qusai-Peak value is measured for frequency below 1GHz except for 9–90 kHz, 110–490 kHz frequency band. Peak and average value are measured for frequency above 1GHz. The limit on average radio frequency emission is as above table. The limit on peak radio frequency emissions is 20 dB above the maximum permitted average emission limit

Note 2:
Measurements may be performed at a distance other than what is specified provided. When performing measurements at a distance other than that specified, the results shall be extrapolated to the specified distance using an extrapolation factor as below, Frequency at or above 30 MHz: 20 dB/decade Frequency below 30 MHz: 40 dB/decade.

3.5.2 Test Procedures

1. Measurement is made at a semi-anechoic chamber that incorporates a turntable allowing a EUT rotation of 360°. A continuously-rotating, remotely-controlled turntable is installed at the test site to support the EUT and facilitate determination of the direction of maximum radiation for each EUT emission frequency. The EUT is placed at test table. For emissions testing at or below 1 GHz, the table height is 80 cm above the reference ground plane. For emission measurements above 1 GHz, the table height is 1.5 m
2. Measurement is made with the antenna positioned in both the horizontal and vertical planes of polarization. The measurement antenna is varied in height (1m ~ 4m) above the reference ground plane to obtain the maximum signal strength. Distance between EUT and antenna is 3 m.
3. This investigation is performed with the EUT rotated 360°, the antenna height scanned between 1 m and 4 m, and the antenna rotated to repeat the measurements for both the horizontal and vertical antenna polarizations.

Note:

1. 120kHz measurement bandwidth of test receiver and Quasi-peak detector is for radiated emission below 1GHz.
2. RBW=1MHz, VBW=3MHz and Peak detector is for peak measured value of radiated emission above 1GHz.
3. RBW=1MHz, VBW=1/T and Peak detector is for average measured value of radiated emission above 1GHz.

3.5.3 Test Setup

Radiated Emissions below 1 GHz

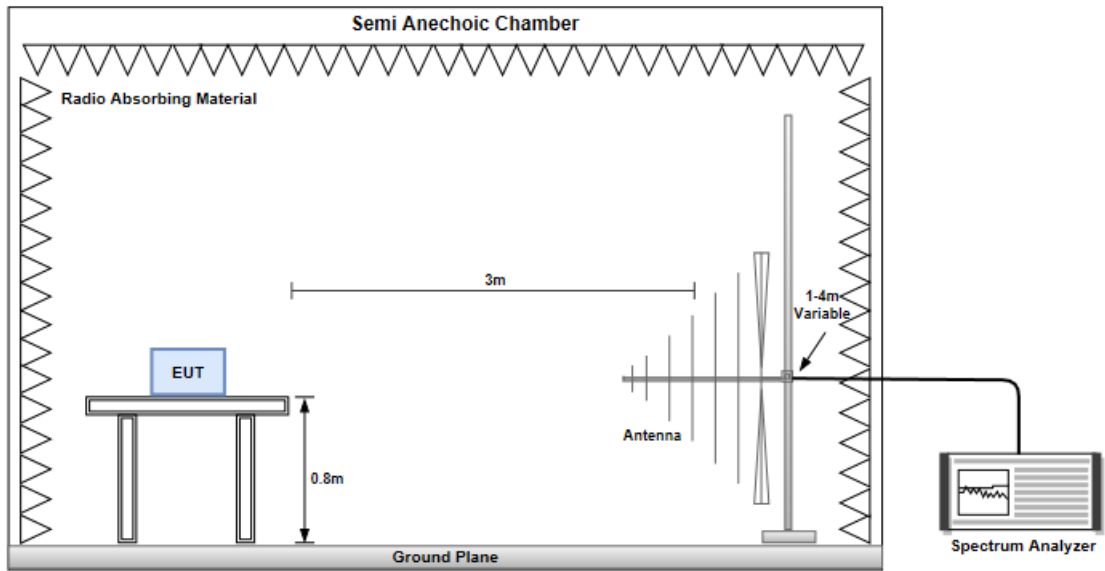

Radiated Emissions above 1 GHz

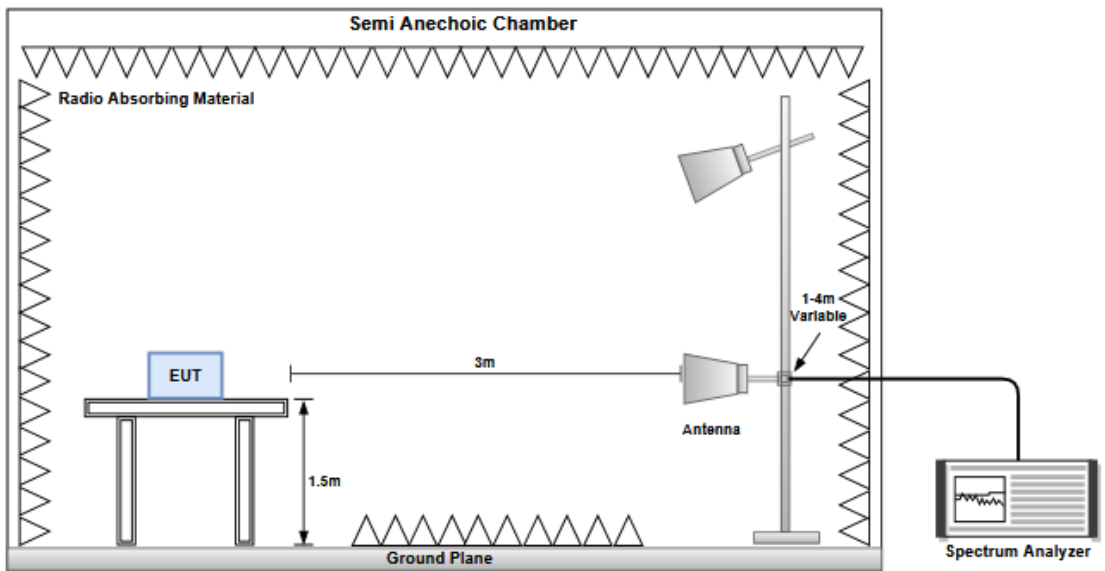

3.5.4 Transmitter Radiated Unwanted Emissions (Below 1GHz)

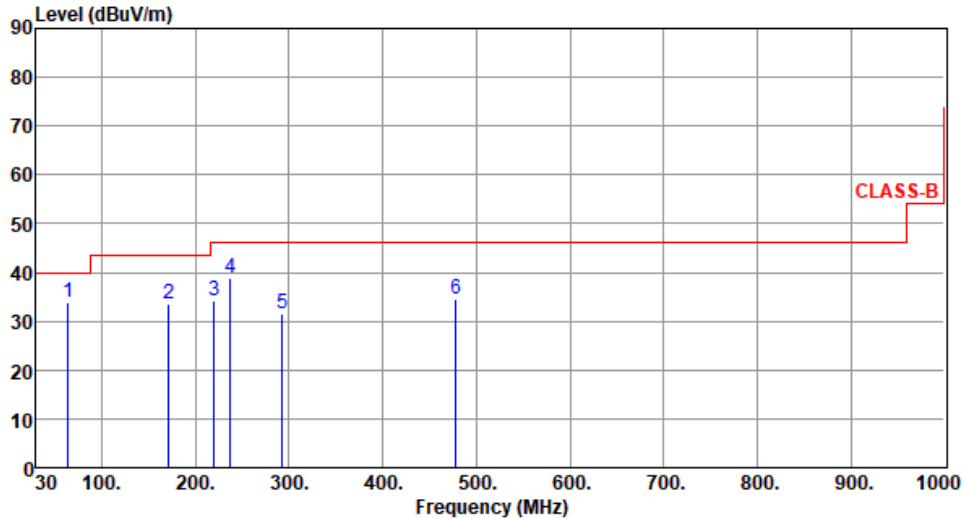
Modulation	GFSK	Test Freq. (MHz)	2402																																																															
Polarization	Horizontal																																																																	
Test By :BRAD WU Temperature(°C):22 Humidity(%):65																																																																		
 <p>The graph plots Level (dBuV/m) on the y-axis (0 to 90) against Frequency (MHz) on the x-axis (30 to 1000). A red line represents the CLASS-B limit, which is constant at 46 dBuV/m from 30 MHz to 1000 MHz. Six blue vertical lines indicate emission peaks at frequencies 64.42, 171.96, 220.12, 237.42, 292.87, and 478.14 MHz. The peak levels are 33.94, 33.45, 34.11, 39.01, 31.71, and 34.48 dBuV/m respectively. The margin values are -6.06, -10.05, -11.89, -6.99, -14.29, and -11.52 dB.</p>																																																																		
	<table border="1"> <thead> <tr> <th>Freq. MHz</th> <th>Emission level dBuV/m</th> <th>Limit dBuV/m</th> <th>Margin dB</th> <th>SA reading dBuV</th> <th>Factor dB</th> <th>Remark</th> <th>ANT High cm</th> <th>Turn Table deg</th> </tr> </thead> <tbody> <tr> <td>1</td> <td>64.42</td> <td>33.94</td> <td>40.00</td> <td>-6.06</td> <td>43.75</td> <td>-9.81</td> <td>Peak</td> <td>---</td> </tr> <tr> <td>2</td> <td>171.96</td> <td>33.45</td> <td>43.50</td> <td>-10.05</td> <td>42.84</td> <td>-9.39</td> <td>Peak</td> <td>---</td> </tr> <tr> <td>3</td> <td>220.12</td> <td>34.11</td> <td>46.00</td> <td>-11.89</td> <td>46.47</td> <td>-12.36</td> <td>Peak</td> <td>---</td> </tr> <tr> <td>4</td> <td>237.42</td> <td>39.01</td> <td>46.00</td> <td>-6.99</td> <td>49.82</td> <td>-10.81</td> <td>Peak</td> <td>---</td> </tr> <tr> <td>5</td> <td>292.87</td> <td>31.71</td> <td>46.00</td> <td>-14.29</td> <td>40.46</td> <td>-8.75</td> <td>Peak</td> <td>---</td> </tr> <tr> <td>6</td> <td>478.14</td> <td>34.48</td> <td>46.00</td> <td>-11.52</td> <td>38.05</td> <td>-3.57</td> <td>Peak</td> <td>---</td> </tr> </tbody> </table>	Freq. MHz	Emission level dBuV/m	Limit dBuV/m	Margin dB	SA reading dBuV	Factor dB	Remark	ANT High cm	Turn Table deg	1	64.42	33.94	40.00	-6.06	43.75	-9.81	Peak	---	2	171.96	33.45	43.50	-10.05	42.84	-9.39	Peak	---	3	220.12	34.11	46.00	-11.89	46.47	-12.36	Peak	---	4	237.42	39.01	46.00	-6.99	49.82	-10.81	Peak	---	5	292.87	31.71	46.00	-14.29	40.46	-8.75	Peak	---	6	478.14	34.48	46.00	-11.52	38.05	-3.57	Peak	---		
Freq. MHz	Emission level dBuV/m	Limit dBuV/m	Margin dB	SA reading dBuV	Factor dB	Remark	ANT High cm	Turn Table deg																																																										
1	64.42	33.94	40.00	-6.06	43.75	-9.81	Peak	---																																																										
2	171.96	33.45	43.50	-10.05	42.84	-9.39	Peak	---																																																										
3	220.12	34.11	46.00	-11.89	46.47	-12.36	Peak	---																																																										
4	237.42	39.01	46.00	-6.99	49.82	-10.81	Peak	---																																																										
5	292.87	31.71	46.00	-14.29	40.46	-8.75	Peak	---																																																										
6	478.14	34.48	46.00	-11.52	38.05	-3.57	Peak	---																																																										
Note 1: Emission Level (dBuV/m) = SA Reading (dBuV/m) + Factor* (dB) *Factor includes antenna factor , cable loss and amplifier gain Note 2: Margin (dB) = Emission level (dBuV/m) – Limit (dBuV/m). Note 3: All spurious emissions below 30MHz are more than 20 dB below the limit.																																																																		

Modulation	GFSK	Test Freq. (MHz)	2402
Polarization	Vertical		

Test By :BRAD WU Temperature(°C):22 Humidity(%):65

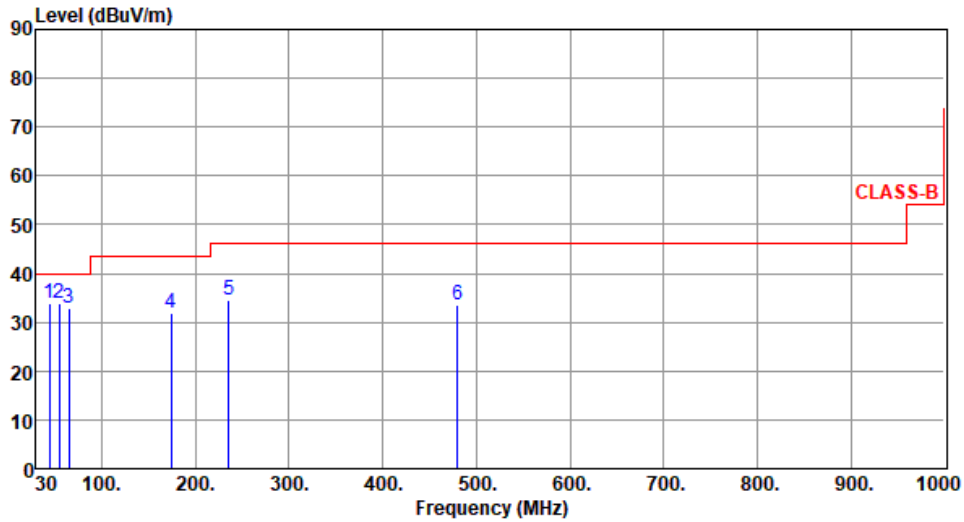

	Freq. MHz	Emission level dBuV/m	Limit dBuV/m	Margin dB	SA reading dBuV	Factor dB	Remark	ANT High cm	Turn Table deg
1	43.88	33.72	40.00	-6.28	42.48	-8.76	Peak	---	---
2	54.46	33.95	40.00	-6.05	42.94	-8.99	Peak	---	---
3	64.85	33.00	40.00	-7.00	42.93	-9.93	Peak	---	---
4	174.46	31.96	43.50	-11.54	41.63	-9.67	Peak	---	---
5	235.39	34.58	46.00	-11.42	45.56	-10.98	Peak	---	---
6	480.26	33.65	46.00	-12.35	37.16	-3.51	Peak	---	---

Note 1: Emission Level (dBuV/m) = SA Reading (dBuV/m) + Factor* (dB)

*Factor includes antenna factor , cable loss and amplifier gain

Note 2: Margin (dB) = Emission level (dBuV/m) – Limit (dBuV/m).

Note 3: All spurious emissions below 30MHz are more than 20 dB below the limit.

3.5.5 Transmitter Radiated Unwanted Emissions (Above 1GHz)

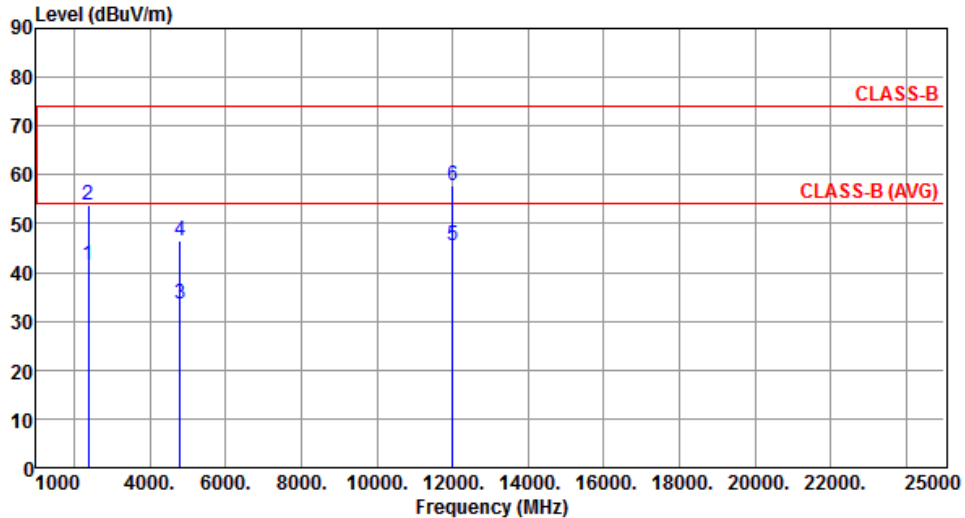
Modulation	GFSK	Test Freq. (MHz)	2402						
Polarization	Horizontal								
Test By : Roger Lu Temperature(°C):24 Humidity(%):61									
									
	Freq.	Emission level	Limit	Margin	SA reading	Factor	Remark	ANT High	Turn Table
	MHz	dBuV/m	dBuV/m	dB	dBuV	dB		cm	deg
1	2390.00	41.39	54.00	-12.61	43.23	-1.84	Average	202	253
2	2390.00	53.74	74.00	-20.26	55.58	-1.84	Peak	202	253
3	4804.00	33.57	54.00	-20.43	28.56	5.01	Average	100	30
4	4804.00	46.48	74.00	-27.52	41.47	5.01	Peak	100	30
5	12010.00	45.38	54.00	-8.62	30.88	14.50	Average	100	50
6	12010.00	57.64	74.00	-16.36	43.14	14.50	Peak	100	50

Note 1: Emission Level (dBuV/m) = SA Reading (dBuV/m) + Factor* (dB)
*Factor includes antenna factor , cable loss and amplifier gain
Note 2: Margin (dB) = Emission level (dBuV/m) – Limit (dBuV/m).

Modulation	GFSK	Test Freq. (MHz)	2402
Polarization	Vertical		

Test By :Roger Lu Temperature(°C):24 Humidity(%):61

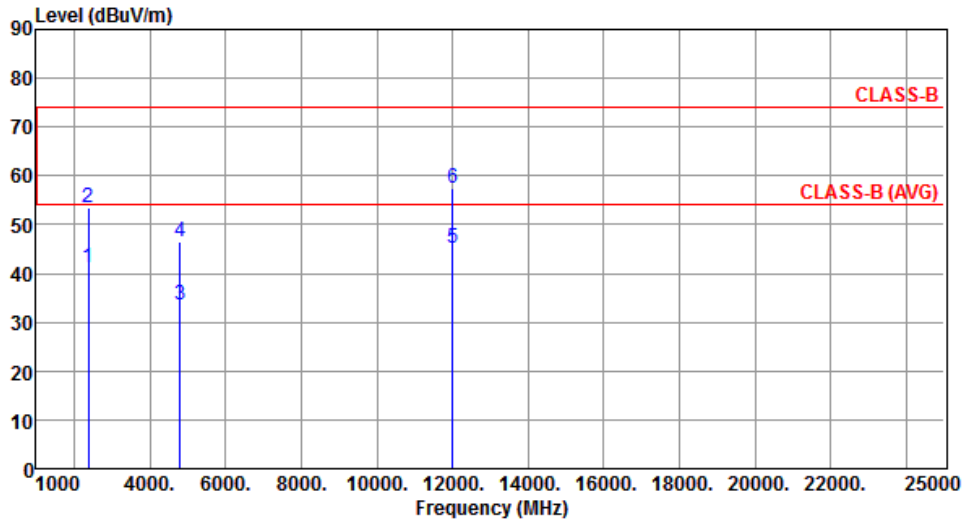

	Freq. MHz	Emission level dBuV/m	Limit dBuV/m	Margin dB	SA reading dBuV	Factor dB	Remark	ANT High cm	Turn Table deg
1	2390.00	41.33	54.00	-12.67	43.17	-1.84	Average	106	267
2	2390.00	53.58	74.00	-20.42	55.42	-1.84	Peak	106	267
3	4804.00	33.49	54.00	-20.51	28.48	5.01	Average	100	90
4	4804.00	46.36	74.00	-27.64	41.35	5.01	Peak	100	90
5	12010.00	45.08	54.00	-8.92	30.58	14.50	Average	100	70
6	12010.00	57.36	74.00	-16.64	42.86	14.50	Peak	100	70

Note 1: Emission Level (dBuV/m) = SA Reading (dBuV/m) + Factor* (dB)

*Factor includes antenna factor , cable loss and amplifier gain

Note 2: Margin (dB) = Emission level (dBuV/m) – Limit (dBuV/m).

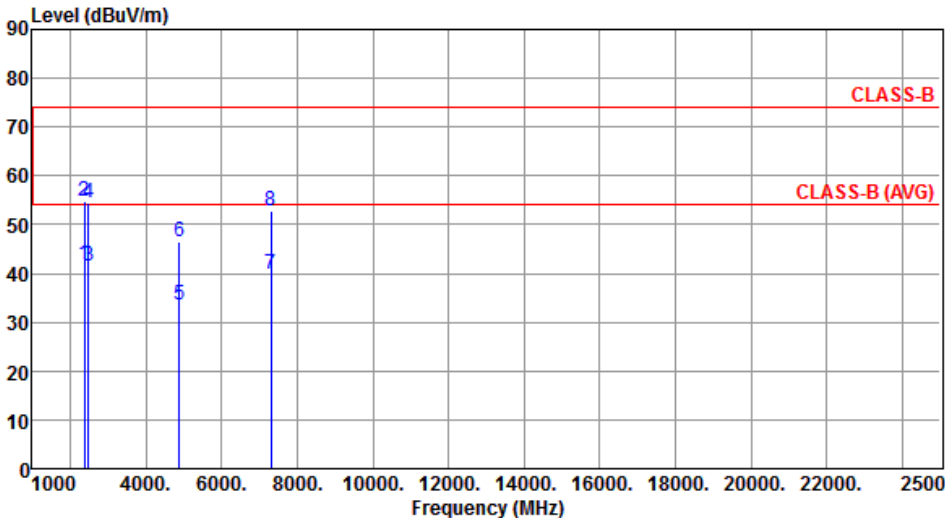
Modulation	GFSK	Test Freq. (MHz)	2440						
Polarization	Horizontal								
Test By : Roger Lu		Temperature(°C): 24	Humidity(%): 61						
									
	Freq.	Emission level	Limit	Margin	SA reading	Factor	Remark	ANT High	Turn Table
	MHz	dBuV/m	dBuV/m	dB	dBuV	dB		cm	deg
1	2390.00	41.71	54.00	-12.29	43.55	-1.84	Average	201	252
2	2390.00	54.90	74.00	-19.10	56.74	-1.84	Peak	201	252
3	2483.50	41.66	54.00	-12.34	43.46	-1.80	Average	201	252
4	2483.50	54.42	74.00	-19.58	56.22	-1.80	Peak	201	252
5	4880.00	33.43	54.00	-20.57	28.38	5.05	Average	100	60
6	4880.00	46.40	74.00	-27.60	41.35	5.05	Peak	100	60
7	7320.00	39.97	54.00	-14.03	29.67	10.30	Average	100	40
8	7320.00	52.74	74.00	-21.26	42.44	10.30	Peak	100	40
<p>Note 1: Emission Level (dBuV/m) = SA Reading (dBuV/m) + Factor* (dB) *Factor includes antenna factor , cable loss and amplifier gain Note 2: Margin (dB) = Emission level (dBuV/m) – Limit (dBuV/m).</p>									

Modulation	GFSK	Test Freq. (MHz)	2440
Polarization	Vertical		

Test By :Roger Lu Temperature(°C):24 Humidity(%):61

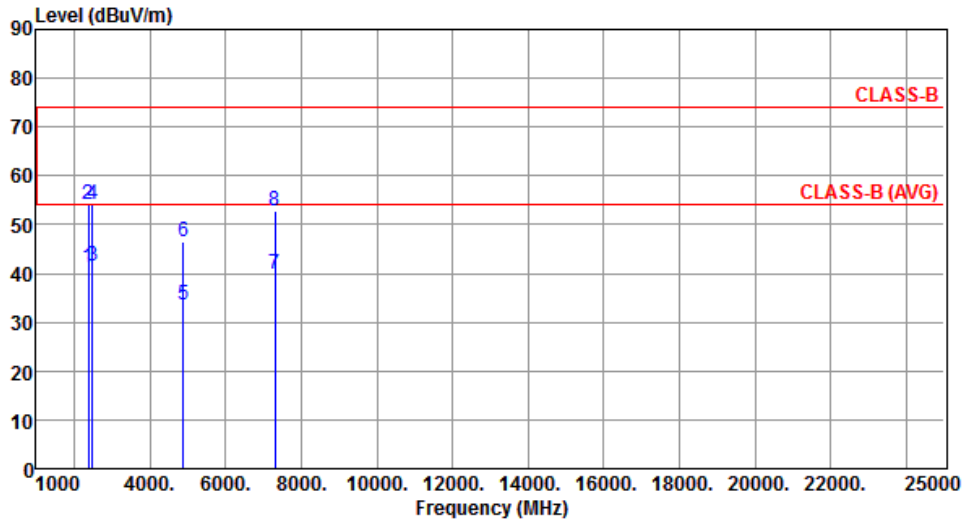

	Freq. MHz	Emission level dBuV/m	Limit dBuV/m	Margin dB	SA reading dBuV	Factor dB	Remark	ANT High cm	Turn Table deg
1	2390.00	41.33	54.00	-12.67	43.17	-1.84	Average	106	261
2	2390.00	54.21	74.00	-19.79	56.05	-1.84	Peak	106	261
3	2483.50	41.48	54.00	-12.52	43.28	-1.80	Average	106	261
4	2483.50	54.16	74.00	-19.84	55.96	-1.80	Peak	106	261
5	4880.00	33.62	54.00	-20.38	28.57	5.05	Average	100	30
6	4880.00	46.41	74.00	-27.59	41.36	5.05	Peak	100	30
7	7320.00	39.85	54.00	-14.15	29.55	10.30	Average	100	50
8	7320.00	52.78	74.00	-21.22	42.48	10.30	Peak	100	50

Note 1: Emission Level (dBuV/m) = SA Reading (dBuV/m) + Factor* (dB)

*Factor includes antenna factor , cable loss and amplifier gain

Note 2: Margin (dB) = Emission level (dBuV/m) – Limit (dBuV/m).

Modulation	GFSK	Test Freq. (MHz)	2480
Polarization	Horizontal		

Test By :Roger Lu Temperature(°C):24 Humidity(%):61

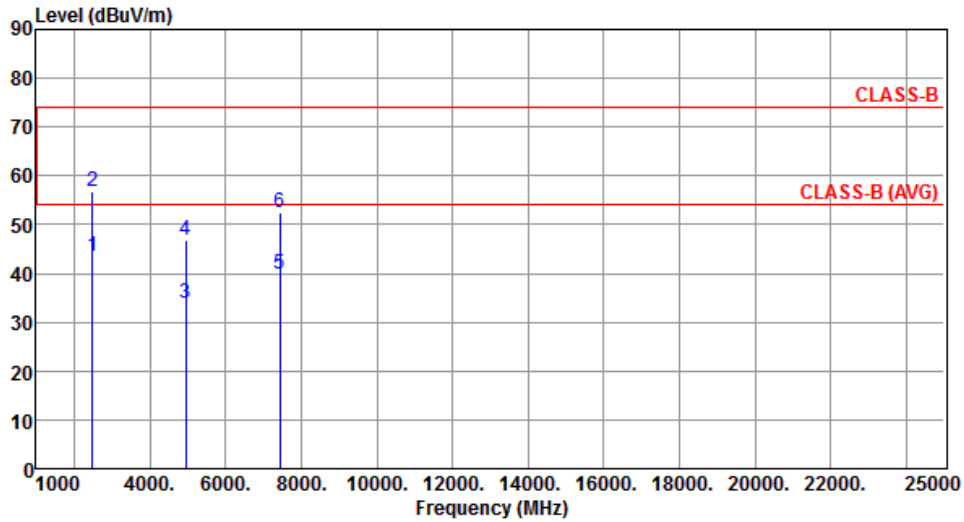

	Freq. MHz	Emission level dBuV/m	Limit dBuV/m	Margin dB	SA reading dBuV	Factor dB	Remark	ANT High cm	Turn Table deg
1	2483.50	43.48	54.00	-10.52	45.28	-1.80	Average	203	251
2	2483.50	56.73	74.00	-17.27	58.53	-1.80	Peak	203	251
3	4960.00	33.94	54.00	-20.06	28.64	5.30	Average	100	40
4	4960.00	46.66	74.00	-27.34	41.36	5.30	Peak	100	40
5	7440.00	39.88	54.00	-14.12	29.67	10.21	Average	100	25
6	7440.00	52.52	74.00	-21.48	42.31	10.21	Peak	100	25

Note 1: Emission Level (dBuV/m) = SA Reading (dBuV/m) + Factor* (dB)

*Factor includes antenna factor , cable loss and amplifier gain

Note 2: Margin (dB) = Emission level (dBuV/m) – Limit (dBuV/m).

Modulation	GFSK	Test Freq. (MHz)	2480
Polarization	Vertical		

Test By :Roger Lu Temperature(°C):24 Humidity(%):61

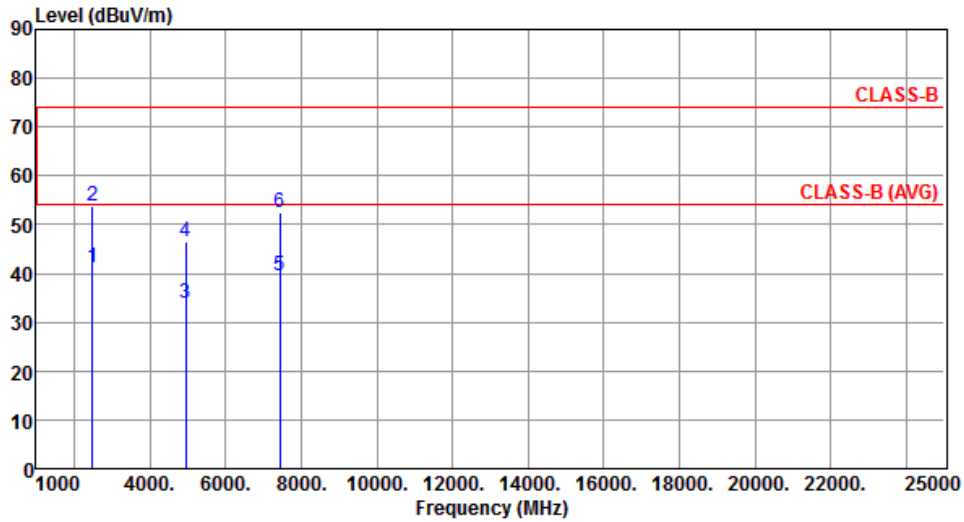

	Freq. MHz	Emission level dBUV/m	Limit dBUV/m	Margin dB	SA reading dBUV	Factor dB	Remark	ANT High cm	Turn Table deg
1	2483.50	41.05	54.00	-12.95	42.85	-1.80	Average	110	263
2	2483.50	53.67	74.00	-20.33	55.47	-1.80	Peak	110	263
3	4960.00	33.74	54.00	-20.26	28.44	5.30	Average	100	30
4	4960.00	46.57	74.00	-27.43	41.27	5.30	Peak	100	30
5	7440.00	39.66	54.00	-14.34	29.45	10.21	Average	100	90
6	7440.00	52.36	74.00	-21.64	42.15	10.21	Peak	100	90

Note 1: Emission Level (dBUV/m) = SA Reading (dBUV/m) + Factor* (dB)

*Factor includes antenna factor , cable loss and amplifier gain

Note 2: Margin (dB) = Emission level (dBUV/m) – Limit (dBUV/m).

3.6 Emissions in non-restricted Frequency Bands

3.6.1 Emissions in non-restricted frequency bands limit

Peak power in any 100 kHz bandwidth outside of the authorized frequency band shall be attenuated by at least 20 dB relative to the maximum in-band peak PSD level in 100 kHz.

3.6.2 Test Procedures

Reference level measurement

1. Set RBW=100kHz, VBW = 300kHz , Detector = Peak, Sweep time = Auto
2. Trace = max hold , Allow Trace to fully stabilize
3. Use the peak marker function to determine the maximum PSD level

Emission level measurement

1. Set RBW=100kHz, VBW = 300kHz , Detector = Peak, Sweep time = Auto
2. Trace = max hold , Allow Trace to fully stabilize
3. Scan Frequency range is up to 25GHz
4. Use the peak marker function to determine the maximum amplitude level

3.6.3 Test Setup

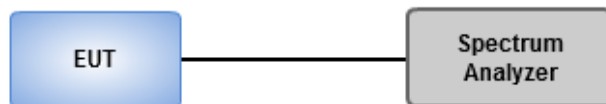

3.6.4 Test Result of Emissions in non-restricted Frequency Bands

Ambient Condition	22°C / 66%	Tested By	Aska Huang
--------------------------	------------	------------------	------------

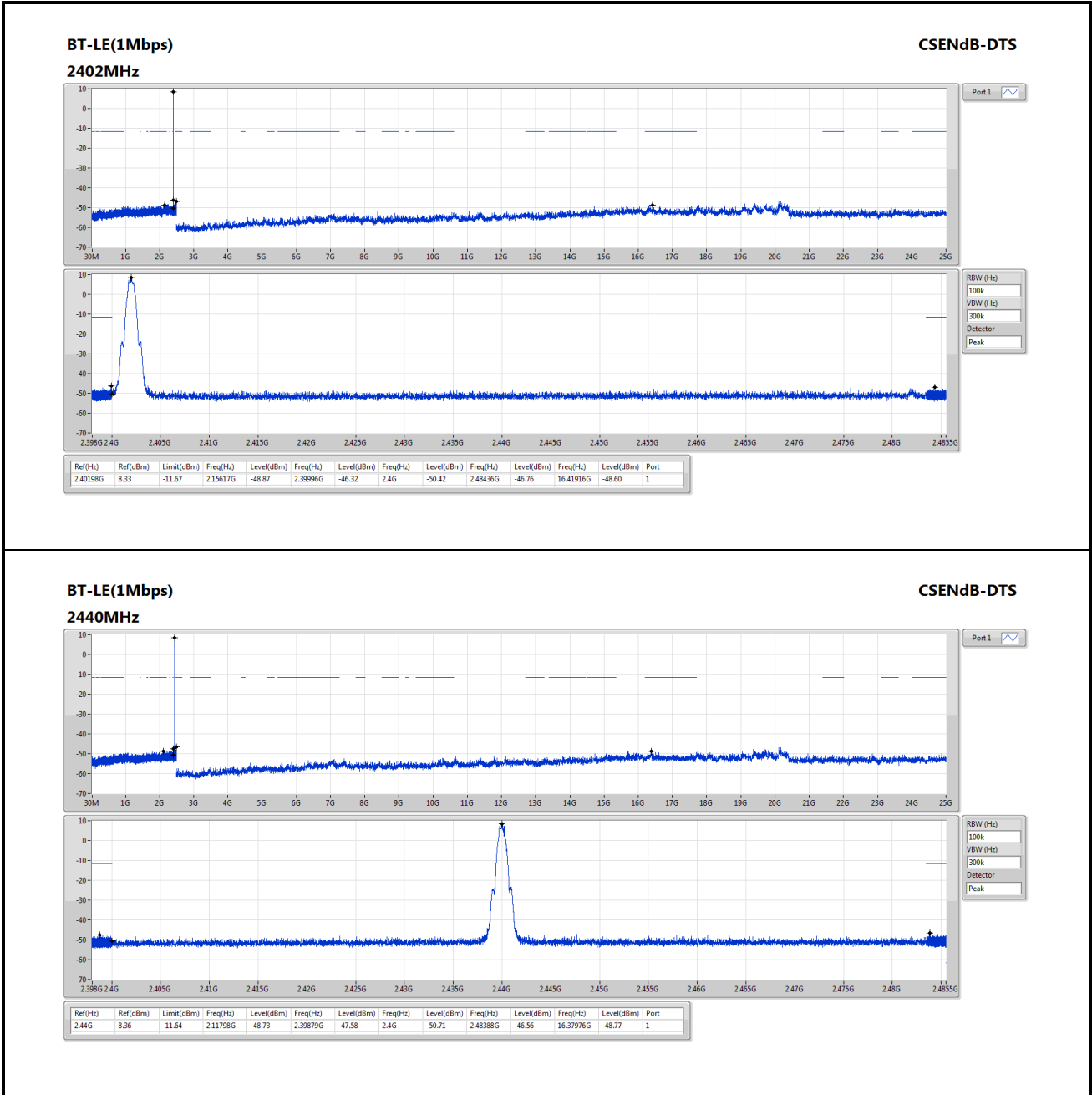

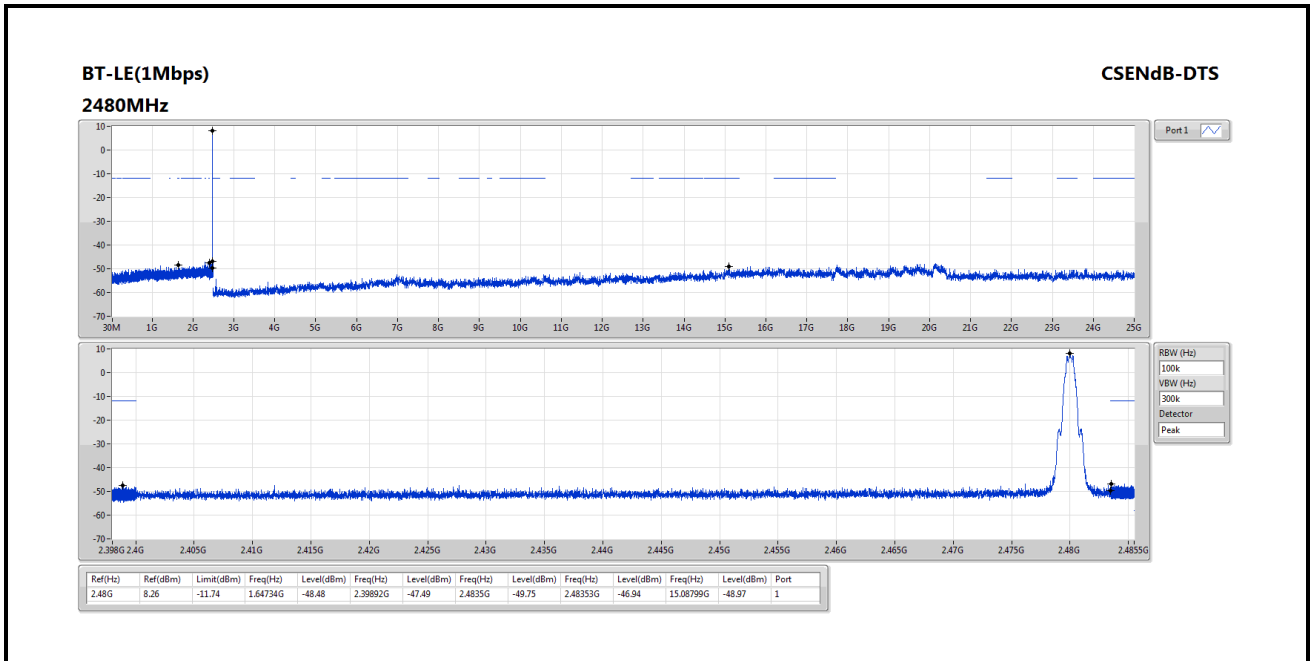

4 Test laboratory information

Established in 2012, ICC provides foremost EMC & RF Testing and advisory consultation services by our skilled engineers and technicians. Our services employ a wide variety of advanced edge test equipment and one of the widest certification extents in the business.

International Certification Corp (EMC and Wireless Communication Laboratory), it is our definitive objective is to institute long term, trust-based associations with our clients. The expectation we set up with our clients is based on outstanding service, practical expertise and devotion to a certified value structure. Our passion is to grant our clients with best EMC / RF services by oriented knowledgeable and accommodating staff.

Our Test sites are located at Linkou District and Kwei Shan District. Location map can be found on our website <http://www.icertifi.com.tw>.

Linkou

Tel: 886-2-2601-1640

No. 30-2, Ding Fwu Tsuen, Lin
Kou District, New Taipei City,
Taiwan, R.O.C.

Kwei Shan

Tel: 886-3-271-8666

No. 3-1, Lane 6, Wen San 3rd St.,
Kwei Shan District, Tao Yuan City
333, Taiwan, R.O.C.

Kwei Shan Site II

Tel: 886-3-271-8640

No. 14-1, Lane 19, Wen San 3rd
St., Kwei Shan District, Tao Yuan
City 333, Taiwan, R.O.C.

If you have any suggestion, please feel free to contact us as below information.

Tel: 886-3-271-8666

Fax: 886-3-318-0155

Email: ICC_Service@icertifi.com.tw

==END==