

Tx. Spurious 802.11ax (20M) RU26 IDX0 2412MHz Ref

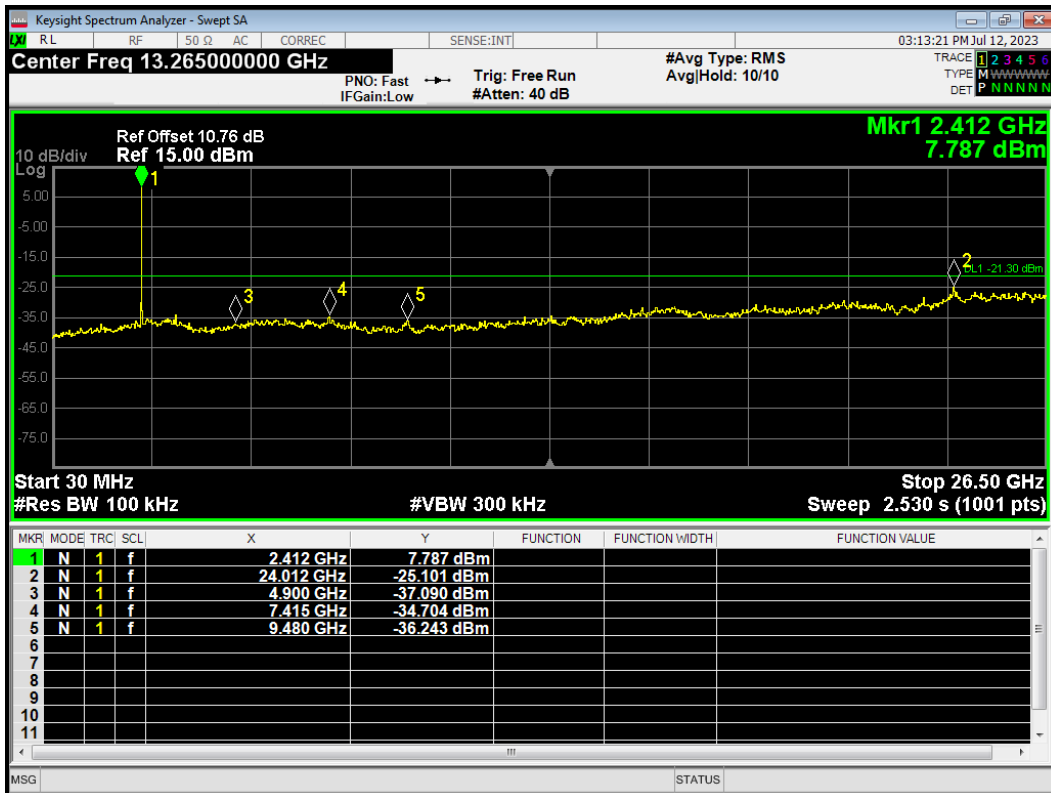

Tx. Spurious 802.11ax (20M) RU26 IDX0 2412MHz Emission



Tx. Spurious 802.11ax (20M) RU26 IDX4 2437MHz Ref

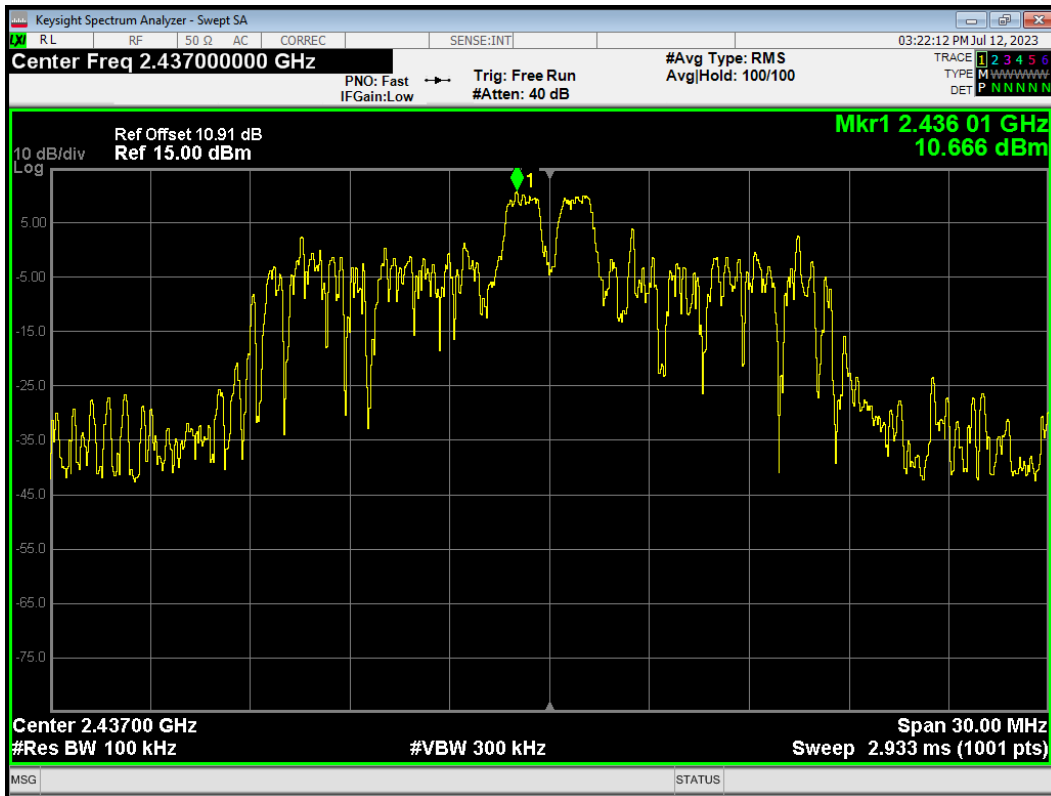

Tx. Spurious 802.11ax (20M) RU26 IDX4 2437MHz Emission

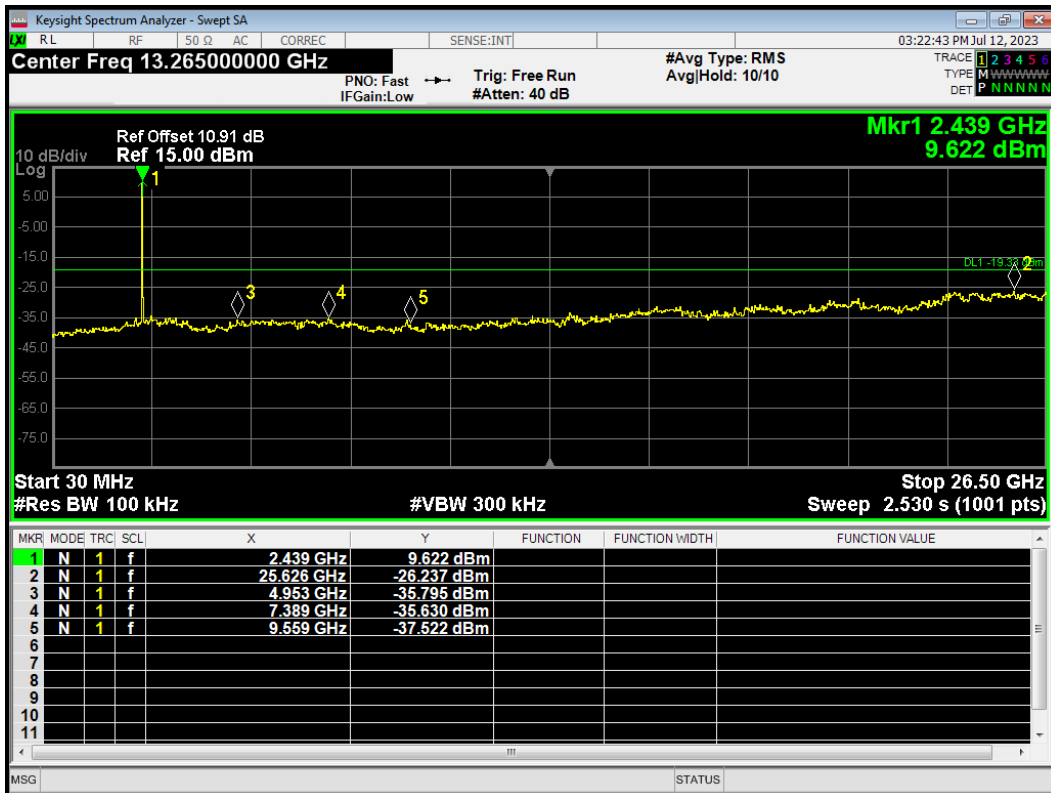

Tx. Spurious 802.11ax (20M) RU26 IDX8 2462MHz Ref

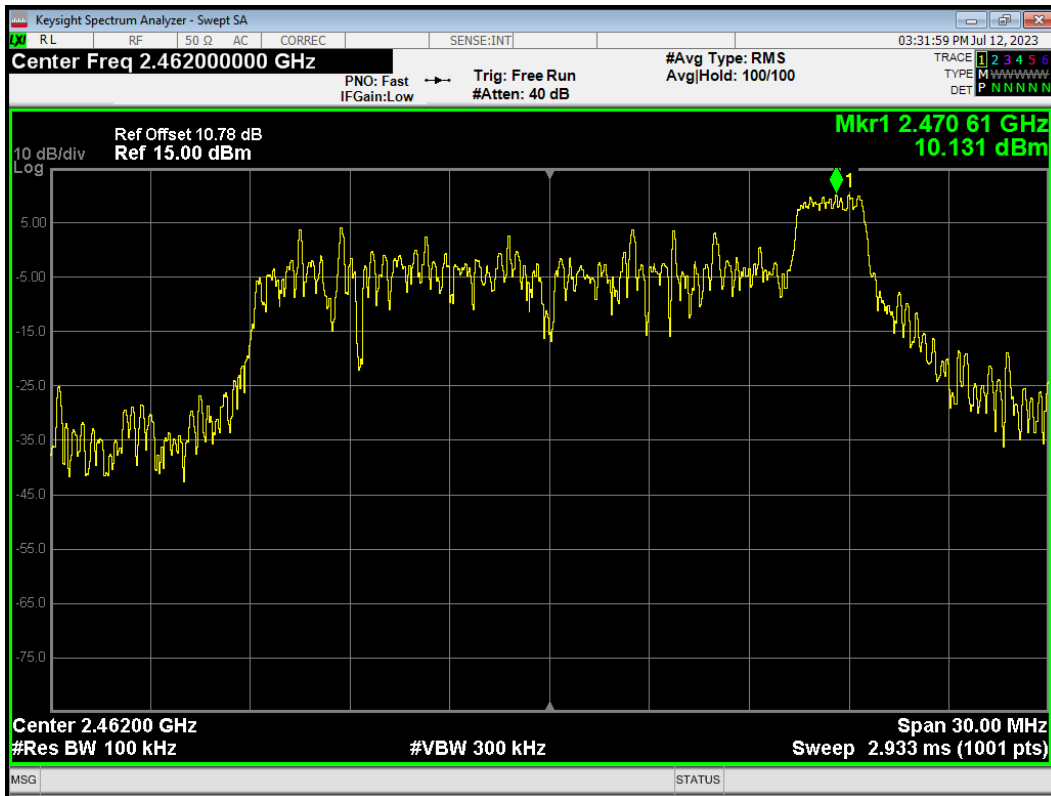

Tx. Spurious 802.11ax (20M) RU26 IDX8 2462MHz Emission

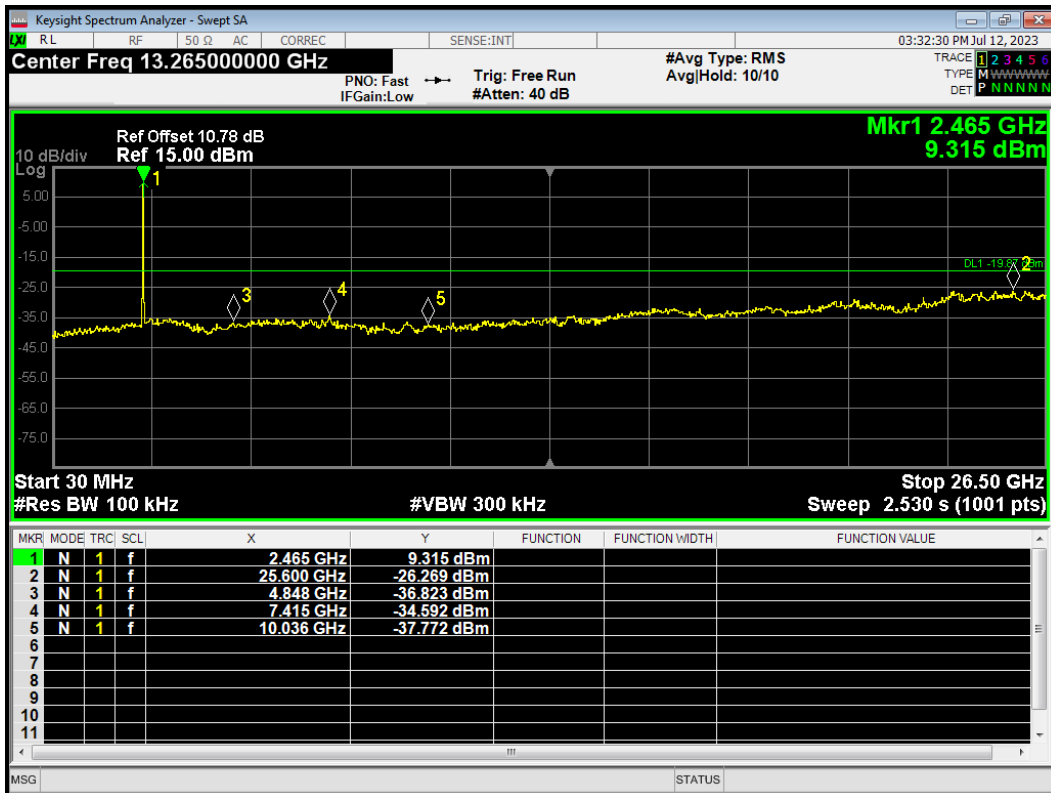

Tx. Spurious 802.11ax (20M) RU52 IDX37 2412MHz Ref

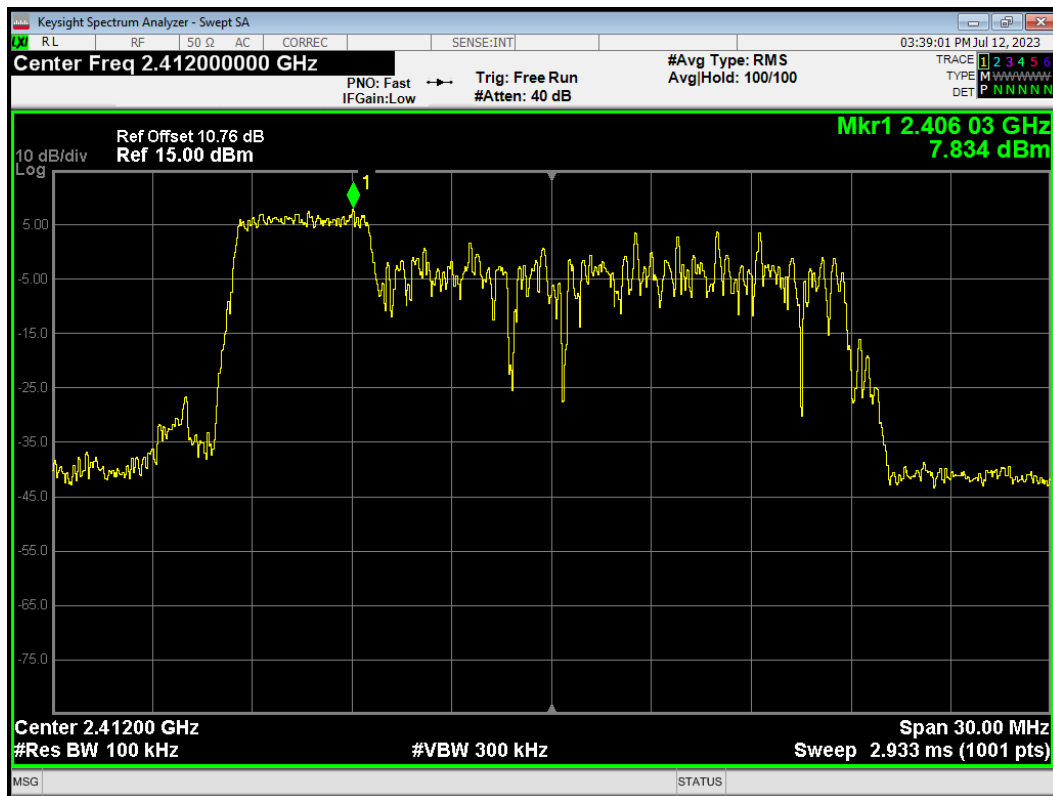

Tx. Spurious 802.11ax (20M) RU52 IDX37 2412MHz Emission

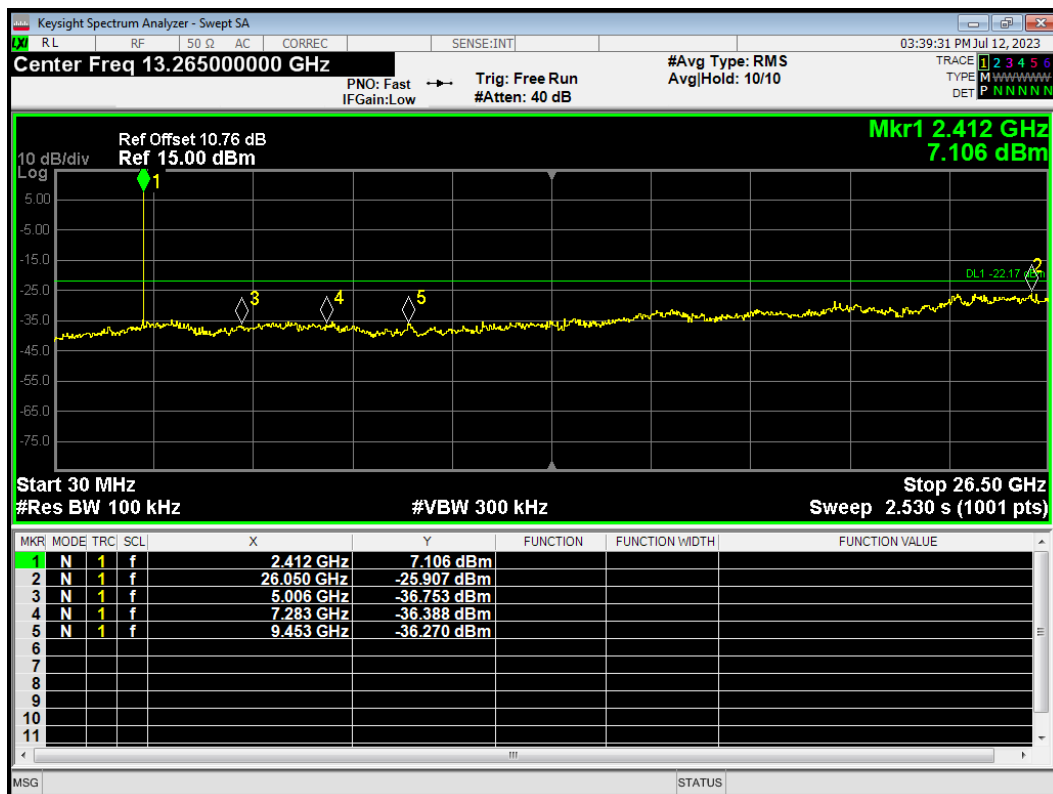

Tx. Spurious 802.11ax (20M) RU52 IDX38 2437MHz Ref

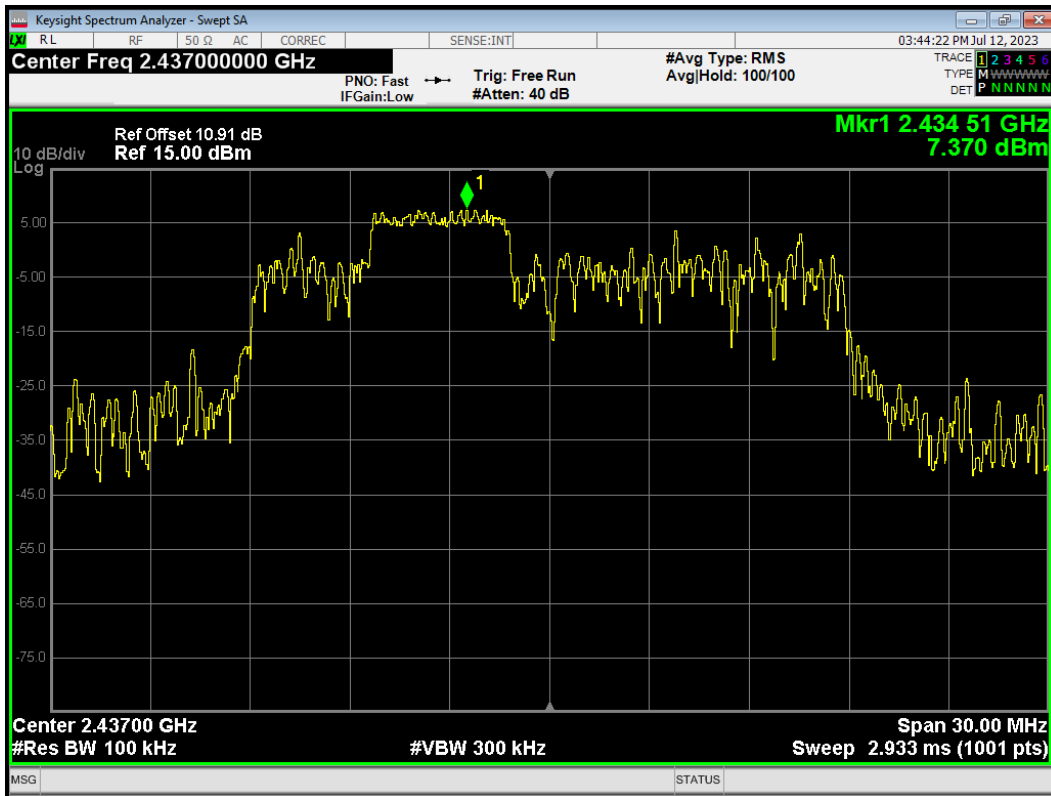

Tx. Spurious 802.11ax (20M) RU52 IDX38 2437MHz Emission

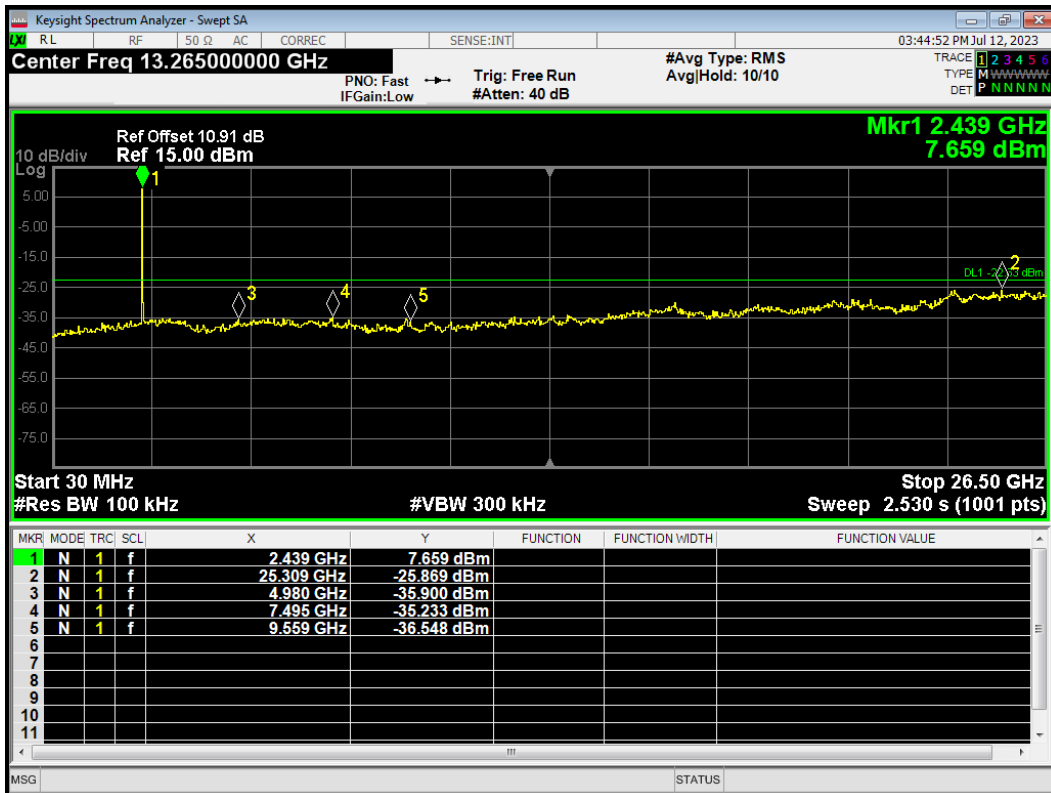

Tx. Spurious 802.11ax (20M) RU52 IDX40 2462MHz Ref

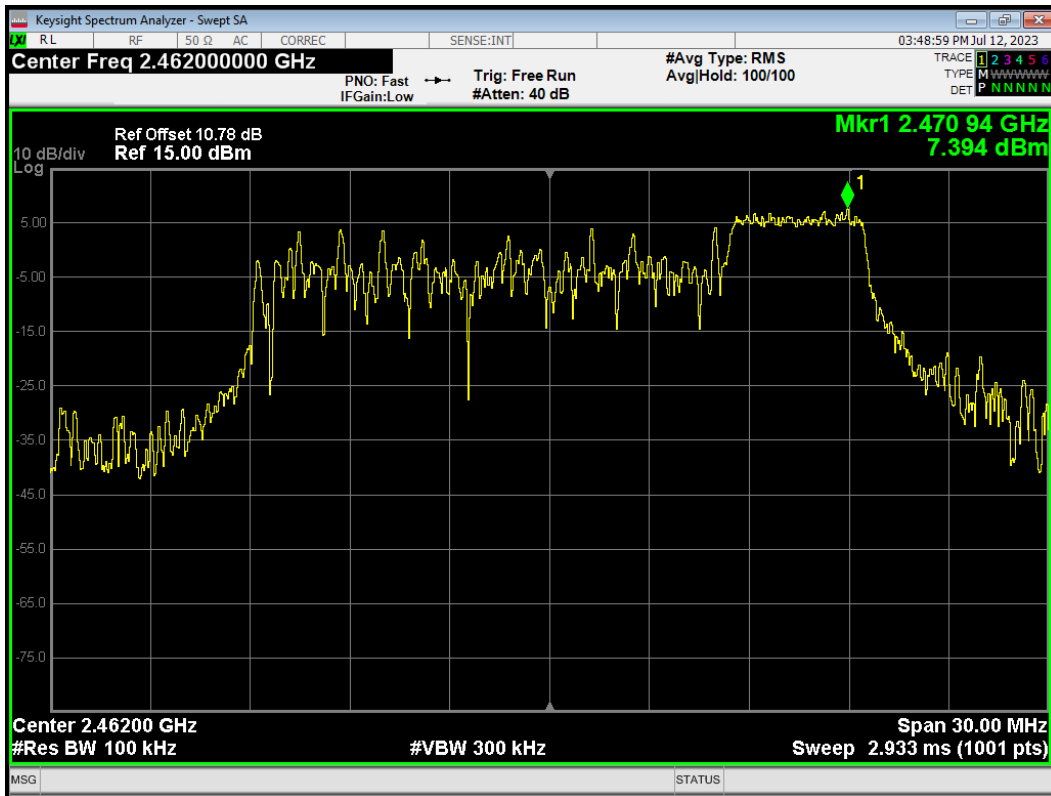

Tx. Spurious 802.11ax (20M) RU52 IDX40 2462MHz Emission

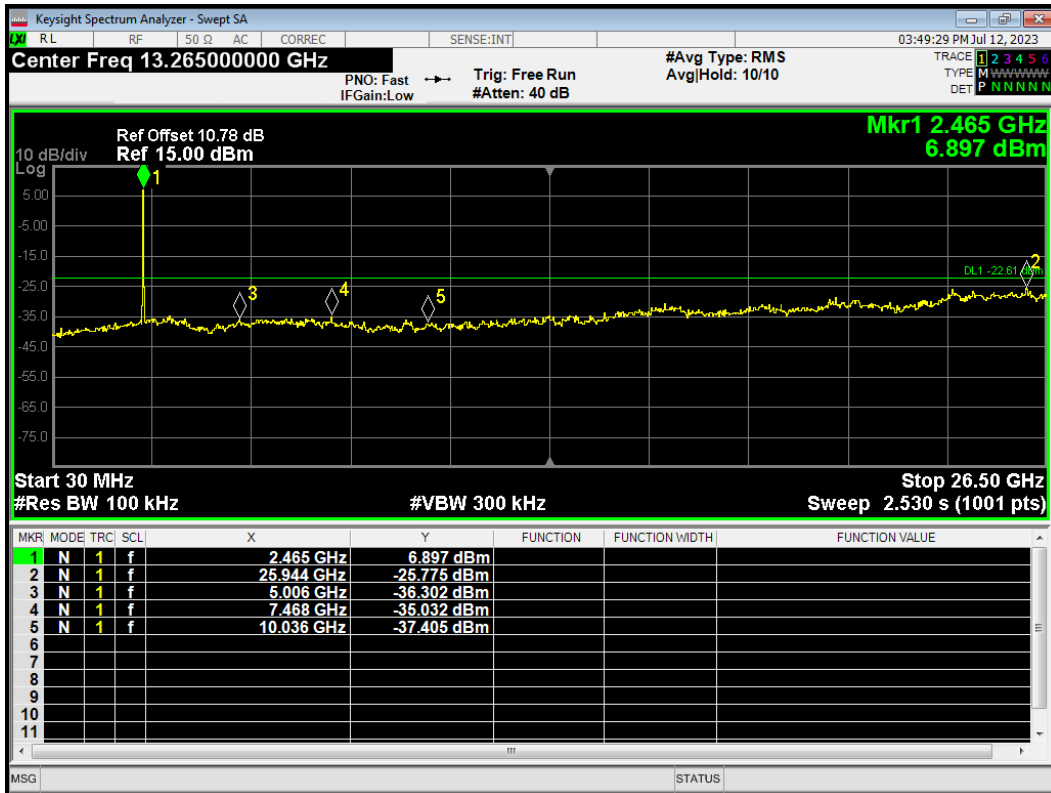

Internal Antenna

Tx. Spurious BLE (1M) 2402MHz Ref



Tx. Spurious BLE (1M) 2402MHz Emission

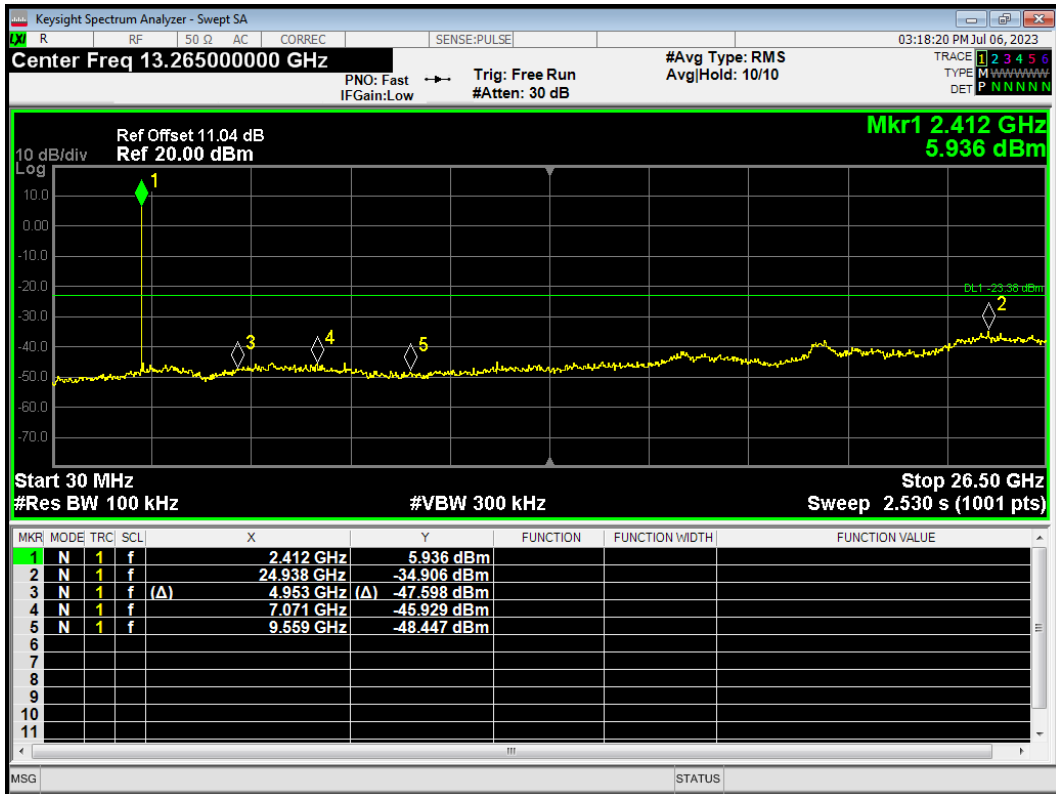

Tx. Spurious BLE (1M) 2440MHz Ref

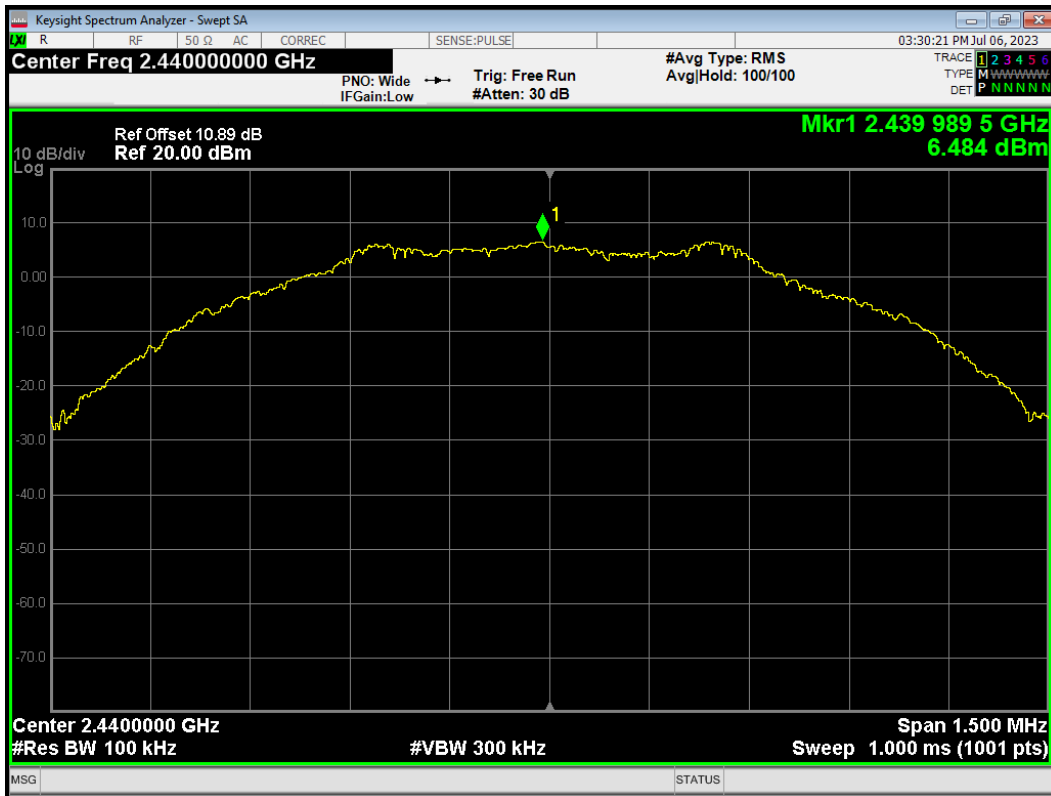

Tx. Spurious BLE (1M) 2440MHz Emission

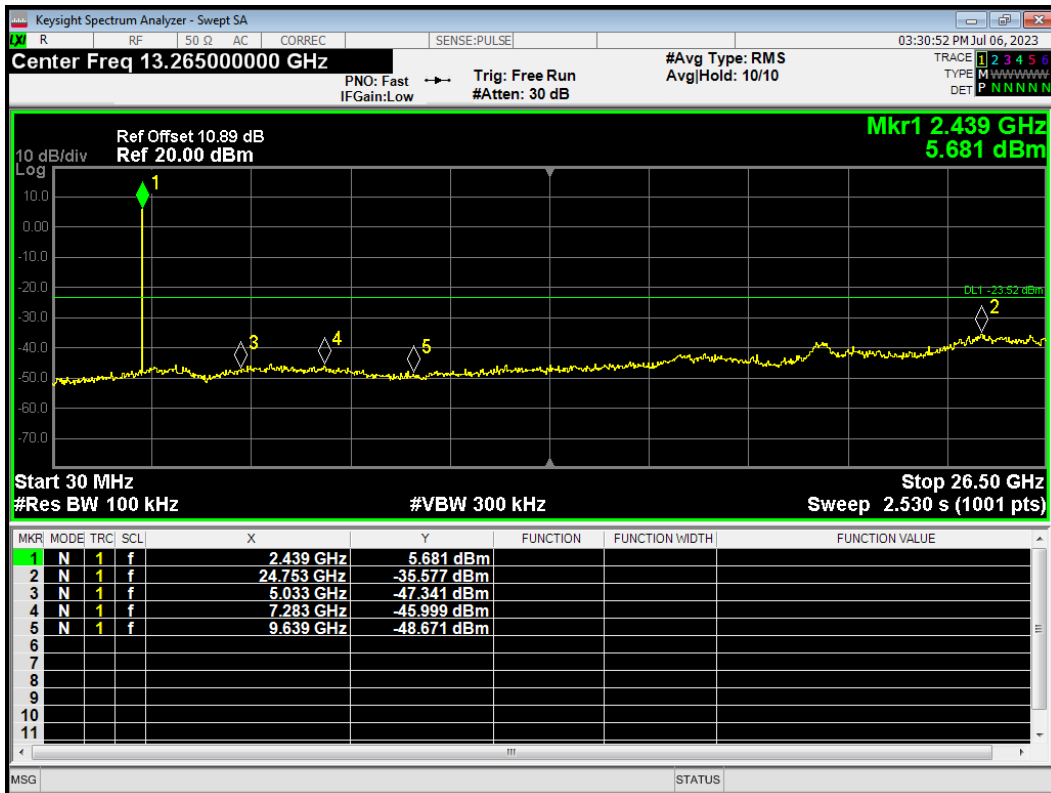

Tx. Spurious BLE (1M) 2480MHz Ref

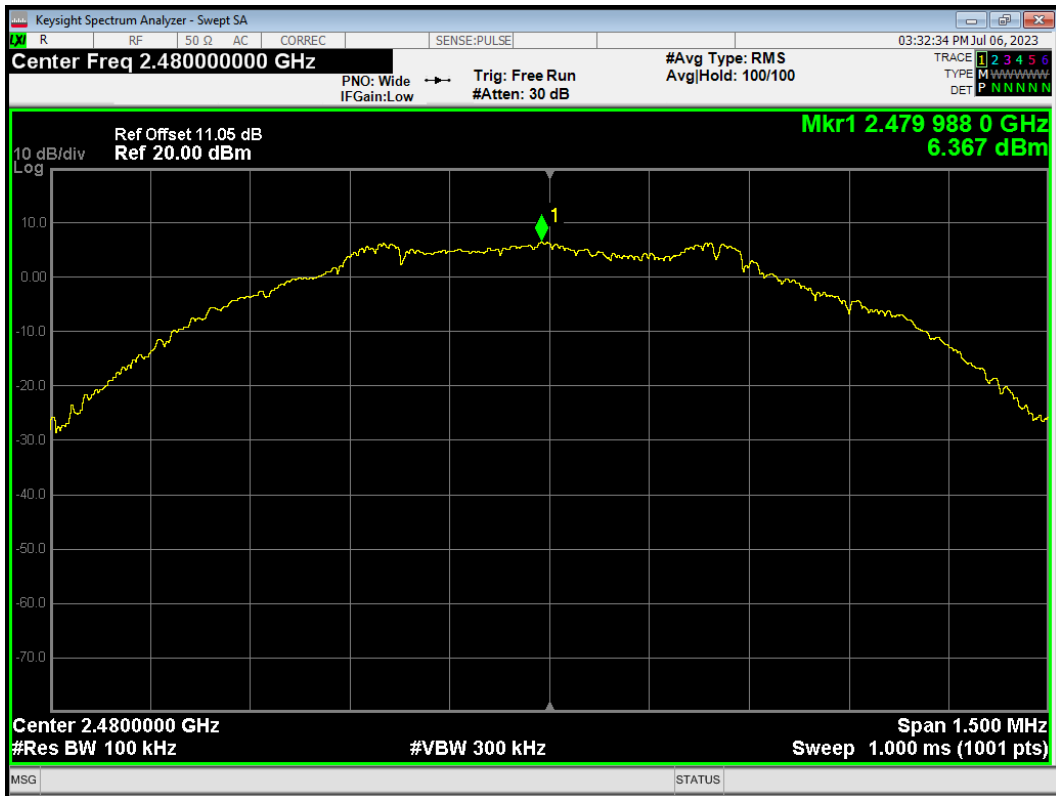

Tx. Spurious BLE (1M) 2480MHz Emission

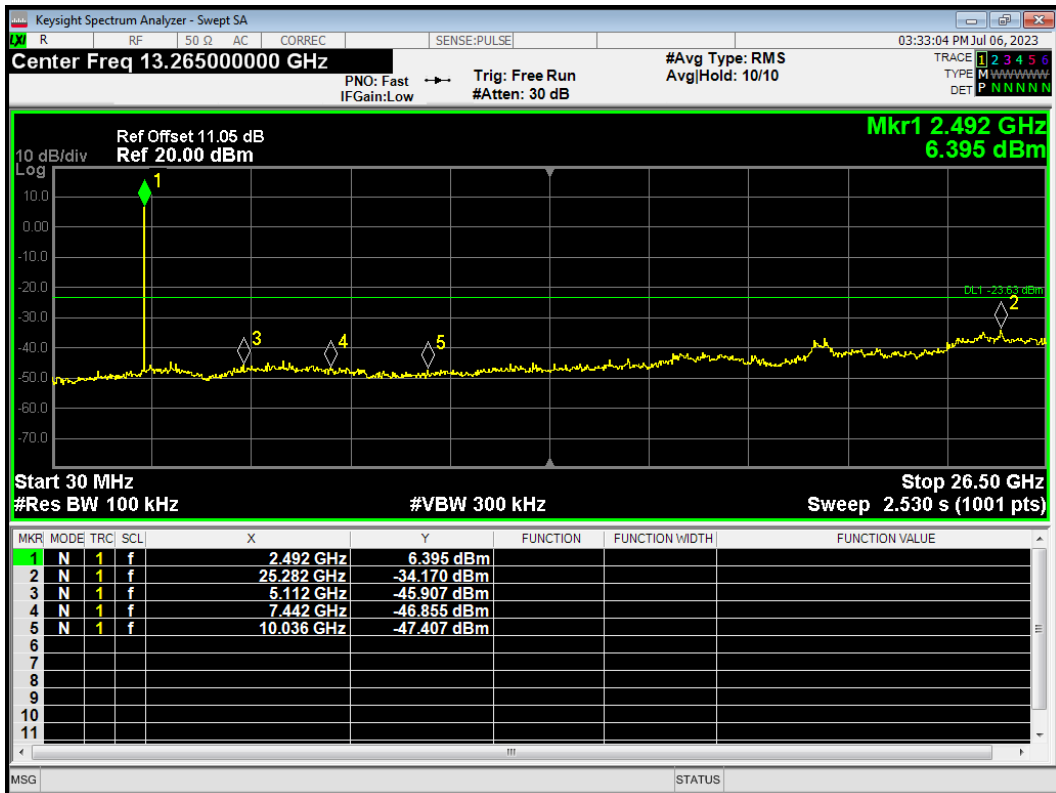

Tx. Spurious BLE (2M) 2402MHz Ref

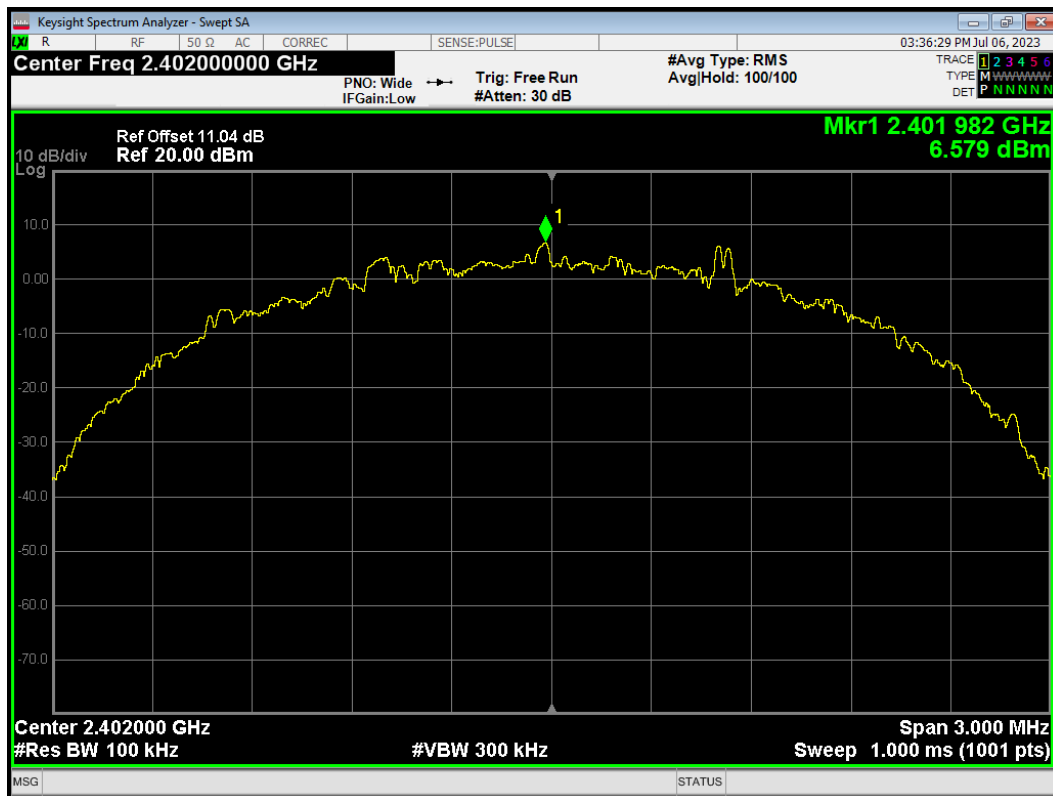

Tx. Spurious BLE (2M) 2402MHz Emission

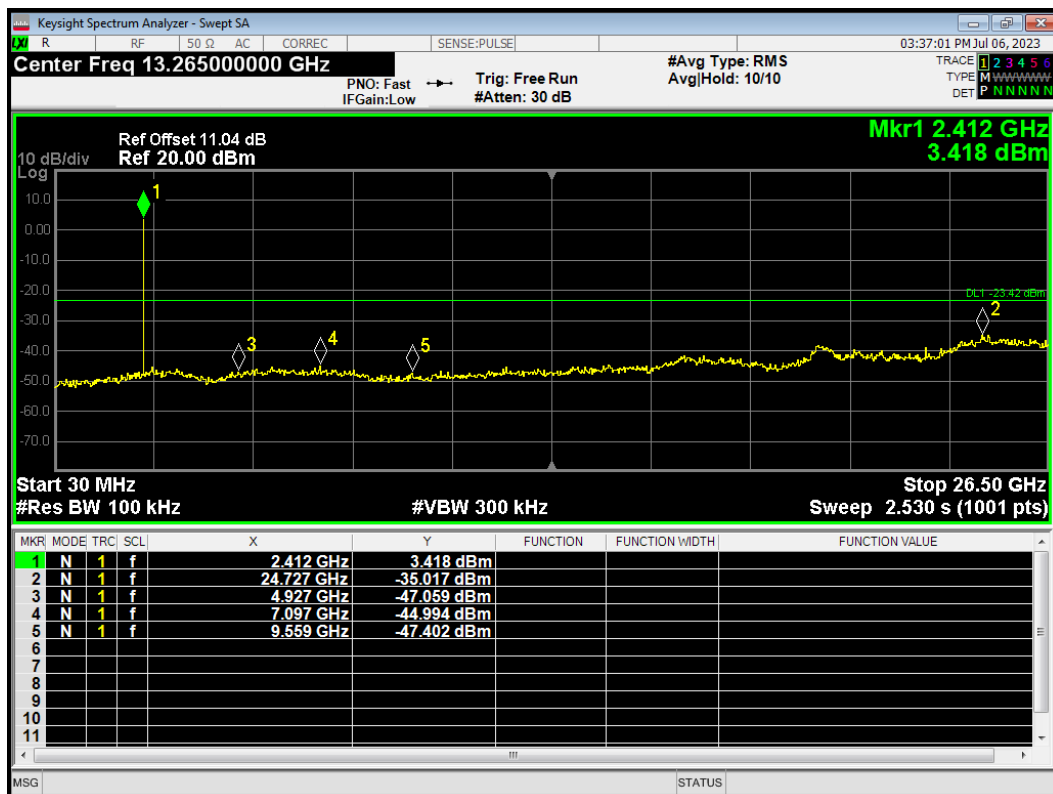

Tx. Spurious BLE (2M) 2440MHz Ref



Tx. Spurious BLE (2M) 2440MHz Emission

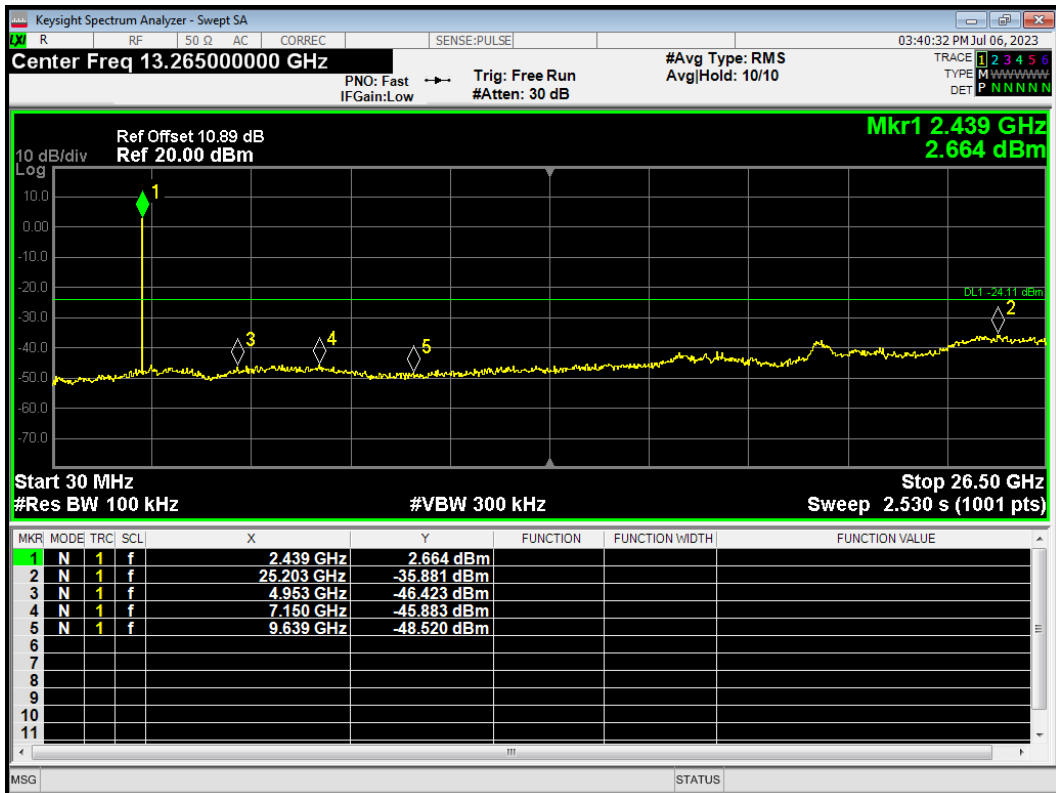

Tx. Spurious BLE (2M) 2480MHz Ref

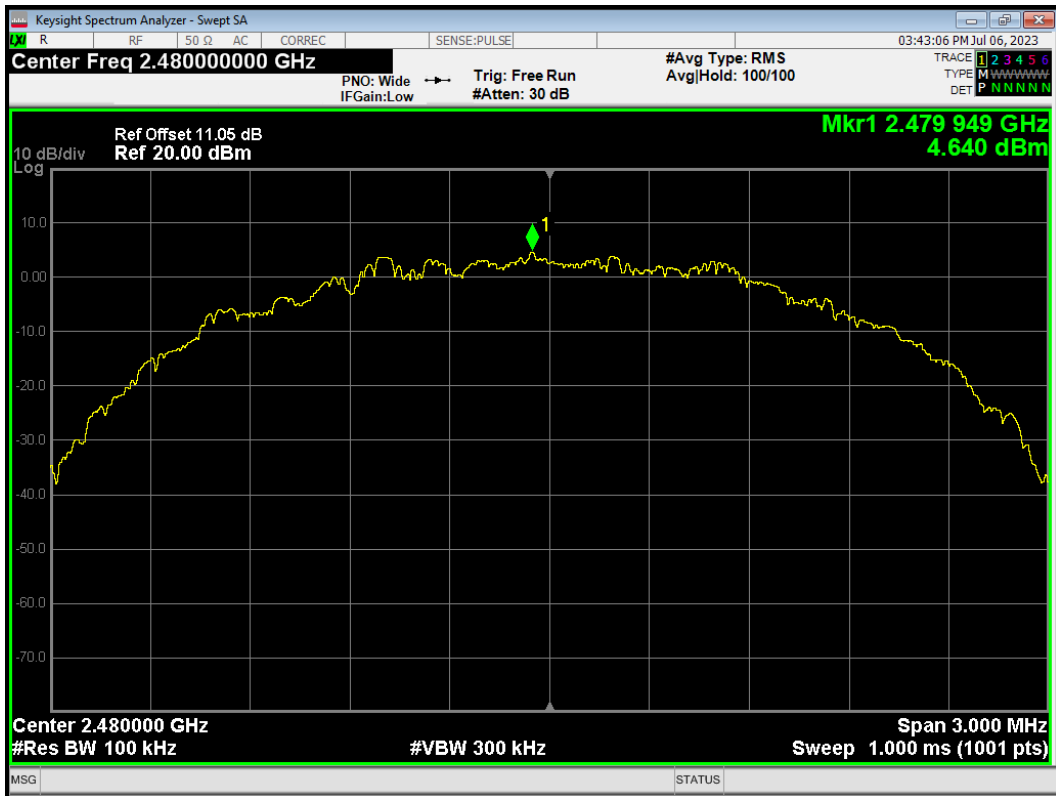

Tx. Spurious BLE (2M) 2480MHz Emission

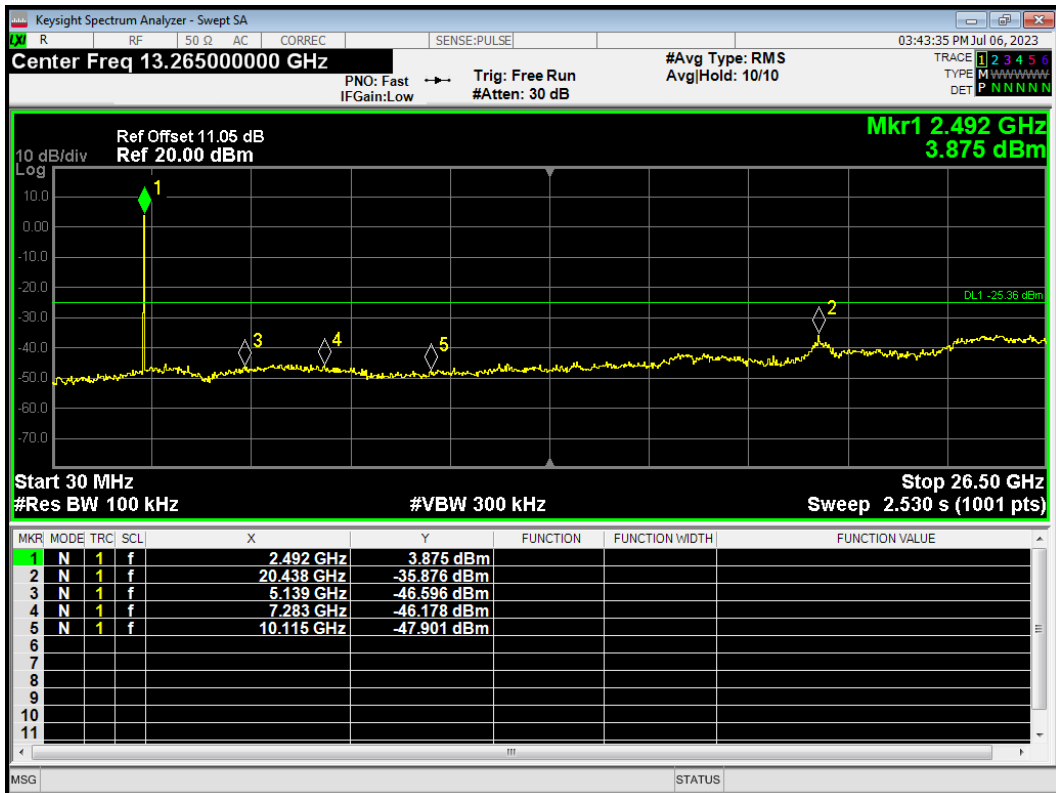

Tx. Spurious BLE (S=2) 2402MHz Ref

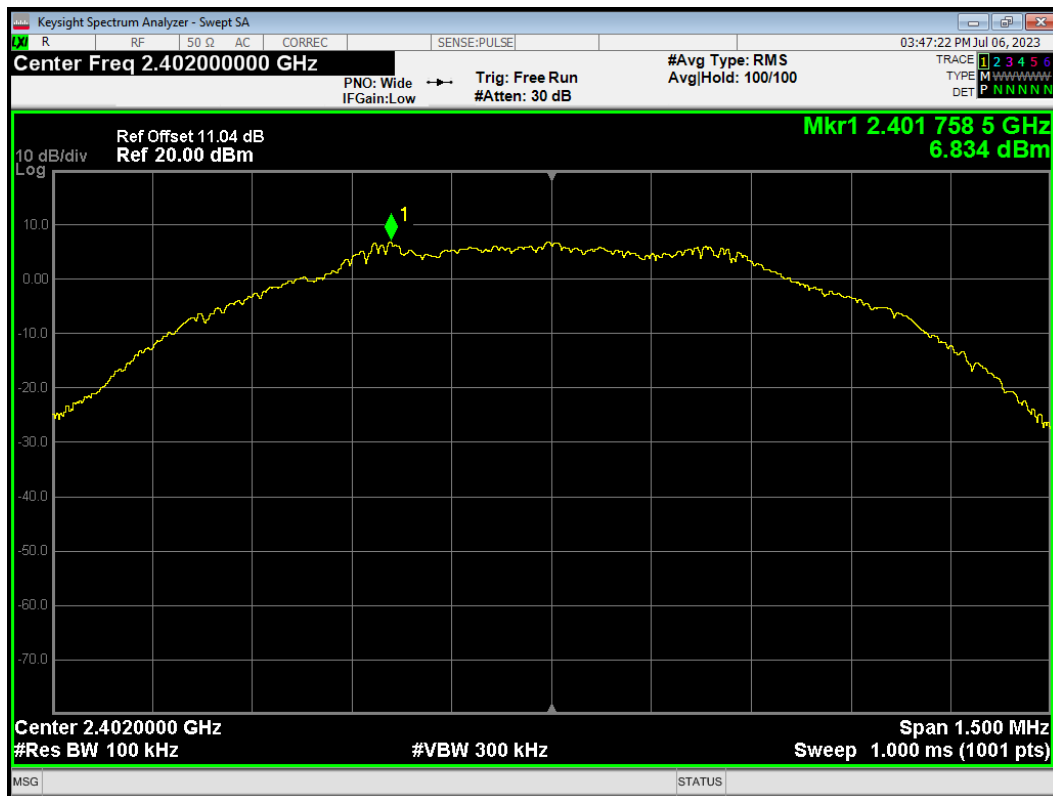

Tx. Spurious BLE (S=2) 2402MHz Emission

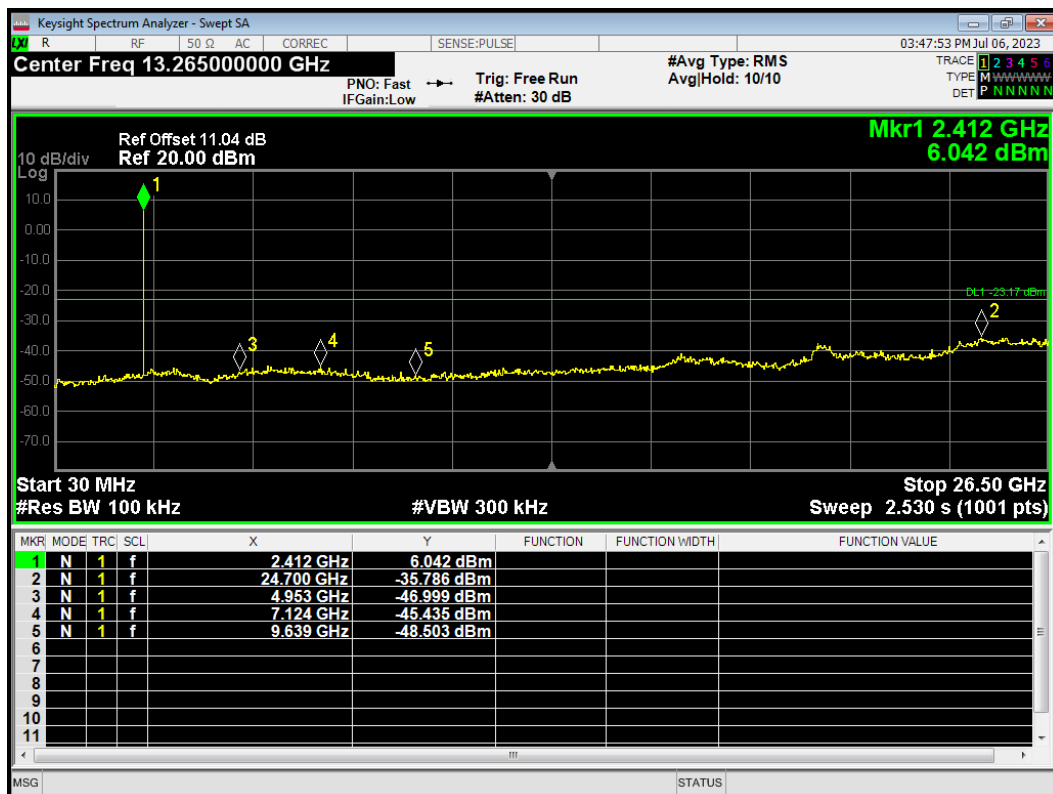

Tx. Spurious BLE (S=2) 2440MHz Ref

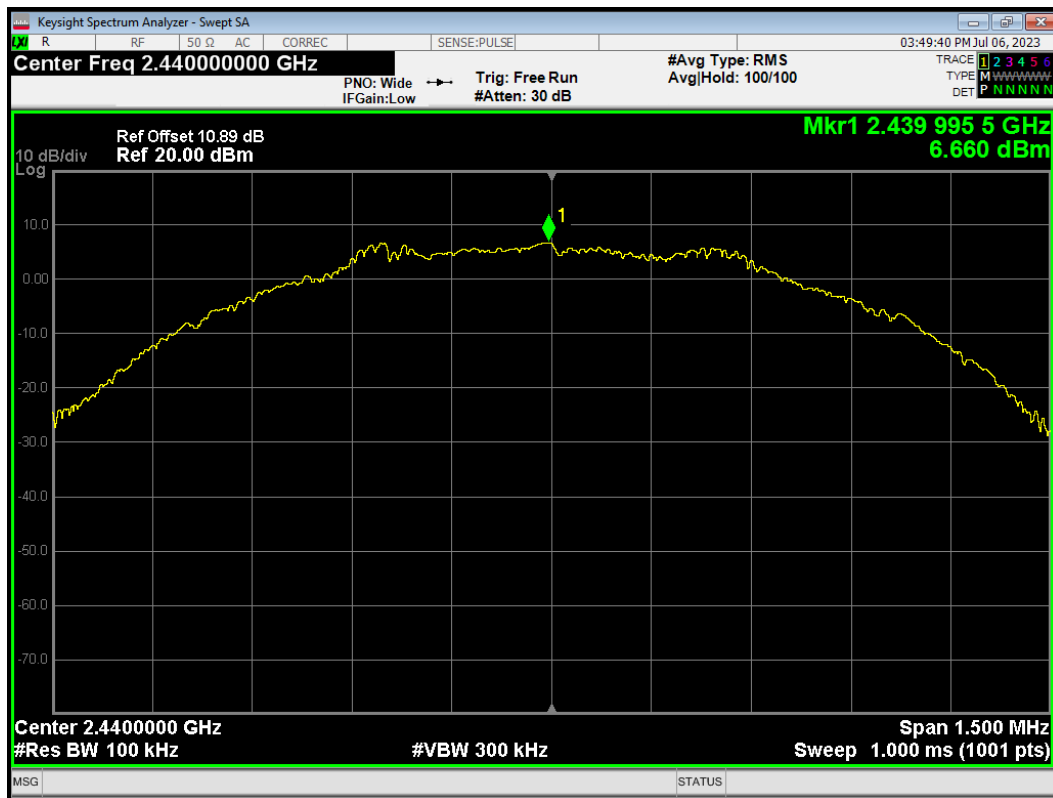

Tx. Spurious BLE (S=2) 2440MHz Emission

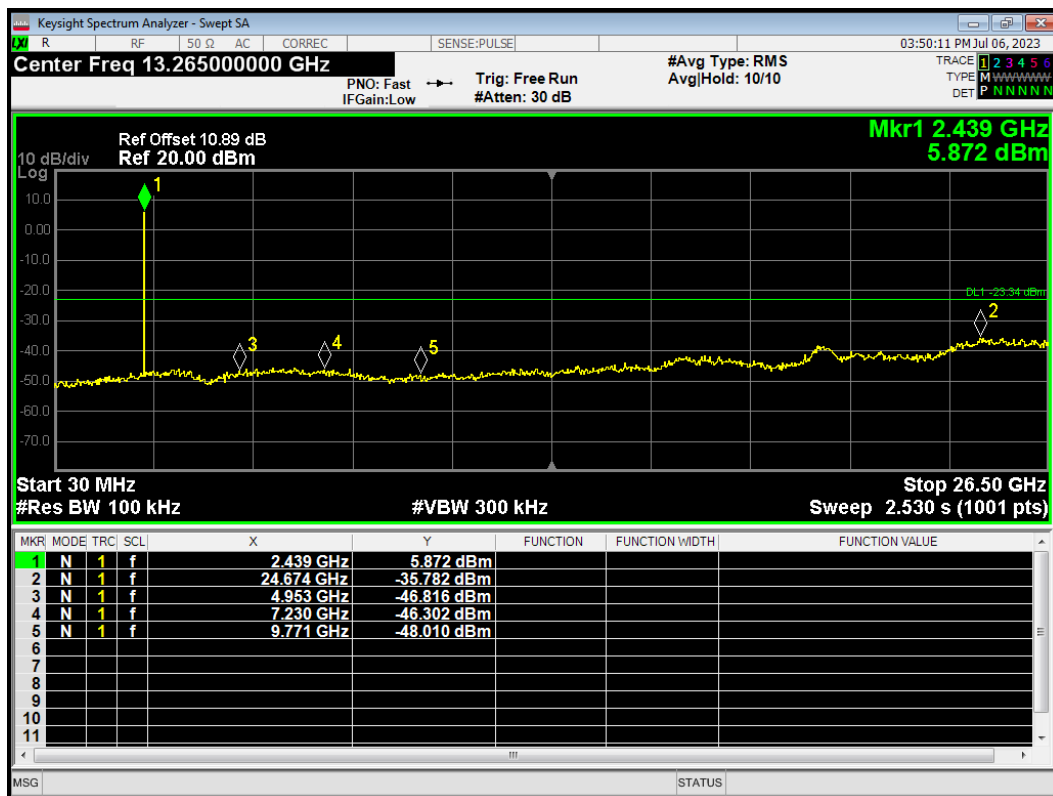

Tx. Spurious BLE (S=2) 2480MHz Ref

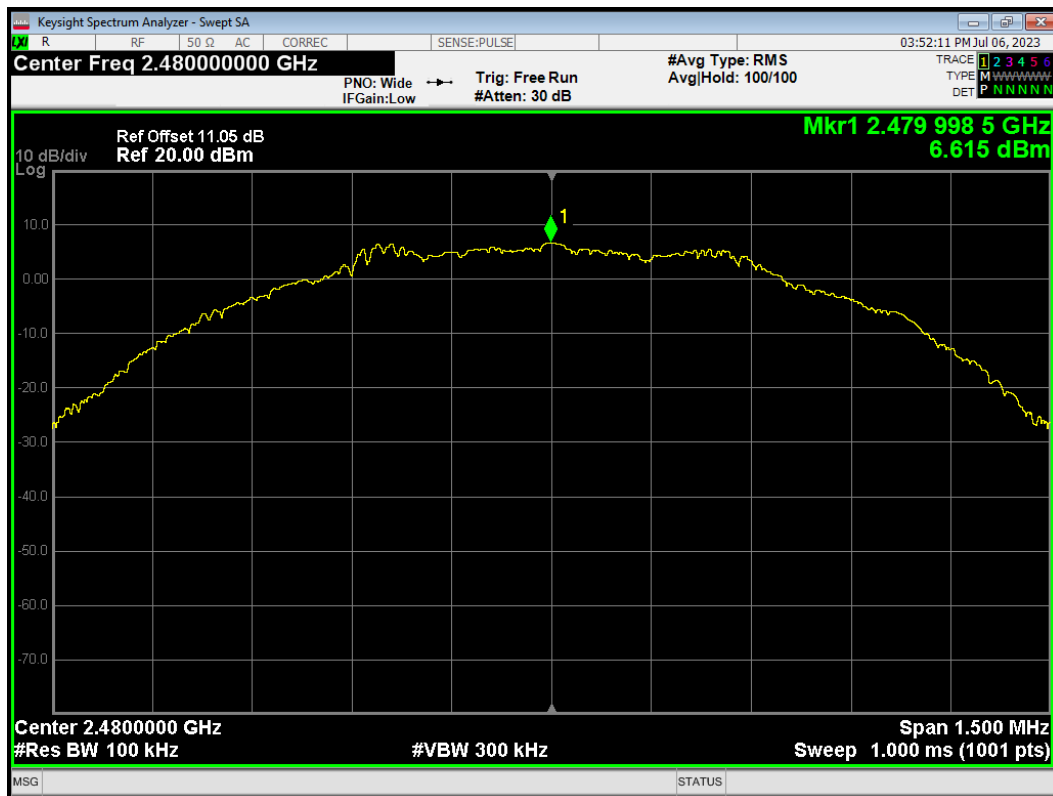

Tx. Spurious BLE (S=2) 2480MHz Emission

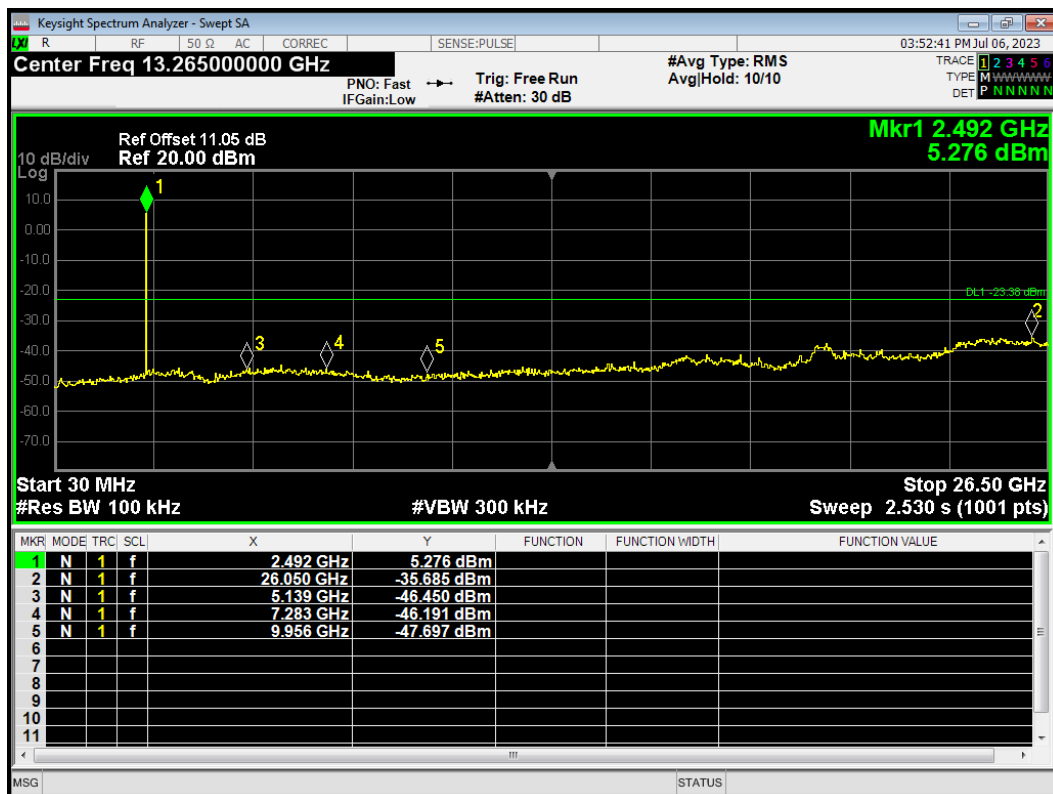

Tx. Spurious BLE (S=8) 2402MHz Ref

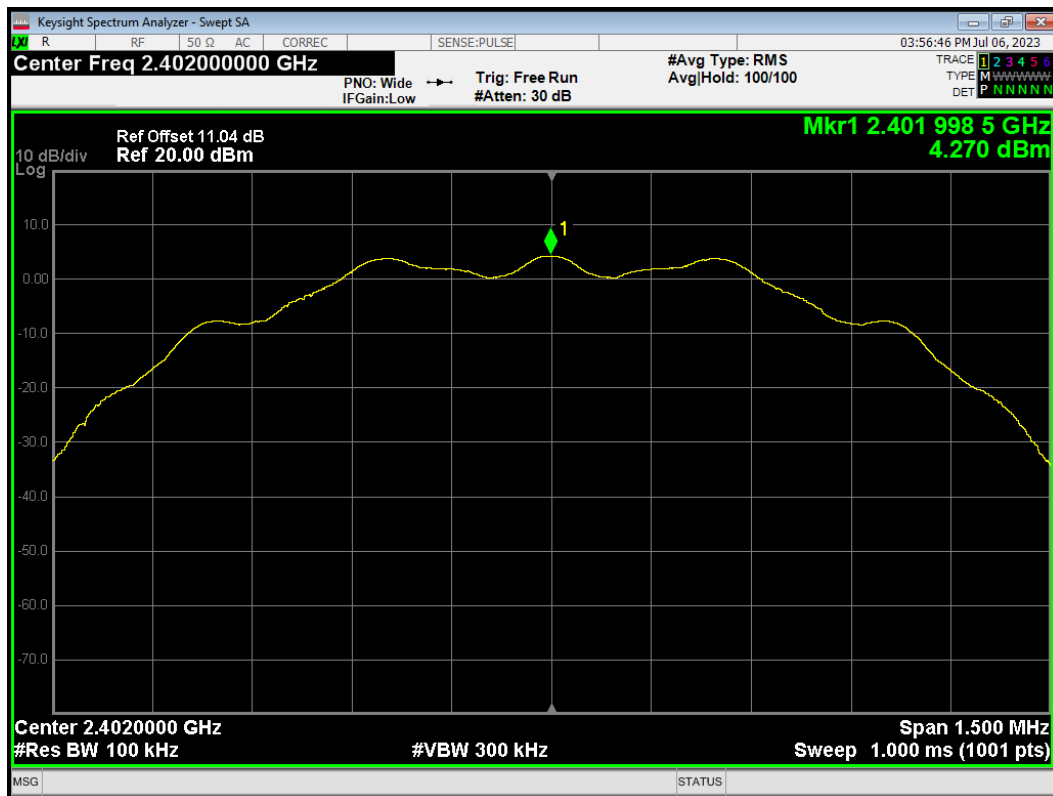

Tx. Spurious BLE (S=8) 2402MHz Emission

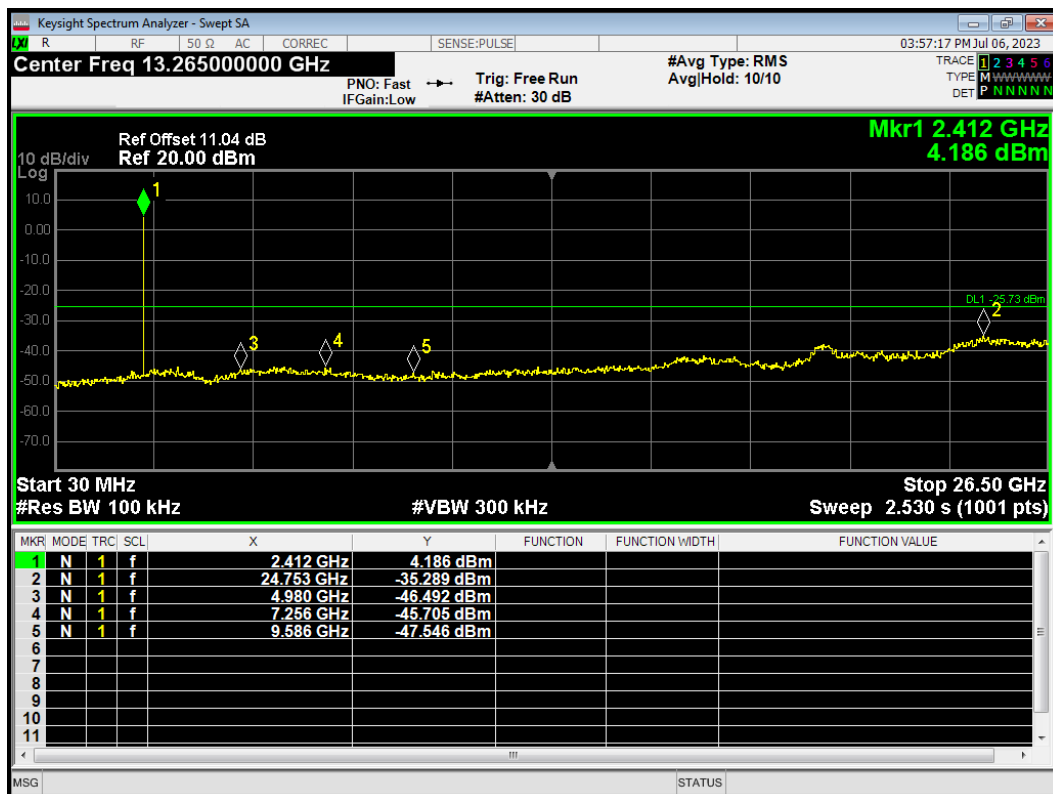

Tx. Spurious BLE (S=8) 2440MHz Ref

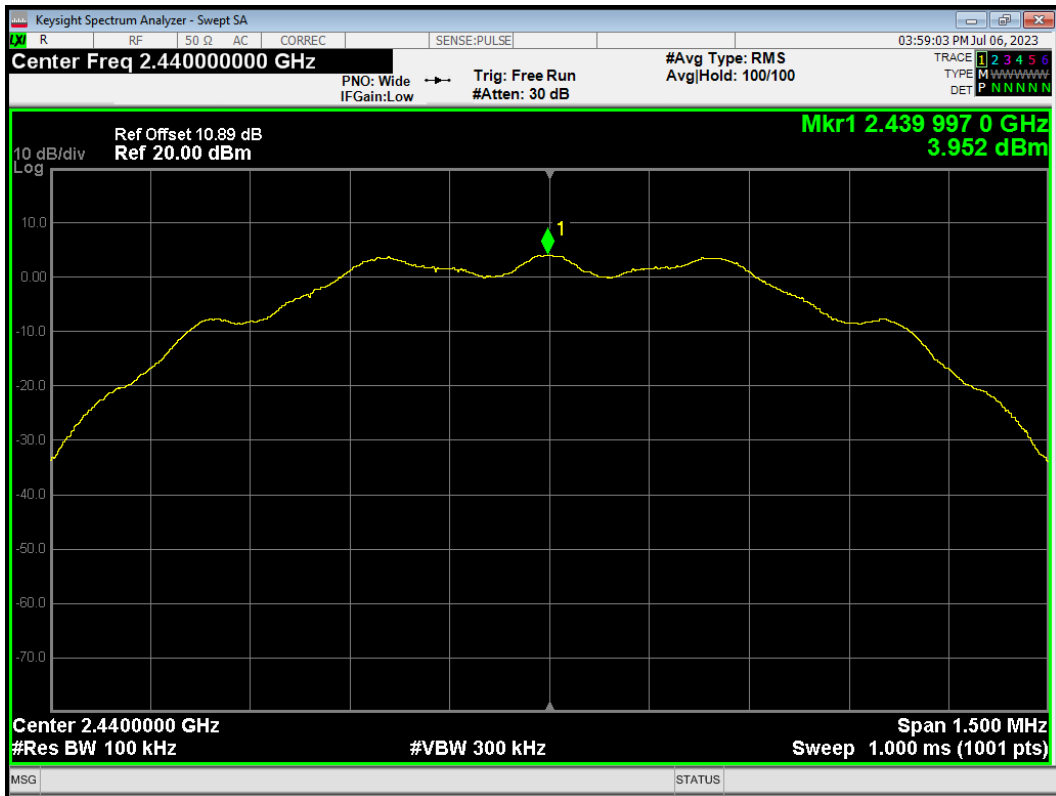

Tx. Spurious BLE (S=8) 2440MHz Emission

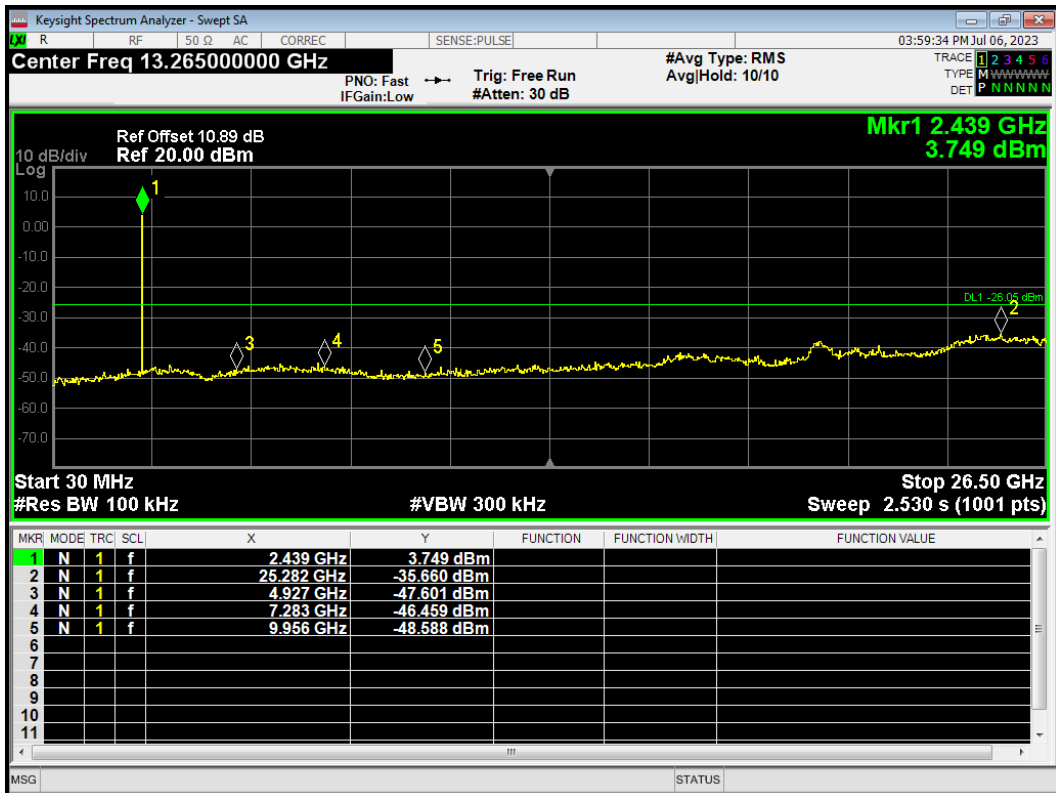

Tx. Spurious BLE (S=8) 2480MHz Ref

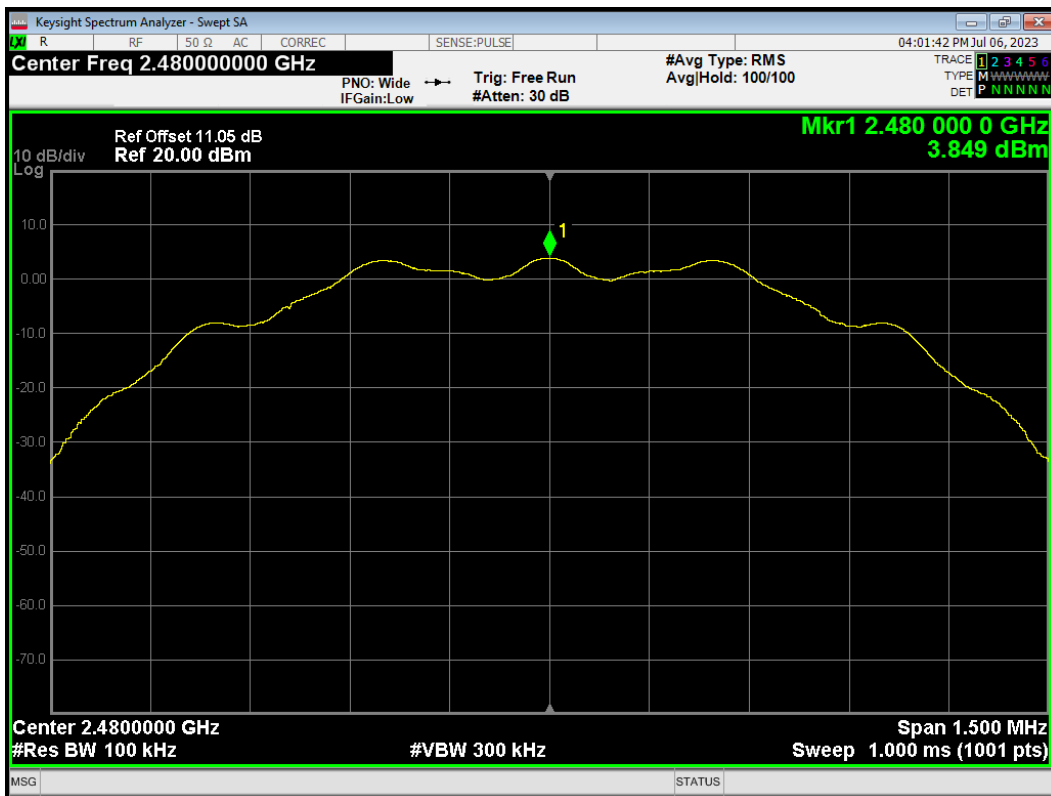

Tx. Spurious BLE (S=8) 2480MHz Emission

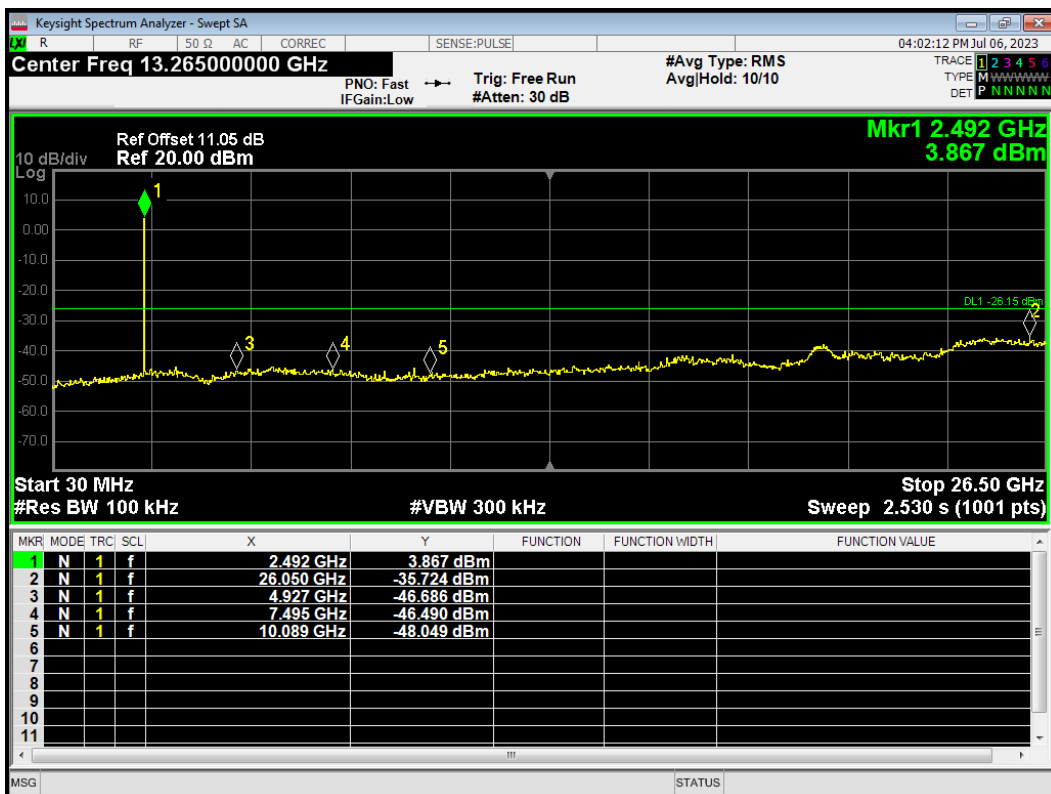

External Antenna

Tx. Spurious BLE (1M) 2402MHz Ref

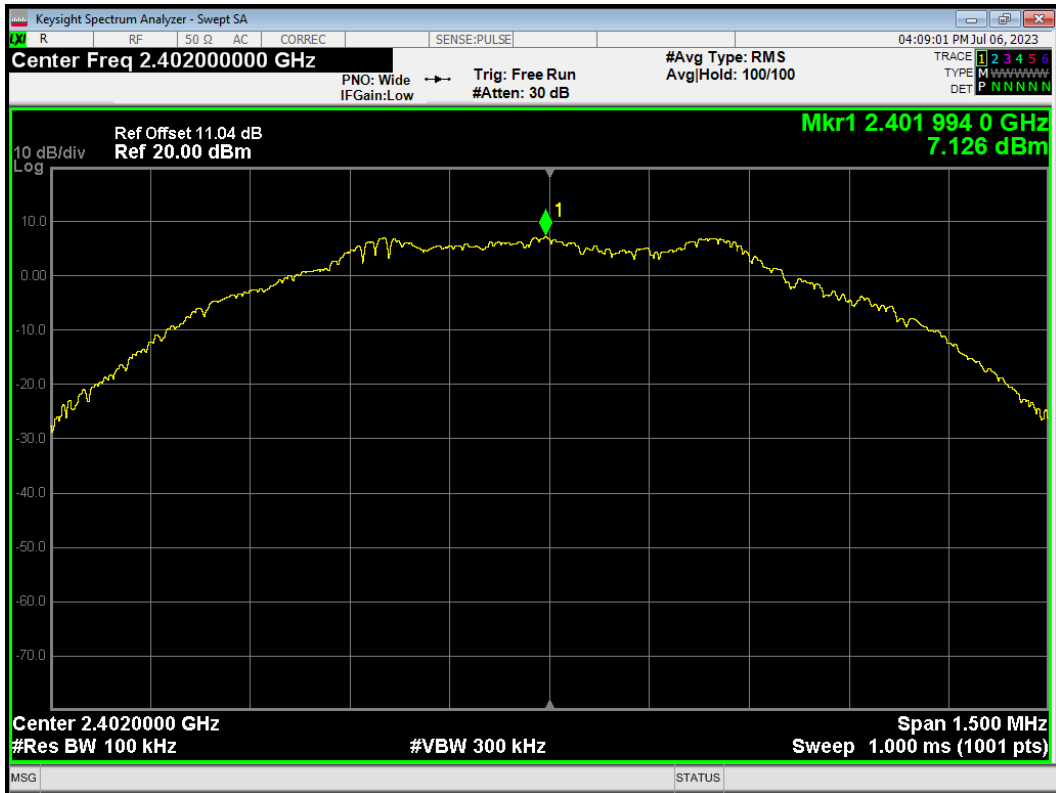

Tx. Spurious BLE (1M) 2402MHz Emission

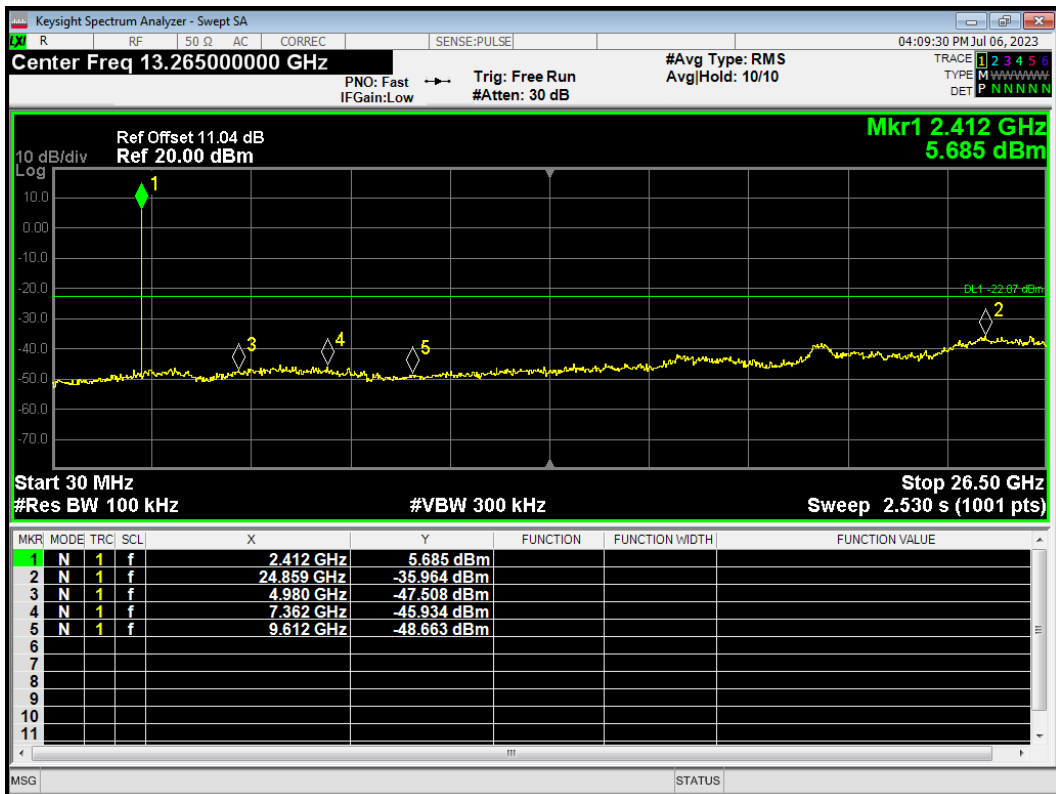

Tx. Spurious BLE (1M) 2440MHz Ref

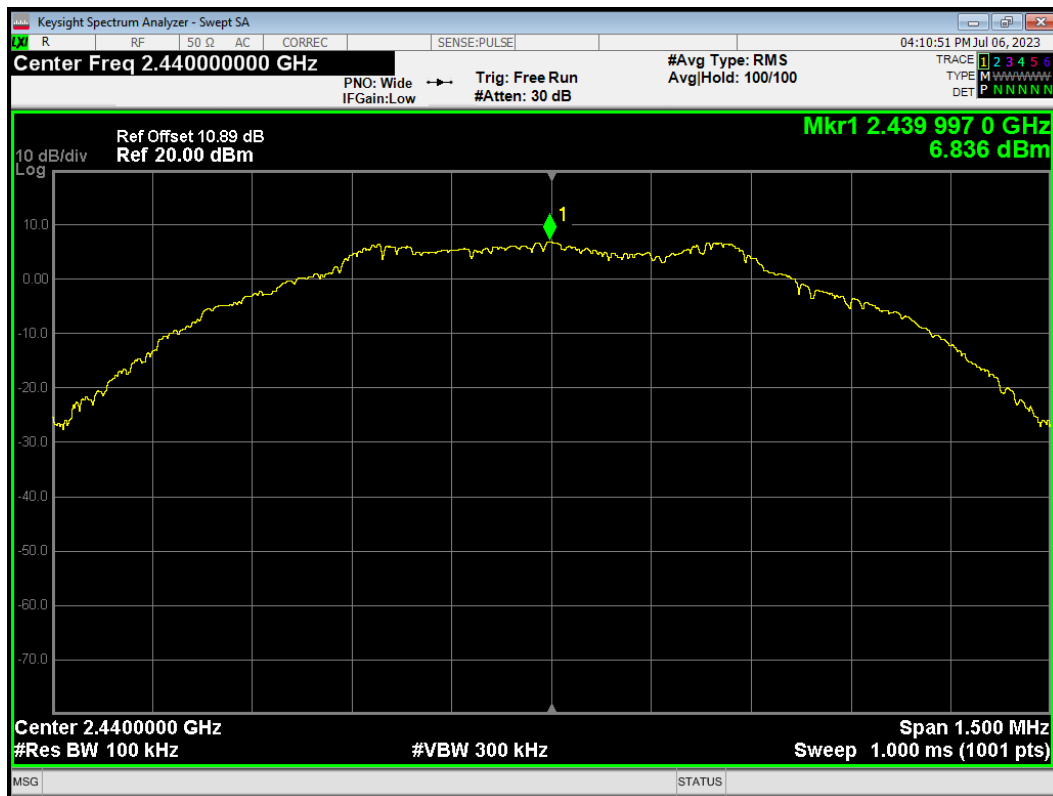

Tx. Spurious BLE (1M) 2440MHz Emission

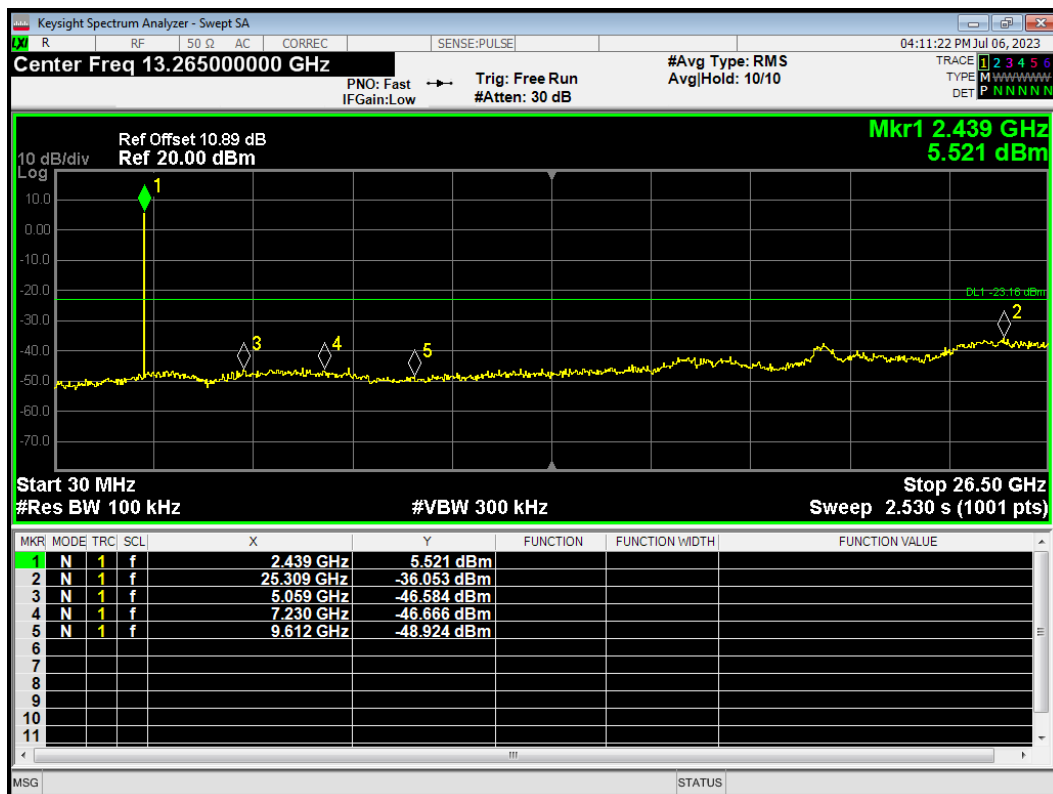

Tx. Spurious BLE (1M) 2480MHz Ref

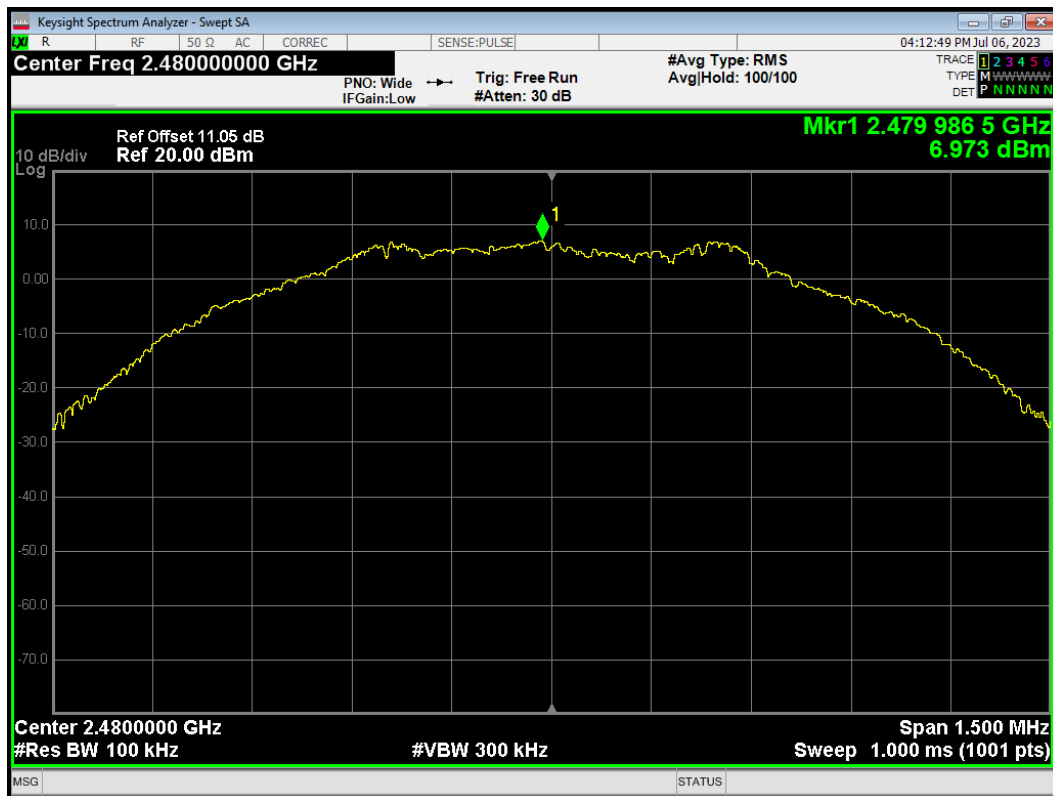

Tx. Spurious BLE (1M) 2480MHz Emission

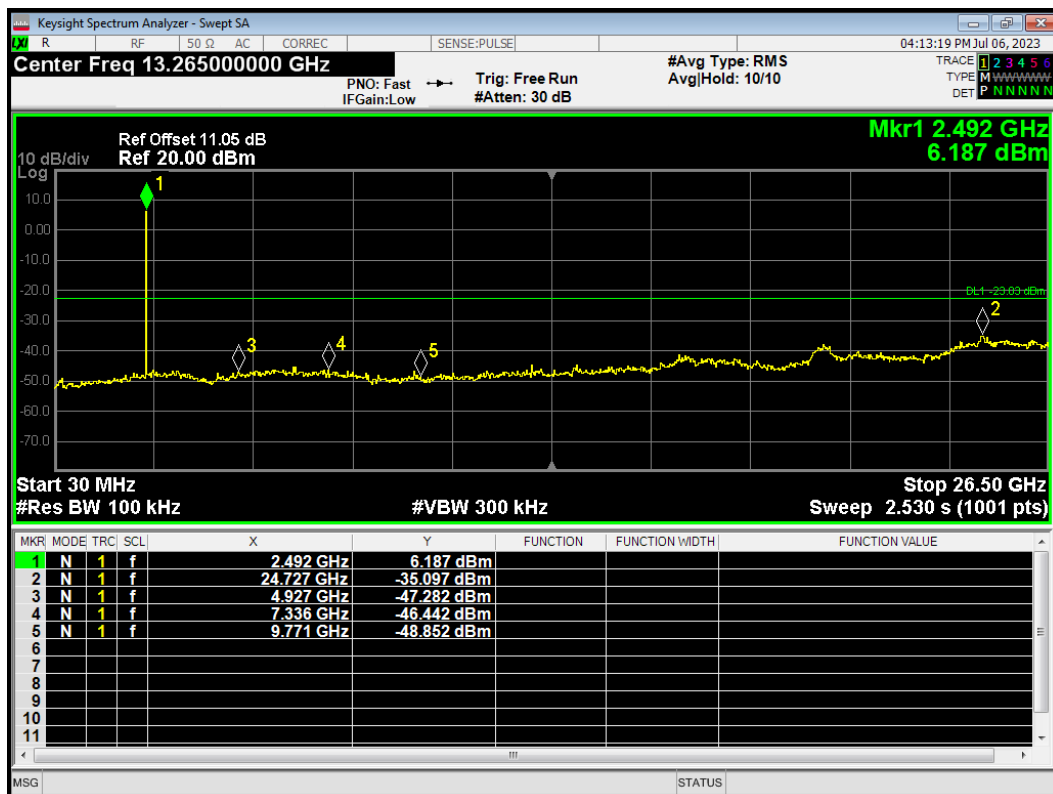

Tx. Spurious BLE (2M) 2402MHz Ref

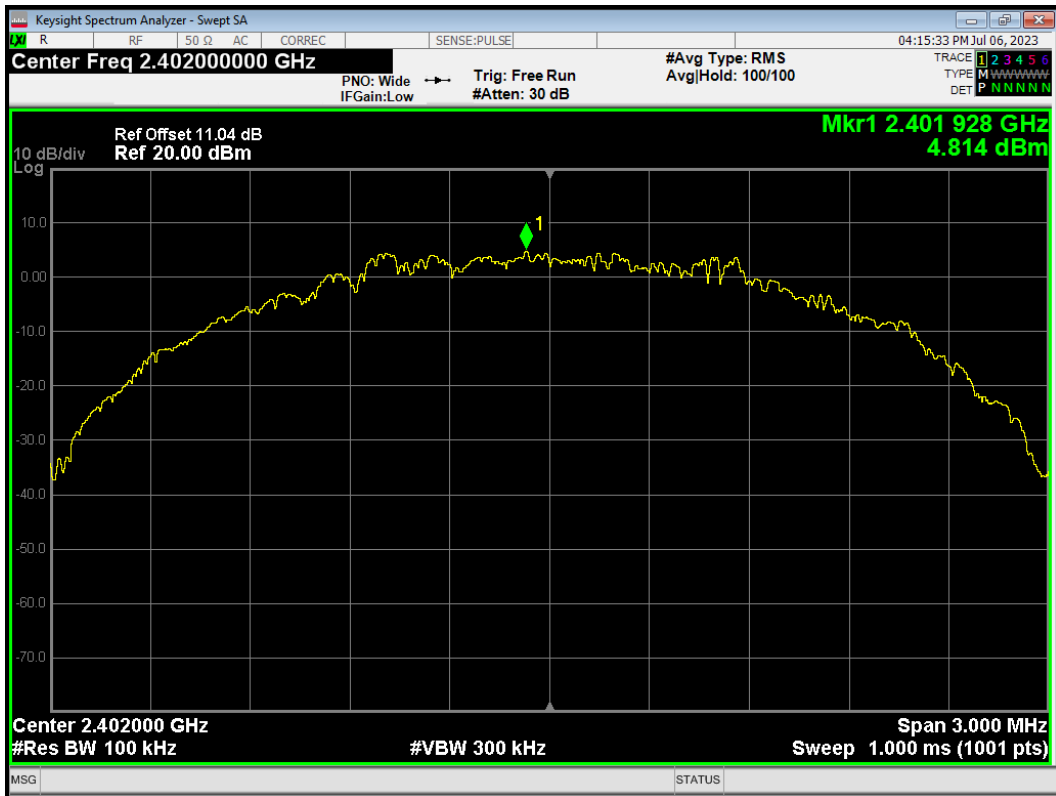

Tx. Spurious BLE (2M) 2402MHz Emission

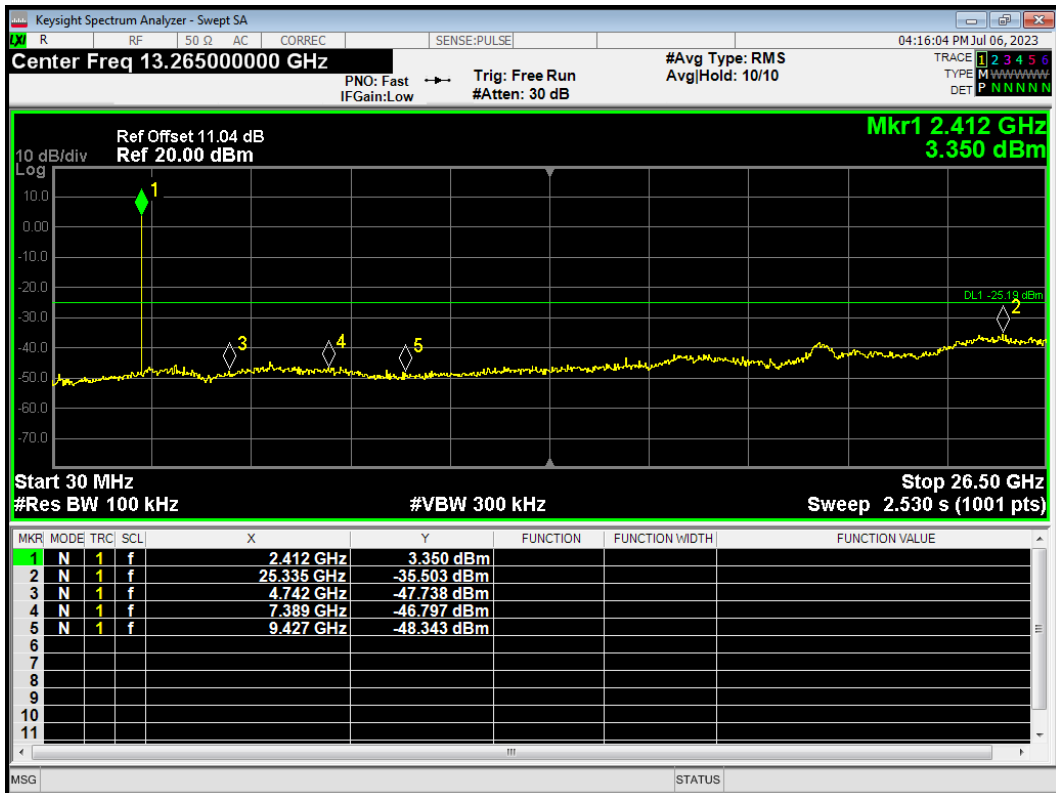

Tx. Spurious BLE (2M) 2440MHz Ref

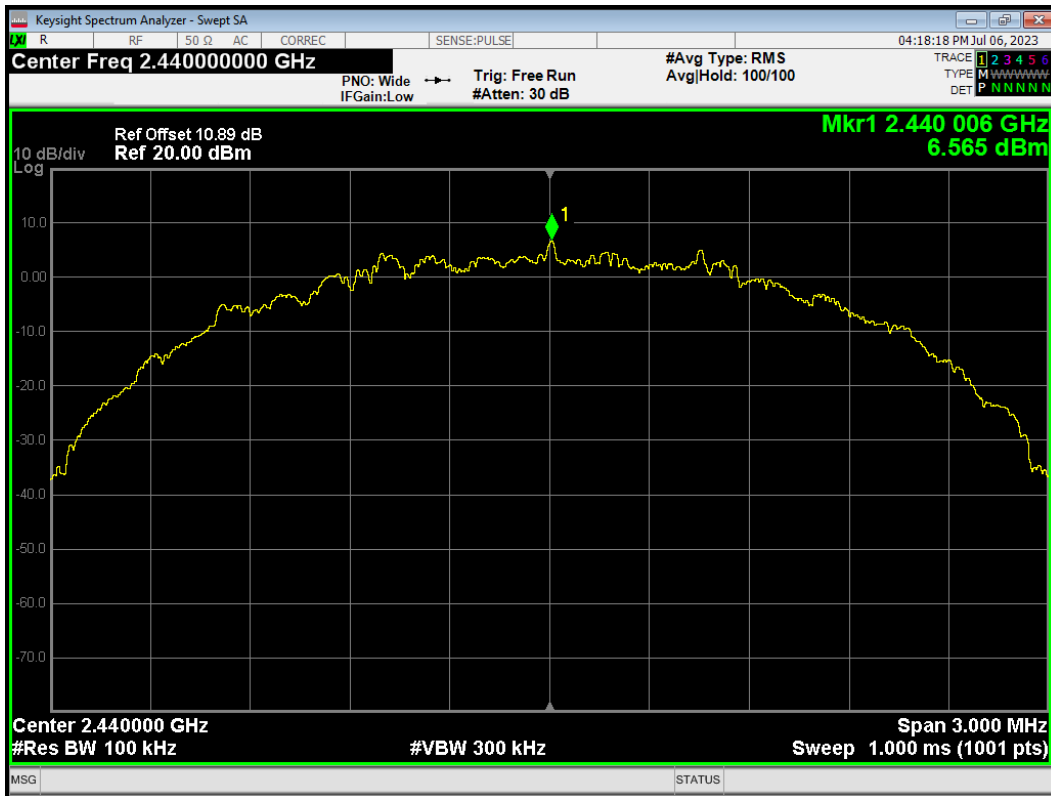

Tx. Spurious BLE (2M) 2440MHz Emission

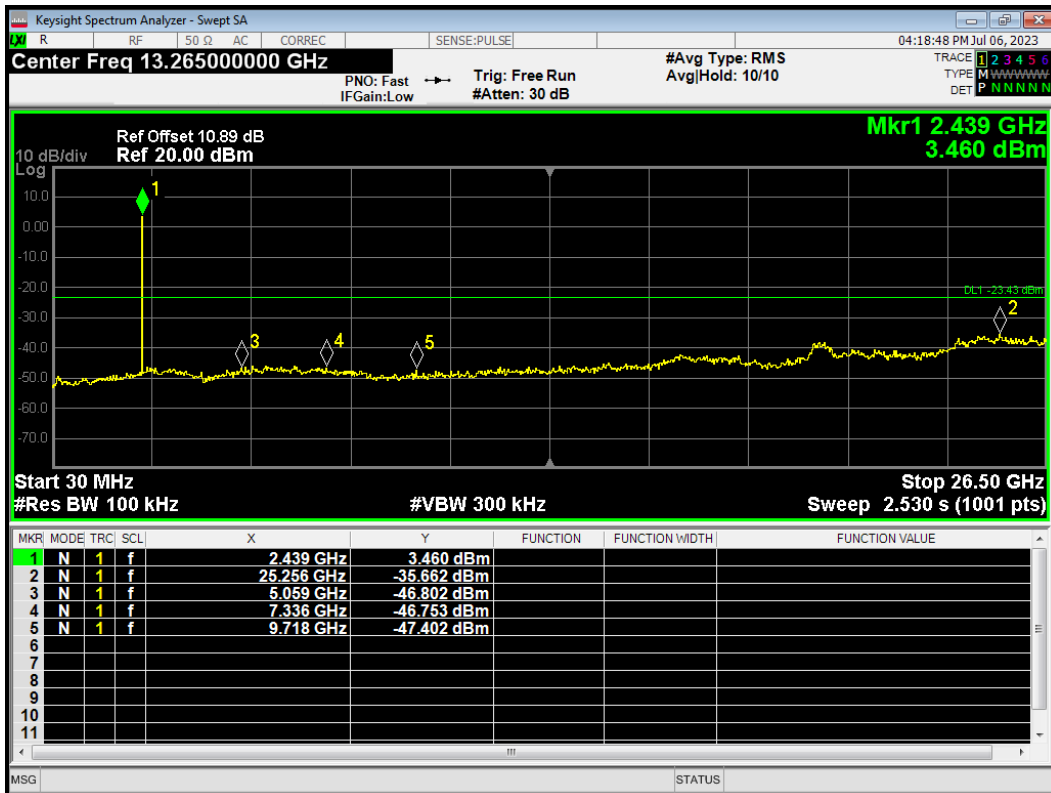

Tx. Spurious BLE (2M) 2480MHz Ref

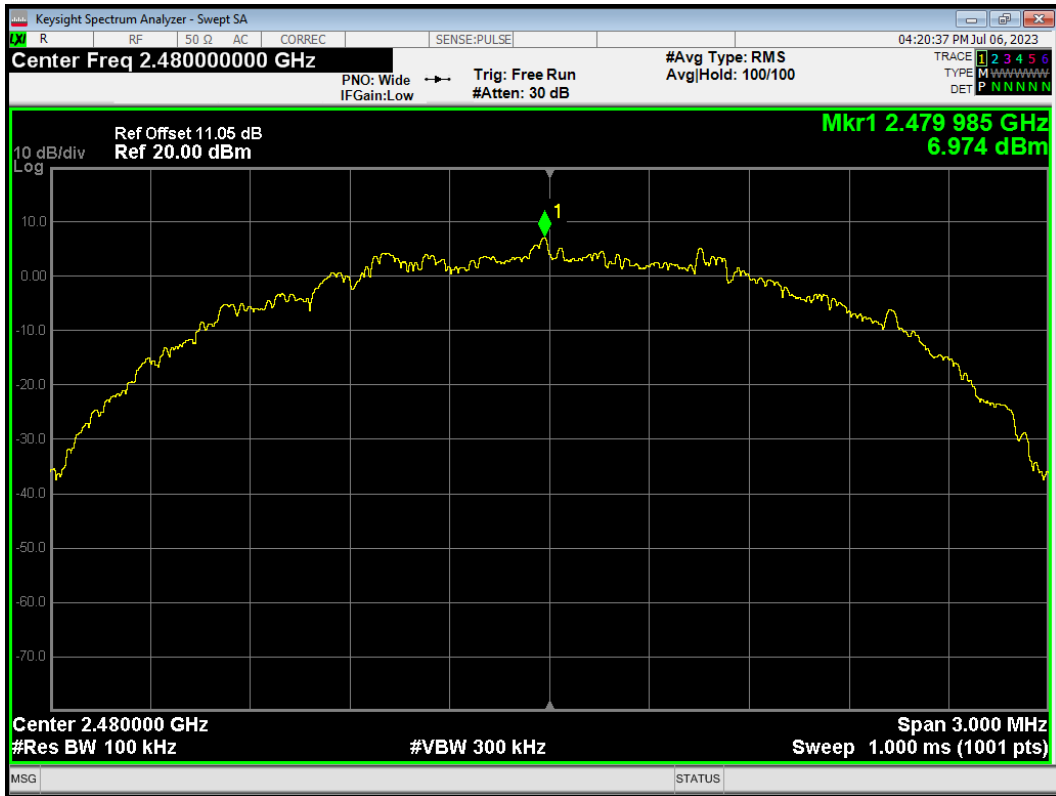

Tx. Spurious BLE (2M) 2480MHz Emission

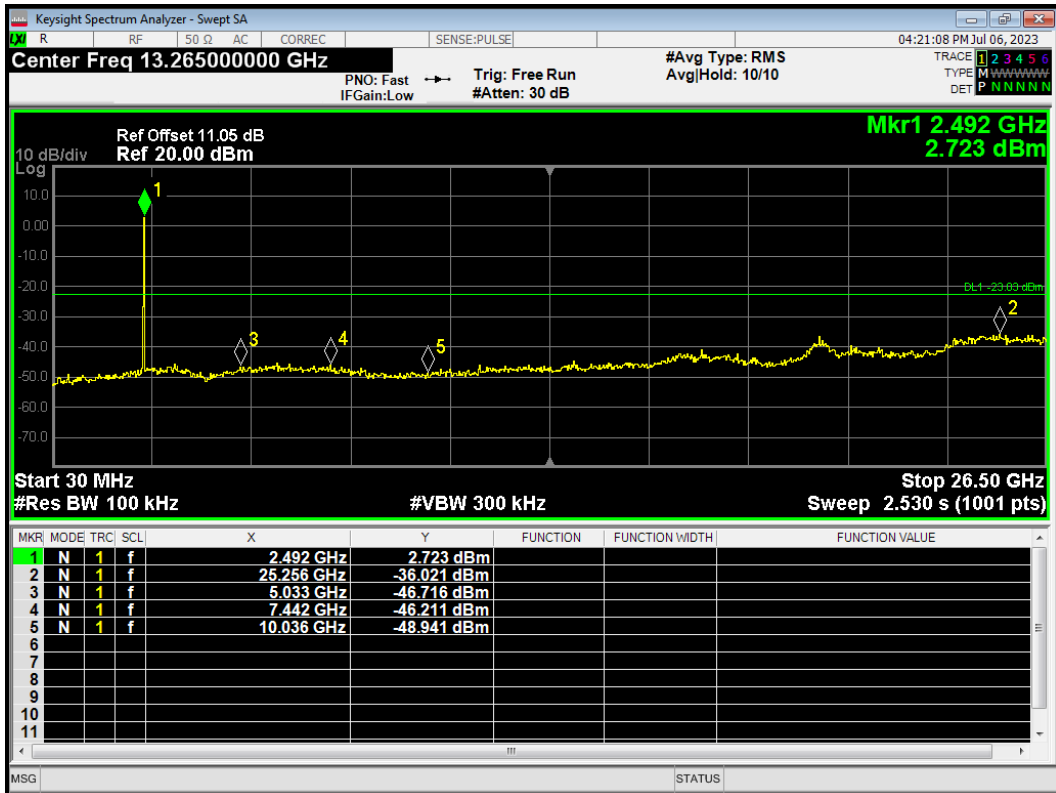

Tx. Spurious BLE (S=2) 2402MHz Ref

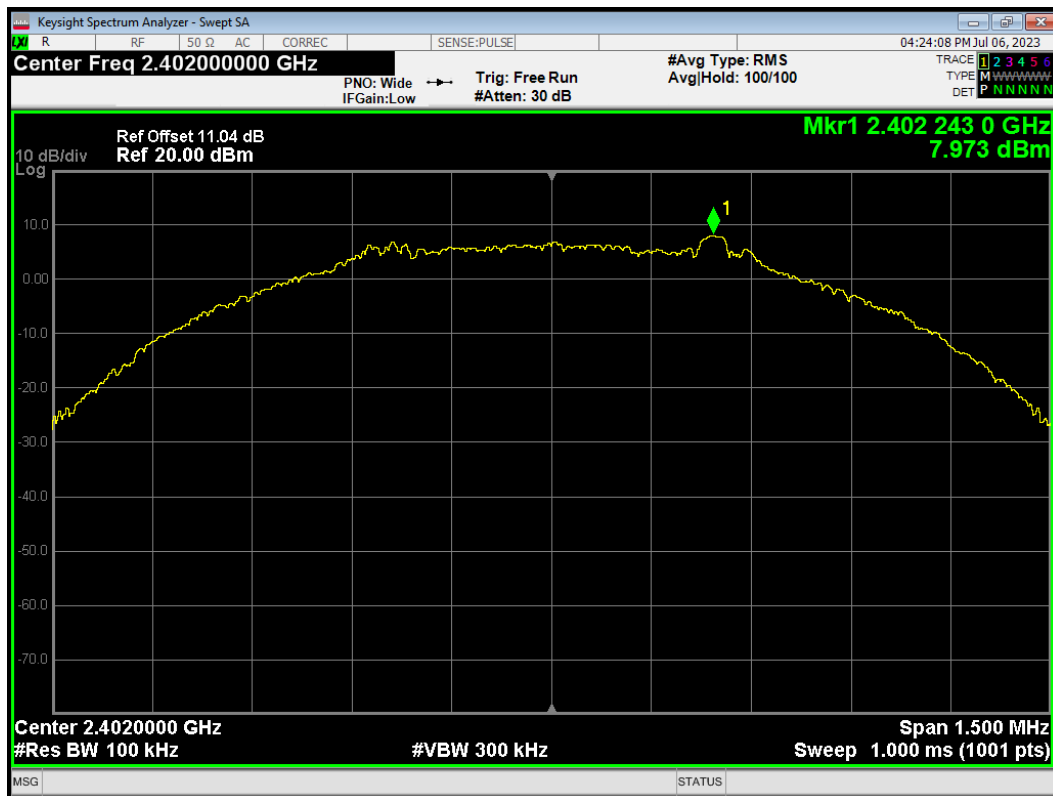

Tx. Spurious BLE (S=2) 2402MHz Emission

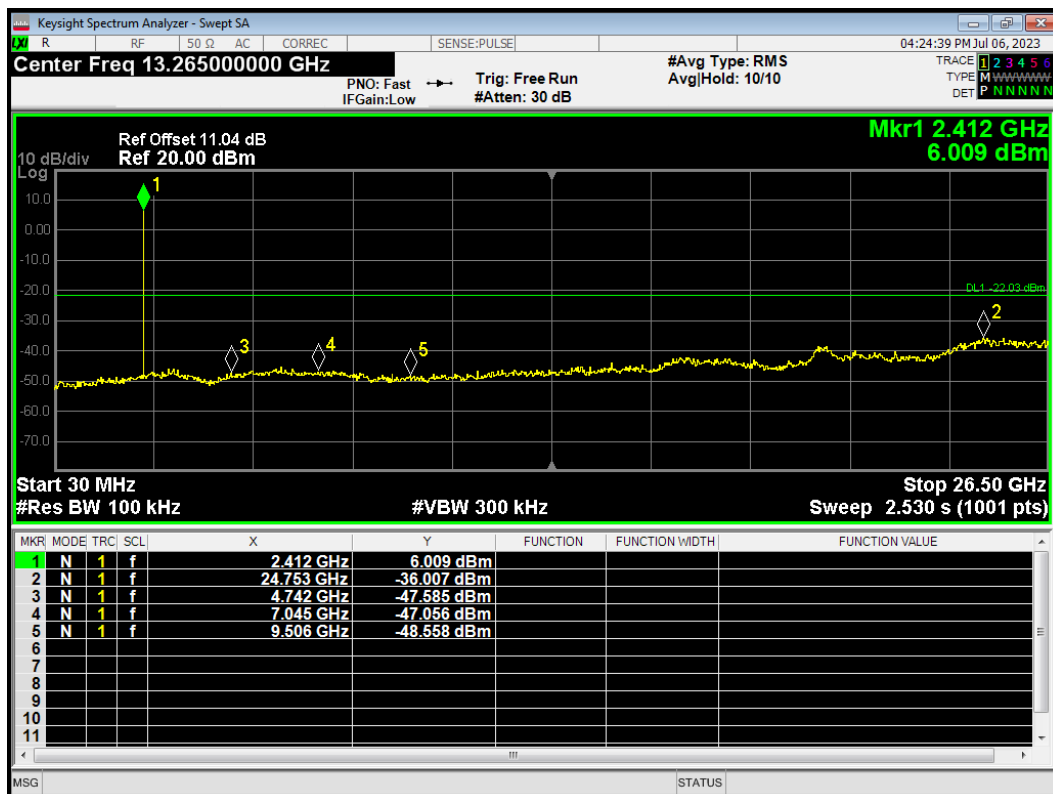

Tx. Spurious BLE (S=2) 2440MHz Ref

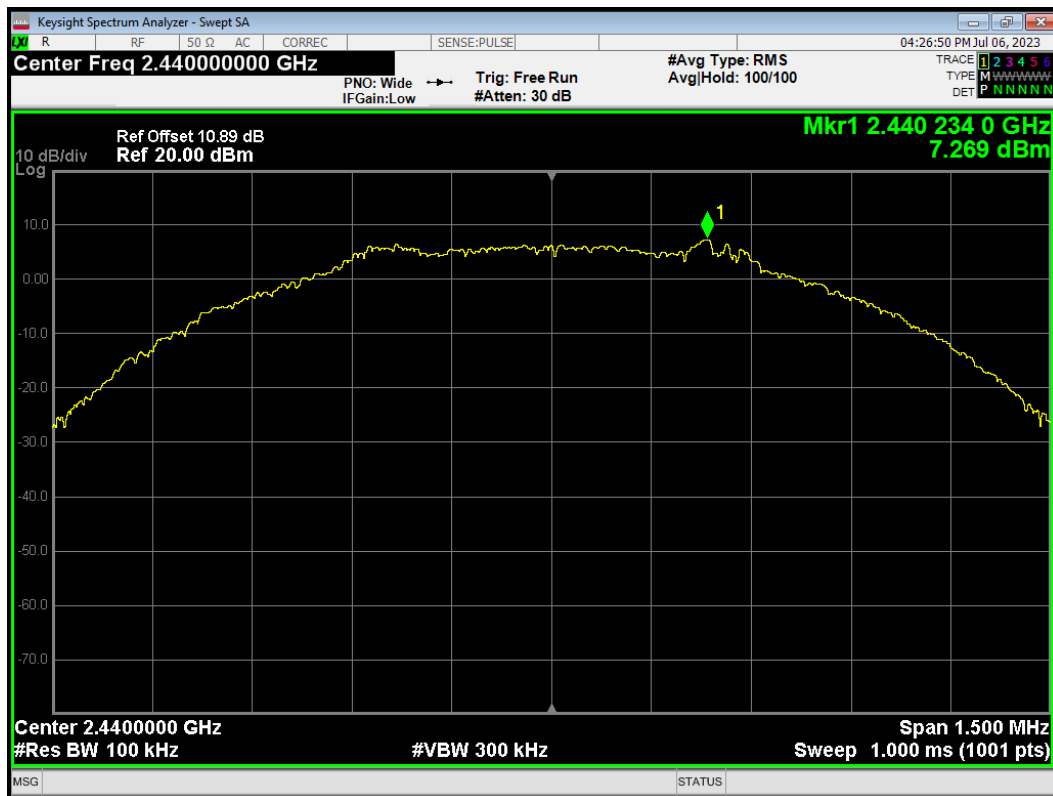

Tx. Spurious BLE (S=2) 2440MHz Emission

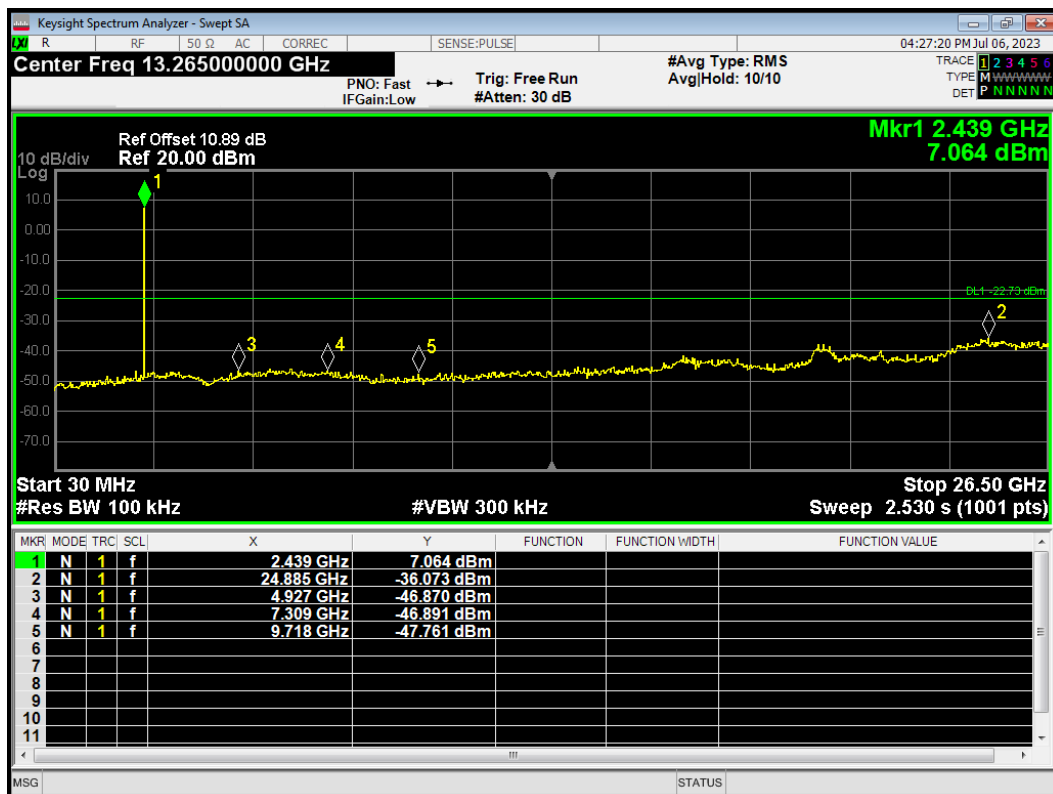

Tx. Spurious BLE (S=2) 2480MHz Ref



Tx. Spurious BLE (S=2) 2480MHz Emission

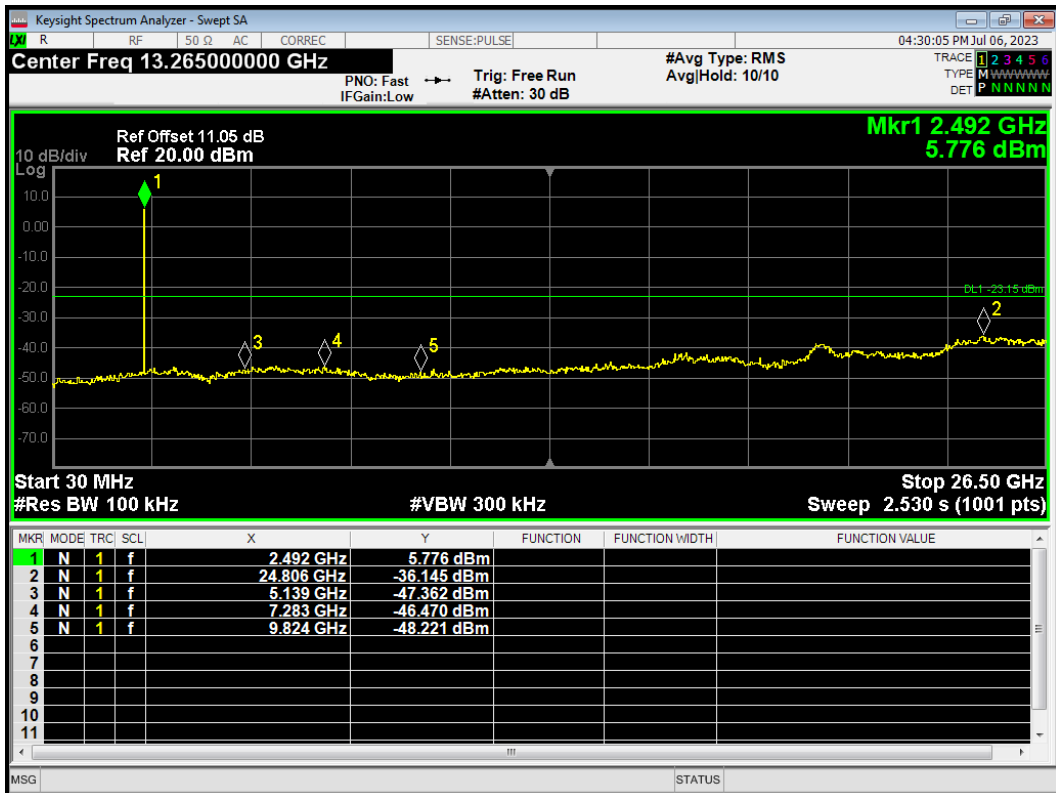

Tx. Spurious BLE (S=8) 2402MHz Ref

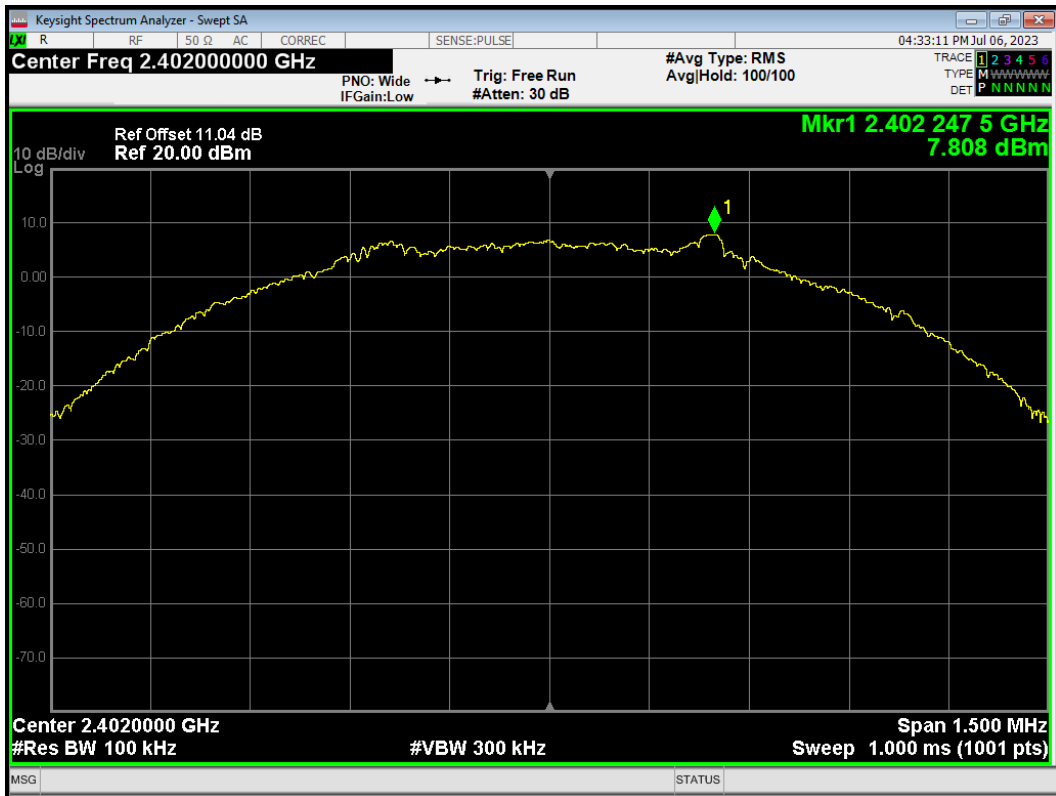

Tx. Spurious BLE (S=8) 2402MHz Emission

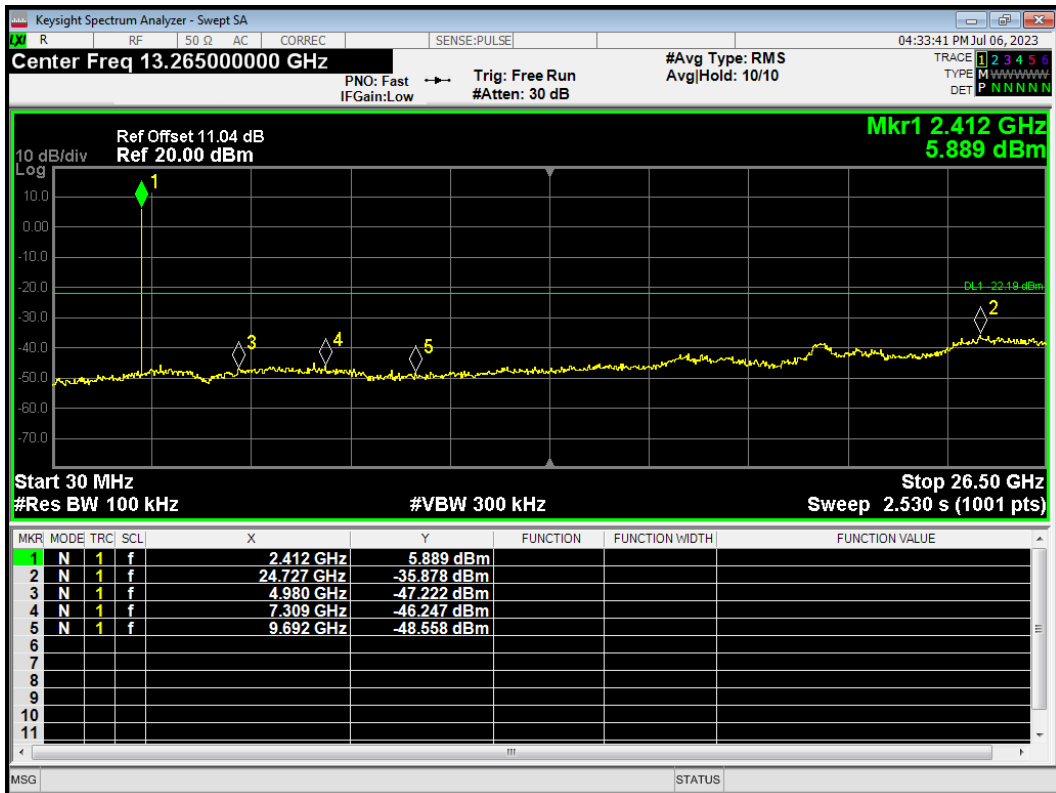

Tx. Spurious BLE (S=8) 2440MHz Ref

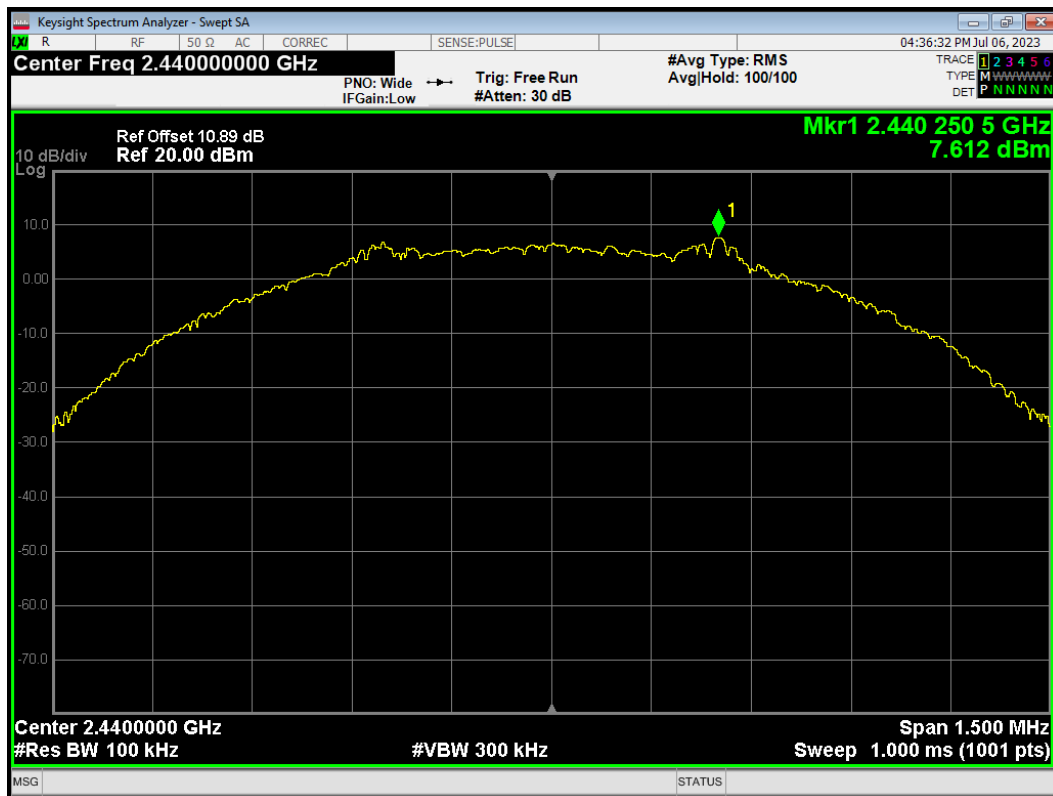

Tx. Spurious BLE (S=8) 2440MHz Emission

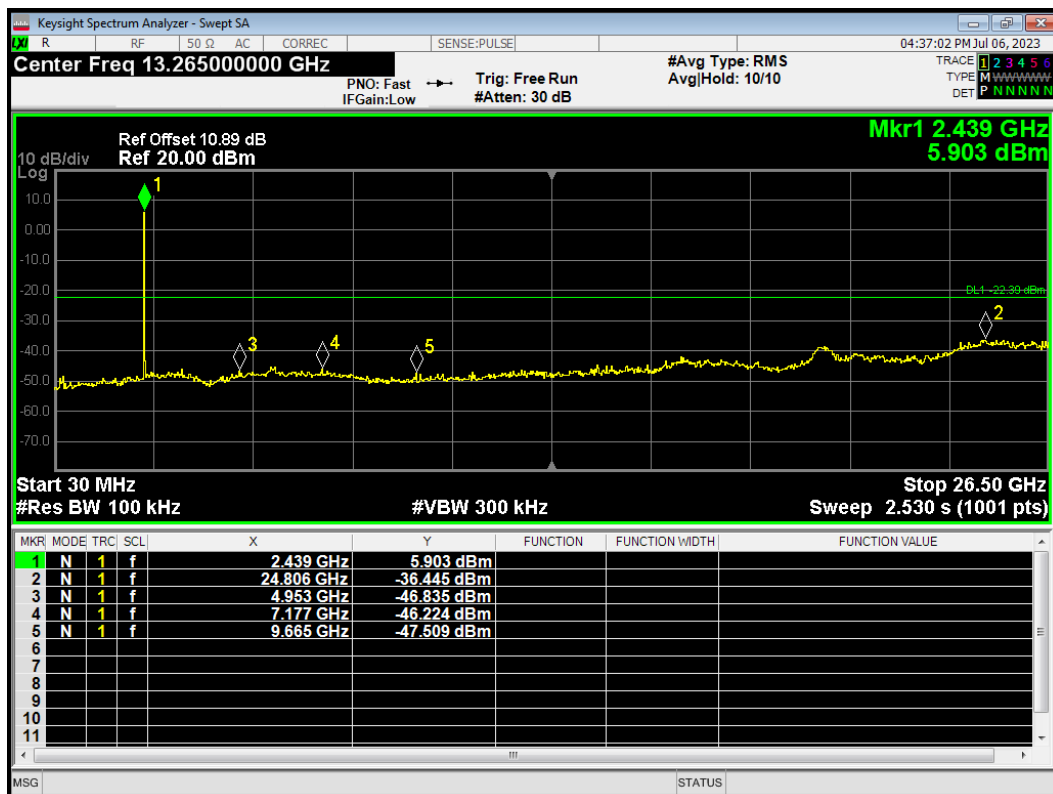

Tx. Spurious BLE (S=8) 2480MHz Ref

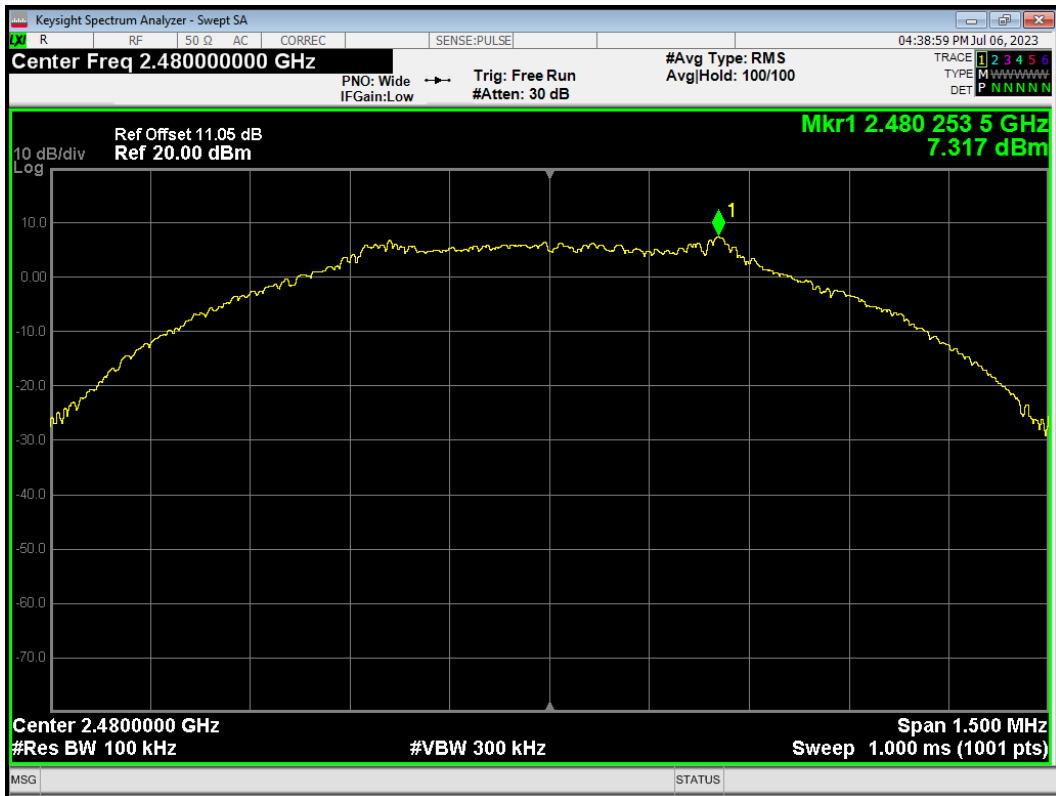

Tx. Spurious BLE (S=8) 2480MHz Emission

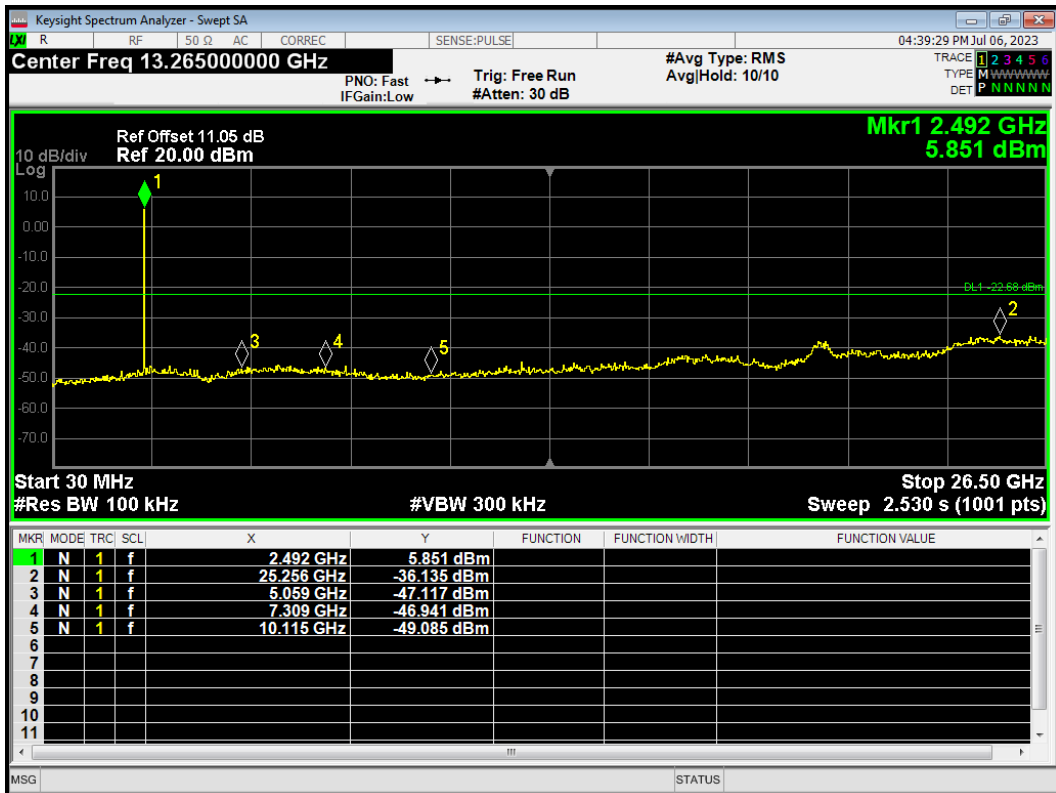

5.6. Unwanted Emission

Ambient Condition

Temperature	Relative humidity
20°C ~ 25°C	45% ~ 50%

Method of Measurement

The test set-up was made in accordance to the general provisions of ANSI C63.10.

The Equipment Under Test (EUT) was set up on a non-conductive table in the semi-anechoic chamber. The test was performed at the distance of 3 m between the EUT and the receiving antenna.

The turntable shall be rotated from 0 to 360 degrees for detecting the maximum of radiated spurious signal level. The measurements shall be repeated with orthogonal polarization of the test antenna. The data of cable loss and antenna factor has been calibrated in full testing frequency range before the testing. Sweep the Restricted Band and the emissions less than 20 dB below the permissible value are reported.

The radiated emissions measurements were made in a typical installation configuration.

Sweep the whole frequency band through the range from 9 kHz to the 10th harmonic of the carrier, and the emissions less than 20 dB below the permissible value are reported.

This method refer to ANSI C63.10.

The procedure for peak unwanted emissions measurements above 1000 MHz is as follows:

Set the spectrum analyzer in the following:

9kHz~150 kHz

RBW=200Hz, VBW=1kHz/ Sweep=AUTO

150 kHz~30MHz

RBW=9KHz, VBW=30KHz,/ Sweep=AUTO

Below 1GHz

RBW=100kHz / VBW=300kHz / Sweep=AUTO

a) Peak emission levels are measured by setting the instrument as follows:

Above 1GHz

PEAK: RBW=1MHz VBW=3MHz/ Sweep=AUTO

b) Average emission levels are measured by setting the instrument as follows:

Above 1GHz

AVERAGE: RBW=1MHz / VBW=3MHz / Sweep=AUTO

c) Detector: The measurements employing a CISPR quasi-peak detector except for the frequency bands 9-90 kHz, 110-490 kHz and above 1000 MHz. Radiated emission limits in these three bands are based on measurements employing an average detector.

d) Averaging type = power (i.e., rms) (As an alternative, the detector and averaging type may be set for linear voltage averaging. Some instruments require linear display mode to use linear voltage

averaging. Log or dB averaging shall not be used.)

e) Sweep time = auto.

f) Perform a trace average of at least 100 traces if the transmission is continuous. If the transmission is not continuous, then the number of traces shall be increased by a factor of $1 / D$, where D is the duty cycle. For example, with 50% duty cycle, at least 200 traces shall be averaged. (If a specific emission is demonstrated to be continuous—i.e., 100% duty cycle—then rather than turning ON and OFF with the transmit cycle, at least 100 traces shall be averaged.)

g) If tests are performed with the EUT transmitting at a duty cycle less than 98%, then a correction factor shall be added to the measurement results prior to comparing with the emission limit, to compute the emission level that would have been measured had the test been performed at 100% duty cycle. The correction factor is computed as follows:

1) If power averaging (rms) mode was used in the preceding step e), then the correction factor is $[10 \log (1 / D)]$, where D is the duty cycle. For example, if the transmit duty cycle was 50%, then 3 dB shall be added to the measured emission levels.

2) If linear voltage averaging mode was used in the preceding step e), then the correction factor is $[20 \log (1 / D)]$, where D is the duty cycle. For example, if the transmit duty cycle was 50%, then 6 dB shall be added to the measured emission levels.

3) If a specific emission is demonstrated to be continuous (100% duty cycle) rather than turning ON and OFF with the transmit cycle, then no duty cycle correction is required for that emission.

The test is in transmitting mode.

Test Setup

9KHz~ 30MHz

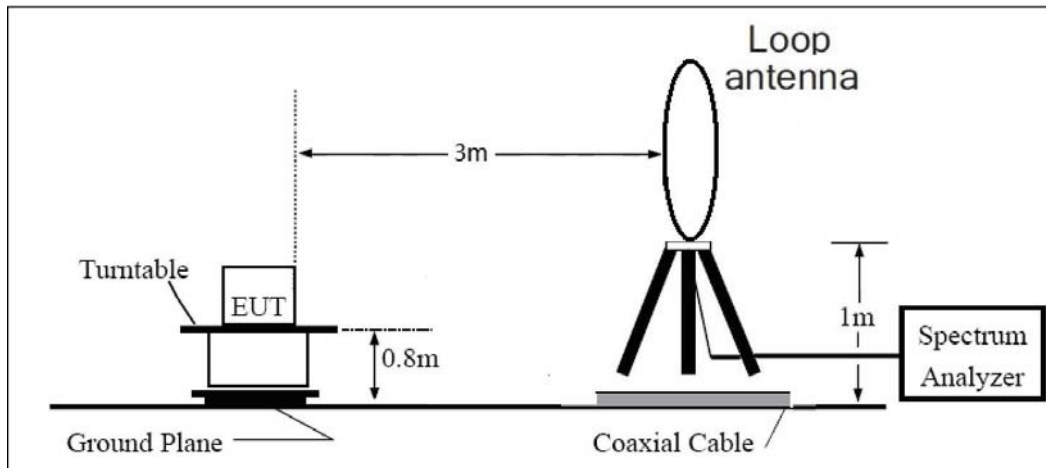

30MHz~ 1GHz

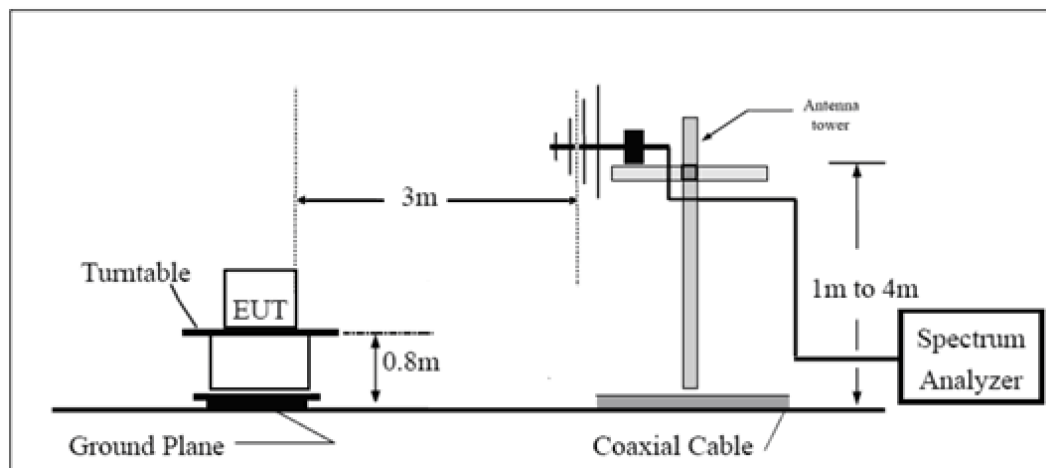

Above 1GHz

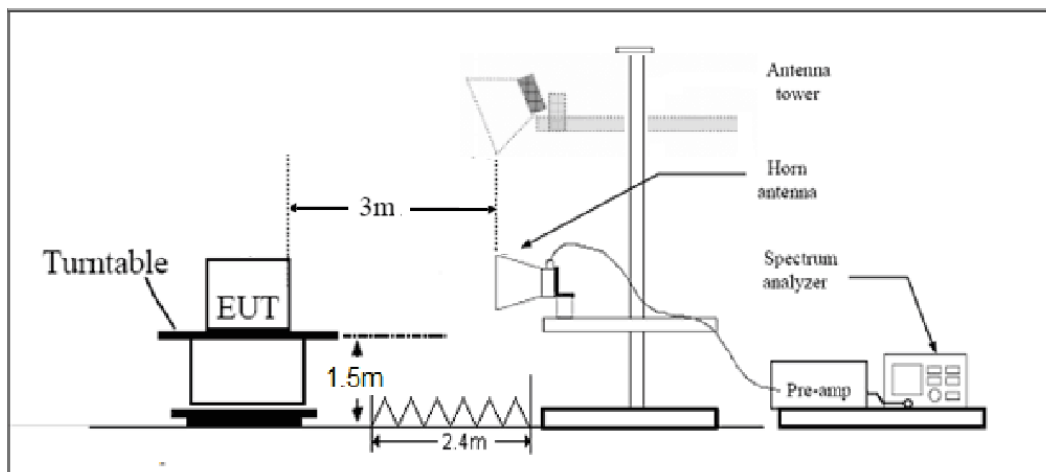

Note: Area side:2.4mX3.6m

Limits

Rule Part 15.247(d) specifies that “In addition, radiated emissions which fall in the restricted bands, as defined in § 15.205(a), must also comply with the radiated emission limits specified in § 15.209(a) (see § 15.205(c)).”

Limit in restricted band

Frequency of emission (MHz)	Field strength($\mu\text{V}/\text{m}$)	Field strength($\text{dB}\mu\text{V}/\text{m}$)
0.009–0.490	2400/F(kHz)	/
0.490–1.705	24000/F(kHz)	/
1.705–30.0	30	/
30-88	100	40
88-216	150	43.5
216-960	200	46
Above960	500	54

§15.35(b)

There is also a limit on the radio frequency emissions, as measured using instrumentation with a peak detector function, corresponding to 20 dB above the maximum permitted average limit.

Peak Limit=74 $\text{dB}\mu\text{V}/\text{m}$

Average Limit=54 $\text{dB}\mu\text{V}/\text{m}$

Spurious Radiated Emissions are permitted in any of the frequency bands listed below:

MHz	MHz	MHz	GHz
0.090-0.110	16.42-16.423	399.9-410	4.5-5.15
¹ 0.495-0.505	16.69475-16.69525	608-614	5.35-5.46
2.1735-2.1905	16.80425-16.80475	960-1240	7.25-7.75
4.125-4.128	25.5-25.67	1300-1427	8.025-8.5
4.17725-4.17775	37.5-38.25	1435-1626.5	9.0-9.2
4.20725-4.20775	73-74.6	1645.5-1646.5	9.3-9.5
6.215-6.218	74.8-75.2	1660-1710	10.6-12.7
6.26775-6.26825	108-121.94	1718.8-1722.2	13.25-13.4
6.31175-6.31225	123-138	2200-2300	14.47-14.5
8.291-8.294	149.9-150.05	2310-2390	15.35-16.2
8.362-8.366	156.52475-156.52525	2483.5-2500	17.7-21.4
8.37625-8.38675	156.7-156.9	2690-2900	22.01-23.12
8.41425-8.41475	162.0125-167.17	3260-3267	23.6-24.0
12.29-12.293	167.72-173.2	3332-3339	31.2-31.8
12.51975-12.52025	240-285	3345.8-3358	36.43-36.5
12.57675-12.57725	322-335.4	3600-4400	(²)
13.36-13.41			

Measurement Uncertainty

The assessed measurement uncertainty to ensure 95% confidence level for the normal distribution is with the coverage factor $k = 1.96$.

Frequency	Uncertainty
9KHz-30MHz	3.55 dB
30MHz-200MHz	4.17 dB
200MHz-1GHz	4.84 dB
1-18GHz	4.35 dB
18-26.5GHz	5.90 dB
26.5GHz~40GHz	5.92 dB

Test Results:

A symbol ($\text{dB } \nabla$) in the test plot below means ($\text{dB}\mu\text{V/m}$)

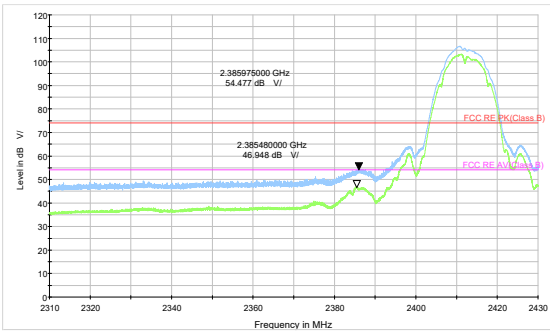

802.11b-Channel 1 Peak+ Average

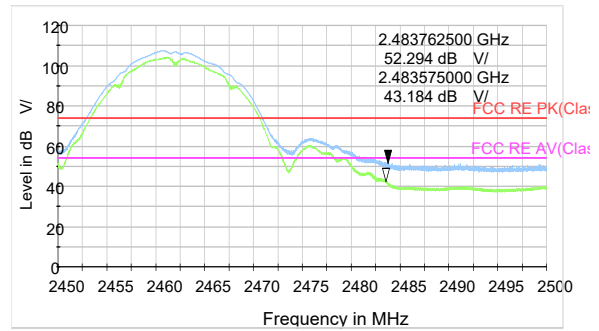

802.11b-Channel 11 Peak+ Average

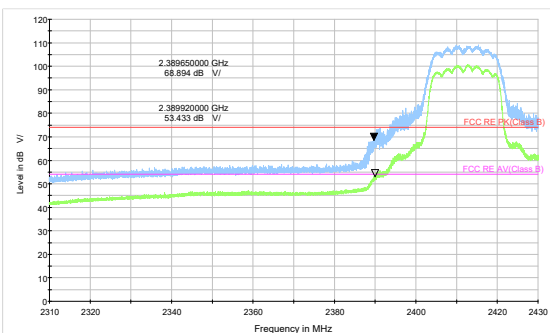

802.11g-Channel 1 Peak+ Average

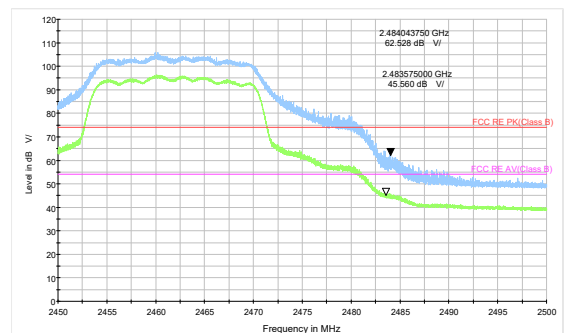

802.11g-Channel 11 Peak+ Average

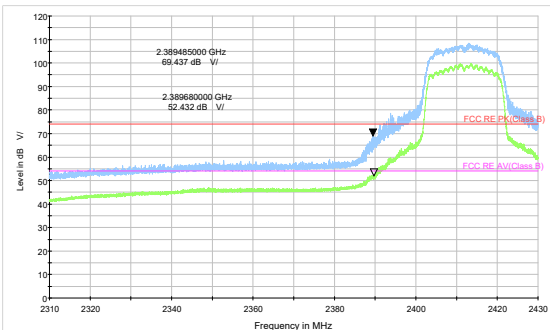

802.11n HT20-Channel 1 Peak+ Average

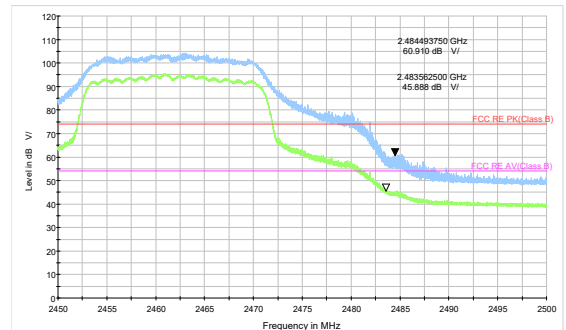

802.11n HT20-Channel 11 Peak+ Average

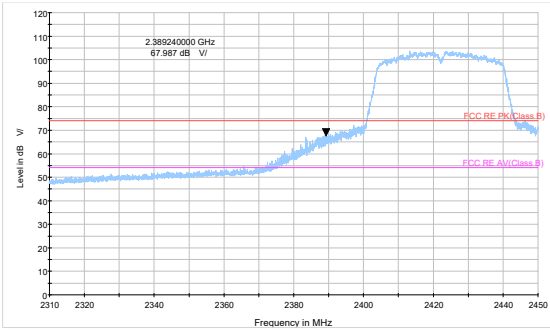

802.11n HT40-Channel 3 Peak

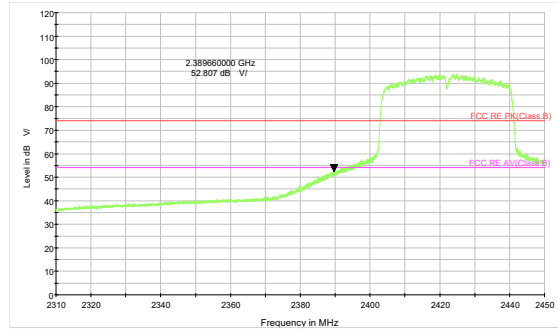

802.11n HT40-Channel 3 Average

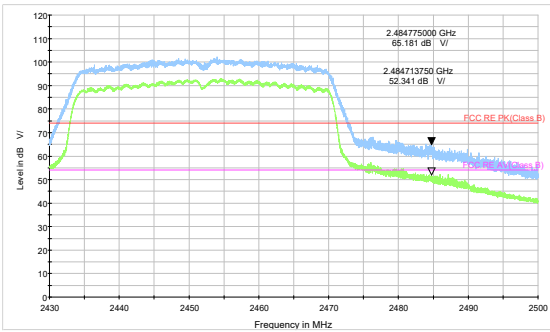

802.11n HT40-Channel 9 Peak+ Average

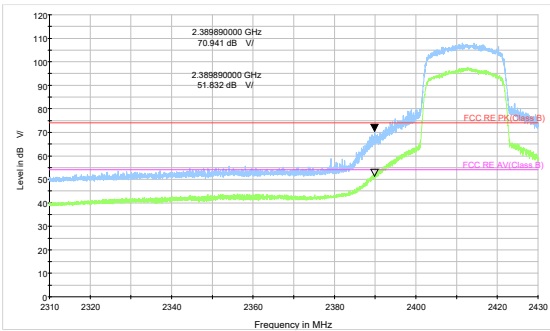

802.11ax HE20-Channel 1 Peak+ Average

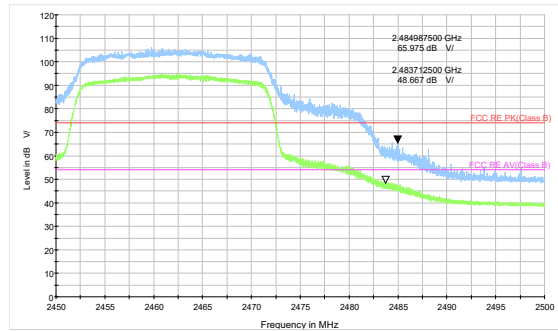

802.11ax HE20-Channel 11 Peak+ Average

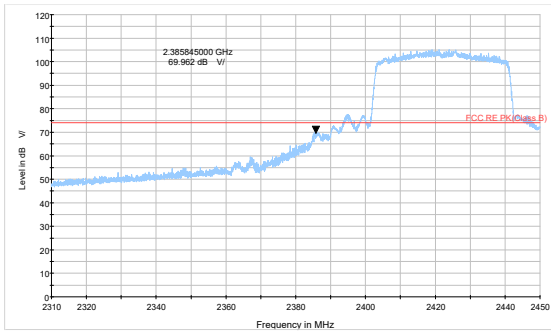

802.11ax HE40-Channel 3 Peak

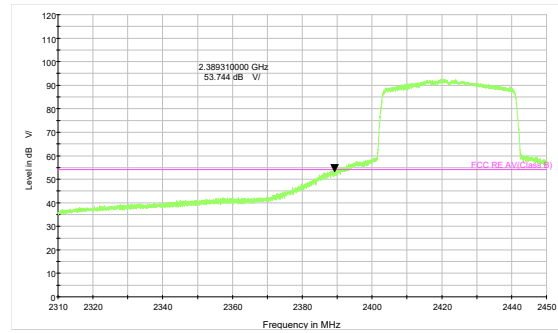

802.11ax HE40-Channel 3 Average

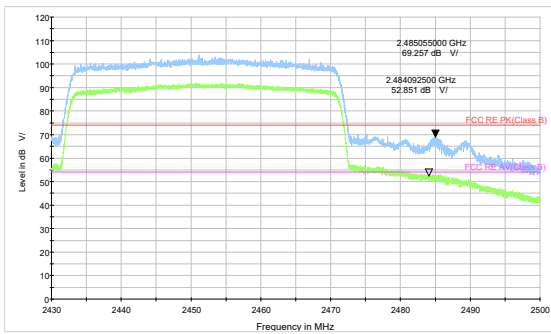

802.11ax HE40-Channel 9 Peak+ Average

TB Mode

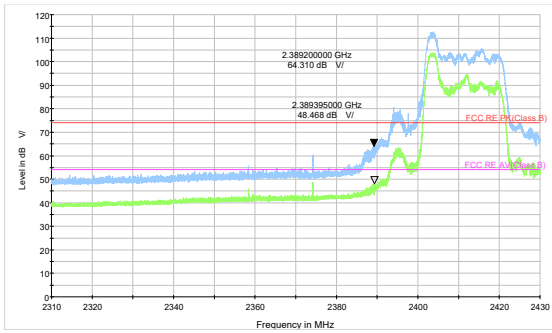

802.11ax HE20 26-Tone-CH1 Peak+ Average

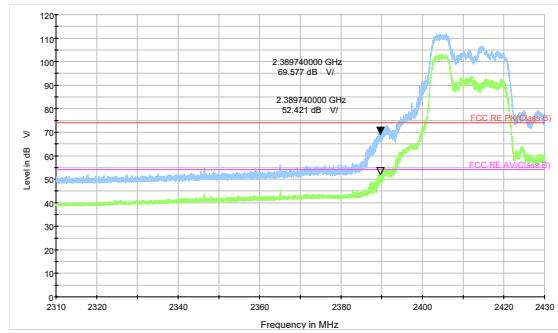

802.11ax HE20 52-Tone-CH1 Peak+ Average

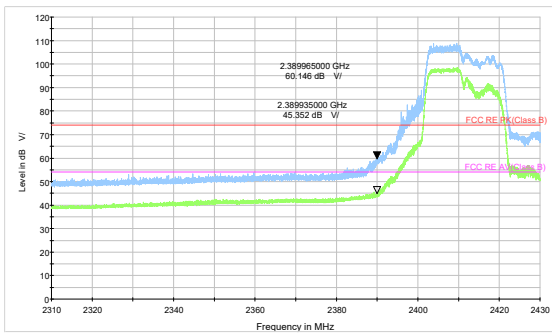

802.11ax HE20 106-Tone-CH1 Peak+ Average

After the pretest, Bluetooth LE (1M) was selected as the worst Mode for Bluetooth LE.

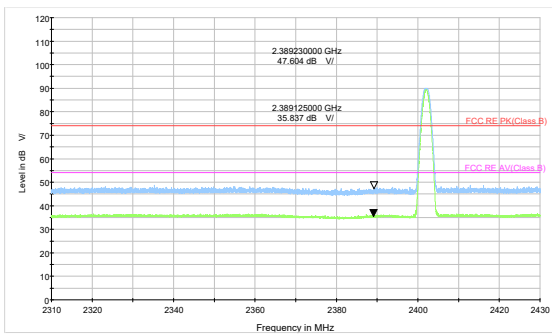

Bluetooth LE (1M) Channel 0 Peak+ Average

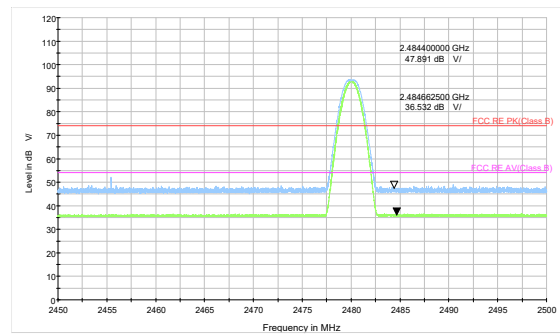

Bluetooth LE (1M) Channel 39 Peak+ Average

Result of RE

Test result

Sweep the whole frequency band through the range from 9kHz to the 10th harmonic of the carrier, the Emissions in the frequency band 9kHz-30MHz and 18GHz-26.5GHz are more than 20dB below the limit are not reported.

The following graphs display the maximum values of horizontal and vertical by software. For above 1GHz, Blue trace uses the peak detection, Green trace uses the average detection.

After the pretest, MIMO was selected as the worst antenna for Wi-Fi 2.4G.

Internal Antenna was selected as the worst antenna for Bluetooth LE

Continuous TX mode:

Wi-Fi 2.4G

During the test, the Radiates Emission from 30MHz to 1GHz was performed in all modes with all channels, 802.11ax HE20, Channel 1 are selected as the worst condition. The test data of the worst-case condition was recorded in this report.

A symbol ($\text{dB } \mu\text{V/m}$) in the test plot below means ($\text{dB}\mu\text{V/m}$)

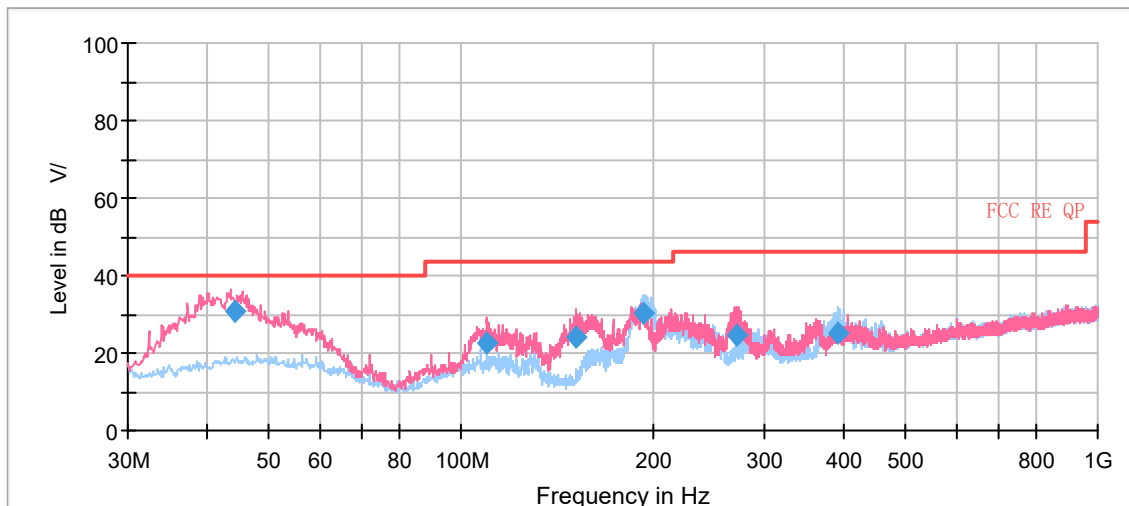

Radiates Emission from 30MHz to 1GHz

Frequency (MHz)	Quasi-Peak ($\text{dB}\mu\text{V/m}$)	Limit ($\text{dB}\mu\text{V/m}$)	Margin (dB)	Height (cm)	Polarization	Azimuth (deg)	Correct Factor (dB)
44.180000	30.64	40.00	9.36	100.0	V	339.0	20.3
109.986250	22.35	43.50	21.15	100.0	V	174.0	18.2
152.175000	24.36	43.50	19.14	100.0	V	33.0	14.7
193.603750	30.39	43.50	13.11	100.0	H	246.0	18.4
270.767500	24.40	46.00	21.60	100.0	V	158.0	19.7
389.748750	25.18	46.00	20.82	100.0	H	240.0	22.7

Remark: 1. Correction Factor = Antenna factor + Insertion loss (cable loss + amplifier gain)

2. Margin = Limit – Quasi-Peak

802.11b CH1

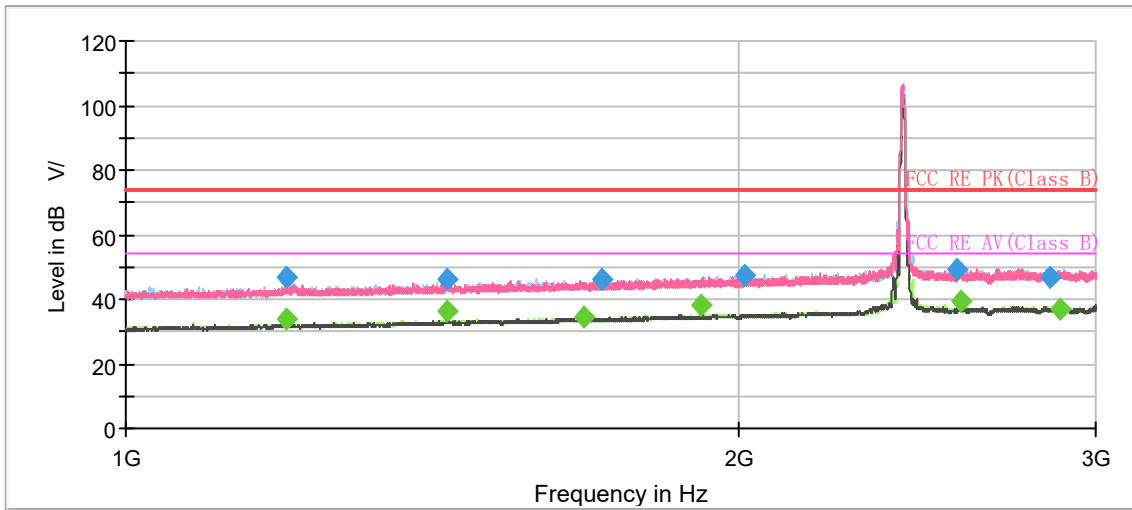

Note: The signal beyond the limit is carrier.
Radiates Emission from 1GHz to 3GHz

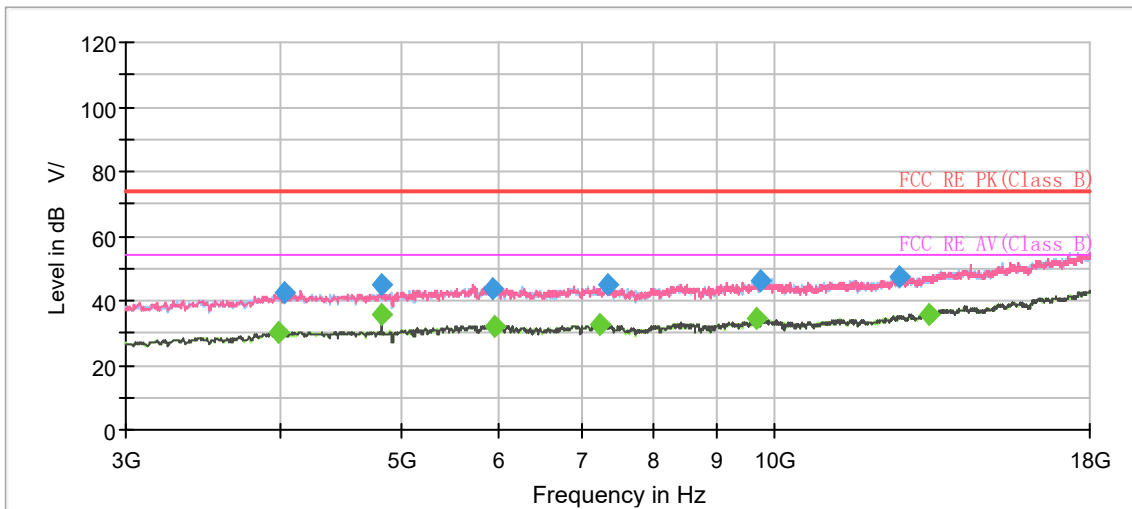

Radiates Emission from 3GHz to 18GHz

Frequency (MHz)	MaxPeak (dB μ V/m)	Average (dB μ V/m)	Limit (dB μ V/m)	Margin (dB)	Meas. Time (ms)	Height (cm)	Pol	Azimuth (deg)	Corr. (dB/m)
1200.000000	---	33.66	54.00	20.34	500.0	200.0	H	96.0	-7.7
1200.500000	46.77	---	74.00	27.23	500.0	200.0	V	128.0	-7.7
1439.750000	---	36.35	54.00	17.65	500.0	100.0	V	177.0	-6.2
1440.250000	46.01	---	74.00	27.99	500.0	100.0	H	61.0	-6.2
1680.000000	---	34.28	54.00	19.72	500.0	200.0	V	160.0	-5.0
1716.250000	45.99	---	74.00	28.01	500.0	100.0	H	162.0	-4.9
1920.500000	---	37.94	54.00	16.06	500.0	100.0	H	236.0	-3.8
2014.000000	47.54	---	74.00	26.46	500.0	200.0	H	77.0	-3.4
2562.750000	49.37	---	74.00	24.63	500.0	200.0	H	104.0	-0.9
2573.750000	---	39.45	54.00	14.55	500.0	200.0	H	312.0	-0.8
2846.750000	46.60	---	74.00	27.40	500.0	200.0	H	18.0	0.2
2882.750000	---	36.74	54.00	17.26	500.0	200.0	V	146.0	0.2

Remark: 1. Correction Factor = Antenna factor + Insertion loss (cable loss + amplifier gain)

2. Margin = Limit –MAX Peak/ Average

802.11b CH6

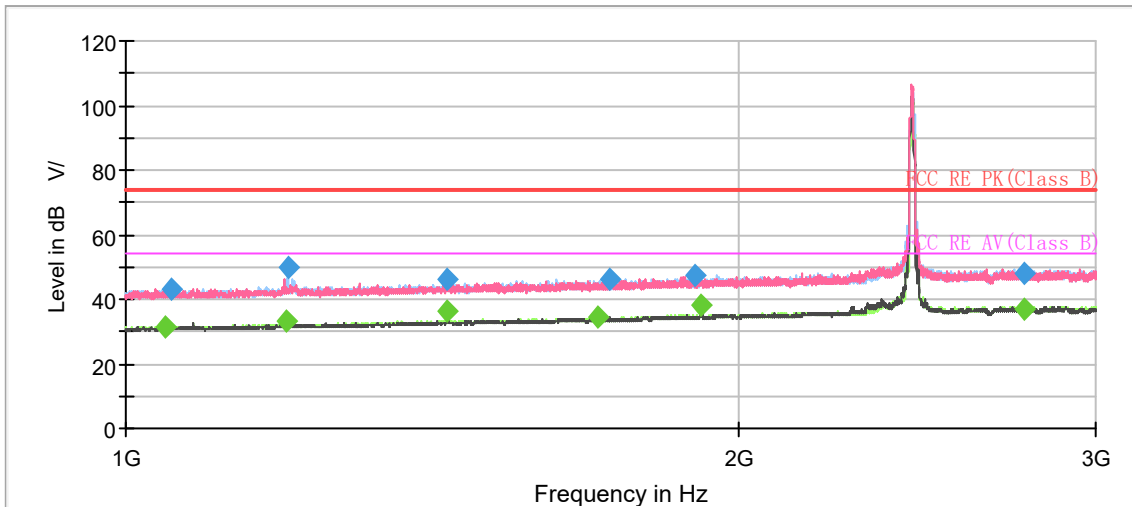

Note: The signal beyond the limit is carrier.
Radiates Emission from 1GHz to 3GHz

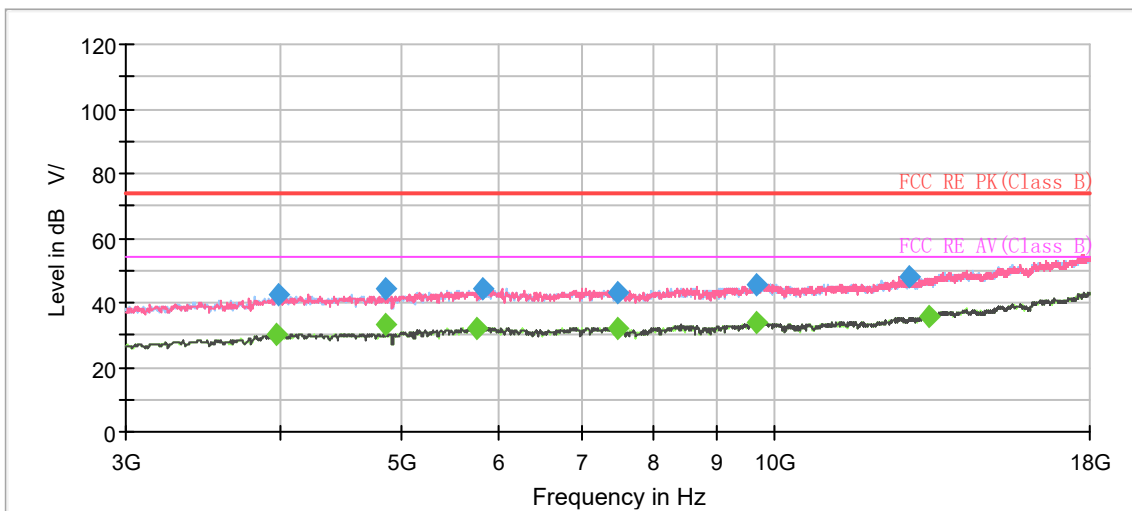

Radiates Emission from 3GHz to 18GHz

Frequency (MHz)	MaxPeak (dB μ V/m)	Average (dB μ V/m)	Limit (dB μ V/m)	Margin (dB)	Meas. Time (ms)	Height (cm)	Pol	Azimuth (deg)	Corr. (dB/m)
1045.750000	---	31.14	54.00	22.86	500.0	100.0	H	242.0	-8.8
1054.000000	42.84	---	74.00	31.16	500.0	200.0	H	348.0	-8.7
1200.250000	---	33.48	54.00	20.52	500.0	200.0	H	98.0	-7.7
1201.000000	50.00	---	74.00	24.00	500.0	200.0	H	258.0	-7.7
1439.750000	45.94	---	74.00	28.06	500.0	100.0	V	188.0	-6.2
1440.000000	---	36.08	54.00	17.92	500.0	100.0	V	178.0	-6.2
1706.750000	---	34.43	54.00	19.57	500.0	200.0	H	31.0	-4.9
1730.000000	46.28	---	74.00	27.72	500.0	100.0	H	68.0	-4.8
1907.250000	47.39	---	74.00	26.61	500.0	200.0	H	17.0	-3.9
1920.250000	---	38.12	54.00	15.88	500.0	100.0	H	115.0	-3.9
2766.250000	---	37.01	54.00	16.99	500.0	100.0	H	210.0	-0.1
2769.500000	48.07	---	74.00	25.93	500.0	200.0	H	67.0	0.0

Remark: 1. Correction Factor = Antenna factor + Insertion loss (cable loss + amplifier gain)

2. Margin = Limit –MAX Peak/ Average

802.11b CH11

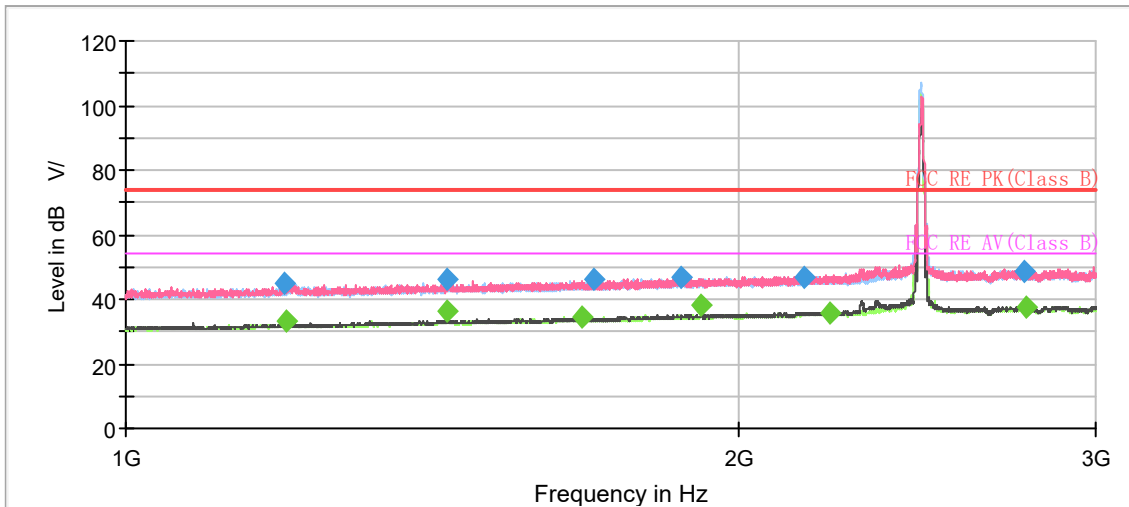

Note: The signal beyond the limit is carrier.
Radiates Emission from 1GHz to 3GHz

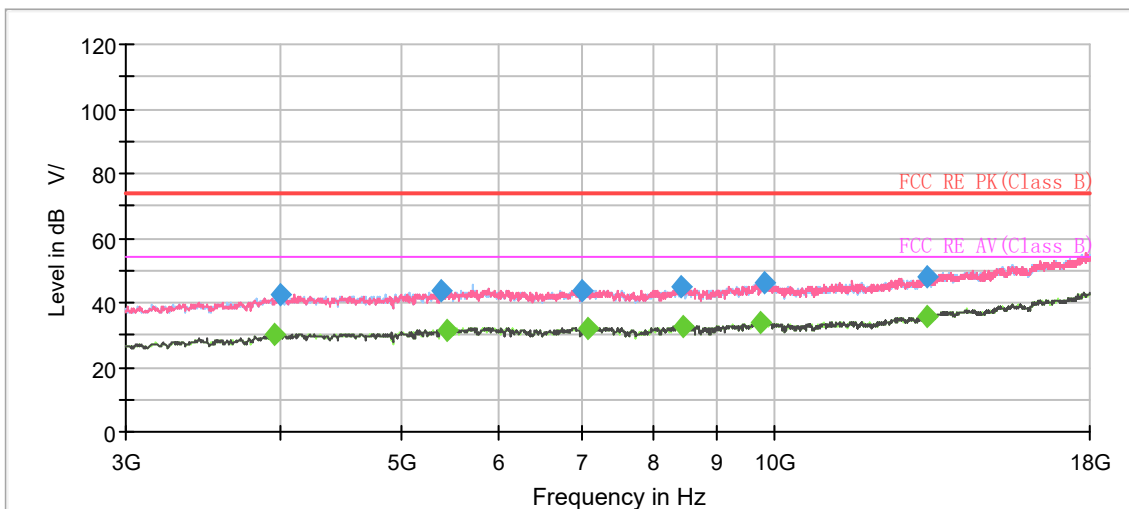

Radiates Emission from 3GHz to 18GHz

Frequency (MHz)	MaxPeak (dB μ V/m)	Average (dB μ V/m)	Limit (dB μ V/m)	Margin (dB)	Meas. Time (ms)	Height (cm)	PoI	Azimuth (deg)	Corr. (dB/m)
1197.000000	44.80	---	74.00	29.20	500.0	100.0	H	193.0	-7.7
1199.750000	---	33.38	54.00	20.62	500.0	200.0	H	102.0	-7.7
1440.250000	---	36.49	54.00	17.51	500.0	100.0	V	184.0	-6.2
1440.500000	46.21	---	74.00	27.79	500.0	100.0	V	179.0	-6.2
1675.250000	---	34.36	54.00	19.64	500.0	200.0	H	74.0	-5.0
1699.750000	46.23	---	74.00	27.77	500.0	200.0	H	74.0	-4.9
1874.750000	46.81	---	74.00	27.19	500.0	200.0	V	355.0	-4.0
1920.250000	---	38.40	54.00	15.60	500.0	100.0	H	110.0	-3.9
2155.750000	46.83	---	74.00	27.17	500.0	200.0	H	107.0	-2.8
2218.750000	---	35.48	54.00	18.52	500.0	100.0	H	10.0	-2.5
2769.750000	48.71	---	74.00	25.29	500.0	200.0	V	119.0	0.0
2772.000000	---	37.31	54.00	16.69	500.0	200.0	H	176.0	0.0

Remark: 1. Correction Factor = Antenna factor + Insertion loss (cable loss + amplifier gain)

2. Margin = Limit –MAX Peak/ Average

802.11g CH1

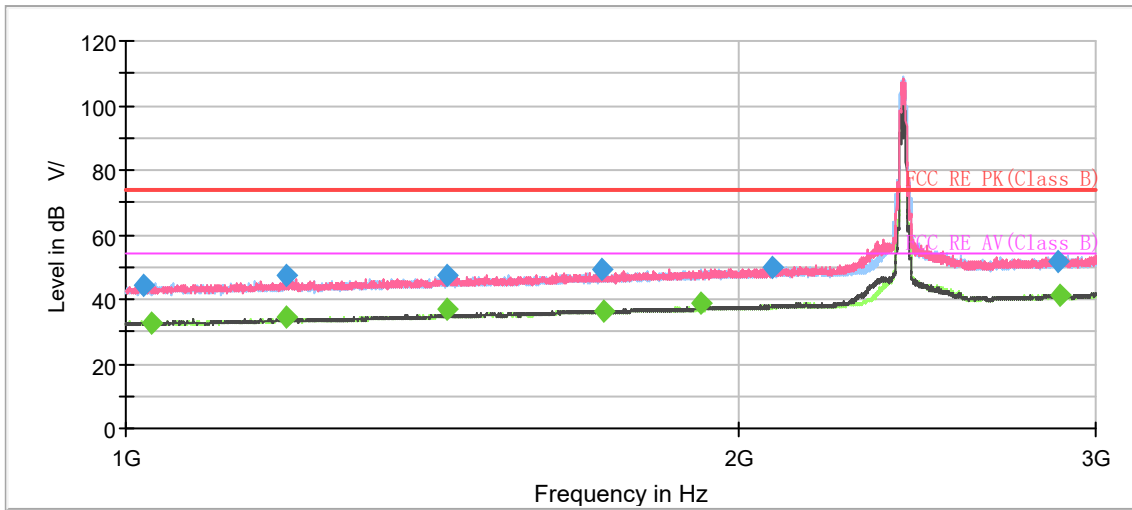

Note: The signal beyond the limit is carrier.
Radiates Emission from 1GHz to 3GHz

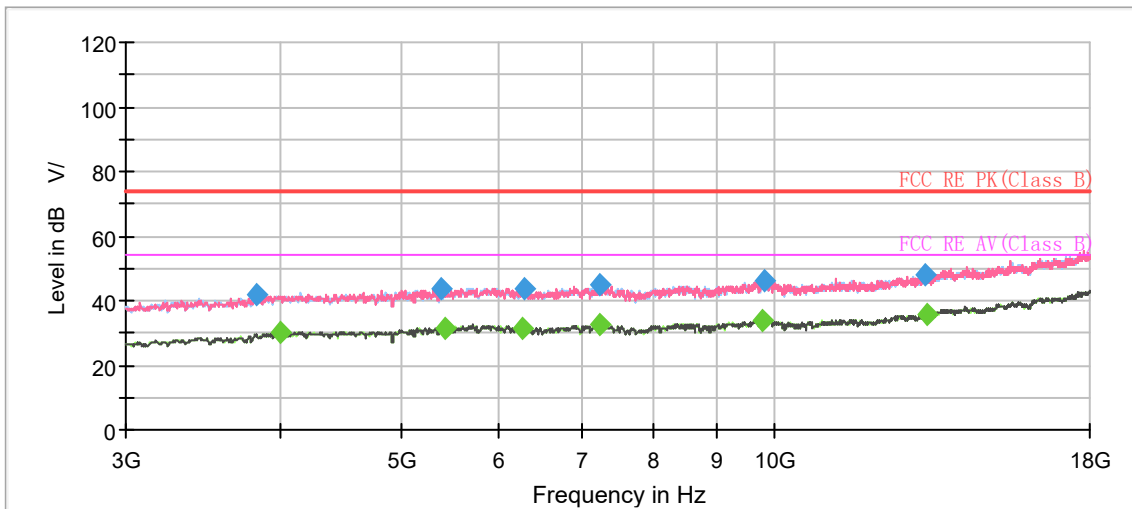

Radiates Emission from 3GHz to 18GHz

Frequency (MHz)	MaxPeak (dB μ V/m)	Average (dB μ V/m)	Limit (dB μ V/m)	Margin (dB)	Meas. Time (ms)	Height (cm)	Pol	Azimuth (deg)	Corr. (dB/m)
1020.250000	44.20	---	74.00	29.80	500.0	200.0	H	162.0	-9.0
1029.500000	---	32.57	54.00	21.43	500.0	200.0	H	267.0	-8.9
1199.500000	47.56	---	74.00	26.44	500.0	100.0	V	136.0	-7.7
1200.000000	---	34.33	54.00	19.67	500.0	200.0	H	89.0	-7.7
1439.500000	47.41	---	74.00	26.59	500.0	100.0	V	173.0	-6.2
1440.250000	---	37.19	54.00	16.81	500.0	100.0	V	173.0	-6.2
1713.750000	49.39	---	74.00	24.61	500.0	200.0	H	56.0	-4.9
1719.250000	---	36.59	54.00	17.41	500.0	100.0	V	86.0	-4.9
1920.250000	---	38.91	54.00	15.09	500.0	100.0	H	120.0	-3.9
2079.500000	49.91	---	74.00	24.09	500.0	200.0	H	157.0	-3.1
2873.750000	51.47	---	74.00	22.53	500.0	200.0	H	29.0	0.2
2878.250000	---	41.19	54.00	12.81	500.0	200.0	H	143.0	0.2

Remark: 1. Correction Factor = Antenna factor + Insertion loss (cable loss + amplifier gain)

2. Margin = Limit - MAX Peak/ Average

802.11g CH6

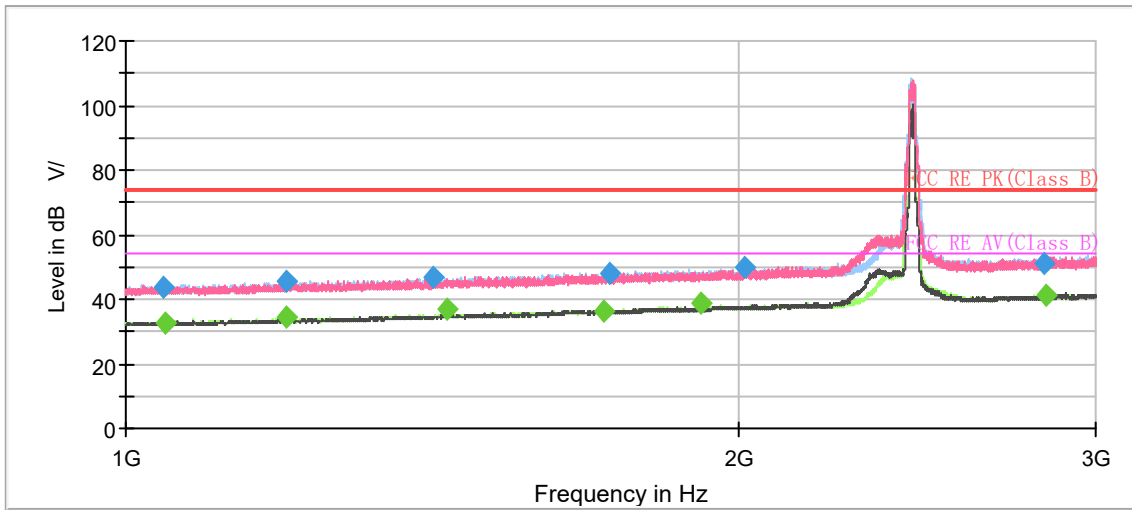

Note: The signal beyond the limit is carrier.
Radiates Emission from 1GHz to 3GHz

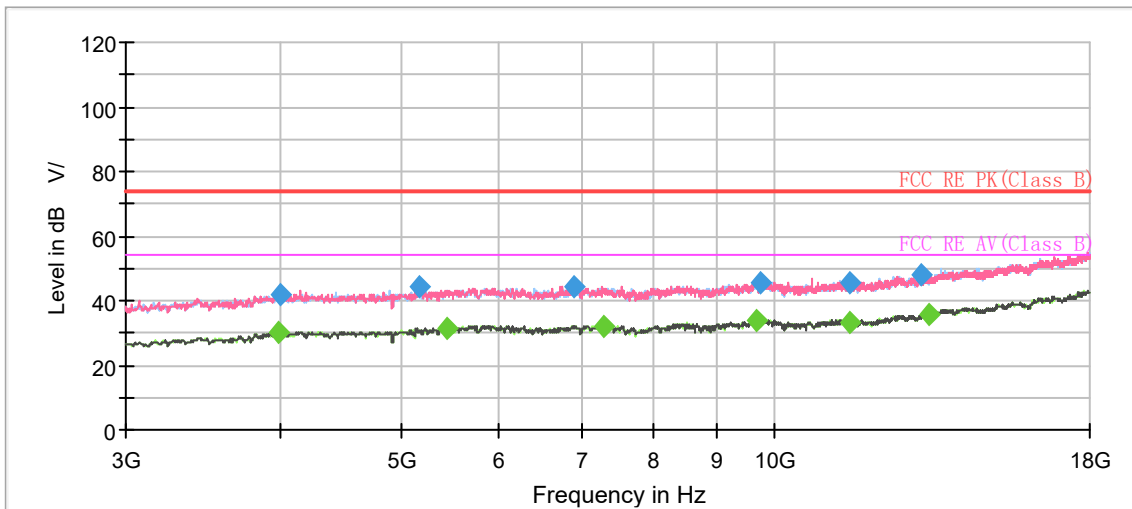

Radiates Emission from 3GHz to 18GHz

Frequency (MHz)	MaxPeak (dB μ V/m)	Average (dB μ V/m)	Limit (dB μ V/m)	Margin (dB)	Meas. Time (ms)	Height (cm)	Pol	Azimuth (deg)	Corr. (dB/m)
1042.500000	43.57	---	74.00	30.43	500.0	200.0	H	12.0	-8.8
1047.000000	---	32.48	54.00	21.52	500.0	200.0	H	2.0	-8.7
1199.250000	45.68	---	74.00	28.32	500.0	200.0	H	48.0	-7.7
1200.000000	---	34.53	54.00	19.47	500.0	200.0	H	94.0	-7.7
1416.000000	46.84	---	74.00	27.16	500.0	200.0	H	57.0	-6.4
1440.000000	---	37.23	54.00	16.77	500.0	100.0	V	170.0	-6.2
1718.250000	---	36.50	54.00	17.50	500.0	200.0	H	194.0	-4.9
1730.000000	48.18	---	74.00	25.82	500.0	200.0	H	43.0	-4.8
1920.000000	---	38.72	54.00	15.28	500.0	200.0	H	140.0	-3.9
2014.250000	49.77	---	74.00	24.23	500.0	100.0	H	344.0	-3.4
2829.750000	51.05	---	74.00	22.95	500.0	200.0	H	144.0	0.1
2835.250000	---	41.23	54.00	12.77	500.0	100.0	H	339.0	0.1

Remark: 1. Correction Factor = Antenna factor + Insertion loss (cable loss + amplifier gain)

2. Margin = Limit - MAX Peak/ Average

802.11g CH11

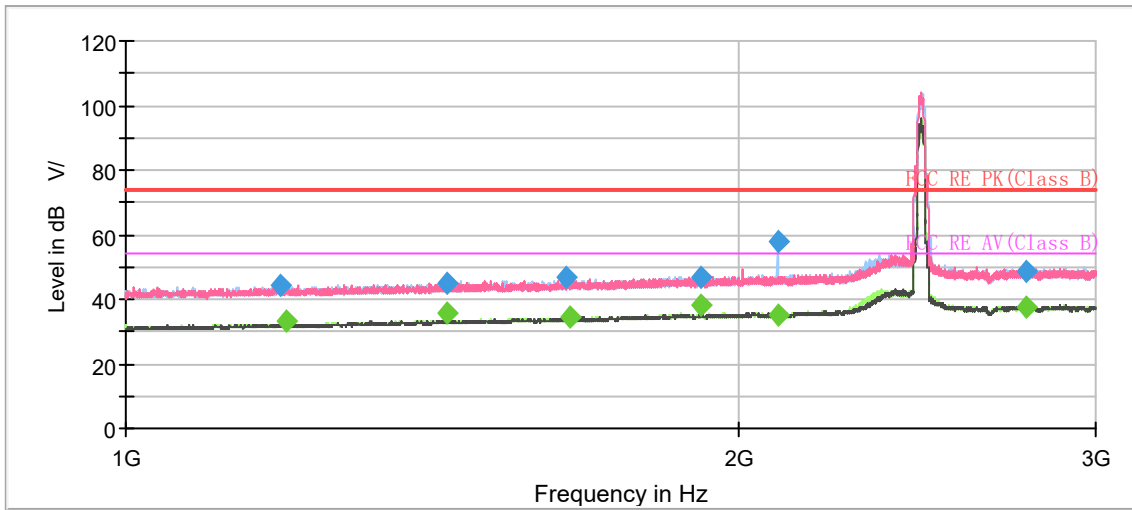

Note: The signal beyond the limit is carrier.
Radiates Emission from 1GHz to 3GHz

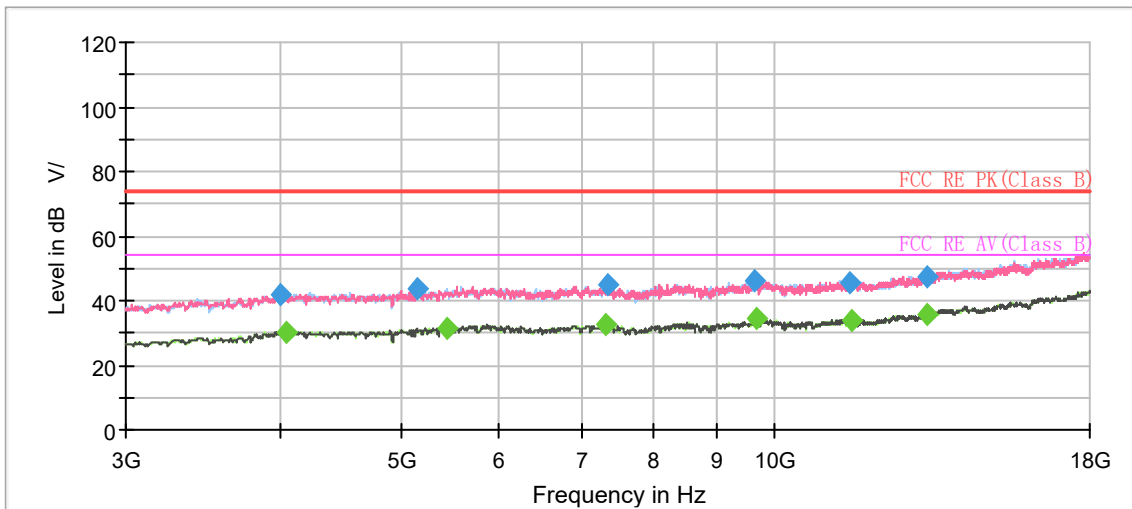

Radiates Emission from 3GHz to 18GHz

Frequency (MHz)	MaxPeak (dB μ V/m)	Average (dB μ V/m)	Limit (dB μ V/m)	Margin (dB)	Meas. Time (ms)	Height (cm)	PoI	Azimuth (deg)	Corr. (dB/m)
1190.500000	44.29	---	74.00	29.71	500.0	200.0	H	33.0	-7.8
1200.000000	---	33.10	54.00	20.90	500.0	100.0	V	112.0	-7.7
1440.000000	---	35.52	54.00	18.48	500.0	100.0	V	186.0	-6.2
1440.000000	45.01	---	74.00	28.99	500.0	100.0	V	186.0	-6.2
1646.250000	46.71	---	74.00	27.29	500.0	100.0	H	0.0	-5.2
1655.250000	---	34.54	54.00	19.46	500.0	100.0	H	337.0	-5.1
1920.000000	47.04	---	74.00	26.96	500.0	200.0	V	160.0	-3.9
1920.250000	---	38.31	54.00	15.69	500.0	100.0	V	104.0	-3.9
2092.000000	57.59	---	74.00	16.41	500.0	100.0	H	44.0	-3.0
2095.000000	---	35.09	54.00	18.91	500.0	200.0	H	160.0	-3.0
2770.250000	48.53	---	74.00	25.47	500.0	200.0	V	60.0	0.0
2773.500000	---	37.31	54.00	16.69	500.0	200.0	H	51.0	0.0

Remark: 1. Correction Factor = Antenna factor + Insertion loss (cable loss + amplifier gain)

2. Margin = Limit - MAX Peak/ Average

802.11n (HT20) CH1

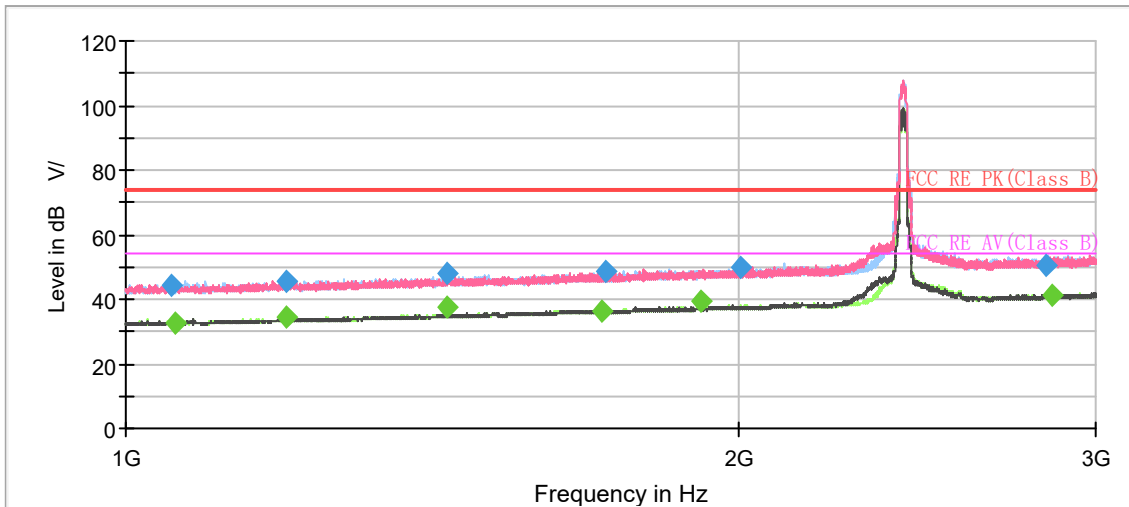

Note: The signal beyond the limit is carrier.
Radiates Emission from 1GHz to 3GHz

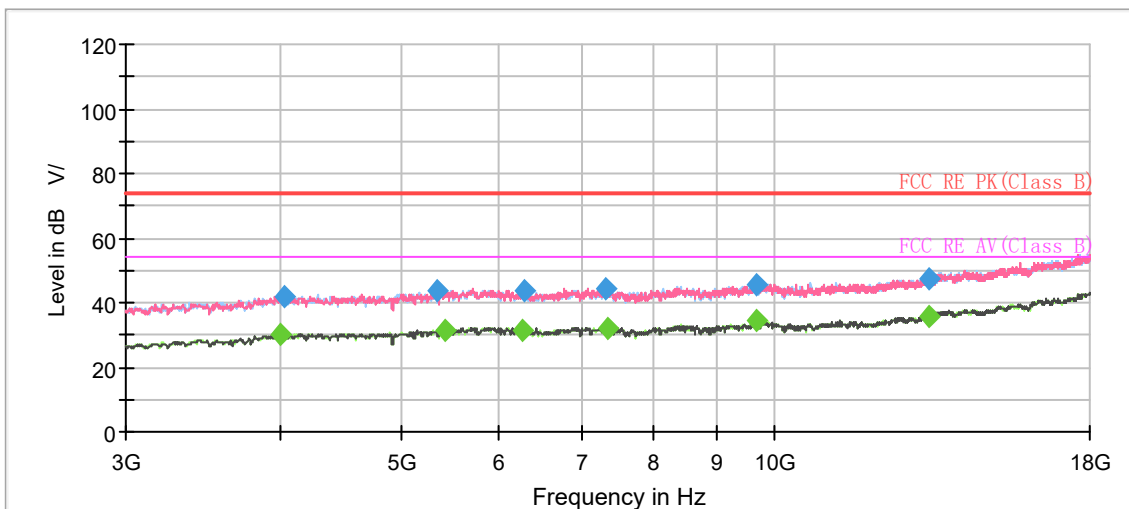

Radiates Emission from 3GHz to 18GHz

Frequency (MHz)	MaxPeak (dB μ V/m)	Average (dB μ V/m)	Limit (dB μ V/m)	Margin (dB)	Meas. Time (ms)	Height (cm)	Pol	Azimuth (deg)	Corr. (dB/m)
1052.500000	44.08	---	74.00	29.92	500.0	100.0	H	172.0	-8.7
1057.000000	---	32.86	54.00	21.14	500.0	200.0	H	44.0	-8.7
1200.000000	45.45	---	74.00	28.55	500.0	100.0	H	232.0	-7.7
1200.250000	---	34.27	54.00	19.73	500.0	200.0	H	99.0	-7.7
1439.750000	47.86	---	74.00	26.14	500.0	100.0	V	173.0	-6.2
1440.000000	---	37.57	54.00	16.43	500.0	100.0	H	227.0	-6.2
1714.000000	---	36.48	54.00	17.52	500.0	200.0	H	76.0	-4.9
1721.250000	48.55	---	74.00	25.45	500.0	100.0	H	285.0	-4.8
1920.000000	---	39.20	54.00	14.80	500.0	200.0	V	208.0	-3.9
2006.500000	49.72	---	74.00	24.28	500.0	100.0	V	29.0	-3.4
2837.250000	50.16	---	74.00	23.84	500.0	200.0	H	218.0	0.1
2858.000000	---	41.05	54.00	12.95	500.0	200.0	H	89.0	0.2

Remark: 1. Correction Factor = Antenna factor + Insertion loss (cable loss + amplifier gain)

2. Margin = Limit –MAX Peak/ Average

802.11n (HT20) CH6

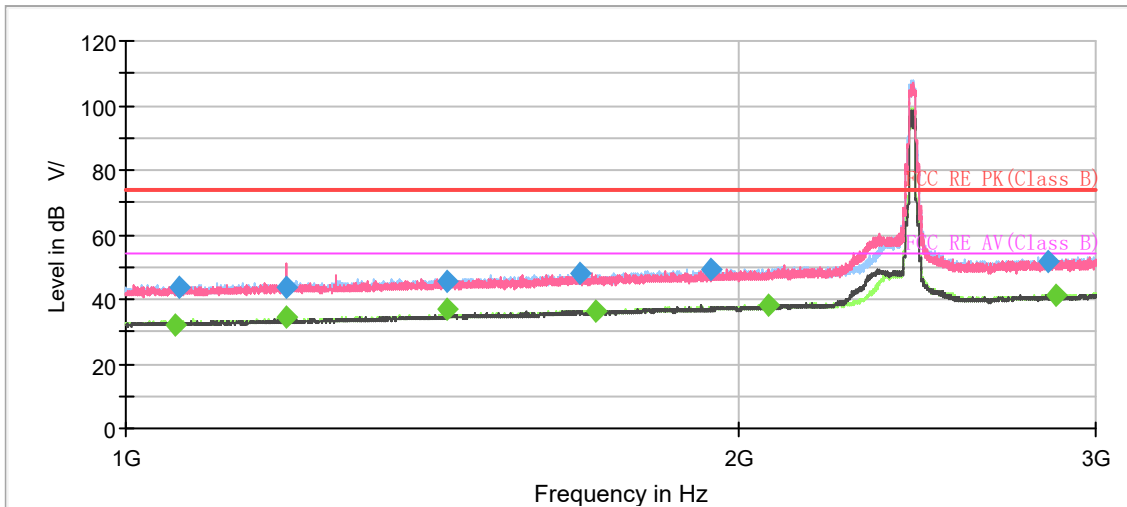

Note: The signal beyond the limit is carrier.
Radiates Emission from 1GHz to 3GHz

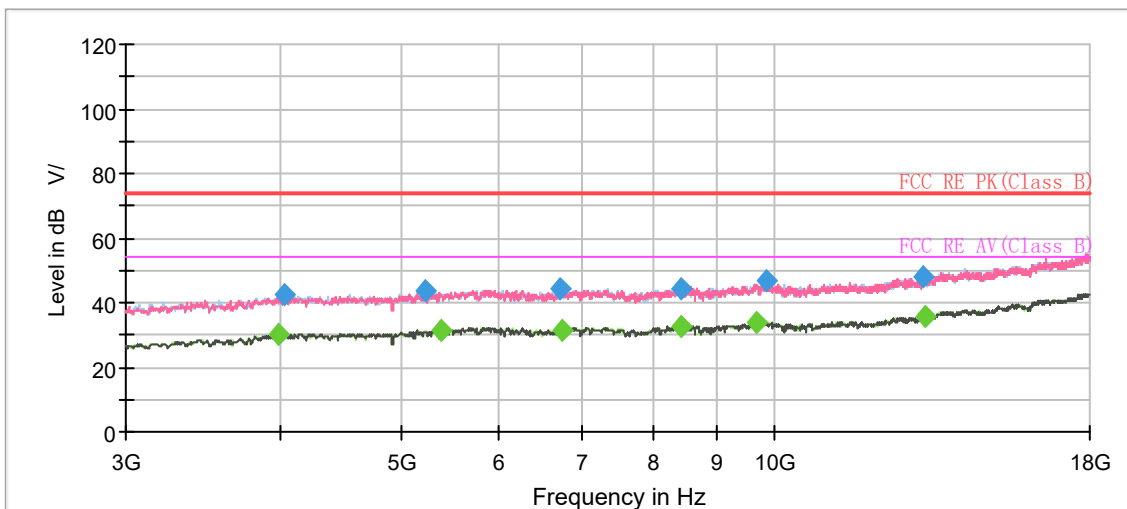

Radiates Emission from 3GHz to 18GHz

Frequency (MHz)	MaxPeak (dB μ V/m)	Average (dB μ V/m)	Limit (dB μ V/m)	Margin (dB)	Meas. Time (ms)	Height (cm)	Pol	Azimuth (deg)	Corr. (dB/m)
1058.500000	---	32.30	54.00	21.70	500.0	200.0	H	86.0	-8.7
1063.500000	43.82	---	74.00	30.18	500.0	200.0	V	305.0	-8.6
1200.000000	---	34.76	54.00	19.24	500.0	200.0	H	109.0	-7.7
1200.500000	43.47	---	74.00	30.53	500.0	200.0	H	40.0	-7.7
1440.000000	---	36.88	54.00	17.12	500.0	100.0	H	126.0	-6.2
1440.000000	45.69	---	74.00	28.31	500.0	100.0	H	126.0	-6.2
1674.500000	48.18	---	74.00	25.82	500.0	200.0	H	1.0	-5.0
1704.750000	---	36.50	54.00	17.50	500.0	200.0	H	68.0	-4.9
1940.250000	49.49	---	74.00	24.51	500.0	200.0	V	357.0	-3.7
2072.500000	---	38.37	54.00	15.63	500.0	200.0	V	0.0	-3.1
2839.500000	51.68	---	74.00	22.32	500.0	200.0	V	0.0	0.1
2871.250000	---	41.02	54.00	12.98	500.0	200.0	H	178.0	0.2

Remark: 1. Correction Factor = Antenna factor + Insertion loss (cable loss + amplifier gain)

2. Margin = Limit –MAX Peak/ Average

802.11n (HT20) CH11

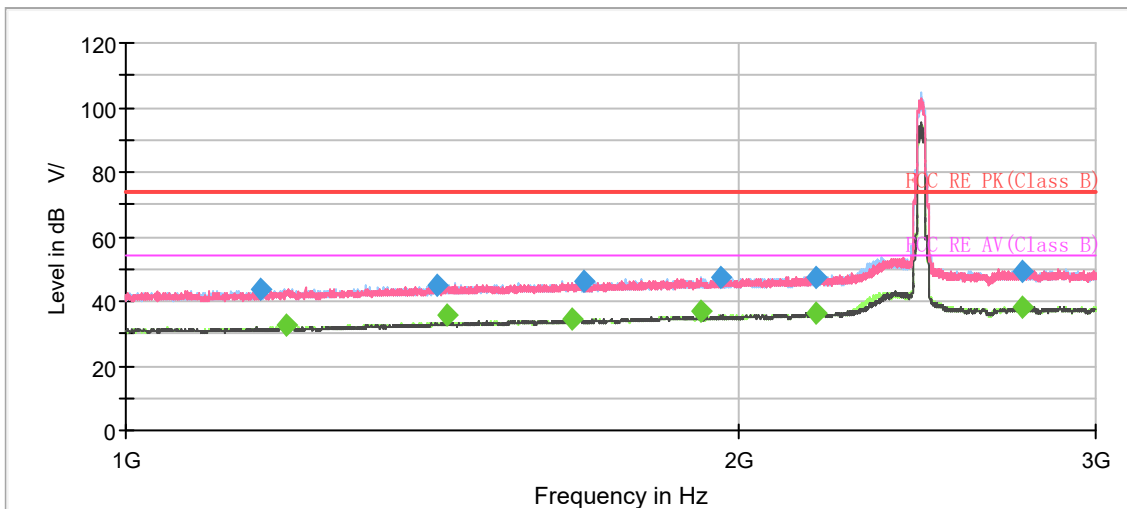

Note: The signal beyond the limit is carrier.
Radiates Emission from 1GHz to 3GHz

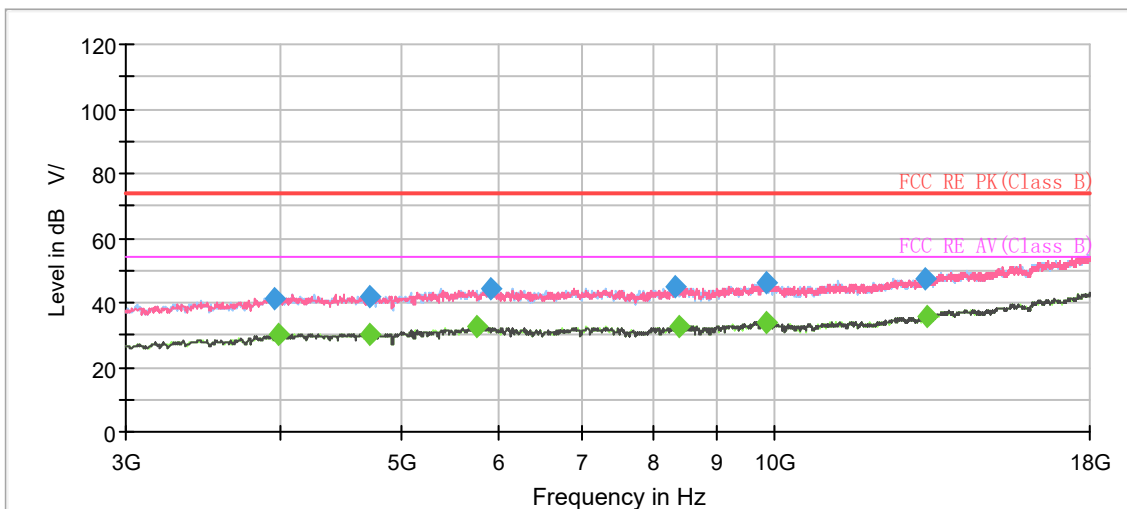

Radiates Emission from 3GHz to 18GHz

Frequency (MHz)	MaxPeak (dB μ V/m)	Average (dB μ V/m)	Limit (dB μ V/m)	Margin (dB)	Meas. Time (ms)	Height (cm)	Pol	Azimuth (deg)	Corr. (dB/m)
1165.500000	43.58	---	74.00	30.42	500.0	100.0	H	184.0	-8.0
1200.250000	---	32.91	54.00	21.09	500.0	100.0	V	116.0	-7.7
1422.000000	45.05	---	74.00	28.95	500.0	100.0	H	0.0	-6.3
1440.250000	---	35.63	54.00	18.37	500.0	100.0	V	170.0	-6.2
1656.000000	---	34.54	54.00	19.46	500.0	200.0	V	200.0	-5.1
1680.000000	46.45	---	74.00	27.55	500.0	100.0	V	5.0	-5.0
1920.250000	---	36.84	54.00	17.16	500.0	100.0	V	93.0	-3.9
1963.250000	47.46	---	74.00	26.54	500.0	200.0	H	105.0	-3.6
2184.000000	47.57	---	74.00	26.43	500.0	100.0	V	13.0	-2.7
2184.250000	---	36.03	54.00	17.97	500.0	200.0	H	237.0	-2.7
2758.250000	49.26	---	74.00	24.74	500.0	100.0	H	354.0	-0.1
2761.000000	---	37.95	54.00	16.05	500.0	100.0	H	89.0	-0.1

Remark: 1. Correction Factor = Antenna factor + Insertion loss (cable loss + amplifier gain)

2. Margin = Limit –MAX Peak/ Average

802.11n (HT40) CH3

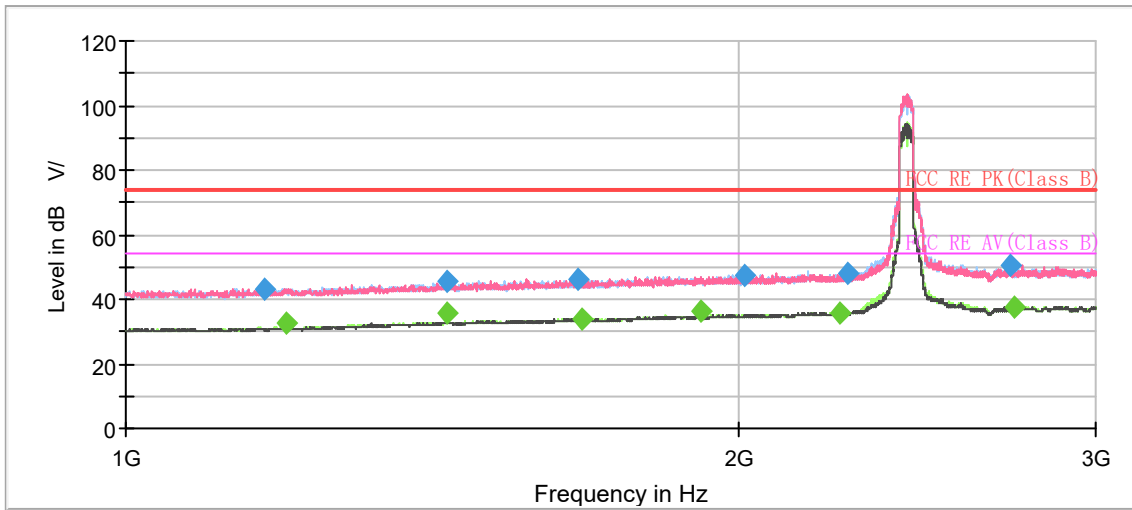

Note: The signal beyond the limit is carrier.
Radiates Emission from 1GHz to 3GHz

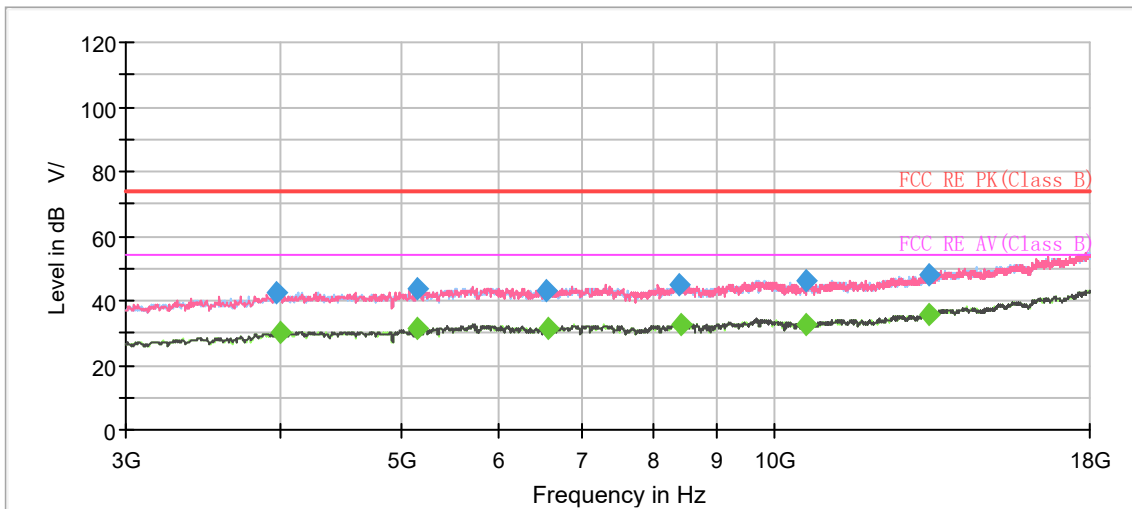

Radiates Emission from 3GHz to 18GHz

Frequency (MHz)	MaxPeak (dB μ V/m)	Average (dB μ V/m)	Limit (dB μ V/m)	Margin (dB)	Meas. Time (ms)	Height (cm)	Pol	Azimuth (deg)	Corr. (dB/m)
1170.000000	43.26	---	74.00	30.74	500.0	100.0	V	0.0	-7.9
1200.000000	---	32.90	54.00	21.10	500.0	100.0	V	73.0	-7.7
1440.000000	---	35.47	54.00	18.53	500.0	100.0	V	141.0	-6.2
1440.000000	45.71	---	74.00	28.29	500.0	100.0	V	141.0	-6.2
1670.500000	46.19	---	74.00	27.81	500.0	200.0	H	11.0	-5.1
1678.000000	---	33.95	54.00	20.05	500.0	100.0	H	118.0	-5.0
1920.000000	---	36.30	54.00	17.70	500.0	100.0	V	141.0	-3.9
2015.500000	47.40	---	74.00	26.60	500.0	100.0	H	49.0	-3.4
2244.000000	---	35.51	54.00	18.49	500.0	200.0	H	165.0	-2.4
2264.500000	47.73	---	74.00	26.27	500.0	200.0	H	285.0	-2.3
2722.000000	50.25	---	74.00	23.75	500.0	100.0	H	7.0	-0.1
2734.000000	---	37.26	54.00	16.74	500.0	200.0	H	108.0	-0.1

Remark: 1. Correction Factor = Antenna factor + Insertion loss (cable loss + amplifier gain)

2. Margin = Limit –MAX Peak/ Average

802.11n (HT40) CH6

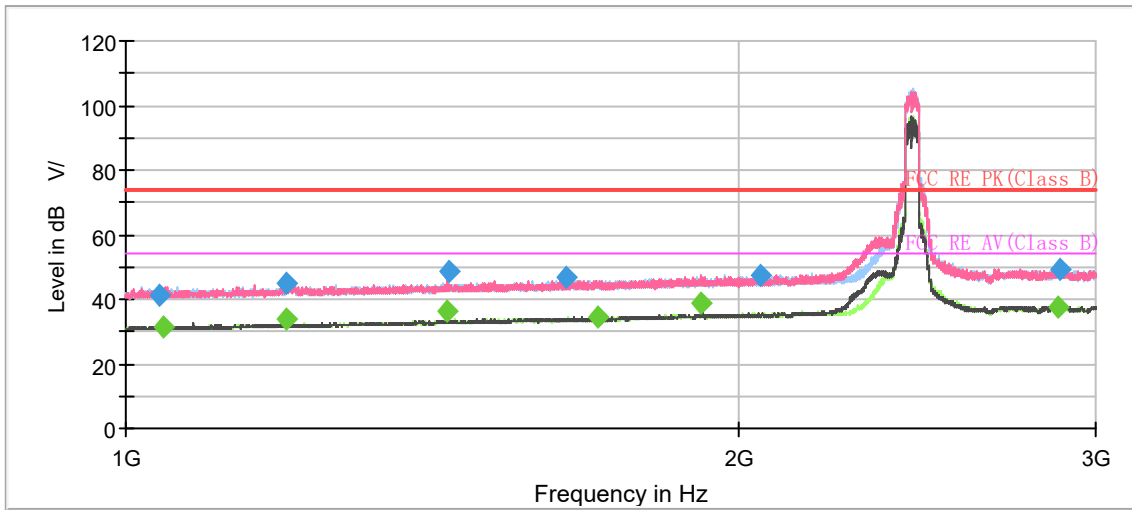

Note: The signal beyond the limit is carrier.
Radiates Emission from 1GHz to 3GHz

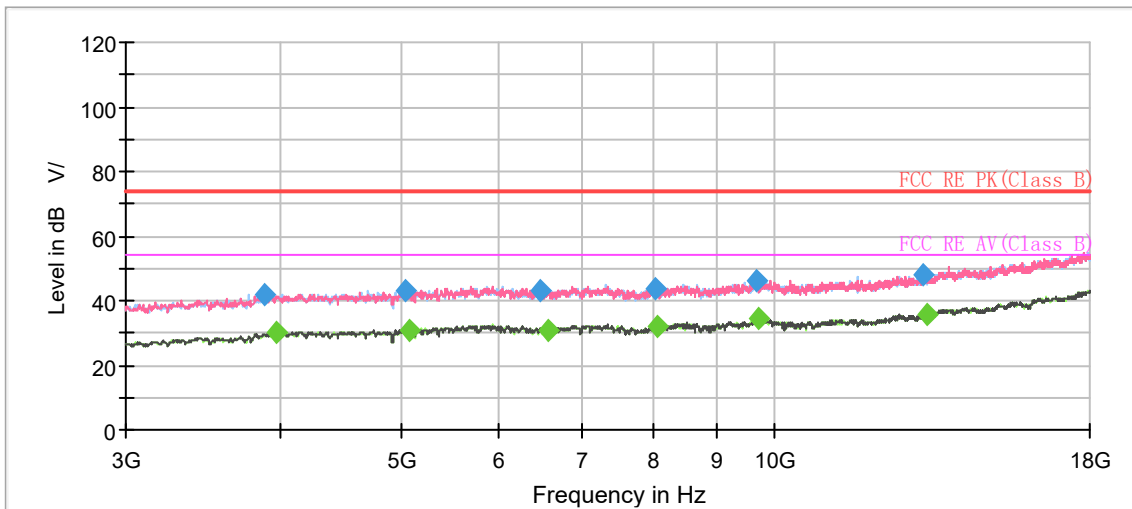

Radiates Emission from 3GHz to 18GHz

Frequency (MHz)	MaxPeak (dB μ V/m)	Average (dB μ V/m)	Limit (dB μ V/m)	Margin (dB)	Meas. Time (ms)	Height (cm)	Pol	Azimuth (deg)	Corr. (dB/m)
1040.000000	41.09	---	74.00	32.91	500.0	100.0	H	140.0	-8.8
1044.000000	---	31.37	54.00	22.63	500.0	100.0	V	335.0	-8.8
1198.750000	44.64	---	74.00	29.36	500.0	200.0	H	9.0	-7.7
1200.250000	---	33.87	54.00	20.13	500.0	200.0	H	101.0	-7.7
1440.250000	---	36.53	54.00	17.47	500.0	100.0	H	136.0	-6.2
1441.000000	48.52	---	74.00	25.48	500.0	200.0	H	146.0	-6.2
1648.500000	46.94	---	74.00	27.06	500.0	100.0	V	34.0	-5.2
1706.500000	---	34.28	54.00	19.72	500.0	200.0	H	239.0	-4.9
1920.250000	---	38.84	54.00	15.16	500.0	200.0	V	154.0	-3.9
2050.500000	47.46	---	74.00	26.54	500.0	200.0	H	159.0	-3.2
2874.250000	---	37.42	54.00	16.58	500.0	200.0	H	114.0	0.2
2880.000000	49.11	---	74.00	24.89	500.0	200.0	H	0.0	0.2

Remark: 1. Correction Factor = Antenna factor + Insertion loss (cable loss + amplifier gain)

2. Margin = Limit - MAX Peak/ Average

802.11n (HT40) CH9

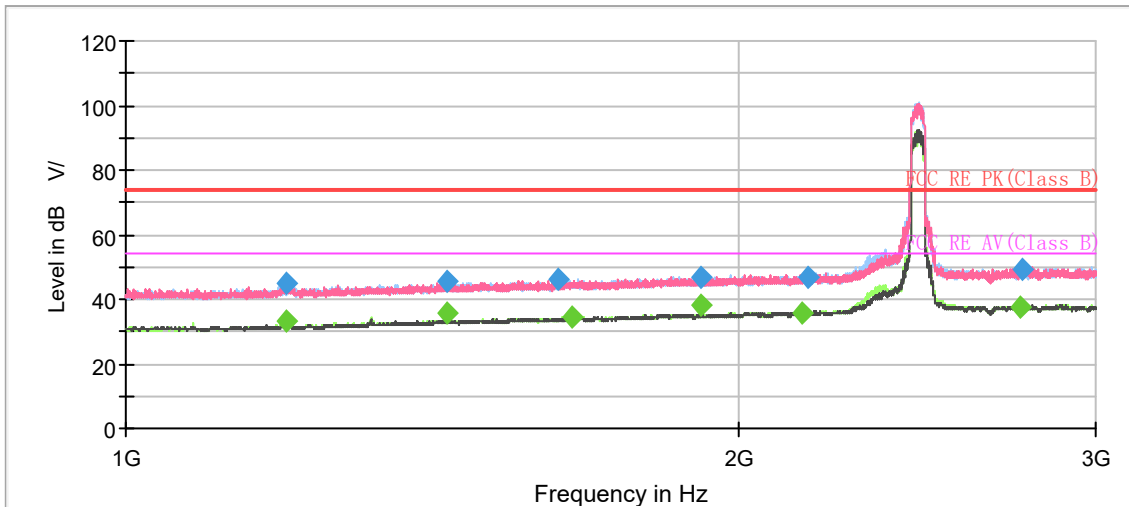

Note: The signal beyond the limit is carrier.
Radiates Emission from 1GHz to 3GHz

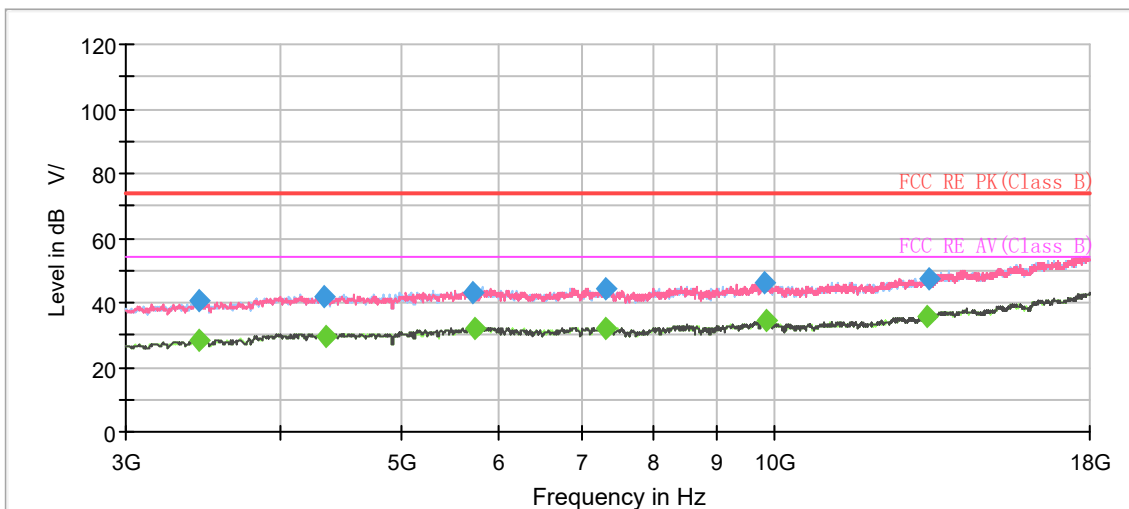

Radiates Emission from 3GHz to 18GHz

Frequency (MHz)	MaxPeak (dB μ V/m)	Average (dB μ V/m)	Limit (dB μ V/m)	Margin (dB)	Meas. Time (ms)	Height (cm)	Pol	Azimuth (deg)	Corr. (dB/m)
1199.750000	---	33.21	54.00	20.79	500.0	100.0	V	212.0	-7.7
1200.250000	44.71	---	74.00	29.29	500.0	100.0	H	47.0	-7.7
1440.000000	---	35.78	54.00	18.22	500.0	100.0	V	12.0	-6.2
1440.250000	45.39	---	74.00	28.61	500.0	100.0	H	75.0	-6.2
1630.250000	46.45	---	74.00	27.55	500.0	100.0	H	242.0	-5.3
1656.500000	---	34.39	54.00	19.61	500.0	200.0	V	252.0	-5.1
1920.000000	47.04	---	74.00	26.96	500.0	100.0	H	173.0	-3.9
1920.250000	---	38.17	54.00	15.83	500.0	100.0	V	166.0	-3.9
2152.750000	---	35.84	54.00	18.16	500.0	100.0	H	292.0	-2.8
2166.000000	47.02	---	74.00	26.98	500.0	200.0	V	175.0	-2.7
2755.750000	---	37.65	54.00	16.35	500.0	200.0	H	102.0	-0.1
2761.500000	49.03	---	74.00	24.97	500.0	100.0	H	178.0	-0.1

Remark: 1. Correction Factor = Antenna factor + Insertion loss (cable loss + amplifier gain)

2. Margin = Limit –MAX Peak/ Average

802.11ax HE20 CH 1

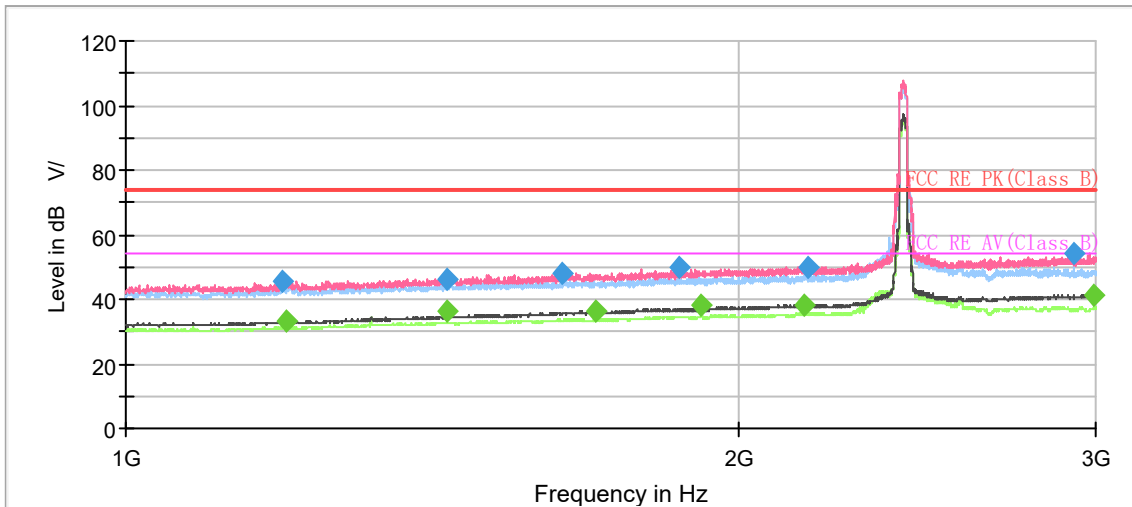

Note: The signal beyond the limit is carrier.
Radiates Emission from 1GHz to 3GHz

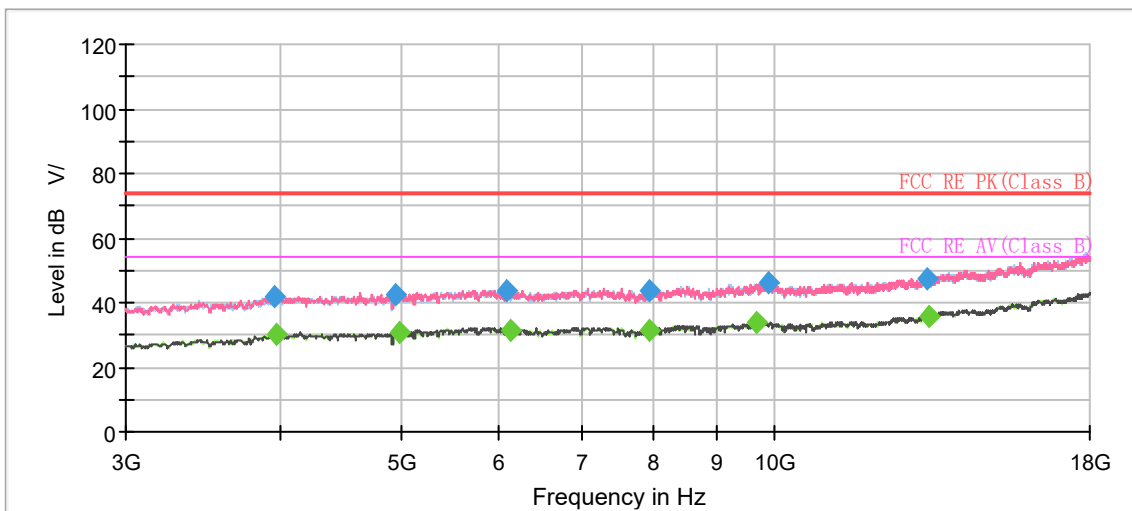

Radiates Emission from 3GHz to 18GHz

Frequency (MHz)	MaxPeak (dB μ V/m)	Average (dB μ V/m)	Limit (dB μ V/m)	Margin (dB)	Meas. Time (ms)	Height (cm)	Pol	Azimuth (deg)	Corr. (dB/m)
1195.000000	45.37	---	74.00	28.63	500.0	200.0	V	113.0	-7.8
1200.000000	---	33.17	54.00	20.83	500.0	100.0	V	212.0	-7.7
1440.000000	---	36.28	54.00	17.72	500.0	200.0	V	0.0	-6.2
1440.000000	46.34	---	74.00	27.66	500.0	200.0	V	0.0	-6.2
1641.000000	48.21	---	74.00	25.79	500.0	200.0	V	89.0	-5.2
1705.000000	---	36.35	54.00	17.65	500.0	200.0	V	146.0	-4.9
1871.000000	49.95	---	74.00	24.05	500.0	200.0	V	196.0	-4.0
1920.000000	---	38.21	54.00	15.79	500.0	100.0	V	159.0	-3.9
2157.000000	---	38.28	54.00	15.72	500.0	200.0	V	47.0	-2.8
2168.000000	49.91	---	74.00	24.09	500.0	200.0	V	167.0	-2.7
2929.000000	54.45	---	74.00	19.55	500.0	100.0	H	145.0	0.3
2995.000000	---	41.51	54.00	12.49	500.0	200.0	V	205.0	0.5

Remark: 1. Correction Factor = Antenna factor + Insertion loss (cable loss + amplifier gain)

2. Margin = Limit –MAX Peak/ Average

802.11ax HE20 CH 6

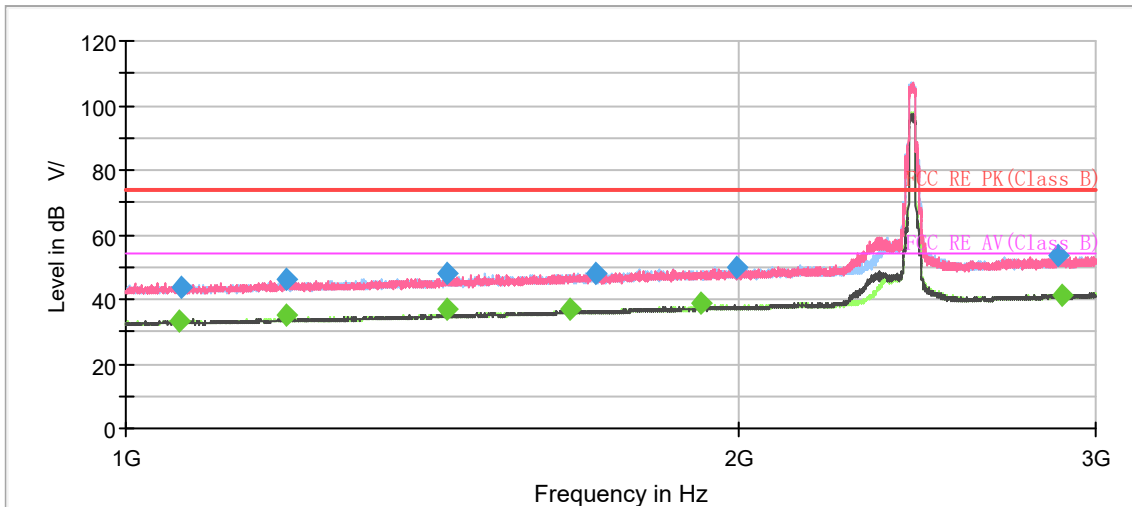

Note: The signal beyond the limit is carrier.
Radiates Emission from 1GHz to 3GHz

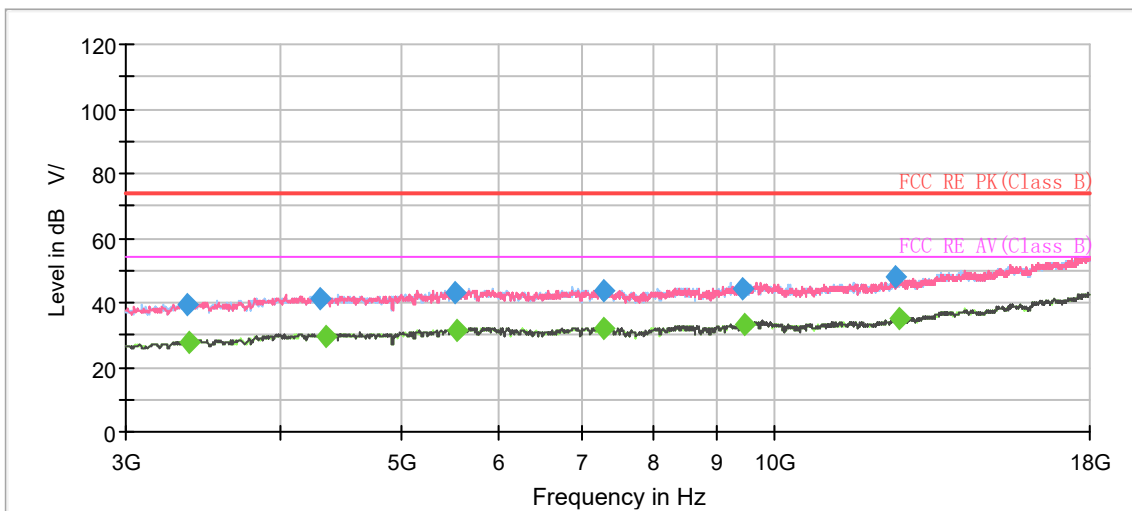

Radiates Emission from 3GHz to 18GHz

Frequency (MHz)	MaxPeak (dB μ V/m)	Average (dB μ V/m)	Limit (dB μ V/m)	Margin (dB)	Meas. Time (ms)	Height (cm)	Pol	Azimuth (deg)	Corr. (dB/m)
1062.500000	---	32.96	54.00	21.04	500.0	200.0	V	266.0	-8.7
1064.000000	43.79	---	74.00	30.21	500.0	200.0	H	174.0	-8.6
1199.500000	46.15	---	74.00	27.85	500.0	200.0	H	95.0	-7.7
1200.250000	---	34.79	54.00	19.21	500.0	200.0	H	104.0	-7.7
1439.750000	48.30	---	74.00	25.70	500.0	200.0	H	237.0	-6.2
1440.250000	---	37.06	54.00	16.94	500.0	100.0	V	173.0	-6.2
1653.500000	---	36.62	54.00	17.38	500.0	200.0	H	191.0	-5.2
1704.000000	48.18	---	74.00	25.82	500.0	200.0	H	63.0	-4.9
1920.000000	---	38.47	54.00	15.53	500.0	200.0	V	298.0	-3.9
1999.000000	49.88	---	74.00	24.12	500.0	200.0	H	86.0	-3.4
2873.750000	53.32	---	74.00	20.68	500.0	100.0	H	317.0	0.2
2886.250000	---	41.25	54.00	12.75	500.0	100.0	H	334.0	0.2

Remark: 1. Correction Factor = Antenna factor + Insertion loss (cable loss + amplifier gain)

2. Margin = Limit - MAX Peak/ Average

802.11ax HE20 CH11

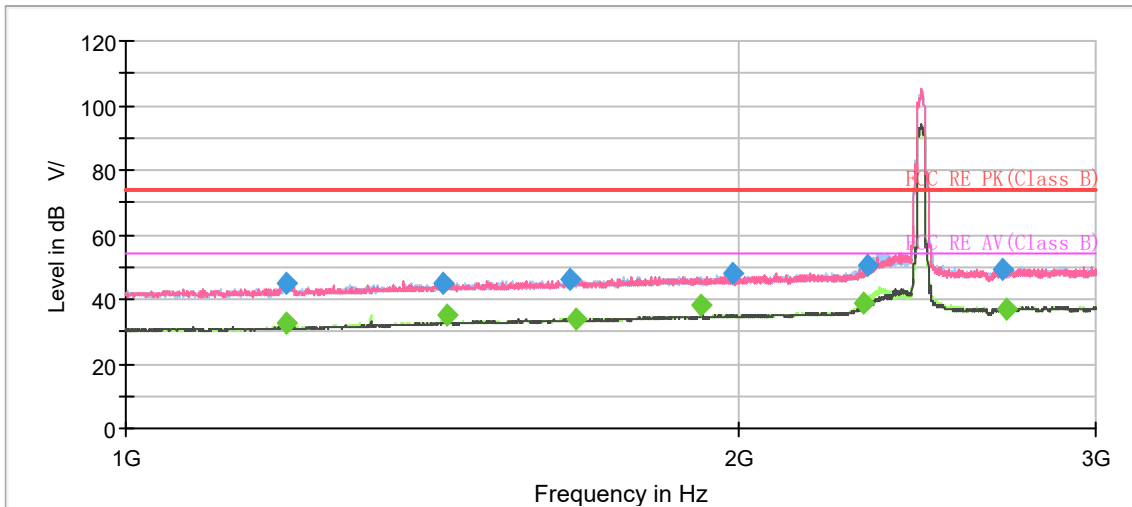

Note: The signal beyond the limit is carrier.
Radiates Emission from 1GHz to 3GHz

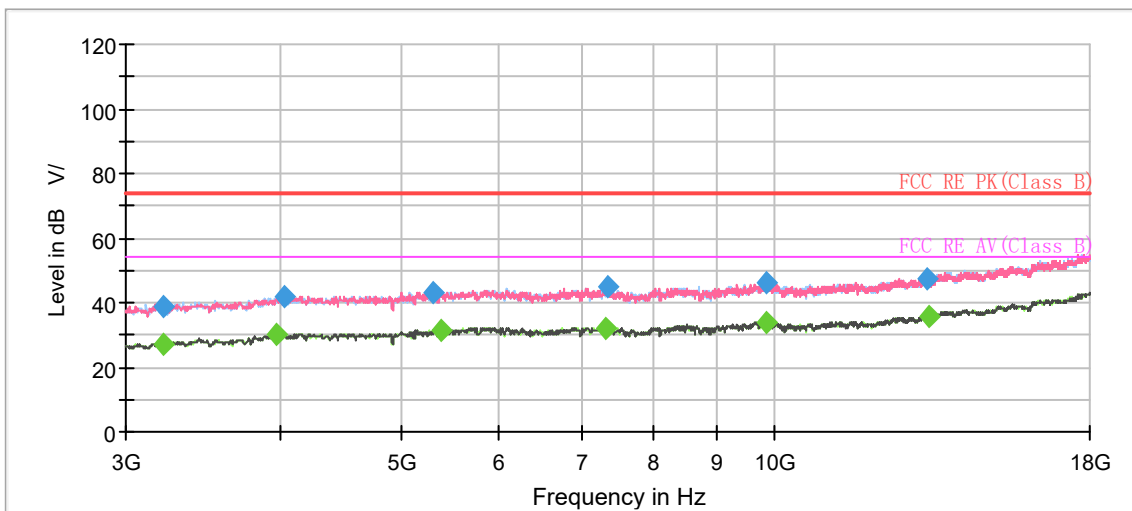

Radiates Emission from 3GHz to 18GHz

Frequency (MHz)	MaxPeak (dB μ V/m)	Average (dB μ V/m)	Limit (dB μ V/m)	Margin (dB)	Meas. Time (ms)	Height (cm)	Pol	Azimuth (deg)	Corr. (dB/m)
1199.500000	44.76	---	74.00	29.24	500.0	100.0	V	244.0	-7.7
1200.000000	---	32.90	54.00	21.10	500.0	100.0	V	211.0	-7.7
1434.000000	44.70	---	74.00	29.30	500.0	200.0	H	289.0	-6.3
1440.000000	---	35.08	54.00	18.92	500.0	100.0	V	269.0	-6.2
1654.500000	45.87	---	74.00	28.14	500.0	200.0	V	48.0	-5.2
1667.000000	---	33.96	54.00	20.04	500.0	200.0	H	236.0	-5.1
1920.000000	---	38.03	54.00	15.97	500.0	100.0	V	161.0	-3.9
1987.000000	47.70	---	74.00	26.30	500.0	100.0	V	0.0	-3.5
2306.000000	---	38.78	54.00	15.22	500.0	200.0	H	273.0	-2.2
2316.000000	50.67	---	74.00	23.33	500.0	200.0	H	277.0	-2.1
2698.500000	49.49	---	74.00	24.51	500.0	200.0	V	26.0	-0.1
2712.000000	---	37.06	54.00	16.94	500.0	200.0	H	318.0	-0.1

Remark: 1. Correction Factor = Antenna factor + Insertion loss (cable loss + amplifier gain)

2. Margin = Limit - MAX Peak/ Average

802.11ax HE40 CH3

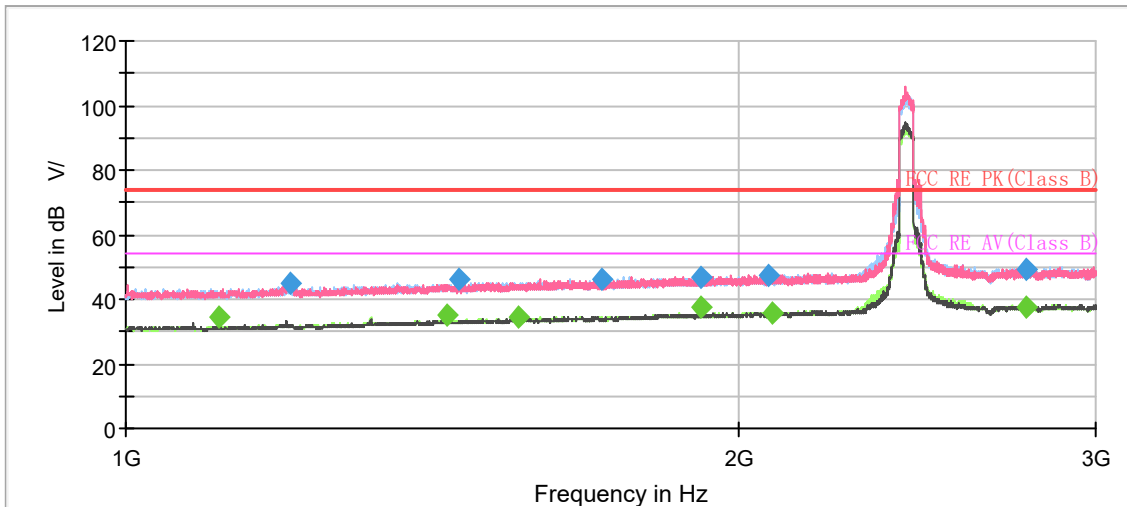

Note: The signal beyond the limit is carrier.
Radiates Emission from 1GHz to 3GHz

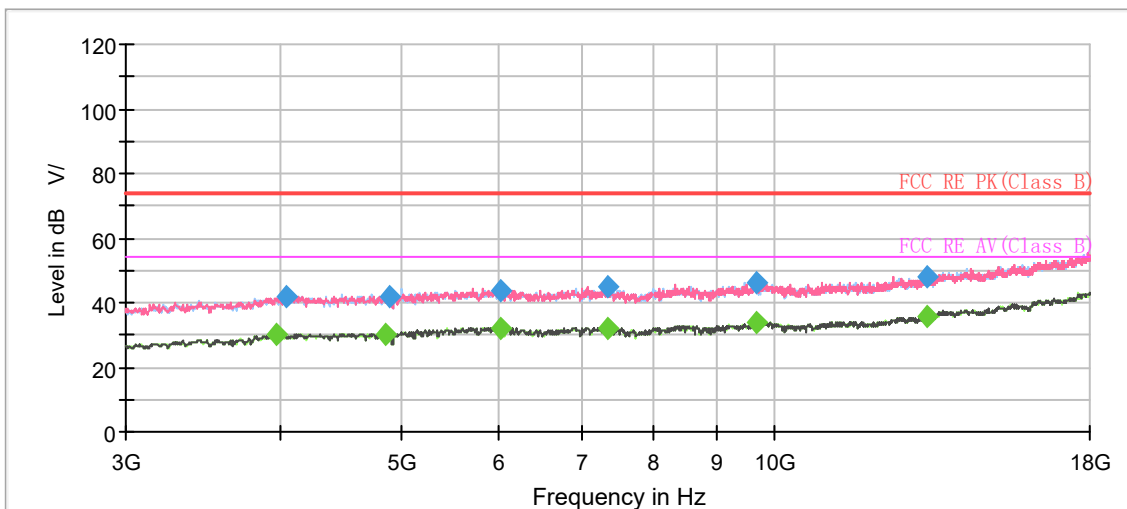

Radiates Emission from 3GHz to 18GHz

Frequency (MHz)	MaxPeak (dB μ V/m)	Average (dB μ V/m)	Limit (dB μ V/m)	Margin (dB)	Meas. Time (ms)	Height (cm)	Pol	Azimuth (deg)	Corr. (dB/m)
1111.500000	---	34.69	54.00	19.31	500.0	100.0	H	319.0	-8.3
1205.250000	44.84	---	74.00	29.16	500.0	100.0	V	55.0	-7.7
1440.000000	---	35.37	54.00	18.63	500.0	100.0	V	252.0	-6.2
1457.250000	46.10	---	74.00	27.90	500.0	100.0	H	268.0	-6.1
1560.250000	---	34.44	54.00	19.56	500.0	100.0	V	252.0	-5.7
1716.500000	46.19	---	74.00	27.81	500.0	200.0	V	5.0	-4.9
1920.000000	46.91	---	74.00	27.09	500.0	100.0	V	193.0	-3.9
1920.250000	---	37.82	54.00	16.18	500.0	100.0	V	336.0	-3.9
2072.000000	47.56	---	74.00	26.44	500.0	200.0	V	106.0	-3.1
2080.750000	---	35.40	54.00	18.60	500.0	200.0	H	165.0	-3.1
2770.500000	---	37.64	54.00	16.36	500.0	200.0	V	92.0	0.0
2771.250000	48.94	---	74.00	25.06	500.0	200.0	H	254.0	0.0

Remark: 1. Correction Factor = Antenna factor + Insertion loss (cable loss + amplifier gain)

2. Margin = Limit –MAX Peak/ Average

802.11ax HE40 CH6

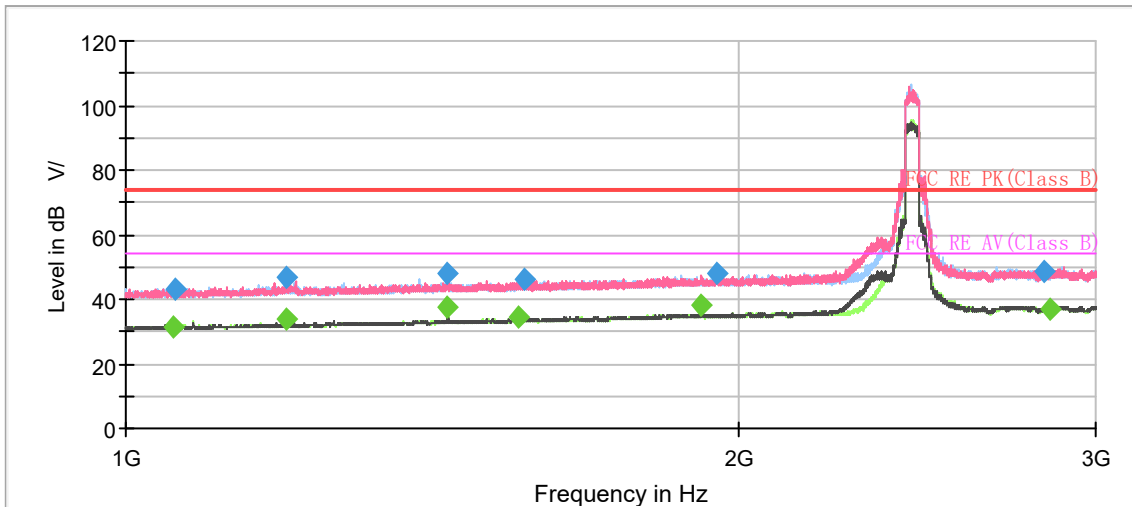

Note: The signal beyond the limit is carrier.
Radiates Emission from 1GHz to 3GHz

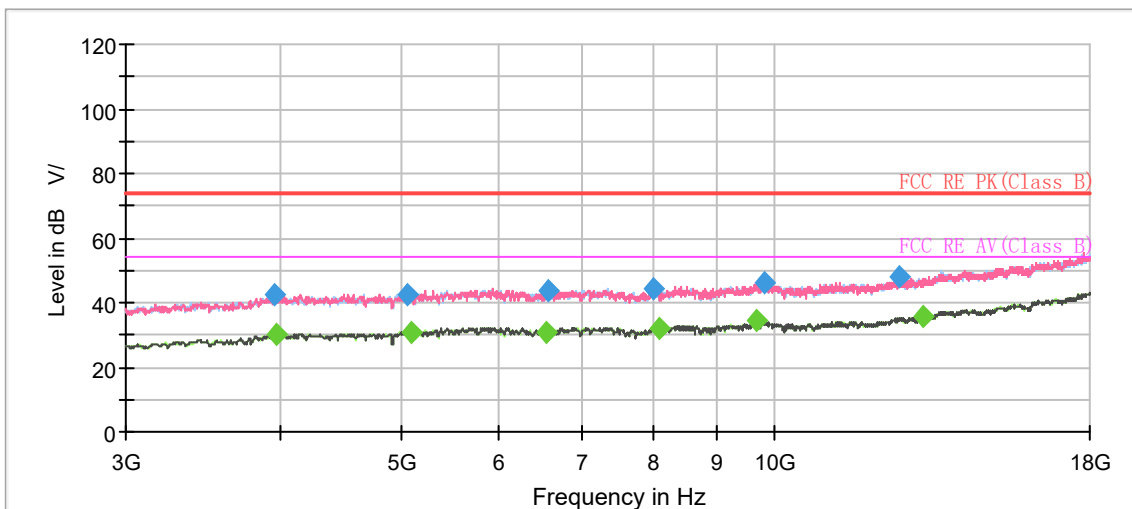

Radiates Emission from 3GHz to 18GHz

Frequency (MHz)	MaxPeak (dB μ V/m)	Average (dB μ V/m)	Limit (dB μ V/m)	Margin (dB)	Meas. Time (ms)	Height (cm)	Pol	Azimuth (deg)	Corr. (dB/m)
1055.750000	---	31.42	54.00	22.58	500.0	200.0	H	49.0	-8.7
1057.000000	43.07	---	74.00	30.93	500.0	200.0	H	81.0	-8.7
1199.500000	46.72	---	74.00	27.28	500.0	100.0	H	329.0	-7.7
1200.000000	---	33.67	54.00	20.33	500.0	200.0	H	105.0	-7.7
1440.000000	---	37.31	54.00	16.69	500.0	100.0	H	128.0	-6.2
1440.250000	48.08	---	74.00	25.92	500.0	100.0	H	132.0	-6.2
1560.000000	---	34.39	54.00	19.61	500.0	100.0	H	109.0	-5.7
1570.750000	46.19	---	74.00	27.81	500.0	200.0	H	175.0	-5.6
1920.000000	---	38.03	54.00	15.97	500.0	100.0	H	109.0	-3.9
1952.750000	47.72	---	74.00	26.28	500.0	200.0	V	327.0	-3.7
2832.500000	48.56	---	74.00	25.44	500.0	200.0	H	17.0	0.1
2850.500000	---	36.76	54.00	17.24	500.0	200.0	V	267.0	0.2

Remark: 1. Correction Factor = Antenna factor + Insertion loss (cable loss + amplifier gain)

2. Margin = Limit –MAX Peak/ Average

802.11ax HE40 CH9

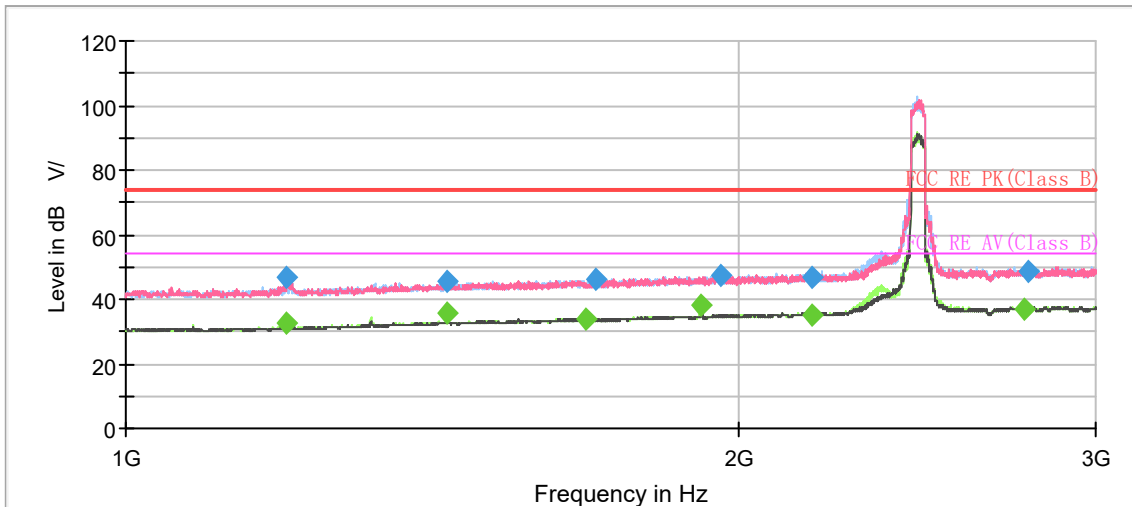

Note: The signal beyond the limit is carrier.
Radiates Emission from 1GHz to 3GHz

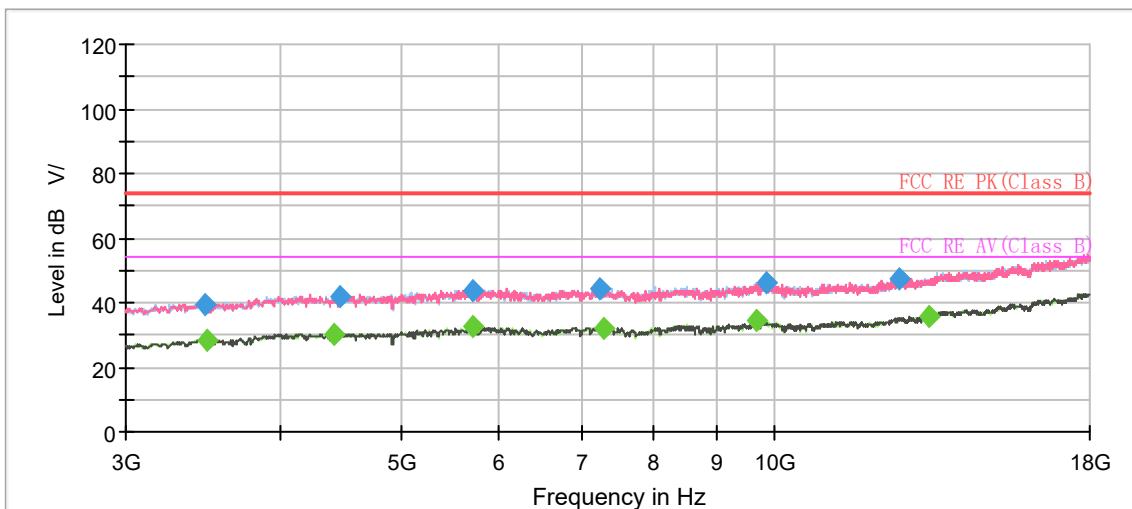

Radiates Emission from 3GHz to 18GHz

Frequency (MHz)	MaxPeak (dB μ V/m)	Average (dB μ V/m)	Limit (dB μ V/m)	Margin (dB)	Meas. Time (ms)	Height (cm)	Pol	Azimuth (deg)	Corr. (dB/m)
1200.000000	---	32.85	54.00	21.15	500.0	100.0	V	208.0	-7.7
1200.500000	46.67	---	74.00	27.33	500.0	100.0	H	77.0	-7.7
1439.000000	45.36	---	74.00	28.64	500.0	100.0	V	356.0	-6.2
1440.000000	---	35.65	54.00	18.35	500.0	200.0	V	0.0	-6.2
1683.000000	---	33.93	54.00	20.07	500.0	200.0	H	349.0	-5.0
1702.500000	45.85	---	74.00	28.15	500.0	200.0	V	21.0	-4.9
1920.000000	---	38.02	54.00	15.98	500.0	100.0	V	166.0	-3.9
1960.500000	47.52	---	74.00	26.48	500.0	100.0	V	322.0	-3.6
2174.000000	---	35.38	54.00	18.62	500.0	200.0	H	309.0	-2.7
2175.500000	47.02	---	74.00	26.98	500.0	200.0	H	189.0	-2.7
2765.500000	---	37.12	54.00	16.88	500.0	200.0	H	272.0	-0.1
2779.500000	48.77	---	74.00	25.23	500.0	200.0	H	193.0	0.0

Remark: 1. Correction Factor = Antenna factor + Insertion loss (cable loss + amplifier gain)

2. Margin = Limit –MAX Peak/ Average

During the test, the Radiates Emission from 18GHz to 26.5GHz was performed in all modes with all channels, 802.11ax HE20, Channel 1 are selected as the worst condition. The test data of the worst-case condition was recorded in this report.

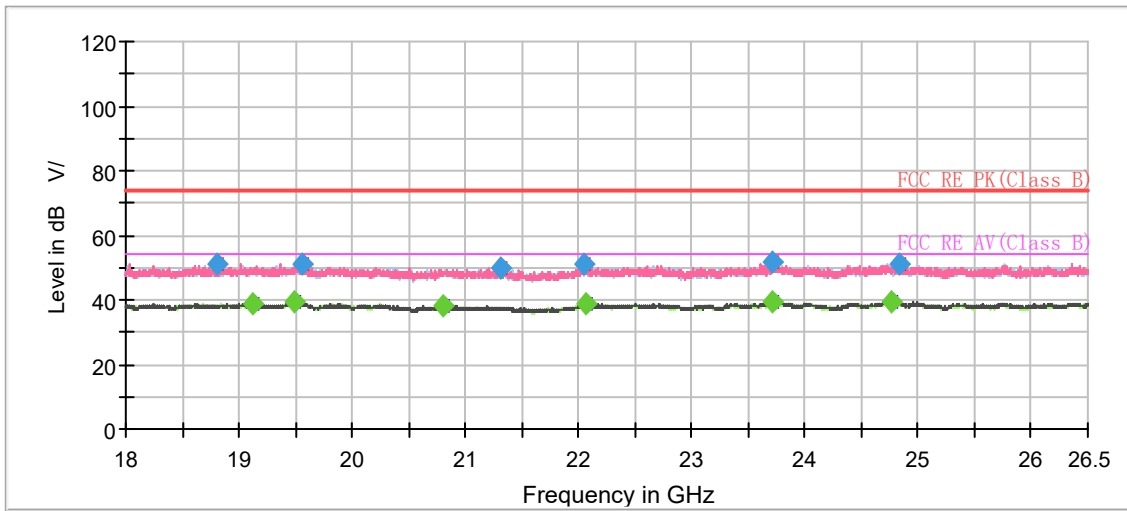

Radiates Emission from 18GHz to 26.5GHz

Frequency (MHz)	MaxPeak (dBμV/m)	Average (dBμV/m)	Limit (dBμV/m)	Margin (dB)	Meas. Time (ms)	Height (cm)	Pol	Azimuth (deg)	Corr. (dB/m)
18810.687500	51.04	---	74.00	22.96	500.0	100.0	V	312.0	-5.5
19118.812500	---	39.04	54.00	14.96	500.0	200.0	V	309.0	-5.7
19490.687500	---	39.15	54.00	14.85	500.0	100.0	V	42.0	-5.3
19561.875000	51.02	---	74.00	22.98	500.0	200.0	V	333.0	-5.3
20806.062500	---	38.44	54.00	15.56	500.0	100.0	V	37.0	-5.1
21319.250000	49.79	---	74.00	24.21	500.0	100.0	V	281.0	-5.2
22050.250000	51.27	---	74.00	22.73	500.0	100.0	V	153.0	-4.2
22073.625000	---	38.82	54.00	15.18	500.0	100.0	V	46.0	-4.2
23721.562500	51.51	---	74.00	22.49	500.0	200.0	V	319.0	-2.4
23721.562500	---	39.08	54.00	14.92	500.0	100.0	H	309.0	-2.4
24769.187500	---	39.09	54.00	14.91	500.0	100.0	V	23.0	-2.2
24826.562500	51.04	---	74.00	22.96	500.0	100.0	V	70.0	-2.2

Remark: 1. Correction Factor = Antenna factor + Insertion loss (cable loss + amplifier gain)

2. Margin = Limit –MAX Peak/ Average

TB Mode

During the test, the Radiates Emission from 30MHz to 1GHz was performed in all modes with all channels, 802.11ax HE20 52-Tone, Channel 1 are selected as the worst condition. The test data of the worst-case condition was recorded in this report.

A symbol ($\text{dB } \mu\text{V/m}$) in the test plot below means ($\text{dB}\mu\text{V/m}$)

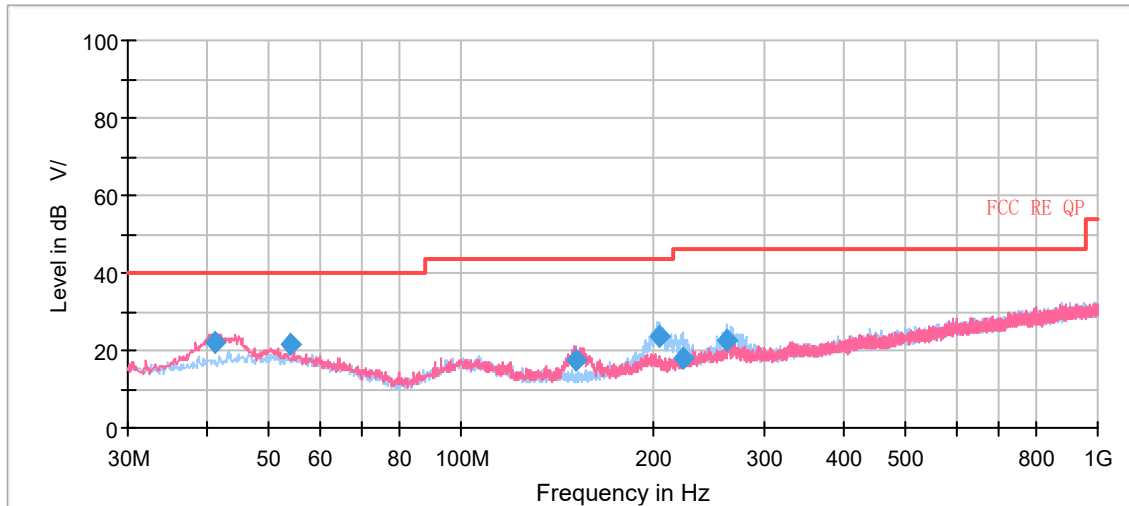

Radiates Emission from 30MHz to 1GHz

Frequency (MHz)	Quasi-Peak ($\text{dB}\mu\text{V/m}$)	Limit ($\text{dB}\mu\text{V/m}$)	Margin (dB)	Height (cm)	Polarization	Azimuth (deg)	Correct Factor (dB)
41.036250	21.92	40.00	18.08	100.0	V	3.0	19.7
54.135000	21.40	40.00	18.60	109.0	V	335.0	20.2
151.850000	17.51	43.50	25.99	100.0	V	94.0	14.7
204.311250	23.60	43.50	19.90	125.0	H	177.0	17.8
222.627500	18.14	46.00	27.86	175.0	H	187.0	18.3
262.310000	22.59	46.00	23.41	100.0	H	213.0	19.7

Remark: 1. Correction Factor = Antenna factor + Insertion loss (cable loss + amplifier gain)

2. Margin = Limit – Quasi-Peak

802.11ax HE20 26-Tone CH1

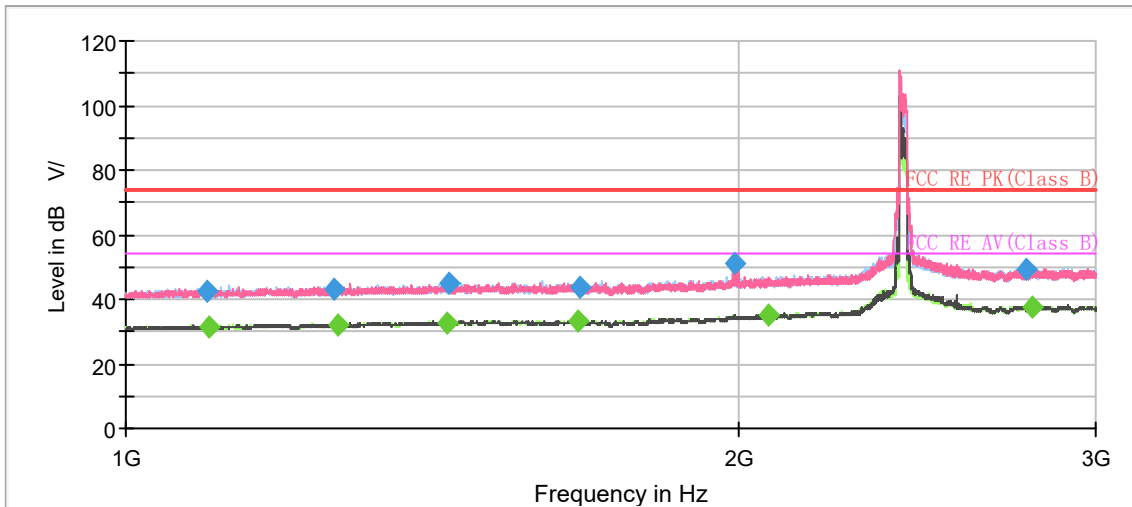

Note: The signal beyond the limit is carrier.
Radiates Emission from 1GHz to 3GHz

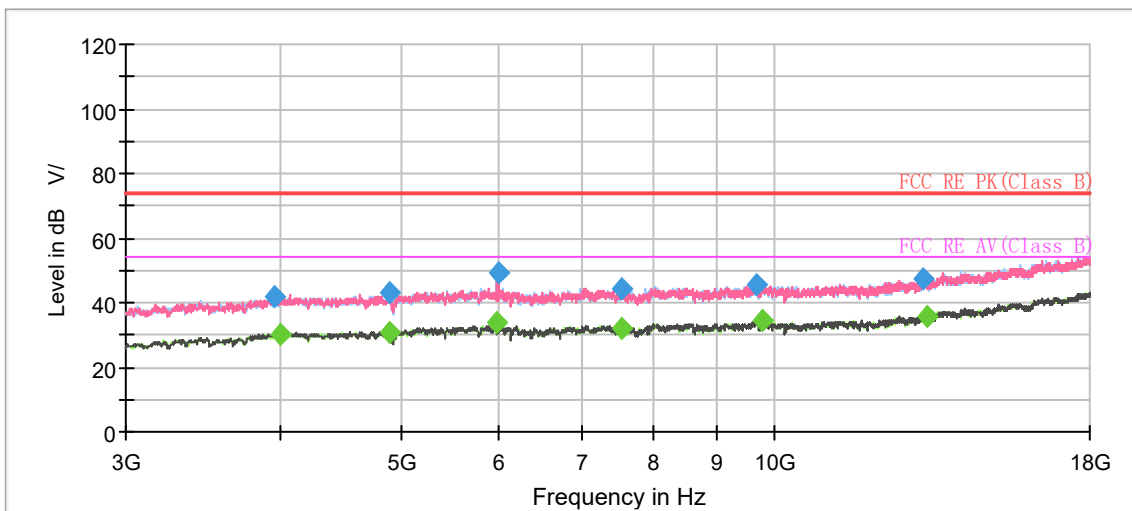

Radiates Emission from 3GHz to 18GHz

Frequency (MHz)	MaxPeak (dB μ V/m)	Average (dB μ V/m)	Limit (dB μ V/m)	Margin (dB)	Meas. Time (ms)	Height (cm)	PoI	Azimuth (deg)	Corr. (dB/m)
1096.000000	42.73	---	74.00	31.27	500.0	100.0	V	244.0	-8.4
1100.000000	---	31.54	54.00	22.46	500.0	100.0	H	264.0	-8.4
1264.750000	43.02	---	74.00	30.98	500.0	100.0	V	194.0	-7.4
1271.250000	---	32.03	54.00	21.97	500.0	200.0	V	269.0	-7.3
1439.750000	---	32.76	54.00	21.24	500.0	100.0	H	58.0	-6.2
1441.000000	44.89	---	74.00	29.11	500.0	100.0	H	71.0	-6.2
1668.250000	---	33.45	54.00	20.55	500.0	100.0	H	161.0	-5.1
1674.250000	43.75	---	74.00	30.25	500.0	200.0	H	296.0	-5.0
1994.000000	51.34	---	74.00	22.66	500.0	200.0	V	165.0	-3.5
2070.000000	---	35.26	54.00	18.74	500.0	200.0	V	197.0	-3.1
2775.000000	49.25	---	74.00	24.75	500.0	200.0	V	138.0	0.0
2793.500000	---	37.34	54.00	16.66	500.0	200.0	H	170.0	0.0

Remark: 1. Correction Factor = Antenna factor + Insertion loss (cable loss + amplifier gain)

2. Margin = Limit -MAX Peak/ Average

802.11ax HE20 52-Tone CH1

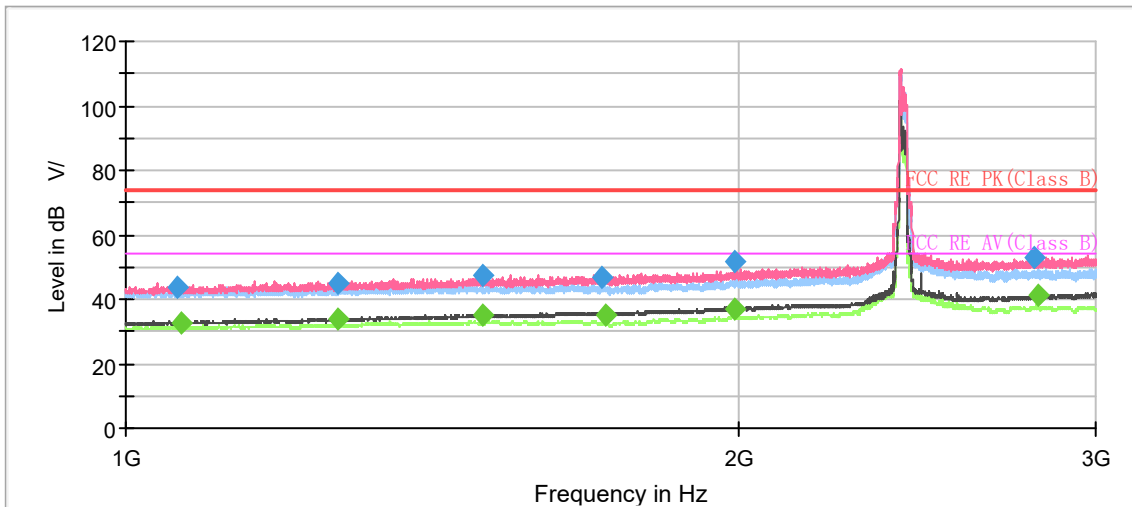

Note: The signal beyond the limit is carrier.
Radiates Emission from 1GHz to 3GHz

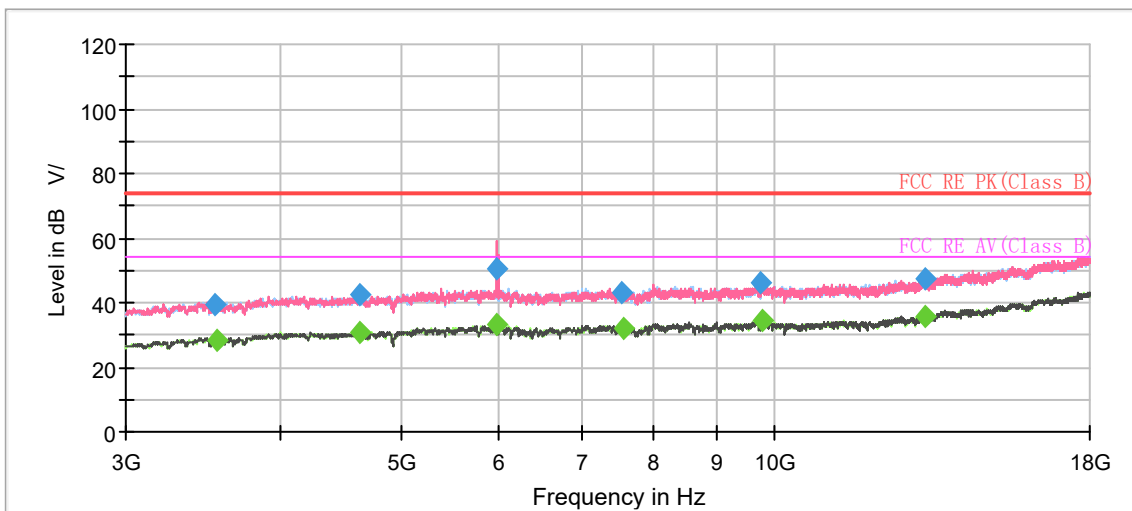

Radiates Emission from 3GHz to 18GHz

Frequency (MHz)	MaxPeak (dB μ V/m)	Average (dB μ V/m)	Limit (dB μ V/m)	Margin (dB)	Meas. Time (ms)	Height (cm)	Pol	Azimuth (deg)	Corr. (dB/m)
1061.000000	43.57	---	74.00	30.43	500.0	200.0	V	287.0	-8.7
1066.000000	---	32.81	54.00	21.19	500.0	200.0	V	225.0	-8.6
1271.250000	---	34.07	54.00	19.93	500.0	200.0	V	134.0	-7.3
1271.750000	44.77	---	74.00	29.23	500.0	200.0	V	148.0	-7.3
1497.250000	---	35.21	54.00	18.79	500.0	200.0	V	188.0	-5.9
1497.500000	47.08	---	74.00	26.92	500.0	200.0	V	349.0	-5.9
1714.000000	47.04	---	74.00	26.96	500.0	200.0	V	143.0	-4.9
1724.250000	---	35.23	54.00	18.77	500.0	200.0	V	120.0	-4.8
1994.250000	51.93	---	74.00	22.07	500.0	100.0	V	2.0	-3.5
1994.250000	---	37.01	54.00	16.99	500.0	200.0	V	279.0	-3.5
2798.750000	53.18	---	74.00	20.82	500.0	200.0	V	57.0	0.0
2808.750000	---	41.14	54.00	12.86	500.0	200.0	V	247.0	0.0

Remark: 1. Correction Factor = Antenna factor + Insertion loss (cable loss + amplifier gain)

2. Margin = Limit –MAX Peak/ Average

802.11ax HE20 106-Tone CH1

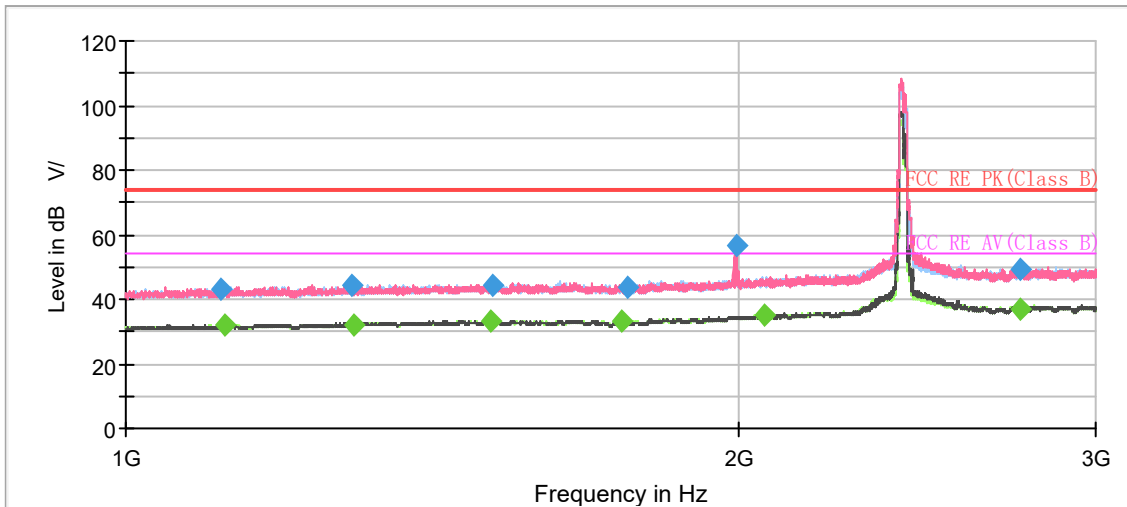

Note: The signal beyond the limit is carrier.
Radiates Emission from 1GHz to 3GHz

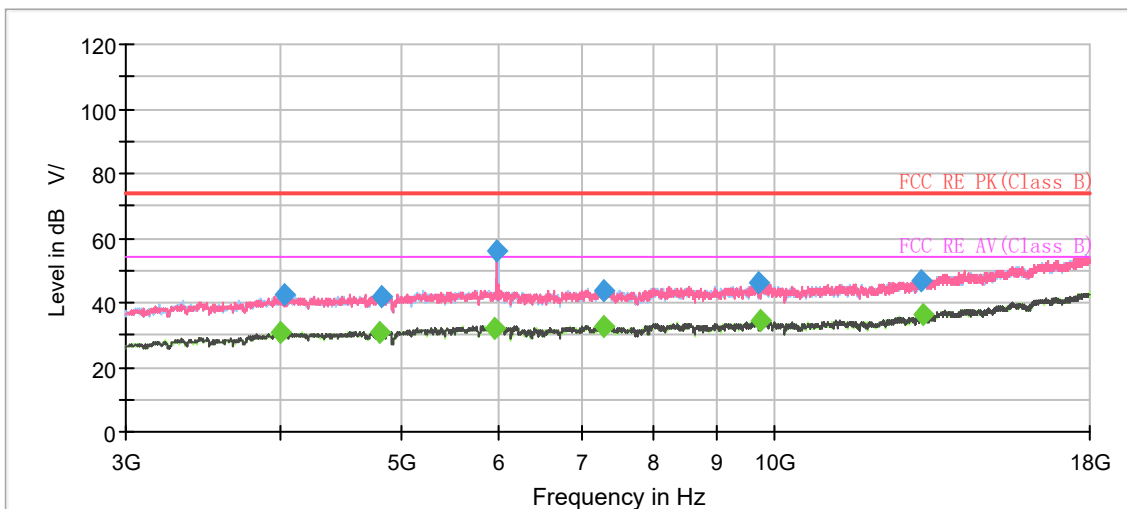

Radiates Emission from 3GHz to 18GHz

Frequency (MHz)	MaxPeak (dB μ V/m)	Average (dB μ V/m)	Limit (dB μ V/m)	Margin (dB)	Meas. Time (ms)	Height (cm)	Pol	Azimuth (deg)	Corr. (dB/m)
1113.750000	43.37	---	74.00	30.63	500.0	100.0	H	219.0	-8.3
1119.500000	---	31.84	54.00	22.16	500.0	200.0	H	222.0	-8.3
1291.500000	44.58	---	74.00	29.42	500.0	200.0	H	58.0	-7.2
1294.250000	---	31.78	54.00	22.22	500.0	200.0	H	254.0	-7.2
1513.250000	---	33.09	54.00	20.91	500.0	200.0	H	357.0	-5.9
1515.750000	44.35	---	74.00	29.65	500.0	100.0	H	11.0	-5.9
1754.250000	---	32.98	54.00	21.02	500.0	200.0	V	150.0	-4.7
1764.500000	44.00	---	74.00	30.00	500.0	100.0	H	269.0	-4.6
1997.750000	56.72	---	74.00	17.28	500.0	200.0	V	209.0	-3.4
2062.250000	---	35.29	54.00	18.71	500.0	200.0	V	7.0	-3.2
2753.500000	49.18	---	74.00	24.82	500.0	200.0	H	348.0	-0.1
2754.250000	---	37.16	54.00	16.84	500.0	100.0	H	209.0	-0.1

Remark: 1. Correction Factor = Antenna factor + Insertion loss (cable loss + amplifier gain)

2. Margin = Limit -MAX Peak/ Average

During the test, the Radiates Emission from 18GHz to 26.5GHz was performed in all modes with all channels, 802.11ax HE20 52-Tone, Channel 1 are selected as the worst condition. The test data of the worst-case condition was recorded in this report.

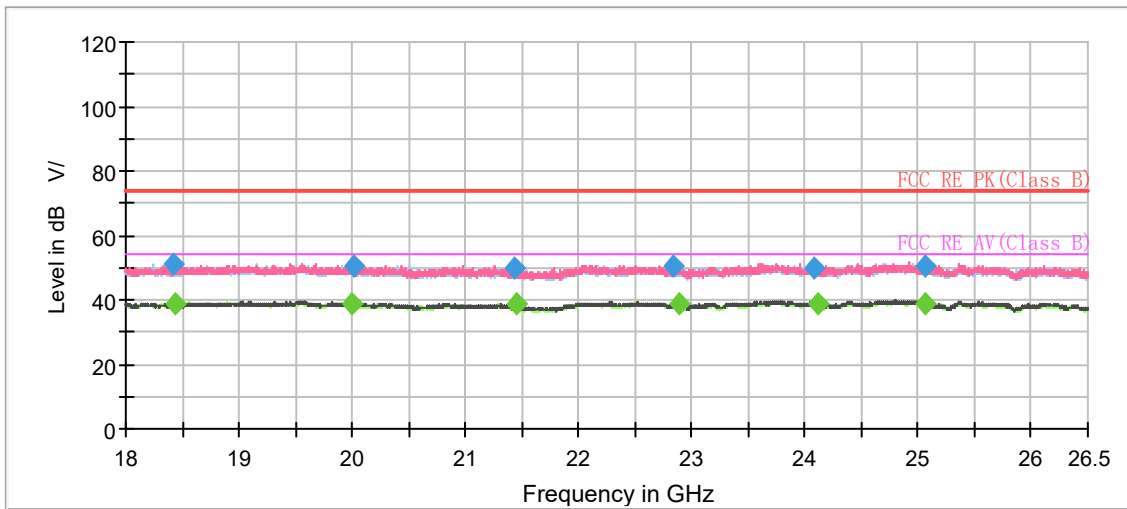

Radiates Emission from 18GHz to 26.5GHz

Frequency (MHz)	MaxPeak (dBµV/m)	Average (dBµV/m)	Limit (dBµV/m)	Margin (dB)	Meas. Time (ms)	Height (cm)	Pol	Azimuth (deg)	Corr. (dB/m)
18425.562500	50.95	---	74.00	23.05	500.0	200.0	H	45.0	-5.5
18441.500000	---	38.47	54.00	15.53	500.0	200.0	H	103.0	-5.6
20004.000000	---	38.58	54.00	15.42	500.0	200.0	H	250.0	-5.2
20018.875000	50.34	---	74.00	23.66	500.0	100.0	V	122.0	-5.2
21441.125000	49.85	---	74.00	24.15	500.0	200.0	V	146.0	-5.1
21454.937500	---	38.49	54.00	15.51	500.0	100.0	V	169.0	-5.1
22833.250000	50.40	---	74.00	23.60	500.0	100.0	V	89.0	-4.2
22893.812500	---	38.95	54.00	15.05	500.0	100.0	V	249.0	-4.1
24083.000000	50.00	---	74.00	24.00	500.0	200.0	H	0.0	-3.8
24119.125000	---	38.55	54.00	15.45	500.0	100.0	V	99.0	-3.8
25060.312500	---	39.00	54.00	15.00	500.0	100.0	V	280.0	-3.1
25065.187500	50.33	---	74.00	23.67	500.0	100.0	V	61.0	-3.1

Remark: 1. Correction Factor = Antenna factor + Insertion loss (cable loss + amplifier gain)

2. Margin = Limit –MAX Peak/ Average

Bluetooth LE

During the test, the Radiates Emission from 30MHz to 1GHz was performed in all modes with all channels, Bluetooth LE-Channel 39 are selected as the worst condition. The test data of the worst-case condition was recorded in this report.

A symbol ($\text{dB } \mu\text{V/m}$) in the test plot below means ($\text{dB}\mu\text{V/m}$)

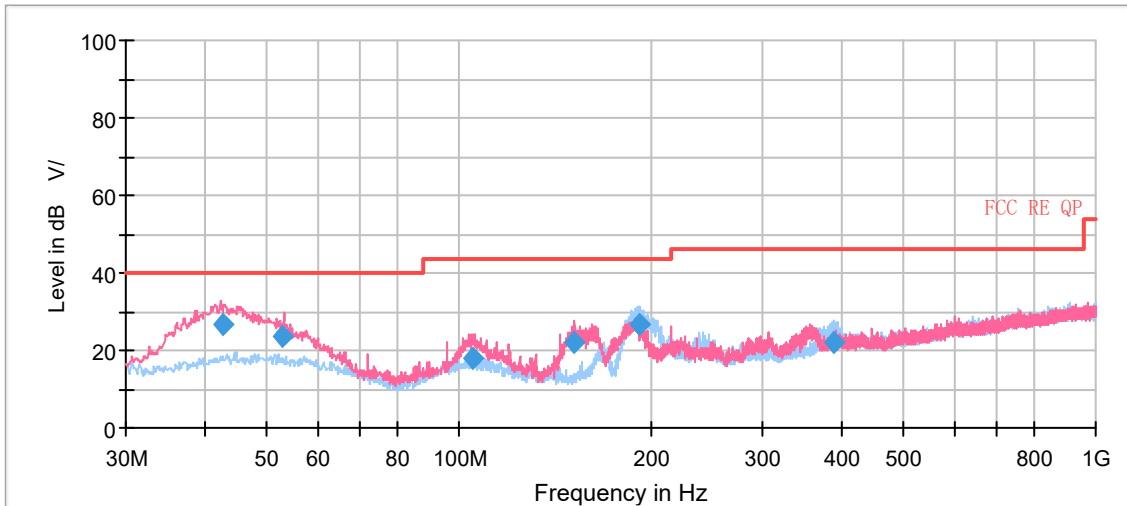

Radiates Emission from 30MHz to 1GHz

Frequency (MHz)	Quasi-Peak ($\text{dB}\mu\text{V/m}$)	Limit ($\text{dB}\mu\text{V/m}$)	Margin (dB)	Height (cm)	Polarization	Azimuth (deg)	Correct Factor (dB)
42.646250	26.65	40.00	13.35	100.0	V	230.0	20.1
52.680000	23.73	40.00	16.27	100.0	V	351.0	20.4
105.090000	17.84	43.50	25.66	175.0	V	173.0	18.7
151.620000	22.09	43.50	21.41	100.0	V	98.0	14.7
192.025000	26.45	43.50	17.05	100.0	H	254.0	18.0
388.247500	22.14	46.00	23.86	100.0	H	233.0	22.7

Remark: 1. Correction Factor = Antenna factor + Insertion loss (cable loss + amplifier gain)

2. Margin = Limit – Quasi-Peak

Bluetooth LE-Channel 0

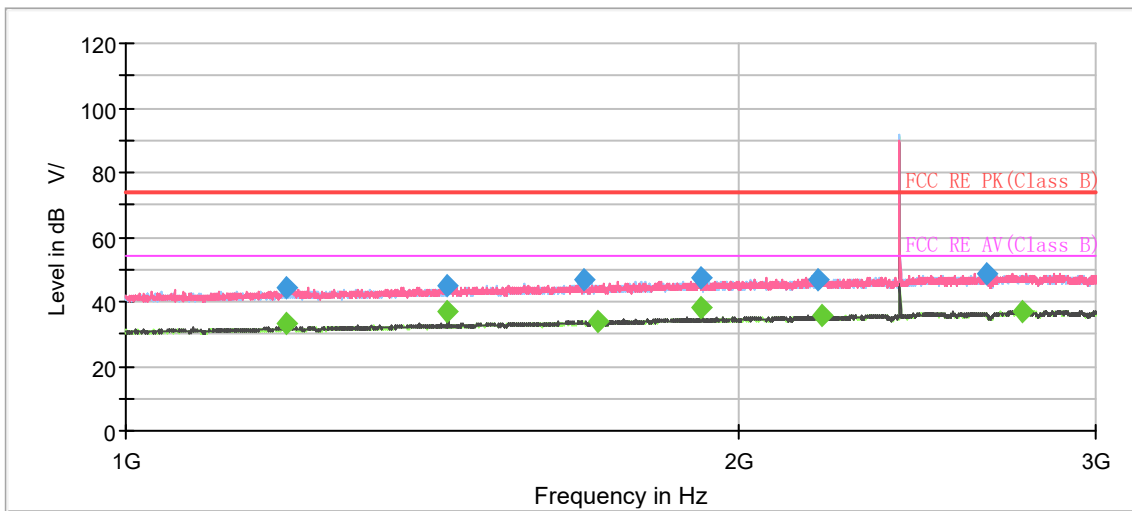

Note: The signal beyond the limit is carrier.
Radiates Emission from 1GHz to 3GHz

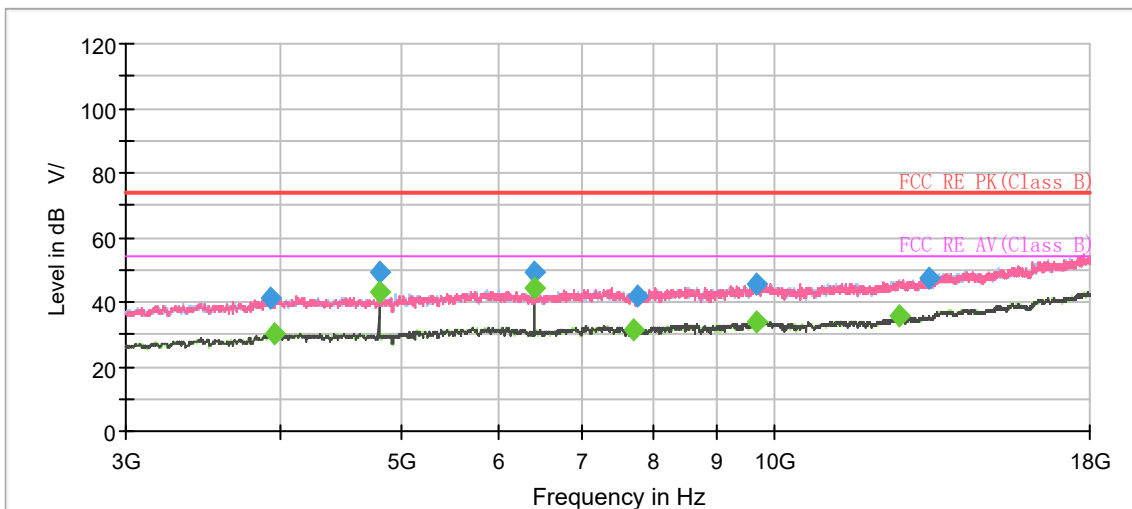

Radiates Emission from 3GHz to 18GHz

Frequency (MHz)	MaxPeak (dB μ V/m)	Average (dB μ V/m)	Limit (dB μ V/m)	Margin (dB)	Meas. Time (ms)	Height (cm)	Pol	Azimuth (deg)	Corr. (dB/m)
1199.500000	44.18	---	74.00	29.82	500.0	100.0	V	254.0	-7.7
1200.000000	---	33.38	54.00	20.62	500.0	100.0	V	272.0	-7.7
1440.250000	---	37.10	54.00	16.90	500.0	100.0	V	167.0	-6.2
1440.500000	45.17	---	74.00	28.83	500.0	200.0	H	216.0	-6.2
1680.500000	46.68	---	74.00	27.32	500.0	100.0	H	62.0	-5.0
1705.250000	---	33.96	54.00	20.04	500.0	200.0	V	0.0	-4.9
1920.250000	47.41	---	74.00	26.59	500.0	100.0	V	104.0	-3.9
1920.250000	---	38.12	54.00	15.88	500.0	100.0	H	112.0	-3.9
2188.000000	46.53	---	74.00	27.47	500.0	100.0	V	172.0	-2.6
2202.250000	---	35.54	54.00	18.46	500.0	100.0	V	286.0	-2.6
2651.750000	48.82	---	74.00	25.18	500.0	100.0	H	14.0	-0.4
2761.000000	---	37.23	54.00	16.77	500.0	200.0	V	350.0	-0.1
6405.000000	---	44.26	54.00	9.74	500.0	100.0	H	239.0	-1.9

Remark: 1. Correction Factor = Antenna factor + Insertion loss (cable loss + amplifier gain)

2. Margin = Limit -MAX Peak/ Average

Bluetooth LE-Channel 19

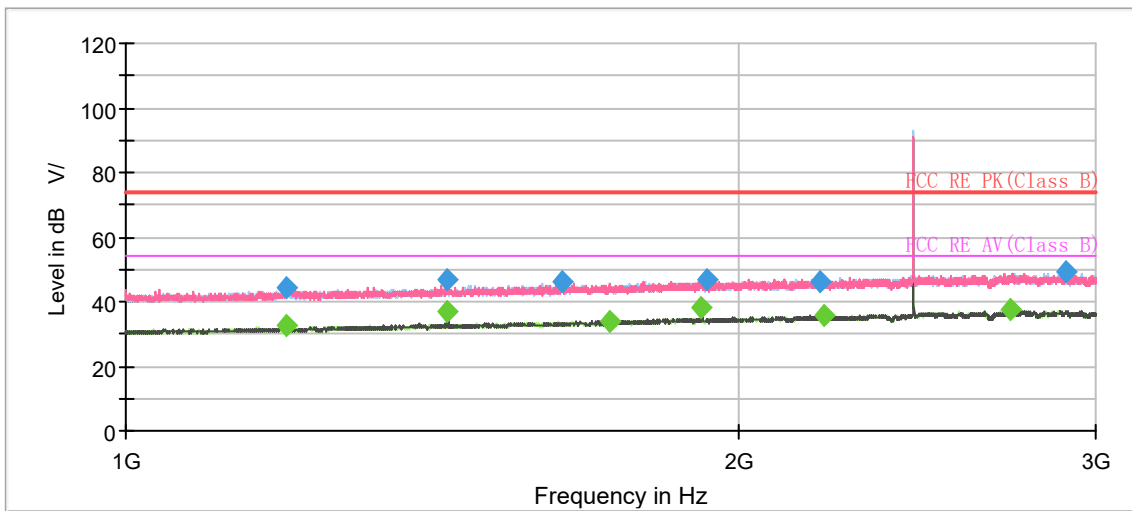

Note: The signal beyond the limit is carrier.
Radiates Emission from 1GHz to 3GHz

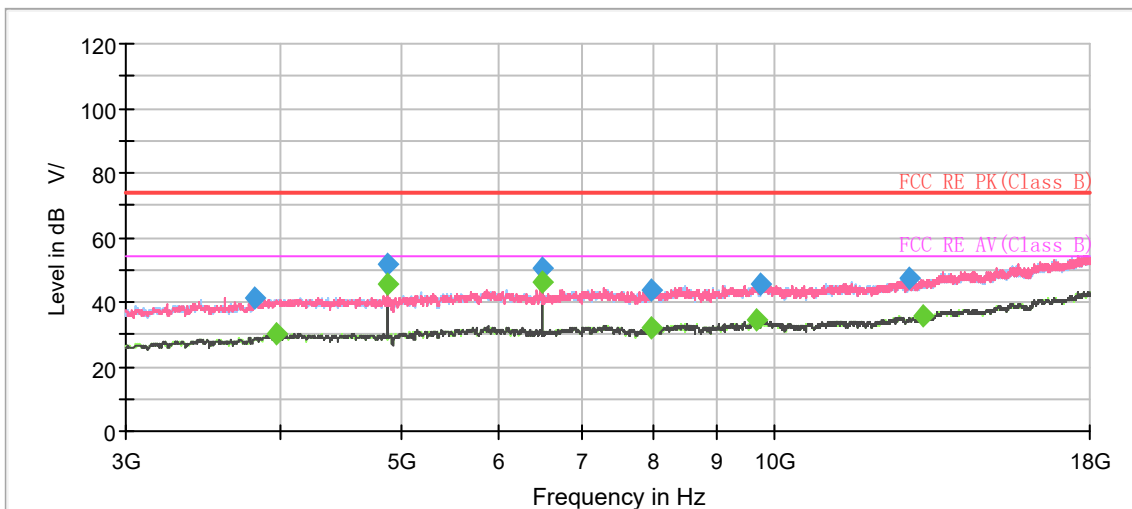

Radiates Emission from 3GHz to 18GHz

Frequency (MHz)	MaxPeak (dB μ V/m)	Average (dB μ V/m)	Limit (dB μ V/m)	Margin (dB)	Meas. Time (ms)	Height (cm)	Pol	Azimuth (deg)	Corr. (dB/m)
1200.000000	---	32.60	54.00	21.40	500.0	100.0	H	183.0	-7.7
1200.250000	44.26	---	74.00	29.74	500.0	100.0	V	45.0	-7.7
1440.000000	---	36.87	54.00	17.13	500.0	100.0	V	162.0	-6.2
1440.000000	46.47	---	74.00	27.53	500.0	100.0	V	162.0	-6.2
1641.000000	46.26	---	74.00	27.74	500.0	200.0	V	102.0	-5.2
1729.750000	---	34.03	54.00	19.97	500.0	100.0	H	301.0	-4.8
1920.250000	---	37.89	54.00	16.11	500.0	100.0	H	143.0	-3.9
1931.500000	46.56	---	74.00	27.44	500.0	100.0	V	45.0	-3.8
2196.000000	46.30	---	74.00	27.70	500.0	200.0	V	116.0	-2.6
2206.000000	---	35.54	54.00	18.46	500.0	200.0	V	139.0	-2.6
2723.000000	---	37.25	54.00	16.75	500.0	200.0	V	139.0	-0.1
2901.000000	49.00	---	74.00	25.00	500.0	100.0	H	257.0	0.3
6506.250000	---	46.33	54.00	7.67	500.0	200.0	V	279.0	-1.9

Remark: 1. Correction Factor = Antenna factor + Insertion loss (cable loss + amplifier gain)

2. Margin = Limit -MAX Peak/ Average

Bluetooth LE-Channel 39

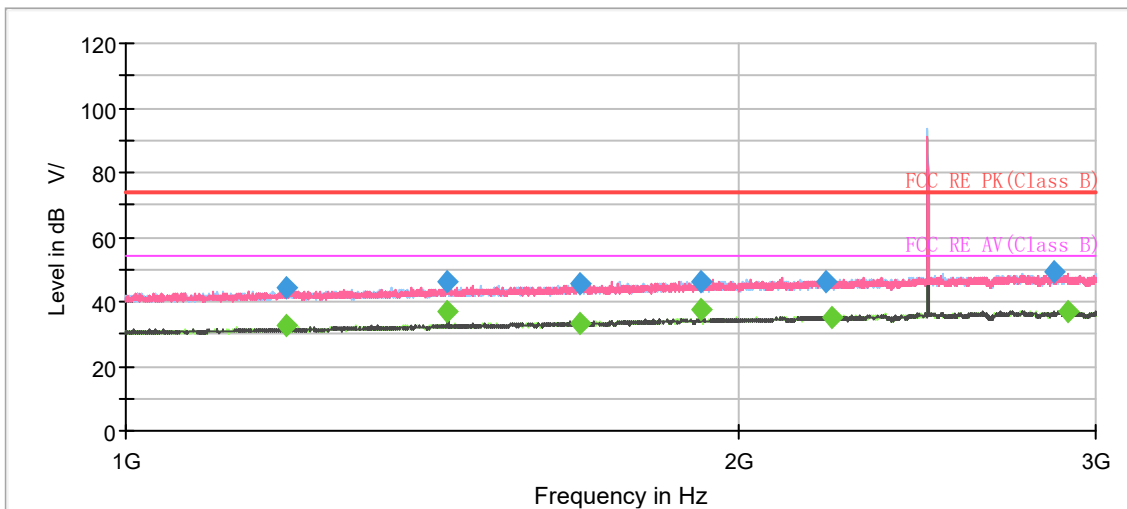

Note: The signal beyond the limit is carrier.
Radiates Emission from 1GHz to 3GHz

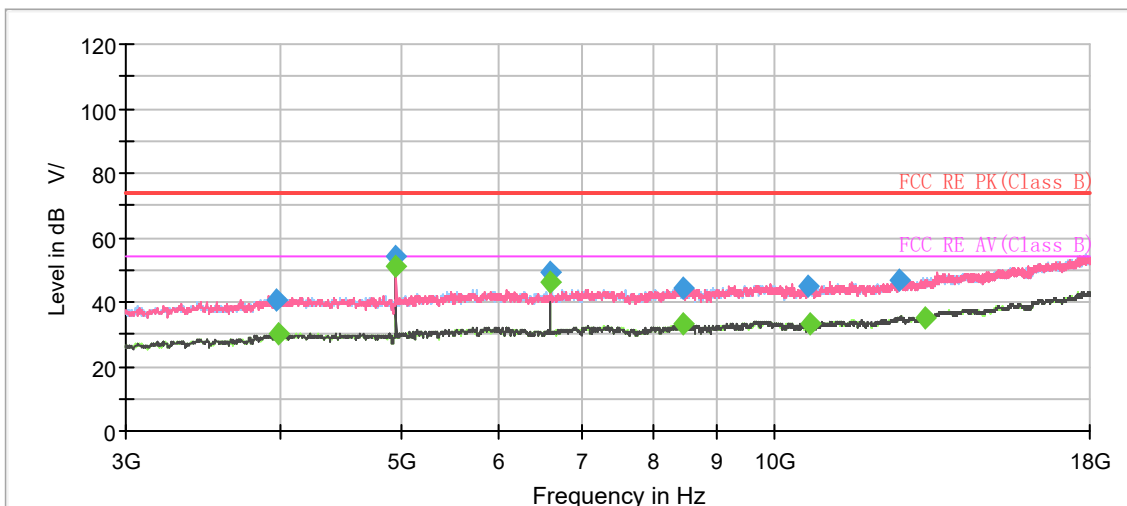

Radiates Emission from 3GHz to 18GHz

Frequency (MHz)	MaxPeak (dB μ V/m)	Average (dB μ V/m)	Limit (dB μ V/m)	Margin (dB)	Meas. Time (ms)	Height (cm)	PoI	Azimuth (deg)	Corr. (dB/m)
1199.750000	---	32.84	54.00	21.16	500.0	200.0	V	253.0	-7.7
1200.750000	44.31	---	74.00	29.69	500.0	200.0	H	251.0	-7.7
1440.000000	46.39	---	74.00	27.61	500.0	100.0	V	171.0	-6.2
1440.250000	---	36.71	54.00	17.29	500.0	100.0	V	138.0	-6.2
1671.500000	45.29	---	74.00	28.71	500.0	200.0	V	244.0	-5.1
1671.750000	---	33.20	54.00	20.80	500.0	100.0	H	313.0	-5.1
1920.000000	---	37.81	54.00	16.19	500.0	100.0	H	290.0	-3.9
1920.250000	46.08	---	74.00	27.92	500.0	100.0	H	277.0	-3.9
2210.500000	46.06	---	74.00	27.94	500.0	200.0	H	13.0	-2.5
2225.500000	---	34.78	54.00	19.22	500.0	200.0	H	22.0	-2.5
2861.500000	49.37	---	74.00	24.63	500.0	100.0	V	0.0	0.2
2904.500000	---	36.94	54.00	17.06	500.0	100.0	V	42.0	0.3
4960.100312	---	51.30	54.00	2.70	500.0	100.0	V	156.0	-3.7
6613.463921	---	46.44	54.00	7.56	500.0	200.0	V	266.0	-1.7

Remark: 1. Correction Factor = Antenna factor + Insertion loss (cable loss + amplifier gain)

2. Margin = Limit -MAX Peak/ Average

During the test, the Radiates Emission from 18GHz to 26.5GHz was performed in all modes with all channels, Bluetooth LE-Channel 39 are selected as the worst condition. The test data of the worst-case condition was recorded in this report.

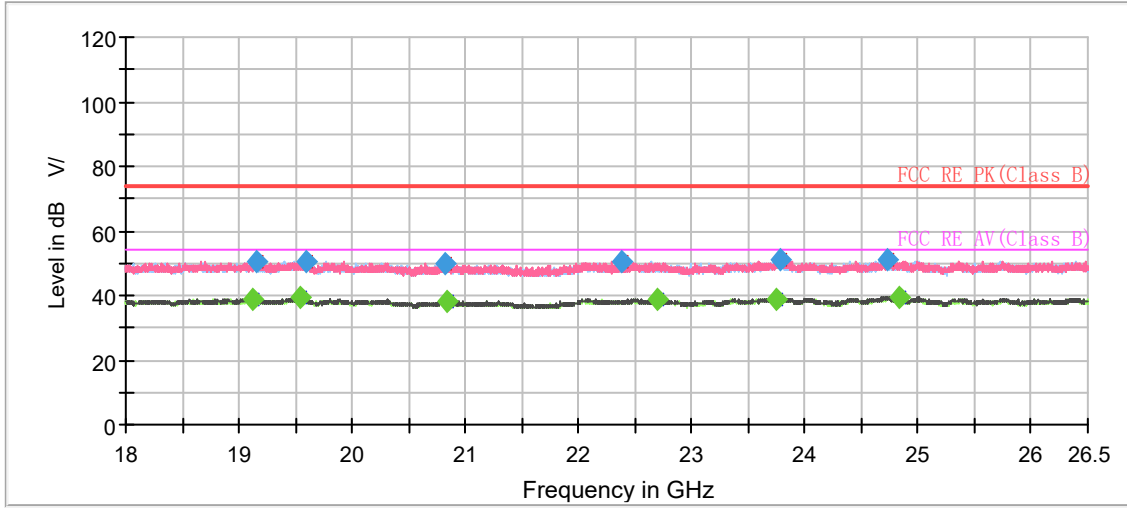

Radiates Emission from 18GHz to 26.5GHz

Frequency (MHz)	MaxPeak (dBµV/m)	Average (dBµV/m)	Limit (dBµV/m)	Margin (dB)	Meas. Time (ms)	Height (cm)	Pol	Azimuth (deg)	Corr. (dB/m)
19117.750000	---	38.91	54.00	15.09	500.0	100.0	V	240.0	-5.7
19156.000000	50.55	---	74.00	23.45	500.0	200.0	H	212.0	-5.7
19547.000000	---	39.41	54.00	14.59	500.0	100.0	V	126.0	-5.3
19599.062500	50.73	---	74.00	23.27	500.0	100.0	H	307.0	-5.3
20814.562500	50.10	---	74.00	23.90	500.0	100.0	V	46.0	-5.1
20831.562500	---	38.31	54.00	15.69	500.0	100.0	H	75.0	-5.1
22383.875000	50.66	---	74.00	23.34	500.0	100.0	H	307.0	-4.0
22689.875000	---	38.81	54.00	15.19	500.0	200.0	V	317.0	-4.0
23747.062500	---	38.93	54.00	15.07	500.0	100.0	H	225.0	-2.3
23790.625000	50.98	---	74.00	23.02	500.0	100.0	V	131.0	-2.4
24737.312500	51.15	---	74.00	22.85	500.0	200.0	H	275.0	-2.1
24835.062500	---	39.39	54.00	14.61	500.0	100.0	V	116.0	-2.3

Remark: 1. Correction Factor = Antenna factor + Insertion loss (cable loss + amplifier gain)

2. Margin = Limit -MAX Peak/ Average

5.7. Conducted Emission

Ambient Condition

Temperature	Relative humidity
20°C ~ 25°C	45% ~ 50%

Methods of Measurement

The EUT is placed on a non-metallic table of 80cm height above the horizontal metal reference ground plane. During the test, the EUT was operating in its typical mode. The test method is according to ANSI C63.10. Connect the AC power line of the EUT to the L.I.S.N. Use EMI receiver to detect the average and Quasi-peak value. RBW is set to 9 kHz, VBW is set to 30kHz.

The measurement result should include both L line and N line.

The test is in transmitting mode.

Test Setup

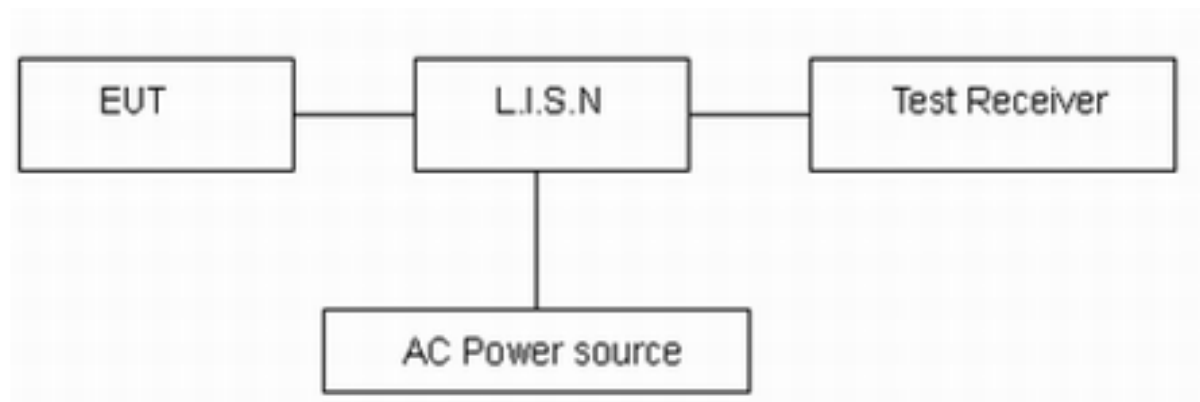

Note: AC Power source is used to change the voltage 110V/60Hz.

Limits

Frequency (MHz)	Conducted Limits(dB μ V)	
	Quasi-peak	Average
0.15 - 0.5	66 to 56 *	56 to 46*
0.5 - 5	56	46
5 - 30	60	50

*: Decreases with the logarithm of the frequency.

Measurement Uncertainty

The assessed measurement uncertainty to ensure 95% confidence level for the normal distribution is with the coverage factor $k = 1.96$, $U = 2.69$ dB.

Test Results:

The equipment doesn't connected to public network, therefore this requirement do not apply.

6. Main Test Instruments

Name	Manufacturer	Type	Serial Number	Calibration Date	Expiration Date
Power sensor	R&S	NRP18S	101954	2023-05-12	2024-05-11
Spectrum Analyzer	KEYSIGHT	N9020A	MY51330870	2023-05-12	2024-05-11
DC Power Supply	UNI-T	UTP1306S+	2205D0517426	2022-12-10	2023-12-09
Unwanted Emission					
EMI Test Receiver	R&S	ESR	102389	2023-05-12	2024-05-11
Spectrum Analyzer	R&S	FSV40	101186	2023-05-12	2024-05-11
Loop Antenna	SCHWARZBECK	FMZB1519	1519-047	2023-04-16	2026-04-15
Horn Antenna	SCHWARZBECK	VULB 9163	1023	2023-07-14	2026-07-13
Horn Antenna	R&S	HF907	102723	2021-07-24	2024-07-23
20dB Attenuator	ETS-Lindgren	3160-09	00102643	2021-10-10	2024-10-09
RF Cable	STEATITE	QSH-SL-26-4 0-K-15	16779	2023-01-17	2026-01-16
Software	R&S	EMC32	9.26.0	/	/

ANNEX A: The EUT Appearance

The EUT Appearance are submitted separately.

ANNEX B: Test Setup Photos

The Test Setup Photos are submitted separately.

***** END OF REPORT *****