

FCC Radio Test Report

FCC ID: ACJ-SL-G700

This report concerns: **Original Grant**

Project No. : 1901C156
Equipment : NETWORK / SUPER AUDIO CD PLAYER
Test Model : SL-G700
Series Model : N/A
Applicant : Panasonic Corporation of North America
Address : Two Riverfront Plaza, 9th Floor Newark, New Jersey
07102-5490, United States

Date of Receipt : Jan. 28, 2019
Date of Test : Feb. 11, 2019 ~ Mar. 05, 2019
Issued Date : Mar. 20, 2019
Tested by : BTL Inc.

Testing Engineer : Vincent Tan
(Vincent Tan)

Technical Manager : Steven Lu
(Steven Lu)

Authorized Signatory : Ethan Ma
(Ethan Ma)

B T L I N C .

No.3, Jinshagang 1st Road, Shixia, Dalang Town, Dongguan,
Guangdong, China.

TEL: +86-769-8318-3000 FAX: +86-769-8319-6000



Certificate #5123.02

Declaration

BTL represents to the client that testing is done in accordance with standard procedures as applicable and that test instruments used has been calibrated with standards traceable to international standard(s) and/or national standard(s).

BTL's reports apply only to the specific samples tested under conditions. It is manufacture's responsibility to ensure that additional production units of this model are manufactured with the identical electrical and mechanical components. **BTL** shall have no liability for any declarations, inferences or generalizations drawn by the client or others from **BTL** issued reports.

The report must not be used by the client to claim product certification, approval, or endorsement by NVLAP, NIST, A2LA, or any agency of the U.S. Government.

This report is the confidential property of the client. As a mutual protection to the clients, the public and ourselves, the test report shall not be reproduced, except in full, without our written approval.

BTL's laboratory quality assurance procedures are in compliance with the **ISO/IEC 17025** requirements, and accredited by the conformity assessment authorities listed in this test report.

BTL is not responsible for the sampling stage, so the results only apply to the sample as received.

The information, data and test plan are provided by manufacturer which may affect the validity of results, so it is manufacturer's responsibility to ensure that the apparatus meets the essential requirements of applied standards and in all the possible configurations as representative of its intended use.

Limitation

For the use of the authority's logo is limited unless the Test Standard(s)/Scope(s)/Item(s) mentioned in this test report is (are) included in the conformity assessment authorities acceptance respective.

Table of Contents**Page**

REPORT ISSUED HISTORY	6
1 . GENERAL SUMMARY	7
2 . SUMMARY OF TEST RESULTS	8
2.1 TEST FACILITY	9
2.2 MEASUREMENT UNCERTAINTY	9
3 . GENERAL INFORMATION	10
3.1 GENERAL DESCRIPTION OF EUT	10
3.2 DESCRIPTION OF TEST MODES	12
3.3 PARAMETERS OF TEST SOFTWARE	14
3.4 DUTY CYCLE	15
3.5 BLOCK DIAGRAM SHOWING THE CONFIGURATION OF SYSTEM TESTED	17
3.6 SUPPORT UNITS	17
4 . AC POWER LINE CONDUCTED EMISSIONS TEST	18
4.1 LIMIT	18
4.2 TEST PROCEDURE	18
4.3 DEVIATION FROM TEST STANDARD	18
4.4 TEST SETUP	19
4.5 EUT OPERATION CONDITIONS	19
4.6 EUT TEST CONDITIONS	19
4.7 TEST RESULTS	19
5 . RADIATED EMISSIONS TEST	20
5.1 LIMIT	20
5.2 TEST PROCEDURE	21
5.3 DEVIATION FROM TEST STANDARD	21
5.4 TEST SETUP	22
5.5 EUT OPERATION CONDITIONS	23
5.6 EUT TEST CONDITIONS	23
5.7 TEST RESULTS - 9 KHZ TO 30 MHZ	23
5.8 TEST RESULTS - 30 MHZ TO 1000 MHZ	23
5.9 TEST RESULTS - ABOVE 1000 MHZ	23
6 . BANDWIDTH TEST	24
6.1 LIMIT	24
6.2 TEST PROCEDURE	24

Table of Contents	Page
6.3 DEVIATION FROM STANDARD	24
6.4 TEST SETUP	24
6.5 EUT OPERATION CONDITIONS	24
6.6 EUT TEST CONDITIONS	24
6.7 TEST RESULTS	24
7 . MAXIMUM OUTPUT POWER TEST	25
7.1 LIMIT	25
7.2 TEST PROCEDURE	25
7.3 DEVIATION FROM STANDARD	25
7.4 TEST SETUP	25
7.5 EUT OPERATION CONDITIONS	25
7.6 EUT TEST CONDITIONS	25
7.7 TEST RESULTS	25
8 . CONDUCTED SPURIOUS EMISSIONS	26
8.1 LIMIT	26
8.2 TEST PROCEDURE	26
8.3 DEVIATION FROM STANDARD	26
8.4 TEST SETUP	26
8.5 EUT OPERATION CONDITIONS	26
8.6 EUT TEST CONDITIONS	26
8.7 TEST RESULTS	26
9 . POWER SPECTRAL DENSITY TEST	27
9.1 LIMIT	27
9.2 TEST PROCEDURE	27
9.3 DEVIATION FROM STANDARD	27
9.4 TEST SETUP	27
9.5 EUT OPERATION CONDITIONS	27
9.6 EUT TEST CONDITIONS	27
9.7 TEST RESULTS	27
10 . MEASUREMENT INSTRUMENTS LIST	28
11 . EUT TEST PHOTO	30
APPENDIX A - AC POWER LINE CONDUCTED EMISSIONS	34
APPENDIX B - RADIATED EMISSION - 9 KHZ TO 30 MHZ	37

Table of Contents**Page**

APPENDIX C - RADIATED EMISSION - 30 MHZ TO 1000 MHZ	42
APPENDIX D - RADIATED EMISSION- ABOVE 1000 MHZ	45
APPENDIX E - BANDWIDTH	94
APPENDIX F - MAXIMUM OUTPUT POWER	97
APPENDIX G - CONDUCTED SPURIOUS EMISSIONS	100
APPENDIX H - POWER SPECTRAL DENSITY	107

REPORT ISSUED HISTORY

Report Version	Description	Issued Date
R00	Original Issue.	Mar. 20, 2019

1. GENERAL SUMMARY

Equipment : NETWORK / SUPER AUDIO CD PLAYER
Brand Name : Technics
Test Model : SL-G700
Series Model : N/A
Applicant : Panasonic Corporation of North America
Manufacturer : Panasonic Corporation
Address : 1-15 Matsuo-cho, Kadoma-shi, Osaka 571-8504, Japan
Factory : Panasonic AVC Networks Johor Malaysia
Address : IE, PLO 460, Jalan Bandar, 81700 Pasir Gudang, Johor, Malaysia
Date of Test : Feb. 11, 2019 ~ Mar. 05, 2019
Test Sample : Engineering Sample No.: D190201223
Standard(s) : FCC Part15, Subpart C (15.247)
ANSI C63.10-2013

The above equipment has been tested and found compliance with the requirement of the relative standards by BTL Inc.

The test data, data evaluation, and equipment configuration contained in our test report (Ref No. BTL-FCCP-3-1901C156) were obtained utilizing the test procedures, test instruments, test sites that has been accredited by the Authority of A2LA according to the ISO/IEC 17025 quality assessment standard and technical standard(s).

Test results included in this report are only for the WLAN 2.4 GHz part.

2. SUMMARY OF TEST RESULTS

Test procedures according to the technical standard(s):

Applied Standard(s): FCC Part15 (15.247) , Subpart C				
Standard(s) Section	Test Item	Test Result	Judgment	Remark
15.207	AC Power Line Conducted Emissions	APPENDIX A	PASS	-----
15.247(d) 15.205(a) 15.209(a)	Radiated Emissions	APPENDIX B APPENDIX C APPENDIX D	PASS	-----
15.247(a)(2)	Bandwidth	APPENDIX E	PASS	-----
15.247(b)(3)	Maximum Output Power	APPENDIX F	PASS	-----
15.247(d)	Conducted Spurious Emissions	APPENDIX G	PASS	-----
15.247(e)	Power Spectral Density	APPENDIX H	PASS	-----
15.203	Antenna Requirement	-----	PASS	-----

Note:

(1) "N/A" denotes test is not applicable in this test report.

2.1 TEST FACILITY

The test facilities used to collect the test data in this report is at the location of No.3, Jinshagang 1st Road, Shixia, Dalang Town, Dongguan, Guangdong, China.

BTL's Test Firm Registration Number for FCC: 357015

BTL's Designation Number for FCC: CN1240

2.2 MEASUREMENT UNCERTAINTY

ISO/IEC 17025 requires that an estimate of the measurement uncertainties associated with the emissions test results be included in the report. The measurement uncertainties given below are based on a 95% confidence level (based on a coverage factor (k=2))

The BTL measurement uncertainty as below table:

A. AC power line conducted emissions test:

Test Site	Method	Measurement Frequency Range	U, (dB)
DG-C02	CISPR	150 kHz ~ 30 MHz	2.32

B. Radiated emissions test:

Test Site	Method	Measurement Frequency Range	Ant. H / V	U, (dB)
DG-CB03	CISPR	9 KHz~30 MHz	V	3.79
		9 KHz~30 MHz	H	3.57
		30 MHz~200 MHz	V	3.82
		30 MHz~200 MHz	H	3.78
		200 MHz~1,000 MHz	V	4.10
		200 MHz~1,000 MHz	H	4.06
		1 GHz~18 GHz	V	3.12
		1 GHz~18 GHz	H	3.68
		18 GHz~40 GHz	V	4.15
		18 GHz~40 GHz	H	4.14

Note: Unless specifically mentioned, the uncertainty of measurement has not been taken into account to declare the compliance or non-compliance to the specification.

3. GENERAL INFORMATION

3.1 GENERAL DESCRIPTION OF EUT

Equipment	NETWORK / SUPER AUDIO CD PLAYER
Brand Name	Technics
Test Model	SL-G700
Series Model	N/A
Model Difference(s)	N/A
Power Source	AC Mains.
Power Rating	120V~ 38W 60Hz
Operation Frequency	2412 MHz ~ 2462 MHz
Modulation Type	IEEE 802.11b: DSSS IEEE 802.11g: OFDM IEEE 802.11n: OFDM
Bit Rate of Transmitter	IEEE 802.11b: 11/5.5/2/1 Mbps IEEE 802.11g: 54/48/36/24/18/12/9/6 Mbps IEEE 802.11n: up to 300 Mbps
Maximum Output Power	IEEE 802.11b: 18.58 dBm (0.0721 W) IEEE 802.11g: 24.18 dBm (0.2618 W) IEEE 802.11n (HT20): 29.01 dBm (0.7967 W) IEEE 802.11n (HT40): 26.45 dBm (0.4411 W)

Note:

1. For a more detailed features description, please refer to the manufacturer's specifications or the user's manual.

2. Channel List:

CH01 - CH11 for 802.11b, 802.11g, 802.11n(20 MHz) CH03 - CH09 for 802.11n(40 MHz)							
Channel	Frequency (MHz)	Channel	Frequency (MHz)	Channel	Frequency (MHz)	Channel	Frequency (MHz)
01	2412	04	2427	07	2442	10	2457
02	2417	05	2432	08	2447	11	2462
03	2422	06	2437	09	2452		

3. Antenna Specification:

Ant.	Brand	Model Name	Antenna Type	Connector	Gain (dBi)
1	N/A	N/A	Dipole	N/A	1.38
2	N/A	N/A	Dipole	N/A	1.28

Note:

The EUT incorporates a MIMO function. Physically, the EUT provides two completed transmitters and receivers (2T2R).

So Directional gain = $10\log[(10^{G1/20} + 10^{G2/20} + \dots + 10^{GN/20})^2 / N]$ dBi, that is

Directional gain = $10\log [(10^{1.38/20} + 10^{1.28/20})^2 / 2]$ dBi = 4.34.

4. Table for Antenna Configuration:

Operating Mode	TX Mode	1TX	2TX
		802.11b	V (Ant. 1)
802.11g	V (Ant. 1)	-	-
802.11n(20MHz)	-	-	V (Ant. 1 + Ant. 2)
802.11n(40MHz)	-	-	V (Ant. 1 + Ant. 2)

3.2 DESCRIPTION OF TEST MODES

The test system was pre-tested based on the consideration of all possible combinations of EUT operation mode.

Pretest Mode	Description
Mode 1	TX B Mode Channel 01/06/11
Mode 2	TX G Mode Channel 01/06/11
Mode 3	TX N-20 MHz Mode Channel 01/06/11
Mode 4	TX N-40 MHz Mode Channel 03/06/09
Mode 5	TX N20 Mode Channel 11

Following mode(s) as (were) found to be the worst case(s) and selected for the final test.

AC power line conducted emissions test	
Final Test Mode:	Description
Mode 5	TX N20 Mode Channel 11

Radiated emissions test	
Final Test Mode:	Description
Mode 1	TX B Mode Channel 01/06/11
Mode 2	TX G Mode Channel 01/06/11
Mode 3	TX N-20 MHz Mode Channel 01/06/11
Mode 4	TX N-40 MHz Mode Channel 03/06/09

Conducted test	
Final Test Mode:	Description
Mode 1	TX B Mode Channel 01/06/11
Mode 2	TX G Mode Channel 01/06/11
Mode 3	TX N-20 MHz Mode Channel 01/06/11
Mode 4	TX N-40 MHz Mode Channel 03/06/09

NOTE:

- (1) The measurements are performed at the high, middle, low available channels.
- (2) 802.11b mode: DBPSK (1 Mbps)
802.11g mode: OFDM (6 Mbps)
802.11n HT20 mode : BPSK (13 Mbps)
802.11n HT40 mode : BPSK (27 Mbps)
For radiated emission tests, the highest output powers were set for final test.
- (3) For radiated emission below 1 GHz test, the IEEE 802.11b is found to be the worst case and recorded.
- (4) For radiated emission above 1 GHz test, 1GHz~26.5GHz have been pre-tested and in this report only recorded the worst case. The remaining spurious points are all below the limit value of 20dB.

3.3 PARAMETERS OF TEST SOFTWARE

Test Software	DutApiMimoBtFmBrdigeEth		
Test Frequency (MHz)	2412	2437	2462
IEEE 802.11b	15	15	15
IEEE 802.11g	13	13	13
IEEE 802.11n (HT20)	13	13	13
Test Frequency (MHz)	2422	2437	2452
IEEE 802.11n (HT40)	11	12	12

3.4 DUTY CYCLE

If duty cycle is $\geq 98\%$, duty factor is not required.
 If duty cycle is $< 98\%$, duty factor shall be considered.

IEEE 802.11b

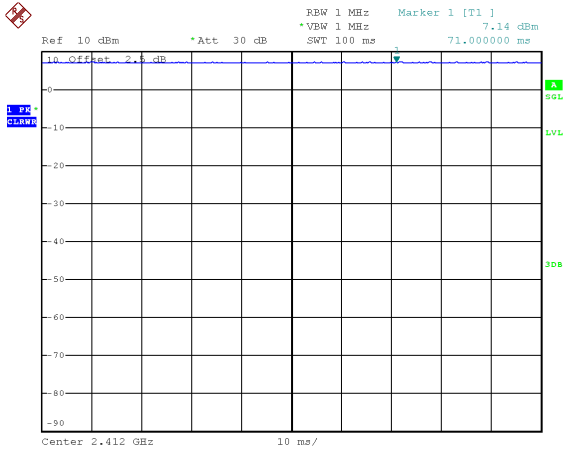

IEEE 802.11g

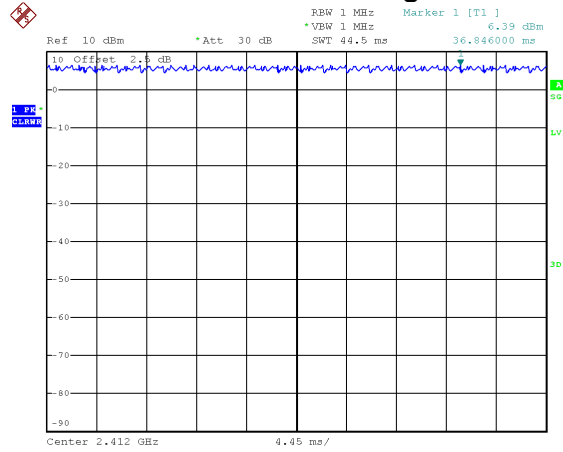

Date: 24.FEB.2019 11:53:08

Duty cycle = 0.000 ms / 0.000 ms = 0.00%
IEEE 802.11n (HT20)

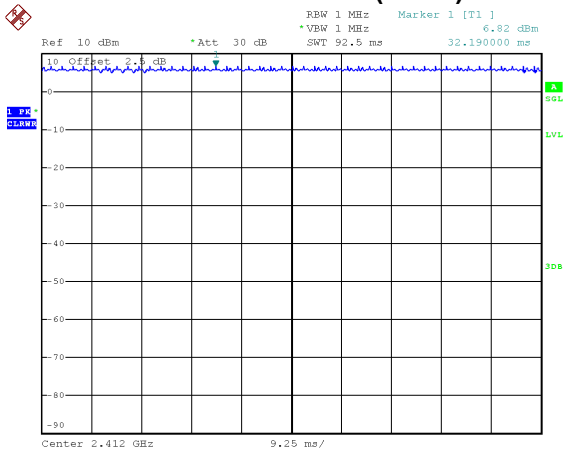

Date: 24.FEB.2019 11:57:15

Duty cycle = 0.000 ms / 0.000 ms = 0.00%

Date: 24.FEB.2019 11:55:31

Duty cycle = 0.000 ms / 0.000 ms = 0.00%
IEEE 802.11n (HT40)

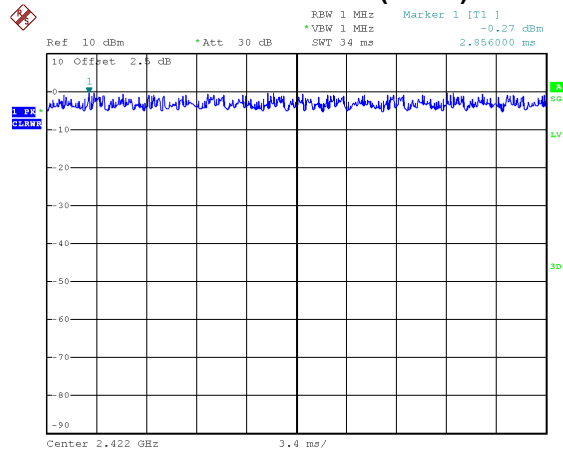

Date: 24.FEB.2019 13:29:17

Duty cycle = 0.000 ms / 0.000 ms = 0.00%

NOTE:

For IEEE 802.11g and IEEE 802.11n (HT20):

For radiated emissions frequency above 1 GHz, the resolution bandwidth of test receiver/spectrum analyzer is 1 MHz and the video bandwidth is 1 kHz (Duty cycle < 98%).

For IEEE 802.11n (HT40):

For radiated emissions frequency above 1 GHz, the resolution bandwidth of test receiver/spectrum analyzer is 1 MHz and the video bandwidth is 2 kHz (Duty cycle < 98%).

For IEEE 802.11b:

Duty Factor = $10 \log(1/\text{Duty cycle}) = 0.00$, the output power = measured power + duty factor.

For IEEE 802.11g:

Duty Factor = $10 \log(1/\text{Duty cycle}) = 0.00$, the output power = measured power + duty factor.

For IEEE IEEE 802.11n (HT20):

Duty Factor = $10 \log(1/\text{Duty cycle}) = 0.00$, the output power = measured power + duty factor.

For IEEE IEEE 802.11n (HT40):

Duty Factor = $10 \log(1/\text{Duty cycle}) = 0.00$, the output power = measured power + duty factor.

3.5 BLOCK DIAGRAM SHOWING THE CONFIGURATION OF SYSTEM TESTED

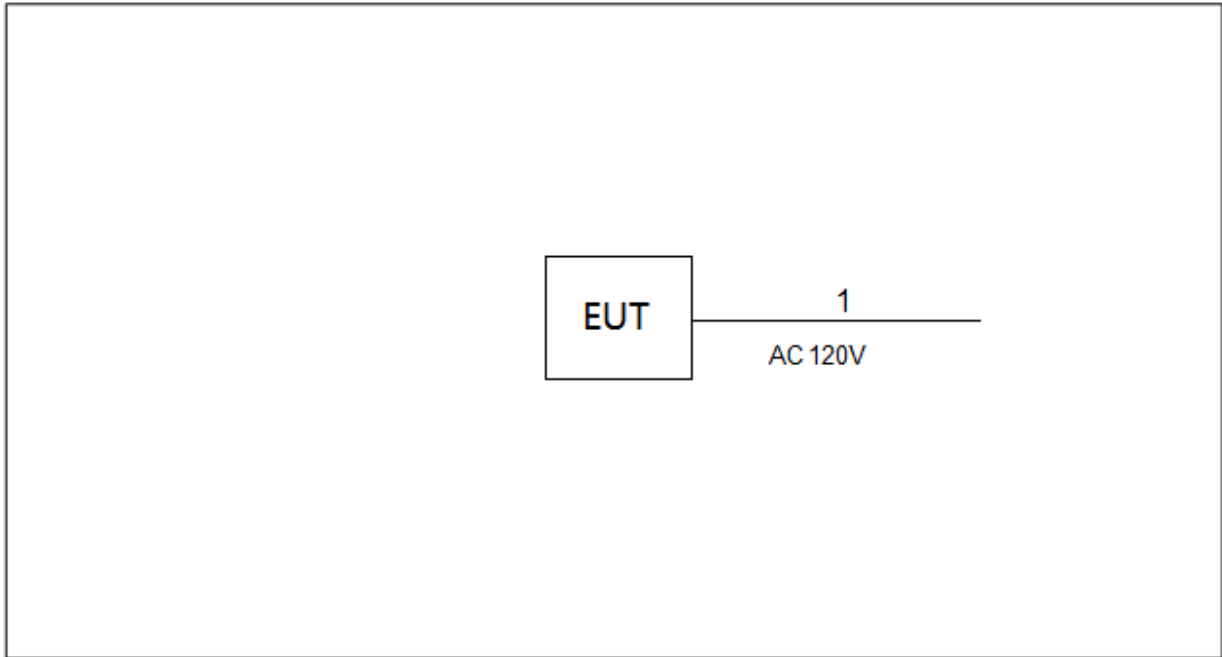

3.6 SUPPORT UNITS

Item	Equipment	Mfr/Brand	Model/Type No.	Series No.
-	-	-	-	-

Item	Shielded Type	Ferrite Core	Length	Note
1	NO	NO	1.8m	AC Cable

4. AC POWER LINE CONDUCTED EMISSIONS TEST

4.1 LIMIT

Frequency of Emission (MHz)	Limit (dB μ V)	
	Quasi-peak	Average
0.15 - 0.50	66 to 56*	56 - 46*
0.50 - 5.0	56	46
5.0 - 30.0	60	50

NOTE:

- (1) The tighter limit applies at the band edges.
- (2) The limit of " * " marked band means the limitation decreases linearly with the logarithm of the frequency in the range.
- (3) The test result calculated as following:

Measurement Value = Reading Level + Correct Factor

Correct Factor = Insertion Loss + Cable Loss + Attenuator Factor (if use)

Margin Level = Measurement Value – Limit Value

Sample calculations: (Refer to page 36, test result No.3.)

Reading Level		Correct Factor		Measurement Value
12.14	+	10.00	=	22.14

Measurement Value		Limit Value		Margin Level
22.14	-	56.00	=	-33.86

The following table is the setting of the receiver

Receiver Parameters	Setting
Attenuation	10 dB
Start Frequency	0.15 MHz
Stop Frequency	30 MHz
IF Bandwidth	9 kHz

4.2 TEST PROCEDURE

- a. The EUT was placed 0.8 meters from the horizontal ground plane with EUT being connected to the power mains through a line impedance stabilization network (LISN). All other support equipment powered from additional LISN(s). The LISN provide 50 Ohm/ 50uH of coupling impedance for the measuring instrument.
- b. Interconnecting cables that hang closer than 40 cm to the ground plane shall be folded back and forth in the center forming a bundle 30 to 40 cm long.
- c. I/O cables that are not connected to a peripheral shall be bundled in the center. The end of the cable may be terminated, if required, using the correct terminating impedance. The overall length shall not exceed 1 m.
- d. LISN at least 80 cm from nearest part of EUT chassis.
- e. For the actual test configuration, please refer to the related Item -EUT Test Photos.

4.3 DEVIATION FROM TEST STANDARD

No deviation

4.4 TEST SETUP

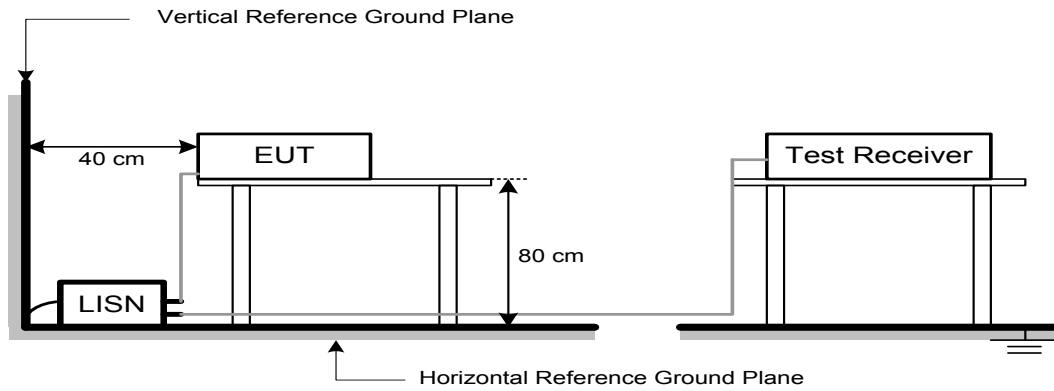

4.5 EUT OPERATION CONDITIONS

The EUT was placed on the test table and programmed in normal function.

4.6 EUT TEST CONDITIONS

Temperature: 25°C Relative Humidity: 53% Test Voltage: AC 120V/60Hz

4.7 TEST RESULTS

Please refer to the APPENDIX A.

5. RADIATED EMISSIONS TEST

5.1 LIMIT

In case the emission fall within the restricted band specified on 15.205(a), then the 15.209(a) limit in the table below has to be followed.

LIMITS OF RADIATED EMISSION MEASUREMENT (9 kHz-1000 MHz)

Frequency (MHz)	Field Strength (microvolts/meter)	Measurement Distance (meters)
0.009-0.490	2400/F(kHz)	300
0.490-1.705	24000/F(kHz)	30
1.705-30.0	30	30
30-88	100	3
88-216	150	3
216-960	200	3
Above 960	500	3

LIMITS OF RADIATED EMISSION MEASUREMENT (Above 1000 MHz)

Frequency (MHz)	(dBuV/m at 3 m)	
	Peak	Average
Above 1000	74	54

NOTE:

- (1) The limit for radiated test was performed according to FCC PART 15C.
- (2) The tighter limit applies at the band edges.
- (3) Emission level (dBuV/m)=20log Emission level (uV/m).
- (4) The test result calculated as following:

Measurement Value = Reading Level + Correct Factor

Correct Factor = Antenna Factor + Cable Loss - Amplifier Gain(if use)

Margin Level = Measurement Value - Limit Value

Sample calculations: (Refer to page 43, test result No.6.)

Reading Level		Correct Factor		Measurement Value
30.17	+	1.35	=	31.52

Measurement Value		Limit Value		Margin Level
31.52	-	46.00	=	-14.48

Spectrum Parameter	Setting
Attenuation	Auto
Start Frequency	1000 MHz
Stop Frequency	10th carrier harmonic
RBW / VBW (Emission in restricted band)	1 MHz / 3 MHz for Peak, 1 MHz / 1/T for Average

Receiver Parameter	Setting
Attenuation	Auto
Start ~ Stop Frequency	9 kHz~90 kHz for PK/AVG detector
Start ~ Stop Frequency	90 kHz~110 kHz for QP detector
Start ~ Stop Frequency	110 kHz~490 kHz for PK/AVG detector
Start ~ Stop Frequency	490 kHz~30 MHz for QP detector
Start ~ Stop Frequency	30 MHz~1000 MHz for QP detector

5.2 TEST PROCEDURE

- a. The measuring distance of 3 m shall be used for measurements. The EUT was placed on the top of a rotating table 0.8 meter above the ground at a 3 meter semi-anechoic chamber. The table was rotated 360 degrees to determine the position of the highest radiation.(below 1 GHz)
- b. The measuring distance of 3 m shall be used for measurements. The EUT was placed on the top of a rotating table 1.5 meter above the ground at a 3 meter semi-anechoic chamber. The table was rotated 360 degrees to determine the position of the highest radiation.(above 1 GHz)
- c. The height of the equipment or of the substitution antenna shall be 0.8m or 1.5m; the height of the test antenna shall vary between 1 m to 4 m. Both horizontal and vertical polarizations of the antenna are set to make the measurement.
- d. For each suspected emission, the EUT was arranged to its worst case and then the antenna was tuned to heights find the maximum reading (used Bore sight function).
- e. The receiver system was set to peak and average detect function and specified bandwidth with maximum hold mode when the test frequency is above 1 GHz.
- f. The initial step in collecting radiated emission data is a receiver peak detector mode pre-scanning the measurement frequency range. Significant peaks are then marked and then Quasi Peak detector mode re-measured.
- g. All readings are Peak unless otherwise stated QP in column of Note. Peak denotes that the Peak reading compliance with the QP Limits and then QP Mode measurement didn't perform. (below 1 GHz)
- h. All readings are Peak Mode value unless otherwise stated AVG in column of Note. If the Peak Mode Measured value compliance with the Peak Limits and lower than AVG Limits, the EUT shall be deemed to meet both Peak & AVG Limits and then only Peak Mode was measured, but AVG Mode didn't perform. (above 1 GHz)
- i. For the actual test configuration, please refer to the related Item -EUT Test Photos.

5.3 DEVIATION FROM TEST STANDARD

No deviation

5.4 TEST SETUP

9 kHz-30 MHz

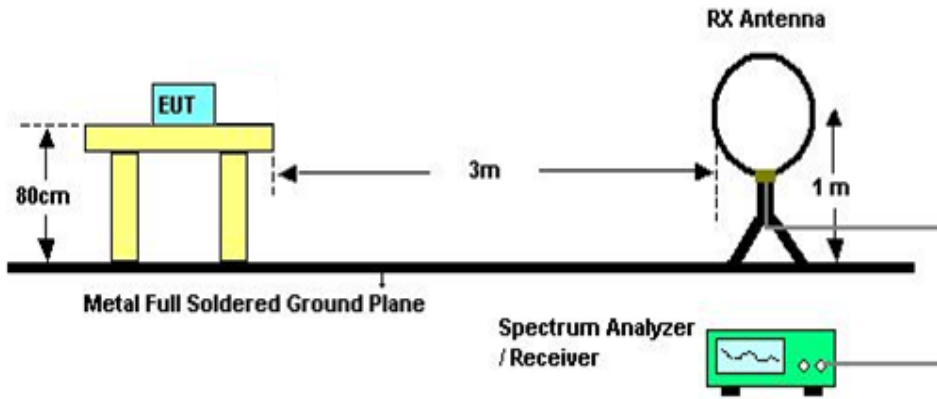

30 MHz to 1 GHz

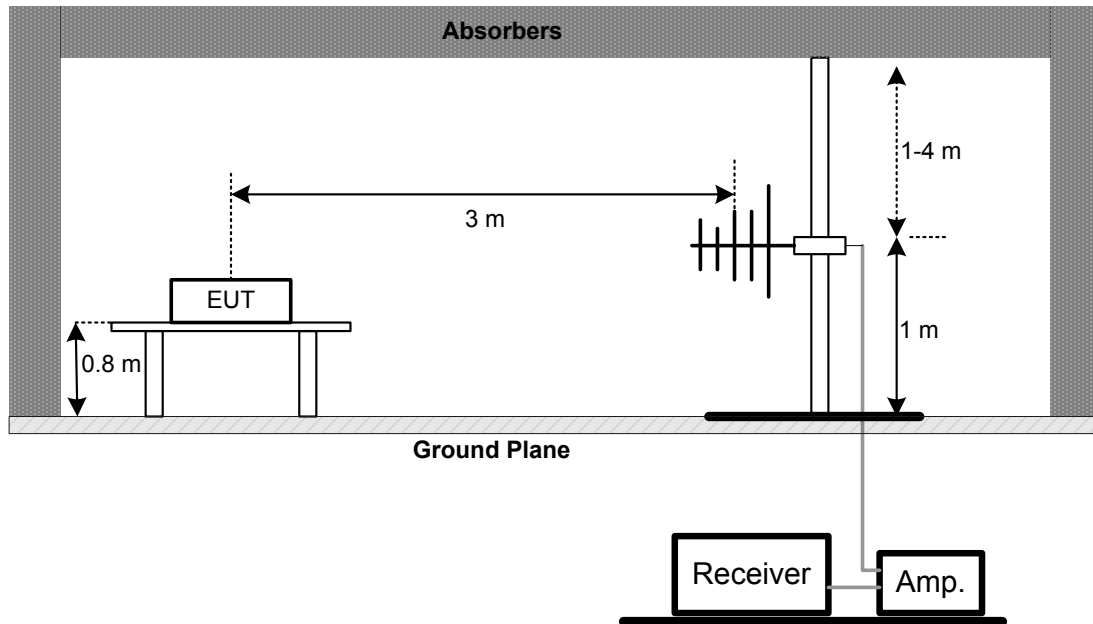

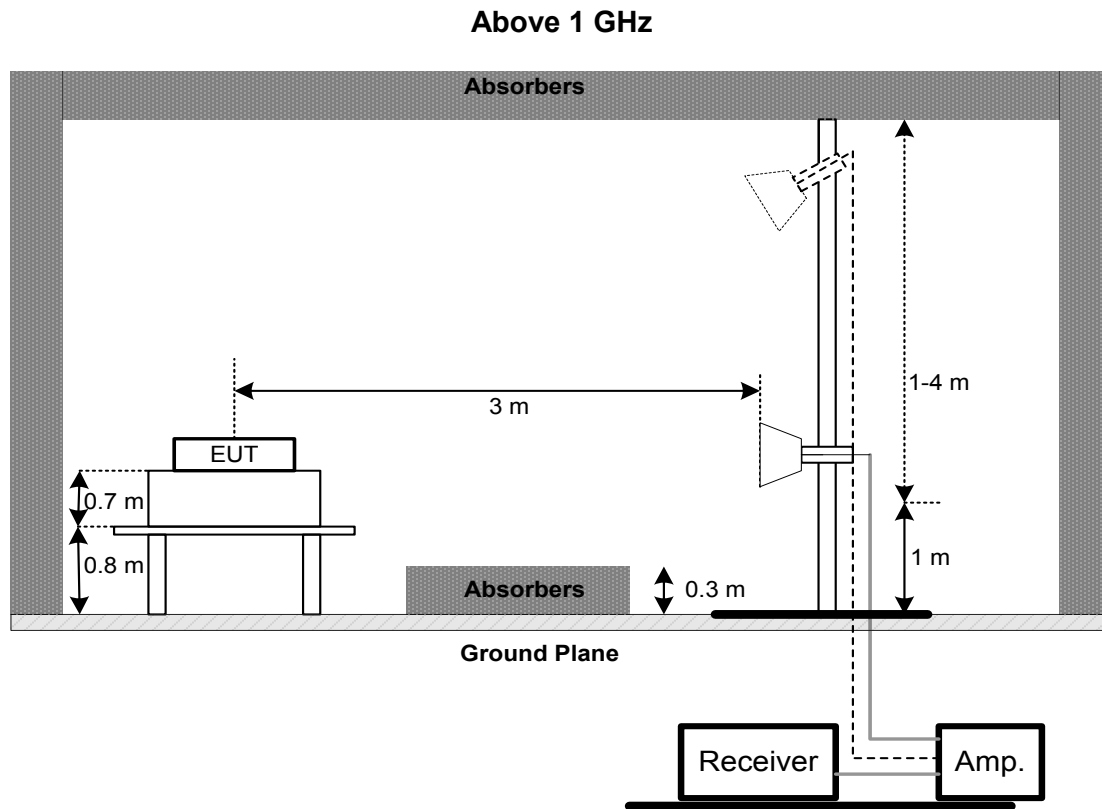

5.5 EUT OPERATION CONDITIONS

The EUT was programmed to be in continuously transmitting mode.

5.6 EUT TEST CONDITIONS

Temperature: 25°C Relative Humidity: 62% Test Voltage: AC 120V/60Hz

5.7 TEST RESULTS - 9 KHZ TO 30 MHZ

Please refer to the APPENDIX B

Remark:

- (1) Distance extrapolation factor = $40 \log(\text{specific distance} / \text{test distance})$ (dB).
- (2) Limit line = specific limits (dBuV) + distance extrapolation factor.

5.8 TEST RESULTS - 30 MHZ TO 1000 MHZ

Please refer to the APPENDIX C.

5.9 TEST RESULTS - ABOVE 1000 MHZ

Please refer to the APPENDIX D.

Remark:

- (1) No limit: This is fundamental signal, the judgment is not applicable.
For fundamental signal judgment was referred to Peak output test.

6. BANDWIDTH TEST

6.1 LIMIT

FCC Part15 (15.247) , Subpart C		
Section	Test Item	Limit
15.247(a)(2)	6 dB Bandwidth	Minimum 500 kHz
	99% Emission Bandwidth	-

6.2 TEST PROCEDURE

- a. The EUT was directly connected to the spectrum analyzer and antenna output port as show in the block diagram below.
- b. Spectrum Setting: RBW= 100 kHz, VBW=300 kHz, Sweep time = 2.5 ms.
- c. The bandwidth was performed in accordance with method 11.8 of ANSI C63.10-2013.

6.3 DEVIATION FROM STANDARD

No deviation.

6.4 TEST SETUP



6.5 EUT OPERATION CONDITIONS

The EUT was programmed to be in continuously transmitting mode.

6.6 EUT TEST CONDITIONS

Temperature: 24°C Relative Humidity: 66% Test Voltage: AC 120V/60Hz

6.7 TEST RESULTS

Please refer to the APPENDIX E.

7. MAXIMUM OUTPUT POWER TEST

7.1 LIMIT

FCC Part15 (15.247) , Subpart C		
Section	Test Item	Limit
15.247(b)(3)	Maximum Output Power	1 Watt or 30dBm

7.2 TEST PROCEDURE

- a. The EUT was directly connected to the power meter and antenna output port as show in the block diagram below.
- b. The maximum conducted output power was performed in accordance with method 11.9.1.3 of ANSI C63.10-2013 and FCC KDB 662911 D01 v02r01 Multiple Transmitter Output.

7.3 DEVIATION FROM STANDARD

No deviation.

7.4 TEST SETUP

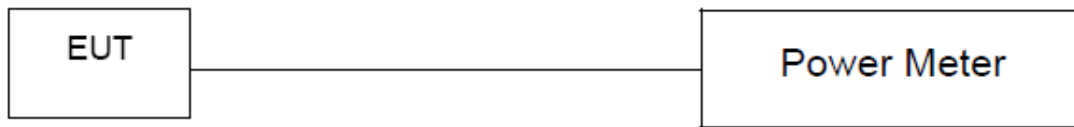

7.5 EUT OPERATION CONDITIONS

The EUT was programmed to be in continuously transmitting mode.

7.6 EUT TEST CONDITIONS

Temperature: 24°C Relative Humidity: 66% Test Voltage: AC 120V/60Hz

7.7 TEST RESULTS

Please refer to the APPENDIX F.

8. CONDUCTED SPURIOUS EMISSIONS

8.1 LIMIT

In any 100 kHz bandwidth outside the frequency band in which the spread spectrum or digitally modulated intentional radiator is operating, the radio frequency power that is produced by the intentional radiator shall be at least 20 dB below that in the 100 kHz bandwidth within the band that contains the highest level of the desired power, based on either an RF conducted or a radiated measurement, provided the transmitter demonstrates compliance with the peak Output Power limits. If the transmitter complies with the Output Power limits based on the use of RMS averaging over a time interval, as permitted under paragraph (b)(3) of this section, the attenuation required under this paragraph shall be 30 dB instead of 20 dB. Attenuation below the general limits specified in Section 15.209(a) is not required. In addition, radiated emissions which fall in the restricted bands, as defined in Section 15.205(a), must also comply with the radiated emission limits specified in Section 15.209(a) (see Section 15.205(c)).

8.2 TEST PROCEDURE

- The EUT was directly connected to the spectrum analyzer and antenna output port as show in the block diagram below.
- Spectrum Setting: RBW= 100 kHz, VBW=300 kHz, Sweep time = Auto.

8.3 DEVIATION FROM STANDARD

No deviation.

8.4 TEST SETUP



8.5 EUT OPERATION CONDITIONS

The EUT was programmed to be in continuously transmitting mode.

8.6 EUT TEST CONDITIONS

Temperature: 24°C Relative Humidity: 66% Test Voltage: AC 120V/60Hz

8.7 TEST RESULTS

Please refer to the APPENDIX G.

9. POWER SPECTRAL DENSITY TEST

9.1 LIMIT

FCC Part15 (15.247) , Subpart C		
Section	Test Item	Limit
15.247(e)	Power Spectral Density	8 dBm (in any 3 kHz)

9.2 TEST PROCEDURE

- a. The EUT was directly connected to the spectrum analyzer and antenna output port as show in the block diagram below.
- b. Spectrum Setting: RBW=3 kHz, VBW=10 kHz, Sweep time = Auto.
- c. The Power Spectral Density was performed in accordance with method 11.10.2 of ANSI C63.10-2013.

9.3 DEVIATION FROM STANDARD

No deviation.

9.4 TEST SETUP

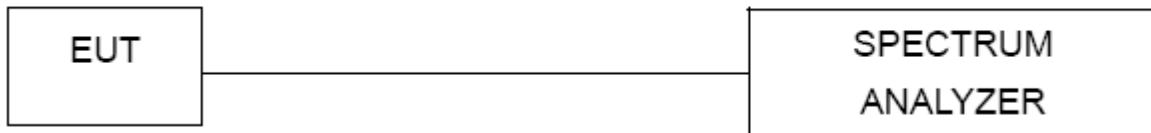

9.5 EUT OPERATION CONDITIONS

The EUT was programmed to be in continuously transmitting mode.

9.6 EUT TEST CONDITIONS

Temperature: 24°C Relative Humidity: 66% Test Voltage: AC 120V/60Hz

9.7 TEST RESULTS

Please refer to the APPENDIX H.

10. MEASUREMENT INSTRUMENTS LIST

AC Power Line Conducted Emissions					
Item	Kind of Equipment	Manufacturer	Type No.	Serial No.	Calibrated until
1	EMI Test Receiver	R&S	ESCI	100382	Mar. 11, 2019
2	LISN	EMCO	3816/2	52765	Mar. 11, 2019
3	50Ω Terminator	SHX	TF2-3G-A	8122901	Mar. 11, 2019
4	TWO-LINE V-NETWORK	R&S	ENV216	101447	Mar. 11, 2019
5	Measurement Software	Farad	EZ-EMC Ver.NB-03A1-01	N/A	N/A
6	Cable	N/A	RG223	12m	Mar. 23, 2019

Radiated Emissions - 9 kHz to 30 MHz					
Item	Kind of Equipment	Manufacturer	Type No.	Serial No.	Calibrated until
1	Loop Antenna	EM	EM-6876-1	230	Jan. 15, 2020
2	Cable	N/A	RG 213/U	C-102	Jun. 01, 2019
3	EMI Test Receiver	R&S	ESCI	100382	Mar. 11, 2019
4	Measurement Software	Farad	EZ-EMC Ver.NB-03A1-01	N/A	N/A

Radiated Emissions - 30 MHz to 1 GHz					
Item	Kind of Equipment	Manufacturer	Type No.	Serial No.	Calibrated until
1	Antenna	Schwarzbeck	VULB9160	9160-3232	Mar. 11, 2019
2	Amplifier	HP	8447D	2944A09673	Aug. 11, 2019
3	Receiver	Agilent	N9038A	MY52130039	Aug. 11, 2019
4	Cable	emci	LMR-400(30MHz- 1GHz)(8m+5m)	N/A	May 25, 2019
5	Controller	CT	SC100	N/A	N/A
6	Controller	MF	MF-7802	MF780208416	N/A
7	Measurement Software	Farad	EZ-EMC Ver.NB-03A1-01	N/A	N/A

Radiated Emissions - Above 1 GHz					
Item	Kind of Equipment	Manufacturer	Type No.	Serial No.	Calibrated until
1	Double Ridged Guide Antenna	ETS	3115	75789	Mar. 11, 2019
2	Broad-Band Horn Antenna	Schwarzbeck	BBHA 9170	9170319	Jun. 30, 2019
3	Amplifier	Agilent	8449B	3008A02274	Mar. 11, 2019
4	Microwave Preamplifier With Adaptor	EMC INSTRUMENT	EMC2654045	980039 & HA01	Mar. 11, 2019
5	Receiver	Agilent	N9038A	MY52130039	Aug. 11, 2019
6	Controller	CT	SC100	N/A	N/A
7	Controller	MF	MF-7802	MF780208416	N/A
8	Cable	mitron	B10-01-01-12M	18072744	Jul. 30, 2019
9	Measurement Software	Farad	EZ-EMC Ver.NB-03A1-01	N/A	N/A

Bandwidth					
Item	Kind of Equipment	Manufacturer	Type No.	Serial No.	Calibrated until
1	Spectrum Analyzer	R&S	FSP40	100185	Aug. 11, 2019

Peak Output Power					
Item	Kind of Equipment	Manufacturer	Type No.	Serial No.	Calibrated until
1	P-series power meter	Agilent	N1911A	MY45100473	Aug. 11, 2019
2	wideband power sensor	Agilent	N1921A	MY51100041	Aug. 11, 2019

Antenna Conducted Spurious Emissions					
Item	Kind of Equipment	Manufacturer	Type No.	Serial No.	Calibrated until
1	Spectrum Analyzer	R&S	FSP40	100185	Aug. 11, 2019

Power Spectral Density					
Item	Kind of Equipment	Manufacturer	Type No.	Serial No.	Calibrated until
1	Spectrum Analyzer	R&S	FSP40	100185	Aug. 11, 2019

Remark: "N/A" denotes no model name, serial no. or calibration specified.
 All calibration period of equipment list is one year.

11. EUT TEST PHOTO**Conducted Measurement Photos**

Radiated Emissions Test Photos

9 kHz to 30 MHz



Radiated Emissions Test Photos

30 MHz to 1 GHz

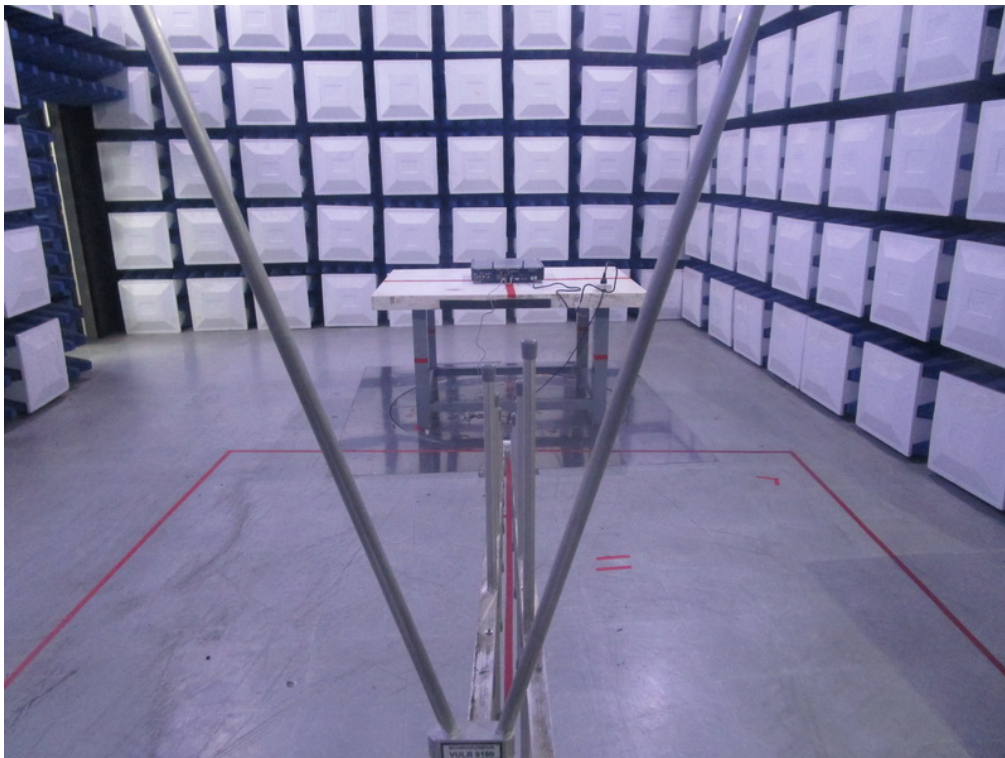
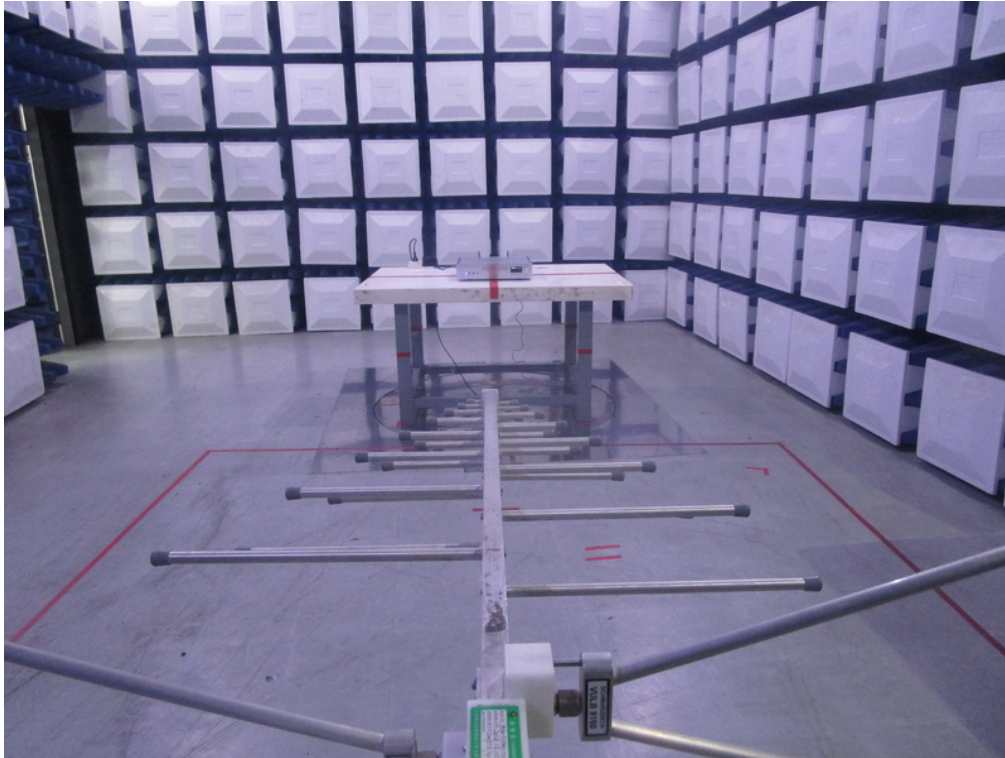

Radiated Emissions Test Photos
Above 1 GHz

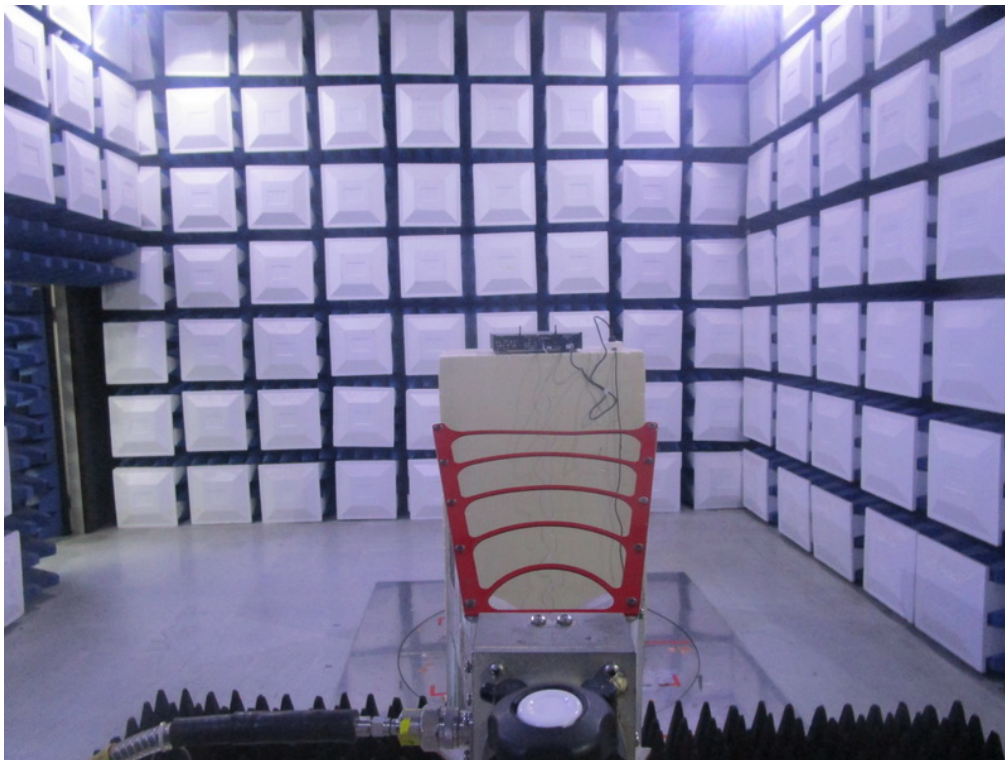

APPENDIX A - AC POWER LINE CONDUCTED EMISSIONS

Test Mode: TX N20 MODE CHANNEL 11

Line

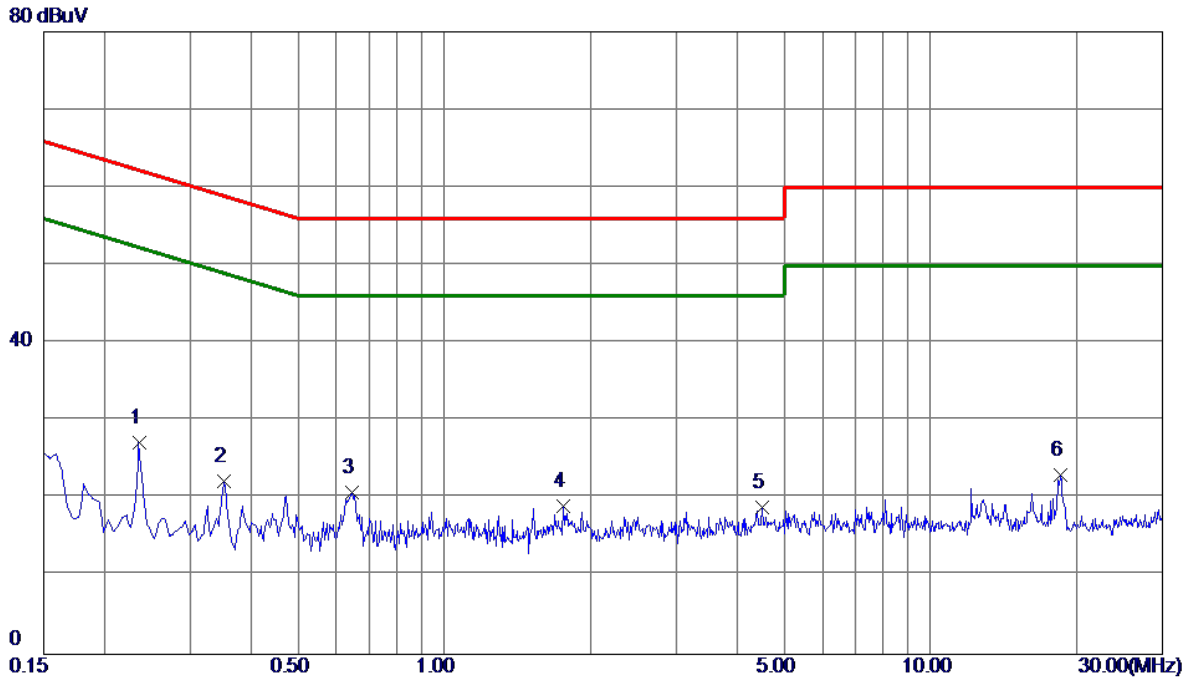

No.	Freq. MHz	Reading Level dBuV	Correct Factor dB	Measure ment dBuV	Limit dBuV	Margin dB	Detector	Comment
1 *	0.2355	17.44	9.82	27.26	62.25	-34.99	Peak	
2	0.3525	12.49	9.81	22.30	58.90	-36.60	Peak	
3	0.6450	10.97	9.85	20.82	56.00	-35.18	Peak	
4	1.7610	9.04	9.98	19.02	56.00	-36.98	Peak	
5	4.5150	8.67	10.16	18.83	56.00	-37.17	Peak	
6	18.4875	11.93	11.06	22.99	60.00	-37.01	Peak	

REMARKS:

- (1) Measurement Value = Reading Level + Correct Factor.
- (2) Margin Level = Measurement Value - Limit Value.

Test Mode: TX N20 MODE CHANNEL 11

Neutral

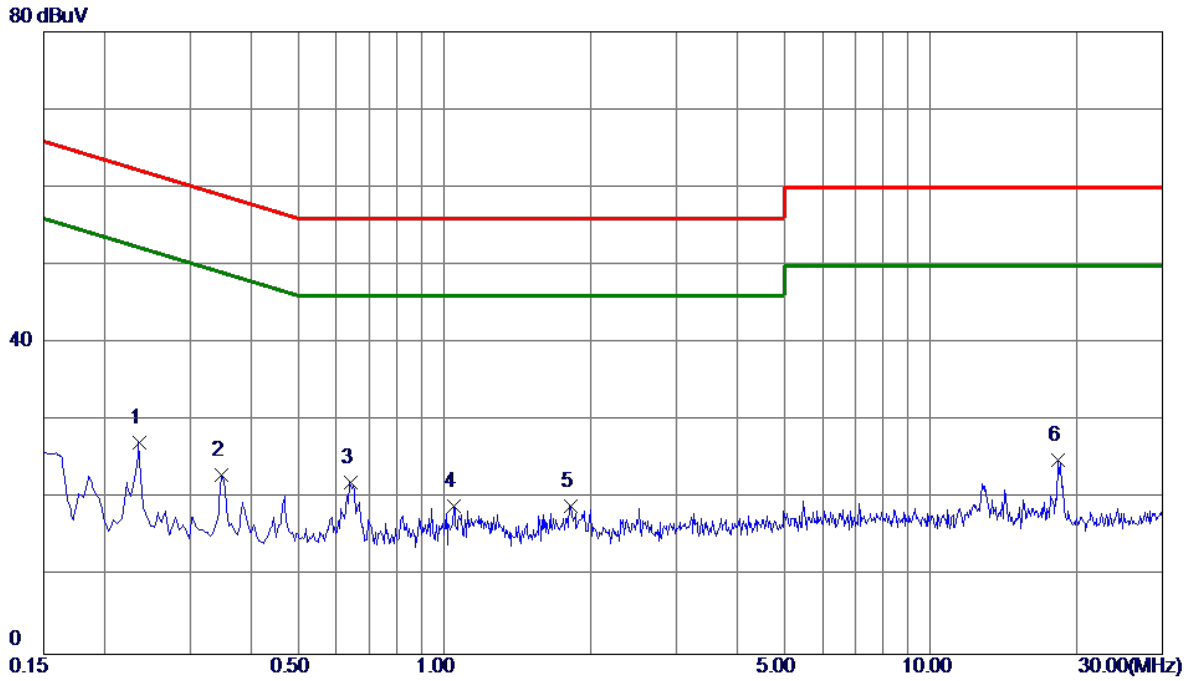

No.	Freq. MHz	Reading Level dBuV	Correct Factor dB	Measure ment dBuV	Limit dBuV	Margin dB	Detector	Comment
1	0.2355	17.22	9.92	27.14	62.25	-35.11	Peak	
2	0.3480	13.09	9.95	23.04	59.01	-35.97	Peak	
3 *	0.6405	12.14	10.00	22.14	56.00	-33.86	Peak	
4	1.0455	8.95	10.12	19.07	56.00	-36.93	Peak	
5	1.8195	8.88	10.18	19.06	56.00	-36.94	Peak	
6	18.2445	13.64	11.34	24.98	60.00	-35.02	Peak	

REMARKS:

- (1) Measurement Value = Reading Level + Correct Factor.
- (2) Margin Level = Measurement Value - Limit Value.

APPENDIX B - RADIATED EMISSION - 9 KHZ TO 30 MHZ

Test Mode: TX B MODE CHANNEL 11

Ant 0°

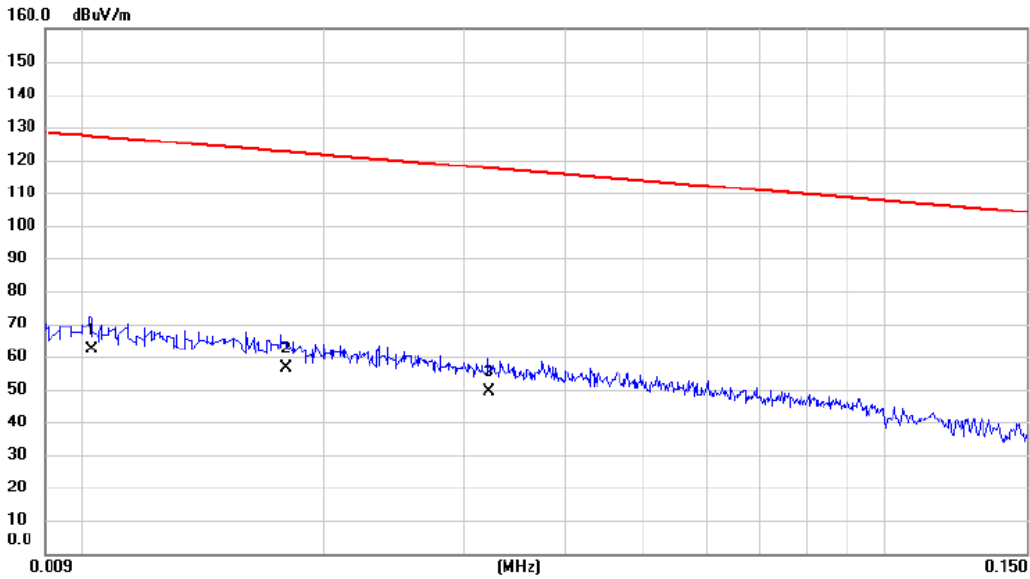

No.	Mk.	Freq. MHz	Reading Level dBuV	Correct Factor dB	Measure- ment dBuV/m	Limit dBuV/m	Margin dB	Detector	Comment
1	*	0.0103	40.94	21.38	62.32	127.35	-65.03	AVG	
2		0.0180	36.23	20.30	56.53	122.50	-65.97	AVG	
3		0.0322	29.51	19.83	49.34	117.45	-68.11	AVG	

REMARKS:

- (1) Measurement Value = Reading Level + Correct Factor.
- (2) Margin Level = Measurement Value - Limit Value.

Test Mode: TX B MODE CHANNEL 11

Ant 0°

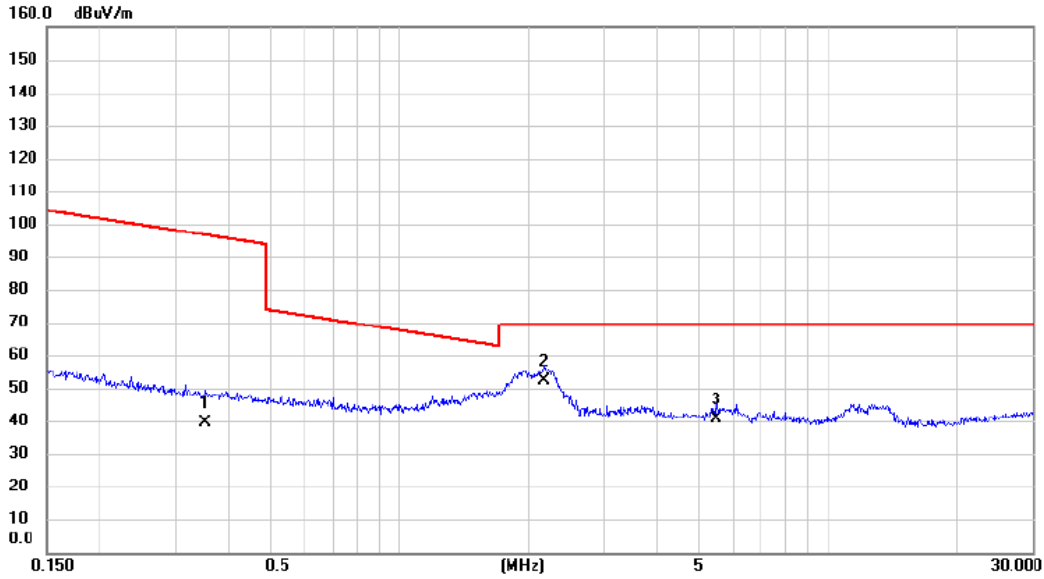

No.	Mk.	Freq. MHz	Reading Level dBuV	Correct Factor dB	Measure- ment dBuV/m	Limit dBuV/m	Margin dB	Detector	Comment
1		0.3520	22.19	17.02	39.21	96.67	-57.46	AVG	
2	*	2.1724	35.02	17.02	52.04	69.54	-17.50	QP	
3		5.5054	25.56	15.08	40.64	69.54	-28.90	QP	

REMARKS:

- (1) Measurement Value = Reading Level + Correct Factor.
- (2) Margin Level = Measurement Value - Limit Value.

Test Mode: TX B MODE CHANNEL 11

Ant 90°

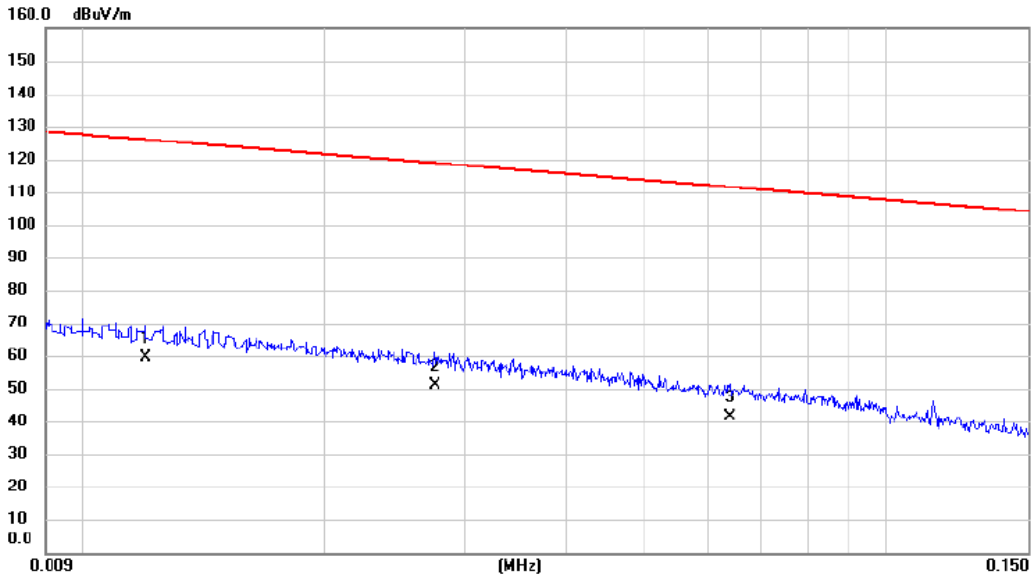

No.	Mk.	Freq. MHz	Reading Level dBuV	Correct Factor dB	Measure- ment dBuV/m	Limit dBuV/m	Margin dB	Detector	Comment
1	*	0.0120	38.11	21.14	59.25	126.02	-66.77	AVG	
2		0.0275	30.94	19.90	50.84	118.82	-67.98	AVG	
3		0.0640	22.23	19.25	41.48	111.48	-70.00	AVG	

REMARKS:

- (1) Measurement Value = Reading Level + Correct Factor.
- (2) Margin Level = Measurement Value - Limit Value.

Test Mode: TX B MODE CHANNEL 11

Ant 90°

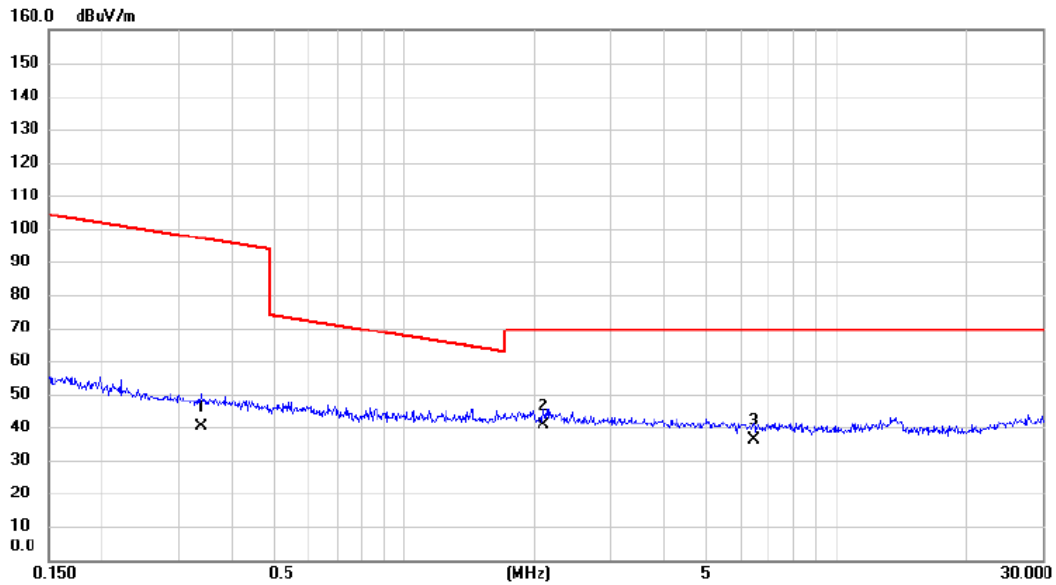

No.	Mk.	Freq. MHz	Reading Level dBuV	Correct Factor dB	Measure- ment dBuV/m	Limit dBuV/m	Margin dB	Detector	Comment
1		0.3401	23.32	17.02	40.34	96.97	-56.63	AVG	
2	*	2.0934	23.52	17.06	40.58	69.54	-28.96	QP	
3		6.4540	21.42	14.92	36.34	69.54	-33.20	QP	

REMARKS:

- (1) Measurement Value = Reading Level + Correct Factor.
- (2) Margin Level = Measurement Value - Limit Value.

APPENDIX C - RADIATED EMISSION - 30 MHZ TO 1000 MHZ

Test Mode: TX B MODE CHANNEL 11

Vertical

80 dBuV/m

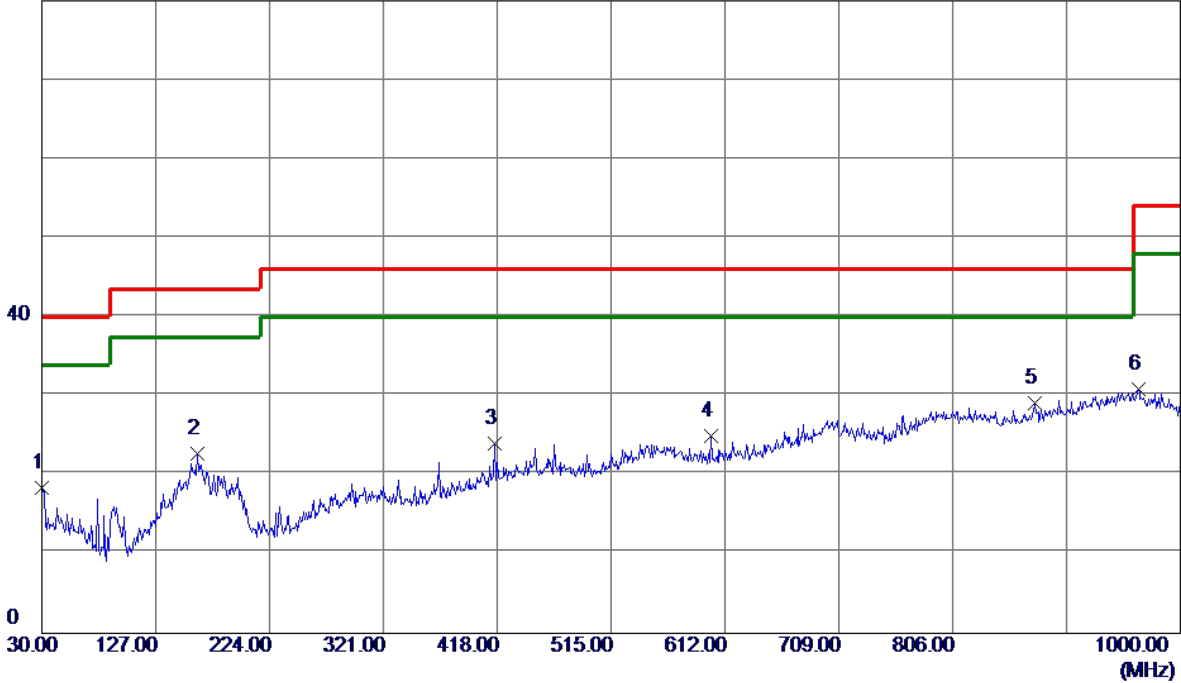

No.	Freq. MHz	Reading Level dBuV/m	Correct Factor dB	Measure ment dBuV/m	Limit dBuV/m	Margin dB	Detector	Comment
1	30.0000	33.44	-14.97	18.47	40.00	-21.53	Peak	
2	162.8900	33.44	-10.77	22.67	43.50	-20.83	Peak	
3	416.0600	32.72	-8.75	23.97	46.00	-22.03	Peak	
4	600.3600	31.31	-6.29	25.02	46.00	-20.98	Peak	
5 *	875.8400	30.28	-1.19	29.09	46.00	-16.91	Peak	
6	964.1100	29.78	1.07	30.85	54.00	-23.15	Peak	

REMARKS:

- (1) Measurement Value = Reading Level + Correct Factor.
- (2) Margin Level = Measurement Value - Limit Value.

Test Mode: TX B MODE CHANNEL 11

Horizontal

80 dBuV/m

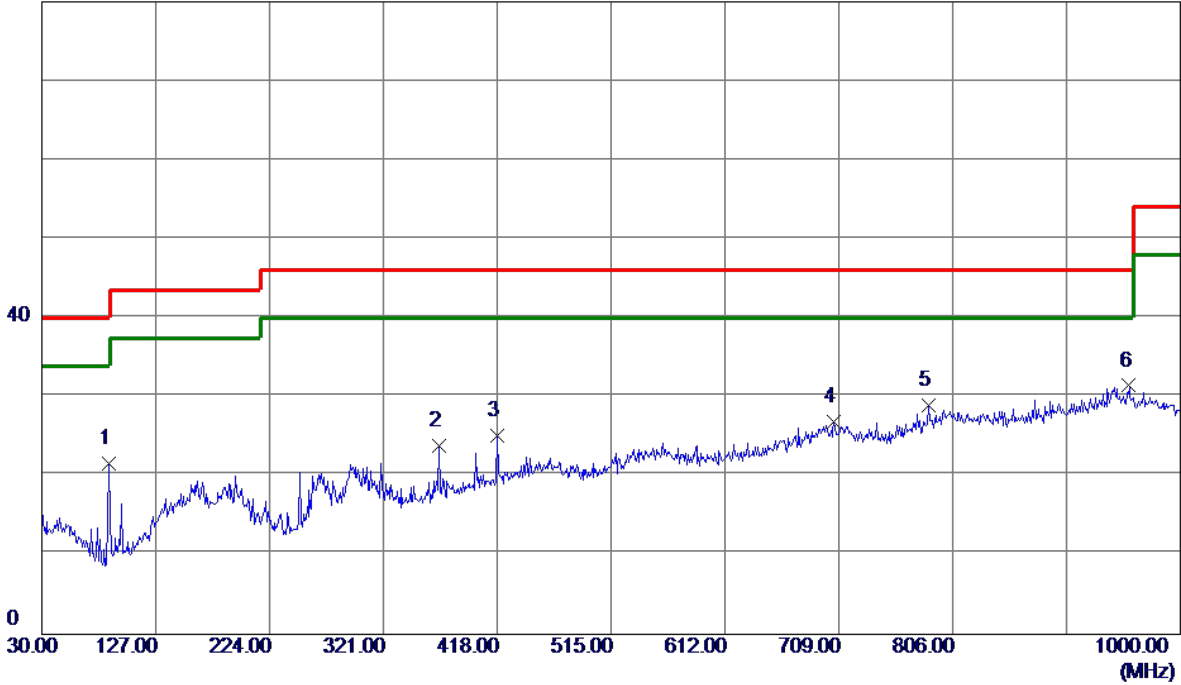

No.	Freq. MHz	Reading Level dBuV/m	Correct Factor dB	Measure ment dBuV/m	Limit dBuV/m	Margin dB	Detector	Comment
1	87.2300	40.88	-19.29	21.59	40.00	-18.41	Peak	
2	368.5300	34.24	-10.45	23.79	46.00	-22.21	Peak	
3	418.0000	33.79	-8.67	25.12	46.00	-20.88	Peak	
4	705.1200	29.80	-2.88	26.92	46.00	-19.08	Peak	
5	785.6300	30.81	-1.90	28.91	46.00	-17.09	Peak	
6 *	956.3500	30.18	1.26	31.44	46.00	-14.56	Peak	

REMARKS:

(1) Measurement Value = Reading Level + Correct Factor.

(2) Margin Level = Measurement Value - Limit Value.

APPENDIX D - RADIATED EMISSION- ABOVE 1000 MHZ

Orthogonal Axis	X
Test Mode:	TX B Mode 2412 MHz

Vertical

130 dBuV/m

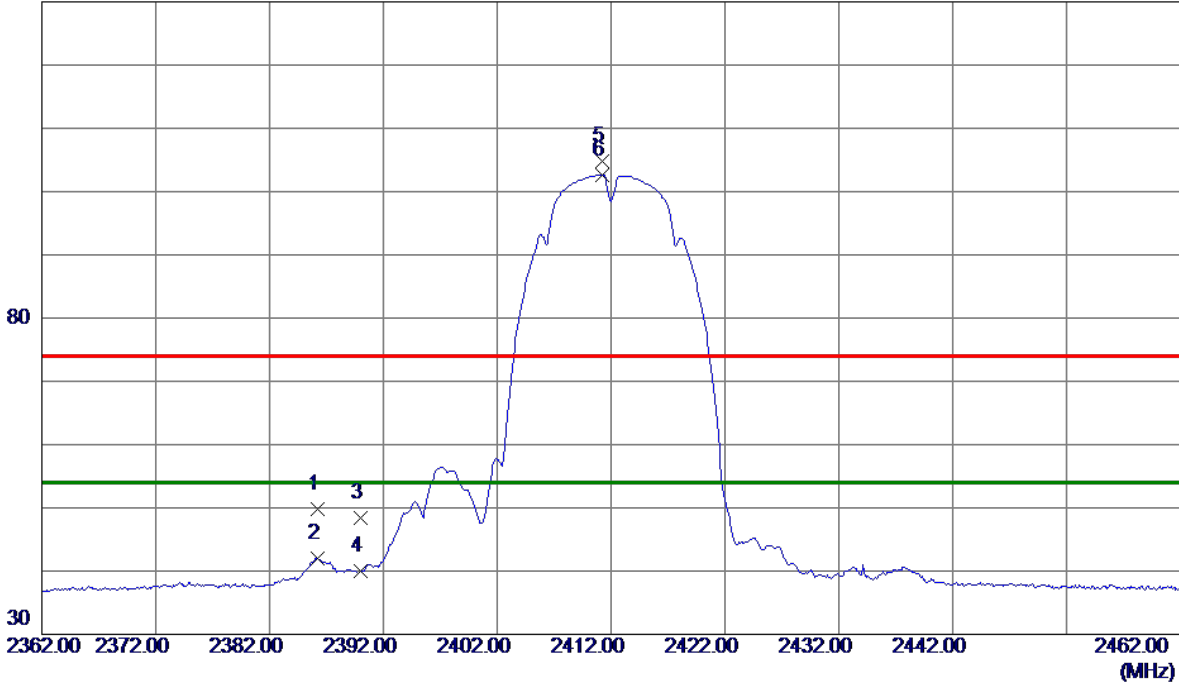

No.	Freq. MHz	Reading Level dBuV/m	Correct Factor dB	Measure ment dBuV/m	Limit dBuV/m	Margin dB	Detector	Comment
1	2386.2000	42.85	7.01	49.86	74.00	-24.14	Peak	
2	2386.2000	35.05	7.01	42.06	54.00	-11.94	AVG	
3	2390.0000	41.34	7.01	48.35	74.00	-25.65	Peak	
4	2390.0000	32.90	7.01	39.91	54.00	-14.09	AVG	
5	2411.2000	97.78	7.02	104.80	74.00	30.80	Peak	No Limit
6 *	2411.2000	95.64	7.02	102.66	54.00	48.66	AVG	No Limit

REMARKS:

- (1) Measurement Value = Reading Level + Correct Factor.
- (2) Margin Level = Measurement Value - Limit Value.

Orthogonal Axis	X
Test Mode:	TX B Mode 2412 MHz

Vertical

80 dBuV/m

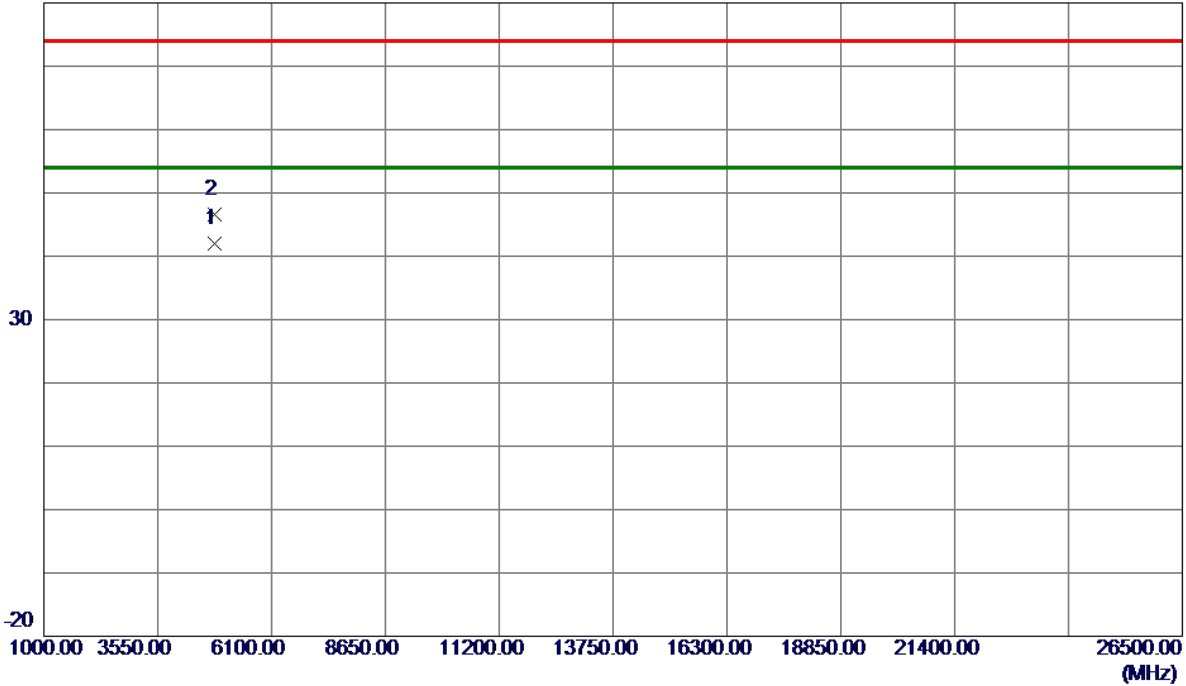

No.	Freq. MHz	Reading Level dBuV/m	Correct Factor dB	Measure ment dBuV/m	Limit dBuV/m	Margin dB	Detector	Comment
1 *	4823.9550	37.76	4.23	41.99	54.00	-12.01	AVG	
2	4824.0200	42.44	4.23	46.67	74.00	-27.33	Peak	

REMARKS:

- (1) Measurement Value = Reading Level + Correct Factor.
- (2) Margin Level = Measurement Value - Limit Value.

Orthogonal Axis	X
Test Mode:	TX B Mode 2412 MHz

Horizontal

130 dBuV/m

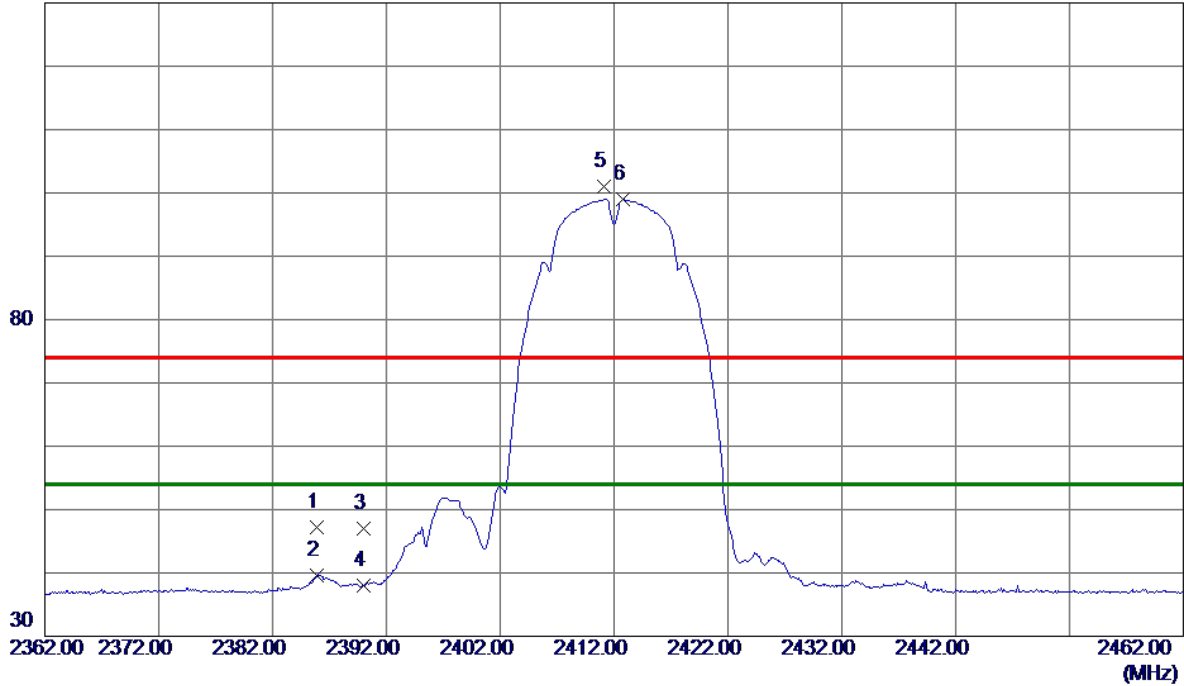

No.	Freq. MHz	Reading Level dBuV/m	Correct Factor dB	Measure ment dBuV/m	Limit dBuV/m	Margin dB	Detector	Comment
1	2385.9000	40.24	7.01	47.25	74.00	-26.75	Peak	
2	2385.9000	32.61	7.01	39.62	54.00	-14.38	AVG	
3	2390.0000	40.03	7.01	47.04	74.00	-26.96	Peak	
4	2390.0000	30.90	7.01	37.91	54.00	-16.09	AVG	
5	2411.1000	93.96	7.02	100.98	74.00	26.98	Peak	No Limit
6 *	2412.8000	92.06	7.02	99.08	54.00	45.08	AVG	No Limit

REMARKS:

- (1) Measurement Value = Reading Level + Correct Factor.
- (2) Margin Level = Measurement Value - Limit Value.

Orthogonal Axis	X
Test Mode:	TX B Mode 2412 MHz

Horizontal

80 dBuV/m

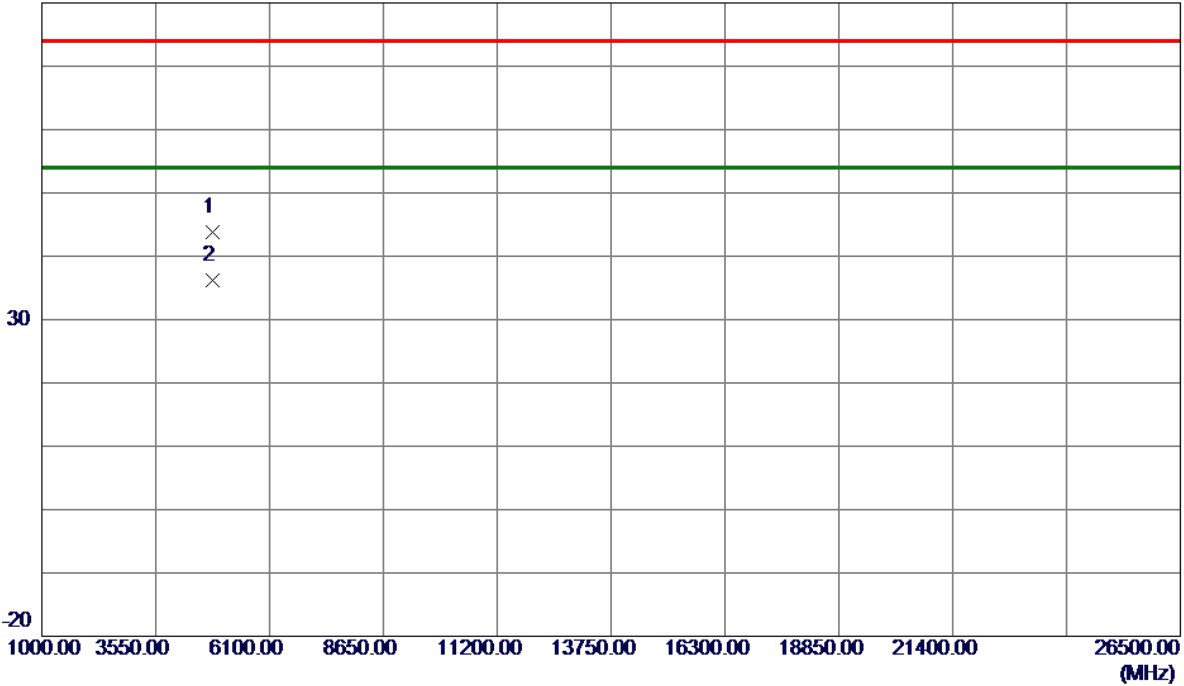

No.	Freq. MHz	Reading Level dBuV/m	Correct Factor dB	Measure ment dBuV/m	Limit dBuV/m	Margin dB	Detector	Comment
1	4823.8100	39.58	4.23	43.81	74.00	-30.19	Peak	
2 *	4823.9600	32.06	4.23	36.29	54.00	-17.71	AVG	

REMARKS:

- (1) Measurement Value = Reading Level + Correct Factor.
- (2) Margin Level = Measurement Value - Limit Value.

Orthogonal Axis	X
Test Mode:	TX B Mode 2437 MHz

Vertical

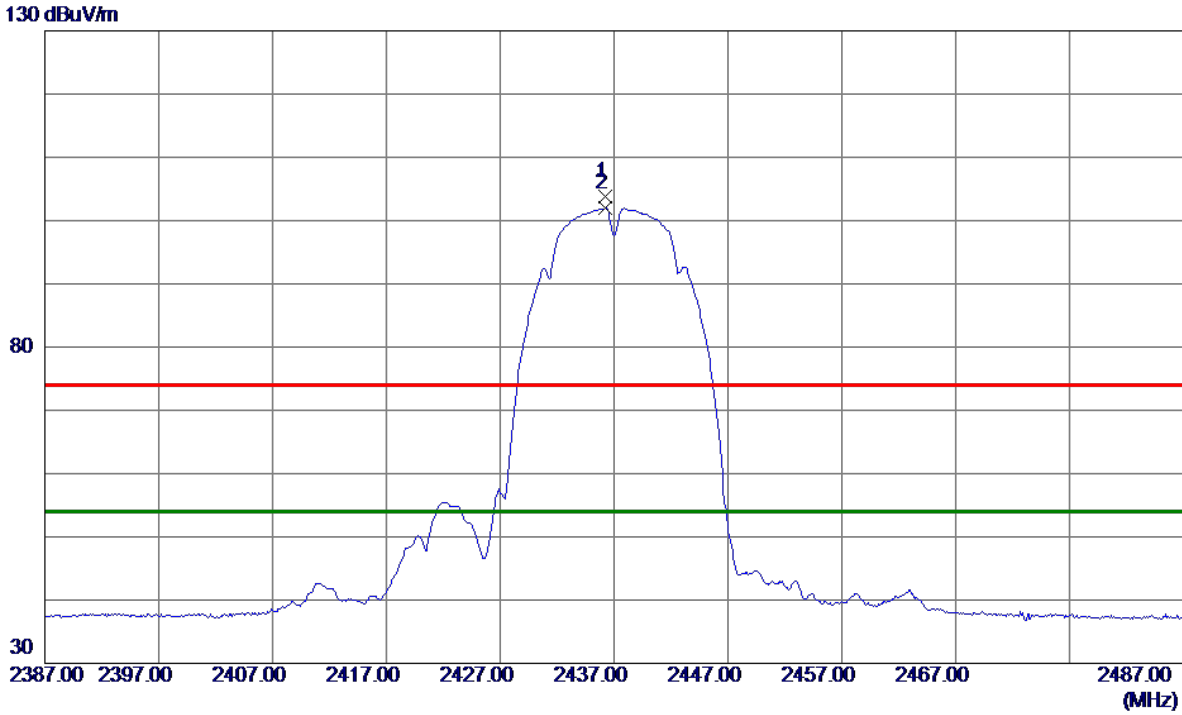

No.	Freq. MHz	Reading Level dBuV/m	Correct Factor dB	Measure ment dBuV/m	Limit dBuV/m	Margin dB	Detector	Comment
1	2436.2000	96.85	7.02	103.87	74.00	29.87	Peak	No Limit
2 *	2436.2000	94.90	7.02	101.92	54.00	47.92	AVG	No Limit

REMARKS:

- (1) Measurement Value = Reading Level + Correct Factor.
- (2) Margin Level = Measurement Value - Limit Value.

Orthogonal Axis	X
Test Mode:	TX B Mode 2437 MHz

Vertical

80 dBuV/m

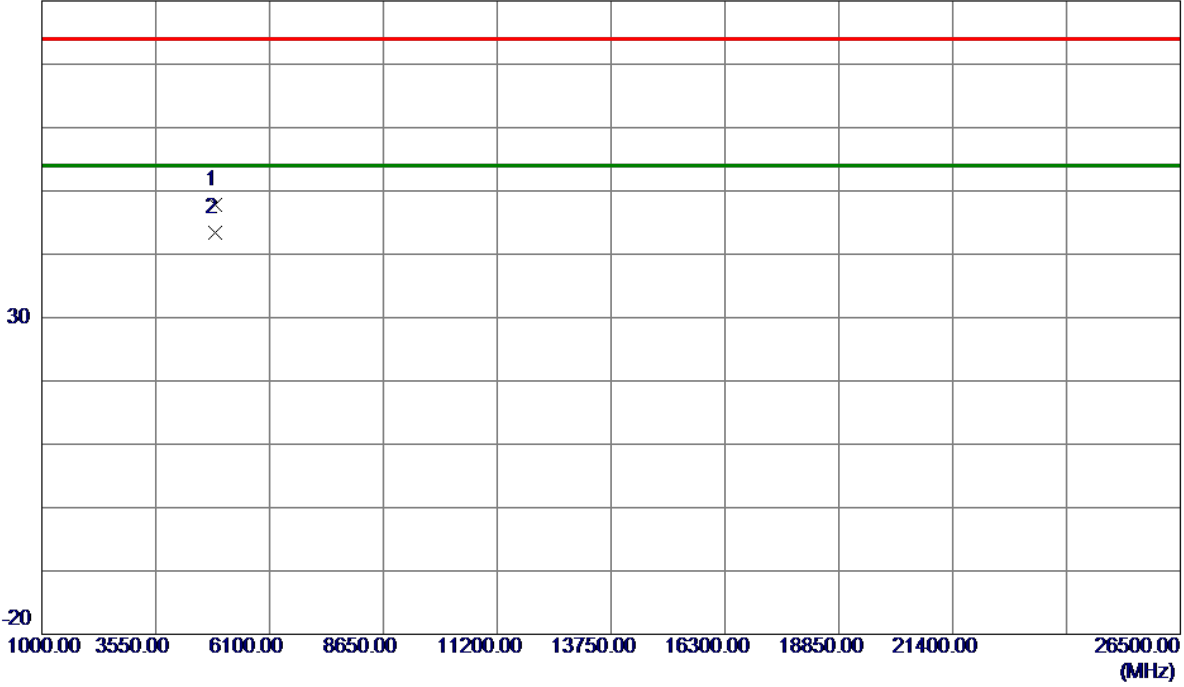

No.	Freq. MHz	Reading Level dBuV/m	Correct Factor dB	Measure ment dBuV/m	Limit dBuV/m	Margin dB	Detector	Comment
1	4873.8800	43.54	4.34	47.88	74.00	-26.12	Peak	
2 *	4873.9860	39.00	4.34	43.34	54.00	-10.66	AVG	

REMARKS:

- (1) Measurement Value = Reading Level + Correct Factor.
- (2) Margin Level = Measurement Value - Limit Value.

Orthogonal Axis	X
Test Mode:	TX B Mode 2437 MHz

Horizontal

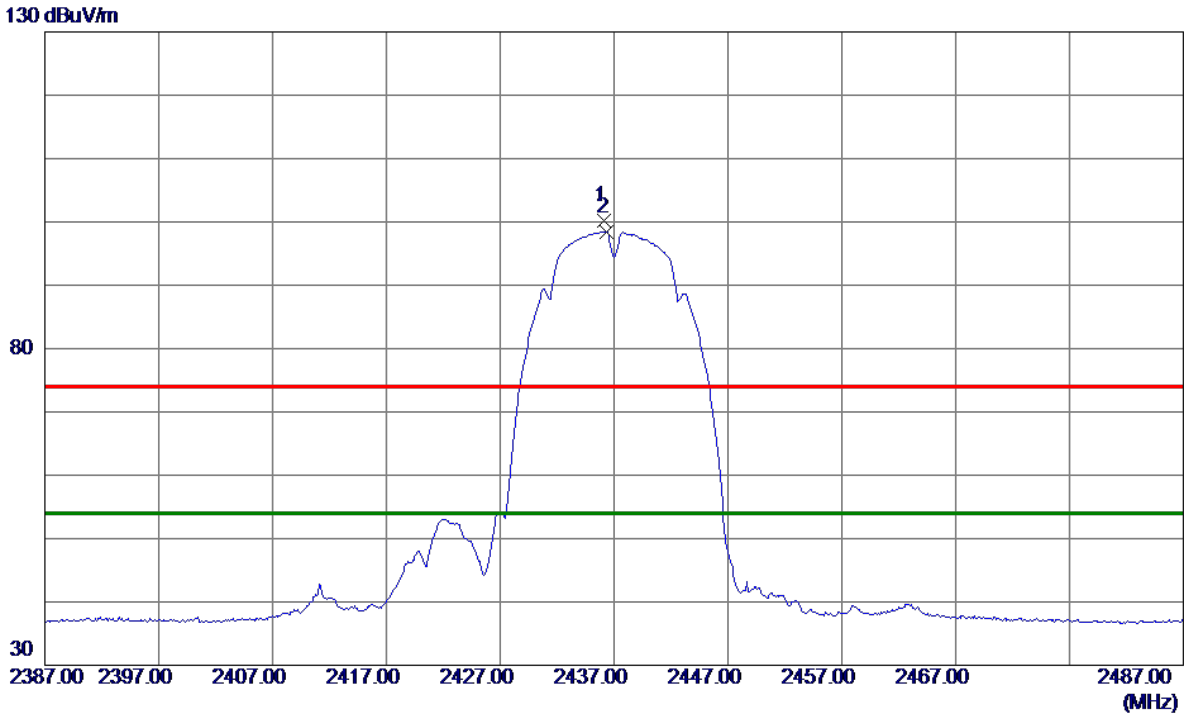

No.	Freq. MHz	Reading Level dBuV/m	Correct Factor dB	Measure ment dBuV/m	Limit dBuV/m	Margin dB	Detector	Comment
1	2436.1000	93.27	7.02	100.29	74.00	26.29	Peak	No Limit
2 *	2436.3000	91.45	7.02	98.47	54.00	44.47	AVG	No Limit

REMARKS:

- (1) Measurement Value = Reading Level + Correct Factor.
- (2) Margin Level = Measurement Value - Limit Value.

Orthogonal Axis	X
Test Mode:	TX B Mode 2437 MHz

Horizontal

80 dBuV/m

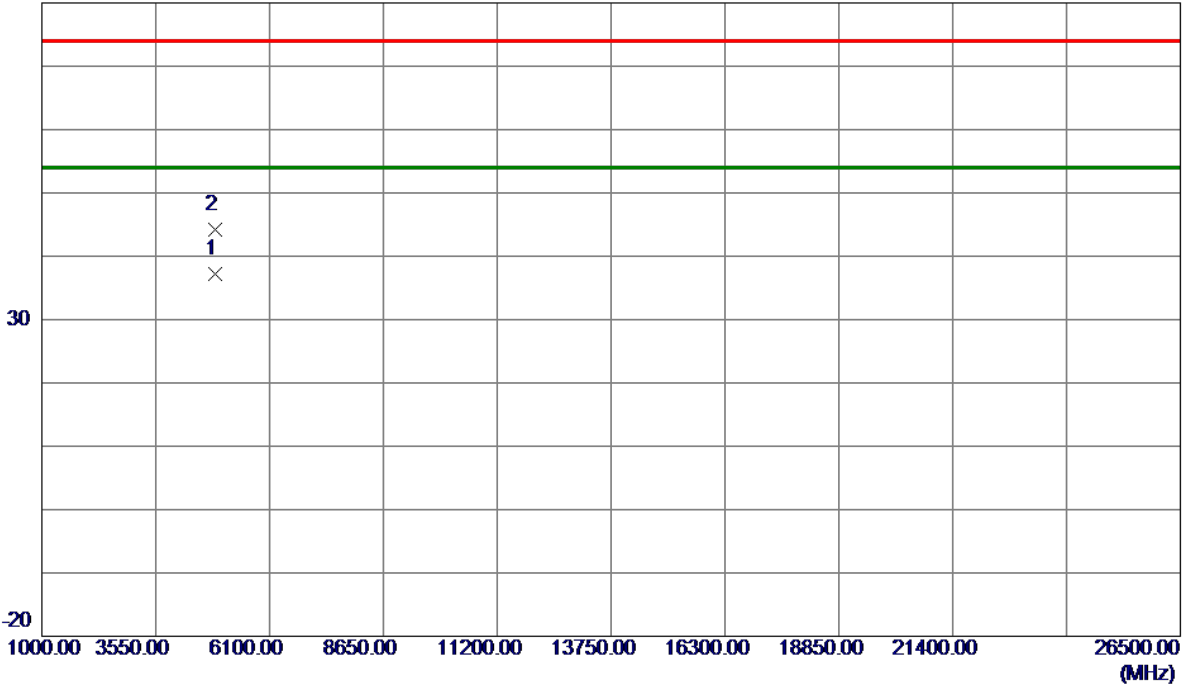

No.	Freq. MHz	Reading Level dBuV/m	Correct Factor dB	Measure ment dBuV/m	Limit dBuV/m	Margin dB	Detector	Comment
1 *	4873.9550	32.95	4.34	37.29	54.00	-16.71	AVG	
2	4874.1150	39.81	4.34	44.15	74.00	-29.85	Peak	

REMARKS:

- (1) Measurement Value = Reading Level + Correct Factor.
- (2) Margin Level = Measurement Value - Limit Value.

Orthogonal Axis	X
Test Mode:	TX B Mode 2462 MHz

Vertical

130 dBuV/m

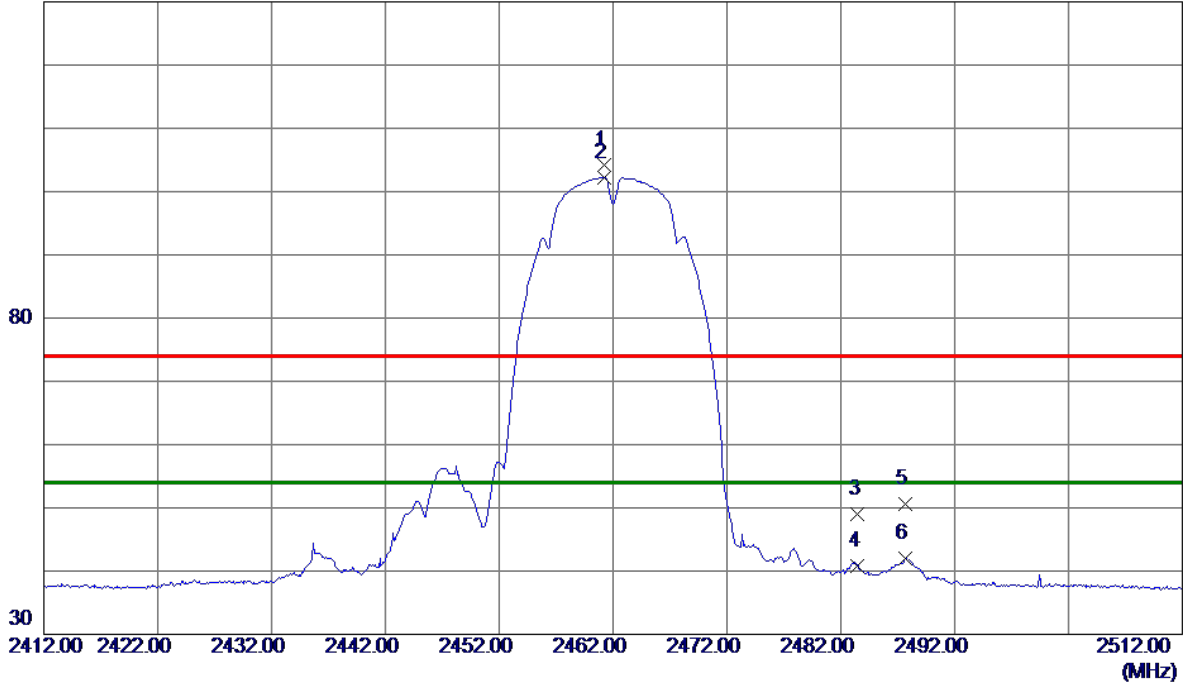

No.	Freq. MHz	Reading Level dBuV/m	Correct Factor dB	Measure ment dBuV/m	Limit dBuV/m	Margin dB	Detector	Comment
1	2461.2000	97.15	7.03	104.18	74.00	30.18	Peak	No Limit
2 *	2461.2000	95.14	7.03	102.17	54.00	48.17	AVG	No Limit
3	2483.5000	41.98	7.03	49.01	74.00	-24.99	Peak	
4	2483.5000	33.76	7.03	40.79	54.00	-13.21	AVG	
5	2487.7000	43.50	7.03	50.53	74.00	-23.47	Peak	
6	2487.7000	34.92	7.03	41.95	54.00	-12.05	AVG	

REMARKS:

- (1) Measurement Value = Reading Level + Correct Factor.
- (2) Margin Level = Measurement Value - Limit Value.

Orthogonal Axis	X
Test Mode:	TX B Mode 2462 MHz

Vertical

80 dBuV/m

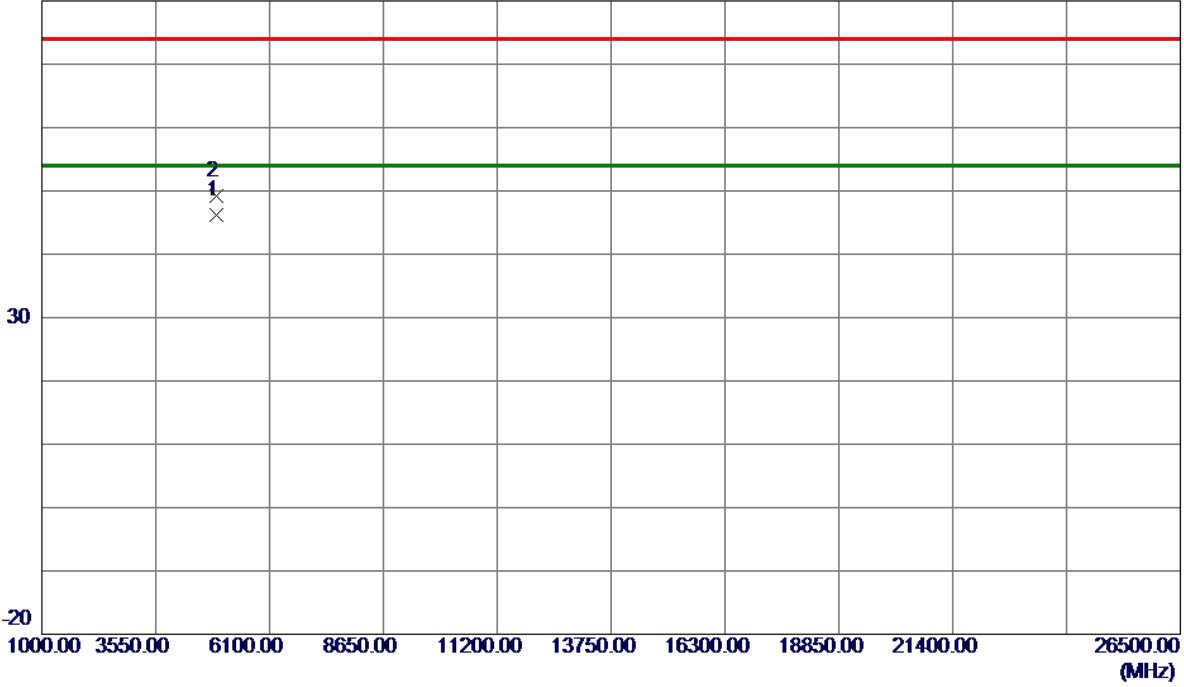

No.	Freq. MHz	Reading Level dBuV/m	Correct Factor dB	Measure ment dBuV/m	Limit dBuV/m	Margin dB	Detector	Comment
1 *	4923.9640	41.68	4.44	46.12	54.00	-7.88	AVG	
2	4924.0000	44.79	4.44	49.23	74.00	-24.77	Peak	

REMARKS:

- (1) Measurement Value = Reading Level + Correct Factor.
- (2) Margin Level = Measurement Value - Limit Value.

Orthogonal Axis	X
Test Mode:	TX B Mode 2462 MHz

Horizontal

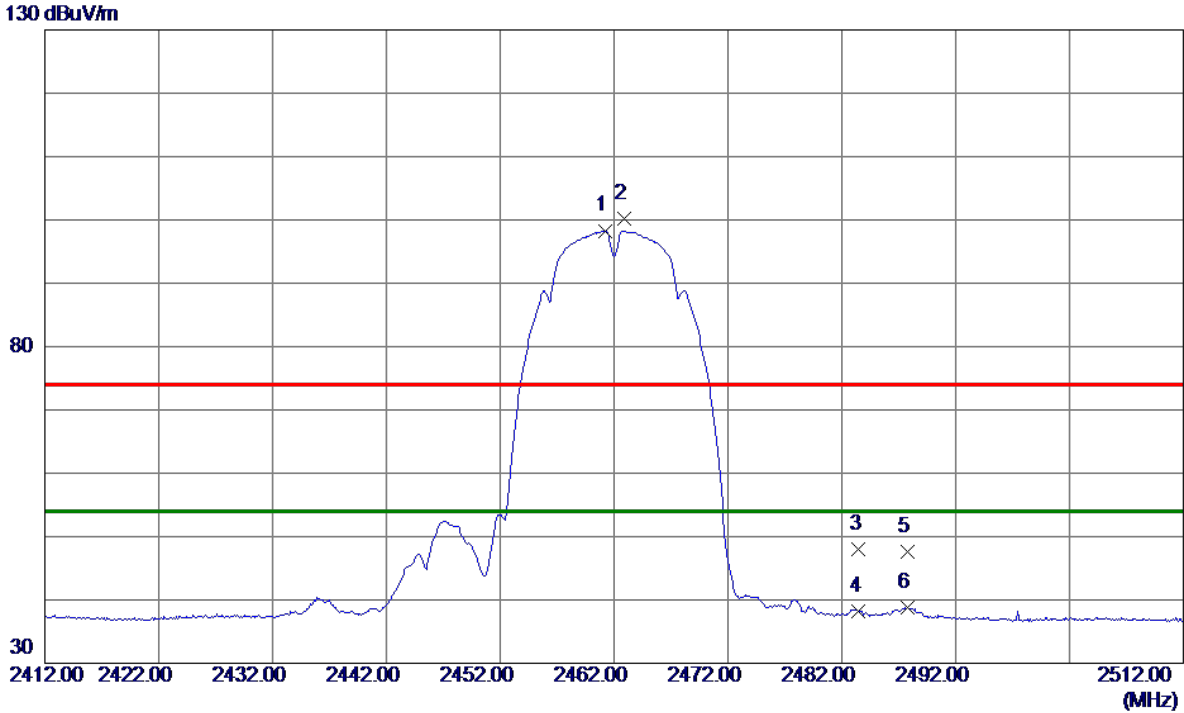

No.	Freq. MHz	Reading Level dBuV/m	Correct Factor dB	Measure ment dBuV/m	Limit dBuV/m	Margin dB	Detector	Comment
1 *	2461.2000	91.27	7.03	98.30	54.00	44.30	AVG	No Limit
2	2462.9000	93.13	7.03	100.16	74.00	26.16	Peak	No Limit
3	2483.5000	40.92	7.03	47.95	74.00	-26.05	Peak	
4	2483.5000	31.18	7.03	38.21	54.00	-15.79	AVG	
5	2487.8000	40.61	7.03	47.64	74.00	-26.36	Peak	
6	2487.8000	31.74	7.03	38.77	54.00	-15.23	AVG	

REMARKS:

- (1) Measurement Value = Reading Level + Correct Factor.
- (2) Margin Level = Measurement Value - Limit Value.

Orthogonal Axis	X
Test Mode:	TX B Mode 2462 MHz

Horizontal

80 dBuV/m

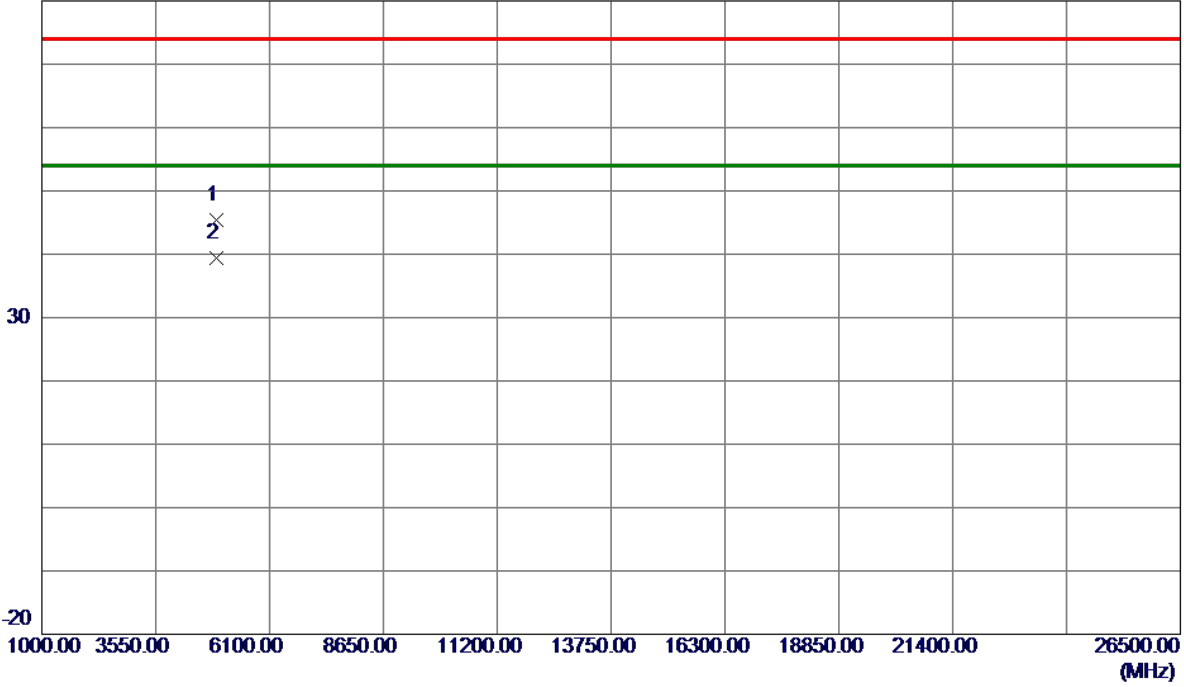

No.	Freq. MHz	Reading Level dBuV/m	Correct Factor dB	Measure ment dBuV/m	Limit dBuV/m	Margin dB	Detector	Comment
1	4923.8760	40.94	4.44	45.38	74.00	-28.62	Peak	
2 *	4923.9680	34.89	4.44	39.33	54.00	-14.67	AVG	

REMARKS:

- (1) Measurement Value = Reading Level + Correct Factor.
- (2) Margin Level = Measurement Value - Limit Value.

Orthogonal Axis	X
Test Mode:	TX G Mode 2412 MHz

Vertical

130 dBuV/m

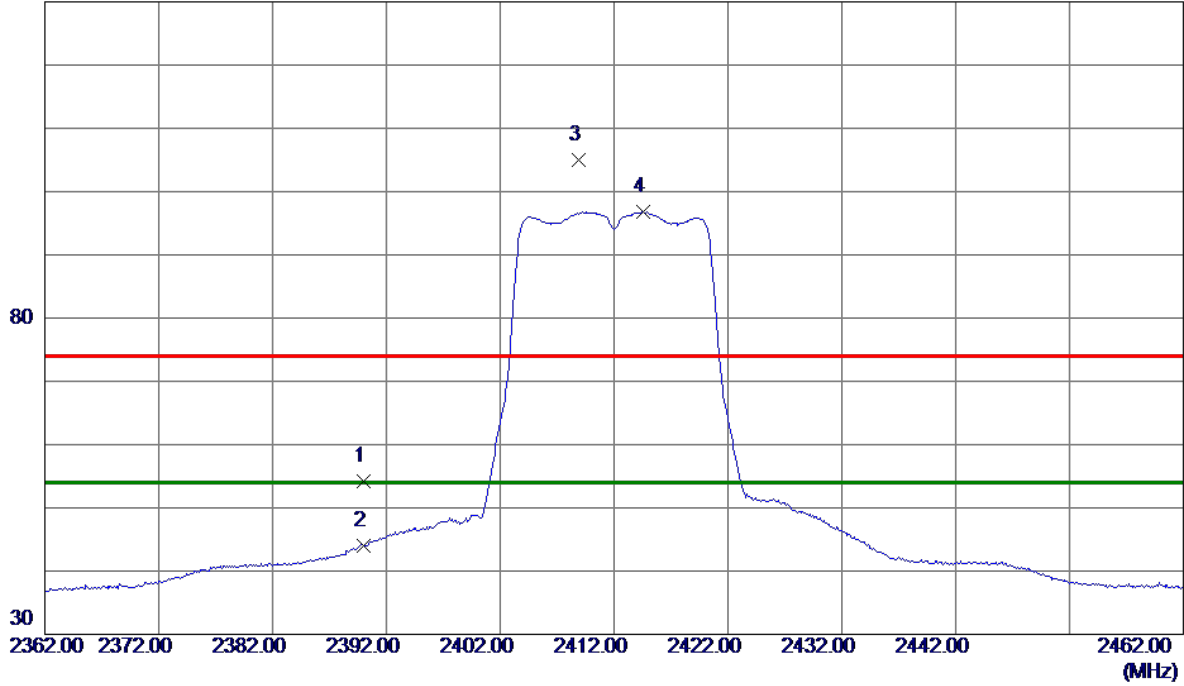

No.	Freq. MHz	Reading Level dBuV/m	Correct Factor dB	Measure ment dBuV/m	Limit dBuV/m	Margin dB	Detector	Comment
1	2390.0000	47.28	7.01	54.29	74.00	-19.71	Peak	
2	2390.0000	36.97	7.01	43.98	54.00	-10.02	AVG	
3	2408.9000	97.88	7.02	104.90	74.00	30.90	Peak	No Limit
4 *	2414.6000	89.81	7.02	96.83	54.00	42.83	AVG	No Limit

REMARKS:

- (1) Measurement Value = Reading Level + Correct Factor.
- (2) Margin Level = Measurement Value - Limit Value.

Orthogonal Axis	X
Test Mode:	TX G Mode 2412 MHz

Vertical

80 dBuV/m

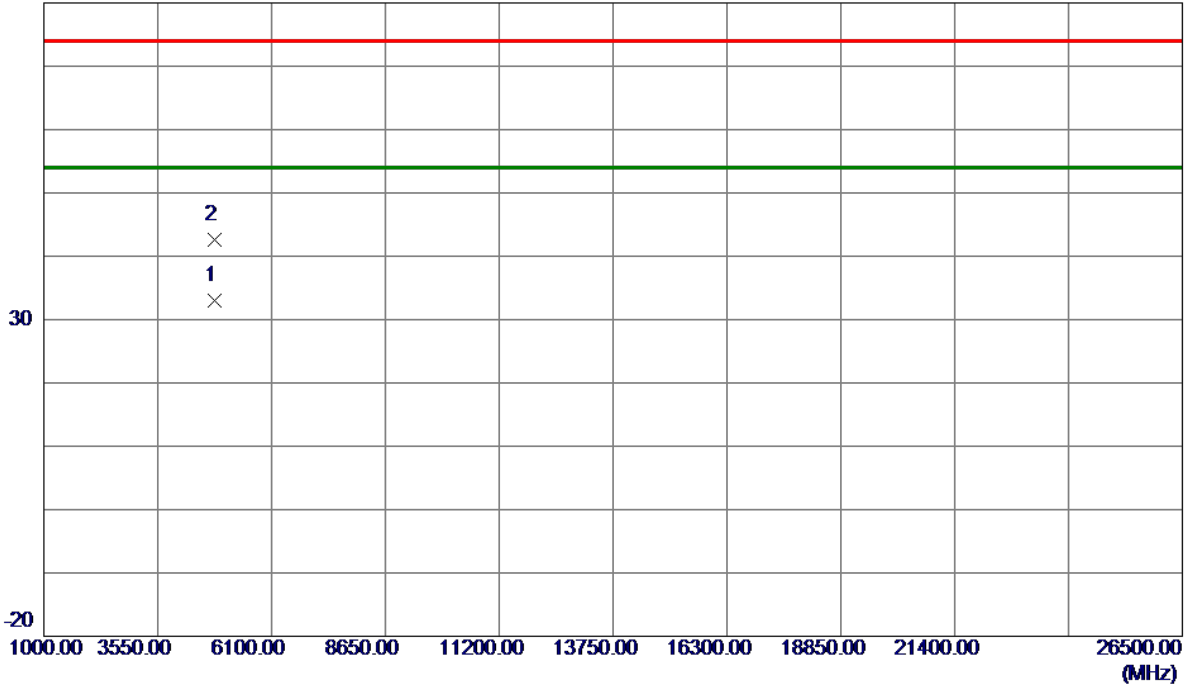

No.	Freq. MHz	Reading Level dBuV/m	Correct Factor dB	Measure ment dBuV/m	Limit dBuV/m	Margin dB	Detector	Comment
1 *	4824.0120	28.70	4.23	32.93	54.00	-21.07	AVG	
2	4824.0560	38.35	4.23	42.58	74.00	-31.42	Peak	

REMARKS:

- (1) Measurement Value = Reading Level + Correct Factor.
- (2) Margin Level = Measurement Value - Limit Value.

Orthogonal Axis	X
Test Mode:	TX G Mode 2412 MHz

Horizontal

130 dBuV/m

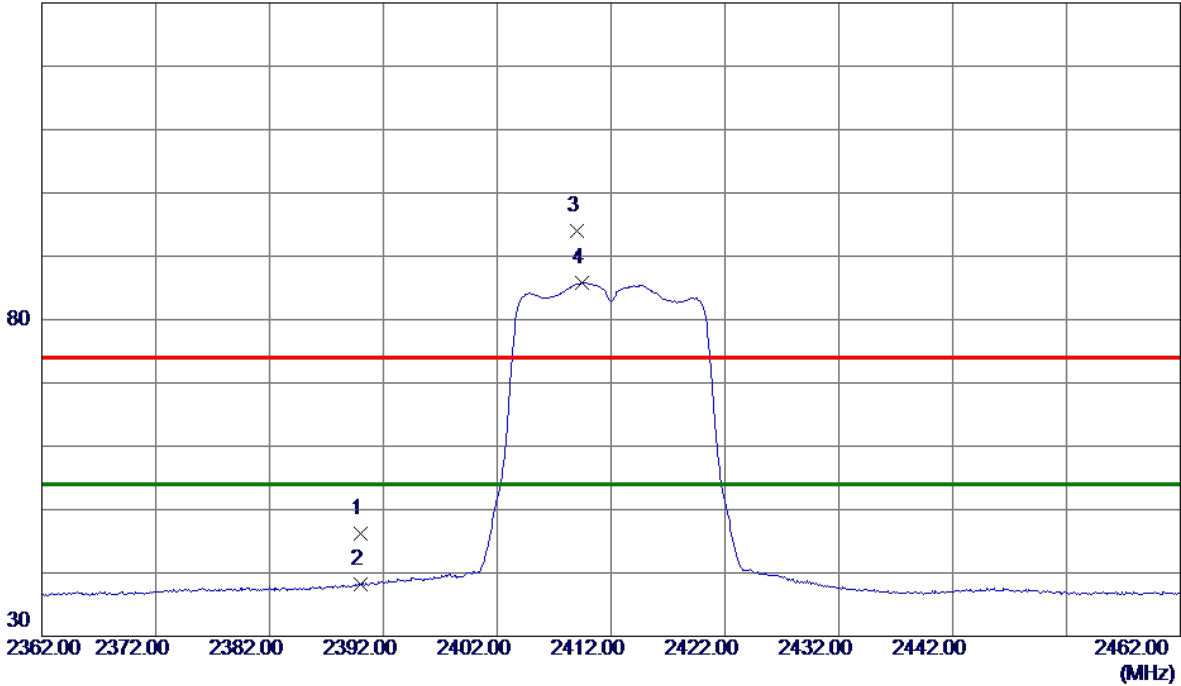

No.	Freq. MHz	Reading Level dBuV/m	Correct Factor dB	Measure ment dBuV/m	Limit dBuV/m	Margin dB	Detector	Comment
1	2390.0000	39.22	7.01	46.23	74.00	-27.77	Peak	
2	2390.0000	31.28	7.01	38.29	54.00	-15.71	AVG	
3	2409.0000	86.98	7.02	94.00	74.00	20.00	Peak	No Limit
4 *	2409.4000	78.77	7.02	85.79	54.00	31.79	AVG	No Limit

REMARKS:

- (1) Measurement Value = Reading Level + Correct Factor.
- (2) Margin Level = Measurement Value - Limit Value.

Orthogonal Axis	X
Test Mode:	TX G Mode 2412 MHz

Horizontal

80 dBuV/m

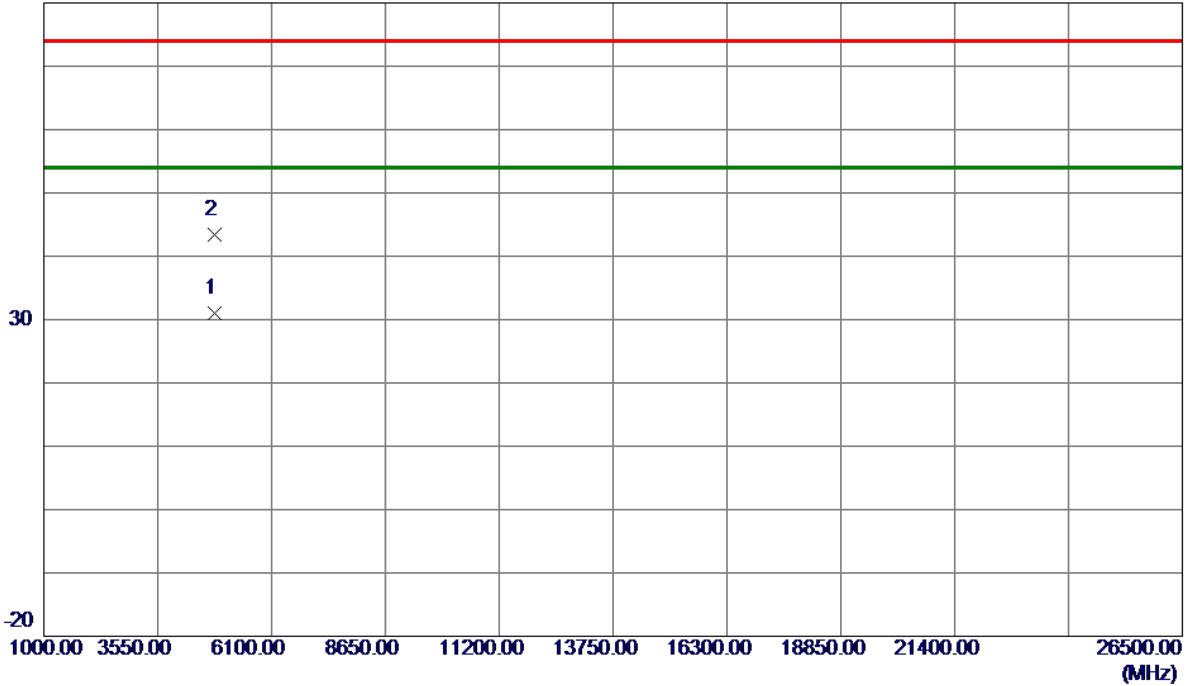

No.	Freq. MHz	Reading Level dBuV/m	Correct Factor dB	Measure ment dBuV/m	Limit dBuV/m	Margin dB	Detector	Comment
1 *	4823.9540	26.83	4.23	31.06	54.00	-22.94	AVG	
2	4824.0840	39.10	4.23	43.33	74.00	-30.67	Peak	

REMARKS:

- (1) Measurement Value = Reading Level + Correct Factor.
- (2) Margin Level = Measurement Value - Limit Value.

Orthogonal Axis	X
Test Mode:	TX G Mode 2437 MHz

Vertical

130 dBuV/m

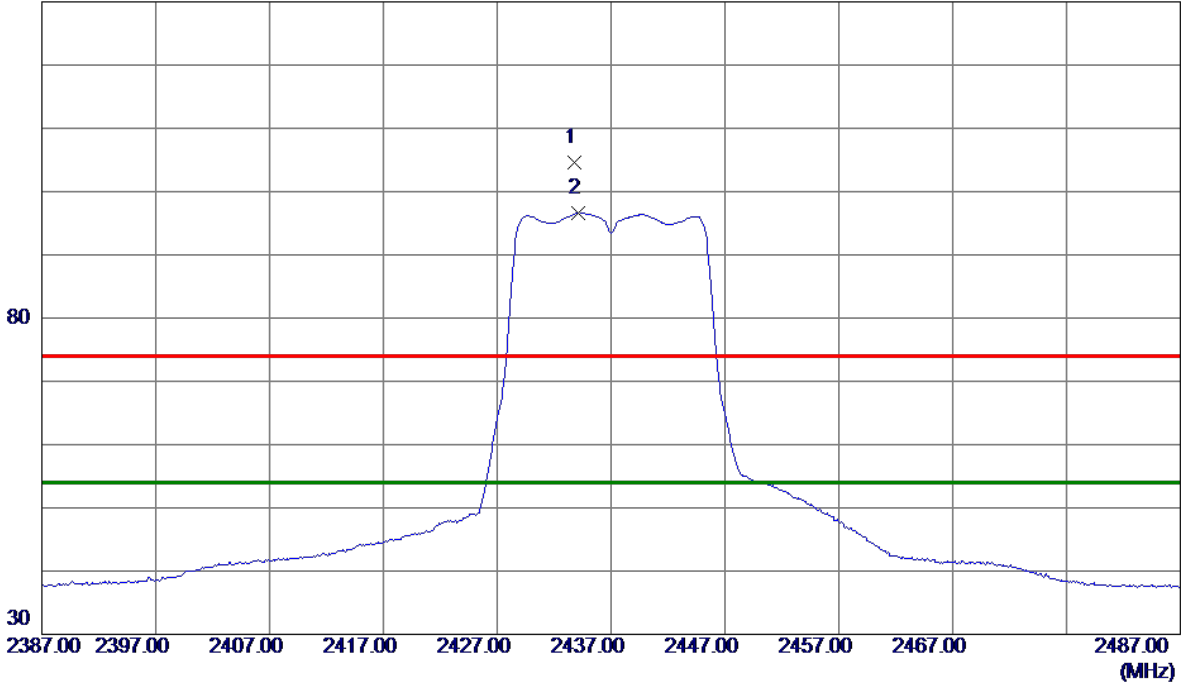

No.	Freq. MHz	Reading Level dBuV/m	Correct Factor dB	Measure ment dBuV/m	Limit dBuV/m	Margin dB	Detector	Comment
1	2433.8000	97.64	7.02	104.66	74.00	30.66	Peak	No Limit
2 *	2434.1000	89.62	7.02	96.64	54.00	42.64	AVG	No Limit

REMARKS:

- (1) Measurement Value = Reading Level + Correct Factor.
- (2) Margin Level = Measurement Value - Limit Value.

Orthogonal Axis	X
Test Mode:	TX G Mode 2437 MHz

Vertical

80 dBuV/m

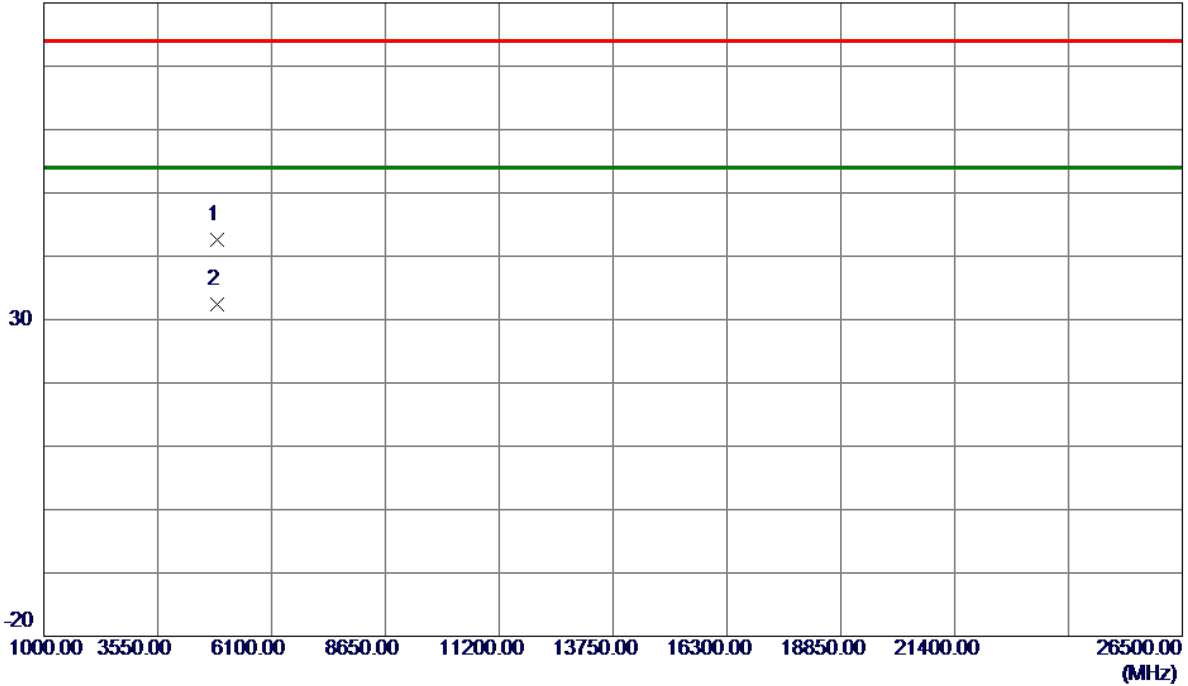

No.	Freq. MHz	Reading Level dBuV/m	Correct Factor dB	Measure ment dBuV/m	Limit dBuV/m	Margin dB	Detector	Comment
1	4873.8100	38.20	4.34	42.54	74.00	-31.46	Peak	
2 *	4874.0740	28.05	4.34	32.39	54.00	-21.61	AVG	

REMARKS:

- (1) Measurement Value = Reading Level + Correct Factor.
- (2) Margin Level = Measurement Value - Limit Value.

Orthogonal Axis	X
Test Mode:	TX G Mode 2437 MHz

Horizontal

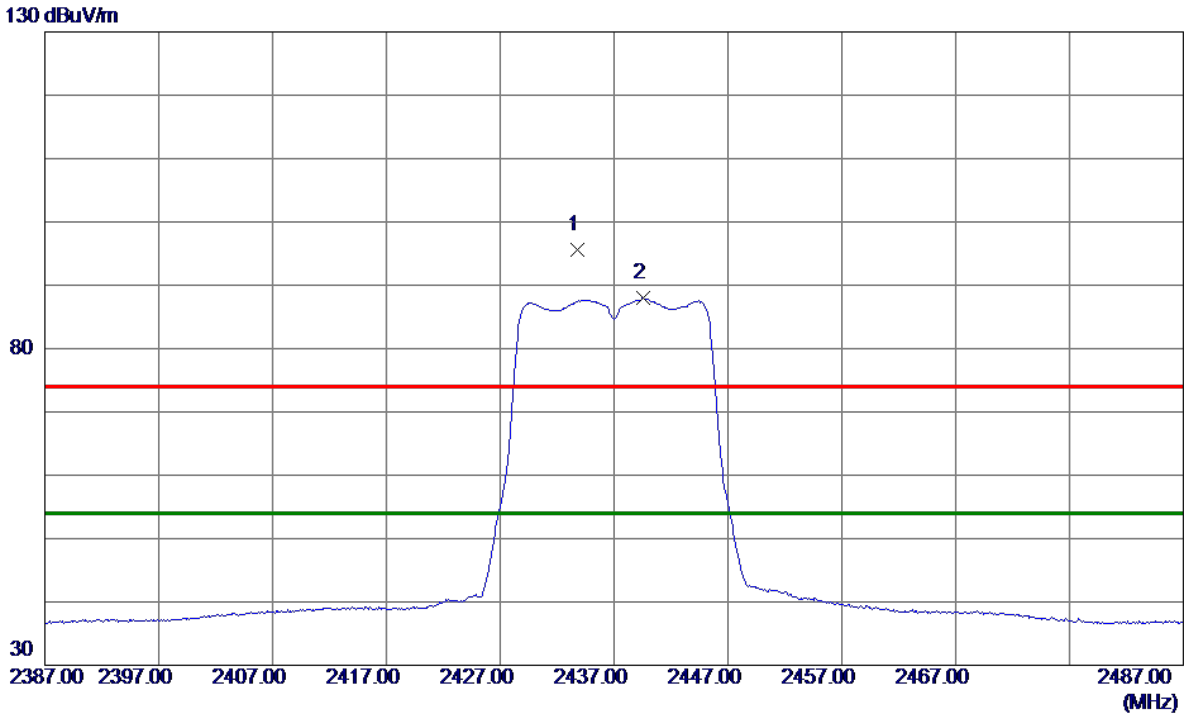

No.	Freq. MHz	Reading Level dBuV/m	Correct Factor dB	Measure ment dBuV/m	Limit dBuV/m	Margin dB	Detector	Comment
1	2433.8000	88.66	7.02	95.68	74.00	21.68	Peak	No Limit
2 *	2439.6000	80.95	7.02	87.97	54.00	33.97	AVG	No Limit

REMARKS:

- (1) Measurement Value = Reading Level + Correct Factor.
- (2) Margin Level = Measurement Value - Limit Value.

Orthogonal Axis	X
Test Mode:	TX G Mode 2437 MHz

Horizontal

80 dBuV/m

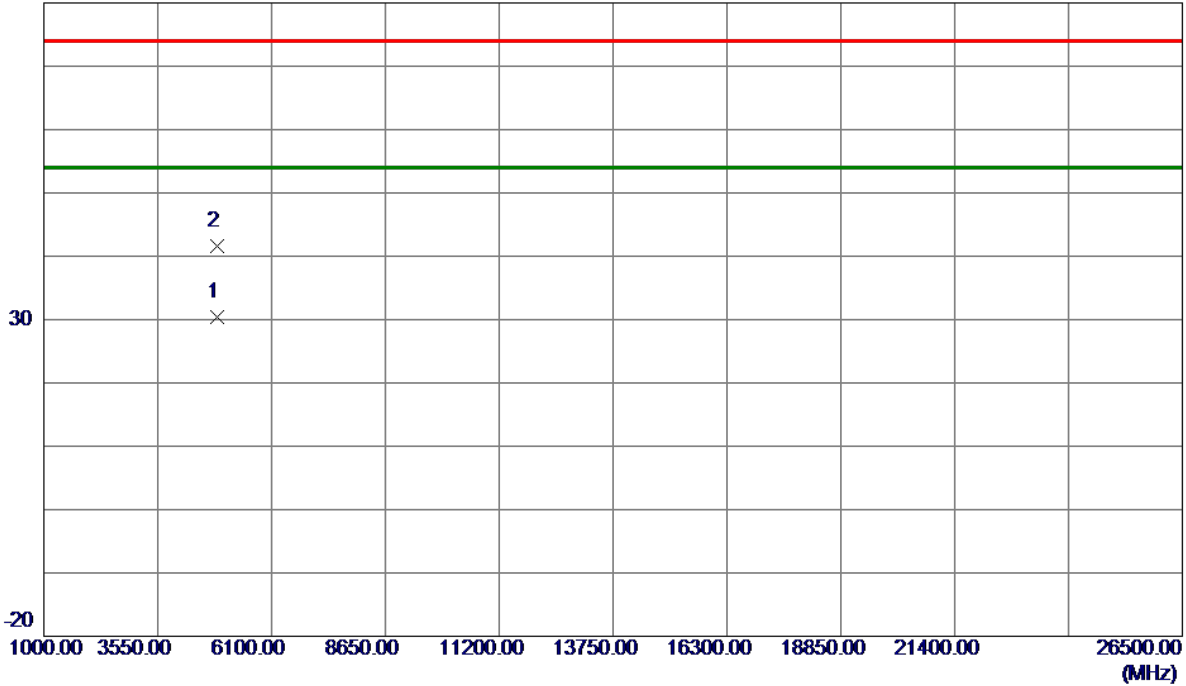

No.	Freq. MHz	Reading Level dBuV/m	Correct Factor dB	Measure ment dBuV/m	Limit dBuV/m	Margin dB	Detector	Comment
1 *	4873.0440	26.16	4.33	30.49	54.00	-23.51	AVG	
2	4873.3340	37.35	4.34	41.69	74.00	-32.31	Peak	

REMARKS:

- (1) Measurement Value = Reading Level + Correct Factor.
- (2) Margin Level = Measurement Value - Limit Value.

Orthogonal Axis	X
Test Mode:	TX G Mode 2462 MHz

Vertical

130 dBuV/m

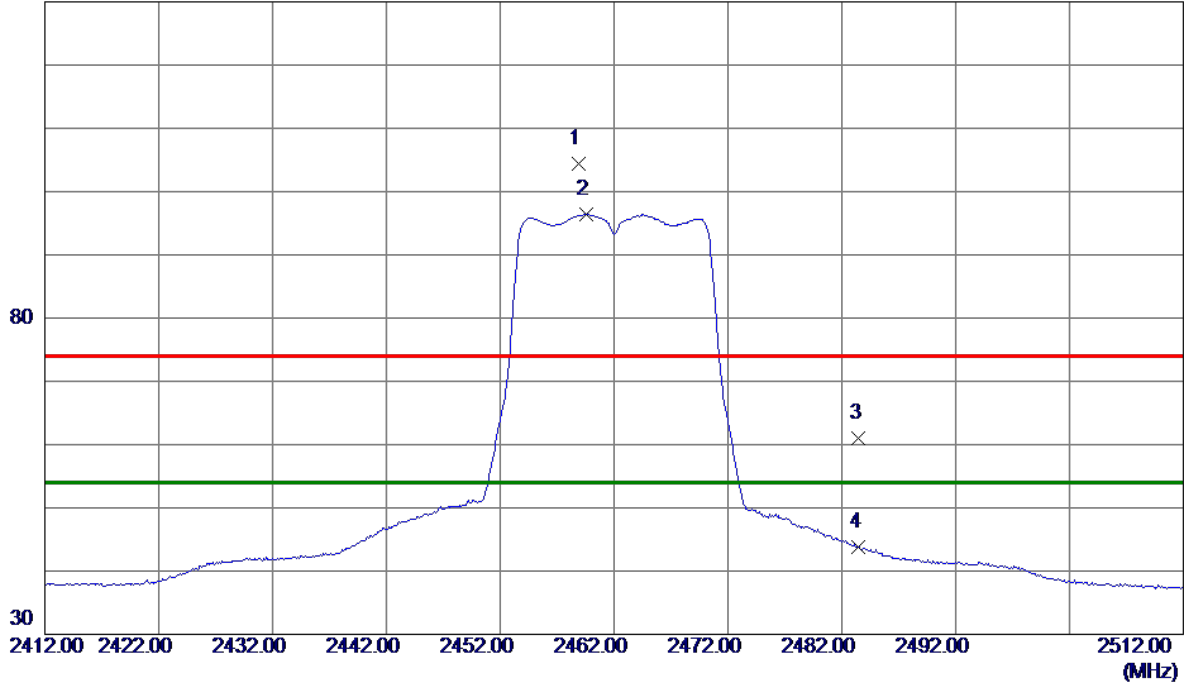

No.	Freq. MHz	Reading Level dBuV/m	Correct Factor dB	Measure ment dBuV/m	Limit dBuV/m	Margin dB	Detector	Comment
1	2458.9000	97.41	7.03	104.44	74.00	30.44	Peak	No Limit
2 *	2459.6000	89.41	7.03	96.44	54.00	42.44	AVG	No Limit
3	2483.5000	53.93	7.03	60.96	74.00	-13.04	Peak	
4	2483.5000	36.75	7.03	43.78	54.00	-10.22	AVG	

REMARKS:

- (1) Measurement Value = Reading Level + Correct Factor.
- (2) Margin Level = Measurement Value - Limit Value.

Orthogonal Axis	X
Test Mode:	TX G Mode 2462 MHz

Vertical

80 dBuV/m

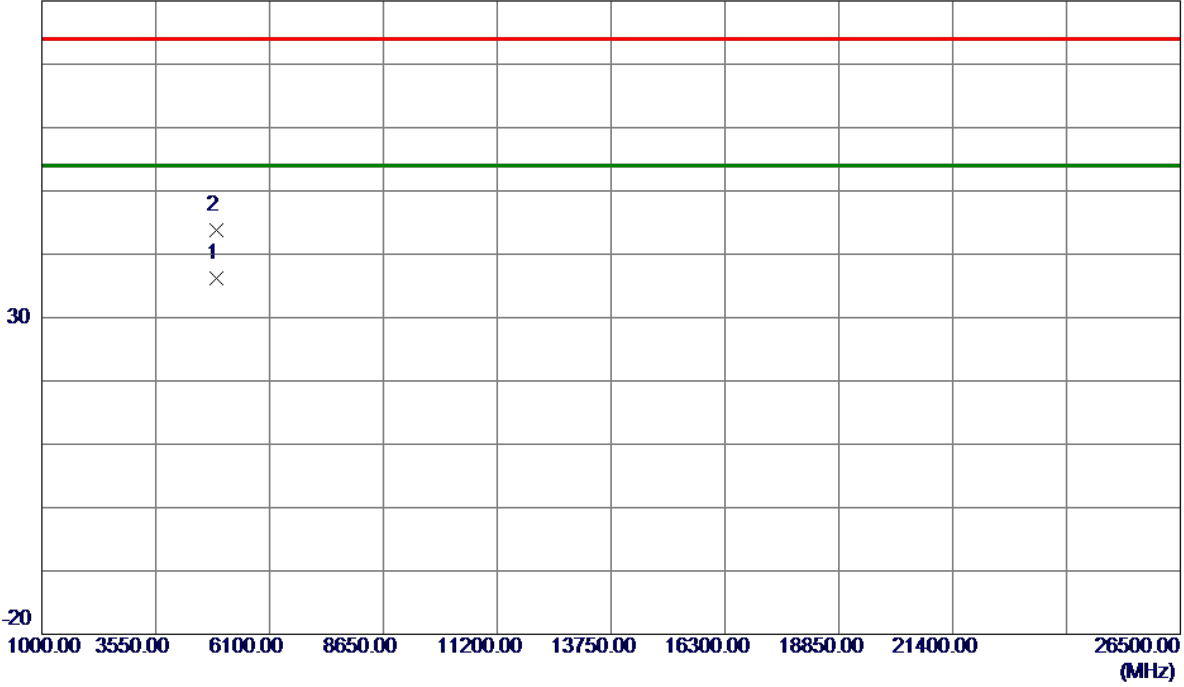

No.	Freq. MHz	Reading Level dBuV/m	Correct Factor dB	Measure ment dBuV/m	Limit dBuV/m	Margin dB	Detector	Comment
1 *	4923.9660	31.75	4.44	36.19	54.00	-17.81	AVG	
2	4924.1480	39.44	4.44	43.88	74.00	-30.12	Peak	

REMARKS:

- (1) Measurement Value = Reading Level + Correct Factor.
- (2) Margin Level = Measurement Value - Limit Value.

Orthogonal Axis	X
Test Mode:	TX G Mode 2462 MHz

Horizontal

130 dBuV/m

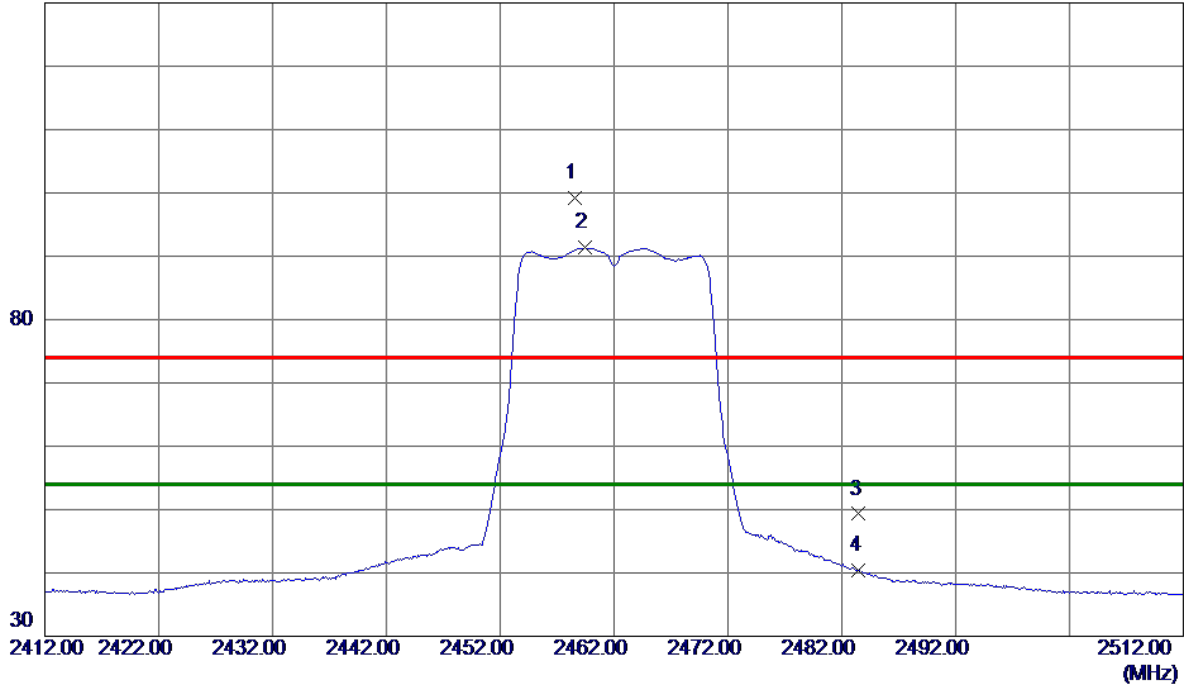

No.	Freq. MHz	Reading Level dBuV/m	Correct Factor dB	Measure ment dBuV/m	Limit dBuV/m	Margin dB	Detector	Comment
1	2458.6000	92.22	7.03	99.25	74.00	25.25	Peak	No Limit
2 *	2459.4000	84.29	7.03	91.32	54.00	37.32	AVG	No Limit
3	2483.5000	42.27	7.03	49.30	74.00	-24.70	Peak	
4	2483.5000	33.29	7.03	40.32	54.00	-13.68	AVG	

REMARKS:

- (1) Measurement Value = Reading Level + Correct Factor.
- (2) Margin Level = Measurement Value - Limit Value.

Orthogonal Axis	X
Test Mode:	TX G Mode 2462 MHz

Horizontal

80 dBuV/m

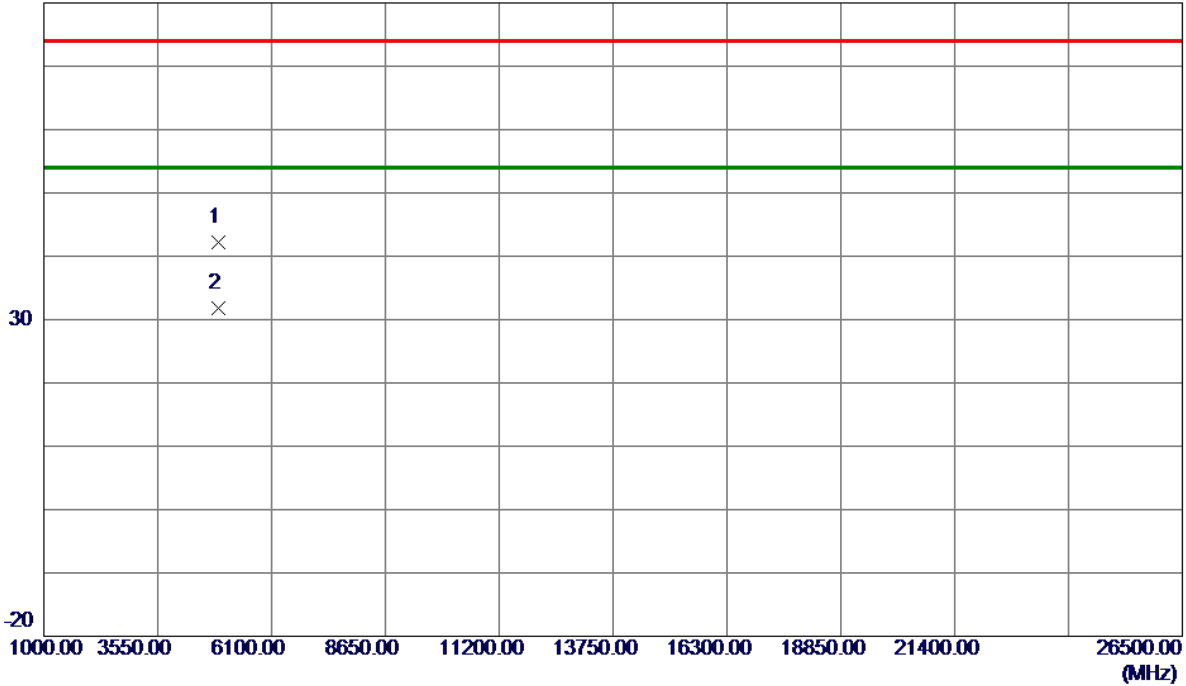

No.	Freq. MHz	Reading Level dBuV/m	Correct Factor dB	Measure ment dBuV/m	Limit dBuV/m	Margin dB	Detector	Comment
1	4923.9620	37.84	4.44	42.28	74.00	-31.72	Peak	
2 *	4923.9840	27.36	4.44	31.80	54.00	-22.20	AVG	

REMARKS:

- (1) Measurement Value = Reading Level + Correct Factor.
- (2) Margin Level = Measurement Value - Limit Value.

Orthogonal Axis	X
Test Mode:	TX N-20M Mode 2412 MHz

Vertical

130 dBuV/m

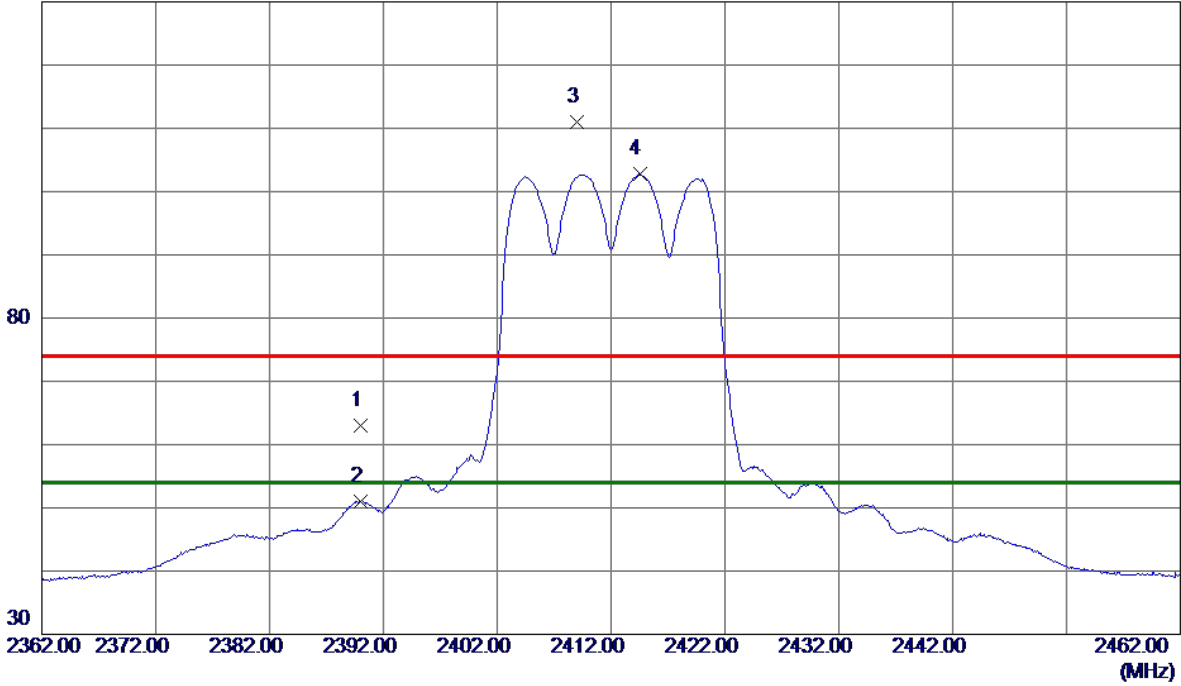

No.	Freq. MHz	Reading Level dBuV/m	Correct Factor dB	Measure ment dBuV/m	Limit dBuV/m	Margin dB	Detector	Comment
1	2390.0000	55.94	7.01	62.95	74.00	-11.05	Peak	
2	2390.0000	43.92	7.01	50.93	54.00	-3.07	AVG	
3	2409.0000	104.03	7.02	111.05	74.00	37.05	Peak	No Limit
4 *	2414.5000	95.69	7.02	102.71	54.00	48.71	AVG	No Limit

REMARKS:

- (1) Measurement Value = Reading Level + Correct Factor.
- (2) Margin Level = Measurement Value - Limit Value.

Orthogonal Axis	X
Test Mode:	TX N-20M Mode 2412 MHz

Vertical

80 dBuV/m

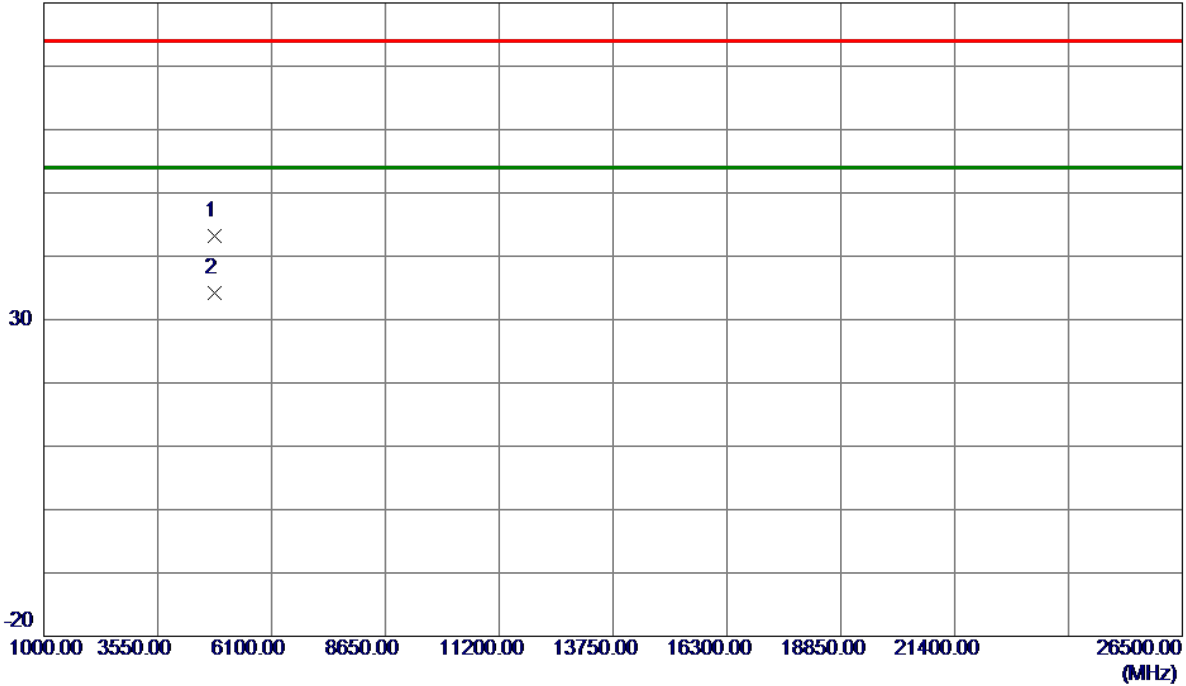

No.	Freq. MHz	Reading Level dBuV/m	Correct Factor dB	Measure ment dBuV/m	Limit dBuV/m	Margin dB	Detector	Comment
1	4824.2500	39.03	4.23	43.26	74.00	-30.74	Peak	
2 *	4824.6500	29.89	4.23	34.12	54.00	-19.88	AVG	

REMARKS:

- (1) Measurement Value = Reading Level + Correct Factor.
- (2) Margin Level = Measurement Value - Limit Value.

Orthogonal Axis	X
Test Mode:	TX N-20M Mode 2412 MHz

Horizontal

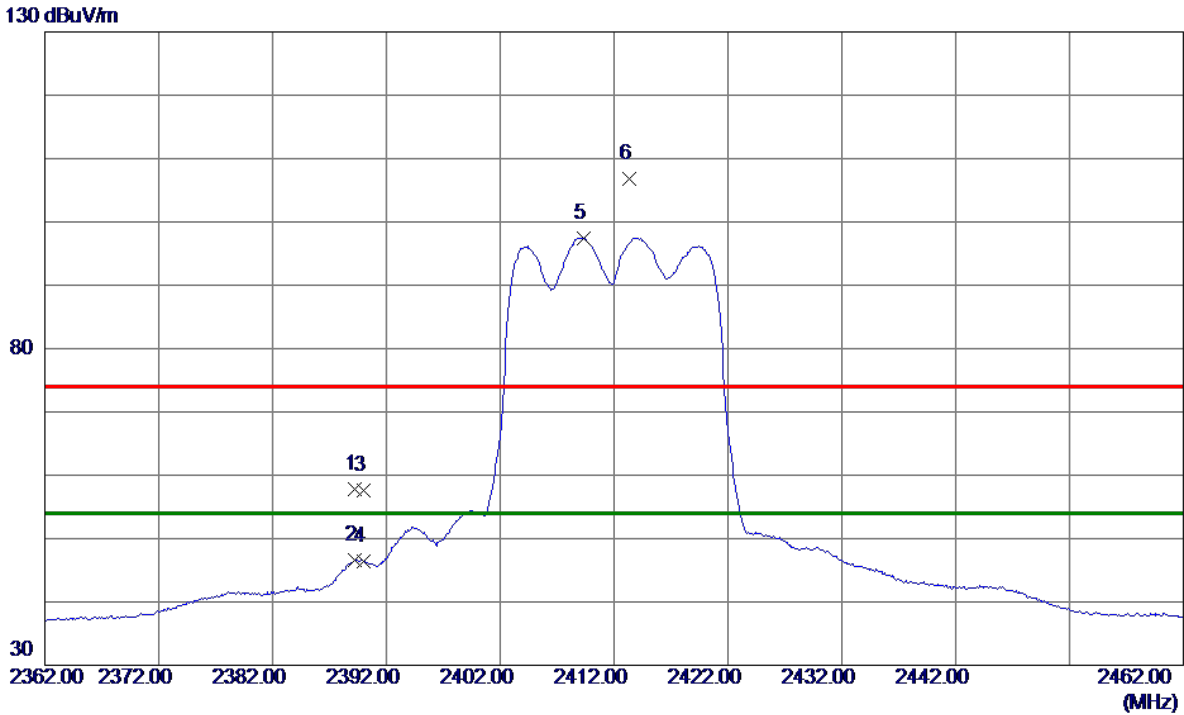

No.	Freq. MHz	Reading Level dBuV/m	Correct Factor dB	Measure ment dBuV/m	Limit dBuV/m	Margin dB	Detector	Comment
1	2389.2000	50.88	7.01	57.89	74.00	-16.11	Peak	
2	2389.2000	39.68	7.01	46.69	54.00	-7.31	AVG	
3	2390.0000	50.67	7.01	57.68	74.00	-16.32	Peak	
4	2390.0000	39.42	7.01	46.43	54.00	-7.57	AVG	
5 *	2409.3000	90.44	7.02	97.46	54.00	43.46	AVG	No Limit
6	2413.3000	99.69	7.02	106.71	74.00	32.71	Peak	No Limit

REMARKS:

- (1) Measurement Value = Reading Level + Correct Factor.
- (2) Margin Level = Measurement Value - Limit Value.

Orthogonal Axis	X
Test Mode:	TX N-20M Mode 2412 MHz

Horizontal

80 dBuV/m

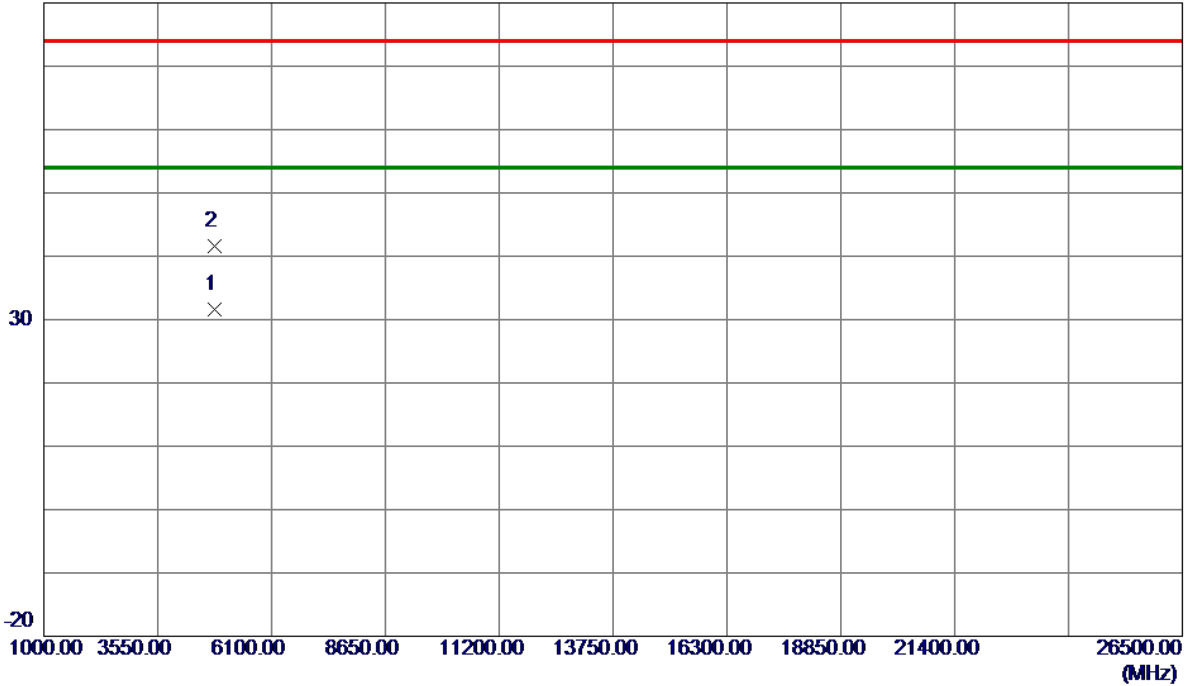

No.	Freq. MHz	Reading Level dBuV/m	Correct Factor dB	Measure ment dBuV/m	Limit dBuV/m	Margin dB	Detector	Comment
1 *	4823.9000	27.43	4.23	31.66	54.00	-22.34	AVG	
2	4830.3000	37.26	4.25	41.51	74.00	-32.49	Peak	

REMARKS:

- (1) Measurement Value = Reading Level + Correct Factor.
- (2) Margin Level = Measurement Value - Limit Value.

Orthogonal Axis	X
Test Mode:	TX N-20M Mode 2437 MHz

Vertical

130 dBuV/m

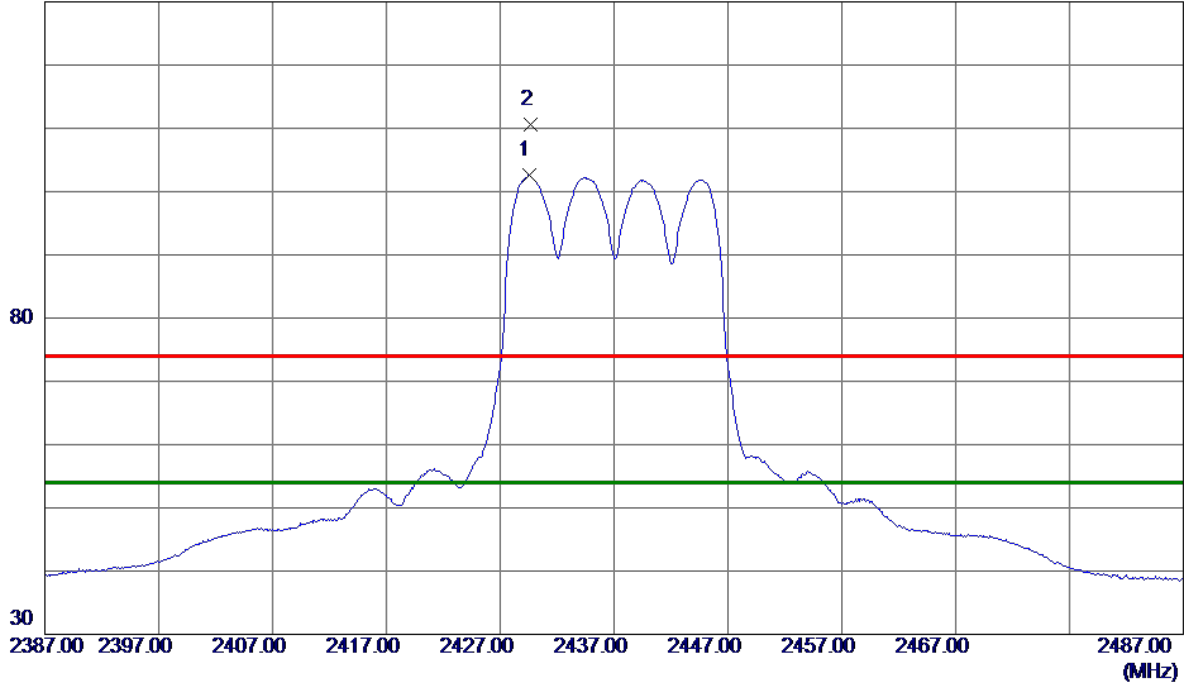

No.	Freq. MHz	Reading Level dBuV/m	Correct Factor dB	Measure ment dBuV/m	Limit dBuV/m	Margin dB	Detector	Comment
1 *	2429.5000	95.60	7.02	102.62	54.00	48.62	AVG	No Limit
2	2429.7000	103.51	7.02	110.53	74.00	36.53	Peak	No Limit

REMARKS:

- (1) Measurement Value = Reading Level + Correct Factor.
- (2) Margin Level = Measurement Value - Limit Value.

Orthogonal Axis	X
Test Mode:	TX N-20M Mode 2437 MHz

Vertical

80 dBuV/m

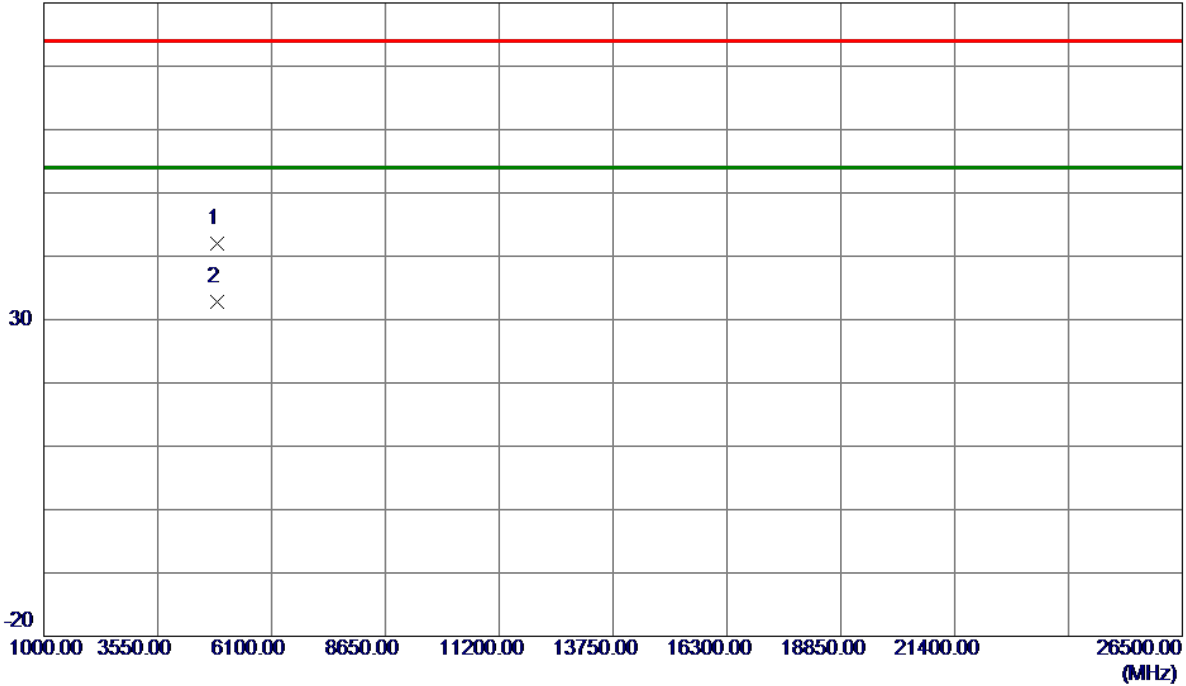

No.	Freq. MHz	Reading Level dBuV/m	Correct Factor dB	Measure ment dBuV/m	Limit dBuV/m	Margin dB	Detector	Comment
1	4873.6500	37.67	4.34	42.01	74.00	-31.99	Peak	
2 *	4874.0000	28.39	4.34	32.73	54.00	-21.27	AVG	

REMARKS:

- (1) Measurement Value = Reading Level + Correct Factor.
- (2) Margin Level = Measurement Value - Limit Value.

Orthogonal Axis	X
Test Mode:	TX N-20M Mode 2437 MHz

Horizontal

130 dBuV/m

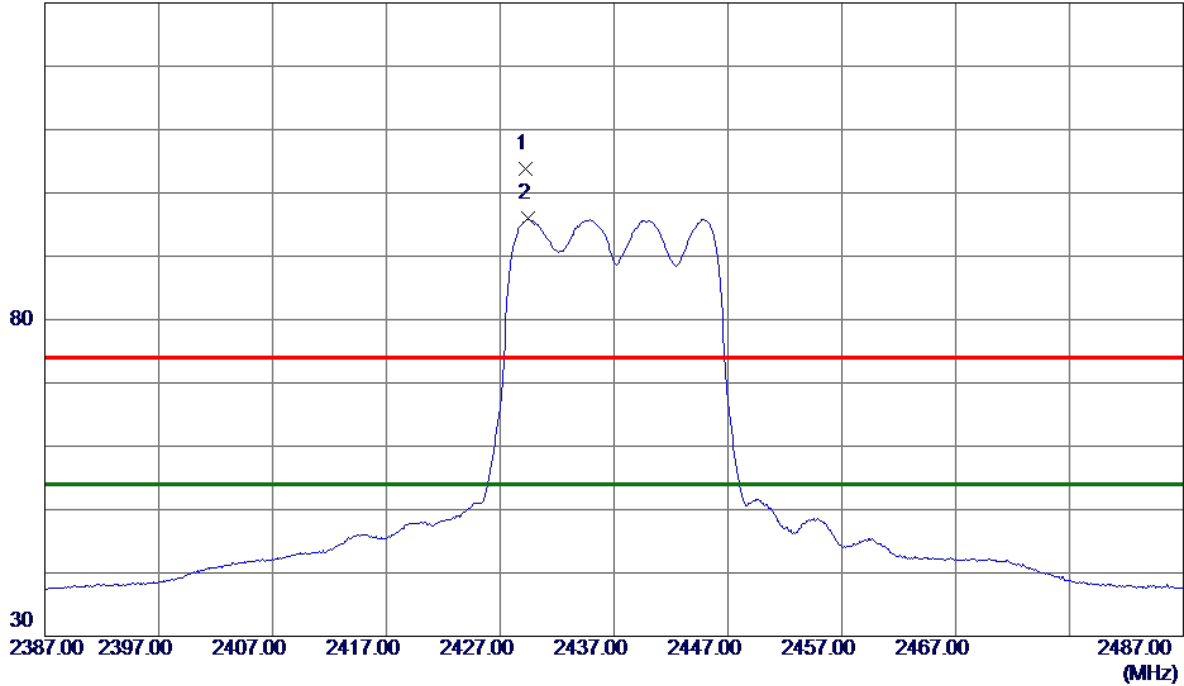

No.	Freq. MHz	Reading Level dBuV/m	Correct Factor dB	Measure ment dBuV/m	Limit dBuV/m	Margin dB	Detector	Comment
1	2429.2000	96.86	7.02	103.88	74.00	29.88	Peak	No Limit
2 *	2429.4000	88.97	7.02	95.99	54.00	41.99	AVG	No Limit

REMARKS:

- (1) Measurement Value = Reading Level + Correct Factor.
- (2) Margin Level = Measurement Value - Limit Value.

Orthogonal Axis	X
Test Mode:	TX N-20M Mode 2437 MHz

Horizontal

80 dBuV/m

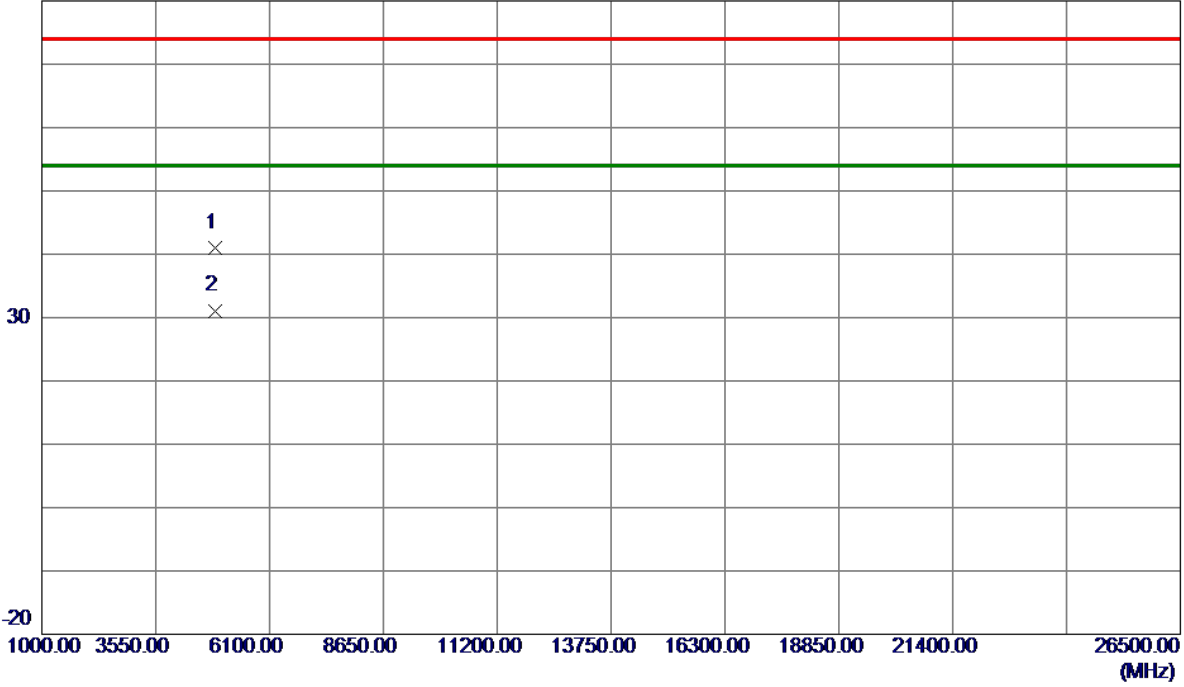

No.	Freq. MHz	Reading Level dBuV/m	Correct Factor dB	Measure ment dBuV/m	Limit dBuV/m	Margin dB	Detector	Comment
1	4872.7500	36.67	4.33	41.00	74.00	-33.00	Peak	
2 *	4873.8500	26.76	4.34	31.10	54.00	-22.90	AVG	

REMARKS:

- (1) Measurement Value = Reading Level + Correct Factor.
- (2) Margin Level = Measurement Value - Limit Value.

Orthogonal Axis	X
Test Mode:	TX N-20M Mode 2462 MHz

Vertical

130 dBuV/m

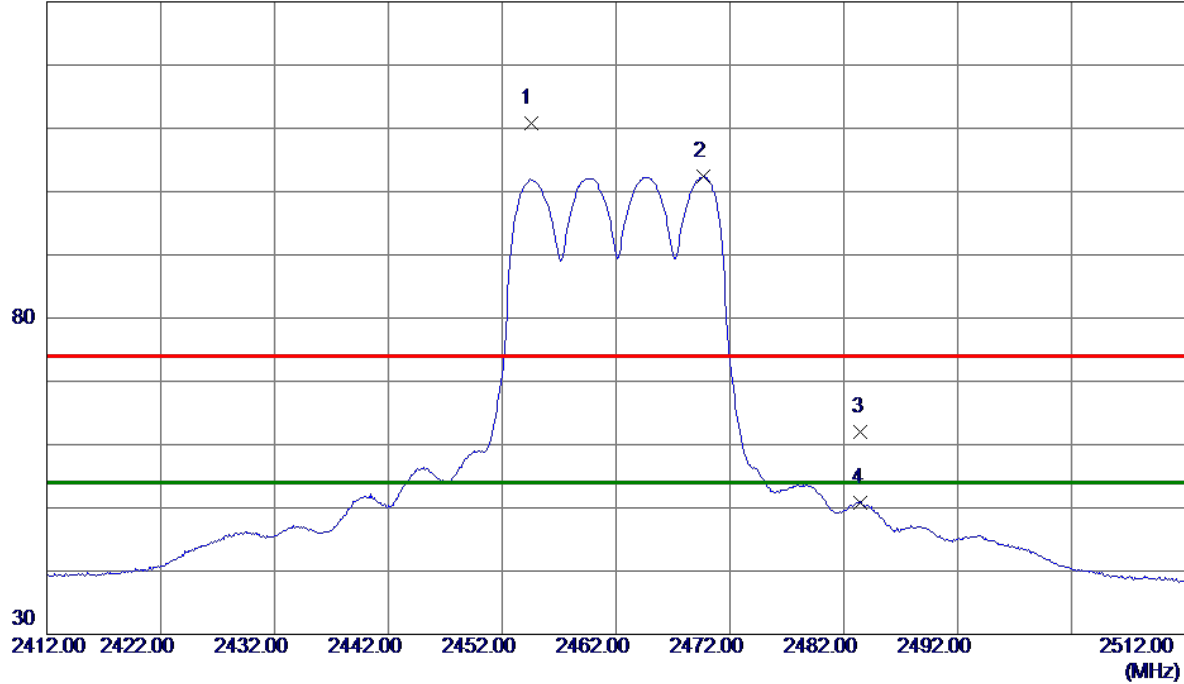

No.	Freq. MHz	Reading Level dBuV/m	Correct Factor dB	Measure ment dBuV/m	Limit dBuV/m	Margin dB	Detector	Comment
1	2454.5000	103.80	7.03	110.83	74.00	36.83	Peak	No Limit
2 *	2469.7000	95.39	7.03	102.42	54.00	48.42	AVG	No Limit
3	2483.5000	55.03	7.03	62.06	74.00	-11.94	Peak	
4	2483.5000	43.81	7.03	50.84	54.00	-3.16	AVG	

REMARKS:

- (1) Measurement Value = Reading Level + Correct Factor.
- (2) Margin Level = Measurement Value - Limit Value.

Orthogonal Axis	X
Test Mode:	TX N-20M Mode 2462 MHz

Vertical

80 dBuV/m

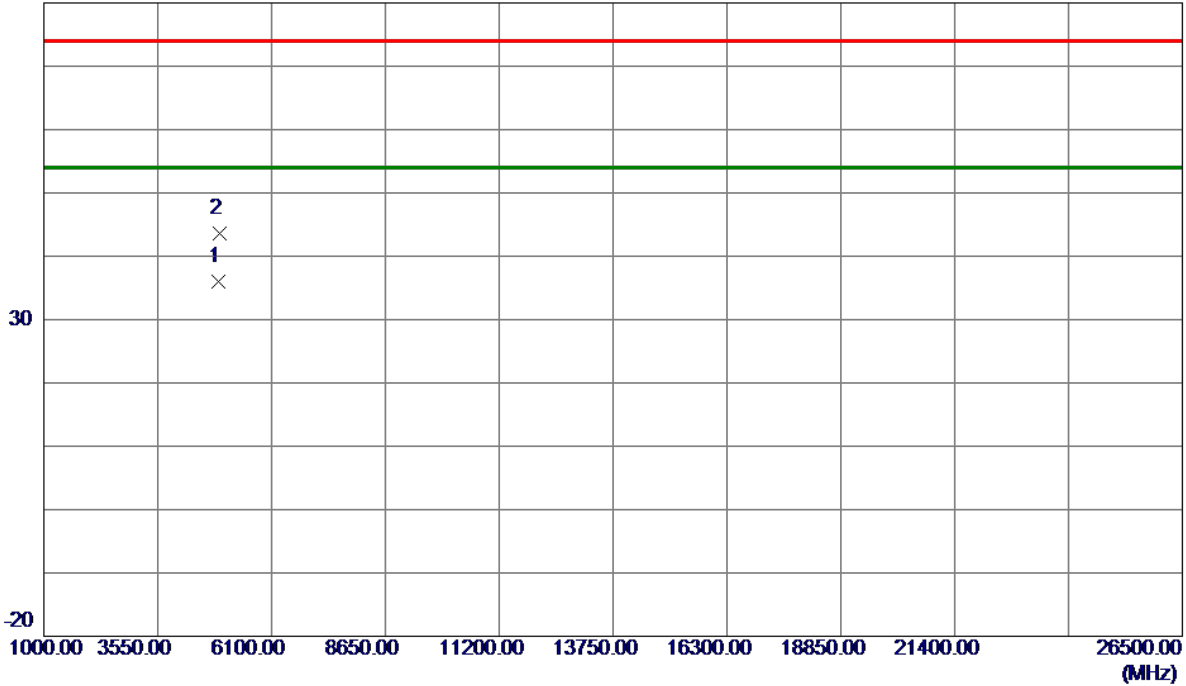

No.	Freq. MHz	Reading Level dBuV/m	Correct Factor dB	Measure ment dBuV/m	Limit dBuV/m	Margin dB	Detector	Comment
1 *	4924.0000	31.56	4.44	36.00	54.00	-18.00	AVG	
2	4924.3000	39.11	4.44	43.55	74.00	-30.45	Peak	

REMARKS:

- (1) Measurement Value = Reading Level + Correct Factor.
- (2) Margin Level = Measurement Value - Limit Value.

Orthogonal Axis	X
Test Mode:	TX N-20M Mode 2462 MHz

Horizontal

130 dBuV/m

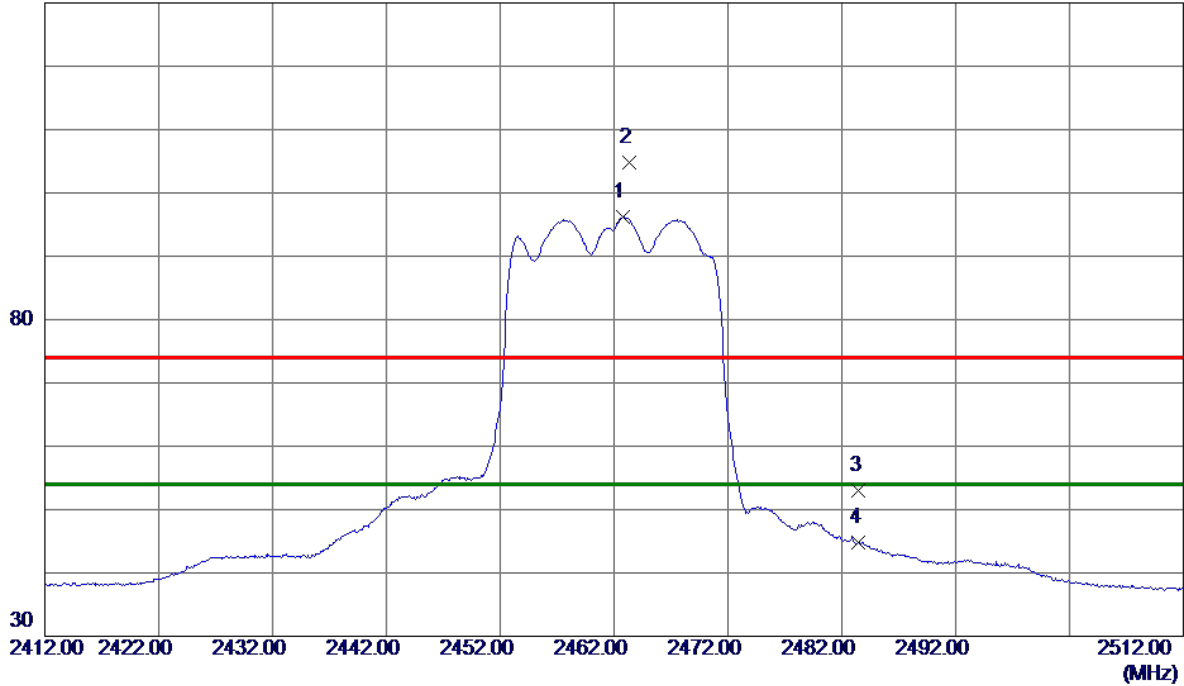

No.	Freq. MHz	Reading Level dBuV/m	Correct Factor dB	Measure ment dBuV/m	Limit dBuV/m	Margin dB	Detector	Comment
1 *	2462.8000	89.13	7.03	96.16	54.00	42.16	AVG	No Limit
2	2463.3000	97.76	7.03	104.79	74.00	30.79	Peak	No Limit
3	2483.5000	45.94	7.03	52.97	74.00	-21.03	Peak	
4	2483.5000	37.70	7.03	44.73	54.00	-9.27	AVG	

REMARKS:

- (1) Measurement Value = Reading Level + Correct Factor.
- (2) Margin Level = Measurement Value - Limit Value.

Orthogonal Axis	X
Test Mode:	TX N-20M Mode 2462 MHz

Horizontal

80 dBuV/m

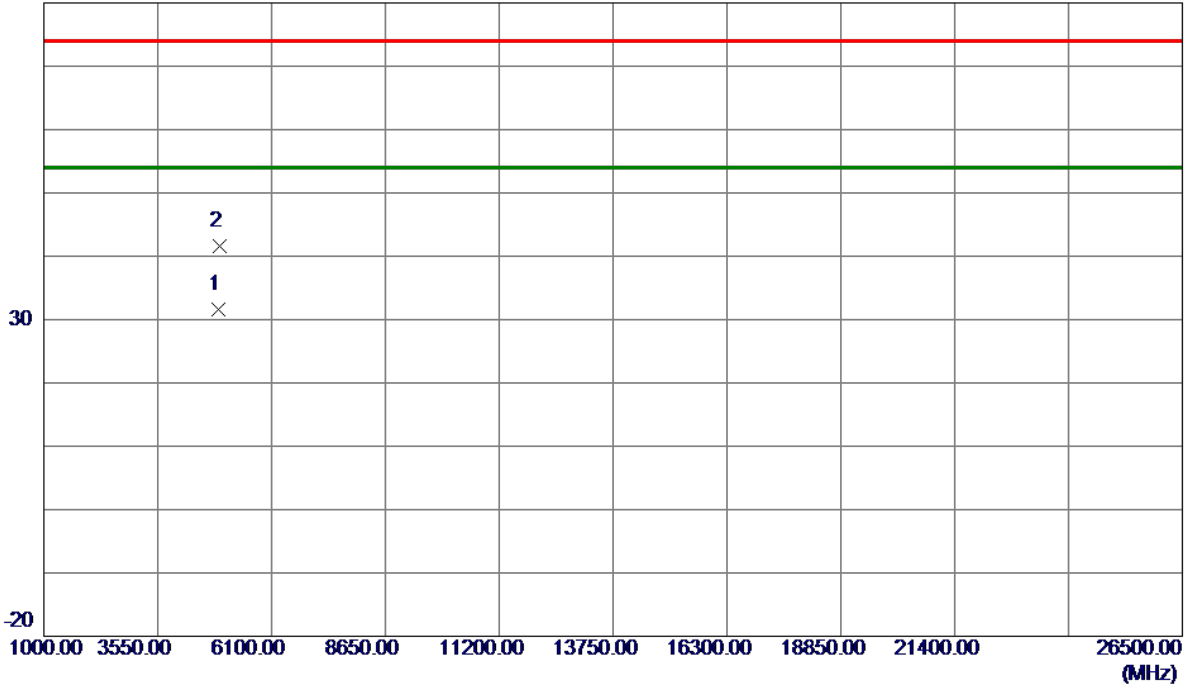

No.	Freq. MHz	Reading Level dBuV/m	Correct Factor dB	Measure ment dBuV/m	Limit dBuV/m	Margin dB	Detector	Comment
1 *	4923.9000	27.08	4.44	31.52	54.00	-22.48	AVG	
2	4926.4000	37.16	4.45	41.61	74.00	-32.39	Peak	

REMARKS:

- (1) Measurement Value = Reading Level + Correct Factor.
- (2) Margin Level = Measurement Value - Limit Value.

Orthogonal Axis	X
Test Mode:	TX N-40M Mode 2422MHz

Vertical

130 dBuV/m

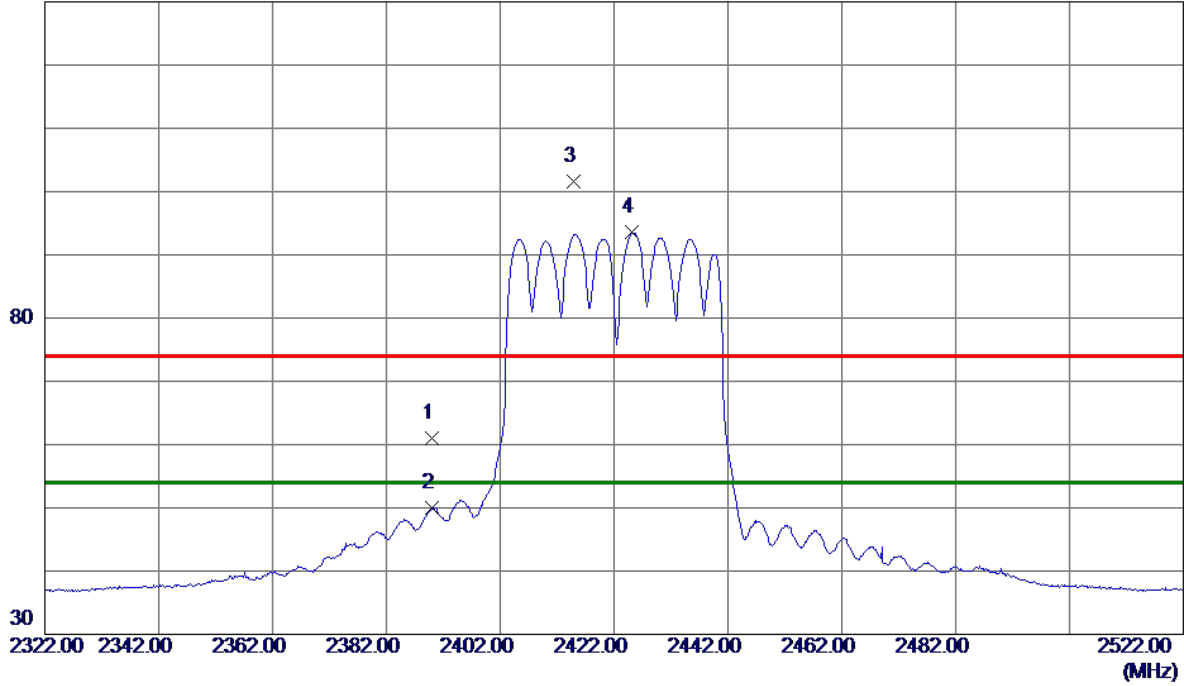

No.	Freq. MHz	Reading Level dBuV/m	Correct Factor dB	Measure ment dBuV/m	Limit dBuV/m	Margin dB	Detector	Comment
1	2390.0000	53.96	7.01	60.97	74.00	-13.03	Peak	
2	2390.0000	42.95	7.01	49.96	54.00	-4.04	AVG	
3	2414.8000	94.50	7.02	101.52	74.00	27.52	Peak	No Limit
4 *	2425.2000	86.61	7.02	93.63	54.00	39.63	AVG	No Limit

REMARKS:

- (1) Measurement Value = Reading Level + Correct Factor.
- (2) Margin Level = Measurement Value - Limit Value.

Orthogonal Axis	X
Test Mode:	TX N-40M Mode 2422MHz

Vertical

80 dBuV/m

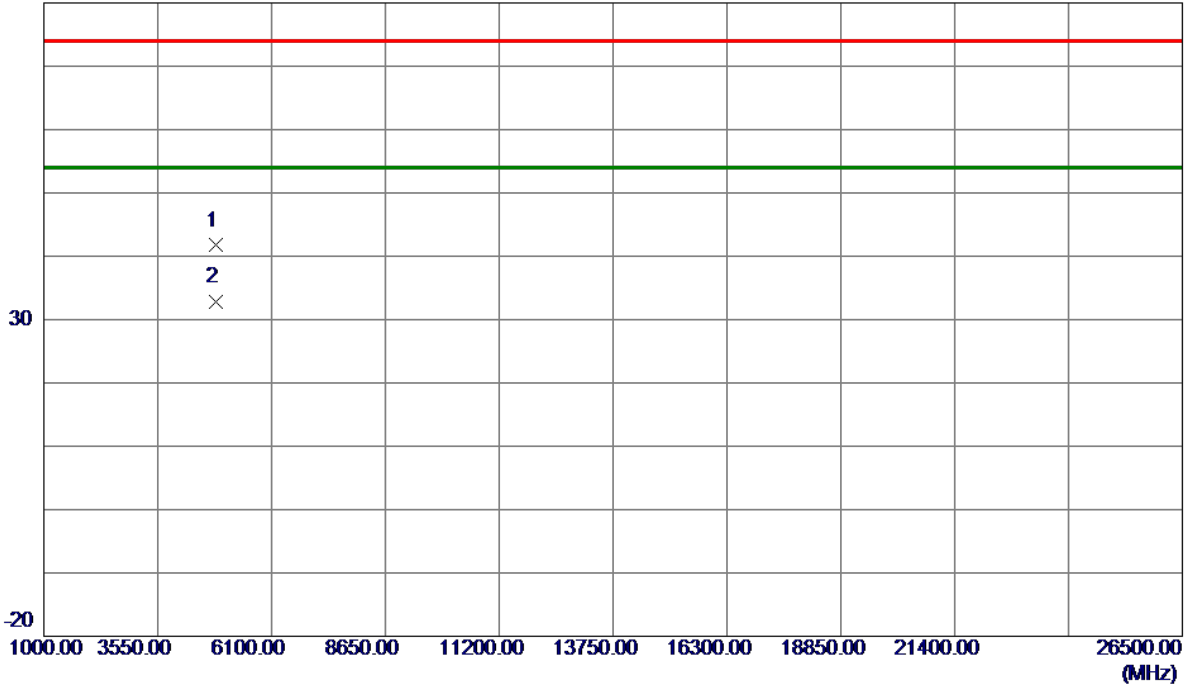

No.	Freq. MHz	Reading Level dBuV/m	Correct Factor dB	Measure ment dBuV/m	Limit dBuV/m	Margin dB	Detector	Comment
1	4843.0500	37.43	4.27	41.70	74.00	-32.30	Peak	
2 *	4844.0000	28.55	4.27	32.82	54.00	-21.18	AVG	

REMARKS:

- (1) Measurement Value = Reading Level + Correct Factor.
- (2) Margin Level = Measurement Value - Limit Value.

Orthogonal Axis	X
Test Mode:	TX N-40M Mode 2422MHz

Horizontal

130 dBuV/m

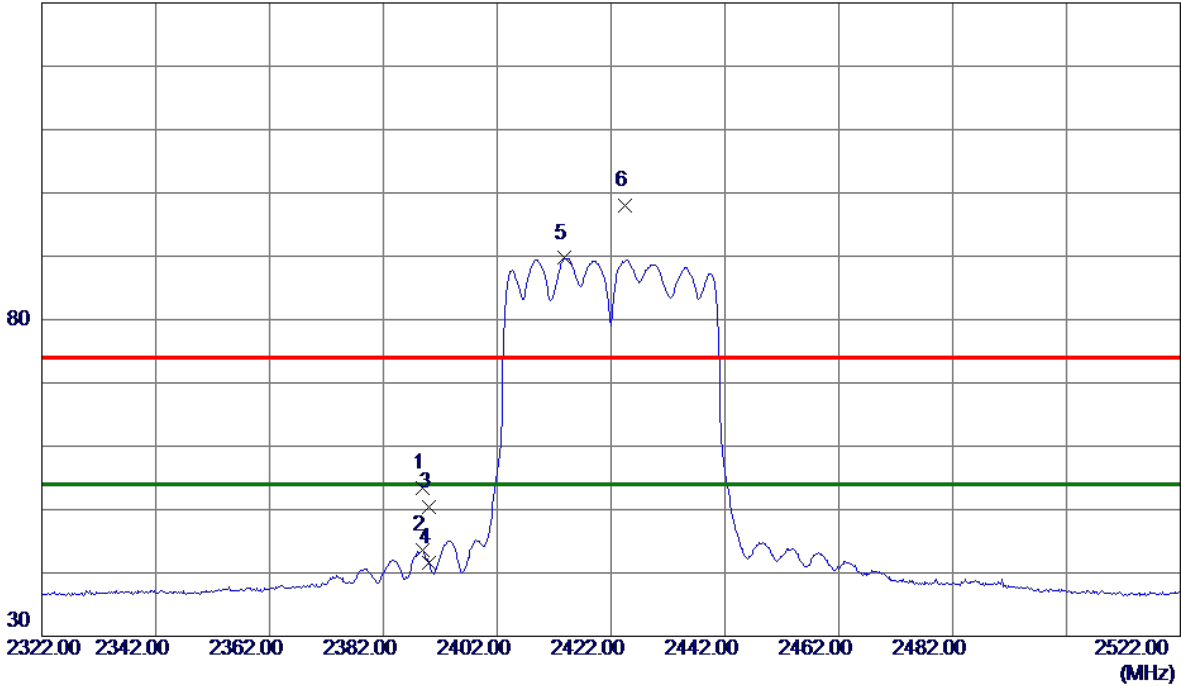

No.	Freq. MHz	Reading Level dBuV/m	Correct Factor dB	Measure ment dBuV/m	Limit dBuV/m	Margin dB	Detector	Comment
1	2388.8000	46.30	7.01	53.31	74.00	-20.69	Peak	
2	2388.8000	36.52	7.01	43.53	54.00	-10.47	AVG	
3	2390.0000	43.47	7.01	50.48	74.00	-23.52	Peak	
4	2390.0000	34.55	7.01	41.56	54.00	-12.44	AVG	
5 *	2413.8000	82.68	7.02	89.70	54.00	35.70	AVG	No Limit
6	2424.4000	91.06	7.02	98.08	74.00	24.08	Peak	No Limit

REMARKS:

- (1) Measurement Value = Reading Level + Correct Factor.
- (2) Margin Level = Measurement Value - Limit Value.

Orthogonal Axis	X
Test Mode:	TX N-40M Mode 2422MHz

Horizontal

80 dBuV/m

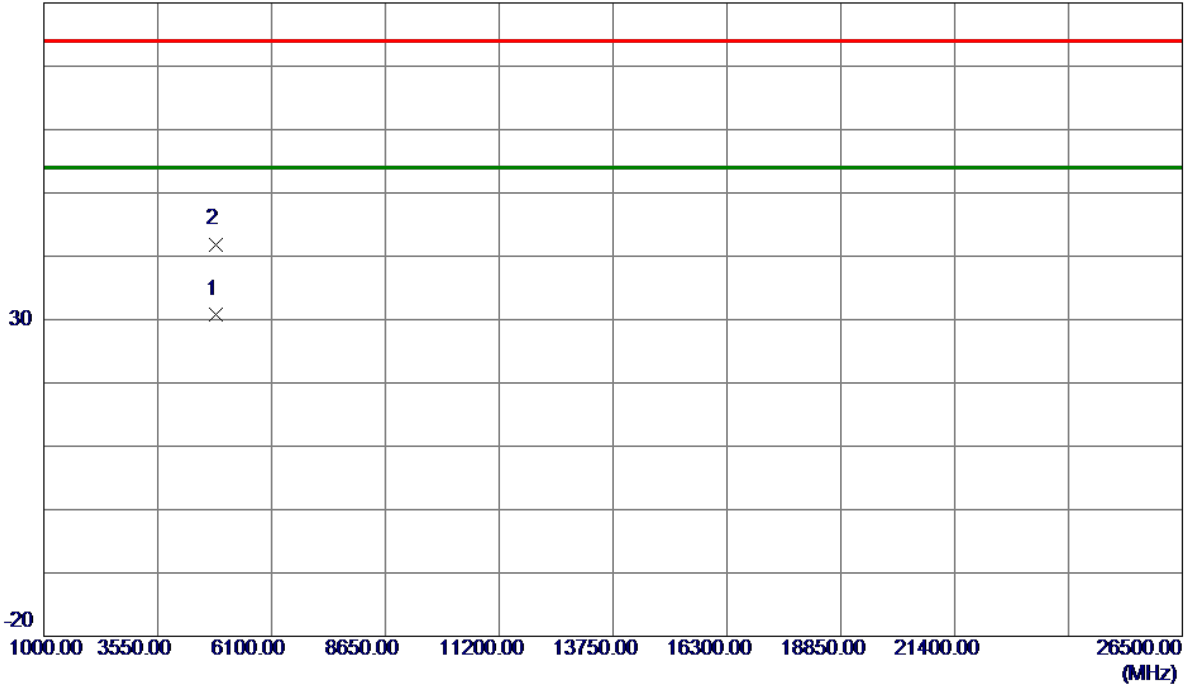

No.	Freq. MHz	Reading Level dBuV/m	Correct Factor dB	Measure ment dBuV/m	Limit dBuV/m	Margin dB	Detector	Comment
1 *	4842.9250	26.44	4.27	30.71	54.00	-23.29	AVG	
2	4844.2450	37.63	4.27	41.90	74.00	-32.10	Peak	

REMARKS:

- (1) Measurement Value = Reading Level + Correct Factor.
- (2) Margin Level = Measurement Value - Limit Value.

Orthogonal Axis	X
Test Mode:	TX N-40M Mode 2437 MHz

Vertical

130 dBuV/m

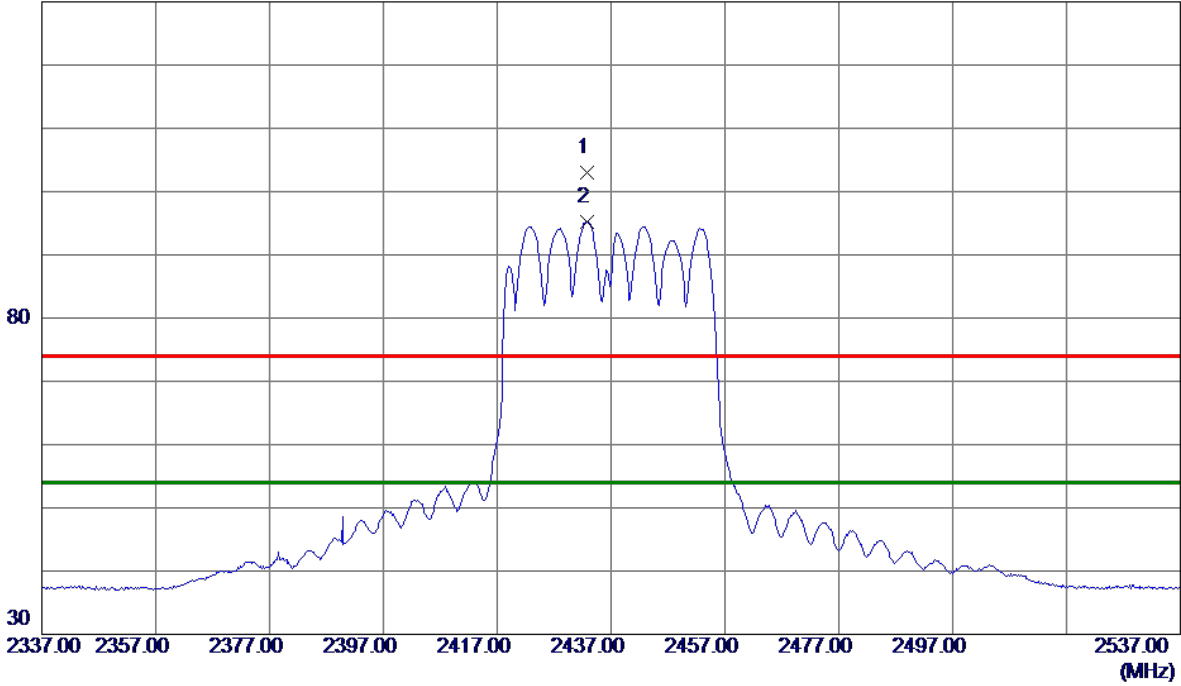

No.	Freq. MHz	Reading Level dBuV/m	Correct Factor dB	Measure ment dBuV/m	Limit dBuV/m	Margin dB	Detector	Comment
1	2432.8000	95.90	7.02	102.92	74.00	28.92	Peak	No Limit
2 *	2432.8000	88.21	7.02	95.23	54.00	41.23	AVG	No Limit

REMARKS:

- (1) Measurement Value = Reading Level + Correct Factor.
- (2) Margin Level = Measurement Value - Limit Value.

Orthogonal Axis	X
Test Mode:	TX N-40M Mode 2437 MHz

Vertical

80 dBuV/m

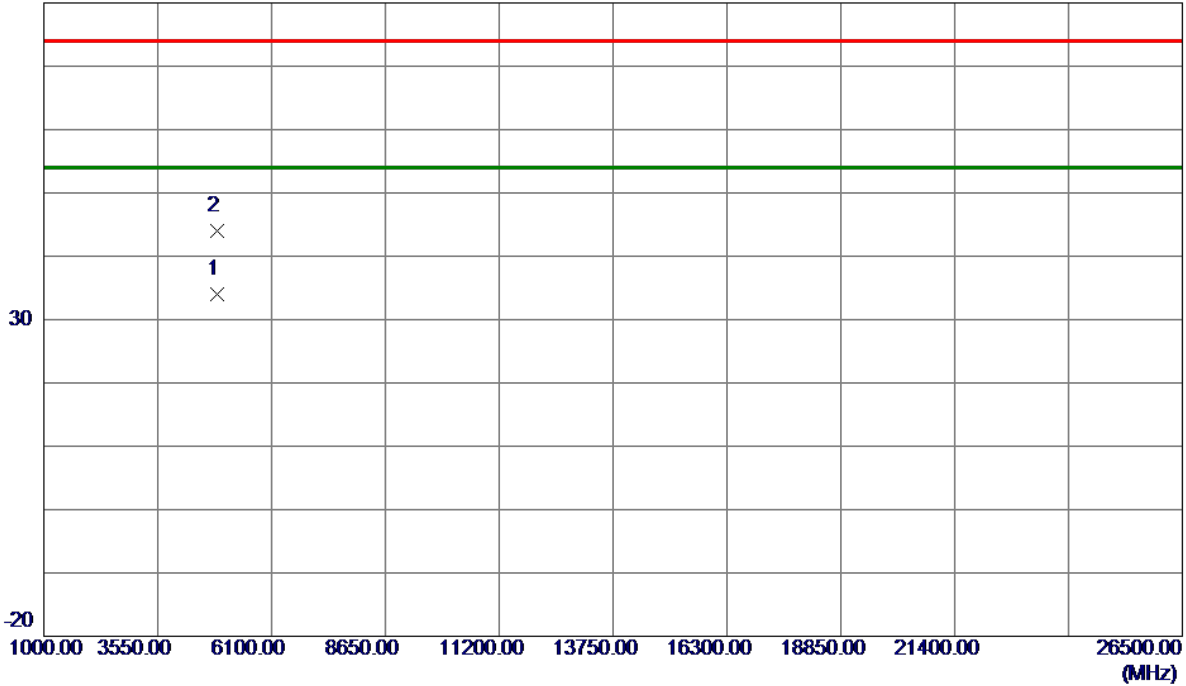

No.	Freq. MHz	Reading Level dBuV/m	Correct Factor dB	Measure ment dBuV/m	Limit dBuV/m	Margin dB	Detector	Comment
1 *	4873.9800	29.69	4.34	34.03	54.00	-19.97	AVG	
2	4874.1450	39.67	4.34	44.01	74.00	-29.99	Peak	

REMARKS:

- (1) Measurement Value = Reading Level + Correct Factor.
- (2) Margin Level = Measurement Value - Limit Value.

Orthogonal Axis	X
Test Mode:	TX N-40M Mode 2437 MHz

Horizontal

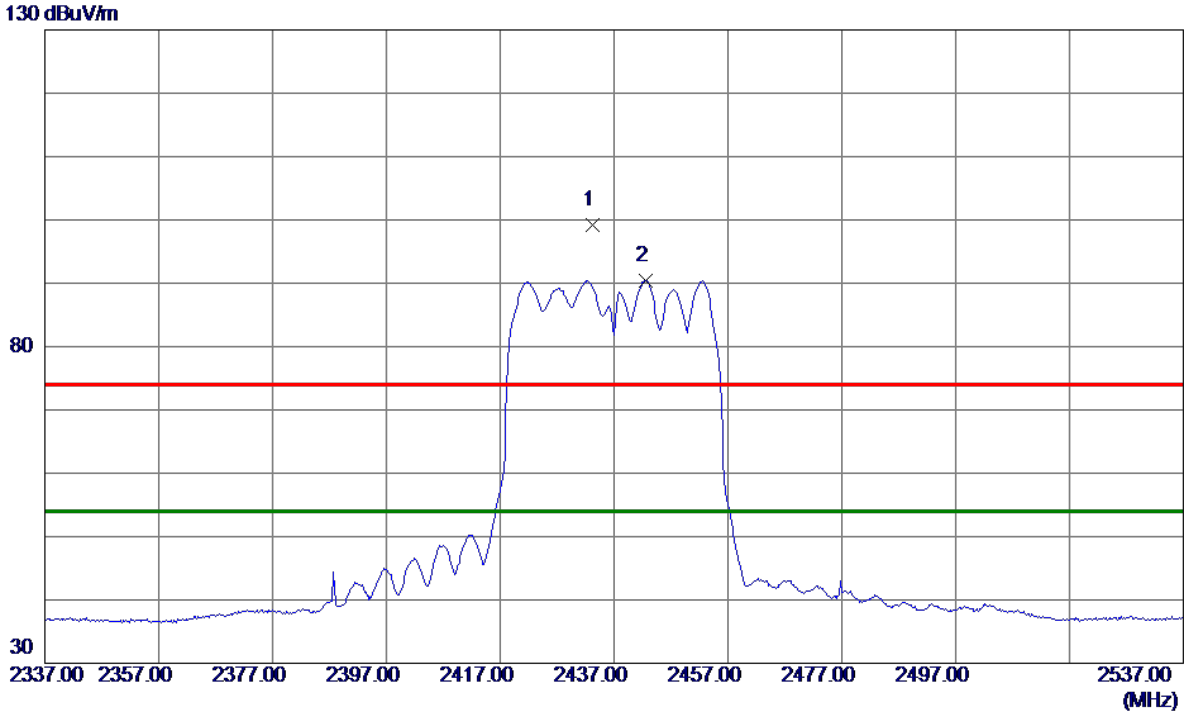

No.	Freq. MHz	Reading Level dBuV/m	Correct Factor dB	Measure ment dBuV/m	Limit dBuV/m	Margin dB	Detector	Comment
1	2433.2000	92.24	7.02	99.26	74.00	25.26	Peak	No Limit
2 *	2442.6000	83.46	7.02	90.48	54.00	36.48	AVG	No Limit

REMARKS:

- (1) Measurement Value = Reading Level + Correct Factor.
- (2) Margin Level = Measurement Value - Limit Value.

Orthogonal Axis	X
Test Mode:	TX N-40M Mode 2437 MHz

Horizontal

80 dBuV/m

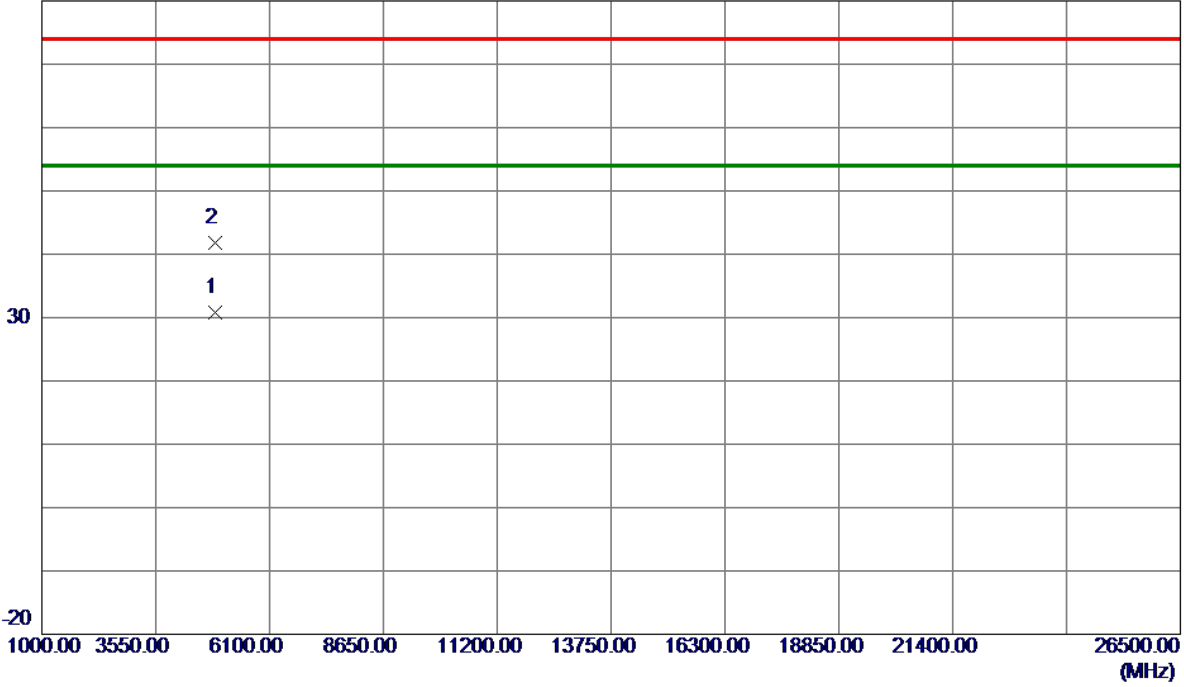

No.	Freq. MHz	Reading Level dBuV/m	Correct Factor dB	Measure ment dBuV/m	Limit dBuV/m	Margin dB	Detector	Comment
1 *	4873.9150	26.46	4.34	30.80	54.00	-23.20	AVG	
2	4875.3500	37.46	4.34	41.80	74.00	-32.20	Peak	

REMARKS:

- (1) Measurement Value = Reading Level + Correct Factor.
- (2) Margin Level = Measurement Value - Limit Value.

Orthogonal Axis	X
Test Mode:	TX N-40M Mode 2452 MHz

Vertical

130 dBuV/m

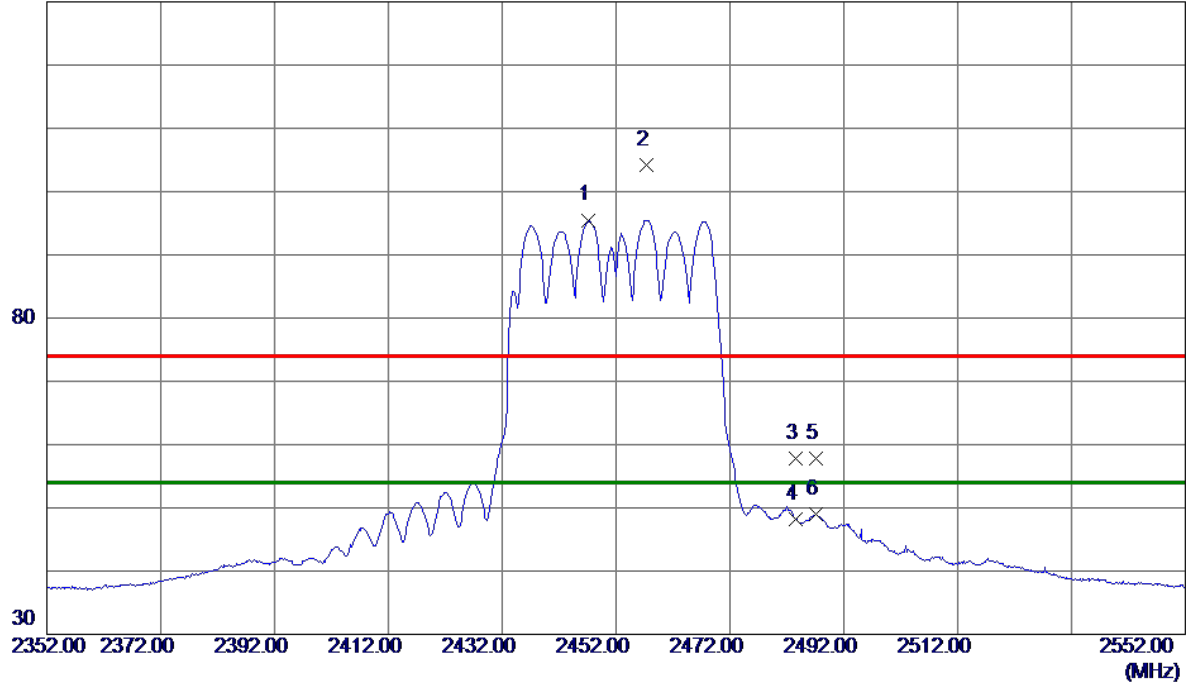

No.	Freq. MHz	Reading Level dBuV/m	Correct Factor dB	Measure ment dBuV/m	Limit dBuV/m	Margin dB	Detector	Comment
1 *	2447.2000	88.48	7.02	95.50	54.00	41.50	AVG	No Limit
2	2457.4000	97.25	7.03	104.28	74.00	30.28	Peak	No Limit
3	2483.5000	50.77	7.03	57.80	74.00	-16.20	Peak	
4	2483.5000	41.19	7.03	48.22	54.00	-5.78	AVG	
5	2487.2000	50.82	7.03	57.85	74.00	-16.15	Peak	
6	2487.2000	41.96	7.03	48.99	54.00	-5.01	AVG	

REMARKS:

- (1) Measurement Value = Reading Level + Correct Factor.
- (2) Margin Level = Measurement Value - Limit Value.

Orthogonal Axis	X
Test Mode:	TX N-40M Mode 2452 MHz

Vertical

80 dBuV/m

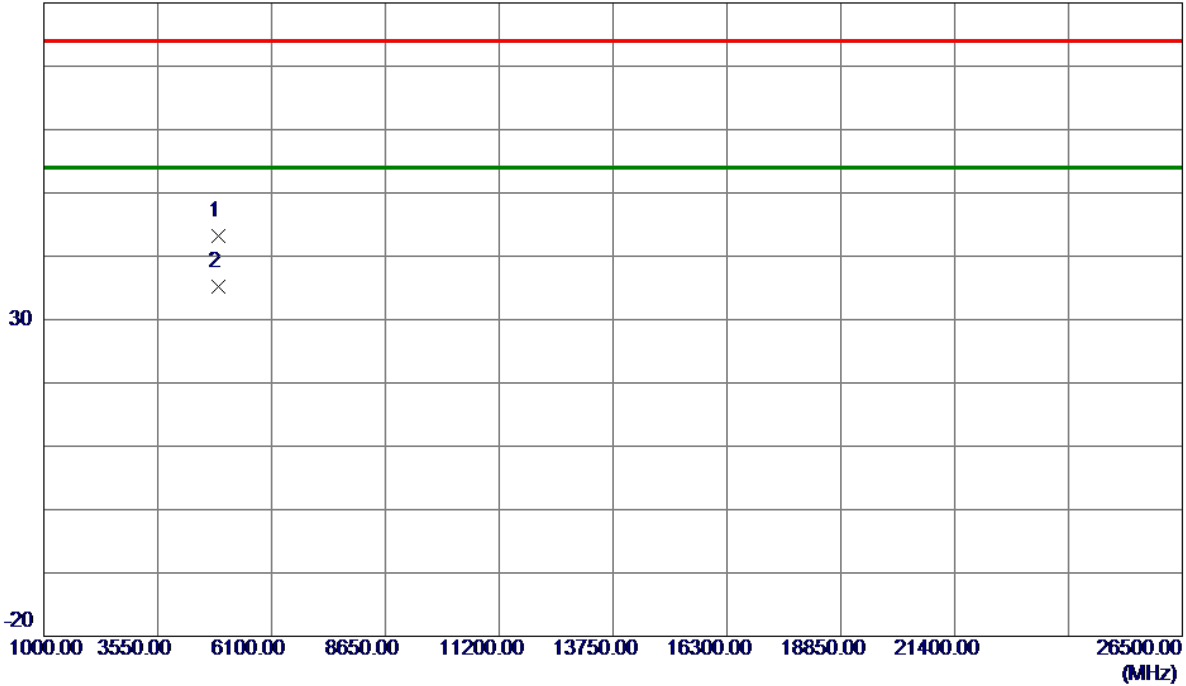

No.	Freq. MHz	Reading Level dBuV/m	Correct Factor dB	Measure ment dBuV/m	Limit dBuV/m	Margin dB	Detector	Comment
1	4902.3500	38.78	4.40	43.18	74.00	-30.82	Peak	
2 *	4903.9150	30.72	4.40	35.12	54.00	-18.88	AVG	

REMARKS:

- (1) Measurement Value = Reading Level + Correct Factor.
- (2) Margin Level = Measurement Value - Limit Value.

Orthogonal Axis	X
Test Mode:	TX N-40M Mode 2452 MHz

Horizontal

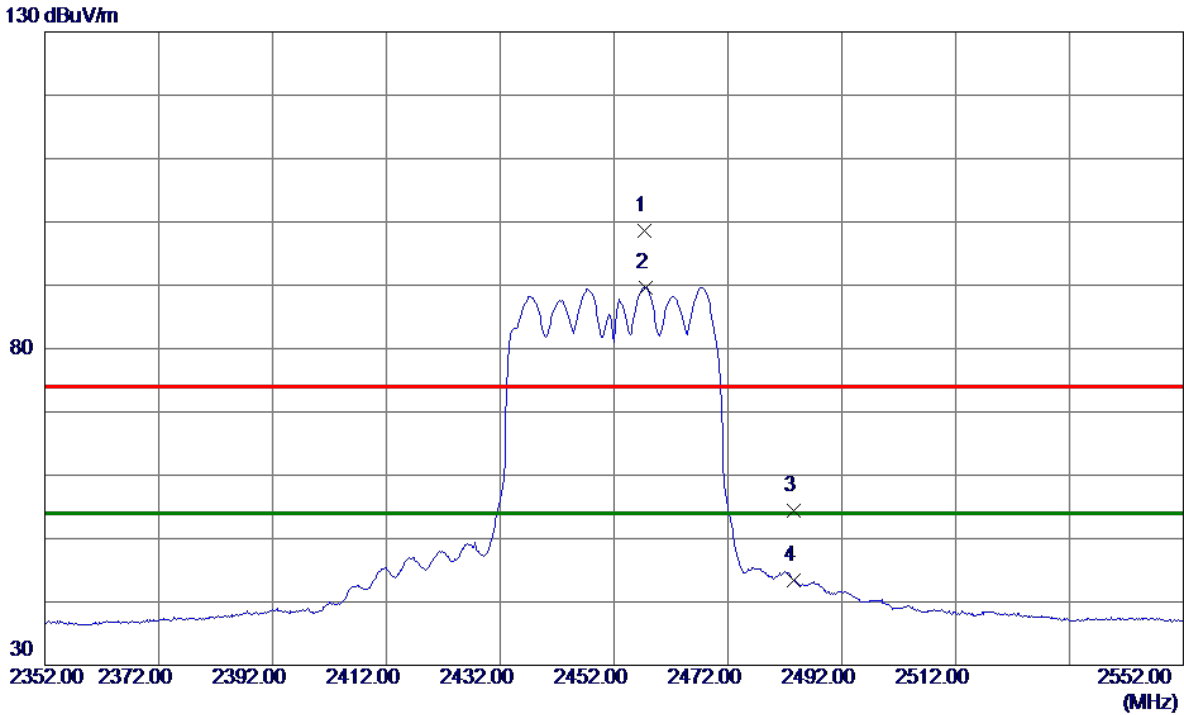

No.	Freq. MHz	Reading Level dBuV/m	Correct Factor dB	Measure ment dBuV/m	Limit dBuV/m	Margin dB	Detector	Comment
1	2457.4000	91.54	7.03	98.57	74.00	24.57	Peak	No Limit
2 *	2457.6000	82.66	7.03	89.69	54.00	35.69	AVG	No Limit
3	2483.5000	47.40	7.03	54.43	74.00	-19.57	Peak	
4	2483.5000	36.45	7.03	43.48	54.00	-10.52	AVG	

REMARKS:

- (1) Measurement Value = Reading Level + Correct Factor.
- (2) Margin Level = Measurement Value - Limit Value.

Orthogonal Axis	X
Test Mode:	TX N-40M Mode 2452 MHz

Horizontal

80 dBuV/m

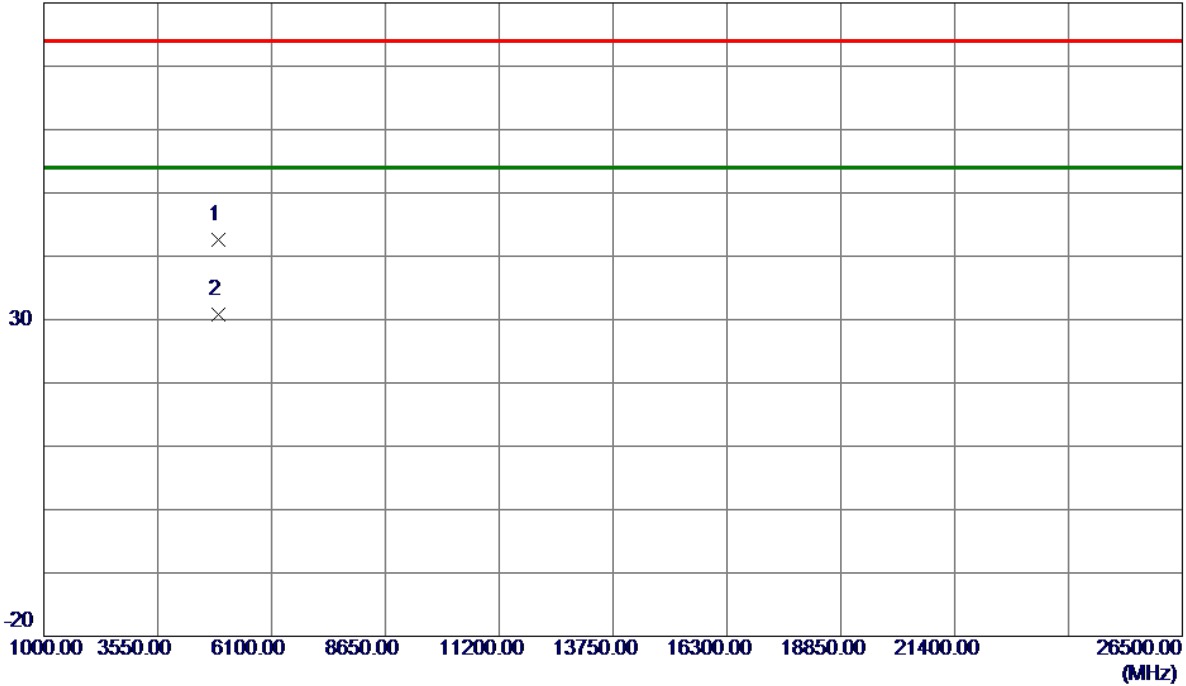

No.	Freq. MHz	Reading Level dBuV/m	Correct Factor dB	Measure ment dBuV/m	Limit dBuV/m	Margin dB	Detector	Comment
1	4903.4300	38.24	4.40	42.64	74.00	-31.36	Peak	
2 *	4903.9800	26.48	4.40	30.88	54.00	-23.12	AVG	

REMARKS:

- (1) Measurement Value = Reading Level + Correct Factor.
- (2) Margin Level = Measurement Value - Limit Value.

APPENDIX E - BANDWIDTH

Test Mode	TX B Mode
-----------	-----------

Channel	Frequency (MHz)	6 dB Bandwidth (MHz)	99 % Emission Bandwidth (MHz)	6 dB Bandwidth Min. Limit (kHz)	Result
01	2412	10.10	13.24	500	Complies
06	2437	10.10	13.24	500	Complies
11	2462	10.10	13.24	500	Complies

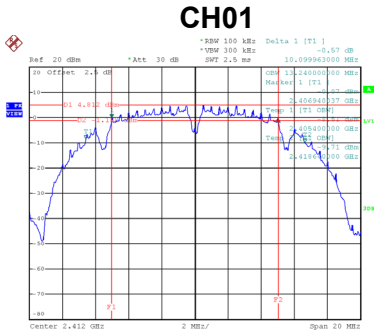

Date: 24.FEB.2019 10:35:46

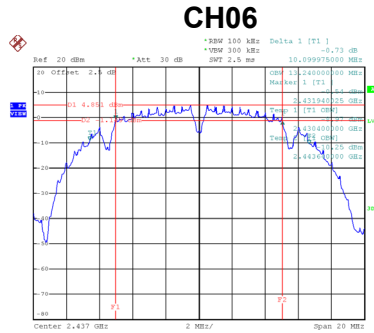

Date: 24.FEB.2019 10:42:00

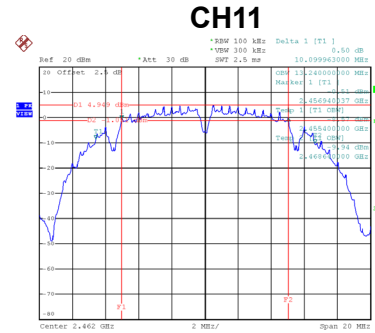

Date: 24.FEB.2019 10:44:06

Test Mode	TX G Mode
-----------	-----------

Channel	Frequency (MHz)	6 dB Bandwidth (MHz)	99 % Emission Bandwidth (MHz)	6 dB Bandwidth Min. Limit (kHz)	Result
01	2412	16.61	16.48	500	Complies
06	2437	16.58	16.48	500	Complies
11	2462	16.64	16.52	500	Complies

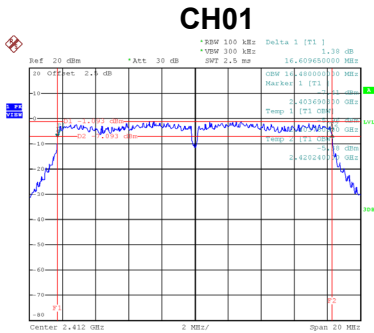

Date: 24.FEB.2019 10:45:37

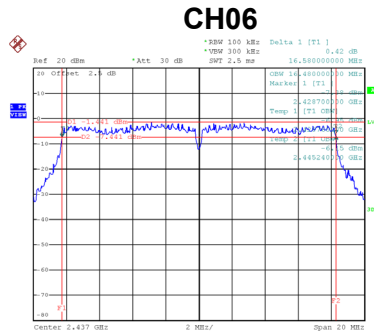

Date: 24.FEB.2019 10:47:13

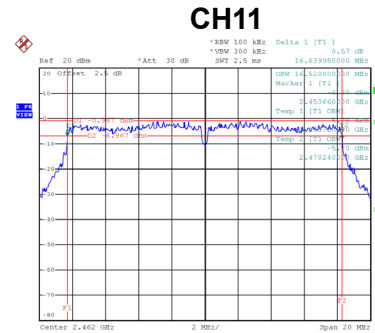

Date: 24.FEB.2019 10:48:55

Test Mode	TX N (HT20) Mode
-----------	------------------

Channel	Frequency (MHz)	6 dB Bandwidth (MHz)	99 % Emission Bandwidth (MHz)	6 dB Bandwidth Min. Limit (kHz)	Result
01	2412	17.80	17.60	500	Complies
06	2437	17.79	17.64	500	Complies
11	2462	17.80	17.64	500	Complies

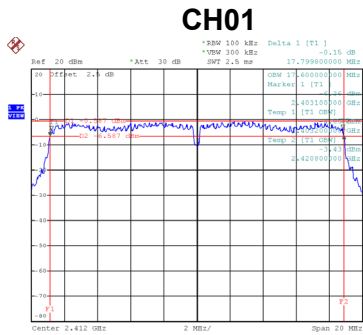

Date: 24.FEB.2019 10:51:09

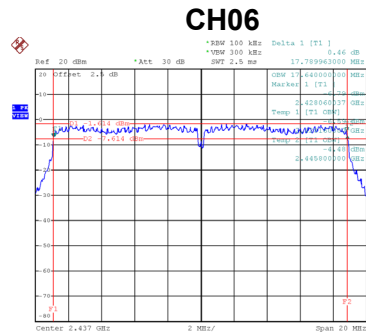

Date: 24.FEB.2019 10:52:41

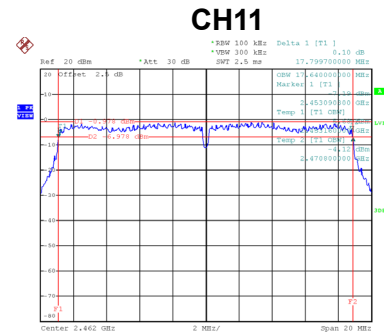

Date: 24.FEB.2019 10:54:24

Test Mode	TX N (HT40) Mode
-----------	------------------

Channel	Frequency (MHz)	6 dB Bandwidth (MHz)	99 % Emission Bandwidth (MHz)	6 dB Bandwidth Min. Limit (kHz)	Result
03	2422	36.44	36.16	500	Complies
06	2437	36.52	36.16	500	Complies
09	2452	36.56	36.16	500	Complies

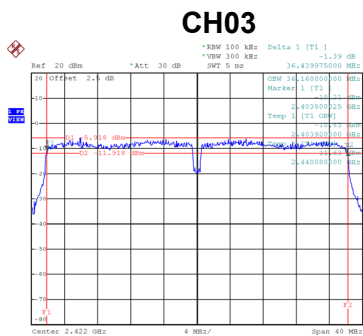

Date: 24.FEB.2019 11:00:25

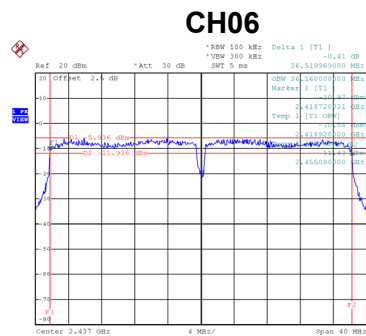

Date: 24.FEB.2019 11:04:07

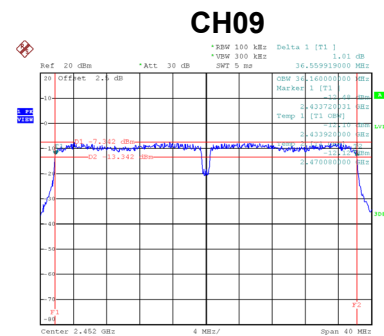

Date: 24.FEB.2019 11:08:23

APPENDIX F - MAXIMUM OUTPUT POWER

Test Mode	TX B Mode
-----------	-----------

Channel	Frequency (MHz)	Output Power (dBm)	Output Power (W)	Max. Limit (dBm)	Max. Limit (W)	Result
01	2412	18.35	0.0684	30.00	1.0000	Complies
06	2437	18.58	0.0721	30.00	1.0000	Complies
11	2462	18.43	0.0697	30.00	1.0000	Complies

Test Mode	TX G Mode
-----------	-----------

Channel	Frequency (MHz)	Output Power (dBm)	Output Power (W)	Max. Limit (dBm)	Max. Limit (W)	Result
01	2412	24.14	0.2594	30.00	1.0000	Complies
06	2437	23.36	0.2168	30.00	1.0000	Complies
11	2462	24.18	0.2618	30.00	1.0000	Complies

Test Mode	TX N (HT20)_Ant. 1
-----------	--------------------

Channel	Frequency (MHz)	Output Power (dBm)	Output Power (W)	Max. Limit (dBm)	Max. Limit (W)	Result
01	2412	25.76	0.3767	30.00	1.0000	Complies
06	2437	24.35	0.2723	30.00	1.0000	Complies
11	2462	24.42	0.2767	30.00	1.0000	Complies

Test Mode	TX N (HT20)_Ant. 2
-----------	--------------------

Channel	Frequency (MHz)	Output Power (dBm)	Output Power (W)	Max. Limit (dBm)	Max. Limit (W)	Result
01	2412	24.42	0.2767	30.00	1.0000	Complies
06	2437	27.17	0.5212	30.00	1.0000	Complies
11	2462	27.16	0.5200	30.00	1.0000	Complies

Test Mode	TX N (HT20)_Total
-----------	-------------------

Channel	Frequency (MHz)	Output Power (dBm)	Output Power (W)	Max. Limit (dBm)	Max. Limit (W)	Result
01	2412	28.15	0.6534	30.00	1.0000	Complies
06	2437	29.00	0.7935	30.00	1.0000	Complies
11	2462	29.01	0.7967	30.00	1.0000	Complies

Test Mode	TX N (HT40)_Ant. 1
-----------	--------------------

Channel	Frequency (MHz)	Output Power (dBm)	Output Power (W)	Max. Limit (dBm)	Max. Limit (W)	Result
03	2422	22.14	0.1637	30.00	1.0000	Complies
06	2437	21.61	0.1449	30.00	1.0000	Complies
09	2452	21.82	0.1521	30.00	1.0000	Complies

Test Mode	TX N (HT40)_Ant. 2
-----------	--------------------

Channel	Frequency (MHz)	Output Power (dBm)	Output Power (W)	Max. Limit (dBm)	Max. Limit (W)	Result
03	2422	21.02	0.1265	30.00	1.0000	Complies
06	2437	24.13	0.2588	30.00	1.0000	Complies
09	2452	24.61	0.2891	30.00	1.0000	Complies

Test Mode	TX N (HT40)_Total
-----------	-------------------

Channel	Frequency (MHz)	Output Power (dBm)	Output Power (W)	Max. Limit (dBm)	Max. Limit (W)	Result
03	2422	24.63	0.2902	30.00	1.0000	Complies
06	2437	26.06	0.4037	30.00	1.0000	Complies
09	2452	26.45	0.4411	30.00	1.0000	Complies

APPENDIX G - CONDUCTED SPURIOUS EMISSIONS

Test Mode TX B Mode

Bandedge-CH01

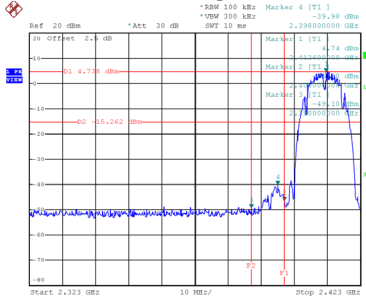

Date: 24.FEB.2019 10:35:53

Bandedge-CH11

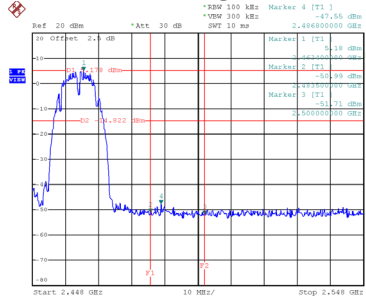

Date: 24.FEB.2019 10:44:13

CH01 – 10th Harmonic of the fundamental frequency

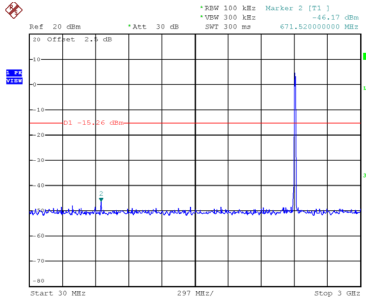

Date: 24.FEB.2019 10:36:05

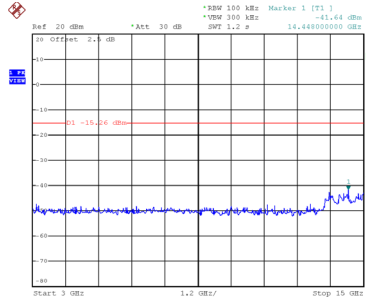

Date: 24.FEB.2019 10:36:12

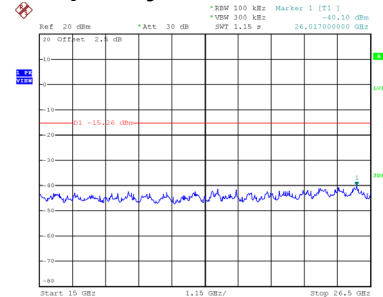

Date: 24.FEB.2019 10:36:19

CH06 – 10th Harmonic of the fundamental frequency

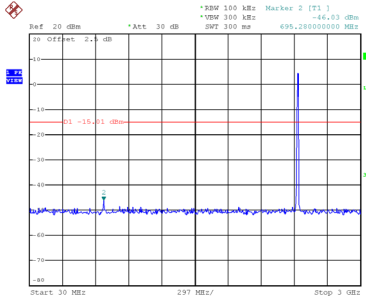

Date: 24.FEB.2019 10:42:20

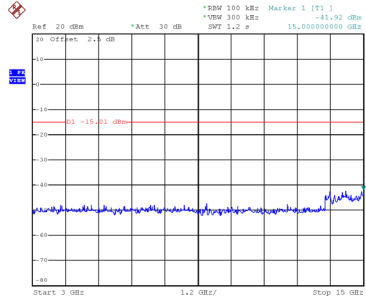

Date: 24.FEB.2019 10:42:26

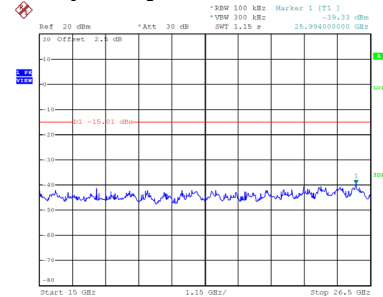

Date: 24.FEB.2019 10:42:33

CH11 – 10th Harmonic of the fundamental frequency

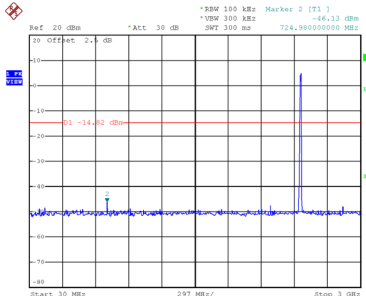

Date: 24.FEB.2019 10:44:26

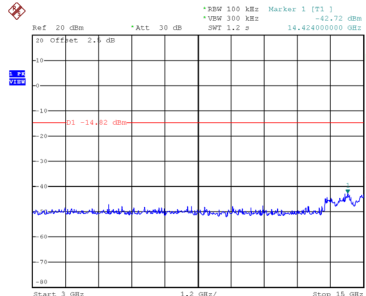

Date: 24.FEB.2019 10:44:32

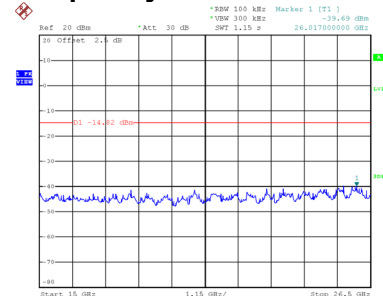

Date: 24.FEB.2019 10:44:39

Test Mode TX G Mode

Bandedge-CH01

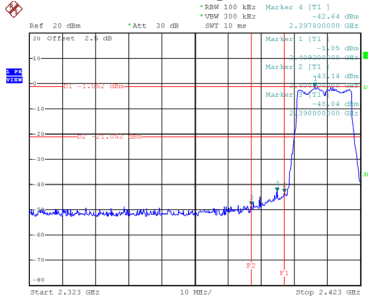

Date: 24.FEB.2019 10:45:14

Bandedge-CH11

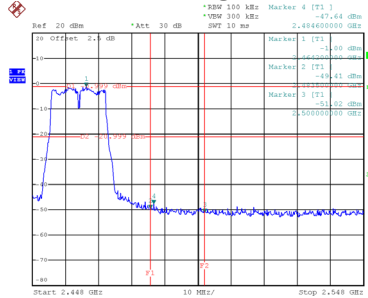

Date: 24.FEB.2019 10:49:02

CH01 – 10th Harmonic of the fundamental frequency

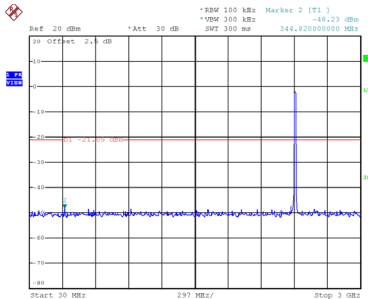

Date: 24.FEB.2019 10:45:57

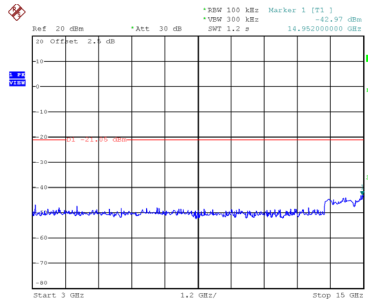

Date: 24.FEB.2019 10:46:04

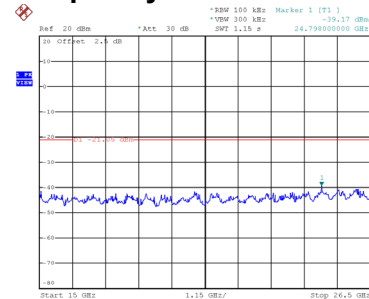

Date: 24.FEB.2019 10:46:10

CH06 – 10th Harmonic of the fundamental frequency

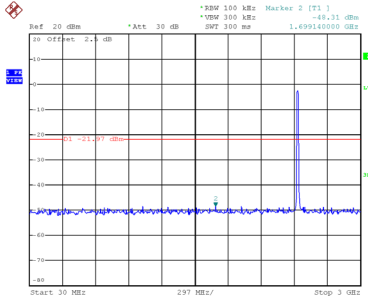

Date: 24.FEB.2019 10:47:32

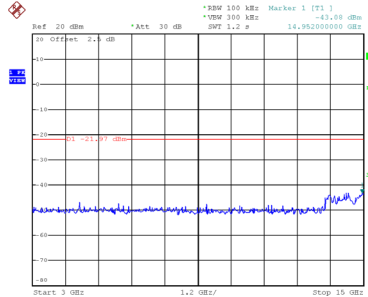

Date: 24.FEB.2019 10:47:39

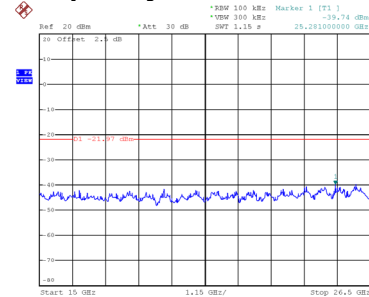

Date: 24.FEB.2019 10:47:46

CH11 – 10th Harmonic of the fundamental frequency

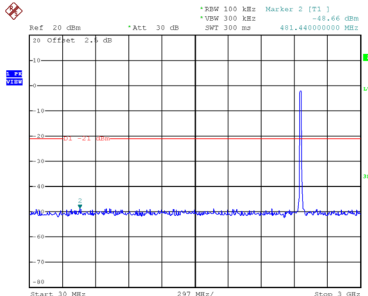

Date: 24.FEB.2019 10:49:14

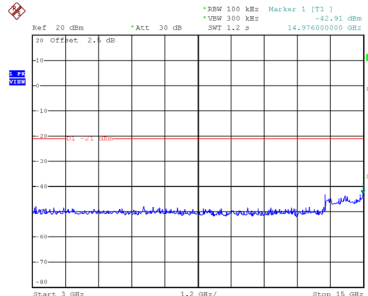

Date: 24.FEB.2019 10:49:21

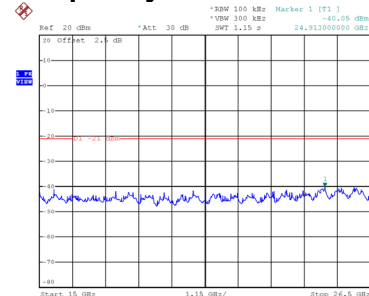

Date: 24.FEB.2019 10:49:28