



<b>Prüfbericht-Nr.:</b> <i>Test report no.:</i>	60364501 002	<b>Auftrags-Nr.:</b> <i>Order no.:</i>	238134909	Seite 1 von 43 <i>Page 1 of 43</i>
<b>Kunden-Referenz-Nr.:</b> <i>Client reference no.:</i>	N/A	<b>Auftragsdatum:</b> <i>Order date:</i>	17-Feb-2020	
<b>Auftraggeber:</b> <i>Client:</i>	Panasonic Corporation of North America Two Riverfront Plaza, 9th Floor, Newark, 07102-5490, New Jersey, United States			
<b>Prüfgegenstand:</b> <i>Test item:</i>	Speaker system			
<b>Bezeichnung / Typ-Nr.:</b> <i>Identification / Type no.:</i>	SC-HTB01, SC-HTB01FF			
<b>Auftrags-Inhalt:</b> <i>Order content:</i>	FCC Part 15C Test report (BDR/EDR)			
<b>Prüfgrundlage:</b> <i>Test specification:</i>	FCC 47CFR Part 15: Subpart C Section 15.247			
<b>Wareneingangsdatum:</b> <i>Date of sample receipt:</i>	06-Mar-2020			
<b>Prüfmuster-Nr.:</b> <i>Test sample no.:</i>	A001065112-001 A001065112-002			
<b>Prüfzeitraum:</b> <i>Testing period:</i>	13-Mar-2020 – 25-Mar-2020			
<b>Ort der Prüfung:</b> <i>Place of testing:</i>	EMC/RF Laboratory Taipei			
<b>Prüflaboratorium:</b> <i>Testing laboratory:</i>	TUV Rheinland Taiwan Ltd.			
<b>Prüfergebnis*:</b> <i>Test result*:</i>	Pass			
<b>überprüft von:</b> <i>reviewed by:</i>		<b>genehmigt von</b> <i>authorized by:</i>		
<b>Datum:</b> 26-May-2020 <i>Date:</i>	<b>Jack H.C. Chang</b>	<b>Datum:</b> 26-May-2020 <i>Date:</i>	<b>Ryan W.T. Chen</b>	
<b>Stellung / Position:</b>	Project Manager	<b>Stellung / Position:</b>	Project Manager	
<b>Sonstiges / Other:</b> The family models are listed are Electrically Identical. The differences are in the model numbers and label for marketing purposes. The test report No. 60364501 001 is replaced by this new test report No. 60364501 002 for correcting the model name from SC-HTB01 to SC-HTB01, SC-HTB01FF. Test report No. 60364501 001 becomes invalid since 2020-05-26.				
<b>Zustand des Prüfgegenstandes bei Anlieferung:</b> <i>Condition of the test item at delivery:</i>		Prüfmuster vollständig und unbeschädigt <i>Test item complete and undamaged</i>		
* Legende:	1 = sehr gut P(ass) = entspricht o.g. Prüfgrundlage(n)	2 = gut F(ail) = entspricht nicht o.g. Prüfgrundlage(n)	3 = befriedigend N/A = nicht anwendbar	4 = ausreichend N/T = nicht getestet
* Legend:	1 = very good P(ass) = passed a.m. test specification(s)	2 = good F(ail) = failed a.m. test specification(s)	3 = satisfactory N/A = not applicable	4 = sufficient N/T = not tested
<b>Dieser Prüfbericht bezieht sich nur auf das o.g. Prüfmuster und darf ohne Genehmigung der Prüfstelle nicht auszugsweise vervielfältigt werden. Dieser Bericht berechtigt nicht zur Verwendung eines Prüfzeichens.</b> <i>This test report only relates to the a. m. test sample. Without permission of the test center this test report is not permitted to be duplicated in extracts. This test report does not entitle to carry any test mark.</i>				

v05

## TEST SUMMARY

**5.1.1 ANTENNA REQUIREMENT***RESULT: Passed***5.1.2 PEAK OUTPUT POWER***RESULT: Passed***5.1.3 20dB BANDWIDTH***RESULT: Passed***5.1.4 CONDUCTED SPURIOUS EMISSIONS AND FREQUENCY BAND EDGE MEASURED IN 100KHZ BANDWIDTH***RESULT: Passed***5.1.5 SPURIOUS EMISSION***RESULT: Passed***5.1.6 FREQUENCY SEPARATION***RESULT: Passed***5.1.7 NUMBER OF HOPPING FREQUENCY***RESULT: Passed***5.1.8 TIME OF OCCUPANCY***RESULT: Passed***5.2.1 MAINS CONDUCTED EMISSIONS***RESULT: Passed***6.1.1 ELECTROMAGNETIC FIELDS***RESULT: Passed*

## Contents

<b>1.</b>	<b>GENERAL REMARKS .....</b>	<b>5</b>
<b>1.1</b>	<b>COMPLEMENTARY MATERIALS.....</b>	<b>5</b>
<b>1.2</b>	<b>DECISION RULE OF CONFORMITY.....</b>	<b>5</b>
<b>2.</b>	<b>TEST SITES .....</b>	<b>6</b>
<b>2.1</b>	<b>TEST LABORATORY .....</b>	<b>6</b>
<b>2.2</b>	<b>TEST FACILITY.....</b>	<b>6</b>
<b>2.3</b>	<b>LIST OF TEST AND MEASUREMENT INSTRUMENTS.....</b>	<b>7</b>
<b>2.4</b>	<b>TRACEABILITY .....</b>	<b>8</b>
<b>2.5</b>	<b>CALIBRATION .....</b>	<b>8</b>
<b>2.6</b>	<b>MEASUREMENT UNCERTAINTY.....</b>	<b>8</b>
<b>3.</b>	<b>GENERAL PRODUCT INFORMATION.....</b>	<b>9</b>
<b>3.1</b>	<b>PRODUCT FUNCTION AND INTENDED USE .....</b>	<b>9</b>
<b>3.2</b>	<b>SYSTEM DETAILS AND RATINGS.....</b>	<b>9</b>
<b>3.3</b>	<b>INDEPENDENT OPERATION MODES.....</b>	<b>11</b>
<b>3.4</b>	<b>NOISE GENERATING AND NOISE SUPPRESSING PARTS .....</b>	<b>11</b>
<b>3.5</b>	<b>SUBMITTED DOCUMENTS.....</b>	<b>11</b>
<b>4.</b>	<b>TEST SET-UP AND OPERATION MODES.....</b>	<b>12</b>
<b>4.1</b>	<b>PRINCIPLE OF CONFIGURATION SELECTION .....</b>	<b>12</b>
<b>4.2</b>	<b>TEST OPERATION AND TEST SOFTWARE.....</b>	<b>13</b>
<b>4.3</b>	<b>SPECIAL ACCESSORIES AND AUXILIARY EQUIPMENT .....</b>	<b>13</b>
<b>4.4</b>	<b>COUNTERMEASURES TO ACHIEVE EMC COMPLIANCE.....</b>	<b>13</b>
<b>4.5</b>	<b>TEST SETUP DIAGRAM .....</b>	<b>14</b>
<b>5.</b>	<b>TEST RESULTS .....</b>	<b>16</b>
<b>5.1</b>	<b>TRANSMITTER REQUIREMENT &amp; TEST SUITES .....</b>	<b>16</b>
5.1.1	<i>Antenna Requirement .....</i>	<i>16</i>
5.1.2	<i>Peak Output Power .....</i>	<i>17</i>
5.1.3	<i>20dB Bandwidth .....</i>	<i>19</i>
5.1.4	<i>Conducted spurious emissions and Frequency Band Edge measured in 100kHz Bandwidth.....</i>	<i>23</i>
5.1.5	<i>Spurious Emission .....</i>	<i>30</i>
5.1.6	<i>Frequency Separation.....</i>	<i>31</i>
5.1.7	<i>Number of hopping frequency.....</i>	<i>35</i>
5.1.8	<i>Time of Occupancy .....</i>	<i>38</i>
<b>5.2</b>	<b>MAINS EMISSIONS.....</b>	<b>41</b>
5.2.1	<i>Mains Conducted Emissions.....</i>	<i>41</i>

Produkte  
Products

**Prüfbericht - Nr.: 60364501 002**  
*Test Report No.*

**Seite 4 von 43**  
*Page 4 of 43*

<b>6.</b>	<b>SAFETY HUMAN EXPOSURE .....</b>	<b>42</b>
<b>6.1</b>	<b>RADIO FREQUENCY EXPOSURE COMPLIANCE .....</b>	<b>42</b>
6.1.1	<i>Electromagnetic Fields.....</i>	<i>42</i>
<b>7.</b>	<b>LIST OF TABLES .....</b>	<b>43</b>

## 1. General Remarks

### 1.1 Complementary Materials

The following attachments are integral parts of this test report:

**Appendix P: Photo Documentation internal view**  
(File Name: 60364501 002, 60364502 001 Appendix P)

**Appendix D: Test Result of Radiated Emissions**  
(File Name: 60364501 002 Appendix D)

**Appendix X: Photographs of the Test Set-Up**  
(File Name: 60364501 002 Appendix X)

#### Test Specifications

The following standards were applied.

**Table 1: Applied Standard and Test Levels**

Radio
FCC 47CFR Part 15: Subpart C Section 15.247 FCC 47CFR Part 2: Subpart J Section 2.1093 ANSI C63.10:2013 KDB558074 D01 DTS Meas Guidance v05r02 KDB447498 D01 General RF Exposure Guidance v06

### 1.2 Decision Rule of conformity

The decision rule of conformity of this test report is following the requirements of the requested standard in the quotation, and agreed among testing laboratory and manufacturer (applicant) to exclude the consideration of Measurement Uncertainty, unless it is required by the specific standard

## 2. Test Sites

### 2.1 Test Laboratory

TUV Rheinland Taiwan Ltd.

11F. No.758, Sec. 4, Bade Rd., Songshan Dist.  
Taipei City 105  
Taiwan (R.O.C.)

### 2.2 Test Facility

TUV Rheinland Taiwan Ltd.

AC Mains Conduction / Radiated Test:  
11F. No.758, Sec. 4, Bade Rd., Songshan Dist.  
Taipei City 105  
Taiwan (R.O.C.)  
FCC Registration No.: 180491  
IC Canada Registration No.: 9465A

Conducted Test:  
No. 458-18, Sec 2, Fenliao., Linkou Dist.  
New Taipei City 244  
Taiwan (R.O.C.)  
FCC Registration No.: 226631  
IC Canada Registration No.: 25563

TAF Accredited NCC Test Lab. No.:3567  
TAF ISO17025 Certification effective period: 6<sup>th</sup>-May-2019 to 05<sup>th</sup>-May-2022



Testing Laboratory  
3567

## 2.3 List of Test and Measurement Instruments

**Table 2: List of Test and Measurement Equipment**

Equipment	Manufacturer	Model No.	Serial No.	Cal. Date	Cal. Due Date
EMI Test Receiver	R&S	ESR7	102109	2019/4/17	2020/4/16
Spectrum Analyzer	R&S	FSV40	101112	2019/10/15	2020/10/15
Pre-Amplifier	Agilent	8447D	2727A05146	2020/2/17	2021/2/16
Pre-Amplifier	EMCI	EMC051845SE	980635	2020/2/11	2021/2/10
Pre-Amplifier	EMCI	EMC184045SE	980656	2020/2/11	2021/2/10
Bilog Antenna	SCHWARZBECK	VULB-9168	00950	2020/1/20	2021/1/19
Horn Antenna	ETS-Lindgren	3117	00218929	2019/11/27	2020/11/26
Horn Antenna	SCHWARZBECK	BBHA 9170	00890	2019/4/12	2020/4/11
Loop Antenna	EMCI	LPA600	287	2019/12/20	2020/12/19
Test Software	Audix	e3	Ver. 9	N/A	N/A
Test Cable	HUBER+SUHNER	SUCOFLEX 104EA	800057/4EA	2019/4/11	2020/4/10
Test Cable	HUBER+SUHNER	SUCOFLEX 104	802244/4	2019/4/11	2020/4/10
Test Cable	HUBER+SUHNER	SUCOFLEX 104	MY37203/4	2019/4/11	2020/4/10
Test Cable	HUBER+SUHNER	SUCOFLEX 102EA	800897/2EA	2019/4/11	2020/4/10
Test Cable	HUBER+SUHNER	SUCOFLEX 102EA	800902/2EA	2019/4/11	2020/4/10
Test Cable	HUBER+SUHNER	SUCOFLEX 102EA	801026/2EA	2019/4/11	2020/4/10
Spectrum Analyzer	R&S	FSV40	101512	2020/02/24	2021/02/23
Power Meter	Anritsu	ML2495A	1901008	2019/4/29	2020/4/28
Power Sensor	Anritsu	MA2411B	1725269	2019/4/29	2020/4/28
EMI Test Receiver	Rohde & Schwarz	ESCI 7	100797	2020/03/13	2021/03/13
Two-Line V-Network (for EUT)	Rohde & Schwarz	ENV216	101243	2019/06/23	2020/06/23
Two-Line V-Network	Rohde & Schwarz	ENV216	101262	2019/07/16	2020/07/16
Telecom ISN 4 Line	Fischer Custom Communications	FFCC-TLISN- T4-02-09	101168	2020/02/03	2021/02/03
Impedance Stabilization Network	TESEQ	ISN T800	51949	2020/02/25	2021/02/25
Pulse Limiter	Rohde & Schwarz	ESH3-Z2	0357.8810.54- 102102-HN	2019/07/25	2020/07/25
Test Software	Audix	e3	Ver. 9	N/A	N/A

## 2.4 Traceability

All measurement equipment calibrations are traceable to NML(Taiwan)/NIST(USA) or where calibration is performed outside Taiwan, to equivalent nationally recognized standards organizations.

## 2.5 Calibration

Equipment requiring calibration is calibrated periodically in a suitably accredited Calibration Lab. Additionally all equipment is verified for proper performance on a regular schedule using in house standards or comparisons.

## 2.6 Measurement Uncertainty

The estimated combined standard uncertainty for radiated emissions and conducted emissions measurements .

**Table 3: Emission Measurement Uncertainty**

Parameter	Uncertainty
Radio Frequency	± 0.1 ppm
RF power/RF Exposure(MPE), conducted	± 1.5 dB
RF power density, conducted	± 3 dB
spurious emissions, conducted	± 3 dB
all emissions, radiated	± 6 dB
Temperature	± 1 °C
Humidity	± 5 %
DC and low frequency voltages	±3 %



### 3. General Product Information

#### 3.1 Product Function and Intended Use

The EUT is a Panasonic SC-HTB01 80W RMS High Resolution Compact 2.1 Ch 4K (Pass Through) Built in Subwoofer Bluetooth Wireless with twin DHMI(ARC) and Remote control. It contains a Bluetooth compatible module enabling the user to communicate data through a Wireless interface. For details refer to the User Guide, Data Sheet and Circuit Diagram.

#### 3.2 System Details and Ratings

**Table 4: Basic Information of EUT**

Item	EUT information
Kind of Equipment/Test Item	Speaker system
Type Identification	SC-HTB01, SC-HTB01FF
FCC ID	ACJ-SCHTB01

**Table 5: Technical Specification of EUT**

Technical Specification	Value
Operating Frequencies	2402~2480 MHz
Channel Spacing	1 MHz
Channel number	79
Operation Voltage	AC 100V – 240V, 50-60Hz to 19.5Vdc (Bluetooth Module: 3.3Vdc)
Modulation	GFSK, $\pi/4$ DQPSK, 8 DPSK
Antenna gain	0.5 dBi

**Table 6: Frequency hopping information**

Technical Specification	Description
Hopping Range	<p>Hereby we declare that the maximum frequency of this device is: 2402-2480MHz. This is according the Bluetooth Core Specification V2.1+EDR for devices which will be operated in the USA. This was checked during the Bluetooth Qualification tests (Test Case: TRM/CA/04).</p>
Hopping Sequence	<p>Example of a 79 hopping sequence in data mode:</p> <p>33,04,21,44,23,42,53,46,55,48,40,59,72,29,76,31,08,73,07,75,09,45,60,39,58,13,47,11,77,52,35,50,65,54,67,56,69,62,71,64, 7,25,27,66,57,70,74,61,78,63,10,41,05,43,15,44,64,68,02,70,06,01,51,03,55,05,03,66,53,49,36,47,</p>
Receiver input bandwidth	<p>The input bandwidth of the receiver is 1MHz. In every connection one Bluetooth device is the master and the other one is the slave. The master determines the hopping sequence. The slave follows this sequence. Both devices shift between RX and TX time slot according to the clock of the master.</p> <p>Additionally the type of connection is set up at the beginning of the connection. The master adapts its hopping frequency and its TX/RX timing according to the packet type of the connection. Also the slave of the connection will use these settings.</p> <p>Repeating of a packer has no influence on the hopping sequence. The hopping sequence generated by the master of the connection will be followed in any case.</p> <p>That means a repeated packet will not be send on the same frequency, it is send on the next frequency of the hopping sequence.</p>

### 3.3 Independent Operation Modes

Basic operation modes are:

- A. Transmitting
  - 1. Low channel
  - 2. Middle channel
  - 3. High channel
- B. Receiving
- C. Hopping
- D. Normal

### 3.4 Noise Generating and Noise Suppressing Parts

Refer to the Circuit Diagram.

### 3.5 Submitted Documents

- Circuit Diagram
- Instruction Manual
- Rating Label
- Technical Description

## 4. Test Set-up and Operation Modes

### 4.1 Principle of Configuration Selection

The test modes were adapted accordingly in reference to the instructions for use.

During testing, Channel and Power Controlling Software provided by the customer was used to control the operating channel as well as the output power level. The RF output power selection is for the setting of RF output power expected by the customer and is going to be fixed on the firmware of the final end product.

**Table 7: Table for Parameters of Test Software Setting**

Mode	Channel Frequency		
	2402 MHz	2441 MHz	2480 MHz
1-DH5	255/30	255/30	255/30
2-DH5	255/30	255/30	255/30
3-DH5	255/30	255/30	255/30

## 4.2 Test Operation and Test Software

Setup for testing: Test samples are provided with a USB interface which makes it possible to control them through a test software installed on a notebook computer.

This software was running on the laptop computer connected to the EUT. It was used to enable the operation modes listed in section 3.3 as appropriate.

The samples were used as follows:

Conducted: A001065112-002

Radiation: A001065112-001

Full test was applied on all test modes, but only worst case was shown

Test Software	
	CSR Bluesuite 2.6.2

## 4.3 Special Accessories and Auxiliary Equipment

The product has been tested together with the following additional accessories:

Description	Manufacturer	Model No.	Serial No.
Notebook(EMC-06)	Lenovo	TP00048A	PB-0F8B2

## 4.4 Countermeasures to achieve EMC Compliance

The test sample which has been tested contained the noise suppression parts as described in the Constructional Data Form or the Technical Construction File. No additional measures were employed to achieve compliance.

## 4.5 Test Setup Diagram

### Diagram of Measurement Configuration for Radiation Test

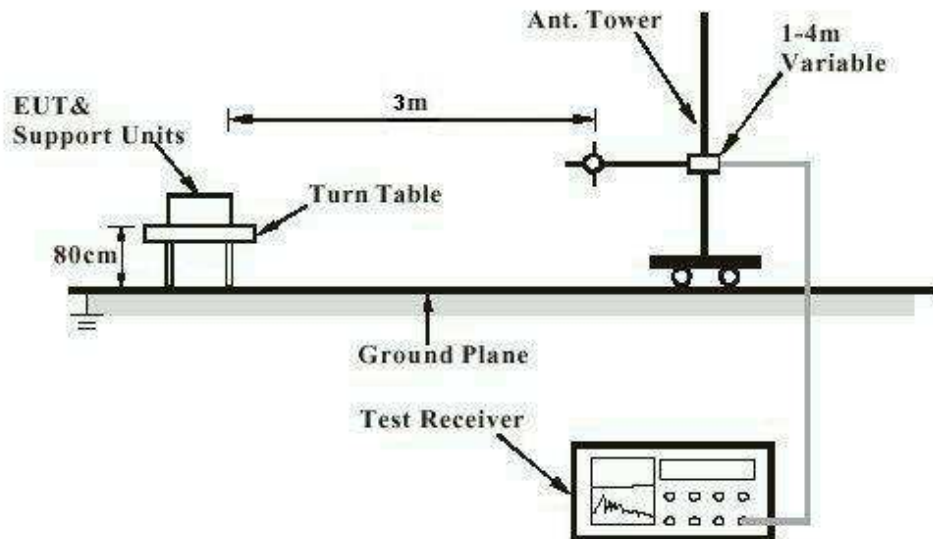

Note: Measurements above 1 GHz are done with a table height of 1.5m

**Diagram of Measurement Equipment Configuration for Mains Conduction Measurement**

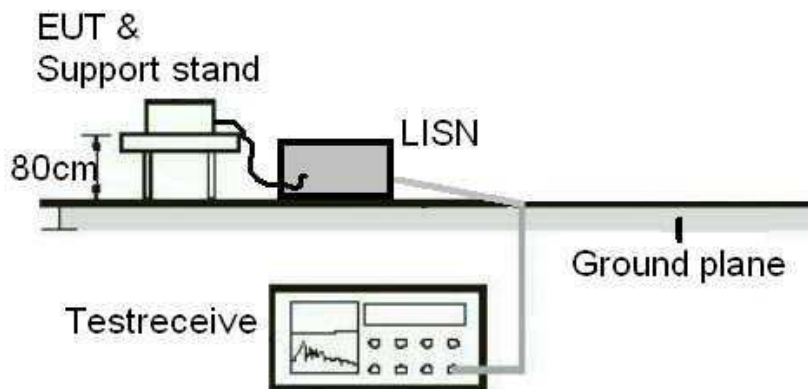

**Diagram of Measurement Equipment Configuration for Conducted Transmitter Measurement**

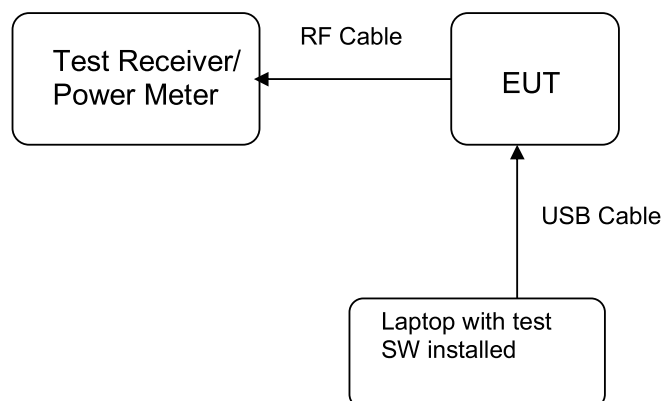

## 5. Test Results

### 5.1 Transmitter Requirement & Test Suites

#### 5.1.1 Antenna Requirement

**RESULT:** **Passed**

Test standard : FCC Part 15.247(b)(4), Part 15.203

Requirement : use of approved antennas only with directional gains that do not exceed 6 dBi

According to the manufacturer declaration, the EUT has an antenna with a directional gain of 0.5 dBi. The antenna is a PCB antenna with no possibility of replacement with a non-approved antenna by the end-user. Therefore, the EUT is considered to comply with this provision.

Refer to EUT photo for details.



### 5.1.2 Peak Output Power

**RESULT:**
**Passed**

Test standard : FCC Part 15.247(b)(1)  
 Basic standard : ANSI C63.10:2013  
 Limit : 125 mW  
 Kind of test site : Shielded room

**Test setup**

Test Channel : Low/ Middle/ High  
 Operation Mode : A  
  
 Ambient temperature : 22-26 °C  
 Relative humidity : 50-65 %  
 Atmospheric pressure : 100-103 kPa

**Table 8: Test result of Peak Output Power 1-DH5**

Channel	Channel Frequency (MHz)	Output Power		Average Output Power	Limit
		(dBm)	(mW)	(mW)	(mW)
Low Channel	2402.0	0.69	1.172	1.014	125
Middle Channel	2441.0	3.99	2.506	2.213	125
High Channel	2480.0	5.18	3.296	2.931	125

**Table 9: Test result of Peak Output Power 2-DH5**

Channel	Channel Frequency (MHz)	Output Power		Average Output Power	Limit
		(dBm)	(mW)	(mW)	(mW)
Low Channel	2402.0	-2.79	0.526	0.223	125
Middle Channel	2441.0	1.05	1.274	0.547	125
High Channel	2480.0	2.61	1.824	0.789	125

**Table 10: Test result of Peak Output Power 3-DH5**

Channel	Channel Frequency (MHz)	Output Power		Average Output Power	Limit
		(dBm)	(mW)	(mW)	(mW)
Low Channel	2402.0	-2.08	0.619	0.223	125
Middle Channel	2441.0	1.61	1.449	0.548	125
High Channel	2480.0	3.16	2.070	0.791	125

### 5.1.3 20dB Bandwidth

**RESULT:**
**Passed**

Test standard : FCC Part 15.247(a)(1)  
 Basic standard : ANSI C63.10:2013  
 Kind of test site : Shielded room

**Test setup**

Test Channel : Low/ Middle/ High  
 Operation Mode : A

Ambient temperature : 22-26°C  
 Relative humidity : 50-65%  
 Atmospheric pressure : 100-103 kPa

**Table 11: Test result of 20dB Bandwidth 1-DH5**

Channel	Channel Frequency (MHz)	20dB Bandwidth (kHz)	Result
Low Channel	2402	950.80	Pass
Mid Channel	2441	955.10	Pass
High Channel	2480	959.50	Pass

**Table 12: Test result of 20dB Bandwidth 3-DH5**

Channel	Channel Frequency (MHz)	20dB Bandwidth (MHz)	Result
Low Channel	2402	1259.00	Pass
Mid Channel	2441	1263.40	Pass
High Channel	2480	1259.00	Pass

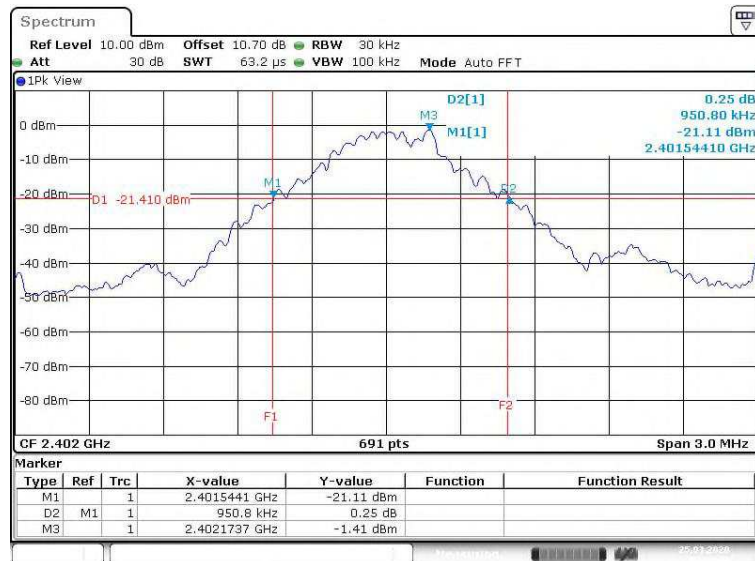
**Test Plot of 20dB Bandwidth**
**1-DH5**
**Low Channel**

Date: 25.MAR.2020 07:14:33

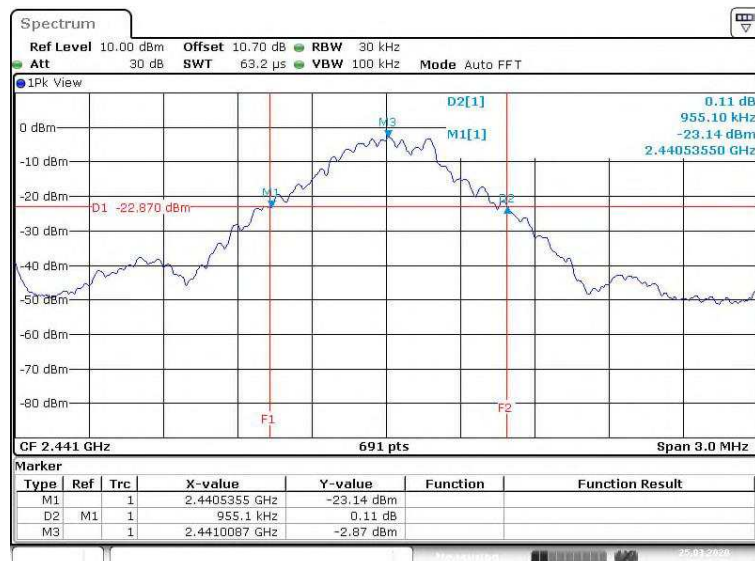
**Middle Channel**

Date: 25.MAR.2020 07:18:31

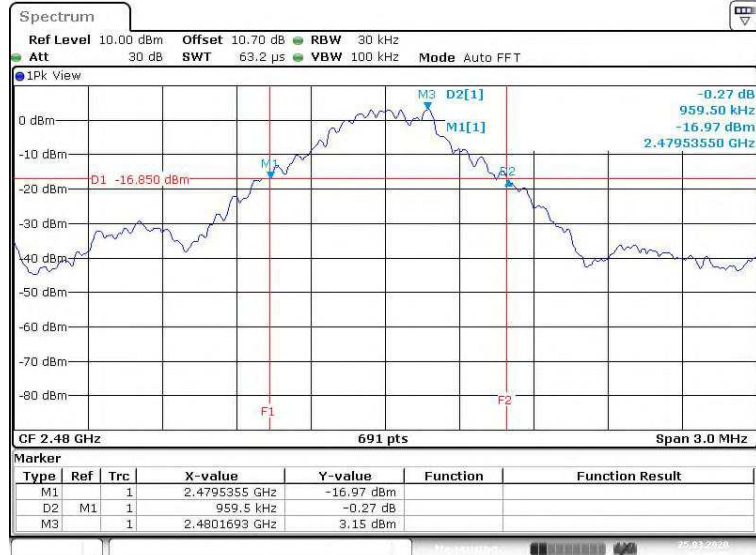
**High Channel**

Date: 25.MAR.2020 07:20:09

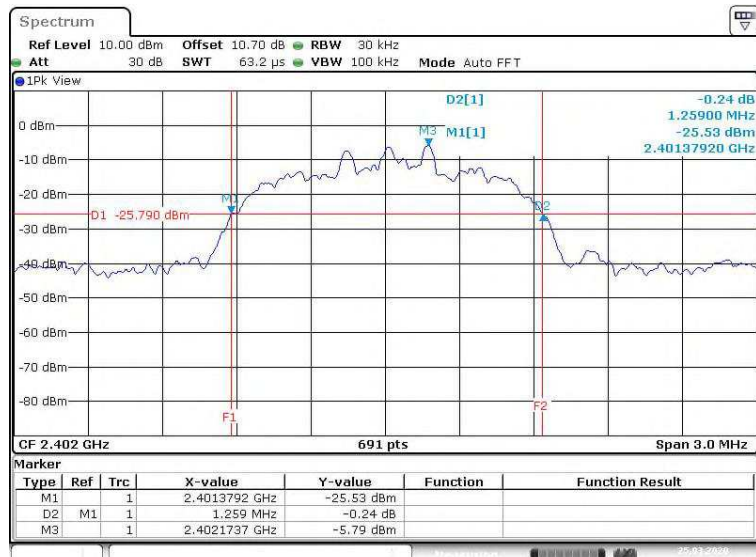
**3-DH5**
**Low Channel**

Date: 25.MAR.2020 07:15:58

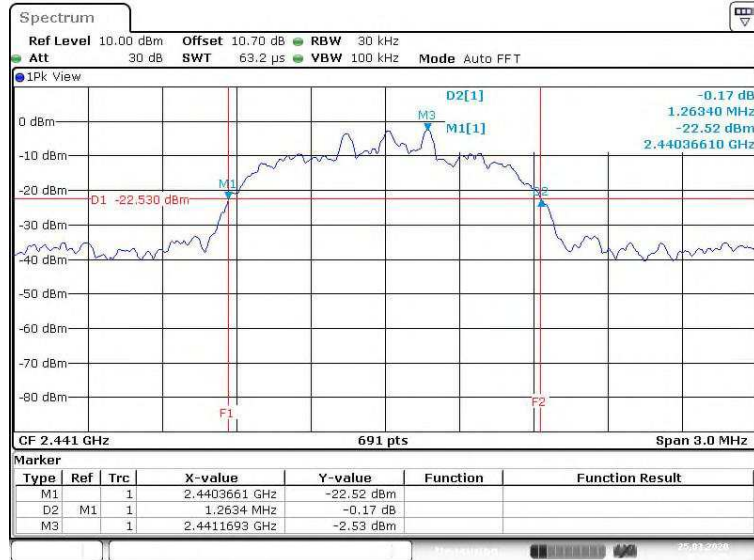
**Middle Channel**

Date: 25.MAR.2020 07:17:16

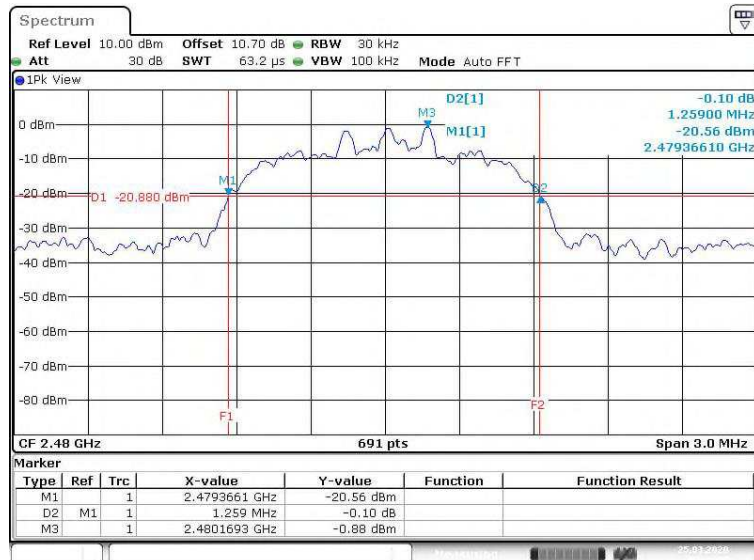
**High Channel**

Date: 25.MAR.2020 07:21:05

#### 5.1.4 Conducted spurious emissions and Frequency Band Edge measured in 100kHz Bandwidth

**RESULT:** **Passed**

Test standard : FCC part 15.247(d)  
Basic standard : ANSI C63.10:2013  
Limit : 20dB (below that in the 100kHz bandwidth within the band that contains the highest level of the desired power)  
Kind of test site : Shielded room

##### Test setup

Test Channel : Low/ Middle/ High for Conducted Spurious Emissions  
Low/ High for Frequency Band Edge  
Operation Mode : A, C  
Ambient temperature : 22-26°C  
Relative humidity : 50-65%  
Atmospheric pressure : 100-103 kPa

All emissions are more than 20dB below fundamental, details refer to following test plot, and compliance is achieved as well.  
Due to the small size of the RF circuit and that there are no inductive components of significant size connected to the antenna port, 9kHz to 30MHz frequency range is not tested based on technical judgment.

## Test Plot 100kHz Conducted Emissions 1-DH5

### Low Channel

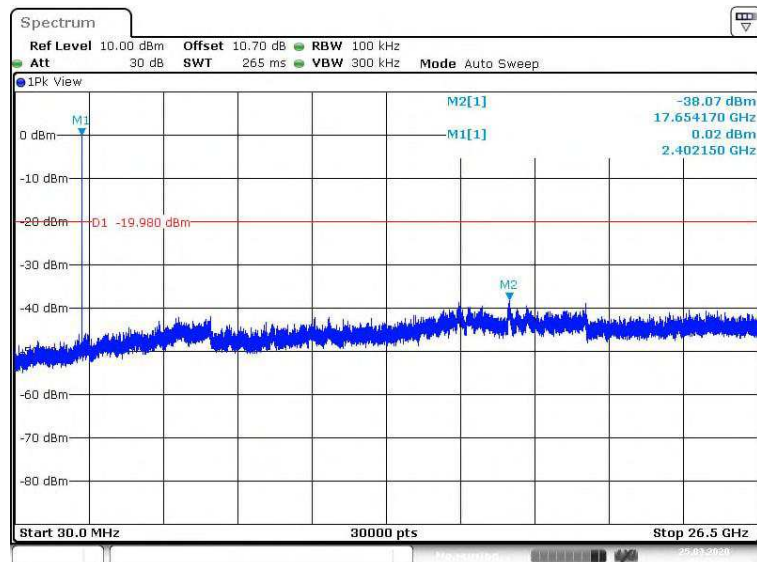

Date: 25.MAR.2020 07:37:02

### Middle Channel

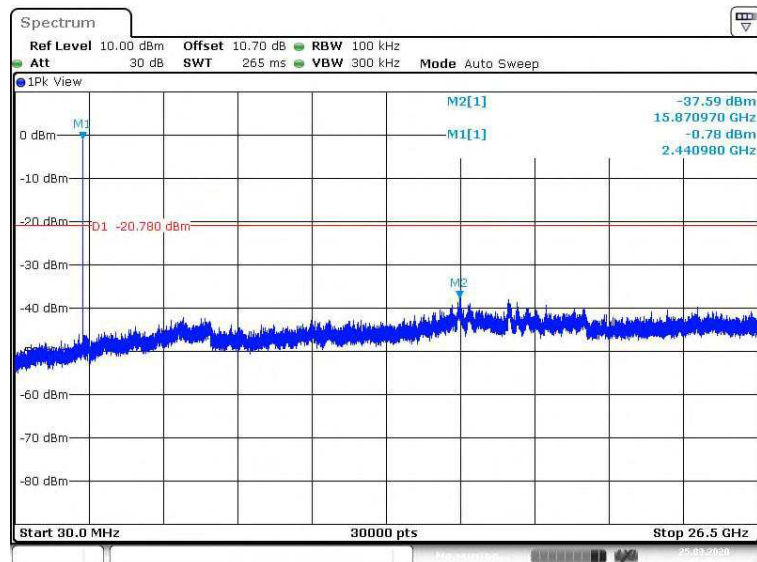

Date: 25.MAR.2020 07:40:09

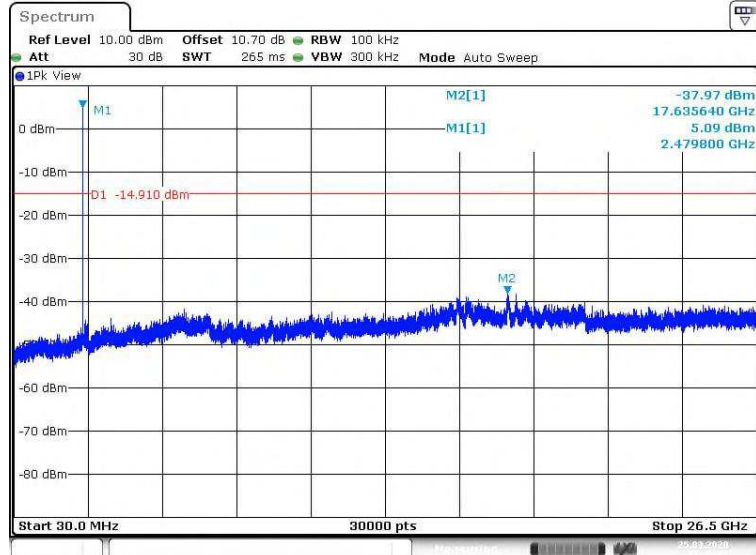

**High Channel**

Date: 25.MAR.2020 07:41:22

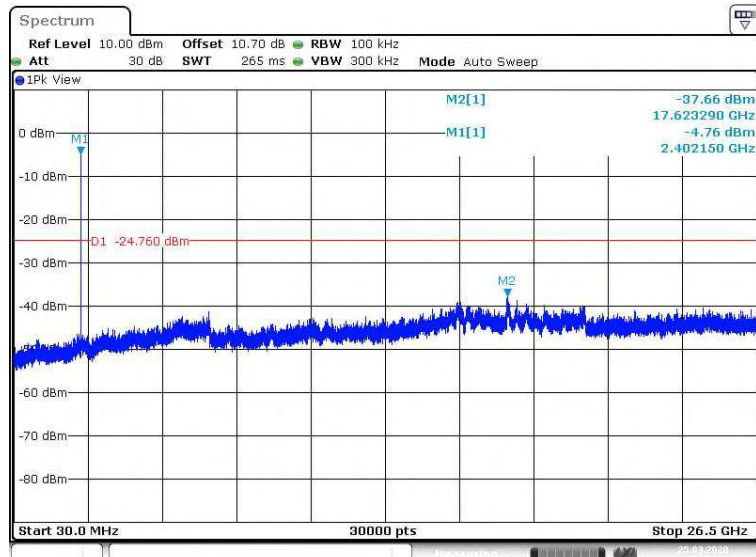
**3-DH5**
**Low Channel**

Date: 25.MAR.2020 07:38:07

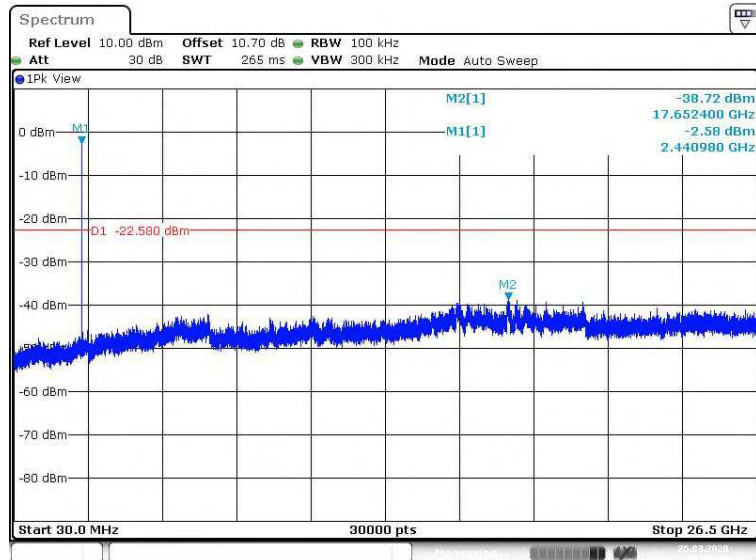
**Middle Channel**

Date: 25.MAR.2020 07:39:07

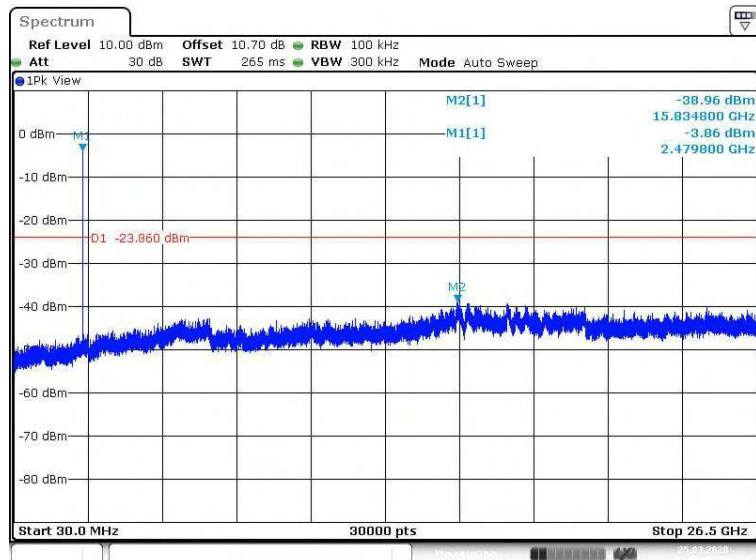
**High Channel**

Date: 25.MAR.2020 07:42:19

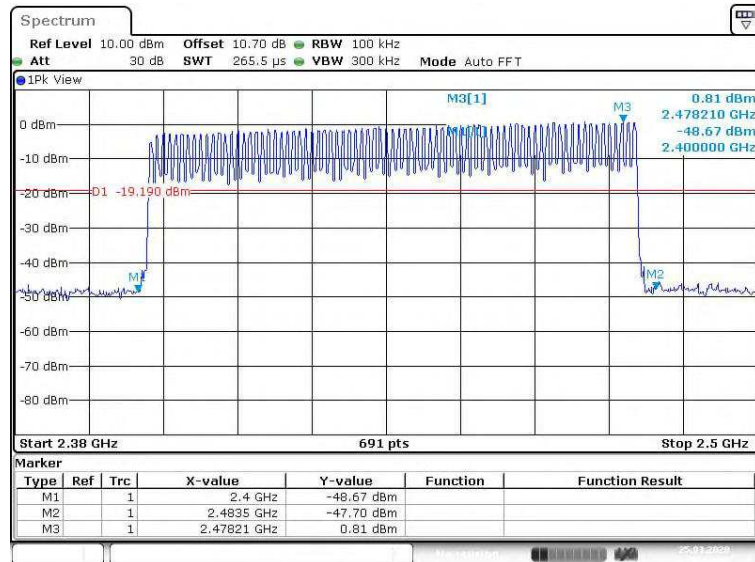
**Test Plot 100kHz RBW of Band Edge**  
**1-DH5**
**Hopping**

Date: 25.MAR.2020 06:24:32

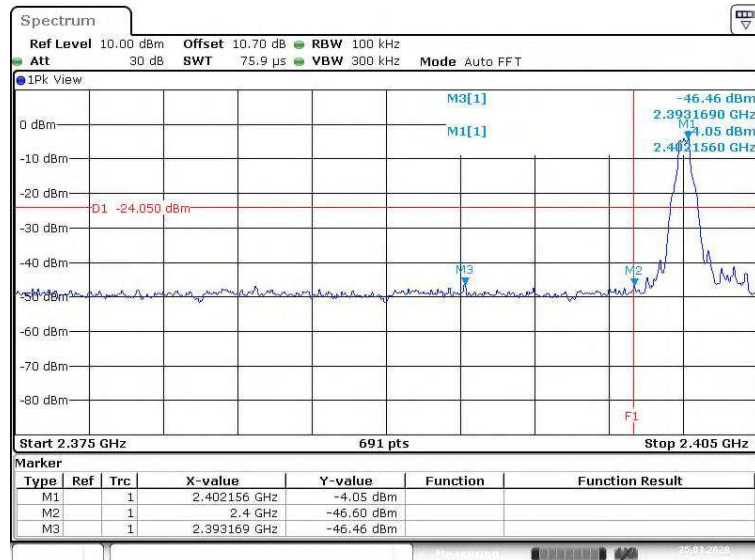
**Low Channel**

Date: 25.MAR.2020 07:27:58

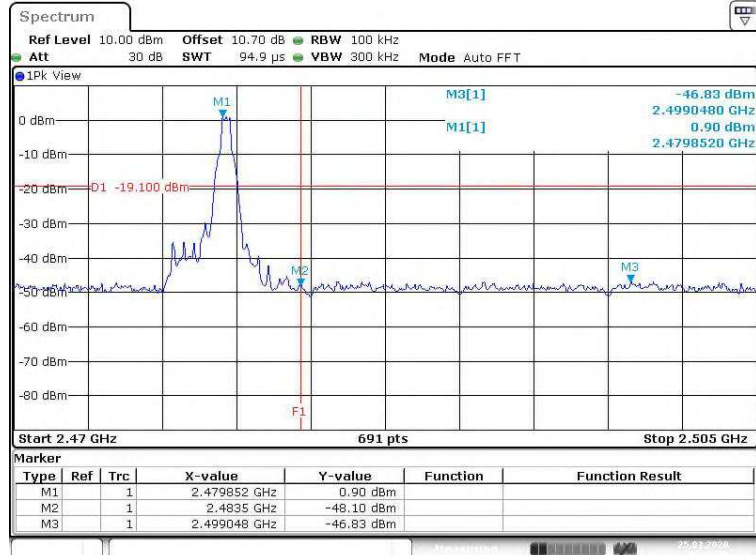
**High Channel**

Date: 25.MAR.2020 07:34:43

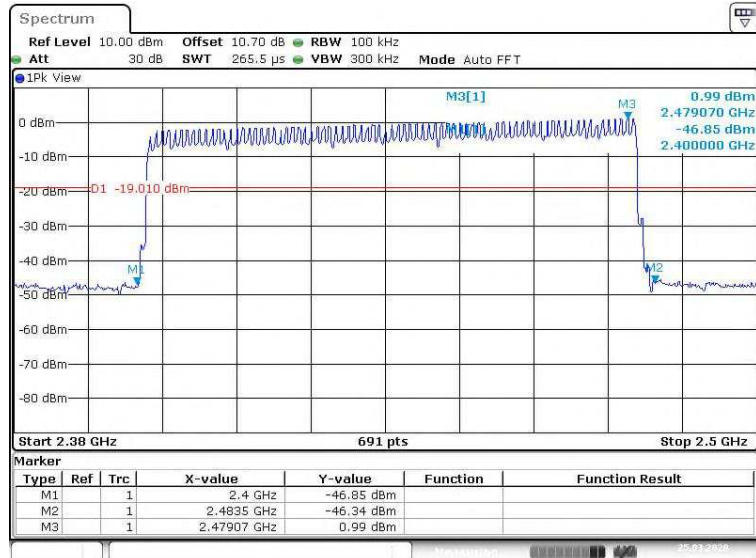
**3-DH5**  
**Hopping**

Date: 25.MAR.2020 06:35:34

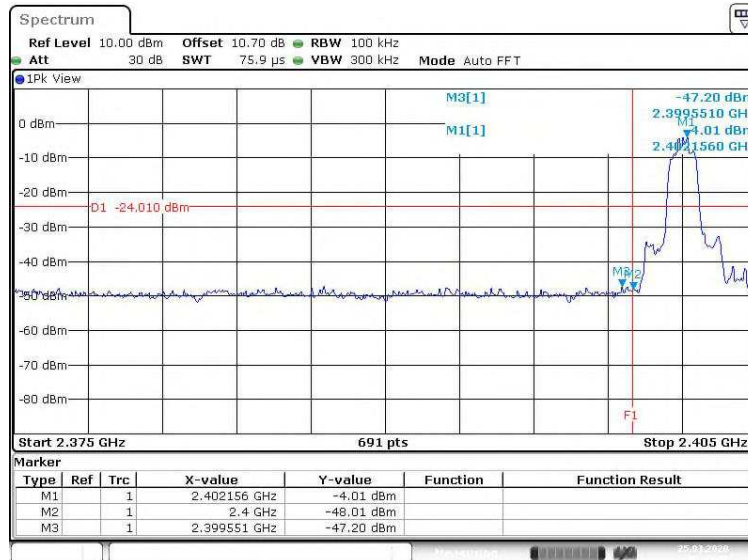
**Low Channel**

Date: 25.MAR.2020 07:29:12

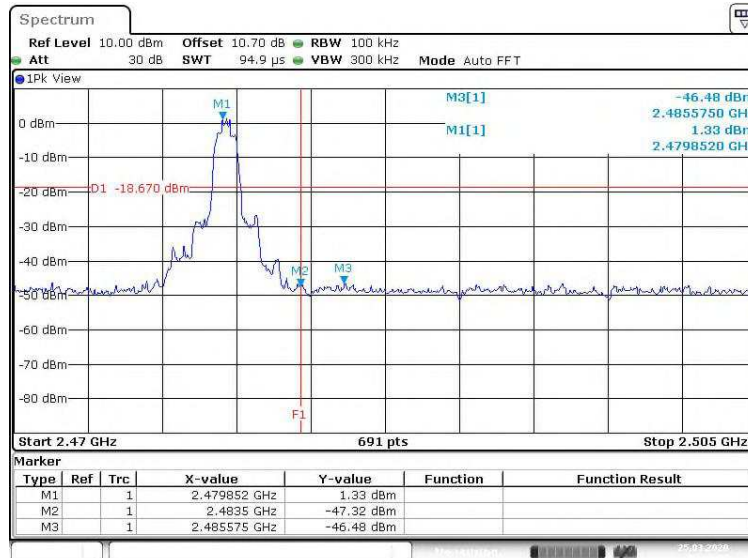
**High Channel**

Date: 25.MAR.2020 07:33:45

### 5.1.5 Spurious Emission

**RESULT:****Passed**

Test standard	:	FCC part 15.247(d), FCC 15.205, FCC 15.209
Basic standard	:	ANSI C63.10: 2013
Limits	:	Radiated emissions which fall in the restricted bands, as defined in FCC 15.205(a), must comply with the radiated emission limits specified in FCC 15.209(a). Emission radiated outside the restricted and authorized frequency bands must either comply with the radiated emission limits specified for the restricted bands or in FCC15.247(d).
Kind of test site	:	3m Semi-Anechoic Chamber

**Test setup**

Test Channel	:	Low/ Middle/ High
Operation mode	:	A, B
Ambient temperature	:	22-26°C
Relative humidity	:	50-65 %
Atmospheric pressure	:	100-103 kPa

Remark: Testing was carried out within frequency range 9kHz to the tenth harmonic. For details refer to Appendix D. The Radiated Emissions testing was performed in the X, Y and Z axis orientation. The worst-case Axis orientation is recorded in this test report.

### 5.1.6 Frequency Separation

**RESULT:**
**Passed**

Test standard : FCC part 15.247(a)(1)  
 Basic standard : ANSI C63.10:2013  
 Limits :  $\geq 25\text{kHz}$  or  $2/3$  of 20dB bandwidth, whichever is greater

**Test setup**

Test Channel : Hopping On  
 Operation mode : C  
  
 Ambient temperature : 22-26°C  
 Relative humidity : 50-65 %  
 Atmospheric pressure : 100-103 kPa

**Table 13: Test result of Frequency Separation, 1-DH5**

Channel	Freq. (MHz)	Adjacent Channel Separation (MHz)	20 dB Bandwidth (kHz)	Minimum Limit (MHz)	Pass / Fail
0	2402	1.00	950.80	0.633866667	Pass
39	2441	1.00	955.10	0.636733333	Pass
78	2480	1.00	959.50	0.639666667	Pass

**Table 14: Test result of Frequency Separation, 3-DH5**

Channel	Freq. (MHz)	Adjacent Channel Separation (MHz)	20 dB Bandwidth (kHz)	Minimum Limit (MHz)	Pass / Fail
0	2402	1.00	1259.00	0.839333333	Pass
39	2441	1.00	1263.40	0.842266667	Pass
78	2480	1.00	1259.00	0.839333333	Pass

## Test Plot of Frequency Separation 1-DH5

### Low Channel

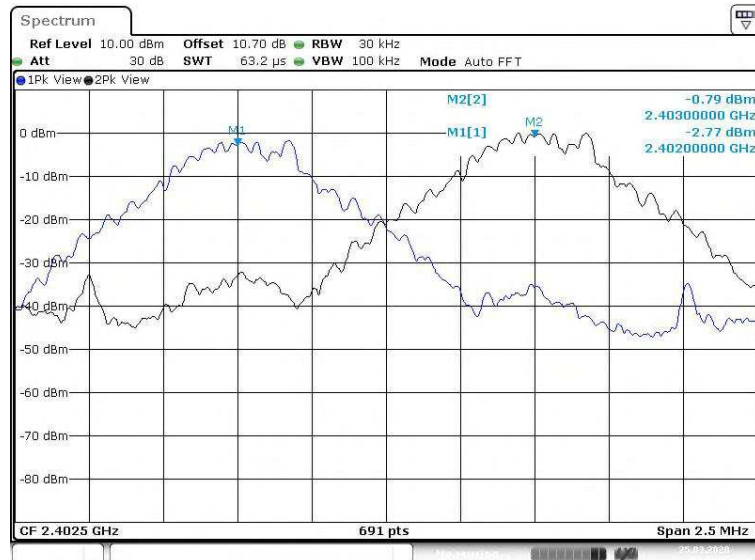

Date: 25.MAR.2020 06:49:03

### Middle Channel

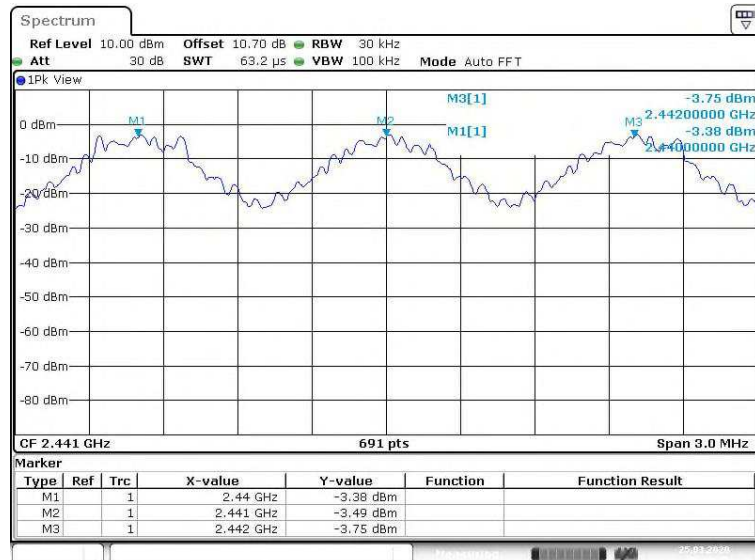

Date: 25.MAR.2020 06:43:36

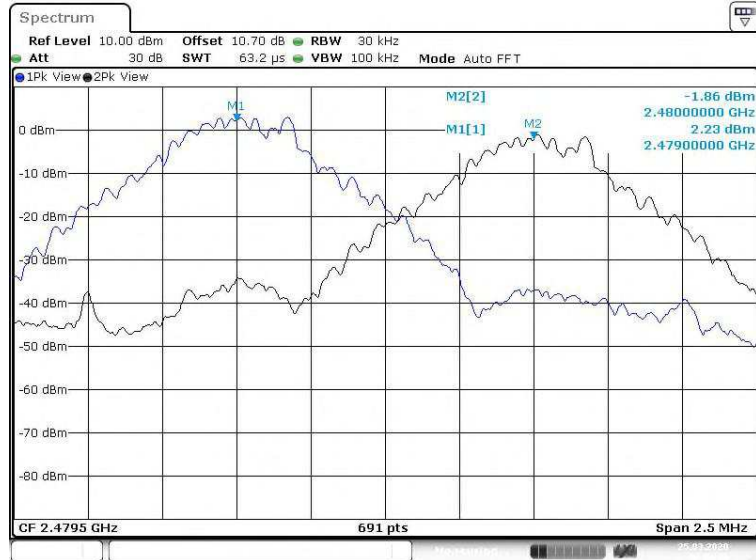
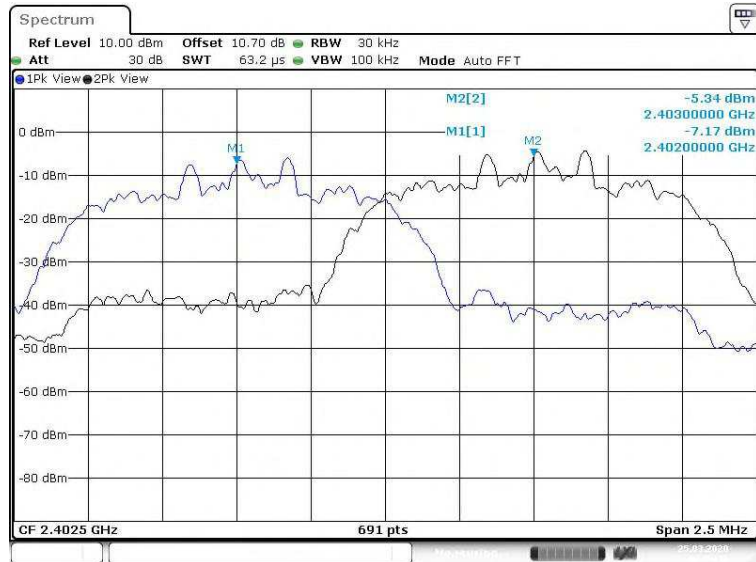

**High Channel**

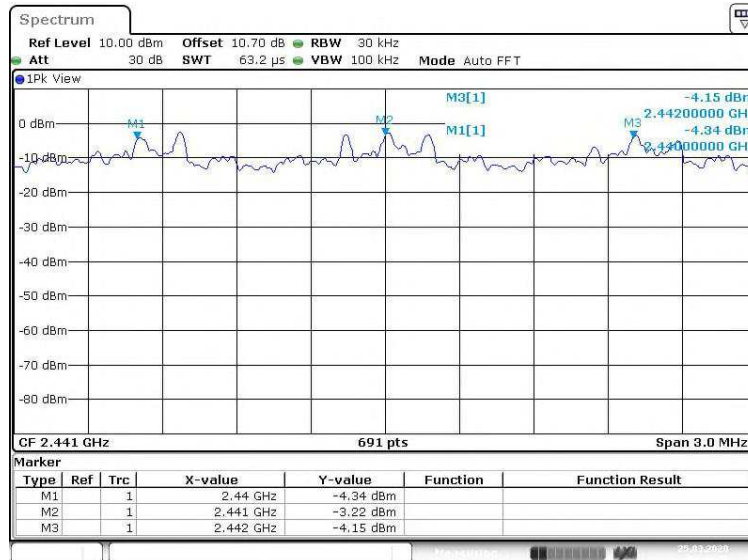
**3-DH5**
**Low Channel**

**Middle Channel**

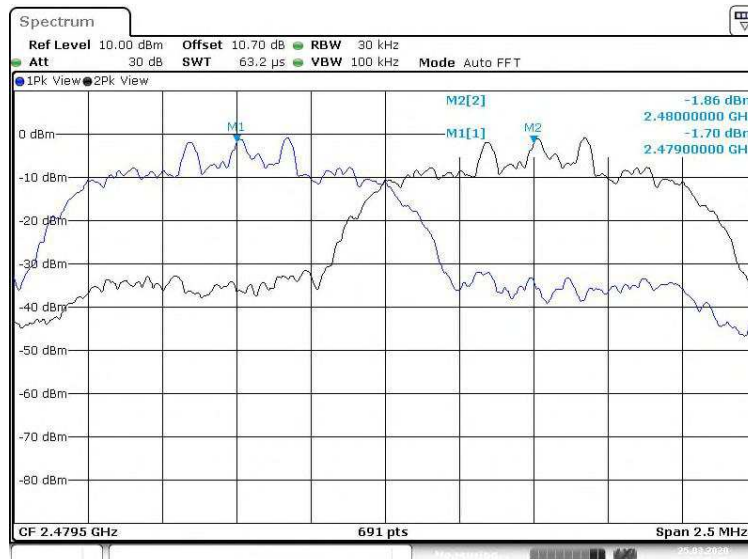
Date: 25.MAR.2020 06:42:36

**High Channel**

Date: 25.MAR.2020 06:51:56

### 5.1.7 Number of hopping frequency

**RESULT:**
**Passed**

Test standard : FCC part 15.247(a)(1)(iii)  
 Basic standard : ANSI C63.10:2013  
 Limits :  $\geq 15$  non-overlapping channels  
 Kind of test site : Shield room

**Test setup**

Test Channel : Hopping On  
 Operation mode : C  
  
 Ambient temperature : 22-26°C  
 Relative humidity : 50-65%  
 Atmospheric pressure : 100-103 kPa

**Table 15: Test result of Number of hopping frequency, 1-DH5**

Frequency Range	Measured Quantity of Hopping Channel	Limit	Result
<u>2402</u> to <u>2480</u> MHz	79	$\geq 15$	Pass

**Table 16: Test result of Number of hopping frequency, 3-DH5**

Frequency Range	Measured Quantity of Hopping Channel	Limit	Result
<u>2402</u> to <u>2480</u> MHz	79	$\geq 15$	Pass

### Test Plot of Number of hopping frequencies

#### 1-DH5

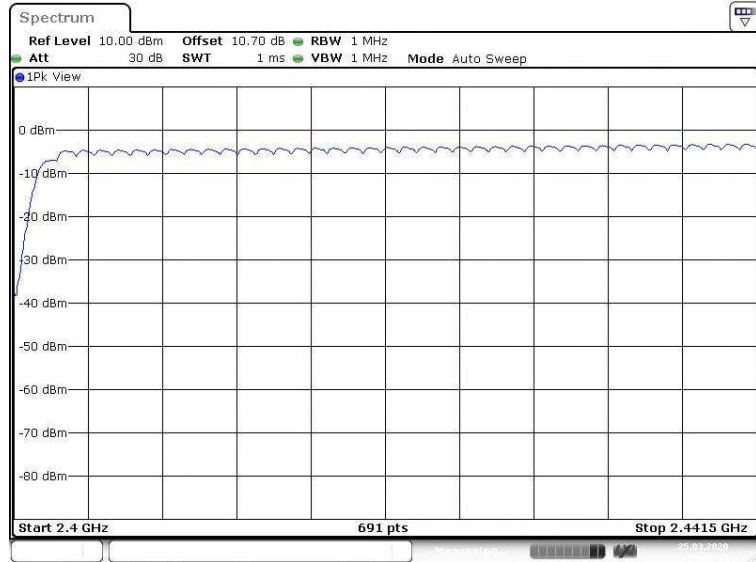

Date: 25.MAR.2020 06:38:31

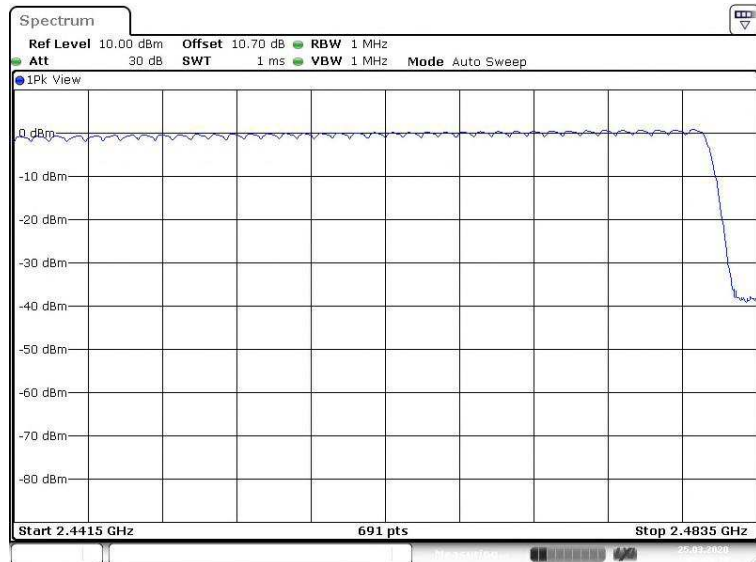

Date: 25.MAR.2020 06:39:19

**3-DH5**

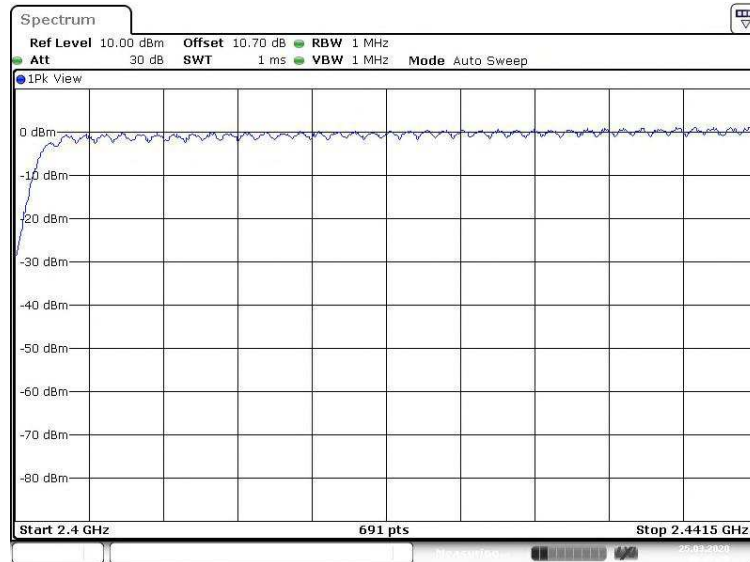

Date: 25.MAR.2020 06:37:27

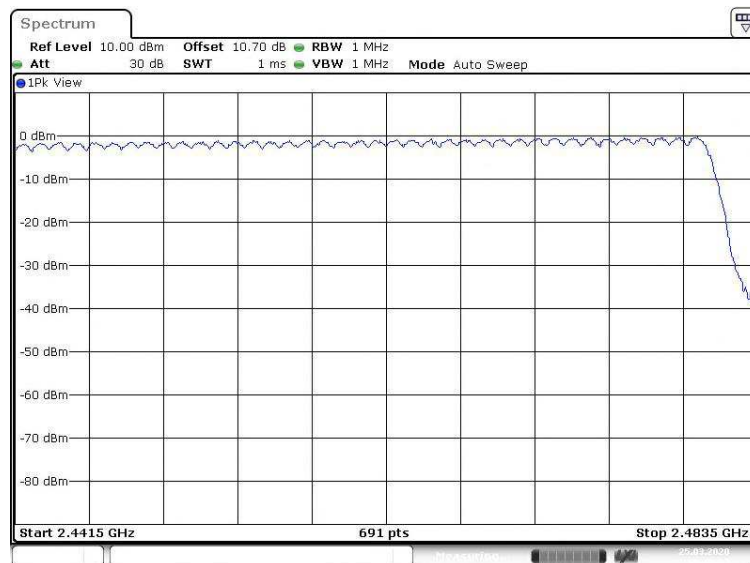

Date: 25.MAR.2020 06:40:05

### 5.1.8 Time of Occupancy

**RESULT:**
**Passed**

Test standard : FCC part 15.247(a)(1)(iii)  
 Basic standard : ANSI C63.10:2013  
 Limits : 0.4s  
 Kind of test site : Conducted room

**Test setup**

Test Channel : Middle  
 Operation Mode : C  
  
 Ambient temperature : 20-24°C  
 Relative humidity : 50-65%  
 Atmospheric pressure : 100-103 kPa

**Table 17: Test result of Time of Occupancy**

Mode	Number of Transmission in a 31.6 (79 Hopping*0.4)	Length of Transmission Time (msec)	Result (msec)	Limit (msec)
1DH5	17 (times / 5 sec) * 6.32 = 107.44 times	2.8986	311.4256	400
3DH5	17 (times / 5 sec) * 6.32 = 107.44 times	2.913	312.9727	400

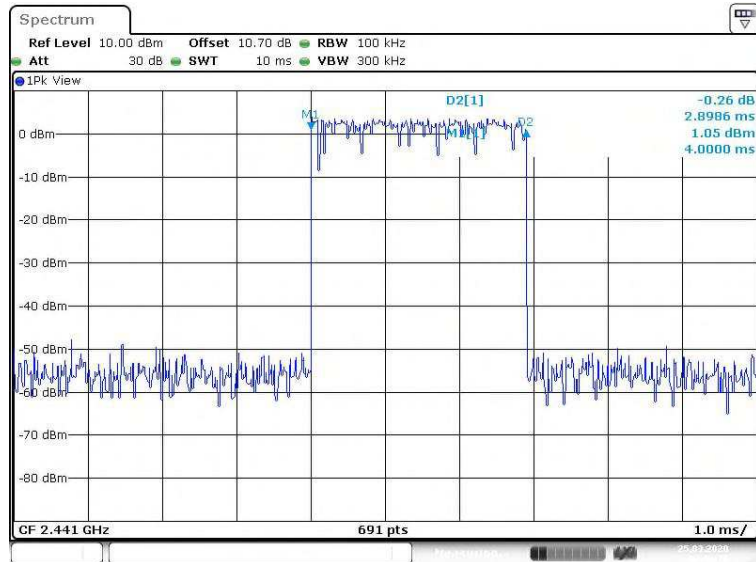
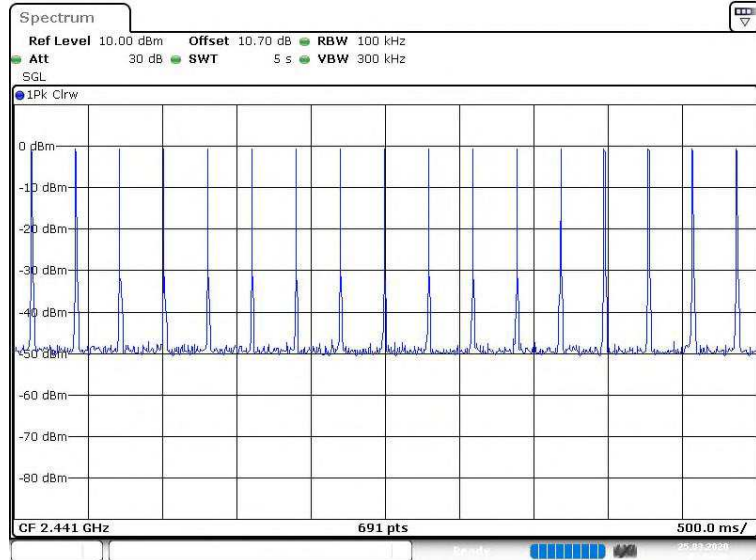
**Test Plot of Time of Occupancy, 1-DH5**

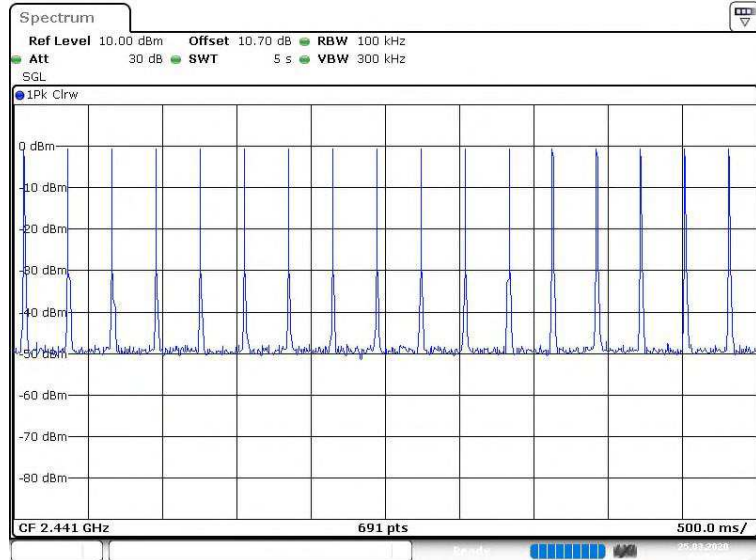
**Test Plot of Time of Occupancy, 3-DH5**

Date: 25.MAR.2020 06:59:00

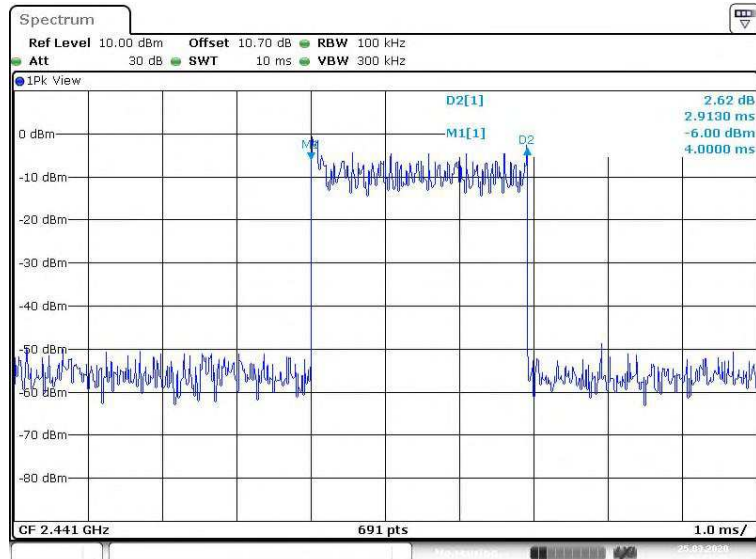

Date: 25.MAR.2020 06:57:33



## 5.2 Mains Emissions

### 5.2.1 Mains Conducted Emissions

**RESULT:****Passed**

Test standard : FCC Part 15.207  
FCC Part 15.107  
Limits : Mains Conducted emissions as defined in  
above test standards must comply with the  
mains conducted emission limits specified  
Kind of test site : Shielded Room

**Test setup**

Test Channel : Middle  
Operation mode : A

Remark: For details refer to Appendix D.

## 6. Safety Human exposure

### 6.1 Radio Frequency Exposure Compliance

#### 6.1.1 Electromagnetic Fields

**RESULT:****Passed**

Test standard : FCC KDB Publication 447498 D01 v06  
47CFR 1.1310  
47CFR 2.1093

**FCC:**

Therefore the maximum output power of the transmitter is 3.296mW < 10mW(Distance: 5 mm), hence the EUT is excluded from SAR evaluation according to FCC KDB publication 447498 D01: Mobile Portable RF Exposure.

**---End---**

## 7. List of Tables

Table 1: Applied Standard and Test Levels .....	5
Table 2: List of Test and Measurement Equipment .....	7
Table 3: Emission Measurement Uncertainty.....	8
Table 4: Basic Information of EUT .....	9
Table 5: Technical Specification of EUT .....	9
Table 6: Frequency hopping information.....	10
Table 7: Table for Parameters of Test Software Setting .....	12
Table 8: Test result of Peak Output Power 1-DH5.....	17
Table 9: Test result of Peak Output Power 2-DH5.....	17
Table 10: Test result of Peak Output Power 3-DH5.....	18
Table 11: Test result of 20dB Bandwidth 1-DH5.....	19
Table 12: Test result of 20dB Bandwidth 3-DH5.....	19
Table 13: Test result of Frequency Separation, 1-DH5.....	31
Table 14: Test result of Frequency Separation, 3-DH5.....	31
Table 15: Test result of Number of hopping frequency, 1-DH5.....	35
Table 16: Test result of Number of hopping frequency, 3-DH5.....	35
Table 17: Test result of Time of Occupancy.....	38