

FCC Radio Test Report

FCC ID: ACJ-SC-C30

This report concerns: **Original Grant**

Project No. : 1906C102
Equipment : Wireless Speaker system
Test Model : SC-C30
Series Model : N/A
Applicant : Panasonic Corporation of North America
Address : Two Riverfront Plaza, 9th Floor Newark, New Jersey
07102-5490, United States

Date of Receipt : Feb. 11, 2019
Date of Test : Feb. 11, 2019 ~ Jun. 24, 2019
Issued Date : Jul. 08, 2019
Tested by : BTL Inc.

Testing Engineer :

Vincent Tan

(Vincent Tan)

Technical Manager :

Steven Lu

(Steven Lu)

Authorized Signatory :

Ethan Ma

(Ethan Ma)

B T L I N C .

No.3, Jinshagang 1st Road, Shixia, Dalang Town, Dongguan,
Guangdong, China.

TEL: +86-769-8318-3000 FAX: +86-769-8319-6000



Certificate #5123.02

Declaration

BTL represents to the client that testing is done in accordance with standard procedures as applicable and that test instruments used has been calibrated with standards traceable to international standard(s) and/or national standard(s).

BTL's reports apply only to the specific samples tested under conditions. It is manufacture's responsibility to ensure that additional production units of this model are manufactured with the identical electrical and mechanical components. **BTL** shall have no liability for any declarations, inferences or generalizations drawn by the client or others from **BTL** issued reports.

The report must not be used by the client to claim product certification, approval, or endorsement by NVLAP, NIST, A2LA, or any agency of the U.S. Government.

This report is the confidential property of the client. As a mutual protection to the clients, the public and ourselves, the test report shall not be reproduced, except in full, without our written approval.

BTL's laboratory quality assurance procedures are in compliance with the **ISO/IEC 17025** requirements, and accredited by the conformity assessment authorities listed in this test report.

BTL is not responsible for the sampling stage, so the results only apply to the sample as received.

The information, data and test plan are provided by manufacturer which may affect the validity of results, so it is manufacturer's responsibility to ensure that the apparatus meets the essential requirements of applied standards and in all the possible configurations as representative of its intended use.

Limitation

For the use of the authority's logo is limited unless the Test Standard(s)/Scope(s)/Item(s) mentioned in this test report is (are) included in the conformity assessment authorities acceptance respective.

Please note that the measurement uncertainty is provided for informational purpose only and are not use in determining the Pass/Fail results.

Table of Contents**Page**

REPORT ISSUED HISTORY	6
1 . GENERAL SUMMARY	7
2 . SUMMARY OF TEST RESULTS	8
2.1 TEST FACILITY	9
2.2 MEASUREMENT UNCERTAINTY	9
3 . GENERAL INFORMATION	10
3.1 GENERAL DESCRIPTION OF EUT	10
3.2 DESCRIPTION OF TEST MODES	12
3.3 PARAMETERS OF TEST SOFTWARE	12
3.4 BLOCK DIAGRAM SHOWING THE CONFIGURATION OF SYSTEM TESTED	13
3.5 SUPPORT UNITS	13
4 . AC POWER LINE CONDUCTED EMISSIONS TEST	14
4.1 LIMIT	14
4.2 TEST PROCEDURE	14
4.3 DEVIATION FROM TEST STANDARD	14
4.4 TEST SETUP	15
4.5 EUT OPERATING CONDITIONS	15
4.6 EUT TEST CONDITIONS	15
4.7 TEST RESULTS	15
5 . RADIATED EMISSION TEST	16
5.1 LIMIT	16
5.2 TEST PROCEDURE	17
5.3 DEVIATION FROM TEST STANDARD	17
5.4 TEST SETUP	18
5.5 EUT OPERATING CONDITIONS	19
5.6 EUT TEST CONDITIONS	19
5.7 TEST RESULT - 9 KHZ TO 30 MHZ	19
5.8 TEST RESULT - 30 MHZ TO 1000 MHZ	19
5.9 TEST RESULT - ABOVE 1000 MHZ	19
6 . BANDWIDTH TEST	20
6.1 LIMIT	20
6.2 TEST PROCEDURE	20
6.3 DEVIATION FROM STANDARD	20

Table of Contents	Page
6.4 TEST SETUP	20
6.5 EUT OPERATION CONDITIONS	20
6.6 EUT TEST CONDITIONS	20
6.7 TEST RESULTS	20
7 . MAXIMUM OUTPUT POWER	21
7.1 LIMIT	21
7.2 TEST PROCEDURE	21
7.3 DEVIATION FROM STANDARD	21
7.4 TEST SETUP	21
7.5 EUT OPERATION CONDITIONS	21
7.6 EUT TEST CONDITIONS	21
7.7 TEST RESULTS	21
8 . CONDUCTED SPURIOUS EMISSION	22
8.1 LIMIT	22
8.2 TEST PROCEDURE	22
8.3 DEVIATION FROM STANDARD	22
8.4 TEST SETUP	22
8.5 EUT OPERATION CONDITIONS	22
8.6 EUT TEST CONDITIONS	22
8.7 TEST RESULTS	22
9 . POWER SPECTRAL DENSITY TEST	23
9.1 LIMIT	23
9.2 TEST PROCEDURE	23
9.3 DEVIATION FROM STANDARD	23
9.4 TEST SETUP	23
9.5 EUT OPERATION CONDITIONS	23
9.6 EUT TEST CONDITIONS	23
9.7 TEST RESULTS	23
10 . MEASUREMENT INSTRUMENTS LIST	24
11 . EUT TEST PHOTO	26
APPENDIX A - AC POWER LINE CONDUCTED EMISSIONS	30
APPENDIX B - RADIATED EMISSION - 9 KHZ TO 30 MHZ	33
APPENDIX C - RADIATED EMISSION - 30 MHZ TO 1000 MHZ	38

Table of Contents

Page

APPENDIX D - RADIATED EMISSION - ABOVE 1000 MHZ	41
APPENDIX E - BANDWIDTH	54
APPENDIX F - MAXIMUM OUTPUT POWER & E.I.R.P.	56
APPENDIX G - CONDUCTED SPURIOUS EMISSION	58
APPENDIX H - POWER SPECTRAL DENSITY	60

REPORT ISSUED HISTORY

Report Version	Description	Issued Date
R00	Original Issue.	Jul. 08, 2019

1. GENERAL SUMMARY

Equipment : Wireless Speaker system
Brand Name : Technics
Test Model : SC-C30
Series Model : N/A
Applicant : Panasonic Corporation of North America
Manufacturer : Panasonic Corporation
Address : 1-15 Matsuo-cho, Kadoma-shi, Osaka 571-8504, Japan
Factory : Panasonic AVC Networks Johor Malaysia
Address : IE,PLO 460, Jalan Bandar, 81700 Pasir Gudang, Johor, Malaysia
Date of Test : Feb. 11, 2019 ~ Jun. 24, 2019
Test Sample : Engineering Sample No.: DG19061045
Standard(s) : FCC Part15, Subpart C (15.247)
ANSI C63.10-2013
KDB 558074 D01 15.247 Meas Guidance V05r02

The above equipment has been tested and found compliance with the requirement of the relative standards by BTL Inc.

The test data, data evaluation, and equipment configuration contained in our test report (Ref No. BTL-FCCP-2-1906C102) were obtained utilizing the test procedures, test instruments, test sites that has been accredited by the Authority of A2LA according to the ISO/IEC 17025 quality assessment standard and technical standard(s).

Test results included in this report are only for the Bluetooth LE part.

2. SUMMARY OF TEST RESULTS

Test procedures according to the technical standard(s):

FCC Part15, Subpart C (15.247)				
Standard(s) Section	Test Item	Test Result	Judgment	Remark
15.207	AC Power Line Conducted Emissions	APPENDIX A	PASS	-----
15.247(d) 15.205(a) 15.209(a)	Radiated Emissions	APPENDIX B APPENDIX C APPENDIX D	PASS	-----
15.247(a)(2)	Bandwidth	APPENDIX E	PASS	-----
15.247(b)(3)	Maximum Output Power	APPENDIX F	PASS	-----
15.247(d)	Conducted Spurious Emission	APPENDIX G	PASS	-----
15.247(e)	Power Spectral Density	APPENDIX H	PASS	-----
15.203	Antenna Requirement	-----	PASS	Note (2)

Note:

- (1) "N/A" denotes test is not applicable to this device.
- (2) The device what use a permanently attached antenna were considered sufficient to comply with the provisions of 15.203.

2.1 TEST FACILITY

The test facilities used to collect the test data in this report is at the location of No.3, Jinshagang 1st Road, Shixia, Dalang Town, Dongguan, Guangdong, China.

BTL's Test Firm Registration Number for FCC: 357015

BTL's Designation Number for FCC: CN1240

2.2 MEASUREMENT UNCERTAINTY

ISO/IEC 17025 requires that an estimate of the measurement uncertainties associated with the emissions test results be included in the report. The measurement uncertainties given below are based on a 95% confidence level (based on a coverage factor (k=2))

The BTL measurement uncertainty as below table:

A. AC power line conducted emissions Measurement:

Test Site	Method	Measurement Frequency Range	U, (dB)
DG-C02	CISPR	150 kHz ~ 30 MHz	2.32

B. Radiated emissions Measurement:

Test Site	Method	Measurement Frequency Range	Ant. H / V	U, (dB)
DG-CB03	CISPR	9 KHz~30 MHz	V	3.79
		9 KHz~30 MHz	H	3.57
		30 MHz~200 MHz	V	3.82
		30 MHz~200 MHz	H	3.78
		200 MHz~1,000 MHz	V	4.10
		200 MHz~1,000 MHz	H	4.06
		1 GHz~18 GHz	V	3.12
		1 GHz~18 GHz	H	3.68
		18 GHz~40 GHz	V	4.15
		18 GHz~40 GHz	H	4.14

Note: Unless specifically mentioned, the uncertainty of measurement has not been taken into account to declare the compliance or non-compliance to the specification.

3. GENERAL INFORMATION

3.1 GENERAL DESCRIPTION OF EUT

Equipment	Wireless Speaker system
Brand Name	Technics
Test Model	SC-C30
Series Model	N/A
Model Difference(s)	N/A
Power Source	AC Mains.
Power Rating	AC 120V/60Hz 30W
Operation Frequency	2402 MHz ~ 2480 MHz
Modulation Technology	GFSK
Bit Rate of Transmitter	1Mbps
Max. Output Power	3.97 dBm (0.0025 W)

Note:

1. For a more detailed features description, please refer to the manufacturer's specifications or the user's manual.

2. Channel List:

Channel	Frequency (MHz)	Channel	Frequency (MHz)
00	2402	20	2442
01	2404	21	2444
02	2406	22	2446
03	2408	23	2448
04	2410	24	2450
05	2412	25	2452
06	2414	26	2454
07	2416	27	2456
08	2418	28	2458
09	2420	29	2460
10	2422	30	2462
11	2424	31	2464
12	2426	32	2466
13	2428	33	2468
14	2430	34	2470
15	2432	35	2472
16	2434	36	2474
17	2436	37	2476
18	2438	38	2478
19	2440	39	2480

3. Table for Filed Antenna:

Ant.	Brand	Model Name	Antenna Type	Connector	Gain (dBi)
1	N/A	N/A	PCB	N/A	1

3.2 DESCRIPTION OF TEST MODES

The test system was pre-tested based on the consideration of all possible combinations of EUT operation mode.

Pretest Mode	Description
Mode 1	TX Mode NOTE (1)
Mode 2	TX Mode Channel 00 _1Mbps

Following mode(s) as (were) found to be the worst case(s) and selected for the final test.

AC power line conducted emissions test	
Final Test Mode	Description
Mode 2	TX Mode Channel 00 _1Mbps

Radiated emissions test - Below 1GHz	
Final Test Mode	Description
Mode 2	TX Mode Channel 00 _1Mbps

Radiated emissions test - Above 1GHz	
Final Test Mode	Description
Mode 1	TX Mode NOTE (1)

Conducted test	
Final Test Mode	Description
Mode 1	TX Mode NOTE (1)

Note:

- (1) The measurements are performed at the high, middle, low available channels.
- (2) For radiated emission above 1 GHz test, 1GHz~26.5GHz have been pre-tested and in this report only recorded the worst case. The remaining spurious points are all below the limit value of 20dB.

3.3 PARAMETERS OF TEST SOFTWARE

During testing channel & power controlling software provided by the customer was used to control the operating channel as well as the output power level. The RF output power selection is for the setting of RF output power expected by the customer and is going to be fixed on the firmware of the final end product power parameters of BT LE

Test Software	DutApiMimoBtFmBrdigeEth		
Frequency (MHz)	2402	2440	2480
Parameters	5	5	5

3.4 BLOCK DIAGRAM SHOWING THE CONFIGURATION OF SYSTEM TESTED

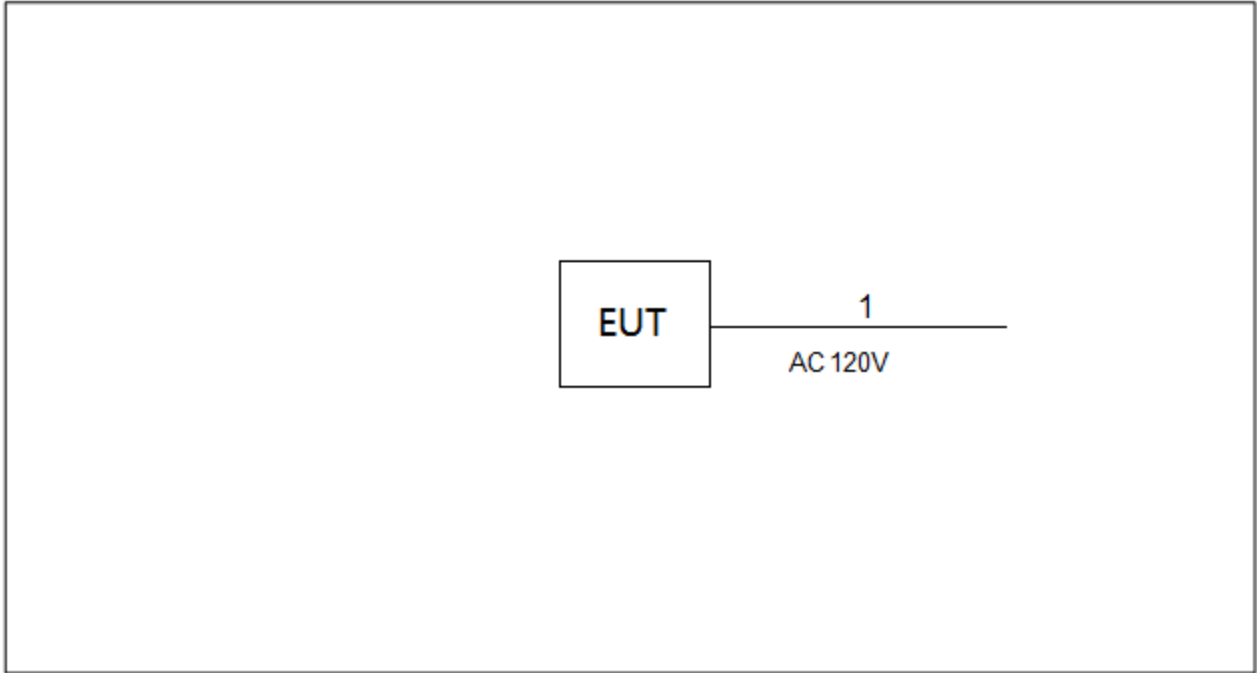

3.5 SUPPORT UNITS

Item	Equipment	Mfr/Brand	Model/Type No.	Series No.
-	-	-	-	-

Item	Cable Type	Shielded Type	Ferrite Core	Length
1	AC Cable	NO	NO	1.8m

4. AC POWER LINE CONDUCTED EMISSIONS TEST

4.1 LIMIT

Frequency of Emission (MHz)	Limit (dB μ V)	
	Quasi-peak	Average
0.15 - 0.5	66 - 56*	56 - 46*
0.50 - 5.0	56	46
5.0 - 30.0	60	50

Note:

- (1) The tighter limit applies at the band edges.
- (2) The limit of " * " marked band means the limitation decreases linearly with the logarithm of the frequency in the range.

The following table is the setting of the receiver

Receiver Parameters	Setting
Attenuation	10 dB
Start Frequency	0.15 MHz
Stop Frequency	30 MHz
IF Bandwidth	9 kHz

4.2 TEST PROCEDURE

- a. The EUT was placed 0.8 meters from the horizontal ground plane with EUT being connected to the power mains through a line impedance stabilization network (LISN). All other support equipment powered from additional LISN(s). The LISN provide 50 Ohm/ 50uH of coupling impedance for the measuring instrument.
- b. Interconnecting cables that hang closer than 40 cm to the ground plane shall be folded back and forth in the center forming a bundle 30 to 40 cm long.
- c. I/O cables that are not connected to a peripheral shall be bundled in the center. The end of the cable may be terminated, if required, using the correct terminating impedance. The overall length shall not exceed 1 m.
- d. LISN at least 80 cm from nearest part of EUT chassis.
- e. For the actual test configuration, please refer to the related Item –EUT Test Photos.

4.3 DEVIATION FROM TEST STANDARD

No deviation

4.4 TEST SETUP

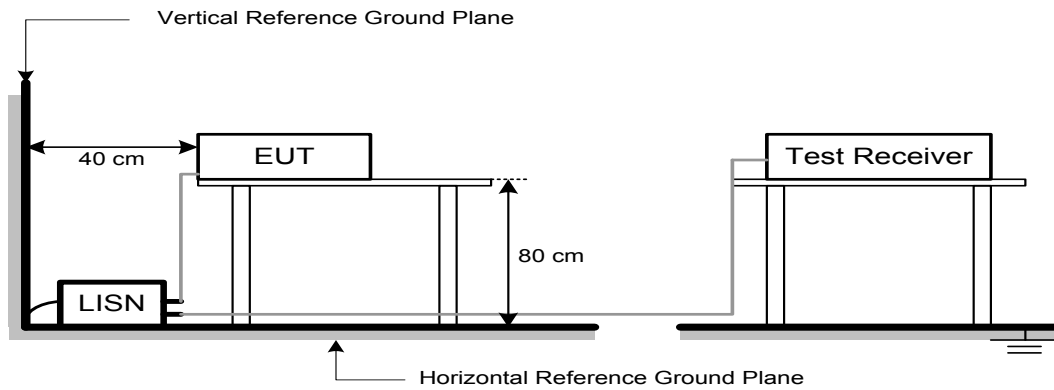

4.5 EUT OPERATING CONDITIONS

The EUT was configured for testing in a typical fashion (as a customer would normally use it). The EUT has been programmed to continuously transmit during test. This operating condition was tested and used to collect the included data.

4.6 EUT TEST CONDITIONS

Temperature: 25°C Relative Humidity: 53% Test Voltage: AC 120V/60Hz

4.7 TEST RESULTS

Please refer to the APPENDIX A.

Remark:

- (1) All readings are QP Mode value unless otherwise stated AVG in column of『Note』. If the QP Mode Measured value compliance with the QP Limits and lower than AVG Limits, the EUT shall be deemed to meet both QP & AVG Limits and then only QP Mode was measured, but AVG Mode didn't perform. In this case, a “*” marked in AVG Mode column of Interference Voltage Measured.
- (2) Measuring frequency range from 150 kHz to 30 MHz.

5. RADIATED EMISSION TEST

5.1 LIMIT

In case the emission fall within the restricted band specified on 15.205(a), then the 15.209(a) limit in the table below has to be followed.

LIMITS OF RADIATED EMISSION MEASUREMENT (9 kHz-1000 MHz)

Frequency (MHz)	Field Strength (microvolts/meter)	Measurement Distance (meters)
0.009-0.490	2400/F(kHz)	300
0.490-1.705	24000/F(kHz)	30
1.705-30.0	30	30
30-88	100	3
88-216	150	3
216-960	200	3
Above 960	500	3

LIMITS OF RADIATED EMISSION MEASUREMENT (Above 1000 MHz)

Frequency (MHz)	(dBuV/m at 3 m)	
	Peak	Average
Above 1000	74	54

Note:

- (1) The limit for radiated test was performed according to FCC PART 15C.
- (2) The tighter limit applies at the band edges.
- (3) Emission level (dBuV/m)=20log Emission level (uV/m).

Spectrum Parameter	Setting
Attenuation	Auto
Start Frequency	1000 MHz
Stop Frequency	10th carrier harmonic
RBW / VBW (Emission in restricted band)	RBW 1 MHz VBW 3 MHz peak detector for Pk value RMS detector for AV value

Receiver Parameter	Setting
Attenuation	Auto
Start ~ Stop Frequency	9 kHz~90 kHz for PK/AVG detector
Start ~ Stop Frequency	90 kHz~110 kHz for QP detector
Start ~ Stop Frequency	110 kHz~490 kHz for PK/AVG detector
Start ~ Stop Frequency	490 kHz~30 MHz for QP detector
Start ~ Stop Frequency	30 MHz~1000 MHz for QP detector

5.2 TEST PROCEDURE

- a. The measuring distance of 3 m shall be used for measurements. The EUT was placed on the top of a rotating table 0.8 meter above the ground at a 3 meter semi-anechoic chamber. The table was rotated 360 degrees to determine the position of the highest radiation.(below 1 GHz)
- b. The measuring distance of 3 m shall be used for measurements. The EUT was placed on the top of a rotating table 1.5 meter above the ground at a 3 meter semi-anechoic chamber. The table was rotated 360 degrees to determine the position of the highest radiation.(above 1 GHz)
- c. The height of the equipment or of the substitution antenna shall be 0.8m or 1.5m; the height of the test antenna shall vary between 1 m to 4 m. Both horizontal and vertical polarizations of the antenna are set to make the measurement.
- d. For each suspected emission, the EUT was arranged to its worst case and then the antenna was tuned to heights find the maximum reading (used Bore sight function).
- e. The receiver system was set to peak and average detect function and specified bandwidth with maximum hold mode when the test frequency is above 1 GHz.
- f. The initial step in collecting radiated emission data is a receiver peak detector mode pre-scanning the measurement frequency range. Significant peaks are then marked and then Quasi Peak detector mode re-measured.
- g. All readings are Peak unless otherwise stated QP in column of Note. Peak denotes that the Peak reading compliance with the QP Limits and then QP Mode measurement didn't perform. (below 1 GHz)
- h. All readings are Peak Mode value unless otherwise stated AVG in column of Note. If the Peak Mode Measured value compliance with the Peak Limits and lower than AVG Limits, the EUT shall be deemed to meet both Peak & AVG Limits and then only Peak Mode was measured, but AVG Mode didn't perform. (above 1 GHz)
- i. For the actual test configuration, please refer to the related Item –EUT Test Photos.

5.3 DEVIATION FROM TEST STANDARD

No deviation

5.4 TEST SETUP

9 kHz-30 MHz

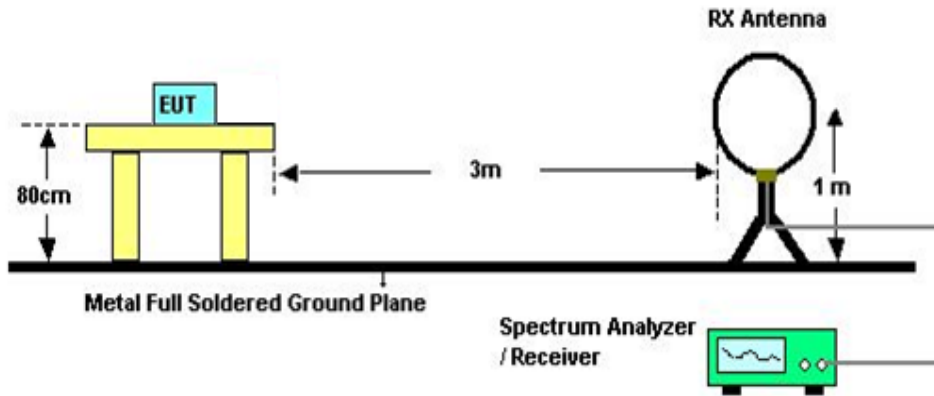

30 MHz to 1 GHz

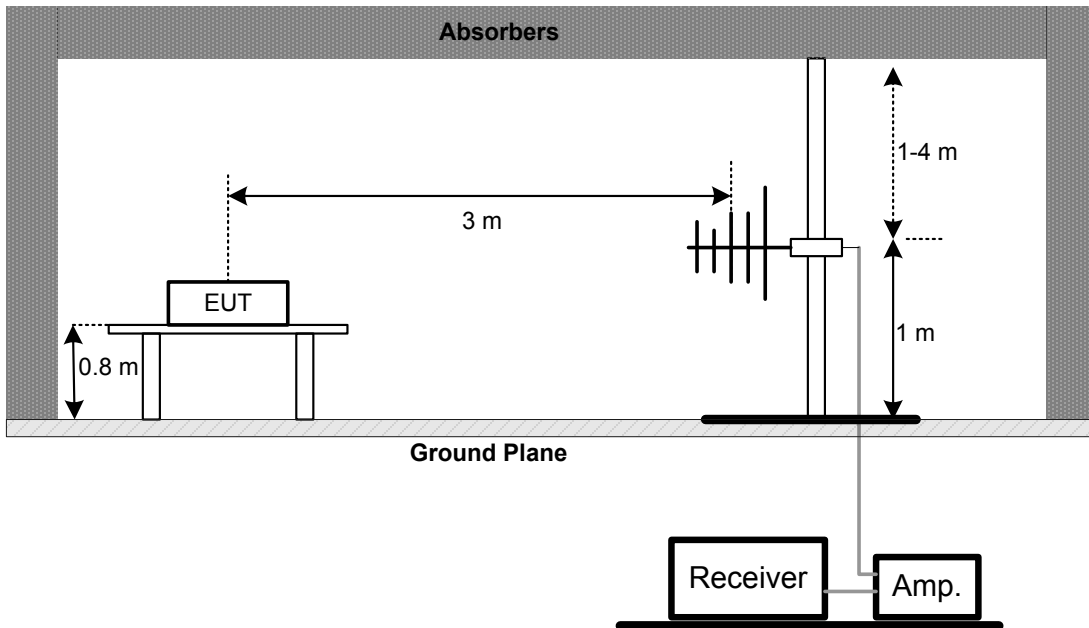

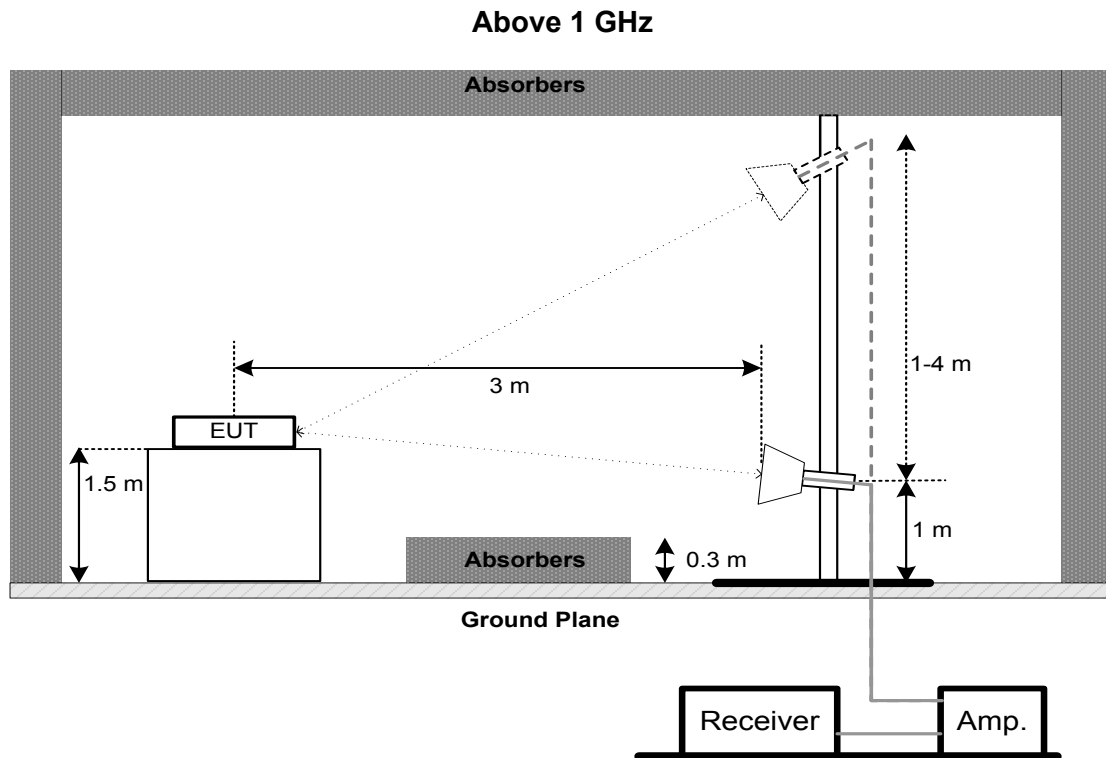

5.5 EUT OPERATING CONDITIONS

The EUT was programmed to be in continuously transmitting mode.

5.6 EUT TEST CONDITIONS

9 kHz-30 MHz:

Temperature: 25°C Relative Humidity: 60% Test Voltage: AC 120V/60Hz

30 MHz-1000 MHz and Above 1000MHz:

Temperature: 24°C Relative Humidity: 68% Test Voltage: AC 120V/60Hz

5.7 TEST RESULT - 9 kHz TO 30 MHz

Please refer to the APPENDIX B

Remark:

- (1) Distance extrapolation factor = $40 \log (\text{specific distance} / \text{test distance})$ (dB).
- (2) Limit line = specific limits (dBuV) + distance extrapolation factor.

5.8 TEST RESULT - 30 MHz TO 1000 MHz

Please refer to the APPENDIX C.

5.9 TEST RESULT - ABOVE 1000 MHz

Please refer to the APPENDIX D.

Remark:

- (1) No limit: This is fundamental signal, the judgment is not applicable.
For fundamental signal judgment was referred to Peak output test.

6. BANDWIDTH TEST

6.1 LIMIT

FCC Part15, Subpart C (15.247)		
Section	Test Item	Limit
15.247(a)(2)	Bandwidth	≥ 500 kHz (6 dB bandwidth)

6.2 TEST PROCEDURE

- The EUT was directly connected to the spectrum analyzer and antenna output port as show in the block diagram below.
- Spectrum Setting : RBW= 100 kHz, VBW=300 kHz, Sweep time = 2.5 ms.

6.3 DEVIATION FROM STANDARD

No deviation.

6.4 TEST SETUP

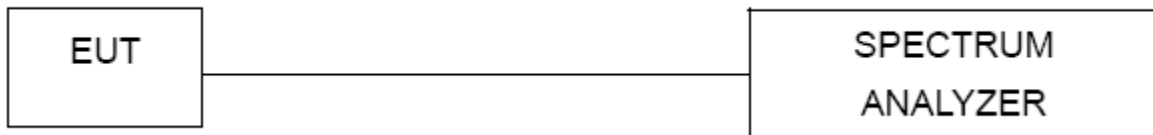

6.5 EUT OPERATION CONDITIONS

The EUT tested system was configured as the statements of 4.5 unless otherwise a special operating condition is specified in the follows during the testing.

6.6 EUT TEST CONDITIONS

Temperature: 24°C Relative Humidity: 60% Test Voltage: AC 120V/60Hz

6.7 TEST RESULTS

Please refer to the APPENDIX E.

7. MAXIMUM OUTPUT POWER

7.1 LIMIT

FCC Part15, Subpart C (15.247)		
Section	Test Item	Limit
15.247(b)(3)	Maximum Output Power	1 watt or 30 dBm

7.2 TEST PROCEDURE

- a. The EUT was directly connected to the spectrum analyzer and antenna output port as show in the block diagram below.
- b. The maximum conducted output power was performed in accordance with method 11.9.1.1 of ANSI C63.10-2013.

7.3 DEVIATION FROM STANDARD

No deviation.

7.4 TEST SETUP



7.5 EUT OPERATION CONDITIONS

The EUT tested system was configured as the statements of 4.5 unless otherwise a special operating condition is specified in the follows during the testing.

7.6 EUT TEST CONDITIONS

Temperature: 24°C Relative Humidity: 66% Test Voltage: AC 120V/60Hz

7.7 TEST RESULTS

Please refer to the APPENDIX F.

8. CONDUCTED SPURIOUS EMISSION

8.1 LIMIT

In any 100 kHz bandwidth outside the frequency band in which the spread spectrum or digitally modulated intentional radiator is operating, the radio frequency power that is produced by the intentional radiator shall be at least 20 dB below that in the 100 kHz bandwidth within the band that contains the highest level of the desired power, based on either an RF conducted or a radiated measurement, provided the transmitter demonstrates compliance with the peak Output Power limits. If the transmitter complies with the Output Power limits based on the use of RMS averaging over a time interval, as permitted under paragraph (b)(3) of this section, the attenuation required under this paragraph shall be 30 dB instead of 20 dB. Attenuation below the general limits specified in Section 15.209(a) is not required.

8.2 TEST PROCEDURE

- a. The EUT was directly connected to the spectrum analyzer and antenna output port as show in the block diagram below.
- b. Spectrum Setting : RBW= 100 kHz, VBW=300 kHz, Sweep time = 10 ms.

8.3 DEVIATION FROM STANDARD

No deviation.

8.4 TEST SETUP



8.5 EUT OPERATION CONDITIONS

The EUT tested system was configured as the statements of 4.5 unless otherwise a special operating condition is specified in the follows during the testing.

8.6 EUT TEST CONDITIONS

Temperature: 24°C Relative Humidity: 66% Test Voltage: AC 120V/60Hz

8.7 TEST RESULTS

Please refer to the APPENDIX G.

9. POWER SPECTRAL DENSITY TEST

9.1 LIMIT

FCC Part15, Subpart C (15.247)		
Section	Test Item	Limit
15.247(e)	Power Spectral Density	8 dBm (in any 3 kHz)

9.2 TEST PROCEDURE

- a. The EUT was directly connected to the spectrum analyzer and antenna output port as show in the block diagram below.
- b. Spectrum Setting: RBW=3 kHz, VBW=10 kHz, Sweep time = auto.

9.3 DEVIATION FROM STANDARD

No deviation.

9.4 TEST SETUP

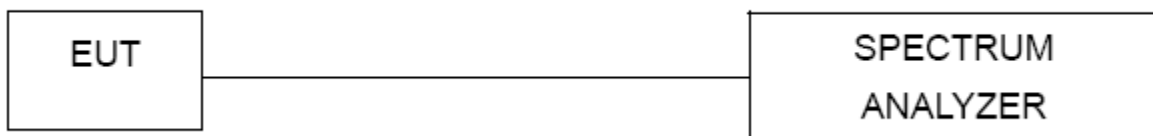

9.5 EUT OPERATION CONDITIONS

The EUT tested system was configured as the statements of 4.5 unless otherwise a special operating condition is specified in the follows during the testing.

9.6 EUT TEST CONDITIONS

Temperature: 24°C Relative Humidity: 66% Test Voltage: AC 120V/60Hz

9.7 TEST RESULTS

Please refer to the APPENDIX H.

10. MEASUREMENT INSTRUMENTS LIST

AC Power Line Conducted Emissions					
Item	Kind of Equipment	Manufacturer	Type No.	Serial No.	Calibrated until
1	EMI Test Receiver	R&S	ESCI	100382	Mar. 10, 2020
2	LISN	EMCO	3816/2	52765	Mar. 10, 2020
3	50ohm Terminator	SHX	TF5-3	15041305	Mar. 10, 2020
4	Artificial-Mains Network	SCHWARZBEC K	NSLK 8127	8127685	Mar. 10, 2020
5	TRANSIENT LIMITER	EM	EM-7600	772	Mar. 10, 2020
6	Measurement Software	Farad	EZ-EMC Ver.NB-03A1-01	N/A	N/A
7	Cable	N/A	RG223	12m	Mar. 12, 2020

Radiated Emissions - 9 kHz to 30 MHz					
Item	Kind of Equipment	Manufacturer	Type No.	Serial No.	Calibrated until
1	Loop Antenna	EM	EM-6876-1	230	Jan. 15, 2020
2	Cable	N/A	RG 213/U	C-102	May 31, 2020
3	EMI Test Receiver	R&S	ESCI	100895	Mar. 10, 2020
4	Measurement Software	Farad	EZ-EMC Ver.NB-03A1-01	N/A	N/A

Radiated Emissions - 30 MHz to 1 GHz					
Item	Kind of Equipment	Manufacturer	Type No.	Serial No.	Calibrated until
1	Antenna	Schwarzbeck	VULB9160	9160-3232	Mar. 09, 2020
2	Amplifier	HP	8447D	2944A09673	Aug. 11, 2019
3	Receiver	Agilent	N9038A	MY52130039	Aug. 11, 2019
4	Cable	emci	LMR-400(30MHz-1GHz)(8m+5m)	N/A	May 24, 2020
5	Controller	CT	SC100	N/A	N/A
6	Controller	MF	MF-7802	MF780208416	N/A
7	Measurement Software	Farad	EZ-EMC Ver.NB-03A1-01	N/A	N/A

Radiated Emissions - Above 1 GHz					
Item	Kind of Equipment	Manufacturer	Type No.	Serial No.	Calibrated until
1	Double Ridged Guide Antenna	ETS	3115	75789	Mar. 09, 2020
2	Broad-Band Horn Antenna	Schwarzbeck	BBHA 9170	9170319	Jun. 30, 2019
3	Amplifier	Agilent	8449B	3008A02333	Mar. 10, 2020
4	Microwave Preamplifier With Adaptor	EMC INSTRUMENT	EMC2654045	980039 & HA01	Mar. 10, 2020
5	Receiver	Agilent	N9038A	MY52130039	Aug. 11, 2019
6	Controller	CT	SC100	N/A	N/A
7	Controller	MF	MF-7802	MF780208416	N/A
8	Cable	mitron	B10-01-01-12M	18072744	Jul. 30, 2019
9	Measurement Software	Farad	EZ-EMC Ver.NB-03A1-01	N/A	N/A

Bandwidth					
Item	Kind of Equipment	Manufacturer	Type No.	Serial No.	Calibrated until
1	Spectrum Analyzer	R&S	FSP40	100185	Aug. 11, 2019

Maximum Output Power					
Item	Kind of Equipment	Manufacturer	Type No.	Serial No.	Calibrated until
1	Spectrum Analyzer	R&S	FSP40	100185	Aug. 11, 2019

Antenna Conducted Spurious Emissions					
Item	Kind of Equipment	Manufacturer	Type No.	Serial No.	Calibrated until
1	Spectrum Analyzer	R&S	FSP40	100185	Aug. 11, 2019

Power Spectral Density					
Item	Kind of Equipment	Manufacturer	Type No.	Serial No.	Calibrated until
1	Spectrum Analyzer	R&S	FSP40	100185	Aug. 11, 2019

Remark: "N/A" denotes no model name, serial no. or calibration specified.
 All calibration period of equipment list is one year.

11. EUT TEST PHOTO

AC Power Line Conducted Emissions Test Photos



Radiated Emissions Test Photos

9 kHz to 30 MHz

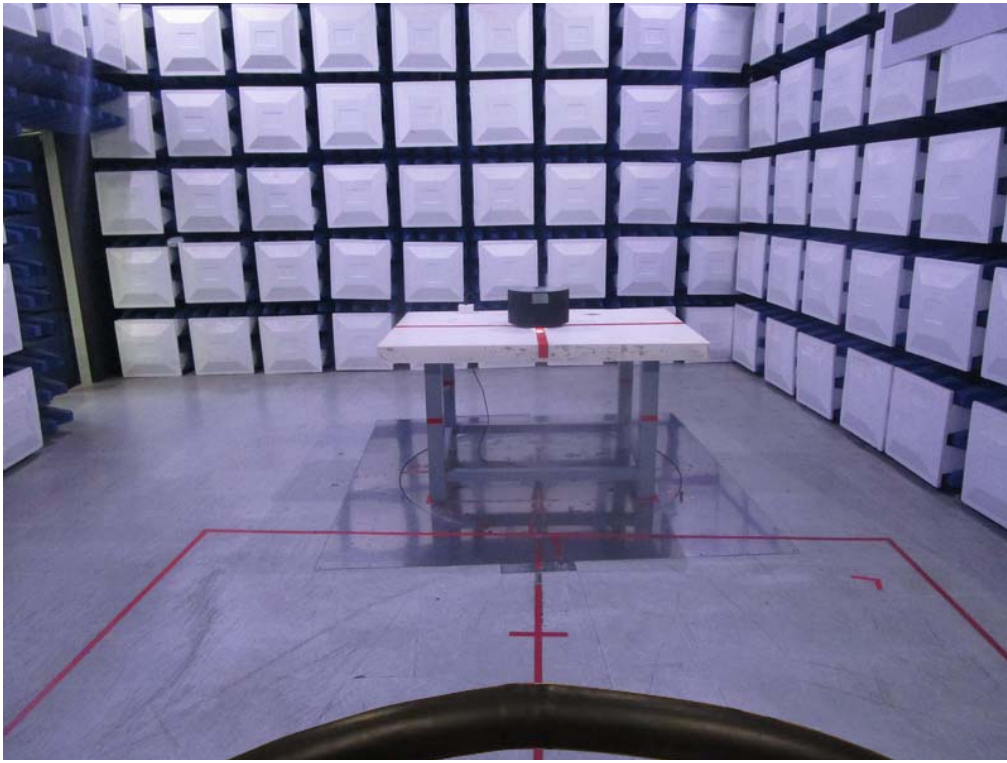

Radiated Emissions Test Photos

30 MHz to 1000 MHz

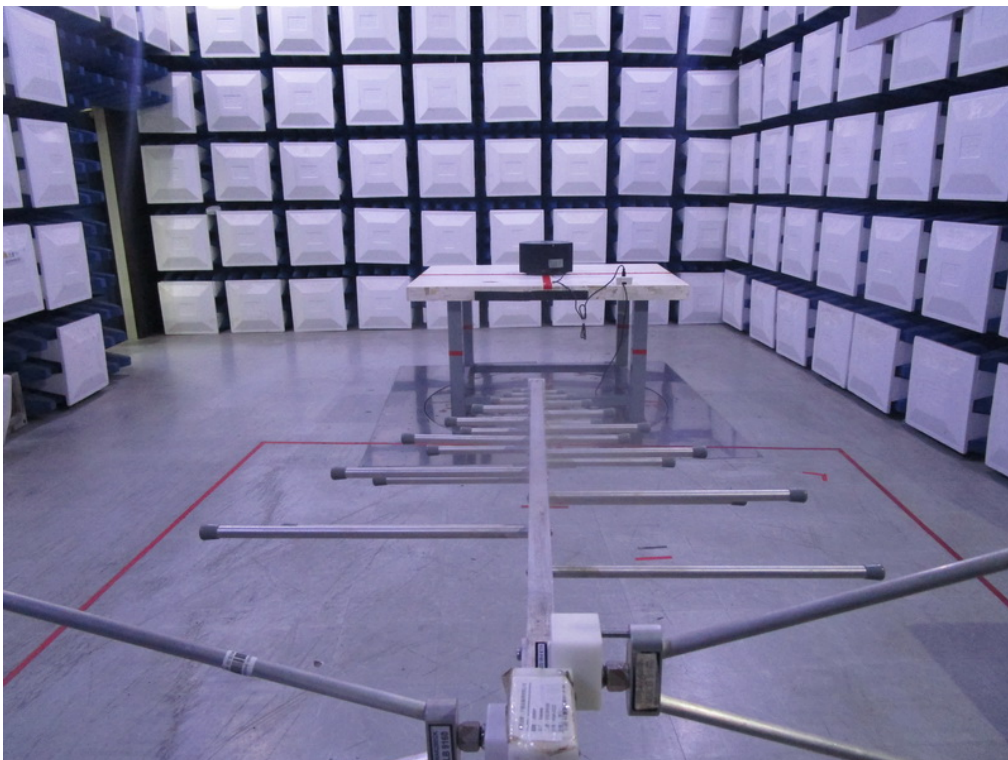

Radiated Emissions Test Photos

Above 1 GHz

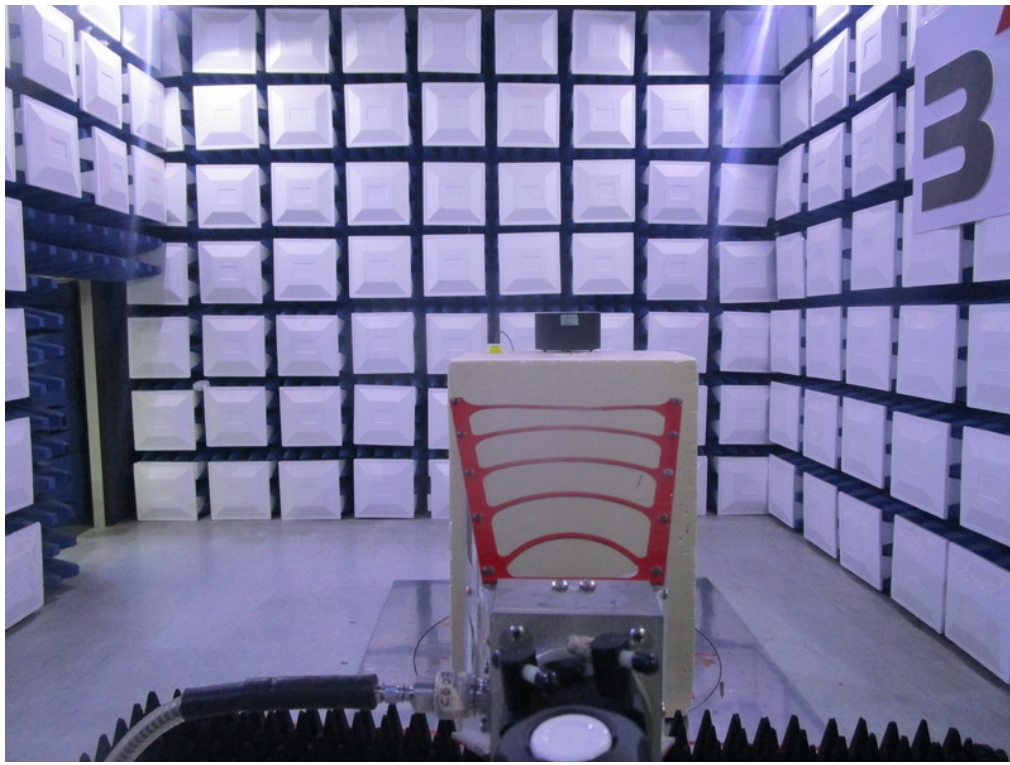

APPENDIX A - AC POWER LINE CONDUCTED EMISSIONS

Test Mode: TX Mode Channel 00 _1Mbps

Line

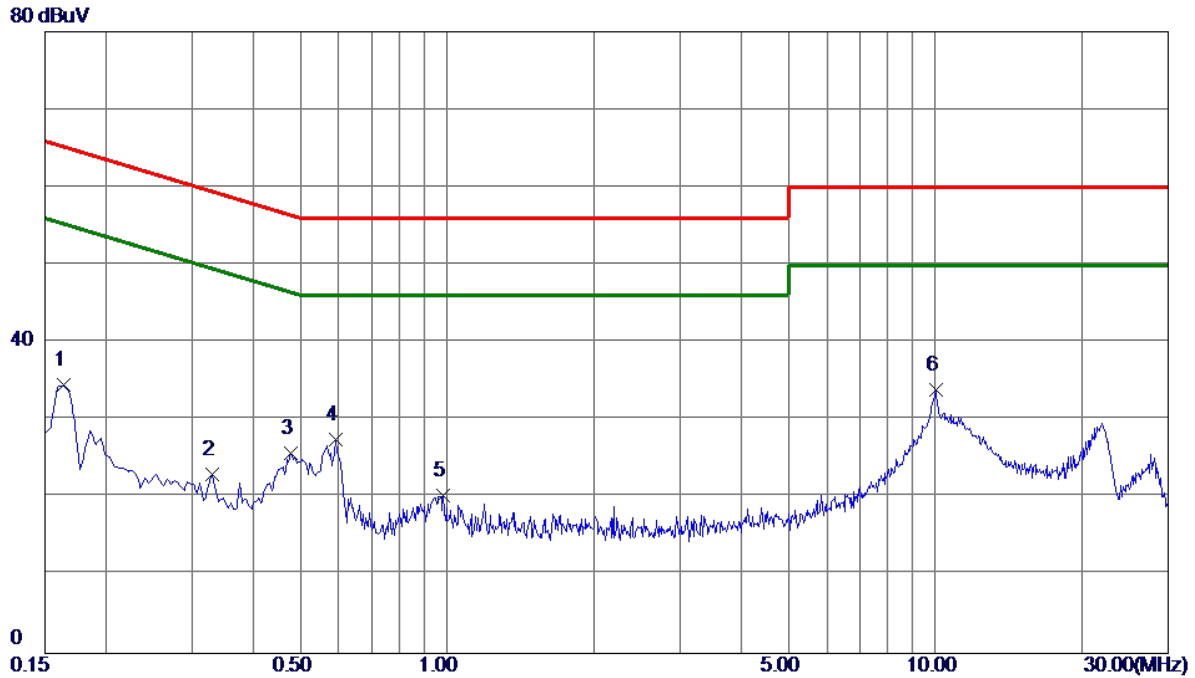

No.	Freq. MHz	Reading Level dBuV	Correct Factor dB	Measure ment dBuV	Limit dBuV	Margin dB	Detector	Comment
1	0.1635	24.71	9.82	34.53	65.28	-30.75	Peak	
2	0.3300	13.21	9.85	23.06	59.45	-36.39	Peak	
3	0.4785	15.88	9.88	25.76	56.37	-30.61	Peak	
4	0.5910	17.61	9.89	27.50	56.00	-28.50	Peak	
5	0.9824	10.39	9.92	20.31	56.00	-35.69	Peak	
6 *	10.0185	23.50	10.49	33.99	60.00	-26.01	Peak	

REMARKS:

- (1) Measurement Value = Reading Level + Correct Factor.
- (2) Margin Level = Measurement Value - Limit Value.

Test Mode: TX Mode Channel 00 _1Mbps

Neutral

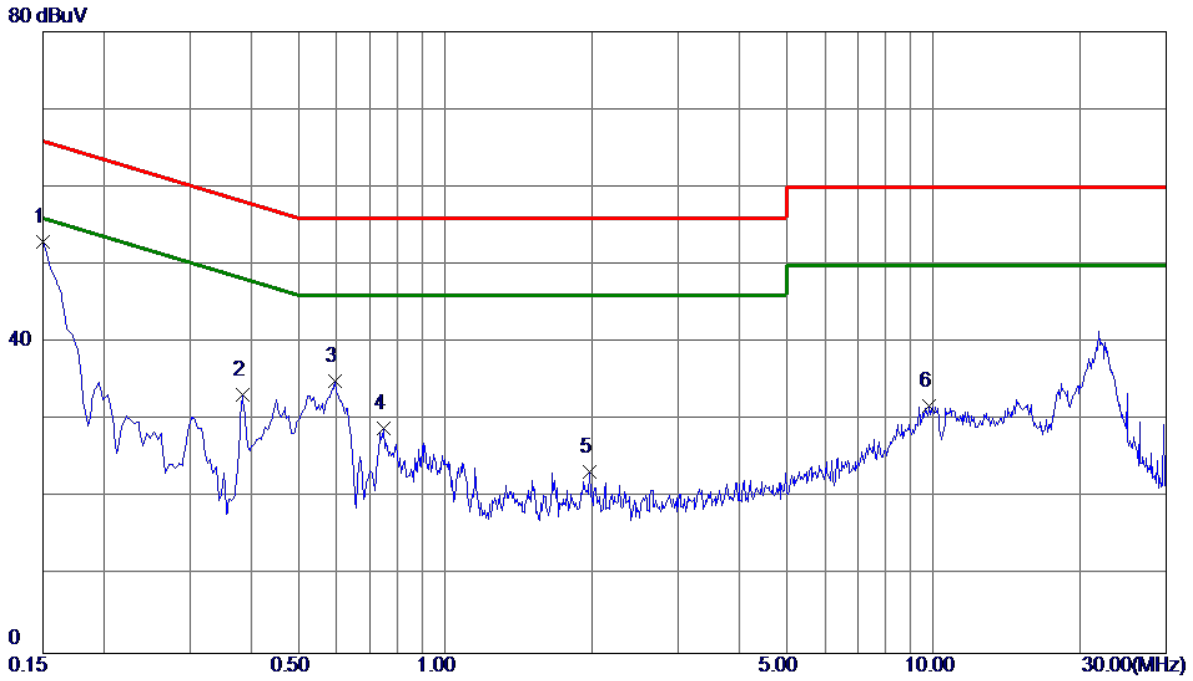

No.	Freq. MHz	Reading Level dBuV	Correct Factor dB	Measure ment dBuV	Limit dBuV	Margin dB	Detector	Comment
1 *	0.1500	43.07	9.91	52.98	66.00	-13.02	Peak	
2	0.3840	23.28	10.00	33.28	58.19	-24.91	Peak	
3	0.5955	24.99	10.04	35.03	56.00	-20.97	Peak	
4	0.7485	18.83	10.08	28.91	56.00	-27.09	Peak	
5	1.9770	13.19	10.19	23.38	56.00	-32.62	Peak	
6	9.8250	21.12	10.73	31.85	60.00	-28.15	Peak	

REMARKS:

- (1) Measurement Value = Reading Level + Correct Factor.
- (2) Margin Level = Measurement Value - Limit Value.

APPENDIX B - RADIATED EMISSION - 9 KHZ TO 30 MHZ

Test Mode: TX Mode Channel 00 _1Mbps

Ant 0°

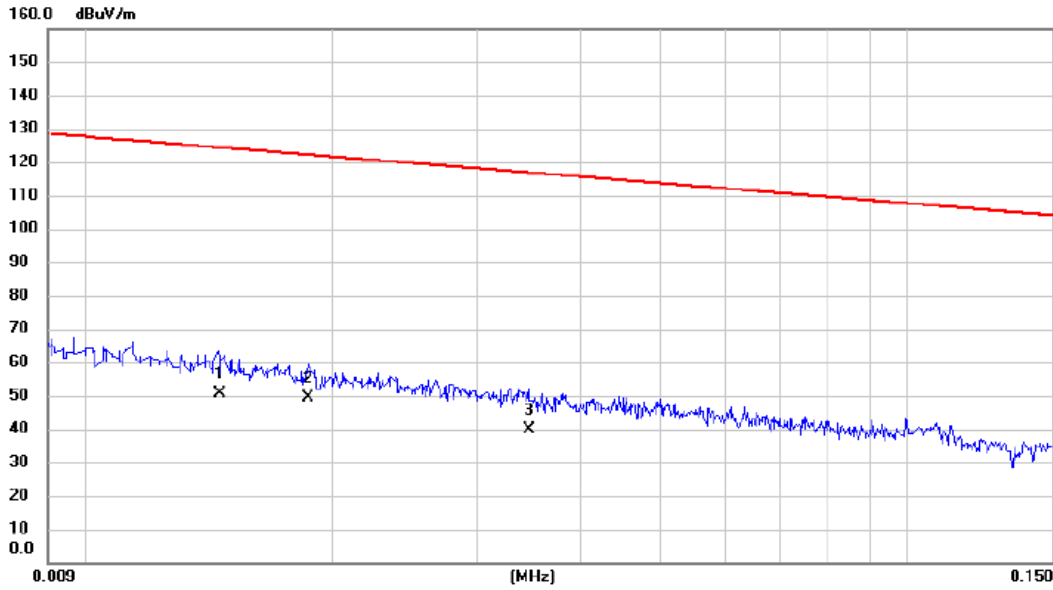

No.	Mk.	Freq. MHz	Reading Level dBuV	Correct Factor dB	Measure- ment dBuV/m	Limit dBuV/m	Margin dB	Detector	Comment
1		0.015	35.20	15.44	50.64	124.32	-73.68	AVG	
2	*	0.019	35.35	14.21	49.56	122.17	-72.61	AVG	
3		0.035	25.90	13.88	39.78	116.80	-77.02	AVG	

REMARKS:

- (1) Measurement Value = Reading Level + Correct Factor.
- (2) Margin Level = Measurement Value - Limit Value.

Test Mode: TX Mode Channel 00 _1Mbps

Ant 0°

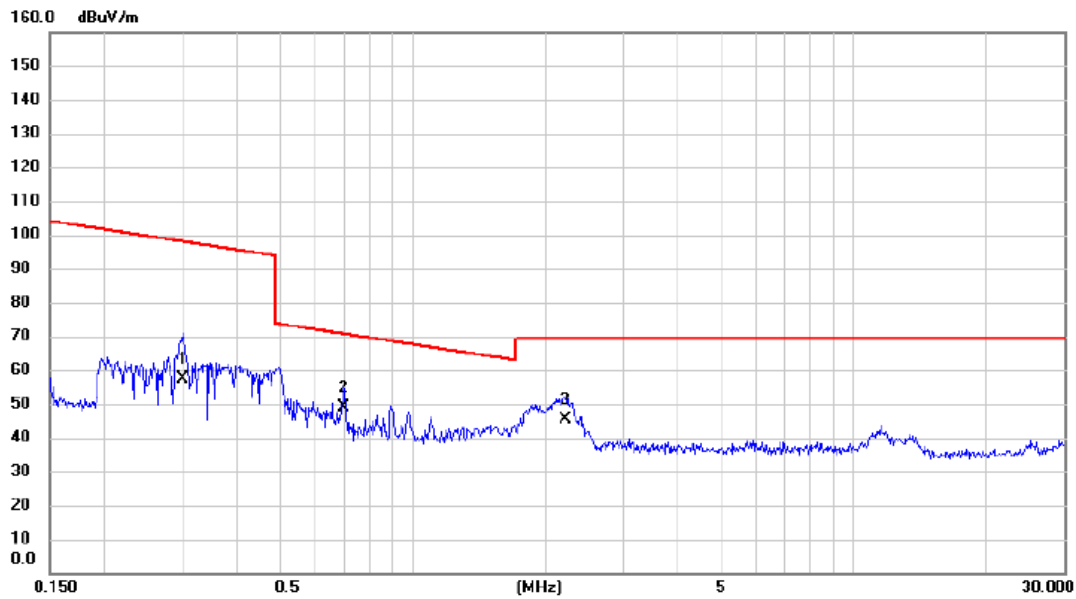

No.	Mk.	Freq. MHz	Reading Level dBuV	Correct Factor dB	Measure- ment dBuV/m	Limit dBuV/m	Margin dB	Detector	Comment
1		0.300	43.80	13.54	57.34	98.05	-40.71	AVG	
2	*	0.697	36.20	12.69	48.89	70.74	-21.85	QP	
3		2.225	33.71	11.68	45.39	69.54	-24.15	QP	

REMARKS:

- (1) Measurement Value = Reading Level + Correct Factor.
- (2) Margin Level = Measurement Value - Limit Value.

Test Mode: TX Mode Channel 00 _1Mbps

Ant 90°

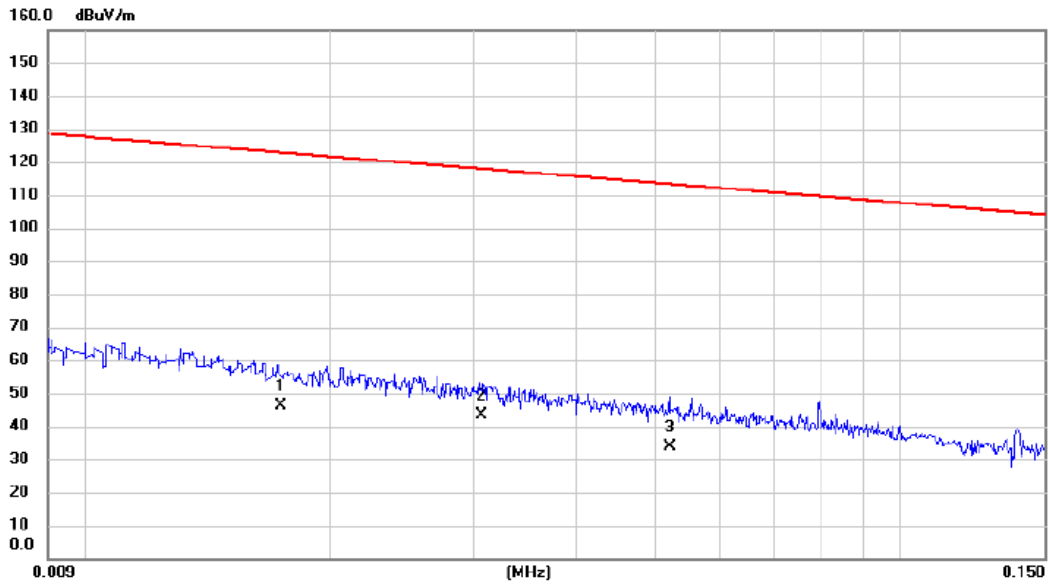

No.	Mk.	Freq. MHz	Reading Level dBuV	Correct Factor dB	Measure- ment dBuV/m	Limit dBuV/m	Margin dB	Detector	Comment
1		0.017	31.60	14.60	46.20	122.79	-76.59	AVG	
2	*	0.031	29.55	13.86	43.41	117.89	-74.48	AVG	
3		0.052	20.10	13.89	33.99	113.25	-79.26	AVG	

REMARKS:

- (1) Measurement Value = Reading Level + Correct Factor.
- (2) Margin Level = Measurement Value - Limit Value.

Test Mode: TX Mode Channel 00 _1Mbps

Ant 90°

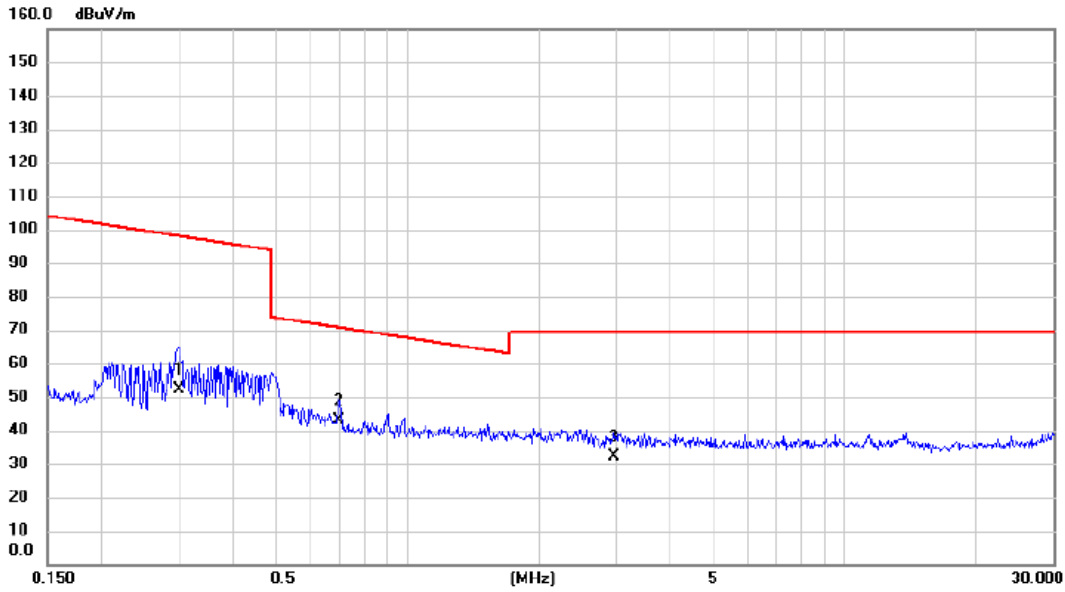

No. Mk.	Freq. MHz	Reading Level dBuV	Correct Factor dB	Measure- ment dBuV/m	Limit dBuV/m	Margin dB	Detector	Comment
1	0.300	38.50	13.54	52.04	98.05	-46.01	AVG	
2 *	0.697	30.20	12.69	42.89	70.74	-27.85	QP	
3	2.978	21.10	11.24	32.34	69.54	-37.20	QP	

REMARKS:

- (1) Measurement Value = Reading Level + Correct Factor.
- (2) Margin Level = Measurement Value - Limit Value.

APPENDIX C - RADIATED EMISSION - 30 MHZ TO 1000 MHZ

Test Mode: TX Mode Channel 00 _1Mbps

Vertical

80 dBuV/m

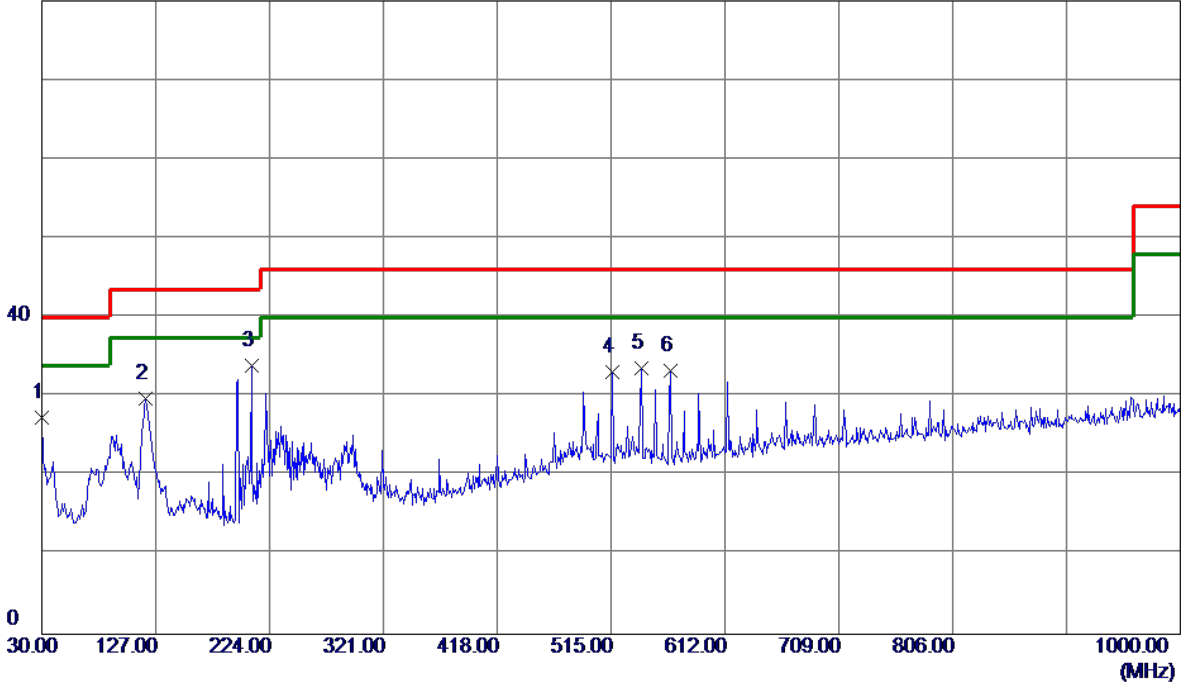

No.	Freq. MHz	Reading Level dBuV/m	Correct Factor dB	Measure ment dBuV/m	Limit dBuV/m	Margin dB	Detector	Comment
1	30.0000	42.41	-15.01	27.40	40.00	-12.60	Peak	
2	118.7550	43.02	-13.22	29.80	43.50	-13.70	Peak	
3 *	208.9650	49.56	-15.57	33.99	43.50	-9.51	Peak	
4	515.9699	40.59	-7.53	33.06	46.00	-12.94	Peak	
5	540.7050	40.83	-7.30	33.53	46.00	-12.47	Peak	
6	565.4400	40.04	-6.75	33.29	46.00	-12.71	Peak	

REMARKS:

- (1) Measurement Value = Reading Level + Correct Factor.
- (2) Margin Level = Measurement Value - Limit Value.

Test Mode: TX Mode Channel 00 _1Mbps

Horizontal

80 dBuV/m

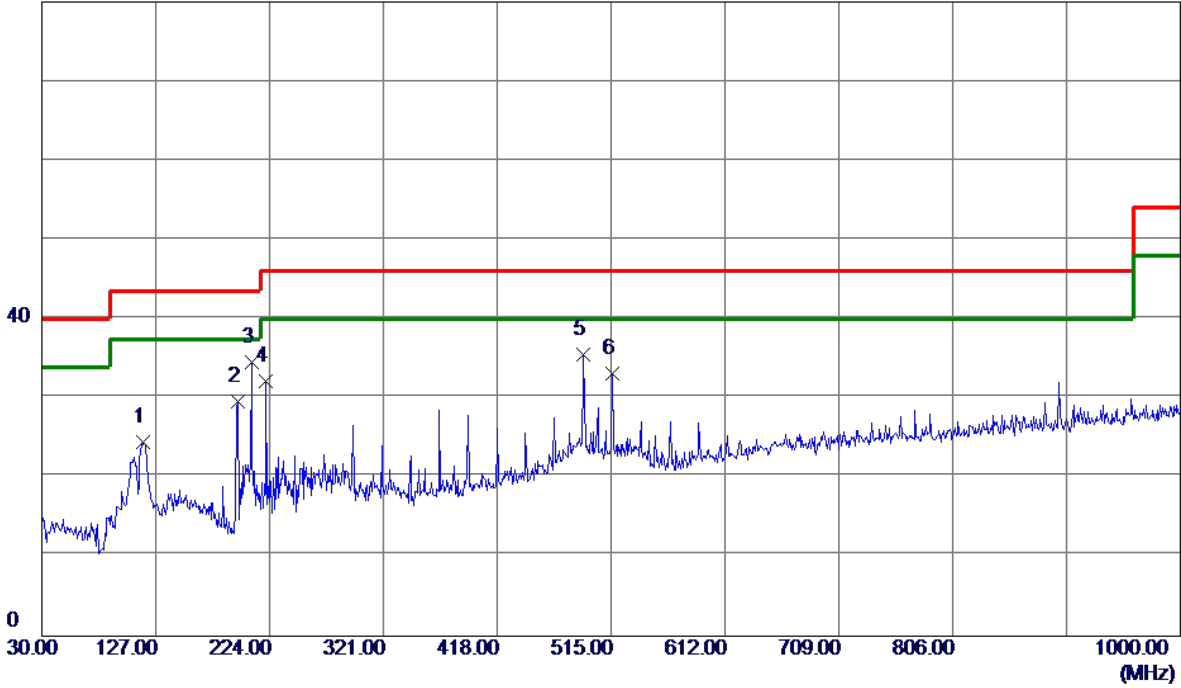

No.	Freq. MHz	Reading Level dBuV/m	Correct Factor dB	Measure ment dBuV/m	Limit dBuV/m	Margin dB	Detector	Comment
1	115.8450	38.13	-13.65	24.48	43.50	-19.02	Peak	
2	196.8400	44.48	-14.95	29.53	43.50	-13.97	Peak	
3 *	208.9650	50.15	-15.57	34.58	43.50	-8.92	Peak	
4	221.0900	46.74	-14.60	32.14	46.00	-13.86	Peak	
5	491.7200	43.26	-7.75	35.51	46.00	-10.49	Peak	
6	515.9699	40.72	-7.53	33.19	46.00	-12.81	Peak	

REMARKS:

- (1) Measurement Value = Reading Level + Correct Factor.
- (2) Margin Level = Measurement Value - Limit Value.

APPENDIX D - RADIATED EMISSION - ABOVE 1000 MHZ

Test Mode : TX 2402 MHz _CH00_1Mbps

Vertical

130 dBuV/m

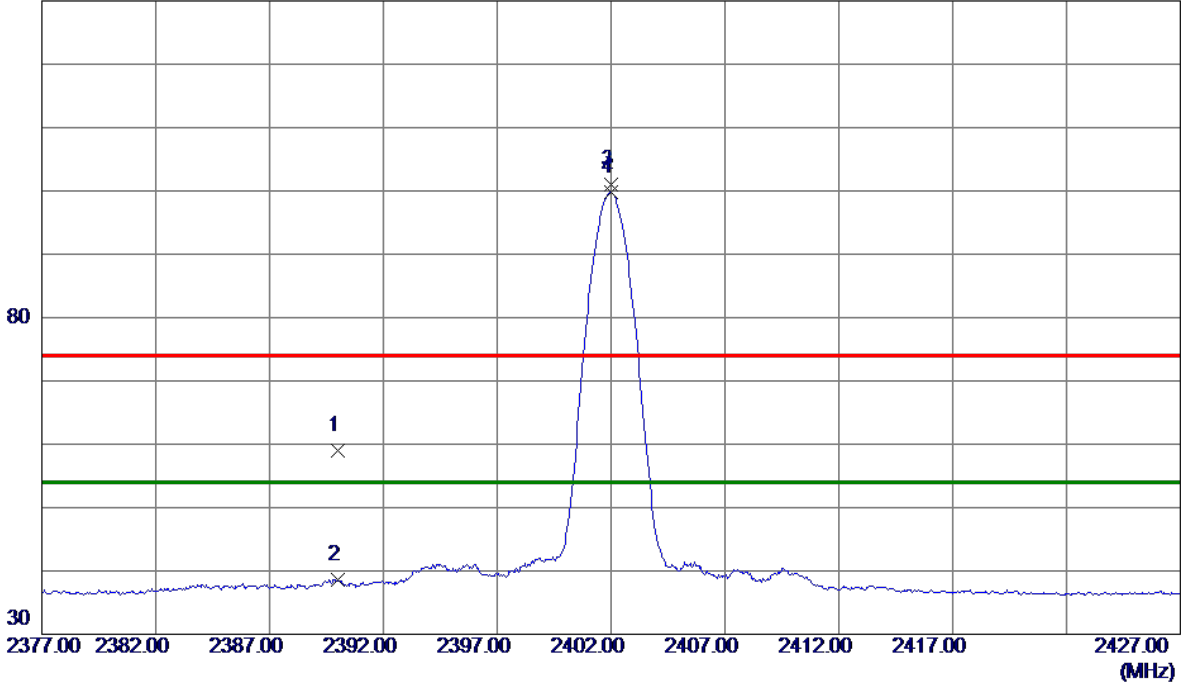

No.	Freq. MHz	Reading Level dBuV/m	Correct Factor dB	Measure ment dBuV/m	Limit dBuV/m	Margin dB	Detector	Comment
1	2390.0000	52.54	6.53	59.07	74.00	-14.93	Peak	
2	2390.0000	32.16	6.53	38.69	54.00	-15.31	AVG	
3	2401.9750	94.58	6.52	101.10	74.00	27.10	Peak	No Limit
4 *	2401.9750	93.26	6.52	99.78	54.00	45.78	AVG	No Limit

REMARKS:

- (1) Measurement Value = Reading Level + Correct Factor.
- (2) Margin Level = Measurement Value - Limit Value.

Test Mode : TX 2402 MHz _CH00_1Mbps

Vertical

80 dBuV/m

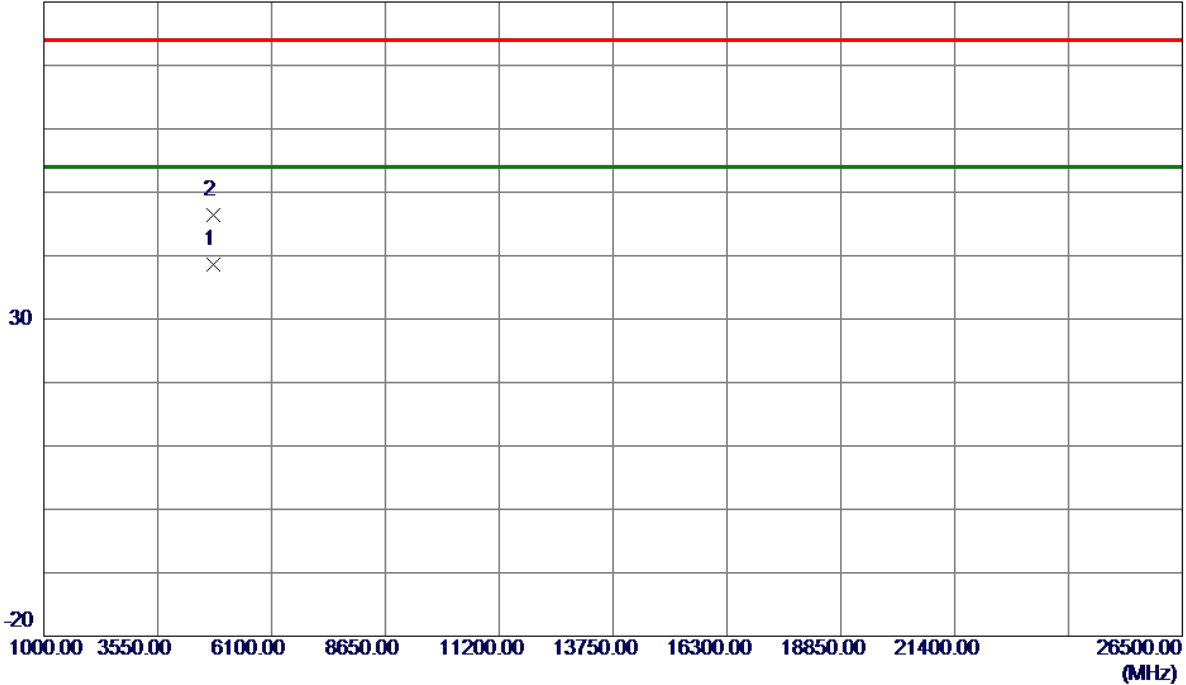

No.	Freq. MHz	Reading Level dBuV/m	Correct Factor dB	Measure ment dBuV/m	Limit dBuV/m	Margin dB	Detector	Comment
1 *	4803.8600	35.27	3.37	38.64	54.00	-15.36	AVG	
2	4804.3080	43.02	3.37	46.39	74.00	-27.61	Peak	

REMARKS:

- (1) Measurement Value = Reading Level + Correct Factor.
- (2) Margin Level = Measurement Value - Limit Value.

Test Mode : TX 2402 MHz _CH00_1Mbps

Horizontal

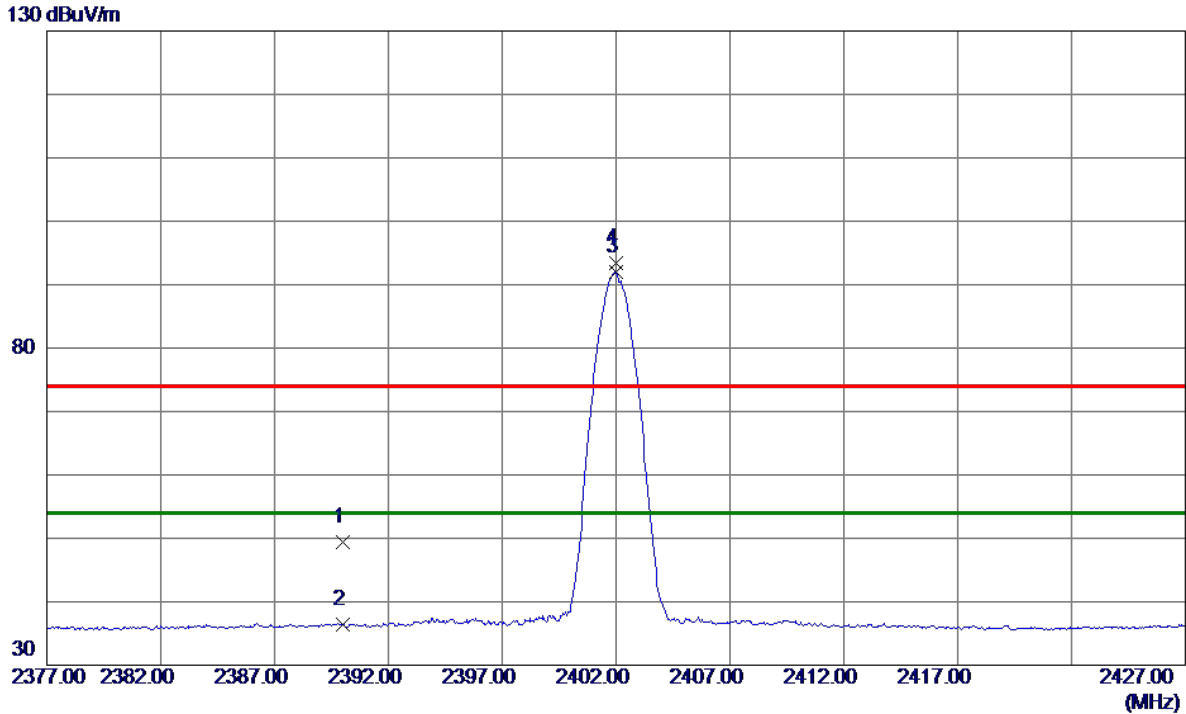

No.	Freq. MHz	Reading Level dBuV/m	Correct Factor dB	Measure ment dBuV/m	Limit dBuV/m	Margin dB	Detector	Comment
1	2390.0000	42.85	6.53	49.38	74.00	-24.62	Peak	
2	2390.0000	29.78	6.53	36.31	54.00	-17.69	AVG	
3 *	2401.9750	85.45	6.52	91.97	54.00	37.97	AVG	No Limit
4	2402.0250	86.86	6.52	93.38	74.00	19.38	Peak	No Limit

REMARKS:

- (1) Measurement Value = Reading Level + Correct Factor.
- (2) Margin Level = Measurement Value - Limit Value.

Test Mode : TX 2402 MHz _CH00_1Mbps

Horizontal

80 dBuV/m

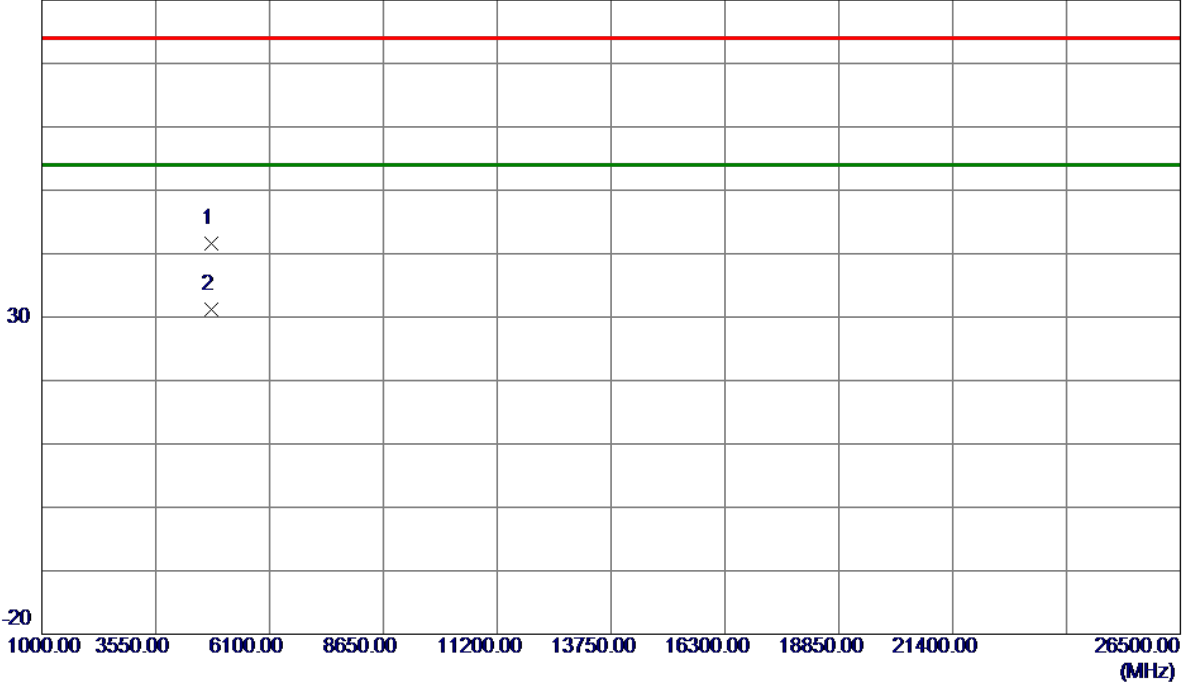

No.	Freq. MHz	Reading Level dBuV/m	Correct Factor dB	Measure ment dBuV/m	Limit dBuV/m	Margin dB	Detector	Comment
1	4803.5110	38.30	3.37	41.67	74.00	-32.33	Peak	
2 *	4803.5780	27.77	3.37	31.14	54.00	-22.86	AVG	

REMARKS:

- (1) Measurement Value = Reading Level + Correct Factor.
- (2) Margin Level = Measurement Value - Limit Value.

Test Mode : TX 2440 MHz _CH19_1Mbps

Vertical

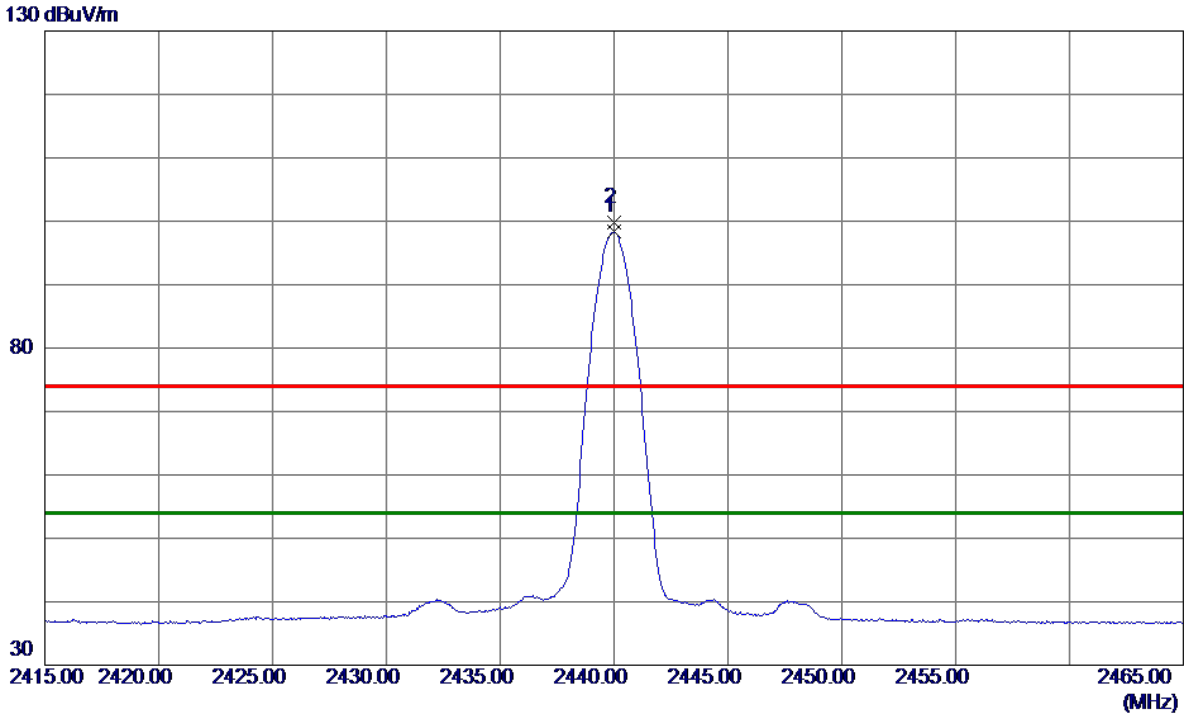

No.	Freq. MHz	Reading Level dBuV/m	Correct Factor dB	Measure ment dBuV/m	Limit dBuV/m	Margin dB	Detector	Comment
1 *	2439.9750	91.85	6.47	98.32	54.00	44.32	AVG	No Limit
2	2440.0000	93.29	6.47	99.76	74.00	25.76	Peak	No Limit

REMARKS:

- (1) Measurement Value = Reading Level + Correct Factor.
- (2) Margin Level = Measurement Value - Limit Value.

Test Mode : TX 2440 MHz _CH19_1Mbps

Vertical

80 dBuV/m

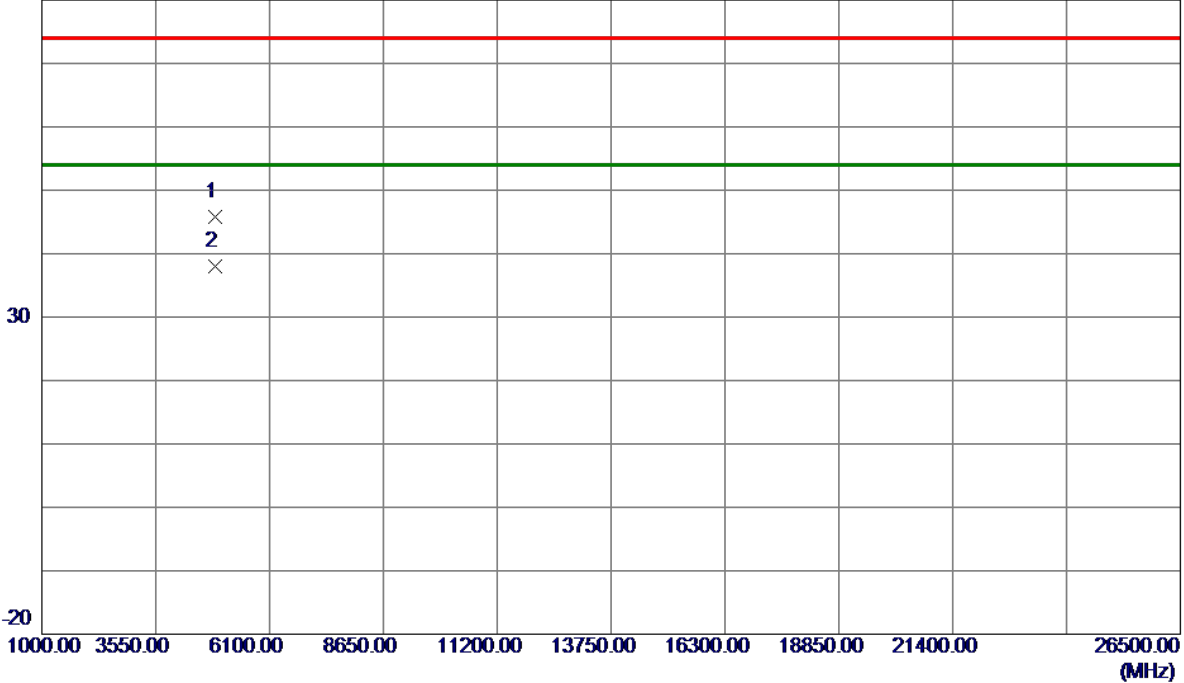

No.	Freq. MHz	Reading Level dBuV/m	Correct Factor dB	Measure ment dBuV/m	Limit dBuV/m	Margin dB	Detector	Comment
1	4879.9500	42.29	3.60	45.89	74.00	-28.11	Peak	
2 *	4880.0540	34.34	3.60	37.94	54.00	-16.06	AVG	

REMARKS:

- (1) Measurement Value = Reading Level + Correct Factor.
- (2) Margin Level = Measurement Value - Limit Value.

Test Mode : TX 2440 MHz _CH19_1Mbps

Horizontal

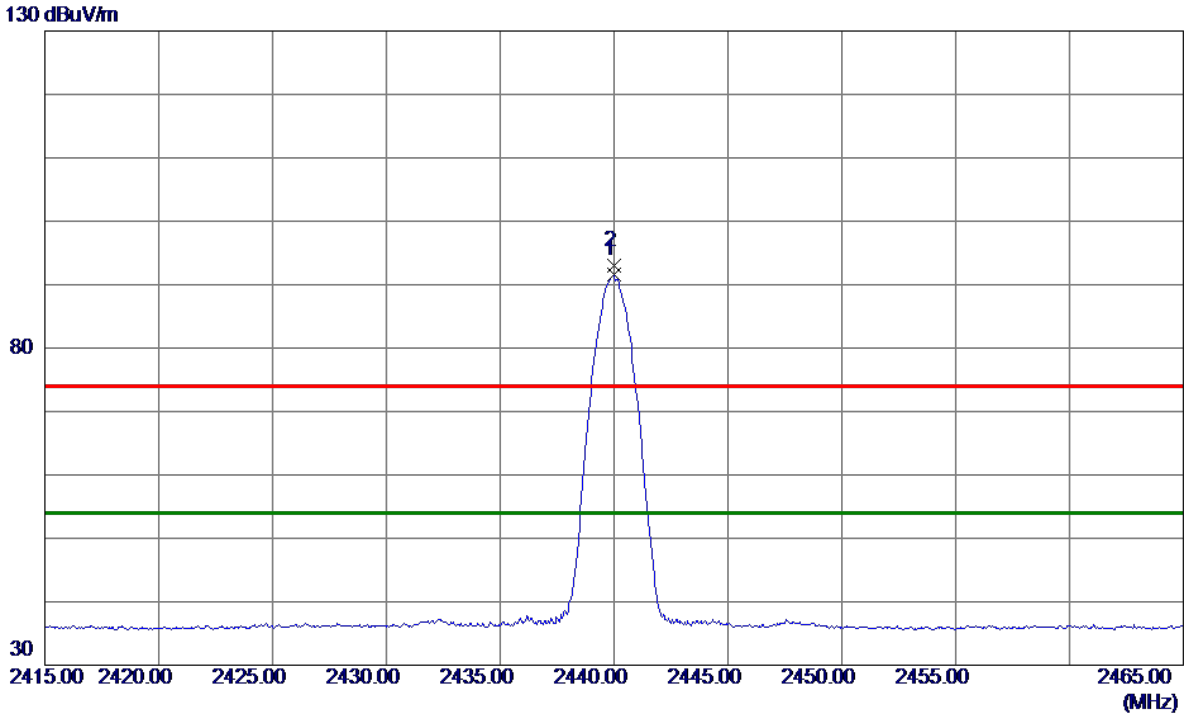

No.	Freq. MHz	Reading Level dBuV/m	Correct Factor dB	Measure ment dBuV/m	Limit dBuV/m	Margin dB	Detector	Comment
1 *	2439.9750	85.06	6.47	91.53	54.00	37.53	AVG	No Limit
2	2440.0250	86.44	6.47	92.91	74.00	18.91	Peak	No Limit

REMARKS:

- (1) Measurement Value = Reading Level + Correct Factor.
- (2) Margin Level = Measurement Value - Limit Value.

Test Mode : TX 2440 MHz _CH19_1Mbps

Horizontal

80 dBuV/m

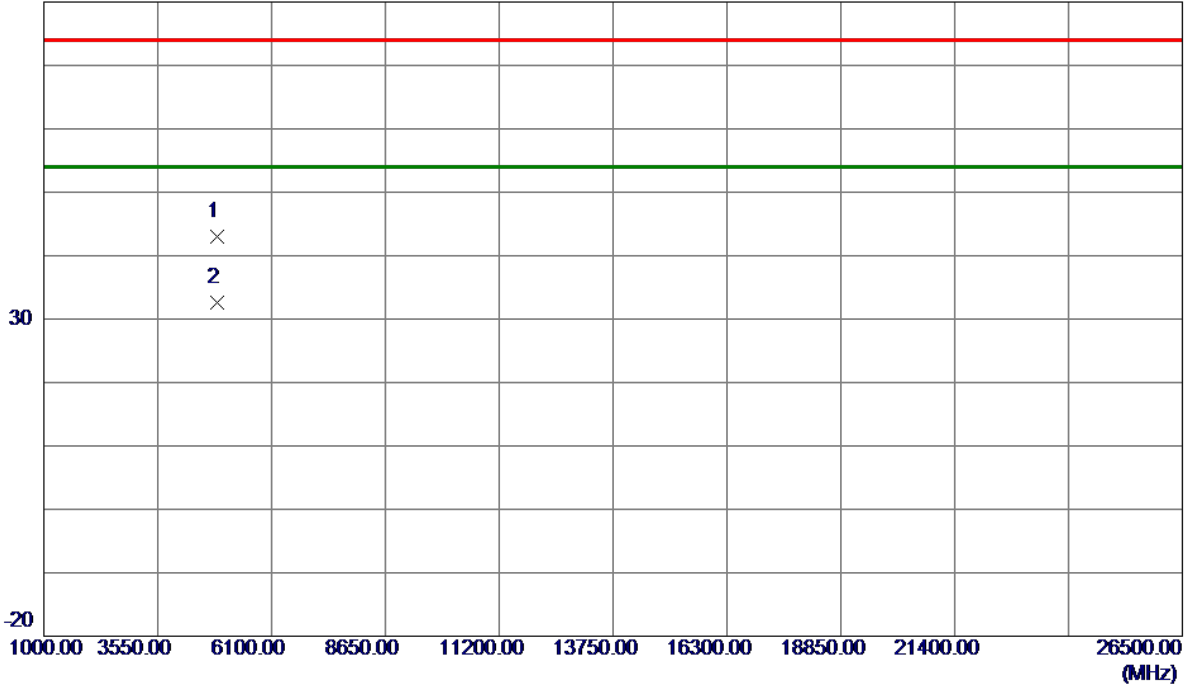

No.	Freq. MHz	Reading Level dBuV/m	Correct Factor dB	Measure ment dBuV/m	Limit dBuV/m	Margin dB	Detector	Comment
1	4879.4950	39.32	3.60	42.92	74.00	-31.08	Peak	
2 *	4880.0570	29.02	3.60	32.62	54.00	-21.38	AVG	

REMARKS:

- (1) Measurement Value = Reading Level + Correct Factor.
- (2) Margin Level = Measurement Value - Limit Value.

Test Mode : TX 2480 MHz _CH39_1Mbps

Vertical

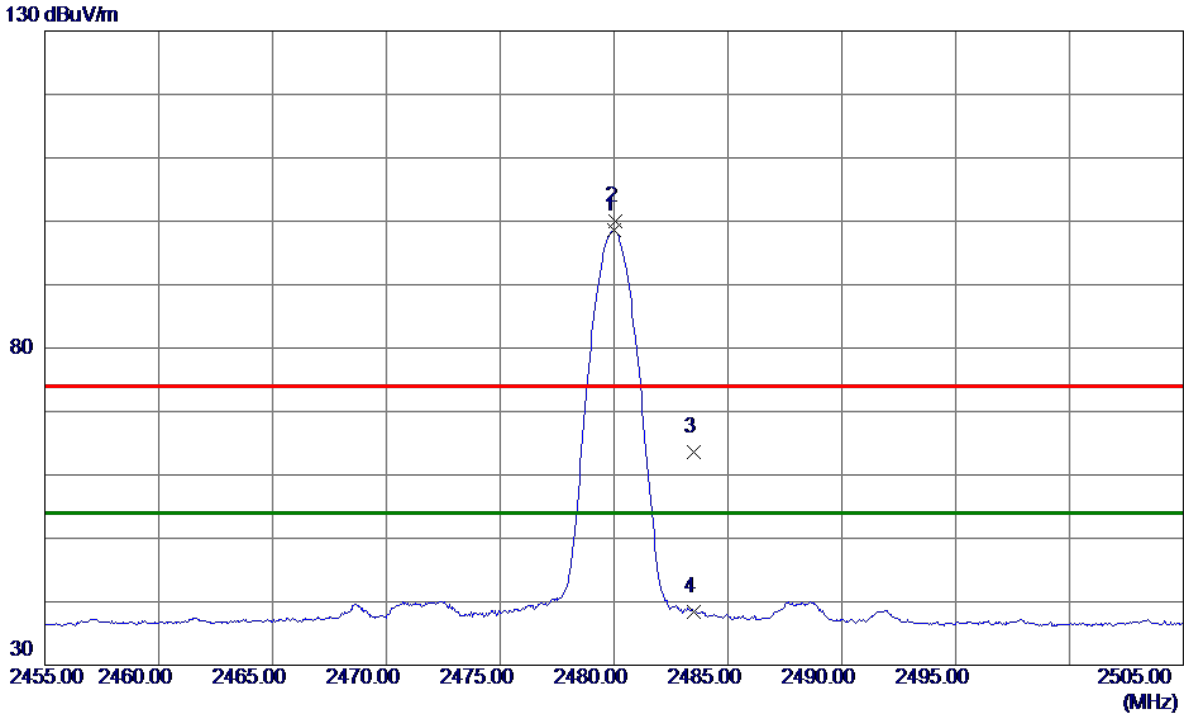

No.	Freq. MHz	Reading Level dBuV/m	Correct Factor dB	Measure ment dBuV/m	Limit dBuV/m	Margin dB	Detector	Comment
1 *	2479.9750	92.08	6.43	98.51	54.00	44.51	AVG	No Limit
2	2480.0500	93.48	6.43	99.91	74.00	25.91	Peak	No Limit
3	2483.5000	57.11	6.42	63.53	74.00	-10.47	Peak	
4	2483.5000	31.93	6.42	38.35	54.00	-15.65	AVG	

REMARKS:

- (1) Measurement Value = Reading Level + Correct Factor.
- (2) Margin Level = Measurement Value - Limit Value.

Test Mode : TX 2480 MHz _CH39_1Mbps

Vertical

80 dBuV/m

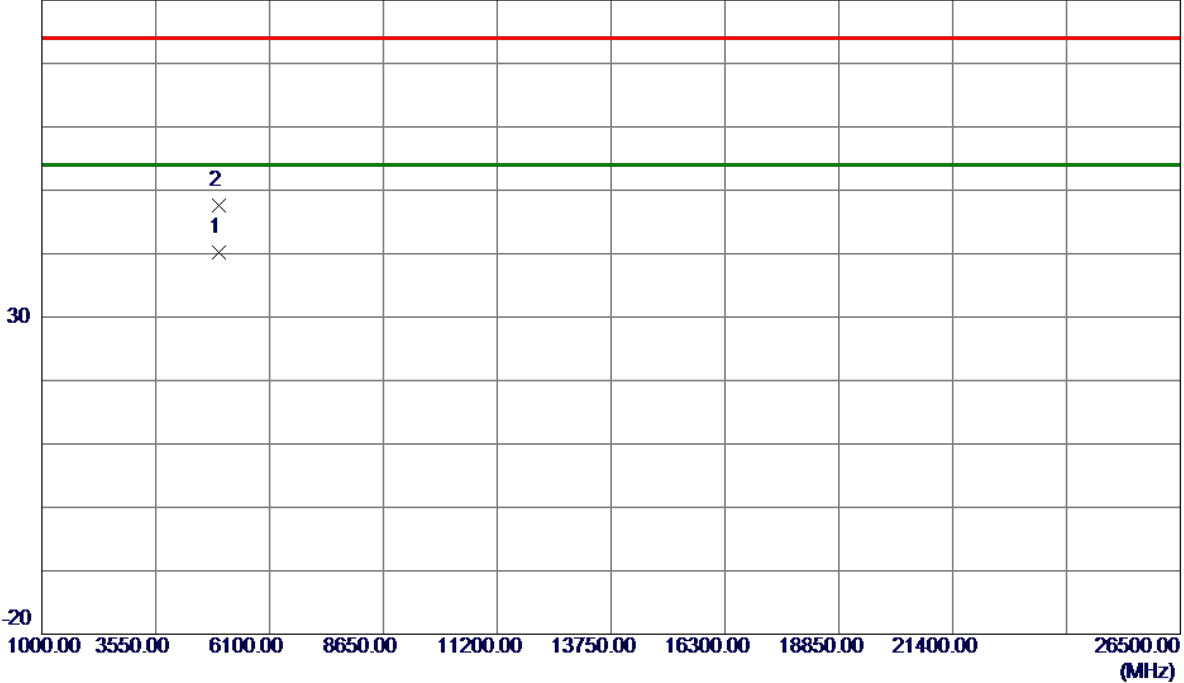

No.	Freq. MHz	Reading Level dBuV/m	Correct Factor dB	Measure ment dBuV/m	Limit dBuV/m	Margin dB	Detector	Comment
1 *	4959.8350	36.43	3.84	40.27	54.00	-13.73	AVG	
2	4959.9049	43.79	3.84	47.63	74.00	-26.37	Peak	

REMARKS:

- (1) Measurement Value = Reading Level + Correct Factor.
- (2) Margin Level = Measurement Value - Limit Value.

Test Mode : TX 2480 MHz _CH39_1Mbps

Horizontal

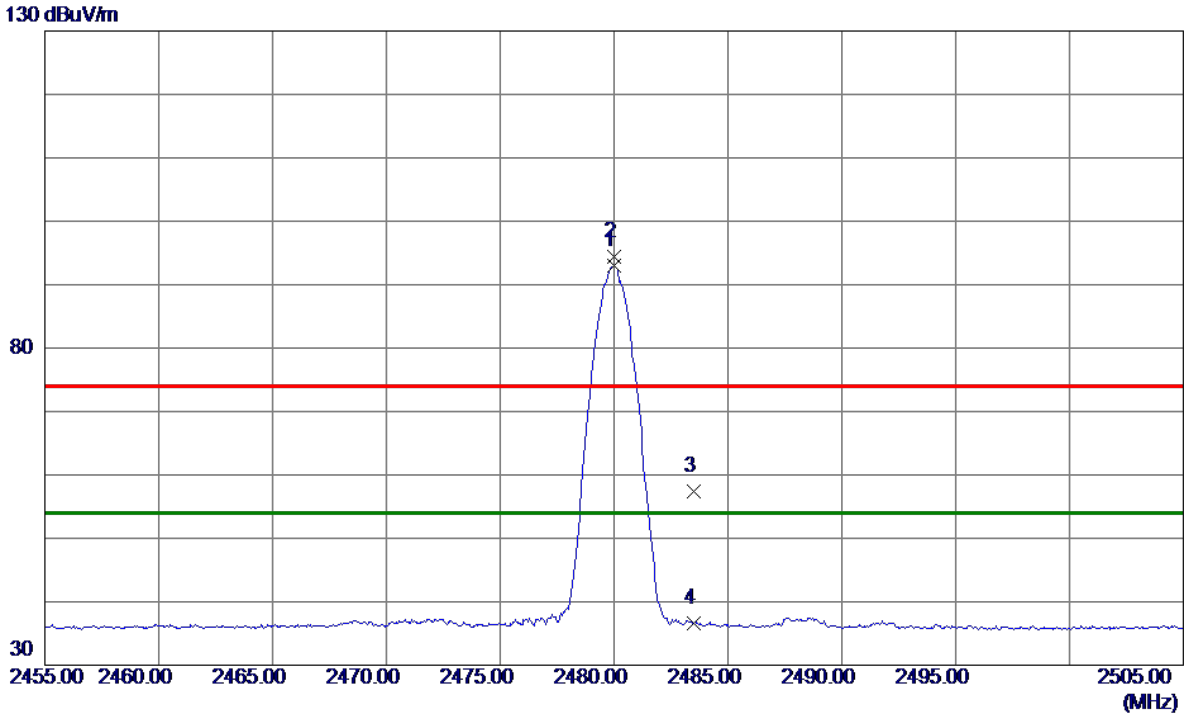

No.	Freq. MHz	Reading Level dBuV/m	Correct Factor dB	Measure ment dBuV/m	Limit dBuV/m	Margin dB	Detector	Comment
1 *	2480.0000	86.50	6.43	92.93	54.00	38.93	AVG	No Limit
2	2480.0250	87.90	6.43	94.33	74.00	20.33	Peak	No Limit
3	2483.5000	50.92	6.42	57.34	74.00	-16.66	Peak	
4	2483.5000	30.25	6.42	36.67	54.00	-17.33	AVG	

REMARKS:

- (1) Measurement Value = Reading Level + Correct Factor.
- (2) Margin Level = Measurement Value - Limit Value.

Test Mode : TX 2480 MHz _CH39_1Mbps

Horizontal

80 dBuV/m

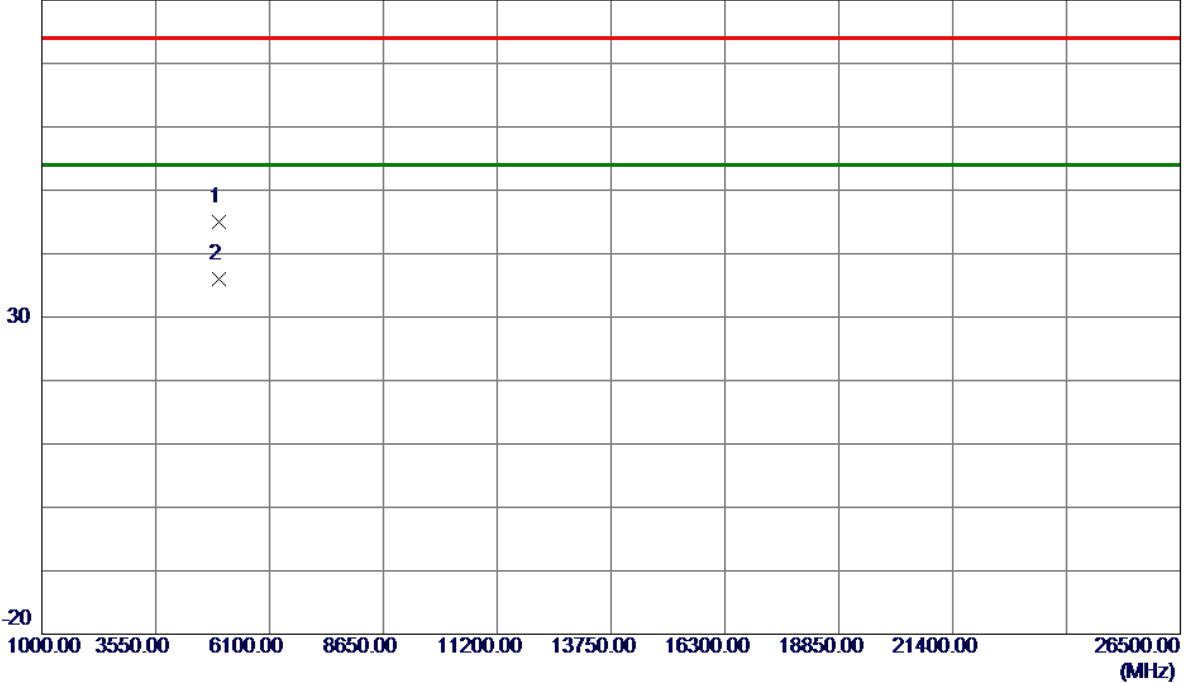

No.	Freq. MHz	Reading Level dBuV/m	Correct Factor dB	Measure ment dBuV/m	Limit dBuV/m	Margin dB	Detector	Comment
1	4959.4580	41.15	3.84	44.99	74.00	-29.01	Peak	
2 *	4959.8380	32.21	3.84	36.05	54.00	-17.95	AVG	

REMARKS:

- (1) Measurement Value = Reading Level + Correct Factor.
- (2) Margin Level = Measurement Value - Limit Value.

APPENDIX E - BANDWIDTH

Test Mode: CH00, CH19 , CH39 - 1Mbps

Channel	Frequency (MHz)	6 dB Bandwidth (MHz)	99 % Emission Bandwidth (MHz)	6 dB Bandwidth Min. Limit (kHz)	Test Result
00	2402	0.672	1.040	500	Pass
19	2440	0.664	1.036	500	Pass
39	2480	0.660	1.040	500	Pass

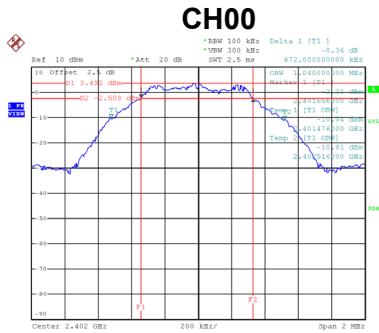

Date: 24.FEB.2019 15:43:35

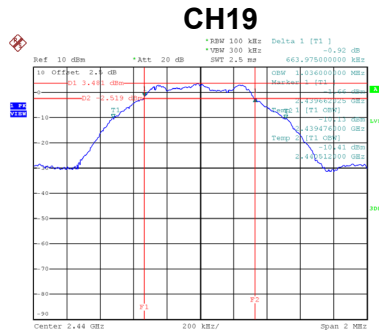

Date: 24.FEB.2019 15:45:15

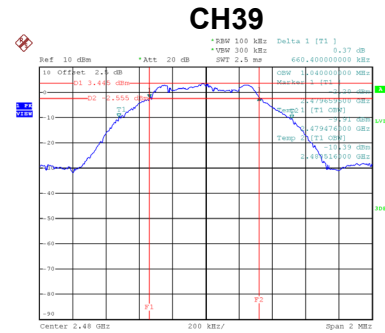

Date: 24.FEB.2019 15:46:51

APPENDIX F - MAXIMUM OUTPUT POWER & E.I.R.P.

Test Mode : CH00, CH19 , CH39 - 1Mbps

Frequency (MHz)	Output Power (dBm)	Output Power (W)	Max. Limit (dBm)	Max. Limit (W)	Test Result
2402	3.97	0.0025	30.00	1.00	Pass
2440	3.87	0.0024	30.00	1.00	Pass
2480	3.83	0.0024	30.00	1.00	Pass

APPENDIX G - CONDUCTED SPURIOUS EMISSION

Test Mode : CH00, CH19 , CH39 - 1Mbps

Bandedge- CH00 (Lower)

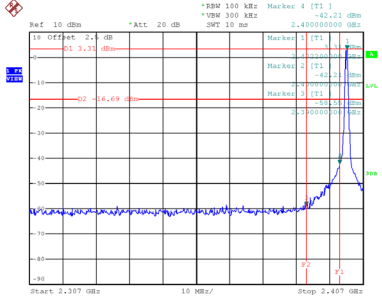

Date: 24.FEB.2019 15:43:43

Bandedge CH39 (Upper)

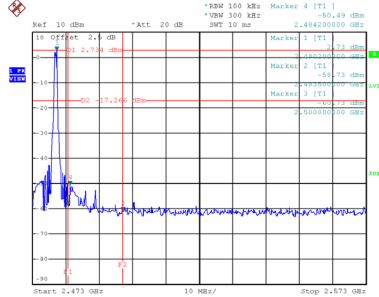

Date: 24.FEB.2019 15:46:58

CH00 – 10th Harmonic of the fundamental frequency

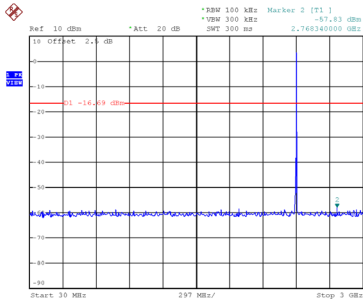

Date: 24.FEB.2019 15:43:56

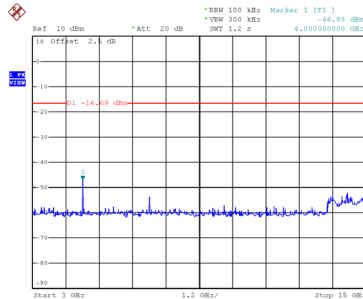

Date: 24.FEB.2019 15:44:04

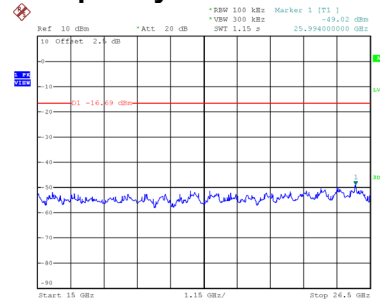

Date: 24.FEB.2019 15:44:12

CH19 – 10th Harmonic of the fundamental frequency

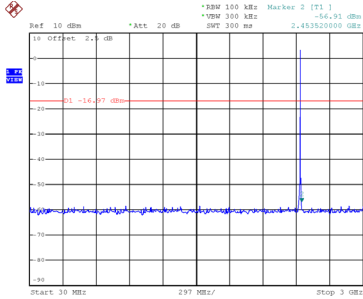

Date: 24.FEB.2019 15:45:36

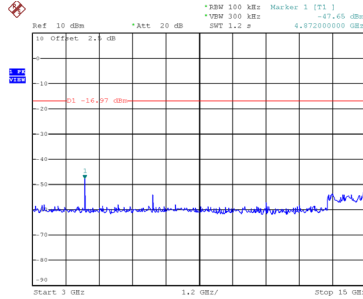

Date: 24.FEB.2019 15:45:44

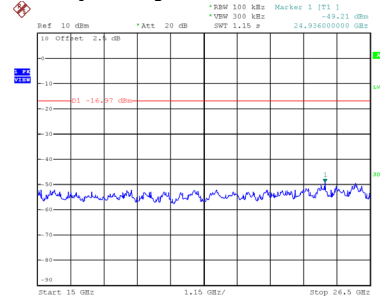

Date: 24.FEB.2019 15:45:52

CH39 – 10th Harmonic of the fundamental frequency

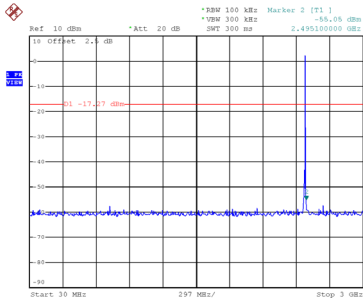

Date: 24.FEB.2019 15:47:12

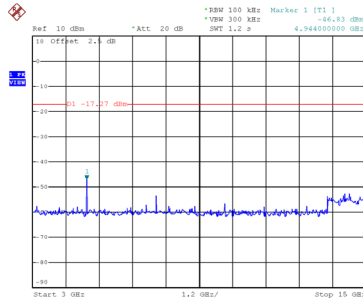

Date: 24.FEB.2019 15:47:20

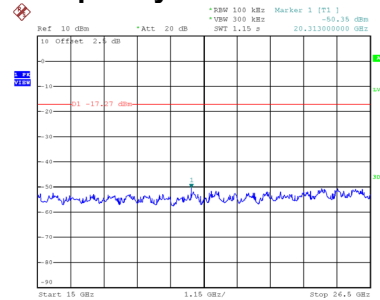

Date: 24.FEB.2019 15:47:27

APPENDIX H - POWER SPECTRAL DENSITY

Test Mode: CH00, CH19 , CH39 - 1Mbps

Channel	Frequency (MHz)	Power Spectral Density (dBm/3 kHz)	Max. Limit (dBm/3 kHz)	Test Result
00	2402	-10.38	8.00	Pass
19	2440	-10.57	8.00	Pass
39	2480	-11.03	8.00	Pass

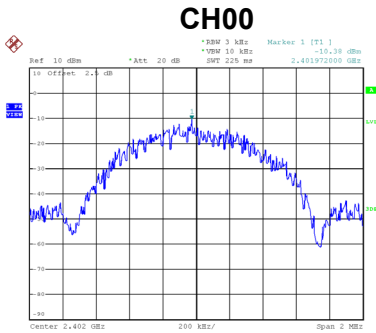

Date: 24.FEB.2019 15:44:18

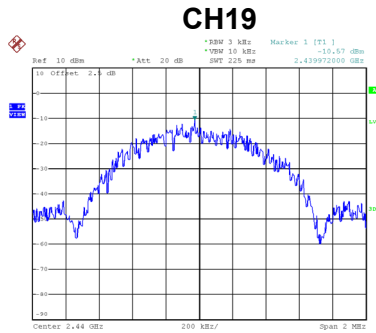

Date: 24.FEB.2019 15:45:58

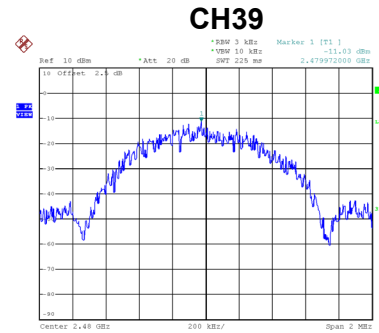

Date: 24.FEB.2019 15:47:34

End of Test Report