

FCC Radio Test Report

FCC ID: ACJ-SA-C600

This report concerns: Original Grant

Project No. : 2108C020
Equipment : NETWORK CD RECEIVER
Brand Name : Technics
Test Model : SA-C600
Series Model : N/A
Applicant : Panasonic Corporation of North America
Address : Two Riverfront Plaza, 9th Floor Newark, New Jersey 07102-5490 United States
Manufacturer : Panasonic Corporation of North America
Address : Two Riverfront Plaza, 9th Floor Newark, New Jersey 07102-5490 United States
Factory : Panasonic AVC Networks Johor Malaysia
Address : IE,PLO 460, Jalan Bandar, 81700 Pasir Gudang, Johor, Malaysia
Date of Receipt : Aug. 03, 2021
Date of Test : Aug. 03, 2021 ~ Sep. 02, 2021
Issued Date : Sep. 23, 2021
Report Version : R01
Test Sample : Engineering Sample No.: DG2021080397
Standard(s) : FCC CFR Title 47, Part 15, Subpart E
FCC KDB 789033 D02 General UNII Test Procedures New Rules v02r01
FCC KDB 662911 D01 Multiple Transmitter Output v02r01
ANSI C63.10-2013

The above equipment has been tested and found compliance with the requirement of the relative standards by BTL Inc.

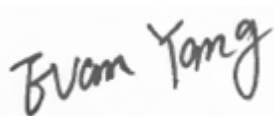

Prepared by : Evan Yang



Approved by : Ethan Ma



TESTING CERT #5123.02

Add: No. 3 Jinshagang 1st Rd. Shixia, Dalang Town, Dongguan City, Guangdong, People's Republic of China

Tel: +86-769-8318-3000

Web: www.newbtl.com

Declaration

BTL represents to the client that testing is done in accordance with standard procedures as applicable and that test instruments used has been calibrated with standards traceable to international standard(s) and/or national standard(s).

BTL's reports apply only to the specific samples tested under conditions. It is manufacture's responsibility to ensure that additional production units of this model are manufactured with the identical electrical and mechanical components. **BTL** shall have no liability for any declarations, inferences or generalizations drawn by the client or others from **BTL** issued reports.

The report must not be used by the client to claim product certification, approval, or endorsement by NVLAP, NIST, A2LA, or any agency of the U.S. Government.

This report is the confidential property of the client. As a mutual protection to the clients, the public and ourselves, the test report shall not be reproduced, except in full, without our written approval.

BTL's laboratory quality assurance procedures are in compliance with the **ISO/IEC 17025** requirements, and accredited by the conformity assessment authorities listed in this test report.

BTL is not responsible for the sampling stage, so the results only apply to the sample as received.

The information, data and test plan are provided by manufacturer which may affect the validity of results, so it is manufacturer's responsibility to ensure that the apparatus meets the essential requirements of applied standards and in all the possible configurations as representative of its intended use.

Limitation

For the use of the authority's logo is limited unless the Test Standard(s)/Scope(s)/Item(s) mentioned in this test report is (are) included in the conformity assessment authorities acceptance respective.

Please note that the measurement uncertainty is provided for informational purpose only and are not use in determining the Pass/Fail results.

Table of Contents	Page
REPORT ISSUED HISTORY	5
1 . SUMMARY OF TEST RESULTS	6
1.1 TEST FACILITY	7
1.2 MEASUREMENT UNCERTAINTY	7
1.3 TEST ENVIRONMENT CONDITIONS	7
2 . GENERAL INFORMATION	8
2.1 GENERAL DESCRIPTION OF EUT	8
2.2 TEST MODES	11
2.3 PARAMETERS OF TEST SOFTWARE	15
2.4 DUTY CYCLE	17
2.5 BLOCK DIAGRAM SHOWING THE CONFIGURATION OF SYSTEM TESTED	19
2.6 SUPPORT UNITS	19
3 . AC POWER LINE CONDUCTED EMISSIONS	20
3.1 LIMIT	20
3.2 TEST PROCEDURE	20
3.3 DEVIATION FROM TEST STANDARD	20
3.4 TEST SETUP	21
3.5 EUT OPERATION CONDITIONS	21
3.6 TEST RESULTS	21
4 . RADIATED EMISSIONS	22
4.1 LIMIT	22
4.2 TEST PROCEDURE	23
4.3 DEVIATION FROM TEST STANDARD	24
4.4 TEST SETUP	24
4.5 EUT OPERATION CONDITIONS	25
4.6 TEST RESULTS - 9 KHZ TO 30 MHZ	25
4.7 TEST RESULTS - 30 MHZ TO 1000 MHZ	25
4.8 TEST RESULTS - ABOVE 1000 MHZ	25
5 . BANDWIDTH	26
5.1 LIMIT	26
5.2 TEST PROCEDURE	26
5.3 DEVIATION FROM STANDARD	26
5.4 TEST SETUP	26

Table of Contents	Page
5.5 EUT OPERATION CONDITIONS	26
5.6 TEST RESULTS	26
6 . MAXIMUM OUTPUT POWER	27
6.1 LIMIT	27
6.2 TEST PROCEDURE	27
6.3 DEVIATION FROM STANDARD	27
6.4 TEST SETUP	27
6.5 EUT OPERATION CONDITIONS	27
6.6 TEST RESULTS	27
7 . POWER SPECTRAL DENSITY	28
7.1 LIMIT	28
7.2 TEST PROCEDURE	28
7.3 DEVIATION FROM STANDARD	28
7.4 TEST SETUP	29
7.5 EUT OPERATION CONDITIONS	29
7.6 TEST RESULTS	29
8 . FREQUENCY STABILITY	30
8.1 LIMIT	30
8.2 TEST PROCEDURE	30
8.3 DEVIATION FROM STANDARD	30
8.4 TEST SETUP	30
8.5 EUT OPERATION CONDITIONS	30
8.6 TEST RESULTS	30
9 . MEASUREMENT INSTRUMENTS LIST	31
APPENDIX A - AC POWER LINE CONDUCTED EMISSIONS	33
APPENDIX B - RADIATED EMISSION - 9 KHZ TO 30 MHZ	36
APPENDIX C - RADIATED EMISSION - 30 MHZ TO 1000 MHZ	41
APPENDIX D - RADIATED EMISSION - ABOVE 1000 MHZ	44
APPENDIX E - BANDWIDTH	197
APPENDIX F - MAXIMUM OUTPUT POWER	214
APPENDIX G - POWER SPECTRAL DENSITY	235
APPENDIX H - FREQUENCY STABILITY	252

REPORT ISSUED HISTORY

Report Version	Description	Issued Date
R00	Original Issue.	Sep. 16, 2021
R01	Remove the EUT test photo.	Sep. 23, 2021

1. SUMMARY OF TEST RESULTS

Test procedures according to the technical standard(s):

FCC CFR Title 47, Part 15, Subpart E				
Standard(s) Section	Test Item	Test Result	Judgment	Remark
15.207 15.407(b)	AC Power Line Conducted Emissions	APPENDIX A	PASS	-----
15.407(b) 15.205(a) 15.209(a)	Radiated Emissions	APPENDIX B APPENDIX C APPENDIX D	PASS	-----
15.407(a) 15.407(e)	Bandwidth	APPENDIX E	PASS	-----
15.407(a)	Maximum Output Power	APPENDIX F	PASS	-----
15.407(a)	Power Spectral Density	APPENDIX G	PASS	-----
15.407(g)	Frequency Stability	APPENDIX H	PASS	-----
15.203	Antenna Requirements	-----	PASS	NOTE (2)
15.407(c)	Automatically Discontinue Transmission	-----	PASS	NOTE (3)

Note:

- (1) "N/A" denotes test is not applicable in this test report.
- (2) The device what use a permanently attached antenna were considered sufficient to comply with the provisions of 15.203.
- (3) During no any information transmission, the EUT can automatically discontinue transmission and become standby mode for power saving. the EUT can detect the controlling signal of ACK message transmitting from remote device and verify whether it shall resend or discontinue transmission.
- (4) For UNII-1 this device was functioned as a
 - Outdoor access point device
 - Indoor access point device
 - Fixed point-to-point access points device
 - Client device

1.1 TEST FACILITY

The test facilities used to collect the test data in this report is at the location of No. 3 Jinshagang 1st Rd. Shixia, Dalang Town, Dongguan City, Guangdong, People's Republic of China.

BTL's Test Firm Registration Number for FCC: 357015

BTL's Designation Number for FCC: CN1240

1.2 MEASUREMENT UNCERTAINTY

ISO/IEC 17025 requires that an estimate of the measurement uncertainties associated with the emissions test results be included in the report. The measurement uncertainties given below are based on a 95% confidence level (based on a coverage factor (k=2))

The BTL measurement uncertainty as below table:

A. AC power line conducted emissions test:

Test Site	Method	Measurement Frequency Range	U, (dB)
DG-C02	CISPR	150kHz ~ 30MHz	2.68

B. Radiated emissions test:

Test Site	Method	Measurement Frequency Range	Ant. H / V	U, (dB)
DG-CB03	CISPR	9kHz ~ 30MHz	-	3.02
		30MHz ~ 200MHz	V	4.36
		30MHz ~ 200MHz	H	3.32
		200MHz ~ 1,000MHz	V	4.08
		200MHz ~ 1,000MHz	H	3.96
		1GHz ~ 6GHz	-	3.80
		6GHz ~ 18GHz	-	4.82
		18GHz ~ 26.5GHz	-	3.62
		26.5GHz ~ 40GHz	-	4.00

C. Other Measurement test:

Test Item	Uncertainty
Bandwidth	±3.8 %
Maximum Output Power	±0.95 dB
Power Spectral Density	±0.86 dB
Frequency Stability	±0.16 dB
Temperature	±0.08 °C
Humidity	±1.5%

Note: Unless specifically mentioned, the uncertainty of measurement has not been taken into account to declare the compliance or non-compliance to the specification.

1.3 TEST ENVIRONMENT CONDITIONS

Test Item	Temperature	Humidity	Test Voltage	Tested By
AC Power Line Conducted Emissions	25°C	53%	AC 120V/60Hz	Laughing Zhang
Radiated Emissions-9kHz to 30MHz	25°C	60%	AC 120V/60Hz	Berton Luo
Radiated Emissions-30MHz to 1000MHz	26°C	52%	AC 120V/60Hz	Berton Luo
Radiated Emissions-Above 1000 MHz	26°C	52%	AC 120V/60Hz	Berton Luo
Bandwidth	25°C	50%	AC 120V/60Hz	Grani Zhou
Maximum Output Power	25°C	50%	AC 120V/60Hz	Laughing Zhang
Power Spectral Density	25°C	50%	AC 120V/60Hz	Grani Zhou
Frequency Stability	Normal & Extreme	50%	Normal & Extreme	Grani Zhou

2. GENERAL INFORMATION

2.1 GENERAL DESCRIPTION OF EUT

Equipment	NETWORK CD RECEIVER
Brand Name	Technics
Test Model	SA-C600
Series Model	N/A
Model Difference(s)	N/A
Power Source	AC Mains.
Power Rating	120V ~ 46W 60Hz
Operation Frequency Band(s)	UNII-1: 5150 MHz ~ 5250 MHz UNII-2A: 5250 MHz ~ 5350 MHz UNII-2C: 5470 MHz ~ 5725 MHz UNII-3: 5725 MHz ~ 5850 MHz
Modulation Type	IEEE 802.11a/n/ac: OFDM
Bit Rate of Transmitter	IEEE 802.11a: 54/48/36/24/18/12/9/6 Mbps IEEE 802.11n: up to 300 Mbps IEEE 802.11ac: up to 866.7 Mbps
Maximum Output Power _UNII-1	IEEE 802.11ac40: 16.71 dBm (0.0469 W)
Maximum Output Power _UNII-2A	IEEE 802.11ac40: 16.73 dBm (0.0471 W)
Maximum Output Power _UNII-2C	IEEE 802.11ac40: 16.65 dBm (0.0462 W)
Maximum Output Power _UNII-3	IEEE 802.11ac40: 16.66 dBm (0.0463 W)

Note:

1. For a more detailed features description, please refer to the manufacturer's specifications or the user's manual.

2. Channel List:

IEEE 802.11a IEEE 802.11n(HT20) IEEE 802.11ac(VHT20)		IEEE 802.11n(HT40) IEEE 802.11ac(VHT40)		IEEE 802.11ac(VHT80)	
UNII-1		UNII-1		UNII-1	
Channel	Frequency (MHz)	Channel	Frequency (MHz)	Channel	Frequency (MHz)
36	5180	38	5190	42	5210
40	5200	46	5230		
44	5220				
48	5240				

IEEE 802.11a IEEE 802.11n(HT20) IEEE 802.11ac(VHT20)		IEEE 802.11n(HT40) IEEE 802.11ac(VHT40)		IEEE 802.11ac(VHT80)	
UNII-2A		UNII-2A		UNII-2A	
Channel	Frequency (MHz)	Channel	Frequency (MHz)	Channel	Frequency (MHz)
52	5260	54	5270	58	5290
56	5280	62	5310		
60	5300				
64	5320				

IEEE 802.11a IEEE 802.11n(HT20) IEEE 802.11ac(VHT20)		IEEE 802.11n(HT40) IEEE 802.11ac(VHT40)		IEEE 802.11ac(VHT80)	
UNII-2C		UNII-2C		UNII-2C	
Channel	Frequency (MHz)	Channel	Frequency (MHz)	Channel	Frequency (MHz)
100	5500	102	5510	106	5530
104	5520	110	5550	122	5610
108	5540	118	5590		
112	5560	126	5630		
116	5580	134	5670		
120	5600				
124	5620				
128	5640				
132	5660				
136	5680				
140	5700				

IEEE 802.11a IEEE 802.11n(HT20) IEEE 802.11ac(VHT20)		IEEE 802.11n(HT40) IEEE 802.11ac(VHT40)		IEEE 802.11ac(VHT80)	
UNII-3		UNII-3		UNII-3	
Channel	Frequency (MHz)	Channel	Frequency (MHz)	Channel	Frequency (MHz)
149	5745	151	5755	155	5775
153	5765	159	5795		
157	5785				
161	5805				
165	5825				

3. Antenna Specification:

Ant.	Manufacturer	P/N	Antenna Type	Connector	Gain (dBi)
1	Panasonic Corporation	TNPA7567-1	PCB	N/A	2.8
2	Panasonic Corporation	TNPA7568-1	PCB	N/A	2.8

Note:

- 1) This EUT supports MIMO 2X2, any transmit signals are correlated with each other, so Directional gain= $G_{ANT}+10\log(N)$ dBi, that is Directional gain= $2.8+10\log(2)$ dBi=5.81.
- 2) The antenna gain and beamforming gain are provided by the manufacturer.

4. Table for Antenna Configuration:

Operating Mode	TX Mode	1TX	2TX
IEEE 802.11a		V (Ant. 1)	-
IEEE 802.11n(HT20)		-	V (Ant. 1 + Ant. 2)
IEEE 802.11n(HT40)		-	V (Ant. 1 + Ant. 2)
IEEE 802.11ac(VHT20)		-	V (Ant. 1 + Ant. 2)
IEEE 802.11ac(VHT40)		-	V (Ant. 1 + Ant. 2)
IEEE 802.11ac(VHT80)		-	V (Ant. 1 + Ant. 2)

2.2 TEST MODES

The test system was pre-tested based on the consideration of all possible combinations of EUT operation mode.

Pretest Mode	Description
Mode 1	TX A Mode Channel 36/40/48 (UNII-1)
Mode 2	TX N(HT20) Mode Channel 36/40/48 (UNII-1)
Mode 3	TX N(HT40) Mode Channel 38/46 (UNII-1)
Mode 4	TX AC(VHT20) Mode Channel 36/40/48 (UNII-1)
Mode 5	TX AC(VHT40) Mode Channel 38/46 (UNII-1)
Mode 6	TX AC(VHT80) Mode Channel 42 (UNII-1)
Mode 10	TX A Mode Channel 52/60/64 (UNII-2A)
Mode 11	TX N(HT20) Mode Channel 52/60/64 (UNII-2A)
Mode 12	TX N(HT40) Mode Channel 54/62 (UNII-2A)
Mode 13	TX AC(VHT20) Mode Channel 52/60/64 (UNII-2A)
Mode 14	TX AC(VHT40) Mode Channel 54/62 (UNII-2A)
Mode 15	TX AC(VHT80) Mode Channel 58 (UNII-2A)
Mode 21	TX A Mode Channel 100/116/140 (UNII-2C)
Mode 22	TX N(HT20) Mode Channel 100/116/140 (UNII-2C)
Mode 23	TX N(HT40) Mode Channel 102/110/134 (UNII-2C)
Mode 24	TX AC(VHT20) Mode Channel 100/116/140 (UNII-2C)
Mode 25	TX AC(VHT40) Mode Channel 102/110/134 (UNII-2C)
Mode 26	TX AC(VHT80) Mode Channel 106/122 (UNII-2C)
Mode 32	TX A Mode Channel 149/157/165 (UNII-3)
Mode 33	TX N(HT20) Mode Channel 149/157/165 (UNII-3)
Mode 34	TX N(HT40) Mode Channel 151/159 (UNII-3)
Mode 35	TX AC(VHT20) Mode Channel 149/157/165 (UNII-3)
Mode 36	TX AC(VHT40) Mode Channel 151/159 (UNII-3)
Mode 37	TX AC(VHT80) Mode Channel 155 (UNII-3)
Mode 38	TX AC(VHT40) Mode Channel 54 (UNII-2A)

Following mode(s) was (were) found to be the worst case(s) and selected for the final test.

AC power line conducted emissions test	
Final Test Mode	Description
Mode 38	TX AC(VHT40) Mode Channel 54 (UNII-2A)

Radiated Emissions Test - Below 1GHz	
Final Test Mode	Description
Mode 38	TX AC(VHT40) Mode Channel 54 (UNII-2A)

Radiated Emissions Test - Above 1GHz	
Final Test Mode	Description
Mode 1	TX A Mode Channel 36/40/48 (UNII-1)
Mode 4	TX AC(VHT20) Mode Channel 36/40/48 (UNII-1)
Mode 5	TX AC(VHT40) Mode Channel 38/46 (UNII-1)
Mode 6	TX AC(VHT80) Mode Channel 42 (UNII-1)
Mode 10	TX A Mode Channel 52/60/64 (UNII-2A)
Mode 13	TX AC(VHT20) Mode Channel 52/60/64 (UNII-2A)
Mode 14	TX AC(VHT40) Mode Channel 54/62 (UNII-2A)
Mode 15	TX AC(VHT80) Mode Channel 58 (UNII-2A)
Mode 21	TX A Mode Channel 100/116/140 (UNII-2C)
Mode 24	TX AC(VHT20) Mode Channel 100/116/140 (UNII-2C)
Mode 25	TX AC(VHT40) Mode Channel 102/110/134 (UNII-2C)
Mode 26	TX AC(VHT80) Mode Channel 106/122 (UNII-2C)
Mode 32	TX A Mode Channel 149/157/165 (UNII-3)
Mode 35	TX AC(VHT20) Mode Channel 149/157/165 (UNII-3)
Mode 36	TX AC(VHT40) Mode Channel 151/159 (UNII-3)
Mode 37	TX AC(VHT80) Mode Channel 155 (UNII-3)

Output Power Test	
Final Test Mode	Description
Mode 1	TX A Mode Channel 36/40/48 (UNII-1)
Mode 2	TX N(HT20) Mode Channel 36/40/48 (UNII-1)
Mode 3	TX N(HT40) Mode Channel 38/46 (UNII-1)
Mode 4	TX AC(VHT20) Mode Channel 36/40/48 (UNII-1)
Mode 5	TX AC(VHT40) Mode Channel 38/46 (UNII-1)
Mode 6	TX AC(VHT80) Mode Channel 42 (UNII-1)
Mode 10	TX A Mode Channel 52/60/64 (UNII-2A)
Mode 11	TX N(HT20) Mode Channel 52/60/64 (UNII-2A)
Mode 12	TX N(HT40) Mode Channel 54/62 (UNII-2A)
Mode 13	TX AC(VHT20) Mode Channel 52/60/64 (UNII-2A)
Mode 14	TX AC(VHT40) Mode Channel 54/62 (UNII-2A)
Mode 15	TX AC(VHT80) Mode Channel 58 (UNII-2A)
Mode 21	TX A Mode Channel 100/116/140 (UNII-2C)
Mode 22	TX N(HT20) Mode Channel 100/116/140 (UNII-2C)
Mode 23	TX N(HT40) Mode Channel 102/110/134 (UNII-2C)
Mode 24	TX AC(VHT20) Mode Channel 100/116/140 (UNII-2C)
Mode 25	TX AC(VHT40) Mode Channel 102/110/134 (UNII-2C)
Mode 26	TX AC(VHT80) Mode Channel 106/122 (UNII-2C)
Mode 32	TX A Mode Channel 149/157/165 (UNII-3)
Mode 33	TX N(HT20) Mode Channel 149/157/165 (UNII-3)
Mode 34	TX N(HT40) Mode Channel 151/159 (UNII-3)
Mode 35	TX AC(VHT20) Mode Channel 149/157/165 (UNII-3)
Mode 36	TX AC(VHT40) Mode Channel 151/159 (UNII-3)
Mode 37	TX AC(VHT80) Mode Channel 155 (UNII-3)

Other Conducted Test	
Final Test Mode	Description
Mode 1	TX A Mode Channel 36/40/48 (UNII-1)
Mode 4	TX AC(VHT20) Mode Channel 36/40/48 (UNII-1)
Mode 5	TX AC(VHT40) Mode Channel 38/46 (UNII-1)
Mode 6	TX AC(VHT80) Mode Channel 42 (UNII-1)
Mode 10	TX A Mode Channel 52/60/64 (UNII-2A)
Mode 13	TX AC(VHT20) Mode Channel 52/60/64 (UNII-2A)
Mode 14	TX AC(VHT40) Mode Channel 54/62 (UNII-2A)
Mode 15	TX AC(VHT80) Mode Channel 58 (UNII-2A)
Mode 21	TX A Mode Channel 100/116/140 (UNII-2C)
Mode 24	TX AC(VHT20) Mode Channel 100/116/140 (UNII-2C)
Mode 25	TX AC(VHT40) Mode Channel 102/110/134 (UNII-2C)
Mode 26	TX AC(VHT80) Mode Channel 106/122 (UNII-2C)
Mode 32	TX A Mode Channel 149/157/165 (UNII-3)
Mode 35	TX AC(VHT20) Mode Channel 149/157/165 (UNII-3)
Mode 36	TX AC(VHT40) Mode Channel 151/159 (UNII-3)
Mode 37	TX AC(VHT80) Mode Channel 155 (UNII-3)

Note:

- (1) For AC power line conducted emissions and radiated emission below 1 GHz test, the TX AC(VHT40) Mode Channel 54 (UNII-2A) is found to be the worst case and recorded.
- (2) For radiated emission above 1 GHz test, the spurious points of 1GHz~26.5GHz and 26.5GHz~40GHz have been pre-tested and in this report only recorded the worst case. The remaining spurious points are all below the limit value of 20dB.
- (3) All the bit rate of transmitter have been tested and found the lowest rate is found to be the worst case and recorded.
- (4) The measurements for Output Power are tested, the worst case are IEEE 802.11a mode, IEEE 802.11ac(VHT20) mode, IEEE 802.11ac(VHT40) mode and IEEE 802.11ac(VHT80) mode , only the worst cases are documented for other test items.

2.3 PARAMETERS OF TEST SOFTWARE

UNII-1			
Test Software Version	DutApiMimoBtFmBrdigeEth		
Frequency (MHz)	5180	5200	5240
IEEE 802.11a	17	17	17
IEEE 802.11n(HT20)	14	17	17
IEEE 802.11ac(VHT20)	14	17	17
Frequency (MHz)	5190	5230	
IEEE 802.11n(HT40)	9	18	
IEEE 802.11ac(VHT40)	9	18	
Frequency (MHz)	5210		
IEEE 802.11ac(VHT80)	5		

UNII-2A			
Test Software Version	DutApiMimoBtFmBrdigeEth		
Frequency (MHz)	5260	5300	5320
IEEE 802.11a	17	17	17
IEEE 802.11n(HT20)	17	17	16
IEEE 802.11ac(VHT20)	17	17	16
Frequency (MHz)	5270	5310	
IEEE 802.11n(HT40)	18	13	
IEEE 802.11ac(VHT40)	18	13	
Frequency (MHz)	5290		
IEEE 802.11ac(VHT80)	6		

UNII-2C			
Test Software Version	DutApiMimoBtFmBrdigeEth		
Frequency (MHz)	5500	5580	5700
IEEE 802.11a	17	17	17
IEEE 802.11n(HT20)	17	17	17
IEEE 802.11ac(VHT20)	17	17	17
Frequency (MHz)	5510	5550	5670
IEEE 802.11n(HT40)	13	18	18
IEEE 802.11ac(VHT40)	13	18	18
Frequency (MHz)	5530	5610	
IEEE 802.11ac(VHT80)	6	13	

UNII-3			
Test Software Version	DutApiMimoBtFmBrdigeEth		
Frequency (MHz)	5745	5785	5825
IEEE 802.11a	17	17	17
IEEE 802.11n(HT20)	17	17	17
IEEE 802.11ac(VHT20)	17	17	17
Frequency (MHz)	5755	5795	
IEEE 802.11n(HT40)	18	18	
IEEE 802.11ac(VHT40)	18	18	
Frequency (MHz)	5775		
IEEE 802.11ac(VHT80)	13		

2.4 DUTY CYCLE

If duty cycle is $\geq 98\%$, duty factor is not required.

If duty cycle is $< 98\%$, duty factor shall be considered.

The output power = measured power + duty factor.

The power spectral density = measured power spectral density + duty factor.

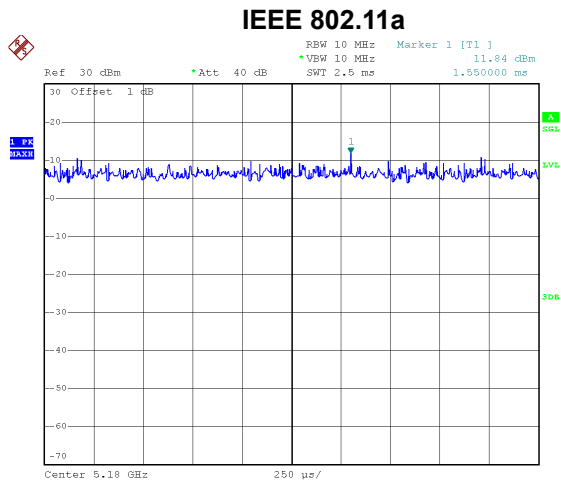

Date: 24.AUG.2021 20:24:24

Duty cycle = $2.500 \text{ ms} / 2.500 \text{ ms} = 100\%$
 Duty Factor = $10 \log(1 / \text{Duty cycle}) = 0.00$

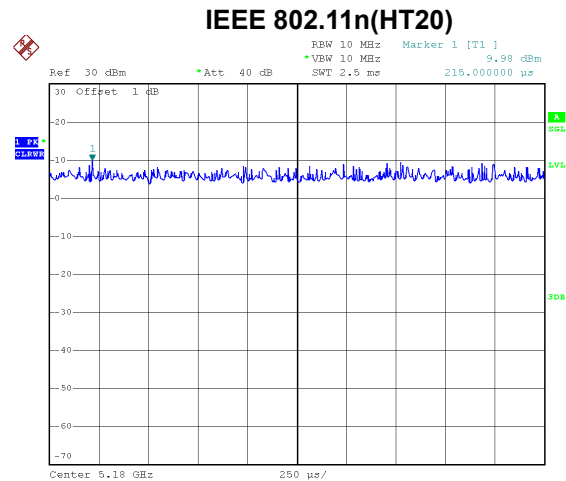

Date: 24.AUG.2021 20:25:05

Duty cycle = $2.500 \text{ ms} / 2.500 \text{ ms} = 100\%$
 Duty Factor = $10 \log(1 / \text{Duty cycle}) = 0.00$

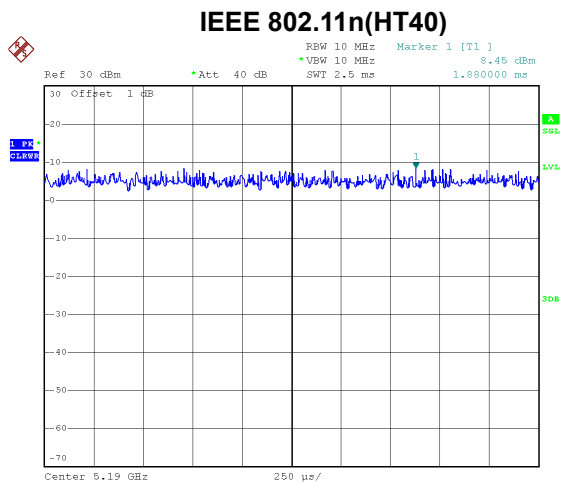

Date: 24.AUG.2021 20:26:48

Duty cycle = $2.500 \text{ ms} / 2.500 \text{ ms} = 100\%$
 Duty Factor = $10 \log(1 / \text{Duty cycle}) = 0.00$

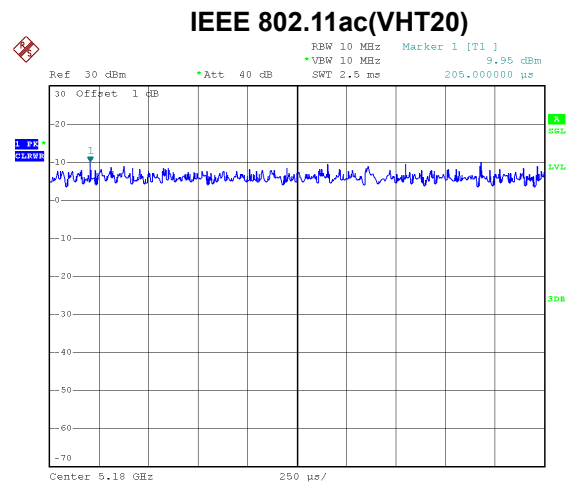

Date: 24.AUG.2021 20:25:47

Duty cycle = $2.500 \text{ ms} / 2.500 \text{ ms} = 100\%$
 Duty Factor = $10 \log(1 / \text{Duty cycle}) = 0.00$

IEEE 802.11ac(VHT40)

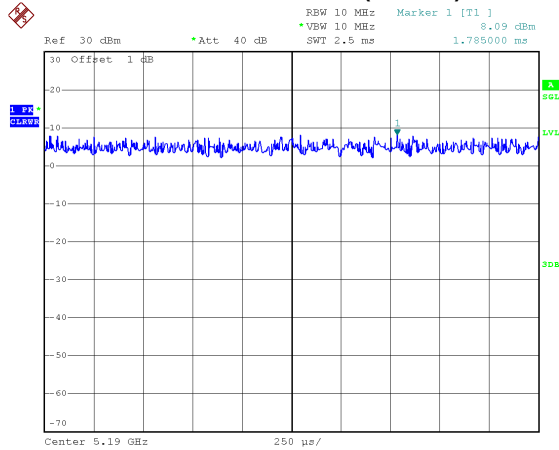

Date: 24.AUG.2021 20:27:44

Duty cycle = 2.500 ms / 2.500 ms = 100%
 Duty Factor = 10 log(1 / Duty cycle) = 0.00

IEEE 802.11ac(VHT80)

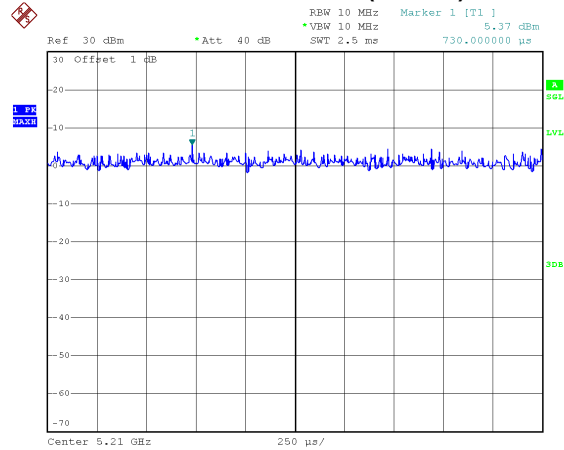

Date: 24.AUG.2021 20:38:01

Duty cycle = 2.500 ms / 2.500 ms = 100%
 Duty Factor = 10 log(1 / Duty cycle) = 0.00

NOTE:

For IEEE 802.11a:

For radiated emissions frequency above 1 GHz, the resolution bandwidth of test receiver/spectrum analyzer is 1 MHz and the video bandwidth is 1 kHz (Duty cycle ≥ 98%).

For IEEE 802.11n(HT20):

For radiated emissions frequency above 1 GHz, the resolution bandwidth of test receiver/spectrum analyzer is 1 MHz and the video bandwidth is 1 kHz (Duty cycle ≥ 98%).

For IEEE 802.11n(HT40):

For radiated emissions frequency above 1 GHz, the resolution bandwidth of test receiver/spectrum analyzer is 1 MHz and the video bandwidth is 2 kHz (Duty cycle ≥ 98%).

For IEEE 802.11ac(VHT20):

For radiated emissions frequency above 1 GHz, the resolution bandwidth of test receiver/spectrum analyzer is 1 MHz and the video bandwidth is 1 kHz (Duty cycle ≥ 98%).

For IEEE 802.11ac(VHT40):

For radiated emissions frequency above 1 GHz, the resolution bandwidth of test receiver/spectrum analyzer is 1 MHz and the video bandwidth is 2 kHz (Duty cycle ≥ 98%).

For IEEE 802.11ac(VHT80):

For radiated emissions frequency above 1 GHz, the resolution bandwidth of test receiver/spectrum analyzer is 1 MHz and the video bandwidth is 3 kHz (Duty cycle ≥ 98%).

2.5 BLOCK DIAGRAM SHOWING THE CONFIGURATION OF SYSTEM TESTED

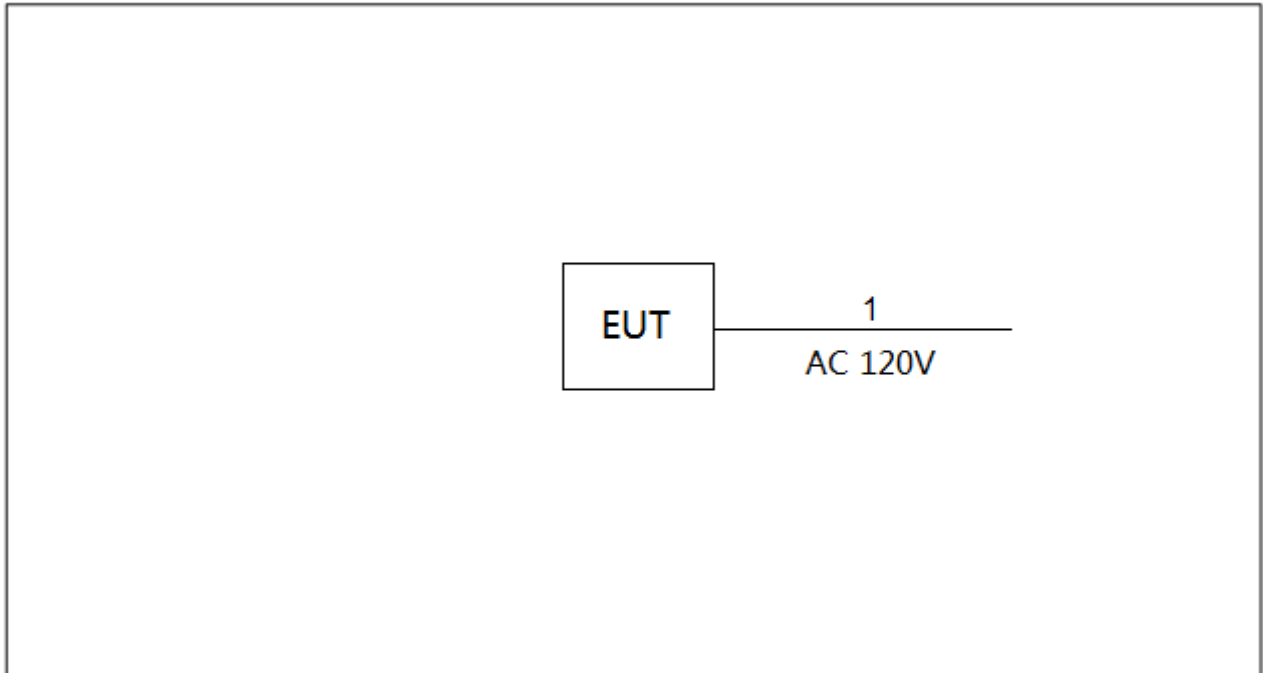

2.6 SUPPORT UNITS

Item	Equipment	Brand	Model No.	Series No.
-	-	-	-	-

Item	Cable Type	Shielded Type	Ferrite Core	Length
1	AC Cable	NO	NO	1.2m

3. AC POWER LINE CONDUCTED EMISSIONS

3.1 LIMIT

Frequency (MHz)	Limit (dB μ V)	
	Quasi-peak	Average
0.15 - 0.5	66 to 56*	56 to 46*
0.5 - 5.0	56	46
5.0 - 30.0	60	50

NOTE:

- (1) The tighter limit applies at the band edges.
- (2) The limit of " * " marked band means the limitation decreases linearly with the logarithm of the frequency in the range.

3.2 TEST PROCEDURE

- a. The EUT was placed 0.8 meters from the horizontal ground plane with EUT being connected to the power mains through a line impedance stabilization network (LISN). All other support equipment powered from additional LISN(s). The LISN provide 50 Ohm/ 50uH of coupling impedance for the measuring instrument.
- b. Interconnecting cables that hang closer than 40 cm to the ground plane shall be folded back and forth in the center forming a bundle 30 to 40 cm long.
- c. I/O cables that are not connected to a peripheral shall be bundled in the center. The end of the cable may be terminated, if required, using the correct terminating impedance. The overall length shall not exceed 1 m.
- d. LISN at least 80 cm from nearest part of EUT chassis.
- e. For the actual test configuration, please refer to the related Item -EUT Test Photos.

The following table is the setting of the receiver:

Receiver Parameter	Setting
Start Frequency	0.15 MHz
Stop Frequency	30 MHz
IF Bandwidth	9 kHz

3.3 DEVIATION FROM TEST STANDARD

No deviation

3.4 TEST SETUP

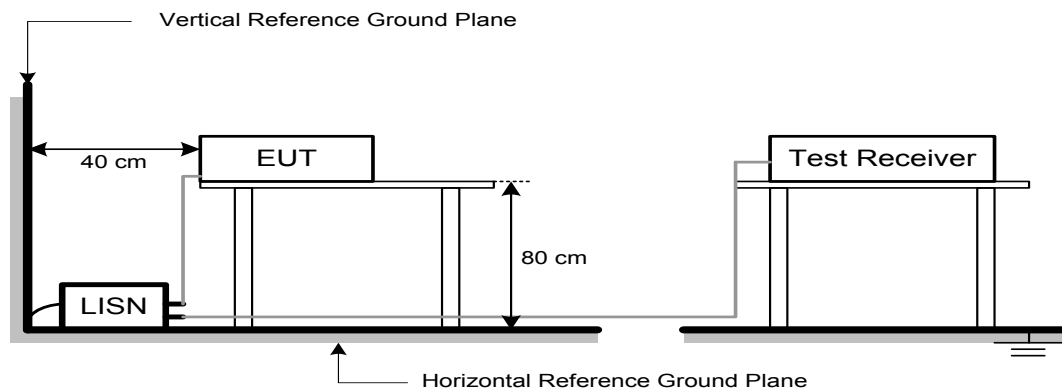

3.5 EUT OPERATION CONDITIONS

The EUT was configured for testing in a typical fashion (as a customer would normally use it). The EUT has been programmed to continuously transmit during test. This operating condition was tested and used to collect the included data.

The EUT was programmed to be in continuously transmitting/TX mode.

3.6 TEST RESULTS

Please refer to the APPENDIX A.

4. RADIATED EMISSIONS

4.1 LIMIT

In case the emission fall within the restricted band specified on 15.205(a), then the 15.209(a) limit in the table below has to be followed.

LIMITS OF RADIATED EMISSIONS MEASUREMENT (9 kHz to 1000 MHz)

Frequency (MHz)	Field Strength (microvolts/meter)	Measurement Distance (meters)
0.009-0.490	2400/F(kHz)	300
0.490-1.705	24000/F(kHz)	30
1.705-30.0	30	30
30-88	100	3
88-216	150	3
216-960	200	3
Above 960	500	3

LIMITS OF UNWANTED EMISSION OUT OF THE RESTRICTED BANDS (Above 1000 MHz)

Frequency (MHz)	EIRP Limit (dBm/MHz)	Equivalent Field Strength at 3m (dBμV/m)
5150-5250	-27	68.2
5250-5350	-27	68.2
5470-5725	-27	68.2
5725-5850 NOTE (2)	-27	68.2
	10	105.2
	15.6	110.8
	27	122.2

NOTE:

(1) The following formula is used to convert the equipment isotropic radiated power (eirp) to field strength:

$$E = \frac{1000000\sqrt{30P}}{3} \mu\text{V/m, where P is the eirp (Watts)}$$

(2) According to 15.407(b)(4)(i), all emissions shall be limited to a level of -27 dBm/MHz at 75 MHz or more above or below the band edge increasing linearly to 10 dBm/MHz at 25 MHz above or below the band edge, and from 25 MHz above or below the band edge increasing linearly to a level of 15.6 dBm/MHz at 5 MHz above or below the band edge, and from 5 MHz above or below the band edge increasing linearly to a level of 27 dBm/MHz at the band edge.

4.2 TEST PROCEDURE

- a. The measuring distance of 3 m shall be used for measurements. The EUT was placed on the top of a rotating table 0.8 meter above the ground at a 3 meter semi-anechoic chamber. The table was rotated 360 degrees to determine the position of the highest radiation.(below 1GHz)
- b. The measuring distance of 3 m shall be used for measurements. The EUT was placed on the top of a rotating table 1.5 meter above the ground at a 3 meter semi-anechoic chamber. The table was rotated 360 degrees to determine the position of the highest radiation.(above 1GHz)
- c. The height of the equipment or of the substitution antenna shall be 0.8m or 1.5m; the height of the test antenna shall vary between 1 m to 4 m. Both horizontal and vertical polarizations of the antenna are set to make the measurement.
- d. For each suspected emission, the EUT was arranged to its worst case and then the antenna was tuned to heights find the maximum reading (used Bore sight function).
- e. The receiver system was set to peak and average detect function and specified bandwidth with maximum hold mode when the test frequency is above 1 GHz.
- f. The initial step in collecting radiated emission data is a receiver peak detector mode pre-scanning the measurement frequency range. Significant peaks are then marked and then Quasi Peak detector mode re-measured.
- g. All readings are Peak unless otherwise stated QP in column of Note. Peak denotes that the Peak reading compliance with the QP Limits and then QP Mode measurement didn't perform. (below 1 GHz)
- h. All readings are Peak Mode value unless otherwise stated AVG in column of Note. If the Peak Mode Measured value compliance with the Peak Limits and lower than AVG Limits, the EUT shall be deemed to meet both Peak & AVG Limits and then only Peak Mode was measured, but AVG Mode didn't perform. (above 1 GHz)
- i. For the actual test configuration, please refer to the related Item –EUT Test Photos.

The following table is the setting of the receiver:

Spectrum Parameters	Setting
Start ~ Stop Frequency	9 kHz~150 kHz for RBW 200 Hz
Start ~ Stop Frequency	0.15 MHz~30 MHz for RBW 9 kHz
Start ~ Stop Frequency	30 MHz~1000 MHz for RBW 100 kHz

Spectrum Parameters	Setting
Start Frequency	1000 MHz
Stop Frequency	10th carrier harmonic or 40 GHz, whichever is lower
RBW / VBW (Emission in restricted band)	1 MHz / 3 MHz for PK value 1 MHz / 1/T Hz for AVG value

Receiver Parameters	Setting
Start ~ Stop Frequency	9 kHz~90 kHz for PK/AVG detector
Start ~ Stop Frequency	90 kHz~110 kHz for QP detector
Start ~ Stop Frequency	110 kHz~490 kHz for PK/AVG detector
Start ~ Stop Frequency	490 kHz~30 MHz for QP detector
Start ~ Stop Frequency	30 MHz~1000 MHz for QP detector
Start ~ Stop Frequency	1 GHz~40 GHz for PK/AVG detector

4.3 DEVIATION FROM TEST STANDARD

No deviation.

4.4 TEST SETUP

9 kHz to 30 MHz

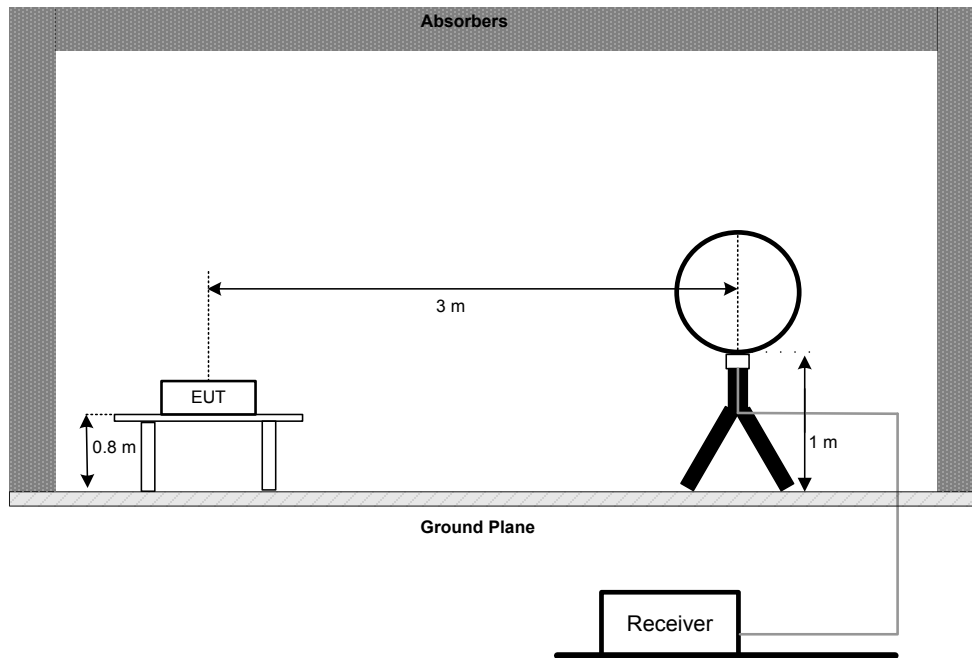

30 MHz to 1 GHz

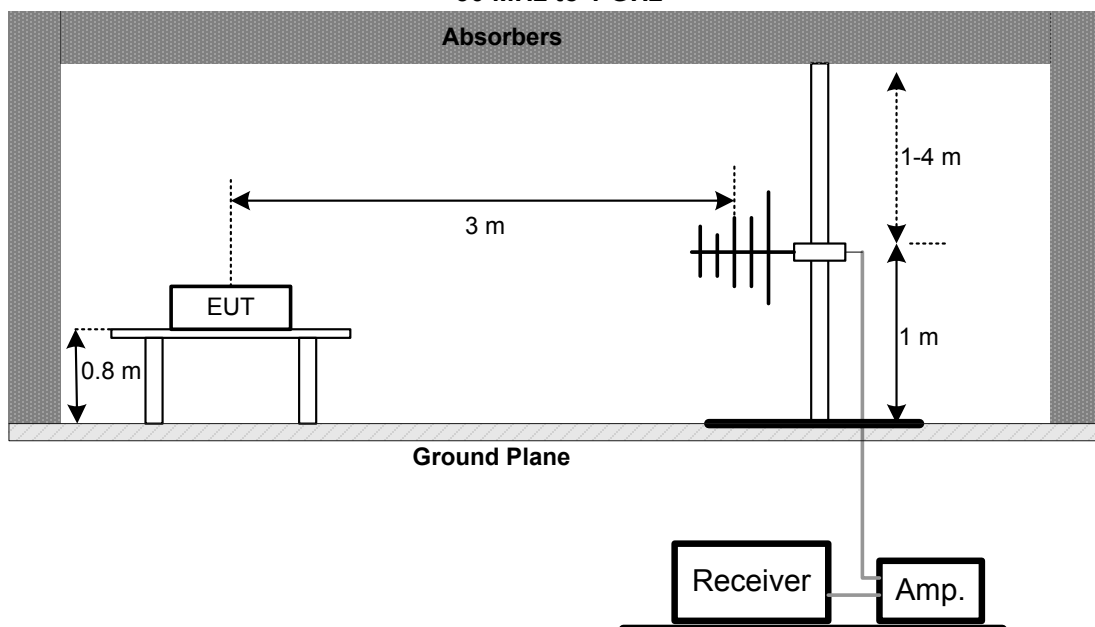

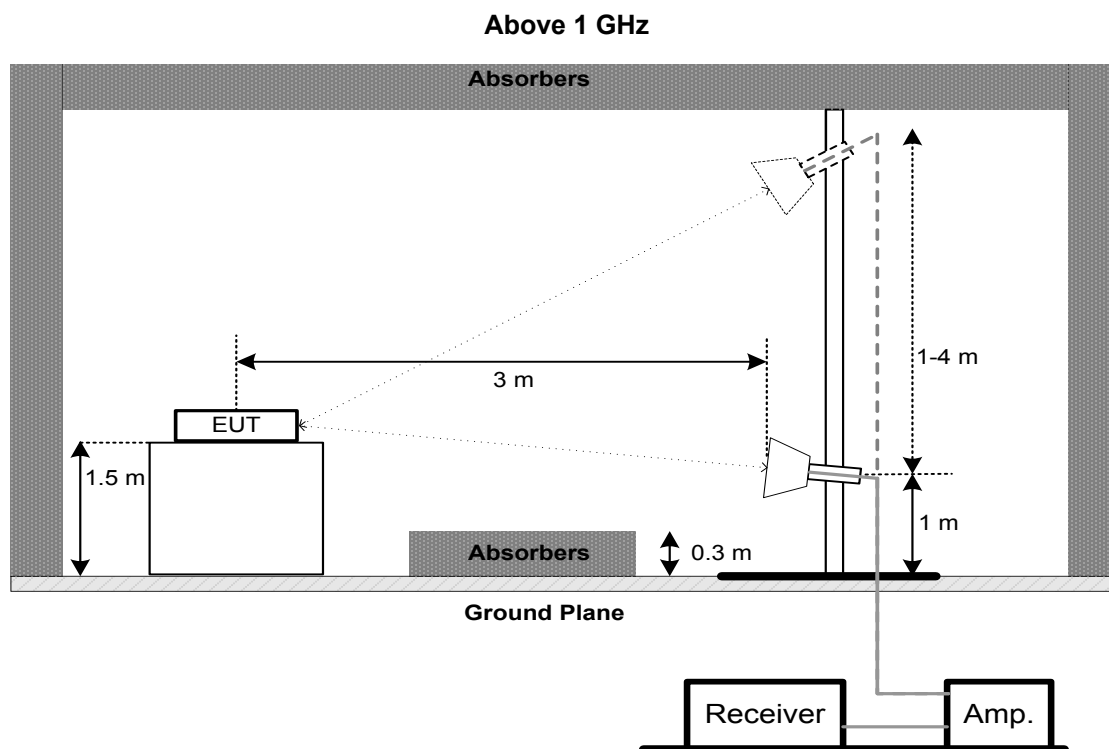

4.5 EUT OPERATION CONDITIONS

The EUT tested system was configured as the statements of 3.5 unless otherwise a special operating condition is specified in the follows during the testing.

4.6 TEST RESULTS - 9 KHZ TO 30 MHZ

Please refer to the APPENDIX B.

Remark:

- (1) Distance extrapolation factor = $40 \log (\text{specific distance} / \text{test distance})$ (dB).
- (2) Limit line = specific limits (dBuV) + distance extrapolation factor.

4.7 TEST RESULTS - 30 MHZ TO 1000 MHZ

Please refer to the APPENDIX C.

4.8 TEST RESULTS - ABOVE 1000 MHZ

Please refer to the APPENDIX D.

Remark:

- (1) No limit: This is fundamental signal, the judgment is not applicable.
For fundamental signal judgment was referred to Peak output test.

5. BANDWIDTH

5.1 LIMIT

Section	Test Item	Limit	Frequency Range (MHz)
FCC 15.407(a) FCC 15.407(e)	26 dB Bandwidth	-	5150-5250
	26 dB Bandwidth	-	5250-5350
	26 dB Bandwidth	-	5470-5725
	6 dB Bandwidth	Minimum 500 kHz	5725-5850

5.2 TEST PROCEDURE

- a. The EUT was directly connected to the spectrum analyzer and antenna output port as show in the block diagram below
- b. Spectrum Setting:
For UNII-1, UNII-2A, UNII-2C:

Spectrum Parameter	Setting
Span Frequency	> 26 dB Bandwidth
RBW	Appromiximately 1% of the emission bandwidth
VBW	> RBW
Detector	Peak
Trace	Max Hold
Sweep Time	Auto

For UNII-3:

Spectrum Parameter	Setting
Span Frequency	> 6 dB Bandwidth
RBW	100 kHz
VBW	300 kHz
Detector	Peak
Trace	Max Hold
Sweep Time	Auto

- c. Measured the spectrum width with power higher than 26 dB / 6 dB below carrier.

5.3 DEVIATION FROM STANDARD

No deviation.

5.4 TEST SETUP



5.5 EUT OPERATION CONDITIONS

The EUT was programmed to be in continuously transmitting mode.

5.6 TEST RESULTS

Please refer to the APPENDIX E.

6. MAXIMUM OUTPUT POWER

6.1 LIMIT

Section	Test Item	Limit	Frequency Range (MHz)
FCC 15.407(a)	Maximum Output Power	AP device: 1 Watt (30 dBm) Client device: 250 mW (23.98 dBm)	5150-5250
		250 mW (23.98 dBm)	5250-5350
		250 mW (23.98 dBm)	5470-5725
		1 Watt (30dBm)	5725-5850

Note:

- a. For client devices in the 5.15-5.25 GHz band, the maximum conducted output power over the frequency band of operation shall not exceed 250 mW provided the maximum antenna gain does not exceed 6 dBi. In addition, the maximum power spectral density shall not exceed 11 dBm in any 1 megahertz band. If transmitting antennas of directional gain greater than 6 dBi are used, both the maximum conducted output power and the maximum power spectral density shall be reduced by the amount in dB that the directional gain of the antenna exceeds 6 dBi.
- b. For the 5.25-5.35 GHz and 5.47-5.725 GHz bands, the maximum conducted output power over the frequency bands of operation shall not exceed the lesser of 250 mW or 11 dBm + 10log B, where B is the 26dB Bandwidth in megahertz.

6.2 TEST PROCEDURE

- a. The EUT was directly connected to the power meter and antenna output port as show in the block diagram below.
- b. Test test was performed in accordance with method of FCC KDB 789033 D02 General UNII Test Procedures New Rules v02r01.

6.3 DEVIATION FROM STANDARD

No deviation.

6.4 TEST SETUP

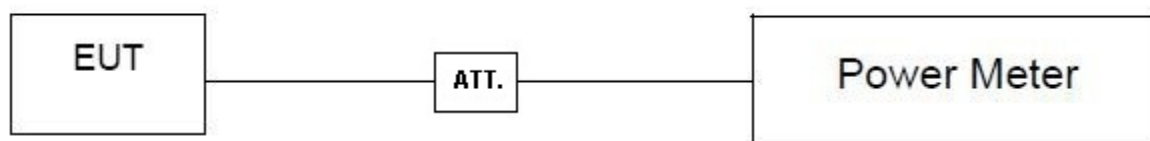

6.5 EUT OPERATION CONDITIONS

The EUT was programmed to be in continuously transmitting mode.

6.6 TEST RESULTS

Please refer to the APPENDIX F.

7. POWER SPECTRAL DENSITY

7.1 LIMIT

Section	Test Item	Limit	Frequency Range (MHz)
FCC 15.407(a)	Power Spectral Density	AP device: 17 dBm/MHz Client device: 11 dBm/MHz	5150-5250
		11 dBm/MHz	5250-5350
		11 dBm/MHz	5470-5725
		30 dBm/500 kHz	5725-5850

7.2 TEST PROCEDURE

- a. The EUT was directly connected to the spectrum analyzer and antenna output port as show in the block diagram below.
- b. Spectrum Setting:

For UNII-1, UNII-2A, UNII-2C:

Spectrum Parameter	Setting
Span Frequency	Encompass the entire emissions bandwidth (EBW) of the signal
RBW	1 MHz.
VBW	3 MHz.
Detector	RMS
Trace average	100 trace
Sweep Time	Auto

For UNII-3:

Spectrum Parameter	Setting
Span Frequency	Encompass the entire emissions bandwidth (EBW) of the signal
RBW	100 kHz.
VBW	300 kHz.
Detector	RMS
Trace average	100 trace
Sweep Time	Auto

Note:

- For UNII-3, according to KDB publication 789033 D02 General UNII Test Procedures New Rules v02r01, section II.F.5., it is acceptable to set RBW at 100kHz and VBW at 300kHz if the spectrum analyzer does not have 500 kHz RBW. Then, add $10 \log (500 \text{ kHz}/100 \text{ kHz})$ to the measured result, i.e. 7 dB.
- During the test of U-NII 3 PSD, the measurement result with RBW=100kHz has been added 7 dB by compensating offset. For example, the cable loss is 3 dB, and the final offset is $3 + 7 = 10 \text{ dB}$ when RBW=100kHz is used.

7.3 DEVIATION FROM STANDARD

No deviation.

7.4 TEST SETUP

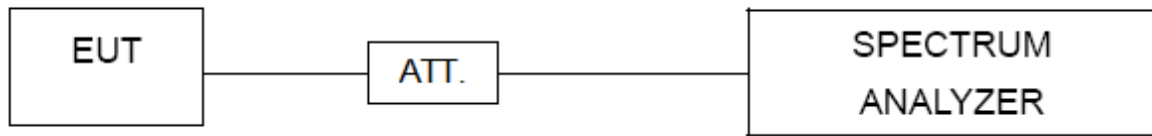

7.5 EUT OPERATION CONDITIONS

The EUT was programmed to be in continuously transmitting mode.

7.6 TEST RESULTS

Please refer to the APPENDIX G.

8. FREQUENCY STABILITY

8.1 LIMIT

Section	Test Item	Limit	Frequency Range (MHz)
FCC 15.407(g)	Frequency Stability	An emission is maintained within the band of operation under all conditions of normal operation as specified in the users manual.	5150-5250
			5250-5350
			5470-5725
			5725-5850

8.2 TEST PROCEDURE

- The EUT was directly connected to the spectrum analyzer and antenna output port as show in the block diagram below.
- Spectrum Setting:

Spectrum Parameter	Setting
Span Frequency	Entire absence of modulation emissions bandwidth
RBW	10 kHz
VBW	10 kHz
Detector	Peak
Trace	Max Hold
Sweep Time	Auto

- The test extreme voltage is to change the primary supply voltage from 85 to 115 percent of the nominal value.
- User manual temperature is 0°C~40°C.

8.3 DEVIATION FROM STANDARD

No deviation.

8.4 TEST SETUP

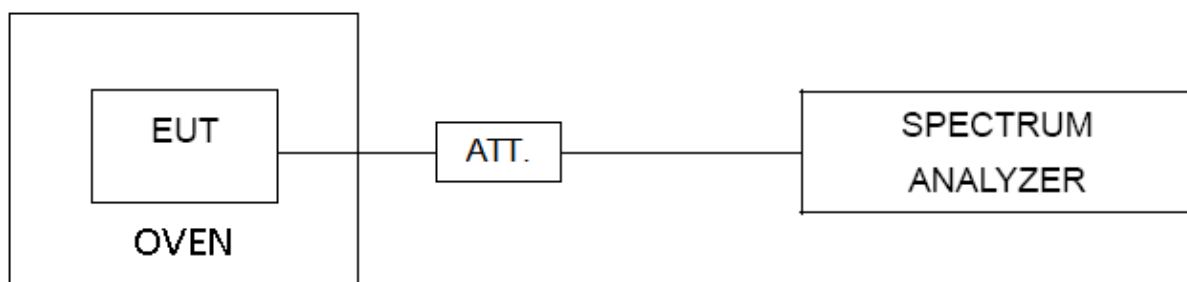

8.5 EUT OPERATION CONDITIONS

The EUT was programmed to be in continuously transmitting mode.

8.6 TEST RESULTS

Please refer to the APPENDIX H.

9. MEASUREMENT INSTRUMENTS LIST

AC Power Line Conducted Emissions					
Item	Kind of Equipment	Manufacturer	Type No.	Serial No.	Calibrated until
1	EMI Test Receiver	R&S	ESCI	100382	Feb. 28, 2022
2	LISN	EMCO	3816/2	52765	Feb. 27, 2022
3	TWO-LINE V-NETWORK	R&S	ENV216	101447	Feb. 27, 2022
4	50Ω Terminator	SHX	TF5-3	15041305	Feb. 27, 2022
5	Measurement Software	Farad	EZ-EMC Ver.NB-03A1-01	N/A	N/A
6	Cable	N/A	RG223	12m	Mar. 09, 2022
7	643 Shield Room	ETS	6*4*3m	N/A	N/A

Radiated Emissions - 9 kHz to 30 MHz					
Item	Kind of Equipment	Manufacturer	Type No.	Serial No.	Calibrated until
1	Loop Antenna	EM	EM-6876-1	230	Apr. 28, 2022
2	Cable	N/A	RG 213/U	N/A	May 27, 2022
3	EMI Test Receiver	R&S	ESCI	100895	Feb. 27, 2022
4	Measurement Software	Farad	EZ-EMC Ver.NB-03A1-01	N/A	N/A
5	966 Chambe Room	RM	9*6*6m	N/A	Jul. 24, 2022

Radiated Emissions - 30 MHz to 1 GHz					
Item	Kind of Equipment	Manufacturer	Type No.	Serial No.	Calibrated until
1	Antenna	Schwarzbeck	VULB9160	9160-3232	Mar. 15, 2022
2	Amplifier	HP	8447D	2944A08742	Feb. 28, 2022
3	Receiver	Agilent	N9038A	MY52130039	Mar. 19, 2022
4	Cable	emci	LMR-400(30MHz-1 GHz)(8m+5m)	N/A	May 20, 2022
5	Controller	CT	SC100	N/A	N/A
6	Controller	MF	MF-7802	MF780208416	N/A
7	Measurement Software	Farad	EZ-EMC Ver.NB-03A1-01	N/A	N/A
8	966 Chambe Room	RM	9*6*6m	N/A	Jul. 24, 2022

Radiated Emissions - Above 1 GHz					
Item	Kind of Equipment	Manufacturer	Type No.	Serial No.	Calibrated until
1	Double Ridged Guide Antenna	ETS	3115	75789	May 10, 2022
2	Broad-Band Horn Antenna	Schwarzbeck	BBHA 9170	9170319	Jun. 30, 2022
3	Amplifier	Agilent	8449B	3008A02584	Jul. 10, 2022
4	Microwave Preamplifier With Adaptor	EMC INSTRUMENT	EMC2654045	980039 & HA01	Feb. 28, 2022
5	Receiver	Agilent	N9038A	MY52130039	Mar. 19, 2022
6	Controller	CT	SC100	N/A	N/A
7	Controller	MF	MF-7802	MF780208416	N/A
8	Cable	N/A	EMC104-SM-SM-6000	N/A	Oct. 16, 2021
9	Measurement Software	Farad	EZ-EMC Ver.NB-03A1-01	N/A	N/A
10	Band Reject Filter	Micro-Tronics	BRC50705-01	10	Feb. 27, 2022
11	Band Reject Filter	Micro-Tronics	BRC50704-01	8	Feb. 27, 2022
12	Band Reject Filter	Micro-Tronics	BRC50703-01	7	Feb. 27, 2022
13	966 Chambe Room	RM	9*6*6m	N/A	Jul. 24, 2022

Bandwidth & Power Spectral Density					
Item	Kind of Equipment	Manufacturer	Type No.	Serial No.	Calibrated until
1	Spectrum Analyzer	R&S	FSP40	100185	Jul. 10, 2022
2	Attenuator	WOKEN	6SM3502	VAS1214NL	Feb. 07, 2022
3	RF Cable	Tongkaichuan	N/A	N/A	N/A
4	DC Block	Mini	N/A	N/A	N/A

Maximum Output Power					
Item	Kind of Equipment	Manufacturer	Type No.	Serial No.	Calibrated until
1	Peak Power Analyzer	Keysight	8990B	MY51000506	Jul. 10, 2022
2	Wideband power sensor	Keysight	N1923A	MY58310004	Jul. 10, 2022
3	Attenuator	WOKEN	6SM3502	VAS1214NL	Feb. 07, 2022
4	RF Cable	Tongkaichuan	N/A	N/A	N/A

Frequency Stability					
Item	Kind of Equipment	Manufacturer	Type No.	Serial No.	Calibrated until
1	Spectrum Analyzer	R&S	FSP40	100185	Jul. 10, 2022
2	Precision Oven Tester	CEPREI	CEEC-M64T-40	15-008	Feb. 27, 2022
3	Attenuator	WOKEN	6SM3502	VAS1214NL	Feb. 07, 2022
4	RF Cable	Tongkaichuan	N/A	N/A	N/A
5	DC Block	Mini	N/A	N/A	N/A

Remark: "N/A" denotes no model name, serial no. or calibration specified.

All calibration period of equipment list is one year.

APPENDIX A - AC POWER LINE CONDUCTED EMISSIONS

Test Mode	TX AC(VHT40) Mode Channel 54 (UNII-2A)	Phase	Line
-----------	--	-------	------

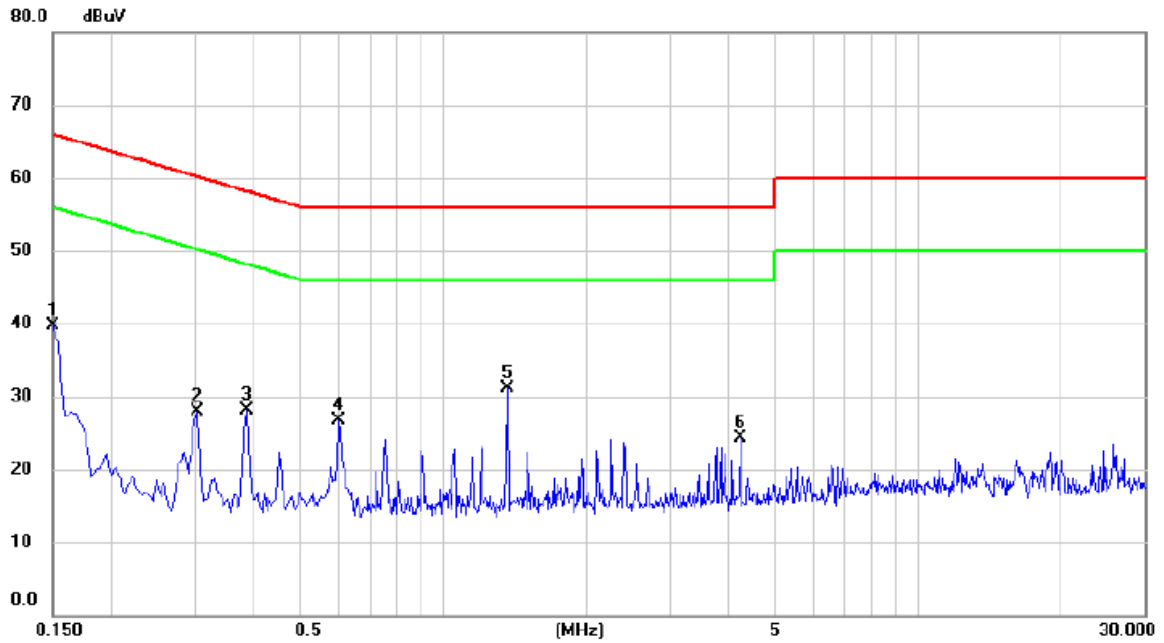

No.	Mk.	Freq. MHz	Reading Level dBuV	Correct Factor dB	Measure- ment dBuV	Limit dBuV	Margin dB	Detector	Comment
1		0.1500	30.06	9.67	39.73	66.00	-26.27	peak	
2		0.3030	17.97	9.88	27.85	60.16	-32.31	peak	
3		0.3840	18.20	9.90	28.10	58.19	-30.09	peak	
4		0.6000	16.69	9.94	26.63	56.00	-29.37	peak	
5	*	1.3650	21.13	10.00	31.13	56.00	-24.87	peak	
6		4.2225	14.13	10.22	24.35	56.00	-31.65	peak	

REMARKS:

- (1) Measurement Value = Reading Level + Correct Factor.
- (2) Margin Level = Measurement Value - Limit Value.

Test Mode	TX AC(VHT40) Mode Channel 54 (UNII-2A)	Phase	Neutral
-----------	--	-------	---------

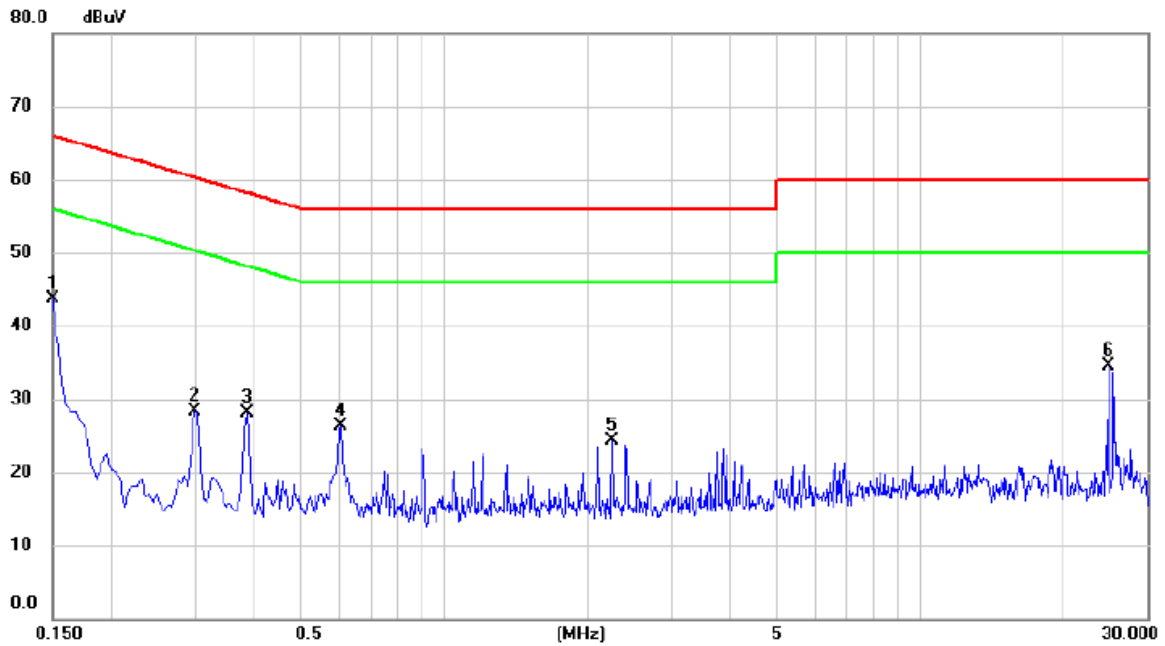

No.	Mk.	Freq. MHz	Reading Level dBuV	Correct Factor dB	Measure- ment dBuV	Limit dBuV	Margin dB	Detector	Comment
1	*	0.1500	34.02	9.74	43.76	66.00	-22.24	peak	
2		0.2985	18.29	10.01	28.30	60.28	-31.98	peak	
3		0.3840	18.07	10.06	28.13	58.19	-30.06	peak	
4		0.6045	16.14	10.17	26.31	56.00	-29.69	peak	
5		2.2560	13.85	10.41	24.26	56.00	-31.74	peak	
6		24.8640	23.16	11.36	34.52	60.00	-25.48	peak	

REMARKS:

- (1) Measurement Value = Reading Level + Correct Factor.
- (2) Margin Level = Measurement Value - Limit Value.

APPENDIX B - RADIATED EMISSION - 9 KHZ TO 30 MHZ

Test Mode	TX AC(VHT40) Mode Channel 54 (UNII-2A)	Polarization	Ant 0°
-----------	--	--------------	--------

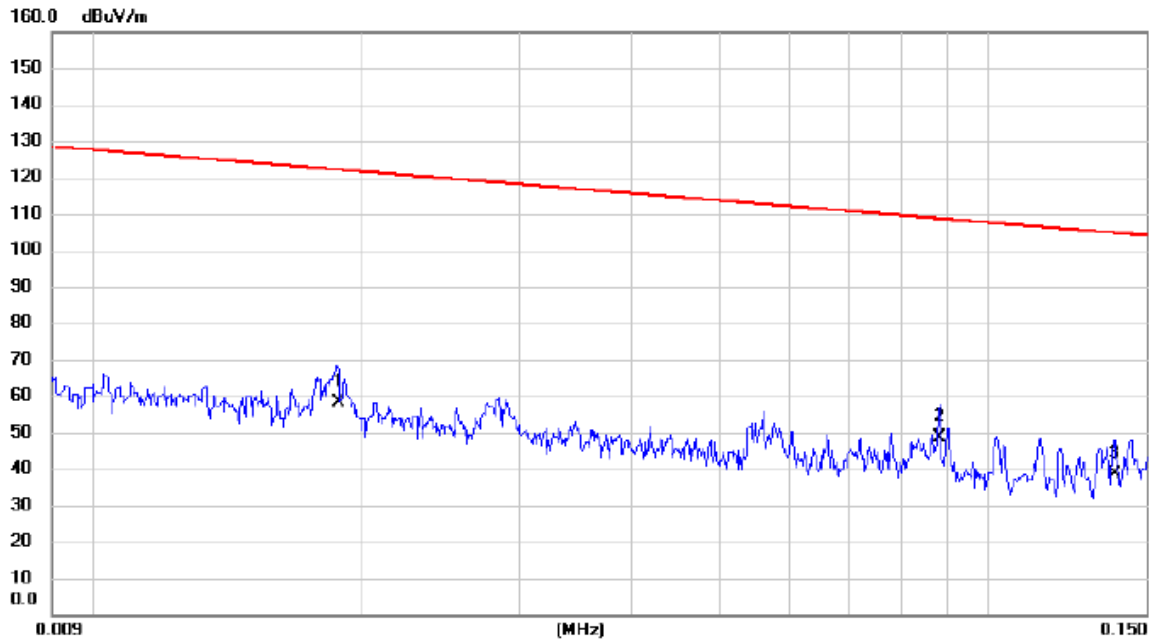

No.	Mk.	Freq.	Reading Level	Correct Factor	Measurement	Limit	Margin	Antenna Height	Table Degree	
		MHz	dBuV	dB	dBuV/m	dBuV/m	dB	cm	degree	Comment
1		0.0188	44.76	13.59	58.35	122.12	-63.77	AVG		
2	*	0.0881	35.96	12.65	48.61	108.71	-60.10	AVG		
3		0.1382	25.83	12.74	38.57	104.80	-66.23	AVG		

REMARKS:

- (1) Measurement Value = Reading Level + Correct Factor.
- (2) Margin Level = Measurement Value - Limit Value.

Test Mode	TX AC(VHT40) Mode Channel 54 (UNII-2A)	Polarization	Ant 0°
-----------	--	--------------	--------

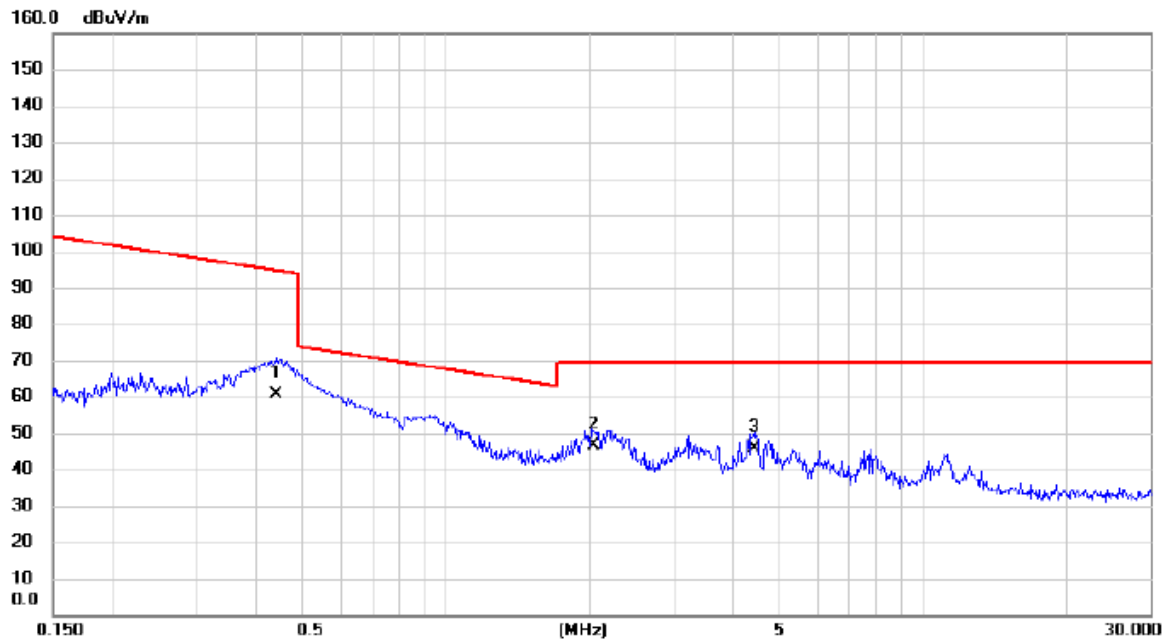

No.	Mk.	Freq. MHz	Reading Level dBuV	Correct Factor dB	Measure- ment dBuV/m	Limit dBuV/m	Margin dB	Detector	Antenna Height cm	Table Degree	Comment
1		0.4397	48.52	12.16	60.68	94.74	-34.06	AVG			
2	*	2.0333	35.41	11.29	46.70	69.54	-22.84	QP			
3		4.4305	34.98	11.01	45.99	69.54	-23.55	QP			

REMARKS:

- (1) Measurement Value = Reading Level + Correct Factor.
- (2) Margin Level = Measurement Value - Limit Value.

Test Mode	TX AC(VHT40) Mode Channel 54 (UNII-2A)	Polarization	Ant 90°
-----------	--	--------------	---------

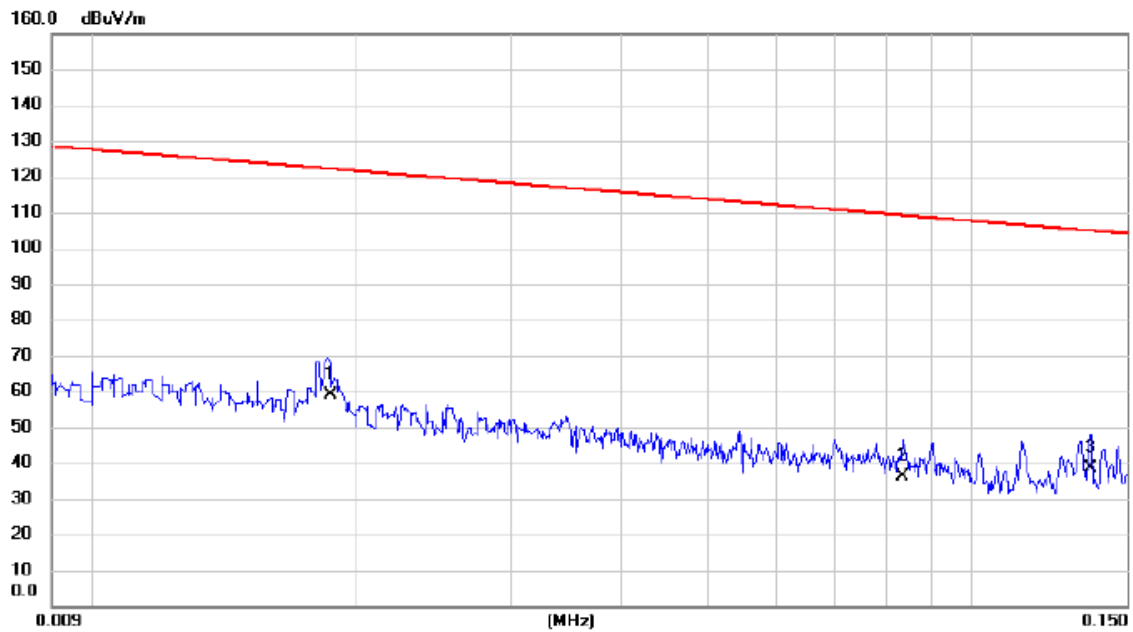

No.	Mk.	Freq.	Reading Level	Correct Factor	Measurement	Limit	Margin	Antenna Height	Table Degree	
		MHz	dBuV	dB	dBuV/m	dBuV/m	dB	cm	degree	Comment
1	*	0.0187	45.29	13.62	58.91	122.17	-63.26	AVG		
2		0.0834	23.56	12.62	36.18	109.18	-73.00	AVG		
3		0.1363	25.74	12.73	38.47	104.92	-66.45	AVG		

REMARKS:

- (1) Measurement Value = Reading Level + Correct Factor.
- (2) Margin Level = Measurement Value - Limit Value.

Test Mode	TX AC(VHT40) Mode Channel 54 (UNII-2A)	Polarization	Ant 90°
-----------	--	--------------	---------

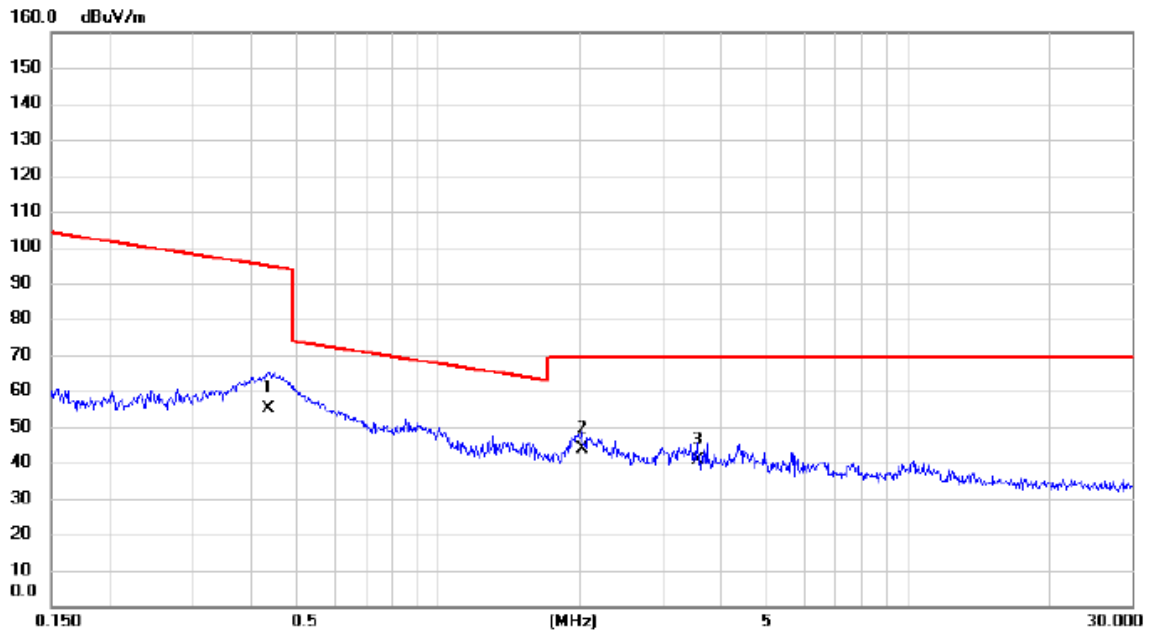

No.	Mk.	Freq.	Reading Level	Correct Factor	Measurement	Limit	Margin	Antenna Height	Table Degree	
		MHz	dBuV	dB	dBuV/m	dBuV/m	dB	cm	degree	Comment
1		0.4351	42.78	12.17	54.95	94.83	-39.88	AVG		
2	*	2.0225	32.59	11.29	43.88	69.54	-25.66	QP		
3		3.5654	29.86	10.88	40.74	69.54	-28.80	QP		

REMARKS:

- (1) Measurement Value = Reading Level + Correct Factor.
- (2) Margin Level = Measurement Value - Limit Value.

APPENDIX C - RADIATED EMISSION - 30 MHZ TO 1000 MHZ

Test Mode	TX AC(VHT40) Mode Channel 54 (UNII-2A)	Polarization	Vertical
-----------	--	--------------	----------

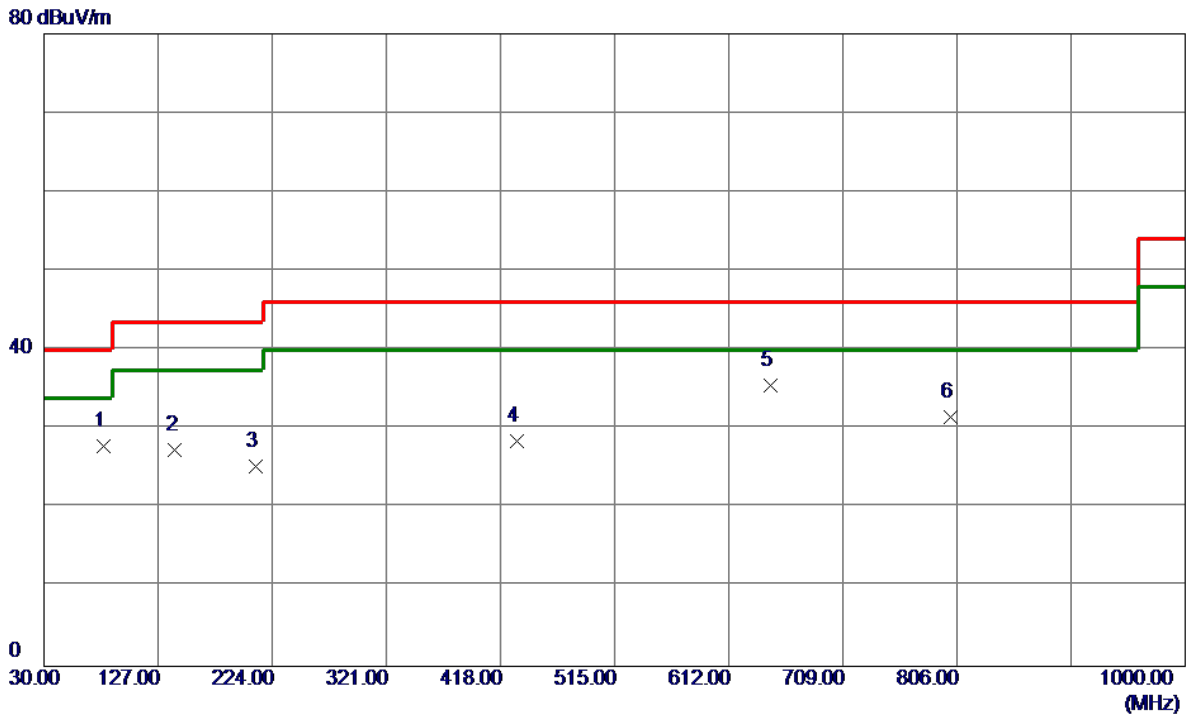

No.	Freq. MHz	Reading Level dBuV/m	Correct Factor dB	Measure ment dBuV/m	Limit dBuV/m	Margin dB	Detector	Comment
1	80.4400	46.19	-18.40	27.79	40.00	-12.21	Peak	
2	141.5500	40.24	-12.84	27.40	43.50	-16.10	Peak	
3	209.9350	40.54	-15.23	25.31	43.50	-18.19	Peak	
4	432.0650	36.31	-7.90	28.41	46.00	-17.59	Peak	
5 *	647.8900	39.22	-3.77	35.45	46.00	-10.55	Peak	
6	800.1800	32.20	-0.68	31.52	46.00	-14.48	Peak	

REMARKS:

- (1) Measurement Value = Reading Level + Correct Factor.
- (2) Margin Level = Measurement Value - Limit Value.

Test Mode	TX AC(VHT40) Mode Channel 54 (UNII-2A)	Polarization	Horizontal
-----------	--	--------------	------------

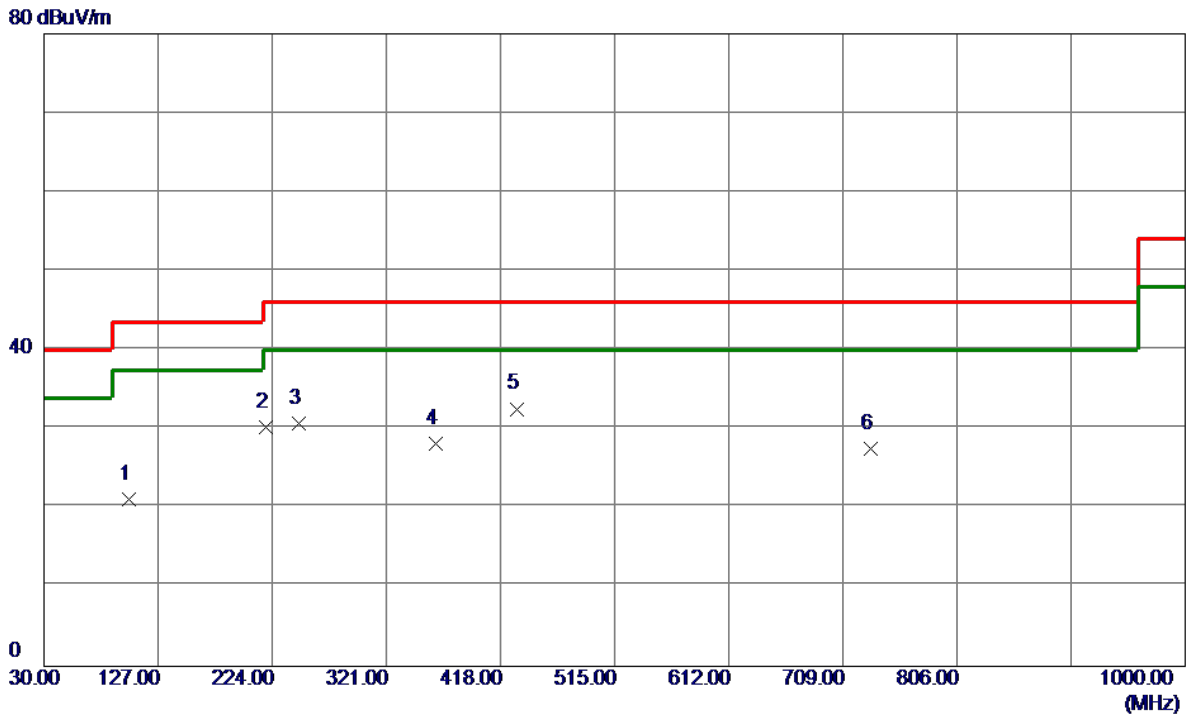

No.	Freq. MHz	Reading Level dBuV/m	Correct Factor dB	Measure ment dBuV/m	Limit dBuV/m	Margin dB	Detector	Comment
1	101.7800	37.40	-16.28	21.12	43.50	-22.38	Peak	
2	218.6650	45.15	-14.87	30.28	46.00	-15.72	Peak	
3	246.3100	43.89	-13.10	30.79	46.00	-15.21	Peak	
4	363.1950	37.76	-9.65	28.11	46.00	-17.89	Peak	
5 *	432.0650	40.46	-7.90	32.56	46.00	-13.44	Peak	
6	732.2800	29.92	-2.34	27.58	46.00	-18.42	Peak	

REMARKS:

- (1) Measurement Value = Reading Level + Correct Factor.
- (2) Margin Level = Measurement Value - Limit Value.

APPENDIX D - RADIATED EMISSION - ABOVE 1000 MHZ

Test Mode	UNII-1_TX A Mode 5180 MHz	Polarization	Vertical
-----------	---------------------------	--------------	----------

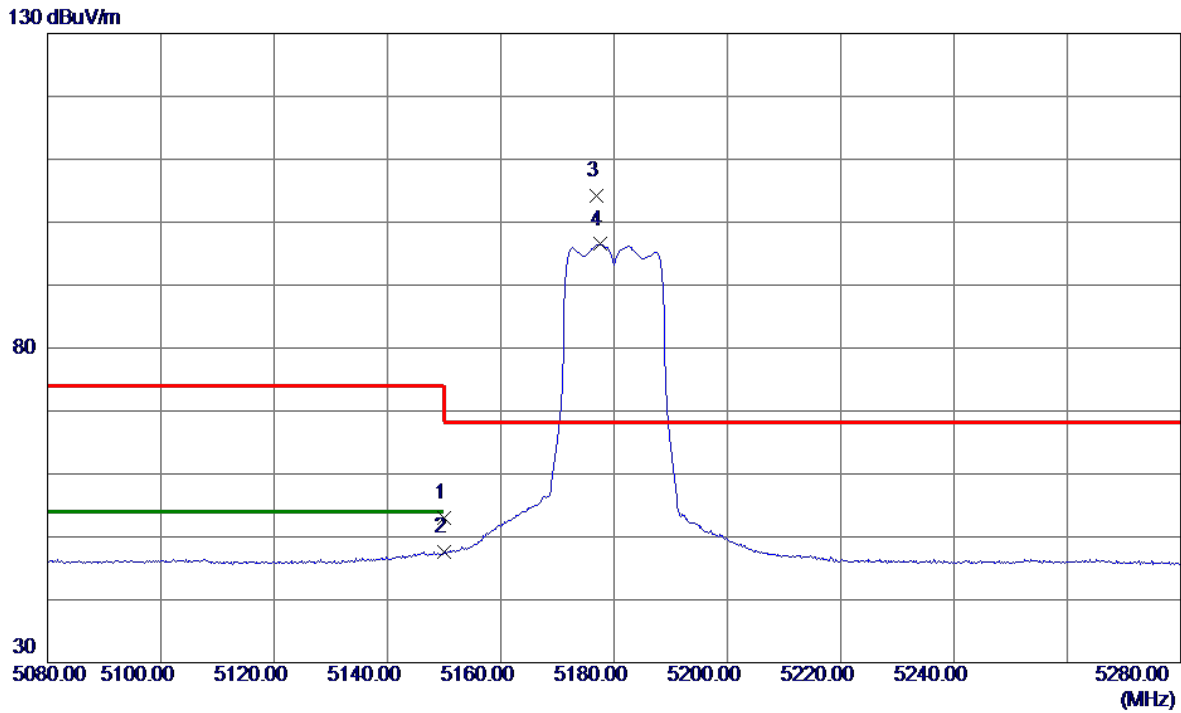

No.	Freq. MHz	Reading Level dBuV/m	Correct Factor dB	Measure ment dBuV/m	Limit dBuV/m	Margin dB	Detector	Comment
1	5150.0000	36.78	16.28	53.06	74.00	-20.94	Peak	
2	5150.0000	31.28	16.28	47.56	54.00	-6.44	AVG	
3 *	5176.8000	87.93	16.31	104.24	68.20	36.04	Peak	No Limit
4	5177.6000	80.19	16.31	96.50	999.00	-902.50	AVG	No Limit

REMARKS:

- (1) Measurement Value = Reading Level + Correct Factor.
- (2) Margin Level = Measurement Value - Limit Value.

Test Mode	UNII-1_TX A Mode 5180 MHz	Polarization	Vertical
-----------	---------------------------	--------------	----------

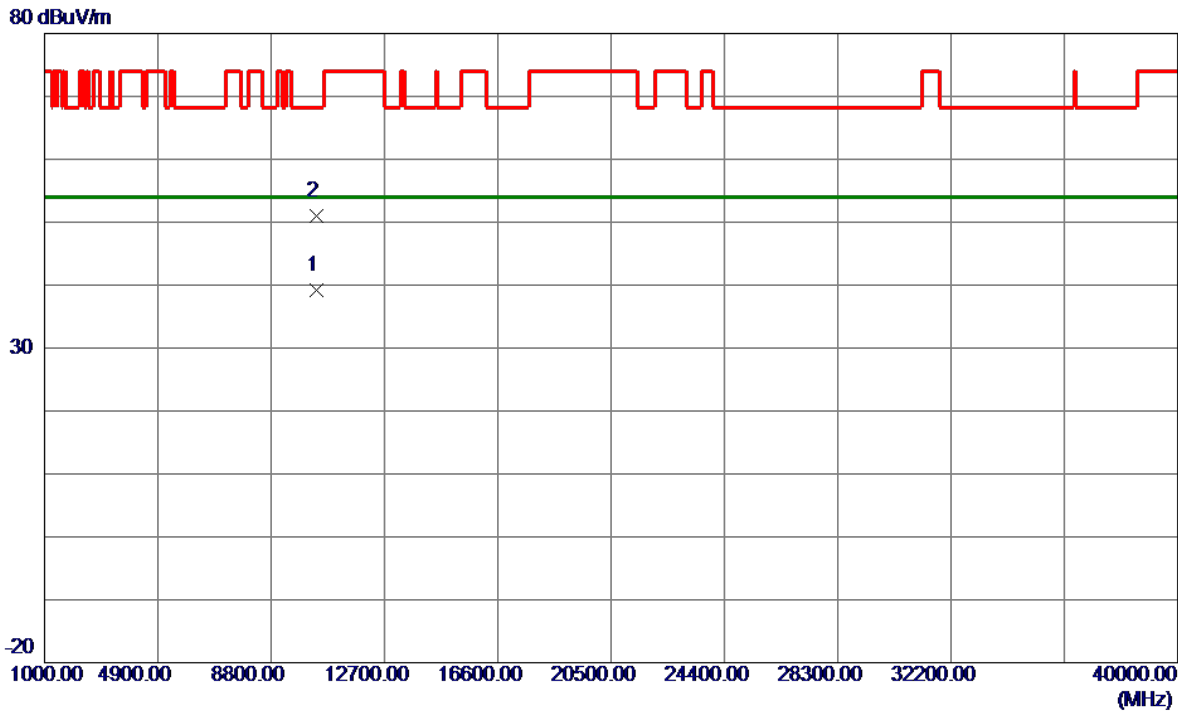

No.	Freq. MHz	Reading Level dBuV/m	Correct Factor dB	Measure ment dBuV/m	Limit dBuV/m	Margin dB	Detector	Comment
1 *	10357.5150	26.84	12.29	39.13	54.00	-14.87	AVG	
2	10361.6849	38.70	12.29	50.99	68.20	-17.21	Peak	

REMARKS:

- (1) Measurement Value = Reading Level + Correct Factor.
- (2) Margin Level = Measurement Value - Limit Value.

Test Mode	UNII-1_TX A Mode 5180 MHz	Polarization	Horizontal
-----------	---------------------------	--------------	------------

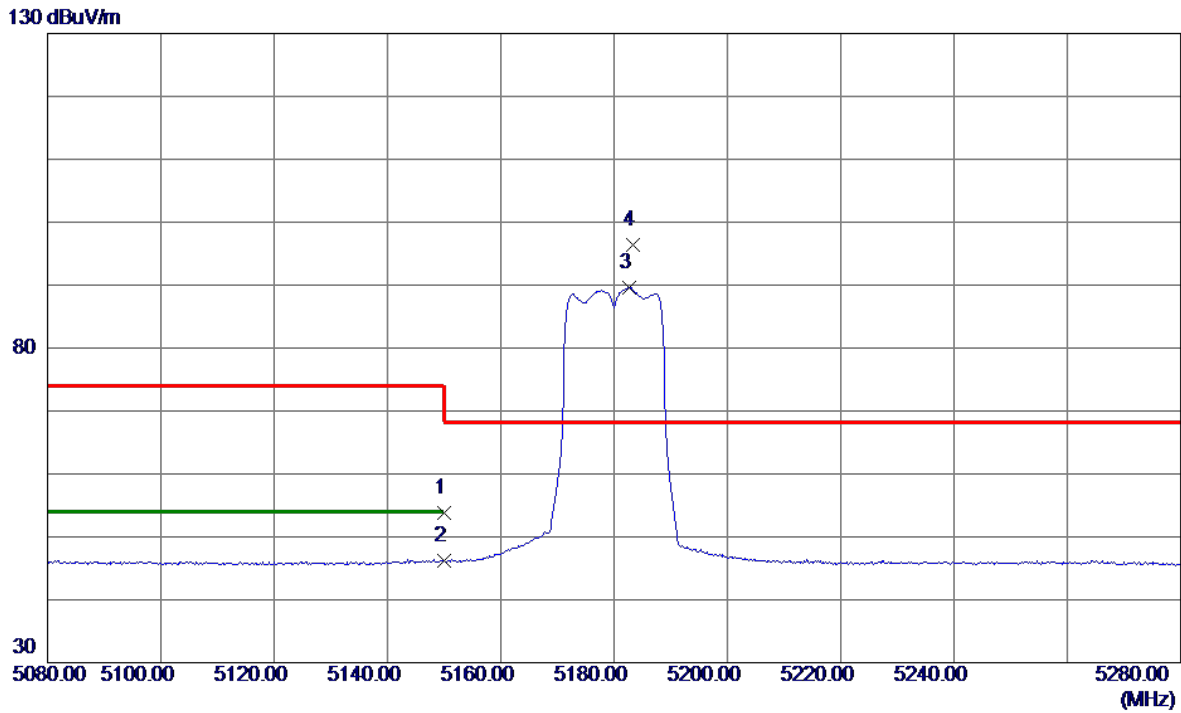

No.	Freq. MHz	Reading Level dBuV/m	Correct Factor dB	Measure ment dBuV/m	Limit dBuV/m	Margin dB	Detector	Comment
1	5150.0000	37.56	16.28	53.84	74.00	-20.16	Peak	
2	5150.0000	29.90	16.28	46.18	54.00	-7.82	AVG	
3	5182.6000	73.36	16.32	89.68	999.00	-909.32	AVG	No Limit
4 *	5183.4000	80.06	16.32	96.38	68.20	28.18	Peak	No Limit

REMARKS:

- (1) Measurement Value = Reading Level + Correct Factor.
- (2) Margin Level = Measurement Value - Limit Value.

Test Mode	UNII-1_TX A Mode 5180 MHz	Polarization	Horizontal
-----------	---------------------------	--------------	------------

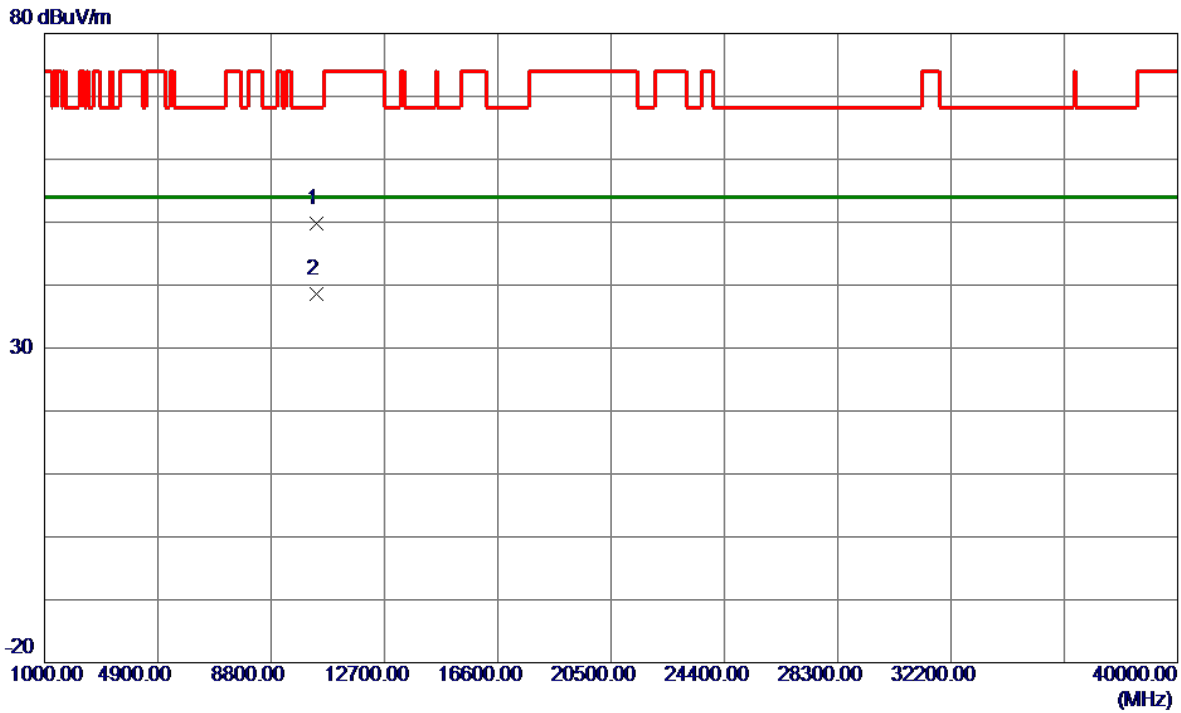

No.	Freq. MHz	Reading Level dBuV/m	Correct Factor dB	Measure ment dBuV/m	Limit dBuV/m	Margin dB	Detector	Comment
1	10360.0000	37.45	12.29	49.74	68.20	-18.46	Peak	
2 *	10360.0000	26.32	12.29	38.61	54.00	-15.39	AVG	

REMARKS:

- (1) Measurement Value = Reading Level + Correct Factor.
- (2) Margin Level = Measurement Value - Limit Value.

Test Mode	UNII-1_TX A Mode 5200 MHz	Polarization	Vertical
-----------	---------------------------	--------------	----------

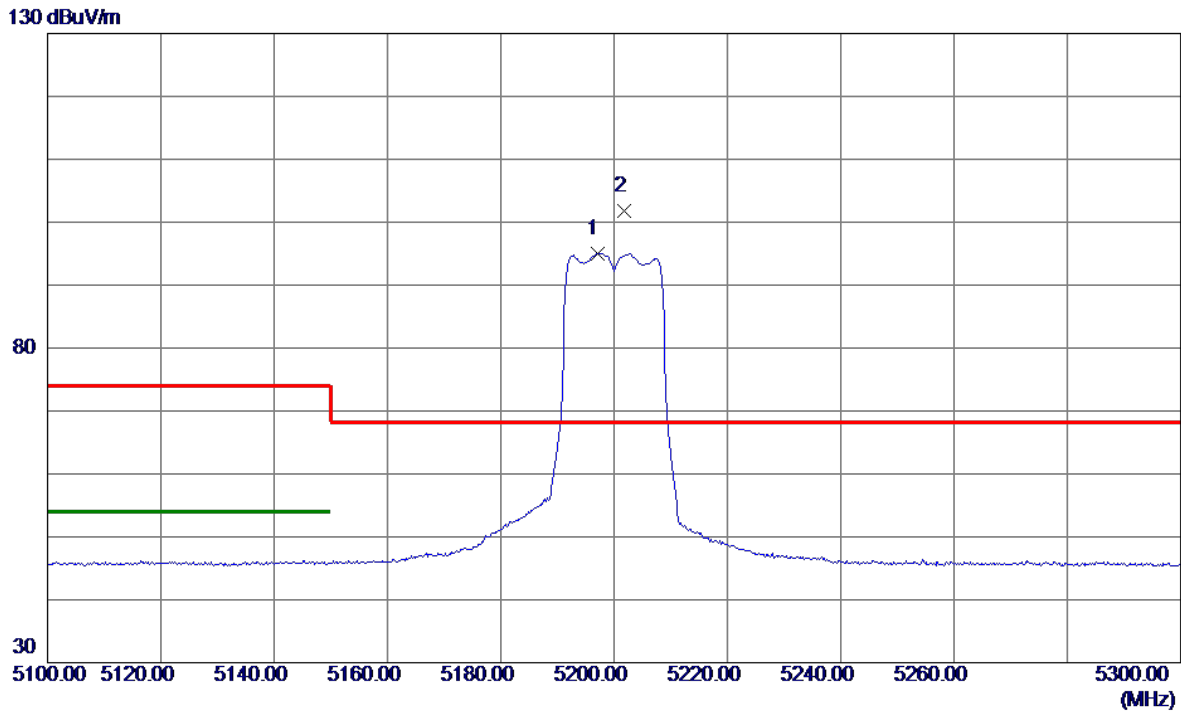

No.	Freq. MHz	Reading Level dBuV/m	Correct Factor dB	Measure ment dBuV/m	Limit dBuV/m	Margin dB	Detector	Comment
1	5197.0000	78.71	16.33	95.04	999.00	-903.96	AVG	No Limit
2 *	5201.8000	85.45	16.34	101.79	68.20	33.59	Peak	No Limit

REMARKS:

- (1) Measurement Value = Reading Level + Correct Factor.
- (2) Margin Level = Measurement Value - Limit Value.

Test Mode	UNII-1_TX A Mode 5200 MHz	Polarization	Vertical
-----------	---------------------------	--------------	----------

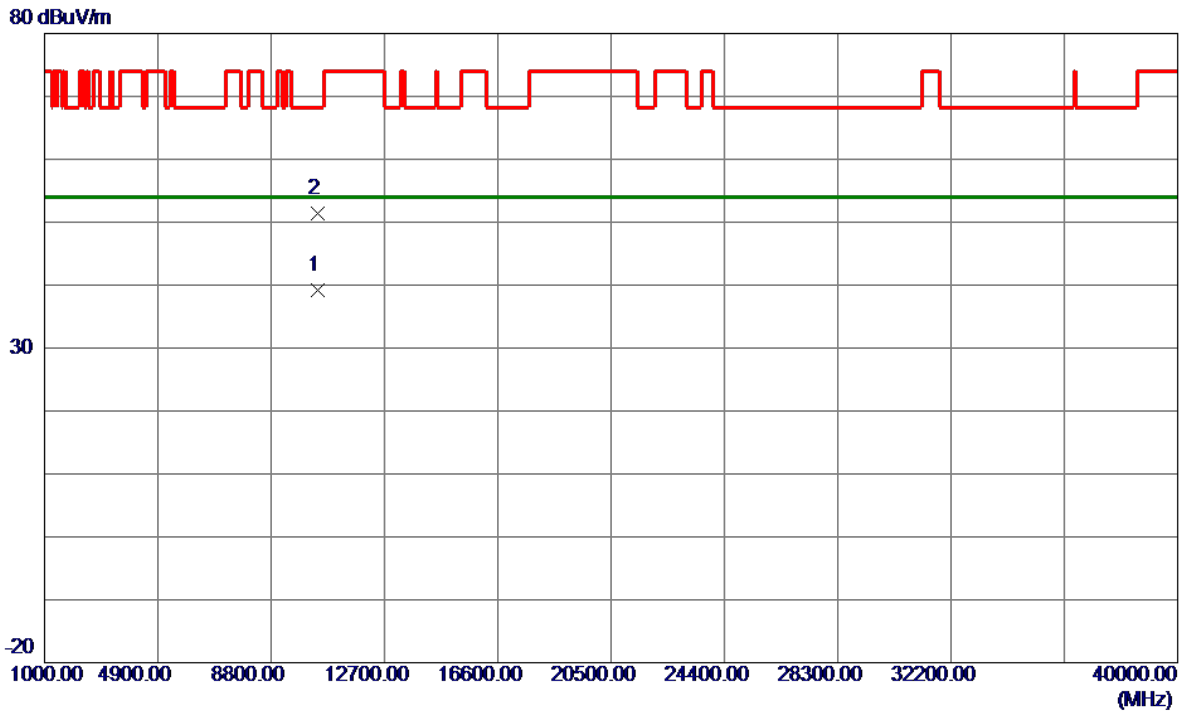

No.	Freq. MHz	Reading Level dBuV/m	Correct Factor dB	Measure ment dBuV/m	Limit dBuV/m	Margin dB	Detector	Comment
1 *	10400.1800	26.83	12.31	39.14	54.00	-14.86	AVG	
2	10402.4050	39.03	12.31	51.34	68.20	-16.86	Peak	

REMARKS:

- (1) Measurement Value = Reading Level + Correct Factor.
- (2) Margin Level = Measurement Value - Limit Value.

Test Mode	UNII-1_TX A Mode 5200 MHz	Polarization	Horizontal
-----------	---------------------------	--------------	------------

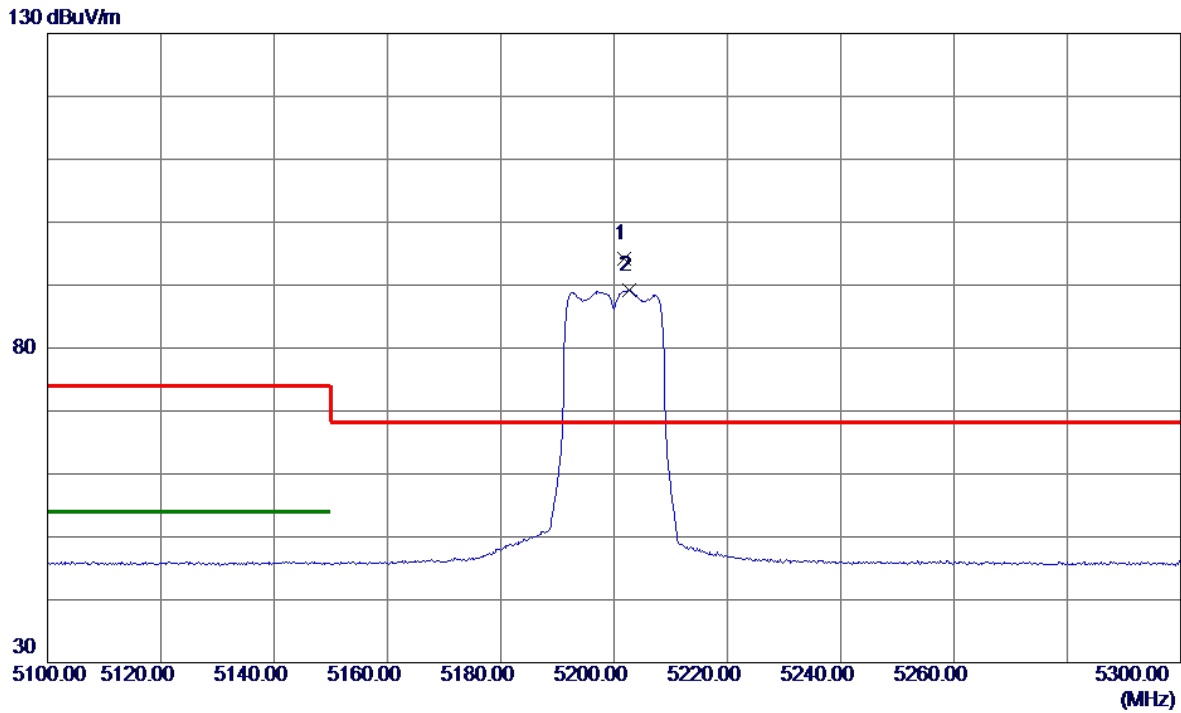

No.	Freq. MHz	Reading Level dBuV/m	Correct Factor dB	Measure ment dBuV/m	Limit dBuV/m	Margin dB	Detector	Comment
1 *	5201.8000	77.87	16.34	94.21	68.20	26.01	Peak	No Limit
2	5202.6000	72.93	16.34	89.27	999.00	-909.73	AVG	No Limit

REMARKS:

- (1) Measurement Value = Reading Level + Correct Factor.
- (2) Margin Level = Measurement Value - Limit Value.

Test Mode	UNII-1_TX A Mode 5200 MHz	Polarization	Horizontal
-----------	---------------------------	--------------	------------

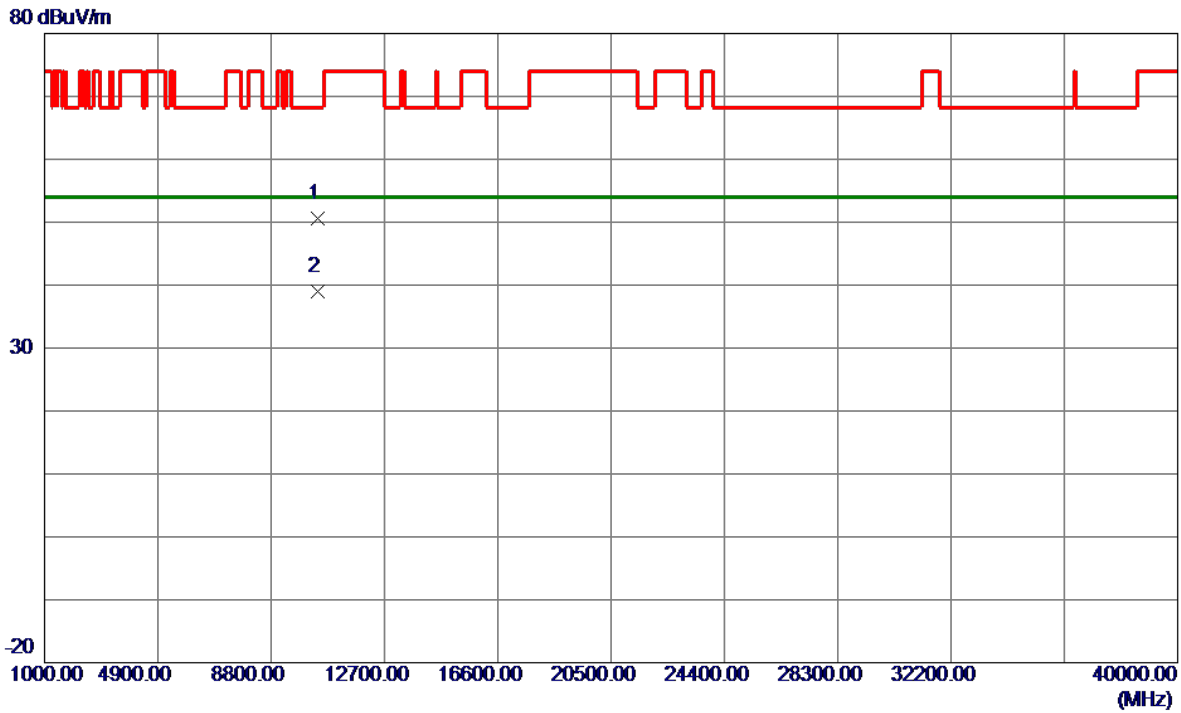

No.	Freq. MHz	Reading Level dBuV/m	Correct Factor dB	Measure ment dBuV/m	Limit dBuV/m	Margin dB	Detector	Comment
1	10400.0000	38.29	12.31	50.60	68.20	-17.60	Peak	
2 *	10400.0000	26.67	12.31	38.98	54.00	-15.02	AVG	

REMARKS:

- (1) Measurement Value = Reading Level + Correct Factor.
- (2) Margin Level = Measurement Value - Limit Value.

Test Mode	UNII-1_TX A Mode 5240 MHz	Polarization	Vertical
-----------	---------------------------	--------------	----------

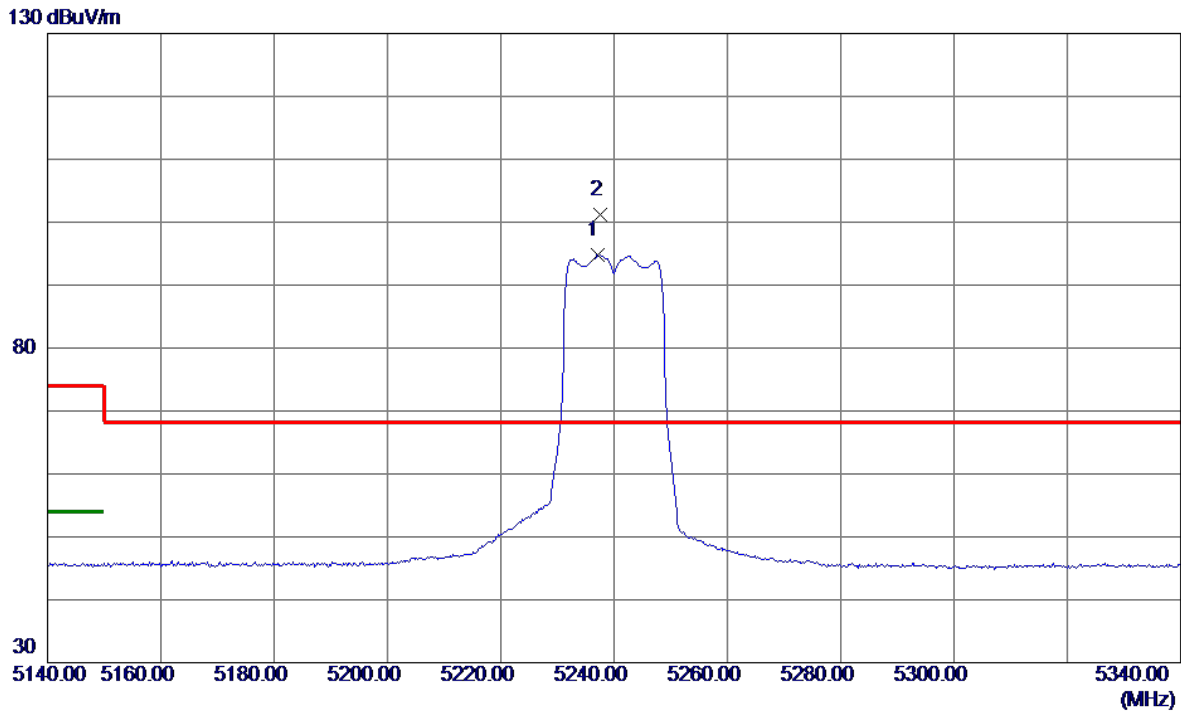

No.	Freq. MHz	Reading Level dBuV/m	Correct Factor dB	Measure ment dBuV/m	Limit dBuV/m	Margin dB	Detector	Comment
1	5237.0000	78.37	16.38	94.75	999.00	-904.25	AVG	No Limit
2 *	5237.6000	84.91	16.38	101.29	68.20	33.09	Peak	No Limit

REMARKS:

- (1) Measurement Value = Reading Level + Correct Factor.
- (2) Margin Level = Measurement Value - Limit Value.

Test Mode	UNII-1_TX A Mode 5240 MHz	Polarization	Vertical
-----------	---------------------------	--------------	----------

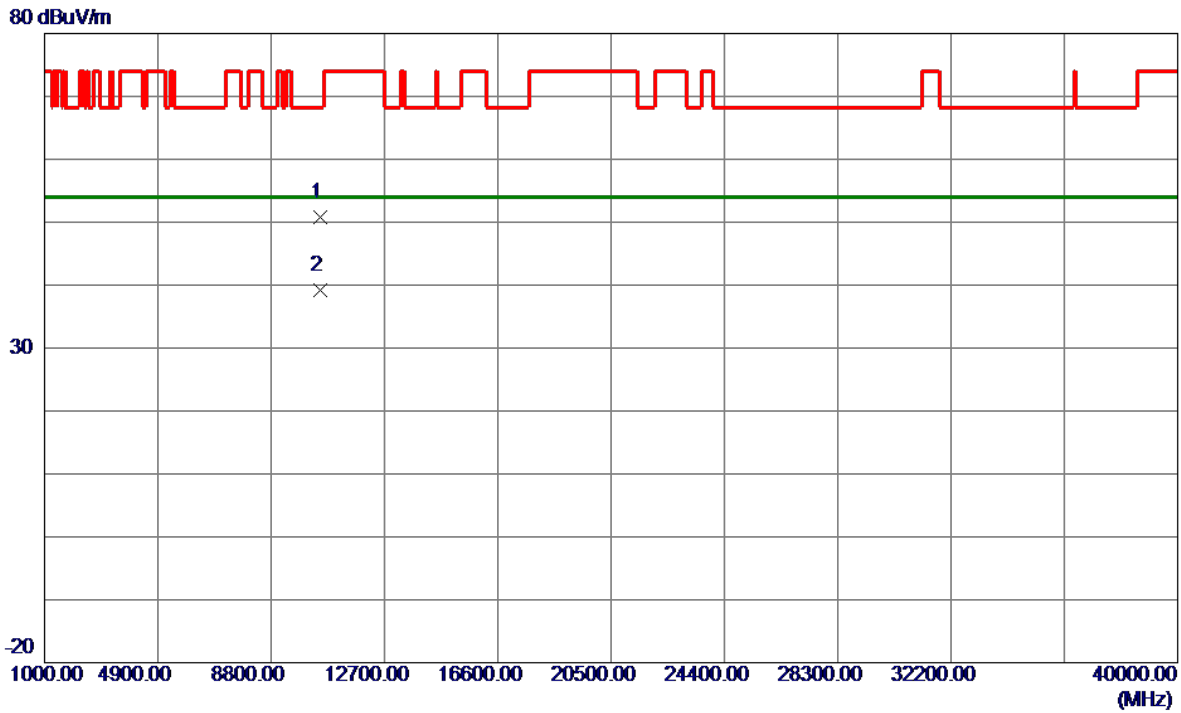

No.	Freq. MHz	Reading Level dBuV/m	Correct Factor dB	Measure ment dBuV/m	Limit dBuV/m	Margin dB	Detector	Comment
1	10480.5700	38.48	12.36	50.84	68.20	-17.36	Peak	
2 *	10481.7000	26.89	12.36	39.25	54.00	-14.75	AVG	

REMARKS:

- (1) Measurement Value = Reading Level + Correct Factor.
- (2) Margin Level = Measurement Value - Limit Value.

Test Mode	UNII-1_TX A Mode 5240 MHz	Polarization	Horizontal
-----------	---------------------------	--------------	------------

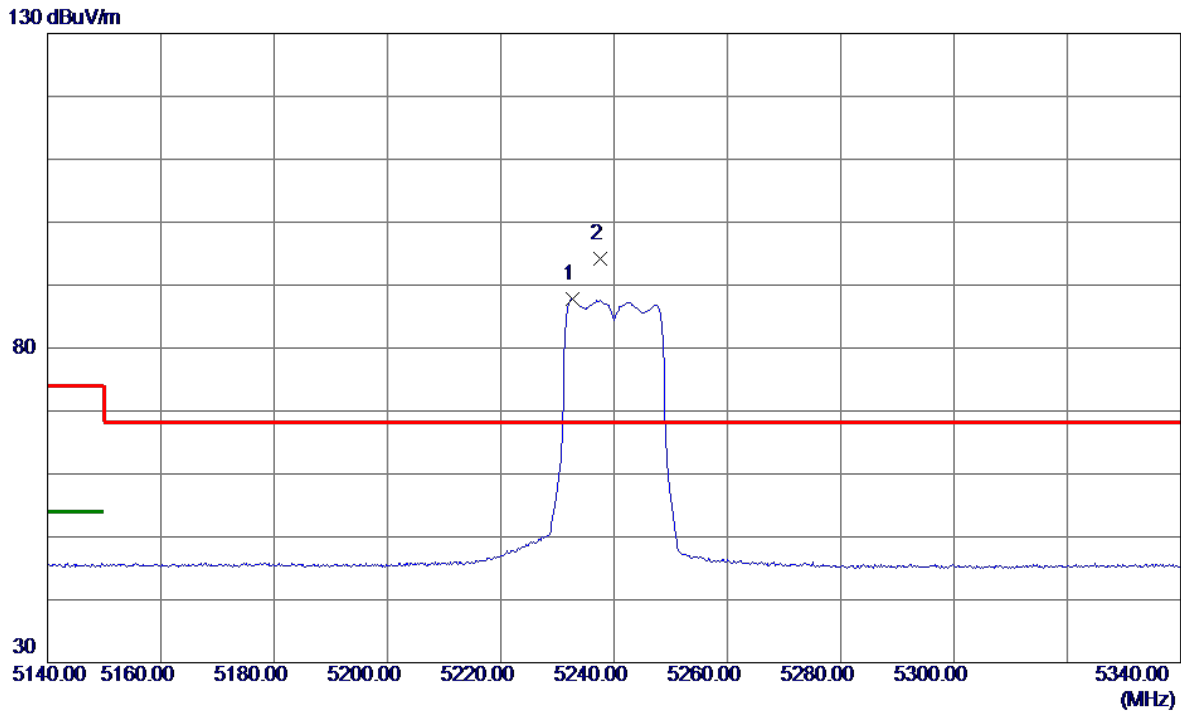

No.	Freq. MHz	Reading Level dBuV/m	Correct Factor dB	Measure ment dBuV/m	Limit dBuV/m	Margin dB	Detector	Comment
1	5232.6000	71.38	16.37	87.75	999.00	-911.25	AVG	No Limit
2 *	5237.6000	77.73	16.38	94.11	68.20	25.91	Peak	No Limit

REMARKS:

- (1) Measurement Value = Reading Level + Correct Factor.
- (2) Margin Level = Measurement Value - Limit Value.

Test Mode	UNII-1_TX A Mode 5240 MHz	Polarization	Horizontal
-----------	---------------------------	--------------	------------

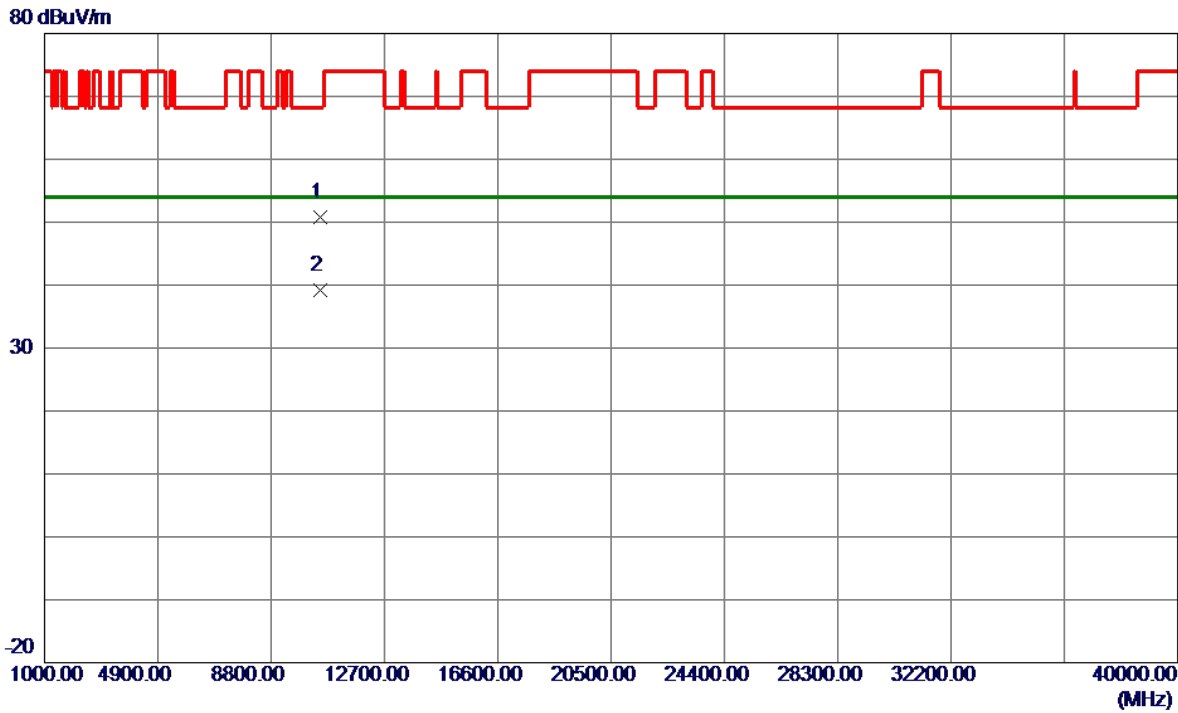

No.	Freq. MHz	Reading Level dBuV/m	Correct Factor dB	Measure ment dBuV/m	Limit dBuV/m	Margin dB	Detector	Comment
1	10480.0000	38.44	12.36	50.80	68.20	-17.40	Peak	
2 *	10480.0000	26.82	12.36	39.18	54.00	-14.82	AVG	

REMARKS:

- (1) Measurement Value = Reading Level + Correct Factor.
- (2) Margin Level = Measurement Value - Limit Value.

Test Mode	UNII-1_TX AC(VHT20) Mode 5180 MHz	Polarization	Vertical
-----------	-----------------------------------	--------------	----------

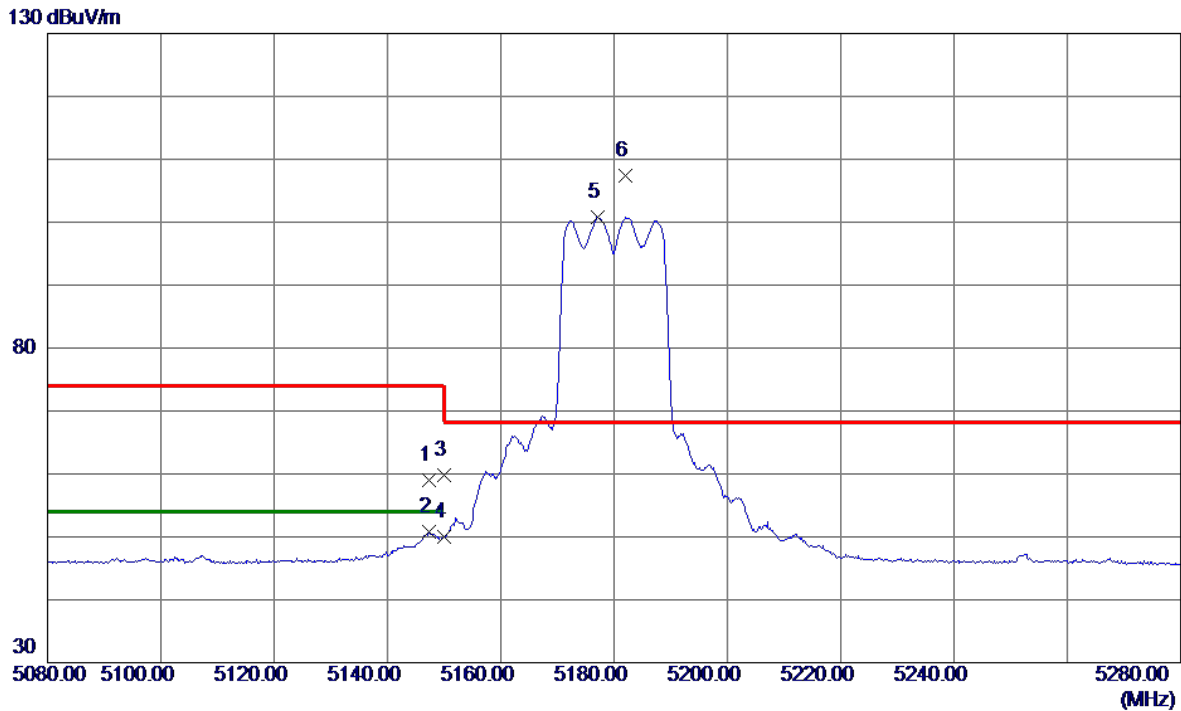

No.	Freq. MHz	Reading Level dBuV/m	Correct Factor dB	Measure ment dBuV/m	Limit dBuV/m	Margin dB	Detector	Comment
1	5147.4000	42.67	16.28	58.95	74.00	-15.05	Peak	
2	5147.4000	34.45	16.28	50.73	54.00	-3.27	AVG	
3	5150.0000	43.48	16.28	59.76	74.00	-14.24	Peak	
4	5150.0000	33.68	16.28	49.96	54.00	-4.04	AVG	
5	5177.2000	84.43	16.31	100.74	999.00	-898.26	AVG	No Limit
6 *	5182.0000	91.10	16.32	107.42	68.20	39.22	Peak	No Limit

REMARKS:

- (1) Measurement Value = Reading Level + Correct Factor.
- (2) Margin Level = Measurement Value - Limit Value.

Test Mode	UNII-1_TX AC(VHT20) Mode 5180 MHz	Polarization	Vertical
-----------	-----------------------------------	--------------	----------

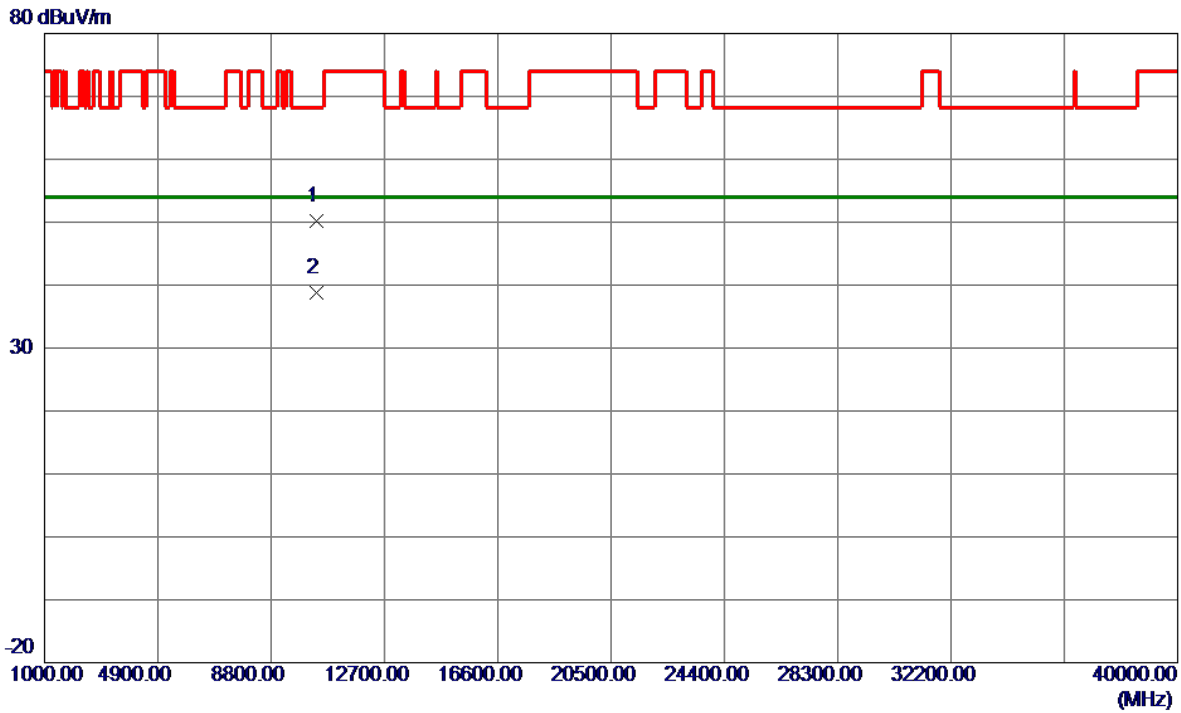

No.	Freq. MHz	Reading Level dBuV/m	Correct Factor dB	Measure ment dBuV/m	Limit dBuV/m	Margin dB	Detector	Comment
1	10357.6500	37.82	12.29	50.11	68.20	-18.09	Peak	
2 *	10357.7650	26.53	12.29	38.82	54.00	-15.18	AVG	

REMARKS:

- (1) Measurement Value = Reading Level + Correct Factor.
- (2) Margin Level = Measurement Value - Limit Value.

Test Mode	UNII-1_TX AC(VHT20) Mode 5180 MHz	Polarization	Horizontal
-----------	-----------------------------------	--------------	------------

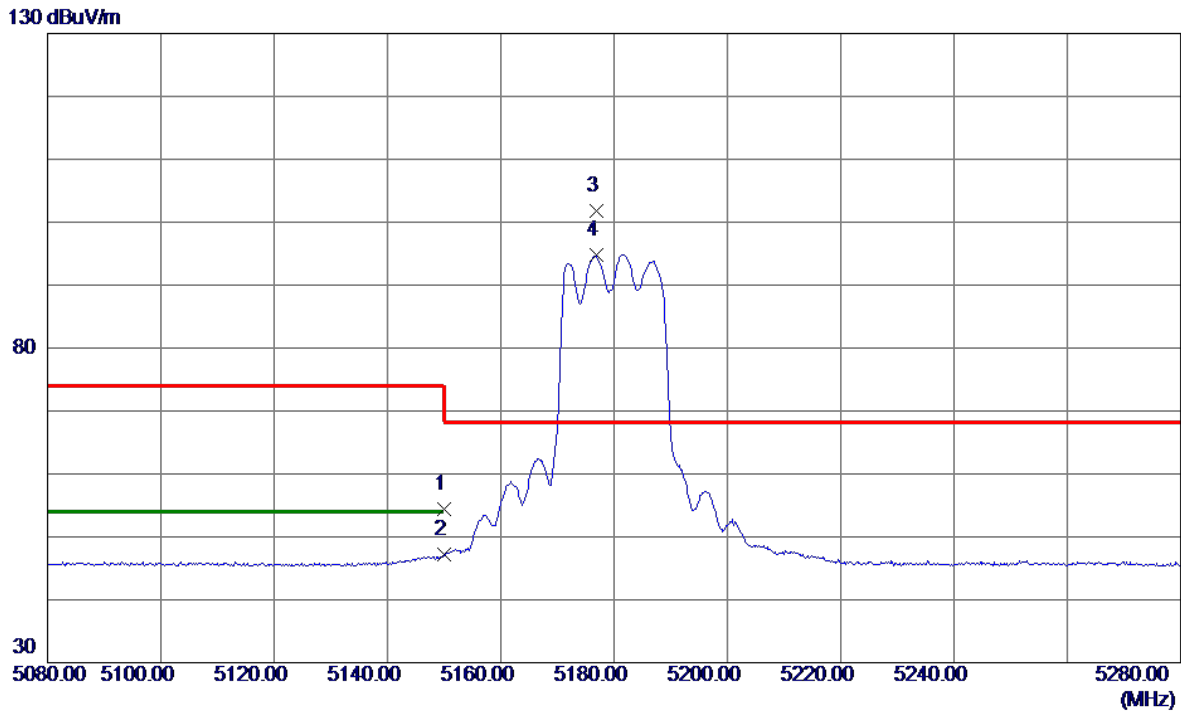

No.	Freq. MHz	Reading Level dBuV/m	Correct Factor dB	Measure ment dBuV/m	Limit dBuV/m	Margin dB	Detector	Comment
1	5150.0000	38.03	16.28	54.31	74.00	-19.69	Peak	
2	5150.0000	30.91	16.28	47.19	54.00	-6.81	AVG	
3 *	5176.8000	85.44	16.31	101.75	68.20	33.55	Peak	No Limit
4	5176.8000	78.45	16.31	94.76	999.00	-904.24	AVG	No Limit

REMARKS:

- (1) Measurement Value = Reading Level + Correct Factor.
- (2) Margin Level = Measurement Value - Limit Value.

Test Mode	UNII-1_TX AC(VHT20) Mode 5180 MHz	Polarization	Horizontal
-----------	-----------------------------------	--------------	------------

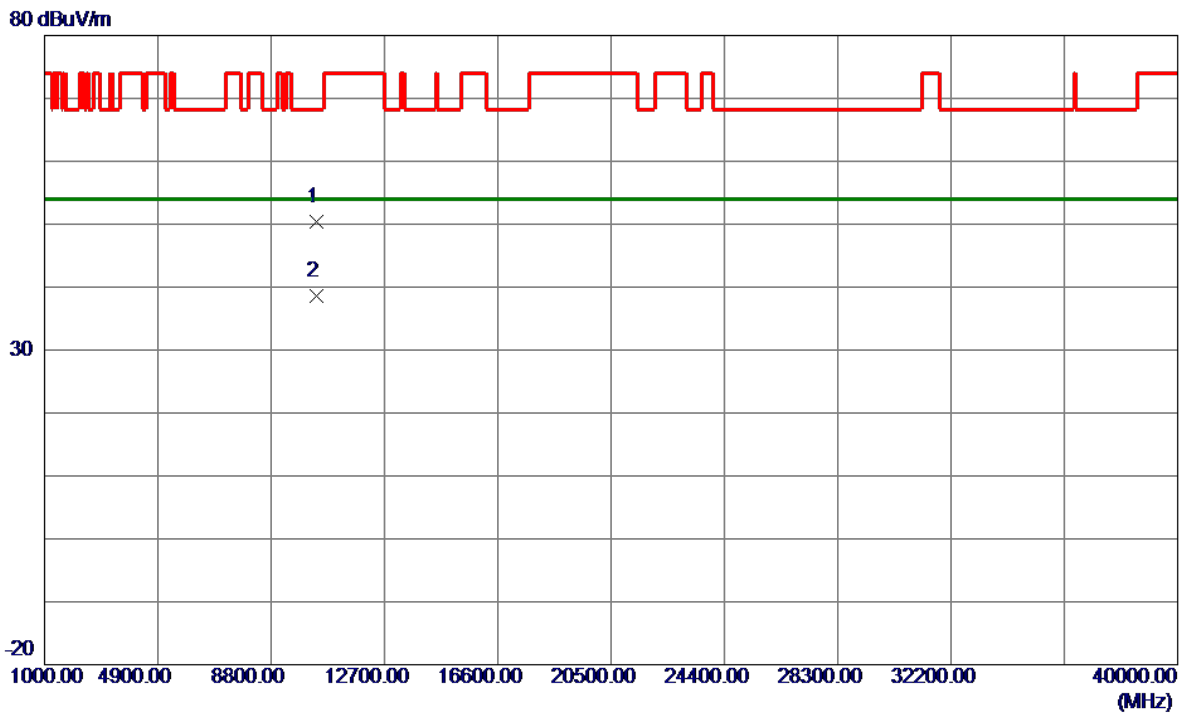

No.	Freq. MHz	Reading Level dBuV/m	Correct Factor dB	Measure ment dBuV/m	Limit dBuV/m	Margin dB	Detector	Comment
1	10360.0000	38.20	12.29	50.49	68.20	-17.71	Peak	
2 *	10360.0000	26.35	12.29	38.64	54.00	-15.36	AVG	

REMARKS:

- (1) Measurement Value = Reading Level + Correct Factor.
- (2) Margin Level = Measurement Value - Limit Value.

Test Mode	UNII-1_TX AC(VHT20) Mode 5200 MHz	Polarization	Vertical
-----------	-----------------------------------	--------------	----------

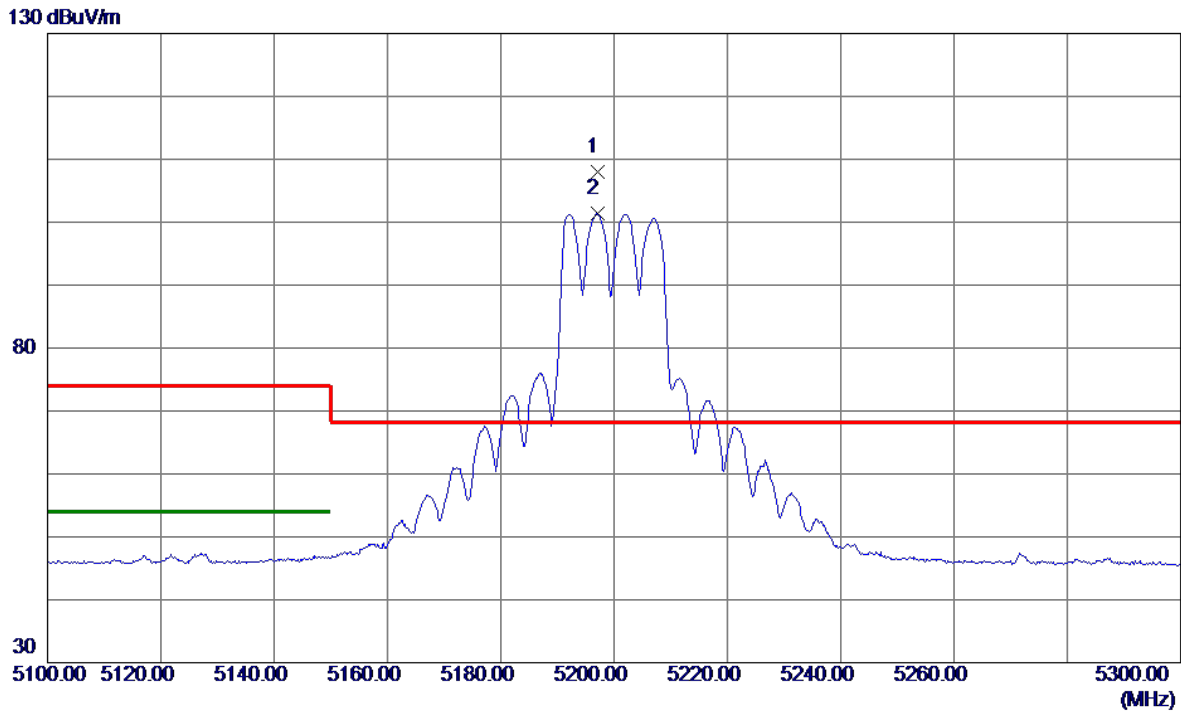

No.	Freq. MHz	Reading Level dBuV/m	Correct Factor dB	Measure ment dBuV/m	Limit dBuV/m	Margin dB	Detector	Comment
1 *	5197.0000	91.65	16.33	107.98	68.20	39.78	Peak	No Limit
2	5197.0000	85.05	16.33	101.38	999.00	-897.62	AVG	No Limit

REMARKS:

- (1) Measurement Value = Reading Level + Correct Factor.
- (2) Margin Level = Measurement Value - Limit Value.

Test Mode	UNII-1_TX AC(VHT20) Mode 5200 MHz	Polarization	Vertical
-----------	-----------------------------------	--------------	----------

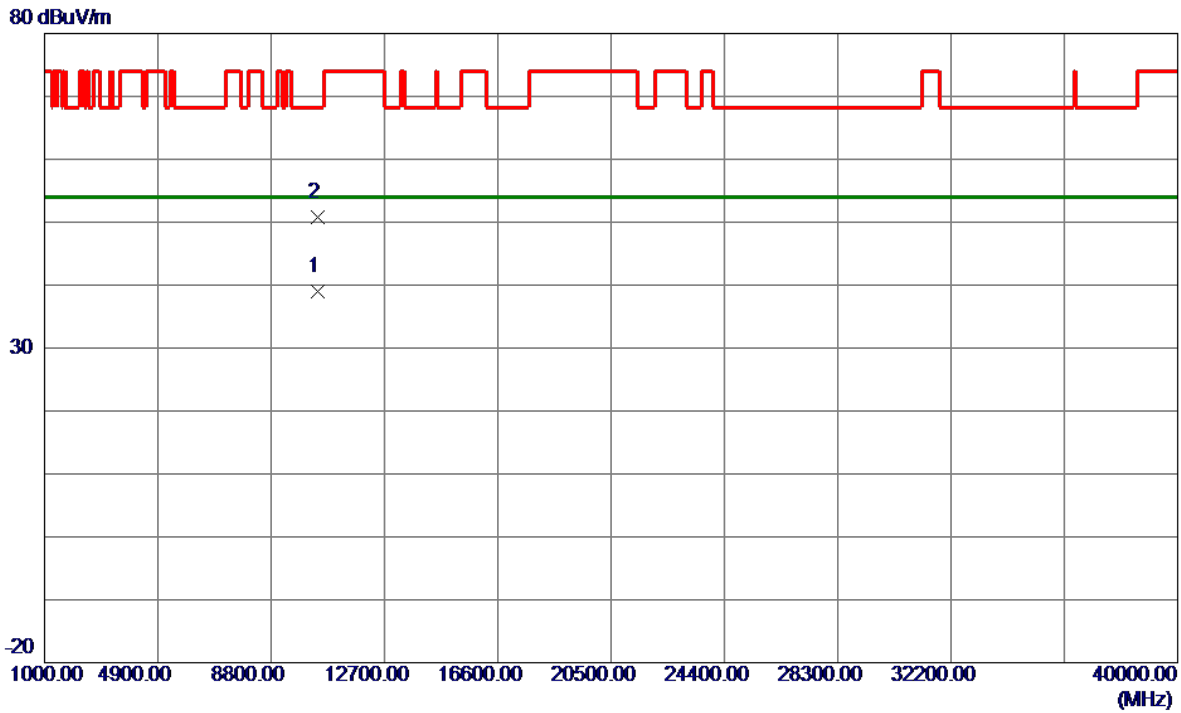

No.	Freq. MHz	Reading Level dBuV/m	Correct Factor dB	Measure ment dBuV/m	Limit dBuV/m	Margin dB	Detector	Comment
1 *	10400.4900	26.67	12.31	38.98	54.00	-15.02	AVG	
2	10400.7850	38.54	12.31	50.85	68.20	-17.35	Peak	

REMARKS:

- (1) Measurement Value = Reading Level + Correct Factor.
- (2) Margin Level = Measurement Value - Limit Value.

Test Mode	UNII-1_TX AC(VHT20) Mode 5200 MHz	Polarization	Horizontal
-----------	-----------------------------------	--------------	------------

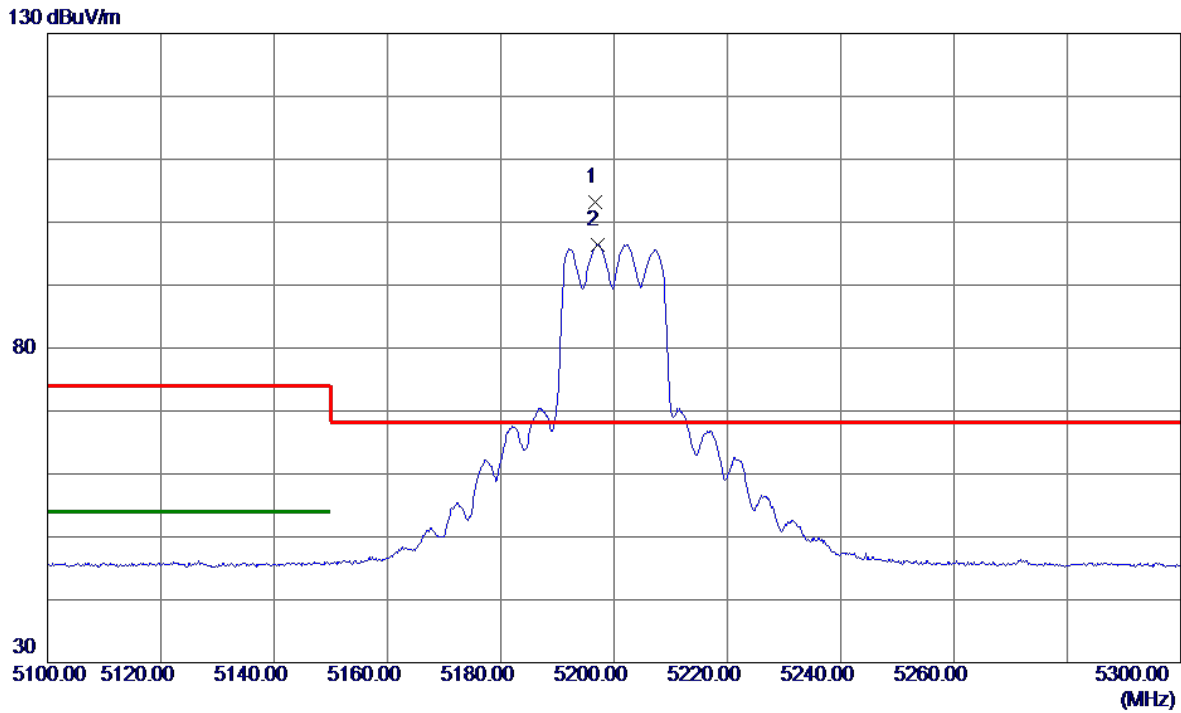

No.	Freq. MHz	Reading Level dBuV/m	Correct Factor dB	Measure ment dBuV/m	Limit dBuV/m	Margin dB	Detector	Comment
1 *	5196.6000	86.85	16.33	103.18	68.20	34.98	Peak	No Limit
2	5197.0000	80.14	16.33	96.47	999.00	-902.53	AVG	No Limit

REMARKS:

- (1) Measurement Value = Reading Level + Correct Factor.
- (2) Margin Level = Measurement Value - Limit Value.

Test Mode	UNII-1_TX AC(VHT20) Mode 5200 MHz	Polarization	Horizontal
-----------	-----------------------------------	--------------	------------

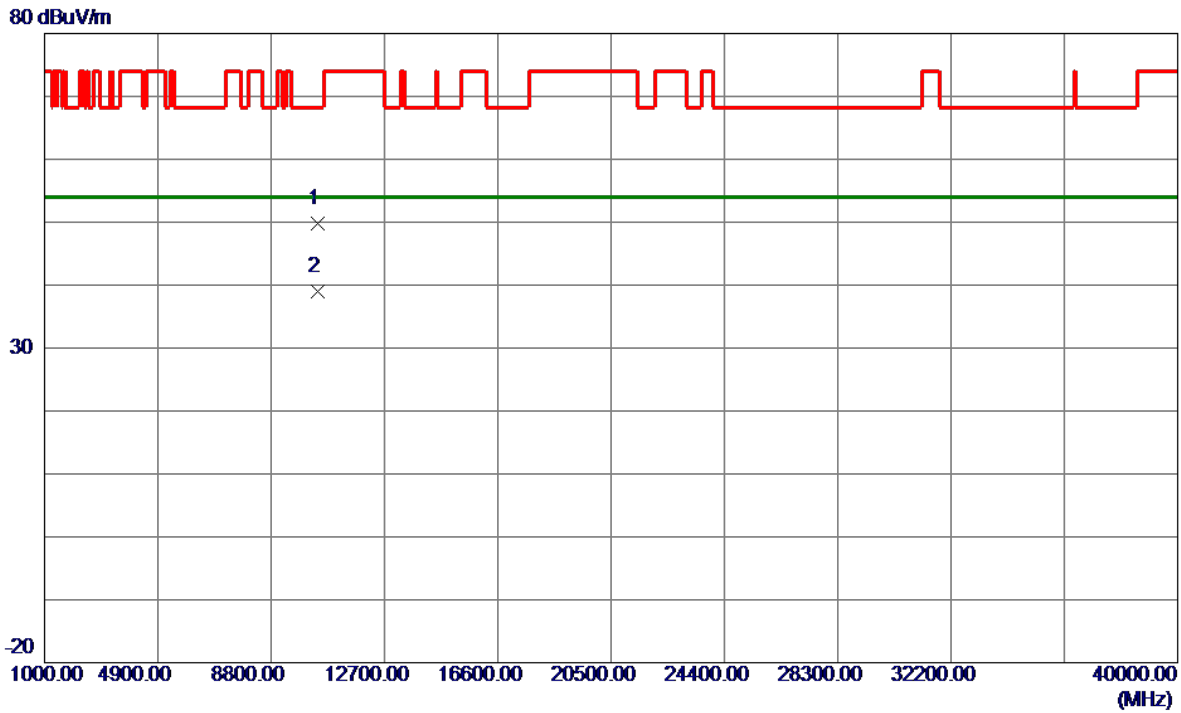

No.	Freq. MHz	Reading Level dBuV/m	Correct Factor dB	Measure ment dBuV/m	Limit dBuV/m	Margin dB	Detector	Comment
1	10400.0000	37.53	12.31	49.84	68.20	-18.36	Peak	
2 *	10400.0000	26.71	12.31	39.02	54.00	-14.98	AVG	

REMARKS:

- (1) Measurement Value = Reading Level + Correct Factor.
- (2) Margin Level = Measurement Value - Limit Value.

Test Mode	UNII-1_TX AC(VHT20) Mode 5240 MHz	Polarization	Vertical
-----------	-----------------------------------	--------------	----------

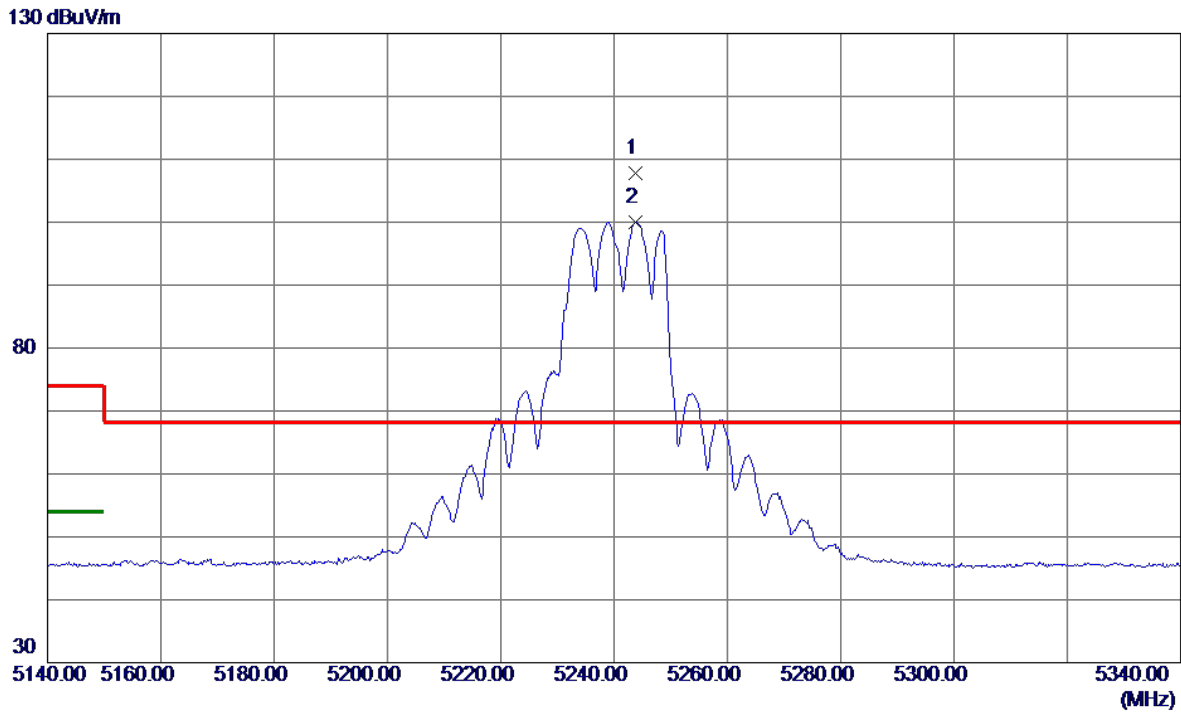

No.	Freq. MHz	Reading Level dBuV/m	Correct Factor dB	Measure ment dBuV/m	Limit dBuV/m	Margin dB	Detector	Comment
1 *	5243.8000	91.42	16.39	107.81	68.20	39.61	Peak	No Limit
2	5243.8000	83.69	16.39	100.08	999.00	-898.92	AVG	No Limit

REMARKS:

- (1) Measurement Value = Reading Level + Correct Factor.
- (2) Margin Level = Measurement Value - Limit Value.

Test Mode	UNII-1_TX AC(VHT20) Mode 5240 MHz	Polarization	Vertical
-----------	-----------------------------------	--------------	----------

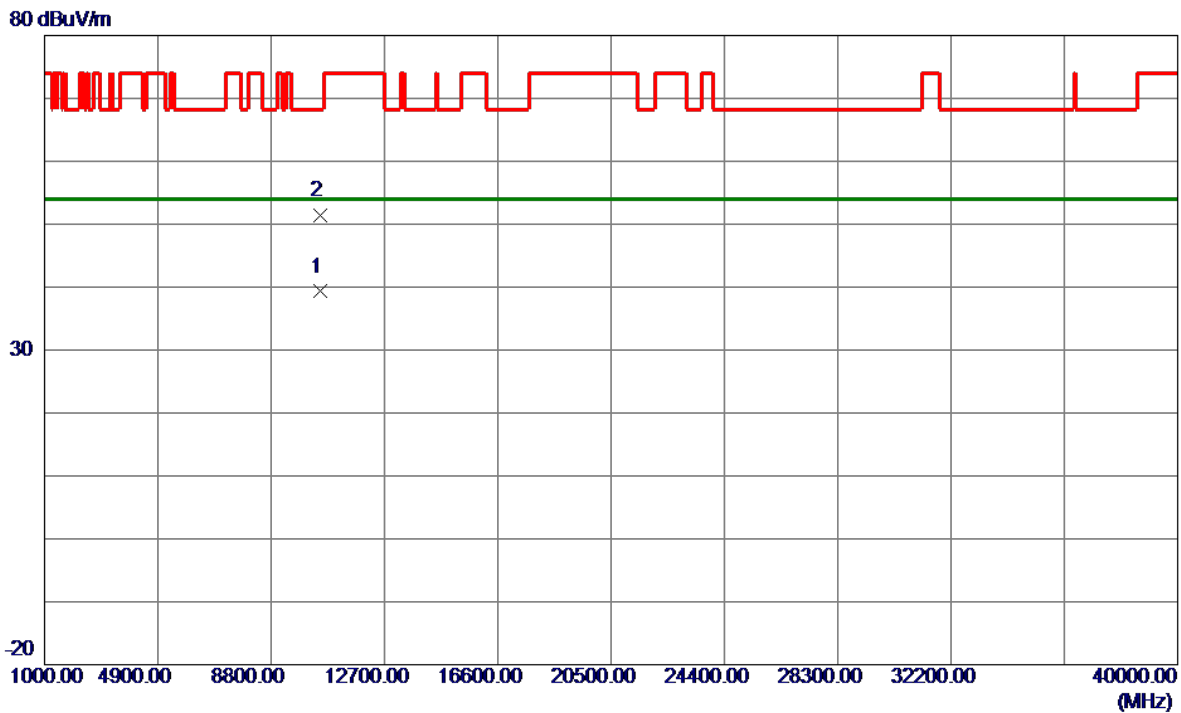

No.	Freq. MHz	Reading Level dBuV/m	Correct Factor dB	Measure ment dBuV/m	Limit dBuV/m	Margin dB	Detector	Comment
1 *	10477.8750	26.94	12.36	39.30	54.00	-14.70	AVG	
2	10478.5500	38.97	12.36	51.33	68.20	-16.87	Peak	

REMARKS:

- (1) Measurement Value = Reading Level + Correct Factor.
- (2) Margin Level = Measurement Value - Limit Value.

Test Mode	UNII-1_TX AC(VHT20) Mode 5240 MHz	Polarization	Horizontal
-----------	-----------------------------------	--------------	------------

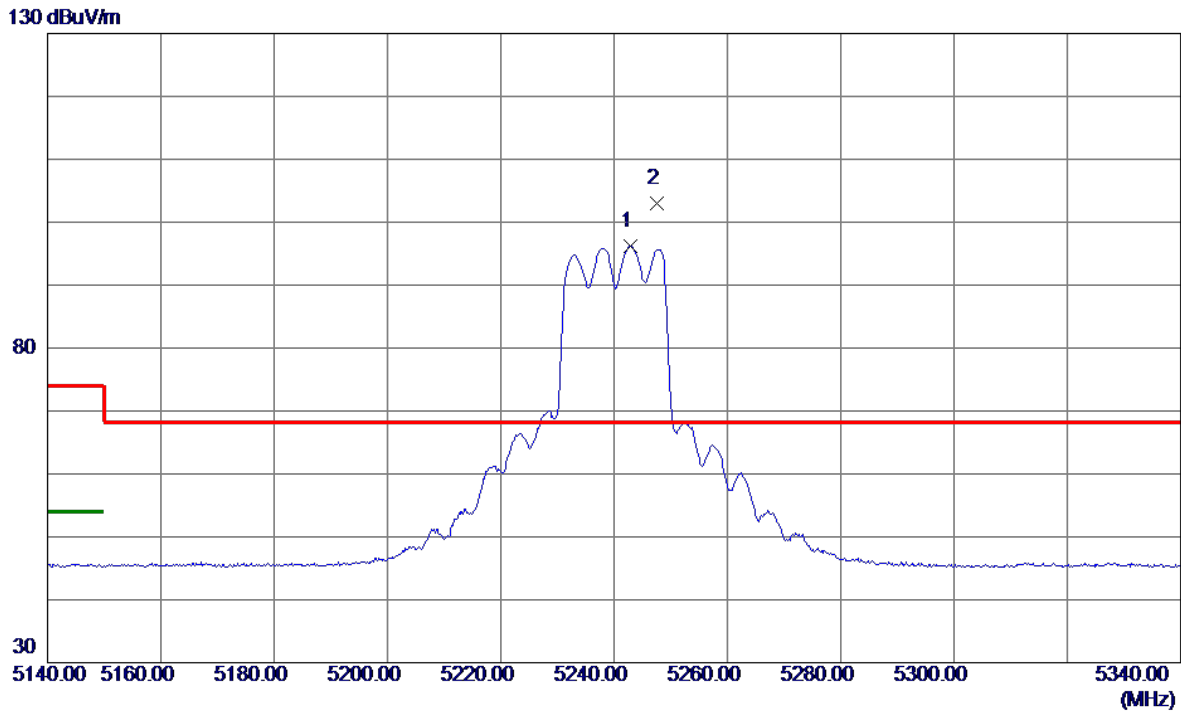

No.	Freq. MHz	Reading Level dBuV/m	Correct Factor dB	Measure ment dBuV/m	Limit dBuV/m	Margin dB	Detector	Comment
1	5242.8000	79.84	16.38	96.22	999.00	-902.78	AVG	No Limit
2 *	5247.6000	86.65	16.39	103.04	68.20	34.84	Peak	No Limit

REMARKS:

- (1) Measurement Value = Reading Level + Correct Factor.
- (2) Margin Level = Measurement Value - Limit Value.

Test Mode	UNII-1_TX AC(VHT20) Mode 5240 MHz	Polarization	Horizontal
-----------	-----------------------------------	--------------	------------

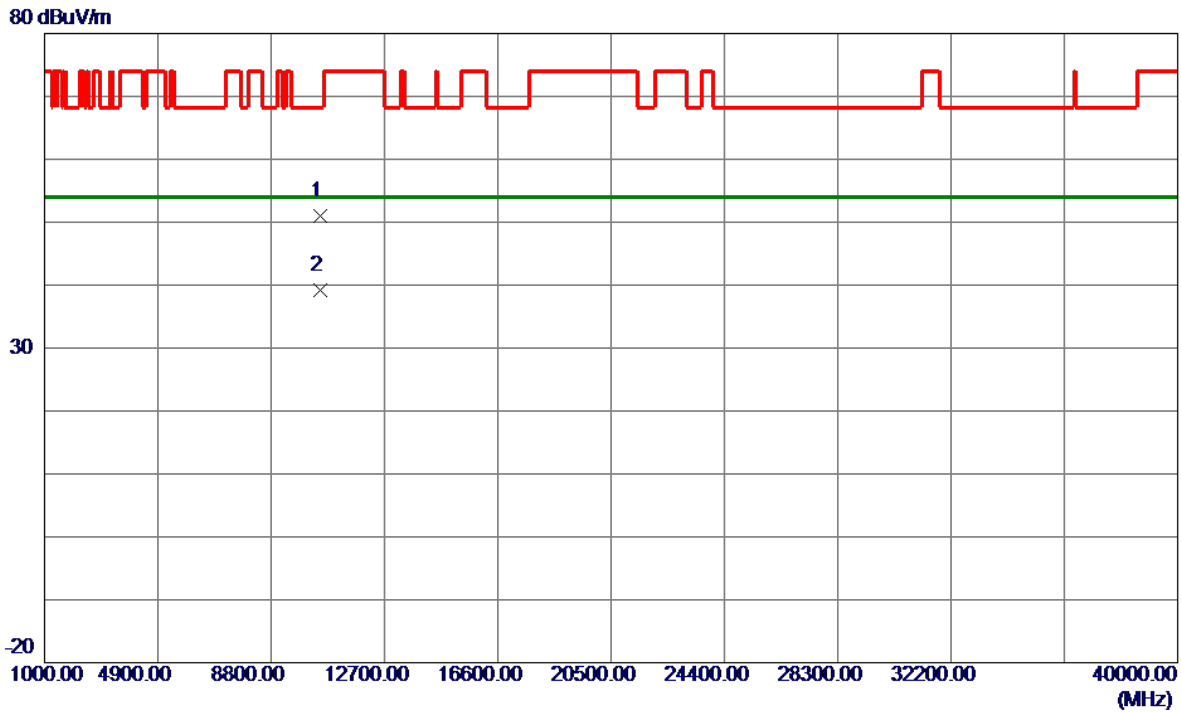

No.	Freq. MHz	Reading Level dBuV/m	Correct Factor dB	Measure ment dBuV/m	Limit dBuV/m	Margin dB	Detector	Comment
1	10480.0000	38.72	12.36	51.08	68.20	-17.12	Peak	
2 *	10480.0000	26.89	12.36	39.25	54.00	-14.75	AVG	

REMARKS:

- (1) Measurement Value = Reading Level + Correct Factor.
- (2) Margin Level = Measurement Value - Limit Value.

Test Mode	UNII-1_TX AC(VHT40) Mode 5190 MHz	Polarization	Vertical
-----------	-----------------------------------	--------------	----------

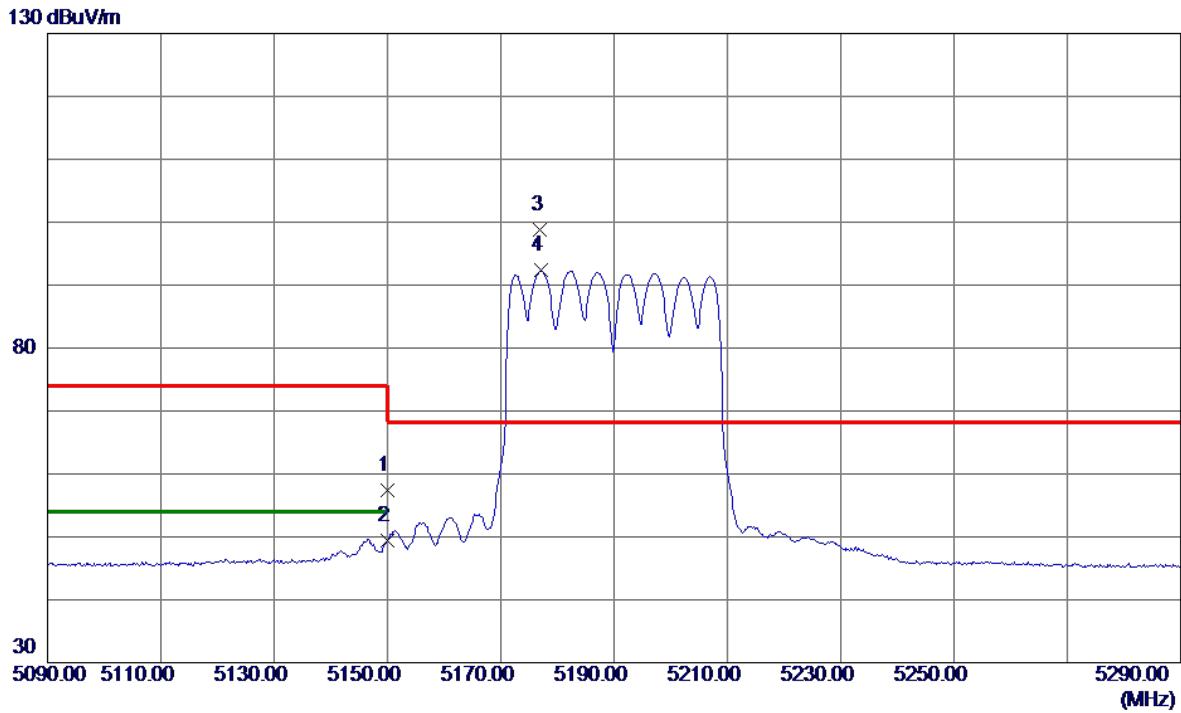

No.	Freq. MHz	Reading Level dBuV/m	Correct Factor dB	Measure ment dBuV/m	Limit dBuV/m	Margin dB	Detector	Comment
1	5150.0000	41.19	16.28	57.47	74.00	-16.53	Peak	
2	5150.0000	33.21	16.28	49.49	54.00	-4.51	AVG	
3 *	5177.0000	82.48	16.31	98.79	68.20	30.59	Peak	No Limit
4	5177.2000	76.02	16.31	92.33	999.00	-906.67	AVG	No Limit

REMARKS:

- (1) Measurement Value = Reading Level + Correct Factor.
- (2) Margin Level = Measurement Value - Limit Value.

Test Mode	UNII-1_TX AC(VHT40) Mode 5190 MHz	Polarization	Vertical
-----------	-----------------------------------	--------------	----------

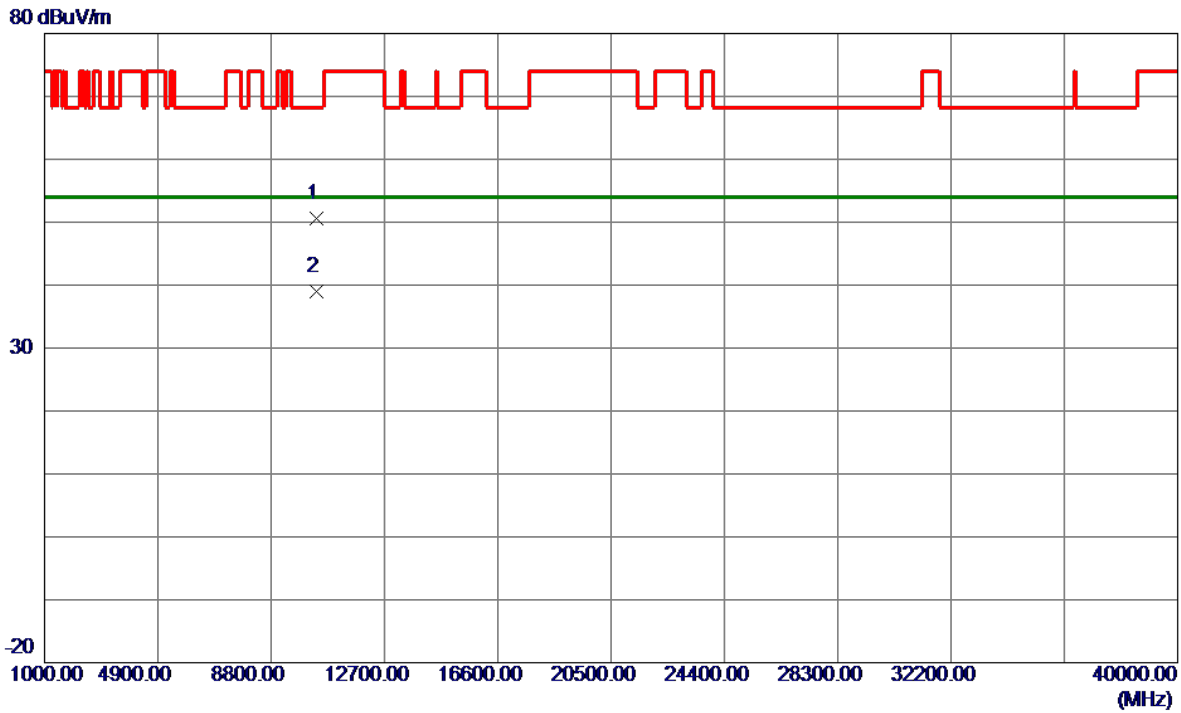

No.	Freq. MHz	Reading Level dBuV/m	Correct Factor dB	Measure ment dBuV/m	Limit dBuV/m	Margin dB	Detector	Comment
1	10380.0000	38.34	12.30	50.64	68.20	-17.56	Peak	
2 *	10380.0000	26.72	12.30	39.02	54.00	-14.98	AVG	

REMARKS:

- (1) Measurement Value = Reading Level + Correct Factor.
- (2) Margin Level = Measurement Value - Limit Value.

Test Mode	UNII-1_TX AC(VHT40) Mode 5190 MHz	Polarization	Horizontal
-----------	-----------------------------------	--------------	------------

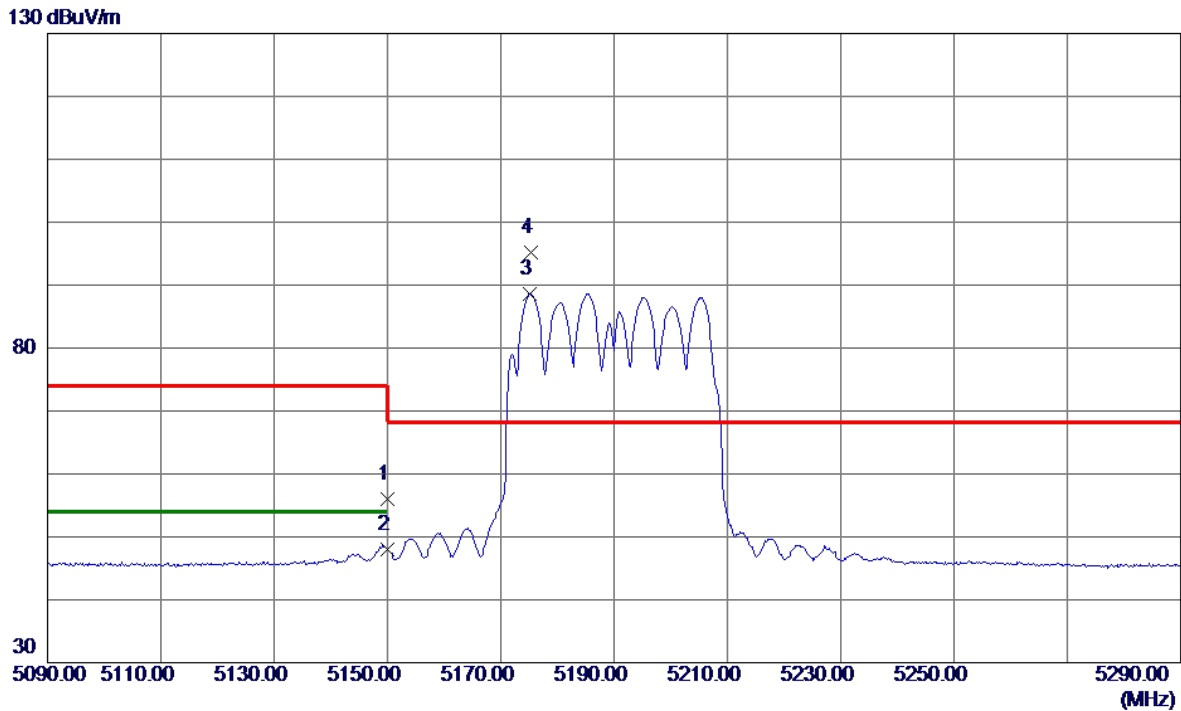

No.	Freq. MHz	Reading Level dBuV/m	Correct Factor dB	Measure ment dBuV/m	Limit dBuV/m	Margin dB	Detector	Comment
1	5150.0000	39.74	16.28	56.02	74.00	-17.98	Peak	
2	5150.0000	31.78	16.28	48.06	54.00	-5.94	AVG	
3	5175.2000	72.33	16.31	88.64	999.00	-910.36	AVG	No Limit
4 *	5175.4000	78.86	16.31	95.17	68.20	26.97	Peak	No Limit

REMARKS:

- (1) Measurement Value = Reading Level + Correct Factor.
- (2) Margin Level = Measurement Value - Limit Value.

Test Mode	UNII-1_TX AC(VHT40) Mode 5190 MHz	Polarization	Horizontal
-----------	-----------------------------------	--------------	------------

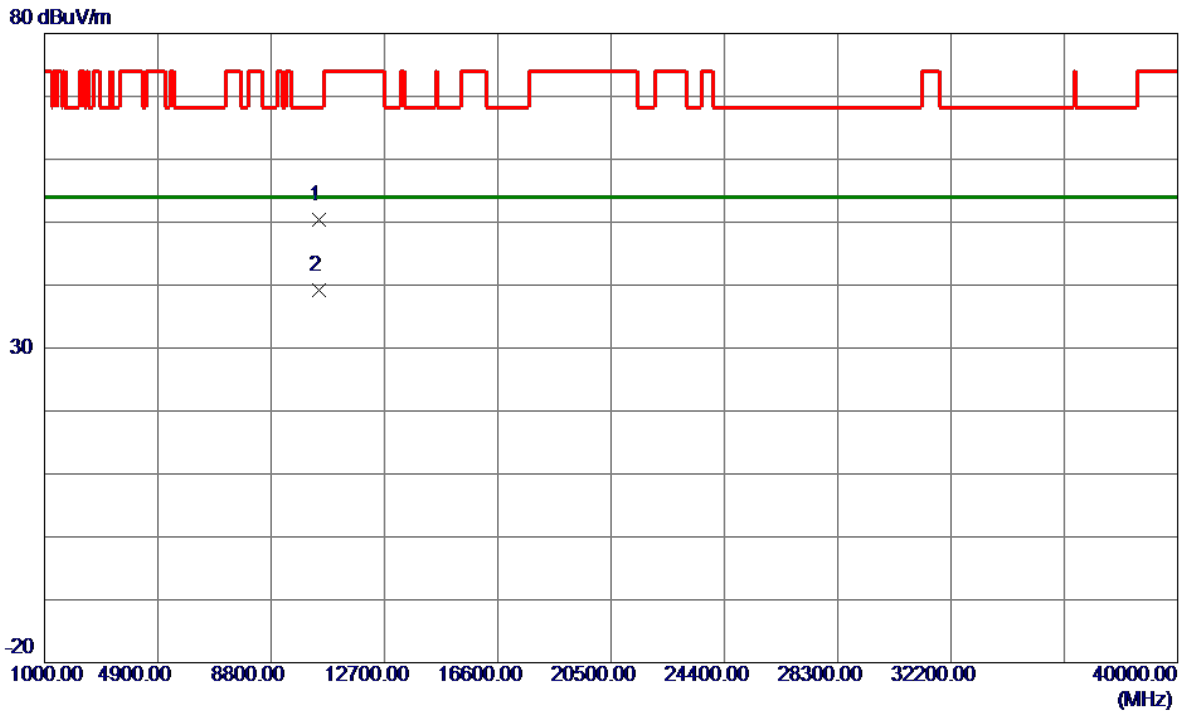

No.	Freq. MHz	Reading Level dBuV/m	Correct Factor dB	Measure ment dBuV/m	Limit dBuV/m	Margin dB	Detector	Comment
1	10460.0000	38.08	12.35	50.43	68.20	-17.77	Peak	
2 *	10460.0000	26.77	12.35	39.12	54.00	-14.88	AVG	

REMARKS:

- (1) Measurement Value = Reading Level + Correct Factor.
- (2) Margin Level = Measurement Value - Limit Value.

Test Mode	UNII-1_TX AC(VHT40) Mode 5230 MHz	Polarization	Vertical
-----------	-----------------------------------	--------------	----------

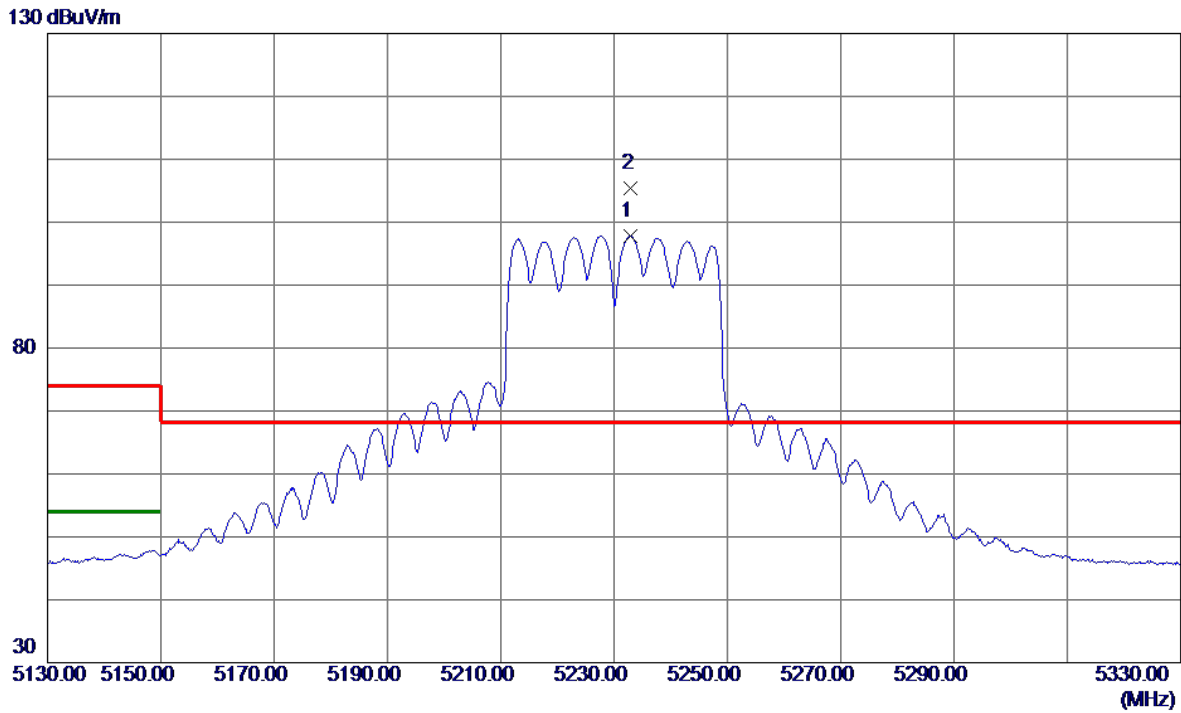

No.	Freq. MHz	Reading Level dBuV/m	Correct Factor dB	Measure ment dBuV/m	Limit dBuV/m	Margin dB	Detector	Comment
1	5232.8000	81.48	16.37	97.85	999.00	-901.15	AVG	No Limit
2 *	5233.0000	89.03	16.37	105.40	68.20	37.20	Peak	No Limit

REMARKS:

- (1) Measurement Value = Reading Level + Correct Factor.
- (2) Margin Level = Measurement Value - Limit Value.

Test Mode	UNII-1_TX AC(VHT40) Mode 5230 MHz	Polarization	Vertical
-----------	-----------------------------------	--------------	----------

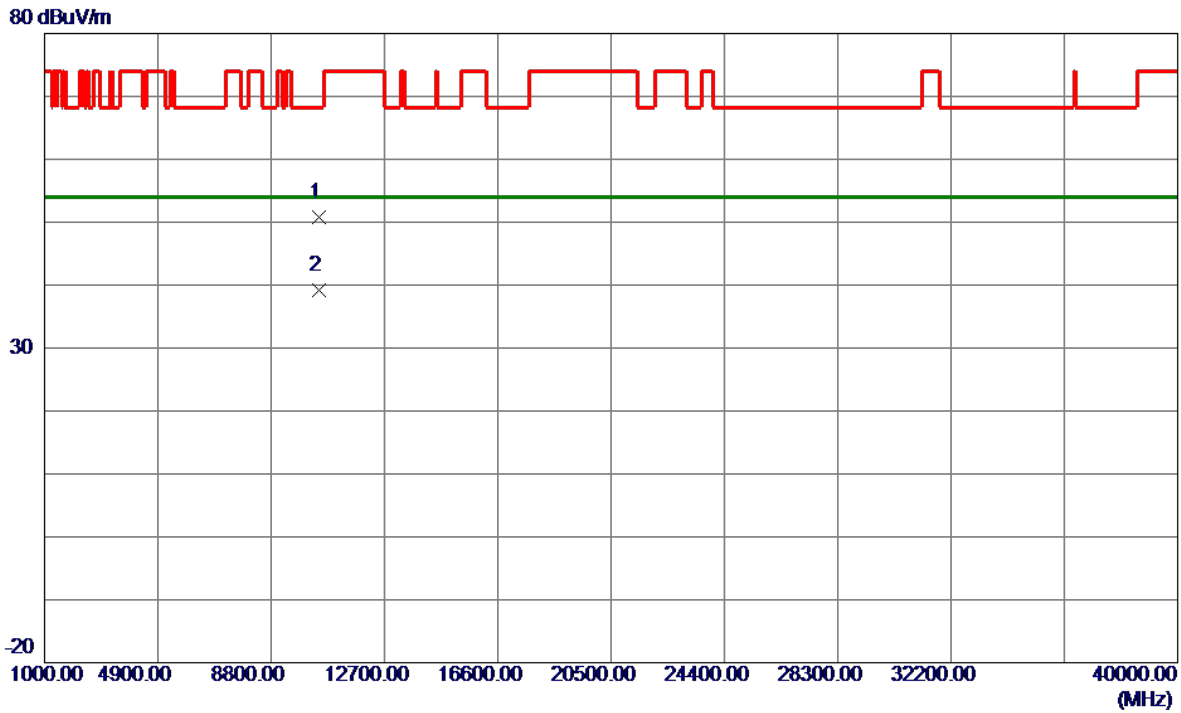

No.	Freq. MHz	Reading Level dBuV/m	Correct Factor dB	Measure ment dBuV/m	Limit dBuV/m	Margin dB	Detector	Comment
1	10460.0000	38.49	12.35	50.84	68.20	-17.36	Peak	
2 *	10460.0000	26.82	12.35	39.17	54.00	-14.83	AVG	

REMARKS:

- (1) Measurement Value = Reading Level + Correct Factor.
- (2) Margin Level = Measurement Value - Limit Value.

Test Mode	UNII-1_TX AC(VHT40) Mode 5230 MHz	Polarization	Horizontal
-----------	-----------------------------------	--------------	------------

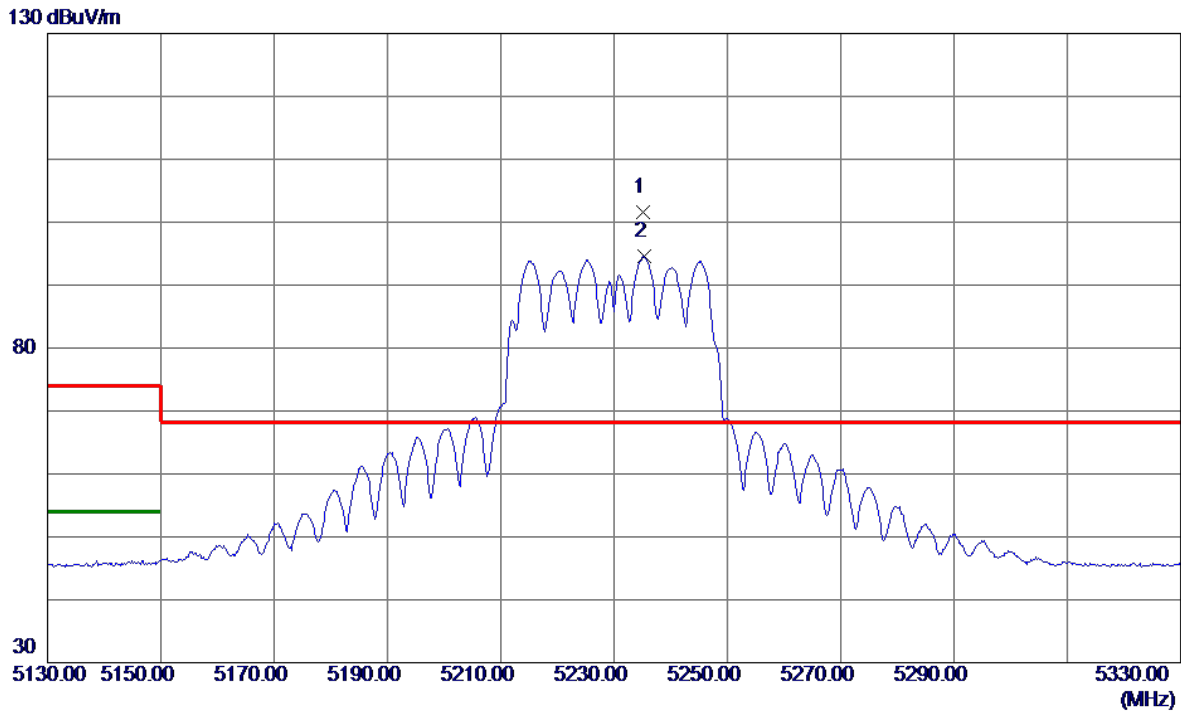

No.	Freq. MHz	Reading Level dBuV/m	Correct Factor dB	Measure ment dBuV/m	Limit dBuV/m	Margin dB	Detector	Comment
1 *	5235.2000	85.17	16.38	101.55	68.20	33.35	Peak	No Limit
2	5235.4000	78.19	16.38	94.57	999.00	-904.43	AVG	No Limit

REMARKS:

- (1) Measurement Value = Reading Level + Correct Factor.
- (2) Margin Level = Measurement Value - Limit Value.

Test Mode	UNII-1_TX AC(VHT40) Mode 5230 MHz	Polarization	Horizontal
-----------	-----------------------------------	--------------	------------

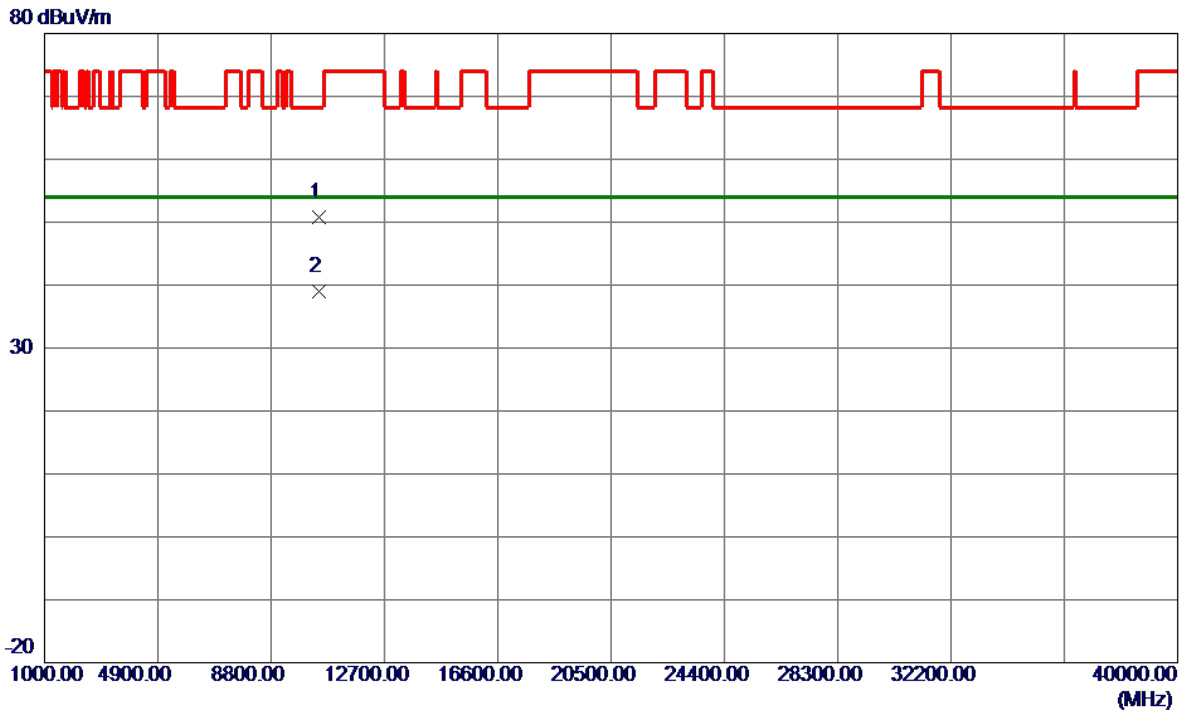

No.	Freq. MHz	Reading Level dBuV/m	Correct Factor dB	Measure ment dBuV/m	Limit dBuV/m	Margin dB	Detector	Comment
1	10460.0000	38.37	12.35	50.72	68.20	-17.48	Peak	
2 *	10460.0000	26.71	12.35	39.06	54.00	-14.94	AVG	

REMARKS:

- (1) Measurement Value = Reading Level + Correct Factor.
- (2) Margin Level = Measurement Value - Limit Value.

Test Mode	UNII-1_TX AC(VHT80) Mode 5210 MHz	Polarization	Vertical
-----------	-----------------------------------	--------------	----------

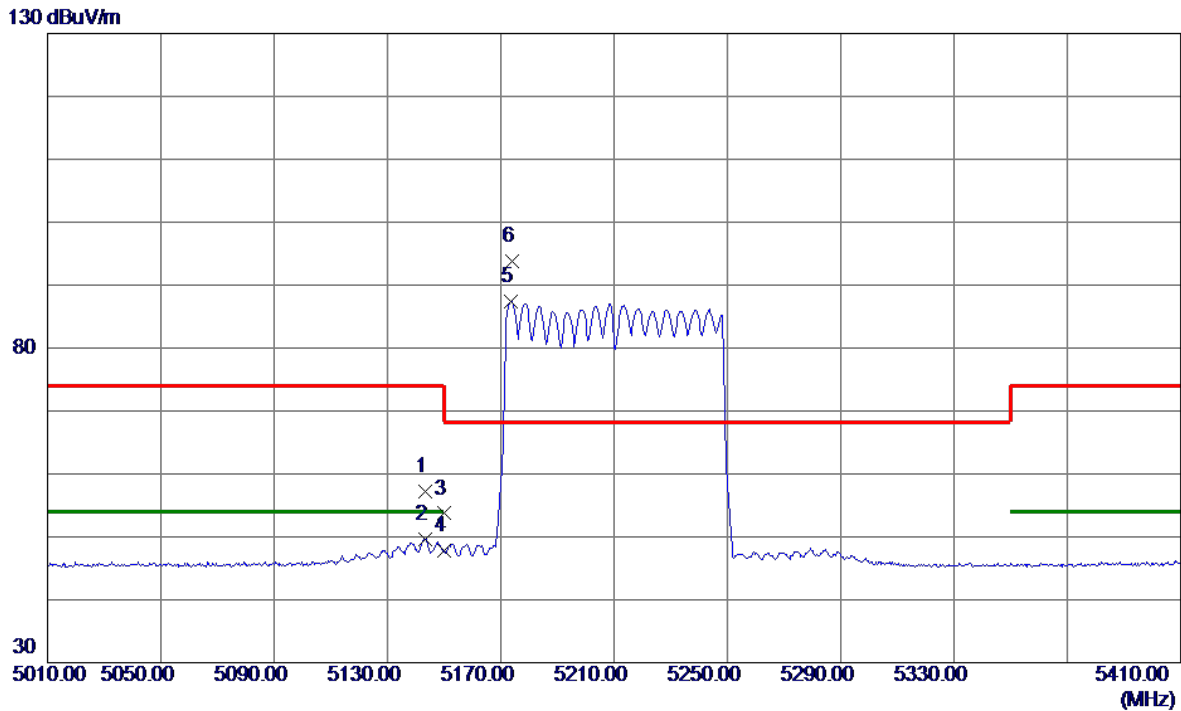

No.	Freq. MHz	Reading Level dBuV/m	Correct Factor dB	Measure ment dBuV/m	Limit dBuV/m	Margin dB	Detector	Comment
1	5143.2000	40.95	16.28	57.23	74.00	-16.77	Peak	
2	5143.2000	33.31	16.28	49.59	54.00	-4.41	AVG	
3	5150.0000	37.42	16.28	53.70	74.00	-20.30	Peak	
4	5150.0000	31.43	16.28	47.71	54.00	-6.29	AVG	
5	5173.6000	71.09	16.31	87.40	999.00	-911.60	AVG	No Limit
6 *	5174.0000	77.50	16.31	93.81	68.20	25.61	Peak	No Limit

REMARKS:

- (1) Measurement Value = Reading Level + Correct Factor.
- (2) Margin Level = Measurement Value - Limit Value.

Test Mode	UNII-1_TX AC(VHT80) Mode 5210 MHz	Polarization	Vertical
-----------	-----------------------------------	--------------	----------

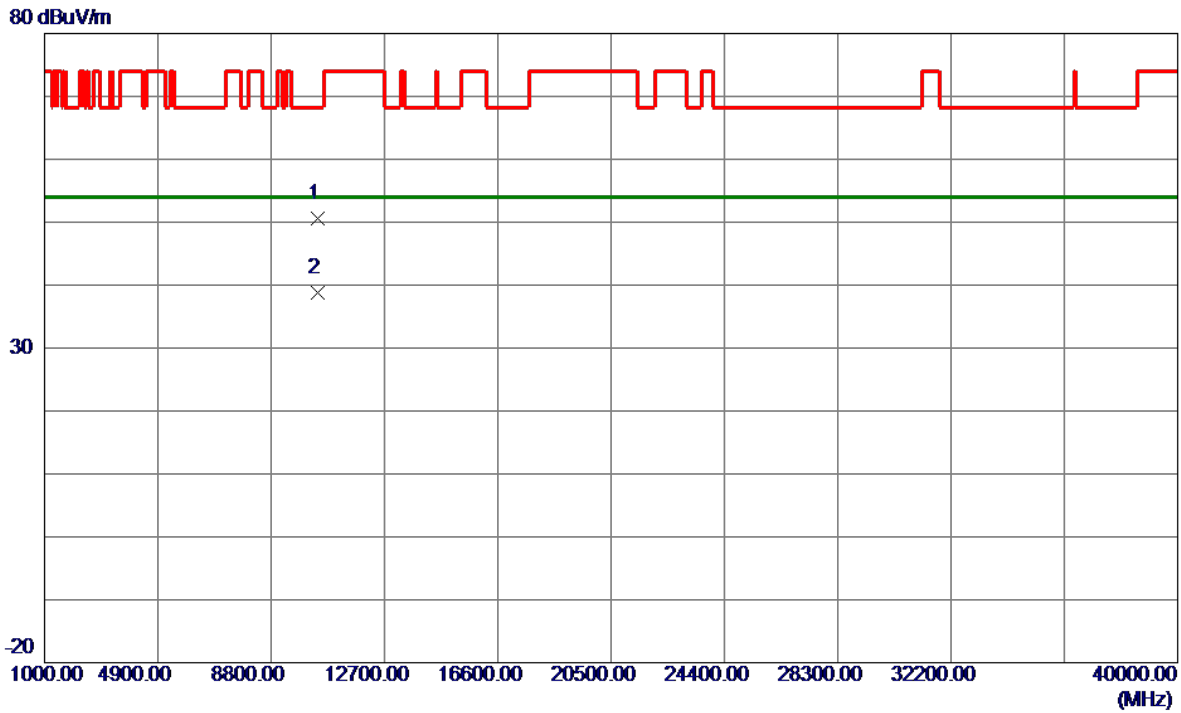

No.	Freq. MHz	Reading Level dBuV/m	Correct Factor dB	Measure ment dBuV/m	Limit dBuV/m	Margin dB	Detector	Comment
1	10420.0000	38.23	12.32	50.55	68.20	-17.65	Peak	
2 *	10420.0000	26.46	12.32	38.78	54.00	-15.22	AVG	

REMARKS:

- (1) Measurement Value = Reading Level + Correct Factor.
- (2) Margin Level = Measurement Value - Limit Value.

Test Mode	UNII-1_TX AC(VHT80) Mode 5210 MHz	Polarization	Horizontal
-----------	-----------------------------------	--------------	------------

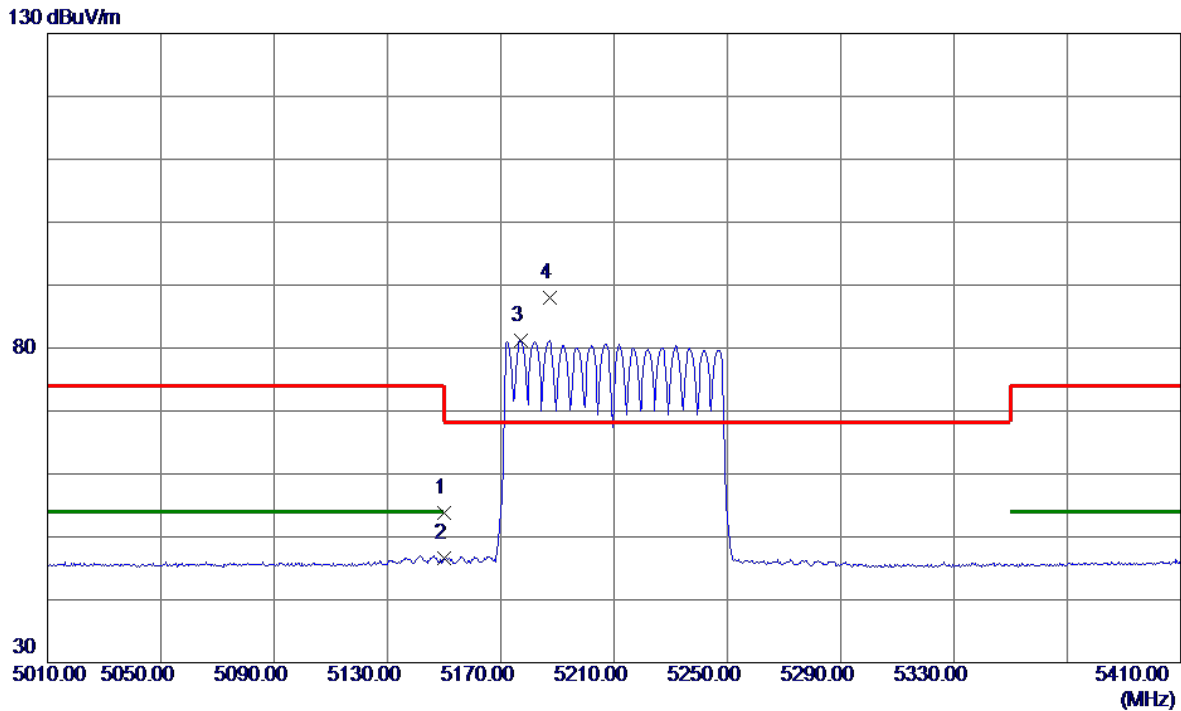

No.	Freq. MHz	Reading Level dBuV/m	Correct Factor dB	Measure ment dBuV/m	Limit dBuV/m	Margin dB	Detector	Comment
1	5150.0000	37.53	16.28	53.81	74.00	-20.19	Peak	
2	5150.0000	30.30	16.28	46.58	54.00	-7.42	AVG	
3	5177.2000	64.87	16.31	81.18	999.00	-917.82	AVG	No Limit
4 *	5187.2000	71.76	16.32	88.08	68.20	19.88	Peak	No Limit

REMARKS:

- (1) Measurement Value = Reading Level + Correct Factor.
- (2) Margin Level = Measurement Value - Limit Value.

Test Mode	UNII-1_TX AC(VHT80) Mode 5210 MHz	Polarization	Horizontal
-----------	-----------------------------------	--------------	------------

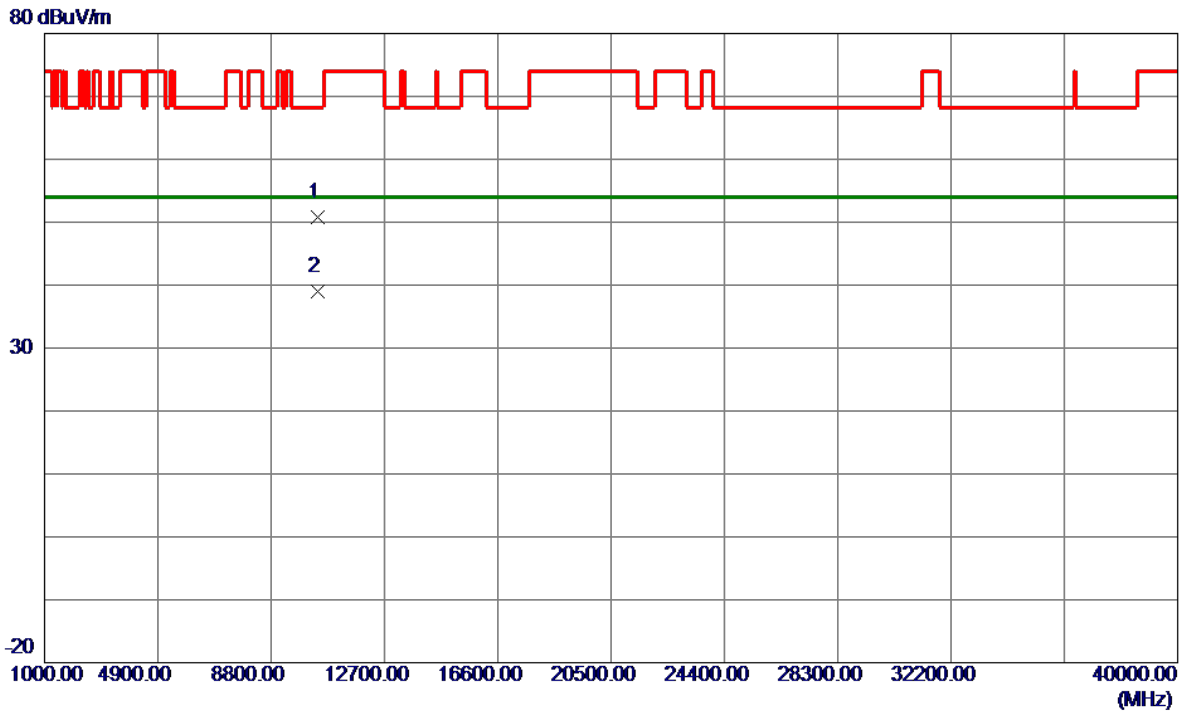

No.	Freq. MHz	Reading Level dBuV/m	Correct Factor dB	Measure ment dBuV/m	Limit dBuV/m	Margin dB	Detector	Comment
1	10420.0000	38.53	12.32	50.85	68.20	-17.35	Peak	
2 *	10420.0000	26.63	12.32	38.95	54.00	-15.05	AVG	

REMARKS:

- (1) Measurement Value = Reading Level + Correct Factor.
- (2) Margin Level = Measurement Value - Limit Value.

Test Mode	UNII-2A_TX A Mode 5260 MHz	Polarization	Vertical
-----------	----------------------------	--------------	----------

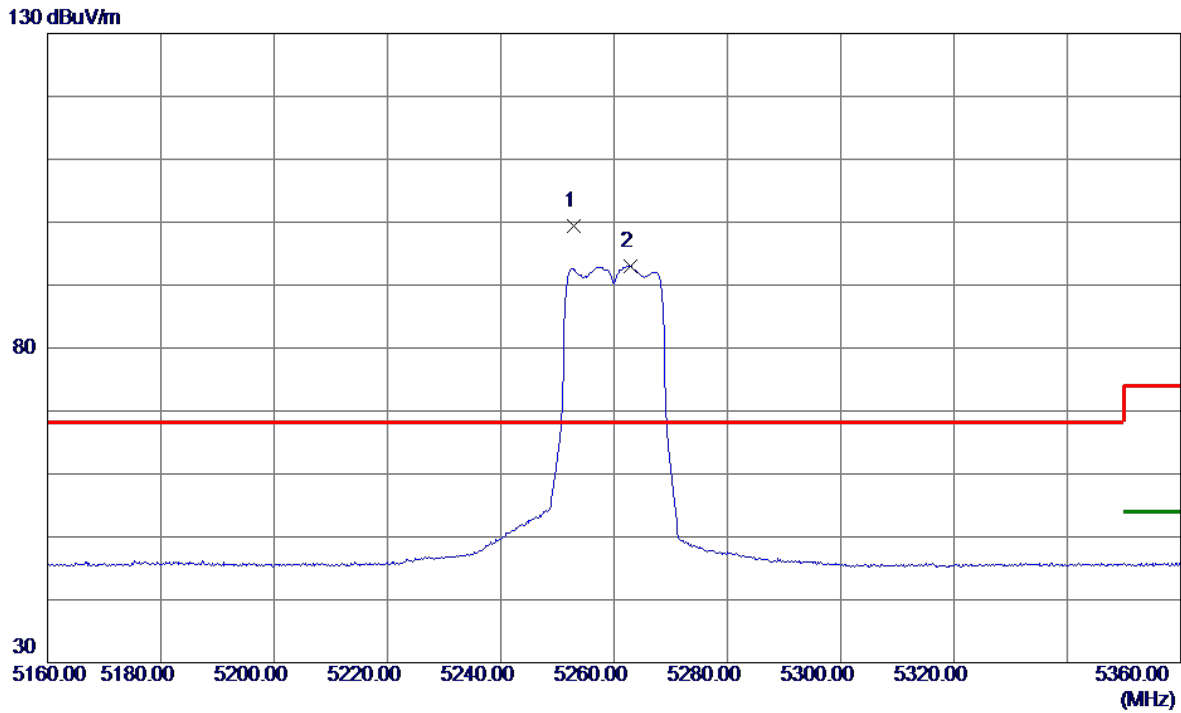

No.	Freq. MHz	Reading Level dBuV/m	Correct Factor dB	Measure ment dBuV/m	Limit dBuV/m	Margin dB	Detector	Comment
1 *	5252.8000	82.96	16.40	99.36	68.20	31.16	Peak	No Limit
2	5262.8000	76.67	16.41	93.08	999.00	-905.92	AVG	No Limit

REMARKS:

- (1) Measurement Value = Reading Level + Correct Factor.
- (2) Margin Level = Measurement Value - Limit Value.

Test Mode	UNII-2A_TX A Mode 5260 MHz	Polarization	Vertical
-----------	----------------------------	--------------	----------

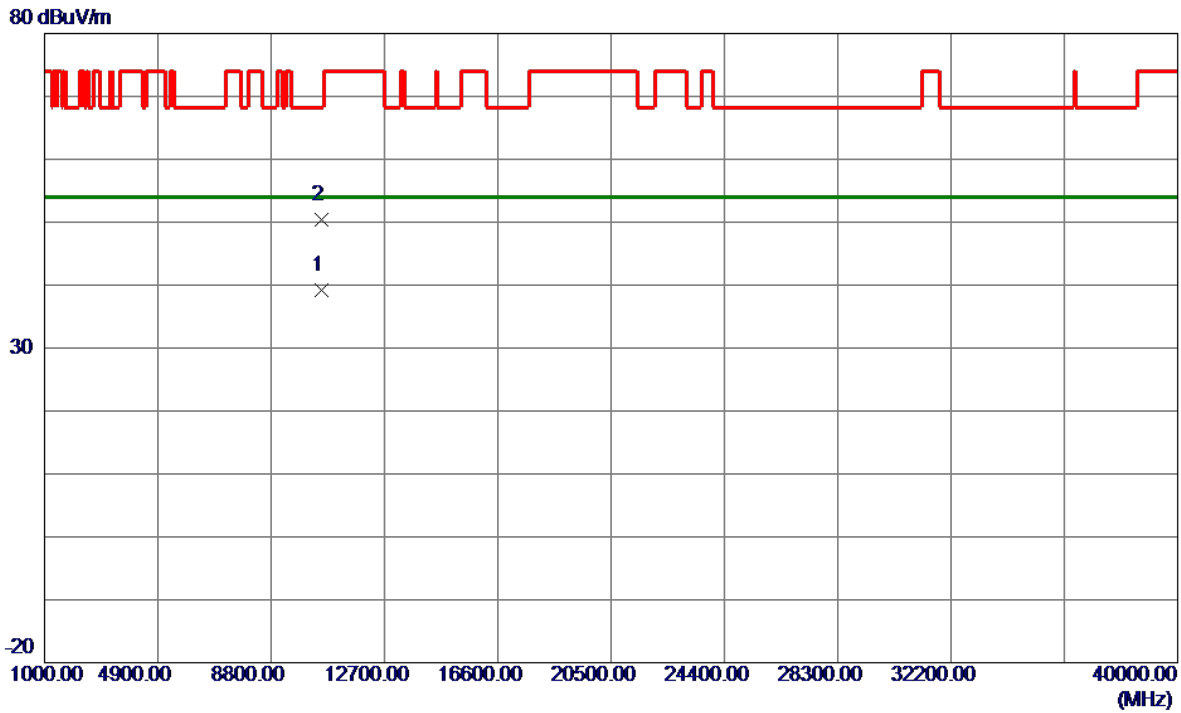

No.	Freq. MHz	Reading Level dBuV/m	Correct Factor dB	Measure ment dBuV/m	Limit dBuV/m	Margin dB	Detector	Comment
1 *	10519.0050	26.81	12.39	39.20	54.00	-14.80	AVG	
2	10519.1150	37.94	12.39	50.33	68.20	-17.87	Peak	

REMARKS:

- (1) Measurement Value = Reading Level + Correct Factor.
- (2) Margin Level = Measurement Value - Limit Value.

Test Mode	UNII-2A_TX A Mode 5260 MHz	Polarization	Horizontal
-----------	----------------------------	--------------	------------

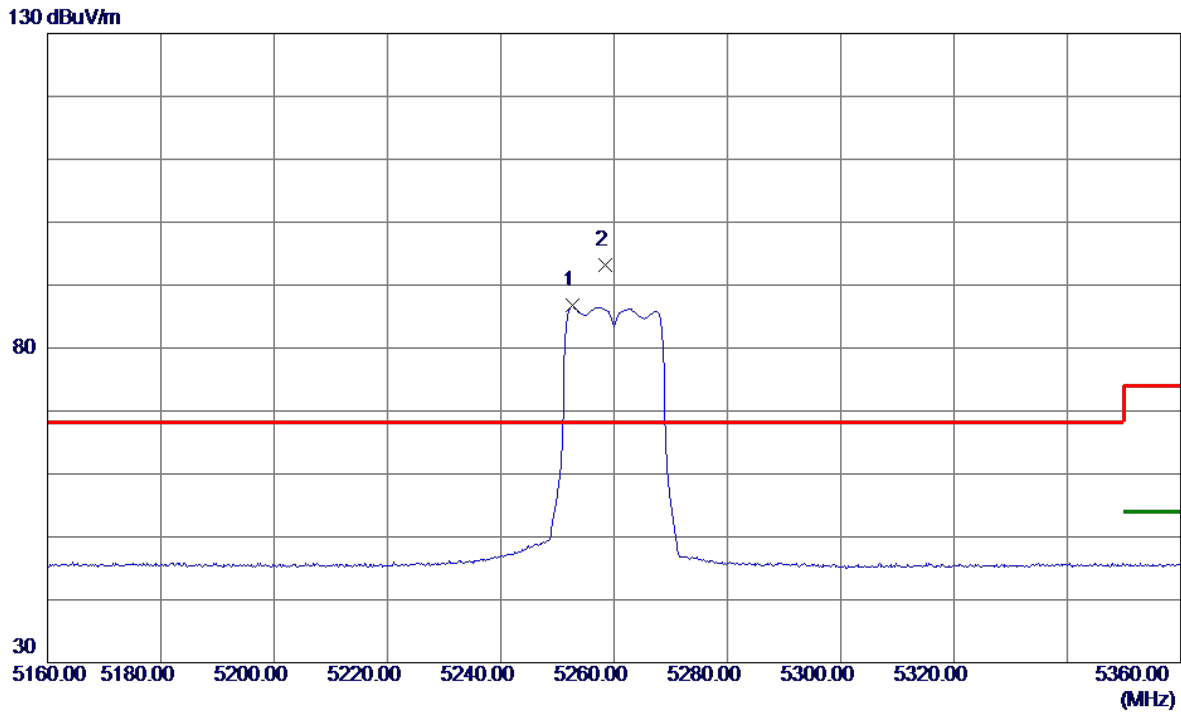

No.	Freq. MHz	Reading Level dBuV/m	Correct Factor dB	Measure ment dBuV/m	Limit dBuV/m	Margin dB	Detector	Comment
1	5252.6000	70.34	16.40	86.74	999.00	-912.26	AVG	No Limit
2 *	5258.4000	76.86	16.40	93.26	68.20	25.06	Peak	No Limit

REMARKS:

- (1) Measurement Value = Reading Level + Correct Factor.
- (2) Margin Level = Measurement Value - Limit Value.

Test Mode	UNII-2A_TX A Mode 5260 MHz	Polarization	Horizontal
-----------	----------------------------	--------------	------------

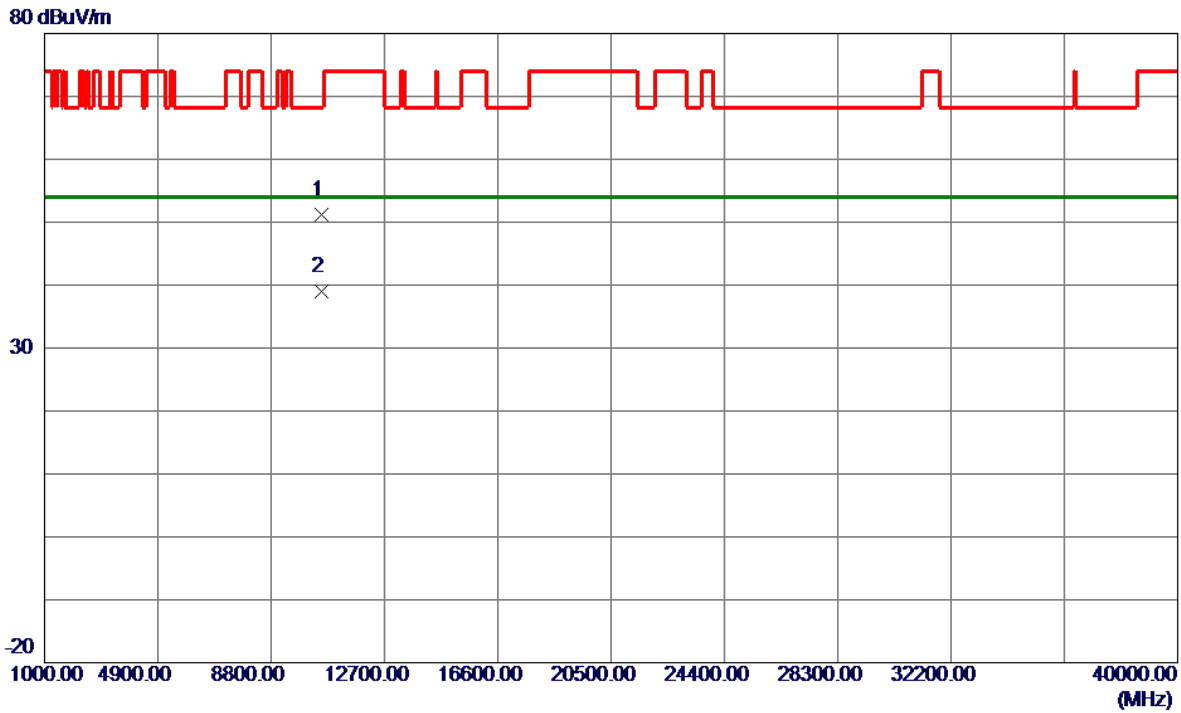

No.	Freq. MHz	Reading Level dBuV/m	Correct Factor dB	Measure ment dBuV/m	Limit dBuV/m	Margin dB	Detector	Comment
1	10520.0000	38.77	12.39	51.16	68.20	-17.04	Peak	
2 *	10520.0000	26.59	12.39	38.98	54.00	-15.02	AVG	

REMARKS:

- (1) Measurement Value = Reading Level + Correct Factor.
- (2) Margin Level = Measurement Value - Limit Value.

Test Mode	UNII-2A_TX A Mode 5300 MHz	Polarization	Vertical
-----------	----------------------------	--------------	----------

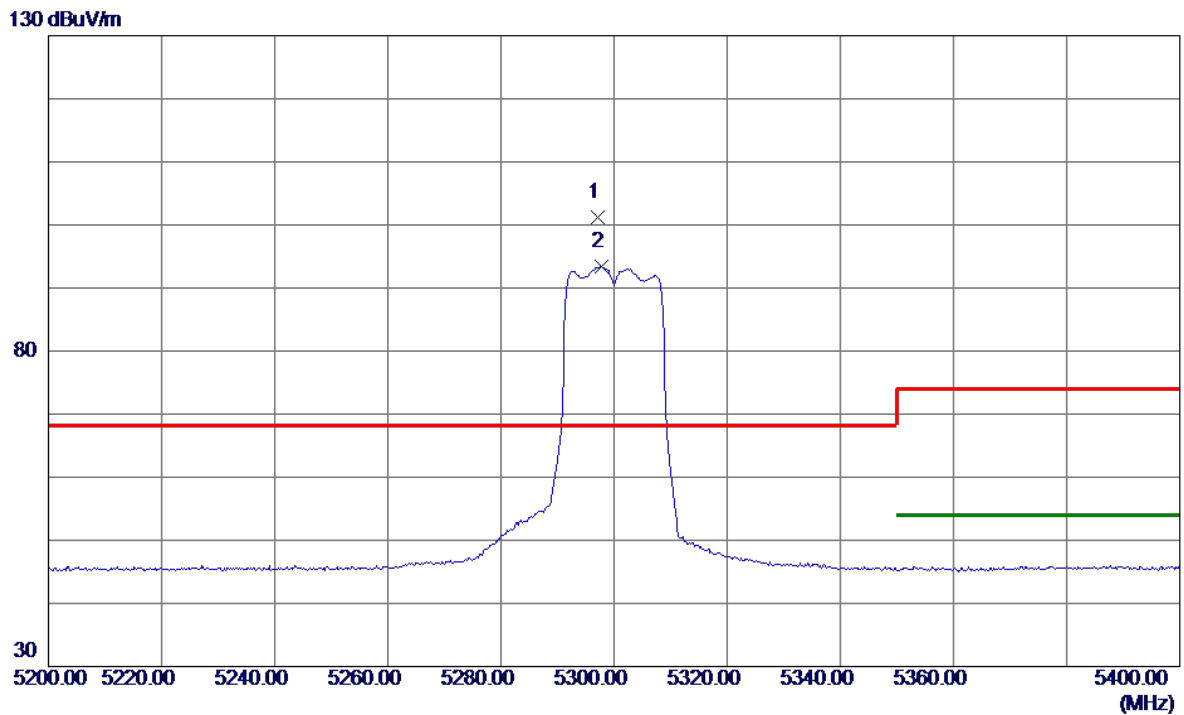

No.	Freq. MHz	Reading Level dBuV/m	Correct Factor dB	Measure ment dBuV/m	Limit dBuV/m	Margin dB	Detector	Comment
1 *	5297.2000	84.85	16.44	101.29	68.20	33.09	Peak	No Limit
2	5297.8000	76.93	16.44	93.37	999.00	-905.63	AVG	No Limit

REMARKS:

- (1) Measurement Value = Reading Level + Correct Factor.
- (2) Margin Level = Measurement Value - Limit Value.

Test Mode	UNII-2A_TX A Mode 5300 MHz	Polarization	Vertical
-----------	----------------------------	--------------	----------

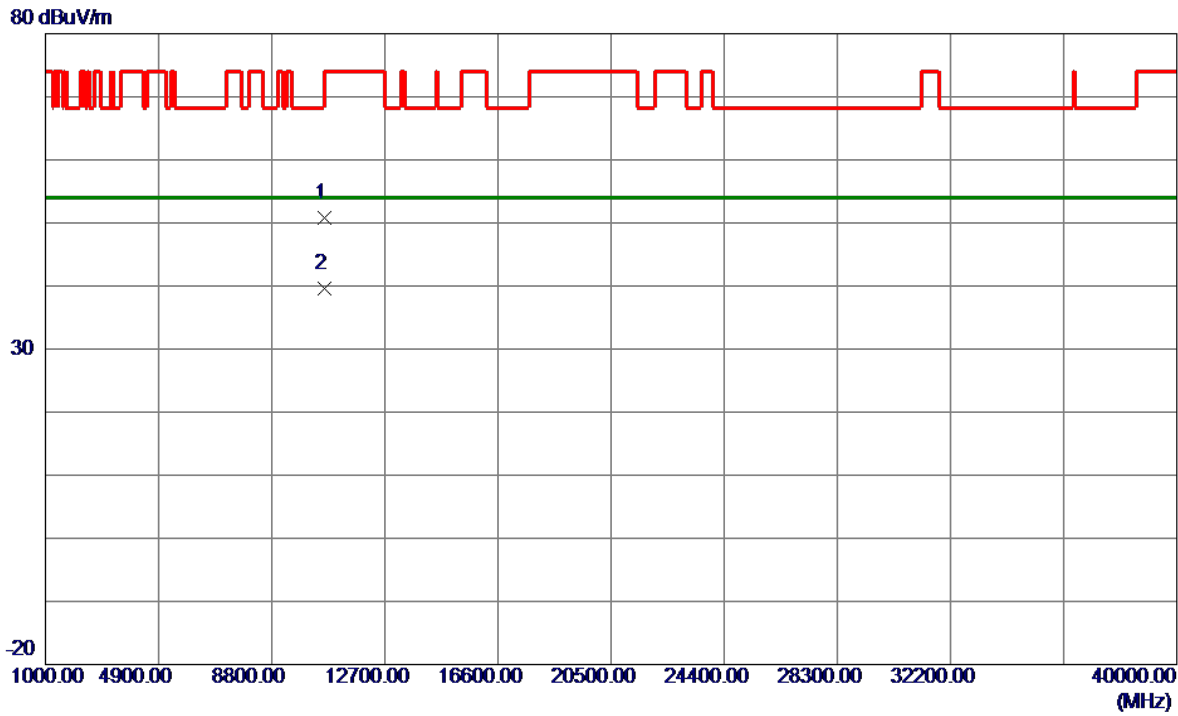

No.	Freq. MHz	Reading Level dBuV/m	Correct Factor dB	Measure ment dBuV/m	Limit dBuV/m	Margin dB	Detector	Comment
1	10600.8600	38.32	12.46	50.78	74.00	-23.22	Peak	
2 *	10602.2800	27.16	12.46	39.62	54.00	-14.38	AVG	

REMARKS:

- (1) Measurement Value = Reading Level + Correct Factor.
- (2) Margin Level = Measurement Value - Limit Value.

Test Mode	UNII-2A_TX A Mode 5300 MHz	Polarization	Horizontal
-----------	----------------------------	--------------	------------

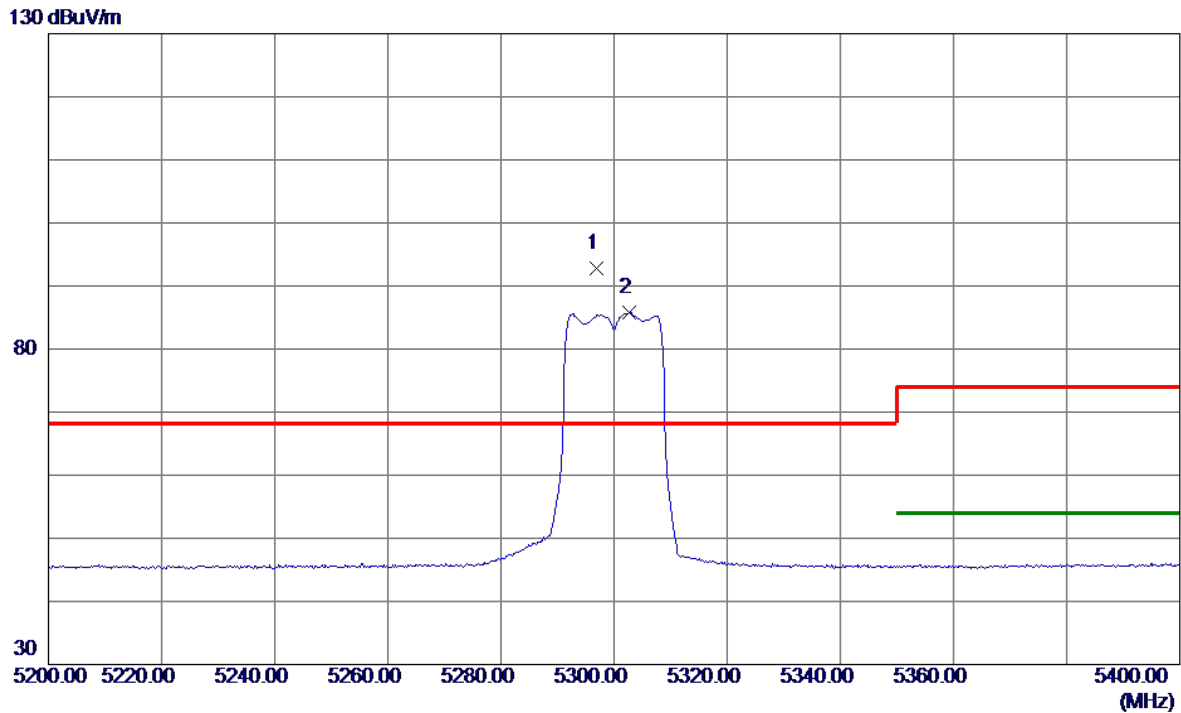

No.	Freq. MHz	Reading Level dBuV/m	Correct Factor dB	Measure ment dBuV/m	Limit dBuV/m	Margin dB	Detector	Comment
1 *	5296.8000	76.32	16.44	92.76	68.20	24.56	Peak	No Limit
2	5302.6000	69.40	16.45	85.85	999.00	-913.15	AVG	No Limit

REMARKS:

- (1) Measurement Value = Reading Level + Correct Factor.
- (2) Margin Level = Measurement Value - Limit Value.

Test Mode	UNII-2A_TX A Mode 5300 MHz	Polarization	Horizontal
-----------	----------------------------	--------------	------------

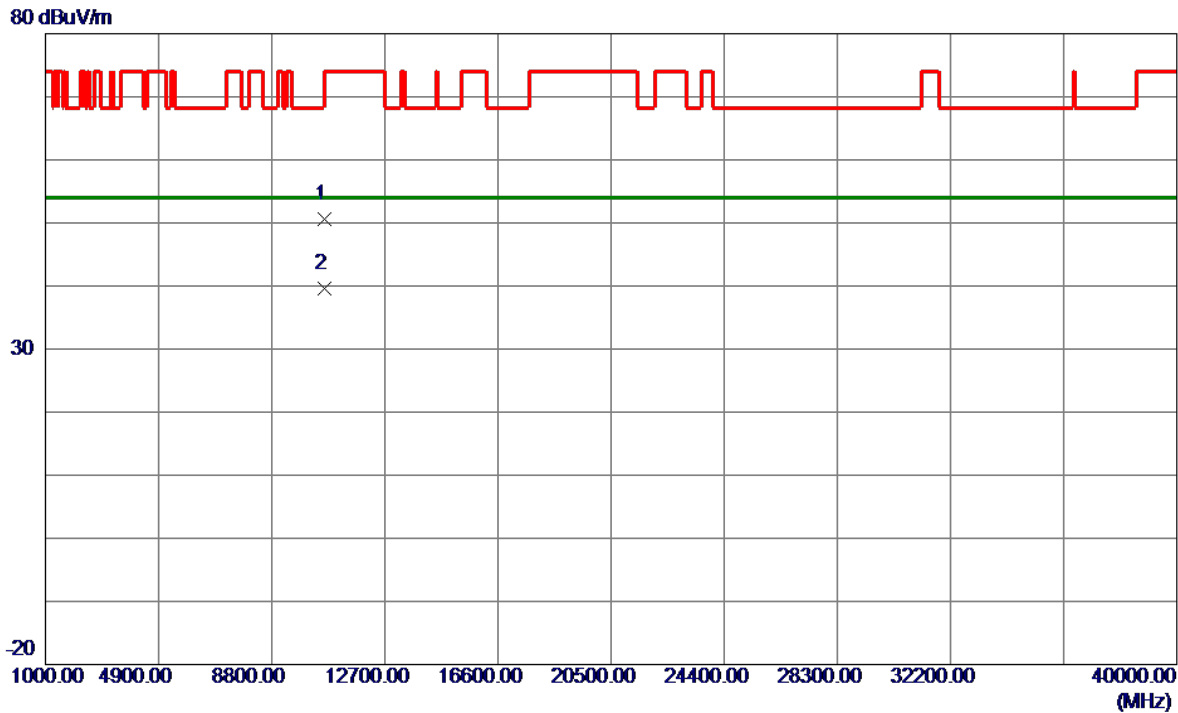

No.	Freq. MHz	Reading Level dBuV/m	Correct Factor dB	Measure ment dBuV/m	Limit dBuV/m	Margin dB	Detector	Comment
1	10600.0000	38.11	12.46	50.57	68.20	-17.63	Peak	
2 *	10600.0000	27.08	12.46	39.54	54.00	-14.46	AVG	

REMARKS:

- (1) Measurement Value = Reading Level + Correct Factor.
- (2) Margin Level = Measurement Value - Limit Value.

Test Mode	UNII-2A_TX A Mode 5320 MHz	Polarization	Vertical
-----------	----------------------------	--------------	----------

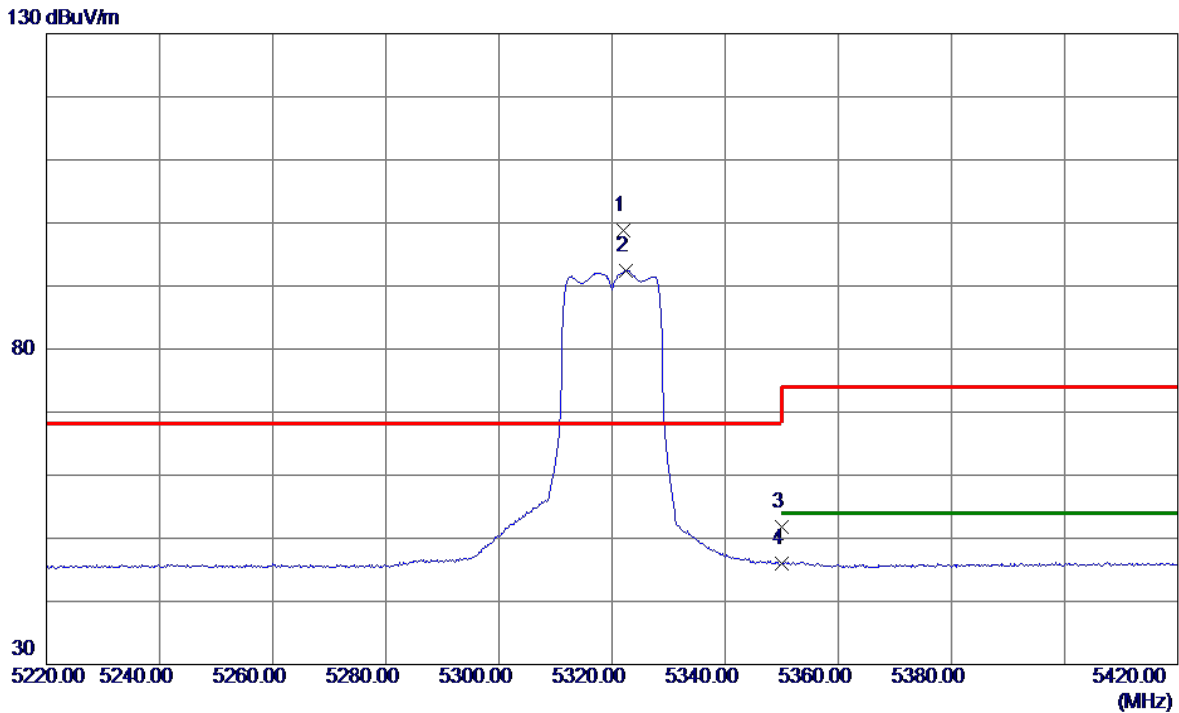

No.	Freq. MHz	Reading Level dBuV/m	Correct Factor dB	Measure ment dBuV/m	Limit dBuV/m	Margin dB	Detector	Comment
1 *	5322.0000	82.32	16.47	98.79	68.20	30.59	Peak	No Limit
2	5322.4000	76.01	16.47	92.48	999.00	-906.52	AVG	No Limit
3	5350.0000	35.28	16.50	51.78	74.00	-22.22	Peak	
4	5350.0000	29.50	16.50	46.00	54.00	-8.00	AVG	

REMARKS:

- (1) Measurement Value = Reading Level + Correct Factor.
- (2) Margin Level = Measurement Value - Limit Value.

Test Mode	UNII-2A_TX A Mode 5320 MHz	Polarization	Vertical
-----------	----------------------------	--------------	----------

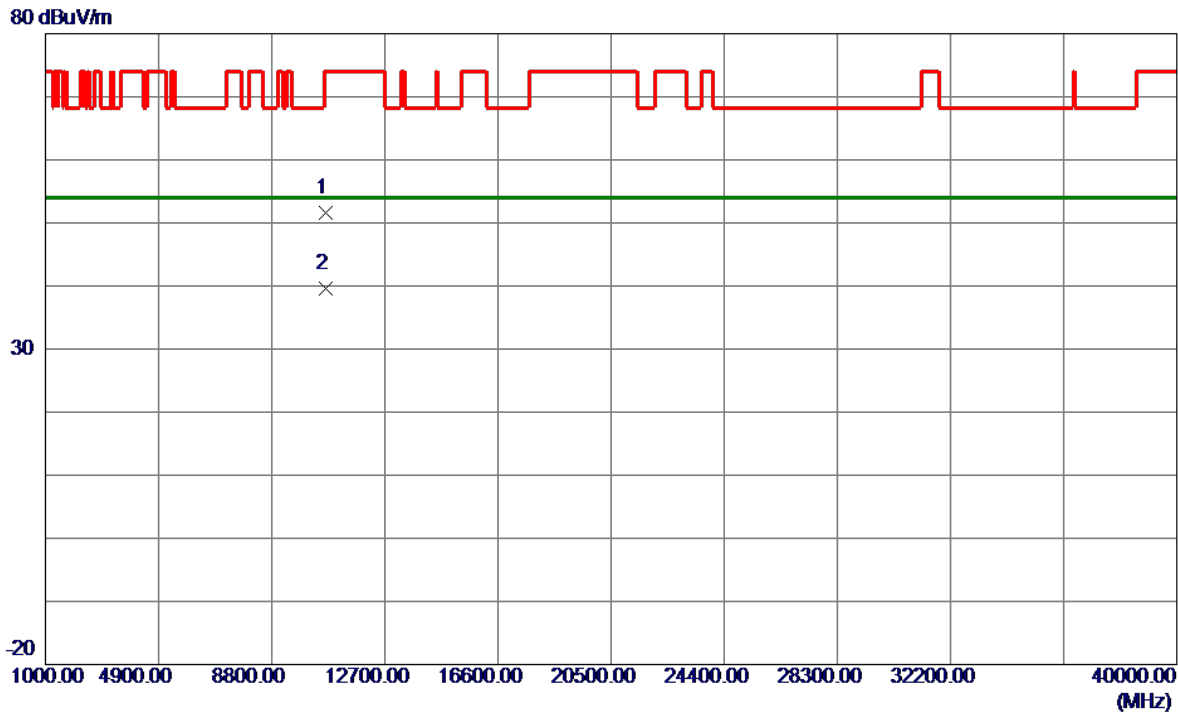

No.	Freq. MHz	Reading Level dBuV/m	Correct Factor dB	Measure ment dBuV/m	Limit dBuV/m	Margin dB	Detector	Comment
1	10642.0650	39.06	12.49	51.55	74.00	-22.45	Peak	
2 *	10642.3949	27.10	12.49	39.59	54.00	-14.41	AVG	

REMARKS:

- (1) Measurement Value = Reading Level + Correct Factor.
- (2) Margin Level = Measurement Value - Limit Value.

Test Mode	UNII-2A_TX A Mode 5320 MHz	Polarization	Horizontal
-----------	----------------------------	--------------	------------

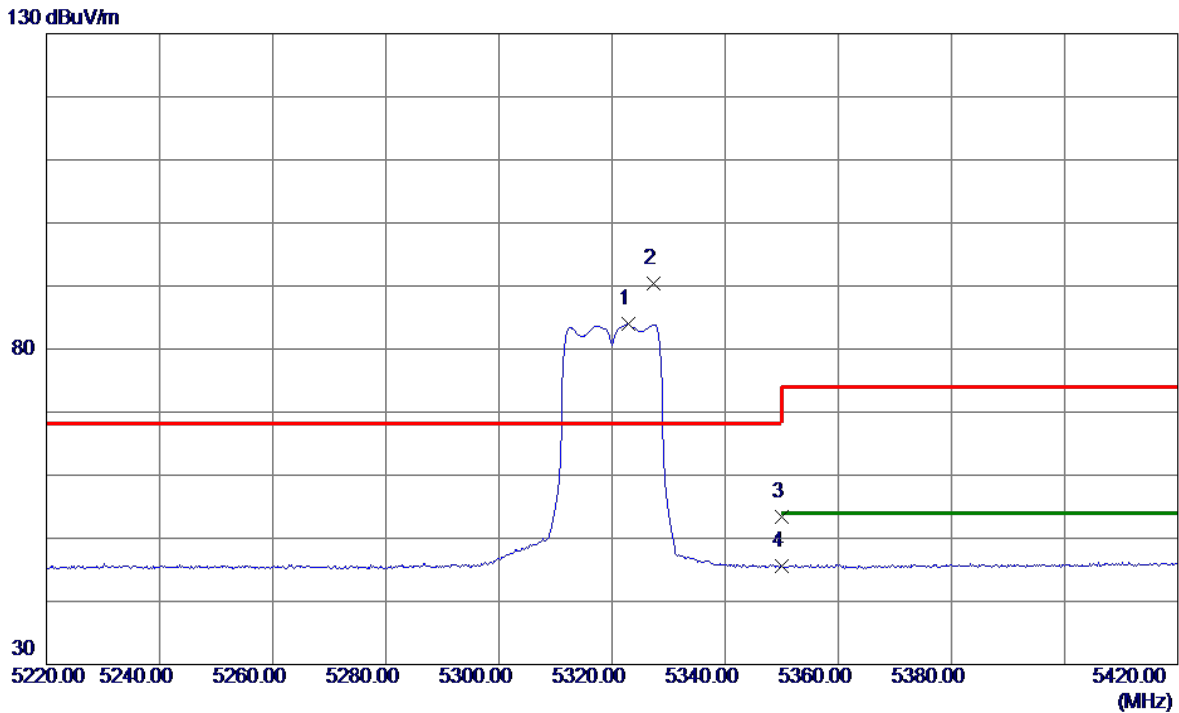

No.	Freq. MHz	Reading Level dBuV/m	Correct Factor dB	Measure ment dBuV/m	Limit dBuV/m	Margin dB	Detector	Comment
1	5322.8000	67.44	16.47	83.91	999.00	-915.09	AVG	No Limit
2 *	5327.4000	73.87	16.48	90.35	68.20	22.15	Peak	No Limit
3	5350.0000	36.87	16.50	53.37	74.00	-20.63	Peak	
4	5350.0000	29.08	16.50	45.58	54.00	-8.42	AVG	

REMARKS:

- (1) Measurement Value = Reading Level + Correct Factor.
- (2) Margin Level = Measurement Value - Limit Value.

Test Mode	UNII-2A_TX A Mode 5320 MHz	Polarization	Horizontal
-----------	----------------------------	--------------	------------

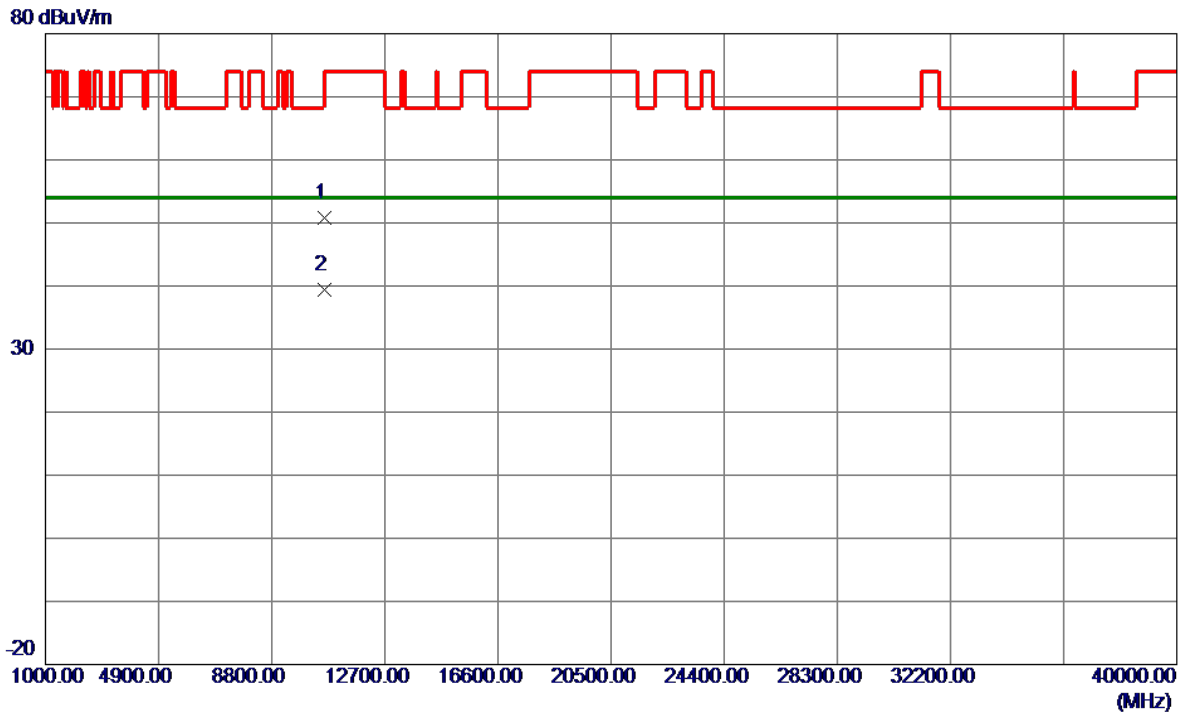

No.	Freq. MHz	Reading Level dBuV/m	Correct Factor dB	Measure ment dBuV/m	Limit dBuV/m	Margin dB	Detector	Comment
1	10640.0000	38.28	12.49	50.77	74.00	-23.23	Peak	
2 *	10640.0000	26.85	12.49	39.34	54.00	-14.66	AVG	

REMARKS:

- (1) Measurement Value = Reading Level + Correct Factor.
- (2) Margin Level = Measurement Value - Limit Value.

Test Mode	UNII-2A_TX AC(VHT20) Mode 5260 MHz	Polarization	Vertical
-----------	------------------------------------	--------------	----------

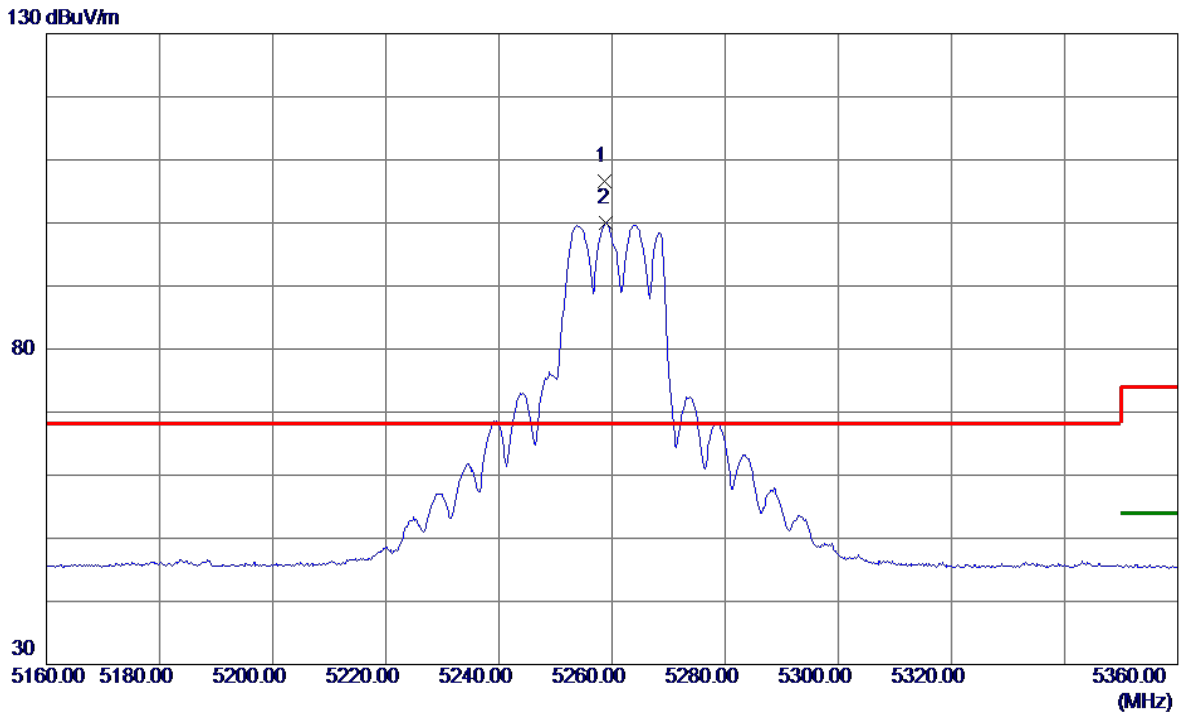

No.	Freq. MHz	Reading Level dBuV/m	Correct Factor dB	Measure ment dBuV/m	Limit dBuV/m	Margin dB	Detector	Comment
1 *	5258.6000	90.25	16.40	106.65	68.20	38.45	Peak	No Limit
2	5259.0000	83.62	16.40	100.02	999.00	-898.98	AVG	No Limit

REMARKS:

- (1) Measurement Value = Reading Level + Correct Factor.
- (2) Margin Level = Measurement Value - Limit Value.

Test Mode	UNII-2A_TX AC(VHT20) Mode 5260 MHz	Polarization	Vertical
-----------	------------------------------------	--------------	----------

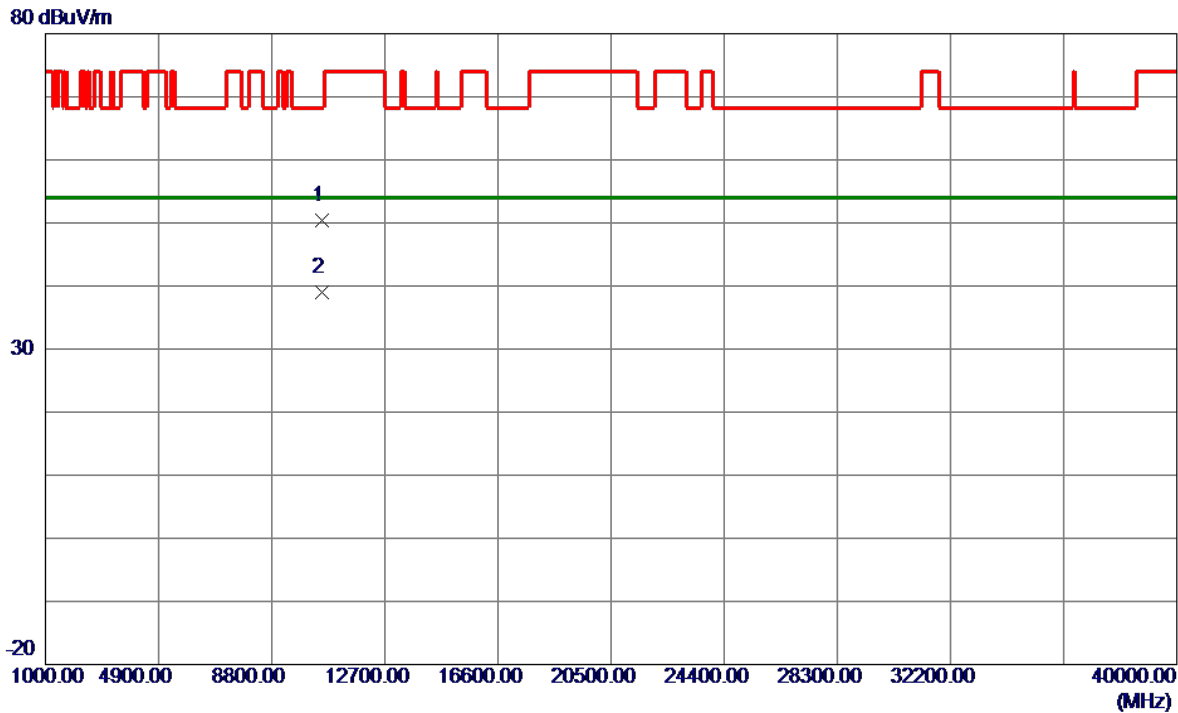

No.	Freq. MHz	Reading Level dBuV/m	Correct Factor dB	Measure ment dBuV/m	Limit dBuV/m	Margin dB	Detector	Comment
1	10518.5950	37.95	12.39	50.34	68.20	-17.86	Peak	
2 *	10519.3850	26.68	12.39	39.07	54.00	-14.93	AVG	

REMARKS:

- (1) Measurement Value = Reading Level + Correct Factor.
- (2) Margin Level = Measurement Value - Limit Value.

Test Mode	UNII-2A_TX AC(VHT20) Mode 5260 MHz	Polarization	Horizontal
-----------	------------------------------------	--------------	------------

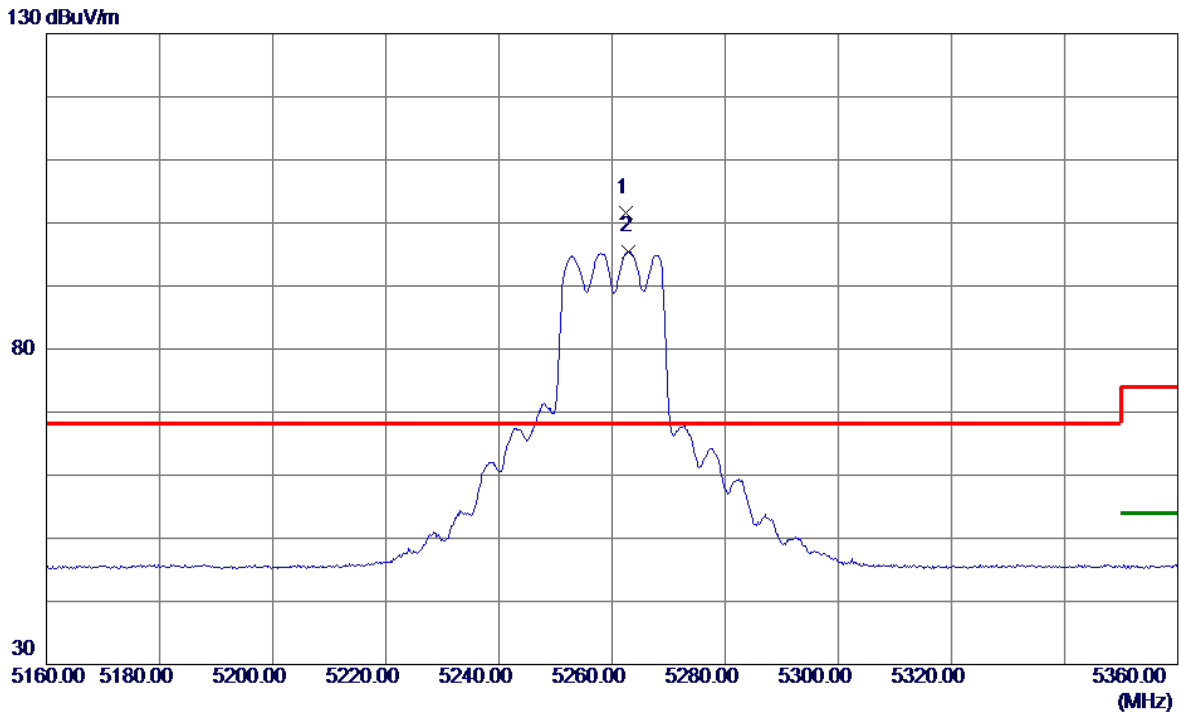

No.	Freq. MHz	Reading Level dBuV/m	Correct Factor dB	Measure ment dBuV/m	Limit dBuV/m	Margin dB	Detector	Comment
1 *	5262.4000	85.24	16.41	101.65	68.20	33.45	Peak	No Limit
2	5263.0000	79.09	16.41	95.50	999.00	-903.50	AVG	No Limit

REMARKS:

- (1) Measurement Value = Reading Level + Correct Factor.
- (2) Margin Level = Measurement Value - Limit Value.

Test Mode	UNII-2A_TX AC(VHT20) Mode 5260 MHz	Polarization	Horizontal
-----------	------------------------------------	--------------	------------

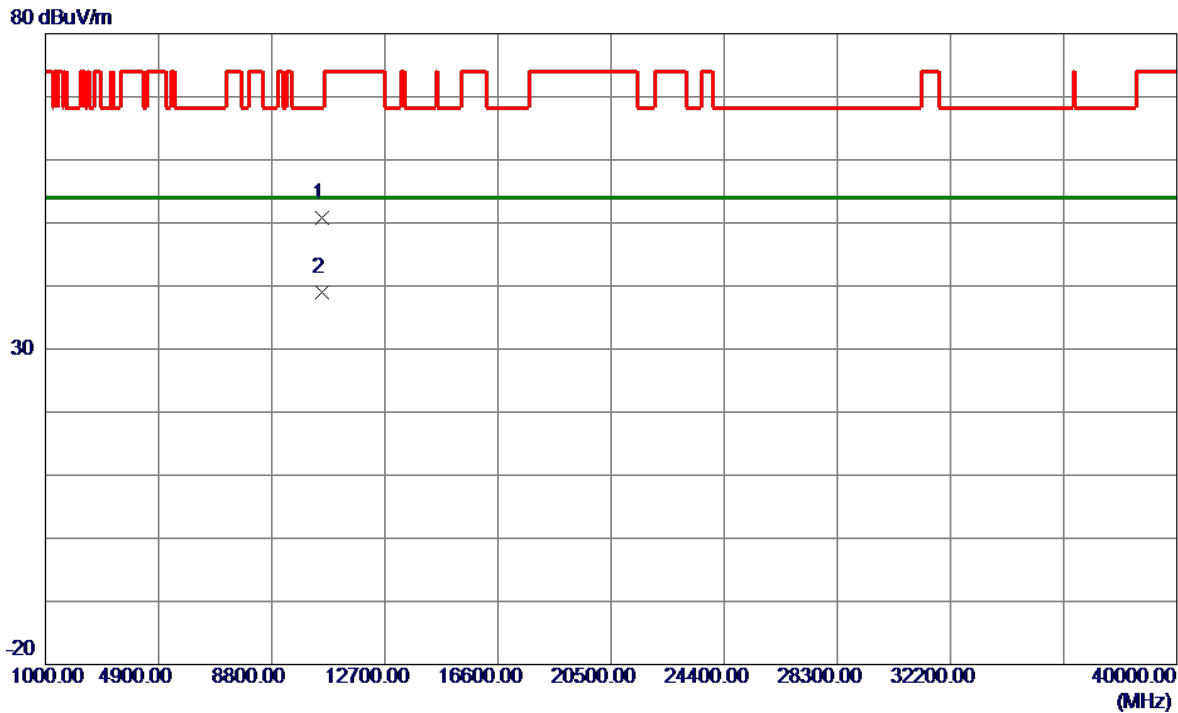

No.	Freq. MHz	Reading Level dBuV/m	Correct Factor dB	Measure ment dBuV/m	Limit dBuV/m	Margin dB	Detector	Comment
1	10520.0000	38.50	12.39	50.89	68.20	-17.31	Peak	
2 *	10520.0000	26.64	12.39	39.03	54.00	-14.97	AVG	

REMARKS:

- (1) Measurement Value = Reading Level + Correct Factor.
- (2) Margin Level = Measurement Value - Limit Value.

Test Mode	UNII-2A_TX AC(VHT20) Mode 5300 MHz	Polarization	Vertical
-----------	------------------------------------	--------------	----------

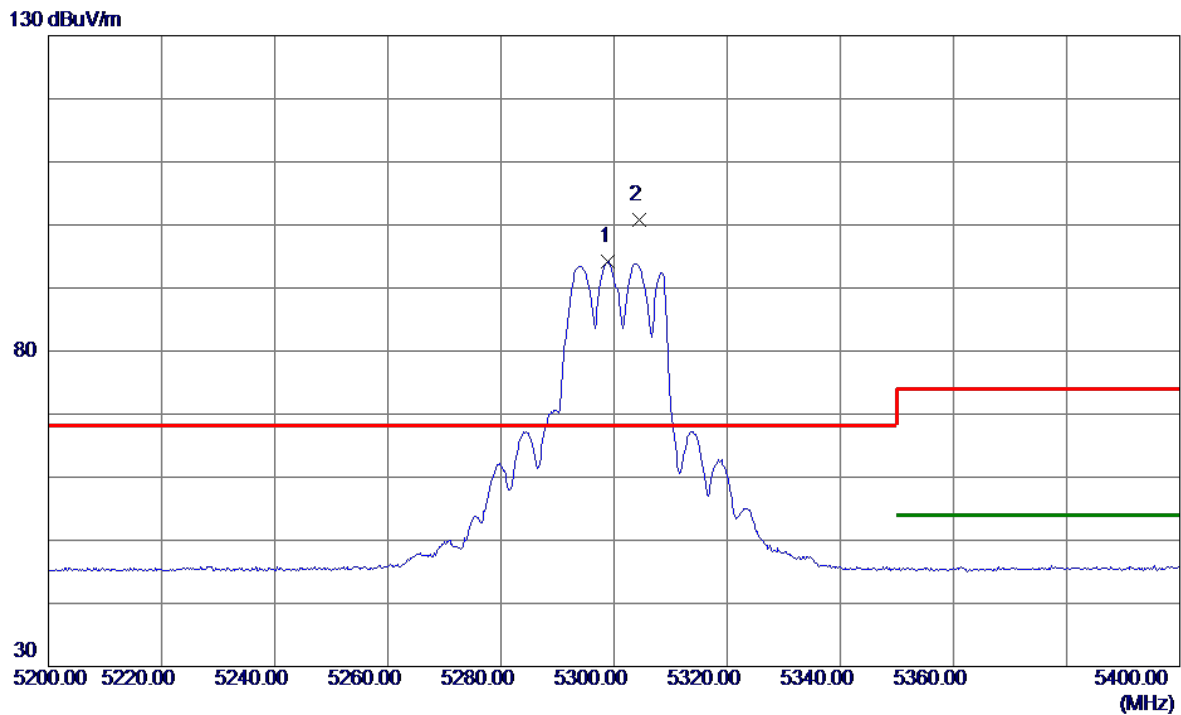

No.	Freq. MHz	Reading Level dBuV/m	Correct Factor dB	Measure ment dBuV/m	Limit dBuV/m	Margin dB	Detector	Comment
1	5299.0000	77.71	16.45	94.16	999.00	-904.84	AVG	No Limit
2 *	5304.4000	84.42	16.45	100.87	68.20	32.67	Peak	No Limit

REMARKS:

- (1) Measurement Value = Reading Level + Correct Factor.
- (2) Margin Level = Measurement Value - Limit Value.

Test Mode	UNII-2A_TX AC(VHT20) Mode 5300 MHz	Polarization	Vertical
-----------	------------------------------------	--------------	----------

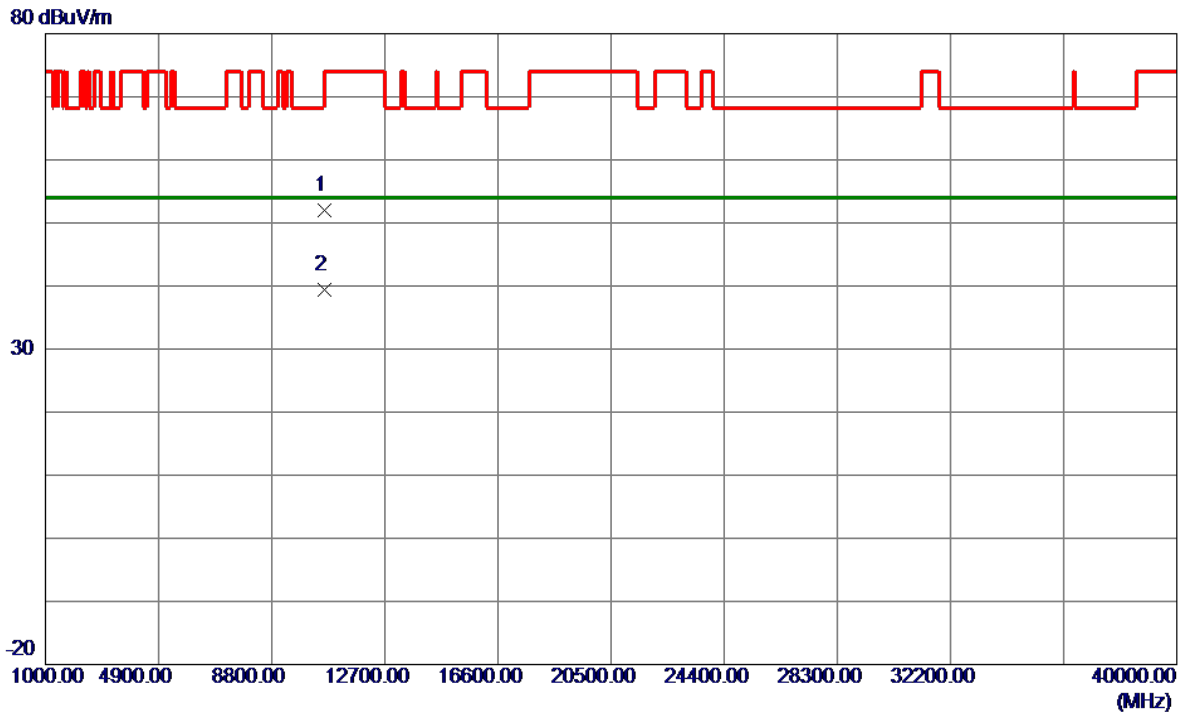

No.	Freq. MHz	Reading Level dBuV/m	Correct Factor dB	Measure ment dBuV/m	Limit dBuV/m	Margin dB	Detector	Comment
1	10601.5800	39.58	12.46	52.04	74.00	-21.96	Peak	
2 *	10601.9650	27.02	12.46	39.48	54.00	-14.52	AVG	

REMARKS:

- (1) Measurement Value = Reading Level + Correct Factor.
- (2) Margin Level = Measurement Value - Limit Value.

Test Mode	UNII-2A_TX AC(VHT20) Mode 5300 MHz	Polarization	Horizontal
-----------	------------------------------------	--------------	------------

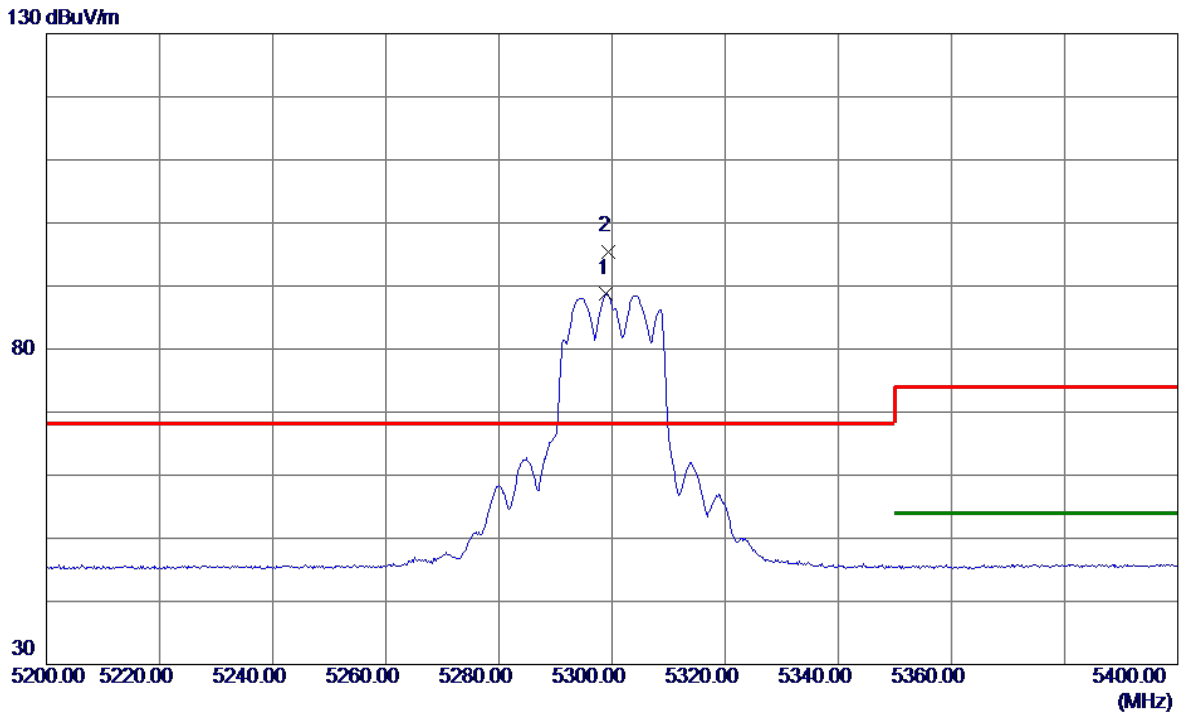

No.	Freq. MHz	Reading Level dBuV/m	Correct Factor dB	Measure ment dBuV/m	Limit dBuV/m	Margin dB	Detector	Comment
1	5299.0000	72.39	16.45	88.84	999.00	-910.16	AVG	No Limit
2 *	5299.4000	79.05	16.45	95.50	68.20	27.30	Peak	No Limit

REMARKS:

- (1) Measurement Value = Reading Level + Correct Factor.
- (2) Margin Level = Measurement Value - Limit Value.

Test Mode	UNII-2A_TX AC(VHT20) Mode 5300 MHz	Polarization	Horizontal
-----------	------------------------------------	--------------	------------

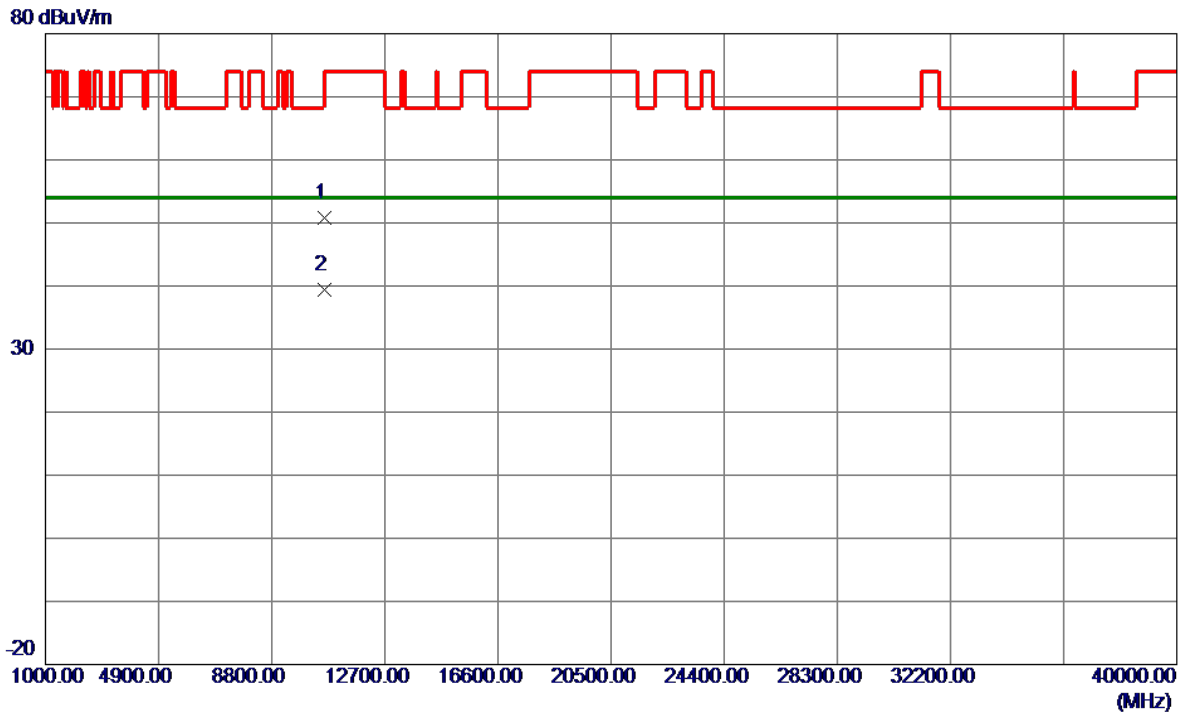

No.	Freq. MHz	Reading Level dBuV/m	Correct Factor dB	Measure ment dBuV/m	Limit dBuV/m	Margin dB	Detector	Comment
1	10600.0000	38.26	12.46	50.72	68.20	-17.48	Peak	
2 *	10600.0000	26.92	12.46	39.38	54.00	-14.62	AVG	

REMARKS:

- (1) Measurement Value = Reading Level + Correct Factor.
- (2) Margin Level = Measurement Value - Limit Value.

Test Mode	UNII-2A_TX AC(VHT20) Mode 5320 MHz	Polarization	Vertical
-----------	------------------------------------	--------------	----------

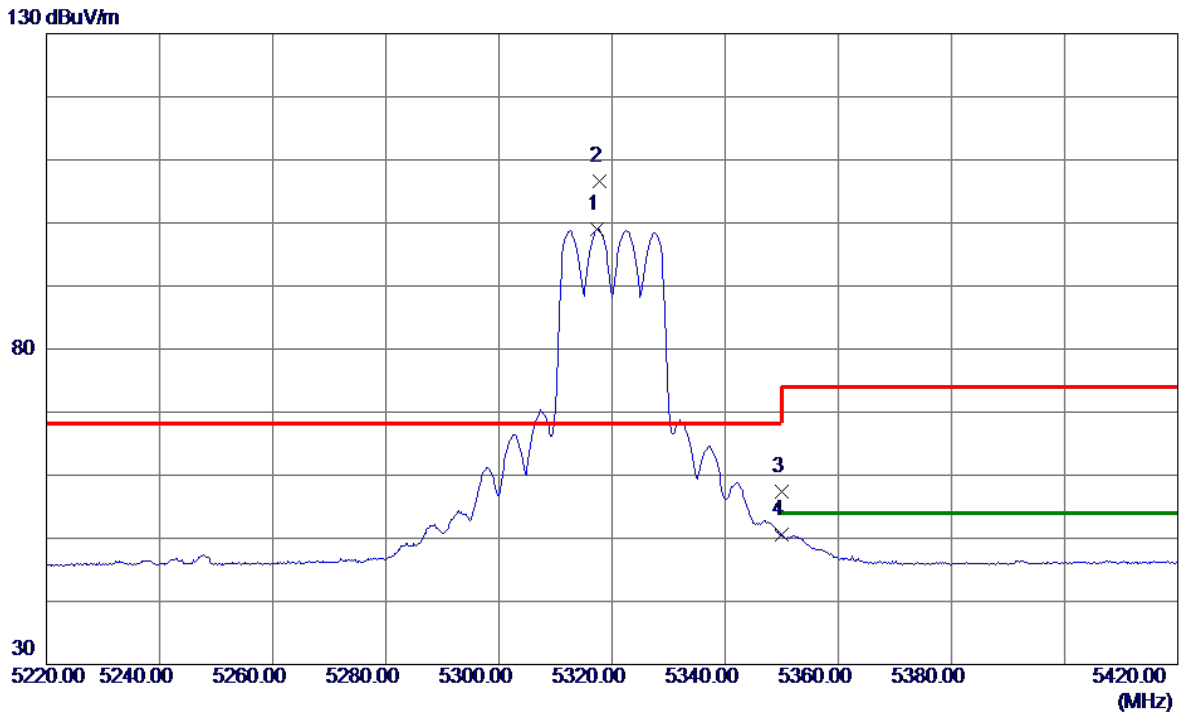

No.	Freq. MHz	Reading Level dBuV/m	Correct Factor dB	Measure ment dBuV/m	Limit dBuV/m	Margin dB	Detector	Comment
1	5317.4000	82.50	16.47	98.97	999.00	-900.03	AVG	No Limit
2 *	5317.8000	90.12	16.47	106.59	68.20	38.39	Peak	No Limit
3	5350.0000	40.97	16.50	57.47	74.00	-16.53	Peak	
4	5350.0000	34.03	16.50	50.53	54.00	-3.47	AVG	

REMARKS:

- (1) Measurement Value = Reading Level + Correct Factor.
- (2) Margin Level = Measurement Value - Limit Value.

Test Mode	UNII-2A_TX AC(VHT20) Mode 5320 MHz	Polarization	Vertical
-----------	------------------------------------	--------------	----------

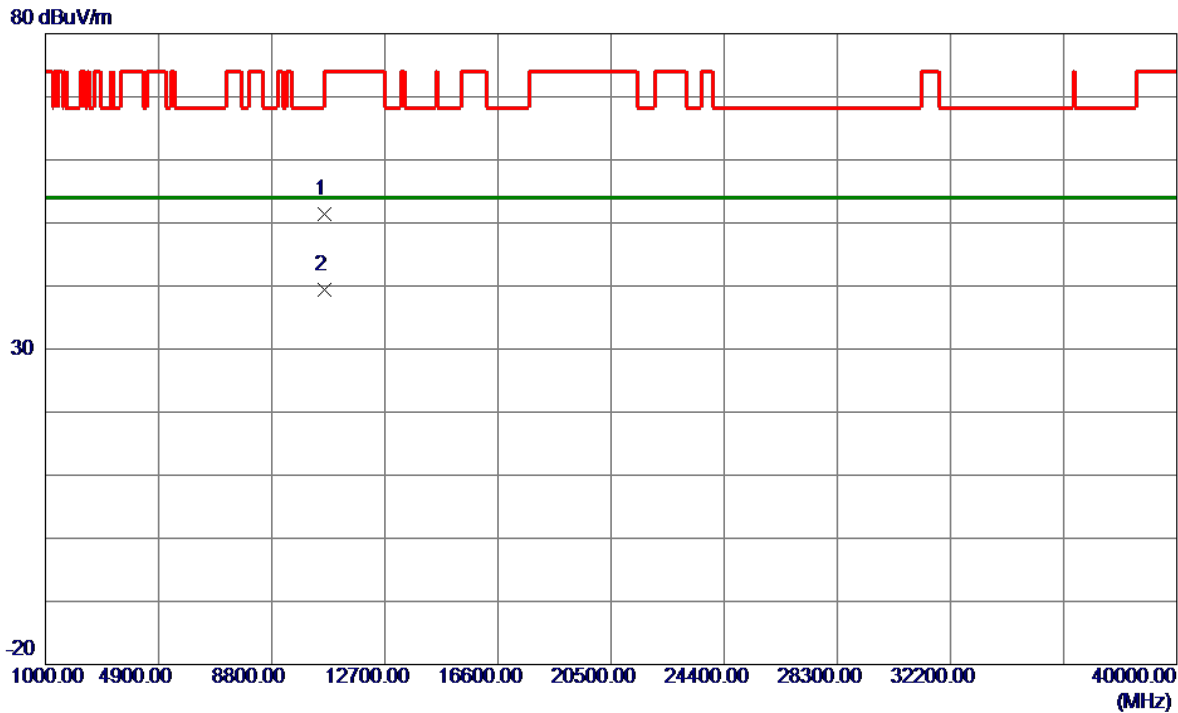

No.	Freq. MHz	Reading Level dBuV/m	Correct Factor dB	Measure ment dBuV/m	Limit dBuV/m	Margin dB	Detector	Comment
1	10639.6050	38.88	12.49	51.37	74.00	-22.63	Peak	
2 *	10641.3949	26.93	12.49	39.42	54.00	-14.58	AVG	

REMARKS:

- (1) Measurement Value = Reading Level + Correct Factor.
- (2) Margin Level = Measurement Value - Limit Value.

Test Mode	UNII-2A_TX AC(VHT20) Mode 5320 MHz	Polarization	Horizontal
-----------	------------------------------------	--------------	------------

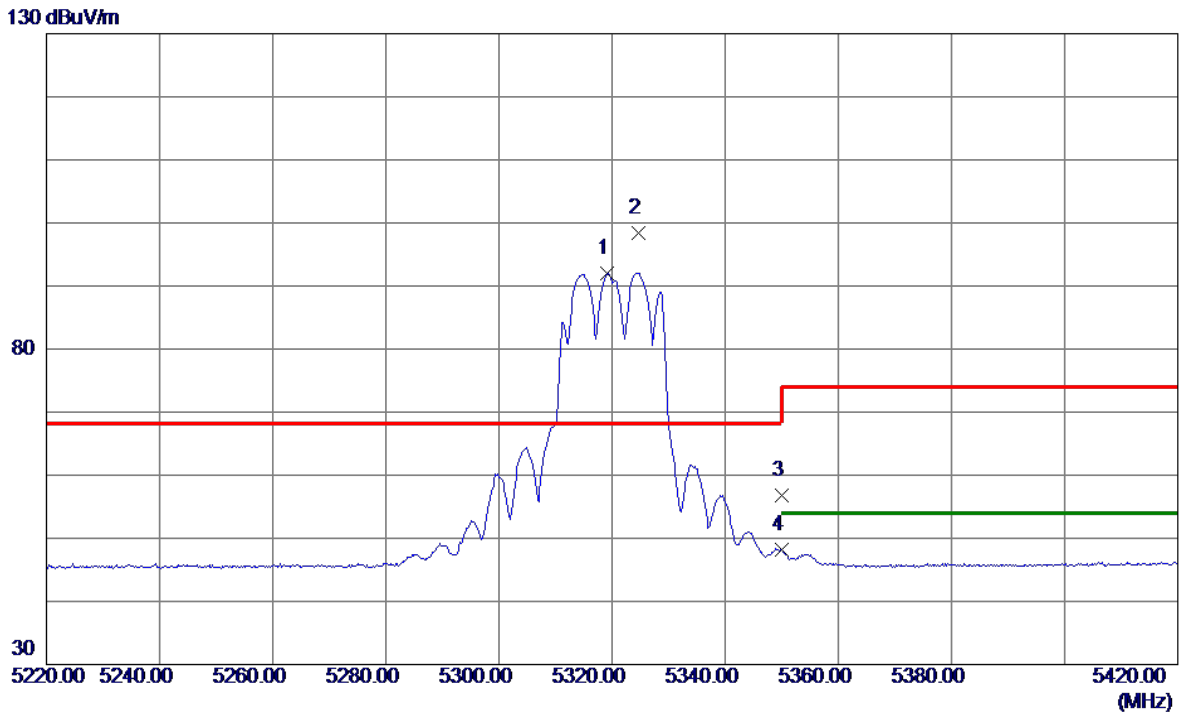

No.	Freq. MHz	Reading Level dBuV/m	Correct Factor dB	Measure ment dBuV/m	Limit dBuV/m	Margin dB	Detector	Comment
1	5319.2000	75.62	16.47	92.09	999.00	-906.91	AVG	No Limit
2 *	5324.6000	81.99	16.47	98.46	68.20	30.26	Peak	No Limit
3	5350.0000	40.27	16.50	56.77	74.00	-17.23	Peak	
4	5350.0000	31.68	16.50	48.18	54.00	-5.82	AVG	

REMARKS:

- (1) Measurement Value = Reading Level + Correct Factor.
- (2) Margin Level = Measurement Value - Limit Value.

Test Mode	UNII-2A_TX AC(VHT20) Mode 5320 MHz	Polarization	Horizontal
-----------	------------------------------------	--------------	------------

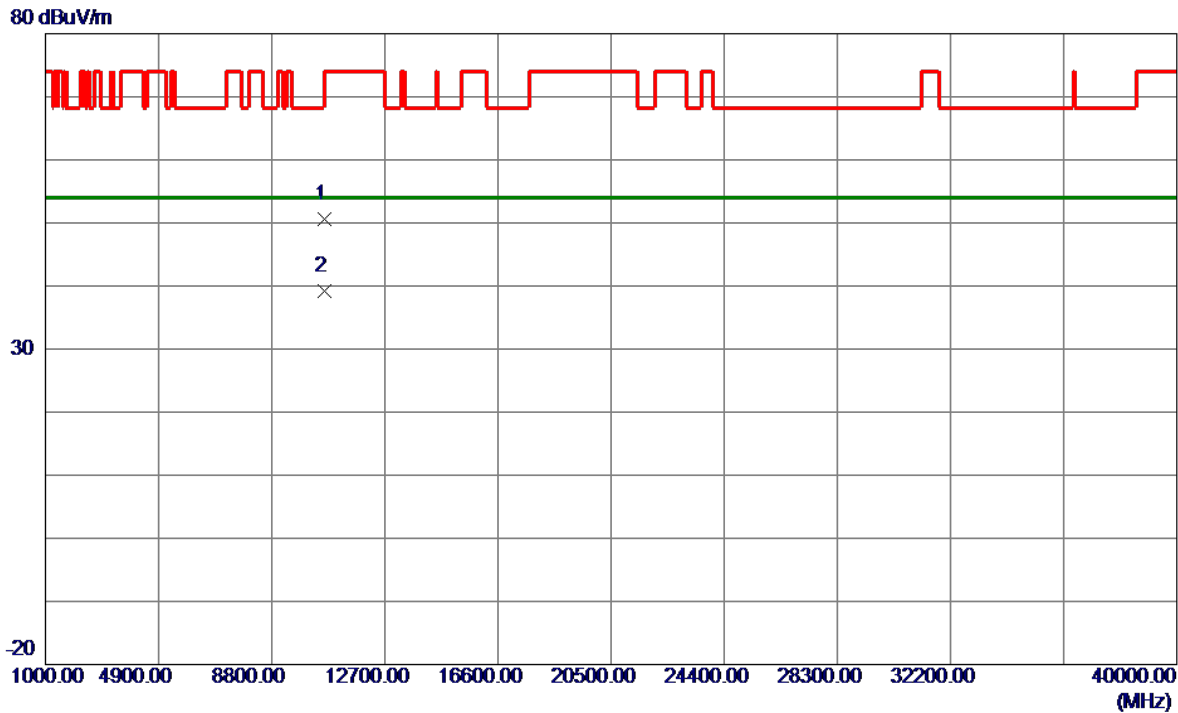

No.	Freq. MHz	Reading Level dBuV/m	Correct Factor dB	Measure ment dBuV/m	Limit dBuV/m	Margin dB	Detector	Comment
1	10640.0000	38.12	12.49	50.61	74.00	-23.39	Peak	
2 *	10640.0000	26.80	12.49	39.29	54.00	-14.71	AVG	

REMARKS:

- (1) Measurement Value = Reading Level + Correct Factor.
- (2) Margin Level = Measurement Value - Limit Value.

Test Mode	UNII-2A_TX AC(VHT40) Mode 5270 MHz	Polarization	Vertical
-----------	------------------------------------	--------------	----------

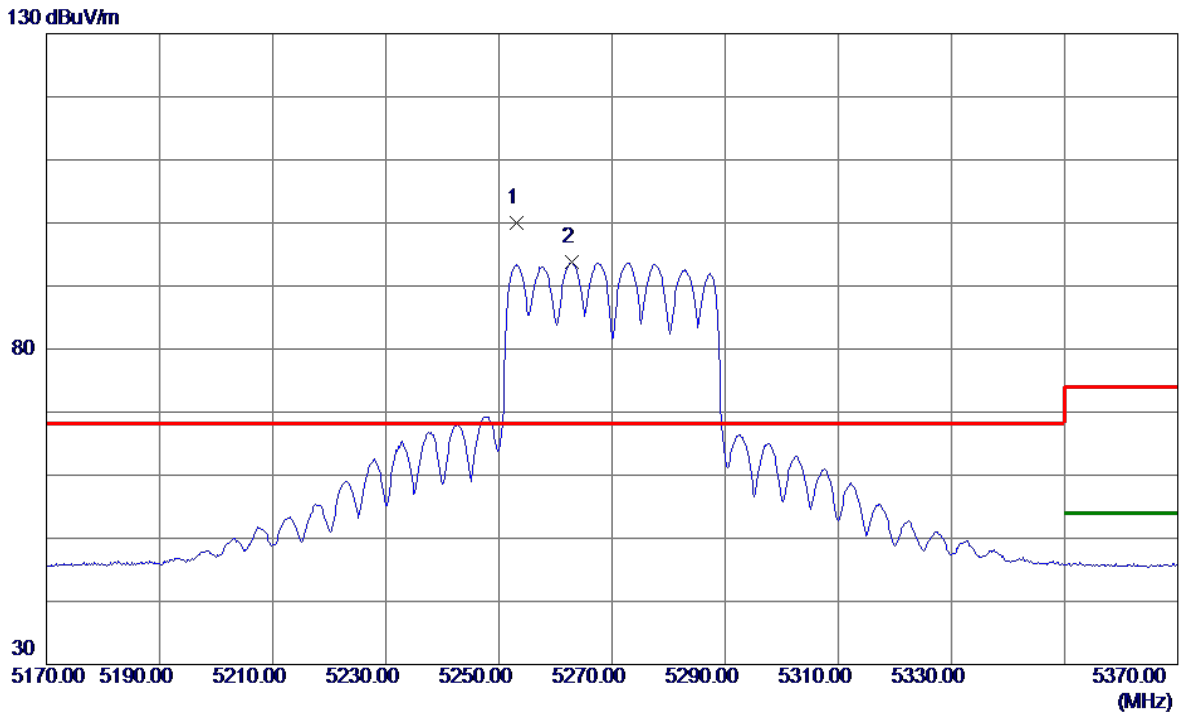

No.	Freq. MHz	Reading Level dBuV/m	Correct Factor dB	Measure ment dBuV/m	Limit dBuV/m	Margin dB	Detector	Comment
1 *	5253.2000	83.56	16.40	99.96	68.20	31.76	Peak	No Limit
2	5262.8000	77.41	16.41	93.82	999.00	-905.18	AVG	No Limit

REMARKS:

- (1) Measurement Value = Reading Level + Correct Factor.
- (2) Margin Level = Measurement Value - Limit Value.

Test Mode	UNII-2A_TX AC(VHT40) Mode 5270 MHz	Polarization	Vertical
-----------	------------------------------------	--------------	----------

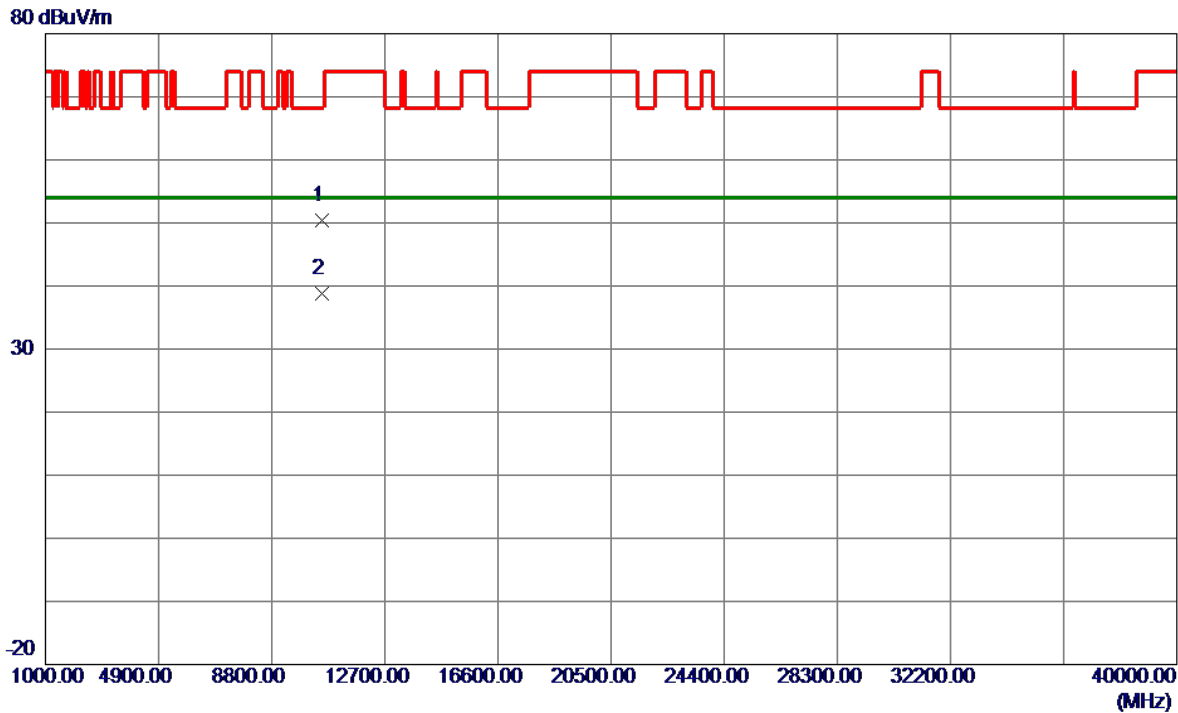

No.	Freq. MHz	Reading Level dBuV/m	Correct Factor dB	Measure ment dBuV/m	Limit dBuV/m	Margin dB	Detector	Comment
1	10540.0000	38.05	12.41	50.46	68.20	-17.74	Peak	
2 *	10540.0000	26.47	12.41	38.88	54.00	-15.12	AVG	

REMARKS:

- (1) Measurement Value = Reading Level + Correct Factor.
- (2) Margin Level = Measurement Value - Limit Value.

Test Mode	UNII-2A_TX AC(VHT40) Mode 5270 MHz	Polarization	Horizontal
-----------	------------------------------------	--------------	------------

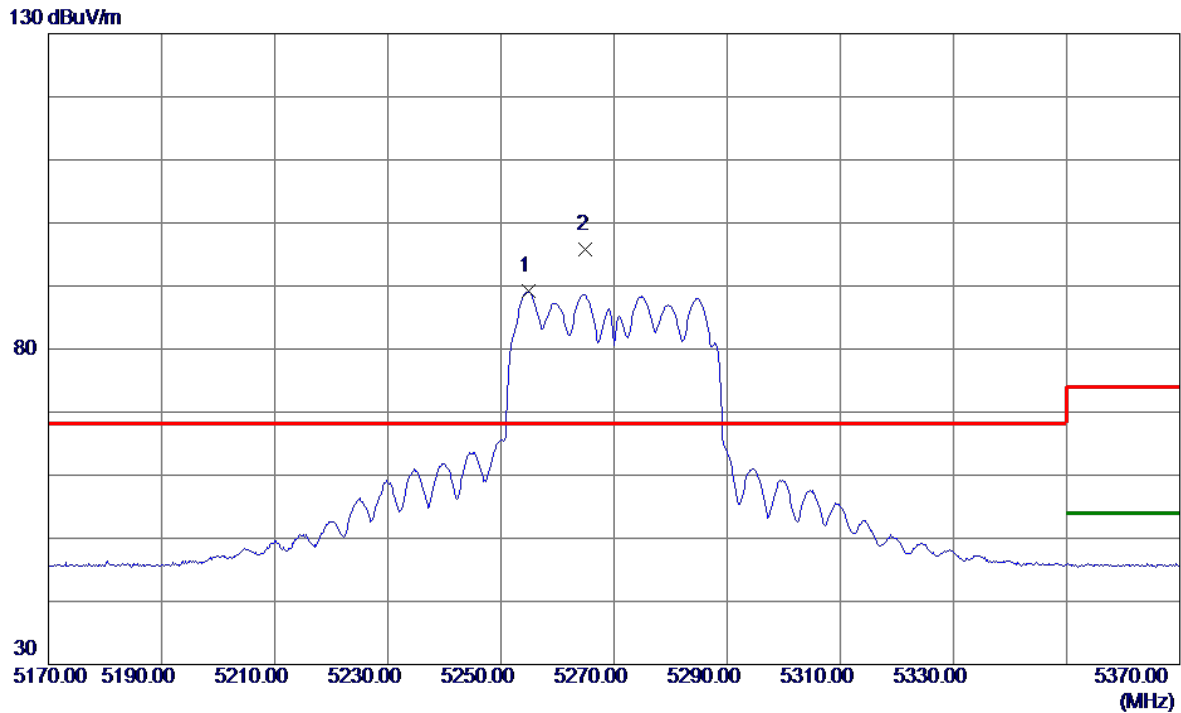

No.	Freq. MHz	Reading Level dBuV/m	Correct Factor dB	Measure ment dBuV/m	Limit dBuV/m	Margin dB	Detector	Comment
1	5254.8000	72.83	16.40	89.23	999.00	-909.77	AVG	No Limit
2 *	5265.0000	79.38	16.41	95.79	68.20	27.59	Peak	No Limit

REMARKS:

- (1) Measurement Value = Reading Level + Correct Factor.
- (2) Margin Level = Measurement Value - Limit Value.

Test Mode	UNII-2A_TX AC(VHT40) Mode 5270 MHz	Polarization	Horizontal
-----------	------------------------------------	--------------	------------

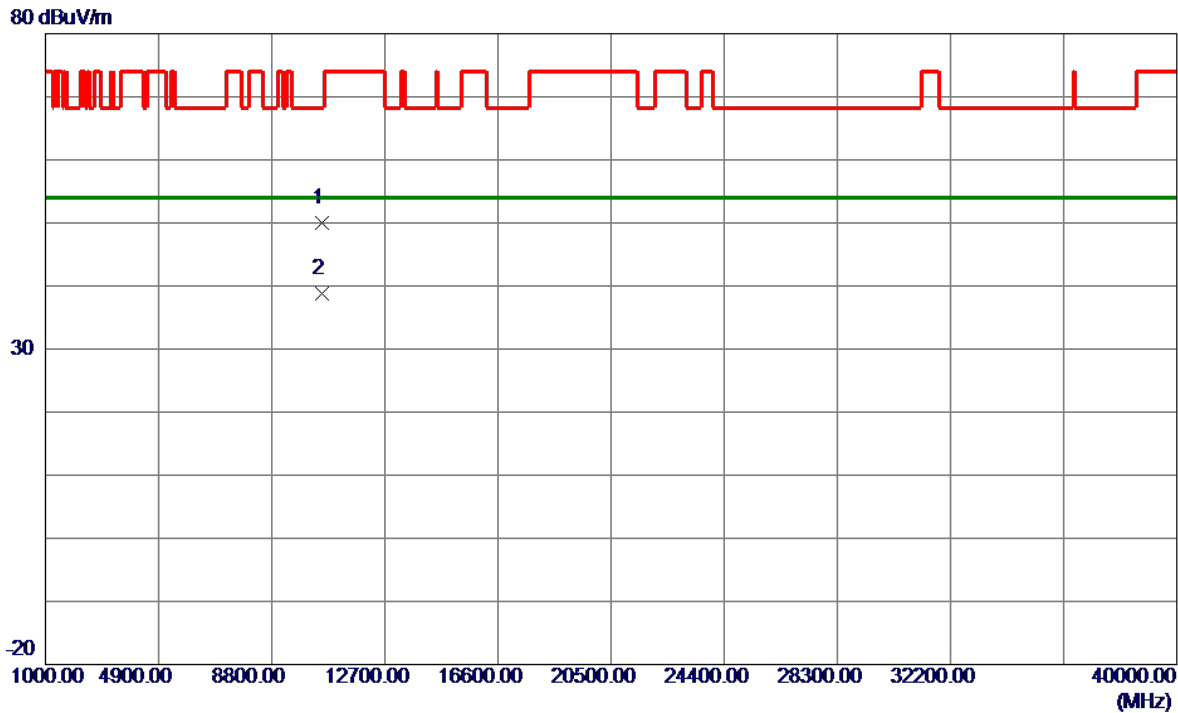

No.	Freq. MHz	Reading Level dBuV/m	Correct Factor dB	Measure ment dBuV/m	Limit dBuV/m	Margin dB	Detector	Comment
1	10540.0000	37.55	12.41	49.96	68.20	-18.24	Peak	
2 *	10540.0000	26.38	12.41	38.79	54.00	-15.21	AVG	

REMARKS:

- (1) Measurement Value = Reading Level + Correct Factor.
- (2) Margin Level = Measurement Value - Limit Value.

Test Mode	UNII-2A_TX AC(VHT40) Mode 5310 MHz	Polarization	Vertical
-----------	------------------------------------	--------------	----------

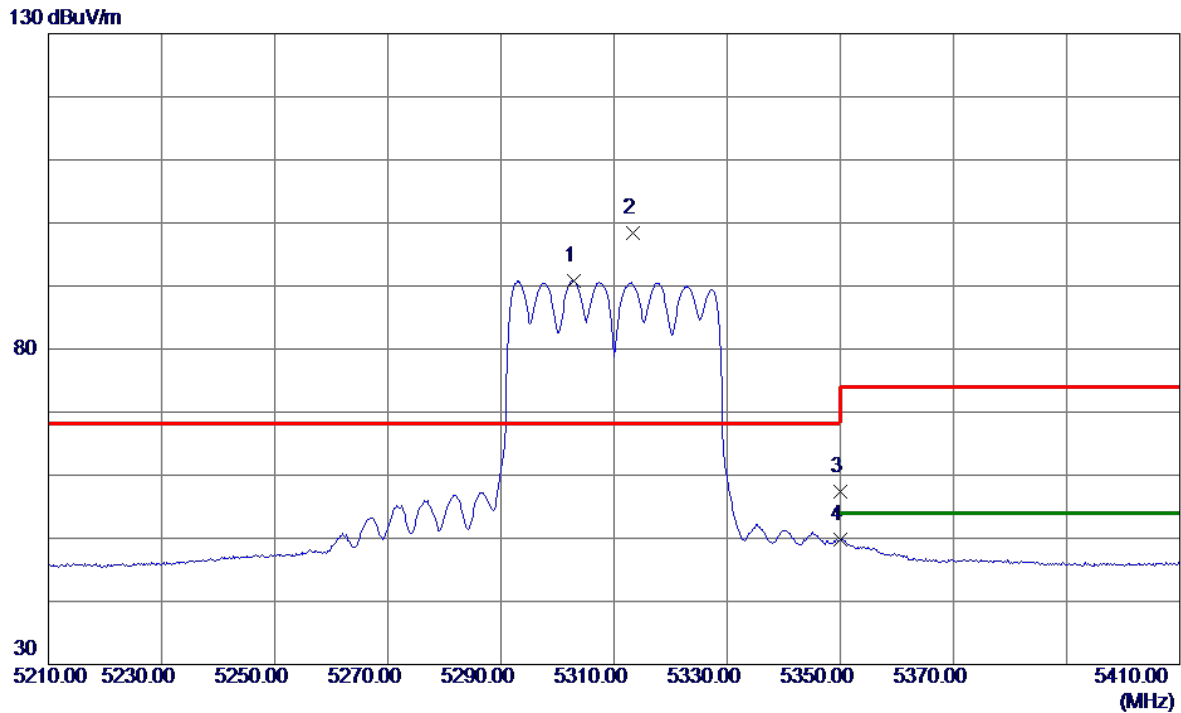

No.	Freq. MHz	Reading Level dBuV/m	Correct Factor dB	Measure ment dBuV/m	Limit dBuV/m	Margin dB	Detector	Comment
1	5302.8000	74.42	16.45	90.87	999.00	-908.13	AVG	No Limit
2 *	5313.4000	81.92	16.46	98.38	68.20	30.18	Peak	No Limit
3	5350.0000	40.94	16.50	57.44	74.00	-16.56	Peak	
4	5350.0000	33.26	16.50	49.76	54.00	-4.24	AVG	

REMARKS:

- (1) Measurement Value = Reading Level + Correct Factor.
- (2) Margin Level = Measurement Value - Limit Value.

Test Mode	UNII-2A_TX AC(VHT40) Mode 5310 MHz	Polarization	Vertical
-----------	------------------------------------	--------------	----------

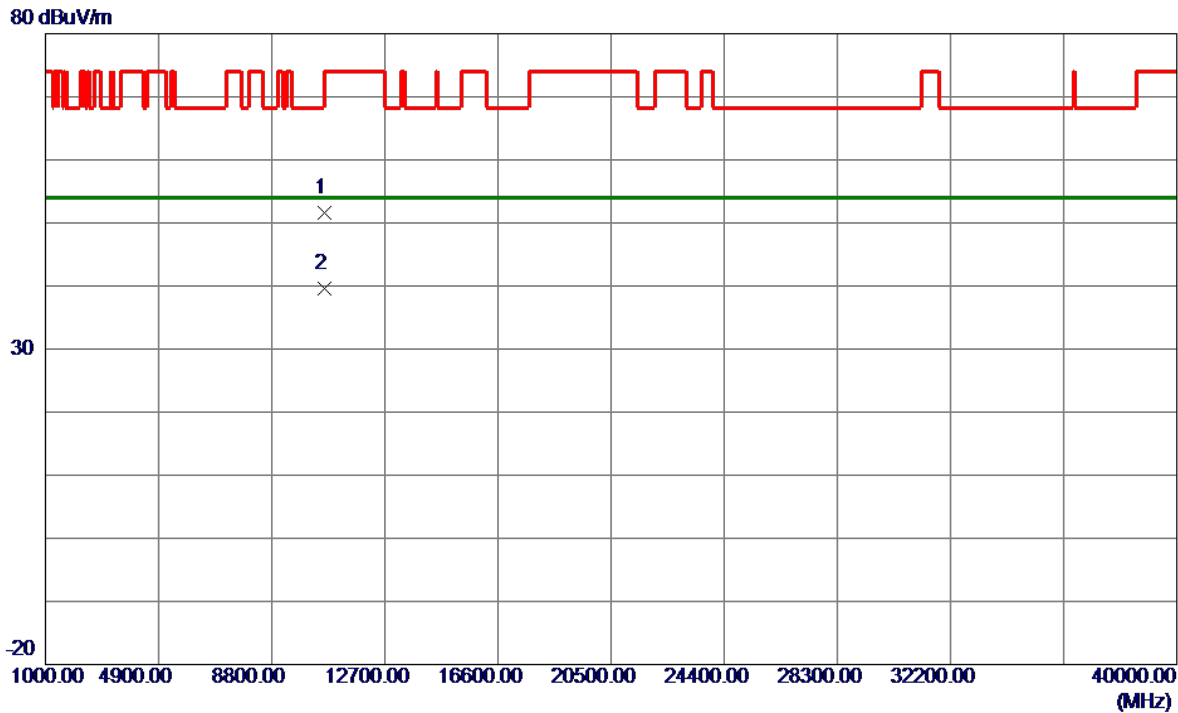

No.	Freq. MHz	Reading Level dBuV/m	Correct Factor dB	Measure ment dBuV/m	Limit dBuV/m	Margin dB	Detector	Comment
1	10620.0000	39.06	12.47	51.53	74.00	-22.47	Peak	
2 *	10620.0000	27.19	12.47	39.66	54.00	-14.34	AVG	

REMARKS:

- (1) Measurement Value = Reading Level + Correct Factor.
- (2) Margin Level = Measurement Value - Limit Value.

Test Mode	UNII-2A_TX AC(VHT40) Mode 5310 MHz	Polarization	Horizontal
-----------	------------------------------------	--------------	------------

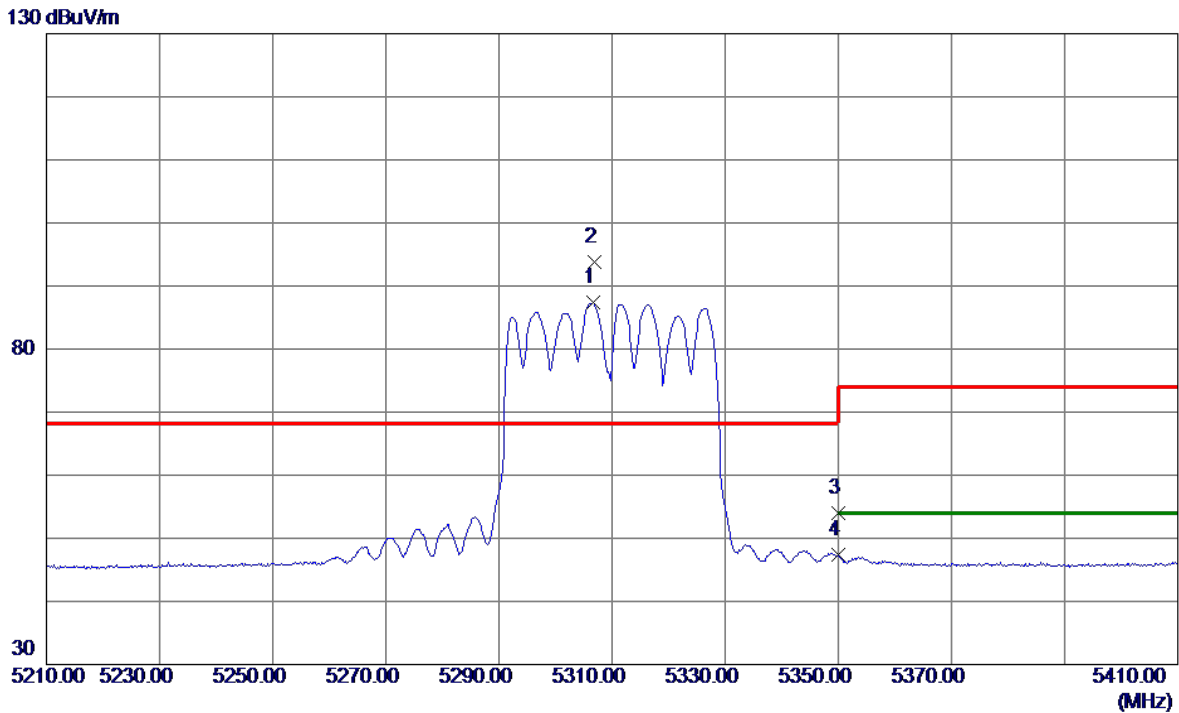

No.	Freq. MHz	Reading Level dBuV/m	Correct Factor dB	Measure ment dBuV/m	Limit dBuV/m	Margin dB	Detector	Comment
1	5306.6000	70.89	16.45	87.34	999.00	-911.66	AVG	No Limit
2 *	5306.8000	77.44	16.45	93.89	68.20	25.69	Peak	No Limit
3	5350.0000	37.52	16.50	54.02	74.00	-19.98	Peak	
4	5350.0000	30.94	16.50	47.44	54.00	-6.56	AVG	

REMARKS:

- (1) Measurement Value = Reading Level + Correct Factor.
- (2) Margin Level = Measurement Value - Limit Value.

Test Mode	UNII-2A_TX AC(VHT40) Mode 5310 MHz	Polarization	Horizontal
-----------	------------------------------------	--------------	------------

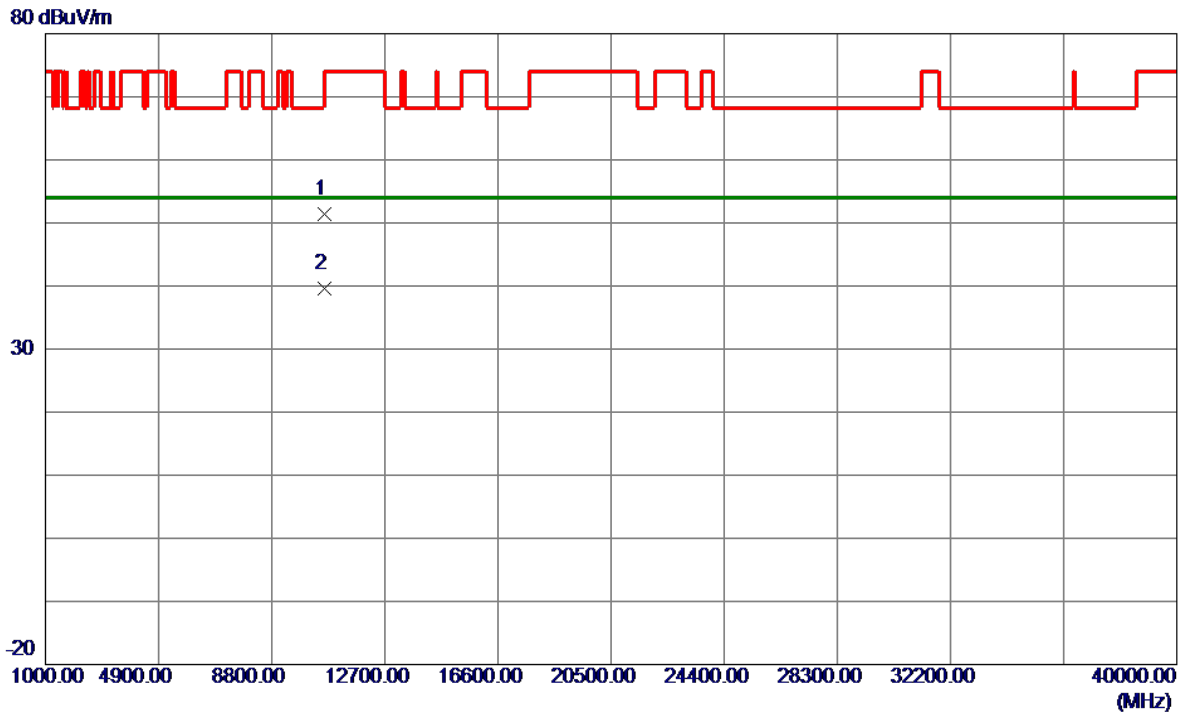

No.	Freq. MHz	Reading Level dBuV/m	Correct Factor dB	Measure ment dBuV/m	Limit dBuV/m	Margin dB	Detector	Comment
1	10620.0000	38.97	12.47	51.44	74.00	-22.56	Peak	
2 *	10620.0000	27.11	12.47	39.58	54.00	-14.42	AVG	

REMARKS:

- (1) Measurement Value = Reading Level + Correct Factor.
- (2) Margin Level = Measurement Value - Limit Value.

Test Mode	UNII-2A_TX AC(VHT80) Mode 5290 MHz	Polarization	Vertical
-----------	------------------------------------	--------------	----------

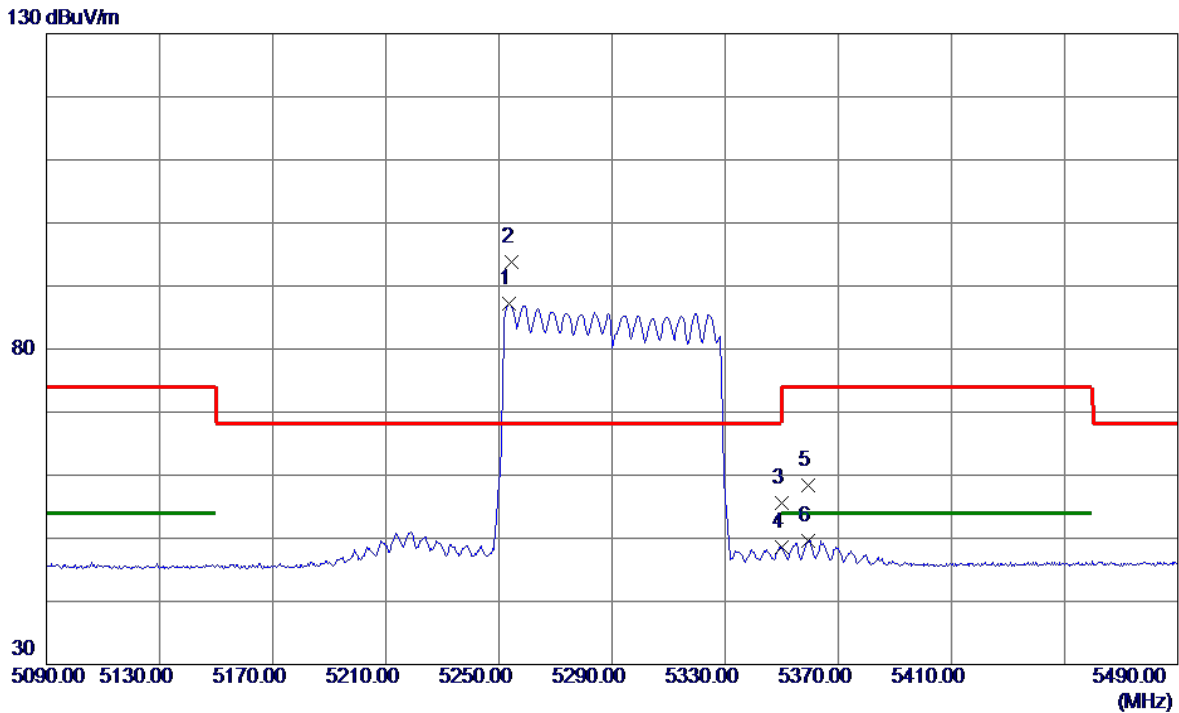

No.	Freq. MHz	Reading Level dBuV/m	Correct Factor dB	Measure ment dBuV/m	Limit dBuV/m	Margin dB	Detector	Comment
1	5253.6000	70.71	16.40	87.11	999.00	-911.89	AVG	No Limit
2 *	5254.4000	77.38	16.40	93.78	68.20	25.58	Peak	No Limit
3	5350.0000	39.08	16.50	55.58	74.00	-18.42	Peak	
4	5350.0000	32.03	16.50	48.53	54.00	-5.47	AVG	
5	5359.2000	41.90	16.51	58.41	74.00	-15.59	Peak	
6	5359.2000	33.06	16.51	49.57	54.00	-4.43	AVG	

REMARKS:

- (1) Measurement Value = Reading Level + Correct Factor.
- (2) Margin Level = Measurement Value - Limit Value.

Test Mode	UNII-2A_TX AC(VHT80) Mode 5290 MHz	Polarization	Vertical
-----------	------------------------------------	--------------	----------

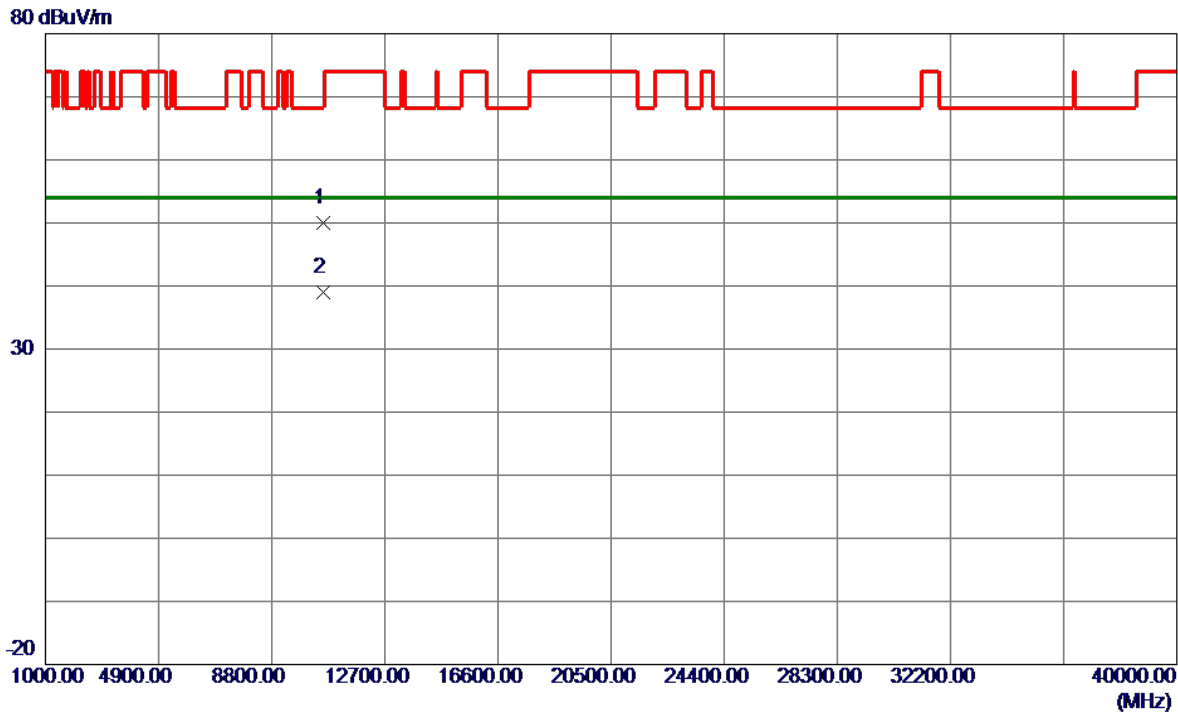

No.	Freq. MHz	Reading Level dBuV/m	Correct Factor dB	Measure ment dBuV/m	Limit dBuV/m	Margin dB	Detector	Comment
1	10580.0000	37.65	12.44	50.09	68.20	-18.11	Peak	
2 *	10580.0000	26.61	12.44	39.05	54.00	-14.95	AVG	

REMARKS:

- (1) Measurement Value = Reading Level + Correct Factor.
- (2) Margin Level = Measurement Value - Limit Value.

Test Mode	UNII-2A_TX AC(VHT80) Mode 5290 MHz	Polarization	Horizontal
-----------	------------------------------------	--------------	------------

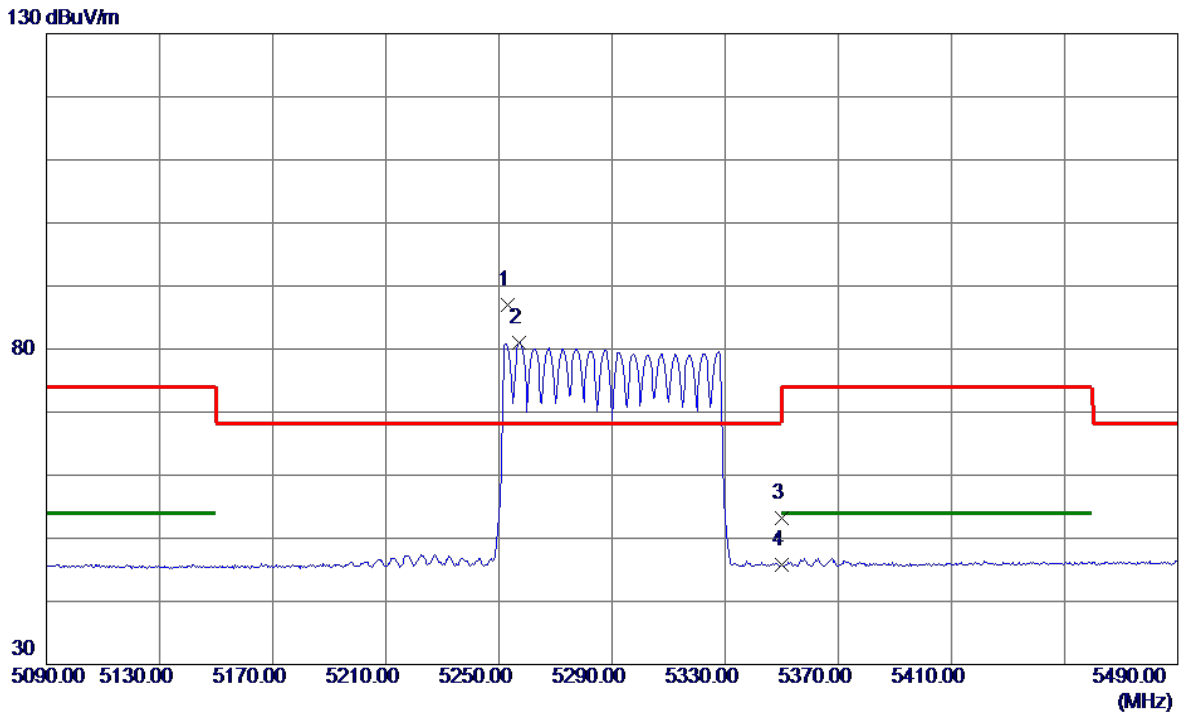

No.	Freq. MHz	Reading Level dBuV/m	Correct Factor dB	Measure ment dBuV/m	Limit dBuV/m	Margin dB	Detector	Comment
1 *	5253.2000	70.55	16.40	86.95	68.20	18.75	Peak	No Limit
2	5257.2000	64.65	16.40	81.05	999.00	-917.95	AVG	No Limit
3	5350.0000	36.66	16.50	53.16	74.00	-20.84	Peak	
4	5350.0000	29.22	16.50	45.72	54.00	-8.28	AVG	

REMARKS:

- (1) Measurement Value = Reading Level + Correct Factor.
- (2) Margin Level = Measurement Value - Limit Value.

Test Mode	UNII-2A_TX AC(VHT80) Mode 5290 MHz	Polarization	Horizontal
-----------	------------------------------------	--------------	------------

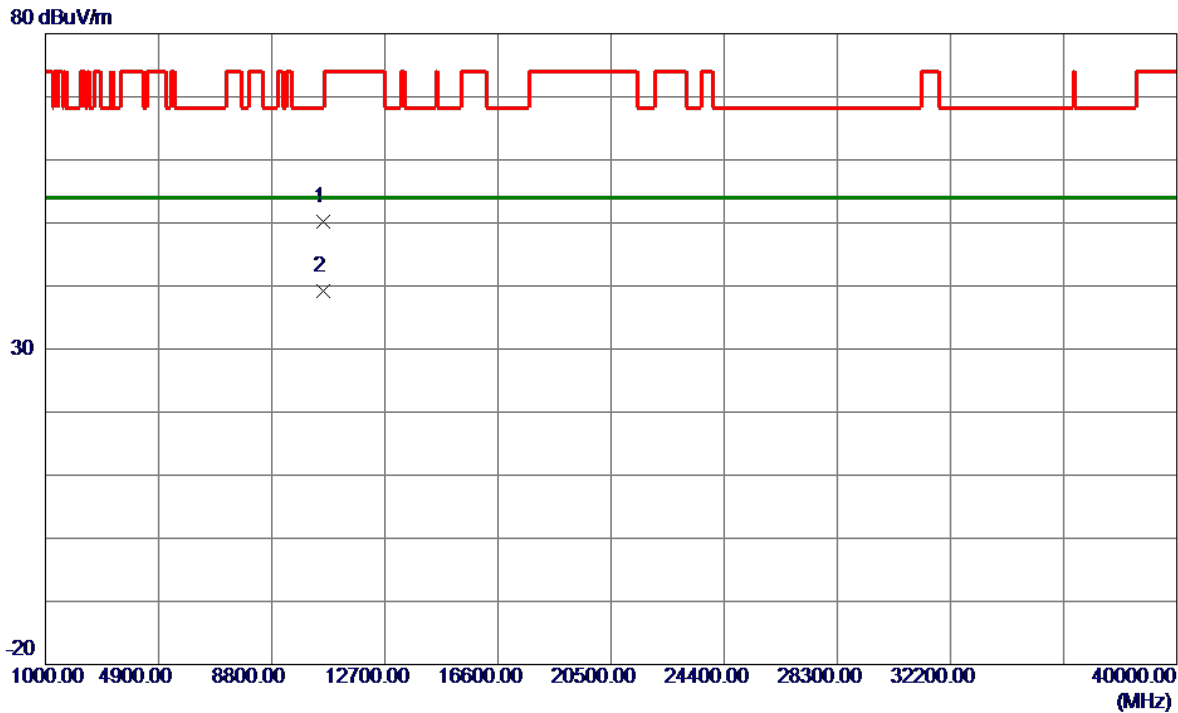

No.	Freq. MHz	Reading Level dBuV/m	Correct Factor dB	Measure ment dBuV/m	Limit dBuV/m	Margin dB	Detector	Comment
1	10580.0000	37.83	12.44	50.27	68.20	-17.93	Peak	
2 *	10580.0000	26.75	12.44	39.19	54.00	-14.81	AVG	

REMARKS:

- (1) Measurement Value = Reading Level + Correct Factor.
- (2) Margin Level = Measurement Value - Limit Value.

Test Mode	UNII-2C_TX A Mode 5500 MHz	Polarization	Vertical
-----------	----------------------------	--------------	----------

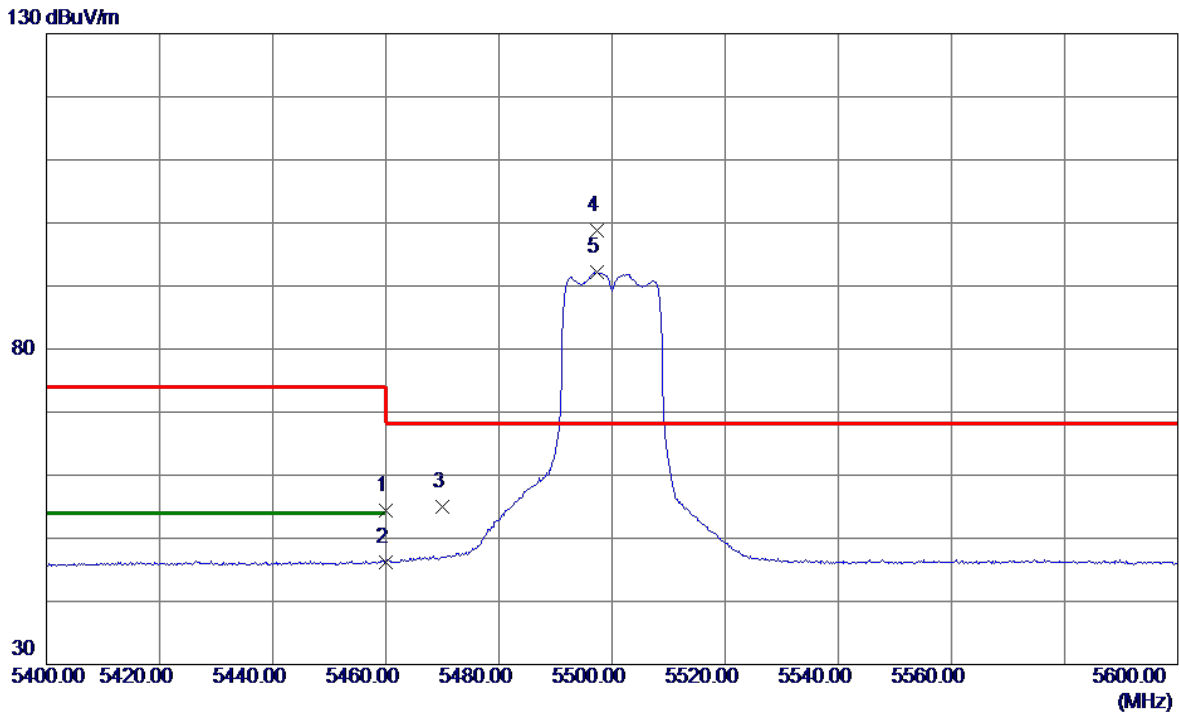

No.	Freq. MHz	Reading Level dBuV/m	Correct Factor dB	Measure ment dBuV/m	Limit dBuV/m	Margin dB	Detector	Comment
1	5460.0000	37.85	16.62	54.47	74.00	-19.53	Peak	
2	5460.0000	29.63	16.62	46.25	54.00	-7.75	AVG	
3	5470.0000	38.31	16.63	54.94	68.20	-13.26	Peak	
4 *	5497.4000	82.21	16.66	98.87	68.20	30.67	Peak	No Limit
5	5497.4000	75.48	16.66	92.14	999.00	-906.86	AVG	No Limit

REMARKS:

- (1) Measurement Value = Reading Level + Correct Factor.
- (2) Margin Level = Measurement Value - Limit Value.

Test Mode	UNII-2C_TX A Mode 5500 MHz	Polarization	Vertical
-----------	----------------------------	--------------	----------

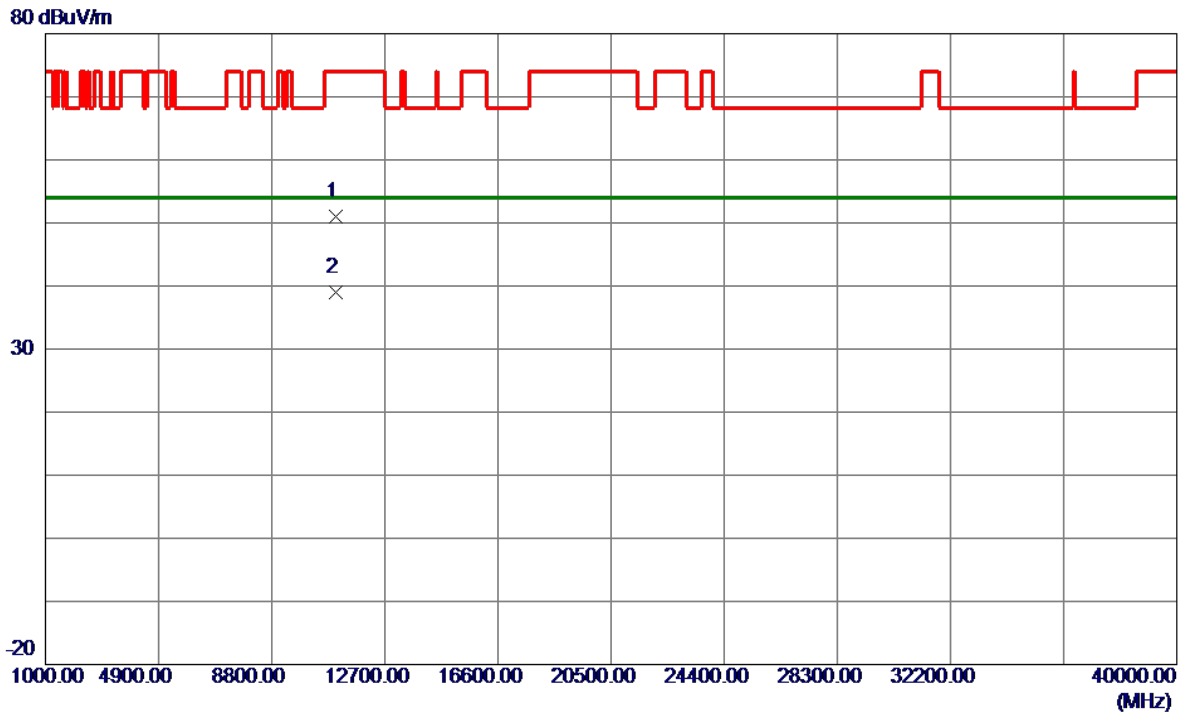

No.	Freq. MHz	Reading Level dBuV/m	Correct Factor dB	Measure ment dBuV/m	Limit dBuV/m	Margin dB	Detector	Comment
1	10999.9750	38.13	12.78	50.91	74.00	-23.09	Peak	
2 *	11002.4300	26.29	12.78	39.07	54.00	-14.93	AVG	

REMARKS:

- (1) Measurement Value = Reading Level + Correct Factor.
- (2) Margin Level = Measurement Value - Limit Value.

Test Mode	UNII-2C_TX A Mode 5500 MHz	Polarization	Horizontal
-----------	----------------------------	--------------	------------

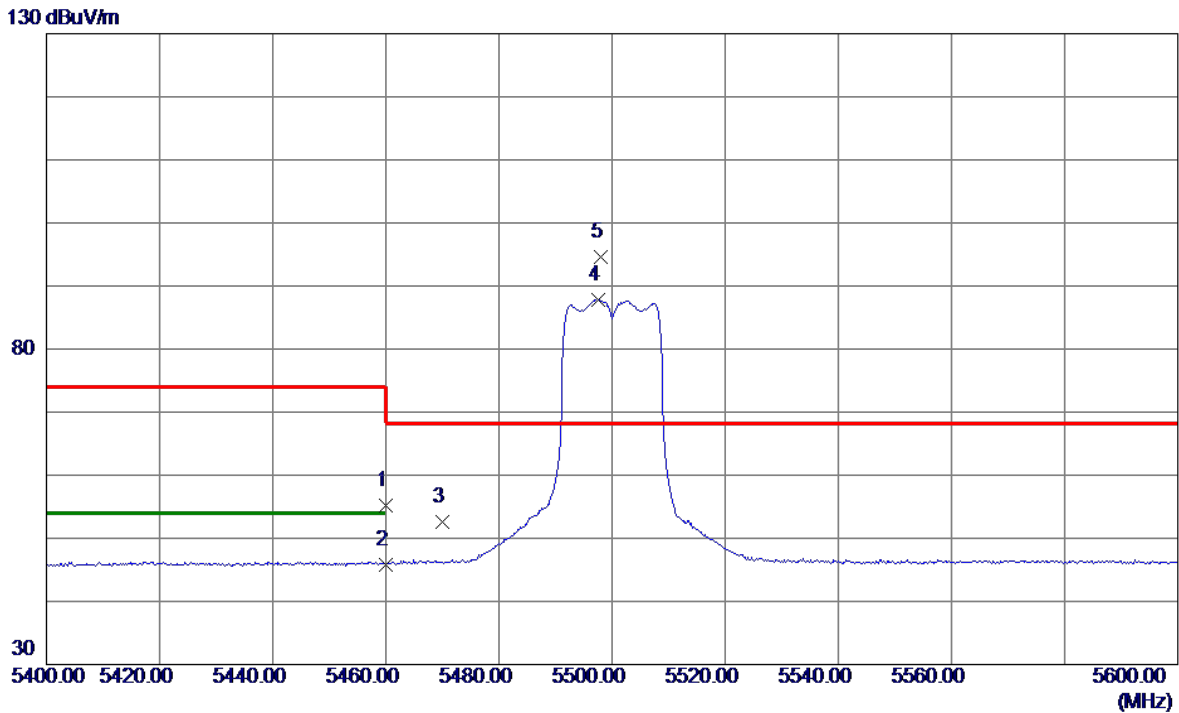

No.	Freq. MHz	Reading Level dBuV/m	Correct Factor dB	Measure ment dBuV/m	Limit dBuV/m	Margin dB	Detector	Comment
1	5460.0000	38.56	16.62	55.18	74.00	-18.82	Peak	
2	5460.0000	29.24	16.62	45.86	54.00	-8.14	AVG	
3	5470.0000	36.06	16.63	52.69	68.20	-15.51	Peak	
4	5497.6000	71.13	16.66	87.79	999.00	-911.21	AVG	No Limit
5 *	5498.0000	77.89	16.66	94.55	68.20	26.35	Peak	No Limit

REMARKS:

- (1) Measurement Value = Reading Level + Correct Factor.
- (2) Margin Level = Measurement Value - Limit Value.

Test Mode	UNII-2C_TX A Mode 5500 MHz	Polarization	Horizontal
-----------	----------------------------	--------------	------------

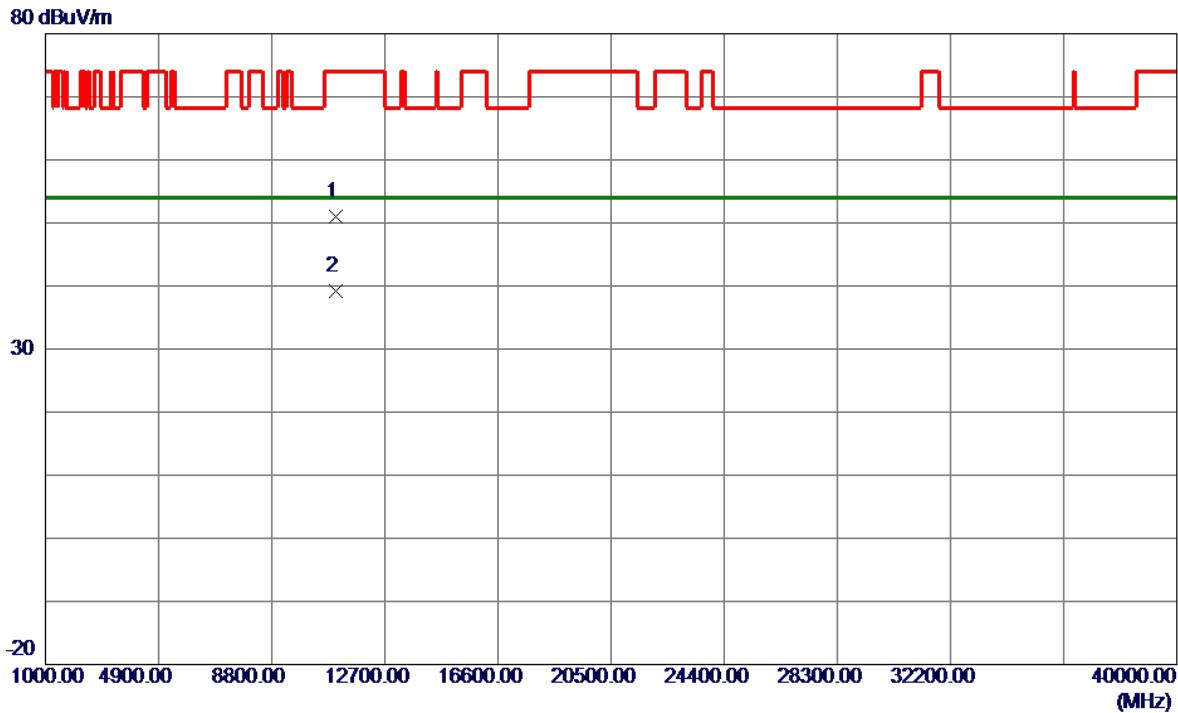

No.	Freq. MHz	Reading Level dBuV/m	Correct Factor dB	Measure ment dBuV/m	Limit dBuV/m	Margin dB	Detector	Comment
1	11000.0000	38.17	12.78	50.95	74.00	-23.05	Peak	
2 *	11000.0000	26.37	12.78	39.15	54.00	-14.85	AVG	

REMARKS:

- (1) Measurement Value = Reading Level + Correct Factor.
- (2) Margin Level = Measurement Value - Limit Value.

Test Mode	UNII-2C_TX A Mode 5580 MHz	Polarization	Vertical
-----------	----------------------------	--------------	----------

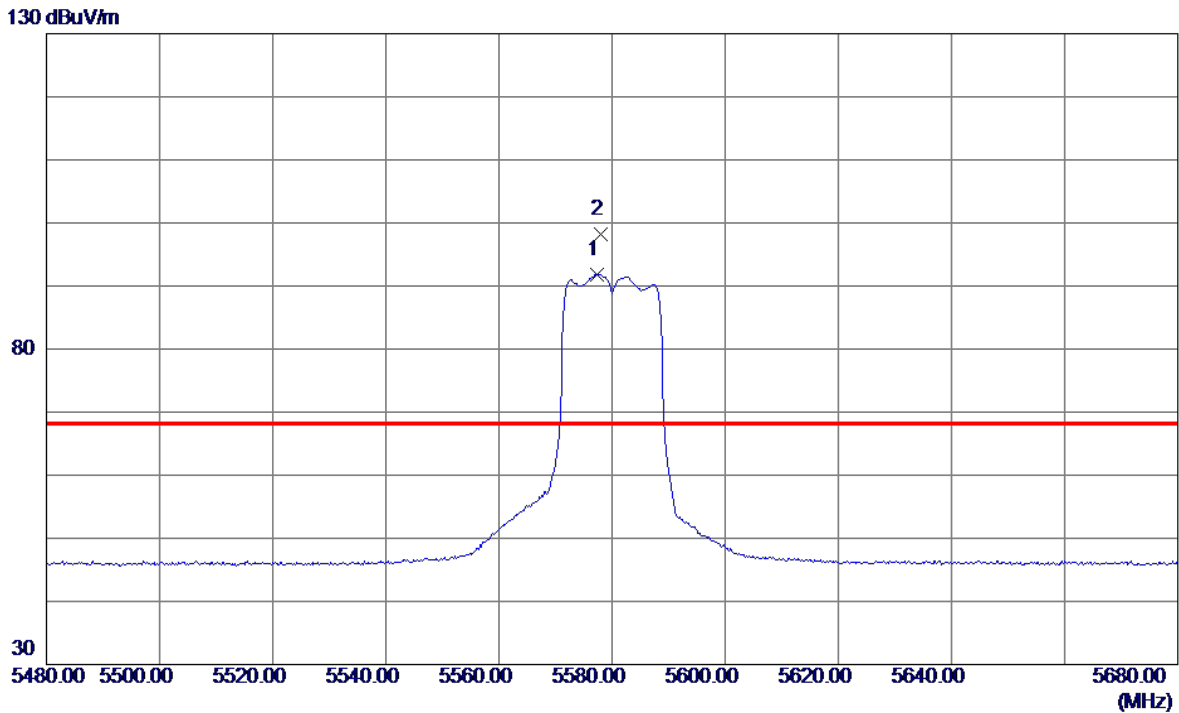

No.	Freq. MHz	Reading Level dBuV/m	Correct Factor dB	Measure ment dBuV/m	Limit dBuV/m	Margin dB	Detector	Comment
1	5577.4000	75.11	16.71	91.82	999.00	-907.18	AVG	No Limit
2 *	5578.0000	81.46	16.71	98.17	68.20	29.97	Peak	No Limit

REMARKS:

- (1) Measurement Value = Reading Level + Correct Factor.
- (2) Margin Level = Measurement Value - Limit Value.

Test Mode	UNII-2C_TX A Mode 5580 MHz	Polarization	Vertical
-----------	----------------------------	--------------	----------

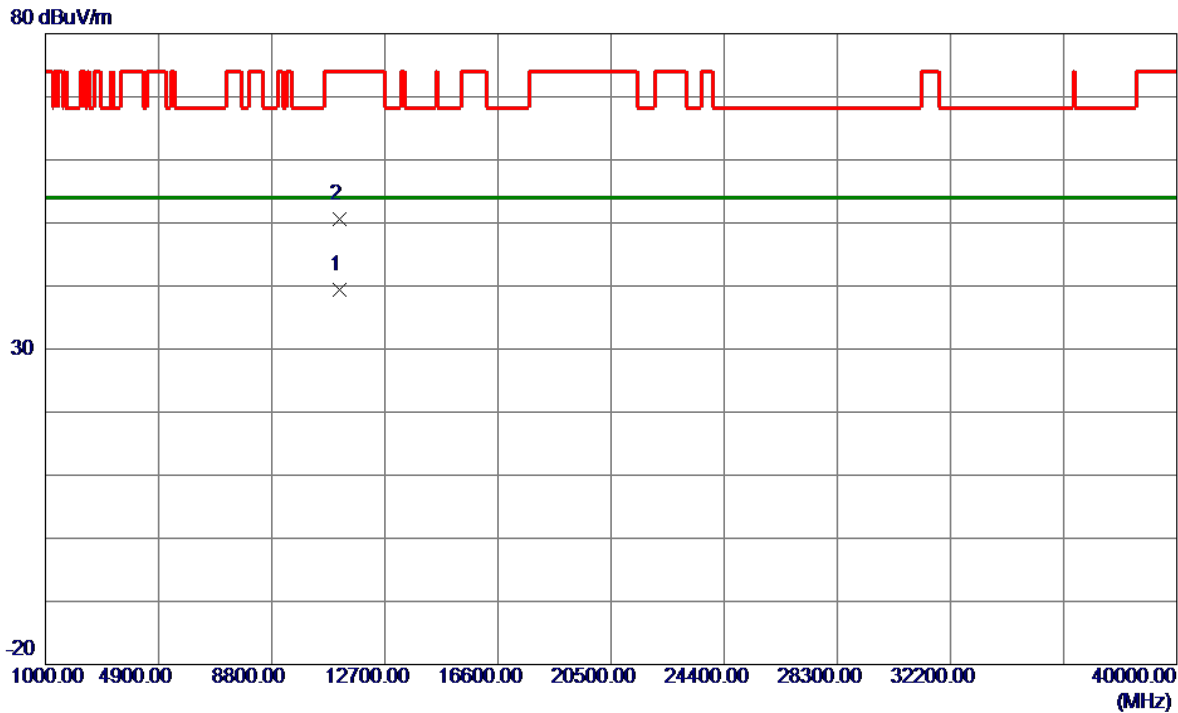

No.	Freq. MHz	Reading Level dBuV/m	Correct Factor dB	Measure ment dBuV/m	Limit dBuV/m	Margin dB	Detector	Comment
1 *	11159.7050	26.47	12.90	39.37	54.00	-14.63	AVG	
2	11160.7650	37.78	12.90	50.68	74.00	-23.32	Peak	

REMARKS:

- (1) Measurement Value = Reading Level + Correct Factor.
- (2) Margin Level = Measurement Value - Limit Value.

Test Mode	UNII-2C_TX A Mode 5580 MHz	Polarization	Horizontal
-----------	----------------------------	--------------	------------

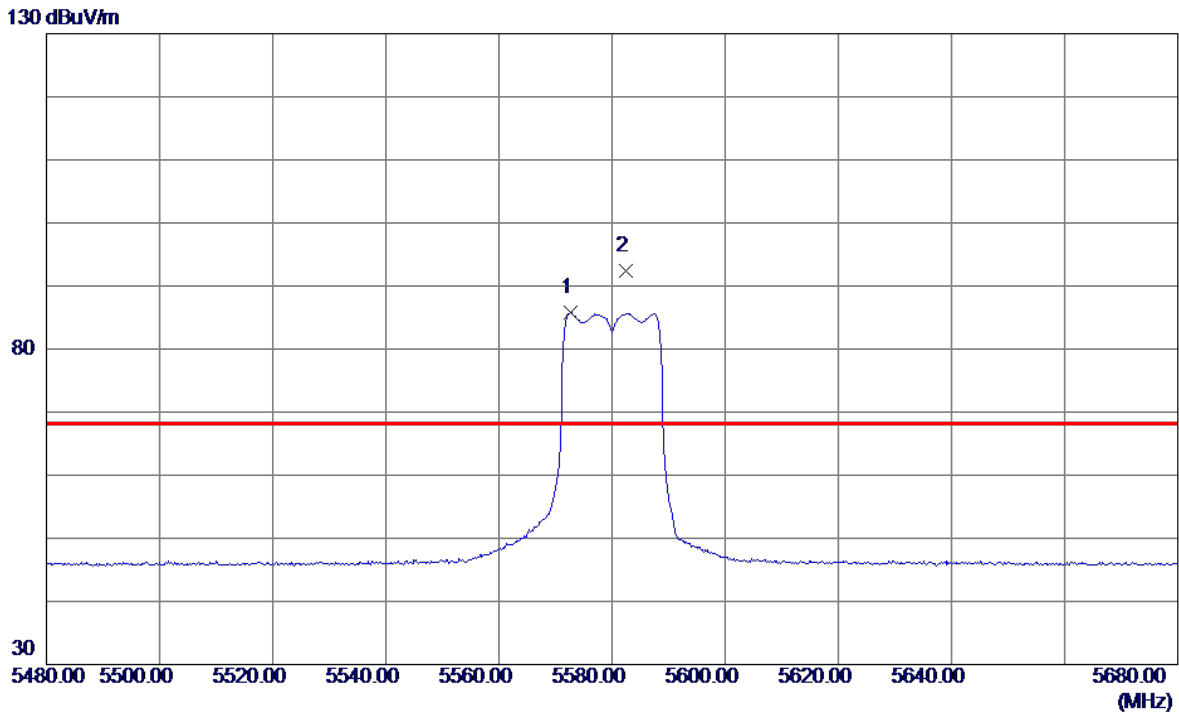

No.	Freq. MHz	Reading Level dBuV/m	Correct Factor dB	Measure ment dBuV/m	Limit dBuV/m	Margin dB	Detector	Comment
1	5572.6000	69.06	16.71	85.77	999.00	-913.23	AVG	No Limit
2 *	5582.4000	75.71	16.71	92.42	68.20	24.22	Peak	No Limit

REMARKS:

- (1) Measurement Value = Reading Level + Correct Factor.
- (2) Margin Level = Measurement Value - Limit Value.

Test Mode	UNII-2C_TX A Mode 5580 MHz	Polarization	Horizontal
-----------	----------------------------	--------------	------------

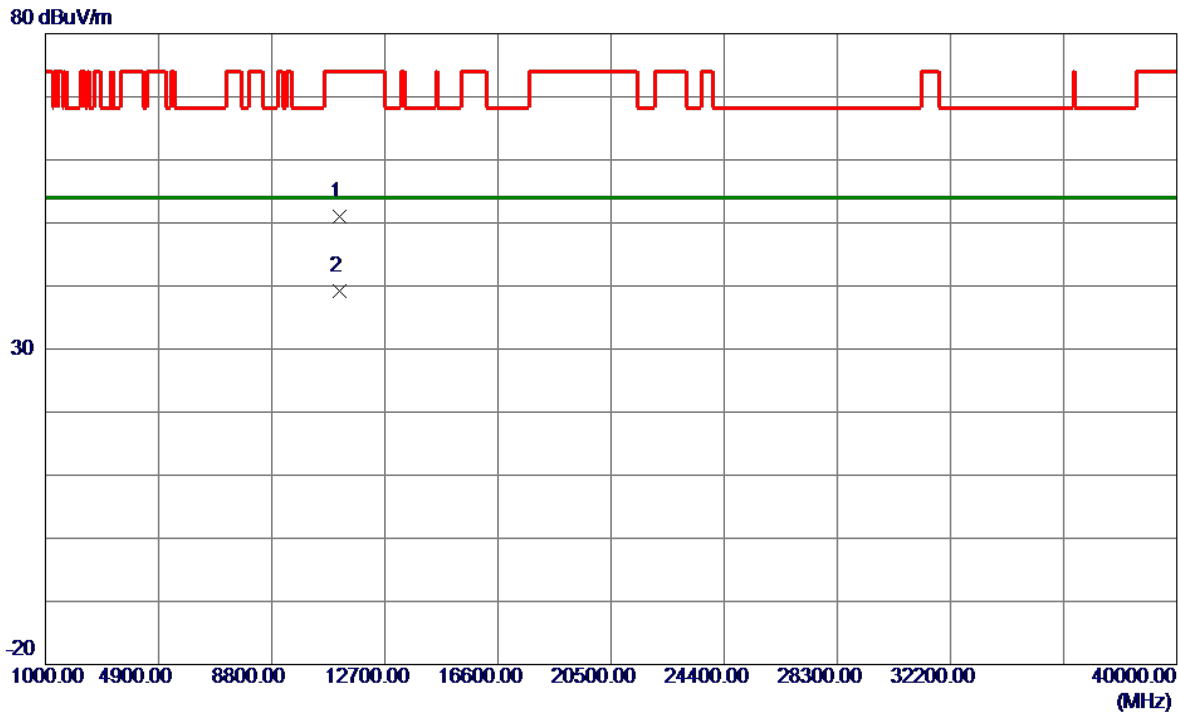

No.	Freq. MHz	Reading Level dBuV/m	Correct Factor dB	Measure ment dBuV/m	Limit dBuV/m	Margin dB	Detector	Comment
1	11160.0000	38.04	12.90	50.94	74.00	-23.06	Peak	
2 *	11160.0000	26.31	12.90	39.21	54.00	-14.79	AVG	

REMARKS:

- (1) Measurement Value = Reading Level + Correct Factor.
- (2) Margin Level = Measurement Value - Limit Value.

Test Mode	UNII-2C_TX A Mode 5700 MHz	Polarization	Vertical
-----------	----------------------------	--------------	----------

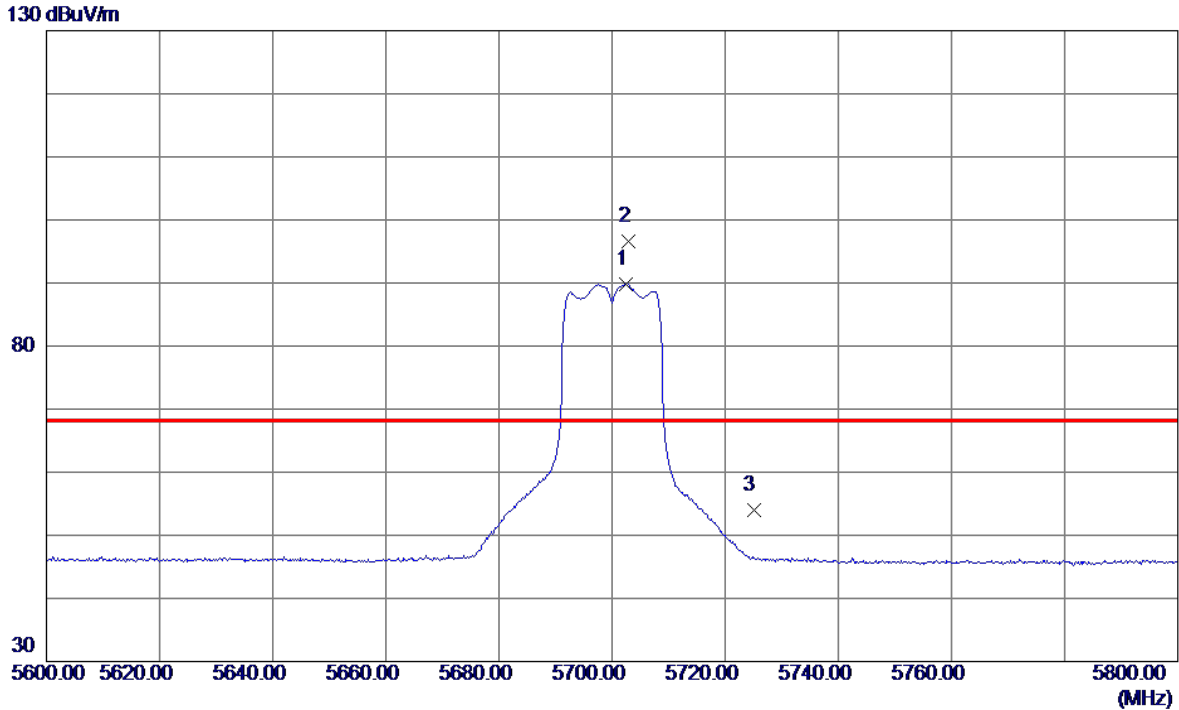

No.	Freq. MHz	Reading Level dBuV/m	Correct Factor dB	Measure ment dBuV/m	Limit dBuV/m	Margin dB	Detector	Comment
1	5702.4000	72.96	16.78	89.74	999.00	-909.26	AVG	No Limit
2 *	5702.8000	79.88	16.78	96.66	68.20	28.46	Peak	No Limit
3	5725.0000	37.26	16.80	54.06	68.20	-14.14	Peak	

REMARKS:

- (1) Measurement Value = Reading Level + Correct Factor.
- (2) Margin Level = Measurement Value - Limit Value.

Test Mode	UNII-2C_TX A Mode 5700 MHz	Polarization	Vertical
-----------	----------------------------	--------------	----------

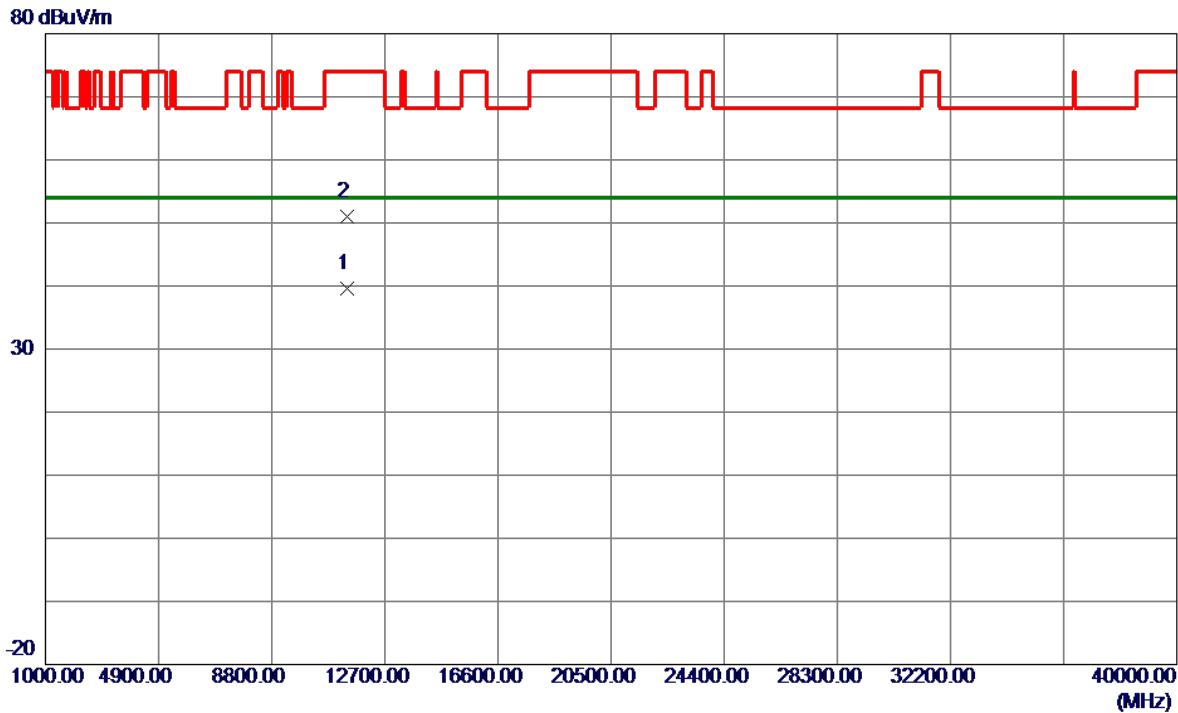

No.	Freq. MHz	Reading Level dBuV/m	Correct Factor dB	Measure ment dBuV/m	Limit dBuV/m	Margin dB	Detector	Comment
1 *	11398.5850	26.52	13.08	39.60	54.00	-14.40	AVG	
2	11400.6849	37.95	13.08	51.03	74.00	-22.97	Peak	

REMARKS:

- (1) Measurement Value = Reading Level + Correct Factor.
- (2) Margin Level = Measurement Value - Limit Value.

Test Mode	UNII-2C_TX A Mode 5700 MHz	Polarization	Horizontal
-----------	----------------------------	--------------	------------

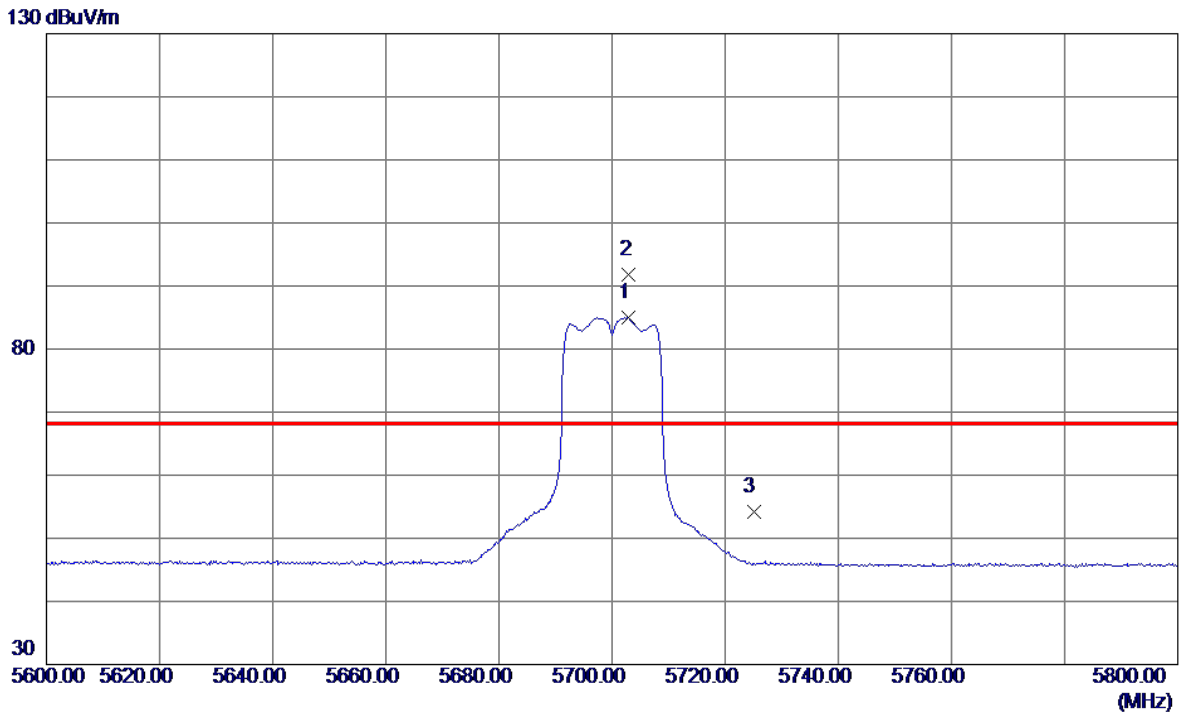

No.	Freq. MHz	Reading Level dBuV/m	Correct Factor dB	Measure ment dBuV/m	Limit dBuV/m	Margin dB	Detector	Comment
1	5702.8000	68.16	16.78	84.94	999.00	-914.06	AVG	No Limit
2 *	5703.0000	74.97	16.78	91.75	68.20	23.55	Peak	No Limit
3	5725.0000	37.47	16.80	54.27	68.20	-13.93	Peak	

REMARKS:

- (1) Measurement Value = Reading Level + Correct Factor.
- (2) Margin Level = Measurement Value - Limit Value.

Test Mode	UNII-2C_TX A Mode 5700 MHz	Polarization	Horizontal
-----------	----------------------------	--------------	------------

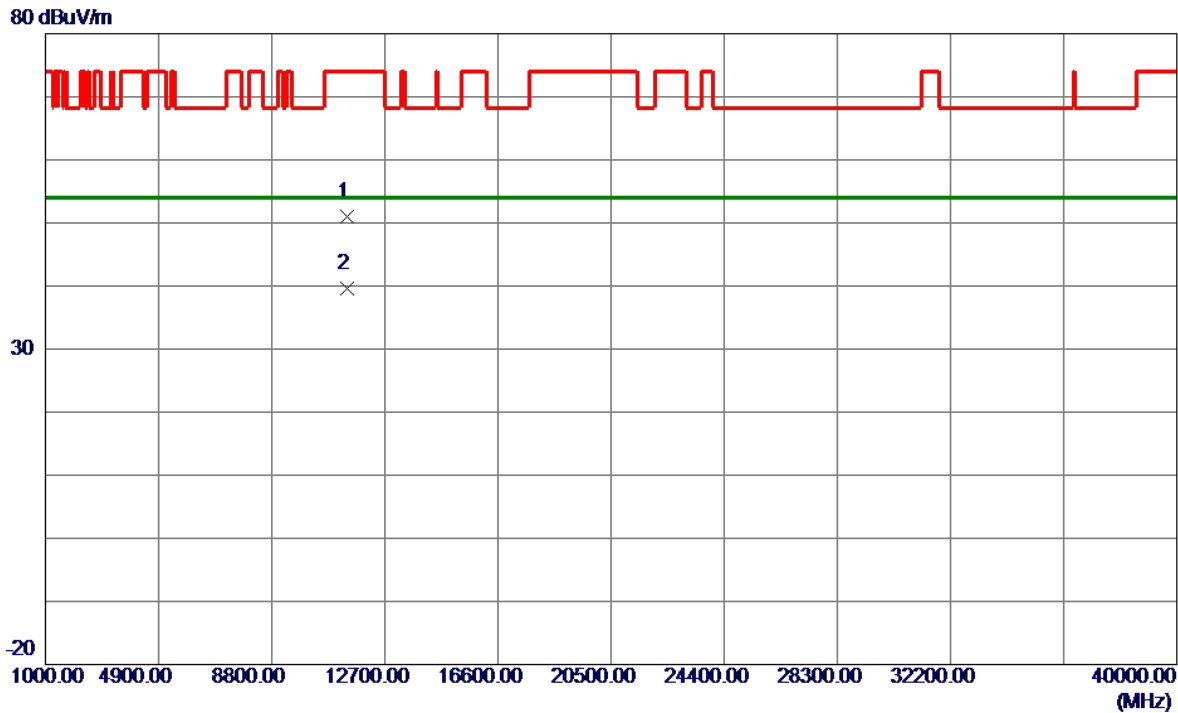

No.	Freq. MHz	Reading Level dBuV/m	Correct Factor dB	Measure ment dBuV/m	Limit dBuV/m	Margin dB	Detector	Comment
1	11400.0000	37.86	13.08	50.94	74.00	-23.06	Peak	
2 *	11400.0000	26.57	13.08	39.65	54.00	-14.35	AVG	

REMARKS:

- (1) Measurement Value = Reading Level + Correct Factor.
- (2) Margin Level = Measurement Value - Limit Value.

Test Mode	UNII-2C_TX AC(VHT20) Mode 5500 MHz	Polarization	Vertical
-----------	------------------------------------	--------------	----------

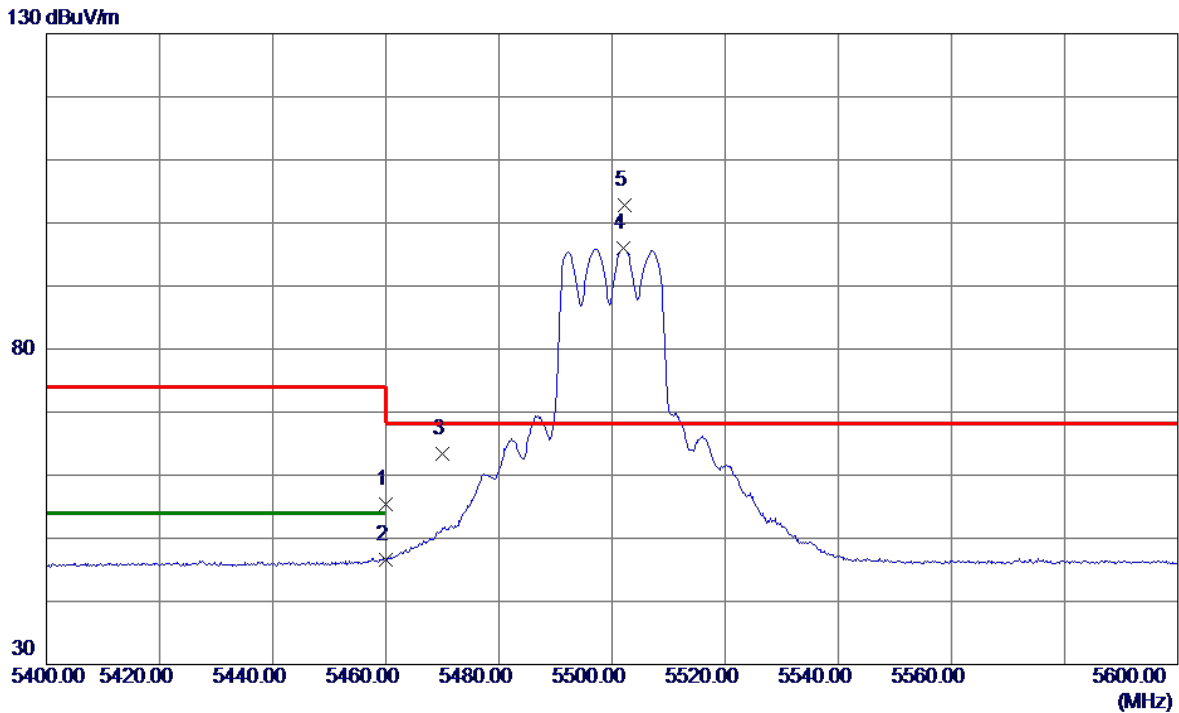

No.	Freq. MHz	Reading Level dBuV/m	Correct Factor dB	Measure ment dBuV/m	Limit dBuV/m	Margin dB	Detector	Comment
1	5460.0000	38.80	16.62	55.42	74.00	-18.58	Peak	
2	5460.0000	30.01	16.62	46.63	54.00	-7.37	AVG	
3	5470.0000	46.82	16.63	63.45	68.20	-4.75	Peak	
4	5502.0000	79.25	16.67	95.92	999.00	-903.08	AVG	No Limit
5 *	5502.2000	86.08	16.67	102.75	68.20	34.55	Peak	No Limit

REMARKS:

- (1) Measurement Value = Reading Level + Correct Factor.
- (2) Margin Level = Measurement Value - Limit Value.

Test Mode	UNII-2C_TX AC(VHT20) Mode 5500 MHz	Polarization	Vertical
-----------	------------------------------------	--------------	----------

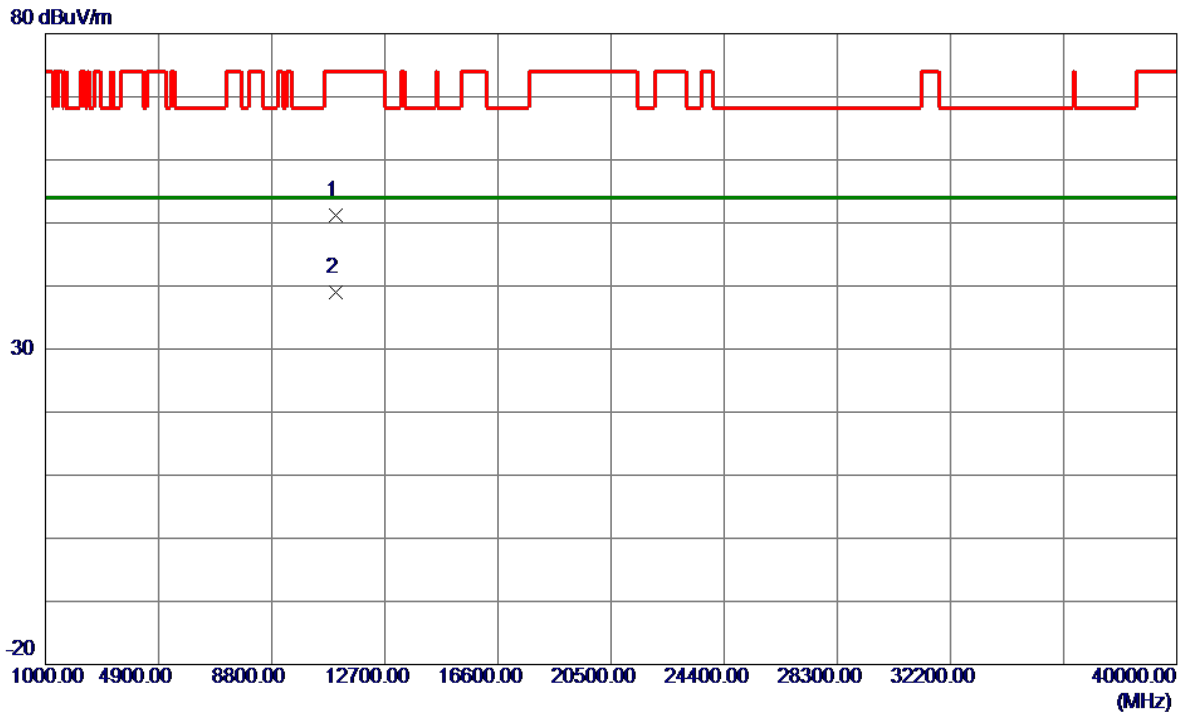

No.	Freq. MHz	Reading Level dBuV/m	Correct Factor dB	Measure ment dBuV/m	Limit dBuV/m	Margin dB	Detector	Comment
1	11000.9950	38.33	12.78	51.11	74.00	-22.89	Peak	
2 *	11001.2600	26.20	12.78	38.98	54.00	-15.02	AVG	

REMARKS:

- (1) Measurement Value = Reading Level + Correct Factor.
- (2) Margin Level = Measurement Value - Limit Value.

Test Mode	UNII-2C_TX AC(VHT20) Mode 5500 MHz	Polarization	Horizontal
-----------	------------------------------------	--------------	------------

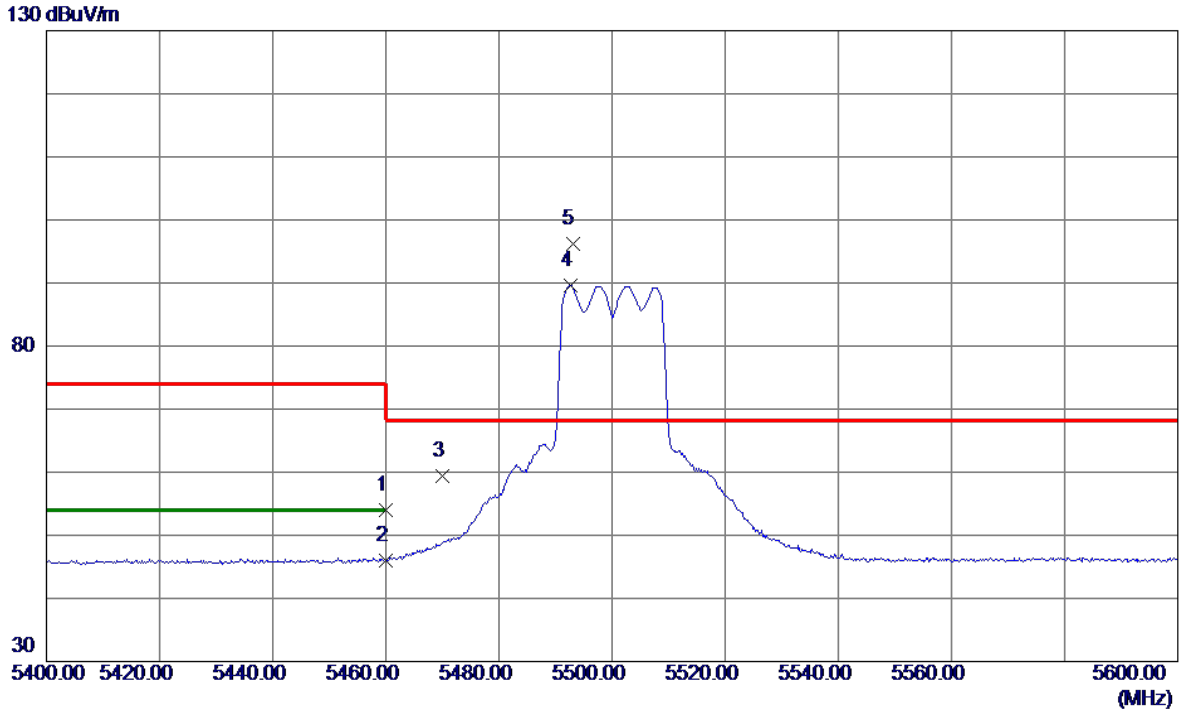

No.	Freq. MHz	Reading Level dBuV/m	Correct Factor dB	Measure ment dBuV/m	Limit dBuV/m	Margin dB	Detector	Comment
1	5460.0000	37.30	16.62	53.92	74.00	-20.08	Peak	
2	5460.0000	29.31	16.62	45.93	54.00	-8.07	AVG	
3	5470.0000	42.76	16.63	59.39	68.20	-8.81	Peak	
4	5492.6000	72.88	16.66	89.54	999.00	-909.46	AVG	No Limit
5 *	5493.0000	79.55	16.66	96.21	68.20	28.01	Peak	No Limit

REMARKS:

- (1) Measurement Value = Reading Level + Correct Factor.
- (2) Margin Level = Measurement Value - Limit Value.

Test Mode	UNII-2C_TX AC(VHT20) Mode 5500 MHz	Polarization	Horizontal
-----------	------------------------------------	--------------	------------

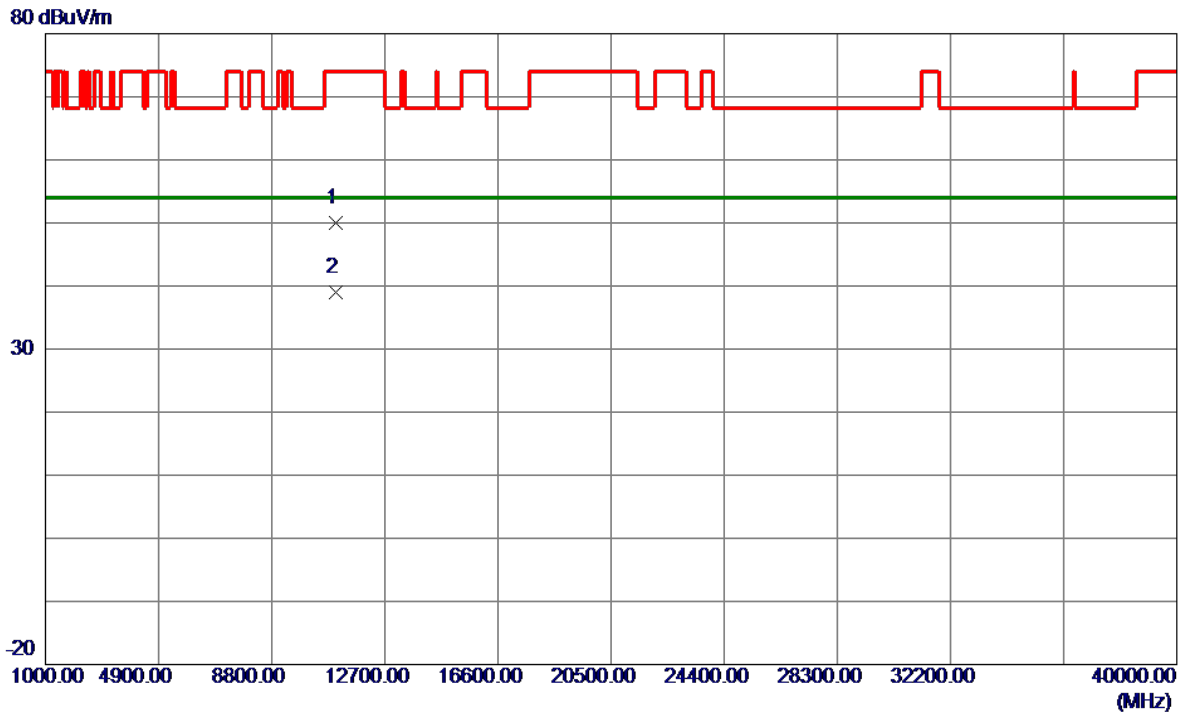

No.	Freq. MHz	Reading Level dBuV/m	Correct Factor dB	Measure ment dBuV/m	Limit dBuV/m	Margin dB	Detector	Comment
1	11000.0000	37.20	12.78	49.98	74.00	-24.02	Peak	
2 *	11000.0000	26.27	12.78	39.05	54.00	-14.95	AVG	

REMARKS:

- (1) Measurement Value = Reading Level + Correct Factor.
- (2) Margin Level = Measurement Value - Limit Value.

Test Mode	UNII-2C_TX AC(VHT20) Mode 5580 MHz	Polarization	Vertical
-----------	------------------------------------	--------------	----------

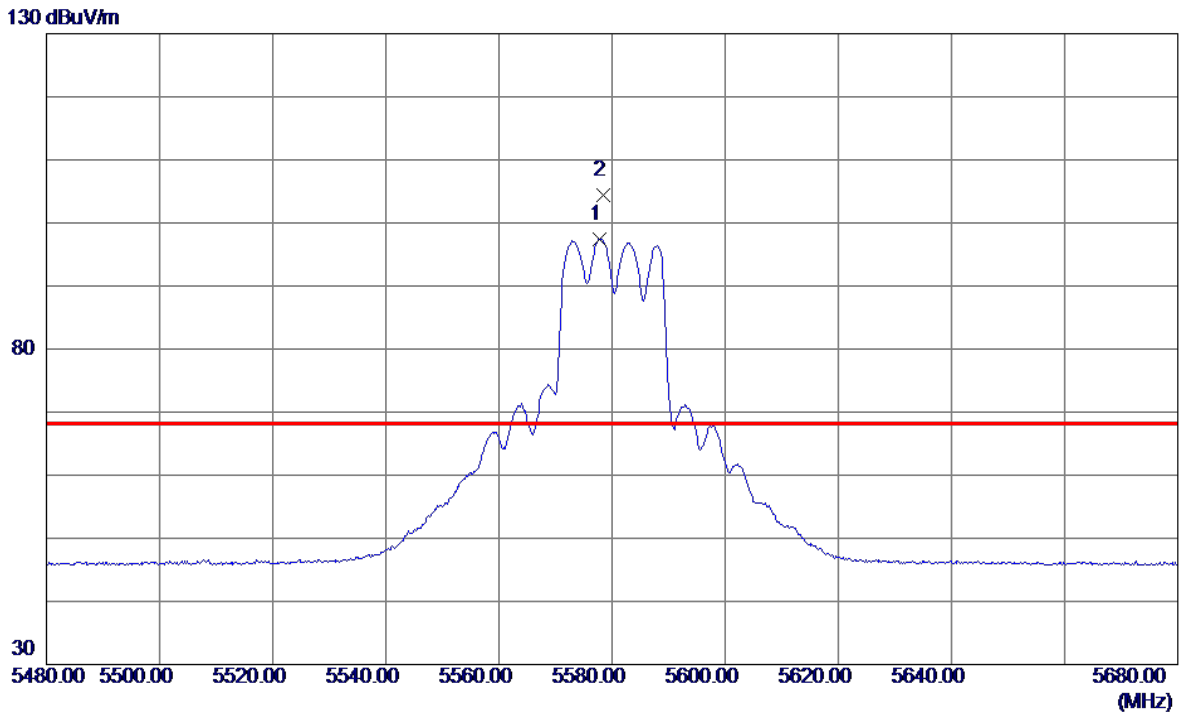

No.	Freq. MHz	Reading Level dBuV/m	Correct Factor dB	Measure ment dBuV/m	Limit dBuV/m	Margin dB	Detector	Comment
1	5577.8000	80.70	16.71	97.41	999.00	-901.59	AVG	No Limit
2 *	5578.4000	87.60	16.71	104.31	68.20	36.11	Peak	No Limit

REMARKS:

- (1) Measurement Value = Reading Level + Correct Factor.
- (2) Margin Level = Measurement Value - Limit Value.

Test Mode	UNII-2C_TX AC(VHT20) Mode 5580 MHz	Polarization	Vertical
-----------	------------------------------------	--------------	----------

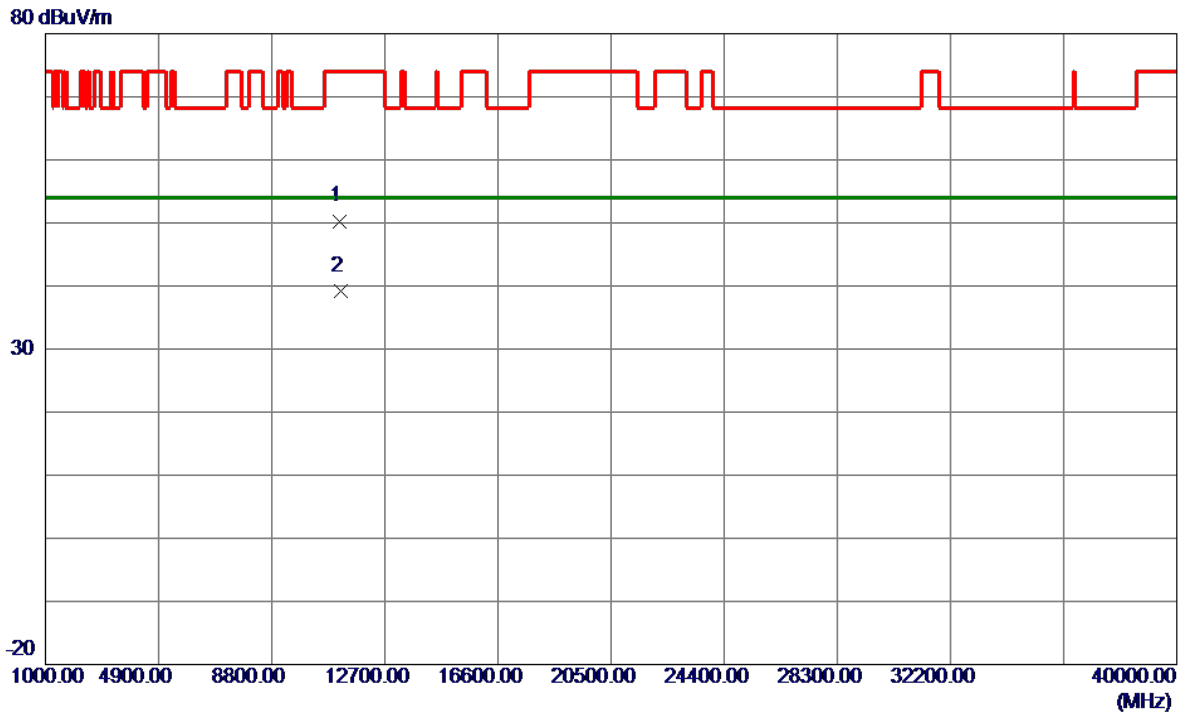

No.	Freq. MHz	Reading Level dBuV/m	Correct Factor dB	Measure ment dBuV/m	Limit dBuV/m	Margin dB	Detector	Comment
1	11158.2400	37.40	12.90	50.30	74.00	-23.70	Peak	
2 *	11162.1750	26.38	12.90	39.28	54.00	-14.72	AVG	

REMARKS:

- (1) Measurement Value = Reading Level + Correct Factor.
- (2) Margin Level = Measurement Value - Limit Value.

Test Mode	UNII-2C_TX AC(VHT20) Mode 5580 MHz	Polarization	Horizontal
-----------	------------------------------------	--------------	------------

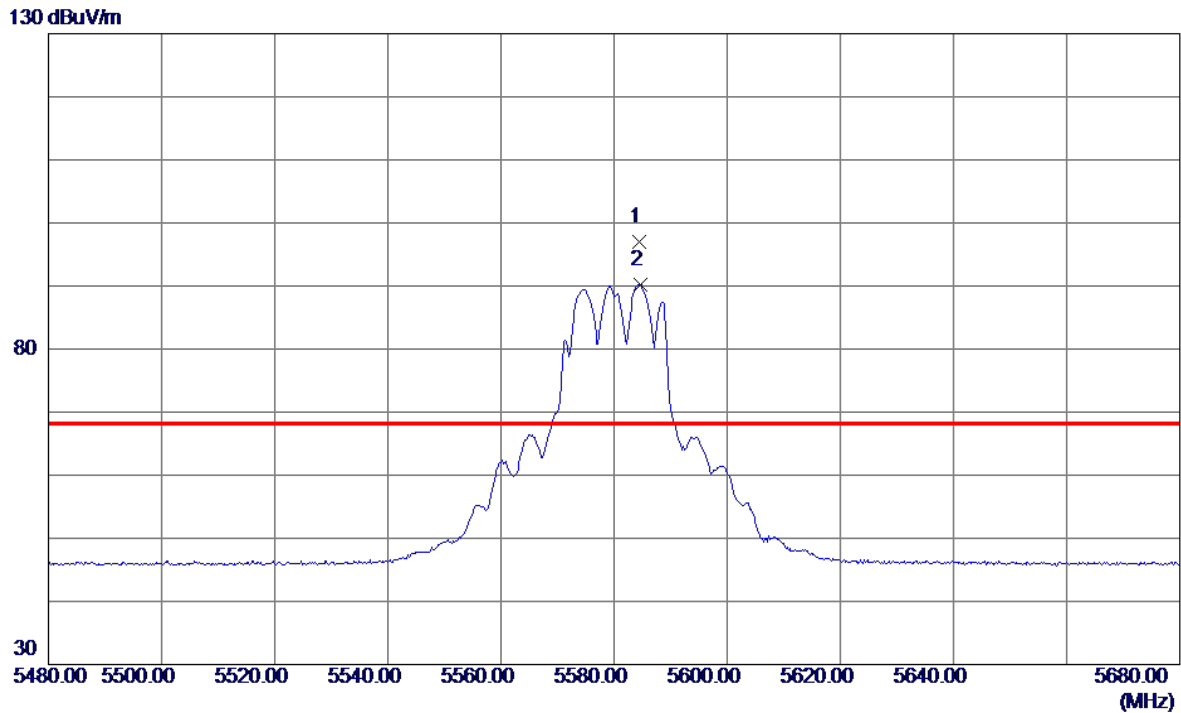

No.	Freq. MHz	Reading Level dBuV/m	Correct Factor dB	Measure ment dBuV/m	Limit dBuV/m	Margin dB	Detector	Comment
1 *	5584.4000	80.34	16.71	97.05	68.20	28.85	Peak	No Limit
2	5584.6000	73.56	16.71	90.27	999.00	-908.73	AVG	No Limit

REMARKS:

- (1) Measurement Value = Reading Level + Correct Factor.
- (2) Margin Level = Measurement Value - Limit Value.

Test Mode	UNII-2C_TX AC(VHT20) Mode 5580 MHz	Polarization	Horizontal
-----------	------------------------------------	--------------	------------

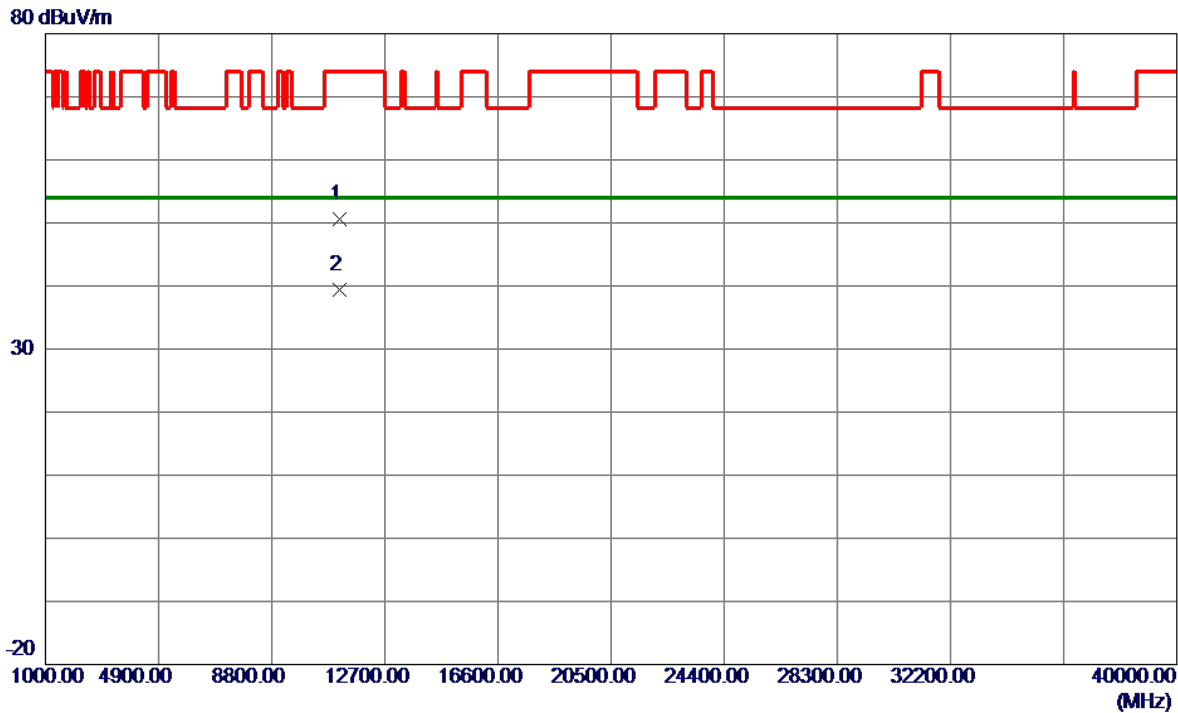

No.	Freq. MHz	Reading Level dBuV/m	Correct Factor dB	Measure ment dBuV/m	Limit dBuV/m	Margin dB	Detector	Comment
1	11160.0000	37.75	12.90	50.65	74.00	-23.35	Peak	
2 *	11160.0000	26.45	12.90	39.35	54.00	-14.65	AVG	

REMARKS:

- (1) Measurement Value = Reading Level + Correct Factor.
- (2) Margin Level = Measurement Value - Limit Value.

Test Mode	UNII-2C_TX AC(VHT20) Mode 5700 MHz	Polarization	Vertical
-----------	------------------------------------	--------------	----------

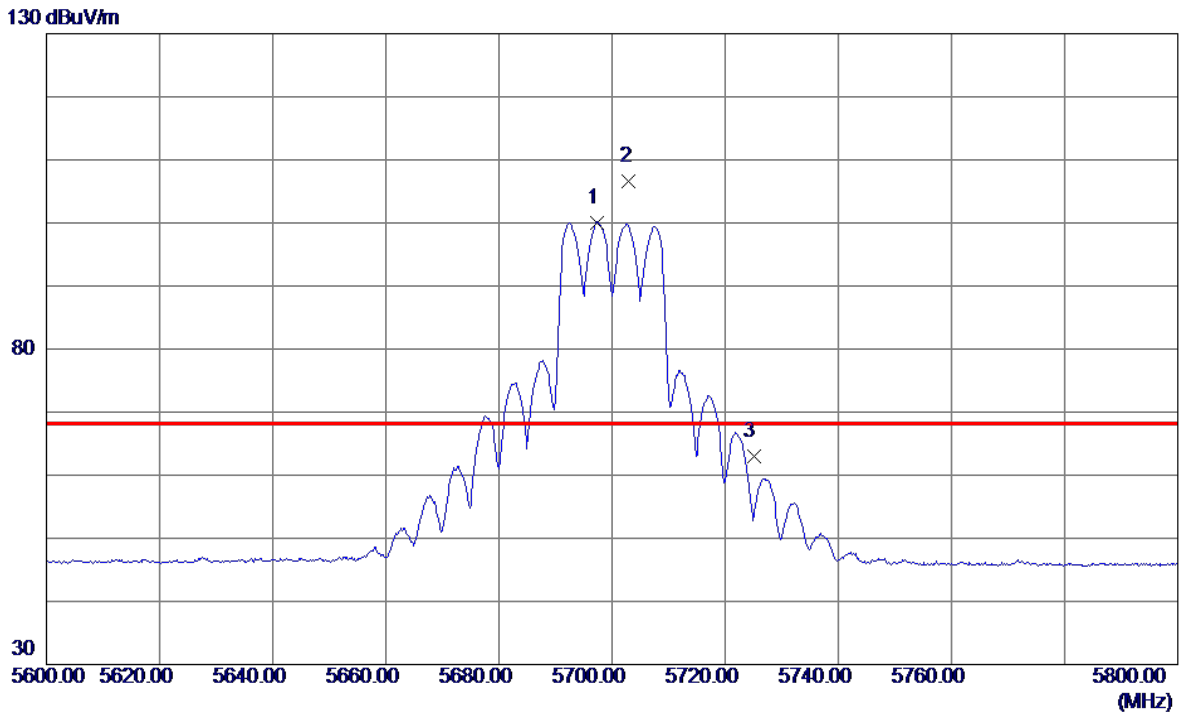

No.	Freq. MHz	Reading Level dBuV/m	Correct Factor dB	Measure ment dBuV/m	Limit dBuV/m	Margin dB	Detector	Comment
1	5697.4000	83.32	16.78	100.10	999.00	-898.90	AVG	No Limit
2 *	5703.0000	89.89	16.78	106.67	68.20	38.47	Peak	No Limit
3	5725.0000	46.12	16.80	62.92	68.20	-5.28	Peak	

REMARKS:

- (1) Measurement Value = Reading Level + Correct Factor.
- (2) Margin Level = Measurement Value - Limit Value.

Test Mode	UNII-2C_TX AC(VHT20) Mode 5700 MHz	Polarization	Vertical
-----------	------------------------------------	--------------	----------

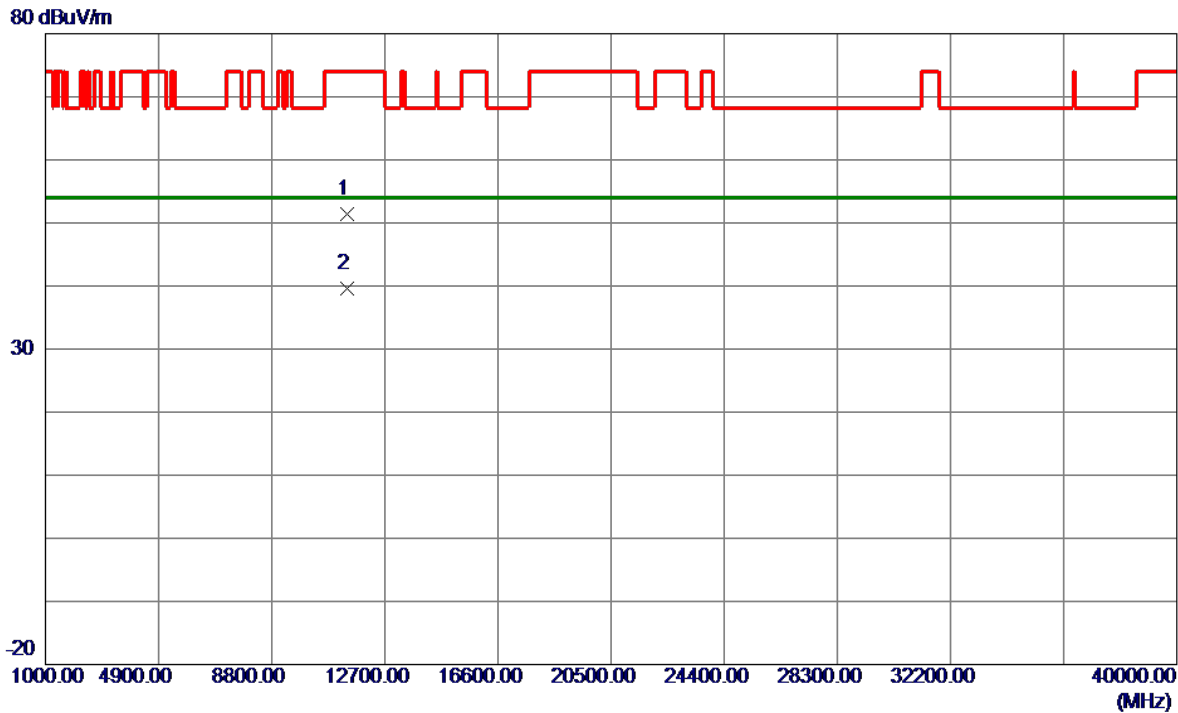

No.	Freq. MHz	Reading Level dBuV/m	Correct Factor dB	Measure ment dBuV/m	Limit dBuV/m	Margin dB	Detector	Comment
1	11398.9800	38.41	13.08	51.49	74.00	-22.51	Peak	
2 *	11400.3099	26.55	13.08	39.63	54.00	-14.37	AVG	

REMARKS:

- (1) Measurement Value = Reading Level + Correct Factor.
- (2) Margin Level = Measurement Value - Limit Value.

Test Mode	UNII-2C_TX AC(VHT20) Mode 5700 MHz	Polarization	Horizontal
-----------	------------------------------------	--------------	------------

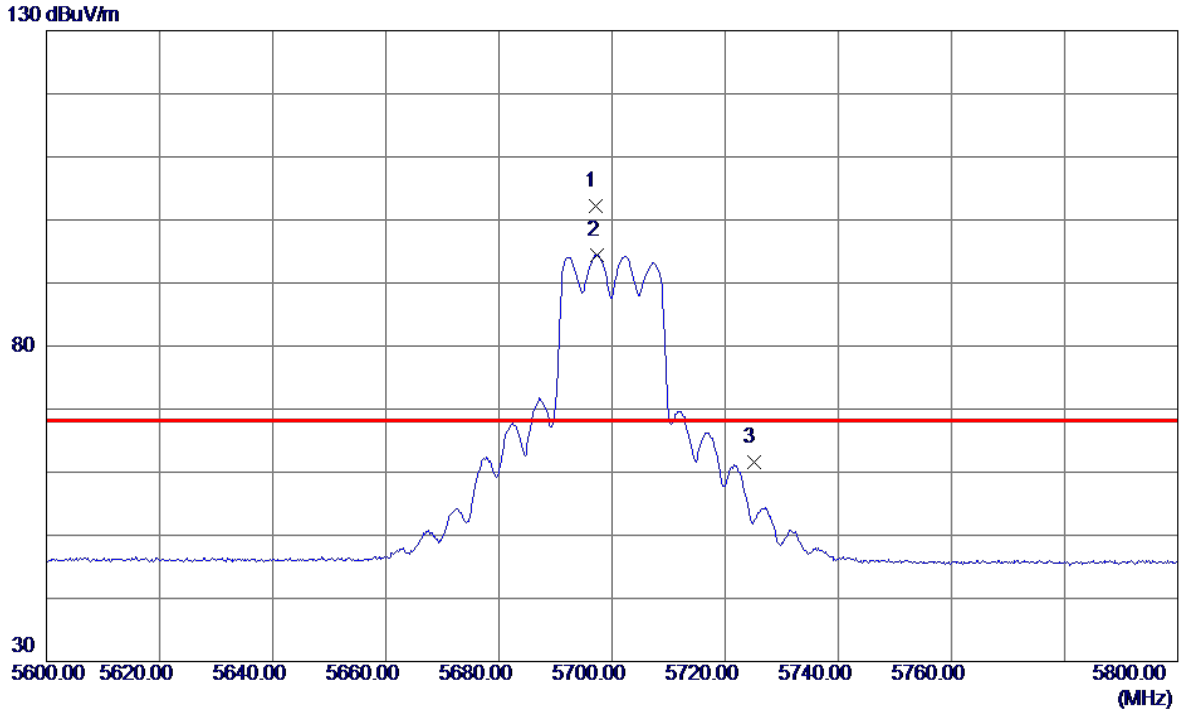

No.	Freq. MHz	Reading Level dBuV/m	Correct Factor dB	Measure ment dBuV/m	Limit dBuV/m	Margin dB	Detector	Comment
1 *	5697.0000	85.45	16.78	102.23	68.20	34.03	Peak	No Limit
2	5697.4000	77.70	16.78	94.48	999.00	-904.52	AVG	No Limit
3	5725.0000	44.83	16.80	61.63	68.20	-6.57	Peak	

REMARKS:

- (1) Measurement Value = Reading Level + Correct Factor.
- (2) Margin Level = Measurement Value - Limit Value.

Test Mode	UNII-2C_TX AC(VHT20) Mode 5700 MHz	Polarization	Horizontal
-----------	------------------------------------	--------------	------------

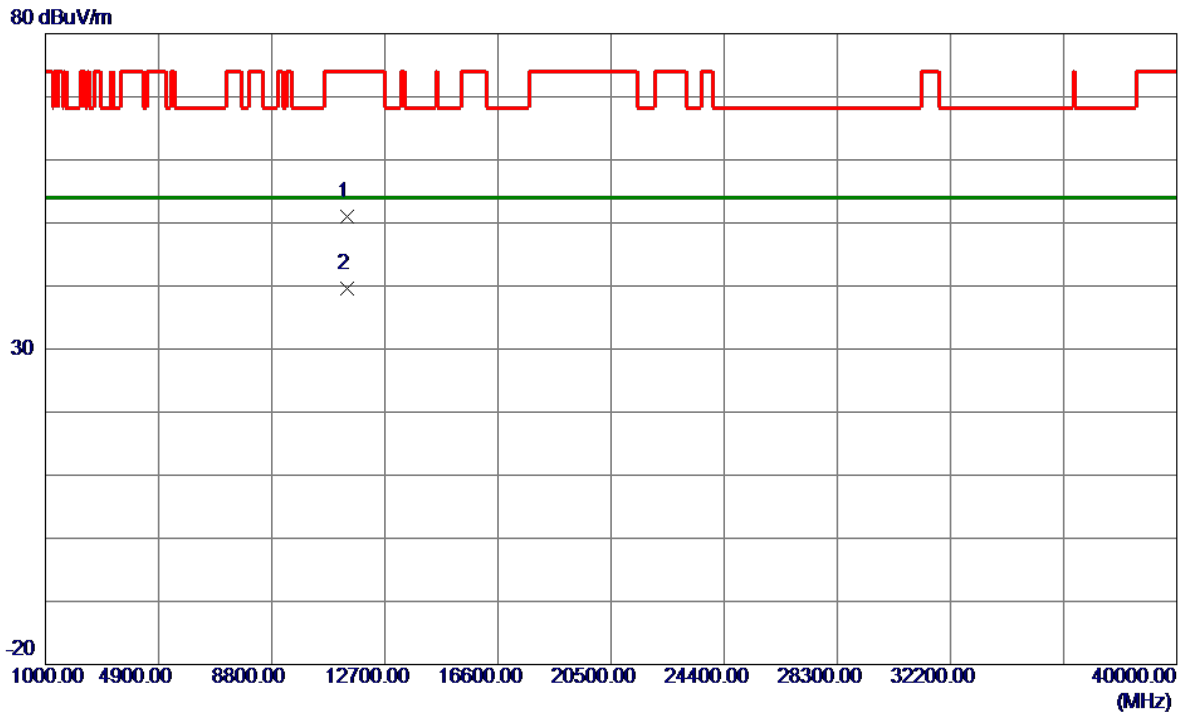

No.	Freq. MHz	Reading Level dBuV/m	Correct Factor dB	Measure ment dBuV/m	Limit dBuV/m	Margin dB	Detector	Comment
1	11400.0000	37.97	13.08	51.05	74.00	-22.95	Peak	
2 *	11400.0000	26.50	13.08	39.58	54.00	-14.42	AVG	

REMARKS:

- (1) Measurement Value = Reading Level + Correct Factor.
- (2) Margin Level = Measurement Value - Limit Value.

Test Mode	UNII-2C_TX AC(VHT40) Mode 5510 MHz	Polarization	Vertical
-----------	------------------------------------	--------------	----------

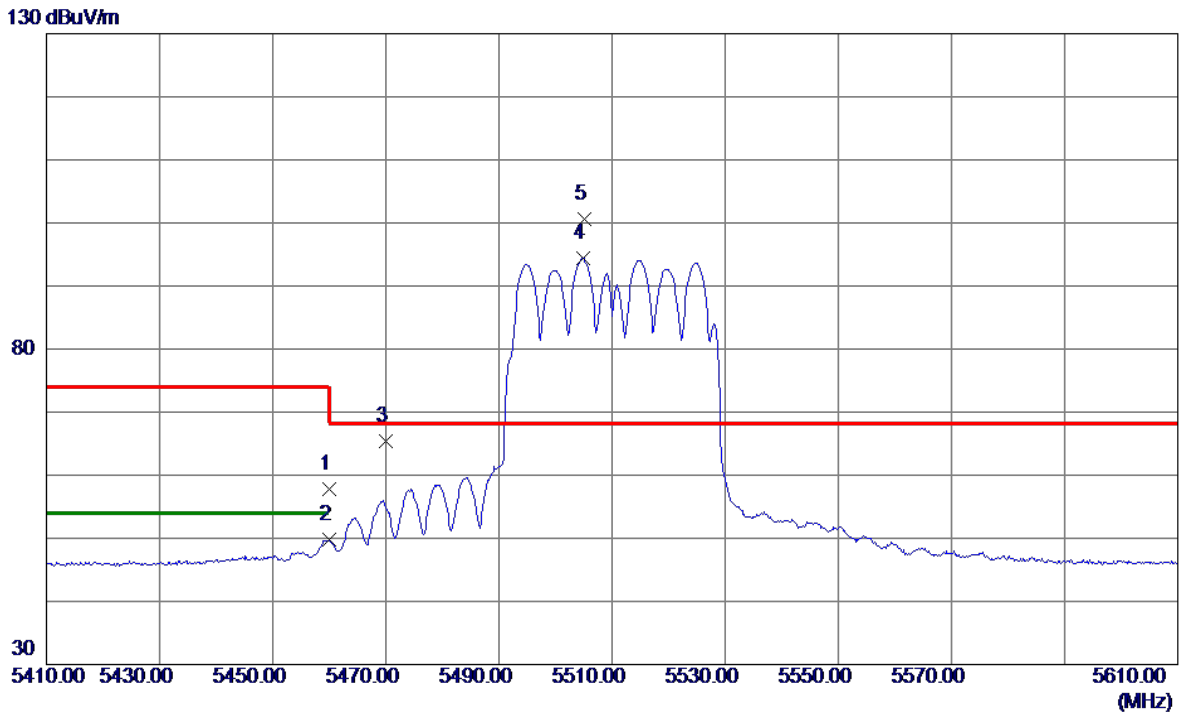

No.	Freq. MHz	Reading Level dBuV/m	Correct Factor dB	Measure ment dBuV/m	Limit dBuV/m	Margin dB	Detector	Comment
1	5460.0000	41.09	16.62	57.71	74.00	-16.29	Peak	
2	5460.0000	33.14	16.62	49.76	54.00	-4.24	AVG	
3	5470.0000	48.71	16.63	65.34	68.20	-2.86	Peak	
4	5504.8000	77.66	16.67	94.33	999.00	-904.67	AVG	No Limit
5 *	5505.2000	83.92	16.67	100.59	68.20	32.39	Peak	No Limit

REMARKS:

- (1) Measurement Value = Reading Level + Correct Factor.
- (2) Margin Level = Measurement Value - Limit Value.

Test Mode	UNII-2C_TX AC(VHT40) Mode 5510 MHz	Polarization	Vertical
-----------	------------------------------------	--------------	----------

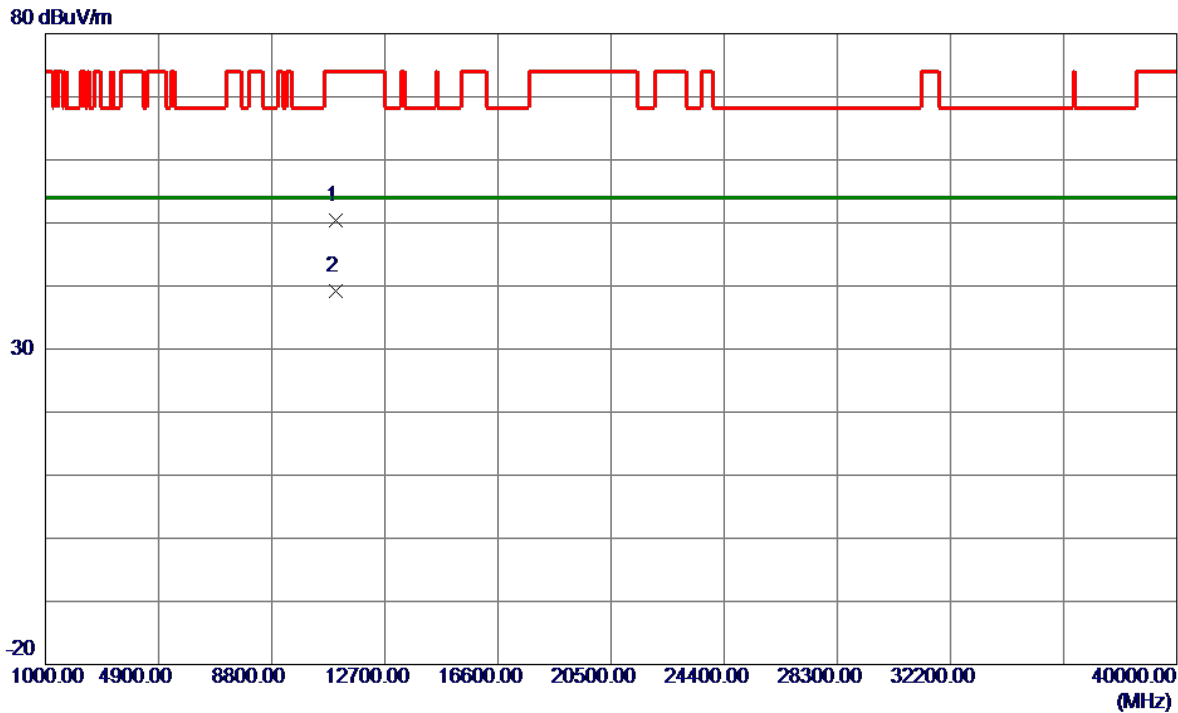

No.	Freq. MHz	Reading Level dBuV/m	Correct Factor dB	Measure ment dBuV/m	Limit dBuV/m	Margin dB	Detector	Comment
1	11020.0000	37.52	12.79	50.31	74.00	-23.69	Peak	
2 *	11020.0000	26.39	12.79	39.18	54.00	-14.82	AVG	

REMARKS:

- (1) Measurement Value = Reading Level + Correct Factor.
- (2) Margin Level = Measurement Value - Limit Value.

Test Mode	UNII-2C_TX AC(VHT40) Mode 5510 MHz	Polarization	Horizontal
-----------	------------------------------------	--------------	------------

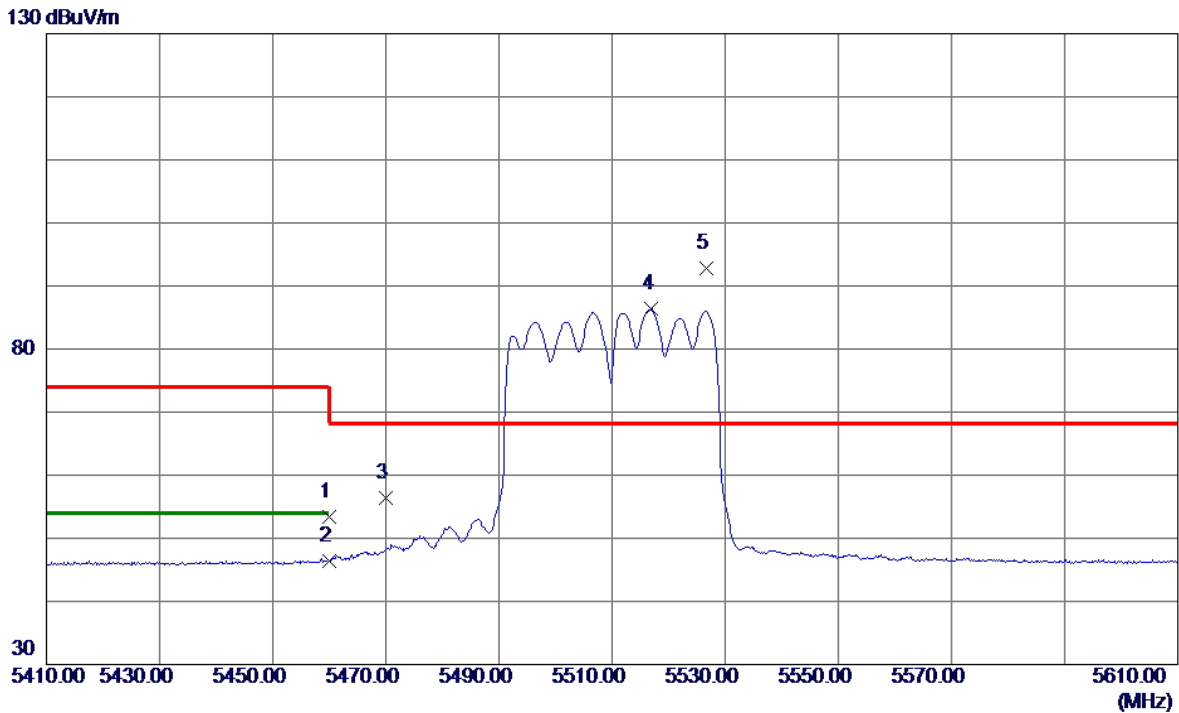

No.	Freq. MHz	Reading Level dBuV/m	Correct Factor dB	Measure ment dBuV/m	Limit dBuV/m	Margin dB	Detector	Comment
1	5460.0000	36.75	16.62	53.37	74.00	-20.63	Peak	
2	5460.0000	29.86	16.62	46.48	54.00	-7.52	AVG	
3	5470.0000	39.75	16.63	56.38	68.20	-11.82	Peak	
4	5517.0000	69.65	16.68	86.33	999.00	-912.67	AVG	No Limit
5 *	5526.6000	76.03	16.68	92.71	68.20	24.51	Peak	No Limit

REMARKS:

- (1) Measurement Value = Reading Level + Correct Factor.
- (2) Margin Level = Measurement Value - Limit Value.

Test Mode	UNII-2C_TX AC(VHT40) Mode 5510 MHz	Polarization	Horizontal
-----------	------------------------------------	--------------	------------

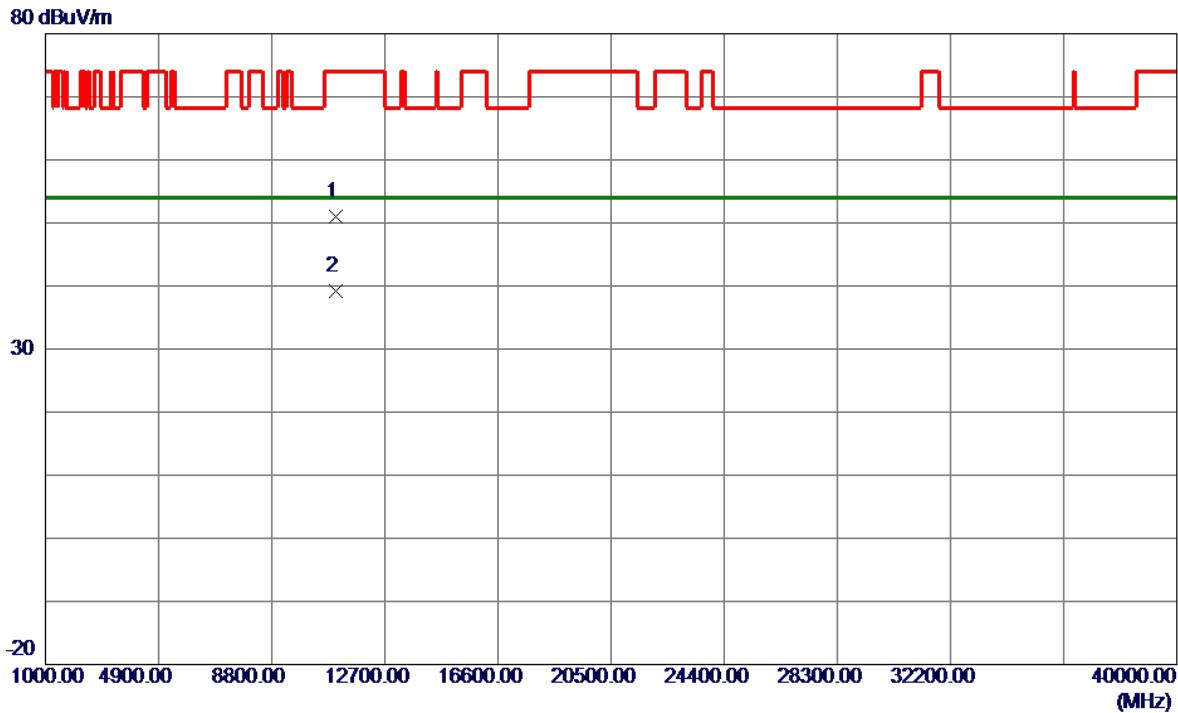

No.	Freq. MHz	Reading Level dBuV/m	Correct Factor dB	Measure ment dBuV/m	Limit dBuV/m	Margin dB	Detector	Comment
1	11020.0000	38.18	12.79	50.97	74.00	-23.03	Peak	
2 *	11020.0000	26.33	12.79	39.12	54.00	-14.88	AVG	

REMARKS:

- (1) Measurement Value = Reading Level + Correct Factor.
- (2) Margin Level = Measurement Value - Limit Value.

Test Mode	UNII-2C_TX AC(VHT40) Mode 5550 MHz	Polarization	Vertical
-----------	------------------------------------	--------------	----------

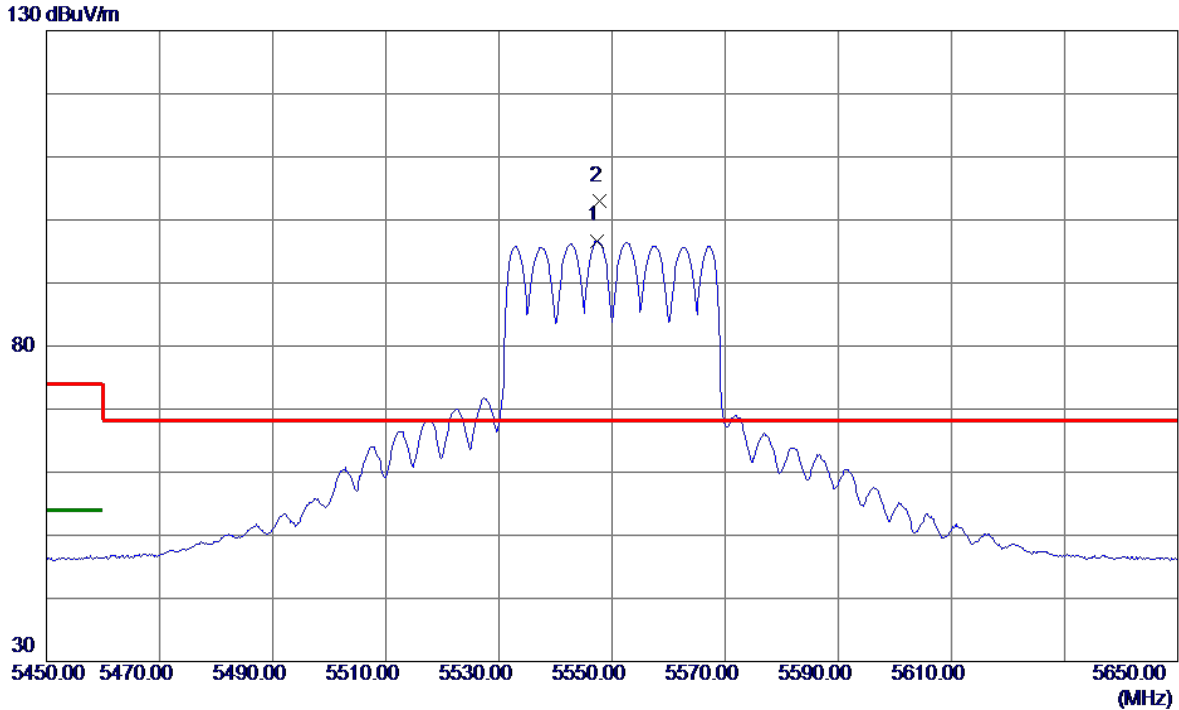

No.	Freq. MHz	Reading Level dBuV/m	Correct Factor dB	Measure ment dBuV/m	Limit dBuV/m	Margin dB	Detector	Comment
1	5547.4000	80.01	16.69	96.70	999.00	-902.30	AVG	No Limit
2 *	5547.8000	86.40	16.69	103.09	68.20	34.89	Peak	No Limit

REMARKS:

- (1) Measurement Value = Reading Level + Correct Factor.
- (2) Margin Level = Measurement Value - Limit Value.

Test Mode	UNII-2C_TX AC(VHT40) Mode 5550 MHz	Polarization	Vertical
-----------	------------------------------------	--------------	----------

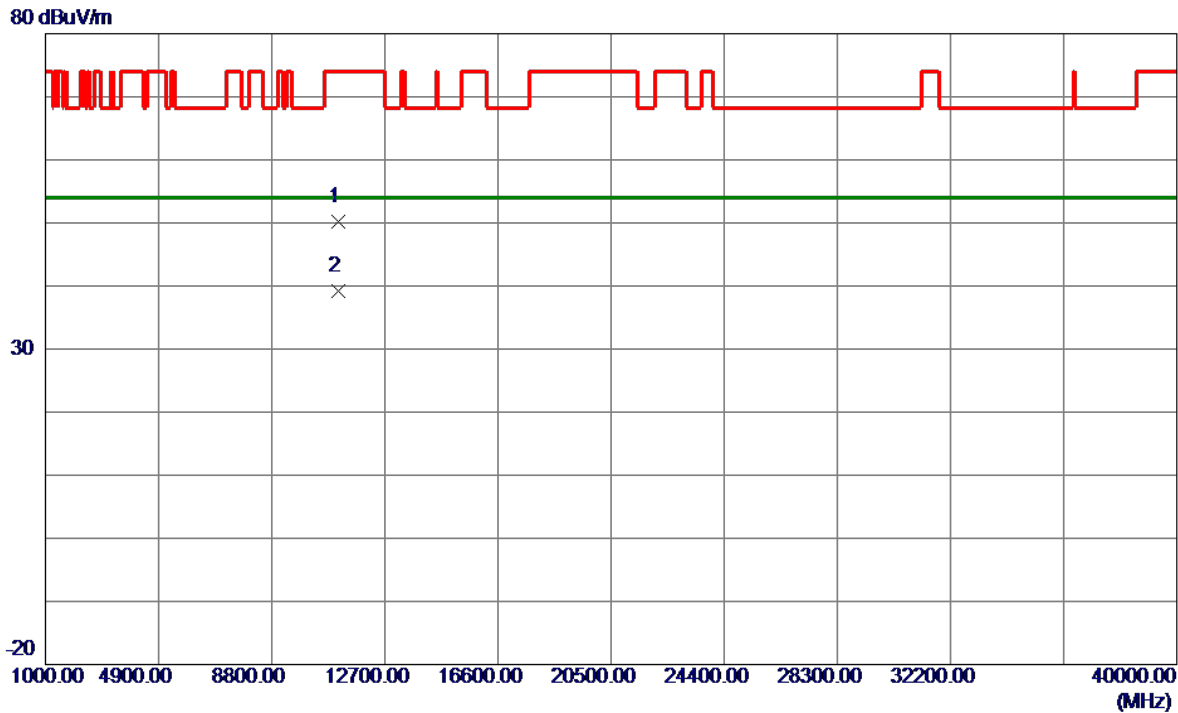

No.	Freq. MHz	Reading Level dBuV/m	Correct Factor dB	Measure ment dBuV/m	Limit dBuV/m	Margin dB	Detector	Comment
1	11100.0000	37.35	12.85	50.20	74.00	-23.80	Peak	
2 *	11100.0000	26.41	12.85	39.26	54.00	-14.74	AVG	

REMARKS:

- (1) Measurement Value = Reading Level + Correct Factor.
- (2) Margin Level = Measurement Value - Limit Value.

Test Mode	UNII-2C_TX AC(VHT40) Mode 5550 MHz	Polarization	Horizontal
-----------	------------------------------------	--------------	------------

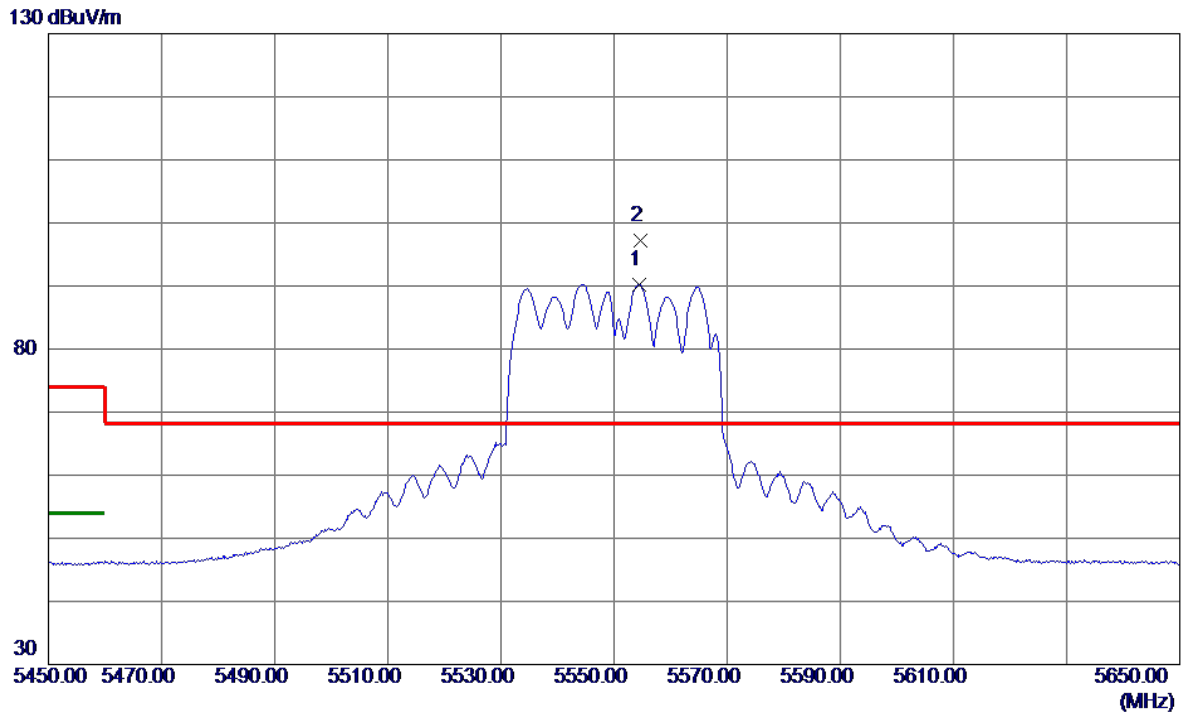

No.	Freq. MHz	Reading Level dBuV/m	Correct Factor dB	Measure ment dBuV/m	Limit dBuV/m	Margin dB	Detector	Comment
1	5554.4000	73.57	16.70	90.27	999.00	-908.73	AVG	No Limit
2 *	5554.6000	80.52	16.70	97.22	68.20	29.02	Peak	No Limit

REMARKS:

- (1) Measurement Value = Reading Level + Correct Factor.
- (2) Margin Level = Measurement Value - Limit Value.

Test Mode	UNII-2C_TX AC(VHT40) Mode 5550 MHz	Polarization	Horizontal
-----------	------------------------------------	--------------	------------

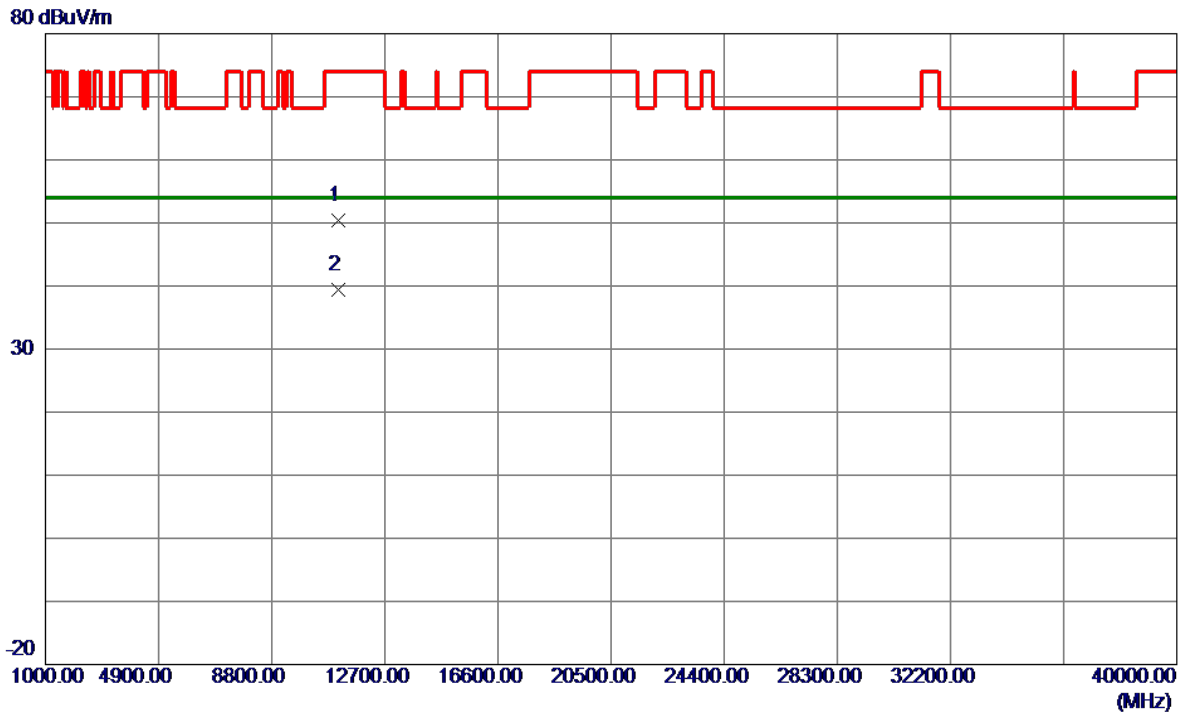

No.	Freq. MHz	Reading Level dBuV/m	Correct Factor dB	Measure ment dBuV/m	Limit dBuV/m	Margin dB	Detector	Comment
1	11100.0000	37.50	12.85	50.35	74.00	-23.65	Peak	
2 *	11100.0000	26.47	12.85	39.32	54.00	-14.68	AVG	

REMARKS:

- (1) Measurement Value = Reading Level + Correct Factor.
- (2) Margin Level = Measurement Value - Limit Value.

Test Mode	UNII-2C_TX AC(VHT40) Mode 5670 MHz	Polarization	Vertical
-----------	------------------------------------	--------------	----------

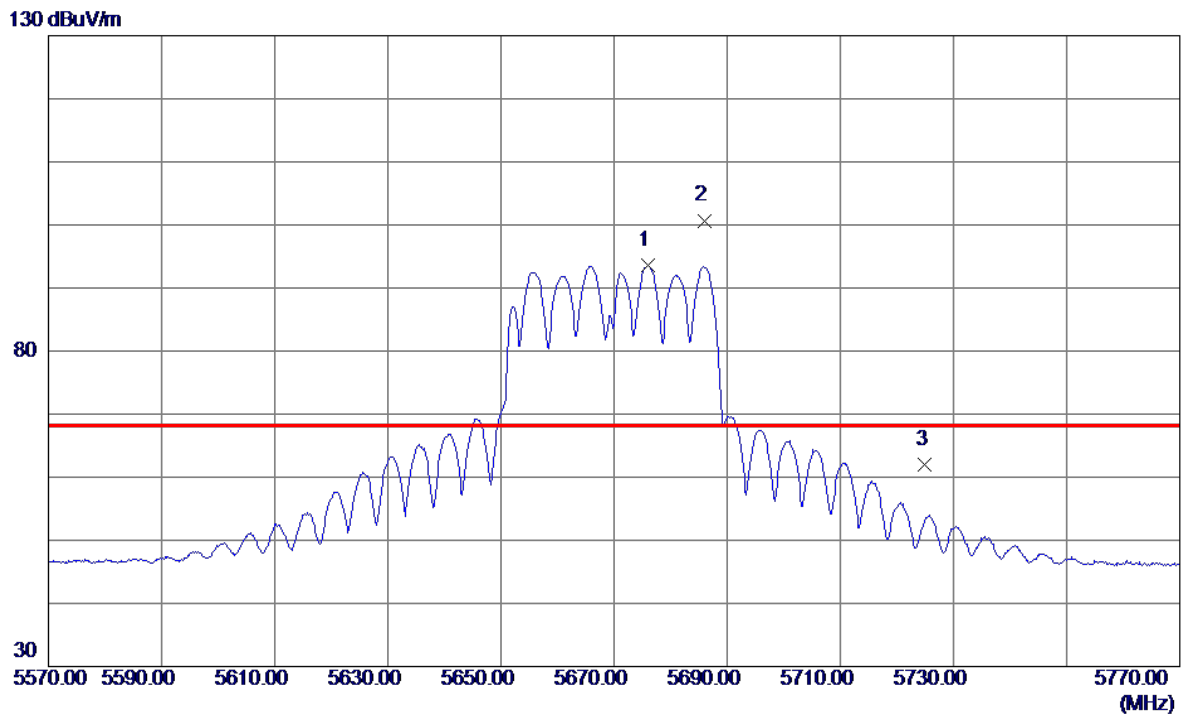

No.	Freq. MHz	Reading Level dBuV/m	Correct Factor dB	Measurement dBuV/m	Limit dBuV/m	Margin dB	Detector	Comment
1	5676.0000	76.76	16.77	93.53	999.00	-905.47	AVG	No Limit
2 *	5686.0000	83.93	16.77	100.70	68.20	32.50	Peak	No Limit
3	5725.0000	45.17	16.80	61.97	68.20	-6.23	Peak	

REMARKS:

- (1) Measurement Value = Reading Level + Correct Factor.
- (2) Margin Level = Measurement Value - Limit Value.

Test Mode	UNII-2C_TX AC(VHT40) Mode 5670 MHz	Polarization	Vertical
-----------	------------------------------------	--------------	----------

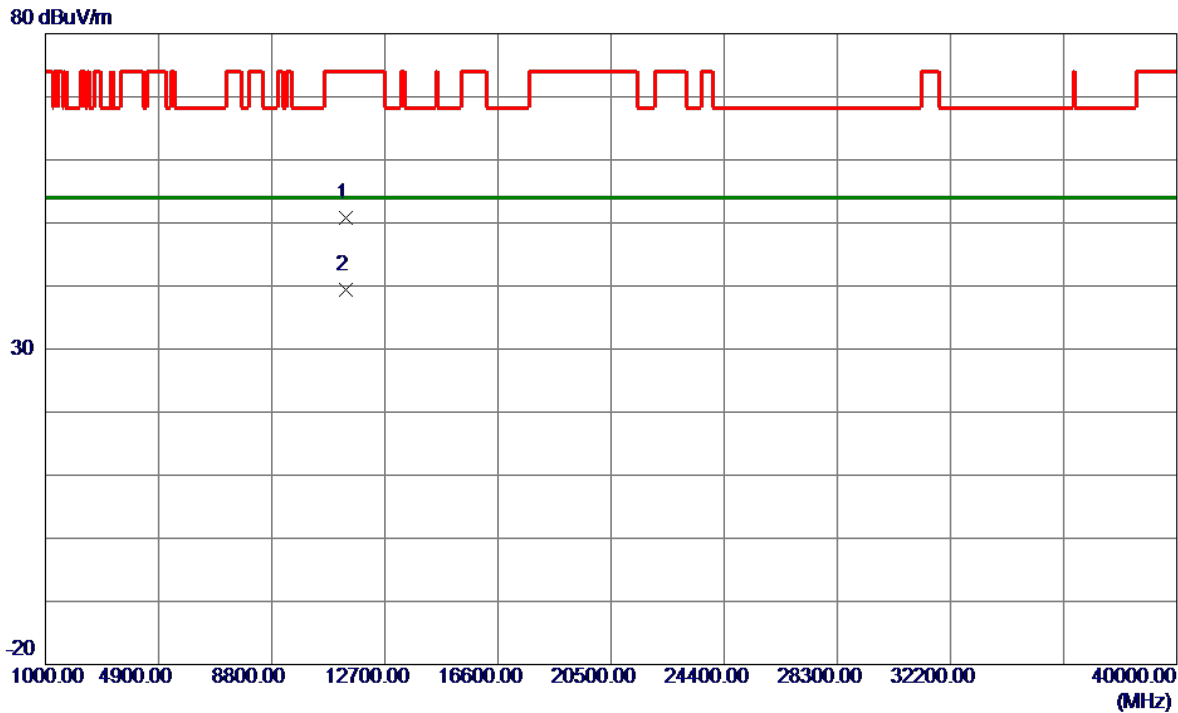

No.	Freq. MHz	Reading Level dBuV/m	Correct Factor dB	Measure ment dBuV/m	Limit dBuV/m	Margin dB	Detector	Comment
1	11340.0000	37.86	13.03	50.89	74.00	-23.11	Peak	
2 *	11340.0000	26.31	13.03	39.34	54.00	-14.66	AVG	

REMARKS:

- (1) Measurement Value = Reading Level + Correct Factor.
- (2) Margin Level = Measurement Value - Limit Value.

Test Mode	UNII-2C_TX AC(VHT40) Mode 5670 MHz	Polarization	Horizontal
-----------	------------------------------------	--------------	------------

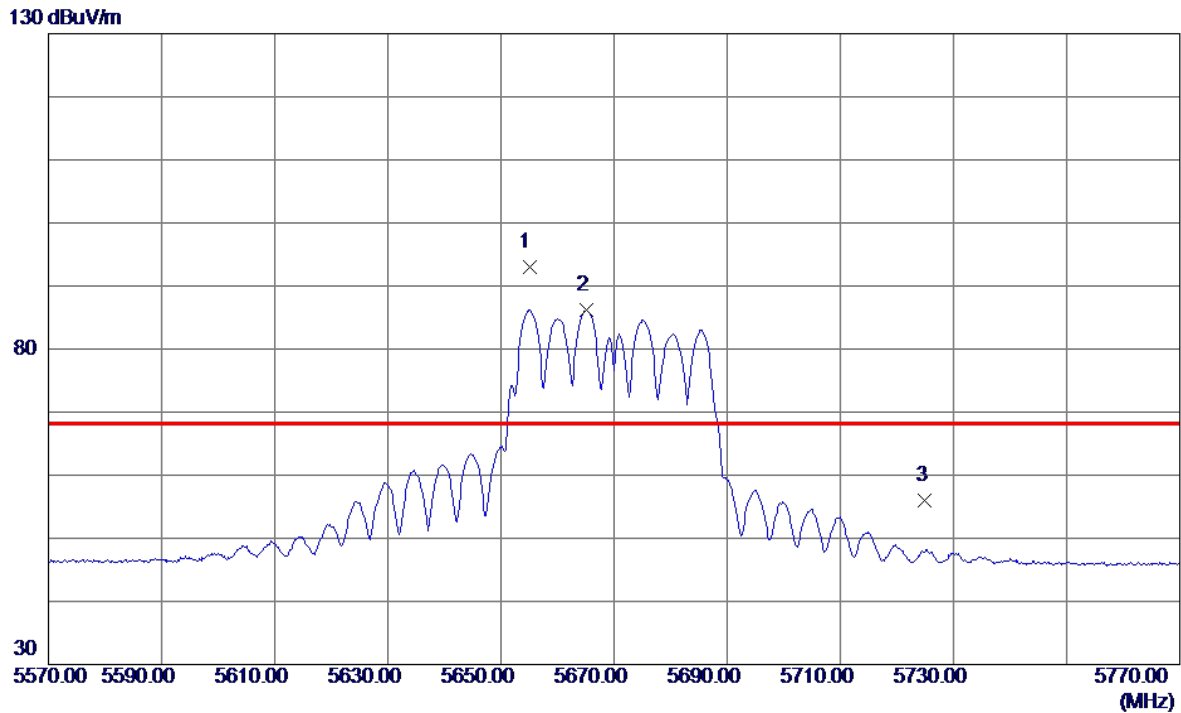

No.	Freq. MHz	Reading Level dBuV/m	Correct Factor dB	Measure ment dBuV/m	Limit dBuV/m	Margin dB	Detector	Comment
1 *	5655.0000	76.30	16.76	93.06	68.20	24.86	Peak	No Limit
2	5665.2000	69.38	16.76	86.14	999.00	-912.86	AVG	No Limit
3	5725.0000	39.22	16.80	56.02	68.20	-12.18	Peak	

REMARKS:

- (1) Measurement Value = Reading Level + Correct Factor.
- (2) Margin Level = Measurement Value - Limit Value.

Test Mode	UNII-2C_TX AC(VHT40) Mode 5670 MHz	Polarization	Horizontal
-----------	------------------------------------	--------------	------------

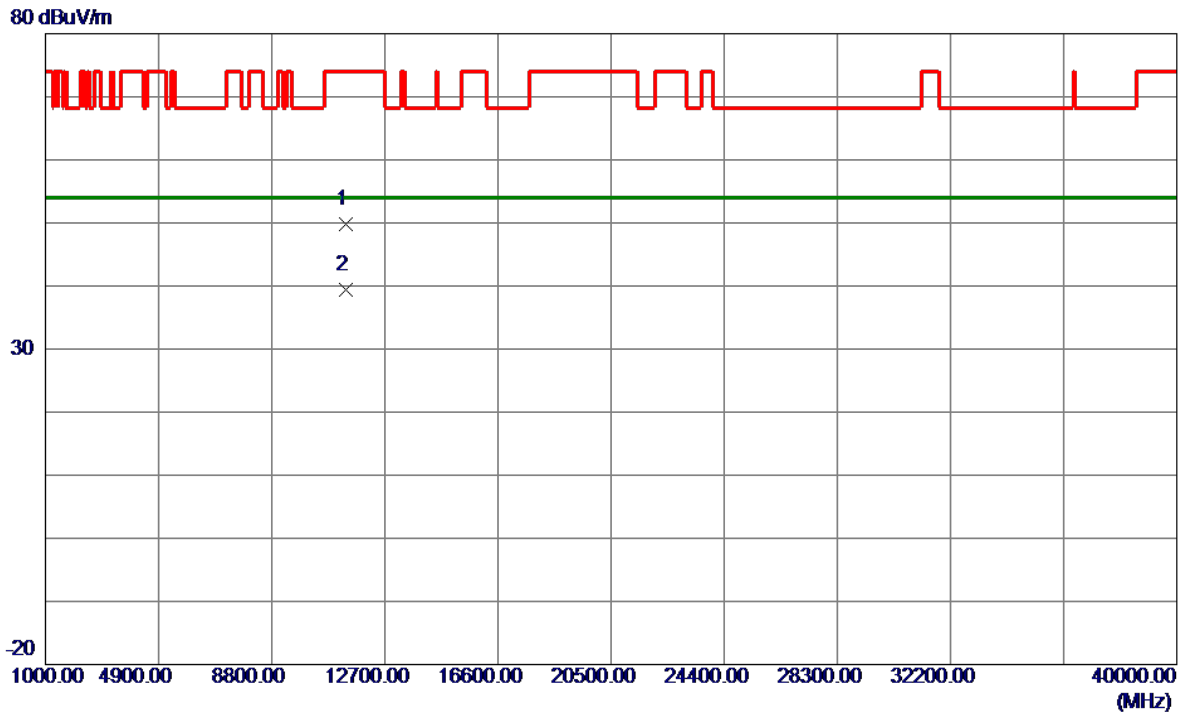

No.	Freq. MHz	Reading Level dBuV/m	Correct Factor dB	Measure ment dBuV/m	Limit dBuV/m	Margin dB	Detector	Comment
1	11340.0000	36.74	13.03	49.77	74.00	-24.23	Peak	
2 *	11340.0000	26.31	13.03	39.34	54.00	-14.66	AVG	

REMARKS:

- (1) Measurement Value = Reading Level + Correct Factor.
- (2) Margin Level = Measurement Value - Limit Value.

Test Mode	UNII-2C_TX AC(VHT80) Mode 5530 MHz	Polarization	Vertical
-----------	------------------------------------	--------------	----------

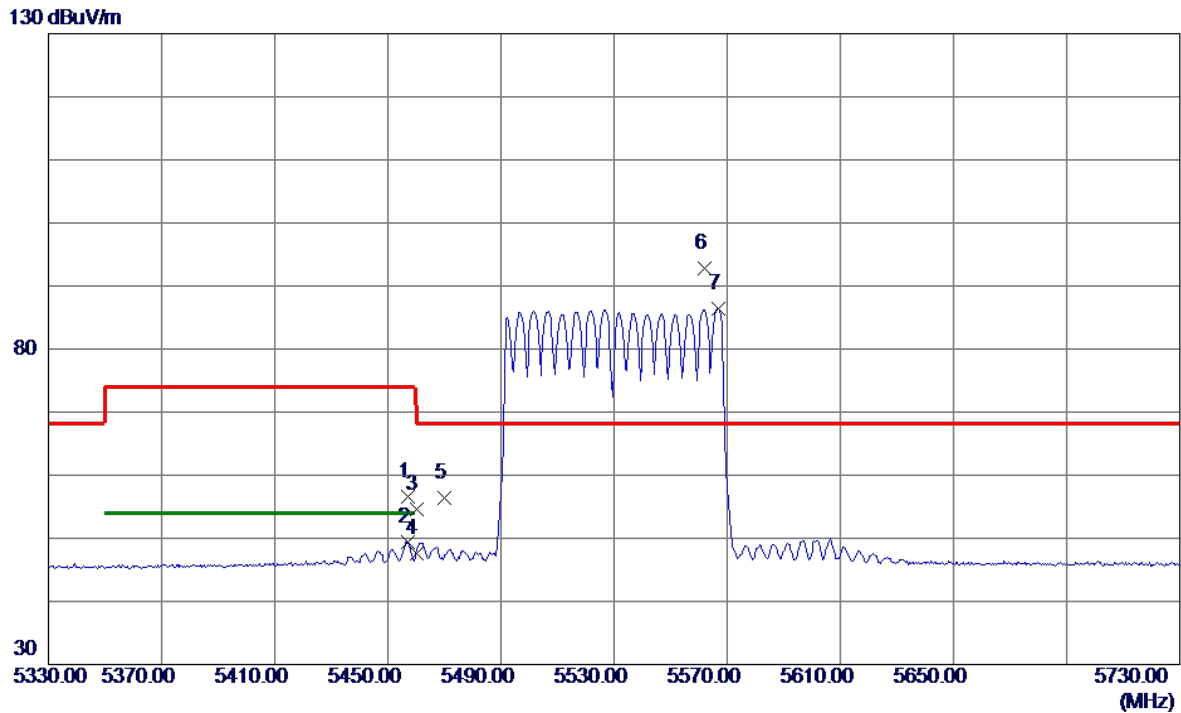

No.	Freq. MHz	Reading Level dBuV/m	Correct Factor dB	Measure ment dBuV/m	Limit dBuV/m	Margin dB	Detector	Comment
1	5457.2000	40.00	16.62	56.62	74.00	-17.38	Peak	
2	5457.2000	32.74	16.62	49.36	54.00	-4.64	AVG	
3	5460.0000	37.97	16.62	54.59	74.00	-19.41	Peak	
4	5460.0000	30.98	16.62	47.60	54.00	-6.40	AVG	
5	5470.0000	39.75	16.63	56.38	68.20	-11.82	Peak	
6 *	5562.0000	76.03	16.70	92.73	68.20	24.53	Peak	No Limit
7	5566.8000	69.76	16.70	86.46	999.00	-912.54	AVG	No Limit

REMARKS:

- (1) Measurement Value = Reading Level + Correct Factor.
- (2) Margin Level = Measurement Value - Limit Value.

Test Mode	UNII-2C_TX AC(VHT80) Mode 5530 MHz	Polarization	Vertical
-----------	------------------------------------	--------------	----------

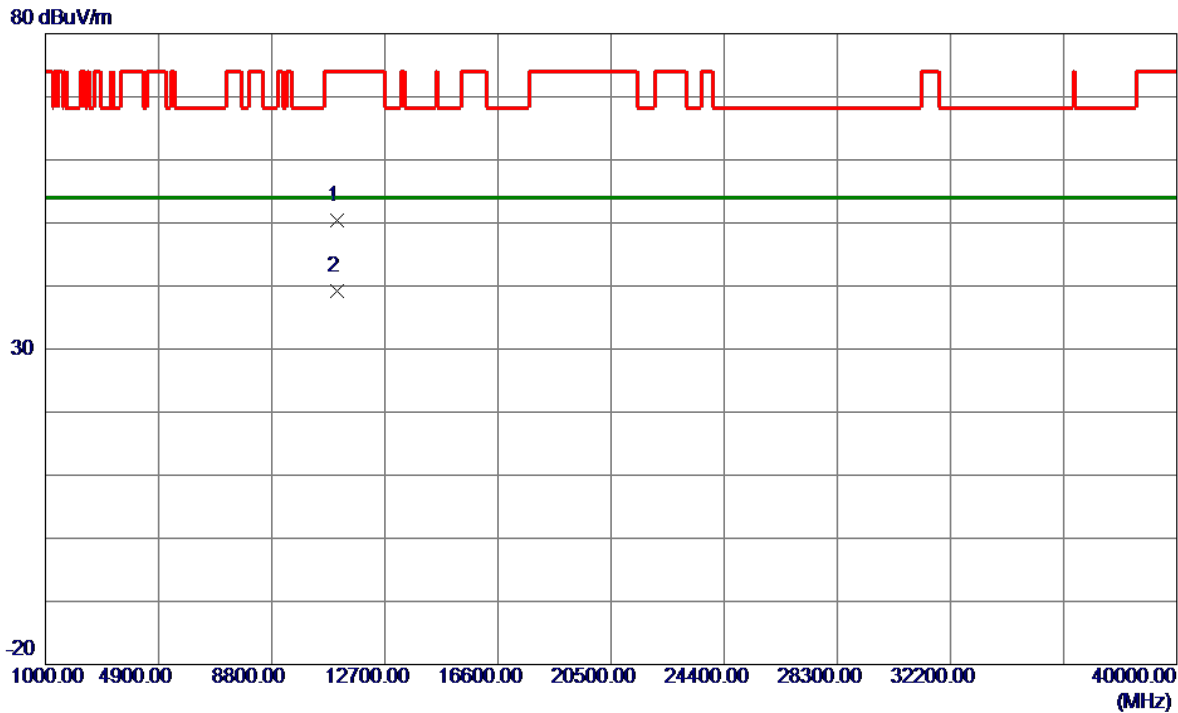

No.	Freq. MHz	Reading Level dBuV/m	Correct Factor dB	Measure ment dBuV/m	Limit dBuV/m	Margin dB	Detector	Comment
1	11060.0000	37.66	12.82	50.48	74.00	-23.52	Peak	
2 *	11060.0000	26.32	12.82	39.14	54.00	-14.86	AVG	

REMARKS:

- (1) Measurement Value = Reading Level + Correct Factor.
- (2) Margin Level = Measurement Value - Limit Value.

Test Mode	UNII-2C_TX AC(VHT80) Mode 5530 MHz	Polarization	Horizontal
-----------	------------------------------------	--------------	------------

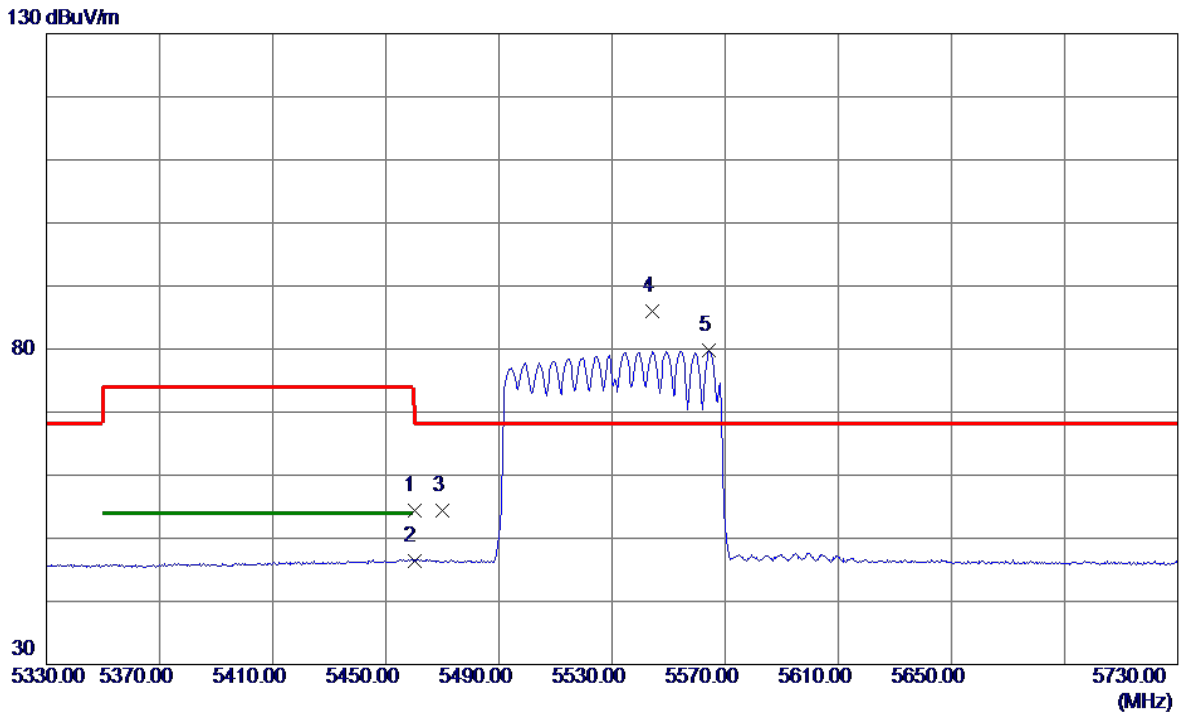

No.	Freq. MHz	Reading Level dBuV/m	Correct Factor dB	Measure ment dBuV/m	Limit dBuV/m	Margin dB	Detector	Comment
1	5460.0000	37.83	16.62	54.45	74.00	-19.55	Peak	
2	5460.0000	29.84	16.62	46.46	54.00	-7.54	AVG	
3	5470.0000	37.79	16.63	54.42	68.20	-13.78	Peak	
4 *	5544.4000	69.35	16.69	86.04	68.20	17.84	Peak	No Limit
5	5564.4000	63.01	16.70	79.71	999.00	-919.29	AVG	No Limit

REMARKS:

- (1) Measurement Value = Reading Level + Correct Factor.
- (2) Margin Level = Measurement Value - Limit Value.

Test Mode	UNII-2C_TX AC(VHT80) Mode 5530 MHz	Polarization	Horizontal
-----------	------------------------------------	--------------	------------

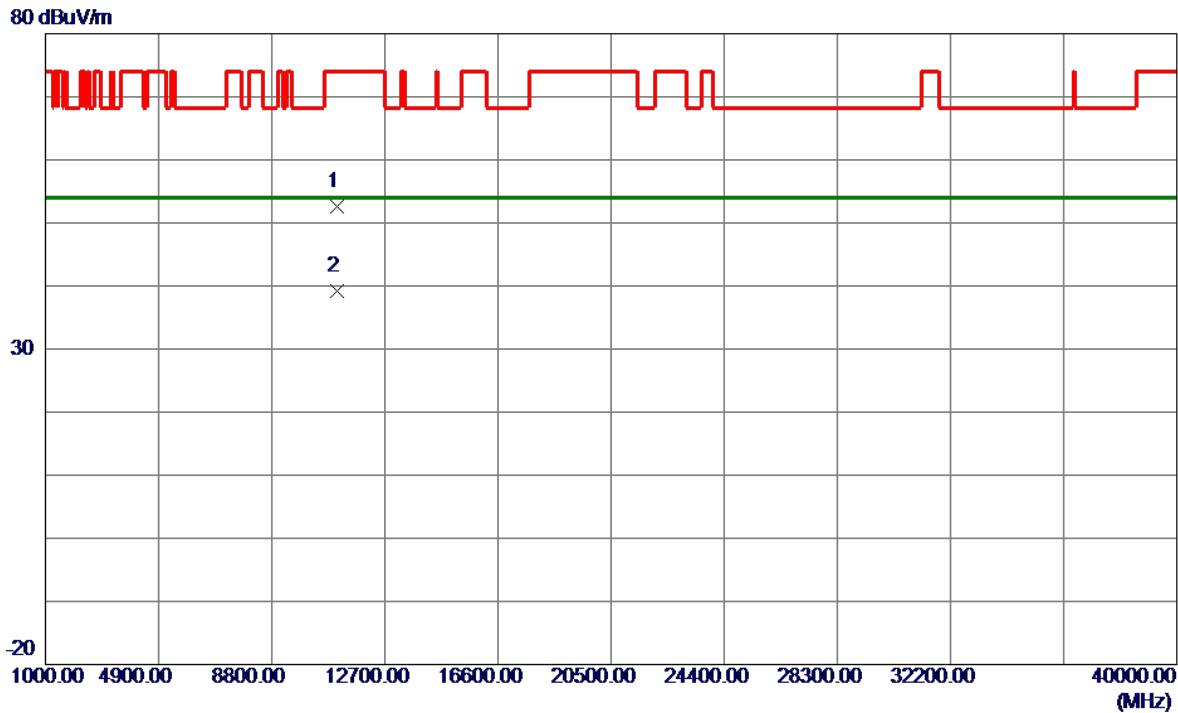

No.	Freq. MHz	Reading Level dBuV/m	Correct Factor dB	Measure ment dBuV/m	Limit dBuV/m	Margin dB	Detector	Comment
1	11060.0000	39.82	12.82	52.64	74.00	-21.36	Peak	
2 *	11060.0000	26.46	12.82	39.28	54.00	-14.72	AVG	

REMARKS:

- (1) Measurement Value = Reading Level + Correct Factor.
- (2) Margin Level = Measurement Value - Limit Value.

Test Mode	UNII-2C_TX AC(VHT80) Mode 5610 MHz	Polarization	Vertical
-----------	------------------------------------	--------------	----------

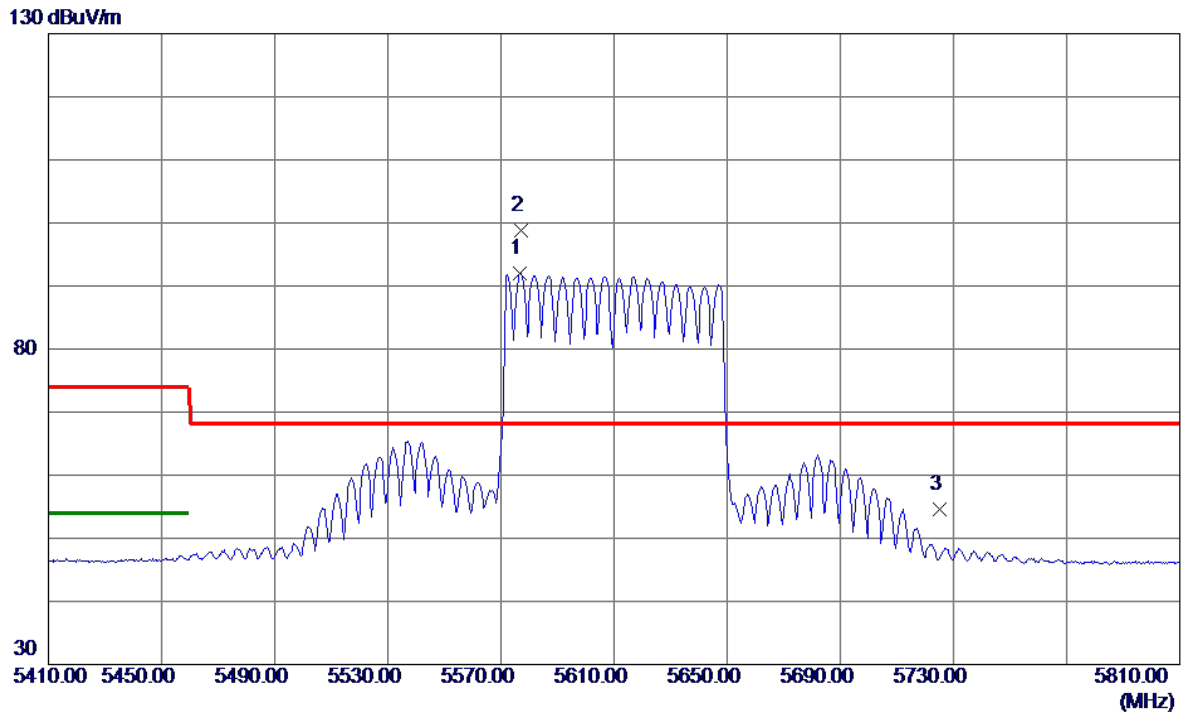

No.	Freq. MHz	Reading Level dBuV/m	Correct Factor dB	Measure ment dBuV/m	Limit dBuV/m	Margin dB	Detector	Comment
1	5576.8000	75.31	16.71	92.02	999.00	-906.98	AVG	No Limit
2 *	5577.2000	82.15	16.71	98.86	68.20	30.66	Peak	No Limit
3	5725.0000	37.80	16.80	54.60	68.20	-13.60	Peak	

REMARKS:

- (1) Measurement Value = Reading Level + Correct Factor.
- (2) Margin Level = Measurement Value - Limit Value.

Test Mode	UNII-2C_TX AC(VHT80) Mode 5610 MHz	Polarization	Vertical
-----------	------------------------------------	--------------	----------

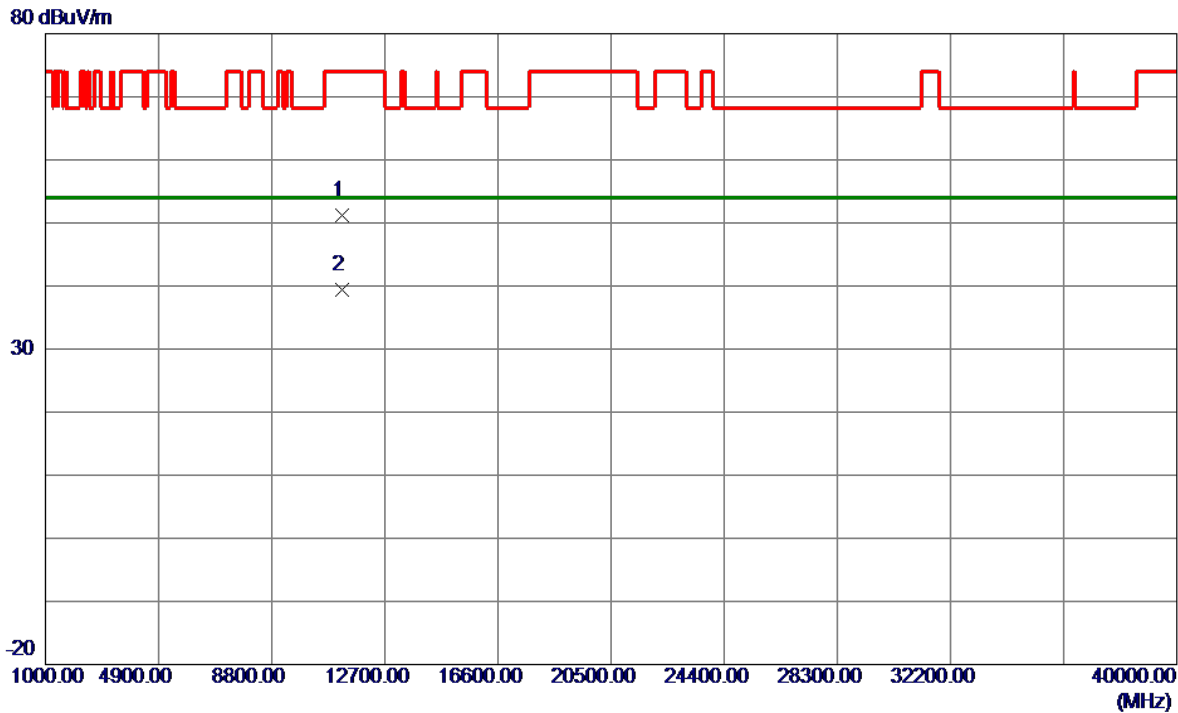

No.	Freq. MHz	Reading Level dBuV/m	Correct Factor dB	Measure ment dBuV/m	Limit dBuV/m	Margin dB	Detector	Comment
1	11220.0000	38.23	12.94	51.17	74.00	-22.83	Peak	
2 *	11220.0000	26.55	12.94	39.49	54.00	-14.51	AVG	

REMARKS:

- (1) Measurement Value = Reading Level + Correct Factor.
- (2) Margin Level = Measurement Value - Limit Value.

Test Mode	UNII-2C_TX AC(VHT80) Mode 5610 MHz	Polarization	Horizontal
-----------	------------------------------------	--------------	------------

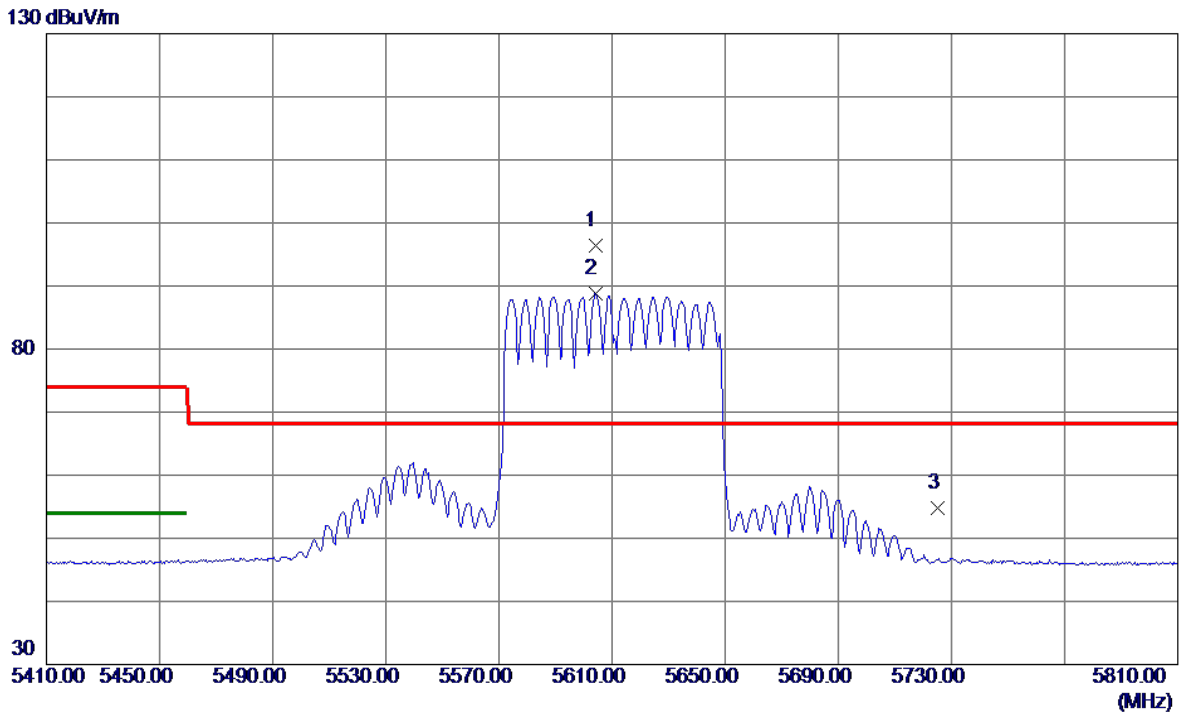

No.	Freq. MHz	Reading Level dBuV/m	Correct Factor dB	Measure ment dBuV/m	Limit dBuV/m	Margin dB	Detector	Comment
1 *	5604.0000	79.58	16.73	96.31	68.20	28.11	Peak	No Limit
2	5604.0000	72.01	16.73	88.74	999.00	-910.26	AVG	No Limit
3	5725.0000	38.00	16.80	54.80	68.20	-13.40	Peak	

REMARKS:

- (1) Measurement Value = Reading Level + Correct Factor.
- (2) Margin Level = Measurement Value - Limit Value.

Test Mode	UNII-2C_TX AC(VHT80) Mode 5610 MHz	Polarization	Horizontal
-----------	------------------------------------	--------------	------------

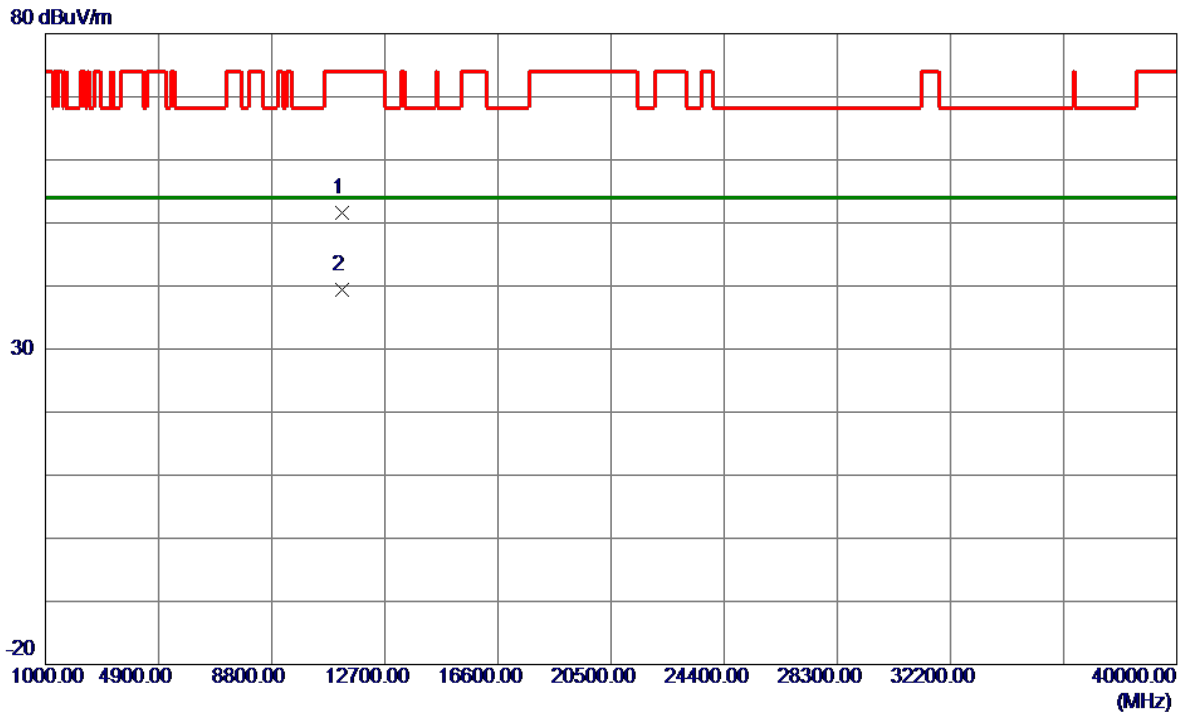

No.	Freq. MHz	Reading Level dBuV/m	Correct Factor dB	Measure ment dBuV/m	Limit dBuV/m	Margin dB	Detector	Comment
1	11220.0000	38.73	12.94	51.67	74.00	-22.33	Peak	
2 *	11220.0000	26.55	12.94	39.49	54.00	-14.51	AVG	

REMARKS:

- (1) Measurement Value = Reading Level + Correct Factor.
- (2) Margin Level = Measurement Value - Limit Value.

Test Mode	UNII-3_TX A Mode 5745 MHz	Polarization	Vertical
-----------	---------------------------	--------------	----------

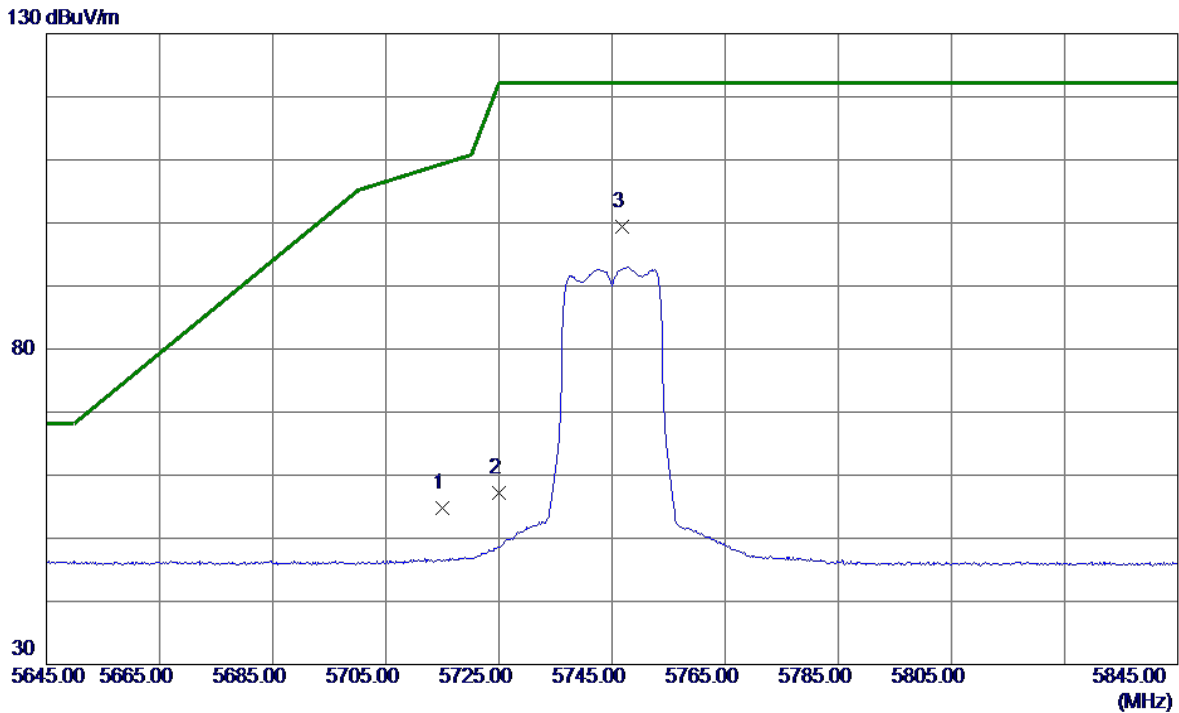

No.	Freq. MHz	Reading Level dBuV/m	Correct Factor dB	Measure ment dBuV/m	Limit dBuV/m	Margin dB	Detector	Comment
1	5715.0000	38.09	16.79	54.88	109.40	-54.52	Peak	
2	5725.0000	40.33	16.80	57.13	122.20	-65.07	Peak	
3 *	5746.8000	82.63	16.81	99.44	122.20	-22.76	Peak	No Limit

REMARKS:

- (1) Measurement Value = Reading Level + Correct Factor.
- (2) Margin Level = Measurement Value - Limit Value.

Test Mode	UNII-3_TX A Mode 5745 MHz	Polarization	Vertical
-----------	---------------------------	--------------	----------

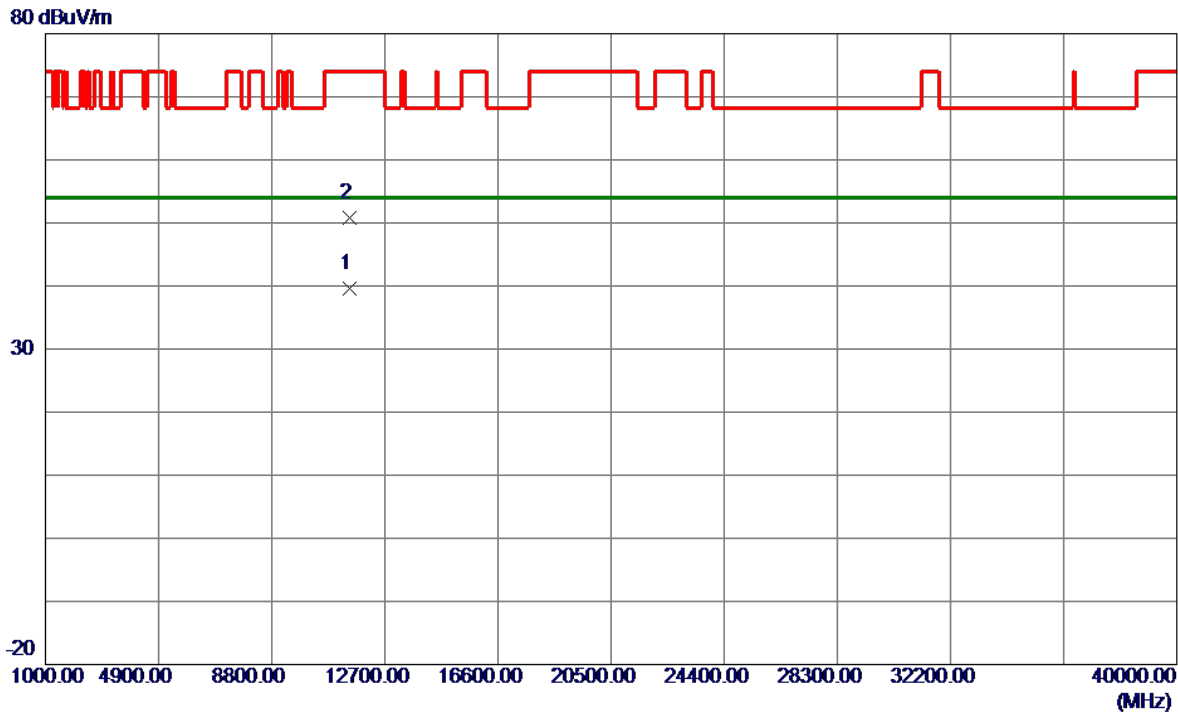

No.	Freq. MHz	Reading Level dBuV/m	Correct Factor dB	Measure ment dBuV/m	Limit dBuV/m	Margin dB	Detector	Comment
1 *	11487.8800	26.51	13.15	39.66	54.00	-14.34	AVG	
2	11488.9400	37.61	13.15	50.76	74.00	-23.24	Peak	

REMARKS:

- (1) Measurement Value = Reading Level + Correct Factor.
- (2) Margin Level = Measurement Value - Limit Value.

Test Mode	UNII-3_TX A Mode 5745 MHz	Polarization	Horizontal
-----------	---------------------------	--------------	------------

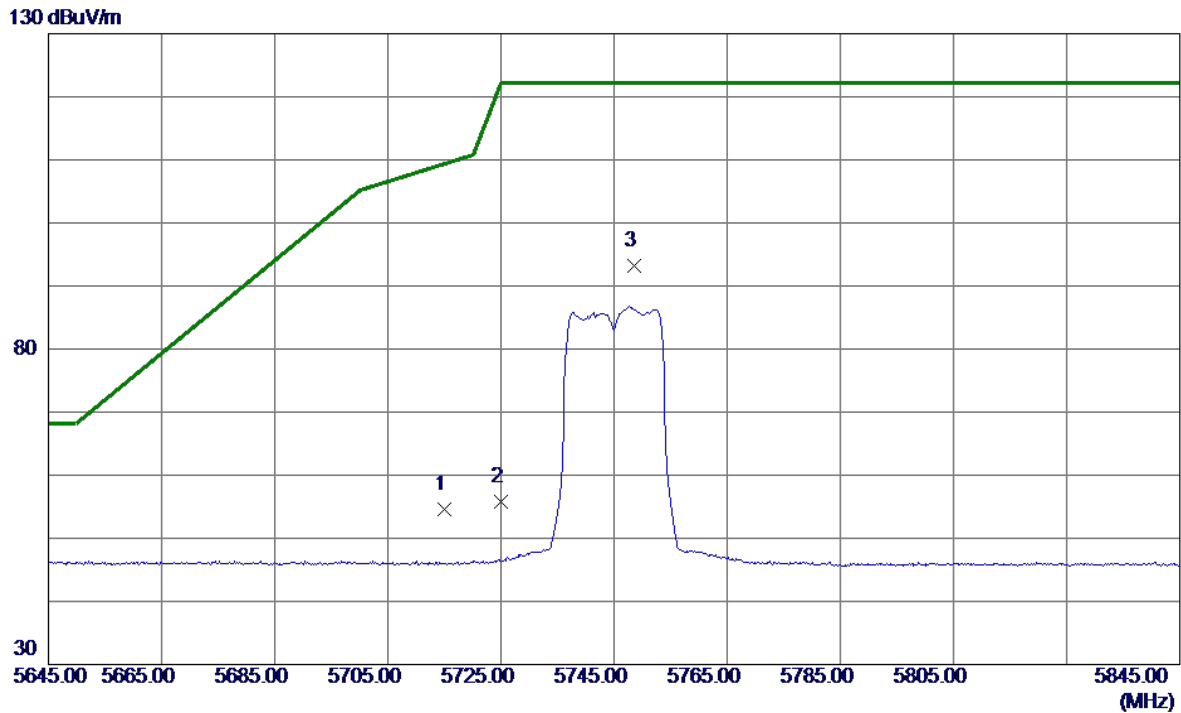

No.	Freq. MHz	Reading Level dBuV/m	Correct Factor dB	Measure ment dBuV/m	Limit dBuV/m	Margin dB	Detector	Comment
1	5715.0000	37.80	16.79	54.59	109.40	-54.81	Peak	
2	5725.0000	39.07	16.80	55.87	122.20	-66.33	Peak	
3 *	5748.6000	76.45	16.81	93.26	122.20	-28.94	Peak	No Limit

REMARKS:

- (1) Measurement Value = Reading Level + Correct Factor.
- (2) Margin Level = Measurement Value - Limit Value.

Test Mode	UNII-3_TX A Mode 5745 MHz	Polarization	Horizontal
-----------	---------------------------	--------------	------------

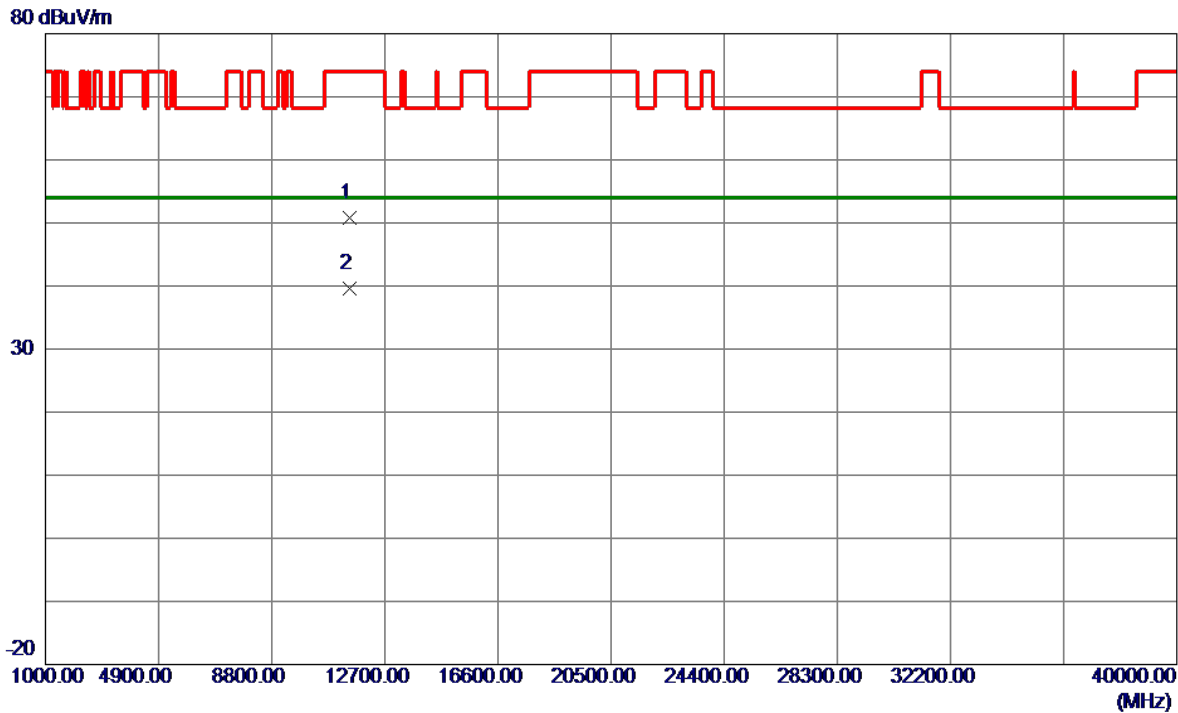

No.	Freq. MHz	Reading Level dBuV/m	Correct Factor dB	Measure ment dBuV/m	Limit dBuV/m	Margin dB	Detector	Comment
1	11490.0000	37.67	13.15	50.82	74.00	-23.18	Peak	
2 *	11490.0000	26.51	13.15	39.66	54.00	-14.34	AVG	

REMARKS:

- (1) Measurement Value = Reading Level + Correct Factor.
- (2) Margin Level = Measurement Value - Limit Value.

Test Mode	UNII-3_TX A Mode 5785 MHz	Polarization	Vertical
-----------	---------------------------	--------------	----------

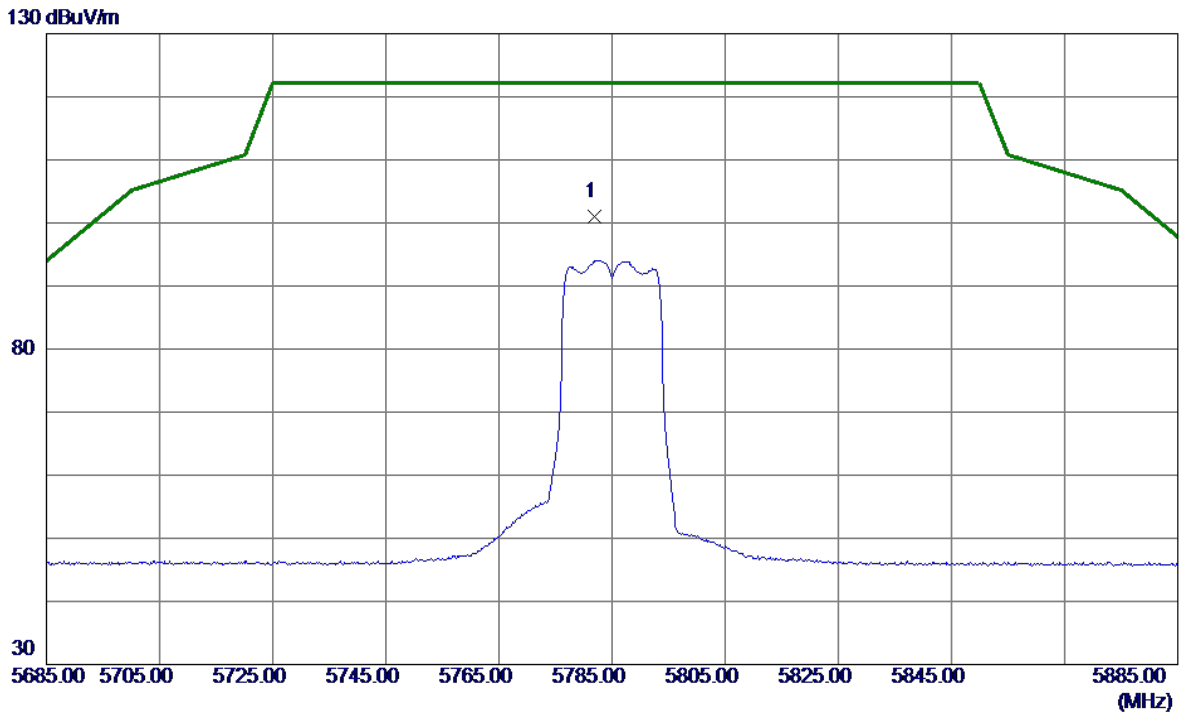

No.	Freq. MHz	Reading Level dBuV/m	Correct Factor dB	Measure ment dBuV/m	Limit dBuV/m	Margin dB	Detector	Comment
1 *	5781.8000	84.17	16.83	101.00	122.20	-21.20	Peak	No Limit

REMARKS:

- (1) Measurement Value = Reading Level + Correct Factor.
- (2) Margin Level = Measurement Value - Limit Value.

Test Mode	UNII-3_TX A Mode 5785 MHz	Polarization	Vertical
-----------	---------------------------	--------------	----------

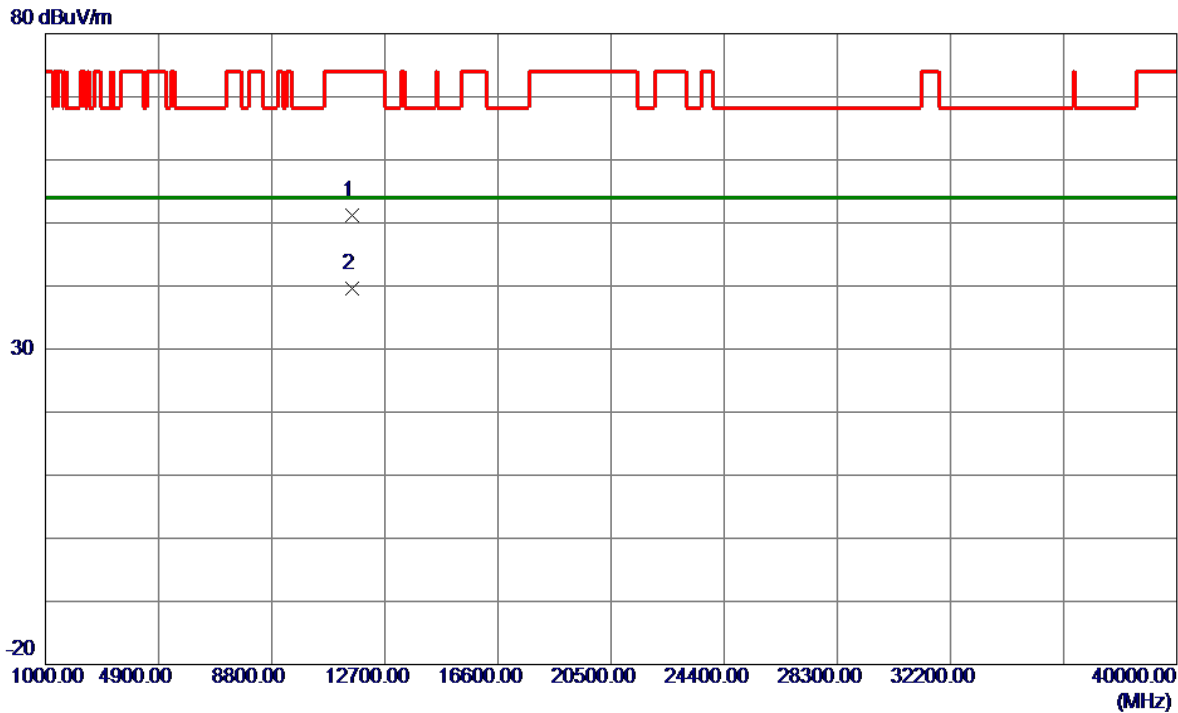

No.	Freq. MHz	Reading Level dBuV/m	Correct Factor dB	Measure ment dBuV/m	Limit dBuV/m	Margin dB	Detector	Comment
1	11567.5950	37.99	13.20	51.19	74.00	-22.81	Peak	
2 *	11567.9800	26.41	13.20	39.61	54.00	-14.39	AVG	

REMARKS:

- (1) Measurement Value = Reading Level + Correct Factor.
- (2) Margin Level = Measurement Value - Limit Value.

Test Mode	UNII-3_TX A Mode 5785 MHz	Polarization	Horizontal
-----------	---------------------------	--------------	------------

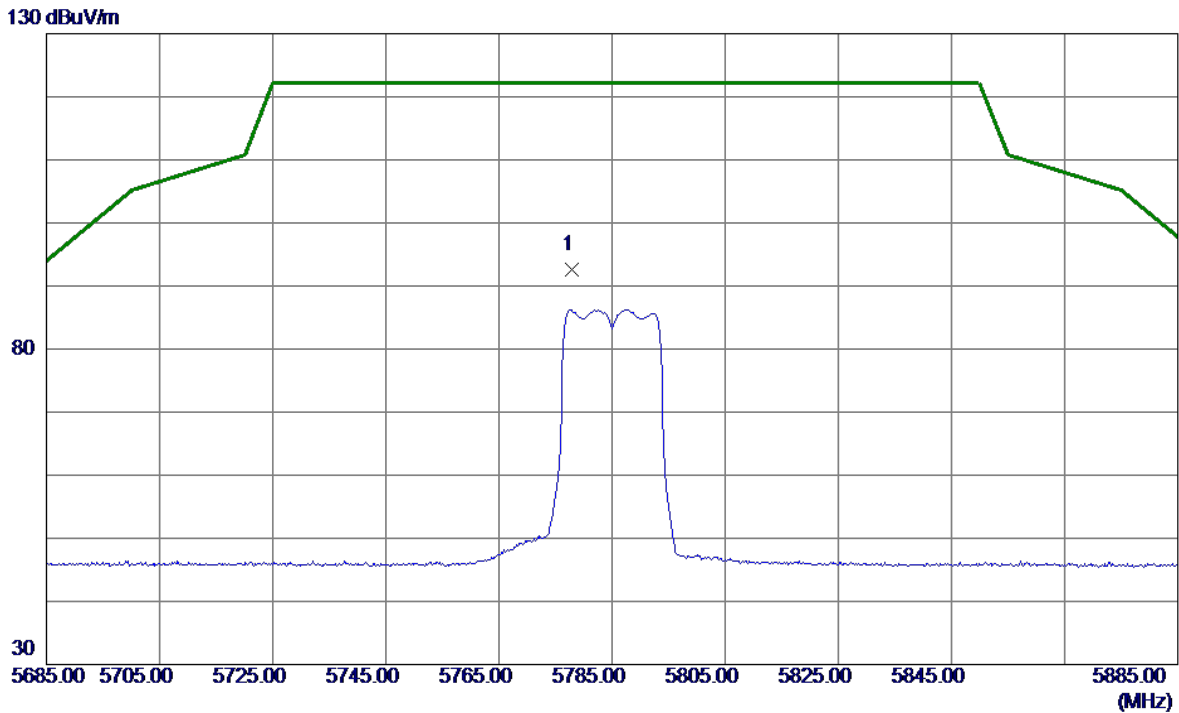

No.	Freq. MHz	Reading Level dBuV/m	Correct Factor dB	Measure ment dBuV/m	Limit dBuV/m	Margin dB	Detector	Comment
1 *	5777.8000	75.81	16.83	92.64	122.20	-29.56	Peak	No Limit

REMARKS:

- (1) Measurement Value = Reading Level + Correct Factor.
- (2) Margin Level = Measurement Value - Limit Value.

Test Mode	UNII-3_TX A Mode 5785 MHz	Polarization	Horizontal
-----------	---------------------------	--------------	------------

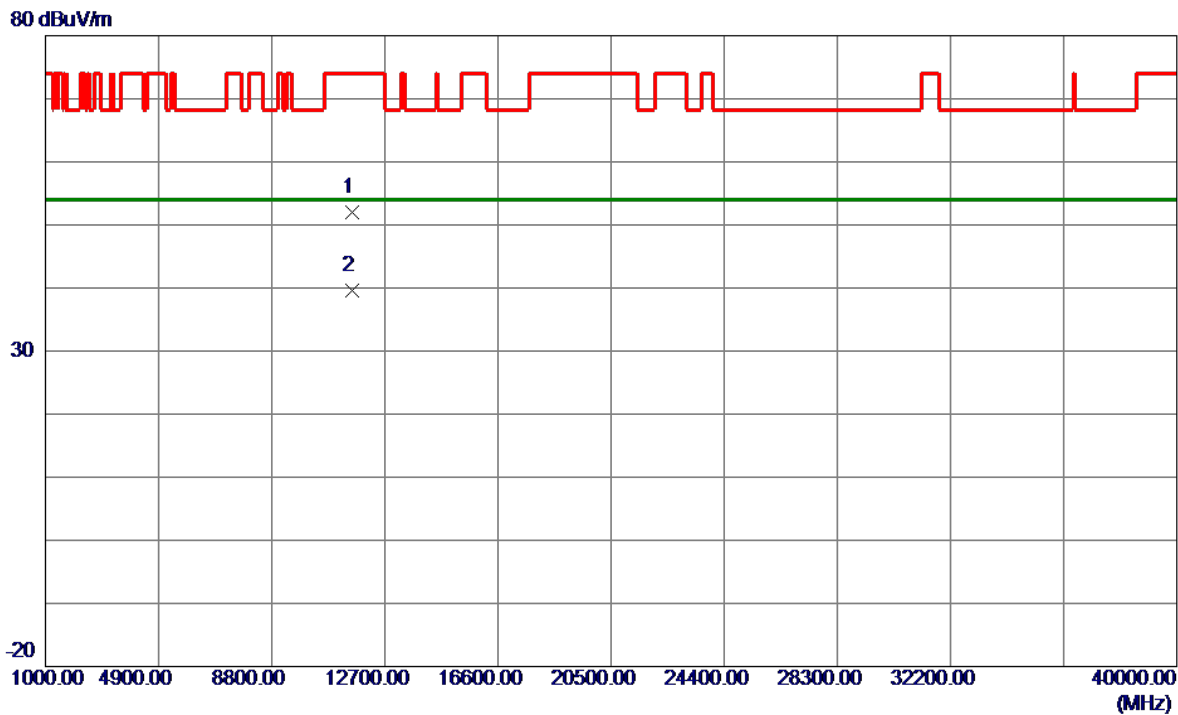

No.	Freq. MHz	Reading Level dBuV/m	Correct Factor dB	Measure ment dBuV/m	Limit dBuV/m	Margin dB	Detector	Comment
1	11570.0000	38.79	13.20	51.99	74.00	-22.01	Peak	
2 *	11570.0000	26.49	13.20	39.69	54.00	-14.31	AVG	

REMARKS:

- (1) Measurement Value = Reading Level + Correct Factor.
- (2) Margin Level = Measurement Value - Limit Value.

Test Mode	UNII-3_TX A Mode 5825 MHz	Polarization	Vertical
-----------	---------------------------	--------------	----------

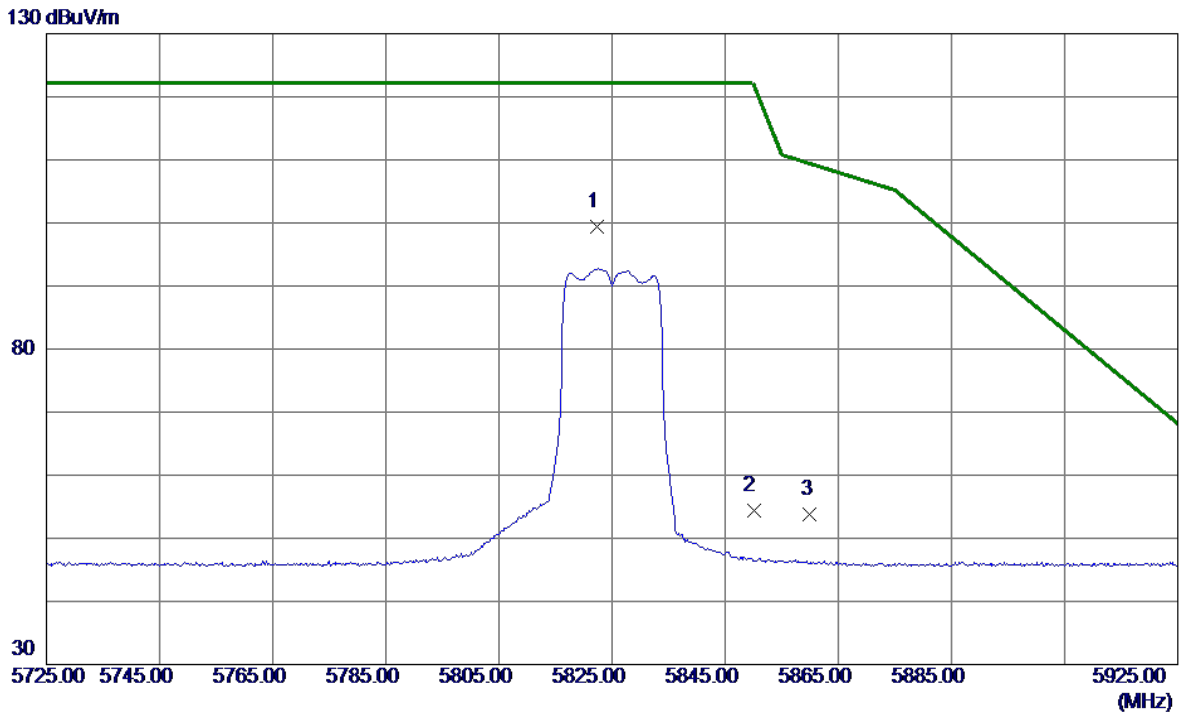

No.	Freq. MHz	Reading Level dBuV/m	Correct Factor dB	Measure ment dBuV/m	Limit dBuV/m	Margin dB	Detector	Comment
1 *	5822.4000	82.53	16.86	99.39	122.20	-22.81	Peak	No Limit
2	5850.0000	37.56	16.87	54.43	122.20	-67.77	Peak	
3	5860.0000	36.94	16.88	53.82	109.40	-55.58	Peak	

REMARKS:

- (1) Measurement Value = Reading Level + Correct Factor.
- (2) Margin Level = Measurement Value - Limit Value.

Test Mode	UNII-3_TX A Mode 5825 MHz	Polarization	Vertical
-----------	---------------------------	--------------	----------

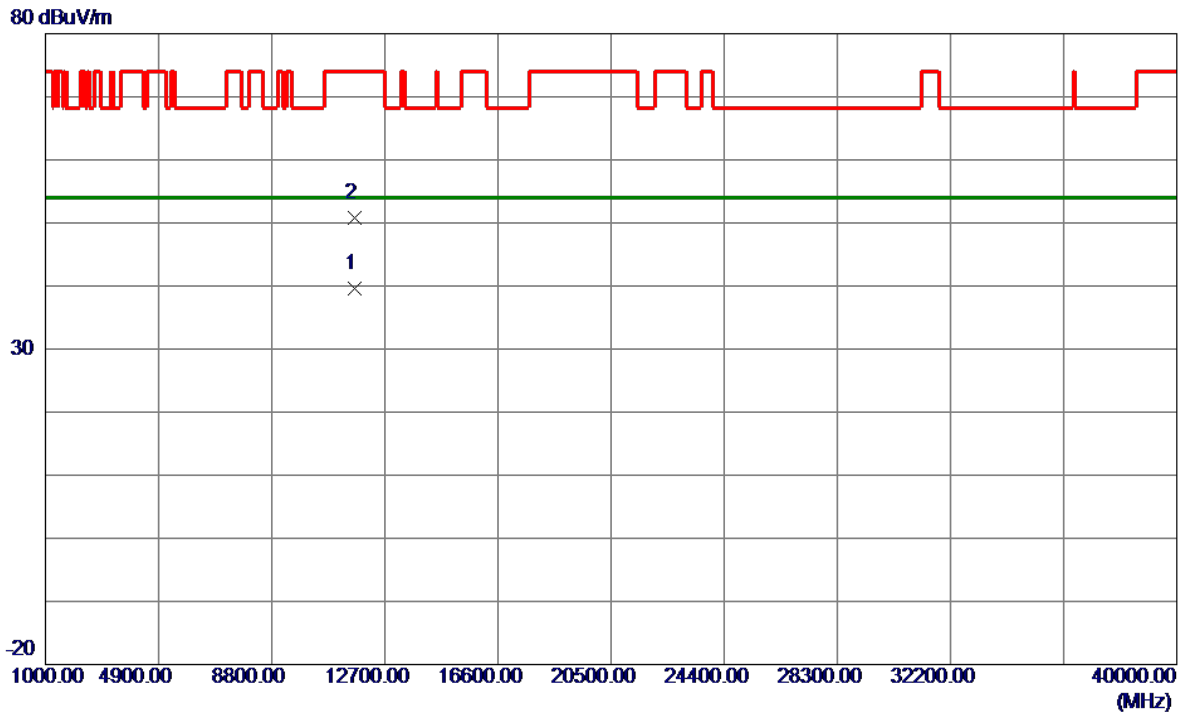

No.	Freq. MHz	Reading Level dBuV/m	Correct Factor dB	Measure ment dBuV/m	Limit dBuV/m	Margin dB	Detector	Comment
1 *	11647.8300	26.41	13.25	39.66	54.00	-14.34	AVG	
2	11651.0650	37.55	13.25	50.80	74.00	-23.20	Peak	

REMARKS:

- (1) Measurement Value = Reading Level + Correct Factor.
- (2) Margin Level = Measurement Value - Limit Value.

Test Mode	UNII-3_TX A Mode 5825 MHz	Polarization	Horizontal
-----------	---------------------------	--------------	------------

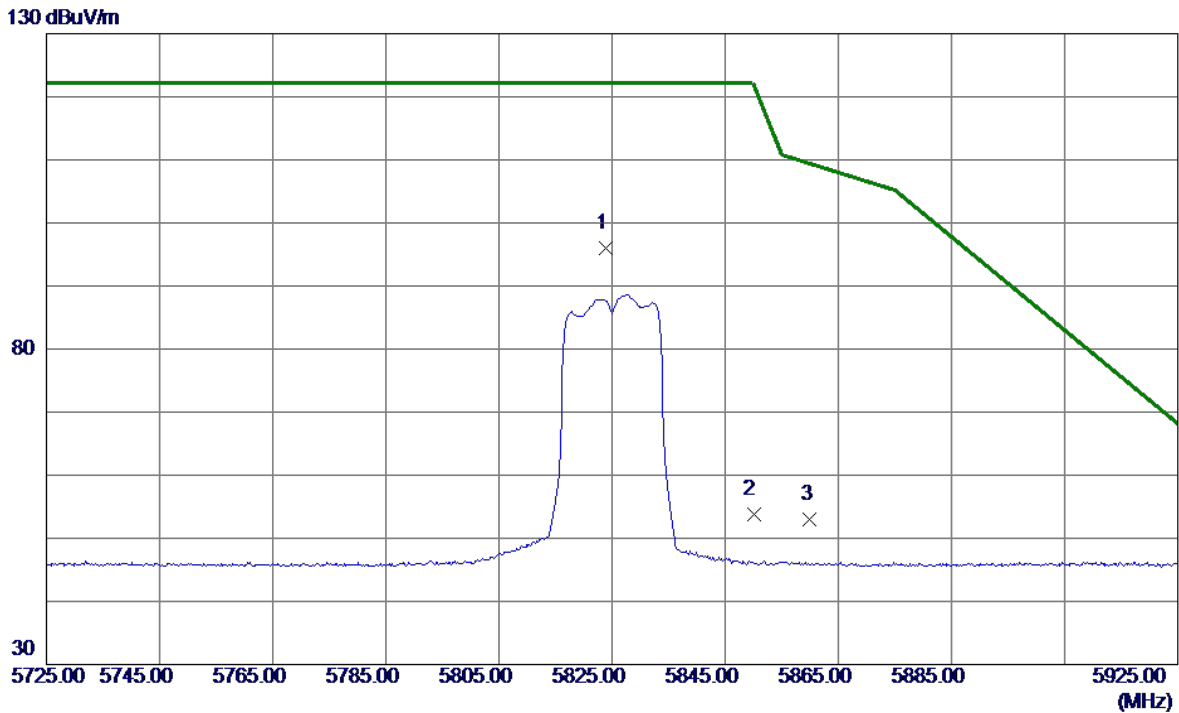

No.	Freq. MHz	Reading Level dBuV/m	Correct Factor dB	Measure ment dBuV/m	Limit dBuV/m	Margin dB	Detector	Comment
1 *	5823.8000	79.09	16.86	95.95	122.20	-26.25	Peak	No Limit
2	5850.0000	37.02	16.87	53.89	122.20	-68.31	Peak	
3	5860.0000	36.07	16.88	52.95	109.40	-56.45	Peak	

REMARKS:

- (1) Measurement Value = Reading Level + Correct Factor.
- (2) Margin Level = Measurement Value - Limit Value.

Test Mode	UNII-3_TX A Mode 5825 MHz	Polarization	Horizontal
-----------	---------------------------	--------------	------------

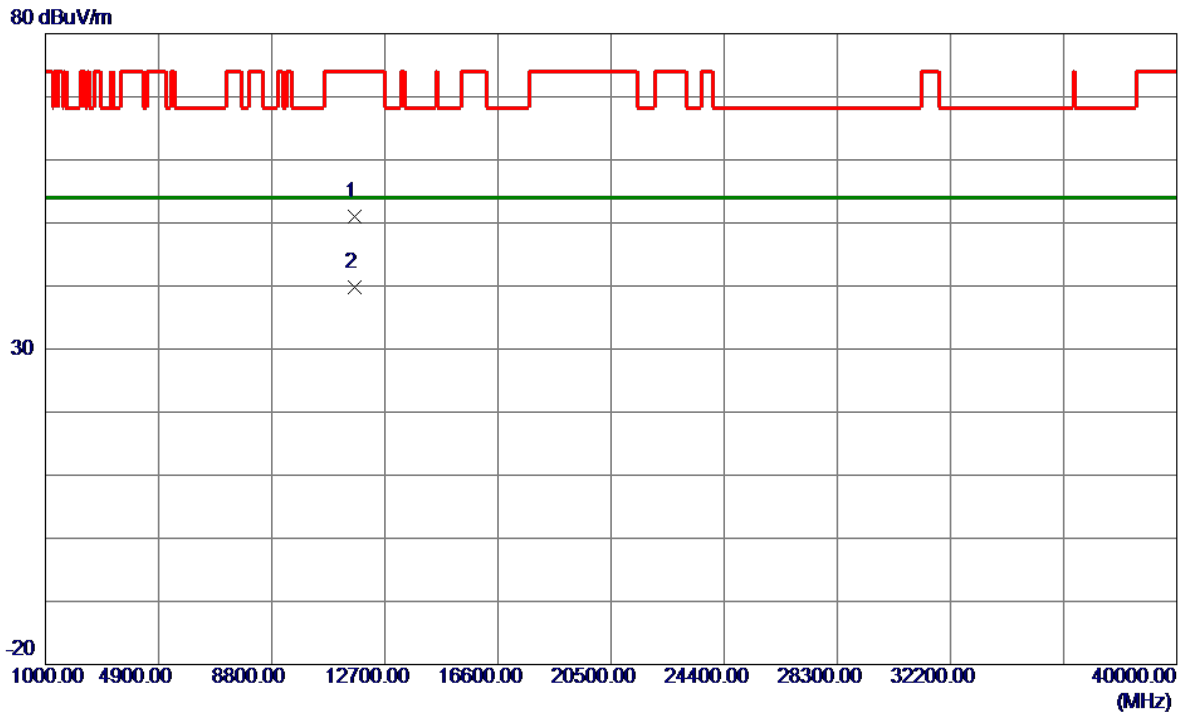

No.	Freq. MHz	Reading Level dBuV/m	Correct Factor dB	Measure ment dBuV/m	Limit dBuV/m	Margin dB	Detector	Comment
1	11650.0000	37.83	13.25	51.08	74.00	-22.92	Peak	
2 *	11650.0000	26.54	13.25	39.79	54.00	-14.21	AVG	

REMARKS:

- (1) Measurement Value = Reading Level + Correct Factor.
- (2) Margin Level = Measurement Value - Limit Value.

Test Mode	UNII-3_TX AC(VHT20) Mode 5745 MHz	Polarization	Vertical
-----------	-----------------------------------	--------------	----------

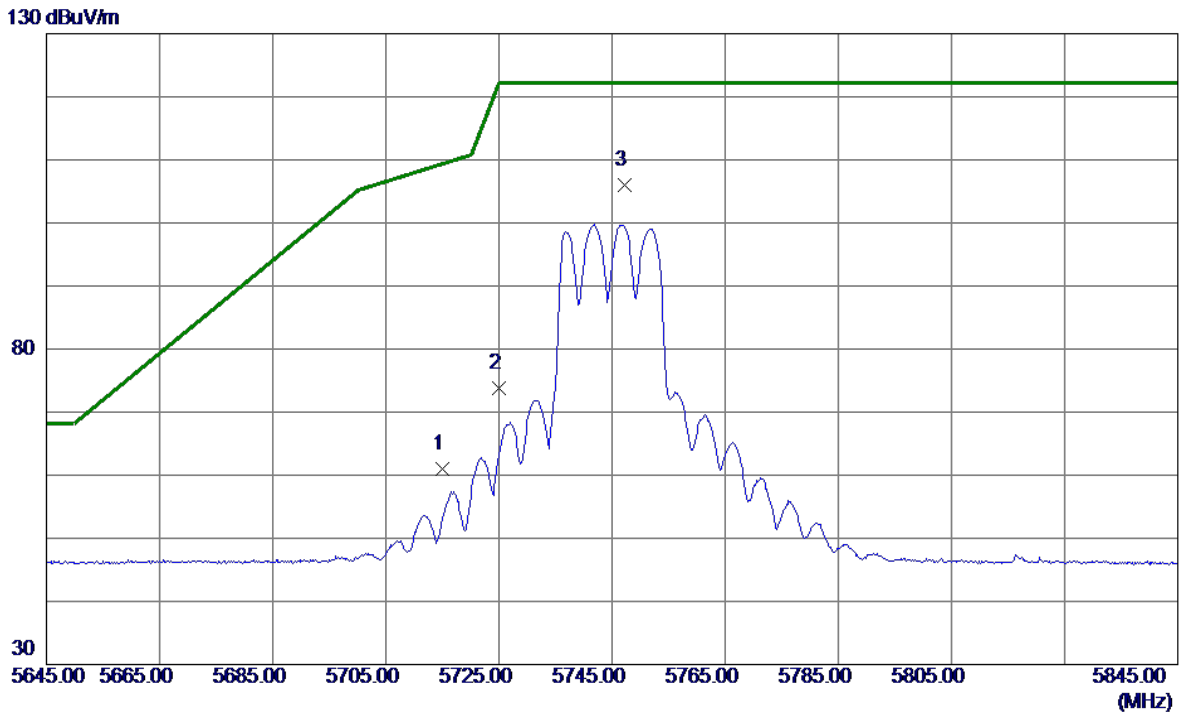

No.	Freq. MHz	Reading Level dBuV/m	Correct Factor dB	Measure ment dBuV/m	Limit dBuV/m	Margin dB	Detector	Comment
1	5715.0000	44.25	16.79	61.04	109.40	-48.36	Peak	
2	5725.0000	56.95	16.80	73.75	122.20	-48.45	Peak	
3 *	5747.2000	89.14	16.81	105.95	122.20	-16.25	Peak	No Limit

REMARKS:

- (1) Measurement Value = Reading Level + Correct Factor.
- (2) Margin Level = Measurement Value - Limit Value.

Test Mode	UNII-3_TX AC(VHT20) Mode 5745 MHz	Polarization	Vertical
-----------	-----------------------------------	--------------	----------

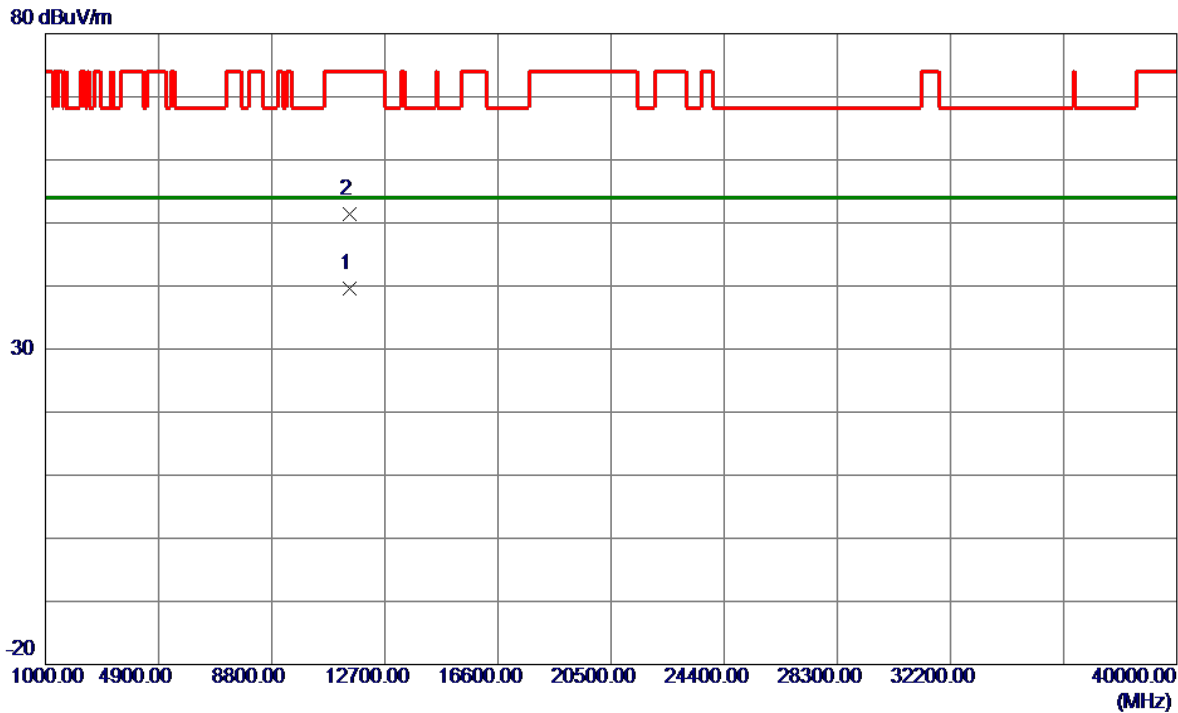

No.	Freq. MHz	Reading Level dBuV/m	Correct Factor dB	Measure ment dBuV/m	Limit dBuV/m	Margin dB	Detector	Comment
1 *	11488.8550	26.50	13.15	39.65	54.00	-14.35	AVG	
2	11490.7250	38.34	13.15	51.49	74.00	-22.51	Peak	

REMARKS:

- (1) Measurement Value = Reading Level + Correct Factor.
- (2) Margin Level = Measurement Value - Limit Value.

Test Mode	UNII-3_TX AC(VHT20) Mode 5745 MHz	Polarization	Horizontal
-----------	-----------------------------------	--------------	------------

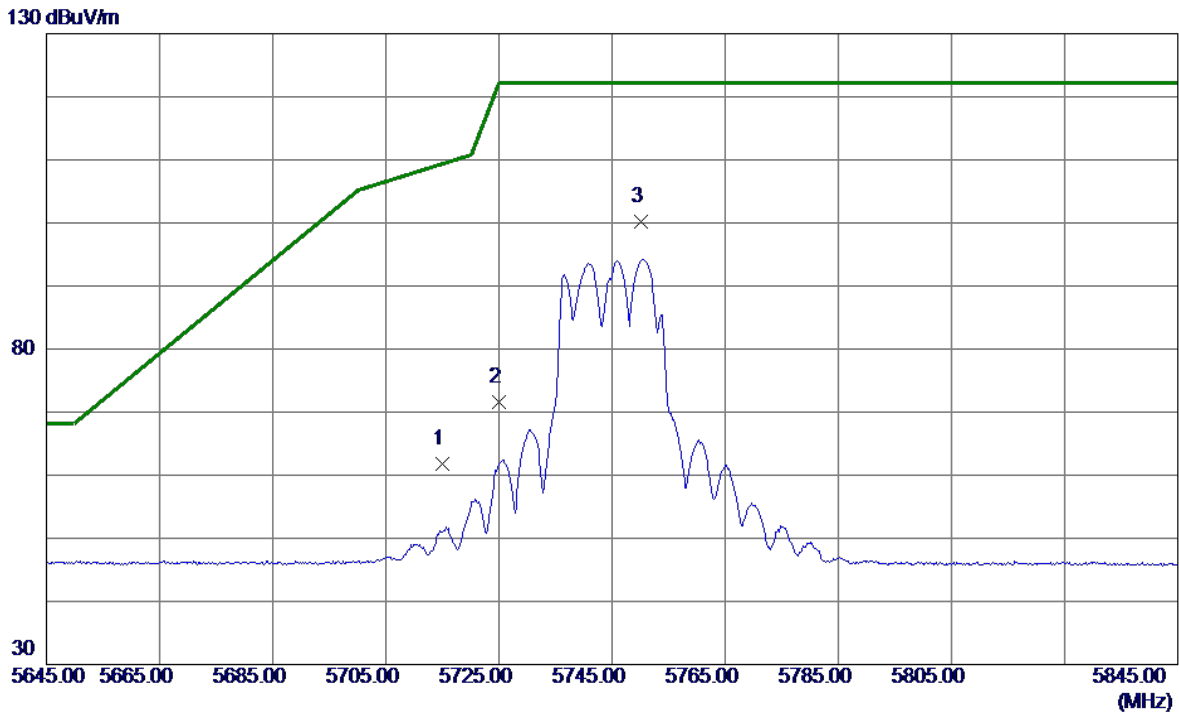

No.	Freq. MHz	Reading Level dBuV/m	Correct Factor dB	Measure ment dBuV/m	Limit dBuV/m	Margin dB	Detector	Comment
1	5715.0000	45.03	16.79	61.82	109.40	-47.58	Peak	
2	5725.0000	54.85	16.80	71.65	122.20	-50.55	Peak	
3 *	5750.2000	83.47	16.81	100.28	122.20	-21.92	Peak	No Limit

REMARKS:

- (1) Measurement Value = Reading Level + Correct Factor.
- (2) Margin Level = Measurement Value - Limit Value.

Test Mode	UNII-3_TX AC(VHT20) Mode 5745 MHz	Polarization	Horizontal
-----------	-----------------------------------	--------------	------------

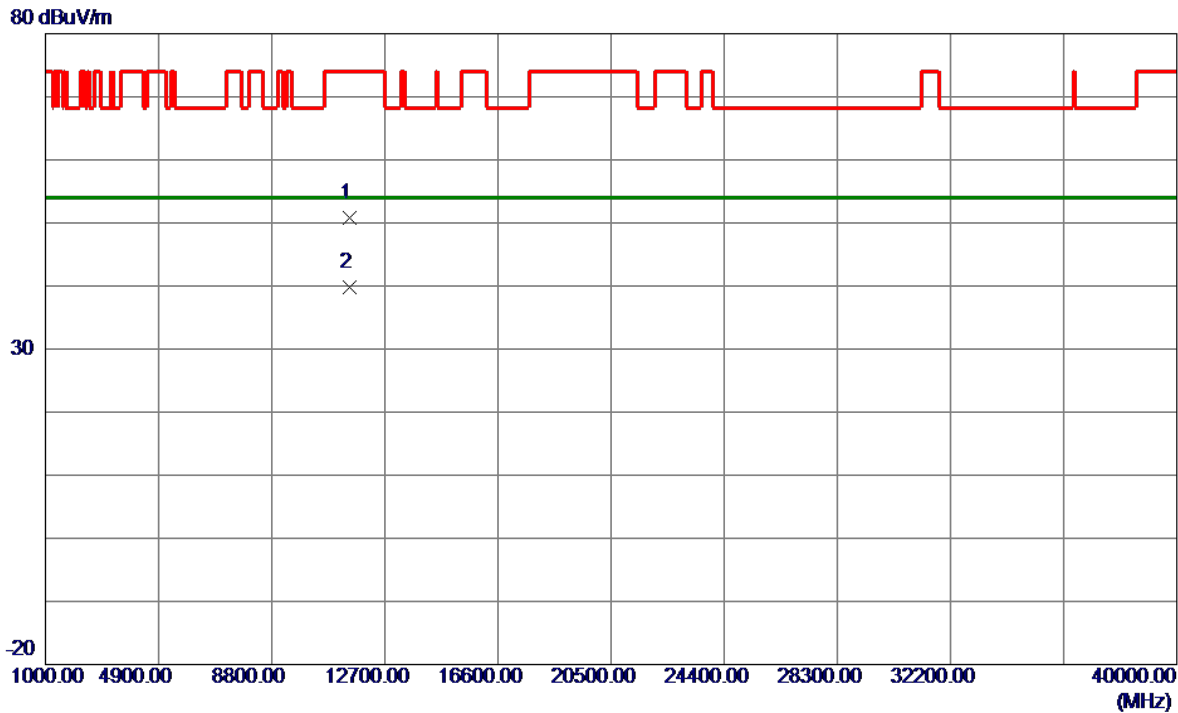

No.	Freq. MHz	Reading Level dBuV/m	Correct Factor dB	Measure ment dBuV/m	Limit dBuV/m	Margin dB	Detector	Comment
1	11490.0000	37.67	13.15	50.82	74.00	-23.18	Peak	
2 *	11490.0000	26.62	13.15	39.77	54.00	-14.23	AVG	

REMARKS:

- (1) Measurement Value = Reading Level + Correct Factor.
- (2) Margin Level = Measurement Value - Limit Value.

Test Mode	UNII-3_TX AC(VHT20) Mode 5785 MHz	Polarization	Vertical
-----------	-----------------------------------	--------------	----------

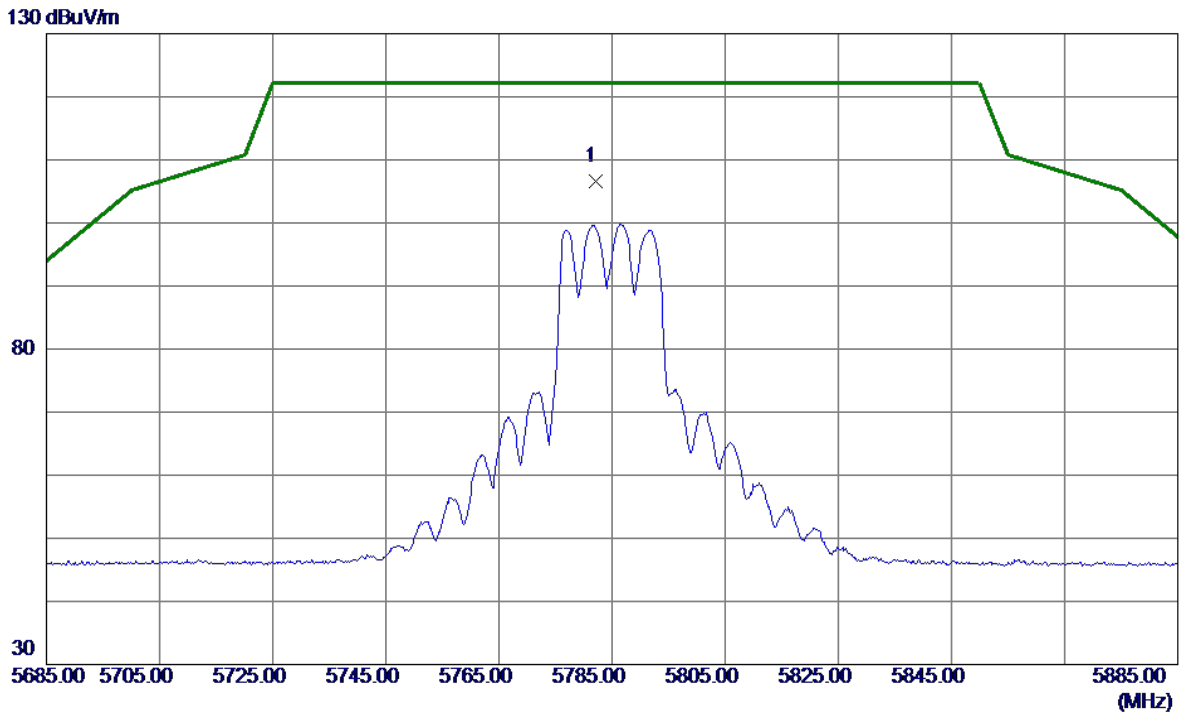

No.	Freq. MHz	Reading Level dBuV/m	Correct Factor dB	Measure ment dBuV/m	Limit dBuV/m	Margin dB	Detector	Comment
1 *	5782.0000	89.82	16.83	106.65	122.20	-15.55	Peak	No Limit

REMARKS:

- (1) Measurement Value = Reading Level + Correct Factor.
- (2) Margin Level = Measurement Value - Limit Value.

Test Mode	UNII-3_TX AC(VHT20) Mode 5785 MHz	Polarization	Vertical
-----------	-----------------------------------	--------------	----------

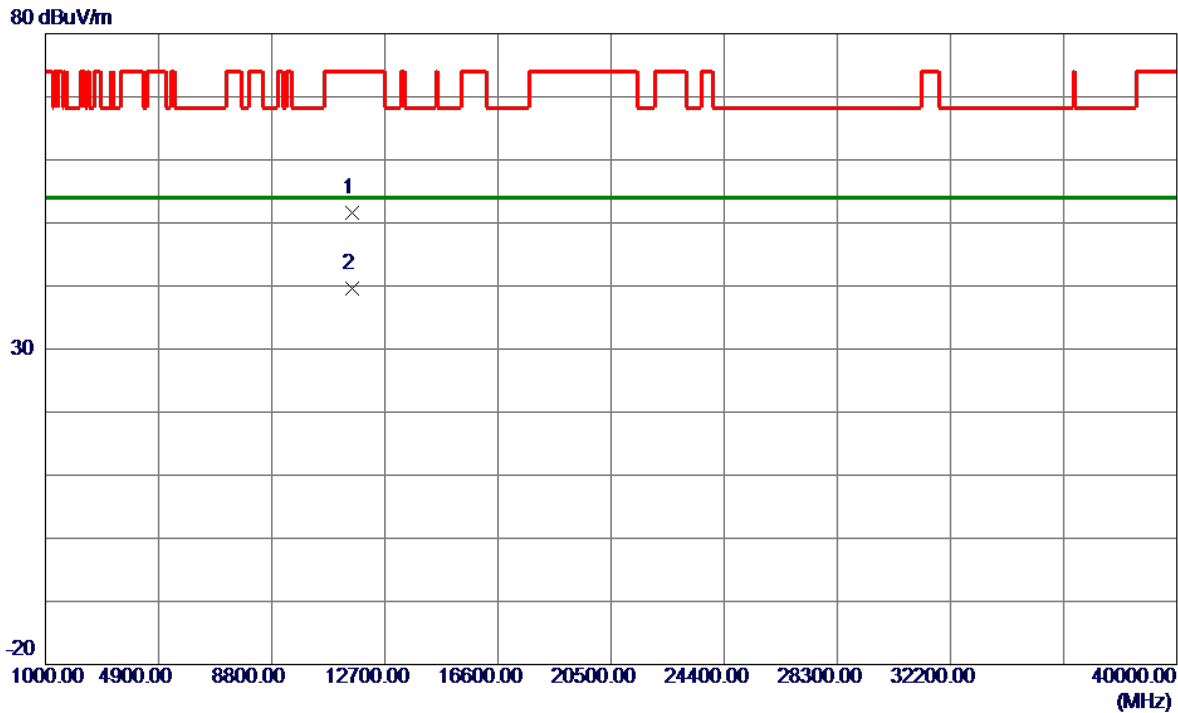

No.	Freq. MHz	Reading Level dBuV/m	Correct Factor dB	Measure ment dBuV/m	Limit dBuV/m	Margin dB	Detector	Comment
1	11570.7200	38.45	13.20	51.65	74.00	-22.35	Peak	
2 *	11571.2100	26.48	13.20	39.68	54.00	-14.32	AVG	

REMARKS:

- (1) Measurement Value = Reading Level + Correct Factor.
- (2) Margin Level = Measurement Value - Limit Value.

Test Mode	UNII-3_TX AC(VHT20) Mode 5785 MHz	Polarization	Horizontal
-----------	-----------------------------------	--------------	------------

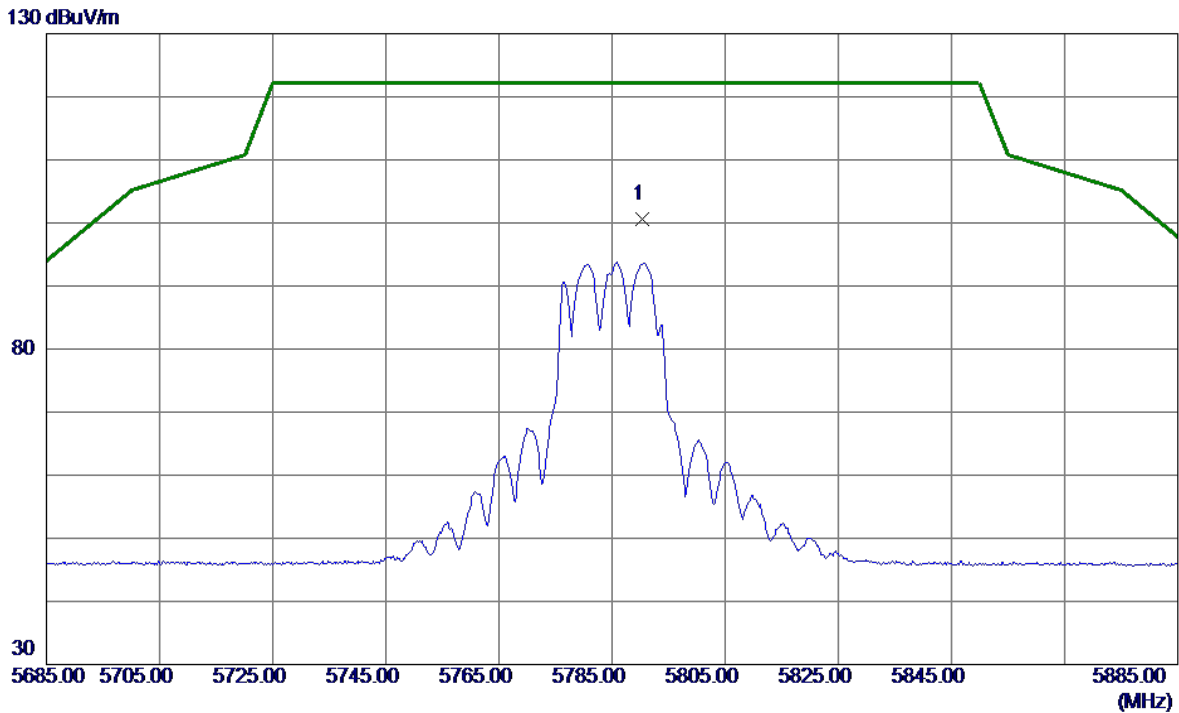

No.	Freq. MHz	Reading Level dBuV/m	Correct Factor dB	Measure ment dBuV/m	Limit dBuV/m	Margin dB	Detector	Comment
1 *	5790.4000	83.83	16.84	100.67	122.20	-21.53	Peak	No Limit

REMARKS:

- (1) Measurement Value = Reading Level + Correct Factor.
- (2) Margin Level = Measurement Value - Limit Value.

Test Mode	UNII-3_TX AC(VHT20) Mode 5785 MHz	Polarization	Horizontal
-----------	-----------------------------------	--------------	------------

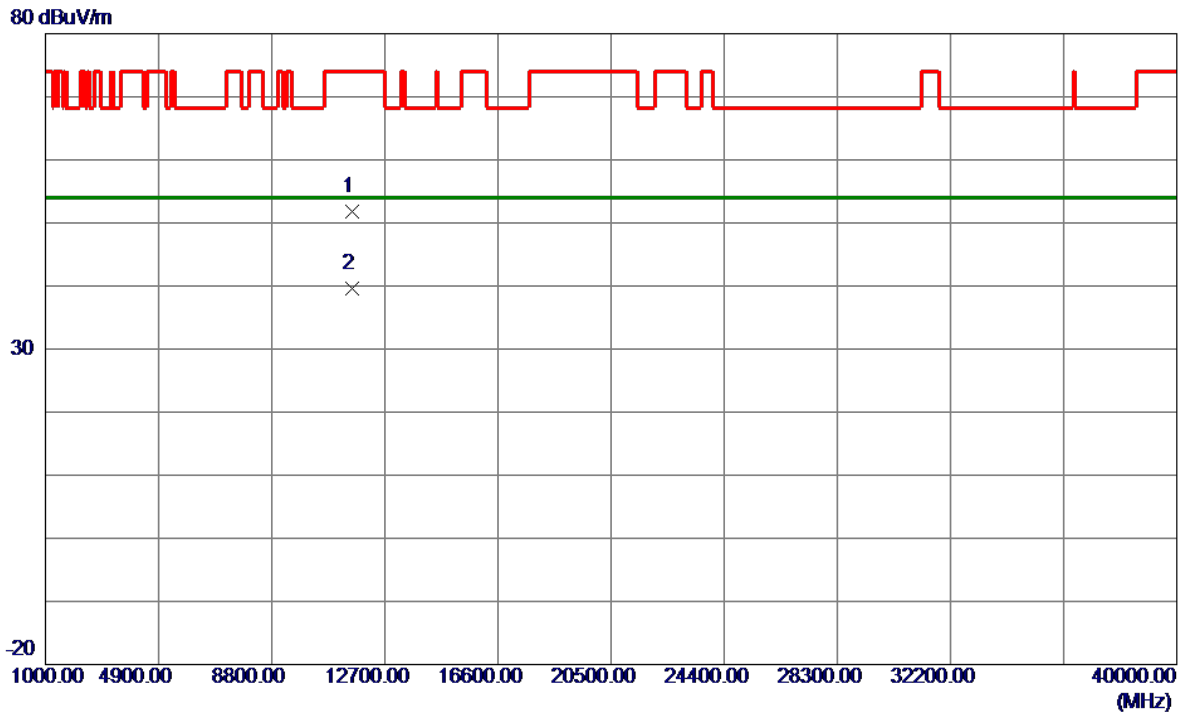

No.	Freq. MHz	Reading Level dBuV/m	Correct Factor dB	Measure ment dBuV/m	Limit dBuV/m	Margin dB	Detector	Comment
1	11570.0000	38.53	13.20	51.73	74.00	-22.27	Peak	
2 *	11570.0000	26.45	13.20	39.65	54.00	-14.35	AVG	

REMARKS:

- (1) Measurement Value = Reading Level + Correct Factor.
- (2) Margin Level = Measurement Value - Limit Value.

Test Mode	UNII-3_TX AC(VHT20) Mode 5825 MHz	Polarization	Vertical
-----------	-----------------------------------	--------------	----------

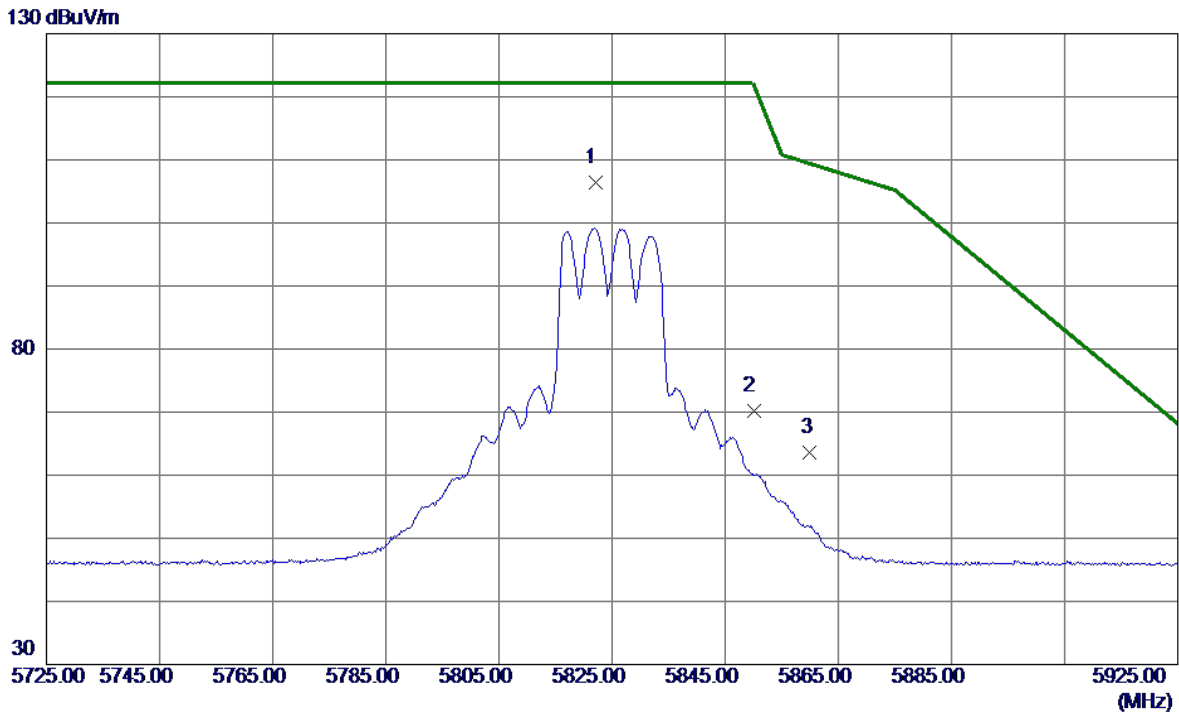

No.	Freq. MHz	Reading Level dBuV/m	Correct Factor dB	Measure ment dBuV/m	Limit dBuV/m	Margin dB	Detector	Comment
1 *	5822.0000	89.60	16.85	106.45	122.20	-15.75	Peak	No Limit
2	5850.0000	53.42	16.87	70.29	122.20	-51.91	Peak	
3	5860.0000	46.74	16.88	63.62	109.40	-45.78	Peak	

REMARKS:

- (1) Measurement Value = Reading Level + Correct Factor.
- (2) Margin Level = Measurement Value - Limit Value.

Test Mode	UNII-3_TX AC(VHT20) Mode 5825 MHz	Polarization	Vertical
-----------	-----------------------------------	--------------	----------

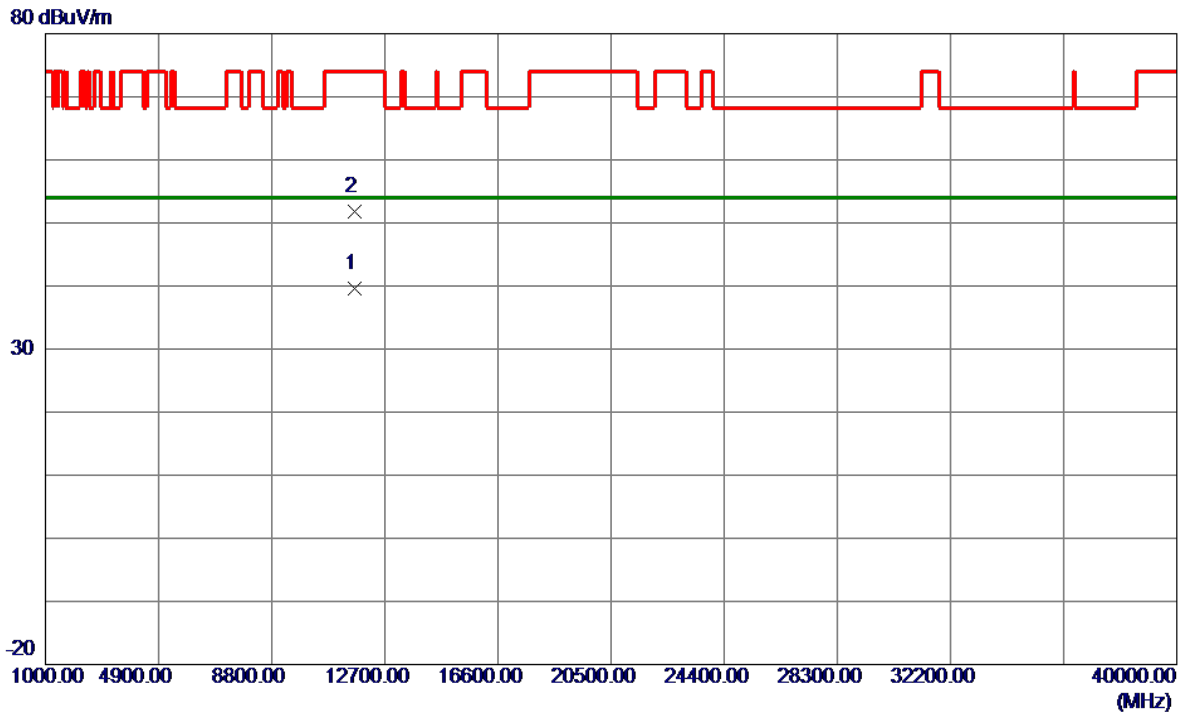

No.	Freq. MHz	Reading Level dBuV/m	Correct Factor dB	Measure ment dBuV/m	Limit dBuV/m	Margin dB	Detector	Comment
1 *	11648.7300	26.37	13.25	39.62	54.00	-14.38	AVG	
2	11649.0500	38.57	13.25	51.82	74.00	-22.18	Peak	

REMARKS:

- (1) Measurement Value = Reading Level + Correct Factor.
- (2) Margin Level = Measurement Value - Limit Value.

Test Mode	UNII-3_TX AC(VHT20) Mode 5825 MHz	Polarization	Horizontal
-----------	-----------------------------------	--------------	------------

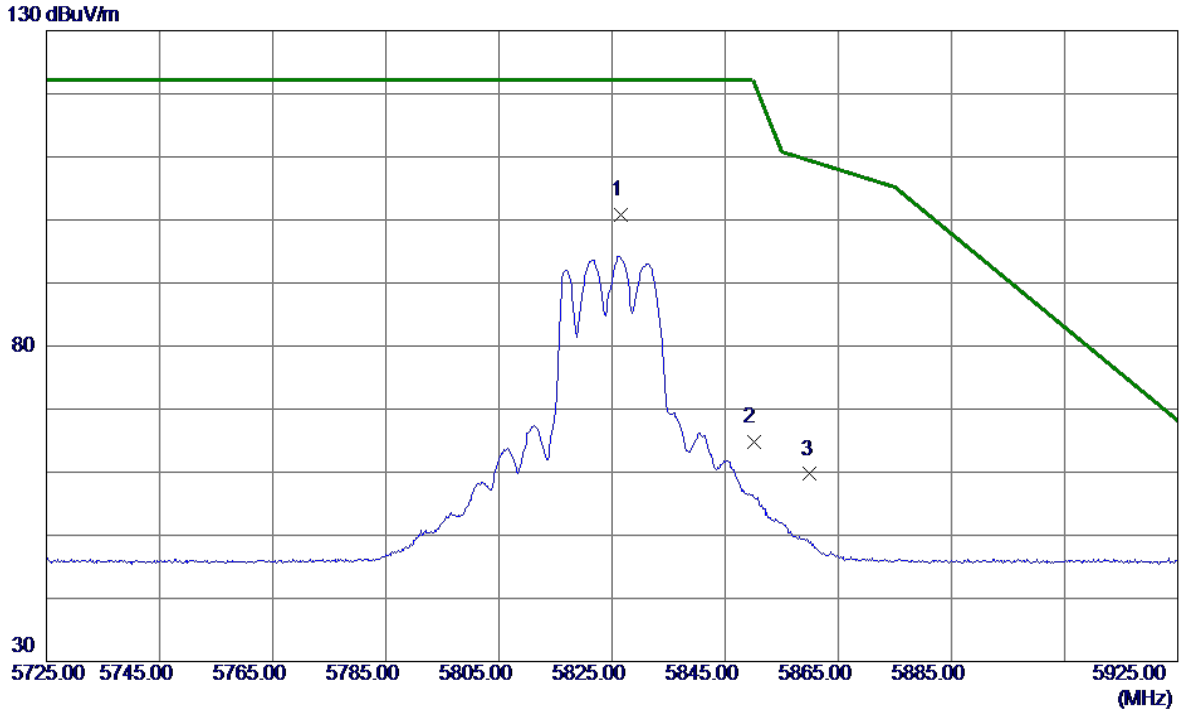

No.	Freq. MHz	Reading Level dBuV/m	Correct Factor dB	Measure ment dBuV/m	Limit dBuV/m	Margin dB	Detector	Comment
1 *	5826.6000	83.97	16.86	100.83	122.20	-21.37	Peak	No Limit
2	5850.0000	47.91	16.87	64.78	122.20	-57.42	Peak	
3	5860.0000	42.82	16.88	59.70	109.40	-49.70	Peak	

REMARKS:

- (1) Measurement Value = Reading Level + Correct Factor.
- (2) Margin Level = Measurement Value - Limit Value.

Test Mode	UNII-3_TX AC(VHT20) Mode 5825 MHz	Polarization	Horizontal
-----------	-----------------------------------	--------------	------------

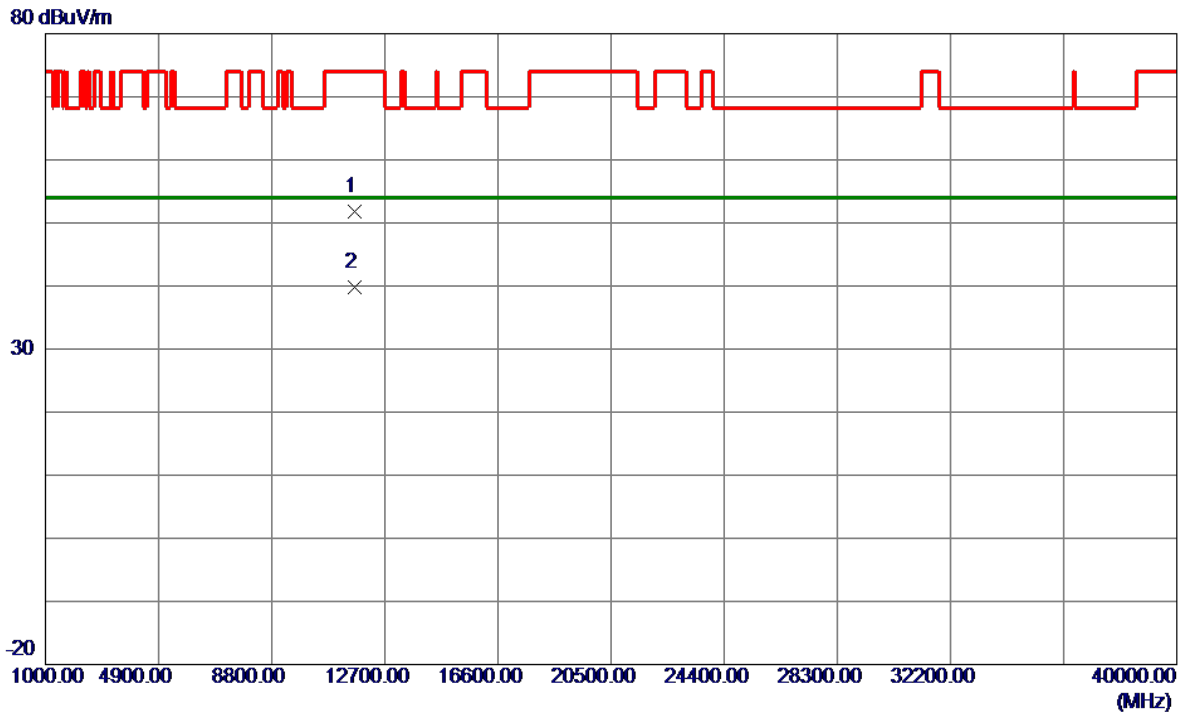

No.	Freq. MHz	Reading Level dBuV/m	Correct Factor dB	Measure ment dBuV/m	Limit dBuV/m	Margin dB	Detector	Comment
1	11650.0000	38.60	13.25	51.85	74.00	-22.15	Peak	
2 *	11650.0000	26.53	13.25	39.78	54.00	-14.22	AVG	

REMARKS:

- (1) Measurement Value = Reading Level + Correct Factor.
- (2) Margin Level = Measurement Value - Limit Value.

Test Mode	UNII-3_TX AC(VHT40) Mode 5755 MHz	Polarization	Vertical
-----------	-----------------------------------	--------------	----------

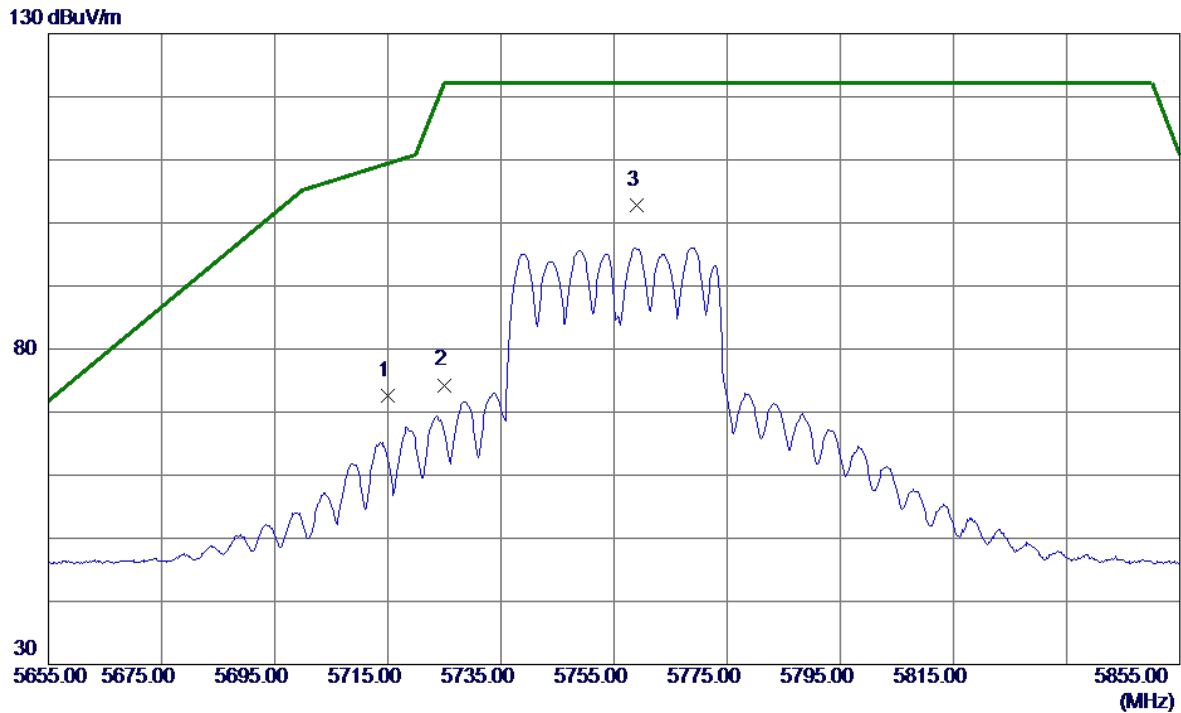

No.	Freq. MHz	Reading Level dBuV/m	Correct Factor dB	Measure ment dBuV/m	Limit dBuV/m	Margin dB	Detector	Comment
1	5715.0000	55.80	16.79	72.59	109.40	-36.81	Peak	
2	5725.0000	57.50	16.80	74.30	122.20	-47.90	Peak	
3 *	5759.0000	85.89	16.82	102.71	122.20	-19.49	Peak	No Limit

REMARKS:

- (1) Measurement Value = Reading Level + Correct Factor.
- (2) Margin Level = Measurement Value - Limit Value.

Test Mode	UNII-3_TX AC(VHT40) Mode 5755 MHz	Polarization	Vertical
-----------	-----------------------------------	--------------	----------

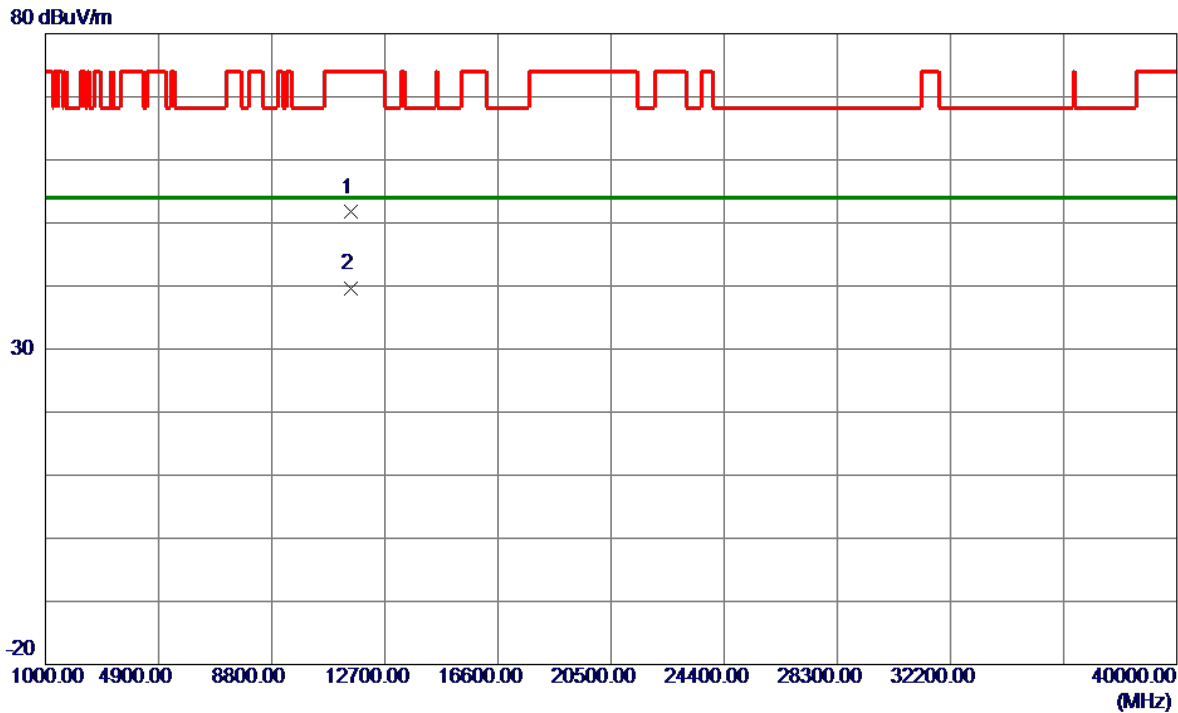

No.	Freq. MHz	Reading Level dBuV/m	Correct Factor dB	Measure ment dBuV/m	Limit dBuV/m	Margin dB	Detector	Comment
1	11510.0000	38.54	13.16	51.70	74.00	-22.30	Peak	
2 *	11510.0000	26.50	13.16	39.66	54.00	-14.34	AVG	

REMARKS:

- (1) Measurement Value = Reading Level + Correct Factor.
- (2) Margin Level = Measurement Value - Limit Value.

Test Mode	UNII-3_TX AC(VHT40) Mode 5755 MHz	Polarization	Horizontal
-----------	-----------------------------------	--------------	------------

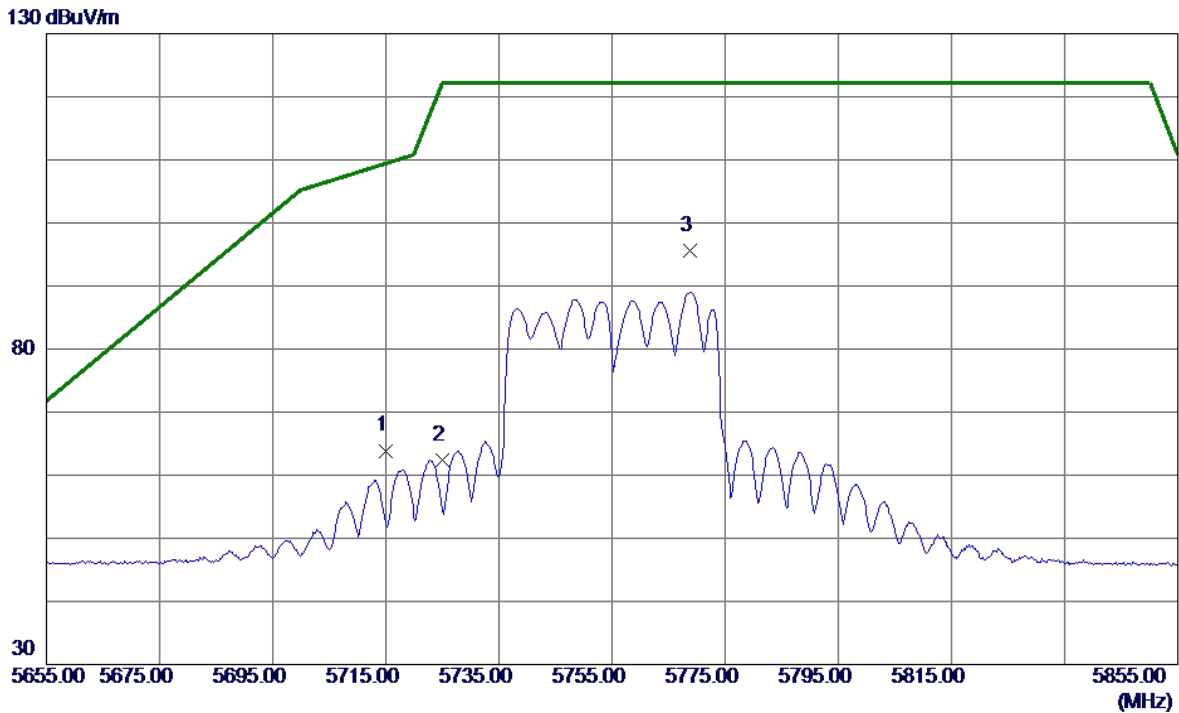

No.	Freq. MHz	Reading Level dBuV/m	Correct Factor dB	Measure ment dBuV/m	Limit dBuV/m	Margin dB	Detector	Comment
1	5715.0000	47.11	16.79	63.90	109.40	-45.50	Peak	
2	5725.0000	45.60	16.80	62.40	122.20	-59.80	Peak	
3 *	5768.8000	78.83	16.82	95.65	122.20	-26.55	Peak	No Limit

REMARKS:

- (1) Measurement Value = Reading Level + Correct Factor.
- (2) Margin Level = Measurement Value - Limit Value.

Test Mode	UNII-3_TX AC(VHT40) Mode 5755 MHz	Polarization	Horizontal
-----------	-----------------------------------	--------------	------------

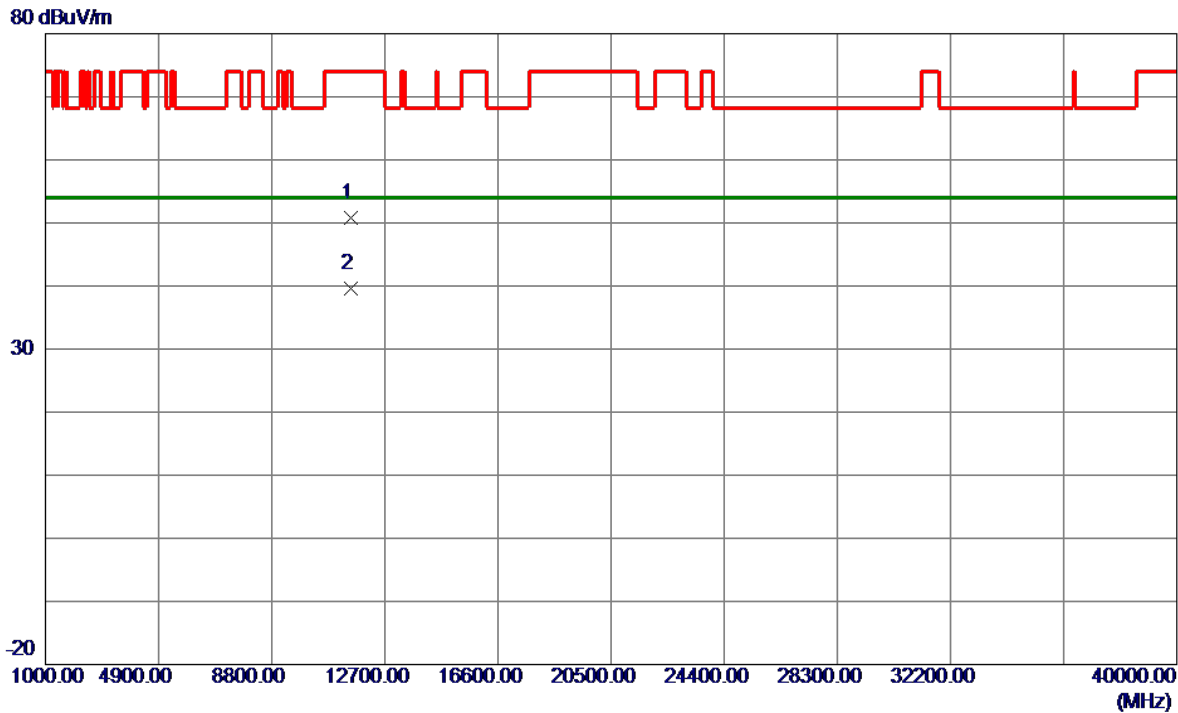

No.	Freq. MHz	Reading Level dBuV/m	Correct Factor dB	Measure ment dBuV/m	Limit dBuV/m	Margin dB	Detector	Comment
1	11510.0000	37.63	13.16	50.79	74.00	-23.21	Peak	
2 *	11510.0000	26.49	13.16	39.65	54.00	-14.35	AVG	

REMARKS:

- (1) Measurement Value = Reading Level + Correct Factor.
- (2) Margin Level = Measurement Value - Limit Value.

Test Mode	UNII-3_TX AC(VHT40) Mode 5795 MHz	Polarization	Vertical
-----------	-----------------------------------	--------------	----------

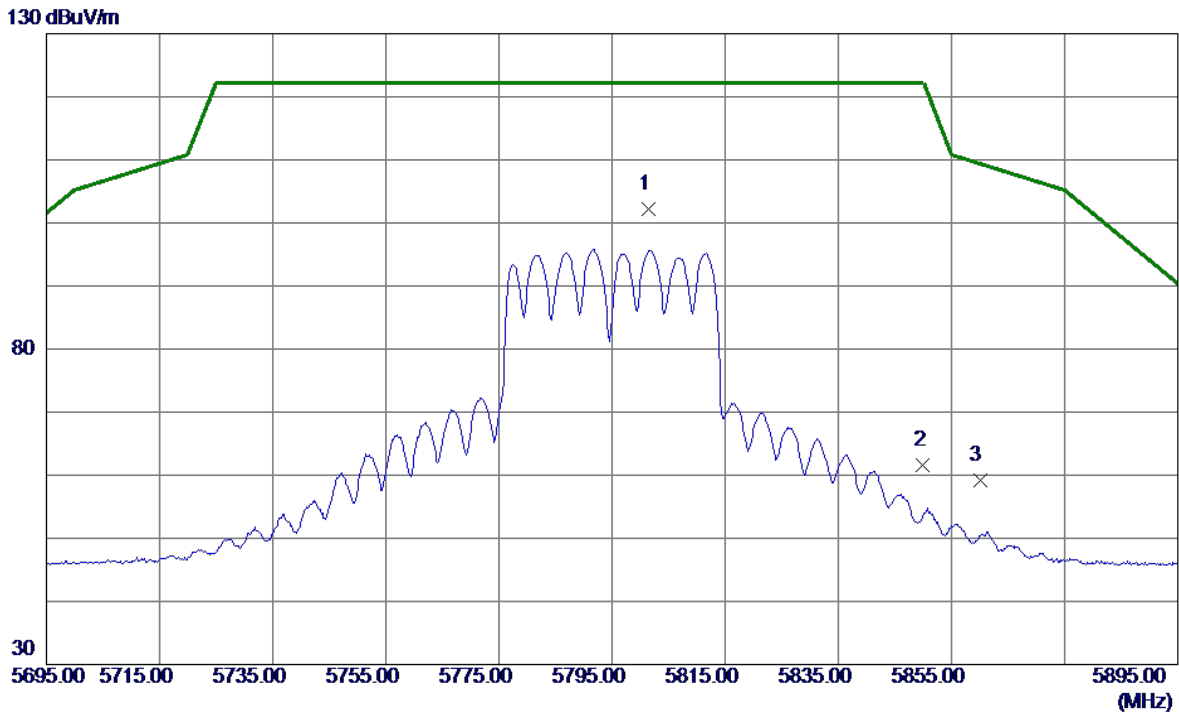

No.	Freq. MHz	Reading Level dBuV/m	Correct Factor dB	Measure ment dBuV/m	Limit dBuV/m	Margin dB	Detector	Comment
1 *	5801.4000	85.40	16.84	102.24	122.20	-19.96	Peak	No Limit
2	5850.0000	44.79	16.87	61.66	122.20	-60.54	Peak	
3	5860.0000	42.41	16.88	59.29	109.40	-50.11	Peak	

REMARKS:

- (1) Measurement Value = Reading Level + Correct Factor.
- (2) Margin Level = Measurement Value - Limit Value.

Test Mode	UNII-3_TX AC(VHT40) Mode 5795 MHz	Polarization	Vertical
-----------	-----------------------------------	--------------	----------

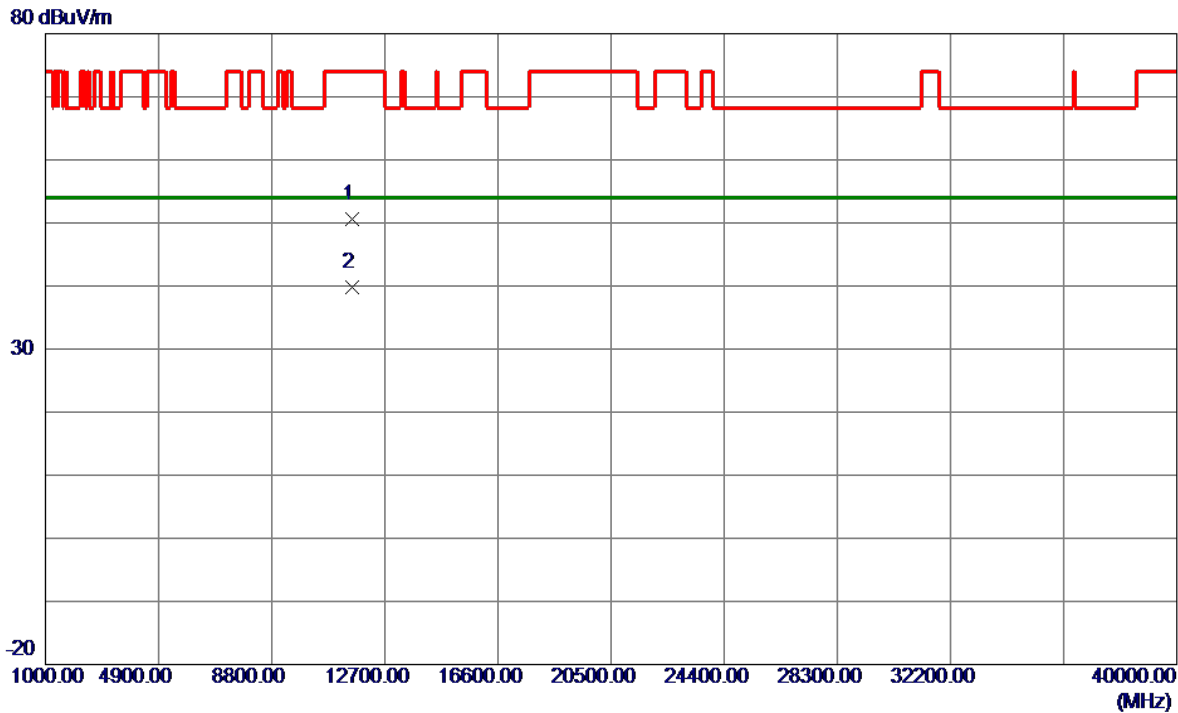

No.	Freq. MHz	Reading Level dBuV/m	Correct Factor dB	Measure ment dBuV/m	Limit dBuV/m	Margin dB	Detector	Comment
1	11590.0000	37.43	13.21	50.64	74.00	-23.36	Peak	
2 *	11590.0000	26.51	13.21	39.72	54.00	-14.28	AVG	

REMARKS:

- (1) Measurement Value = Reading Level + Correct Factor.
- (2) Margin Level = Measurement Value - Limit Value.

Test Mode	UNII-3_TX AC(VHT40) Mode 5795 MHz	Polarization	Horizontal
-----------	-----------------------------------	--------------	------------

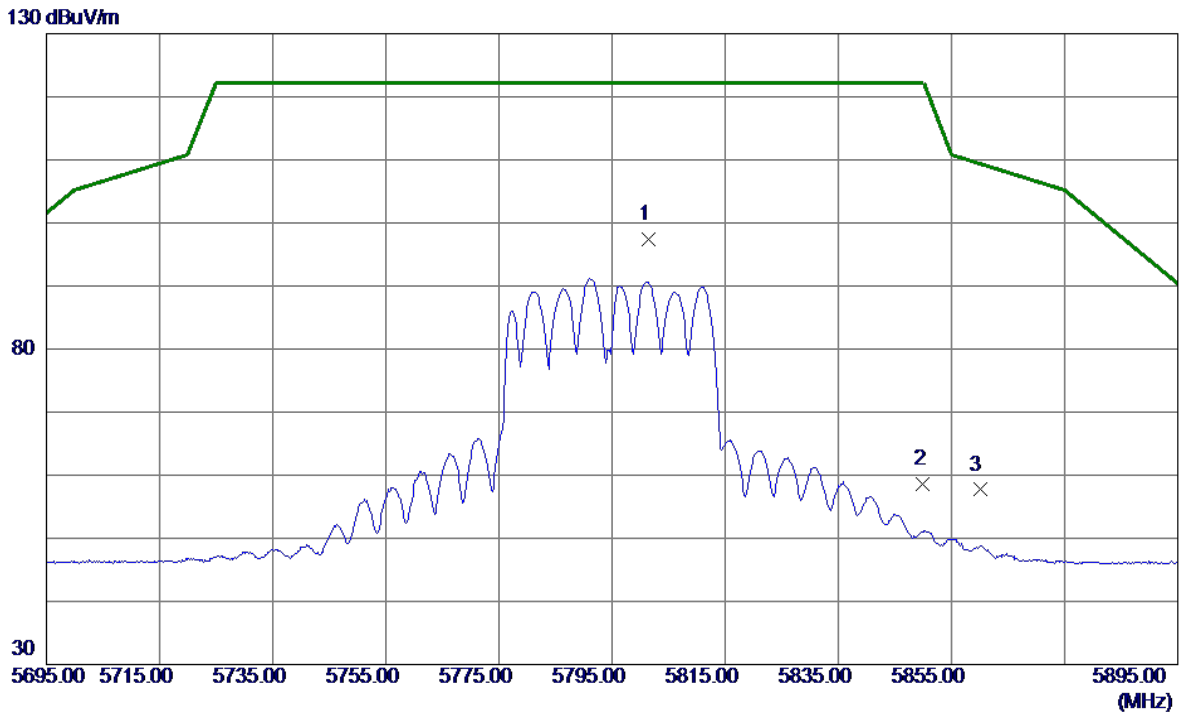

No.	Freq. MHz	Reading Level dBuV/m	Correct Factor dB	Measure ment dBuV/m	Limit dBuV/m	Margin dB	Detector	Comment
1 *	5801.4000	80.64	16.84	97.48	122.20	-24.72	Peak	No Limit
2	5850.0000	41.66	16.87	58.53	122.20	-63.67	Peak	
3	5860.0000	40.82	16.88	57.70	109.40	-51.70	Peak	

REMARKS:

- (1) Measurement Value = Reading Level + Correct Factor.
- (2) Margin Level = Measurement Value - Limit Value.

Test Mode	UNII-3_TX AC(VHT40) Mode 5795 MHz	Polarization	Horizontal
-----------	-----------------------------------	--------------	------------

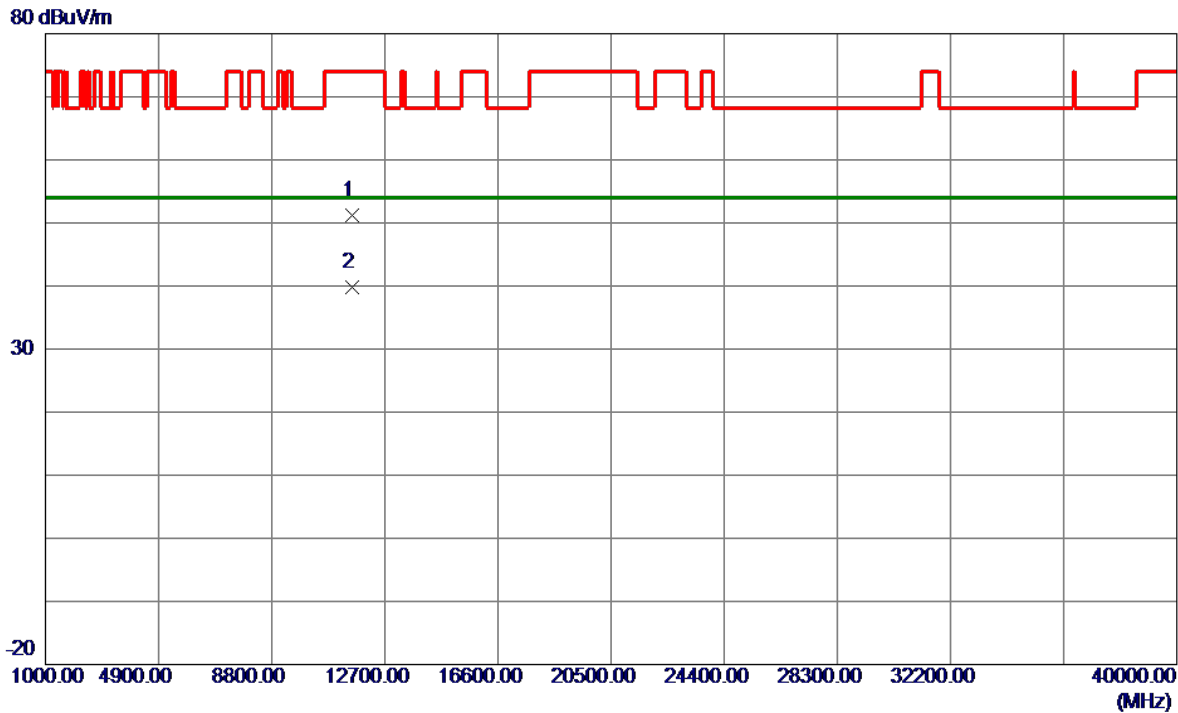

No.	Freq. MHz	Reading Level dBuV/m	Correct Factor dB	Measure ment dBuV/m	Limit dBuV/m	Margin dB	Detector	Comment
1	11590.0000	38.03	13.21	51.24	74.00	-22.76	Peak	
2 *	11590.0000	26.51	13.21	39.72	54.00	-14.28	AVG	

REMARKS:

- (1) Measurement Value = Reading Level + Correct Factor.
- (2) Margin Level = Measurement Value - Limit Value.

Test Mode	UNII-3_TX AC(VHT80) Mode 5775 MHz	Polarization	Vertical
-----------	-----------------------------------	--------------	----------

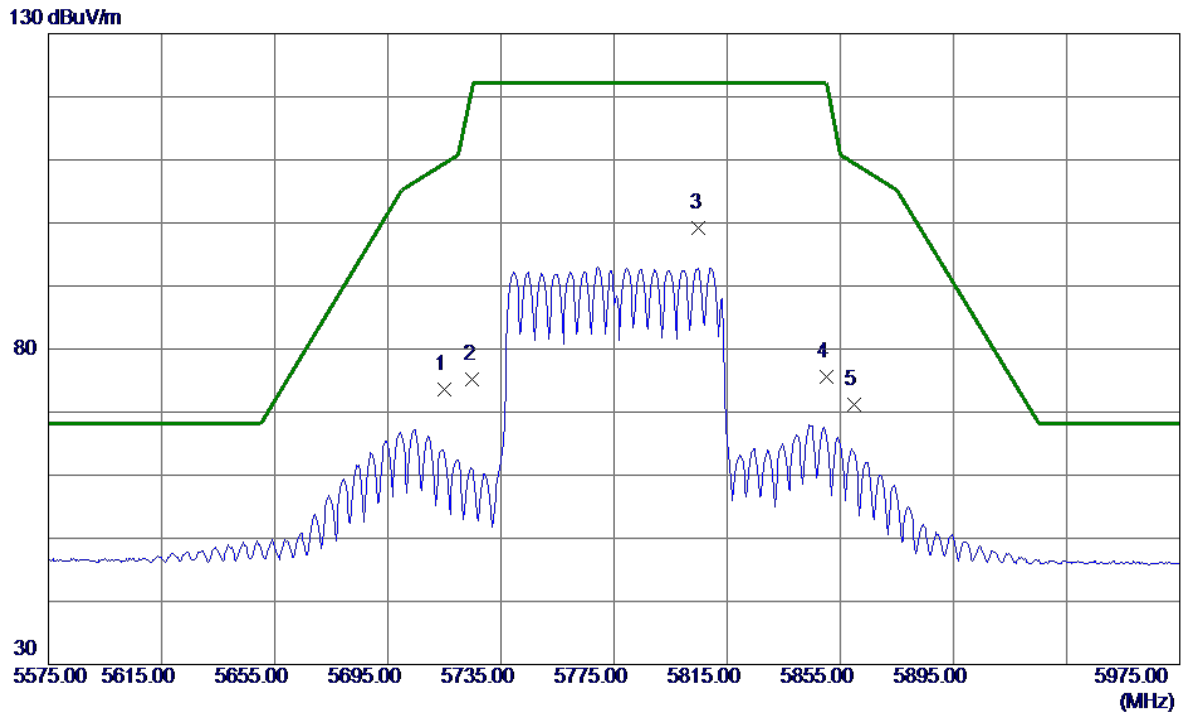

No.	Freq. MHz	Reading Level dBuV/m	Correct Factor dB	Measure ment dBuV/m	Limit dBuV/m	Margin dB	Detector	Comment
1	5715.0000	56.80	16.79	73.59	109.40	-35.81	Peak	
2	5725.0000	58.43	16.80	75.23	122.20	-46.97	Peak	
3 *	5805.0000	82.44	16.84	99.28	122.20	-22.92	Peak	No Limit
4	5850.0000	58.67	16.87	75.54	122.20	-46.66	Peak	
5	5860.0000	54.30	16.88	71.18	109.40	-38.22	Peak	

REMARKS:

- (1) Measurement Value = Reading Level + Correct Factor.
- (2) Margin Level = Measurement Value - Limit Value.

Test Mode	UNII-3_TX AC(VHT80) Mode 5775 MHz	Polarization	Vertical
-----------	-----------------------------------	--------------	----------

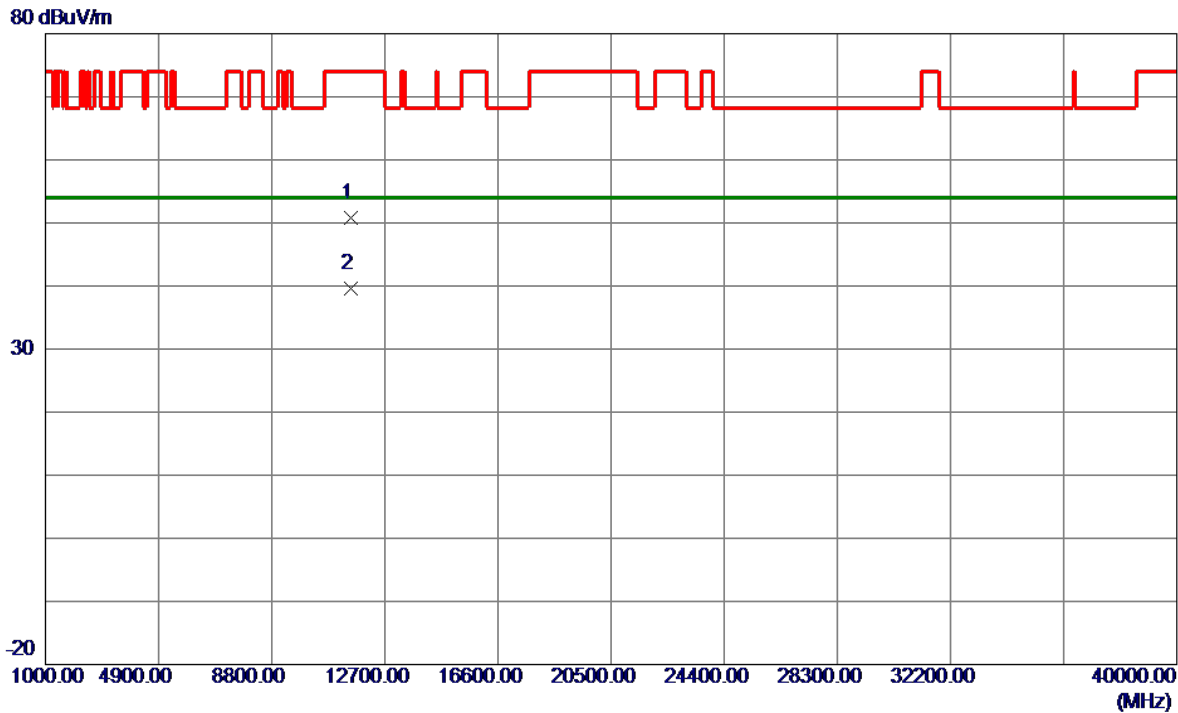

No.	Freq. MHz	Reading Level dBuV/m	Correct Factor dB	Measure ment dBuV/m	Limit dBuV/m	Margin dB	Detector	Comment
1	11550.0000	37.64	13.19	50.83	74.00	-23.17	Peak	
2 *	11550.0000	26.45	13.19	39.64	54.00	-14.36	AVG	

REMARKS:

- (1) Measurement Value = Reading Level + Correct Factor.
- (2) Margin Level = Measurement Value - Limit Value.

Test Mode	UNII-3_TX AC(VHT80) Mode 5775 MHz	Polarization	Horizontal
-----------	-----------------------------------	--------------	------------

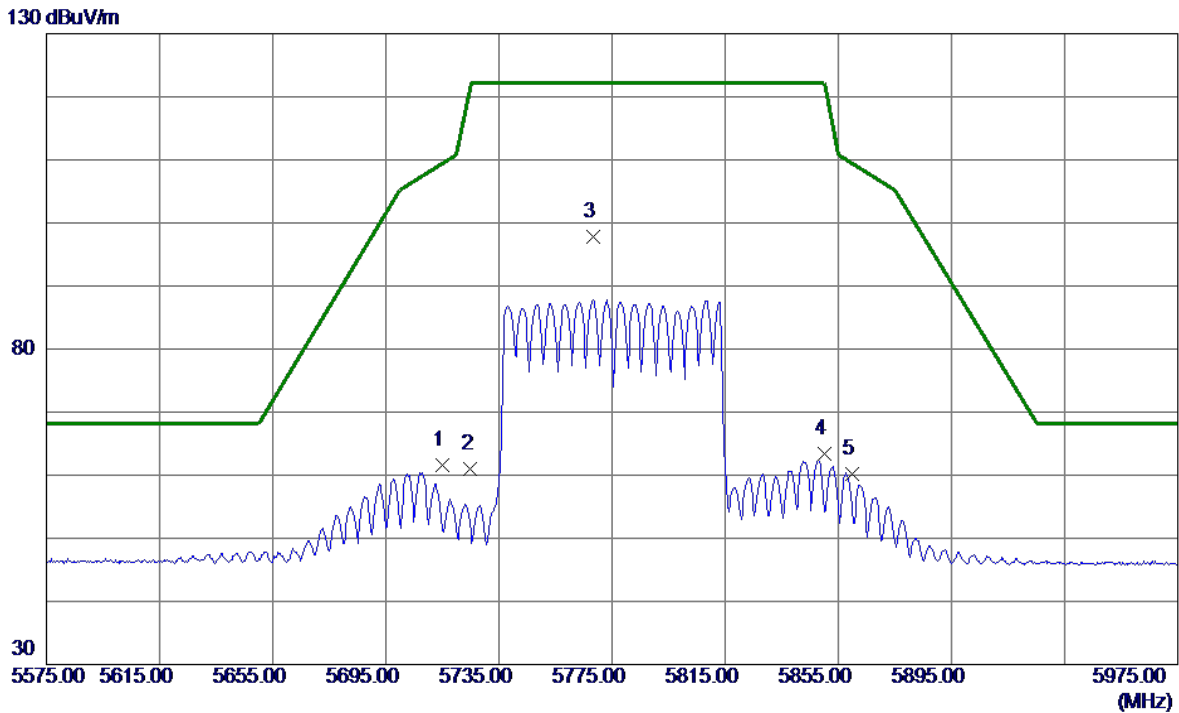

No.	Freq. MHz	Reading Level dBuV/m	Correct Factor dB	Measure ment dBuV/m	Limit dBuV/m	Margin dB	Detector	Comment
1	5715.0000	44.83	16.79	61.62	109.40	-47.78	Peak	
2	5725.0000	44.26	16.80	61.06	122.20	-61.14	Peak	
3 *	5768.2000	81.05	16.82	97.87	122.20	-24.33	Peak	No Limit
4	5850.0000	46.57	16.87	63.44	122.20	-58.76	Peak	
5	5860.0000	43.35	16.88	60.23	109.40	-49.17	Peak	

REMARKS:

- (1) Measurement Value = Reading Level + Correct Factor.
- (2) Margin Level = Measurement Value - Limit Value.

Test Mode	UNII-3_TX AC(VHT80) Mode 5775 MHz	Polarization	Horizontal
-----------	-----------------------------------	--------------	------------

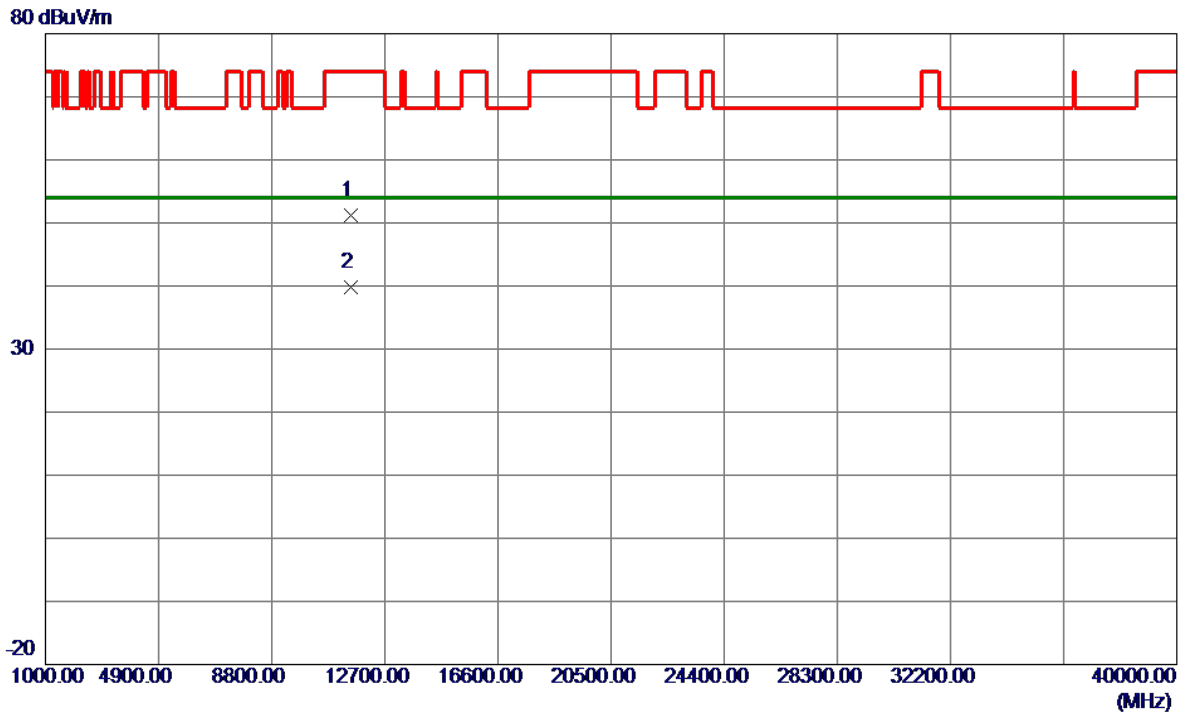

No.	Freq. MHz	Reading Level dBuV/m	Correct Factor dB	Measure ment dBuV/m	Limit dBuV/m	Margin dB	Detector	Comment
1	11550.0000	38.01	13.19	51.20	74.00	-22.80	Peak	
2 *	11550.0000	26.53	13.19	39.72	54.00	-14.28	AVG	

REMARKS:

- (1) Measurement Value = Reading Level + Correct Factor.
- (2) Margin Level = Measurement Value - Limit Value.

APPENDIX E - BANDWIDTH

Test Mode	UNII-1_TX A Mode
-----------	------------------

Channel	Frequency (MHz)	26 dB Bandwidth (MHz)	99 % Occupied Bandwidth (MHz)
36	5180	35.297	17.800
40	5200	32.498	17.500
48	5240	23.789	17.100

CH36

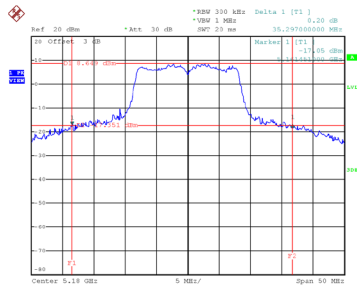

Date: 24.AUG.2021 10:04:46

CH40 26 dB Bandwidth

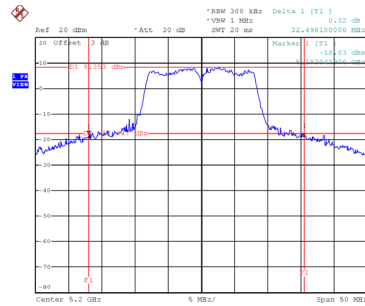

Date: 24.AUG.2021 10:05:57

CH48

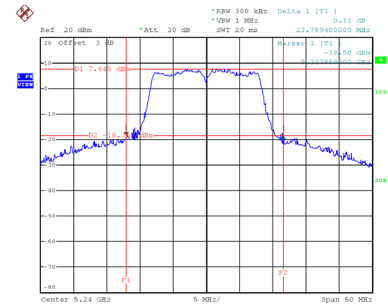

Date: 24.AUG.2021 10:07:10

99 % Occupied Bandwidth

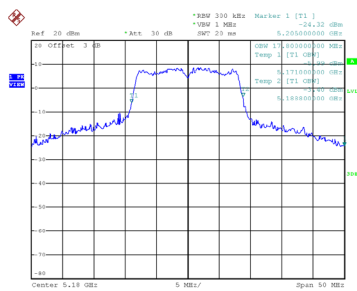

Date: 24.AUG.2021 10:04:27

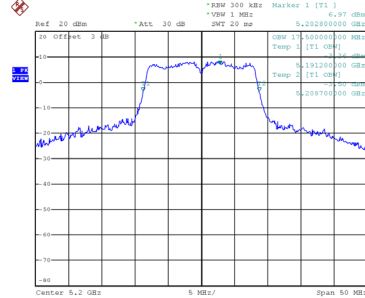

Date: 24.AUG.2021 10:05:35

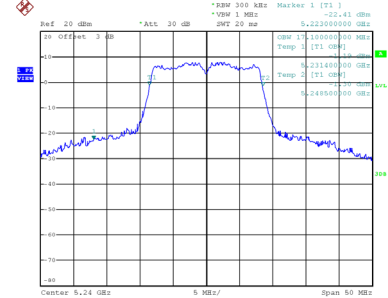

Date: 24.AUG.2021 10:06:51