

ELECTROMAGNETIC EMISSIONS COMPLIANCE REPORT

INTENTIONAL RADIATOR CERTIFICATION TO FCC PART 15 SUBPART E AND INDUSTRY CANADA RSS 247 REQUIREMENT

OF

Product Name: Panasonic FG-185-SG32-MH
Brand Name: Panasonic
Model No.: FG-185-SG32-MH
Model Difference: N/A
FCC ID: ACJ-FG-185-SG32MH
IC: 216B-FG185SG32MH
Report No.: E2/2017/60108
Issue Date: Aug. 02, 2017
FCC Rule Part: §15.407
IC Rule Part: RSS-247 issue 2 Feb. 2017
Prepared for: Panasonic Automotive Systems Company of America
 776 Highway 74 South, Peachtree City, GA 30269,
 USA

Prepared by: SGS Taiwan Ltd.
 Electronics & Communication Laboratory
 No.2, Keji 1st Rd., Guishan District, Taoyuan City,
 Taiwan 333



Note: This report shall not be reproduced except in full, without the written approval of SGS Taiwan Ltd. This document may be altered or revised by SGS Taiwan Ltd. personnel only, and shall be noted in the revision section of the document.

Unless otherwise stated the results shown in this test report refer only to the sample(s) tested and such sample(s) are retained for 90 days only.

除非另有說明，此報告結果僅對測試之樣品負責，同時此樣品僅保留90天。本報告未經本公司書面許可，不可部份複製。

This document is issued by the Company subject to its General Conditions of Service printed overleaf, available on request or accessible at www.sgs.com/terms_and_conditions.htm and, for electronic format documents, subject to Terms and Conditions for Electronic Documents at www.sgs.com/terms_e-document.htm. Attention is drawn to the limitation of liability, indemnification and jurisdiction issues defined therein. Any holder of this document is advised that information contained hereon reflects the Company's findings at the time of its intervention only and within the limits of Client's instructions, if any. The Company's sole responsibility is to its Client and this document does not exonerate parties to a transaction from exercising all their rights and obligations under the transaction documents. This document cannot be reproduced except in full, without prior written approval of the Company. Any unauthorized alteration, forgery or falsification of the content or appearance of this document is unlawful and offenders may be prosecuted to the fullest extent of the law.

SGS Taiwan Ltd.

No.134,WuKungRoad,NewTaipeiIndustrialPark,WukuDistrict,NewTaipeiCity,Taiwan24803/新北市五股區新北產業園區五工路 134 號

台灣檢驗科技股份有限公司

t (886-2) 2299-3279

f (886-2) 2298-0488

www.tw.sgs.com

Member of SGS Group

VERIFICATION OF COMPLIANCE

Applicant: Panasonic Automotive Systems Company of America
776 Highway 74 South, Peachtree City, GA 30269, USA

Product Name: Panasonic FG-185-SG32-MH

Brand Name: Panasonic

Model No.: FG-185-SG32-MH

Model Difference: N/A

FCC ID: ACJ-FG-185-SG32MH

IC : 216B-FG185SG32MH

File Number: E2/2017/60108

Date of test: Jun. 29, 2017 ~ Jul. 27, 2017

Date of EUT Received: Jun. 29, 2017

We hereby certify that:

The above equipment was tested by SGS Taiwan Ltd. Electronics & Communication Laboratory. The test data, data evaluation, test procedures, and equipment configurations shown in this report were made in accordance with the procedures given in ANSI C63.10: 2013 and the energy emitted by the sample EUT tested as described in this report is in compliance with conducted and radiated emission limits.

The test results of this report relate only to the tested sample identified in this report.

Test By:  **Date:** Aug. 02, 2017

Aken Huang / Engineer

Prepared By:  **Date:** Aug. 02, 2017

Karen Huang / Clerk

Approved By:  **Date:** Aug. 02, 2017

Jim Chang / Asst. Manager

Unless otherwise stated the results shown in this test report refer only to the sample(s) tested and such sample(s) are retained for 90 days only.

除非另有說明，此報告結果僅對測試之樣品負責，同時此樣品僅保留90天。本報告未經本公司書面許可，不可部份複製。

This document is issued by the Company subject to its General Conditions of Service printed overleaf, available on request or accessible at www.sgs.com/terms_and_conditions.htm and, for electronic format documents, subject to Terms and Conditions for Electronic Documents at www.sgs.com/terms_e-document.htm. Attention is drawn to the limitation of liability, indemnification and jurisdiction issues defined therein. Any holder of this document is advised that information contained hereon reflects the Company's findings at the time of its intervention only and within the limits of Client's instructions, if any. The Company's sole responsibility is to its Client and this document does not exonerate parties to a transaction from exercising all their rights and obligations under the transaction documents. This document cannot be reproduced except in full, without prior written approval of the Company. Any unauthorized alteration, forgery or falsification of the content or appearance of this document is unlawful and offenders may be prosecuted to the fullest extent of the law.

Revision History

Report Number	Revision	Description	Issue Date
E2/2017/60108	Rev.00	Initial creation of document	Aug. 02, 2017

Unless otherwise stated the results shown in this test report refer only to the sample(s) tested and such sample(s) are retained for 90 days only.

除非另有說明，此報告結果僅對測試之樣品負責，同時此樣品僅保留90天。本報告未經本公司書面許可，不可部份複製。

This document is issued by the Company subject to its General Conditions of Service printed overleaf, available on request or accessible at www.sgs.com/terms_and_conditions.htm and, for electronic format documents, subject to Terms and Conditions for Electronic Documents at www.sgs.com/terms_e-document.htm. Attention is drawn to the limitation of liability, indemnification and jurisdiction issues defined therein. Any holder of this document is advised that information contained hereon reflects the Company's findings at the time of its intervention only and within the limits of Client's instructions, if any. The Company's sole responsibility is to its Client and this document does not exonerate parties to a transaction from exercising all their rights and obligations under the transaction documents. This document cannot be reproduced except in full, without prior written approval of the Company. Any unauthorized alteration, forgery or falsification of the content or appearance of this document is unlawful and offenders may be prosecuted to the fullest extent of the law.

SGS Taiwan Ltd.

No. 134, WuKungRoad, New Taipei Industrial Park, Wuku District, New Taipei City, Taiwan 24803 / 新北市五股區新北產業園區五工路 134 號

台灣檢驗科技股份有限公司

t (886-2) 2299-3279

f (886-2) 2298-0488

www.tw.sgs.com

Member of SGS Group

Table of Contents

1	GENERAL INFORMATION	5
2	SYSTEM TEST CONFIGURATION.....	8
3	SUMMARY OF TEST RESULT	10
4	DESCRIPTION OF TEST MODES.....	11
5	MEASUREMENT UNCERTAINTY	14
6	CONDUCTED EMISSION TEST.....	15
7	DUTY CYCLE TEST SIGNAL.....	17
8	26dB & 6dB EMISSION BANDWIDTH MEASUREMENT.....	19
9	MAXIMUM CONDUCTED OUTPUT POWER MEASUREMENT	30
10	PEAK POWER SPECTRAL DENSITY	35
11	UNDESIRABLE RADIATED EMISSION MEASUREMENT.....	42
12	TRANSMISSION IN THE ABSENCE OF DATA	132
13	FREQUENCY STABILITY.....	133

Unless otherwise stated the results shown in this test report refer only to the sample(s) tested and such sample(s) are retained for 90 days only.

除非另有說明，此報告結果僅對測試之樣品負責，同時此樣品僅保留90天。本報告未經本公司書面許可，不可部份複製。

This document is issued by the Company subject to its General Conditions of Service printed overleaf, available on request or accessible at www.sgs.com/terms_and_conditions.htm and, for electronic format documents, subject to Terms and Conditions for Electronic Documents at www.sgs.com/terms_e-document.htm. Attention is drawn to the limitation of liability, indemnification and jurisdiction issues defined therein. Any holder of this document is advised that information contained hereon reflects the Company's findings at the time of its intervention only and within the limits of Client's instructions, if any. The Company's sole responsibility is to its Client and this document does not exonerate parties to a transaction from exercising all their rights and obligations under the transaction documents. This document cannot be reproduced except in full, without prior written approval of the Company. Any unauthorized alteration, forgery or falsification of the content or appearance of this document is unlawful and offenders may be prosecuted to the fullest extent of the law.

SGS Taiwan Ltd.

No. 134, WuKungRoad, New Taipei Industrial Park, Wuku District, New Taipei City, Taiwan 24803/新北市五股區新北產業園區五工路 134 號

台灣檢驗科技股份有限公司

t (886-2) 2299-3279

f (886-2) 2298-0488

www.tw.sgs.com

Member of SGS Group

1 GENERAL INFORMATION

1.1 Product Description

General:

Product Name:	Panasonic FG-185-SG32-MH
Brand Name:	Panasonic
Model No.:	FG-185-SG32-MH
Model Difference:	N/A
Product SW/HW version:	N/A/ N/A
Radio SW/HW version:	N/A / N/A
Test SW Version:	N/A
RF power setting in TEST SW:	N/A
Power Supply:	12V DC from Power Supply

Antenna Designation	PCB Antenna, 5GHz Gain: 2dBi (5150MHz-5250MHz) 5GHz Gain: 2dBi (5250MHz-5350MHz) 5GHz Gain: 2dBi (5470MHz-5725MHz) 5GHz Gain: 2dBi (5725MHz-5850MHz)
Modulation type	64QAM, 16QAM, QPSK, BPSK for OFDM
Transition Rate:	802.11 a: 6/9/12/18/24/36/48/54 Mbps 802.11 n_20MHz: 6.5 – 72.2Mbps

Unless otherwise stated the results shown in this test report refer only to the sample(s) tested and such sample(s) are retained for 90 days only.

除非另有說明，此報告結果僅對測試之樣品負責，同時此樣品僅保留90天。本報告未經本公司書面許可，不可部份複製。

This document is issued by the Company subject to its General Conditions of Service printed overleaf, available on request or accessible at www.sgs.com/terms_and_conditions.htm and, for electronic format documents, subject to Terms and Conditions for Electronic Documents at www.sgs.com/terms_e-document.htm. Attention is drawn to the limitation of liability, indemnification and jurisdiction issues defined therein. Any holder of this document is advised that information contained hereon reflects the Company's findings at the time of its intervention only and within the limits of Client's instructions, if any. The Company's sole responsibility is to its Client and this document does not exonerate parties to a transaction from exercising all their rights and obligations under the transaction documents. This document cannot be reproduced except in full, without prior written approval of the Company. Any unauthorized alteration, forgery or falsification of the content or appearance of this document is unlawful and offenders may be prosecuted to the fullest extent of the law.

SGS Taiwan Ltd.

No.134,WuKungRoad,NewTaipeiIndustrialPark,WukuDistrict,NewTaipeiCity,Taiwan24803/新北市五股區新北產業園區五工路 134 號

台灣檢驗科技股份有限公司

t (886-2) 2299-3279

f (886-2) 2298-0488

www.tw.sgs.com

Member of SGS Group

FCC WLAN 5GHz:

Wi-Fi	Frequency Range	Channels	Rated Power (Avg.)	Modulation Technology
11a	5150~5250	4	10.68 dBm	OFDM
	5250~5350	4	10.67 dBm	
	5470~5725	12	10.71 dBm	
	5725-5850	5	10.67 dBm	
11n	HT20 5150~5250	4	10.72 dBm	OFDM
	HT20 5250~5350	4	10.73 dBm	
	HT20 5470~5725	12	10.71 dBm	
	HT20 5725-5850	5	10.73 dBm	

IC WLAN 5GHz:

Wi-Fi	Frequency Range	Channels	Rated Power (Avg.) / (EIRP)	Modulation Technology
11a	5150~5250	4	12.68 dBm (EIRP)	OFDM
	5250~5350	4	10.67 dBm	
	5500~5580	5	10.56 dBm	
	5660~5700	3	10.71 dBm	
	5745-5825	5	10.67 dBm	
11n	HT20 5150~5250	4	12.72 dBm (EIRP)	OFDM
	HT20 5250~5350	4	10.73 dBm	
	HT20 5500~5580	5	10.71 dBm	
	HT20 5660~5700	3	10.45 dBm	
	HT20 5745-5825	5	10.73 dBm	

Unless otherwise stated the results shown in this test report refer only to the sample(s) tested and such sample(s) are retained for 90 days only.

除非另有說明，此報告結果僅對測試之樣品負責，同時此樣品僅保留90天。本報告未經本公司書面許可，不可部份複製。

This document is issued by the Company subject to its General Conditions of Service printed overleaf, available on request or accessible at www.sgs.com/terms_and_conditions.htm and, for electronic format documents, subject to Terms and Conditions for Electronic Documents at www.sgs.com/terms_e-document.htm. Attention is drawn to the limitation of liability, indemnification and jurisdiction issues defined therein. Any holder of this document is advised that information contained hereon reflects the Company's findings at the time of its intervention only and within the limits of Client's instructions, if any. The Company's sole responsibility is to its Client and this document does not exonerate parties to a transaction from exercising all their rights and obligations under the transaction documents. This document cannot be reproduced except in full, without prior written approval of the Company. Any unauthorized alteration, forgery or falsification of the content or appearance of this document is unlawful and offenders may be prosecuted to the fullest extent of the law.

SGS Taiwan Ltd.

No.134,WuKungRoad,NewTaipeiIndustrialPark,WukuDistrict,NewTaipeiCity,Taiwan24803/新北市五股區新北產業園區五工路134號

台灣檢驗科技股份有限公司

t (886-2) 2299-3279

f (886-2) 2298-0488

www.tw.sgs.com

Member of SGS Group

1.2 Test Methodology of Applied Standards

FCC Part 15, Subpart E §15.407

FCC KDB 789033 D02 General UNII Test Procedures New Rules

RSS-247 issue 2 Feb. 2017

RSS-Gen issue4 Nov. 2014

ANSI C63.10:2013

Note: All test items have been performed and record as per the above standards.

1.3 Test Facility

SGS Taiwan Ltd. Electronics & Communication Laboratory No.2, Keji 1st Rd.,
Guishan District, Taoyuan City, Taiwan 333 (TAF code 0513)

FCC Registration Numbers are: 735305

Canada Registration Number: 4620A-5

1.4 Special Accessories

There are no special accessories used while test was conducted.

1.5 Equipment Modifications

There was no modification incorporated into the EUT.

Unless otherwise stated the results shown in this test report refer only to the sample(s) tested and such sample(s) are retained for 90 days only.

除非另有說明，此報告結果僅對測試之樣品負責，同時此樣品僅保留90天。本報告未經本公司書面許可，不可部份複製。

This document is issued by the Company subject to its General Conditions of Service printed overleaf, available on request or accessible at www.sgs.com/terms_and_conditions.htm and, for electronic format documents, subject to Terms and Conditions for Electronic Documents at www.sgs.com/terms_e-document.htm. Attention is drawn to the limitation of liability, indemnification and jurisdiction issues defined therein. Any holder of this document is advised that information contained hereon reflects the Company's findings at the time of its intervention only and within the limits of Client's instructions, if any. The Company's sole responsibility is to its Client and this document does not exonerate parties to a transaction from exercising all their rights and obligations under the transaction documents. This document cannot be reproduced except in full, without prior written approval of the Company. Any unauthorized alteration, forgery or falsification of the content or appearance of this document is unlawful and offenders may be prosecuted to the fullest extent of the law.

SGS Taiwan Ltd.

No.134,WuKungRoad,NewTaipeiIndustrialPark,WukuDistrict,NewTaipeiCity,Taiwan24803/新北市五股區新北產業園區五工路 134 號

台灣檢驗科技股份有限公司

t (886-2) 2299-3279

f (886-2) 2298-0488

www.tw.sgs.com

Member of SGS Group

2 SYSTEM TEST CONFIGURATION

2.1 EUT Configuration

The EUT configuration for testing is installed on RF field strength measurement to meet the Commissions requirement and operating in a manner which intends to maximize its emission characteristics in a continuous normal application.

2.2 EUT Exercise

An engineering test mode (software/firmware) that applicant provided was utilized to manipulate the EUT into transmit, selection of the test channel, and modulation scheme.

2.3 Test Procedure

2.3.1 Conducted Emissions

The EUT is placed on a turn table which is 0.8 m above ground plane. Conducted emissions from the EUT measured in the frequency range between 0.15 MHz and 30 MHz. The CISPR Quasi-Peak and Average detector mode is employed according to §15.207. The two LISNs provide 50 ohm/ 50uH of coupling impedance for the measuring instrument. Both lines of the power mains connected to the EUT were checked for maximum conducted interference.

2.3.2 Radiated Emissions

The EUT is placed on a turn table. For emissions testing at or below 1 GHz, the table height shall be 0.8 m above the reference ground plane. For emission measurements above 1 GHz, the table height shall be 1.5 m. The turn table shall rotate 360 degrees to determine the position of maximum emission level. EUT is set 3m away from the receiving antenna which varied from 1m to 4m to find out the highest emission. And also, each emission was to be maximized by changing the polarization of receiving antenna both horizontal and vertical. In order to find out the max. emission, the relative positions of this hand-held transmitter (EUT) was rotated through three orthogonal axes and measurement procedures for electric field radiated emissions above 1 GHz the EUT measurement is to be made "while keeping the antenna in the 'cone of radiation' from that area and pointed at the area both in azimuth and elevation, with polarization oriented for maximum response." is still within the 3dB illumination BW of the measurement antenna.

Unless otherwise stated the results shown in this test report refer only to the sample(s) tested and such sample(s) are retained for 90 days only.

除非另有說明，此報告結果僅對測試之樣品負責，同時此樣品僅保留90天。本報告未經本公司書面許可，不可部份複製。

This document is issued by the Company subject to its General Conditions of Service printed overleaf, available on request or accessible at www.sgs.com/terms_and_conditions.htm and, for electronic format documents, subject to Terms and Conditions for Electronic Documents at www.sgs.com/terms_e-document.htm. Attention is drawn to the limitation of liability, indemnification and jurisdiction issues defined therein. Any holder of this document is advised that information contained hereon reflects the Company's findings at the time of its intervention only and within the limits of Client's instructions, if any. The Company's sole responsibility is to its Client and this document does not exonerate parties to a transaction from exercising all their rights and obligations under the transaction documents. This document cannot be reproduced except in full, without prior written approval of the Company. Any unauthorized alteration, forgery or falsification of the content or appearance of this document is unlawful and offenders may be prosecuted to the fullest extent of the law.

SGS Taiwan Ltd.

台灣檢驗科技股份有限公司

No.134,WuKungRoad,NewTaipeiIndustrialPark,WukuDistrict,NewTaipeiCity,Taiwan24803/新北市五股區新北產業園區五工路134號

t (886-2) 2299-3279

f (886-2) 2298-0488

www.tw.sgs.com

Member of SGS Group

2.4 Measurement Results Explanation Example

For all conducted test items:

The offset level is set in the spectrum analyzer to compensate the RF cable loss and attenuation factor between EUT conducted port and spectrum analyzer. With the offset compensation, the spectrum analyzer reading level is exactly EUT RF output level.

Note:

The spectrum analyzer offset is derived from RF cable loss and attenuator factor. Following shows an offset computation example with cable loss 1.6dB, and 10dB attenuator.

$$= \text{RF cable loss (dB)} + \text{attenuation factor (dB)} = 11.6(\text{dB})$$

2.5 Configuration of Tested System

Fig. 2-1 Radiated Emission & Conducted Emission (Antenna Port) Configuration

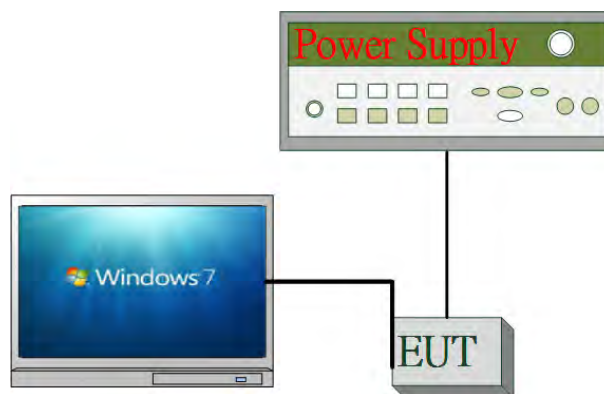

Table 2-1 Equipment Used in Tested System

Item	Equipment	Mfr/Brand	Model/Type No.	Series No.	Data Cable	Power Cord
1	WLAN Test Software	N/A	N/A	N/A	N/A	N/A
2	Notebook	Lenovo	L430	PK-OCGFF	Shielded	Un-Shielded
3	DC Power Supply	Agilent	E3640A	MY53140006	N/A	Un-Shielded

Unless otherwise stated the results shown in this test report refer only to the sample(s) tested and such sample(s) are retained for 90 days only.

除非另有說明，此報告結果僅對測試之樣品負責，同時此樣品僅保留90天。本報告未經本公司書面許可，不可部份複製。

This document is issued by the Company subject to its General Conditions of Service printed overleaf, available on request or accessible at www.sgs.com/terms_and_conditions.htm and, for electronic format documents, subject to Terms and Conditions for Electronic Documents at www.sgs.com/terms_e-document.htm. Attention is drawn to the limitation of liability, indemnification and jurisdiction issues defined therein. Any holder of this document is advised that information contained hereon reflects the Company's findings at the time of its intervention only and within the limits of Client's instructions, if any. The Company's sole responsibility is to its Client and this document does not exonerate parties to a transaction from exercising all their rights and obligations under the transaction documents. This document cannot be reproduced except in full, without prior written approval of the Company. Any unauthorized alteration, forgery or falsification of the content or appearance of this document is unlawful and offenders may be prosecuted to the fullest extent of the law.

SGS Taiwan Ltd.

No. 134, WuKungRoad, NewTaipeiIndustrialPark, WukuDistrict, NewTaipeiCity, Taiwan24803/新北市五股區新北產業園區五工路 134 號

台灣檢驗科技股份有限公司

t (886-2) 2299-3279

f (886-2) 2298-0488

www.tw.sgs.com

Member of SGS Group

3 SUMMARY OF TEST RESULT

FCC Rules	IC Rules	Description Of Test	Result
§15.207	RSS-Gen §8.8	AC Power Line Conducted Emission	N/A
§15.403(i) §15.407(e)	RSS-247 §6.2.1~ 4 (1) RSS-Gen §6.6	26 dB & 6dB & 99% Emission Bandwidth	Compliant
§15.407(a)	RSS-247 §6.2.1~ 4 (1)	Maximum Conducted Output Power	Compliant
§15.407(a)	RSS-247 §6.2.1~ 4 (1)	Power Spectral Density	Compliant
§15.407(b)	RSS-247 §6.2.1~ 4 (2)	Undesirable Radiated Emissions	Compliant
§15.407(c)	RSS-247 §6.4	Transmission in case of Absence of Information	Compliant
§15.407(g)	RSS-Gen §6.11	Frequency Stability	Compliant
§15.203 §15.407(a)	-	Antenna Requirement	Compliant

Unless otherwise stated the results shown in this test report refer only to the sample(s) tested and such sample(s) are retained for 90 days only.

除非另有說明，此報告結果僅對測試之樣品負責，同時此樣品僅保留90天。本報告未經本公司書面許可，不可部份複製。

This document is issued by the Company subject to its General Conditions of Service printed overleaf, available on request or accessible at www.sgs.com/terms_and_conditions.htm and, for electronic format documents, subject to Terms and Conditions for Electronic Documents at www.sgs.com/terms_e-document.htm. Attention is drawn to the limitation of liability, indemnification and jurisdiction issues defined therein. Any holder of this document is advised that information contained hereon reflects the Company's findings at the time of its intervention only and within the limits of Client's instructions, if any. The Company's sole responsibility is to its Client and this document does not exonerate parties to a transaction from exercising all their rights and obligations under the transaction documents. This document cannot be reproduced except in full, without prior written approval of the Company. Any unauthorized alteration, forgery or falsification of the content or appearance of this document is unlawful and offenders may be prosecuted to the fullest extent of the law.

SGS Taiwan Ltd.

No.134,WuKungRoad,NewTaipeiIndustrialPark,WukuDistrict,NewTaipeiCity,Taiwan24803/新北市五股區新北產業園區五工路 134 號

台灣檢驗科技股份有限公司

t (886-2) 2299-3279

f (886-2) 2298-0488

www.tw.sgs.com

Member of SGS Group

4 DESCRIPTION OF TEST MODES

4.1 Operated in U-NII Bands

Operated band in 5150 MHz ~5250 MHz:

4 channels are provided for 802.11a, 802.11n_HT20

CHANNEL	FREQUENCY	CHANNEL	FREQUENCY
36	5180 MHz	44	5220 MHz
40	5200 MHz	48	5240 MHz

Operated band in 5250 MHz ~5350 MHz:

4 channels are provided for 802.11a, 802.11n_HT20

CHANNEL	FREQUENCY	CHANNEL	FREQUENCY
52	5260 MHz	60	5300 MHz
56	5280 MHz	64	5320 MHz

Operated band in 5470 MHz ~5725 MHz:

11 channels are provided for FCC 802.11a, 802.11n_HT20

CHANNEL	FREQUENCY	CHANNEL	FREQUENCY
100	5500 MHz	124	5620 MHz
104	5520 MHz	128	5640 MHz
108	5540 MHz	132	5660 MHz
112	5560 MHz	136	5680 MHz
116	5580 MHz	140	5700 MHz
120	5600 MHz		

Note: Channels from 5600MHz ~ 5650MHz are disabled when this product is marketed withing Canada.

Operated band in 5725 MHz ~5850 MHz:

5 channels are provided for 802.11a, 802.11n_HT20

CHANNEL	FREQUENCY	CHANNEL	FREQUENCY
149	5745 MHz	161	5805 MHz
153	5765 MHz	165	5825 MHz
157	5785 MHz		

Unless otherwise stated the results shown in this test report refer only to the sample(s) tested and such sample(s) are retained for 90 days only.

除非另有說明，此報告結果僅對測試之樣品負責，同時此樣品僅保留90天。本報告未經本公司書面許可，不可部份複製。

This document is issued by the Company subject to its General Conditions of Service printed overleaf, available on request or accessible at www.sgs.com/terms_and_conditions.htm and, for electronic format documents, subject to Terms and Conditions for Electronic Documents at www.sgs.com/terms_e-document.htm. Attention is drawn to the limitation of liability, indemnification and jurisdiction issues defined therein. Any holder of this document is advised that information contained hereon reflects the Company's findings at the time of its intervention only and within the limits of Client's instructions, if any. The Company's sole responsibility is to its Client and this document does not exonerate parties to a transaction from exercising all their rights and obligations under the transaction documents. This document cannot be reproduced except in full, without prior written approval of the Company. Any unauthorized alteration, forgery or falsification of the content or appearance of this document is unlawful and offenders may be prosecuted to the fullest extent of the law.

4.2 The Worst Test Modes and Channel Details

1. The EUT has been tested under operating condition.
2. Test program used to control the EUT for staying in continuous transmitting mode is programmed.
3. Investigation has been done on all the possible configurations for searching the worst case.

RADIATED EMISSION TEST:

RADIATED EMISSION TEST (BELOW 1 GHz)					
MODE	FREQUENCY BAND (MHz)	AVAILABLE CHANNEL	TESTED CHANNEL	MODULATION	DATA RATE (Mbps)
802.11a	5180~5240	36 to 48	44	OFDM	6
802.11a	5260~5320	52 to 64	60	OFDM	6
802.11a	5500~5700	100 to 140	116	OFDM	6
802.11a	5745~5825	149 to 165	157	OFDM	6
RADIATED EMISSION TEST (ABOVE 1 GHz)					
MODE	FREQUENCY BAND (MHz)	AVAILABLE CHANNEL	TESTED CHANNEL	MODULATION	DATA RATE (Mbps)
802.11a	5180~5240	36 to 48	36,44,48	OFDM	6
802.11n_HT20				OFDM	MCS0
802.11a	5260~5320	52 to 64	52,60,64	OFDM	6
802.11n_HT20				OFDM	MCS0
802.11a	5500~5700	100 to 140	100,116,140	OFDM	6
802.11n_HT20				OFDM	MCS0
802.11a	5745~5825	149 to 165	149,157,165	OFDM	6
802.11n_HT20				OFDM	MCS0

Note:

The field strength of radiation emission was measured as EUT stand-up position (H mode) and lie down position (E1, E2 mode) for 802.11a/n WLAN Transmitter for channel Low, Mid and High, the worst case H position was reported.

Unless otherwise stated the results shown in this test report refer only to the sample(s) tested and such sample(s) are retained for 90 days only.

除非另有說明，此報告結果僅對測試之樣品負責，同時此樣品僅保留90天。本報告未經本公司書面許可，不可部份複製。

This document is issued by the Company subject to its General Conditions of Service printed overleaf, available on request or accessible at www.sgs.com/terms_and_conditions.htm and, for electronic format documents, subject to Terms and Conditions for Electronic Documents at www.sgs.com/terms_e-document.htm. Attention is drawn to the limitation of liability, indemnification and jurisdiction issues defined therein. Any holder of this document is advised that information contained hereon reflects the Company's findings at the time of its intervention only and within the limits of Client's instructions, if any. The Company's sole responsibility is to its Client and this document does not exonerate parties to a transaction from exercising all their rights and obligations under the transaction documents. This document cannot be reproduced except in full, without prior written approval of the Company. Any unauthorized alteration, forgery or falsification of the content or appearance of this document is unlawful and offenders may be prosecuted to the fullest extent of the law.

SGS Taiwan Ltd.

No.134,WuKungRoad,NewTaipeiIndustrialPark,WukuDistrict,NewTaipeiCity,Taiwan24803/新北市五股區新北產業園區五工路 134 號

台灣檢驗科技股份有限公司

t (886-2) 2299-3279

f (886-2) 2298-0488

www.tw.sgs.com

Member of SGS Group

ANTENNA PORT CONDUCTED MEASUREMENT:

CONDUCTED TEST					
MODE	FREQUENCY BAND (MHz)	AVAILABLE CHANNEL	TESTED CHANNEL	MODULATION	DATA RATE (Mbps)
802.11a	5180~5240	36 to 48	36,44,48	OFDM	6
802.11n_HT20				OFDM	MCS0
802.11a	5260~5320	52 to 64	52,60,64	OFDM	6
802.11n_HT20				OFDM	MCS0
802.11a	5500~5700	100 to 140	100,116,140	OFDM	6
802.11n_HT20				OFDM	MCS0
802.11a	5745~5825	149 to 165	149,157,165	OFDM	6
802.11n_HT20				OFDM	MCS0

Unless otherwise stated the results shown in this test report refer only to the sample(s) tested and such sample(s) are retained for 90 days only.

除非另有說明，此報告結果僅對測試之樣品負責，同時此樣品僅保留90天。本報告未經本公司書面許可，不可部份複製。

This document is issued by the Company subject to its General Conditions of Service printed overleaf, available on request or accessible at www.sgs.com/terms_and_conditions.htm and, for electronic format documents, subject to Terms and Conditions for Electronic Documents at www.sgs.com/terms_e-document.htm. Attention is drawn to the limitation of liability, indemnification and jurisdiction issues defined therein. Any holder of this document is advised that information contained hereon reflects the Company's findings at the time of its intervention only and within the limits of Client's instructions, if any. The Company's sole responsibility is to its Client and this document does not exonerate parties to a transaction from exercising all their rights and obligations under the transaction documents. This document cannot be reproduced except in full, without prior written approval of the Company. Any unauthorized alteration, forgery or falsification of the content or appearance of this document is unlawful and offenders may be prosecuted to the fullest extent of the law.

SGS Taiwan Ltd.

No. 134, WuKungRoad, NewTaipeiIndustrialPark, WukuDistrict, New Taipei City, Taiwan 24803/新北市五股區新北產業園區五工路 134 號

台灣檢驗科技股份有限公司

t (886-2) 2299-3279

f (886-2) 2298-0488

www.tw.sgs.com

Member of SGS Group

5 MEASUREMENT UNCERTAINTY

Test Items	Uncertainty
AC Power Line Conducted Emission	+/- 2.586 dB
26dB & 6dB Emission Bandwidth	+/- 123.36 Hz
The Maximum Output Power Measurement	+/- 0.96 dB
Peak Power Spectral Density Measurement	+/- 1.67 dB
Frequency Stability	+/- 123.36 Hz
Temperature	+/- 0.65 °C
Humidity	+/- 4.6 %
DC / AC Power Source	DC= +/- 0.13%, AC=+/- 0.2%

Radiated Spurious Emission:

Measurement uncertainty (Polarization : Vertical)	9kHz – 30MHz: +/- 2.87 dB
	30MHz - 180MHz: +/- 3.37dB
	180MHz -417MHz: +/- 3.19dB
	0.417GHz-1GHz: +/- 3.19dB
	1GHz - 18GHz: +/- 4.04dB
	18GHz - 40GHz: +/- 4.04dB

Measurement uncertainty (Polarization : Horizontal)	9kHz – 30MHz: +/- 2.87 dB
	30MHz - 167MHz: +/- 4.22dB
	167MHz -500MHz: +/- 3.44dB
	0.5GHz-1GHz: +/- 3.39dB
	1GHz - 18GHz: +/- 4.08dB
	18GHz - 40GHz: +/- 4.08dB

This uncertainty represents an expanded uncertainty expressed at approximately the 95% confidence level using a coverage factor of k=2.

Unless otherwise stated the results shown in this test report refer only to the sample(s) tested and such sample(s) are retained for 90 days only.

除非另有說明，此報告結果僅對測試之樣品負責，同時此樣品僅保留90天。本報告未經本公司書面許可，不可部份複製。

This document is issued by the Company subject to its General Conditions of Service printed overleaf, available on request or accessible at www.sgs.com/terms_and_conditions.htm and, for electronic format documents, subject to Terms and Conditions for Electronic Documents at www.sgs.com/terms_e-document.htm. Attention is drawn to the limitation of liability, indemnification and jurisdiction issues defined therein. Any holder of this document is advised that information contained hereon reflects the Company's findings at the time of its intervention only and within the limits of Client's instructions, if any. The Company's sole responsibility is to its Client and this document does not exonerate parties to a transaction from exercising all their rights and obligations under the transaction documents. This document cannot be reproduced except in full, without prior written approval of the Company. Any unauthorized alteration, forgery or falsification of the content or appearance of this document is unlawful and offenders may be prosecuted to the fullest extent of the law.

SGS Taiwan Ltd.

No.134,WuKungRoad,NewTaipeiIndustrialPark,WukuDistrict,NewTaipeiCity,Taiwan24803/新北市五股區新北產業園區五工路 134 號

台灣檢驗科技股份有限公司

t (886-2) 2299-3279

f (886-2) 2298-0488

www.tw.sgs.com

Member of SGS Group

6 CONDUCTED EMISSION TEST

6.1. Standard Applicable

Frequency range within 150 kHz to 30 MHz shall not exceed the Limit table as below.

Frequency range MHz	Limits dB(uV)	
	Quasi-peak	Average
0.15 to 0.50	66 to 56	56 to 46
0.50 to 5	56	46
5 to 30	60	50

Note

- 1.The lower limit shall apply at the transition frequencies
- 2.The limit decreases linearly with the logarithm of the frequency in the range 0.15 MHz to 0.50 MHz.

6.2. Measurement Equipment Used

Conducted Emission Test Site					
EQUIPMENT TYPE	MFR	MODEL NUMBER	SERIAL NUMBER	LAST CAL.	CAL DUE.
EMI Test Receiver	R&S	ESCI 7	100950	12/12/2016	12/11/2017
Coaxial Cables	N/A	N30N30-1042-150 cm	N/A	08/30/2016	08/29/2017
LISN	Schwarzbeck	NSLK 8127	8127-648	06/18/2017	06/17/2018
Test Software	Farad	EZ-EMC	Ver. SGS-03A2	N.C.R.	N.C.R.

NOTE: N.C.R refers to Not Calibrated Required.

6.3. EUT Setup

1. The conducted emission tests were performed in the test site, using the setup in accordance with the ANSI C63.10:2013.
2. The AC/DC Power adaptor of EUT was plug-in LISN. The rear of the EUT and peripherals were placed flushed with the rear of the tabletop.
3. The LISN was connected with 120Vac/60Hz power source.

Unless otherwise stated the results shown in this test report refer only to the sample(s) tested and such sample(s) are retained for 90 days only.

除非另有說明，此報告結果僅對測試之樣品負責，同時此樣品僅保留90天。本報告未經本公司書面許可，不可部份複製。

This document is issued by the Company subject to its General Conditions of Service printed overleaf, available on request or accessible at www.sgs.com/terms_and_conditions.htm and, for electronic format documents, subject to Terms and Conditions for Electronic Documents at www.sgs.com/terms_e-document.htm. Attention is drawn to the limitation of liability, indemnification and jurisdiction issues defined therein. Any holder of this document is advised that information contained hereon reflects the Company's findings at the time of its intervention only and within the limits of Client's instructions, if any. The Company's sole responsibility is to its Client and this document does not exonerate parties to a transaction from exercising all their rights and obligations under the transaction documents. This document cannot be reproduced except in full, without prior written approval of the Company. Any unauthorized alteration, forgery or falsification of the content or appearance of this document is unlawful and offenders may be prosecuted to the fullest extent of the law.

6.4. Test SET-UP

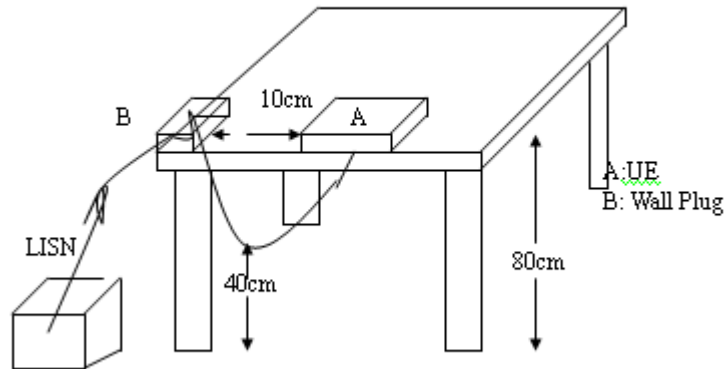

6.5. Measurement Procedure

1. The EUT was placed on a table which is 0.8m above ground plane.
2. Maximum procedure was performed on the six highest emissions to ensure EUT compliance.
3. Repeat above procedures until all phases of power being supplied by given UE are completed.

6.6. Measurement Result

N/A, EUT is powered by car battery.

Unless otherwise stated the results shown in this test report refer only to the sample(s) tested and such sample(s) are retained for 90 days only.

除非另有說明，此報告結果僅對測試之樣品負責，同時此樣品僅保留90天。本報告未經本公司書面許可，不可部份複製。

This document is issued by the Company subject to its General Conditions of Service printed overleaf, available on request or accessible at www.sgs.com/terms_and_conditions.htm and, for electronic format documents, subject to Terms and Conditions for Electronic Documents at www.sgs.com/terms_e-document.htm. Attention is drawn to the limitation of liability, indemnification and jurisdiction issues defined therein. Any holder of this document is advised that information contained hereon reflects the Company's findings at the time of its intervention only and within the limits of Client's instructions, if any. The Company's sole responsibility is to its Client and this document does not exonerate parties to a transaction from exercising all their rights and obligations under the transaction documents. This document cannot be reproduced except in full, without prior written approval of the Company. Any unauthorized alteration, forgery or falsification of the content or appearance of this document is unlawful and offenders may be prosecuted to the fullest extent of the law.

SGS Taiwan Ltd.

No. 134, WuKungRoad, New Taipei Industrial Park, Wuku District, New Taipei City, Taiwan 24803/新北市五股區新北產業園區五工路 134 號

台灣檢驗科技股份有限公司

t (886-2) 2299-3279

f (886-2) 2298-0488

www.tw.sgs.com

Member of SGS Group

7 DUTY CYCLE TEST SIGNAL

Pre-analysis Check: While conducting average power measurement, duty cycle of each mode shall be checked to ensure its duty cycle in order to compensate for the loss due to insufficient ratio of duty cycle.

All duty cycle is pre-scanned, and result as obtained below shows only the most representative ones where duty cycle is conducted as the given transmission with given virtual operation that expresses the percentage.

Formula:

$$\text{Duty Cycle} = \text{Ton} / (\text{Ton} + \text{Toff})$$

Measurement Procedure:

1. Set span = Zero
2. RBW = 8MHz
3. VBW = 8MHz,
4. Detector = Peak

Duty Cycle:

Mode	Duty Cycle (%)	Duty Factor (dB) =10*log (1/Duty Cycle)
802.11a	86.93	0.61
802.11n_20	86.20	0.64

Duty Cycle Factor: $10 * \log(1/0.8693) = 0.61$

Duty Cycle Factor: $10 * \log(1/0.862) = 0.64$

Unless otherwise stated the results shown in this test report refer only to the sample(s) tested and such sample(s) are retained for 90 days only.

除非另有說明，此報告結果僅對測試之樣品負責，同時此樣品僅保留90天。本報告未經本公司書面許可，不可部份複製。

This document is issued by the Company subject to its General Conditions of Service printed overleaf, available on request or accessible at www.sgs.com/terms_and_conditions.htm and, for electronic format documents, subject to Terms and Conditions for Electronic Documents at www.sgs.com/terms_e-document.htm. Attention is drawn to the limitation of liability, indemnification and jurisdiction issues defined therein. Any holder of this document is advised that information contained hereon reflects the Company's findings at the time of its intervention only and within the limits of Client's instructions, if any. The Company's sole responsibility is to its Client and this document does not exonerate parties to a transaction from exercising all their rights and obligations under the transaction documents. This document cannot be reproduced except in full, without prior written approval of the Company. Any unauthorized alteration, forgery or falsification of the content or appearance of this document is unlawful and offenders may be prosecuted to the fullest extent of the law.

SGS Taiwan Ltd.

No.134,WuKungRoad,NewTaipeiIndustrialPark,WukuDistrict,NewTaipeiCity,Taiwan24803/新北市五股區新北產業園區五工路 134 號

台灣檢驗科技股份有限公司

t (886-2) 2299-3279

f (886-2) 2298-0488

www.tw.sgs.com

Member of SGS Group

DUTY CYCLE TEST SIGNAL Measurement Result 802.11a

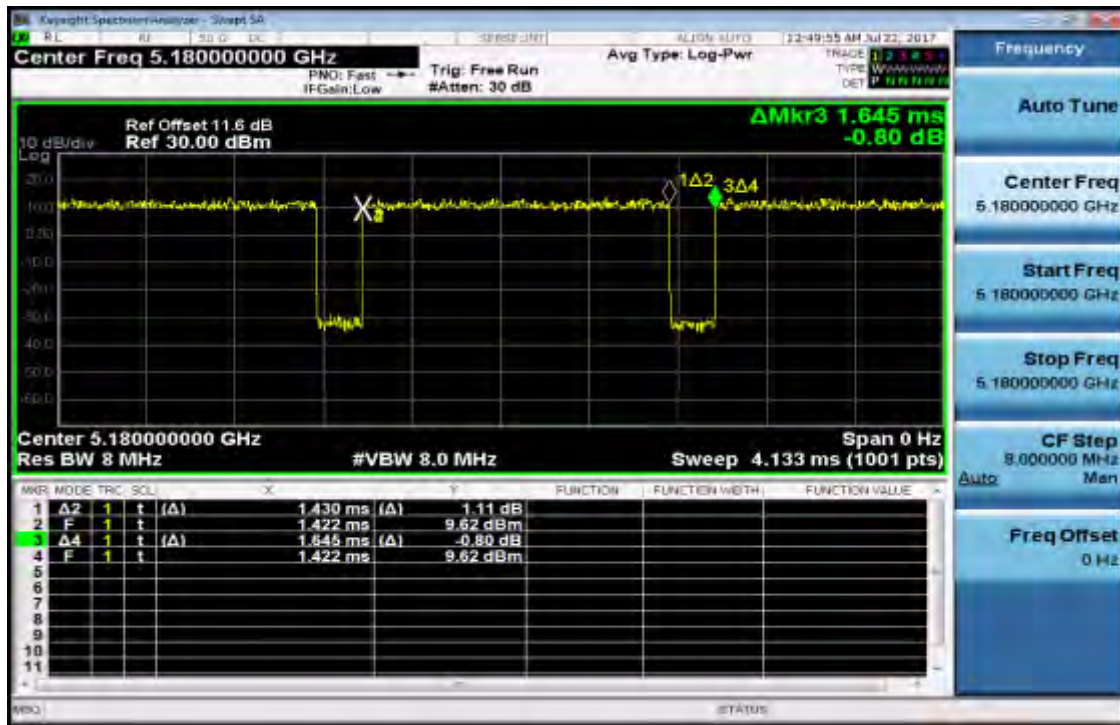

802.11n HT20



Unless otherwise stated the results shown in this test report refer only to the sample(s) tested and such sample(s) are retained for 90 days only.

除非另有說明，此報告結果僅對測試之樣品負責，同時此樣品僅保留90天。本報告未經本公司書面許可，不可部份複製。

This document is issued by the Company subject to its General Conditions of Service printed overleaf, available on request or accessible at www.sgs.com/terms_and_conditions.htm and, for electronic format documents, subject to Terms and Conditions for Electronic Documents at www.sgs.com/terms_e-document.htm. Attention is drawn to the limitation of liability, indemnification and jurisdiction issues defined therein. Any holder of this document is advised that information contained hereon reflects the Company's findings at the time of its intervention only and within the limits of Client's instructions, if any. The Company's sole responsibility is to its Client and this document does not exonerate parties to a transaction from exercising all their rights and obligations under the transaction documents. This document cannot be reproduced except in full, without prior written approval of the Company. Any unauthorized alteration, forgery or falsification of the content or appearance of this document is unlawful and offenders may be prosecuted to the fullest extent of the law.

8 26DB & 6DB EMISSION BANDWIDTH MEASUREMENT

8.1 Standard Applicable

There is no limit bandwidth for U-NII-1, U-NII-2-A and U-NII-2-C.

The minimum of 6dB Bandwidth measurement is 0.5 MHz for U-NII-3

8.2 Measurement Procedure

1. Place the EUT on the table and set it in transmitting mode.
2. The testing follows FCC KDB 789033 D02 General UNII Test Procedures New Rules.
3. Remove the antenna from the EUT and then connect a low loss RF cable from the Antenna port to the spectrum analyzer.
 - a. 26dB Band width Measurement: Set the spectrum analyzer as 1% of emission BW Sweep=auto, Detector = Peak, Trace Mode = Max Hold, Manually readjust RBW until the RBW/EBW ratio is 1% based on EBW as observed on the result of pre-sequence measurement.
 - b. Mark the peak frequency and -26dB (upper and lower) frequency.
4. Repeat the procedures as list above until all test default channels (low, middle, and high) are completed.
5. Minimum Emission Bandwidth for the band 5.725-5.850GHz.
 - a. Set the spectrum analyzer as RBW = 100 kHz, VBW = 3*RBW, Span = 30M/50MHz, Detector=Peak, Sweep=auto
 - b. Mark the peak frequency and -6dB (upper and lower) frequency.
6. Repeat above procedures until all test default channel measured were complete.

Unless otherwise stated the results shown in this test report refer only to the sample(s) tested and such sample(s) are retained for 90 days only.

除非另有說明，此報告結果僅對測試之樣品負責，同時此樣品僅保留90天。本報告未經本公司書面許可，不可部份複製。

This document is issued by the Company subject to its General Conditions of Service printed overleaf, available on request or accessible at www.sgs.com/terms_and_conditions.htm and, for electronic format documents, subject to Terms and Conditions for Electronic Documents at www.sgs.com/terms_e-document.htm. Attention is drawn to the limitation of liability, indemnification and jurisdiction issues defined therein. Any holder of this document is advised that information contained hereon reflects the Company's findings at the time of its intervention only and within the limits of Client's instructions, if any. The Company's sole responsibility is to its Client and this document does not exonerate parties to a transaction from exercising all their rights and obligations under the transaction documents. This document cannot be reproduced except in full, without prior written approval of the Company. Any unauthorized alteration, forgery or falsification of the content or appearance of this document is unlawful and offenders may be prosecuted to the fullest extent of the law.

SGS Taiwan Ltd.

台灣檢驗科技股份有限公司

No.134,WuKungRoad,NewTaipeiIndustrialPark,WukuDistrict,NewTaipeiCity,Taiwan24803/新北市五股區新北產業園區五工路 134 號

t (886-2) 2299-3279

f (886-2) 2298-0488

www.tw.sgs.com

Member of SGS Group

8.3 Measurement Equipment Used

Conducted Emission Test Site					
EQUIPMENT TYPE	MFR	MODEL NUMBER	SERIAL NUMBER	LAST CAL.	CAL DUE.
Spectrum Analyzer	KEYSIGHT	N9010A	MY51440113	06/20/2017	06/19/2018
DC Block	PASTERNAK	PE8210	RF29	12/12/2016	12/11/2017
Coaxial Cable 30cm	WOKEN	00100A1F1A1 95C	RF01	12/12/2016	12/11/2017
Attenuator	WOKEN	218FS-10	RF23	12/12/2016	12/11/2017
Splitter	RF-LAMBAD	RFLT2W1G18G	RF35	12/12/2016	12/11/2017

8.4 Test Set-up

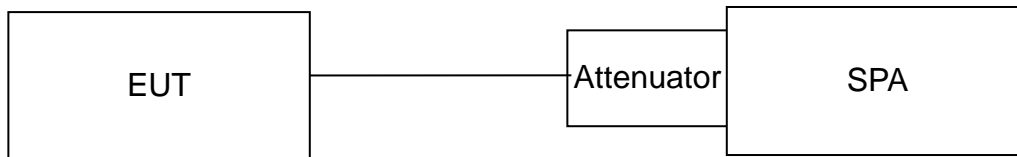

8.5 Measurement Result

26dB Bandwidth

802.11a_Main

802.11n_HT20_Main

Frequency (MHz)	26dB BW (MHz)	10 Log (B) (dB)	Frequency (MHz)	26dB BW (MHz)	10 Log (B) (dB)
5180	25.45	14.057	5180	26.29	14.198
5220	23.22	13.659	5220	25.84	14.123
5240	26.93	14.302	5240	26.87	14.293
5260	28.00	14.472	5260	26.32	14.203
5300	26.17	14.178	5300	29.21	14.655
5320	26.42	14.219	5320	25.84	14.123
5500	27.20	14.346	5500	29.58	14.710
5580	26.76	14.275	5580	29.24	14.660
5700	29.60	14.713	5700	26.09	14.165

Unless otherwise stated the results shown in this test report refer only to the sample(s) tested and such sample(s) are retained for 90 days only.

除非另有說明，此報告結果僅對測試之樣品負責，同時此樣品僅保留90天。本報告未經本公司書面許可，不可部份複製。

This document is issued by the Company subject to its General Conditions of Service printed overleaf, available on request or accessible at www.sgs.com/terms_and_conditions.htm and, for electronic format documents, subject to Terms and Conditions for Electronic Documents at www.sgs.com/terms_e-document.htm. Attention is drawn to the limitation of liability, indemnification and jurisdiction issues defined therein. Any holder of this document is advised that information contained hereon reflects the Company's findings at the time of its intervention only and within the limits of Client's instructions, if any. The Company's sole responsibility is to its Client and this document does not exonerate parties to a transaction from exercising all their rights and obligations under the transaction documents. This document cannot be reproduced except in full, without prior written approval of the Company. Any unauthorized alteration, forgery or falsification of the content or appearance of this document is unlawful and offenders may be prosecuted to the fullest extent of the law.

SGS Taiwan Ltd.

No.134,WuKungRoad,NewTaipeiIndustrialPark,WukuDistrict,NewTaipeiCity,Taiwan24803/新北市五股區新北產業園區五工路 134 號

台灣檢驗科技股份有限公司

t (886-2) 2299-3279

f (886-2) 2298-0488

www.tw.sgs.com

Member of SGS Group

802.11a_Main

802.11n_HT20_Main

Frequency (MHz)	6dB BW (MHz)	10 Log (B) (dB)	Frequency (MHz)	6dB BW (MHz)	10 Log (B) (dB)
5745	14.70	11.672	5745	14.47	11.605
5785	15.05	11.775	5785	15.11	11.791
5825	15.06	11.777	5825	15.03	11.771

99% Bandwidth

802.11a_Main

802.11n_HT20_Main

Frequency (MHz)	99% BW (MHz)	10 Log (B) (dB)	Frequency (MHz)	99% BW (MHz)	10 Log (B) (dB)
5180	16.502	12.175	5180	17.445	12.417
5220	16.358	12.137	5220	17.394	12.404
5240	16.393	12.147	5240	17.434	12.414
5260	16.381	12.143	5260	17.465	12.422
5300	16.353	12.136	5300	17.513	12.434
5320	16.386	12.145	5320	17.529	12.438
5500	16.517	12.179	5500	17.646	12.466
5580	16.359	12.138	5580	17.643	12.466
5700	16.492	12.173	5700	17.499	12.430

802.11a_Main

802.11n_HT20_Main

Frequency (MHz)	6dB BW (MHz)	10 Log (B) (dB)	Frequency (MHz)	6dB BW (MHz)	10 Log (B) (dB)
5745	15.24	11.830	5745	14.74	11.686
5785	14.77	11.693	5785	17.12	12.335
5825	15.23	11.826	5825	10.83	10.348

Unless otherwise stated the results shown in this test report refer only to the sample(s) tested and such sample(s) are retained for 90 days only.

除非另有說明，此報告結果僅對測試之樣品負責，同時此樣品僅保留90天。本報告未經本公司書面許可，不可部份複製。

This document is issued by the Company subject to its General Conditions of Service printed overleaf, available on request or accessible at www.sgs.com/terms_and_conditions.htm and, for electronic format documents, subject to Terms and Conditions for Electronic Documents at www.sgs.com/terms_e-document.htm. Attention is drawn to the limitation of liability, indemnification and jurisdiction issues defined therein. Any holder of this document is advised that information contained hereon reflects the Company's findings at the time of its intervention only and within the limits of Client's instructions, if any. The Company's sole responsibility is to its Client and this document does not exonerate parties to a transaction from exercising all their rights and obligations under the transaction documents. This document cannot be reproduced except in full, without prior written approval of the Company. Any unauthorized alteration, forgery or falsification of the content or appearance of this document is unlawful and offenders may be prosecuted to the fullest extent of the law.

SGS Taiwan Ltd.

No.134,WuKungRoad,NewTaipeiIndustrialPark,WukuDistrict,NewTaipeiCity,Taiwan24803/新北市五股區新北產業園區五工路 134 號

台灣檢驗科技股份有限公司

t (886-2) 2299-3279

f (886-2) 2298-0488

www.tw.sgs.com

Member of SGS Group

802.11a, 5150~5250 MHz (Main)
26dB Band Width Test Data CH-Low (5180MHz)

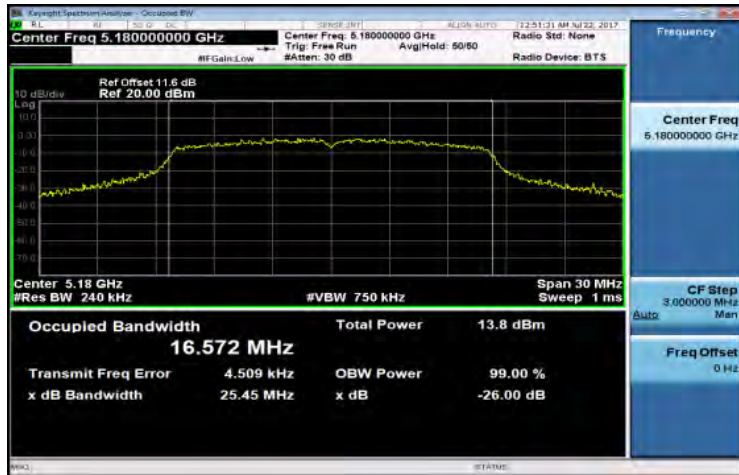

802.11a, 5250~5350 MHz (Main)
26dB Band Width Test Data CH-Low (5260MHz)

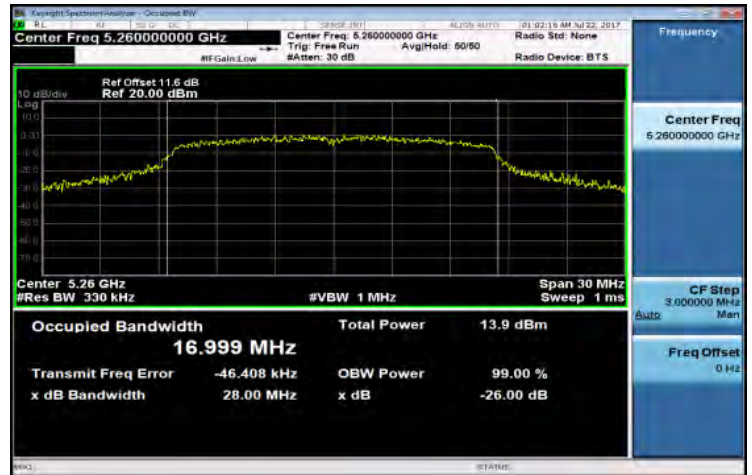

26dB Band Width Test Data CH-Mid (5220MHz)

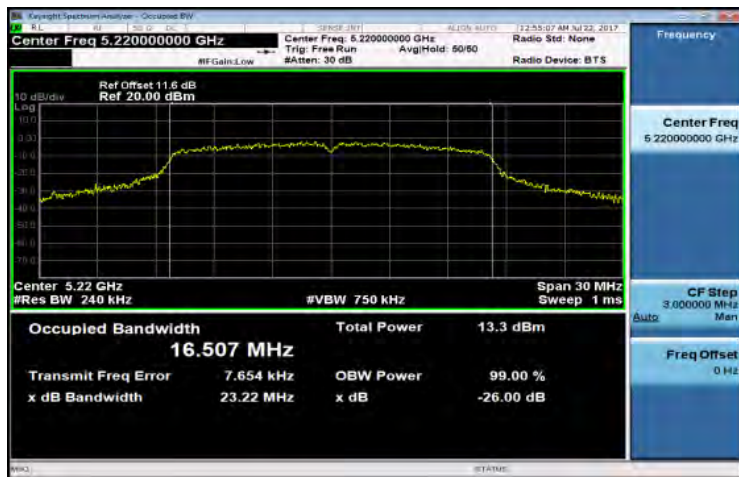

26dB Band Width Test Data CH-Mid (5300MHz)

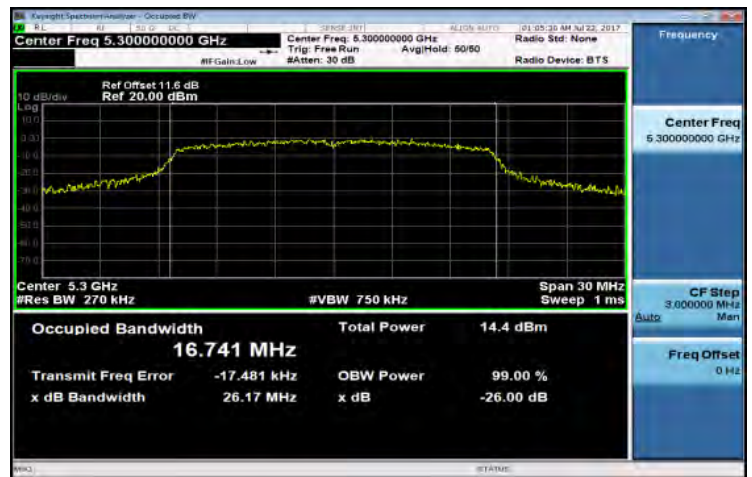

26dB Band Width Test Data CH-High (5240MHz)

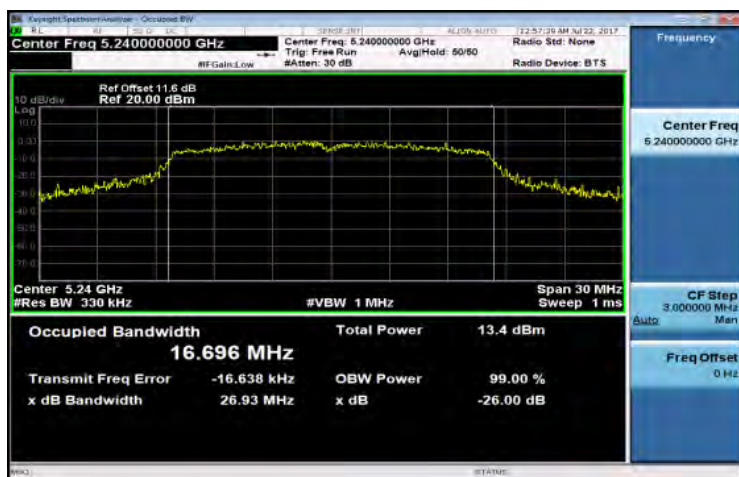

26dB Band Width Test Data CH-High (5320MHz)

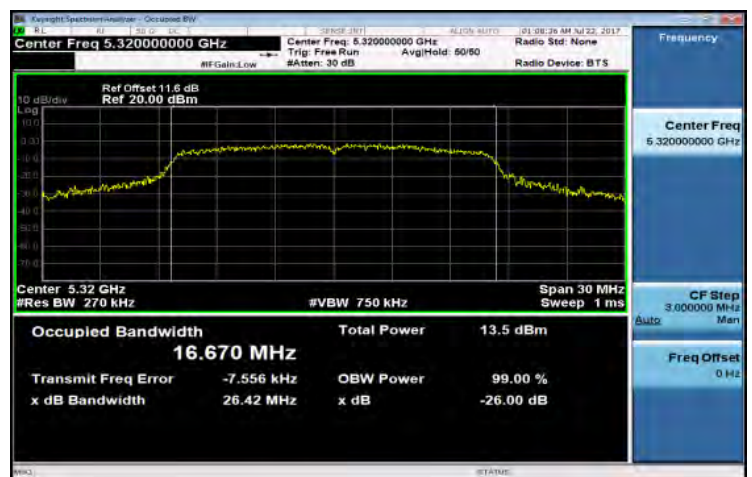

Unless otherwise stated the results shown in this test report refer only to the sample(s) tested and such sample(s) are retained for 90 days only.
除非另有說明，此報告結果僅對測試之樣品負責，同時此樣品僅保留90天。本報告未經本公司書面許可，不可部份複製。

This document is issued by the Company subject to its General Conditions of Service printed overleaf, available on request or accessible at www.sgs.com/terms_and_conditions.htm and, for electronic format documents, subject to Terms and Conditions for Electronic Documents at www.sgs.com/terms_e-document.htm. Attention is drawn to the limitation of liability, indemnification and jurisdiction issues defined therein. Any holder of this document is advised that information contained hereon reflects the Company's findings at the time of its intervention only and within the limits of Client's instructions, if any. The Company's sole responsibility is to its Client and this document does not exonerate parties to a transaction from exercising all their rights and obligations under the transaction documents. This document cannot be reproduced except in full, without prior written approval of the Company. Any unauthorized alteration, forgery or falsification of the content or appearance of this document is unlawful and offenders may be prosecuted to the fullest extent of the law.

802.11a, 5470~5725 MHz (Main)
26dB Band Width Test Data CH-Low (5500MHz)

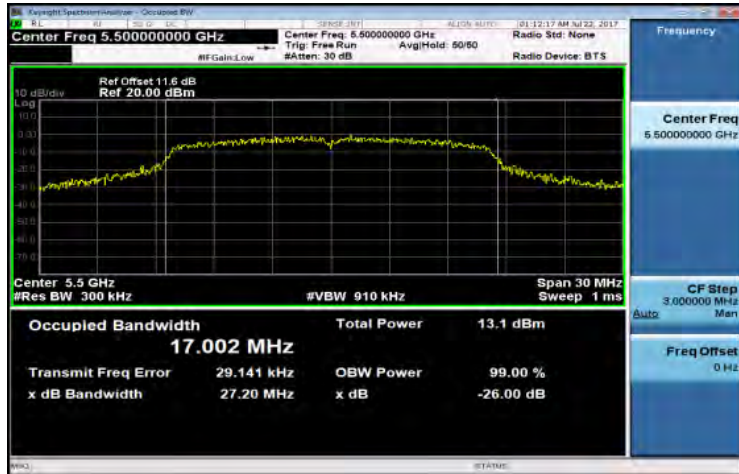

802.11n HT20, 5150~5250 MHz (Main)
26dB Band Width Test Data CH-Low (5180 MHz)

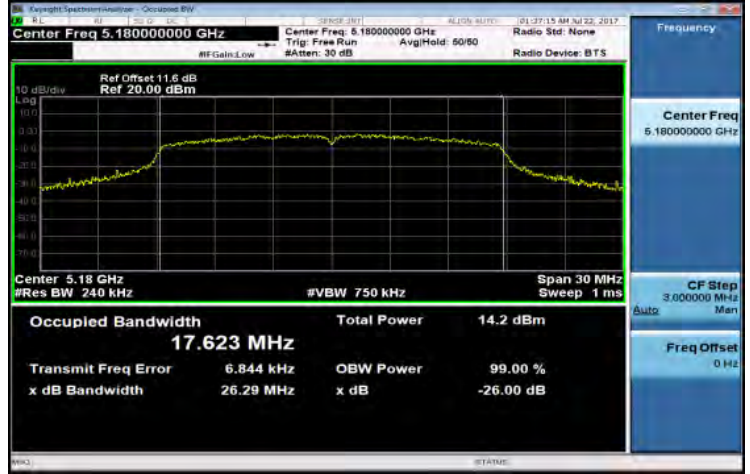

26dB Band Width Test Data CH-Mid (5580MHz)

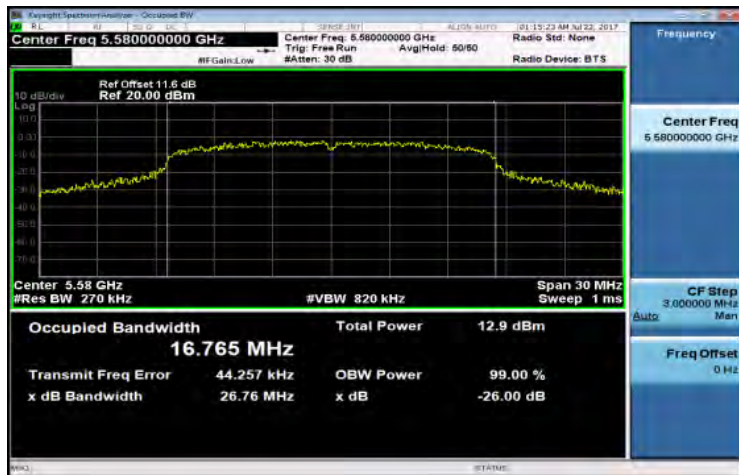

26dB Band Width Test Data CH-Mid (5220 MHz)

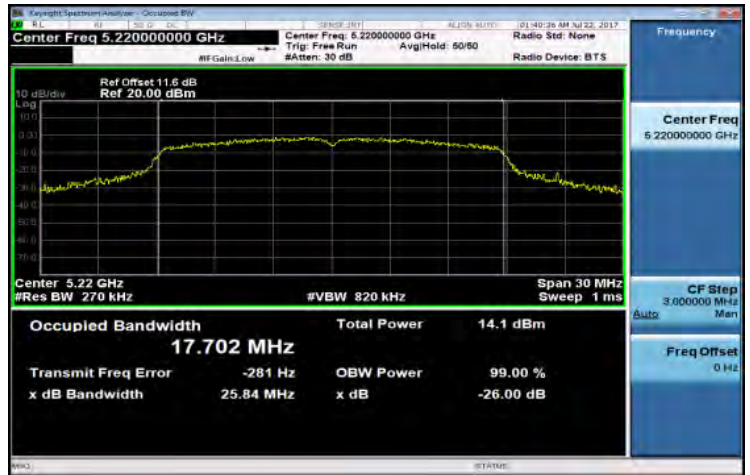

26dB Band Width Test Data CH-High (5700MHz)

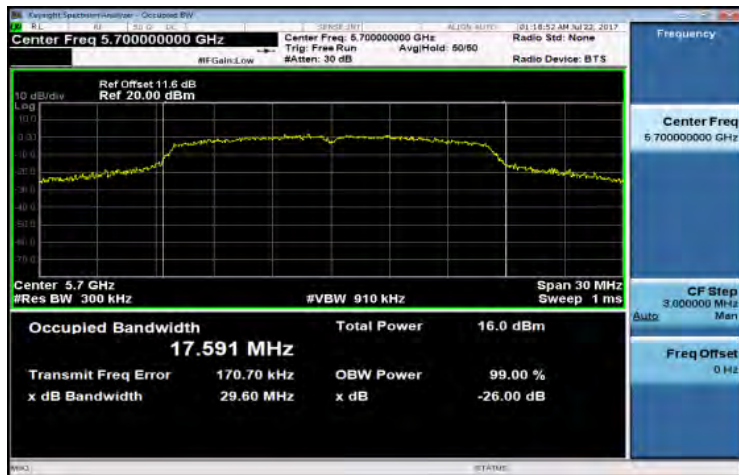

26dB Band Width Test Data CH-High (5240 MHz)

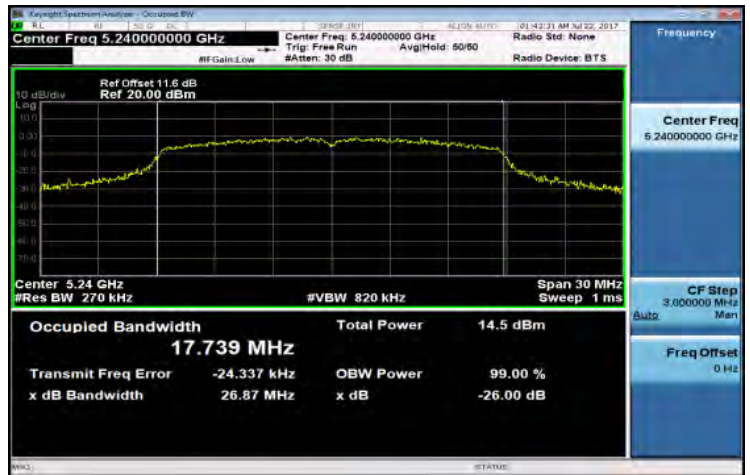

Unless otherwise stated the results shown in this test report refer only to the sample(s) tested and such sample(s) are retained for 90 days only.
除非另有說明，此報告結果僅對測試之樣品負責，同時此樣品僅保留90天。本報告未經本公司書面許可，不可部份複製。

This document is issued by the Company subject to its General Conditions of Service printed overleaf, available on request or accessible at www.sgs.com/terms_and_conditions.htm and, for electronic format documents, subject to Terms and Conditions for Electronic Documents at www.sgs.com/terms_e-document.htm. Attention is drawn to the limitation of liability, indemnification and jurisdiction issues defined therein. Any holder of this document is advised that information contained hereon reflects the Company's findings at the time of its intervention only and within the limits of Client's instructions, if any. The Company's sole responsibility is to its Client and this document does not exonerate parties to a transaction from exercising all their rights and obligations under the transaction documents. This document cannot be reproduced except in full, without prior written approval of the Company. Any unauthorized alteration, forgery or falsification of the content or appearance of this document is unlawful and offenders may be prosecuted to the fullest extent of the law.

802.11n HT20, 5250~5350 MHz (Main)
26dB Band Width Test Data CH-Low (5260 MHz)

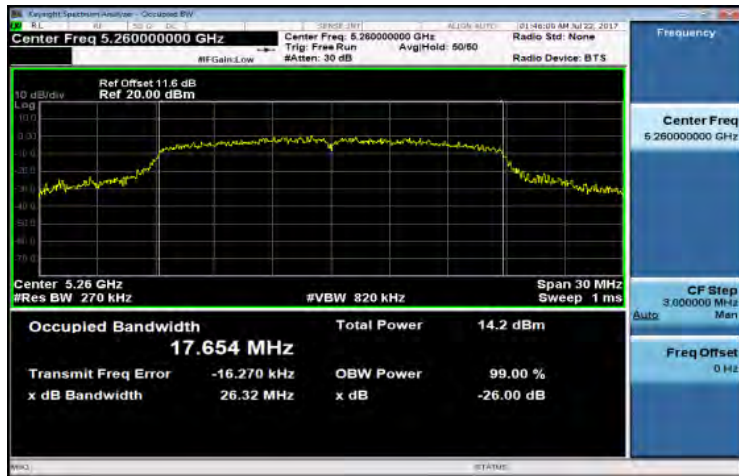

802.11n HT20, 5470~5725 MHz (Main)
26dB Band Width Test Data CH-Low (5500 MHz)

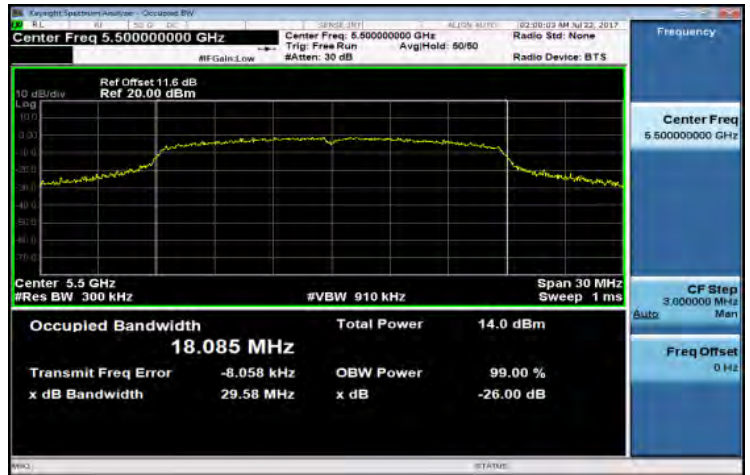

26dB Band Width Test Data CH-Mid (5300 MHz)

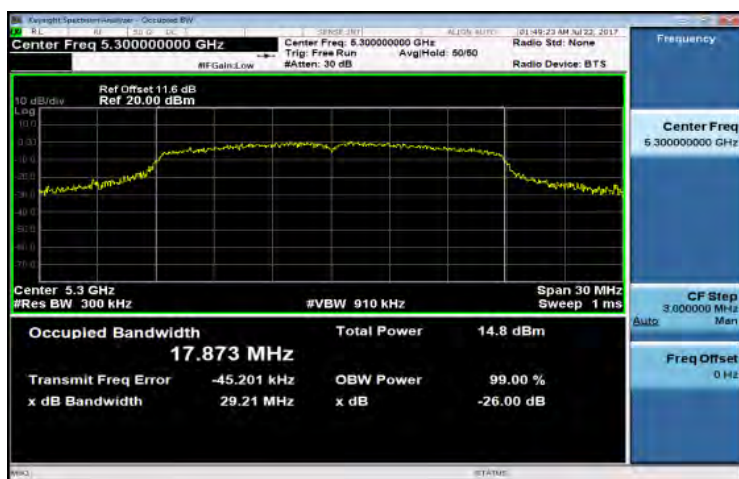

26dB Band Width Test Data CH-Mid (5580 MHz)

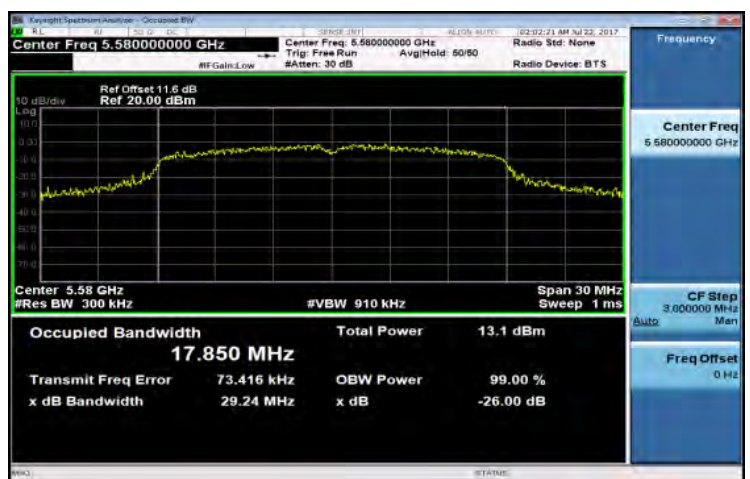

26dB Band Width Test Data CH-High (5320 MHz)

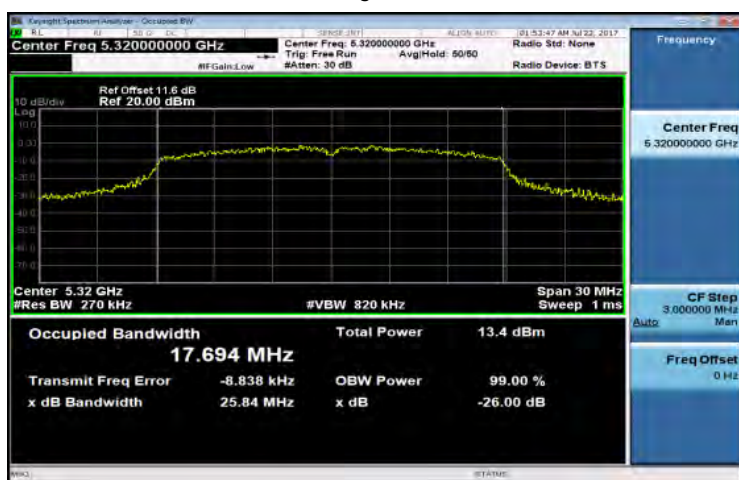

26dB Band Width Test Data CH-High (5700 MHz)

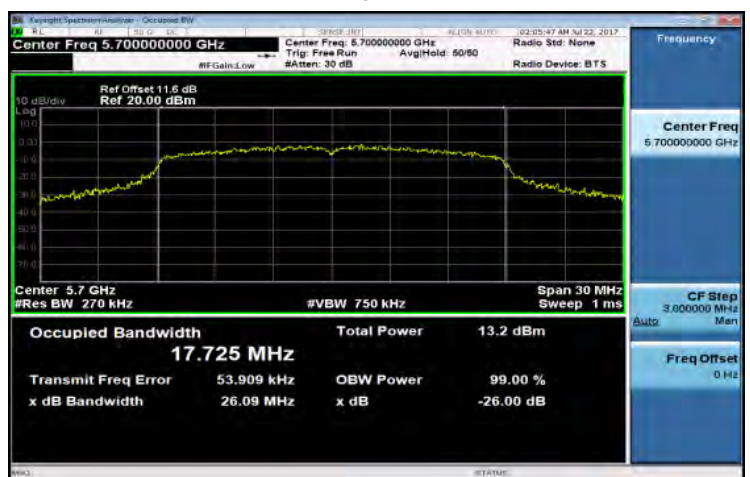

Unless otherwise stated the results shown in this test report refer only to the sample(s) tested and such sample(s) are retained for 90 days only.

除非另有說明，此報告結果僅對測試之樣品負責，同時此樣品僅保留90天。本報告未經本公司書面許可，不可部份複製。

This document is issued by the Company subject to its General Conditions of Service printed overleaf, available on request or accessible at www.sgs.com/terms_and_conditions.htm and, for electronic format documents, subject to Terms and Conditions for Electronic Documents at www.sgs.com/terms_e-document.htm. Attention is drawn to the limitation of liability, indemnification and jurisdiction issues defined therein. Any holder of this document is advised that information contained hereon reflects the Company's findings at the time of its intervention only and within the limits of Client's instructions, if any. The Company's sole responsibility is to its Client and this document does not exonerate parties to a transaction from exercising all their rights and obligations under the transaction documents. This document cannot be reproduced except in full, without prior written approval of the Company. Any unauthorized alteration, forgery or falsification of the content or appearance of this document is unlawful and offenders may be prosecuted to the fullest extent of the law.

802.11a, 5150~5250 MHz (Main)
99% Band Width Test Data CH-Low (5180MHz)

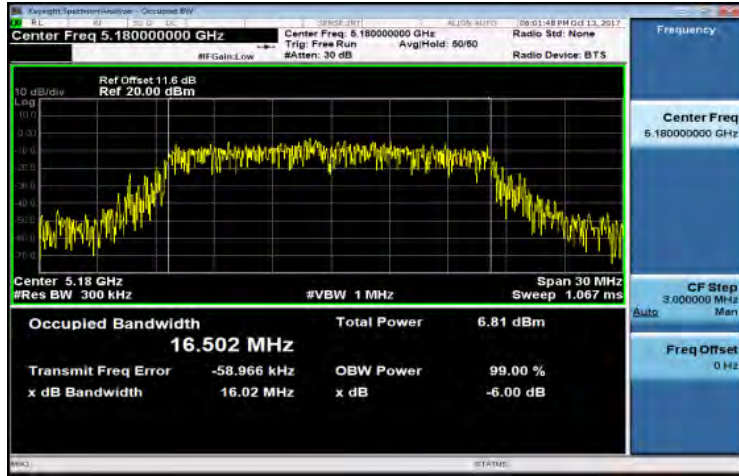

802.11a, 5250~5350 MHz (Main)
99% Band Width Test Data CH-Low (5260MHz)

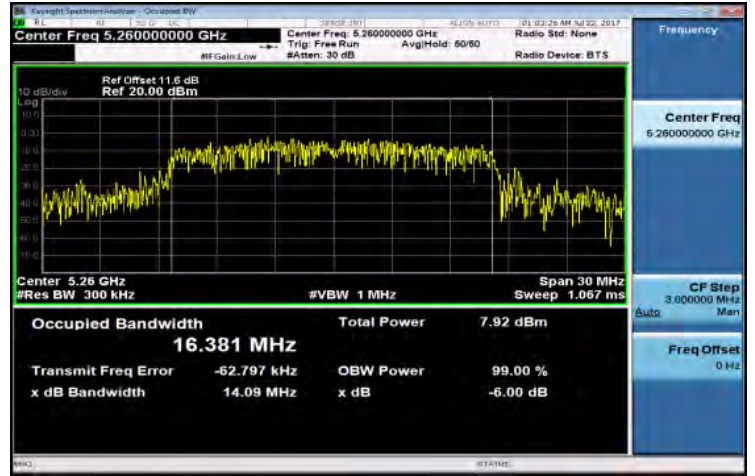

99% Band Width Test Data CH-Mid (5220MHz)

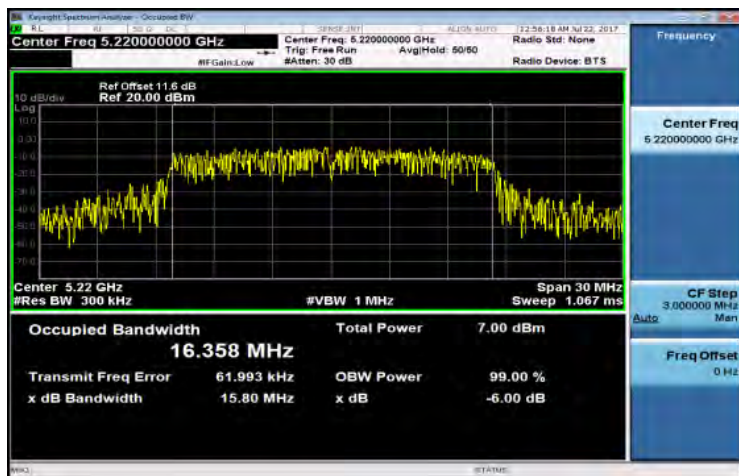

99% Band Width Test Data CH-Mid (5300MHz)

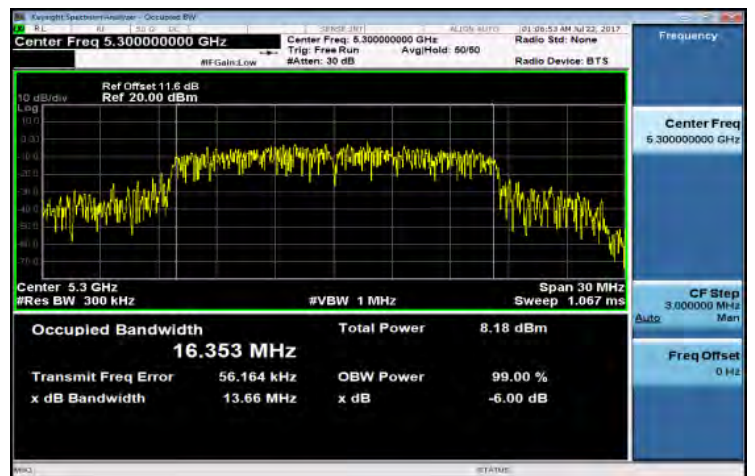

99% Band Width Test Data CH-High (5240MHz)

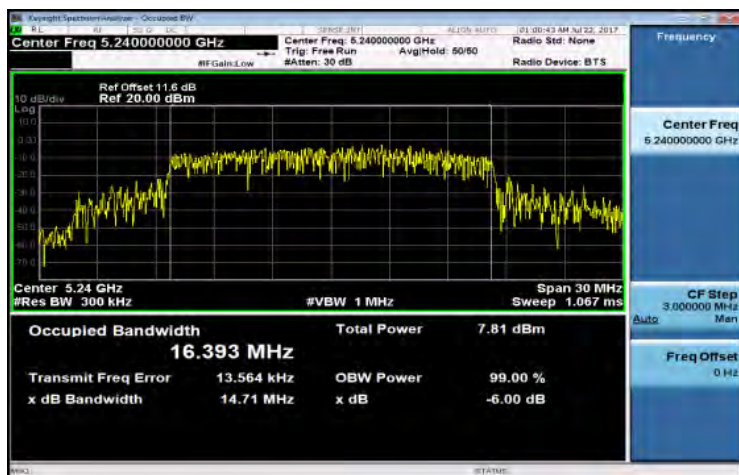

99% Band Width Test Data CH-High (5320MHz)

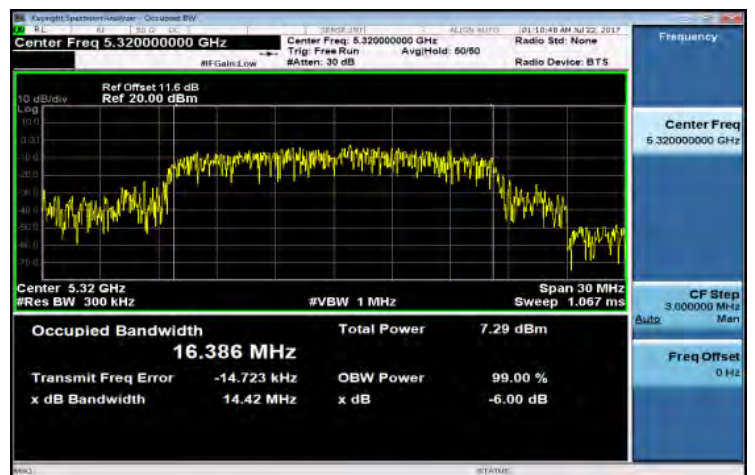

Unless otherwise stated the results shown in this test report refer only to the sample(s) tested and such sample(s) are retained for 90 days only.
除非另有說明，此報告結果僅對測試之樣品負責，同時此樣品僅保留90天。本報告未經本公司書面許可，不可部份複製。

This document is issued by the Company subject to its General Conditions of Service printed overleaf, available on request or accessible at www.sgs.com/terms_and_conditions.htm and, for electronic format documents, subject to Terms and Conditions for Electronic Documents at www.sgs.com/terms_e-document.htm. Attention is drawn to the limitation of liability, indemnification and jurisdiction issues defined therein. Any holder of this document is advised that information contained hereon reflects the Company's findings at the time of its intervention only and within the limits of Client's instructions, if any. The Company's sole responsibility is to its Client and this document does not exonerate parties to a transaction from exercising all their rights and obligations under the transaction documents. This document cannot be reproduced except in full, without prior written approval of the Company. Any unauthorized alteration, forgery or falsification of the content or appearance of this document is unlawful and offenders may be prosecuted to the fullest extent of the law.

802.11a, 5470~5725 MHz (Main)
99% Band Width Test Data CH-Low (5500MHz)

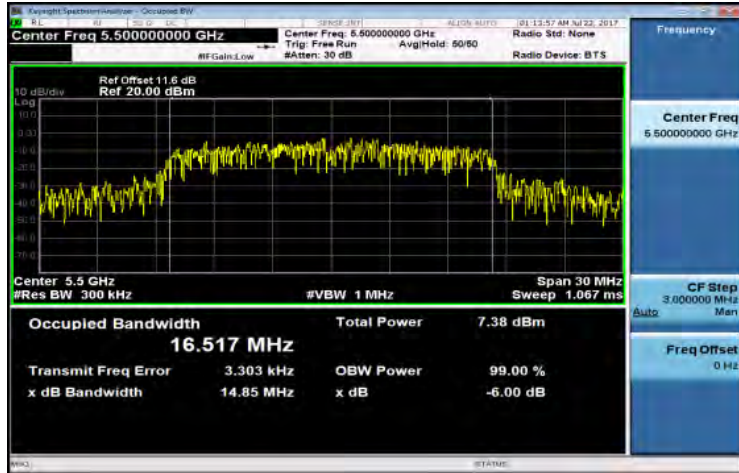

802.11n HT20, 5150~5250 MHz (Main)
99% Band Width Test Data CH-Low (5180 MHz)

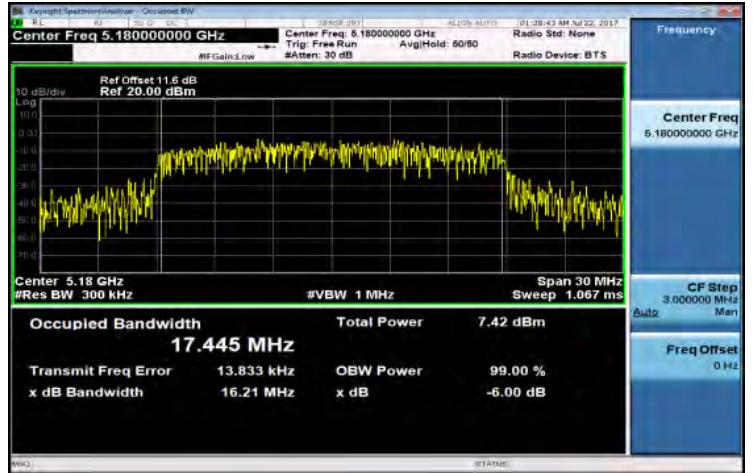

99% Band Width Test Data CH-Mid (5580MHz)

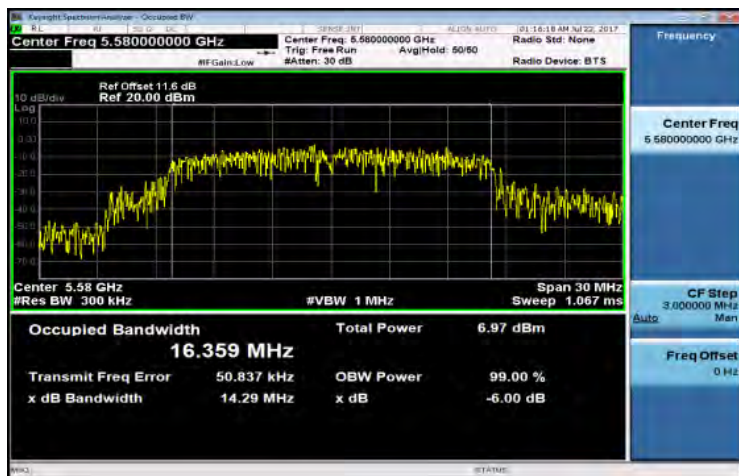

99% Band Width Test Data CH-Mid (5220 MHz)

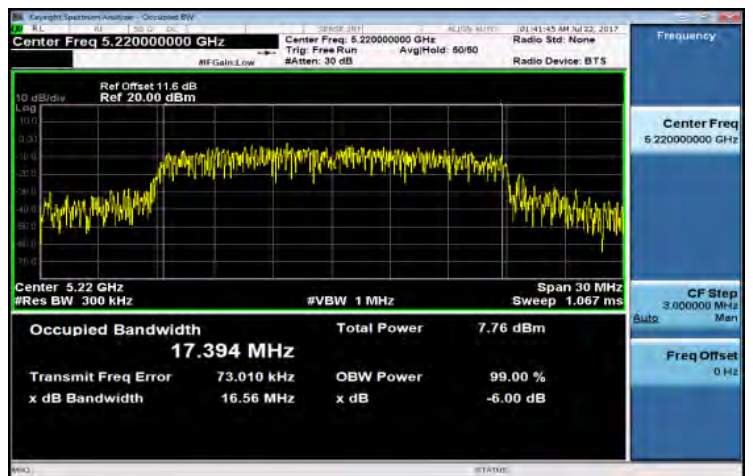

99% Band Width Test Data CH-High (5700MHz)

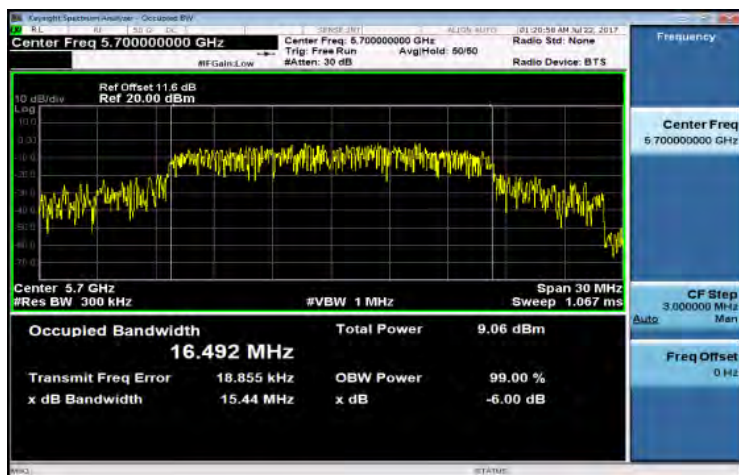

99% Band Width Test Data CH-High (5240 MHz)

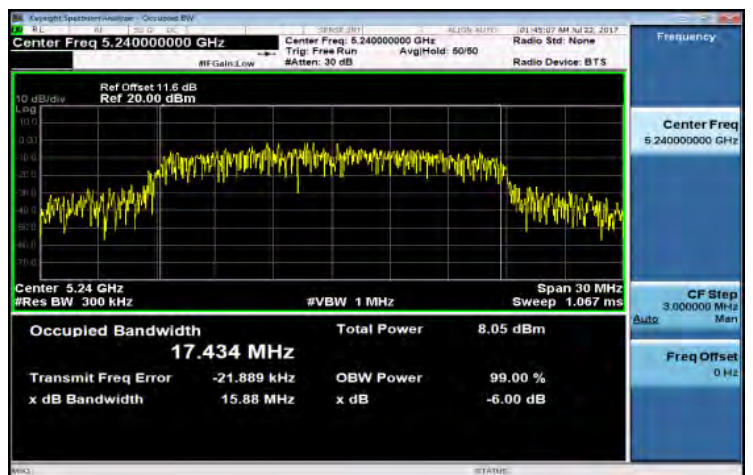

Unless otherwise stated the results shown in this test report refer only to the sample(s) tested and such sample(s) are retained for 90 days only.

除非另有說明，此報告結果僅對測試之樣品負責，同時此樣品僅保留90天。本報告未經本公司書面許可，不可部份複製。

This document is issued by the Company subject to its General Conditions of Service printed overleaf, available on request or accessible at www.sgs.com/terms_and_conditions.htm and, for electronic format documents, subject to Terms and Conditions for Electronic Documents at www.sgs.com/terms_e-document.htm. Attention is drawn to the limitation of liability, indemnification and jurisdiction issues defined therein. Any holder of this document is advised that information contained hereon reflects the Company's findings at the time of its intervention only and within the limits of Client's instructions, if any. The Company's sole responsibility is to its Client and this document does not exonerate parties to a transaction from exercising all their rights and obligations under the transaction documents. This document cannot be reproduced except in full, without prior written approval of the Company. Any unauthorized alteration, forgery or falsification of the content or appearance of this document is unlawful and offenders may be prosecuted to the fullest extent of the law.

802.11n HT20, 5250~5350 MHz (Main)
99% Band Width Test Data CH-Low (5260 MHz)

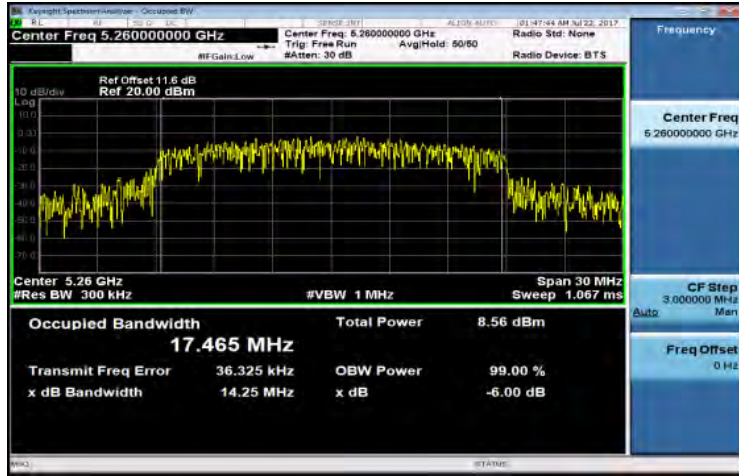

802.11n HT20, 5470~5725 MHz (Main)
99% Band Width Test Data CH-Low (5500 MHz)

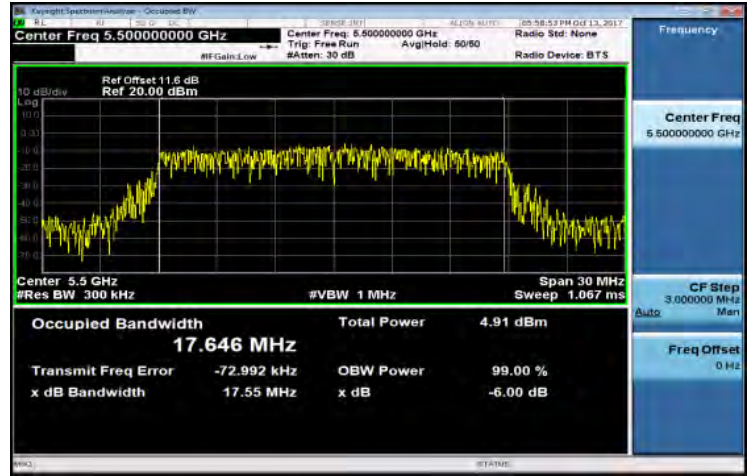

99% Band Width Test Data CH-Mid (5300 MHz)

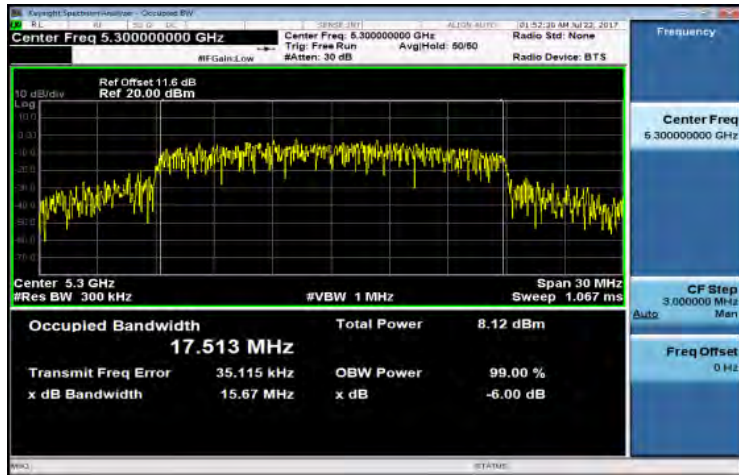

99% Band Width Test Data CH-Mid (5580 MHz)

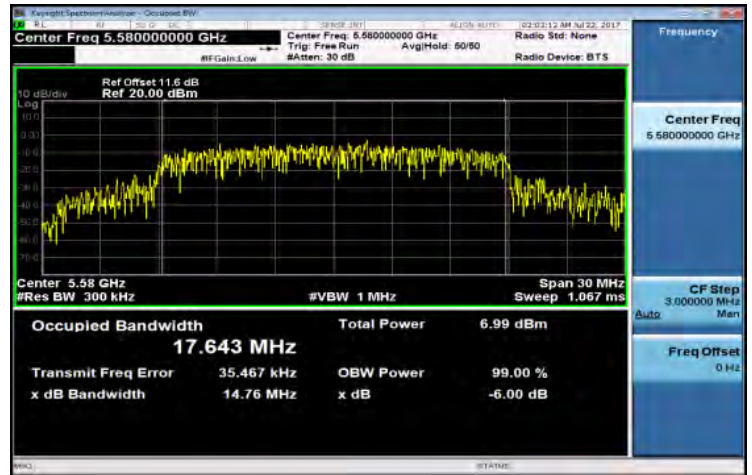

99% Band Width Test Data CH-High (5320 MHz)

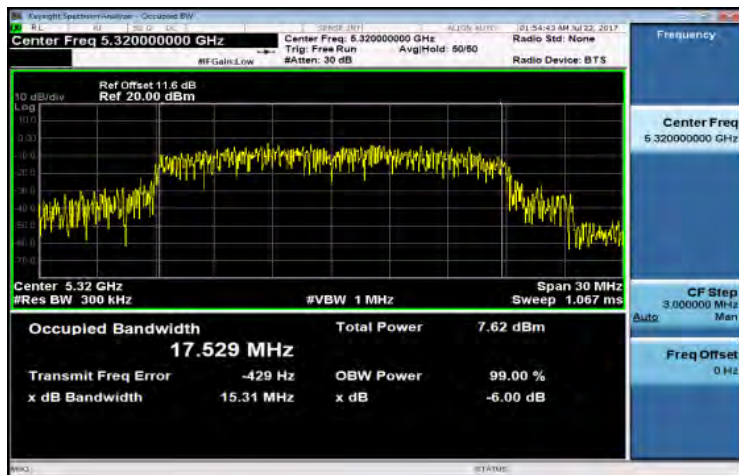

99% Band Width Test Data CH-High (5700 MHz)

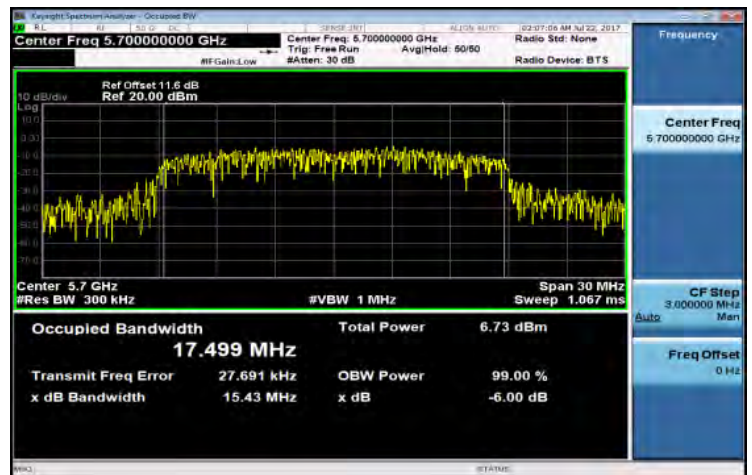

Unless otherwise stated the results shown in this test report refer only to the sample(s) tested and such sample(s) are retained for 90 days only.

除非另有說明，此報告結果僅對測試之樣品負責，同時此樣品僅保留90天。本報告未經本公司書面許可，不可部份複製。

This document is issued by the Company subject to its General Conditions of Service printed overleaf, available on request or accessible at www.sgs.com/terms_and_conditions.htm and, for electronic format documents, subject to Terms and Conditions for Electronic Documents at www.sgs.com/terms_e-document.htm. Attention is drawn to the limitation of liability, indemnification and jurisdiction issues defined therein. Any holder of this document is advised that information contained hereon reflects the Company's findings at the time of its intervention only and within the limits of Client's instructions, if any. The Company's sole responsibility is to its Client and this document does not exonerate parties to a transaction from exercising all their rights and obligations under the transaction documents. This document cannot be reproduced except in full, without prior written approval of the Company. Any unauthorized alteration, forgery or falsification of the content or appearance of this document is unlawful and offenders may be prosecuted to the fullest extent of the law.

6dB Band Width measure with Peak detector for FCC
802.11a, 5725~5850 MHz (Main)
6dB Band Width Test Data CH-Low (5745 MHz)

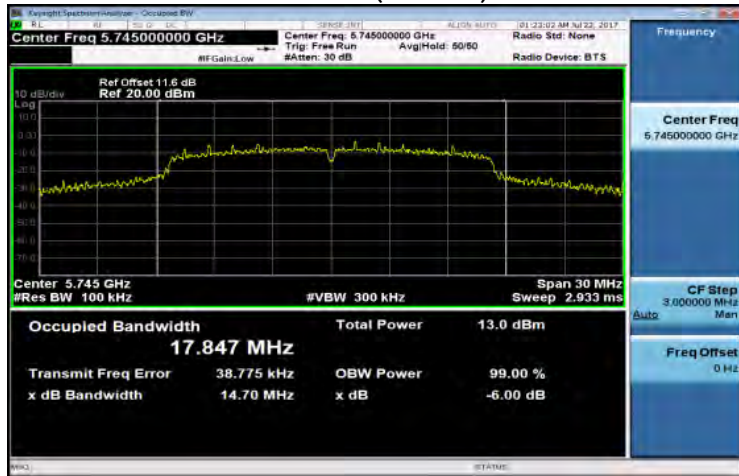

802.11n_HT20, 5725~5850 MHz (Main)
6dB Band Width Test Data CH-Low (5745 MHz)

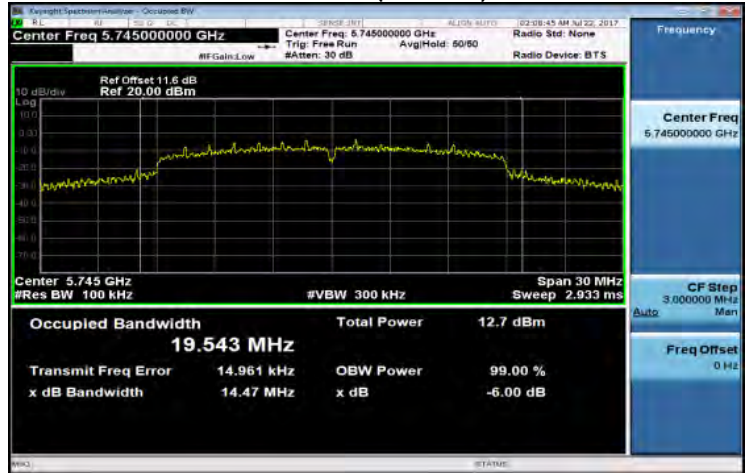

6dB Band Width Test Data CH-Mid (5785 MHz)

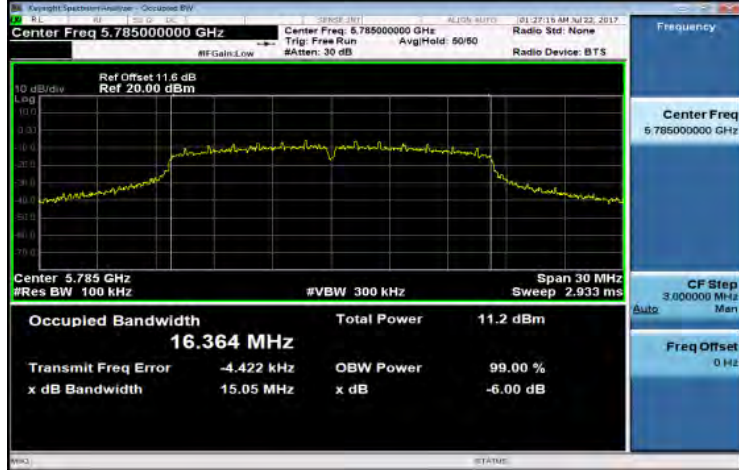

6dB Band Width Test Data CH-Mid (5785 MHz)

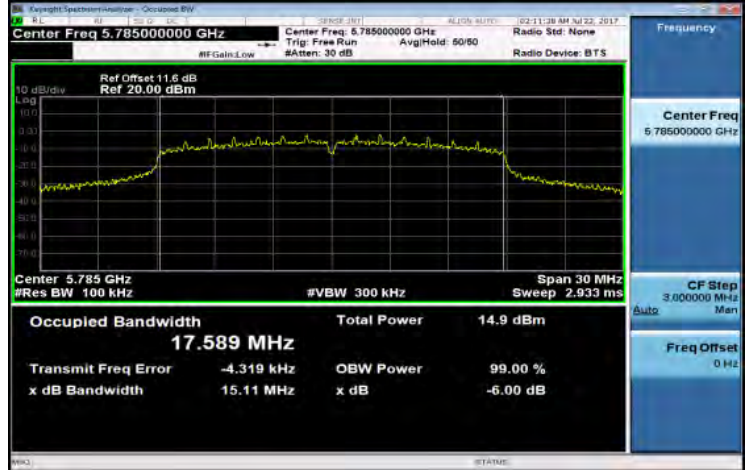

6dB Band Width Test Data CH-High (5825 MHz)

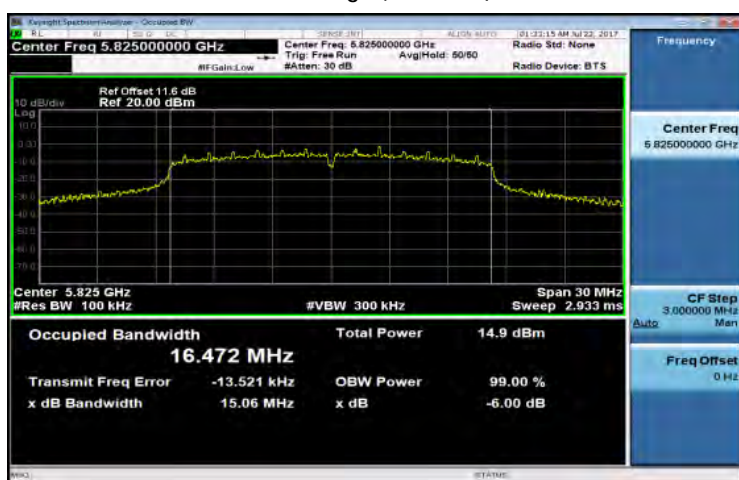

6dB Band Width Test Data CH-High (5825 MHz)



Unless otherwise stated the results shown in this test report refer only to the sample(s) tested and such sample(s) are retained for 90 days only.
除非另有說明，此報告結果僅對測試之樣品負責，同時此樣品僅保留90天。本報告未經本公司書面許可，不可部份複製。

This document is issued by the Company subject to its General Conditions of Service printed overleaf, available on request or accessible at www.sgs.com/terms_and_conditions.htm and, for electronic format documents, subject to Terms and Conditions for Electronic Documents at www.sgs.com/terms_e-document.htm. Attention is drawn to the limitation of liability, indemnification and jurisdiction issues defined therein. Any holder of this document is advised that information contained hereon reflects the Company's findings at the time of its intervention only and within the limits of Client's instructions, if any. The Company's sole responsibility is to its Client and this document does not exonerate parties to a transaction from exercising all their rights and obligations under the transaction documents. This document cannot be reproduced except in full, without prior written approval of the Company. Any unauthorized alteration, forgery or falsification of the content or appearance of this document is unlawful and offenders may be prosecuted to the fullest extent of the law.

6dB Band Width measure with Average detector for IC
802.11a, 5725~5850 MHz (Main)
6dB Band Width Test Data CH-Low (5745 MHz)

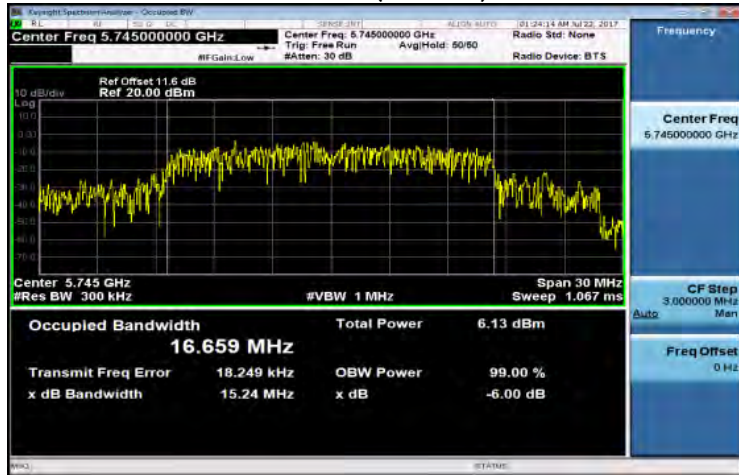

802.11n_HT20, 5725~5850 MHz (Main)
6dB Band Width Test Data CH-Low (5745 MHz)

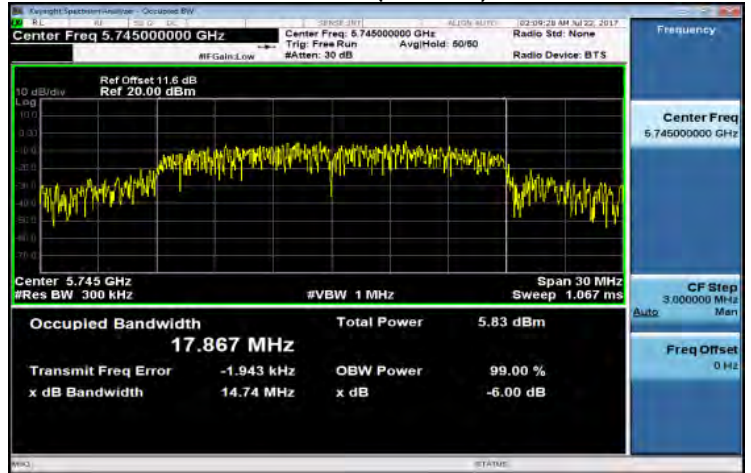

6dB Band Width Test Data CH-Mid (5785 MHz)

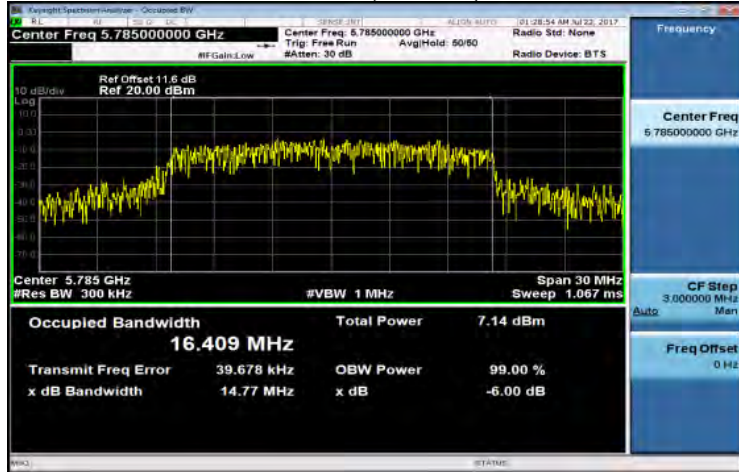

6dB Band Width Test Data CH-Mid (5785 MHz)

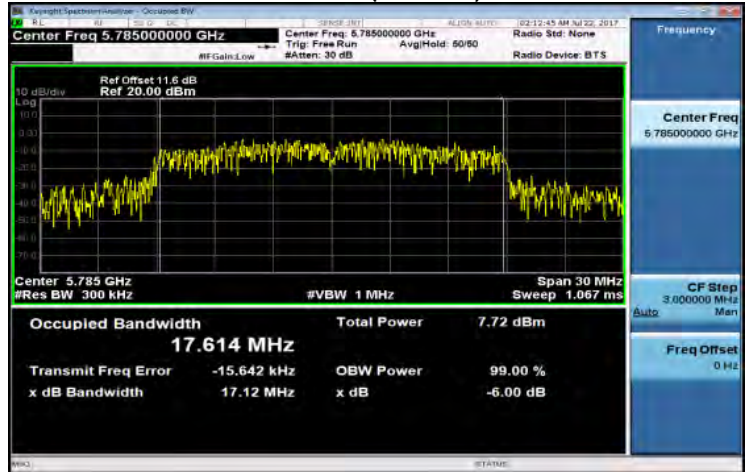

6dB Band Width Test Data CH-High (5825 MHz)

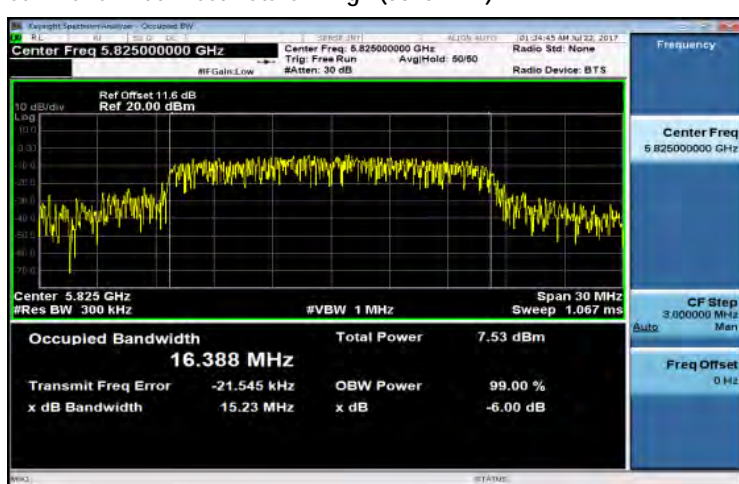

6dB Band Width Test Data CH-High (5825 MHz)

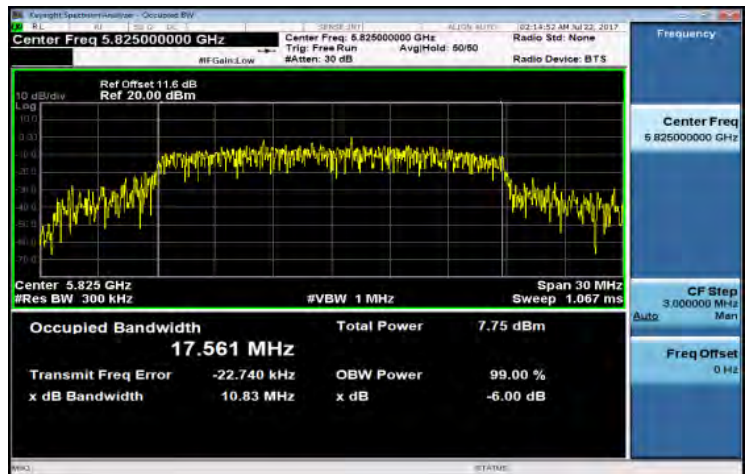

Unless otherwise stated the results shown in this test report refer only to the sample(s) tested and such sample(s) are retained for 90 days only.
除非另有說明，此報告結果僅對測試之樣品負責，同時此樣品僅保留90天。本報告未經本公司書面許可，不可部份複製。

This document is issued by the Company subject to its General Conditions of Service printed hereon, available on request or accessible at www.sgs.com/terms_and_conditions.htm and, for electronic format documents, subject to Terms and Conditions for Electronic Documents at www.sgs.com/terms_e-document.htm. Attention is drawn to the limitation of liability, indemnification and jurisdiction issues defined therein. Any holder of this document is advised that information contained hereon reflects the Company's findings at the time of its intervention only and within the limits of Client's instructions, if any. The Company's sole responsibility is to its Client and this document does not exonerate parties to a transaction from exercising all their rights and obligations under the transaction documents. This document cannot be reproduced except in full, without prior written approval of the Company. Any unauthorized alteration, forgery or falsification of the content or appearance of this document is unlawful and offenders may be prosecuted to the fullest extent of the law.

9 MAXIMUM CONDUCTED OUTPUT POWER MEASUREMENT

9.1 Standard Applicable

FCC

OPERZTION Band	EUT CATEGORY	LIMIT
U-NII-1	Access Point (Mater device)	1 Watt(30dBm)
	Fixed point-to-point Acess Ponit	1 Watt(30dBm)
	√ Mobile and portable clinet device	250mW(23.98dBm)
U-NII-2A	√	250mW(23.98dBm) or 11dBm+10 log B
U-NII-2C	√	250mW(23.98dBm) or 11dBm+10 log B
U-NII-3	√	1 Watt(30dBm)

IC

OPERZTION FREQUENCY BAND	LIMIT
5150~5250 MHz	EIRP shall not exceed 30mW or $1.76 + 10 \log_{10}B$, dBm
5250~5350 MHz	EIRP shall not exceed 30mW or $1.76 + 10 \log_{10}B$, dBm
5470-5600 MHz and 5650-5725 MHz	Conducted output power shall not exceed 250 mW or $11 + 10 \log_{10} B$ EIRP shall not exceed 1.0 W or $17 + 10 \log_{10}B$, dBm
5725~5850 MHz	Conducted output power shall not exceed 1 W

If transmitting antennas of directional gain greater than 6 dBi are used, both the peak transmit power and the peak power spectral density shall be reduced by the amount in dB that the directional gain of the antenna exceeds 6 dBi.

9.2 Measurement Procedure

1. Place the EUT on the table and set it in transmitting mode.
2. The testing follows FCC KDB 789033 D02 General UNII Test Procedures New Rules .
3. Remove the antenna from the EUT and then connect a low loss RF cable from the antenna port to the power meter
4. Power Meter is used as the auxiliary test equipment to conduct the output power measurement.
5. Record the max. reading and add $10 \log(1/\text{duty cycle})$.
6. Repeat above procedures until all frequency (low, middle, and high channel) measured were complete.

Unless otherwise stated the results shown in this test report refer only to the sample(s) tested and such sample(s) are retained for 90 days only.

除非另有說明，此報告結果僅對測試之樣品負責，同時此樣品僅保留90天。本報告未經本公司書面許可，不可部份複製。

This document is issued by the Company subject to its General Conditions of Service printed overleaf, available on request or accessible at www.sgs.com/terms_and_conditions.htm and, for electronic format documents, subject to Terms and Conditions for Electronic Documents at www.sgs.com/terms_e-document.htm. Attention is drawn to the limitation of liability, indemnification and jurisdiction issues defined therein. Any holder of this document is advised that information contained hereon reflects the Company's findings at the time of its intervention only and within the limits of Client's instructions, if any. The Company's sole responsibility is to its Client and this document does not exonerate parties to a transaction from exercising all their rights and obligations under the transaction documents. This document cannot be reproduced except in full, without prior written approval of the Company. Any unauthorized alteration, forgery or falsification of the content or appearance of this document is unlawful and offenders may be prosecuted to the fullest extent of the law.

9.3 Measurement Equipment Used

Refer to section 8.3 for details.

Conducted Emission Test Site					
EQUIPMENT TYPE	MFR	MODEL NUMBER	SERIAL NUMBER	LAST CAL.	CAL DUE.
Power Meter	Anritsu	ML2496A	1326001	06/23/2017	06/22/2018
Power Sensor	Anritsu	MA2411B	1315048	06/23/2017	06/22/2018
Power Sensor	Anritsu	MA2411B	1315049	06/23/2017	06/22/2018
Coaxial Cable 30cm	WOKEN	00100A1F1A 195C	RF01	12/12/2016	12/11/2017
DC Block	PASTERNAK	PE8210	RF29	12/12/2016	12/11/2017
Attenuator	WOKEN	218FS-10	RF23	12/12/2016	12/11/2017

9.4 Test Set-up

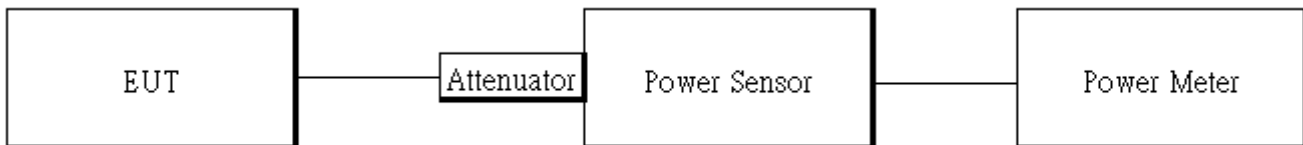

9.5 Measurement Result

FCC

802.11a_Main

CH	Frequency (MHz)	Data Rate	TOTAL POWER (dBm)	REQUIRED LIMIT (dBm)	RESULT
36	5180	6	10.68	23.98	PASS
44	5220	6	10.65	23.98	PASS
48	5240	6	10.56	23.98	PASS
52	5260	6	10.59	23.98 or $11+10\log(B) = 25.47$	PASS
60	5300	6	10.63	23.98 or $11+10\log(B) = 25.18$	PASS
64	5320	6	10.67	23.98 or $11+10\log(B) = 25.22$	PASS
100	5500	6	10.49	23.98 or $11+10\log(B) = 25.35$	PASS
116	5580	6	10.56	23.98 or $11+10\log(B) = 25.27$	PASS
140	5700	6	10.71	23.98 or $11+10\log(B) = 25.71$	PASS
149	5745	6	10.57	30	PASS
157	5785	6	10.67	30	PASS
165	5825	6	10.49	30	PASS

Unless otherwise stated the results shown in this test report refer only to the sample(s) tested and such sample(s) are retained for 90 days only.

除非另有說明，此報告結果僅對測試之樣品負責，同時此樣品僅保留90天。本報告未經本公司書面許可，不可部份複製。

This document is issued by the Company subject to its General Conditions of Service printed overleaf, available on request or accessible at www.sgs.com/terms_and_conditions.htm and, for electronic format documents, subject to Terms and Conditions for Electronic Documents at www.sgs.com/terms_e-document.htm. Attention is drawn to the limitation of liability, indemnification and jurisdiction issues defined therein. Any holder of this document is advised that information contained hereon reflects the Company's findings at the time of its intervention only and within the limits of Client's instructions, if any. The Company's sole responsibility is to its Client and this document does not exonerate parties to a transaction from exercising all their rights and obligations under the transaction documents. This document cannot be reproduced except in full, without prior written approval of the Company. Any unauthorized alteration, forgery or falsification of the content or appearance of this document is unlawful and offenders may be prosecuted to the fullest extent of the law.

802.11n_HT20_Main

CH	Frequency (MHz)	Data Rate	TOTAL POWER (dBm)	REQUIRED LIMIT (dBm)		RESULT
36	5180	MCS0	10.72	23.98		PASS
44	5220	MCS0	10.70	23.98		PASS
48	5240	MCS0	10.68	23.98		PASS
52	5260	MCS0	10.70	23.98	or $11+10\log(B) = 25.20$	PASS
60	5300	MCS0	10.73	23.98	or $11+10\log(B) = 25.66$	PASS
64	5320	MCS0	10.59	23.98	or $11+10\log(B) = 25.12$	PASS
100	5500	MCS0	10.51	23.98	or $11+10\log(B) = 25.71$	PASS
116	5580	MCS0	10.71	23.98	or $11+10\log(B) = 25.66$	PASS
140	5700	MCS0	10.45	23.98	or $11+10\log(B) = 25.16$	PASS
149	5745	MCS0	10.65	30		PASS
157	5785	MCS0	10.73	30		PASS
165	5825	MCS0	10.66	30		PASS

Unless otherwise stated the results shown in this test report refer only to the sample(s) tested and such sample(s) are retained for 90 days only.

除非另有說明，此報告結果僅對測試之樣品負責，同時此樣品僅保留90天。本報告未經本公司書面許可，不可部份複製。

This document is issued by the Company subject to its General Conditions of Service printed overleaf, available on request or accessible at www.sgs.com/terms_and_conditions.htm and, for electronic format documents, subject to Terms and Conditions for Electronic Documents at www.sgs.com/terms_e-document.htm. Attention is drawn to the limitation of liability, indemnification and jurisdiction issues defined therein. Any holder of this document is advised that information contained hereon reflects the Company's findings at the time of its intervention only and within the limits of Client's instructions, if any. The Company's sole responsibility is to its Client and this document does not exonerate parties to a transaction from exercising all their rights and obligations under the transaction documents. This document cannot be reproduced except in full, without prior written approval of the Company. Any unauthorized alteration, forgery or falsification of the content or appearance of this document is unlawful and offenders may be prosecuted to the fullest extent of the law.

SGS Taiwan Ltd.

No.134,WuKungRoad,NewTaipeiIndustrialPark,WukuDistrict,NewTaipeiCity,Taiwan24803/新北市五股區新北產業園區五工路 134 號

台灣檢驗科技股份有限公司

t (886-2) 2299-3279

f (886-2) 2298-0488

www.tw.sgs.com

Member of SGS Group

IC

802.11a_Main

CH	Frequency (MHz)	TOTAL POWER (dBm)	TOTAL POWER (mW)	REQUIRED LIMIT (dBm)	RESULT
100	5500	10.49	11.190	23.98 or $11+10\log(B) = 23.18$	PASS
116	5580	10.56	11.372	23.98 or $11+10\log(B) = 23.14$	PASS
140	5700	10.71	11.771	23.98 or $11+10\log(B) = 23.17$	PASS
149	5745	10.57	11.398	30	PASS
157	5785	10.67	11.664	30	PASS
165	5825	10.49	11.190	30	PASS

802.11n_HT20_Main

CH	Frequency (MHz)	TOTAL POWER (dBm)	TOTAL POWER (mW)	REQUIRED LIMIT (dBm)	RESULT
100	5500	10.51	11.259	23.98 or $11+10\log(B) = 23.47$	PASS
116	5580	10.71	11.789	23.98 or $11+10\log(B) = 23.47$	PASS
140	5700	10.45	11.104	23.98 or $11+10\log(B) = 23.43$	PASS
149	5745	10.65	11.628	30	PASS
157	5785	10.73	11.844	30	PASS
165	5825	10.66	11.654	30	PASS

Unless otherwise stated the results shown in this test report refer only to the sample(s) tested and such sample(s) are retained for 90 days only.

除非另有說明，此報告結果僅對測試之樣品負責，同時此樣品僅保留90天。本報告未經本公司書面許可，不可部份複製。

This document is issued by the Company subject to its General Conditions of Service printed overleaf, available on request or accessible at www.sgs.com/terms_and_conditions.htm and, for electronic format documents, subject to Terms and Conditions for Electronic Documents at www.sgs.com/terms_e-document.htm. Attention is drawn to the limitation of liability, indemnification and jurisdiction issues defined therein. Any holder of this document is advised that information contained hereon reflects the Company's findings at the time of its intervention only and within the limits of Client's instructions, if any. The Company's sole responsibility is to its Client and this document does not exonerate parties to a transaction from exercising all their rights and obligations under the transaction documents. This document cannot be reproduced except in full, without prior written approval of the Company. Any unauthorized alteration, forgery or falsification of the content or appearance of this document is unlawful and offenders may be prosecuted to the fullest extent of the law.

SGS Taiwan Ltd.

No.134,WuKungRoad,NewTaipeiIndustrialPark,WukuDistrict,NewTaipeiCity,Taiwan24803/新北市五股區新北產業園區五工路 134 號

台灣檢驗科技股份有限公司

t (886-2) 2299-3279

f (886-2) 2298-0488

www.tw.sgs.com

Member of SGS Group

802.11a_Main

CH	Frequency (MHz)	TOTAL POWER (dBm)	Antenna Gain (dBi)	EIRP (dBm)	EIRP (mW)	REQUIRED LIMIT (dBm)	RESULT
36	5180	10.68	2.000	12.68	18.528	14.77 or $1.76+10\log(B)=$ 13.94	PASS
44	5220	10.65	2.000	12.65	18.401	14.77 or $1.76+10\log(B)=$ 13.90	PASS
48	5240	10.56	2.000	12.56	18.023	14.77 or $1.76+10\log(B)=$ 13.91	PASS
52	5260	10.59	2.000	12.59	18.148	14.77 or $1.76+10\log(B)=$ 13.90	PASS
60	5300	10.63	2.000	12.63	18.316	14.77 or $1.76+10\log(B)=$ 13.90	PASS
64	5320	10.67	2.000	12.67	18.485	14.77 or $1.76+10\log(B)=$ 13.90	PASS
100	5500	10.49	2.000	12.49	17.735	30 or $17+10\log(B)=$ 29.18	PASS
116	5580	10.56	2.000	12.56	18.023	30 or $17+10\log(B)=$ 29.14	PASS
140	5700	10.71	2.000	12.71	18.657	30 or $17+10\log(B)=$ 29.17	PASS

802.11n_HT20_Main

CH	Frequency (MHz)	TOTAL POWER (dBm)	Antenna Gain (dBi)	EIRP (dBm)	EIRP (mW)	REQUIRED LIMIT (dBm)	RESULT
36	5180	10.72	2.000	12.72	18.728	14.77 or $1.76+10\log(B)=$ 14.18	PASS
44	5220	10.70	2.000	12.70	18.642	14.77 or $1.76+10\log(B)=$ 14.16	PASS
48	5240	10.68	2.000	12.68	18.556	14.77 or $1.76+10\log(B)=$ 14.17	PASS
52	5260	10.70	2.000	12.70	18.642	14.77 or $1.76+10\log(B)=$ 14.18	PASS
60	5300	10.73	2.000	12.73	18.771	14.77 or $1.76+10\log(B)=$ 14.19	PASS
64	5320	10.59	2.000	12.59	18.176	14.77 or $1.76+10\log(B)=$ 14.20	PASS
100	5500	10.51	2.000	12.51	17.844	30 or $17+10\log(B)=$ 29.47	PASS
116	5580	10.71	2.000	12.71	18.685	30 or $17+10\log(B)=$ 29.47	PASS
140	5700	10.45	2.000	12.45	17.599	30 or $17+10\log(B)=$ 29.43	PASS

Unless otherwise stated the results shown in this test report refer only to the sample(s) tested and such sample(s) are retained for 90 days only.

除非另有說明，此報告結果僅對測試之樣品負責，同時此樣品僅保留90天。本報告未經本公司書面許可，不可部份複製。

This document is issued by the Company subject to its General Conditions of Service printed overleaf, available on request or accessible at www.sgs.com/terms_and_conditions.htm and, for electronic format documents, subject to Terms and Conditions for Electronic Documents at www.sgs.com/terms_e-document.htm. Attention is drawn to the limitation of liability, indemnification and jurisdiction issues defined therein. Any holder of this document is advised that information contained hereon reflects the Company's findings at the time of its intervention only and within the limits of Client's instructions, if any. The Company's sole responsibility is to its Client and this document does not exonerate parties to a transaction from exercising all their rights and obligations under the transaction documents. This document cannot be reproduced except in full, without prior written approval of the Company. Any unauthorized alteration, forgery or falsification of the content or appearance of this document is unlawful and offenders may be prosecuted to the fullest extent of the law.

SGS Taiwan Ltd.

No.134,WuKungRoad,NewTaipeiIndustrialPark,WukuDistrict,NewTaipeiCity,Taiwan24803/新北市五股區新北產業園區五工路 134 號

台灣檢驗科技股份有限公司

t (886-2) 2299-3279

f (886-2) 2298-0488

www.tw.sgs.com

Member of SGS Group

10 PEAK POWER SPECTRAL DENSITY

10.1 Standard Applicable

FCC

OPERATION Band	EUT CATEGORY		LIMIT
U-NII-1		Access Point (Mater device)	17dBm/ MHz
		Fixed point-to-point Access Ponit	
	√	Mobile and portable clinet device	11dBm/ MHz
U-NII-2A	√		11dBm/ MHz
U-NII-2C	√		11dBm/ MHz
U-NII-3	√		30dBm/ 500kHz

IC

OPERATION FREQUENCY BAND	LIMIT
5150~5250 MHz	EIRP spectral density 10 dBm / MHz
5250~5350 MHz	11dBm / MHz
5470-5600 MHz and 5650-5725 MHz	11dBm / MHz
5725~5850 MHz	30dBm / 500 kHz

If transmitting antennas of directional gain greater than 6 dBi are used, both the peak transmit power and the peak power spectral density shall be reduced by the amount in dB that the directional gain of the antenna exceeds 6 dBi.

Unless otherwise stated the results shown in this test report refer only to the sample(s) tested and such sample(s) are retained for 90 days only.

除非另有說明，此報告結果僅對測試之樣品負責，同時此樣品僅保留90天。本報告未經本公司書面許可，不可部份複製。

This document is issued by the Company subject to its General Conditions of Service printed overleaf, available on request or accessible at www.sgs.com/terms_and_conditions.htm and, for electronic format documents, subject to Terms and Conditions for Electronic Documents at www.sgs.com/terms_e-document.htm. Attention is drawn to the limitation of liability, indemnification and jurisdiction issues defined therein. Any holder of this document is advised that information contained hereon reflects the Company's findings at the time of its intervention only and within the limits of Client's instructions, if any. The Company's sole responsibility is to its Client and this document does not exonerate parties to a transaction from exercising all their rights and obligations under the transaction documents. This document cannot be reproduced except in full, without prior written approval of the Company. Any unauthorized alteration, forgery or falsification of the content or appearance of this document is unlawful and offenders may be prosecuted to the fullest extent of the law.

SGS Taiwan Ltd.

No.134,WuKungRoad,NewTaipeiIndustrialPark,WukuDistrict,NewTaipeiCity,Taiwan24803/新北市五股區新北產業園區五工路 134 號

台灣檢驗科技股份有限公司

t (886-2) 2299-3279

f (886-2) 2298-0488

www.tw.sgs.com

Member of SGS Group

10.2 Measurement Procedure

1. Place the EUT on the table and set it in transmitting mode.
2. The testing follows FCC KDB 789033 D02 General UNII Test Procedures New Rules .
3. Remove the antenna from the EUT and then connect a low loss RF cable from the antenna port to Spectrum.
4. **For U-NII1, U-NII-2A, U-NII-2C Band:**
Set RBW=1MHz, VBW=3MHz, where span is enough to capture the entire bandwidth, Sweep time = Auto (601 pts), detector = sample, traces 100 sweeps of video averaging. (SA-2 with the omission of procedure x, the integration with 26dB EBW bandwidth)
For U-NII-3 Band:
Set RBW=500 kHz, VBW≥ 3RBW, where span is enough to capture the entire bandwidth, Sweep time = Auto (601 pts), detector = sample, traces 100 sweeps of video averaging. (SA-2 with the omission of procedure x, the integration with 26dB EBW bandwidth)
5. Use the cursor on spectrum to peak search the highest level of trace
6. Record the max. reading and add 10 log(1/duty cycle).
7. Repeat above procedures until all default test channel (low, middle, and high) was complete.

Note: For the test of PSD at MIMO mode, the highest emission of worst case employing Measure and add 10 log (N) technical is reported on this report after the comparison between Main Antenna at single transmitting mode and Aux that yields the higher value. The MIMO transmitting mode produces higher value of outcome.

10.3 Measurement Equipment Used

Conducted Emission Test Site					
EQUIPMENT TYPE	MFR	MODEL NUMBER	SERIAL NUMBER	LAST CAL.	CAL DUE.
Spectrum Analyzer	KEYSIGHT	N9010A	MY51440113	06/20/2017	06/19/2018
DC Block	PASTERNAK	PE8210	RF29	12/12/2016	12/11/2017
Coaxial Cable 30cm	WOKEN	00100A1F1A 195C	RF01	12/12/2016	12/11/2017
Attenuator	WOKEN	218FS-10	RF23	12/12/2016	12/11/2017

10.4 Test Set-up

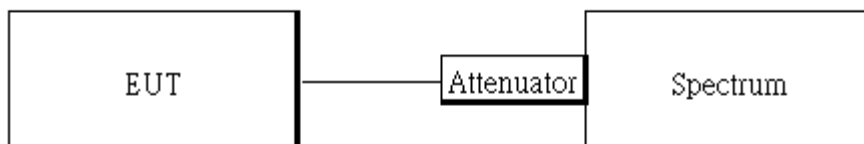

Unless otherwise stated the results shown in this test report refer only to the sample(s) tested and such sample(s) are retained for 90 days only.

除非另有說明，此報告結果僅對測試之樣品負責，同時此樣品僅保留90天。本報告未經本公司書面許可，不可部份複製。

This document is issued by the Company subject to its General Conditions of Service printed overleaf, available on request or accessible at www.sgs.com/terms_and_conditions.htm and, for electronic format documents, subject to Terms and Conditions for Electronic Documents at www.sgs.com/terms_e-document.htm. Attention is drawn to the limitation of liability, indemnification and jurisdiction issues defined therein. Any holder of this document is advised that information contained hereon reflects the Company's findings at the time of its intervention only and within the limits of Client's instructions, if any. The Company's sole responsibility is to its Client and this document does not exonerate parties to a transaction from exercising all their rights and obligations under the transaction documents. This document cannot be reproduced except in full, without prior written approval of the Company. Any unauthorized alteration, forgery or falsification of the content or appearance of this document is unlawful and offenders may be prosecuted to the fullest extent of the law.

SGS Taiwan Ltd.

No.134,WuKungRoad,NewTaipeiIndustrialPark,WukuDistrict,NewTaipeiCity,Taiwan24803/新北市五股區新北產業園區五工路 134 號

台灣檢驗科技股份有限公司

t (886-2) 2299-3279

f (886-2) 2298-0488

www.tw.sgs.com

Member of SGS Group

10.5 Measurement Result

POWER DENSITY 802.11a MODE					
Frequency (MHz)	PPSD W/O Duty Factor (dBm)	Duty Factor	PPSD With Duty Factor (dBm)	Limit (dBm)	Margin (dB)
5180	-7.47	0.61	-6.86	11	-17.86
5220	-7.33	0.61	-6.72	11	-17.72
5240	-8.32	0.61	-7.71	11	-18.71
5260	-6.39	0.61	-5.78	11	-16.78
5300	-8.87	0.61	-8.26	11	-19.26
5320	-9.31	0.61	-8.70	11	-19.70
5500	-9.16	0.61	-8.55	11	-19.55
5580	-10.43	0.61	-9.82	11	-20.82
5700	-11.41	0.61	-10.80	11	-21.80
5745	0.55	0.61	0.55	30	-29.45
5785	2.10	0.61	2.10	30	-27.90
5825	1.49	0.61	1.49	30	-28.51

POWER DENSITY 802.11n HT20 MODE					
Frequency (MHz)	PPSD W/O Duty Factor (dBm)	Duty Factor	PPSD With Duty Factor (dBm)	Limit (dBm)	Margin (dB)
5180	-10.39	0.64	-9.75	11	-20.75
5220	-8.60	0.64	-7.96	11	-18.96
5240	-6.51	0.64	-5.87	11	-16.87
5260	-7.66	0.64	-7.02	11	-18.02
5300	-8.87	0.64	-8.23	11	-19.23
5320	-10.29	0.64	-9.65	11	-20.65
5500	-10.77	0.64	-10.13	11	-21.13
5580	-8.84	0.64	-8.20	11	-19.20
5700	-10.07	0.64	-9.43	11	-20.43
5745	-0.01	0.64	-0.01	30	-30.01
5785	1.29	0.64	1.29	30	-28.71
5825	2.05	0.64	2.05	30	-27.95

EIRP

EIRP spectral density 802.11a MODE						EIRP spectral density 802.11n HT20 MODE					
Freq. (MHz)	PPSD (dBm)	Ant. Gain (dBi)	EIRP SD (dBm)	Limit (dBm)	Margin (dB)	Freq. (MHz)	PPSD (dBm)	Ant. Gain (dBi)	EIRP SD (dBm)	Limit (dBm)	Margin (dB)
5180	-6.86	2.00	-4.86	10	-16.86	5180	-9.75	2.00	-7.75	10	-19.75
5220	-6.72	2.00	-4.72	10	-16.72	5220	-7.96	2.00	-5.96	10	-17.96
5240	-7.71	2.00	-5.71	10	-17.71	5240	-5.87	2.00	-3.87	10	-15.87

Note:

SISO offset=

11.6 dB

Unless otherwise stated the results shown in this test report refer only to the sample(s) tested and such sample(s) are retained for 90 days only.

除非另有說明，此報告結果僅對測試之樣品負責，同時此樣品僅保留90天。本報告未經本公司書面許可，不可部份複製。

This document is issued by the Company subject to its General Conditions of Service printed overleaf, available on request or accessible at www.sgs.com/terms_and_conditions.htm and, for electronic format documents, subject to Terms and Conditions for Electronic Documents at www.sgs.com/terms_e-document.htm. Attention is drawn to the limitation of liability, indemnification and jurisdiction issues defined therein. Any holder of this document is advised that information contained hereon reflects the Company's findings at the time of its intervention only and within the limits of Client's instructions, if any. The Company's sole responsibility is to its Client and this document does not exonerate parties to a transaction from exercising all their rights and obligations under the transaction documents. This document cannot be reproduced except in full, without prior written approval of the Company. Any unauthorized alteration, forgery or falsification of the content or appearance of this document is unlawful and offenders may be prosecuted to the fullest extent of the law.

SGS Taiwan Ltd.

No.134,WuKungRoad,NewTaipeiIndustrialPark,WukuDistrict,NewTaipeiCity,Taiwan24803/新北市五股區新北產業園區五工路 134 號

台灣檢驗科技股份有限公司

t (886-2) 2299-3279

f (886-2) 2298-0488

www.tw.sgs.com

Member of SGS Group

802.11a 5150–5250 MHz
Peak Power Spectral Density Data Plot (CH Low 5180 MHz)



802.11a 5250–5350 MHz
Peak Power Spectral Density Data Plot (CH Low 5260 MHz)

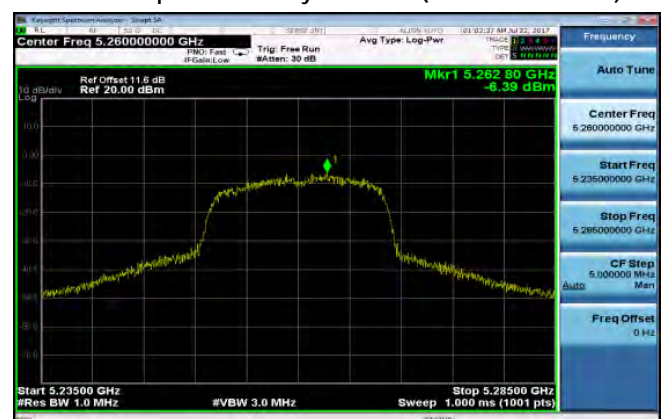

Peak Power Spectral Density Data Plot (CH Mid 5220 MHz)



Peak Power Spectral Density Data Plot (CH Mid 5300 MHz)

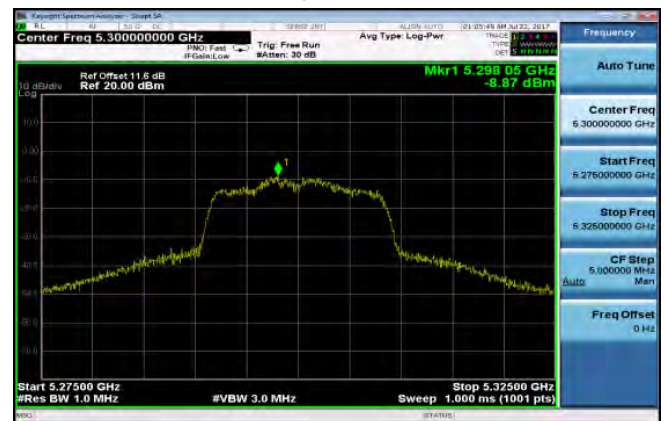

Peak Power Spectral Density Data Plot (CH High 5240 MHz)

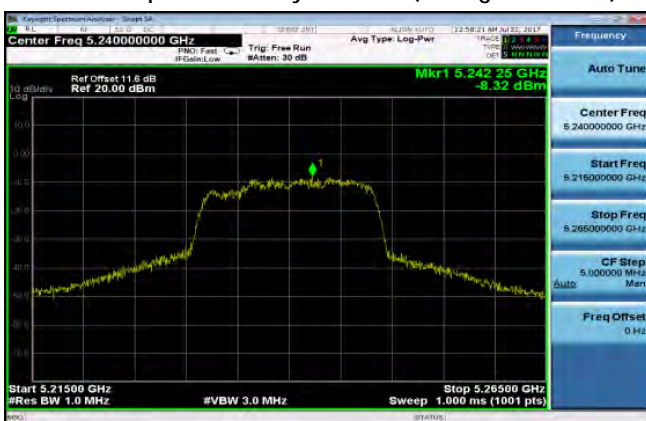

Peak Power Spectral Density Data Plot (CH High 5320 MHz)

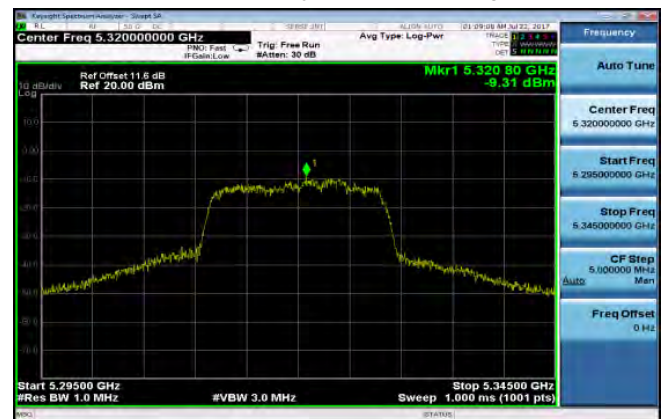

Unless otherwise stated the results shown in this test report refer only to the sample(s) tested and such sample(s) are retained for 90 days only.

除非另有說明，此報告結果僅對測試之樣品負責，同時此樣品僅保留90天。本報告未經本公司書面許可，不可部份複製。

This document is issued by the Company subject to its General Conditions of Service printed overleaf, available on request or accessible at www.sgs.com/terms_and_conditions.htm and, for electronic format documents, subject to Terms and Conditions for Electronic Documents at www.sgs.com/terms_e-document.htm. Attention is drawn to the limitation of liability, indemnification and jurisdiction issues defined therein. Any holder of this document is advised that information contained hereon reflects the Company's findings at the time of its intervention only and within the limits of Client's instructions, if any. The Company's sole responsibility is to its Client and this document does not exonerate parties to a transaction from exercising all their rights and obligations under the transaction documents. This document cannot be reproduced except in full, without prior written approval of the Company. Any unauthorized alteration, forgery or falsification of the content or appearance of this document is unlawful and offenders may be prosecuted to the fullest extent of the law.

802.11a 5470~5725 MHz

Peak Power Spectral Density Data Plot (CH Low 5500 MHz)

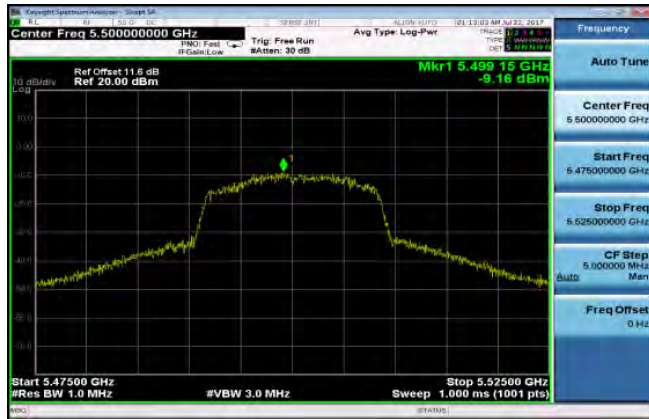

Peak Power Spectral Density Data Plot (CH Mid 5580 MHz)



Peak Power Spectral Density Data Plot (CH High 5700 MHz)



802.11a 5725~5850 MHz

Peak Power Spectral Density Data Plot (CH Low 5745 MHz)

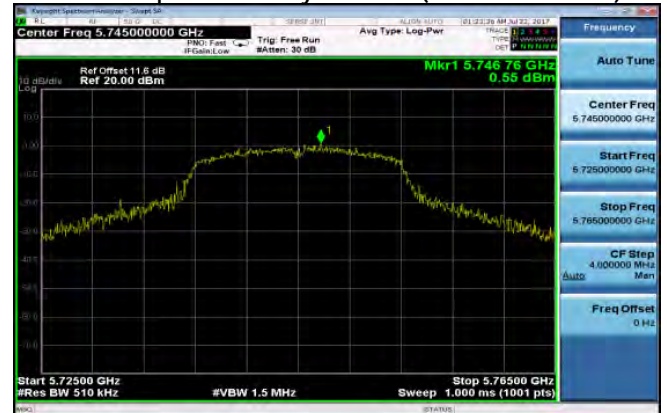

Peak Power Spectral Density Data Plot (CH Mid 5785 MHz)



Peak Power Spectral Density Data Plot (CH High 5825 MHz)



Unless otherwise stated the results shown in this test report refer only to the sample(s) tested and such sample(s) are retained for 90 days only.

除非另有說明，此報告結果僅對測試之樣品負責，同時此樣品僅保留90天。本報告未經本公司書面許可，不可部份複製。
This document is issued by the Company subject to its General Conditions of Service printed overleaf, available on request or accessible at www.sgs.com/terms_and_conditions.htm and, for electronic format documents, subject to Terms and Conditions for Electronic Documents at www.sgs.com/terms_e-document.htm. Attention is drawn to the limitation of liability, indemnification and jurisdiction issues defined therein. Any holder of this document is advised that information contained hereon reflects the Company's findings at the time of its intervention only and within the limits of Client's instructions, if any. The Company's sole responsibility is to its Client and this document does not exonerate parties to a transaction from exercising all their rights and obligations under the transaction documents. This document cannot be reproduced except in full, without prior written approval of the Company. Any unauthorized alteration, forgery or falsification of the content or appearance of this document is unlawful and offenders may be prosecuted to the fullest extent of the law.

802.11n HT20, 5150~5250 MHz

Peak Power Spectral Density Data Plot (CH Low 5180 MHz)

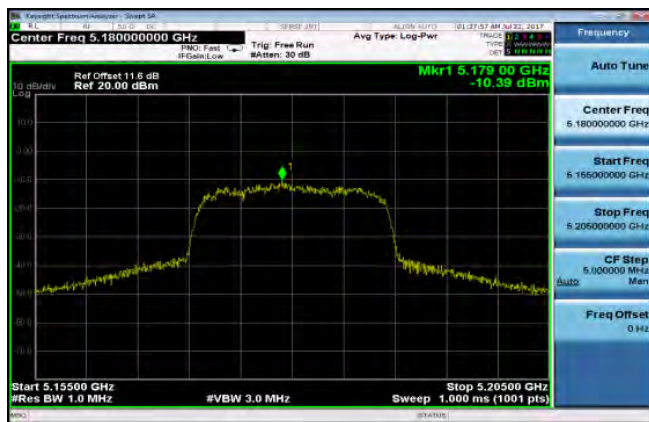

Peak Power Spectral Density Data Plot (CH Mid 5220 MHz)



Peak Power Spectral Density Data Plot (CH High 5240 MHz)



802.11n HT20, 5250~5350 MHz

Peak Power Spectral Density Data Plot (CH Low 5260MHz)



Peak Power Spectral Density Data Plot (CH Mid 5300 MHz)



Peak Power Spectral Density Data Plot (CH High 5320 MHz)

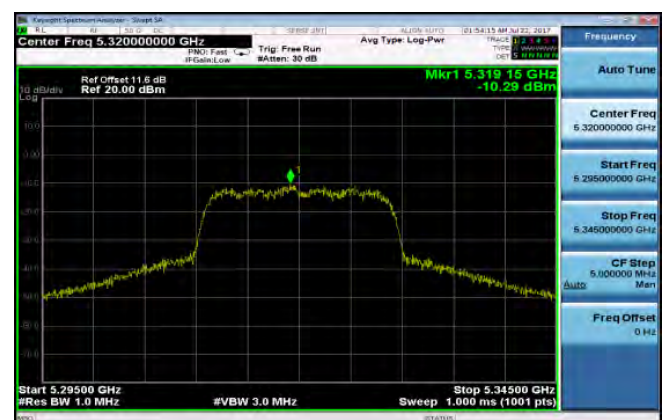

Unless otherwise stated the results shown in this test report refer only to the sample(s) tested and such sample(s) are retained for 90 days only.

除非另有說明，此報告結果僅對測試之樣品負責，同時此樣品僅保留90天。本報告未經本公司書面許可，不可部份複製。

This document is issued by the Company subject to its General Conditions of Service printed overleaf, available on request or accessible at www.sgs.com/terms_and_conditions.htm and, for electronic format documents, subject to Terms and Conditions for Electronic Documents at www.sgs.com/terms_e-document.htm. Attention is drawn to the limitation of liability, indemnification and jurisdiction issues defined therein. Any holder of this document is advised that information contained hereon reflects the Company's findings at the time of its intervention only and within the limits of Client's instructions, if any. The Company's sole responsibility is to its Client and this document does not exonerate parties to a transaction from exercising all their rights and obligations under the transaction documents. This document cannot be reproduced except in full, without prior written approval of the Company. Any unauthorized alteration, forgery or falsification of the content or appearance of this document is unlawful and offenders may be prosecuted to the fullest extent of the law.

802.11n HT20, 5470~5725 MHz

Peak Power Spectral Density Data Plot (CH Low 5500 MHz)



Peak Power Spectral Density Data Plot (CH Mid 5580MHz)

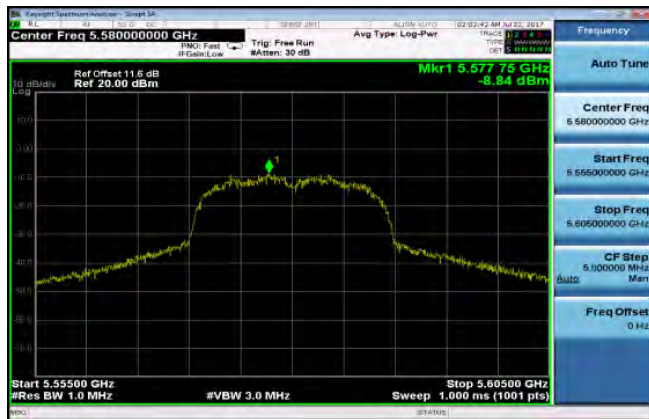

Peak Power Spectral Density Data Plot (CH High 5700 MHz)



802.11n HT20, 5725~5850 MHz

Peak Power Spectral Density Data Plot (CH Low 5745 MHz)

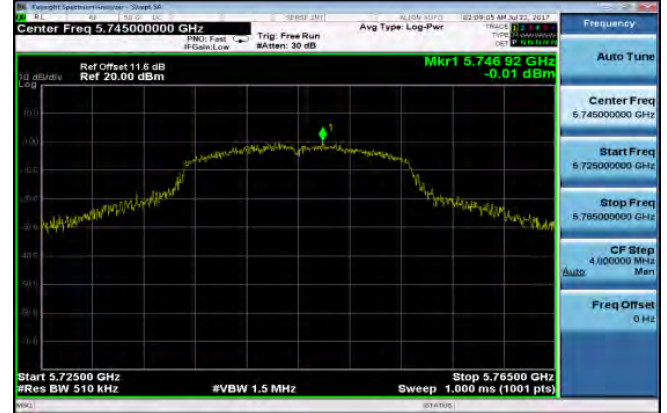

Peak Power Spectral Density Data Plot (CH Mid 5785 MHz)



Peak Power Spectral Density Data Plot (CH High 5825 MHz)

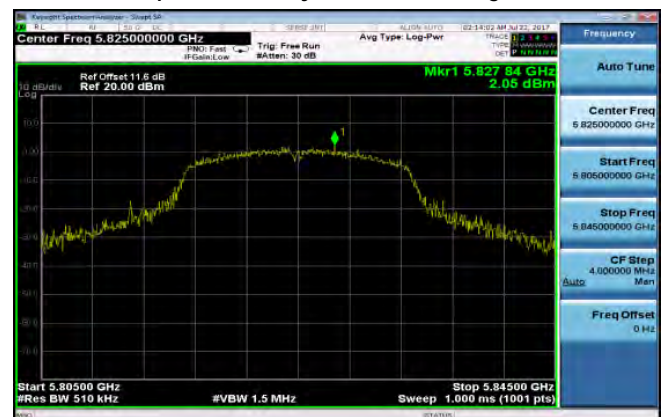

Unless otherwise stated the results shown in this test report refer only to the sample(s) tested and such sample(s) are retained for 90 days only.

除非另有說明，此報告結果僅對測試之樣品負責，同時此樣品僅保留90天。本報告未經本公司書面許可，不可部份複製。
This document is issued by the Company subject to its General Conditions of Service printed overleaf, available on request or accessible at www.sgs.com/terms_and_conditions.htm and, for electronic format documents, subject to Terms and Conditions for Electronic Documents at www.sgs.com/terms_e-document.htm. Attention is drawn to the limitation of liability, indemnification and jurisdiction issues defined therein. Any holder of this document is advised that information contained hereon reflects the Company's findings at the time of its intervention only and within the limits of Client's instructions, if any. The Company's sole responsibility is to its Client and this document does not exonerate parties to a transaction from exercising all their rights and obligations under the transaction documents. This document cannot be reproduced except in full, without prior written approval of the Company. Any unauthorized alteration, forgery or falsification of the content or appearance of this document is unlawful and offenders may be prosecuted to the fullest extent of the law.

11 UNDESIRABLE RADIATED EMISSION MEASUREMENT

11.1 Standard Applicable

The maximum emissions outside of the frequency bands of operation shall be attenuated in accordance with the following limits:

1. For transmitters operating in the 5.15-5.25 GHz band: All emissions outside of the 5.15-5.35 GHz band shall not exceed an e.i.r.p. of -27 dBm/MHz.
2. For transmitters operating in the 5.725-5.85 GHz band: All emissions shall be limited to a level of -27 dBm/MHz at 75 MHz or more above or below the band edge increasing linearly to 10 dBm/MHz at 25 MHz above or below the band edge, and from 25 MHz above or below the band edge increasing linearly to a level of 15.6 dBm/MHz at 5 MHz above or below the band edge, and from 5 MHz above or below the band edge increasing linearly to a level of 27 dBm/MHz at the band edge.

APPLICABLE TO	LIMIT	
FCC KDB 789033 D02 General UNII Test Procedures New Rules	FIELD STRENGTH AT 3m	
	PK: 74 (dBµV/m)	AV 54 (dBµV/m)
APPLICABLE TO	EIRP LIMIT	FIELD STRENGTH AT 3m
15.407(b)(1) RSS-247 6.2.1.2	PK: -27 (dBm/MHz)	PK: 68.3 (dBµV/m)
15.407(b)(2) RSS-247 6.2.2.2		
15.407(b)(3) RSS-247 6.2.3.2		
15.407(b)(4)(i) RSS-247 6.2.4.2	PK:-27 (dBm/MHz) *1 PK:10 (dBm/MHz) *2 PK:15.6 (dBm/MHz) *3 PK:27 (dBm/MHz) *4	PK: 68.2(dBµV/m) *1 PK:105.2 (dBµV/m) *2 PK: 110.8(dBµV/m) *3 PK:122.2 (dBµV/m) *4
*1 beyond 75 MHz or more above of the bandedge. *2 below the band edge increasing linearly to 10 dBm/MHz at 25 MHz above. *3 below the band edge increasing linearly to a level of 15.6 dBm/MHz at 5 MHz above. *4 from 5 MHz above or below the band edge increasing linearly to a level of 27 dBm/MHz at the band edge.		

$EIRP = (E \cdot d)^2 / 30$, where E is the field in V/m, d is the measurement distance (3m), EIRP is the equivalent isotropically radiated power in Watts..

Unless otherwise stated the results shown in this test report refer only to the sample(s) tested and such sample(s) are retained for 90 days only.

除非另有說明，此報告結果僅對測試之樣品負責，同時此樣品僅保留90天。本報告未經本公司書面許可，不可部份複製。

This document is issued by the Company subject to its General Conditions of Service printed overleaf, available on request or accessible at www.sgs.com/terms_and_conditions.htm and, for electronic format documents, subject to Terms and Conditions for Electronic Documents at www.sgs.com/terms_e-document.htm. Attention is drawn to the limitation of liability, indemnification and jurisdiction issues defined therein. Any holder of this document is advised that information contained hereon reflects the Company's findings at the time of its intervention only and within the limits of Client's instructions, if any. The Company's sole responsibility is to its Client and this document does not exonerate parties to a transaction from exercising all their rights and obligations under the transaction documents. This document cannot be reproduced except in full, without prior written approval of the Company. Any unauthorized alteration, forgery or falsification of the content or appearance of this document is unlawful and offenders may be prosecuted to the fullest extent of the law.

Unwanted spurious emissions which fall in the restricted bands must comply with the radiated emission limits specified as below table:

Frequency (MHz)	Field strength (microvolts/meter)	Distance (meters)
0.009-0.490	2400/F(KHz)	300
0.490-1.705	24000/F(KHz)	30
1.705-30	30	30
30-88	100	3
88-216	150	3
216-960	200	3
Above 960	500	3

Note:

1. The lower limit shall apply at the transition frequencies.
2. Emission level (dBµV/m) = 20 log Emission level (dBµV/m)

Unless otherwise stated the results shown in this test report refer only to the sample(s) tested and such sample(s) are retained for 90 days only.

除非另有說明，此報告結果僅對測試之樣品負責，同時此樣品僅保留90天。本報告未經本公司書面許可，不可部份複製。

This document is issued by the Company subject to its General Conditions of Service printed overleaf, available on request or accessible at www.sgs.com/terms_and_conditions.htm and, for electronic format documents, subject to Terms and Conditions for Electronic Documents at www.sgs.com/terms_e-document.htm. Attention is drawn to the limitation of liability, indemnification and jurisdiction issues defined therein. Any holder of this document is advised that information contained hereon reflects the Company's findings at the time of its intervention only and within the limits of Client's instructions, if any. The Company's sole responsibility is to its Client and this document does not exonerate parties to a transaction from exercising all their rights and obligations under the transaction documents. This document cannot be reproduced except in full, without prior written approval of the Company. Any unauthorized alteration, forgery or falsification of the content or appearance of this document is unlawful and offenders may be prosecuted to the fullest extent of the law.

SGS Taiwan Ltd.

No. 134, WuKungRoad, NewTaipeiIndustrialPark, WukuDistrict, New Taipei City, Taiwan 24803/新北市五股區新北產業園區五工路 134 號

台灣檢驗科技股份有限公司

t (886-2) 2299-3279

f (886-2) 2298-0488

www.tw.sgs.com

Member of SGS Group

11.2 Measurement Equipment Used

SGS 966 Chamber No.C					
EQUIPMENT TYPE	EQUIPMENT TYPE	EQUIPMENT TYPE	EQUIPMENT TYPE	EQUIPMENT TYPE	EQUIPMENT TYPE
EMI Test Receiver	R&S	ESU 40	100363	04/18/2017	04/17/2018
Loop Antenna	ETS-Lindgren	6502	00143303	12/23/2016	12/22/2017
Broadband Antenna	TESEQ	CBL 6112D	35240	11/03/2016	11/02/2017
Horn Antenna	ETS-Lindgren	3117	00143272	12/15/2016	12/16/2017
Horn Antenna	Schwarzbeck	BBHA9170	185	07/24/2016	07/23/2017
Pre Amplifier	EMC Instruments	EMC330	980096	12/12/2016	12/11/2017
Pre Amplifier	EMC Instruments	EMC0011830	980199	12/12/2016	12/11/2017
Pre Amplifier	R&S	SCU-18	10204	12/12/2016	12/11/2017
Pre Amplifier	EMC Instruments	EMC184045B	980135	12/12/2016	12/11/2017
Coaxial Cable	Huber+Suhner	RG 214/U	966Rx 9K-30M	12/12/2016	12/11/2017
Coaxial Cable	Huber+Suhner	RG 214/U SUCOFLEX 104	966Rx 30M-3G	12/12/2016	12/11/2017
Coaxial Cable	Huber+Suhner	SUCOFLEX 104	966Rx 1G-18G	12/12/2016	12/11/2017
Coaxial Cable	Huber+Suhner	mini 141-12 SUCOFLEX 104	966Rx 18G-40G	12/12/2016	12/11/2017
Coaxial Cable	Huber+Suhner	SUCOFLEX 104	966Tx 30M-18G	12/12/2016	12/11/2017
Coaxial Cable	Huber+Suhner	SUCOFLEX 102	966Tx 18G-40G	12/12/2016	12/11/2017
Attenuator	WOKEN	218FS-10	RF27	12/12/2016	12/11/2017
Site NSA	SGS	966 Chamber C	SAC-C	03/02/2017	03/01/2018
Site VSWR	SGS	966 Chamber C	SAC-C	03/02/2017	03/01/2018
DC Power Supply	HOLA	DP-3003	D7070035	05/04/2017	05/03/2018
Controller	MF	MF-7802	N/A	N.C.R.	N.C.R.
Antenna Master	MF	N/A	N/A	N.C.R.	N.C.R.
Turn Table	MF	N/A	N/A	N.C.R.	N.C.R.
Test Software	World-Pallas	Dr. E	V 3.0 Lite	N.C.R.	N.C.R.

NOTE: N.C.R refers to Not Calibrated Required.

Unless otherwise stated the results shown in this test report refer only to the sample(s) tested and such sample(s) are retained for 90 days only.

除非另有說明，此報告結果僅對測試之樣品負責，同時此樣品僅保留90天。本報告未經本公司書面許可，不可部份複製。

This document is issued by the Company subject to its General Conditions of Service printed overleaf, available on request or accessible at www.sgs.com/terms_and_conditions.htm and, for electronic format documents, subject to Terms and Conditions for Electronic Documents at www.sgs.com/terms_e-document.htm. Attention is drawn to the limitation of liability, indemnification and jurisdiction issues defined therein. Any holder of this document is advised that information contained hereon reflects the Company's findings at the time of its intervention only and within the limits of Client's instructions, if any. The Company's sole responsibility is to its Client and this document does not exonerate parties to a transaction from exercising all their rights and obligations under the transaction documents. This document cannot be reproduced except in full, without prior written approval of the Company. Any unauthorized alteration, forgery or falsification of the content or appearance of this document is unlawful and offenders may be prosecuted to the fullest extent of the law.

SGS Taiwan Ltd.

No.134,WuKungRoad,NewTaipeiIndustrialPark,WukuDistrict,NewTaipeiCity,Taiwan24803/新北市五股區新北產業園區五工路 134 號

台灣檢驗科技股份有限公司

t (886-2) 2299-3279

f (886-2) 2298-0488

www.tw.sgs.com

Member of SGS Group

11.3 Test SET-UP

(A) Radiated Emission Test Set-UP Frequency Below 30MHz.

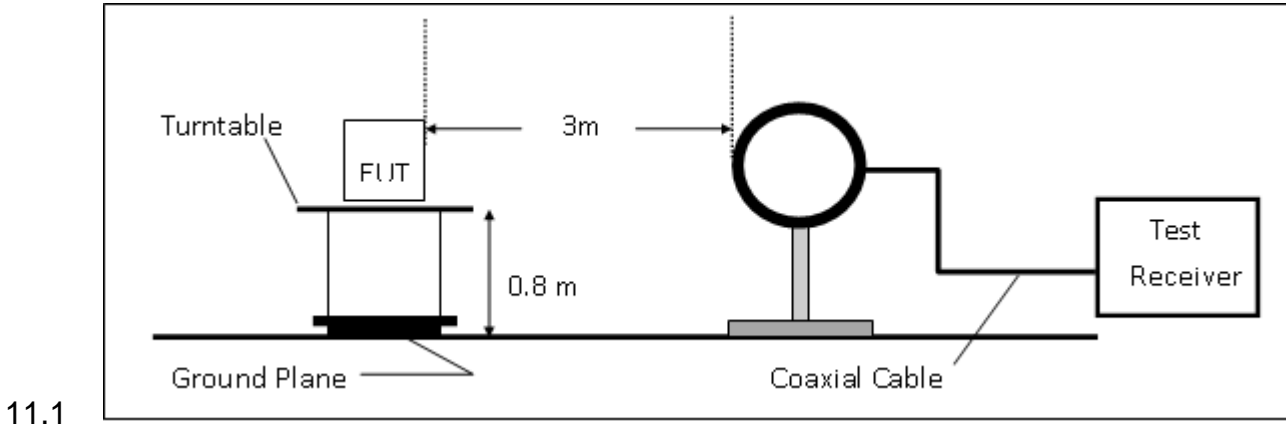

(B) Radiated Emission Test Set-UP, Frequency form 30MHz to 1000MHz

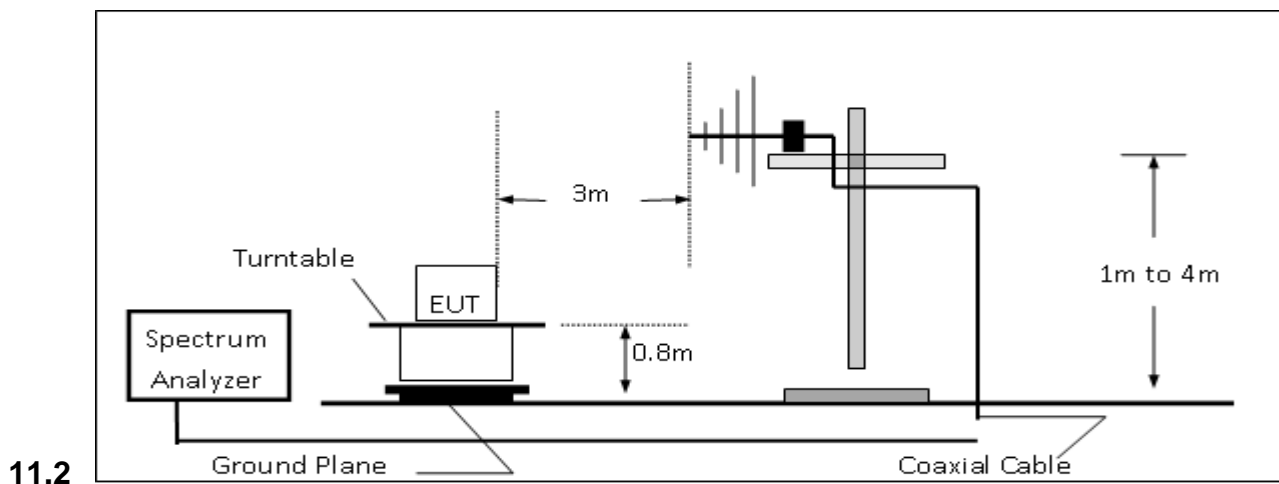

(C) Radiated Emission Test Set-UP Frequency Over 1 GHz

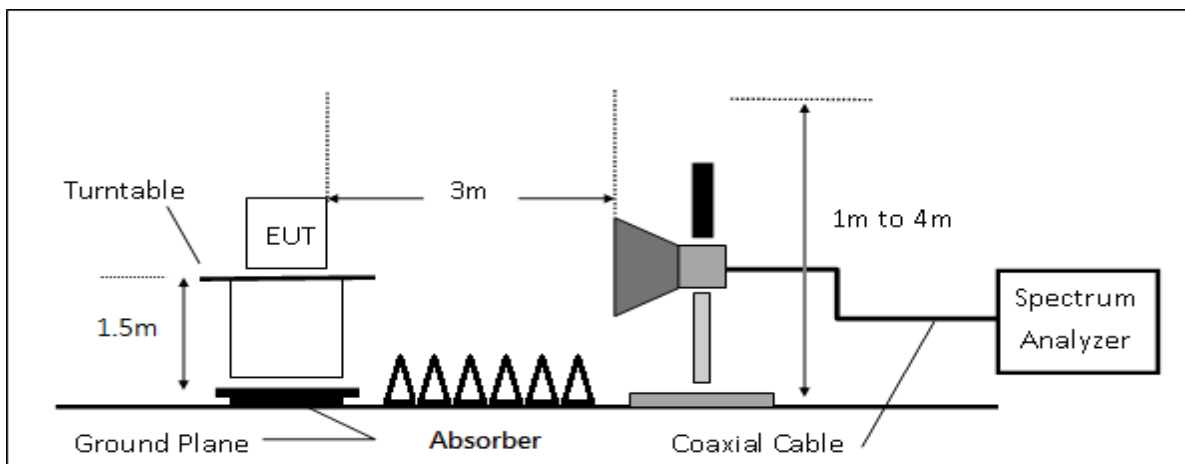

Unless otherwise stated the results shown in this test report refer only to the sample(s) tested and such sample(s) are retained for 90 days only.

除非另有說明，此報告結果僅對測試之樣品負責，同時此樣品僅保留90天。本報告未經本公司書面許可，不可部份複製。

This document is issued by the Company subject to its General Conditions of Service printed overleaf, available on request or accessible at www.sgs.com/terms_and_conditions.htm and, for electronic format documents, subject to Terms and Conditions for Electronic Documents at www.sgs.com/terms_e-document.htm. Attention is drawn to the limitation of liability, indemnification and jurisdiction issues defined therein. Any holder of this document is advised that information contained hereon reflects the Company's findings at the time of its intervention only and within the limits of Client's instructions, if any. The Company's sole responsibility is to its Client and this document does not exonerate parties to a transaction from exercising all their rights and obligations under the transaction documents. This document cannot be reproduced except in full, without prior written approval of the Company. Any unauthorized alteration, forgery or falsification of the content or appearance of this document is unlawful and offenders may be prosecuted to the fullest extent of the law.

11.4 Measurement Procedure

1. The EUT was placed on a turn table which is 0.8m above ground plane.
2. The testing follows FCC KDB 789033 D02 General UNII Test Procedures New Rules .
3. The EUT was placed on a turn table with 0.8m for frequency< 1GHz and 1.5m for frequency> 1GHz above ground plane.
4. The turn table shall rotate 360 degrees to determine the position of maximum emission level.
5. EUT is set 3m away from the receiving antenna which varied from 1m to 4m to find out the highest emissions.
6. Set the spectrum analyzer as RBW=120 kHz and VBW=300 kHz for Peak Detector (PK) and Quasi-peak (QP) at frequency below 1 GHz.
7. Set the spectrum analyzer as RBW=1 MHz, VBW=3 MHz for Peak Detector at frequency above 1 GHz.
8. Set the spectrum analyzer as RBW=1 MHz, VBW=10 Hz (Duty cycle > 98%) or VBW ≥ 1/T (Duty cycle < 98%) for Average Detector at frequency above 1 GHz.
9. Maximum procedure was performed on the six highest emissions to ensure EUT compliance.
10. And also, each emission was to be maximized by changing the polarization of receiving antenna both horizontal and vertical.
11. Repeat above procedures until all frequency measured were complete.

11.5 Field Strength Calculation

The field strength is calculated by adding the Antenna Factor and Cable Factor and subtracting the Amplifier Gain and Duty Cycle Correction Factor (if any) from the measured reading. The basic equation with a sample calculation is as follows:

$$FS = RA + AF + CL - AG$$

Where	FS = Field Strength	CL = Cable Attenuation Factor (Cable Loss)
	RA = Reading Amplitude	AG = Amplifier Gain
	AF = Antenna Factor	

$$\text{Actual FS(dB}\mu\text{V/m)} = \text{SPA. Reading level(dB}\mu\text{V)} + \text{Factor(dB)}$$

$$\text{Factor(dB)} = \text{Antenna Factor(dB}\mu\text{V/m)} + \text{Cable Loss(dB)} - \text{Pre_Amplifier Gain(dB)}$$

Unless otherwise stated the results shown in this test report refer only to the sample(s) tested and such sample(s) are retained for 90 days only.

除非另有說明，此報告結果僅對測試之樣品負責，同時此樣品僅保留90天。本報告未經本公司書面許可，不可部份複製。

This document is issued by the Company subject to its General Conditions of Service printed overleaf, available on request or accessible at www.sgs.com/terms_and_conditions.htm and, for electronic format documents, subject to Terms and Conditions for Electronic Documents at www.sgs.com/terms_e-document.htm. Attention is drawn to the limitation of liability, indemnification and jurisdiction issues defined therein. Any holder of this document is advised that information contained hereon reflects the Company's findings at the time of its intervention only and within the limits of Client's instructions, if any. The Company's sole responsibility is to its Client and this document does not exonerate parties to a transaction from exercising all their rights and obligations under the transaction documents. This document cannot be reproduced except in full, without prior written approval of the Company. Any unauthorized alteration, forgery or falsification of the content or appearance of this document is unlawful and offenders may be prosecuted to the fullest extent of the law.

Note :

“F” : denotes Fundamental Frequency. ; “H” : denotes Harmonic Frequency.

“E” : denotes Band Edge Frequency. ; “S” : denotes Spurious Frequency.

11.6 Test Results of Radiated Spurious Emissions form 9 KHz to 30 MHz

The low frequency, which started from 9 kHz to 30MHz, was pre-scanned and the result which was 20dB lower than the limit per 15.31(o) was not reported.

11.7 Measurement Result

Refer to attach tabular data sheets.

Unless otherwise stated the results shown in this test report refer only to the sample(s) tested and such sample(s) are retained for 90 days only.

除非另有說明，此報告結果僅對測試之樣品負責，同時此樣品僅保留90天。本報告未經本公司書面許可，不可部份複製。

This document is issued by the Company subject to its General Conditions of Service printed overleaf, available on request or accessible at www.sgs.com/terms_and_conditions.htm and, for electronic format documents, subject to Terms and Conditions for Electronic Documents at www.sgs.com/terms_e-document.htm. Attention is drawn to the limitation of liability, indemnification and jurisdiction issues defined therein. Any holder of this document is advised that information contained hereon reflects the Company's findings at the time of its intervention only and within the limits of Client's instructions, if any. The Company's sole responsibility is to its Client and this document does not exonerate parties to a transaction from exercising all their rights and obligations under the transaction documents. This document cannot be reproduced except in full, without prior written approval of the Company. Any unauthorized alteration, forgery or falsification of the content or appearance of this document is unlawful and offenders may be prosecuted to the fullest extent of the law.

SGS Taiwan Ltd.

台灣檢驗科技股份有限公司

No.134,WuKungRoad,NewTaipeiIndustrialPark,WukuDistrict,NewTaipeiCity,Taiwan24803/新北市五股區新北產業園區五工路 134 號

t (886-2) 2299-3279

f (886-2) 2298-0488

www.tw.sgs.com

Member of SGS Group

Radiated Spurious Emission Measurement Result

Below 1GHz Worst-Case Data:

802.11a 5150~5250 MHz

Operation Mode :	802.11a	Test Date :	2017/7/18
Fundamental Frequency :	5220 MHz	Temp. / Humi. :	22.7deg_C/57RH
Operation Band :	Tx CH Mid	Test Engineer :	Ashton
EUT Pol. :	H	Measurement Antenna Pol. :	Vertical

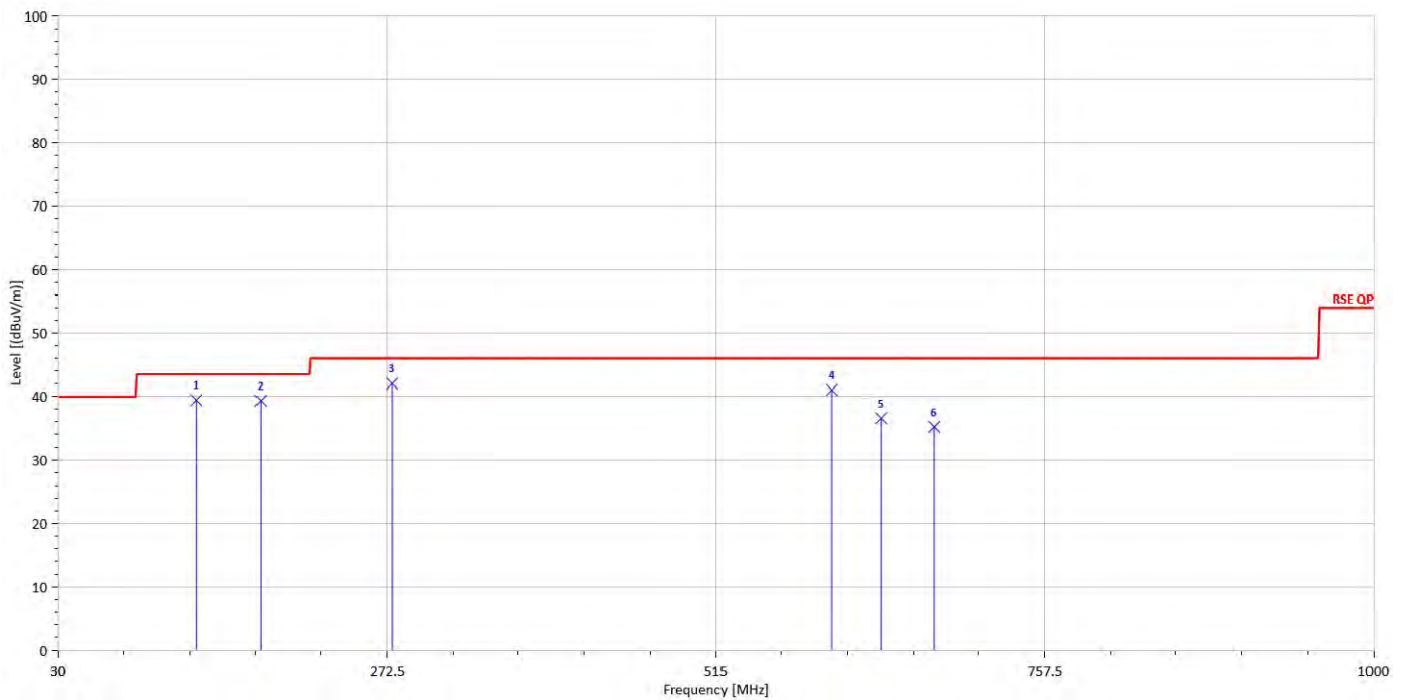

Freq. MHz	Note F/H/E/S	Detector Mode PK/QP/AV	Spectrum Reading Level dB μ V	Factor dB	Actual FS dB μ V/m	Limit @3m dB μ V/m	Margin dB
131.85	S	Peak	51.93	-12.47	39.45	43.5	-4.05
179.38	S	Peak	54.63	-15.25	39.38	43.5	-4.12
276.38	S	Peak	52.68	-10.64	42.04	46	-3.96
600.36	S	Peak	43.90	-2.86	41.04	46	-4.96
637.22	S	Peak	38.85	-2.25	36.59	46	-9.41
676.02	S	Peak	37.23	-1.99	35.23	46	-10.77

Unless otherwise stated the results shown in this test report refer only to the sample(s) tested and such sample(s) are retained for 90 days only.

除非另有說明，此報告結果僅對測試之樣品負責，同時此樣品僅保留90天。本報告未經本公司書面許可，不可部份複製。

This document is issued by the Company subject to its General Conditions of Service printed overleaf, available on request or accessible at www.sgs.com/terms_and_conditions.htm and, for electronic format documents, subject to Terms and Conditions for Electronic Documents at www.sgs.com/terms_e-document.htm. Attention is drawn to the limitation of liability, indemnification and jurisdiction issues defined therein. Any holder of this document is advised that information contained hereon reflects the Company's findings at the time of its intervention only and within the limits of Client's instructions, if any. The Company's sole responsibility is to its Client and this document does not exonerate parties to a transaction from exercising all their rights and obligations under the transaction documents. This document cannot be reproduced except in full, without prior written approval of the Company. Any unauthorized alteration, forgery or falsification of the content or appearance of this document is unlawful and offenders may be prosecuted to the fullest extent of the law.

SGS Taiwan Ltd.

No.134,WuKungRoad,NewTaipeiIndustrialPark,WukuDistrict,NewTaipeiCity,Taiwan24803/新北市五股區新北產業園區五工路 134 號

台灣檢驗科技股份有限公司

t (886-2) 2299-3279

f (886-2) 2298-0488

www.tw.sgs.com

Member of SGS Group

Operation Mode : 802.11a Test Date : 2017/7/18
 Fundamental Frequency : 5220 MHz Temp. / Humi. : 22.7deg_C/57RH
 Operation Band : Tx CH Mid Test Engineer : Ashton
 EUT Pol. : H Measurement Antenna Pol. : Horizontal

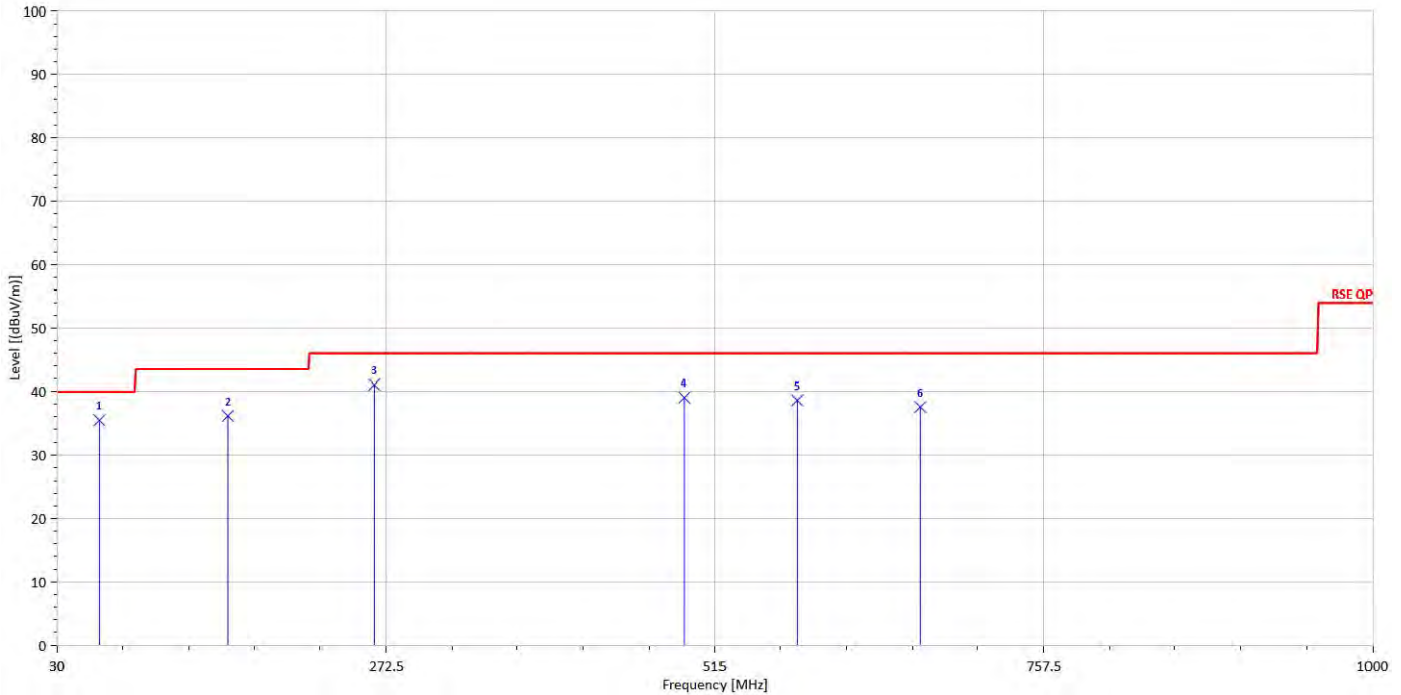

Freq. MHz	Note F/H/E/S	Detector Mode PK/QP/AV	Spectrum Reading Level dBμV	Factor dB	Actual FS dBμV/m	Limit @3m dBμV/m	Margin dB
61.04	S	Peak	55.24	-19.73	35.50	40	-4.50
156.10	S	Peak	50.08	-13.90	36.18	43.5	-7.32
263.77	S	Peak	51.56	-10.47	41.09	46	-4.91
492.69	S	Peak	43.93	-4.85	39.07	46	-6.93
576.11	S	Peak	41.86	-3.20	38.66	46	-7.34
666.32	S	Peak	39.32	-1.74	37.58	46	-8.42

Unless otherwise stated the results shown in this test report refer only to the sample(s) tested and such sample(s) are retained for 90 days only.

除非另有說明，此報告結果僅對測試之樣品負責，同時此樣品僅保留90天。本報告未經本公司書面許可，不可部份複製。

This document is issued by the Company subject to its General Conditions of Service printed overleaf, available on request or accessible at www.sgs.com/terms_and_conditions.htm and, for electronic format documents, subject to Terms and Conditions for Electronic Documents at www.sgs.com/terms_e-document.htm. Attention is drawn to the limitation of liability, indemnification and jurisdiction issues defined therein. Any holder of this document is advised that information contained hereon reflects the Company's findings at the time of its intervention only and within the limits of Client's instructions, if any. The Company's sole responsibility is to its Client and this document does not exonerate parties to a transaction from exercising all their rights and obligations under the transaction documents. This document cannot be reproduced except in full, without prior written approval of the Company. Any unauthorized alteration, forgery or falsification of the content or appearance of this document is unlawful and offenders may be prosecuted to the fullest extent of the law.

SGS Taiwan Ltd.

No.134,WuKungRoad,NewTaipeiIndustrialPark,WukuDistrict,NewTaipeiCity,Taiwan24803/新北市五股區新北產業園區五工路 134 號

台灣檢驗科技股份有限公司

t (886-2) 2299-3279

f (886-2) 2298-0488

www.tw.sgs.com

Member of SGS Group

802.11a 5250~5350 MHz

Operation Mode :	802.11a	Test Date :	2017/7/18
Fundamental Frequency :	5300 MHz	Temp. / Humi. :	22.7deg_C/57RH
Operation Band :	Tx CH Mid	Test Engineer :	Ashton
EUT Pol. :	H	Measurement Antenna Pol. :	Vertical

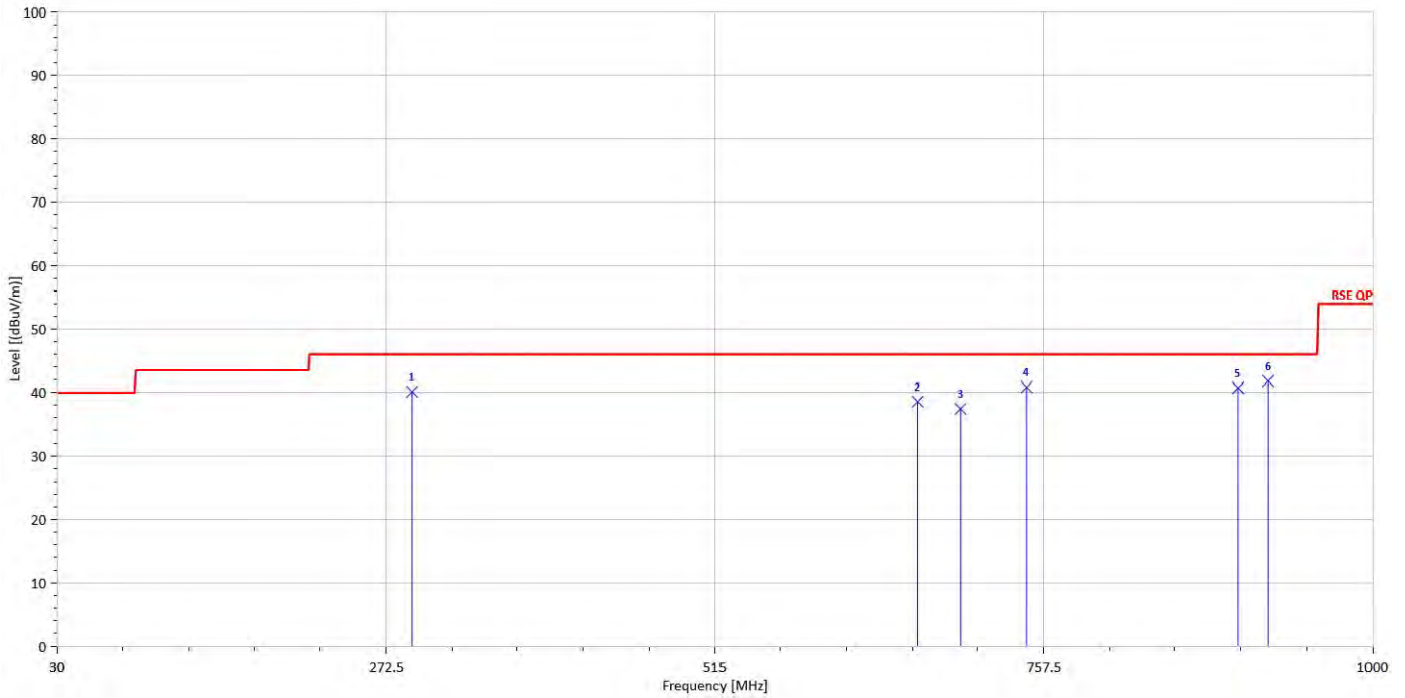

Freq. MHz	Note F/H/E/S	Detector Mode PK/QP/AV	Spectrum Reading Level dBμV	Factor dB	Actual FS dBμV/m	Limit @3m dBμV/m	Margin dB
291.90	S	Peak	50.48	-10.33	40.15	46	-5.85
664.38	S	Peak	40.29	-1.70	38.59	46	-7.41
696.39	S	Peak	39.66	-2.21	37.45	46	-8.55
744.89	S	Peak	41.65	-0.80	40.84	46	-5.16
901.06	S	Peak	39.40	1.35	40.75	46	-5.25
923.37	S	Peak	40.24	1.58	41.82	46	-4.18

Unless otherwise stated the results shown in this test report refer only to the sample(s) tested and such sample(s) are retained for 90 days only.

除非另有說明，此報告結果僅對測試之樣品負責，同時此樣品僅保留90天。本報告未經本公司書面許可，不可部份複製。

This document is issued by the Company subject to its General Conditions of Service printed overleaf, available on request or accessible at www.sgs.com/terms_and_conditions.htm and, for electronic format documents, subject to Terms and Conditions for Electronic Documents at www.sgs.com/terms_e-document.htm. Attention is drawn to the limitation of liability, indemnification and jurisdiction issues defined therein. Any holder of this document is advised that information contained hereon reflects the Company's findings at the time of its intervention only and within the limits of Client's instructions, if any. The Company's sole responsibility is to its Client and this document does not exonerate parties to a transaction from exercising all their rights and obligations under the transaction documents. This document cannot be reproduced except in full, without prior written approval of the Company. Any unauthorized alteration, forgery or falsification of the content or appearance of this document is unlawful and offenders may be prosecuted to the fullest extent of the law.

SGS Taiwan Ltd.

No.134,WuKungRoad,NewTaipeiIndustrialPark,WukuDistrict,NewTaipeiCity,Taiwan24803/新北市五股區新北產業園區五工路 134 號

台灣檢驗科技股份有限公司

t (886-2) 2299-3279

f (886-2) 2298-0488

www.tw.sgs.com

Member of SGS Group

Operation Mode : 802.11a Test Date : 2017/7/18
 Fundamental Frequency : 5300 MHz Temp. / Humi. : 22.7deg_C/57RH
 Operation Band : Tx CH Mid Test Engineer : Ashton
 EUT Pol. : H Measurement Antenna Pol. : Horizontal

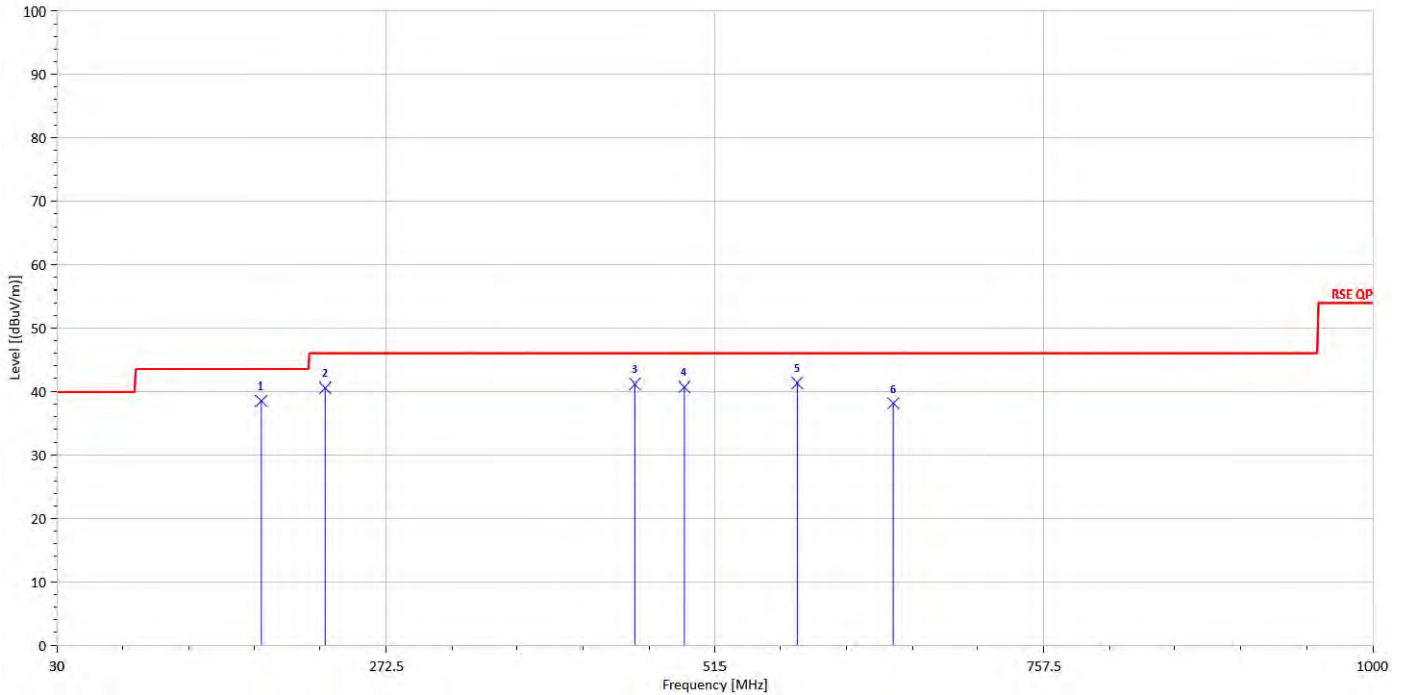

Freq. MHz	Note F/H/E/S	Detector Mode PK/QP/AV	Spectrum Reading Level dBμV	Factor dB	Actual FS dBμV/m	Limit @3m dBμV/m	Margin dB
180.35	S	Peak	53.86	-15.28	38.58	43.5	-4.92
227.88	S	Peak	53.89	-13.27	40.62	46	-5.38
455.83	S	Peak	46.72	-5.54	41.19	46	-4.81
492.69	S	Peak	45.61	-4.85	40.76	46	-5.24
576.11	S	Peak	44.55	-3.20	41.35	46	-4.65
646.92	S	Peak	40.02	-1.81	38.21	46	-7.79

Unless otherwise stated the results shown in this test report refer only to the sample(s) tested and such sample(s) are retained for 90 days only.

除非另有說明，此報告結果僅對測試之樣品負責，同時此樣品僅保留90天。本報告未經本公司書面許可，不可部份複製。

This document is issued by the Company subject to its General Conditions of Service printed overleaf, available on request or accessible at www.sgs.com/terms_and_conditions.htm and, for electronic format documents, subject to Terms and Conditions for Electronic Documents at www.sgs.com/terms_e-document.htm. Attention is drawn to the limitation of liability, indemnification and jurisdiction issues defined therein. Any holder of this document is advised that information contained hereon reflects the Company's findings at the time of its intervention only and within the limits of Client's instructions, if any. The Company's sole responsibility is to its Client and this document does not exonerate parties to a transaction from exercising all their rights and obligations under the transaction documents. This document cannot be reproduced except in full, without prior written approval of the Company. Any unauthorized alteration, forgery or falsification of the content or appearance of this document is unlawful and offenders may be prosecuted to the fullest extent of the law.

SGS Taiwan Ltd.

No.134,WuKungRoad,NewTaipeiIndustrialPark,WukuDistrict,NewTaipeiCity,Taiwan24803/新北市五股區新北產業園區五工路 134 號

台灣檢驗科技股份有限公司

t (886-2) 2299-3279

f (886-2) 2298-0488

www.tw.sgs.com

Member of SGS Group

802.11a, 5470~5725 MHz

Operation Mode :	802.11a	Test Date :	2017/7/18
Fundamental Frequency :	5580 MHz	Temp. / Humi. :	22.7deg_C/57RH
Operation Band :	Tx CH Mid	Test Engineer :	Ashton
EUT Pol. :	H	Measurement Antenna Pol. :	Vertical

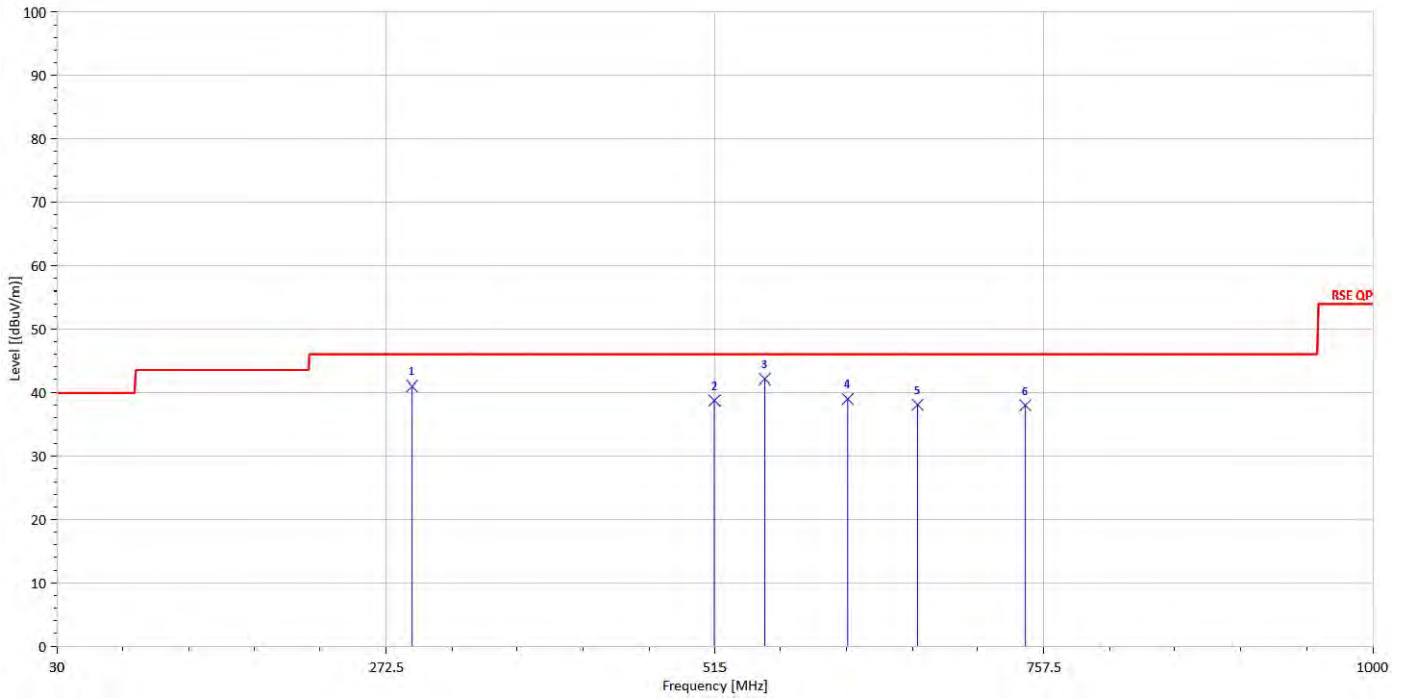

Freq. MHz	Note F/H/E/S	Detector Mode PK/QP/AV	Spectrum Reading Level dBµV	Factor dB	Actual FS dBµV/m	Limit @3m dBµV/m	Margin dB
291.90	S	Peak	51.36	-10.33	41.03	46	-4.97
515.00	S	Peak	43.33	-4.54	38.79	46	-7.21
551.86	S	Peak	45.54	-3.44	42.10	46	-3.90
612.97	S	Peak	41.97	-2.94	39.03	46	-6.97
664.38	S	Peak	39.84	-1.70	38.14	46	-7.86
743.92	S	Peak	38.86	-0.82	38.04	46	-7.96

Unless otherwise stated the results shown in this test report refer only to the sample(s) tested and such sample(s) are retained for 90 days only.

除非另有說明，此報告結果僅對測試之樣品負責，同時此樣品僅保留90天。本報告未經本公司書面許可，不可部份複製。

This document is issued by the Company subject to its General Conditions of Service printed overleaf, available on request or accessible at www.sgs.com/terms_and_conditions.htm and, for electronic format documents, subject to Terms and Conditions for Electronic Documents at www.sgs.com/terms_e-document.htm. Attention is drawn to the limitation of liability, indemnification and jurisdiction issues defined therein. Any holder of this document is advised that information contained hereon reflects the Company's findings at the time of its intervention only and within the limits of Client's instructions, if any. The Company's sole responsibility is to its Client and this document does not exonerate parties to a transaction from exercising all their rights and obligations under the transaction documents. This document cannot be reproduced except in full, without prior written approval of the Company. Any unauthorized alteration, forgery or falsification of the content or appearance of this document is unlawful and offenders may be prosecuted to the fullest extent of the law.

SGS Taiwan Ltd.

No.134,WuKungRoad,NewTaipeiIndustrialPark,WukuDistrict,NewTaipeiCity,Taiwan24803/新北市五股區新北產業園區五工路 134 號

台灣檢驗科技股份有限公司

t (886-2) 2299-3279

f (886-2) 2298-0488

www.tw.sgs.com

Member of SGS Group

Operation Mode : 802.11a Test Date : 2017/7/18
 Fundamental Frequency : 5580 MHz Temp. / Humi. : 22.7deg_C/57RH
 Operation Band : Tx CH Mid Test Engineer : Ashton
 EUT Pol. : H Measurement Antenna Pol. : Horizontal

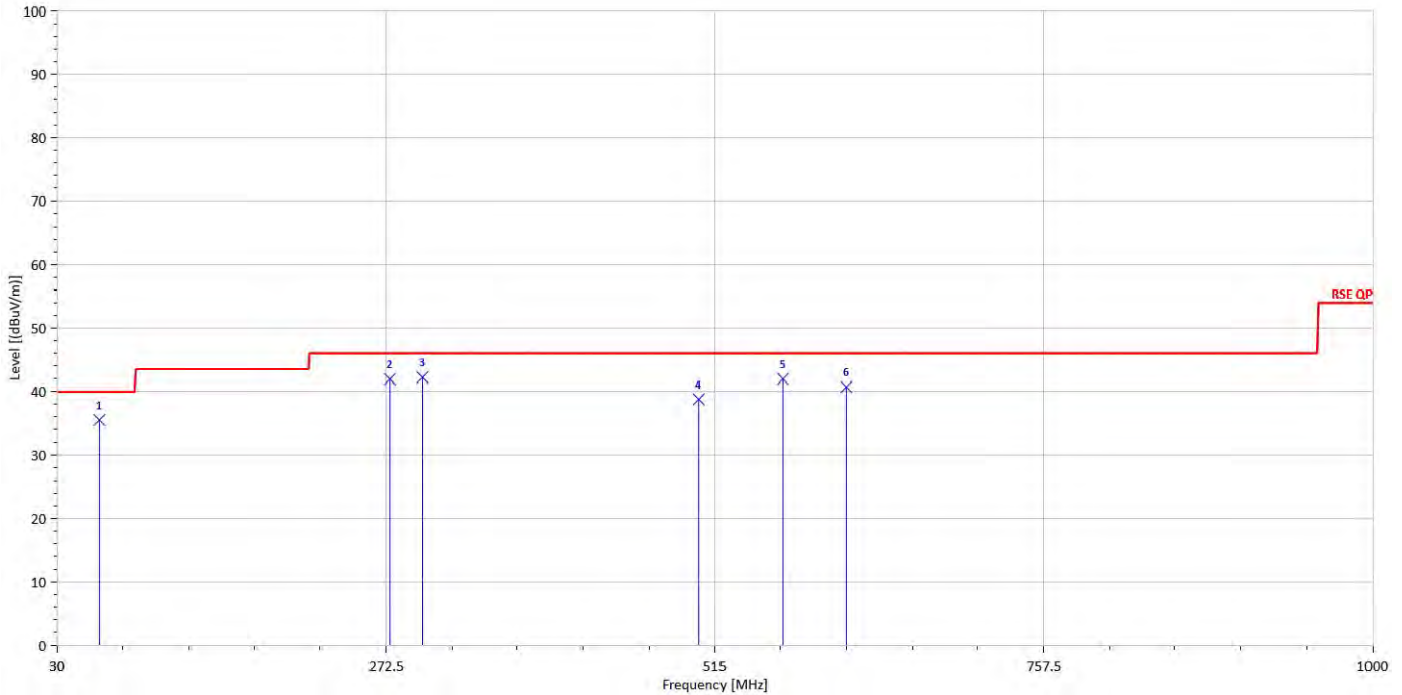

Freq. MHz	Note F/H/E/S	Detector Mode PK/QP/AV	Spectrum Reading Level dBμV	Factor dB	Actual FS dBμV/m	Limit @3m dBμV/m	Margin dB
61.04	S	Peak	55.27	-19.73	35.54	40	-4.46
275.41	S	Peak	52.60	-10.66	41.95	46	-4.05
299.66	S	Peak	52.35	-10.13	42.22	46	-3.78
503.36	S	Peak	43.55	-4.74	38.81	46	-7.19
565.44	S	Peak	45.38	-3.40	41.98	46	-4.02
612.00	S	Peak	43.68	-2.94	40.74	46	-5.26

Unless otherwise stated the results shown in this test report refer only to the sample(s) tested and such sample(s) are retained for 90 days only.

除非另有說明，此報告結果僅對測試之樣品負責，同時此樣品僅保留90天。本報告未經本公司書面許可，不可部份複製。

This document is issued by the Company subject to its General Conditions of Service printed overleaf, available on request or accessible at www.sgs.com/terms_and_conditions.htm and, for electronic format documents, subject to Terms and Conditions for Electronic Documents at www.sgs.com/terms_e-document.htm. Attention is drawn to the limitation of liability, indemnification and jurisdiction issues defined therein. Any holder of this document is advised that information contained hereon reflects the Company's findings at the time of its intervention only and within the limits of Client's instructions, if any. The Company's sole responsibility is to its Client and this document does not exonerate parties to a transaction from exercising all their rights and obligations under the transaction documents. This document cannot be reproduced except in full, without prior written approval of the Company. Any unauthorized alteration, forgery or falsification of the content or appearance of this document is unlawful and offenders may be prosecuted to the fullest extent of the law.

SGS Taiwan Ltd.

No.134,WuKungRoad,NewTaipeiIndustrialPark,WukuDistrict,NewTaipeiCity,Taiwan24803/新北市五股區新北產業園區五工路 134 號

台灣檢驗科技股份有限公司

t (886-2) 2299-3279

f (886-2) 2298-0488

www.tw.sgs.com

Member of SGS Group

802.11a, 5725~5850 MHz

Operation Mode :	802.11a	Test Date :	2017/7/18
Fundamental Frequency :	5785 MHz	Temp. / Humi. :	22.7deg_C/57RH
Operation Band :	Tx CH Mid	Test Engineer :	Ashton
EUT Pol. :	H	Measurement Antenna Pol. :	Vertical

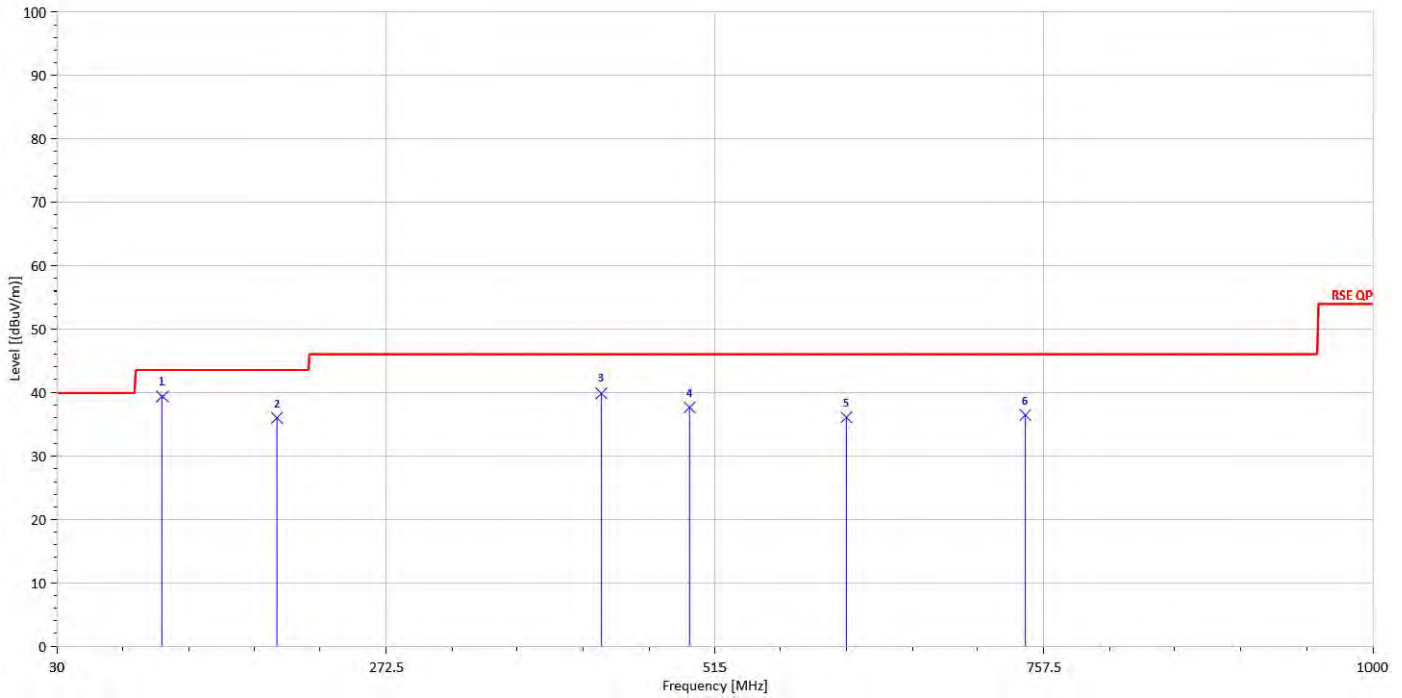

Freq. MHz	Note F/H/E/S	Detector Mode PK/QP/AV	Spectrum Reading Level dBµV	Factor dB	Actual FS dBµV/m	Limit @3m dBµV/m	Margin dB
107.60	S	Peak	53.21	-13.78	39.43	43.5	-4.07
191.99	S	Peak	51.05	-15.02	36.03	43.5	-7.47
431.58	S	Peak	45.63	-5.70	39.93	46	-6.07
496.57	S	Peak	42.52	-4.81	37.71	46	-8.29
612.00	S	Peak	39.04	-2.94	36.11	46	-9.89
743.92	S	Peak	37.30	-0.82	36.49	46	-9.51

Unless otherwise stated the results shown in this test report refer only to the sample(s) tested and such sample(s) are retained for 90 days only.

除非另有說明，此報告結果僅對測試之樣品負責，同時此樣品僅保留90天。本報告未經本公司書面許可，不可部份複製。

This document is issued by the Company subject to its General Conditions of Service printed overleaf, available on request or accessible at www.sgs.com/terms_and_conditions.htm and, for electronic format documents, subject to Terms and Conditions for Electronic Documents at www.sgs.com/terms_e-document.htm. Attention is drawn to the limitation of liability, indemnification and jurisdiction issues defined therein. Any holder of this document is advised that information contained hereon reflects the Company's findings at the time of its intervention only and within the limits of Client's instructions, if any. The Company's sole responsibility is to its Client and this document does not exonerate parties to a transaction from exercising all their rights and obligations under the transaction documents. This document cannot be reproduced except in full, without prior written approval of the Company. Any unauthorized alteration, forgery or falsification of the content or appearance of this document is unlawful and offenders may be prosecuted to the fullest extent of the law.

SGS Taiwan Ltd.

No.134,WuKungRoad,NewTaipeiIndustrialPark,WukuDistrict,NewTaipeiCity,Taiwan24803/新北市五股區新北產業園區五工路 134 號

台灣檢驗科技股份有限公司

t (886-2) 2299-3279

f (886-2) 2298-0488

www.tw.sgs.com

Member of SGS Group

Operation Mode : 802.11a Test Date : 2017/7/18
 Fundamental Frequency : 5785 MHz Temp. / Humi. : 22.7deg_C/57RH
 Operation Band : Tx CH Mid Test Engineer : Ashton
 EUT Pol. : H Measurement Antenna Pol. : Horizontal

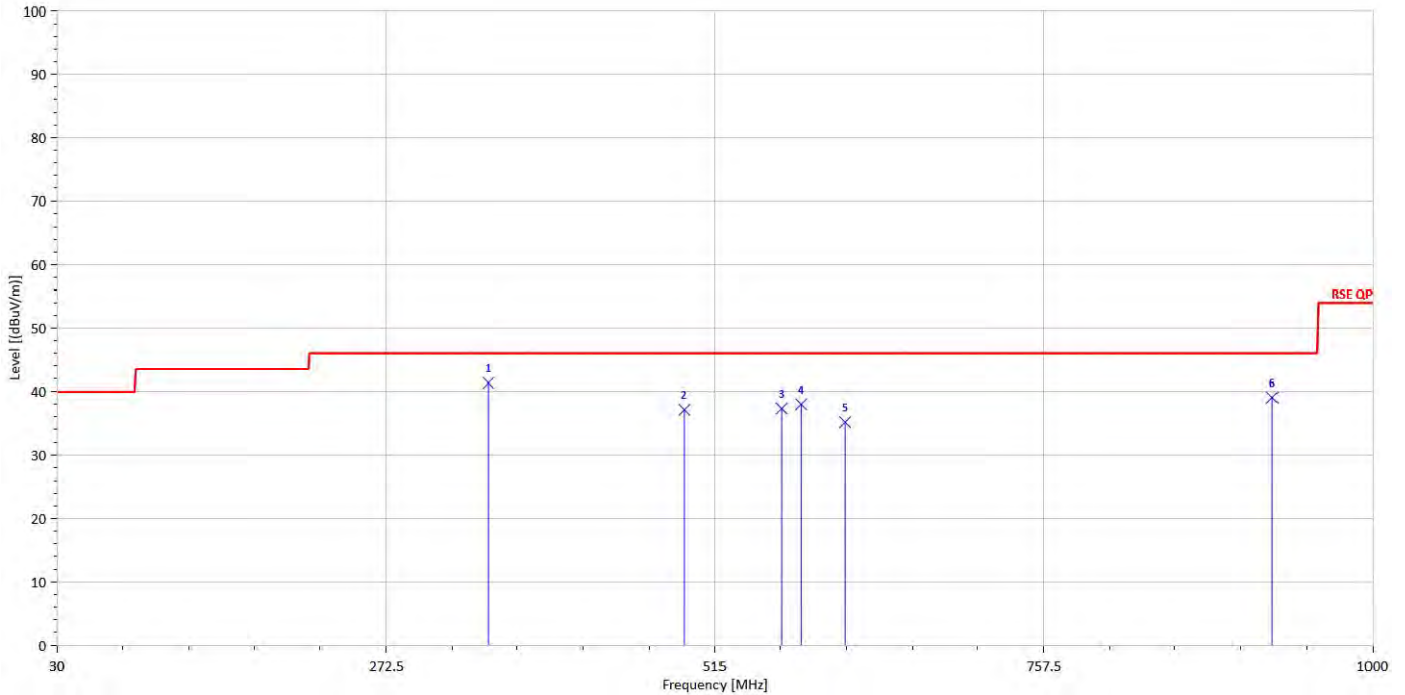

Freq. MHz	Note F/H/E/S	Detector Mode PK/QP/AV	Spectrum Reading Level dB μ V	Factor dB	Actual FS dB μ V/m	Limit @3m dB μ V/m	Margin dB
348.16	S	Peak	49.64	-8.28	41.36	46	-4.64
492.69	S	Peak	42.00	-4.85	37.15	46	-8.85
564.47	S	Peak	40.76	-3.41	37.35	46	-8.65
579.02	S	Peak	41.17	-3.13	38.03	46	-7.97
611.03	S	Peak	38.12	-2.94	35.18	46	-10.82
926.28	S	Peak	37.47	1.62	39.10	46	-6.90

Unless otherwise stated the results shown in this test report refer only to the sample(s) tested and such sample(s) are retained for 90 days only.

除非另有說明，此報告結果僅對測試之樣品負責，同時此樣品僅保留90天。本報告未經本公司書面許可，不可部份複製。

This document is issued by the Company subject to its General Conditions of Service printed overleaf, available on request or accessible at www.sgs.com/terms_and_conditions.htm and, for electronic format documents, subject to Terms and Conditions for Electronic Documents at www.sgs.com/terms_e-document.htm. Attention is drawn to the limitation of liability, indemnification and jurisdiction issues defined therein. Any holder of this document is advised that information contained hereon reflects the Company's findings at the time of its intervention only and within the limits of Client's instructions, if any. The Company's sole responsibility is to its Client and this document does not exonerate parties to a transaction from exercising all their rights and obligations under the transaction documents. This document cannot be reproduced except in full, without prior written approval of the Company. Any unauthorized alteration, forgery or falsification of the content or appearance of this document is unlawful and offenders may be prosecuted to the fullest extent of the law.

SGS Taiwan Ltd.

No.134,WuKungRoad,NewTaipeiIndustrialPark,WukuDistrict,NewTaipeiCity,Taiwan24803/新北市五股區新北產業園區五工路 134 號

台灣檢驗科技股份有限公司

t (886-2) 2299-3279

f (886-2) 2298-0488

www.tw.sgs.com

Member of SGS Group

Above 1GHz Worst-Case Data:

Radiated Spurious Emission Measurement Result 802.11a, 5150~5250 MHz

Operation Mode :	802.11a	Test Date :	2017/7/14
Fundamental Frequency :	5180 MHz	Temp. / Humi. :	22.7deg_C/57RH
Operation Band :	Tx CH Low	Test Engineer :	Ashton
EUT Pol. :	H	Measurement Antenna Pol. :	Vertical

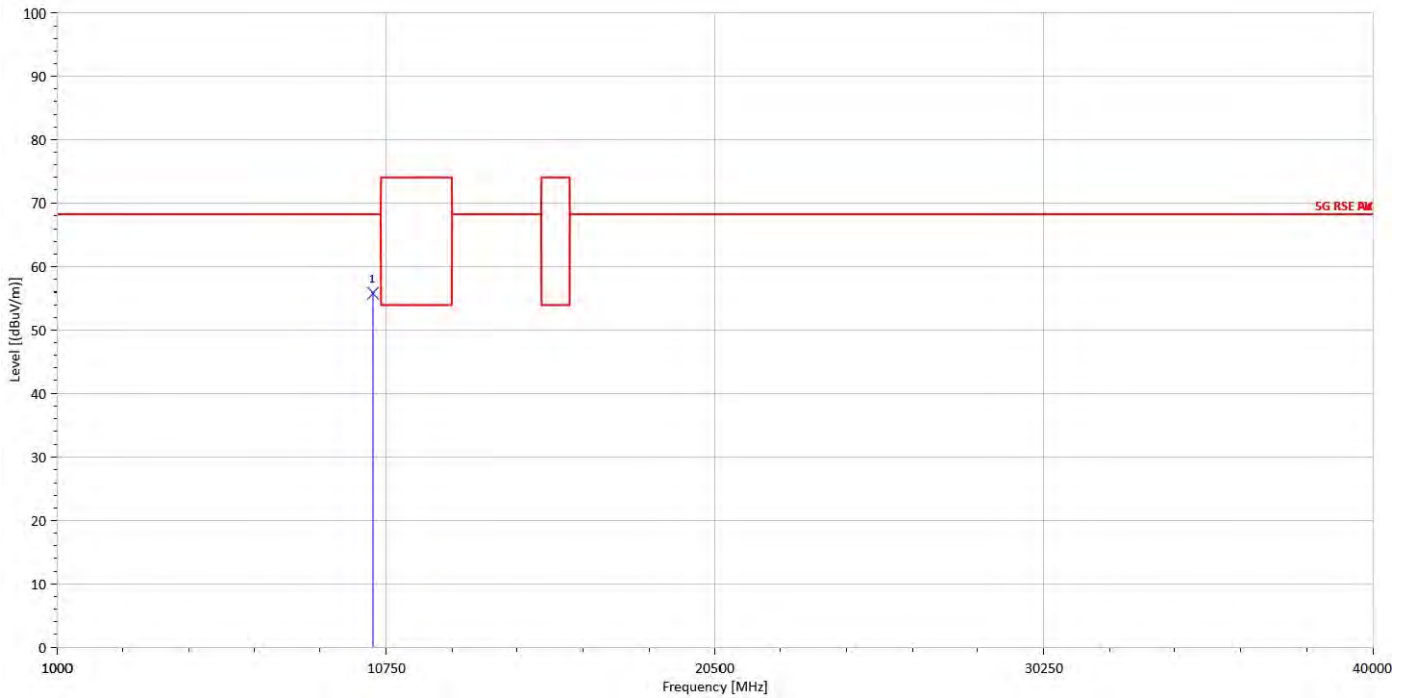

Freq. MHz	Note F/H/E/S	Detector Mode PK/QP/AV	Spectrum Reading Level dBuV	Factor dB	Actual FS dBuV/m	Limit @3m dBuV/m	Margin dB
10360.00	H	Peak	30.06	25.76	55.82	68.3	-12.48

Unless otherwise stated the results shown in this test report refer only to the sample(s) tested and such sample(s) are retained for 90 days only.

除非另有說明，此報告結果僅對測試之樣品負責，同時此樣品僅保留90天。本報告未經本公司書面許可，不可部份複製。

This document is issued by the Company subject to its General Conditions of Service printed overleaf, available on request or accessible at www.sgs.com/terms_and_conditions.htm and, for electronic format documents, subject to Terms and Conditions for Electronic Documents at www.sgs.com/terms_e-document.htm. Attention is drawn to the limitation of liability, indemnification and jurisdiction issues defined therein. Any holder of this document is advised that information contained hereon reflects the Company's findings at the time of its intervention only and within the limits of Client's instructions, if any. The Company's sole responsibility is to its Client and this document does not exonerate parties to a transaction from exercising all their rights and obligations under the transaction documents. This document cannot be reproduced except in full, without prior written approval of the Company. Any unauthorized alteration, forgery or falsification of the content or appearance of this document is unlawful and offenders may be prosecuted to the fullest extent of the law.

SGS Taiwan Ltd.

No.134,WuKungRoad,NewTaipeiIndustrialPark,WukuDistrict,NewTaipeiCity,Taiwan24803/新北市五股區新北產業園區五工路 134 號

台灣檢驗科技股份有限公司

t (886-2) 2299-3279

f (886-2) 2298-0488

www.tw.sgs.com

Member of SGS Group

Operation Mode : 802.11a Test Date : 2017/7/14
 Fundamental Frequency : 5180 MHz Temp. / Humi. : 22.7deg_C/57RH
 Operation Band : Tx CH Low Test Engineer : Ashton
 EUT Pol. : H Measurement Antenna Pol. : Horizontal

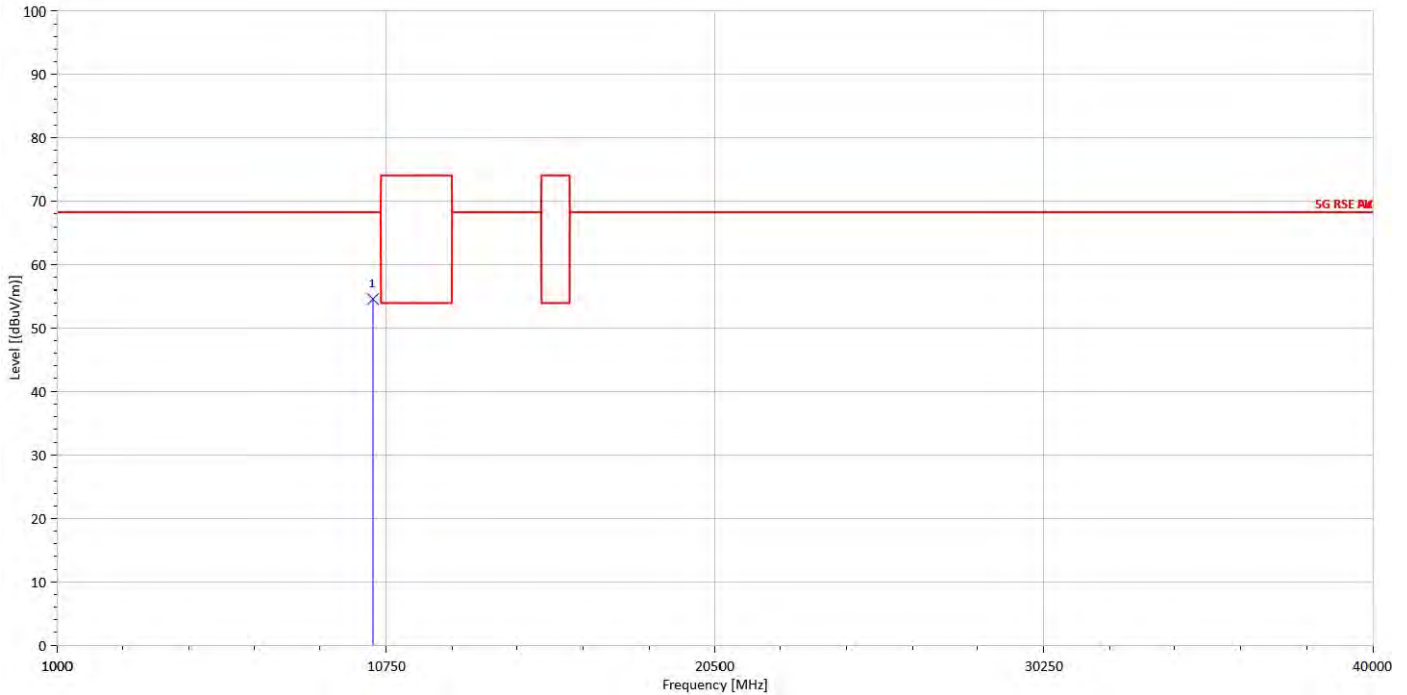

Freq. MHz	Note F/H/E/S	Detector Mode PK/QP/AV	Spectrum Reading Level dB μ V	Factor dB	Actual FS dB μ V/m	Limit @3m dB μ V/m	Margin dB
10360.00	H	Peak	28.88	25.76	54.64	68.3	-13.66

Unless otherwise stated the results shown in this test report refer only to the sample(s) tested and such sample(s) are retained for 90 days only.

除非另有說明，此報告結果僅對測試之樣品負責，同時此樣品僅保留90天。本報告未經本公司書面許可，不可部份複製。

This document is issued by the Company subject to its General Conditions of Service printed overleaf, available on request or accessible at www.sgs.com/terms_and_conditions.htm and, for electronic format documents, subject to Terms and Conditions for Electronic Documents at www.sgs.com/terms_e-document.htm. Attention is drawn to the limitation of liability, indemnification and jurisdiction issues defined therein. Any holder of this document is advised that information contained hereon reflects the Company's findings at the time of its intervention only and within the limits of Client's instructions, if any. The Company's sole responsibility is to its Client and this document does not exonerate parties to a transaction from exercising all their rights and obligations under the transaction documents. This document cannot be reproduced except in full, without prior written approval of the Company. Any unauthorized alteration, forgery or falsification of the content or appearance of this document is unlawful and offenders may be prosecuted to the fullest extent of the law.

SGS Taiwan Ltd.

No. 134, WuKungRoad, New Taipei Industrial Park, Wuku District, New Taipei City, Taiwan 24803 / 新北市五股區新北產業園區五工路 134 號

台灣檢驗科技股份有限公司

t (886-2) 2299-3279

f (886-2) 2298-0488

www.tw.sgs.com

Member of SGS Group

Operation Mode : 802.11a Test Date : 2017/7/14
 Fundamental Frequency : 5220 MHz Temp. / Humi. : 22.7deg_C/57RH
 Operation Band : Tx CH Mid Test Engineer : Ashton
 EUT Pol. : H Measurement Antenna Pol. : Vertical

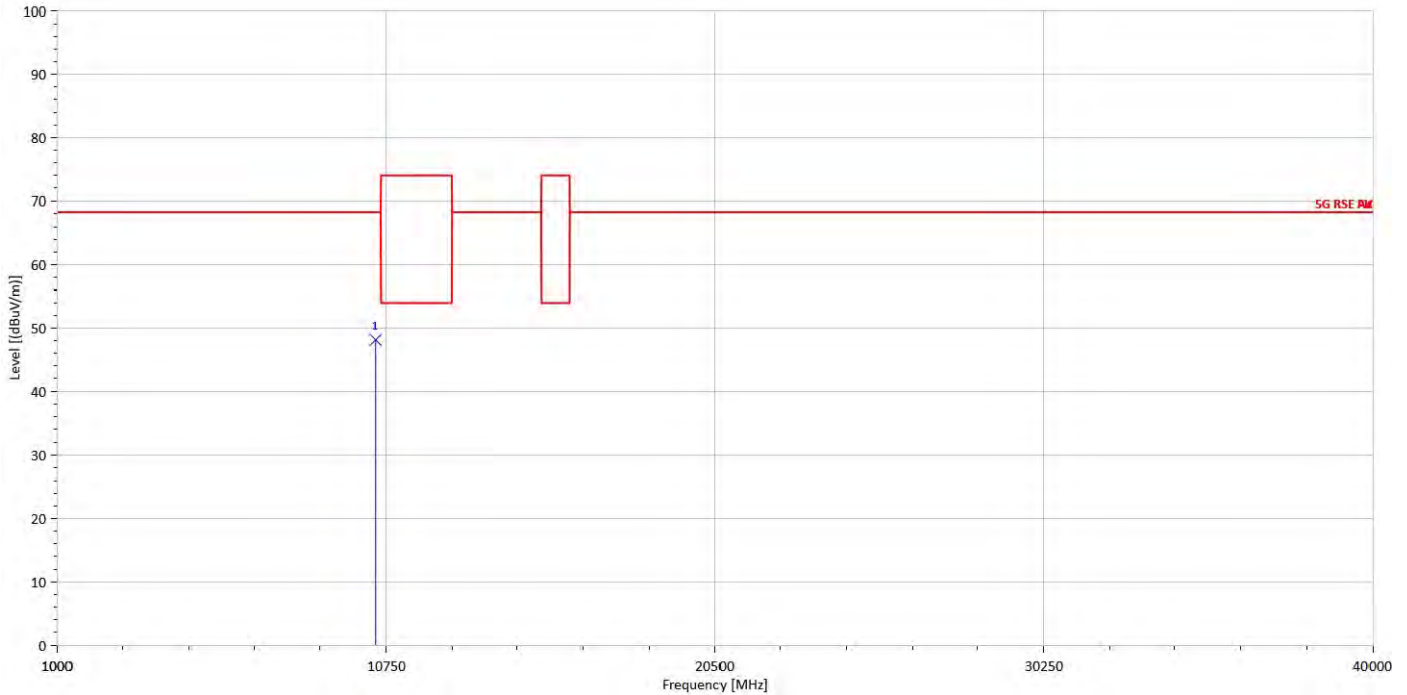

Freq. MHz	Note F/H/E/S	Detector Mode PK/QP/AV	Spectrum Reading Level dB μ V	Factor dB	Actual FS dB μ V/m	Limit @3m dB μ V/m	Margin dB
10440.00	H	Peak	22.37	25.77	48.14	68.3	-20.16

Unless otherwise stated the results shown in this test report refer only to the sample(s) tested and such sample(s) are retained for 90 days only.

除非另有說明，此報告結果僅對測試之樣品負責，同時此樣品僅保留90天。本報告未經本公司書面許可，不可部份複製。

This document is issued by the Company subject to its General Conditions of Service printed overleaf, available on request or accessible at www.sgs.com/terms_and_conditions.htm and, for electronic format documents, subject to Terms and Conditions for Electronic Documents at www.sgs.com/terms_e-document.htm. Attention is drawn to the limitation of liability, indemnification and jurisdiction issues defined therein. Any holder of this document is advised that information contained hereon reflects the Company's findings at the time of its intervention only and within the limits of Client's instructions, if any. The Company's sole responsibility is to its Client and this document does not exonerate parties to a transaction from exercising all their rights and obligations under the transaction documents. This document cannot be reproduced except in full, without prior written approval of the Company. Any unauthorized alteration, forgery or falsification of the content or appearance of this document is unlawful and offenders may be prosecuted to the fullest extent of the law.

SGS Taiwan Ltd.

No.134,WuKungRoad,NewTaipeiIndustrialPark,WukuDistrict,NewTaipeiCity,Taiwan24803/新北市五股區新北產業園區五工路 134 號

台灣檢驗科技股份有限公司

t (886-2) 2299-3279

f (886-2) 2298-0488

www.tw.sgs.com

Member of SGS Group

Operation Mode : 802.11a Test Date : 2017/7/14
 Fundamental Frequency : 5220 MHz Temp. / Humi. : 22.7deg_C/57RH
 Operation Band : Tx CH Mid Test Engineer : Ashton
 EUT Pol. : H Measurement Antenna Pol. : Horizontal

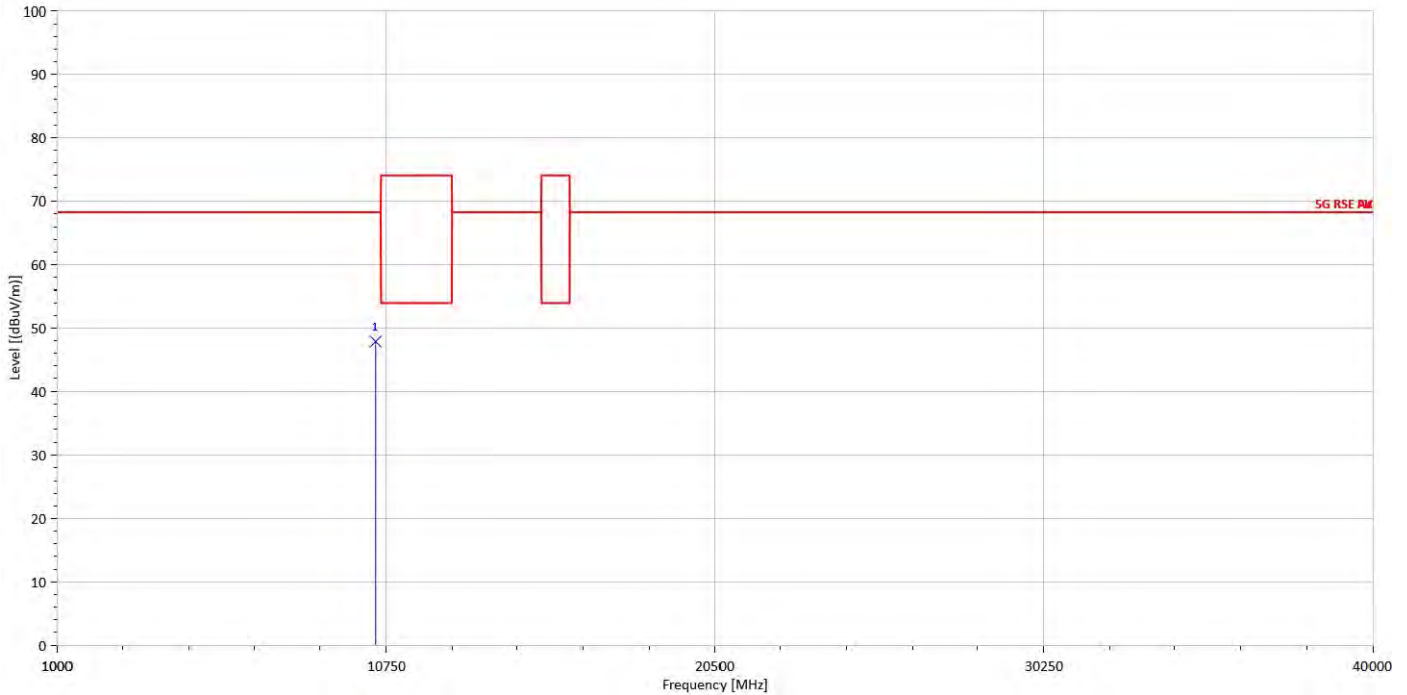

Freq. MHz	Note F/H/E/S	Detector Mode PK/QP/AV	Spectrum Reading Level dB μ V	Factor dB	Actual FS dB μ V/m	Limit @3m dB μ V/m	Margin dB
10440.00	H	Peak	22.10	25.77	47.87	68.3	-20.43

Unless otherwise stated the results shown in this test report refer only to the sample(s) tested and such sample(s) are retained for 90 days only.

除非另有說明，此報告結果僅對測試之樣品負責，同時此樣品僅保留90天。本報告未經本公司書面許可，不可部份複製。

This document is issued by the Company subject to its General Conditions of Service printed overleaf, available on request or accessible at www.sgs.com/terms_and_conditions.htm and, for electronic format documents, subject to Terms and Conditions for Electronic Documents at www.sgs.com/terms_e-document.htm. Attention is drawn to the limitation of liability, indemnification and jurisdiction issues defined therein. Any holder of this document is advised that information contained hereon reflects the Company's findings at the time of its intervention only and within the limits of Client's instructions, if any. The Company's sole responsibility is to its Client and this document does not exonerate parties to a transaction from exercising all their rights and obligations under the transaction documents. This document cannot be reproduced except in full, without prior written approval of the Company. Any unauthorized alteration, forgery or falsification of the content or appearance of this document is unlawful and offenders may be prosecuted to the fullest extent of the law.

SGS Taiwan Ltd.

No.134,WuKungRoad,NewTaipeiIndustrialPark,WukuDistrict,NewTaipeiCity,Taiwan24803/新北市五股區新北產業園區五工路 134 號

台灣檢驗科技股份有限公司

t (886-2) 2299-3279

f (886-2) 2298-0488

www.tw.sgs.com

Member of SGS Group

Operation Mode :	802.11a	Test Date :	2017/7/14
Fundamental Frequency :	5240 MHz	Temp. / Humi. :	22.7deg_C/57RH
Operation Band :	Tx CH High	Test Engineer :	Ashton
EUT Pol. :	H	Measurement Antenna Pol. :	Vertical

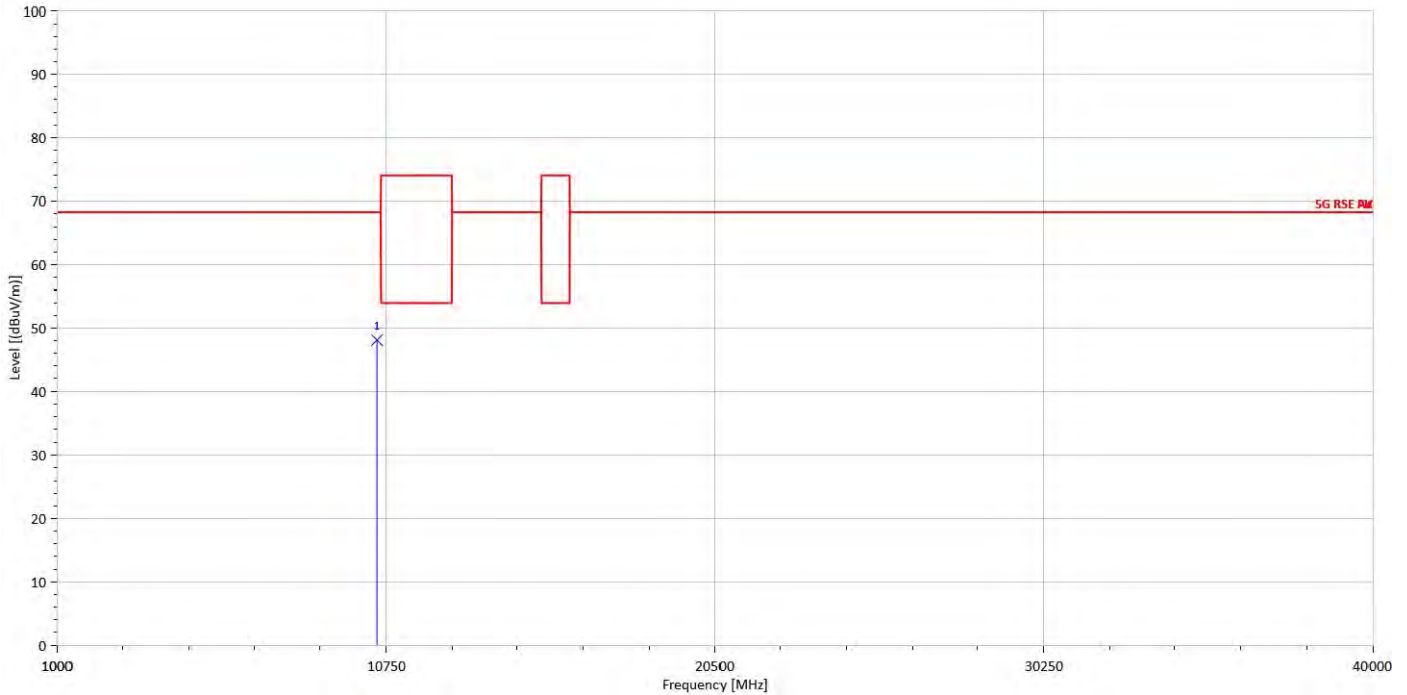

Freq. MHz	Note F/H/E/S	Detector Mode PK/QP/AV	Spectrum Reading Level dB μ V	Factor dB	Actual FS dB μ V/m	Limit @3m dB μ V/m	Margin dB
10480.00	H	Peak	22.34	25.78	48.12	68.3	-20.18

Unless otherwise stated the results shown in this test report refer only to the sample(s) tested and such sample(s) are retained for 90 days only.

除非另有說明，此報告結果僅對測試之樣品負責，同時此樣品僅保留90天。本報告未經本公司書面許可，不可部份複製。

This document is issued by the Company subject to its General Conditions of Service printed overleaf, available on request or accessible at www.sgs.com/terms_and_conditions.htm and, for electronic format documents, subject to Terms and Conditions for Electronic Documents at www.sgs.com/terms_e-document.htm. Attention is drawn to the limitation of liability, indemnification and jurisdiction issues defined therein. Any holder of this document is advised that information contained hereon reflects the Company's findings at the time of its intervention only and within the limits of Client's instructions, if any. The Company's sole responsibility is to its Client and this document does not exonerate parties to a transaction from exercising all their rights and obligations under the transaction documents. This document cannot be reproduced except in full, without prior written approval of the Company. Any unauthorized alteration, forgery or falsification of the content or appearance of this document is unlawful and offenders may be prosecuted to the fullest extent of the law.

SGS Taiwan Ltd.

No.134,WuKungRoad,NewTaipeiIndustrialPark,WukuDistrict,NewTaipeiCity,Taiwan24803/新北市五股區新北產業園區五工路 134 號

台灣檢驗科技股份有限公司

t (886-2) 2299-3279

f (886-2) 2298-0488

www.tw.sgs.com

Member of SGS Group

Operation Mode :	802.11a	Test Date :	2017/7/14
Fundamental Frequency :	5240 MHz	Temp. / Humi. :	22.7deg_C/57RH
Operation Band :	Tx CH High	Test Engineer :	Ashton
EUT Pol. :	H	Measurement Antenna Pol. :	Horizontal

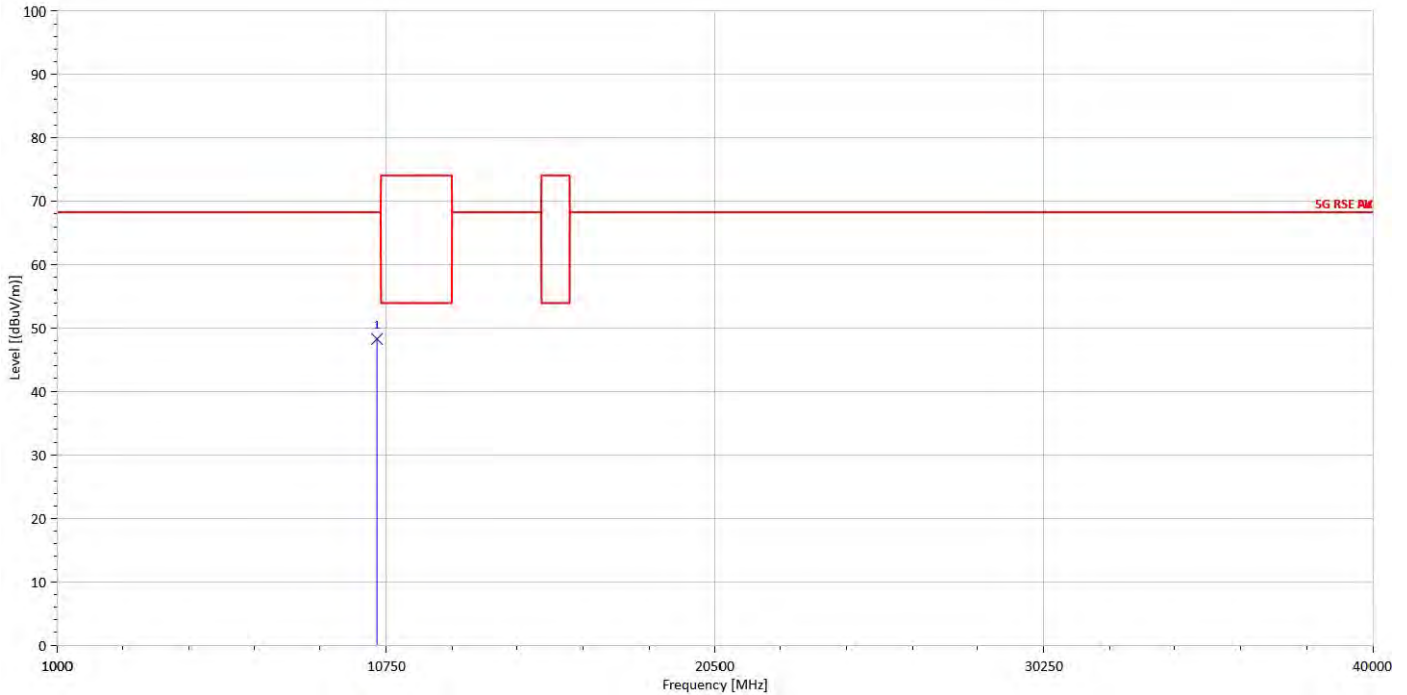

Freq. MHz	Note F/H/E/S	Detector Mode PK/QP/AV	Spectrum Reading Level dB μ V	Factor dB	Actual FS dB μ V/m	Limit @3m dB μ V/m	Margin dB
10480.00	H	Peak	22.50	25.78	48.28	68.3	-20.02

Unless otherwise stated the results shown in this test report refer only to the sample(s) tested and such sample(s) are retained for 90 days only.

除非另有說明，此報告結果僅對測試之樣品負責，同時此樣品僅保留90天。本報告未經本公司書面許可，不可部份複製。

This document is issued by the Company subject to its General Conditions of Service printed overleaf, available on request or accessible at www.sgs.com/terms_and_conditions.htm and, for electronic format documents, subject to Terms and Conditions for Electronic Documents at www.sgs.com/terms_e-document.htm. Attention is drawn to the limitation of liability, indemnification and jurisdiction issues defined therein. Any holder of this document is advised that information contained hereon reflects the Company's findings at the time of its intervention only and within the limits of Client's instructions, if any. The Company's sole responsibility is to its Client and this document does not exonerate parties to a transaction from exercising all their rights and obligations under the transaction documents. This document cannot be reproduced except in full, without prior written approval of the Company. Any unauthorized alteration, forgery or falsification of the content or appearance of this document is unlawful and offenders may be prosecuted to the fullest extent of the law.

SGS Taiwan Ltd.

No. 134, WuKungRoad, New Taipei Industrial Park, Wuku District, New Taipei City, Taiwan 24803 / 新北市五股區新北產業園區五工路 134 號

台灣檢驗科技股份有限公司

t (886-2) 2299-3279

f (886-2) 2298-0488

www.tw.sgs.com

Member of SGS Group

Radiated Spurious Emission Measurement Result 802.11a, 5250MHz-5350MHz

Operation Mode :	802.11a	Test Date :	2017/7/14
Fundamental Frequency :	5260 MHz	Temp. / Humi. :	22.7deg_C/57RH
Operation Band :	Tx CH Low	Test Engineer :	Ashton
EUT Pol. :	H	Measurement Antenna Pol. :	Vertical

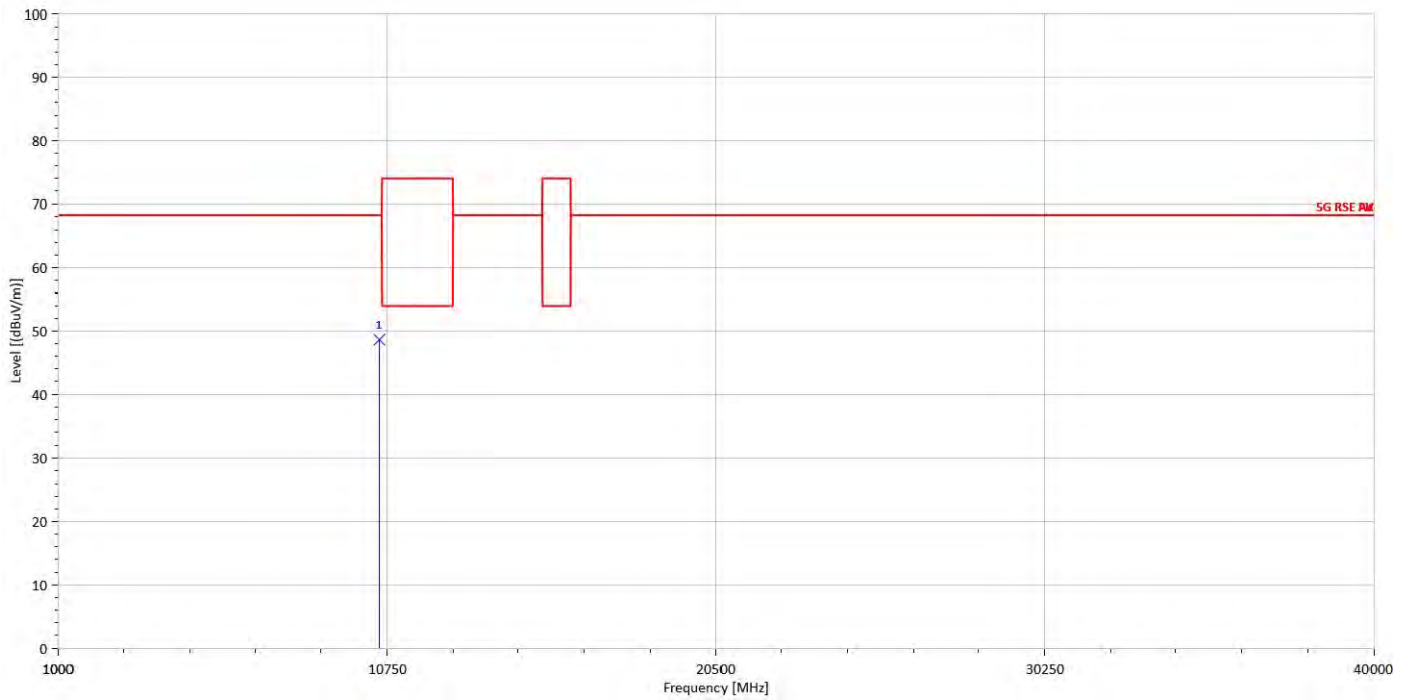

Freq. MHz	Note F/H/E/S	Detector Mode PK/QP/AV	Spectrum Reading Level dBuV	Factor dB	Actual FS dBuV/m	Limit @3m dBuV/m	Margin dB
10520.00	H	Peak	22.82	25.82	48.64	68.3	-19.66

Unless otherwise stated the results shown in this test report refer only to the sample(s) tested and such sample(s) are retained for 90 days only.

除非另有說明，此報告結果僅對測試之樣品負責，同時此樣品僅保留90天。本報告未經本公司書面許可，不可部份複製。

This document is issued by the Company subject to its General Conditions of Service printed overleaf, available on request or accessible at www.sgs.com/terms_and_conditions.htm and, for electronic format documents, subject to Terms and Conditions for Electronic Documents at www.sgs.com/terms_e-document.htm. Attention is drawn to the limitation of liability, indemnification and jurisdiction issues defined therein. Any holder of this document is advised that information contained hereon reflects the Company's findings at the time of its intervention only and within the limits of Client's instructions, if any. The Company's sole responsibility is to its Client and this document does not exonerate parties to a transaction from exercising all their rights and obligations under the transaction documents. This document cannot be reproduced except in full, without prior written approval of the Company. Any unauthorized alteration, forgery or falsification of the content or appearance of this document is unlawful and offenders may be prosecuted to the fullest extent of the law.

SGS Taiwan Ltd.

No.134,WuKungRoad,NewTaipeiIndustrialPark,WukuDistrict,NewTaipeiCity,Taiwan24803/新北市五股區新北產業園區五工路 134 號

台灣檢驗科技股份有限公司

t (886-2) 2299-3279

f (886-2) 2298-0488

www.tw.sgs.com

Member of SGS Group

Operation Mode : 802.11a Test Date : 2017/7/14
 Fundamental Frequency : 5260 MHz Temp. / Humi. : 22.7deg_C/57RH
 Operation Band : Tx CH Low Test Engineer : Ashton
 EUT Pol. : H Measurement Antenna Pol. : Horizontal

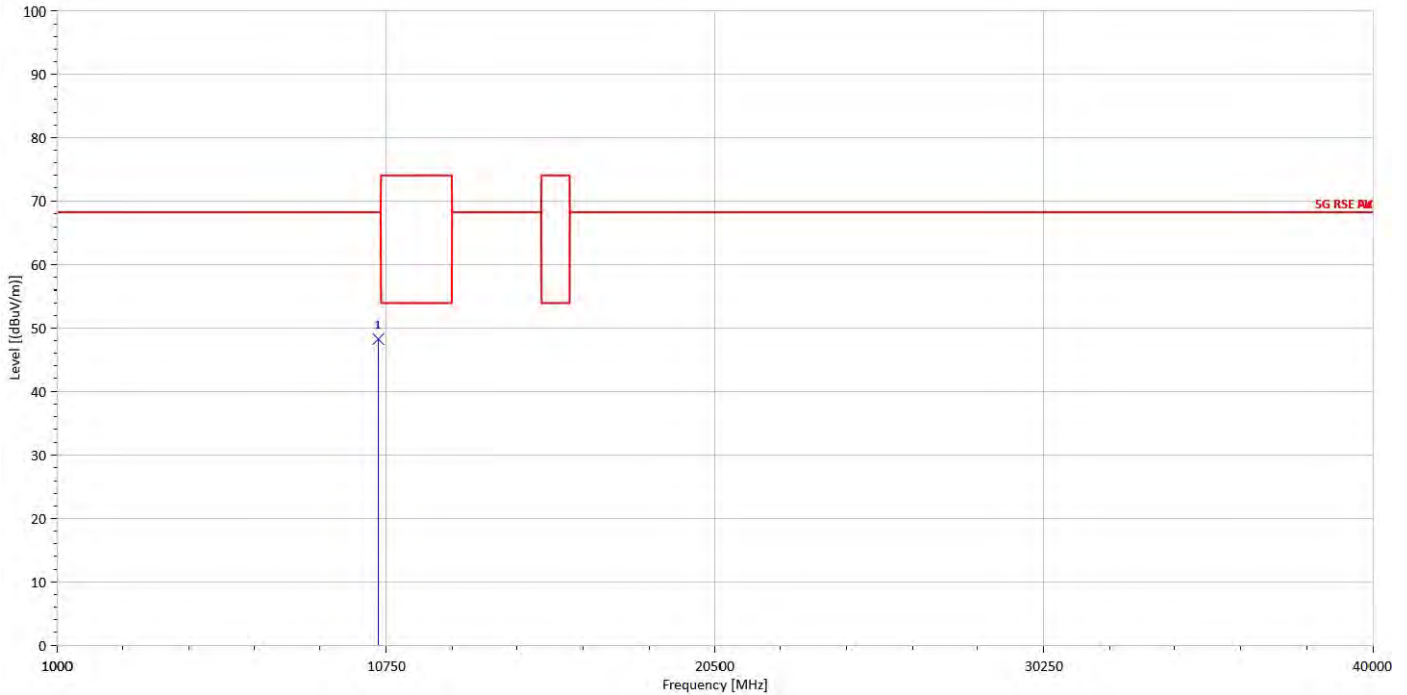

Freq. MHz	Note F/H/E/S	Detector Mode PK/QP/AV	Spectrum Reading Level dB μ V	Factor dB	Actual FS dB μ V/m	Limit @3m dB μ V/m	Margin dB
10520.00	H	Peak	22.43	25.82	48.25	68.3	-20.05

Unless otherwise stated the results shown in this test report refer only to the sample(s) tested and such sample(s) are retained for 90 days only.

除非另有說明，此報告結果僅對測試之樣品負責，同時此樣品僅保留90天。本報告未經本公司書面許可，不可部份複製。

This document is issued by the Company subject to its General Conditions of Service printed overleaf, available on request or accessible at www.sgs.com/terms_and_conditions.htm and, for electronic format documents, subject to Terms and Conditions for Electronic Documents at www.sgs.com/terms_e-document.htm. Attention is drawn to the limitation of liability, indemnification and jurisdiction issues defined therein. Any holder of this document is advised that information contained hereon reflects the Company's findings at the time of its intervention only and within the limits of Client's instructions, if any. The Company's sole responsibility is to its Client and this document does not exonerate parties to a transaction from exercising all their rights and obligations under the transaction documents. This document cannot be reproduced except in full, without prior written approval of the Company. Any unauthorized alteration, forgery or falsification of the content or appearance of this document is unlawful and offenders may be prosecuted to the fullest extent of the law.

SGS Taiwan Ltd.

No. 134, WuKungRoad, New Taipei Industrial Park, Wuku District, New Taipei City, Taiwan 24803 / 新北市五股區新北產業園區五工路 134 號

台灣檢驗科技股份有限公司

t (886-2) 2299-3279

f (886-2) 2298-0488

www.tw.sgs.com

Member of SGS Group

Operation Mode : 802.11a Test Date : 2017/7/14
 Fundamental Frequency : 5300 MHz Temp. / Humi. : 22.7deg_C/57RH
 Operation Band : Tx CH Mid Test Engineer : Ashton
 EUT Pol. : H Measurement Antenna Pol. : Vertical

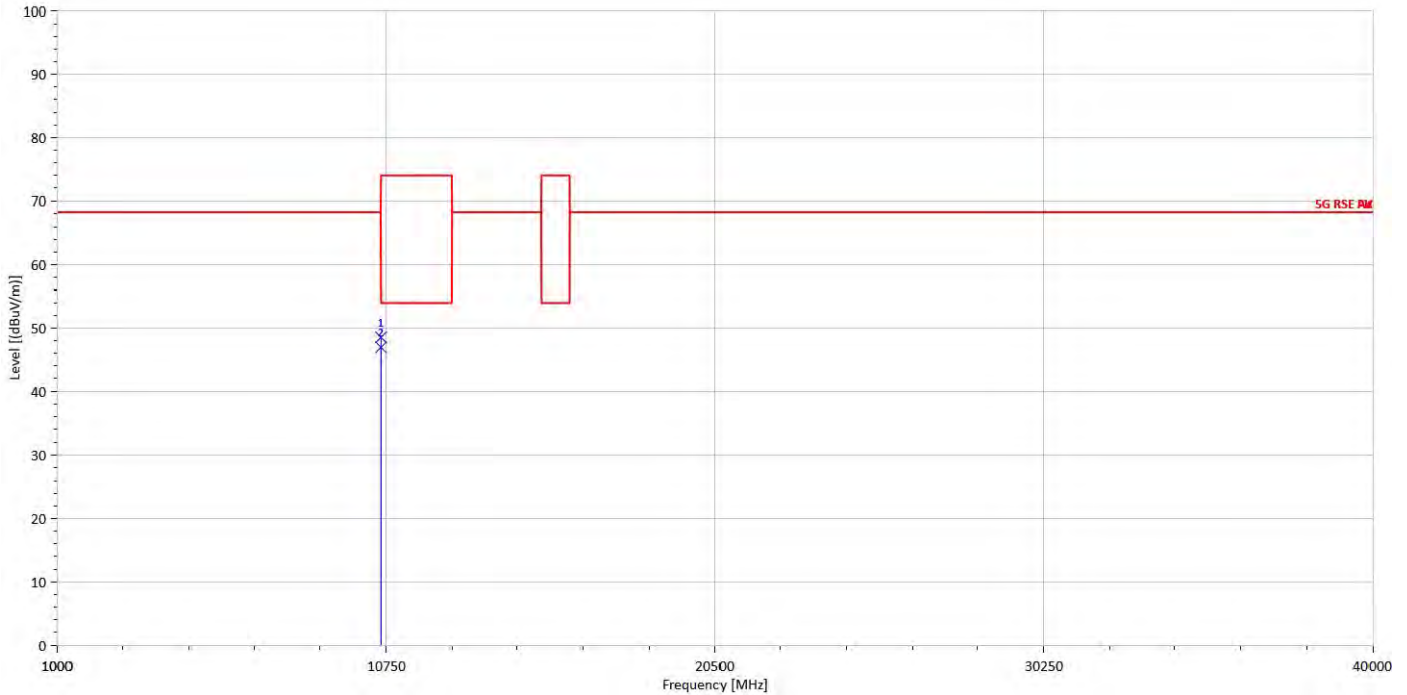

Freq. MHz	Note F/H/E/S	Detector Mode PK/QP/AV	Spectrum Reading Level dBuV	Factor dB	Actual FS dBuV/m	Limit @3m dBuV/m	Margin dB
10600.00	H	Peak	22.60	25.94	48.54	74	-25.46
10600.00	H	Average	21.02	25.94	46.96	54	-7.04

Unless otherwise stated the results shown in this test report refer only to the sample(s) tested and such sample(s) are retained for 90 days only.

除非另有說明，此報告結果僅對測試之樣品負責，同時此樣品僅保留90天。本報告未經本公司書面許可，不可部份複製。

This document is issued by the Company subject to its General Conditions of Service printed overleaf, available on request or accessible at www.sgs.com/terms_and_conditions.htm and, for electronic format documents, subject to Terms and Conditions for Electronic Documents at www.sgs.com/terms_e-document.htm. Attention is drawn to the limitation of liability, indemnification and jurisdiction issues defined therein. Any holder of this document is advised that information contained hereon reflects the Company's findings at the time of its intervention only and within the limits of Client's instructions, if any. The Company's sole responsibility is to its Client and this document does not exonerate parties to a transaction from exercising all their rights and obligations under the transaction documents. This document cannot be reproduced except in full, without prior written approval of the Company. Any unauthorized alteration, forgery or falsification of the content or appearance of this document is unlawful and offenders may be prosecuted to the fullest extent of the law.

SGS Taiwan Ltd.

No. 134, WuKungRoad, New Taipei Industrial Park, Wuku District, New Taipei City, Taiwan 24803 / 新北市五股區新北產業園區五工路 134 號

台灣檢驗科技股份有限公司

t (886-2) 2299-3279

f (886-2) 2298-0488

www.tw.sgs.com

Member of SGS Group

Operation Mode : 802.11a Test Date : 2017/7/14
 Fundamental Frequency : 5300 MHz Temp. / Humi. : 22.7deg_C/57RH
 Operation Band : Tx CH Mid Test Engineer : Ashton
 EUT Pol. : H Measurement Antenna Pol. : Horizontal

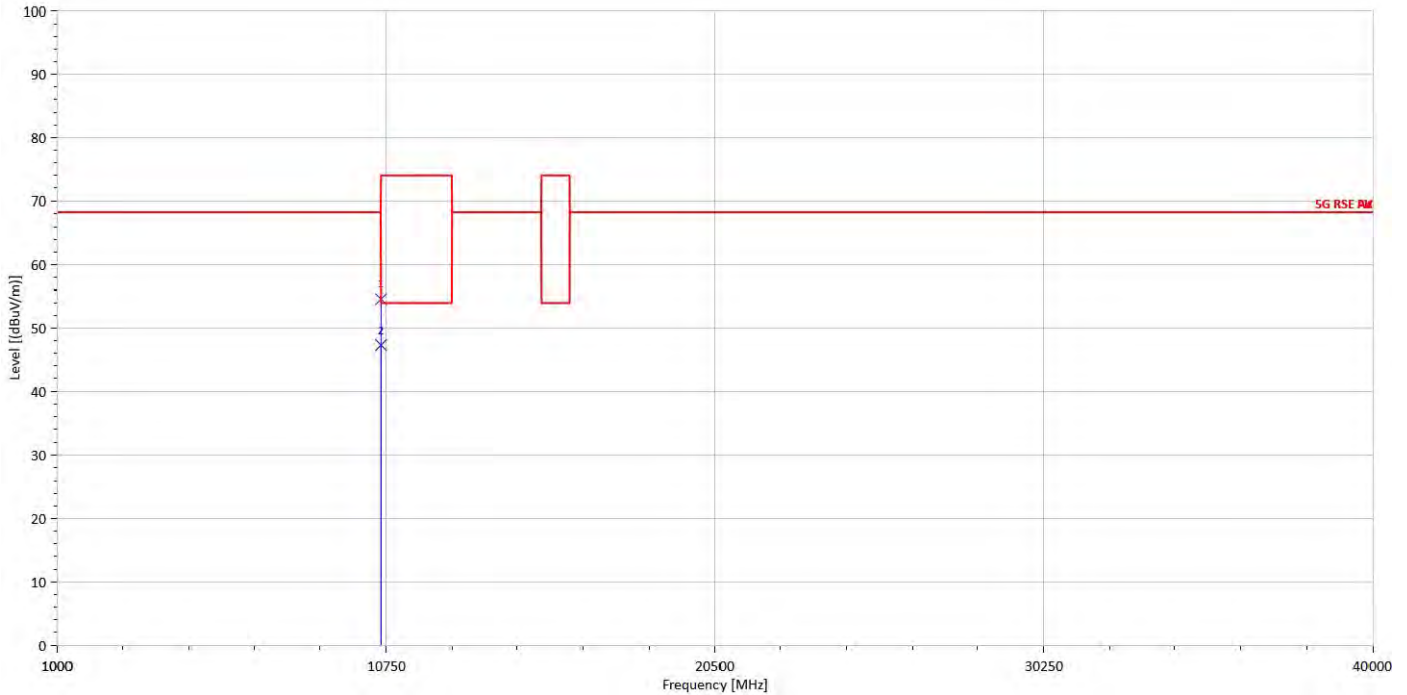

Freq. MHz	Note F/H/E/S	Detector Mode PK/QP/AV	Spectrum Reading Level dBuV	Factor dB	Actual FS dBuV/m	Limit @3m dBuV/m	Margin dB
10600.00	H	Peak	28.67	25.94	54.61	74	-19.39
10600.00	H	Average	21.37	25.94	47.31	54	-6.69

Unless otherwise stated the results shown in this test report refer only to the sample(s) tested and such sample(s) are retained for 90 days only.

除非另有說明，此報告結果僅對測試之樣品負責，同時此樣品僅保留90天。本報告未經本公司書面許可，不可部份複製。

This document is issued by the Company subject to its General Conditions of Service printed overleaf, available on request or accessible at www.sgs.com/terms_and_conditions.htm and, for electronic format documents, subject to Terms and Conditions for Electronic Documents at www.sgs.com/terms_e-document.htm. Attention is drawn to the limitation of liability, indemnification and jurisdiction issues defined therein. Any holder of this document is advised that information contained hereon reflects the Company's findings at the time of its intervention only and within the limits of Client's instructions, if any. The Company's sole responsibility is to its Client and this document does not exonerate parties to a transaction from exercising all their rights and obligations under the transaction documents. This document cannot be reproduced except in full, without prior written approval of the Company. Any unauthorized alteration, forgery or falsification of the content or appearance of this document is unlawful and offenders may be prosecuted to the fullest extent of the law.

SGS Taiwan Ltd.

No. 134, WuKungRoad, New Taipei Industrial Park, Wuku District, New Taipei City, Taiwan 24803/新北市五股區新北產業園區五工路 134 號

台灣檢驗科技股份有限公司

t (886-2) 2299-3279

f (886-2) 2298-0488

www.tw.sgs.com

Member of SGS Group

Operation Mode : 802.11a Test Date : 2017/7/14
 Fundamental Frequency : 5320 MHz Temp. / Humi. : 22.7deg_C/57RH
 Operation Band : Tx CH High Test Engineer : Ashton
 EUT Pol. : H Measurement Antenna Pol. : Vertical

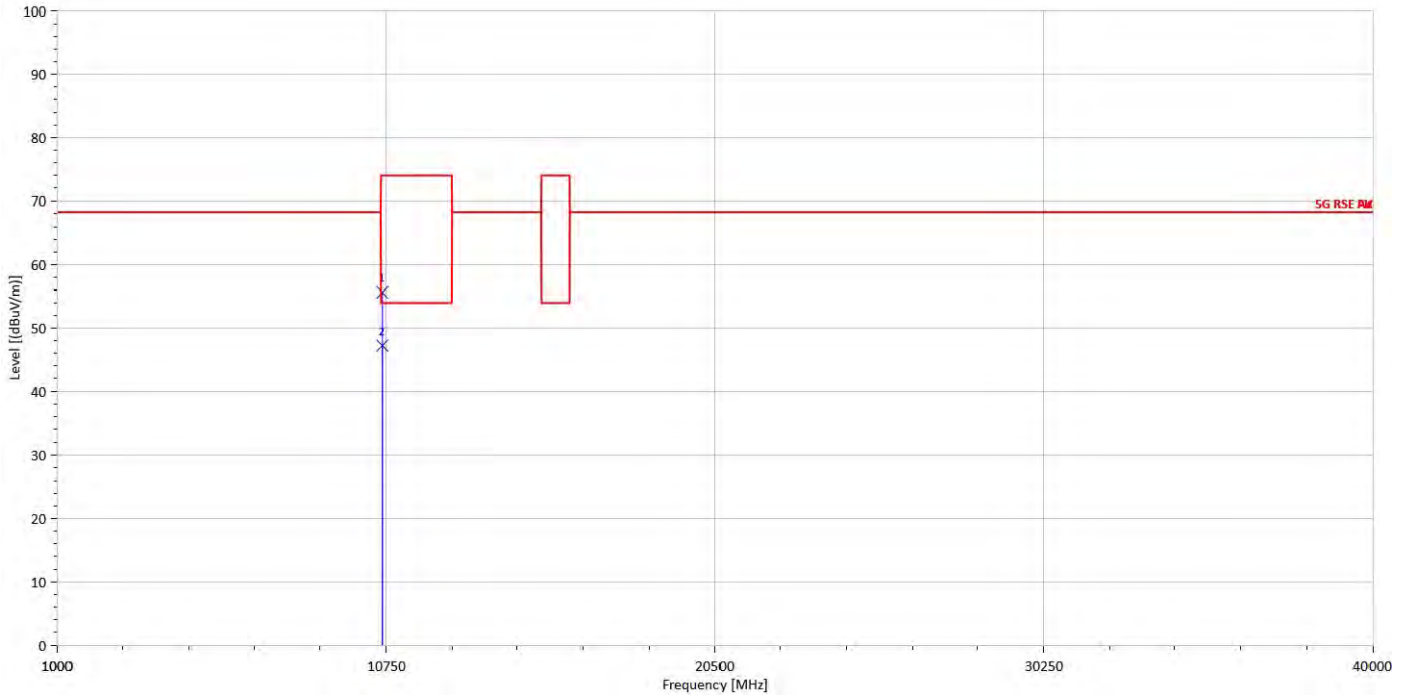

Freq. MHz	Note F/H/E/S	Detector Mode PK/QP/AV	Spectrum Reading Level dB μ V	Factor dB	Actual FS dB μ V/m	Limit @3m dB μ V/m	Margin dB
10640.00	H	Peak	29.56	26.07	55.62	74	-18.38
10640.00	H	Average	21.16	26.07	47.23	54	-6.77

Unless otherwise stated the results shown in this test report refer only to the sample(s) tested and such sample(s) are retained for 90 days only.

除非另有說明，此報告結果僅對測試之樣品負責，同時此樣品僅保留90天。本報告未經本公司書面許可，不可部份複製。

This document is issued by the Company subject to its General Conditions of Service printed overleaf, available on request or accessible at www.sgs.com/terms_and_conditions.htm and, for electronic format documents, subject to Terms and Conditions for Electronic Documents at www.sgs.com/terms_e-document.htm. Attention is drawn to the limitation of liability, indemnification and jurisdiction issues defined therein. Any holder of this document is advised that information contained hereon reflects the Company's findings at the time of its intervention only and within the limits of Client's instructions, if any. The Company's sole responsibility is to its Client and this document does not exonerate parties to a transaction from exercising all their rights and obligations under the transaction documents. This document cannot be reproduced except in full, without prior written approval of the Company. Any unauthorized alteration, forgery or falsification of the content or appearance of this document is unlawful and offenders may be prosecuted to the fullest extent of the law.

SGS Taiwan Ltd.

No. 134, WuKungRoad, NewTaipeiIndustrialPark, WukuDistrict, New Taipei City, Taiwan 24803/新北市五股區新北產業園區五工路 134 號

台灣檢驗科技股份有限公司

t (886-2) 2299-3279

f (886-2) 2298-0488

www.tw.sgs.com

Member of SGS Group

Operation Mode : 802.11a Test Date : 2017/7/14
 Fundamental Frequency : 5320 MHz Temp. / Humi. : 22.7deg_C/57RH
 Operation Band : Tx CH High Test Engineer : Ashton
 EUT Pol. : H Measurement Antenna Pol. : Horizontal

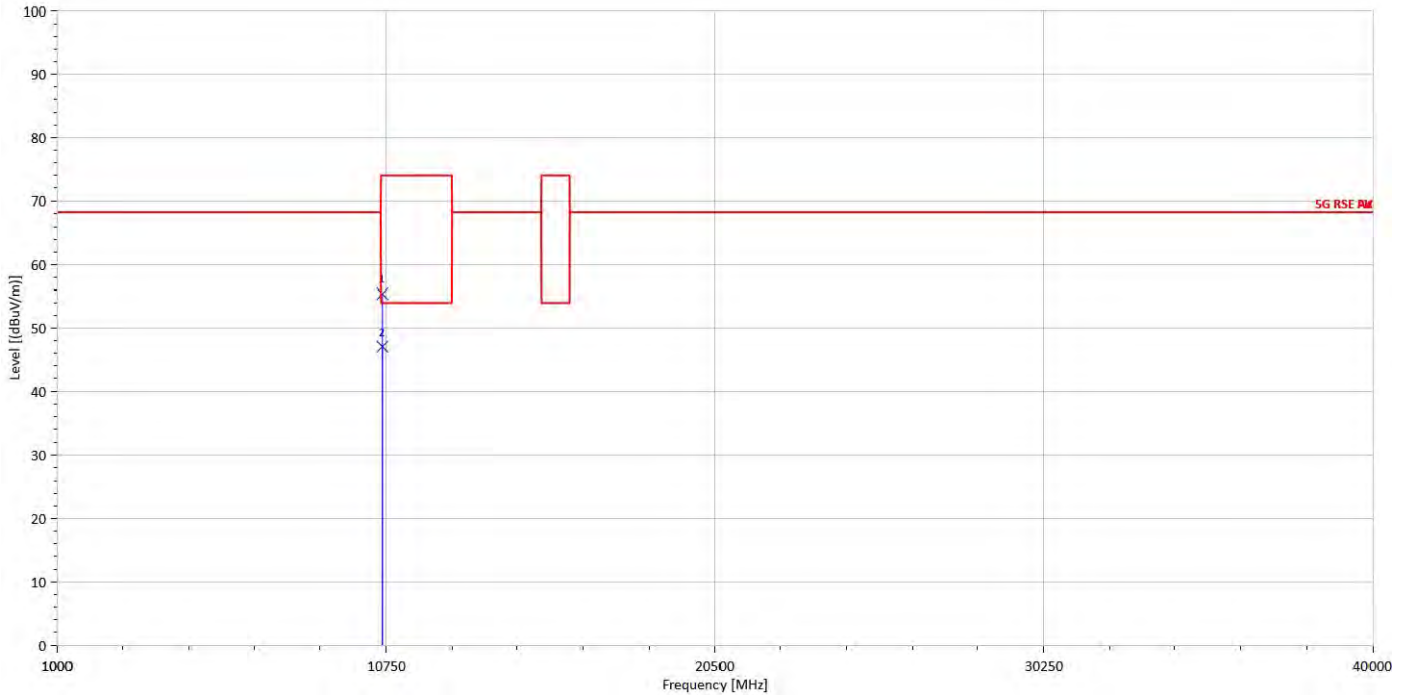

Freq. MHz	Note F/H/E/S	Detector Mode PK/QP/AV	Spectrum Reading Level dBuV	Factor dB	Actual FS dBuV/m	Limit @3m dBuV/m	Margin dB
10640.00	H	Peak	29.33	26.07	55.40	74	-18.60
10640.00	H	Average	21.01	26.07	47.08	54	-6.92

Unless otherwise stated the results shown in this test report refer only to the sample(s) tested and such sample(s) are retained for 90 days only.

除非另有說明，此報告結果僅對測試之樣品負責，同時此樣品僅保留90天。本報告未經本公司書面許可，不可部份複製。

This document is issued by the Company subject to its General Conditions of Service printed overleaf, available on request or accessible at www.sgs.com/terms_and_conditions.htm and, for electronic format documents, subject to Terms and Conditions for Electronic Documents at www.sgs.com/terms_e-document.htm. Attention is drawn to the limitation of liability, indemnification and jurisdiction issues defined therein. Any holder of this document is advised that information contained hereon reflects the Company's findings at the time of its intervention only and within the limits of Client's instructions, if any. The Company's sole responsibility is to its Client and this document does not exonerate parties to a transaction from exercising all their rights and obligations under the transaction documents. This document cannot be reproduced except in full, without prior written approval of the Company. Any unauthorized alteration, forgery or falsification of the content or appearance of this document is unlawful and offenders may be prosecuted to the fullest extent of the law.

SGS Taiwan Ltd.

No. 134, WuKungRoad, New Taipei Industrial Park, Wuku District, New Taipei City, Taiwan 24803 / 新北市五股區新北產業園區五工路 134 號

台灣檢驗科技股份有限公司

t (886-2) 2299-3279

f (886-2) 2298-0488

www.tw.sgs.com

Member of SGS Group

Radiated Spurious Emission Measurement Result 802.11a, 5470~5725 MHz

Operation Mode :	802.11a	Test Date :	2017/7/14
Fundamental Frequency :	5500 MHz	Temp. / Humi. :	22.7deg_C/57RH
Operation Band :	Tx CH Low	Test Engineer :	Ashton
EUT Pol. :	H	Measurement Antenna Pol. :	Vertical

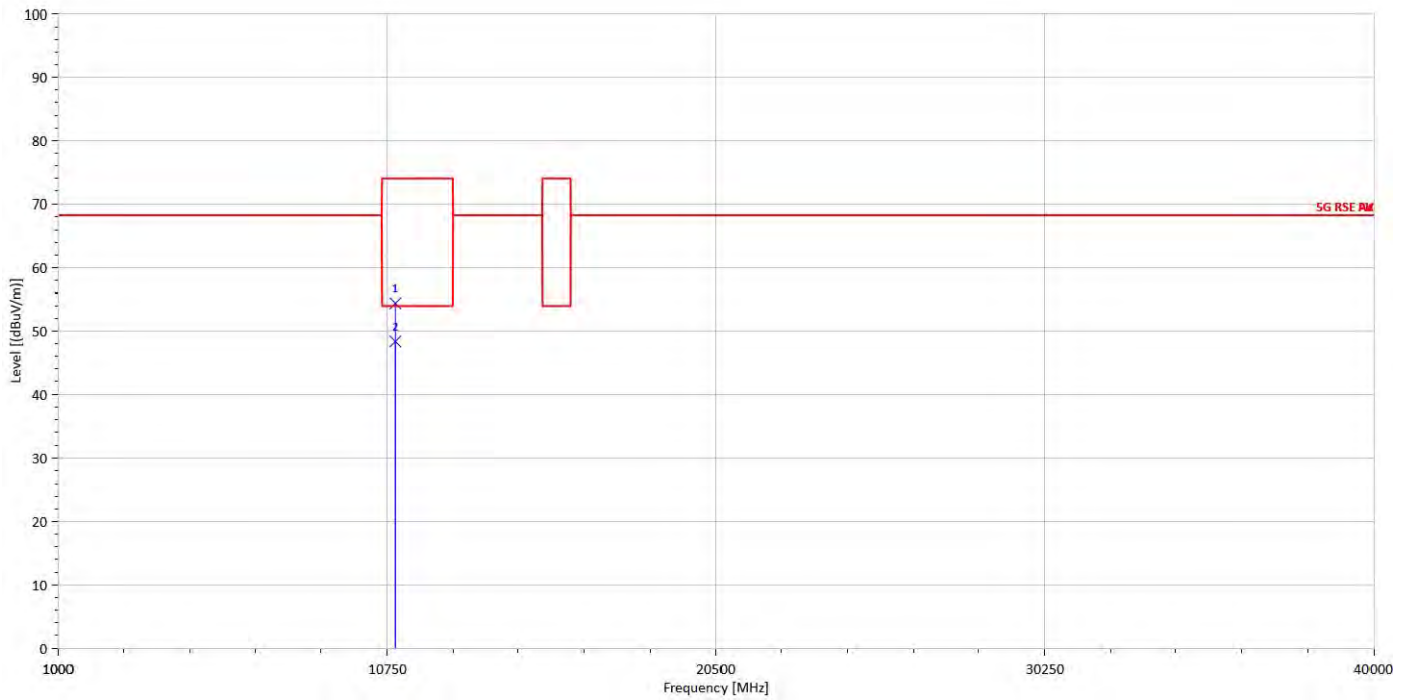

Freq. MHz	Note F/H/E/S	Detector Mode PK/QP/AV	Spectrum Reading Level dBuV	Factor dB	Actual FS dBuV/m	Limit @ 3m dBuV/m	Margin dB
11000.00	H	Peak	27.37	27.06	54.43	74	-19.57
11000.00	H	Average	21.30	27.06	48.36	54	-5.64

Unless otherwise stated the results shown in this test report refer only to the sample(s) tested and such sample(s) are retained for 90 days only.

除非另有說明，此報告結果僅對測試之樣品負責，同時此樣品僅保留90天。本報告未經本公司書面許可，不可部份複製。

This document is issued by the Company subject to its General Conditions of Service printed overleaf, available on request or accessible at www.sgs.com/terms_and_conditions.htm and, for electronic format documents, subject to Terms and Conditions for Electronic Documents at www.sgs.com/terms_e-document.htm. Attention is drawn to the limitation of liability, indemnification and jurisdiction issues defined therein. Any holder of this document is advised that information contained hereon reflects the Company's findings at the time of its intervention only and within the limits of Client's instructions, if any. The Company's sole responsibility is to its Client and this document does not exonerate parties to a transaction from exercising all their rights and obligations under the transaction documents. This document cannot be reproduced except in full, without prior written approval of the Company. Any unauthorized alteration, forgery or falsification of the content or appearance of this document is unlawful and offenders may be prosecuted to the fullest extent of the law.

SGS Taiwan Ltd.

No. 134, WuKungRoad, New Taipei Industrial Park, Wuku District, New Taipei City, Taiwan 24803/新北市五股區新北產業園區五工路 134 號

台灣檢驗科技股份有限公司

t (886-2) 2299-3279

f (886-2) 2298-0488

www.tw.sgs.com

Member of SGS Group

Operation Mode : 802.11a Test Date : 2017/7/14
 Fundamental Frequency : 5500 MHz Temp. / Humi. : 22.7deg_C/57RH
 Operation Band : Tx CH Low Test Engineer : Ashton
 EUT Pol. : H Measurement Antenna Pol. : Horizontal

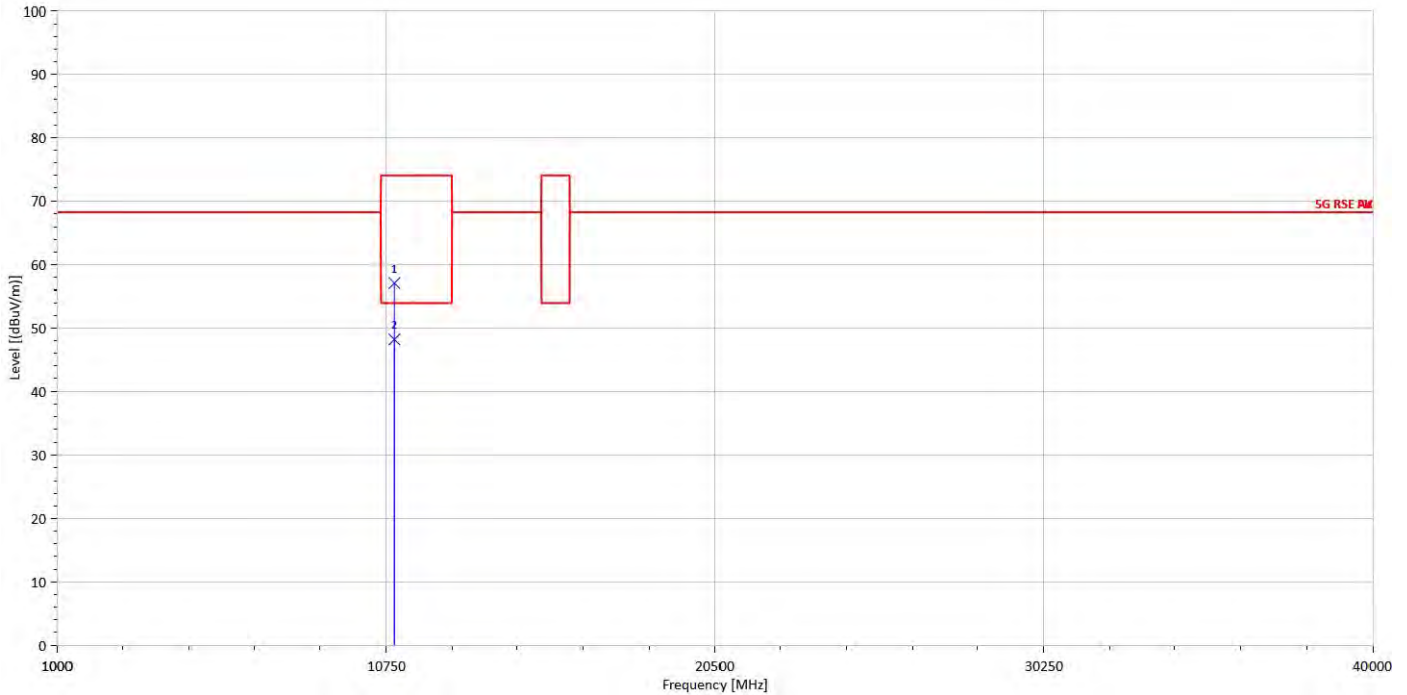

Freq. MHz	Note F/H/E/S	Detector Mode PK/QP/AV	Spectrum Reading Level dBuV	Factor dB	Actual FS dBuV/m	Limit @ 3m dBuV/m	Margin dB
11000.00	H	Peak	29.96	27.06	57.02	74	-16.98
11000.00	H	Average	21.14	27.06	48.20	54	-5.80

Unless otherwise stated the results shown in this test report refer only to the sample(s) tested and such sample(s) are retained for 90 days only.

除非另有說明，此報告結果僅對測試之樣品負責，同時此樣品僅保留90天。本報告未經本公司書面許可，不可部份複製。

This document is issued by the Company subject to its General Conditions of Service printed overleaf, available on request or accessible at www.sgs.com/terms_and_conditions.htm and, for electronic format documents, subject to Terms and Conditions for Electronic Documents at www.sgs.com/terms_e-document.htm. Attention is drawn to the limitation of liability, indemnification and jurisdiction issues defined therein. Any holder of this document is advised that information contained hereon reflects the Company's findings at the time of its intervention only and within the limits of Client's instructions, if any. The Company's sole responsibility is to its Client and this document does not exonerate parties to a transaction from exercising all their rights and obligations under the transaction documents. This document cannot be reproduced except in full, without prior written approval of the Company. Any unauthorized alteration, forgery or falsification of the content or appearance of this document is unlawful and offenders may be prosecuted to the fullest extent of the law.

SGS Taiwan Ltd.

No. 134, WuKungRoad, New Taipei Industrial Park, Wuku District, New Taipei City, Taiwan 24803 / 新北市五股區新北產業園區五工路 134 號

台灣檢驗科技股份有限公司

t (886-2) 2299-3279

f (886-2) 2298-0488

www.tw.sgs.com

Member of SGS Group

Operation Mode : 802.11a Test Date : 2017/7/14
 Fundamental Frequency : 5580 MHz Temp. / Humi. : 22.7deg_C/57RH
 Operation Band : Tx CH Mid Test Engineer : Ashton
 EUT Pol. : H Measurement Antenna Pol. : Vertical

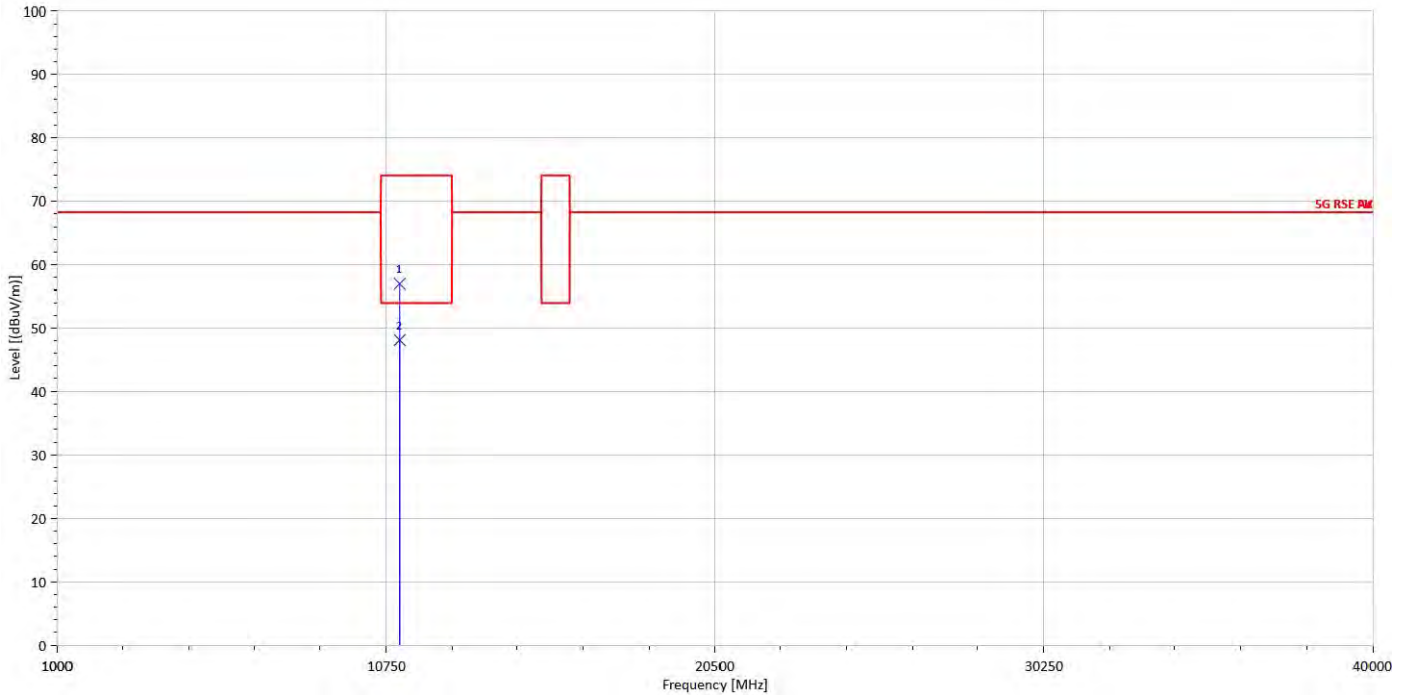

Freq. MHz	Note F/H/E/S	Detector Mode PK/QP/AV	Spectrum Reading Level dBµV	Factor dB	Actual FS dBµV/m	Limit @3m dBµV/m	Margin dB
11160.00	H	Peak	30.17	26.76	56.92	74	-17.08
11160.00	H	Average	21.35	26.76	48.11	54	-5.89

Unless otherwise stated the results shown in this test report refer only to the sample(s) tested and such sample(s) are retained for 90 days only.

除非另有說明，此報告結果僅對測試之樣品負責，同時此樣品僅保留90天。本報告未經本公司書面許可，不可部份複製。

This document is issued by the Company subject to its General Conditions of Service printed overleaf, available on request or accessible at www.sgs.com/terms_and_conditions.htm and, for electronic format documents, subject to Terms and Conditions for Electronic Documents at www.sgs.com/terms_e-document.htm. Attention is drawn to the limitation of liability, indemnification and jurisdiction issues defined therein. Any holder of this document is advised that information contained hereon reflects the Company's findings at the time of its intervention only and within the limits of Client's instructions, if any. The Company's sole responsibility is to its Client and this document does not exonerate parties to a transaction from exercising all their rights and obligations under the transaction documents. This document cannot be reproduced except in full, without prior written approval of the Company. Any unauthorized alteration, forgery or falsification of the content or appearance of this document is unlawful and offenders may be prosecuted to the fullest extent of the law.

SGS Taiwan Ltd.

No.134,WuKungRoad,NewTaipeiIndustrialPark,WukuDistrict,NewTaipeiCity,Taiwan24803/新北市五股區新北產業園區五工路 134 號

台灣檢驗科技股份有限公司

t (886-2) 2299-3279

f (886-2) 2298-0488

www.tw.sgs.com

Member of SGS Group

Operation Mode : 802.11a Test Date : 2017/7/14
 Fundamental Frequency : 5580 MHz Temp. / Humi. : 22.7deg_C/57RH
 Operation Band : Tx CH Mid Test Engineer : Ashton
 EUT Pol. : H Measurement Antenna Pol. : Horizontal

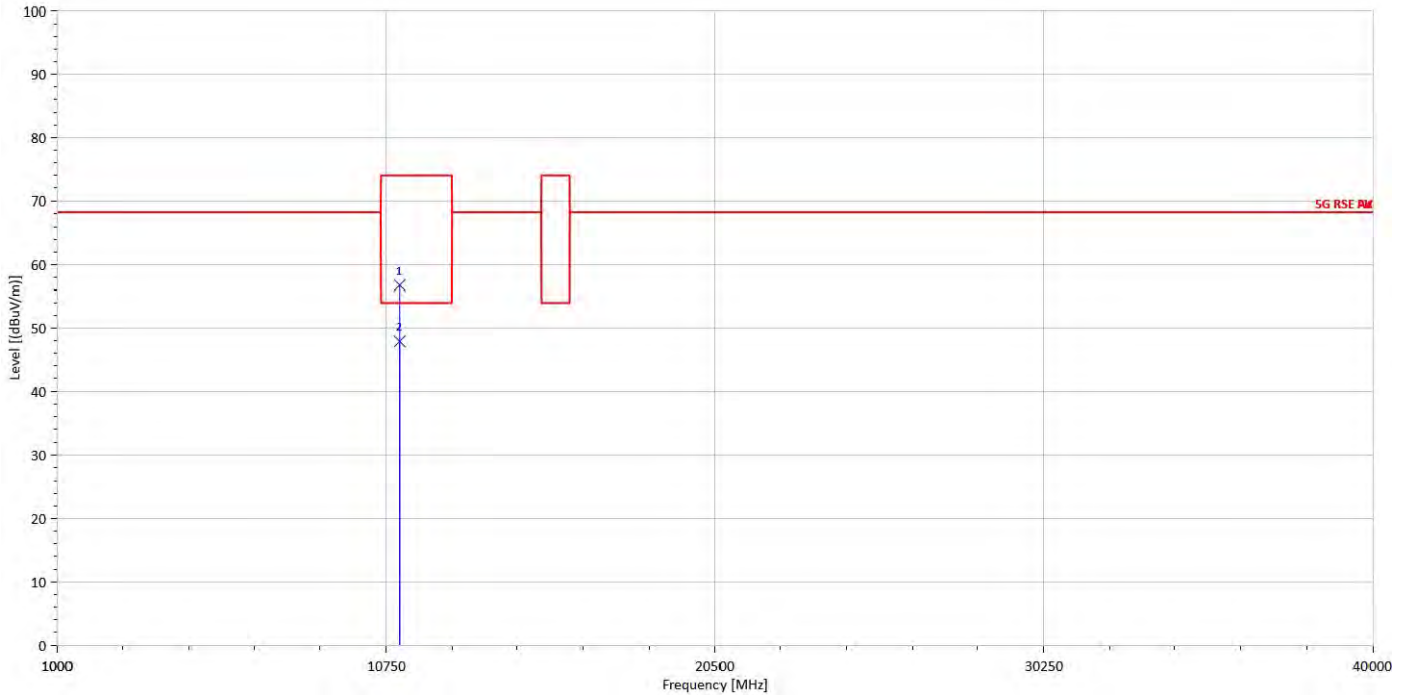

Freq. MHz	Note F/H/E/S	Detector Mode PK/QP/AV	Spectrum Reading Level dBuV	Factor dB	Actual FS dBuV/m	Limit @3m dBuV/m	Margin dB
11160.00	H	Peak	29.97	26.76	56.72	74	-17.28
11160.00	H	Average	21.15	26.76	47.91	54	-6.09

Unless otherwise stated the results shown in this test report refer only to the sample(s) tested and such sample(s) are retained for 90 days only.

除非另有說明，此報告結果僅對測試之樣品負責，同時此樣品僅保留90天。本報告未經本公司書面許可，不可部份複製。

This document is issued by the Company subject to its General Conditions of Service printed overleaf, available on request or accessible at www.sgs.com/terms_and_conditions.htm and, for electronic format documents, subject to Terms and Conditions for Electronic Documents at www.sgs.com/terms_e-document.htm. Attention is drawn to the limitation of liability, indemnification and jurisdiction issues defined therein. Any holder of this document is advised that information contained hereon reflects the Company's findings at the time of its intervention only and within the limits of Client's instructions, if any. The Company's sole responsibility is to its Client and this document does not exonerate parties to a transaction from exercising all their rights and obligations under the transaction documents. This document cannot be reproduced except in full, without prior written approval of the Company. Any unauthorized alteration, forgery or falsification of the content or appearance of this document is unlawful and offenders may be prosecuted to the fullest extent of the law.

SGS Taiwan Ltd.

No.134,WuKungRoad,NewTaipeiIndustrialPark,WukuDistrict,NewTaipeiCity,Taiwan24803/新北市五股區新北產業園區五工路 134 號

台灣檢驗科技股份有限公司

t (886-2) 2299-3279

f (886-2) 2298-0488

www.tw.sgs.com

Member of SGS Group

Operation Mode : 802.11a Test Date : 2017/7/14
 Fundamental Frequency : 5700 MHz Temp. / Humi. : 22.7deg_C/57RH
 Operation Band : Tx CH High Test Engineer : Ashton
 EUT Pol. : H Measurement Antenna Pol. : Vertical

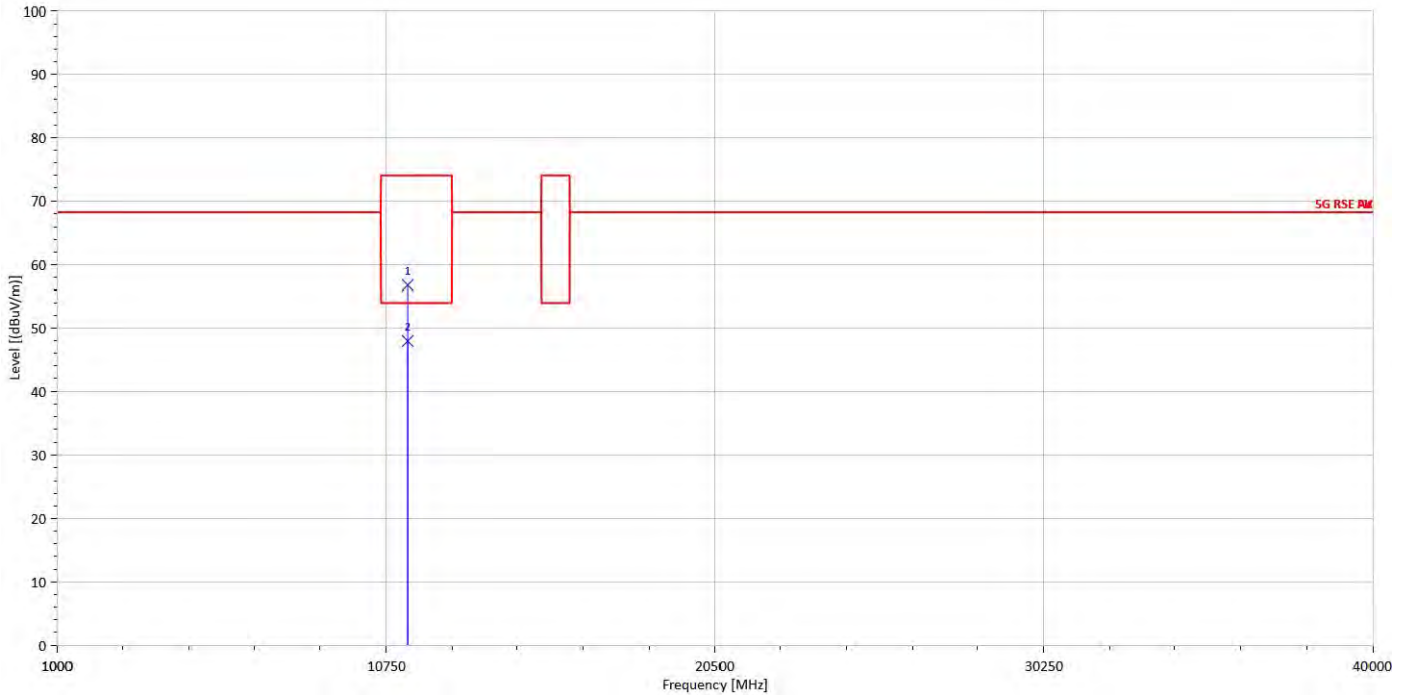

Freq. MHz	Note F/H/E/S	Detector Mode PK/QP/AV	Spectrum Reading Level dBuV	Factor dB	Actual FS dBuV/m	Limit @ 3m dBuV/m	Margin dB
11400.00	H	Peak	30.14	26.59	56.73	74	-17.27
11400.00	H	Average	21.37	26.59	47.96	54	-6.04

Unless otherwise stated the results shown in this test report refer only to the sample(s) tested and such sample(s) are retained for 90 days only.

除非另有說明，此報告結果僅對測試之樣品負責，同時此樣品僅保留90天。本報告未經本公司書面許可，不可部份複製。

This document is issued by the Company subject to its General Conditions of Service printed overleaf, available on request or accessible at www.sgs.com/terms_and_conditions.htm and, for electronic format documents, subject to Terms and Conditions for Electronic Documents at www.sgs.com/terms_e-document.htm. Attention is drawn to the limitation of liability, indemnification and jurisdiction issues defined therein. Any holder of this document is advised that information contained hereon reflects the Company's findings at the time of its intervention only and within the limits of Client's instructions, if any. The Company's sole responsibility is to its Client and this document does not exonerate parties to a transaction from exercising all their rights and obligations under the transaction documents. This document cannot be reproduced except in full, without prior written approval of the Company. Any unauthorized alteration, forgery or falsification of the content or appearance of this document is unlawful and offenders may be prosecuted to the fullest extent of the law.

SGS Taiwan Ltd.

No.134,WuKungRoad,NewTaipeiIndustrialPark,WukuDistrict,NewTaipeiCity,Taiwan24803/新北市五股區新北產業園區五工路 134 號

台灣檢驗科技股份有限公司

t (886-2) 2299-3279

f (886-2) 2298-0488

www.tw.sgs.com

Member of SGS Group

Operation Mode : 802.11a Test Date : 2017/7/14
 Fundamental Frequency : 5700 MHz Temp. / Humi. : 22.7deg_C/57RH
 Operation Band : Tx CH High Test Engineer : Ashton
 EUT Pol. : H Measurement Antenna Pol. : Horizontal

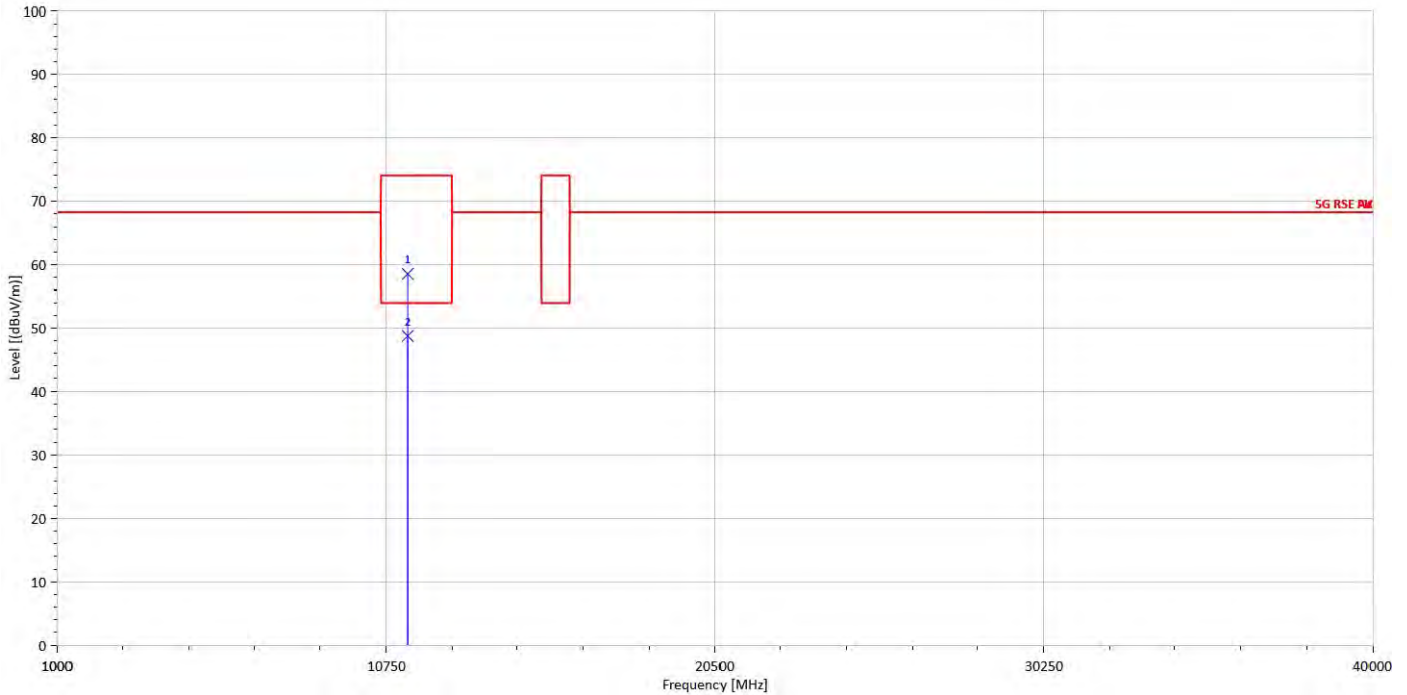

Freq. MHz	Note F/H/E/S	Detector Mode PK/QP/AV	Spectrum Reading Level dBµV	Factor dB	Actual FS dBµV/m	Limit @ 3m dBµV/m	Margin dB
11400.00	H	Peak	31.89	26.59	58.48	74	-15.52
11400.00	H	Average	22.17	26.59	48.76	54	-5.24

Unless otherwise stated the results shown in this test report refer only to the sample(s) tested and such sample(s) are retained for 90 days only.

除非另有說明，此報告結果僅對測試之樣品負責，同時此樣品僅保留90天。本報告未經本公司書面許可，不可部份複製。

This document is issued by the Company subject to its General Conditions of Service printed overleaf, available on request or accessible at www.sgs.com/terms_and_conditions.htm and, for electronic format documents, subject to Terms and Conditions for Electronic Documents at www.sgs.com/terms_e-document.htm. Attention is drawn to the limitation of liability, indemnification and jurisdiction issues defined therein. Any holder of this document is advised that information contained hereon reflects the Company's findings at the time of its intervention only and within the limits of Client's instructions, if any. The Company's sole responsibility is to its Client and this document does not exonerate parties to a transaction from exercising all their rights and obligations under the transaction documents. This document cannot be reproduced except in full, without prior written approval of the Company. Any unauthorized alteration, forgery or falsification of the content or appearance of this document is unlawful and offenders may be prosecuted to the fullest extent of the law.

SGS Taiwan Ltd.

No. 134, WuKungRoad, New Taipei Industrial Park, Wuku District, New Taipei City, Taiwan 24803 / 新北市五股區新北產業園區五工路 134 號

台灣檢驗科技股份有限公司

t (886-2) 2299-3279

f (886-2) 2298-0488

www.tw.sgs.com

Member of SGS Group

Radiated Spurious Emission Measurement Result 802.11a, 5725~5850 MHz

Operation Mode :	802.11a	Test Date :	2017/7/14
Fundamental Frequency :	5745 MHz	Temp. / Humi. :	22.7deg_C/57RH
Operation Band :	Tx CH Low	Test Engineer :	Ashton
EUT Pol. :	H	Measurement Antenna Pol. :	Vertical

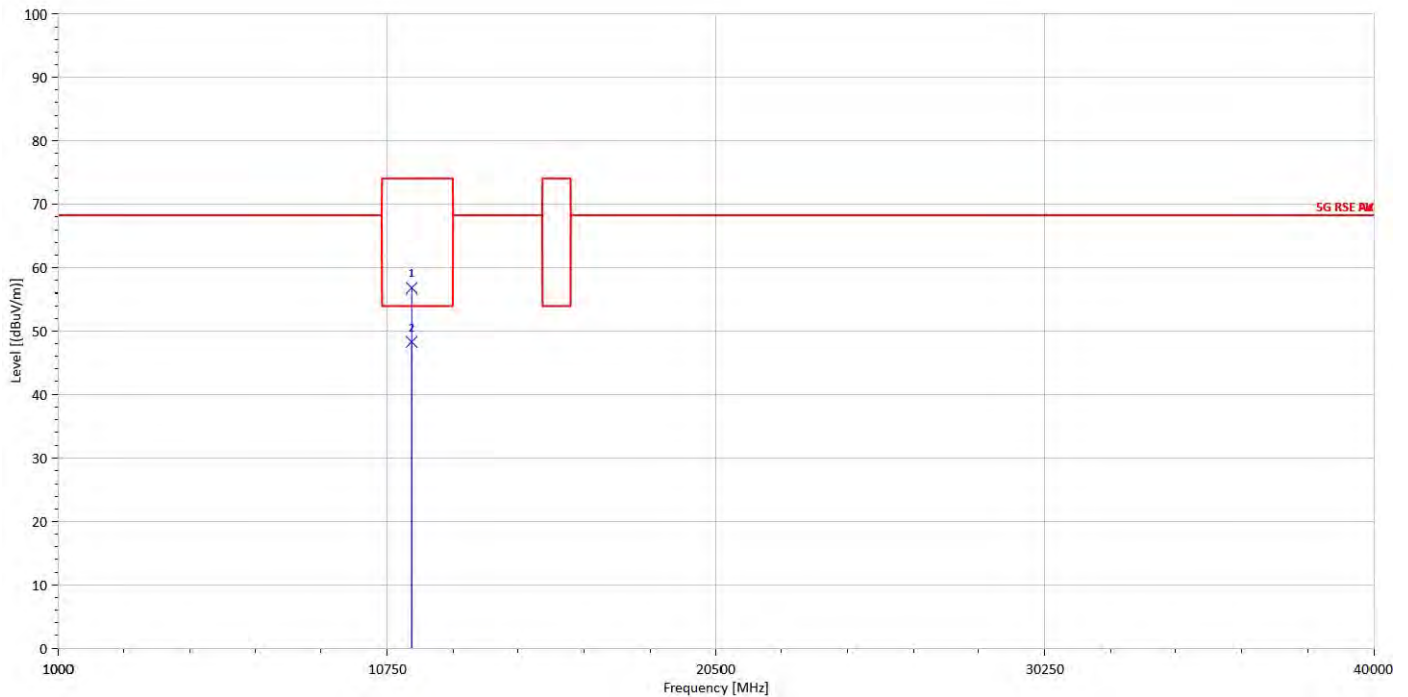

Freq. MHz	Note F/H/E/S	Detector Mode PK/QP/AV	Spectrum Reading Level dBuV	Factor dB	Actual FS dBuV/m	Limit @ 3m dBuV/m	Margin dB
11490.00	H	Peak	30.04	26.70	56.74	74	-17.26
11490.00	H	Average	21.60	26.70	48.30	54	-5.70

Unless otherwise stated the results shown in this test report refer only to the sample(s) tested and such sample(s) are retained for 90 days only.

除非另有說明，此報告結果僅對測試之樣品負責，同時此樣品僅保留90天。本報告未經本公司書面許可，不可部份複製。

This document is issued by the Company subject to its General Conditions of Service printed overleaf, available on request or accessible at www.sgs.com/terms_and_conditions.htm and, for electronic format documents, subject to Terms and Conditions for Electronic Documents at www.sgs.com/terms_e-document.htm. Attention is drawn to the limitation of liability, indemnification and jurisdiction issues defined therein. Any holder of this document is advised that information contained hereon reflects the Company's findings at the time of its intervention only and within the limits of Client's instructions, if any. The Company's sole responsibility is to its Client and this document does not exonerate parties to a transaction from exercising all their rights and obligations under the transaction documents. This document cannot be reproduced except in full, without prior written approval of the Company. Any unauthorized alteration, forgery or falsification of the content or appearance of this document is unlawful and offenders may be prosecuted to the fullest extent of the law.

SGS Taiwan Ltd.

No.134,WuKungRoad,NewTaipeiIndustrialPark,WukuDistrict,NewTaipeiCity,Taiwan24803/新北市五股區新北產業園區五工路 134 號

台灣檢驗科技股份有限公司

t (886-2) 2299-3279

f (886-2) 2298-0488

www.tw.sgs.com

Member of SGS Group

Operation Mode : 802.11a Test Date : 2017/7/14
 Fundamental Frequency : 5745 MHz Temp. / Humi. : 22.7deg_C/57RH
 Operation Band : Tx CH Low Test Engineer : Ashton
 EUT Pol. : H Measurement Antenna Pol. : Horizontal

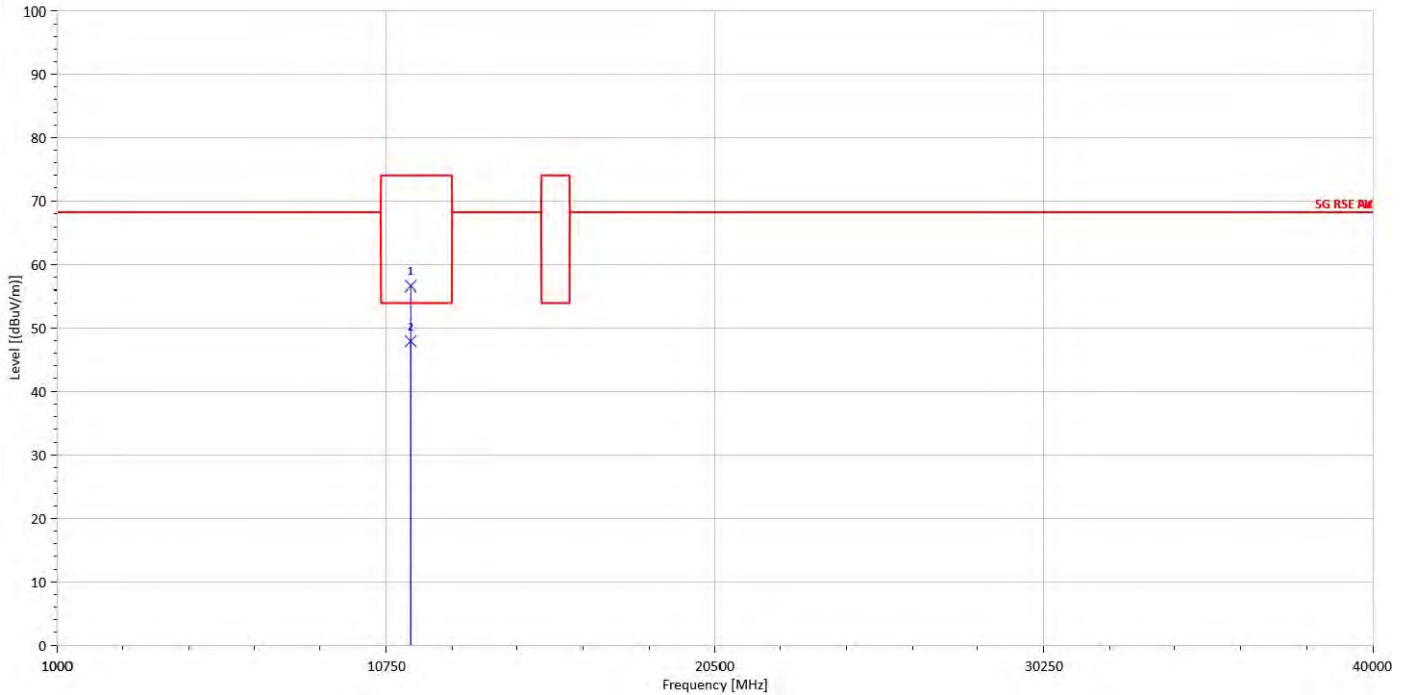

Freq. MHz	Note F/H/E/S	Detector Mode PK/QP/AV	Spectrum Reading Level dBuV	Factor dB	Actual FS dBuV/m	Limit @ 3m dBuV/m	Margin dB
11490.00	H	Peak	29.90	26.70	56.60	74	-17.40
11490.00	H	Average	21.22	26.70	47.92	54	-6.08

Unless otherwise stated the results shown in this test report refer only to the sample(s) tested and such sample(s) are retained for 90 days only.

除非另有說明，此報告結果僅對測試之樣品負責，同時此樣品僅保留90天。本報告未經本公司書面許可，不可部份複製。

This document is issued by the Company subject to its General Conditions of Service printed overleaf, available on request or accessible at www.sgs.com/terms_and_conditions.htm and, for electronic format documents, subject to Terms and Conditions for Electronic Documents at www.sgs.com/terms_e-document.htm. Attention is drawn to the limitation of liability, indemnification and jurisdiction issues defined therein. Any holder of this document is advised that information contained hereon reflects the Company's findings at the time of its intervention only and within the limits of Client's instructions, if any. The Company's sole responsibility is to its Client and this document does not exonerate parties to a transaction from exercising all their rights and obligations under the transaction documents. This document cannot be reproduced except in full, without prior written approval of the Company. Any unauthorized alteration, forgery or falsification of the content or appearance of this document is unlawful and offenders may be prosecuted to the fullest extent of the law.

SGS Taiwan Ltd.

No.134,WuKungRoad,NewTaipeiIndustrialPark,WukuDistrict,NewTaipeiCity,Taiwan24803/新北市五股區新北產業園區五工路 134 號

台灣檢驗科技股份有限公司

t (886-2) 2299-3279

f (886-2) 2298-0488

www.tw.sgs.com

Member of SGS Group

Operation Mode : 802.11a Test Date : 2017/7/14
 Fundamental Frequency : 5785 MHz Temp. / Humi. : 22.7deg_C/57RH
 Operation Band : Tx CH Mid Test Engineer : Ashton
 EUT Pol. : H Measurement Antenna Pol. : Vertical

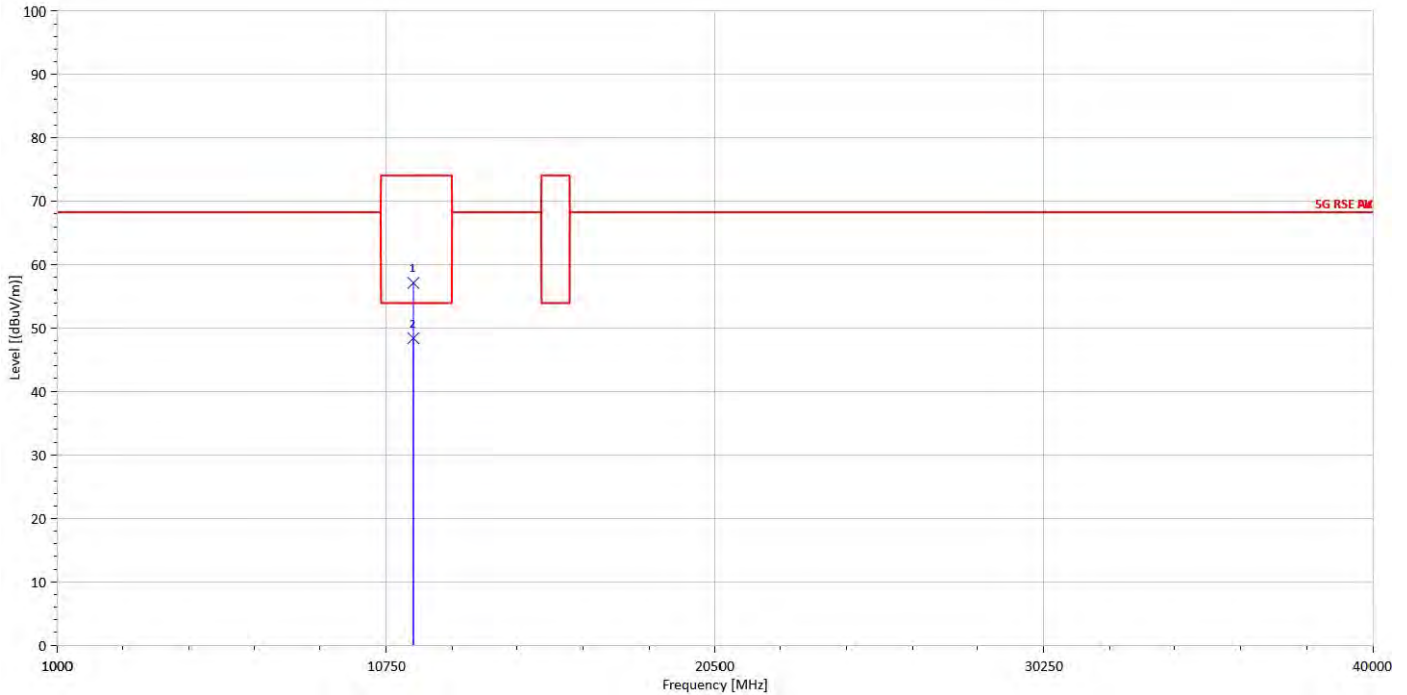

Freq. MHz	Note F/H/E/S	Detector Mode PK/QP/AV	Spectrum Reading Level dBuV	Factor dB	Actual FS dBuV/m	Limit @ 3m dBuV/m	Margin dB
11570.00	H	Peak	30.39	26.68	57.06	74	-16.94
11570.00	H	Average	21.72	26.68	48.40	54	-5.61

Unless otherwise stated the results shown in this test report refer only to the sample(s) tested and such sample(s) are retained for 90 days only.

除非另有說明，此報告結果僅對測試之樣品負責，同時此樣品僅保留90天。本報告未經本公司書面許可，不可部份複製。

This document is issued by the Company subject to its General Conditions of Service printed overleaf, available on request or accessible at www.sgs.com/terms_and_conditions.htm and, for electronic format documents, subject to Terms and Conditions for Electronic Documents at www.sgs.com/terms_e-document.htm. Attention is drawn to the limitation of liability, indemnification and jurisdiction issues defined therein. Any holder of this document is advised that information contained hereon reflects the Company's findings at the time of its intervention only and within the limits of Client's instructions, if any. The Company's sole responsibility is to its Client and this document does not exonerate parties to a transaction from exercising all their rights and obligations under the transaction documents. This document cannot be reproduced except in full, without prior written approval of the Company. Any unauthorized alteration, forgery or falsification of the content or appearance of this document is unlawful and offenders may be prosecuted to the fullest extent of the law.

SGS Taiwan Ltd.

No. 134, WuKungRoad, New Taipei Industrial Park, Wuku District, New Taipei City, Taiwan 24803 / 新北市五股區新北產業園區五工路 134 號

台灣檢驗科技股份有限公司

t (886-2) 2299-3279

f (886-2) 2298-0488

www.tw.sgs.com

Member of SGS Group

Operation Mode : 802.11a Test Date : 2017/7/14
 Fundamental Frequency : 5785 MHz Temp. / Humi. : 22.7deg_C/57RH
 Operation Band : Tx CH Mid Test Engineer : Ashton
 EUT Pol. : H Measurement Antenna Pol. : Horizontal

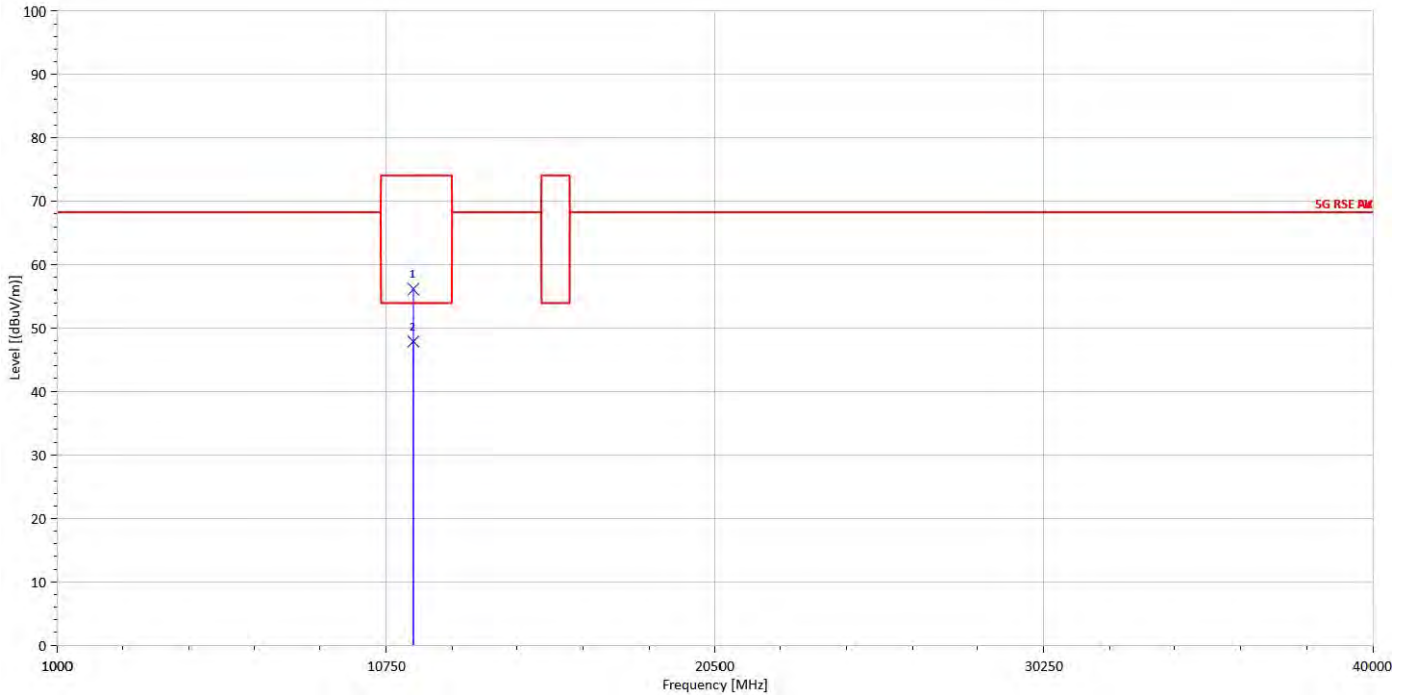

Freq. MHz	Note F/H/E/S	Detector Mode PK/QP/AV	Spectrum Reading Level dBuV	Factor dB	Actual FS dBuV/m	Limit @ 3m dBuV/m	Margin dB
11570.00	H	Peak	29.46	26.68	56.14	74	-17.86
11570.00	H	Average	21.20	26.68	47.88	54	-6.13

Unless otherwise stated the results shown in this test report refer only to the sample(s) tested and such sample(s) are retained for 90 days only.

除非另有說明，此報告結果僅對測試之樣品負責，同時此樣品僅保留90天。本報告未經本公司書面許可，不可部份複製。

This document is issued by the Company subject to its General Conditions of Service printed overleaf, available on request or accessible at www.sgs.com/terms_and_conditions.htm and, for electronic format documents, subject to Terms and Conditions for Electronic Documents at www.sgs.com/terms_e-document.htm. Attention is drawn to the limitation of liability, indemnification and jurisdiction issues defined therein. Any holder of this document is advised that information contained hereon reflects the Company's findings at the time of its intervention only and within the limits of Client's instructions, if any. The Company's sole responsibility is to its Client and this document does not exonerate parties to a transaction from exercising all their rights and obligations under the transaction documents. This document cannot be reproduced except in full, without prior written approval of the Company. Any unauthorized alteration, forgery or falsification of the content or appearance of this document is unlawful and offenders may be prosecuted to the fullest extent of the law.

SGS Taiwan Ltd.

No. 134, WuKungRoad, New Taipei Industrial Park, Wuku District, New Taipei City, Taiwan 24803/新北市五股區新北產業園區五工路 134 號

台灣檢驗科技股份有限公司

t (886-2) 2299-3279

f (886-2) 2298-0488

www.tw.sgs.com

Member of SGS Group

Operation Mode : 802.11a Test Date : 2017/7/14
 Fundamental Frequency : 5825 MHz Temp. / Humi. : 22.7deg_C/57RH
 Operation Band : Tx CH High Test Engineer : Ashton
 EUT Pol. : H Measurement Antenna Pol. : Vertical

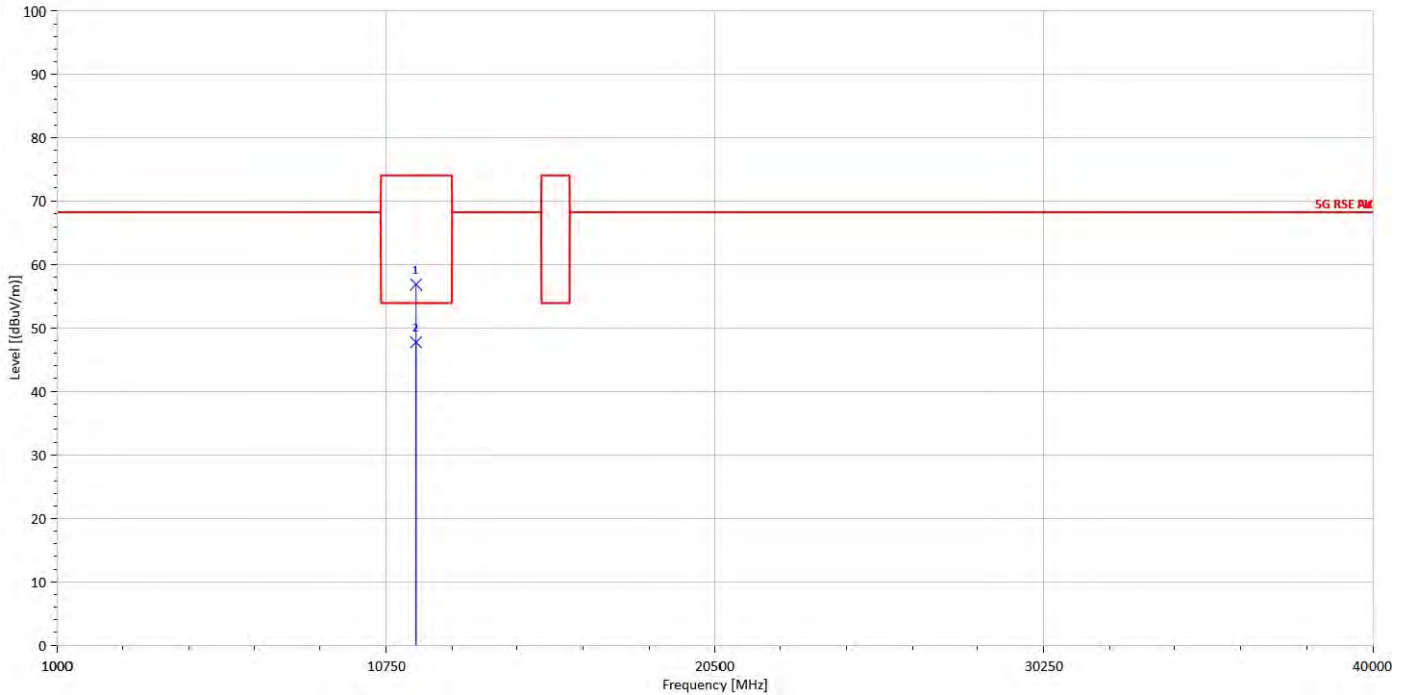

Freq. MHz	Note F/H/E/S	Detector Mode PK/QP/AV	Spectrum Reading Level dBuV	Factor dB	Actual FS dBuV/m	Limit @ 3m dBuV/m	Margin dB
11650.00	H	Peak	30.21	26.62	56.83	74	-17.17
11650.00	H	Average	21.14	26.62	47.76	54	-6.24

Unless otherwise stated the results shown in this test report refer only to the sample(s) tested and such sample(s) are retained for 90 days only.

除非另有說明，此報告結果僅對測試之樣品負責，同時此樣品僅保留90天。本報告未經本公司書面許可，不可部份複製。

This document is issued by the Company subject to its General Conditions of Service printed overleaf, available on request or accessible at www.sgs.com/terms_and_conditions.htm and, for electronic format documents, subject to Terms and Conditions for Electronic Documents at www.sgs.com/terms_e-document.htm. Attention is drawn to the limitation of liability, indemnification and jurisdiction issues defined therein. Any holder of this document is advised that information contained hereon reflects the Company's findings at the time of its intervention only and within the limits of Client's instructions, if any. The Company's sole responsibility is to its Client and this document does not exonerate parties to a transaction from exercising all their rights and obligations under the transaction documents. This document cannot be reproduced except in full, without prior written approval of the Company. Any unauthorized alteration, forgery or falsification of the content or appearance of this document is unlawful and offenders may be prosecuted to the fullest extent of the law.

SGS Taiwan Ltd.

No. 134, WuKungRoad, New Taipei Industrial Park, Wuku District, New Taipei City, Taiwan 24803 / 新北市五股區新北產業園區五工路 134 號

台灣檢驗科技股份有限公司

t (886-2) 2299-3279

f (886-2) 2298-0488

www.tw.sgs.com

Member of SGS Group

Operation Mode : 802.11a Test Date : 2017/7/14
 Fundamental Frequency : 5825 MHz Temp. / Humi. : 22.7deg_C/57RH
 Operation Band : Tx CH High Test Engineer : Ashton
 EUT Pol. : H Measurement Antenna Pol. : Horizontal

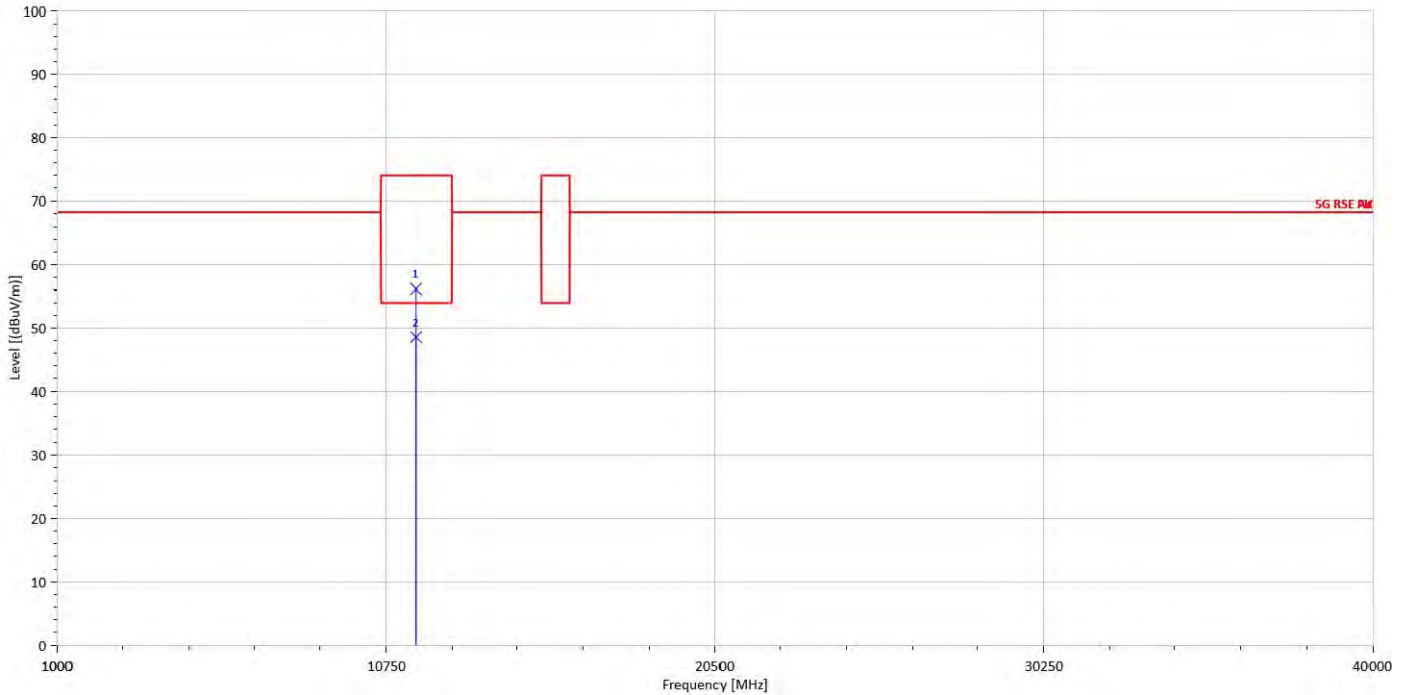

Freq. MHz	Note F/H/E/S	Detector Mode PK/QP/AV	Spectrum Reading Level dBuV	Factor dB	Actual FS dBuV/m	Limit @ 3m dBuV/m	Margin dB
11650.00	H	Peak	29.54	26.62	56.16	74	-17.84
11650.00	H	Average	21.95	26.62	48.57	54	-5.43

Unless otherwise stated the results shown in this test report refer only to the sample(s) tested and such sample(s) are retained for 90 days only.

除非另有說明，此報告結果僅對測試之樣品負責，同時此樣品僅保留90天。本報告未經本公司書面許可，不可部份複製。

This document is issued by the Company subject to its General Conditions of Service printed overleaf, available on request or accessible at www.sgs.com/terms_and_conditions.htm and, for electronic format documents, subject to Terms and Conditions for Electronic Documents at www.sgs.com/terms_e-document.htm. Attention is drawn to the limitation of liability, indemnification and jurisdiction issues defined therein. Any holder of this document is advised that information contained hereon reflects the Company's findings at the time of its intervention only and within the limits of Client's instructions, if any. The Company's sole responsibility is to its Client and this document does not exonerate parties to a transaction from exercising all their rights and obligations under the transaction documents. This document cannot be reproduced except in full, without prior written approval of the Company. Any unauthorized alteration, forgery or falsification of the content or appearance of this document is unlawful and offenders may be prosecuted to the fullest extent of the law.

SGS Taiwan Ltd.

No. 134, WuKungRoad, New Taipei Industrial Park, Wuku District, New Taipei City, Taiwan 24803 / 新北市五股區新北產業園區五工路 134 號

台灣檢驗科技股份有限公司

t (886-2) 2299-3279

f (886-2) 2298-0488

www.tw.sgs.com

Member of SGS Group

Radiated Spurious Emission Measurement Result 802.11n HT20, 5150~5250 MHz

Operation Mode :	802.11n20	Test Date :	2017/7/14
Fundamental Frequency :	5180 MHz	Temp. / Humi. :	22.7 deg_C/57RH
Operation Band :	Tx CH Low	Test Engineer :	Ashton
EUT Pol. :	H	Measurement Antenna Pol. :	Vertical

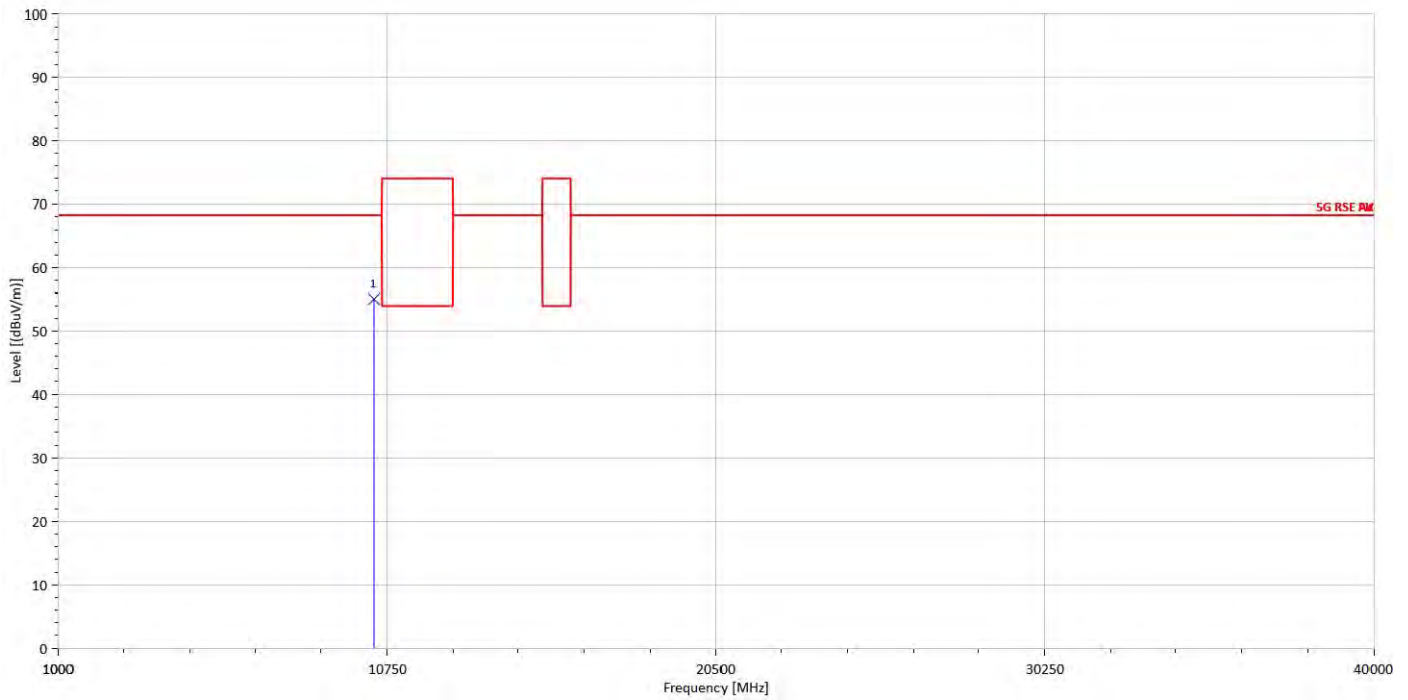

Freq. MHz	Note F/H/E/S	Detector Mode PK/QP/AV	Spectrum Reading Level dB μ V	Factor dB	Actual FS dB μ V/m	Limit @3m dB μ V/m	Margin dB
10360.00	H	Peak	29.32	25.76	55.08	68.3	-13.22

Unless otherwise stated the results shown in this test report refer only to the sample(s) tested and such sample(s) are retained for 90 days only.

除非另有說明，此報告結果僅對測試之樣品負責，同時此樣品僅保留90天。本報告未經本公司書面許可，不可部份複製。

This document is issued by the Company subject to its General Conditions of Service printed overleaf, available on request or accessible at www.sgs.com/terms_and_conditions.htm and, for electronic format documents, subject to Terms and Conditions for Electronic Documents at www.sgs.com/terms_e-document.htm. Attention is drawn to the limitation of liability, indemnification and jurisdiction issues defined therein. Any holder of this document is advised that information contained hereon reflects the Company's findings at the time of its intervention only and within the limits of Client's instructions, if any. The Company's sole responsibility is to its Client and this document does not exonerate parties to a transaction from exercising all their rights and obligations under the transaction documents. This document cannot be reproduced except in full, without prior written approval of the Company. Any unauthorized alteration, forgery or falsification of the content or appearance of this document is unlawful and offenders may be prosecuted to the fullest extent of the law.

SGS Taiwan Ltd.

No.134,WuKungRoad,NewTaipeiIndustrialPark,WukuDistrict,NewTaipeiCity,Taiwan24803/新北市五股區新北產業園區五工路 134 號

台灣檢驗科技股份有限公司

t (886-2) 2299-3279

f (886-2) 2298-0488

www.tw.sgs.com

Member of SGS Group

Operation Mode : 802.11n20 Test Date : 2017/7/14
 Fundamental Frequency : 5180 MHz Temp. / Humi. : 22.7 deg_C/57RH
 Operation Band : Tx CH Low Test Engineer : Ashton
 EUT Pol. : H Measurement Antenna Pol. : Horizontal

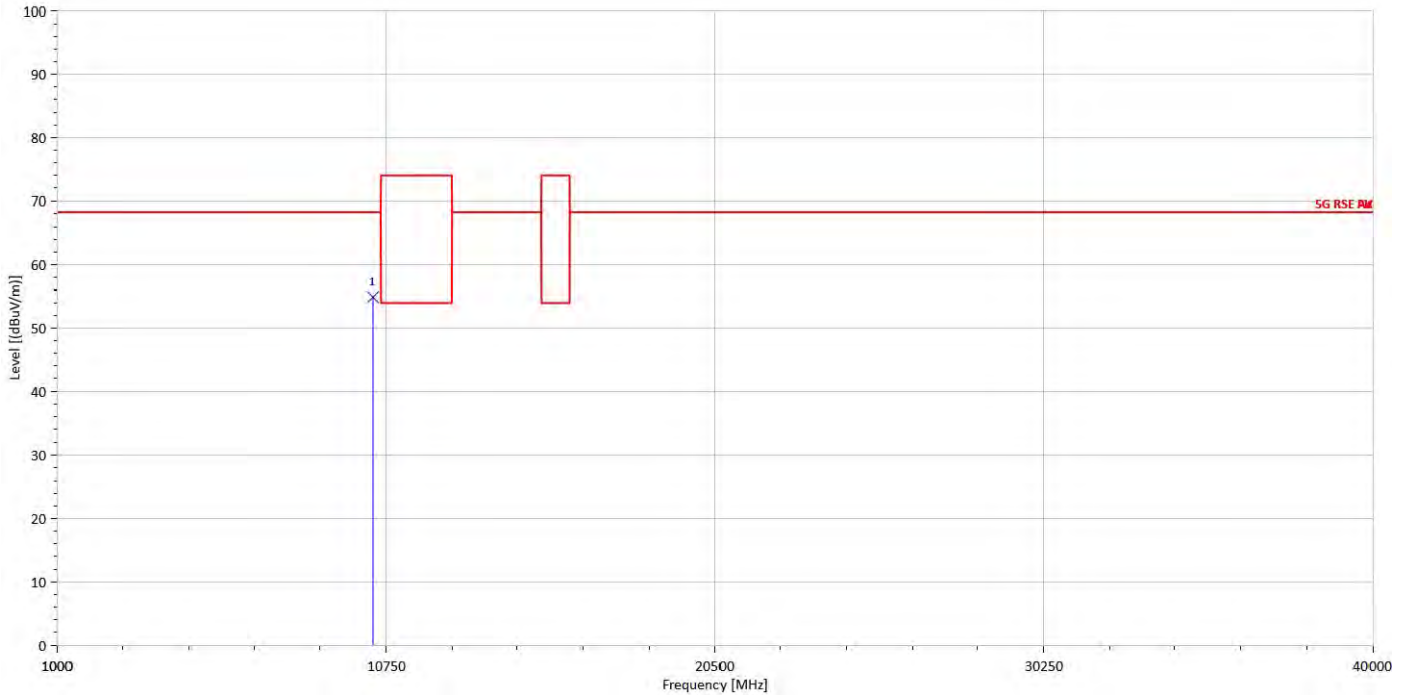

Freq. MHz	Note F/H/E/S	Detector Mode PK/QP/AV	Spectrum Reading Level dB μ V	Factor dB	Actual FS dB μ V/m	Limit @3m dB μ V/m	Margin dB
10360.00	H	Peak	29.16	25.76	54.92	68.3	-13.38

Unless otherwise stated the results shown in this test report refer only to the sample(s) tested and such sample(s) are retained for 90 days only.

除非另有說明，此報告結果僅對測試之樣品負責，同時此樣品僅保留90天。本報告未經本公司書面許可，不可部份複製。

This document is issued by the Company subject to its General Conditions of Service printed overleaf, available on request or accessible at www.sgs.com/terms_and_conditions.htm and, for electronic format documents, subject to Terms and Conditions for Electronic Documents at www.sgs.com/terms_e-document.htm. Attention is drawn to the limitation of liability, indemnification and jurisdiction issues defined therein. Any holder of this document is advised that information contained hereon reflects the Company's findings at the time of its intervention only and within the limits of Client's instructions, if any. The Company's sole responsibility is to its Client and this document does not exonerate parties to a transaction from exercising all their rights and obligations under the transaction documents. This document cannot be reproduced except in full, without prior written approval of the Company. Any unauthorized alteration, forgery or falsification of the content or appearance of this document is unlawful and offenders may be prosecuted to the fullest extent of the law.

SGS Taiwan Ltd.

No.134,WuKungRoad,NewTaipeiIndustrialPark,WukuDistrict,NewTaipeiCity,Taiwan24803/新北市五股區新北產業園區五工路 134 號

台灣檢驗科技股份有限公司

t (886-2) 2299-3279

f (886-2) 2298-0488

www.tw.sgs.com

Member of SGS Group

Operation Mode : 802.11n20 Test Date : 2017/7/14
 Fundamental Frequency : 5220 MHz Temp. / Humi. : 22.7 deg_C/57RH
 Operation Band : Tx CH Mid Test Engineer : Ashton
 EUT Pol. : H Measurement Antenna Pol. : Vertical

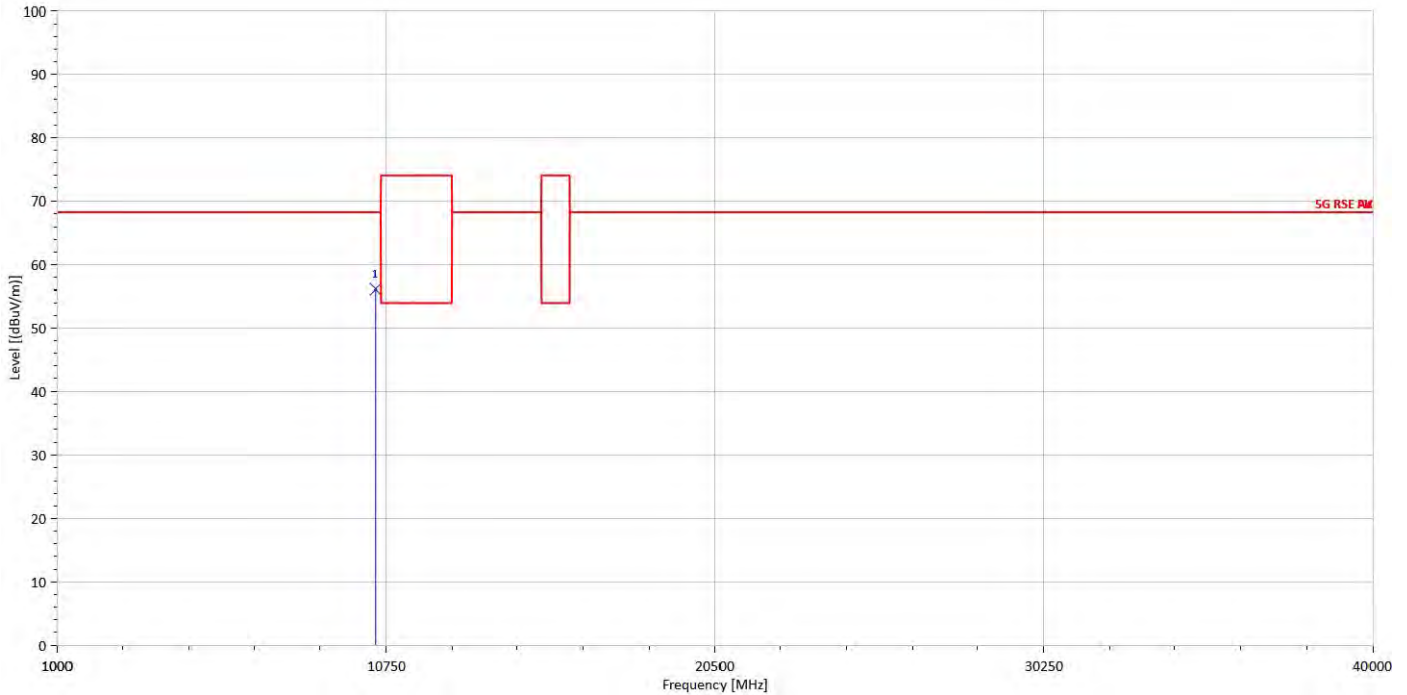

Freq. MHz	Note F/H/E/S	Detector Mode PK/QP/AV	Spectrum Reading Level dB μ V	Factor dB	Actual FS dB μ V/m	Limit @3m dB μ V/m	Margin dB
10440.00	H	Peak	30.37	25.77	56.14	68.3	-12.16

Unless otherwise stated the results shown in this test report refer only to the sample(s) tested and such sample(s) are retained for 90 days only.

除非另有說明，此報告結果僅對測試之樣品負責，同時此樣品僅保留90天。本報告未經本公司書面許可，不可部份複製。

This document is issued by the Company subject to its General Conditions of Service printed overleaf, available on request or accessible at www.sgs.com/terms_and_conditions.htm and, for electronic format documents, subject to Terms and Conditions for Electronic Documents at www.sgs.com/terms_e-document.htm. Attention is drawn to the limitation of liability, indemnification and jurisdiction issues defined therein. Any holder of this document is advised that information contained hereon reflects the Company's findings at the time of its intervention only and within the limits of Client's instructions, if any. The Company's sole responsibility is to its Client and this document does not exonerate parties to a transaction from exercising all their rights and obligations under the transaction documents. This document cannot be reproduced except in full, without prior written approval of the Company. Any unauthorized alteration, forgery or falsification of the content or appearance of this document is unlawful and offenders may be prosecuted to the fullest extent of the law.

SGS Taiwan Ltd.

No.134,WuKungRoad,NewTaipeiIndustrialPark,WukuDistrict,NewTaipeiCity,Taiwan24803/新北市五股區新北產業園區五工路 134 號

台灣檢驗科技股份有限公司

t (886-2) 2299-3279

f (886-2) 2298-0488

www.tw.sgs.com

Member of SGS Group

Operation Mode : 802.11n20 Test Date : 2017/7/14
 Fundamental Frequency : 5220 MHz Temp. / Humi. : 22.7 deg_C/57RH
 Operation Band : Tx CH Mid Test Engineer : Ashton
 EUT Pol. : H Measurement Antenna Pol. : Horizontal

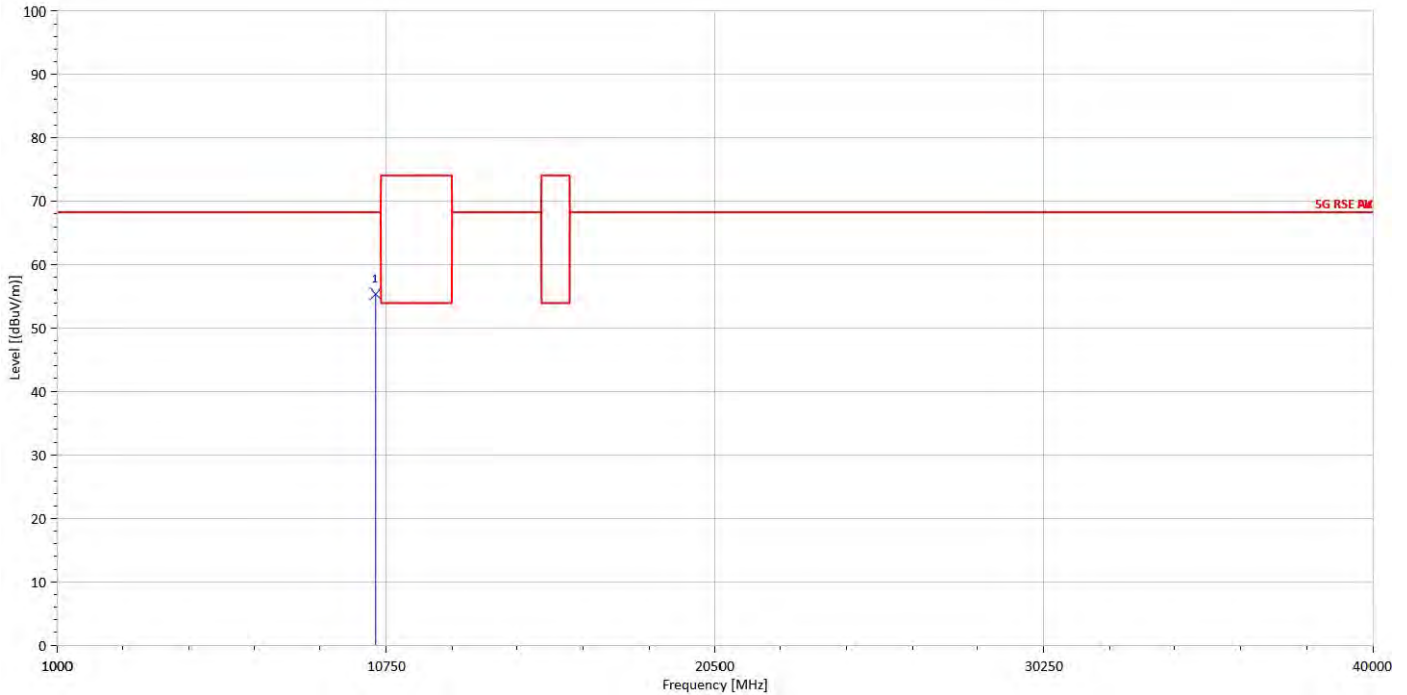

Freq. MHz	Note F/H/E/S	Detector Mode PK/QP/AV	Spectrum Reading Level dB μ V	Factor dB	Actual FS dB μ V/m	Limit @3m dB μ V/m	Margin dB
10440.00	H	Peak	29.65	25.77	55.43	68.3	-12.87

Unless otherwise stated the results shown in this test report refer only to the sample(s) tested and such sample(s) are retained for 90 days only.

除非另有說明，此報告結果僅對測試之樣品負責，同時此樣品僅保留90天。本報告未經本公司書面許可，不可部份複製。

This document is issued by the Company subject to its General Conditions of Service printed overleaf, available on request or accessible at www.sgs.com/terms_and_conditions.htm and, for electronic format documents, subject to Terms and Conditions for Electronic Documents at www.sgs.com/terms_e-document.htm. Attention is drawn to the limitation of liability, indemnification and jurisdiction issues defined therein. Any holder of this document is advised that information contained hereon reflects the Company's findings at the time of its intervention only and within the limits of Client's instructions, if any. The Company's sole responsibility is to its Client and this document does not exonerate parties to a transaction from exercising all their rights and obligations under the transaction documents. This document cannot be reproduced except in full, without prior written approval of the Company. Any unauthorized alteration, forgery or falsification of the content or appearance of this document is unlawful and offenders may be prosecuted to the fullest extent of the law.

SGS Taiwan Ltd.

No.134,WuKungRoad,NewTaipeiIndustrialPark,WukuDistrict,NewTaipeiCity,Taiwan24803/新北市五股區新北產業園區五工路 134 號

台灣檢驗科技股份有限公司

t (886-2) 2299-3279

f (886-2) 2298-0488

www.tw.sgs.com

Member of SGS Group

Operation Mode : 802.11n20 Test Date : 2017/7/14
 Fundamental Frequency : 5240 MHz Temp. / Humi. : 22.7 deg_C/57RH
 Operation Band : Tx CH High Test Engineer : Ashton
 EUT Pol. : H Measurement Antenna Pol. : Vertical

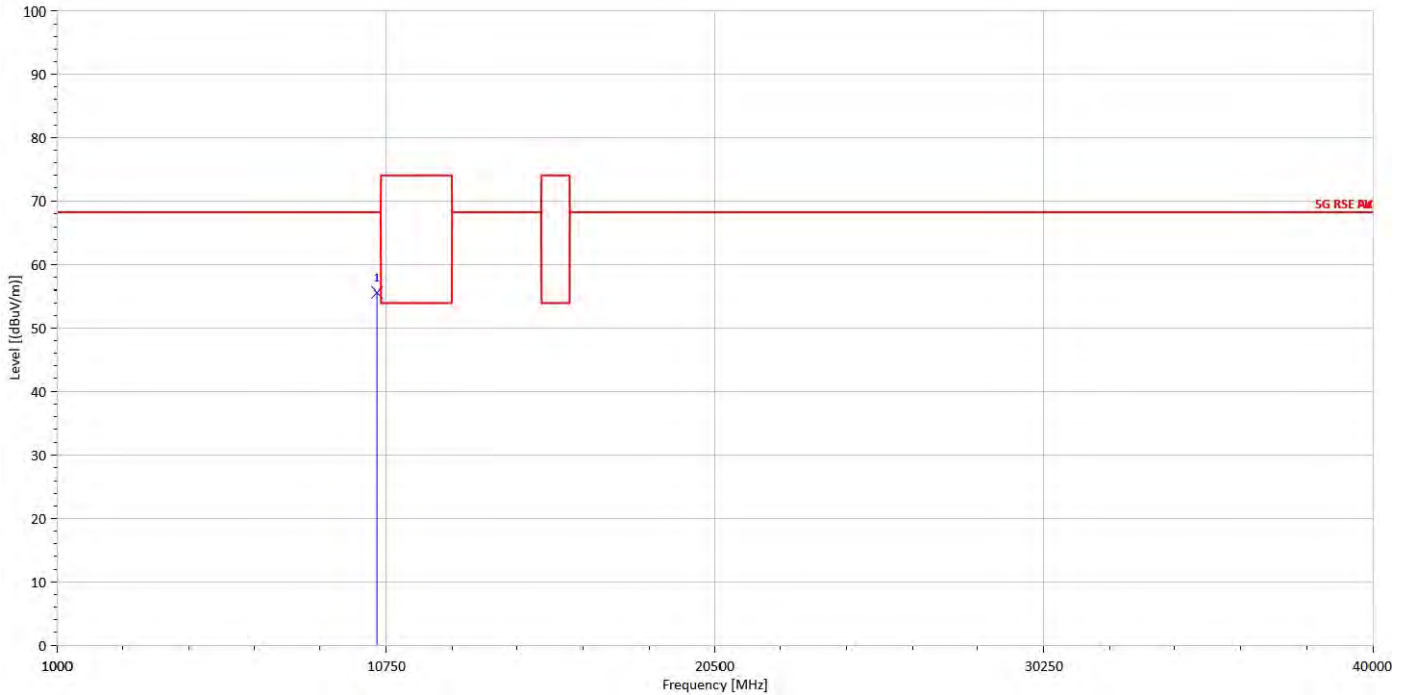

Freq. MHz	Note F/H/E/S	Detector Mode PK/QP/AV	Spectrum Reading Level dB μ V	Factor dB	Actual FS dB μ V/m	Limit @3m dB μ V/m	Margin dB
10480.00	H	Peak	29.86	25.78	55.64	68.3	-12.66

Unless otherwise stated the results shown in this test report refer only to the sample(s) tested and such sample(s) are retained for 90 days only.

除非另有說明，此報告結果僅對測試之樣品負責，同時此樣品僅保留90天。本報告未經本公司書面許可，不可部份複製。

This document is issued by the Company subject to its General Conditions of Service printed overleaf, available on request or accessible at www.sgs.com/terms_and_conditions.htm and, for electronic format documents, subject to Terms and Conditions for Electronic Documents at www.sgs.com/terms_e-document.htm. Attention is drawn to the limitation of liability, indemnification and jurisdiction issues defined therein. Any holder of this document is advised that information contained hereon reflects the Company's findings at the time of its intervention only and within the limits of Client's instructions, if any. The Company's sole responsibility is to its Client and this document does not exonerate parties to a transaction from exercising all their rights and obligations under the transaction documents. This document cannot be reproduced except in full, without prior written approval of the Company. Any unauthorized alteration, forgery or falsification of the content or appearance of this document is unlawful and offenders may be prosecuted to the fullest extent of the law.

SGS Taiwan Ltd.

No. 134, WuKungRoad, New Taipei Industrial Park, Wuku District, New Taipei City, Taiwan 24803 / 新北市五股區新北產業園區五工路 134 號

台灣檢驗科技股份有限公司

t (886-2) 2299-3279

f (886-2) 2298-0488

www.tw.sgs.com

Member of SGS Group

Operation Mode : 802.11n20 Test Date : 2017/7/14
 Fundamental Frequency : 5240 MHz Temp. / Humi. : 22.7 deg_C/57RH
 Operation Band : Tx CH High Test Engineer : Ashton
 EUT Pol. : H Measurement Antenna Pol. : Horizontal

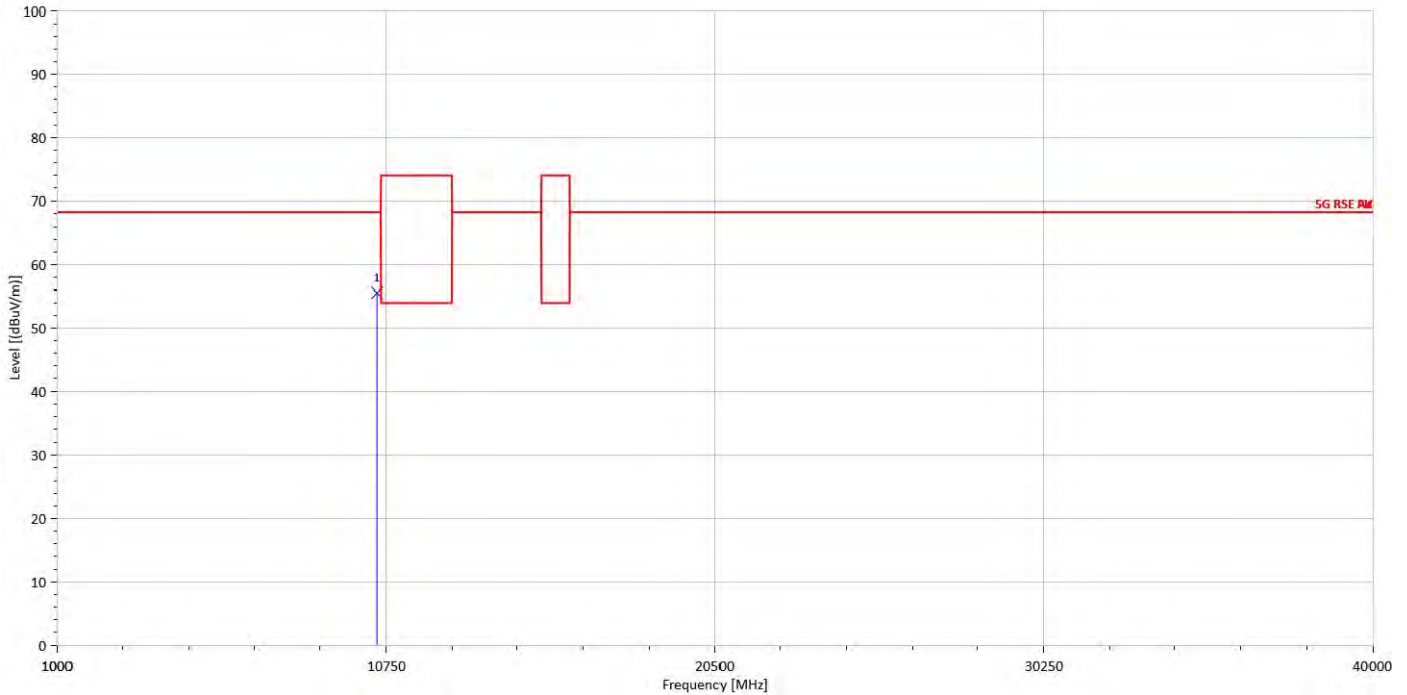

Freq. MHz	Note F/H/E/S	Detector Mode PK/QP/AV	Spectrum Reading Level dB μ V	Factor dB	Actual FS dB μ V/m	Limit @3m dB μ V/m	Margin dB
10480.00	H	Peak	29.78	25.78	55.56	68.3	-12.74

Unless otherwise stated the results shown in this test report refer only to the sample(s) tested and such sample(s) are retained for 90 days only.

除非另有說明，此報告結果僅對測試之樣品負責，同時此樣品僅保留90天。本報告未經本公司書面許可，不可部份複製。

This document is issued by the Company subject to its General Conditions of Service printed overleaf, available on request or accessible at www.sgs.com/terms_and_conditions.htm and, for electronic format documents, subject to Terms and Conditions for Electronic Documents at www.sgs.com/terms_e-document.htm. Attention is drawn to the limitation of liability, indemnification and jurisdiction issues defined therein. Any holder of this document is advised that information contained hereon reflects the Company's findings at the time of its intervention only and within the limits of Client's instructions, if any. The Company's sole responsibility is to its Client and this document does not exonerate parties to a transaction from exercising all their rights and obligations under the transaction documents. This document cannot be reproduced except in full, without prior written approval of the Company. Any unauthorized alteration, forgery or falsification of the content or appearance of this document is unlawful and offenders may be prosecuted to the fullest extent of the law.

SGS Taiwan Ltd.

No.134,WuKungRoad,NewTaipeiIndustrialPark,WukuDistrict,NewTaipeiCity,Taiwan24803/新北市五股區新北產業園區五工路 134 號

台灣檢驗科技股份有限公司

t (886-2) 2299-3279

f (886-2) 2298-0488

www.tw.sgs.com

Member of SGS Group

Radiated Spurious Emission Measurement Result 802.11n HT20, 5250~5350 MHz

Operation Mode :	802.11n20	Test Date :	2017/7/14
Fundamental Frequency :	5260 MHz	Temp. / Humi. :	22.7 deg_C/57RH
Operation Band :	Tx CH Low	Test Engineer :	Ashton
EUT Pol. :	H	Measurement Antenna Pol. :	Vertical

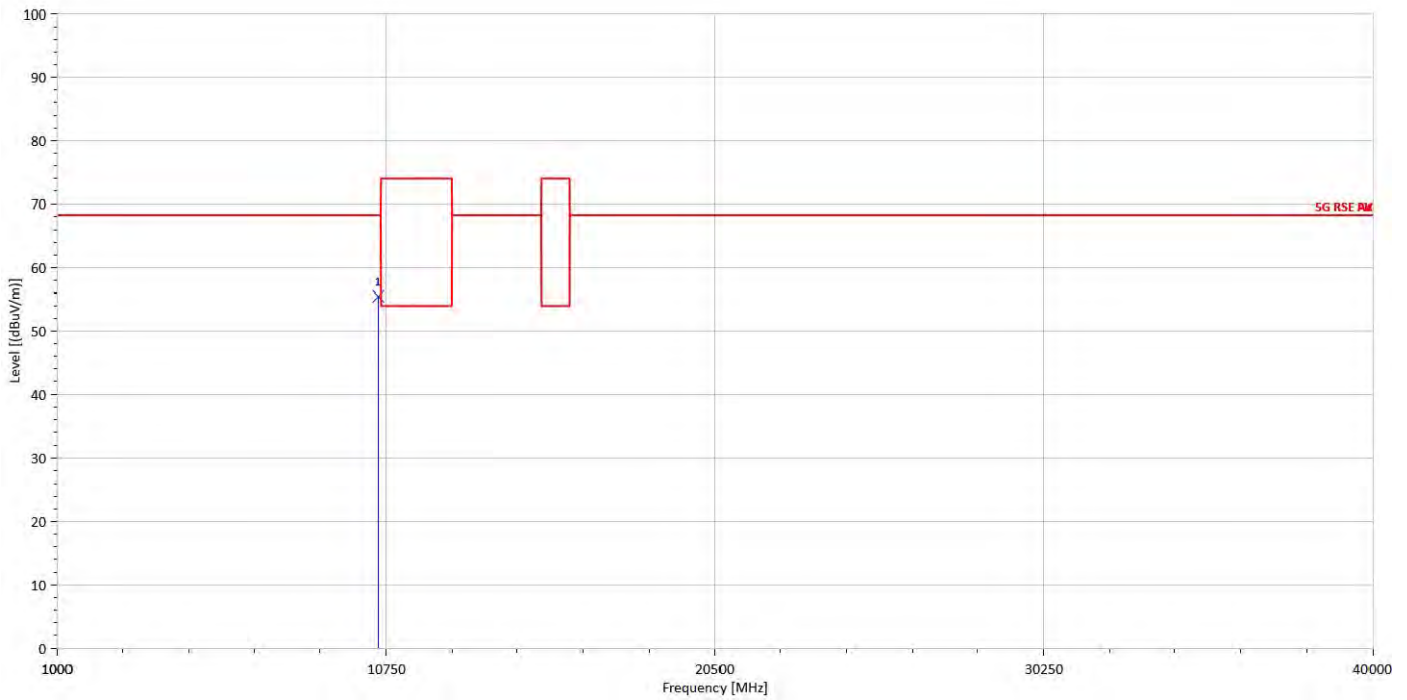

Freq. MHz	Note F/H/E/S	Detector Mode PK/QP/AV	Spectrum Reading Level dBuV	Factor dB	Actual FS dBuV/m	Limit @3m dBuV/m	Margin dB
10520.00	H	Peak	29.65	25.82	55.47	68.3	-12.83

Unless otherwise stated the results shown in this test report refer only to the sample(s) tested and such sample(s) are retained for 90 days only.

除非另有說明，此報告結果僅對測試之樣品負責，同時此樣品僅保留90天。本報告未經本公司書面許可，不可部份複製。

This document is issued by the Company subject to its General Conditions of Service printed overleaf, available on request or accessible at www.sgs.com/terms_and_conditions.htm and, for electronic format documents, subject to Terms and Conditions for Electronic Documents at www.sgs.com/terms_e-document.htm. Attention is drawn to the limitation of liability, indemnification and jurisdiction issues defined therein. Any holder of this document is advised that information contained hereon reflects the Company's findings at the time of its intervention only and within the limits of Client's instructions, if any. The Company's sole responsibility is to its Client and this document does not exonerate parties to a transaction from exercising all their rights and obligations under the transaction documents. This document cannot be reproduced except in full, without prior written approval of the Company. Any unauthorized alteration, forgery or falsification of the content or appearance of this document is unlawful and offenders may be prosecuted to the fullest extent of the law.

SGS Taiwan Ltd.

No.134,WuKungRoad,NewTaipeiIndustrialPark,WukuDistrict,NewTaipeiCity,Taiwan24803/新北市五股區新北產業園區五工路 134 號

台灣檢驗科技股份有限公司

t (886-2) 2299-3279

f (886-2) 2298-0488

www.tw.sgs.com

Member of SGS Group

Operation Mode : 802.11n20 Test Date : 2017/7/14
 Fundamental Frequency : 5260 MHz Temp. / Humi. : 22.7 deg_C/57RH
 Operation Band : Tx CH Low Test Engineer : Ashton
 EUT Pol. : H Measurement Antenna Pol. : Horizontal

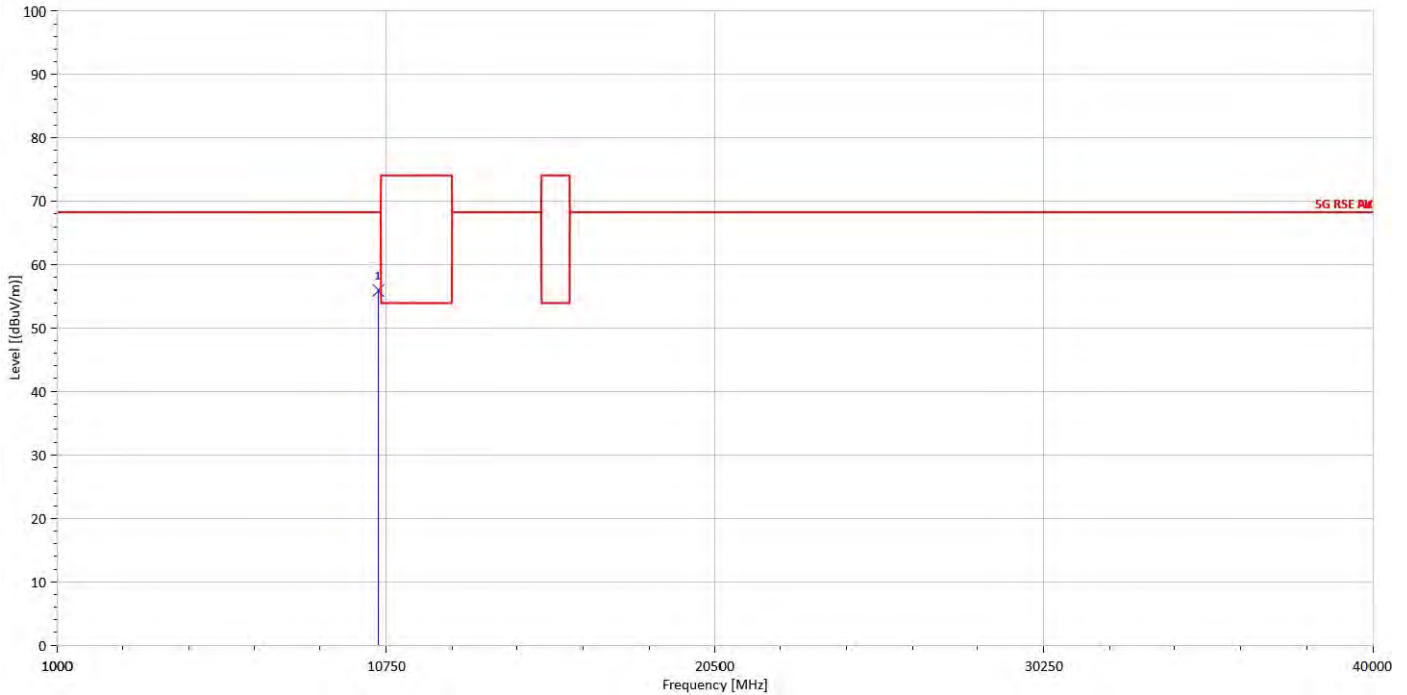

Freq. MHz	Note F/H/E/S	Detector Mode PK/QP/AV	Spectrum Reading Level dB μ V	Factor dB	Actual FS dB μ V/m	Limit @3m dB μ V/m	Margin dB
10520.00	H	Peak	30.11	25.82	55.93	68.3	-12.37

Unless otherwise stated the results shown in this test report refer only to the sample(s) tested and such sample(s) are retained for 90 days only.

除非另有說明，此報告結果僅對測試之樣品負責，同時此樣品僅保留90天。本報告未經本公司書面許可，不可部份複製。

This document is issued by the Company subject to its General Conditions of Service printed overleaf, available on request or accessible at www.sgs.com/terms_and_conditions.htm and, for electronic format documents, subject to Terms and Conditions for Electronic Documents at www.sgs.com/terms_e-document.htm. Attention is drawn to the limitation of liability, indemnification and jurisdiction issues defined therein. Any holder of this document is advised that information contained hereon reflects the Company's findings at the time of its intervention only and within the limits of Client's instructions, if any. The Company's sole responsibility is to its Client and this document does not exonerate parties to a transaction from exercising all their rights and obligations under the transaction documents. This document cannot be reproduced except in full, without prior written approval of the Company. Any unauthorized alteration, forgery or falsification of the content or appearance of this document is unlawful and offenders may be prosecuted to the fullest extent of the law.

SGS Taiwan Ltd.

No. 134, WuKungRoad, New Taipei Industrial Park, Wuku District, New Taipei City, Taiwan 24803 / 新北市五股區新北產業園區五工路 134 號

台灣檢驗科技股份有限公司

t (886-2) 2299-3279

f (886-2) 2298-0488

www.tw.sgs.com

Member of SGS Group

Operation Mode : 802.11n20 Test Date : 2017/7/14
 Fundamental Frequency : 5300 MHz Temp. / Humi. : 22.7 deg_C/57RH
 Operation Band : Tx CH Mid Test Engineer : Ashton
 EUT Pol. : H Measurement Antenna Pol. : Vertical

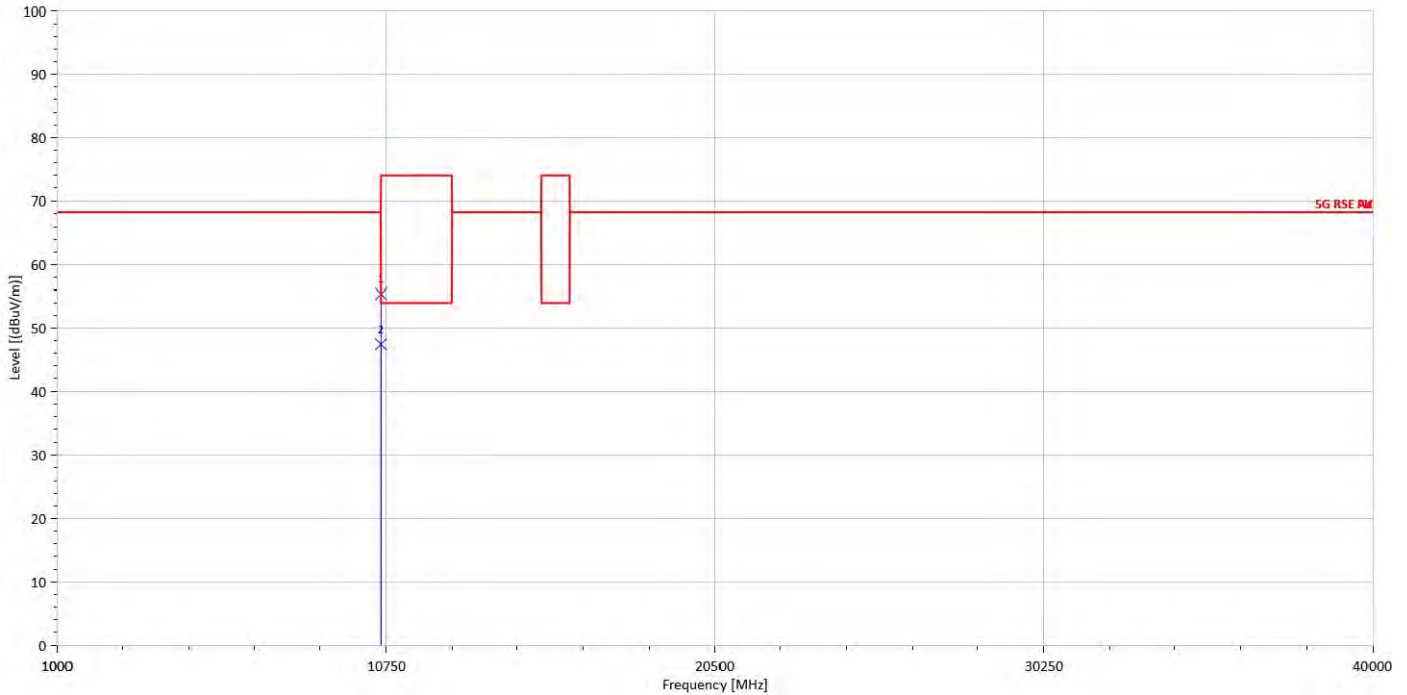

Freq. MHz	Note F/H/E/S	Detector Mode PK/QP/AV	Spectrum Reading Level dBuV	Factor dB	Actual FS dBuV/m	Limit @3m dBuV/m	Margin dB
10600.00	H	Peak	29.44	25.94	55.38	74	-18.62
10600.00	H	Average	21.51	25.94	47.45	54	-6.55

Unless otherwise stated the results shown in this test report refer only to the sample(s) tested and such sample(s) are retained for 90 days only.

除非另有說明，此報告結果僅對測試之樣品負責，同時此樣品僅保留90天。本報告未經本公司書面許可，不可部份複製。

This document is issued by the Company subject to its General Conditions of Service printed overleaf, available on request or accessible at www.sgs.com/terms_and_conditions.htm and, for electronic format documents, subject to Terms and Conditions for Electronic Documents at www.sgs.com/terms_e-document.htm. Attention is drawn to the limitation of liability, indemnification and jurisdiction issues defined therein. Any holder of this document is advised that information contained hereon reflects the Company's findings at the time of its intervention only and within the limits of Client's instructions, if any. The Company's sole responsibility is to its Client and this document does not exonerate parties to a transaction from exercising all their rights and obligations under the transaction documents. This document cannot be reproduced except in full, without prior written approval of the Company. Any unauthorized alteration, forgery or falsification of the content or appearance of this document is unlawful and offenders may be prosecuted to the fullest extent of the law.

SGS Taiwan Ltd.

No. 134, WuKungRoad, New Taipei Industrial Park, Wuku District, New Taipei City, Taiwan 24803 / 新北市五股區新北產業園區五工路 134 號

台灣檢驗科技股份有限公司

t (886-2) 2299-3279

f (886-2) 2298-0488

www.tw.sgs.com

Member of SGS Group

Operation Mode : 802.11n20 Test Date : 2017/7/14
 Fundamental Frequency : 5300 MHz Temp. / Humi. : 22.7 deg_C/57RH
 Operation Band : Tx CH Mid Test Engineer : Ashton
 EUT Pol. : H Measurement Antenna Pol. : Horizontal

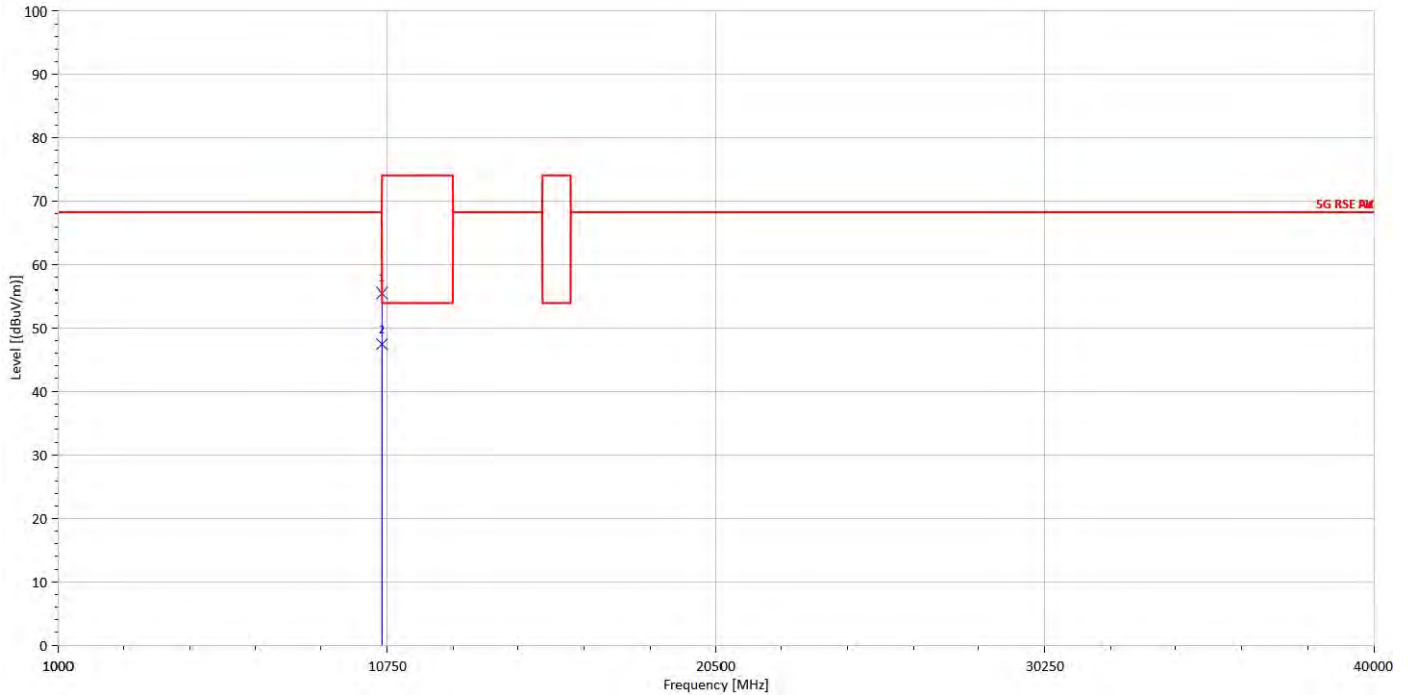

Freq. MHz	Note F/H/E/S	Detector Mode PK/QP/AV	Spectrum Reading Level dBuV	Factor dB	Actual FS dBuV/m	Limit @3m dBuV/m	Margin dB
10600.00	H	Peak	29.60	25.94	55.54	74	-18.46
10600.00	H	Average	21.52	25.94	47.46	54	-6.54

Unless otherwise stated the results shown in this test report refer only to the sample(s) tested and such sample(s) are retained for 90 days only.

除非另有說明，此報告結果僅對測試之樣品負責，同時此樣品僅保留90天。本報告未經本公司書面許可，不可部份複製。

This document is issued by the Company subject to its General Conditions of Service printed overleaf, available on request or accessible at www.sgs.com/terms_and_conditions.htm and, for electronic format documents, subject to Terms and Conditions for Electronic Documents at www.sgs.com/terms_e-document.htm. Attention is drawn to the limitation of liability, indemnification and jurisdiction issues defined therein. Any holder of this document is advised that information contained hereon reflects the Company's findings at the time of its intervention only and within the limits of Client's instructions, if any. The Company's sole responsibility is to its Client and this document does not exonerate parties to a transaction from exercising all their rights and obligations under the transaction documents. This document cannot be reproduced except in full, without prior written approval of the Company. Any unauthorized alteration, forgery or falsification of the content or appearance of this document is unlawful and offenders may be prosecuted to the fullest extent of the law.

SGS Taiwan Ltd.

No. 134, WuKungRoad, New Taipei Industrial Park, Wuku District, New Taipei City, Taiwan 24803 / 新北市五股區新北產業園區五工路 134 號

台灣檢驗科技股份有限公司

t (886-2) 2299-3279

f (886-2) 2298-0488

www.tw.sgs.com

Member of SGS Group

Operation Mode : 802.11n20 Test Date : 2017/7/14
 Fundamental Frequency : 5320 MHz Temp. / Humi. : 22.7 deg_C/57RH
 Operation Band : Tx CH High Test Engineer : Ashton
 EUT Pol. : H Measurement Antenna Pol. : Vertical

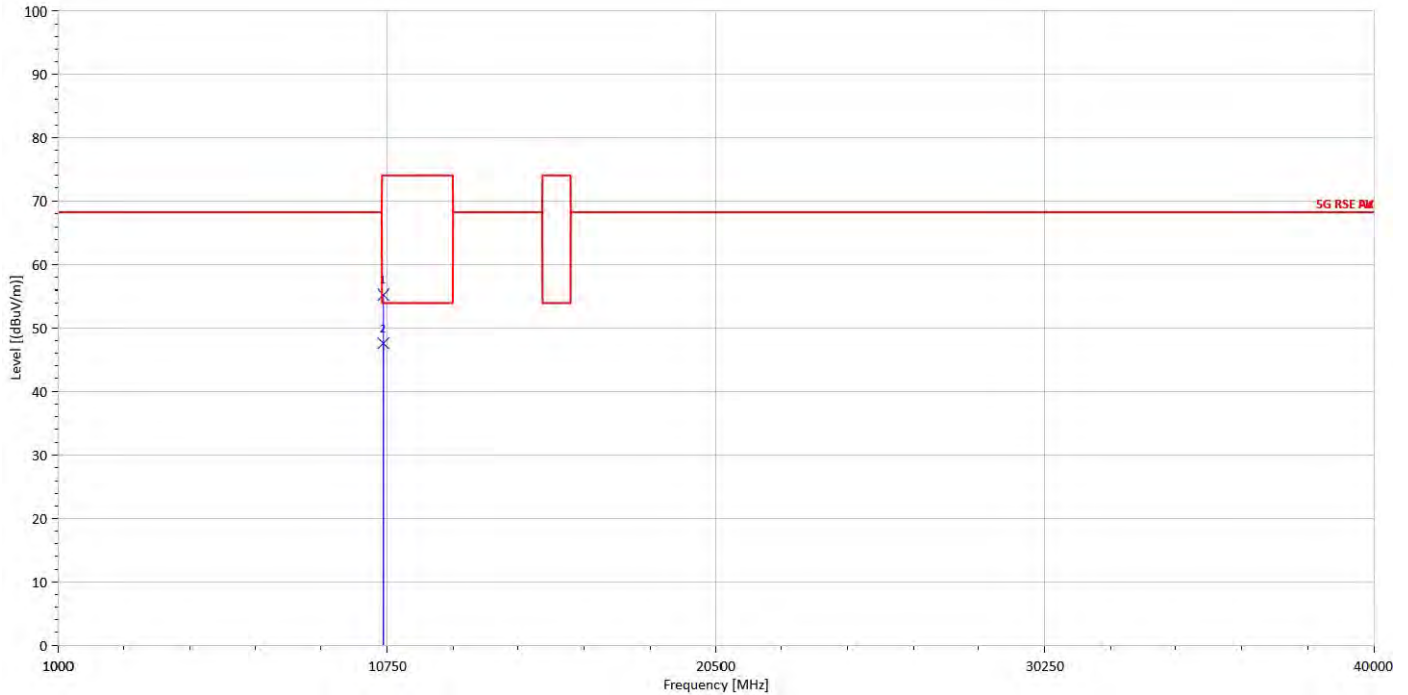

Freq. MHz	Note F/H/E/S	Detector Mode PK/QP/AV	Spectrum Reading Level dBuV	Factor dB	Actual FS dBuV/m	Limit @3m dBuV/m	Margin dB
10640.00	H	Peak	29.21	26.07	55.28	74	-18.72
10640.00	H	Average	21.53	26.07	47.60	54	-6.40

Unless otherwise stated the results shown in this test report refer only to the sample(s) tested and such sample(s) are retained for 90 days only.

除非另有說明，此報告結果僅對測試之樣品負責，同時此樣品僅保留90天。本報告未經本公司書面許可，不可部份複製。

This document is issued by the Company subject to its General Conditions of Service printed overleaf, available on request or accessible at www.sgs.com/terms_and_conditions.htm and, for electronic format documents, subject to Terms and Conditions for Electronic Documents at www.sgs.com/terms_e-document.htm. Attention is drawn to the limitation of liability, indemnification and jurisdiction issues defined therein. Any holder of this document is advised that information contained hereon reflects the Company's findings at the time of its intervention only and within the limits of Client's instructions, if any. The Company's sole responsibility is to its Client and this document does not exonerate parties to a transaction from exercising all their rights and obligations under the transaction documents. This document cannot be reproduced except in full, without prior written approval of the Company. Any unauthorized alteration, forgery or falsification of the content or appearance of this document is unlawful and offenders may be prosecuted to the fullest extent of the law.

SGS Taiwan Ltd.

No. 134, WuKungRoad, New Taipei Industrial Park, Wuku District, New Taipei City, Taiwan 24803 / 新北市五股區新北產業園區五工路 134 號

台灣檢驗科技股份有限公司

t (886-2) 2299-3279

f (886-2) 2298-0488

www.tw.sgs.com

Member of SGS Group

Operation Mode : 802.11n20 Test Date : 2017/7/14
 Fundamental Frequency : 5320 MHz Temp. / Humi. : 22.7 deg_C/57RH
 Operation Band : Tx CH High Test Engineer : Ashton
 EUT Pol. : H Measurement Antenna Pol. : Horizontal

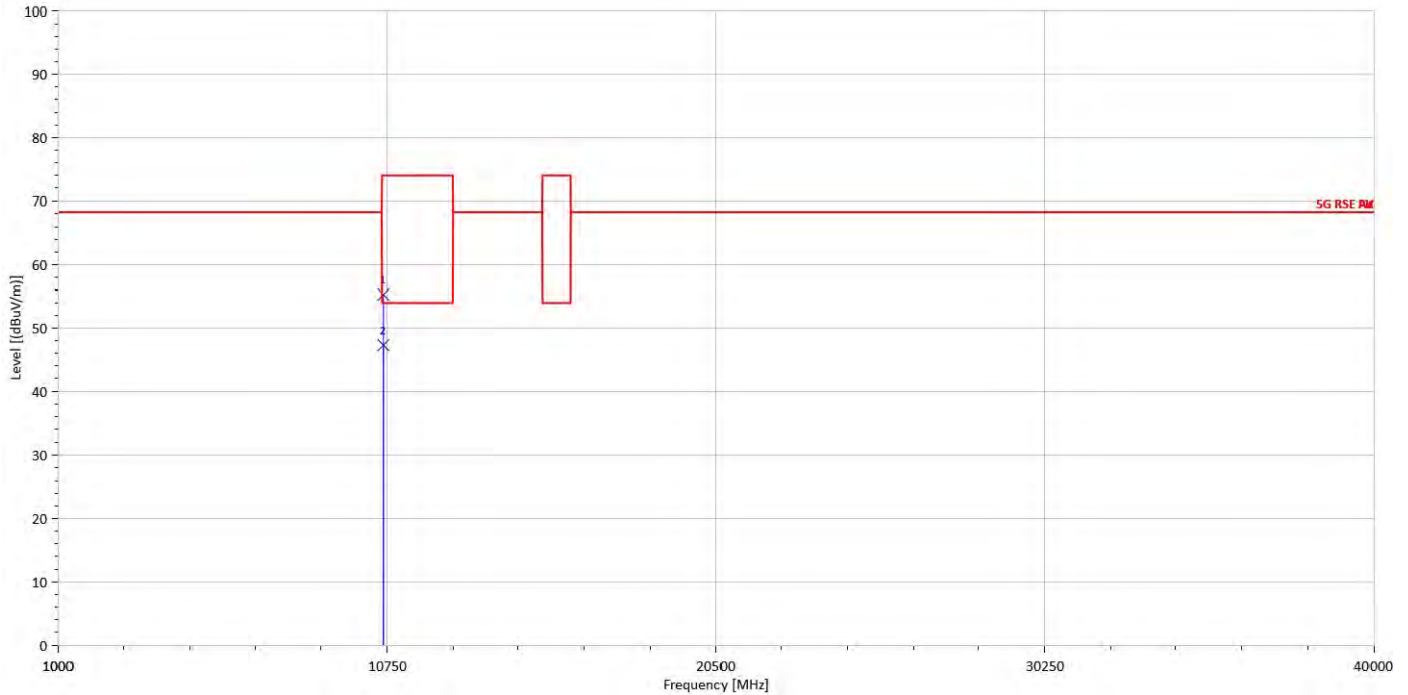

Freq. MHz	Note F/H/E/S	Detector Mode PK/QP/AV	Spectrum Reading Level dBuV	Factor dB	Actual FS dBuV/m	Limit @3m dBuV/m	Margin dB
10640.00	H	Peak	29.24	26.07	55.30	74	-18.70
10640.00	H	Average	21.24	26.07	47.31	54	-6.69

Unless otherwise stated the results shown in this test report refer only to the sample(s) tested and such sample(s) are retained for 90 days only.

除非另有說明，此報告結果僅對測試之樣品負責，同時此樣品僅保留90天。本報告未經本公司書面許可，不可部份複製。

This document is issued by the Company subject to its General Conditions of Service printed overleaf, available on request or accessible at www.sgs.com/terms_and_conditions.htm and, for electronic format documents, subject to Terms and Conditions for Electronic Documents at www.sgs.com/terms_e-document.htm. Attention is drawn to the limitation of liability, indemnification and jurisdiction issues defined therein. Any holder of this document is advised that information contained hereon reflects the Company's findings at the time of its intervention only and within the limits of Client's instructions, if any. The Company's sole responsibility is to its Client and this document does not exonerate parties to a transaction from exercising all their rights and obligations under the transaction documents. This document cannot be reproduced except in full, without prior written approval of the Company. Any unauthorized alteration, forgery or falsification of the content or appearance of this document is unlawful and offenders may be prosecuted to the fullest extent of the law.

SGS Taiwan Ltd.

No. 134, WuKungRoad, New Taipei Industrial Park, Wuku District, New Taipei City, Taiwan 24803 / 新北市五股區新北產業園區五工路 134 號

台灣檢驗科技股份有限公司

t (886-2) 2299-3279

f (886-2) 2298-0488

www.tw.sgs.com

Member of SGS Group

Radiated Spurious Emission Measurement Result 802.11n HT20, 5470~5725 MHz

Operation Mode :	802.11n20	Test Date :	2017/7/14
Fundamental Frequency :	5500 MHz	Temp. / Humi. :	22.7 deg_C/57RH
Operation Band :	Tx CH Low	Test Engineer :	Ashton
EUT Pol. :	H	Measurement Antenna Pol. :	Vertical

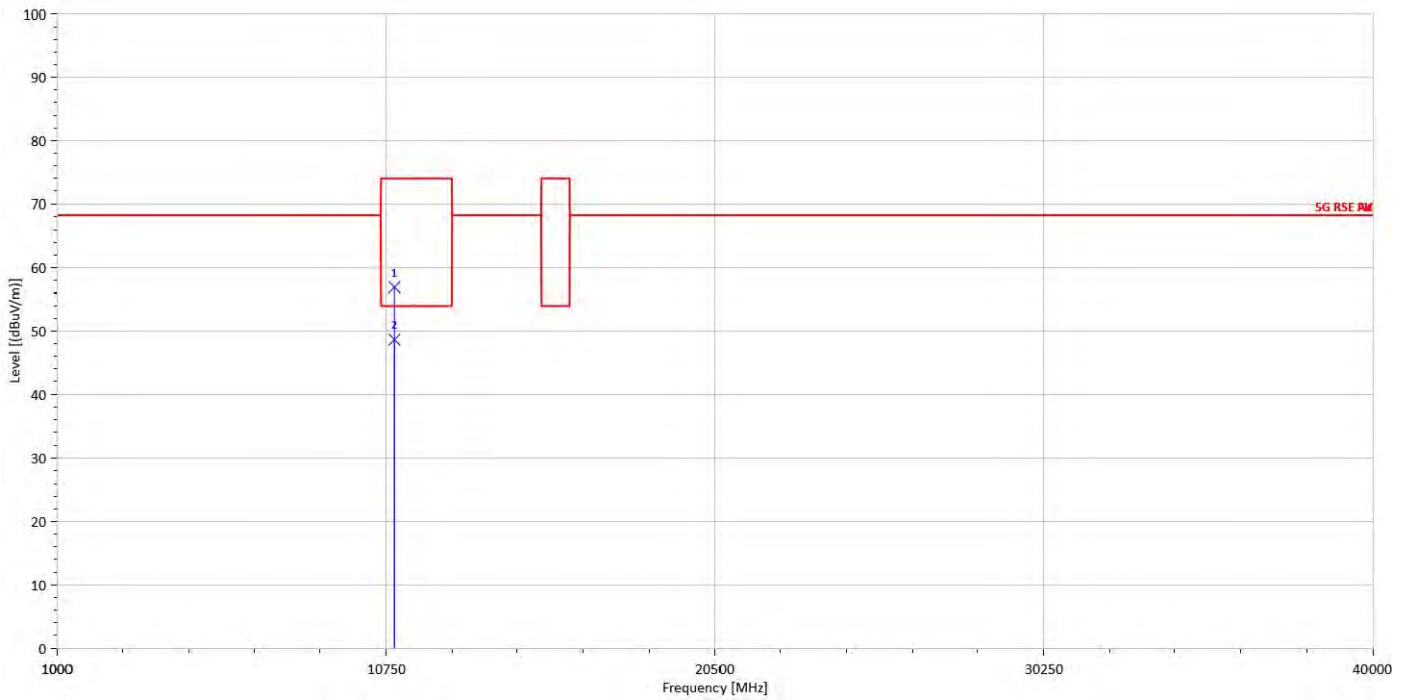

Freq. MHz	Note F/H/E/S	Detector Mode PK/QP/AV	Spectrum Reading Level dBuV	Factor dB	Actual FS dBuV/m	Limit @ 3m dBuV/m	Margin dB
11000.00	H	Peak	29.81	27.06	56.87	74	-17.13
11000.00	H	Average	21.60	27.06	48.66	54	-5.34

Unless otherwise stated the results shown in this test report refer only to the sample(s) tested and such sample(s) are retained for 90 days only.

除非另有說明，此報告結果僅對測試之樣品負責，同時此樣品僅保留90天。本報告未經本公司書面許可，不可部份複製。

This document is issued by the Company subject to its General Conditions of Service printed overleaf, available on request or accessible at www.sgs.com/terms_and_conditions.htm and, for electronic format documents, subject to Terms and Conditions for Electronic Documents at www.sgs.com/terms_e-document.htm. Attention is drawn to the limitation of liability, indemnification and jurisdiction issues defined therein. Any holder of this document is advised that information contained hereon reflects the Company's findings at the time of its intervention only and within the limits of Client's instructions, if any. The Company's sole responsibility is to its Client and this document does not exonerate parties to a transaction from exercising all their rights and obligations under the transaction documents. This document cannot be reproduced except in full, without prior written approval of the Company. Any unauthorized alteration, forgery or falsification of the content or appearance of this document is unlawful and offenders may be prosecuted to the fullest extent of the law.

SGS Taiwan Ltd.

No.134,WuKungRoad,NewTaipeiIndustrialPark,WukuDistrict,NewTaipeiCity,Taiwan24803/新北市五股區新北產業園區五工路 134 號

台灣檢驗科技股份有限公司

t (886-2) 2299-3279

f (886-2) 2298-0488

www.tw.sgs.com

Member of SGS Group

Operation Mode : 802.11n20 Test Date : 2017/7/14
 Fundamental Frequency : 5500 MHz Temp. / Humi. : 22.7 deg_C/57RH
 Operation Band : Tx CH Low Test Engineer : Ashton
 EUT Pol. : H Measurement Antenna Pol. : Horizontal

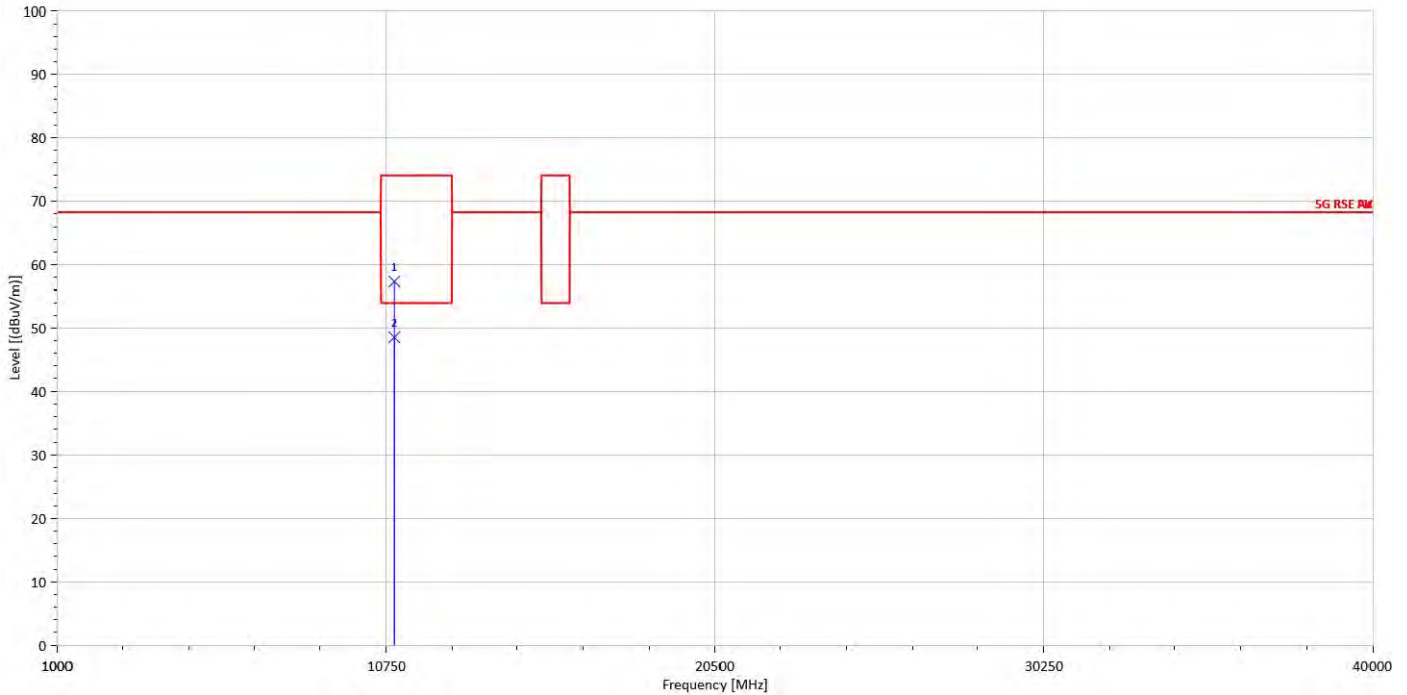

Freq. MHz	Note F/H/E/S	Detector Mode PK/QP/AV	Spectrum Reading Level dBuV	Factor dB	Actual FS dBuV/m	Limit @ 3m dBuV/m	Margin dB
11000.00	H	Peak	30.22	27.06	57.28	74	-16.72
11000.00	H	Average	21.48	27.06	48.54	54	-5.46

Unless otherwise stated the results shown in this test report refer only to the sample(s) tested and such sample(s) are retained for 90 days only.

除非另有說明，此報告結果僅對測試之樣品負責，同時此樣品僅保留90天。本報告未經本公司書面許可，不可部份複製。

This document is issued by the Company subject to its General Conditions of Service printed overleaf, available on request or accessible at www.sgs.com/terms_and_conditions.htm and, for electronic format documents, subject to Terms and Conditions for Electronic Documents at www.sgs.com/terms_e-document.htm. Attention is drawn to the limitation of liability, indemnification and jurisdiction issues defined therein. Any holder of this document is advised that information contained hereon reflects the Company's findings at the time of its intervention only and within the limits of Client's instructions, if any. The Company's sole responsibility is to its Client and this document does not exonerate parties to a transaction from exercising all their rights and obligations under the transaction documents. This document cannot be reproduced except in full, without prior written approval of the Company. Any unauthorized alteration, forgery or falsification of the content or appearance of this document is unlawful and offenders may be prosecuted to the fullest extent of the law.

SGS Taiwan Ltd.

No. 134, WuKungRoad, New Taipei Industrial Park, Wuku District, New Taipei City, Taiwan 24803/新北市五股區新北產業園區五工路 134 號

台灣檢驗科技股份有限公司

t (886-2) 2299-3279

f (886-2) 2298-0488

www.tw.sgs.com

Member of SGS Group

Operation Mode : 802.11n20 Test Date : 2017/7/14
 Fundamental Frequency : 5580 MHz Temp. / Humi. : 22.7 deg_C/57RH
 Operation Band : Tx CH Mid Test Engineer : Ashton
 EUT Pol. : H Measurement Antenna Pol. : Vertical

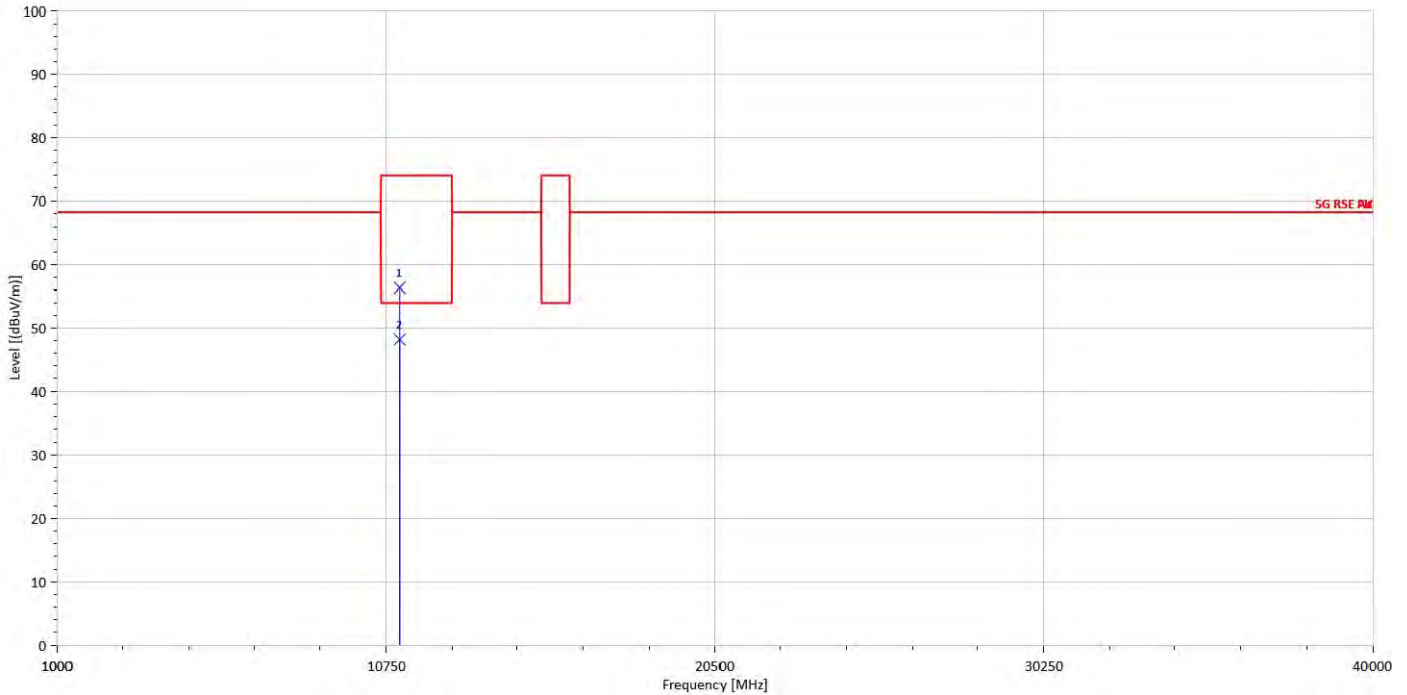

Freq. MHz	Note F/H/E/S	Detector Mode PK/QP/AV	Spectrum Reading Level dBuV	Factor dB	Actual FS dBuV/m	Limit @3m dBuV/m	Margin dB
11160.00	H	Peak	29.58	26.76	56.34	74	-17.66
11160.00	H	Average	21.43	26.76	48.19	54	-5.81

Unless otherwise stated the results shown in this test report refer only to the sample(s) tested and such sample(s) are retained for 90 days only.

除非另有說明，此報告結果僅對測試之樣品負責，同時此樣品僅保留90天。本報告未經本公司書面許可，不可部份複製。

This document is issued by the Company subject to its General Conditions of Service printed overleaf, available on request or accessible at www.sgs.com/terms_and_conditions.htm and, for electronic format documents, subject to Terms and Conditions for Electronic Documents at www.sgs.com/terms_e-document.htm. Attention is drawn to the limitation of liability, indemnification and jurisdiction issues defined therein. Any holder of this document is advised that information contained hereon reflects the Company's findings at the time of its intervention only and within the limits of Client's instructions, if any. The Company's sole responsibility is to its Client and this document does not exonerate parties to a transaction from exercising all their rights and obligations under the transaction documents. This document cannot be reproduced except in full, without prior written approval of the Company. Any unauthorized alteration, forgery or falsification of the content or appearance of this document is unlawful and offenders may be prosecuted to the fullest extent of the law.

SGS Taiwan Ltd.

No.134,WuKungRoad,NewTaipeiIndustrialPark,WukuDistrict,NewTaipeiCity,Taiwan24803/新北市五股區新北產業園區五工路 134 號

台灣檢驗科技股份有限公司

t (886-2) 2299-3279

f (886-2) 2298-0488

www.tw.sgs.com

Member of SGS Group

Operation Mode : 802.11n20 Test Date : 2017/7/14
 Fundamental Frequency : 5580 MHz Temp. / Humi. : 22.7 deg_C/57RH
 Operation Band : Tx CH Mid Test Engineer : Ashton
 EUT Pol. : H Measurement Antenna Pol. : Horizontal

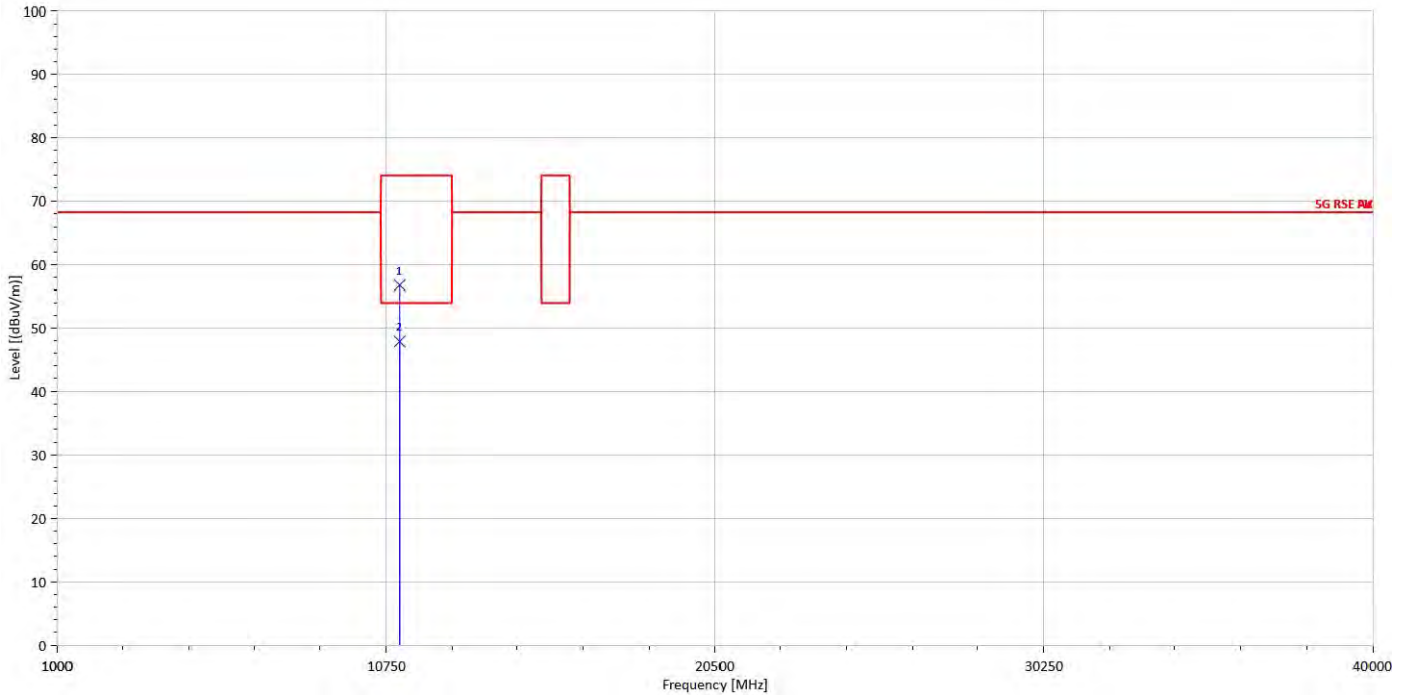

Freq. MHz	Note F/H/E/S	Detector Mode PK/QP/AV	Spectrum Reading Level dBµV	Factor dB	Actual FS dBµV/m	Limit @3m dBµV/m	Margin dB
11160.00	H	Peak	29.97	26.76	56.73	74	-17.27
11160.00	H	Average	21.13	26.76	47.89	54	-6.11

Unless otherwise stated the results shown in this test report refer only to the sample(s) tested and such sample(s) are retained for 90 days only.

除非另有說明，此報告結果僅對測試之樣品負責，同時此樣品僅保留90天。本報告未經本公司書面許可，不可部份複製。

This document is issued by the Company subject to its General Conditions of Service printed overleaf, available on request or accessible at www.sgs.com/terms_and_conditions.htm and, for electronic format documents, subject to Terms and Conditions for Electronic Documents at www.sgs.com/terms_e-document.htm. Attention is drawn to the limitation of liability, indemnification and jurisdiction issues defined therein. Any holder of this document is advised that information contained hereon reflects the Company's findings at the time of its intervention only and within the limits of Client's instructions, if any. The Company's sole responsibility is to its Client and this document does not exonerate parties to a transaction from exercising all their rights and obligations under the transaction documents. This document cannot be reproduced except in full, without prior written approval of the Company. Any unauthorized alteration, forgery or falsification of the content or appearance of this document is unlawful and offenders may be prosecuted to the fullest extent of the law.

SGS Taiwan Ltd.

No.134,WuKungRoad,NewTaipeiIndustrialPark,WukuDistrict,NewTaipeiCity,Taiwan24803/新北市五股區新北產業園區五工路 134 號

台灣檢驗科技股份有限公司

t (886-2) 2299-3279

f (886-2) 2298-0488

www.tw.sgs.com

Member of SGS Group

Operation Mode : 802.11n20 Test Date : 2017/7/14
 Fundamental Frequency : 5700 MHz Temp. / Humi. : 22.7 deg_C/57RH
 Operation Band : Tx CH High Test Engineer : Ashton
 EUT Pol. : H Measurement Antenna Pol. : Vertical

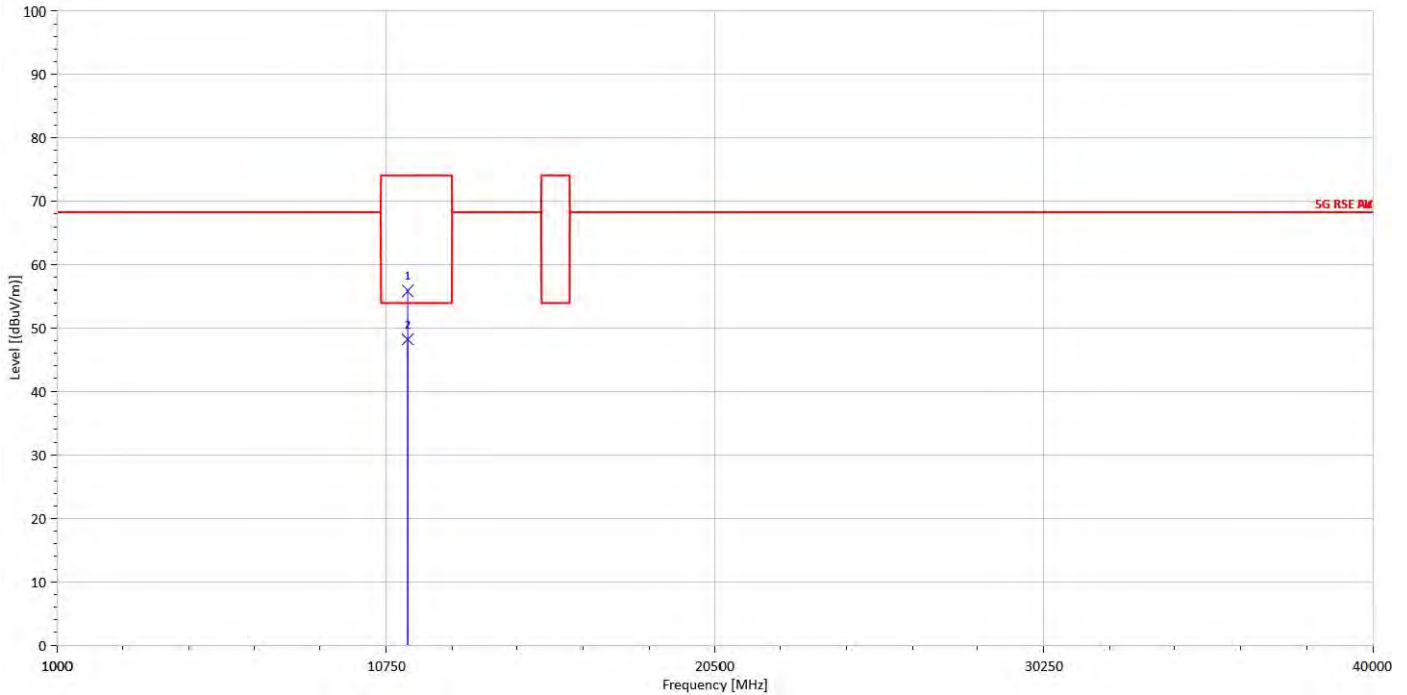

Freq. MHz	Note F/H/E/S	Detector Mode PK/QP/AV	Spectrum Reading Level dBuV	Factor dB	Actual FS dBuV/m	Limit @ 3m dBuV/m	Margin dB
11400.00	H	Peak	29.26	26.59	55.85	74	-18.15
11400.00	H	Average	21.62	26.59	48.21	54	-5.79

Unless otherwise stated the results shown in this test report refer only to the sample(s) tested and such sample(s) are retained for 90 days only.

除非另有說明，此報告結果僅對測試之樣品負責，同時此樣品僅保留90天。本報告未經本公司書面許可，不可部份複製。

This document is issued by the Company subject to its General Conditions of Service printed overleaf, available on request or accessible at www.sgs.com/terms_and_conditions.htm and, for electronic format documents, subject to Terms and Conditions for Electronic Documents at www.sgs.com/terms_e-document.htm. Attention is drawn to the limitation of liability, indemnification and jurisdiction issues defined therein. Any holder of this document is advised that information contained hereon reflects the Company's findings at the time of its intervention only and within the limits of Client's instructions, if any. The Company's sole responsibility is to its Client and this document does not exonerate parties to a transaction from exercising all their rights and obligations under the transaction documents. This document cannot be reproduced except in full, without prior written approval of the Company. Any unauthorized alteration, forgery or falsification of the content or appearance of this document is unlawful and offenders may be prosecuted to the fullest extent of the law.

SGS Taiwan Ltd.

No. 134, WuKungRoad, New Taipei Industrial Park, Wuku District, New Taipei City, Taiwan 24803 / 新北市五股區新北產業園區五工路 134 號

台灣檢驗科技股份有限公司

t (886-2) 2299-3279

f (886-2) 2298-0488

www.tw.sgs.com

Member of SGS Group

Operation Mode : 802.11n20 Test Date : 2017/7/14
 Fundamental Frequency : 5700 MHz Temp. / Humi. : 22.7 deg_C/57RH
 Operation Band : Tx CH High Test Engineer : Ashton
 EUT Pol. : H Measurement Antenna Pol. : Horizontal

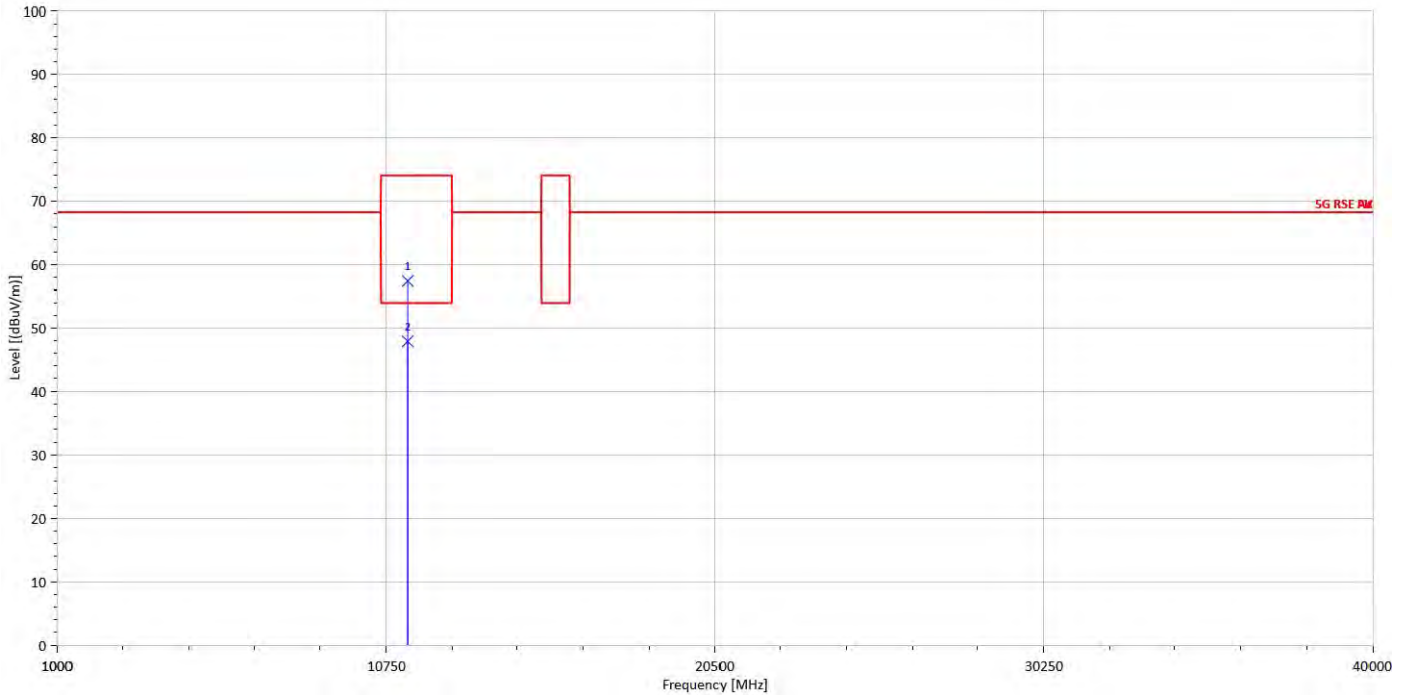

Freq. MHz	Note F/H/E/S	Detector Mode PK/QP/AV	Spectrum Reading Level dBuV	Factor dB	Actual FS dBuV/m	Limit @ 3m dBuV/m	Margin dB
11400.00	H	Peak	30.77	26.59	57.36	74	-16.64
11400.00	H	Average	21.32	26.59	47.91	54	-6.09

Unless otherwise stated the results shown in this test report refer only to the sample(s) tested and such sample(s) are retained for 90 days only.

除非另有說明，此報告結果僅對測試之樣品負責，同時此樣品僅保留90天。本報告未經本公司書面許可，不可部份複製。

This document is issued by the Company subject to its General Conditions of Service printed overleaf, available on request or accessible at www.sgs.com/terms_and_conditions.htm and, for electronic format documents, subject to Terms and Conditions for Electronic Documents at www.sgs.com/terms_e-document.htm. Attention is drawn to the limitation of liability, indemnification and jurisdiction issues defined therein. Any holder of this document is advised that information contained hereon reflects the Company's findings at the time of its intervention only and within the limits of Client's instructions, if any. The Company's sole responsibility is to its Client and this document does not exonerate parties to a transaction from exercising all their rights and obligations under the transaction documents. This document cannot be reproduced except in full, without prior written approval of the Company. Any unauthorized alteration, forgery or falsification of the content or appearance of this document is unlawful and offenders may be prosecuted to the fullest extent of the law.

SGS Taiwan Ltd.

No. 134, WuKungRoad, New Taipei Industrial Park, Wuku District, New Taipei City, Taiwan 24803 / 新北市五股區新北產業園區五工路 134 號

台灣檢驗科技股份有限公司

t (886-2) 2299-3279

f (886-2) 2298-0488

www.tw.sgs.com

Member of SGS Group

Radiated Spurious Emission Measurement Result 802.11n HT20, 5725~5850 MHz

Operation Mode :	802.11n20	Test Date :	2017/7/14
Fundamental Frequency :	5745 MHz	Temp. / Humi. :	22.7 deg_C/57RH
Operation Band :	Tx CH Low	Test Engineer :	Ashton
EUT Pol. :	H	Measurement Antenna Pol. :	Vertical

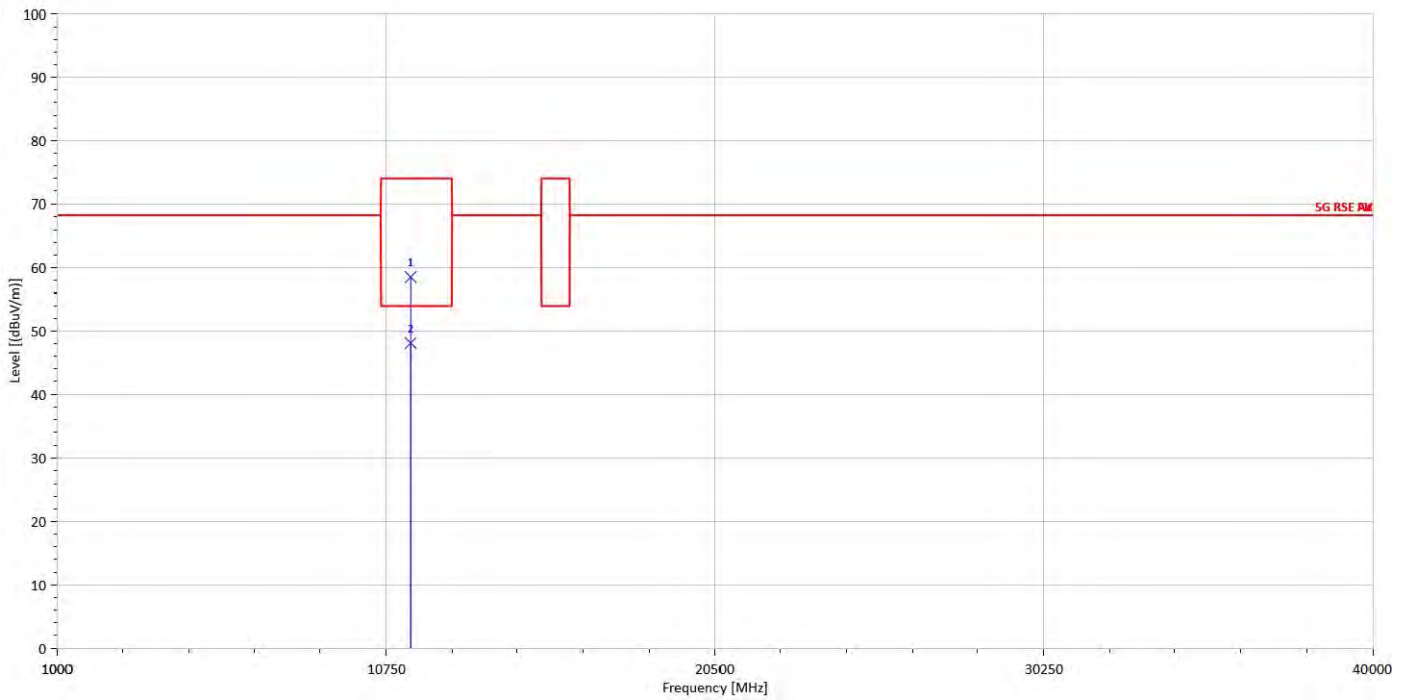

Freq. MHz	Note F/H/E/S	Detector Mode PK/QP/AV	Spectrum Reading Level dBuV	Factor dB	Actual FS dBuV/m	Limit @ 3m dBuV/m	Margin dB
11490.00	H	Peak	31.76	26.70	58.46	74	-15.54
11490.00	H	Average	21.41	26.70	48.11	54	-5.89

Unless otherwise stated the results shown in this test report refer only to the sample(s) tested and such sample(s) are retained for 90 days only.

除非另有說明，此報告結果僅對測試之樣品負責，同時此樣品僅保留90天。本報告未經本公司書面許可，不可部份複製。

This document is issued by the Company subject to its General Conditions of Service printed overleaf, available on request or accessible at www.sgs.com/terms_and_conditions.htm and, for electronic format documents, subject to Terms and Conditions for Electronic Documents at www.sgs.com/terms_e-document.htm. Attention is drawn to the limitation of liability, indemnification and jurisdiction issues defined therein. Any holder of this document is advised that information contained hereon reflects the Company's findings at the time of its intervention only and within the limits of Client's instructions, if any. The Company's sole responsibility is to its Client and this document does not exonerate parties to a transaction from exercising all their rights and obligations under the transaction documents. This document cannot be reproduced except in full, without prior written approval of the Company. Any unauthorized alteration, forgery or falsification of the content or appearance of this document is unlawful and offenders may be prosecuted to the fullest extent of the law.

SGS Taiwan Ltd.

No.134,WuKungRoad,NewTaipeiIndustrialPark,WukuDistrict,NewTaipeiCity,Taiwan24803/新北市五股區新北產業園區五工路 134 號

台灣檢驗科技股份有限公司

t (886-2) 2299-3279

f (886-2) 2298-0488

www.tw.sgs.com

Member of SGS Group

Operation Mode :	802.11n20	Test Date :	2017/7/14
Fundamental Frequency :	5745 MHz	Temp. / Humi. :	22.7 deg_C/57RH
Operation Band :	Tx CH Low	Test Engineer :	Ashton
EUT Pol. :	H	Measurement Antenna Pol. :	Horizontal

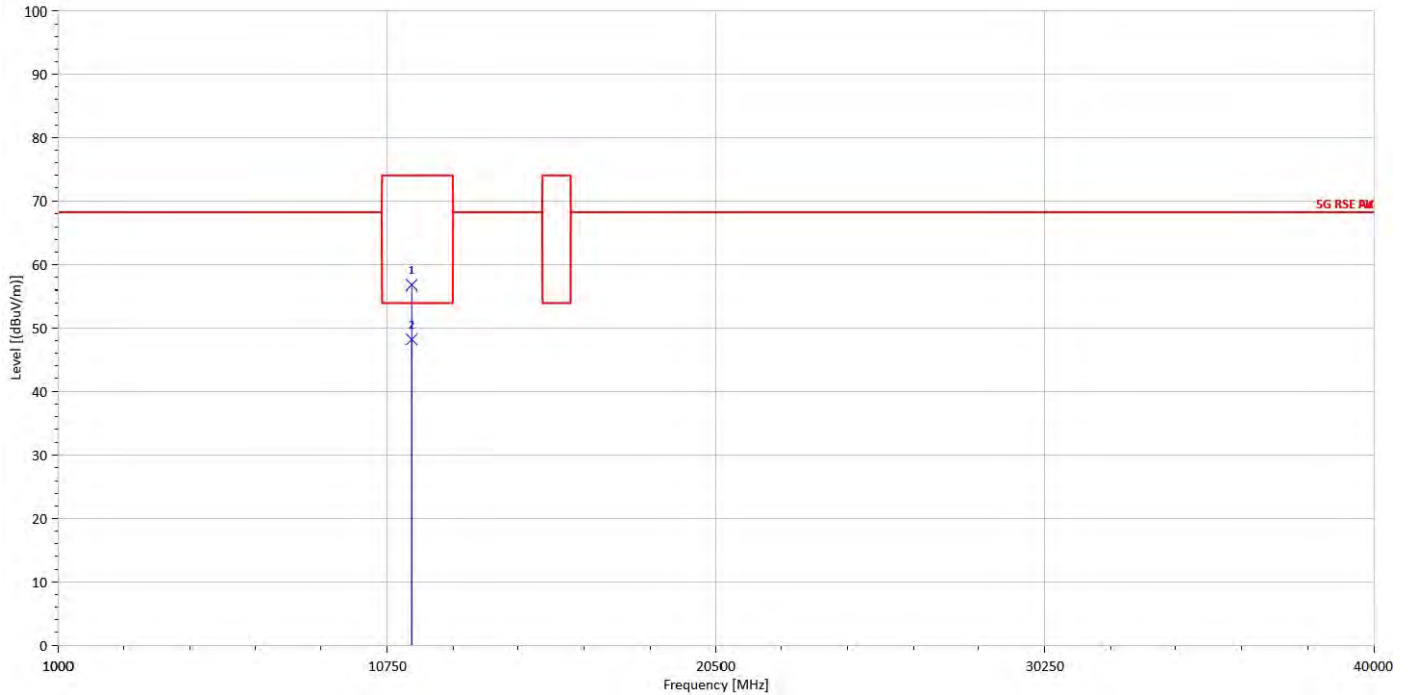

Freq. MHz	Note F/H/E/S	Detector Mode PK/QP/AV	Spectrum Reading Level dBuV	Factor dB	Actual FS dBuV/m	Limit @ 3m dBuV/m	Margin dB
11490.00	H	Peak	30.05	26.70	56.75	74	-17.25
11490.00	H	Average	21.51	26.70	48.21	54	-5.79

Unless otherwise stated the results shown in this test report refer only to the sample(s) tested and such sample(s) are retained for 90 days only.

除非另有說明，此報告結果僅對測試之樣品負責，同時此樣品僅保留90天。本報告未經本公司書面許可，不可部份複製。

This document is issued by the Company subject to its General Conditions of Service printed overleaf, available on request or accessible at www.sgs.com/terms_and_conditions.htm and, for electronic format documents, subject to Terms and Conditions for Electronic Documents at www.sgs.com/terms_e-document.htm. Attention is drawn to the limitation of liability, indemnification and jurisdiction issues defined therein. Any holder of this document is advised that information contained hereon reflects the Company's findings at the time of its intervention only and within the limits of Client's instructions, if any. The Company's sole responsibility is to its Client and this document does not exonerate parties to a transaction from exercising all their rights and obligations under the transaction documents. This document cannot be reproduced except in full, without prior written approval of the Company. Any unauthorized alteration, forgery or falsification of the content or appearance of this document is unlawful and offenders may be prosecuted to the fullest extent of the law.

SGS Taiwan Ltd.

No. 134, WuKungRoad, New Taipei Industrial Park, Wuku District, New Taipei City, Taiwan 24803 / 新北市五股區新北產業園區五工路 134 號

台灣檢驗科技股份有限公司

t (886-2) 2299-3279

f (886-2) 2298-0488

www.tw.sgs.com

Member of SGS Group

Operation Mode : 802.11n20 Test Date : 2017/7/14
 Fundamental Frequency : 5785 MHz Temp. / Humi. : 22.7 deg_C/57RH
 Operation Band : Tx CH Mid Test Engineer : Ashton
 EUT Pol. : H Measurement Antenna Pol. : Vertical

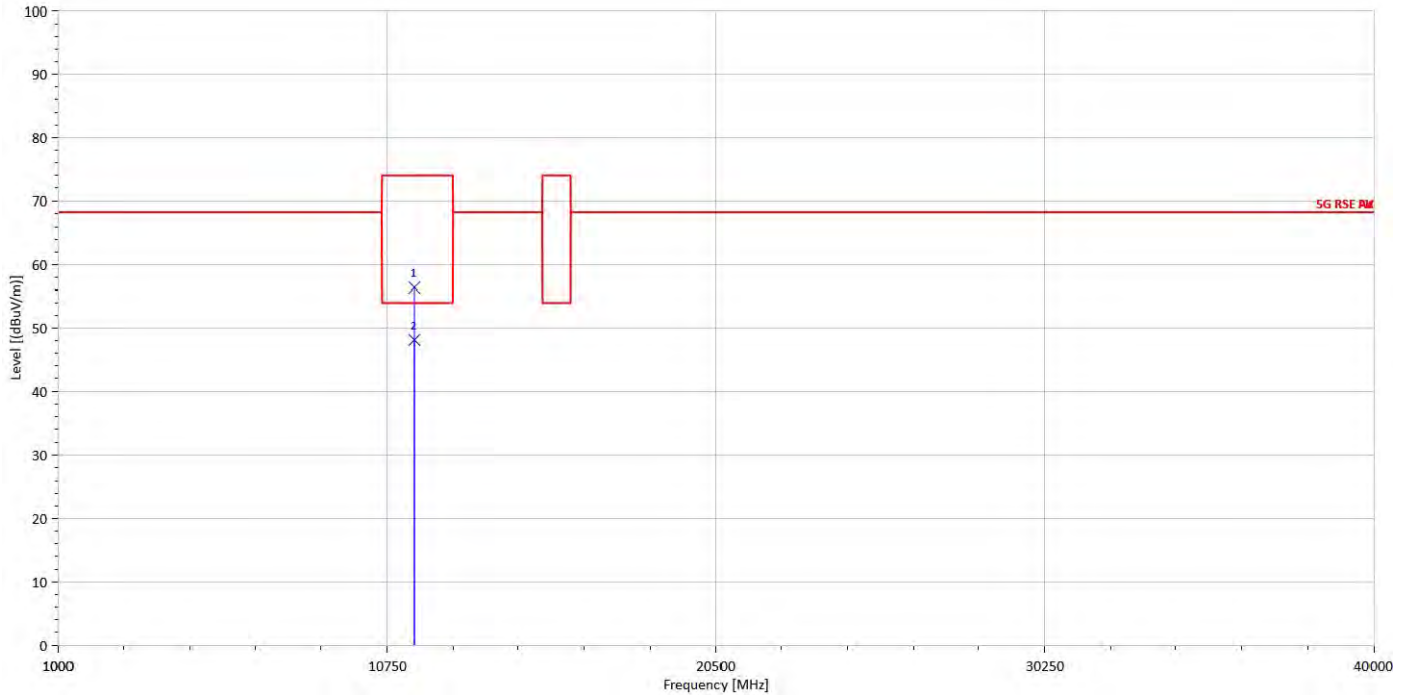

Freq. MHz	Note F/H/E/S	Detector Mode PK/QP/AV	Spectrum Reading Level dBuV	Factor dB	Actual FS dBuV/m	Limit @ 3m dBuV/m	Margin dB
11570.00	H	Peak	29.71	26.68	56.38	74	-17.62
11570.00	H	Average	21.45	26.68	48.13	54	-5.88

Unless otherwise stated the results shown in this test report refer only to the sample(s) tested and such sample(s) are retained for 90 days only.

除非另有說明，此報告結果僅對測試之樣品負責，同時此樣品僅保留90天。本報告未經本公司書面許可，不可部份複製。

This document is issued by the Company subject to its General Conditions of Service printed overleaf, available on request or accessible at www.sgs.com/terms_and_conditions.htm and, for electronic format documents, subject to Terms and Conditions for Electronic Documents at www.sgs.com/terms_e-document.htm. Attention is drawn to the limitation of liability, indemnification and jurisdiction issues defined therein. Any holder of this document is advised that information contained hereon reflects the Company's findings at the time of its intervention only and within the limits of Client's instructions, if any. The Company's sole responsibility is to its Client and this document does not exonerate parties to a transaction from exercising all their rights and obligations under the transaction documents. This document cannot be reproduced except in full, without prior written approval of the Company. Any unauthorized alteration, forgery or falsification of the content or appearance of this document is unlawful and offenders may be prosecuted to the fullest extent of the law.

SGS Taiwan Ltd.

No. 134, WuKungRoad, New Taipei Industrial Park, Wuku District, New Taipei City, Taiwan 24803 / 新北市五股區新北產業園區五工路 134 號

台灣檢驗科技股份有限公司

t (886-2) 2299-3279

f (886-2) 2298-0488

www.tw.sgs.com

Member of SGS Group

Operation Mode :	802.11n20	Test Date :	2017/7/14
Fundamental Frequency :	5785 MHz	Temp. / Humi. :	22.7 deg_C/57RH
Operation Band :	Tx CH Mid	Test Engineer :	Ashton
EUT Pol. :	H	Measurement Antenna Pol. :	Horizontal

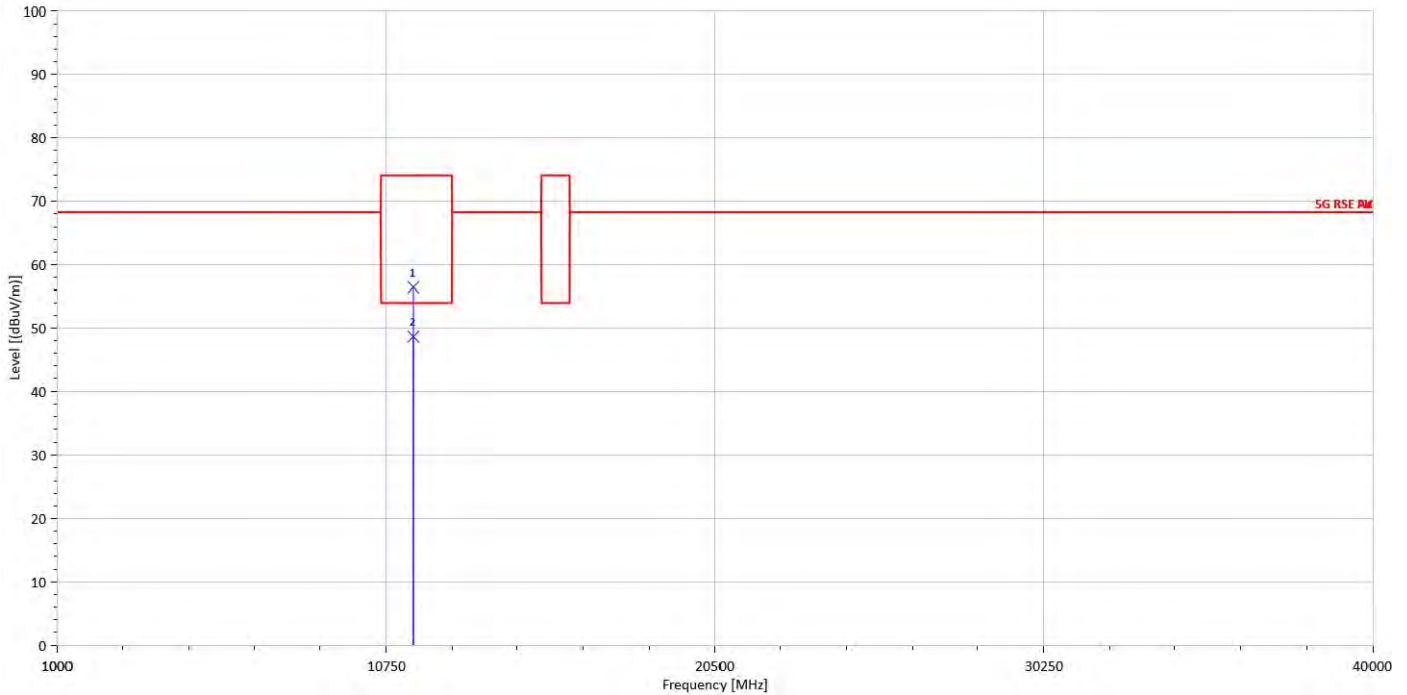

Freq. MHz	Note F/H/E/S	Detector Mode PK/QP/AV	Spectrum Reading Level dBuV	Factor dB	Actual FS dBuV/m	Limit @ 3m dBuV/m	Margin dB
11570.00	H	Peak	29.75	26.68	56.43	74	-17.57
11570.00	H	Average	21.97	26.68	48.65	54	-5.36

Unless otherwise stated the results shown in this test report refer only to the sample(s) tested and such sample(s) are retained for 90 days only.

除非另有說明，此報告結果僅對測試之樣品負責，同時此樣品僅保留90天。本報告未經本公司書面許可，不可部份複製。

This document is issued by the Company subject to its General Conditions of Service printed overleaf, available on request or accessible at www.sgs.com/terms_and_conditions.htm and, for electronic format documents, subject to Terms and Conditions for Electronic Documents at www.sgs.com/terms_e-document.htm. Attention is drawn to the limitation of liability, indemnification and jurisdiction issues defined therein. Any holder of this document is advised that information contained hereon reflects the Company's findings at the time of its intervention only and within the limits of Client's instructions, if any. The Company's sole responsibility is to its Client and this document does not exonerate parties to a transaction from exercising all their rights and obligations under the transaction documents. This document cannot be reproduced except in full, without prior written approval of the Company. Any unauthorized alteration, forgery or falsification of the content or appearance of this document is unlawful and offenders may be prosecuted to the fullest extent of the law.

SGS Taiwan Ltd.

No. 134, WuKungRoad, New Taipei Industrial Park, Wuku District, New Taipei City, Taiwan 24803 / 新北市五股區新北產業園區五工路 134 號

台灣檢驗科技股份有限公司

t (886-2) 2299-3279

f (886-2) 2298-0488

www.tw.sgs.com

Member of SGS Group

Operation Mode : 802.11n20 Test Date : 2017/7/14
 Fundamental Frequency : 5825 MHz Temp. / Humi. : 22.7 deg_C/57RH
 Operation Band : Tx CH High Test Engineer : Ashton
 EUT Pol. : H Measurement Antenna Pol. : Vertical

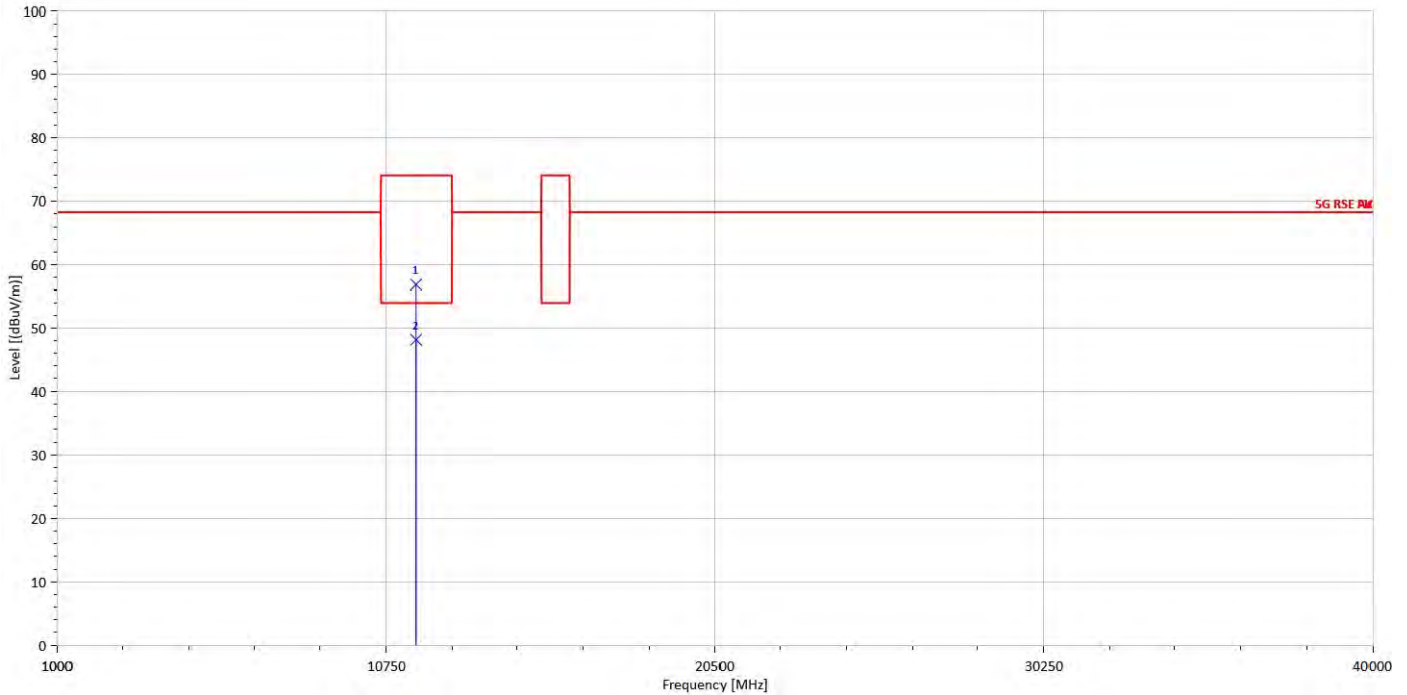

Freq. MHz	Note F/H/E/S	Detector Mode PK/QP/AV	Spectrum Reading Level dBuV	Factor dB	Actual FS dBuV/m	Limit @ 3m dBuV/m	Margin dB
11650.00	H	Peak	30.20	26.62	56.82	74	-17.18
11650.00	H	Average	21.54	26.62	48.16	54	-5.84

Unless otherwise stated the results shown in this test report refer only to the sample(s) tested and such sample(s) are retained for 90 days only.

除非另有說明，此報告結果僅對測試之樣品負責，同時此樣品僅保留90天。本報告未經本公司書面許可，不可部份複製。

This document is issued by the Company subject to its General Conditions of Service printed overleaf, available on request or accessible at www.sgs.com/terms_and_conditions.htm and, for electronic format documents, subject to Terms and Conditions for Electronic Documents at www.sgs.com/terms_e-document.htm. Attention is drawn to the limitation of liability, indemnification and jurisdiction issues defined therein. Any holder of this document is advised that information contained hereon reflects the Company's findings at the time of its intervention only and within the limits of Client's instructions, if any. The Company's sole responsibility is to its Client and this document does not exonerate parties to a transaction from exercising all their rights and obligations under the transaction documents. This document cannot be reproduced in full, without prior written approval of the Company. Any unauthorized alteration, forgery or falsification of the content or appearance of this document is unlawful and offenders may be prosecuted to the fullest extent of the law.

SGS Taiwan Ltd.

No. 134, WuKungRoad, New Taipei Industrial Park, Wuku District, New Taipei City, Taiwan 24803/新北市五股區新北產業園區五工路 134 號

台灣檢驗科技股份有限公司

t (886-2) 2299-3279

f (886-2) 2298-0488

www.tw.sgs.com

Member of SGS Group

Operation Mode : 802.11n20 Test Date : 2017/7/14
 Fundamental Frequency : 5825 MHz Temp. / Humi. : 22.7 deg_C/57RH
 Operation Band : Tx CH High Test Engineer : Ashton
 EUT Pol. : H Measurement Antenna Pol. : Horizontal

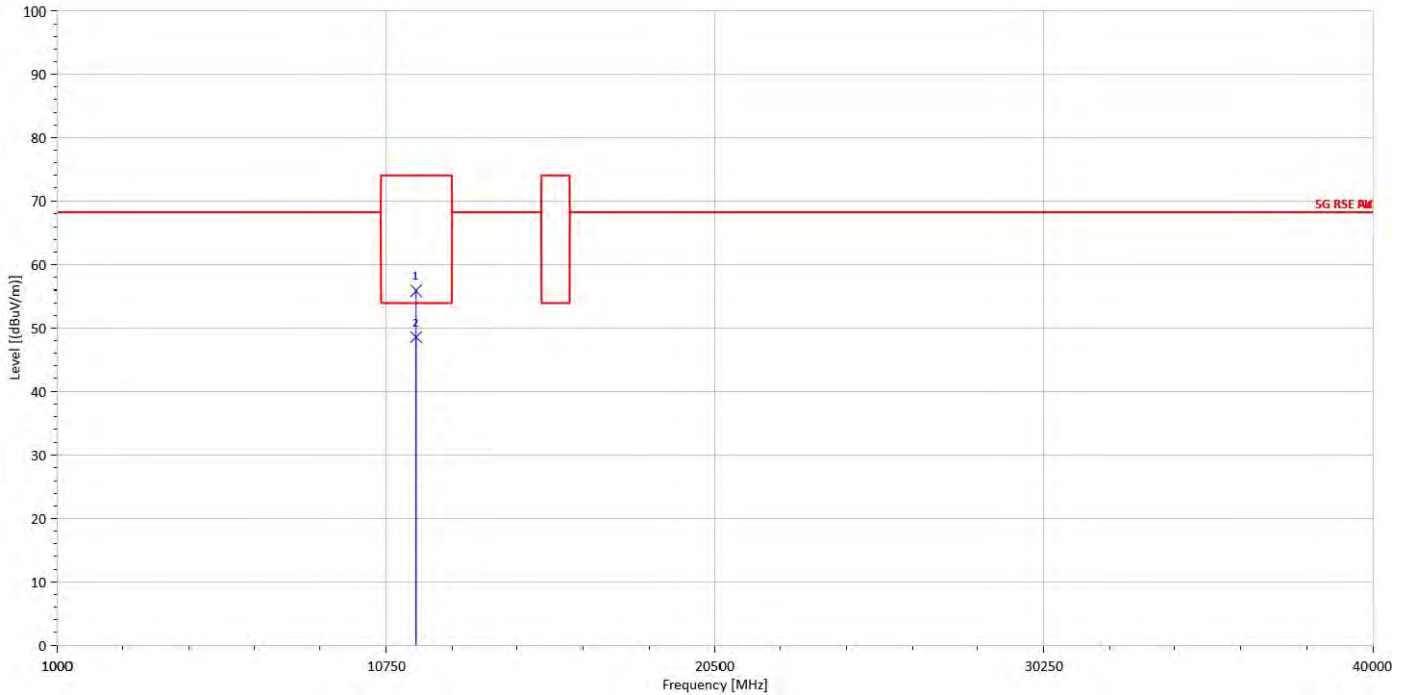

Freq. MHz	Note F/H/E/S	Detector Mode PK/QP/AV	Spectrum Reading Level dBuV	Factor dB	Actual FS dBuV/m	Limit @ 3m dBuV/m	Margin dB
11650.00	H	Peak	29.26	26.62	55.88	74	-18.12
11650.00	H	Average	21.95	26.62	48.57	54	-5.43

Unless otherwise stated the results shown in this test report refer only to the sample(s) tested and such sample(s) are retained for 90 days only.

除非另有說明，此報告結果僅對測試之樣品負責，同時此樣品僅保留90天。本報告未經本公司書面許可，不可部份複製。

This document is issued by the Company subject to its General Conditions of Service printed overleaf, available on request or accessible at www.sgs.com/terms_and_conditions.htm and, for electronic format documents, subject to Terms and Conditions for Electronic Documents at www.sgs.com/terms_e-document.htm. Attention is drawn to the limitation of liability, indemnification and jurisdiction issues defined therein. Any holder of this document is advised that information contained hereon reflects the Company's findings at the time of its intervention only and within the limits of Client's instructions, if any. The Company's sole responsibility is to its Client and this document does not exonerate parties to a transaction from exercising all their rights and obligations under the transaction documents. This document cannot be reproduced except in full, without prior written approval of the Company. Any unauthorized alteration, forgery or falsification of the content or appearance of this document is unlawful and offenders may be prosecuted to the fullest extent of the law.

SGS Taiwan Ltd.

No. 134, WuKungRoad, New Taipei Industrial Park, Wuku District, New Taipei City, Taiwan 24803 / 新北市五股區新北產業園區五工路 134 號

台灣檢驗科技股份有限公司

t (886-2) 2299-3279

f (886-2) 2298-0488

www.tw.sgs.com

Member of SGS Group

Band edge falling to restricted band

802.11a mode

Operation Mode :	802.11a	Test Date :	2017/7/13
Fundamental Frequency :	5180 MHz	Temp. / Humi. :	22.7deg_C/57RH
Operation Band :	BE CH Low	Test Engineer :	Ashton
EUT Pol. :	H	Measurement Antenna Pol. :	Vertical

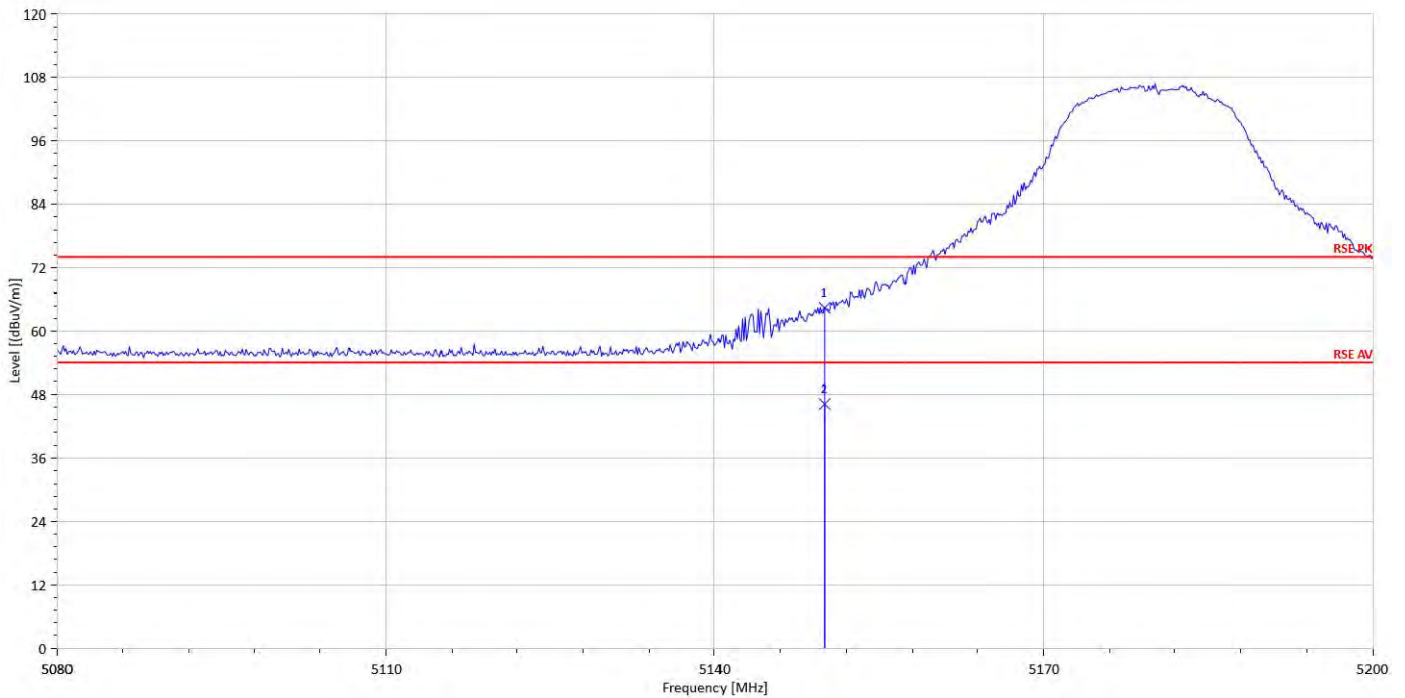

Freq. MHz	Note F/H/E/S	Detector Mode PK/QP/AV	Spectrum Reading Level dBuV	Factor dB	Actual FS dBuV/m	Limit @3m dBuV/m	Margin dB
5150.00	E	Peak	50.12	14.32	64.44	74	-9.56
5150.00	E	Average	31.94	14.32	46.26	54	-7.74

Unless otherwise stated the results shown in this test report refer only to the sample(s) tested and such sample(s) are retained for 90 days only.

除非另有說明，此報告結果僅對測試之樣品負責，同時此樣品僅保留90天。本報告未經本公司書面許可，不可部份複製。

This document is issued by the Company subject to its General Conditions of Service printed overleaf, available on request or accessible at www.sgs.com/terms_and_conditions.htm and, for electronic format documents, subject to Terms and Conditions for Electronic Documents at www.sgs.com/terms_e-document.htm. Attention is drawn to the limitation of liability, indemnification and jurisdiction issues defined therein. Any holder of this document is advised that information contained hereon reflects the Company's findings at the time of its intervention only and within the limits of Client's instructions, if any. The Company's sole responsibility is to its Client and this document does not exonerate parties to a transaction from exercising all their rights and obligations under the transaction documents. This document cannot be reproduced except in full, without prior written approval of the Company. Any unauthorized alteration, forgery or falsification of the content or appearance of this document is unlawful and offenders may be prosecuted to the fullest extent of the law.

SGS Taiwan Ltd.

No. 134, WuKungRoad, New Taipei Industrial Park, Wuku District, New Taipei City, Taiwan 24803/新北市五股區新北產業園區五工路 134 號

台灣檢驗科技股份有限公司

t (886-2) 2299-3279

f (886-2) 2298-0488

www.tw.sgs.com

Member of SGS Group

Operation Mode :	802.11a	Test Date :	2017/7/13
Fundamental Frequency :	5180 MHz	Temp. / Humi. :	22.7deg_C/57RH
Operation Band :	BE CH Low	Test Engineer :	Ashton
EUT Pol. :	H	Measurement Antenna Pol. :	Horizontal

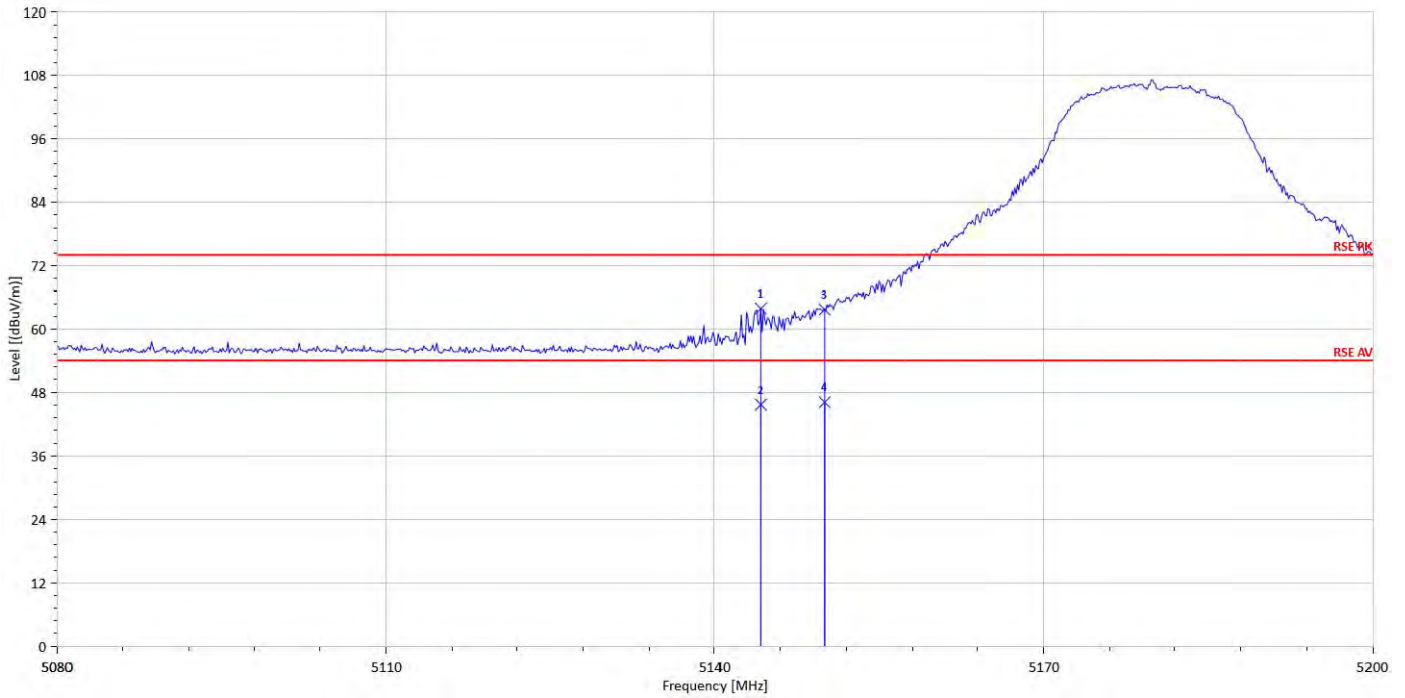

Freq. MHz	Note F/H/E/S	Detector Mode PK/QP/AV	Spectrum Reading Level dBµV	Factor dB	Actual FS dBµV/m	Limit @3m dBµV/m	Margin dB
5144.20	S	Peak	49.63	14.31	63.94	74	-10.06
5144.20	S	Average	31.46	14.31	45.77	54	-8.23
5150.00	E	Peak	49.42	14.32	63.74	74	-10.26
5150.00	E	Average	31.92	14.32	46.24	54	-7.76

Unless otherwise stated the results shown in this test report refer only to the sample(s) tested and such sample(s) are retained for 90 days only.

除非另有說明，此報告結果僅對測試之樣品負責，同時此樣品僅保留90天。本報告未經本公司書面許可，不可部份複製。

This document is issued by the Company subject to its General Conditions of Service printed overleaf, available on request or accessible at www.sgs.com/terms_and_conditions.htm and, for electronic format documents, subject to Terms and Conditions for Electronic Documents at www.sgs.com/terms_e-document.htm. Attention is drawn to the limitation of liability, indemnification and jurisdiction issues defined therein. Any holder of this document is advised that information contained hereon reflects the Company's findings at the time of its intervention only and within the limits of Client's instructions, if any. The Company's sole responsibility is to its Client and this document does not exonerate parties to a transaction from exercising all their rights and obligations under the transaction documents. This document cannot be reproduced except in full, without prior written approval of the Company. Any unauthorized alteration, forgery or falsification of the content or appearance of this document is unlawful and offenders may be prosecuted to the fullest extent of the law.

SGS Taiwan Ltd.

No.134,WuKungRoad,NewTaipeiIndustrialPark,WukuDistrict,NewTaipeiCity,Taiwan24803/新北市五股區新北產業園區五工路 134 號

台灣檢驗科技股份有限公司

t (886-2) 2299-3279

f (886-2) 2298-0488

www.tw.sgs.com

Member of SGS Group

Operation Mode : 802.11a Test Date : 2017/7/13
 Fundamental Frequency : 5320 MHz Temp. / Humi. : 22.7deg_C/57RH
 Operation Band : BE CH High Test Engineer : Ashton
 EUT Pol. : H Measurement Antenna Pol. : Vertical

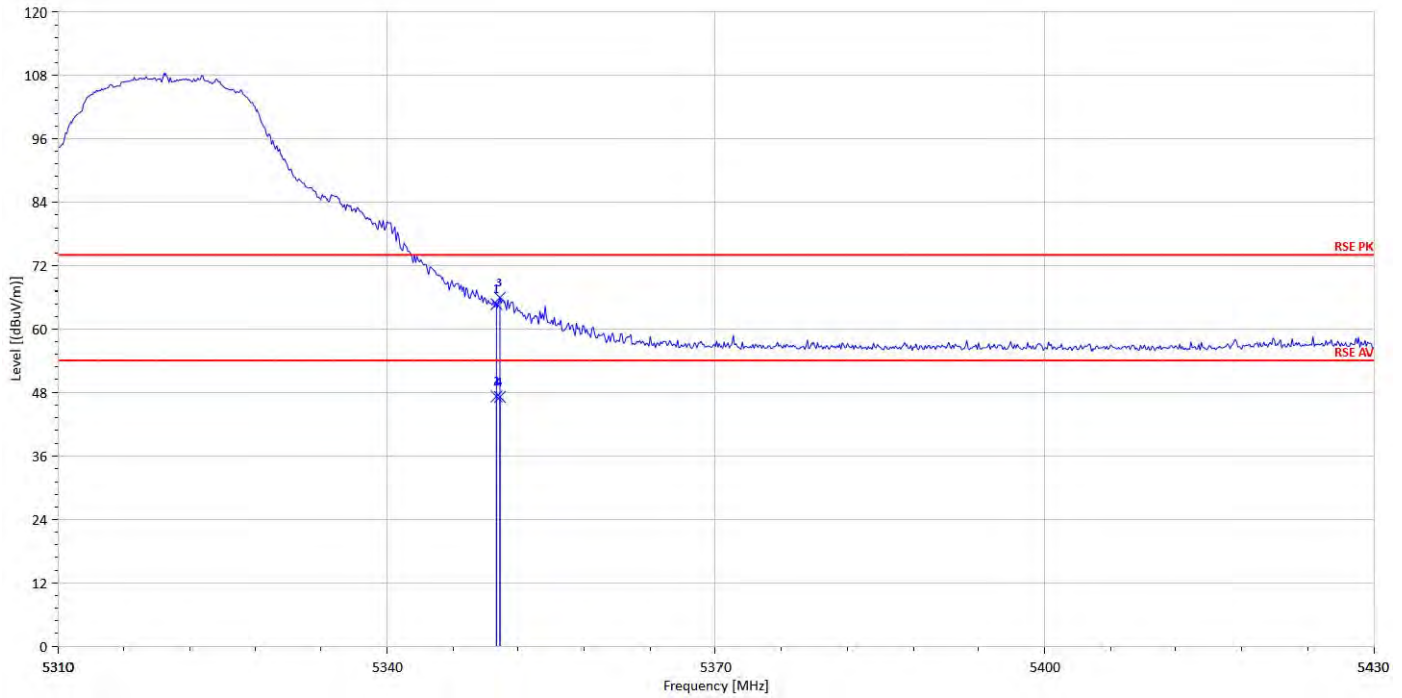

Freq. MHz	Note F/H/E/S	Detector Mode PK/QP/AV	Spectrum Reading Level dBμV	Factor dB	Actual FS dBμV/m	Limit @3m dBμV/m	Margin dB
5350.00	E	Peak	50.36	14.44	64.80	74	-9.20
5350.00	E	Average	32.89	14.44	47.33	54	-6.67
5350.32	S	Peak	51.58	14.44	66.02	74	-7.98
5350.32	S	Average	32.79	14.44	47.23	54	-6.77

Unless otherwise stated the results shown in this test report refer only to the sample(s) tested and such sample(s) are retained for 90 days only.

除非另有說明，此報告結果僅對測試之樣品負責，同時此樣品僅保留90天。本報告未經本公司書面許可，不可部份複製。

This document is issued by the Company subject to its General Conditions of Service printed overleaf, available on request or accessible at www.sgs.com/terms_and_conditions.htm and, for electronic format documents, subject to Terms and Conditions for Electronic Documents at www.sgs.com/terms_e-document.htm. Attention is drawn to the limitation of liability, indemnification and jurisdiction issues defined therein. Any holder of this document is advised that information contained hereon reflects the Company's findings at the time of its intervention only and within the limits of Client's instructions, if any. The Company's sole responsibility is to its Client and this document does not exonerate parties to a transaction from exercising all their rights and obligations under the transaction documents. This document cannot be reproduced except in full, without prior written approval of the Company. Any unauthorized alteration, forgery or falsification of the content or appearance of this document is unlawful and offenders may be prosecuted to the fullest extent of the law.

SGS Taiwan Ltd.

No. 134, WuKungRoad, New Taipei Industrial Park, Wuku District, New Taipei City, Taiwan 24803 / 新北市五股區新北產業園區五工路 134 號

台灣檢驗科技股份有限公司

t (886-2) 2299-3279

f (886-2) 2298-0488

www.tw.sgs.com

Member of SGS Group

Operation Mode :	802.11a	Test Date :	2017/7/13
Fundamental Frequency :	5320 MHz	Temp. / Humi. :	22.7deg_C/57RH
Operation Band :	BE CH High	Test Engineer :	Ashton
EUT Pol. :	H	Measurement Antenna Pol. :	Horizontal

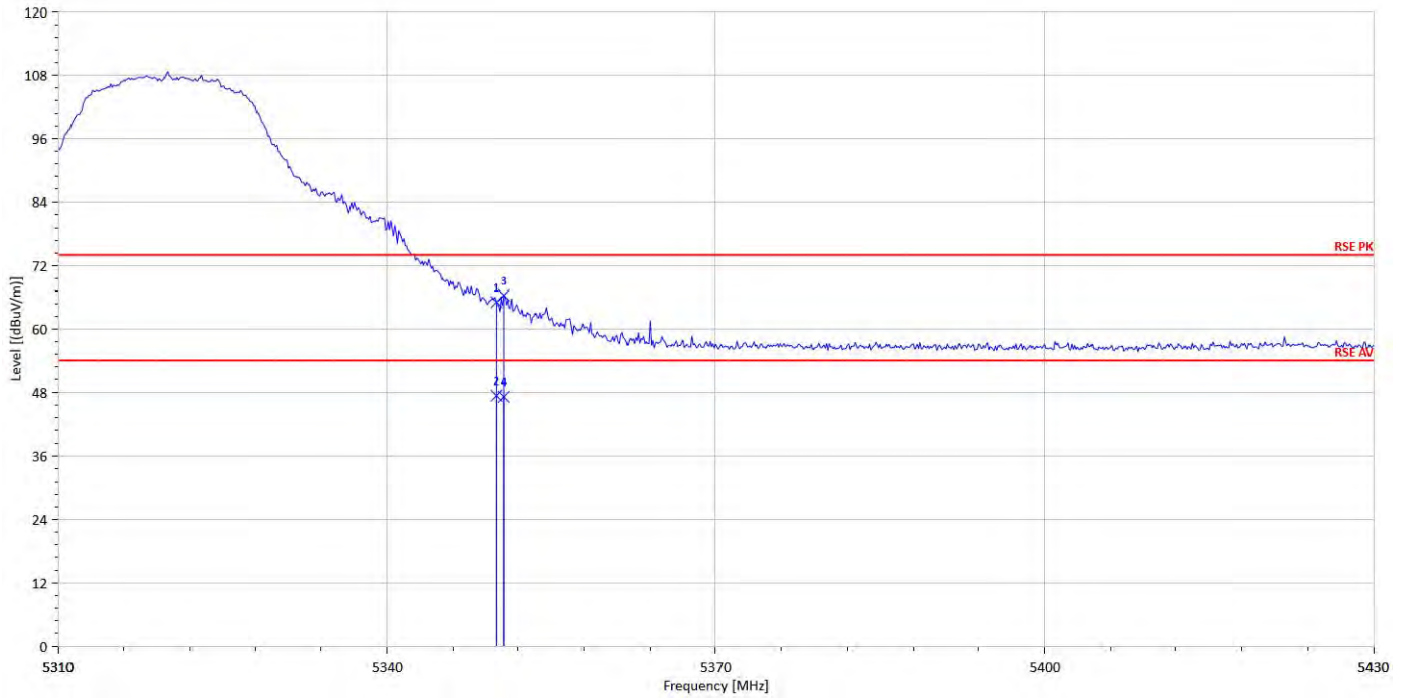

Freq. MHz	Note F/H/E/S	Detector Mode PK/QP/AV	Spectrum Reading Level dBμV	Factor dB	Actual FS dBμV/m	Limit @3m dBμV/m	Margin dB
5350.00	E	Peak	50.69	14.44	65.13	74	-8.87
5350.00	E	Average	33.02	14.44	47.46	54	-6.54
5350.68	S	Peak	51.96	14.44	66.40	74	-7.60
5350.68	S	Average	32.81	14.44	47.25	54	-6.75

Unless otherwise stated the results shown in this test report refer only to the sample(s) tested and such sample(s) are retained for 90 days only.

除非另有說明，此報告結果僅對測試之樣品負責，同時此樣品僅保留90天。本報告未經本公司書面許可，不可部份複製。

This document is issued by the Company subject to its General Conditions of Service printed overleaf, available on request or accessible at www.sgs.com/terms_and_conditions.htm and, for electronic format documents, subject to Terms and Conditions for Electronic Documents at www.sgs.com/terms_e-document.htm. Attention is drawn to the limitation of liability, indemnification and jurisdiction issues defined therein. Any holder of this document is advised that information contained hereon reflects the Company's findings at the time of its intervention only and within the limits of Client's instructions, if any. The Company's sole responsibility is to its Client and this document does not exonerate parties to a transaction from exercising all their rights and obligations under the transaction documents. This document cannot be reproduced except in full, without prior written approval of the Company. Any unauthorized alteration, forgery or falsification of the content or appearance of this document is unlawful and offenders may be prosecuted to the fullest extent of the law.

SGS Taiwan Ltd.

No. 134, WuKungRoad, New Taipei Industrial Park, Wuku District, New Taipei City, Taiwan 24803 / 新北市五股區新北產業園區五工路 134 號

台灣檢驗科技股份有限公司

t (886-2) 2299-3279

f (886-2) 2298-0488

www.tw.sgs.com

Member of SGS Group

Operation Mode :	802.11a	Test Date :	2017/7/13
Fundamental Frequency :	5500 MHz	Temp. / Humi. :	22.7deg_C/57RH
Operation Band :	BE CH Low	Test Engineer :	Ashton
EUT Pol. :	H	Measurement Antenna Pol. :	Vertical

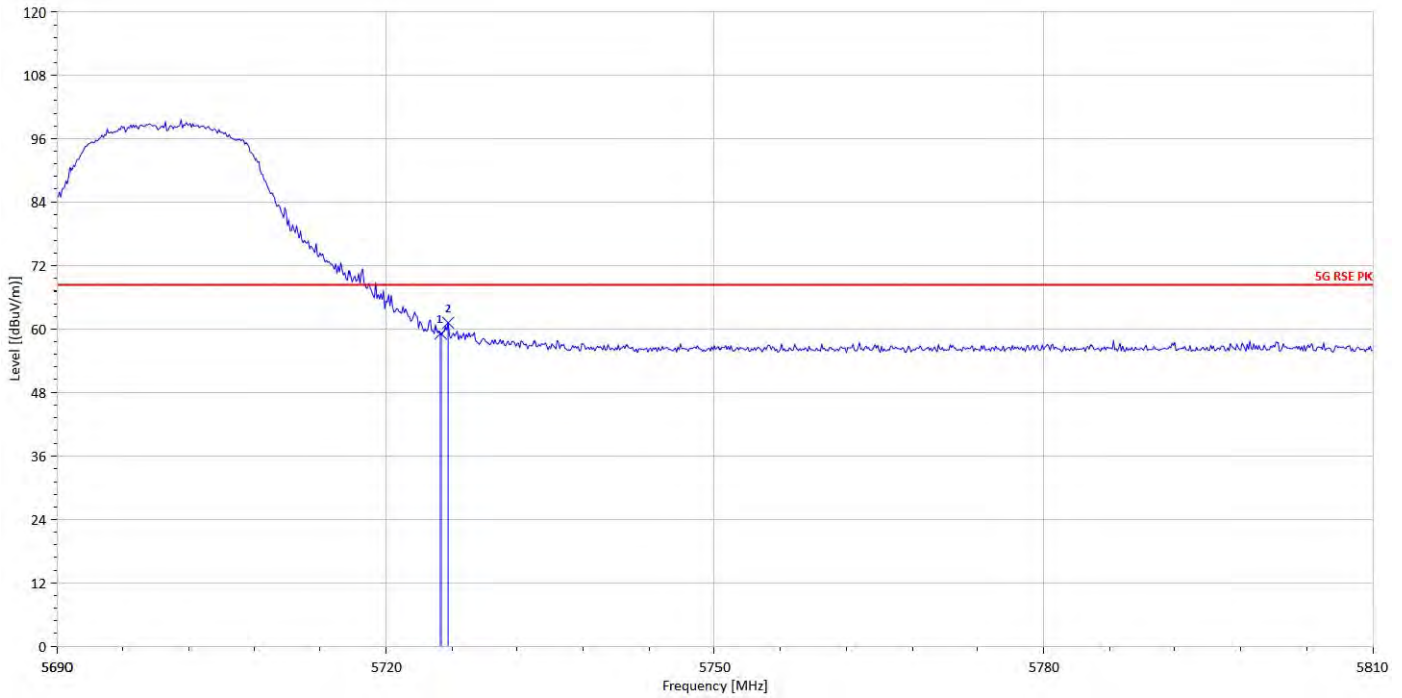

Freq. MHz	Note F/H/E/S	Detector Mode PK/QP/AV	Spectrum Reading Level dB μ V	Factor dB	Actual FS dB μ V/m	Limit @3m dB μ V/m	Margin dB
5458.40	S	Peak	47.59	14.51	62.10	74	-11.90
5458.40	S	Average	31.82	14.51	46.33	54	-7.67
5460.00	E	Peak	45.55	14.51	60.06	74	-13.94
5460.00	E	Average	31.90	14.51	46.41	54	-7.59

Unless otherwise stated the results shown in this test report refer only to the sample(s) tested and such sample(s) are retained for 90 days only.

除非另有說明，此報告結果僅對測試之樣品負責，同時此樣品僅保留90天。本報告未經本公司書面許可，不可部份複製。

This document is issued by the Company subject to its General Conditions of Service printed overleaf, available on request or accessible at www.sgs.com/terms_and_conditions.htm and, for electronic format documents, subject to Terms and Conditions for Electronic Documents at www.sgs.com/terms_e-document.htm. Attention is drawn to the limitation of liability, indemnification and jurisdiction issues defined therein. Any holder of this document is advised that information contained hereon reflects the Company's findings at the time of its intervention only and within the limits of Client's instructions, if any. The Company's sole responsibility is to its Client and this document does not exonerate parties to a transaction from exercising all their rights and obligations under the transaction documents. This document cannot be reproduced except in full, without prior written approval of the Company. Any unauthorized alteration, forgery or falsification of the content or appearance of this document is unlawful and offenders may be prosecuted to the fullest extent of the law.

SGS Taiwan Ltd.

No.134,WuKungRoad,NewTaipeiIndustrialPark,WukuDistrict,NewTaipeiCity,Taiwan24803/新北市五股區新北產業園區五工路 134 號

台灣檢驗科技股份有限公司

t (886-2) 2299-3279

f (886-2) 2298-0488

www.tw.sgs.com

Member of SGS Group

Operation Mode :	802.11a	Test Date :	2017/7/13
Fundamental Frequency :	5500 MHz	Temp. / Humi. :	22.7deg_C/57RH
Operation Band :	BE CH Low	Test Engineer :	Ashton
EUT Pol. :	H	Measurement Antenna Pol. :	Horizontal

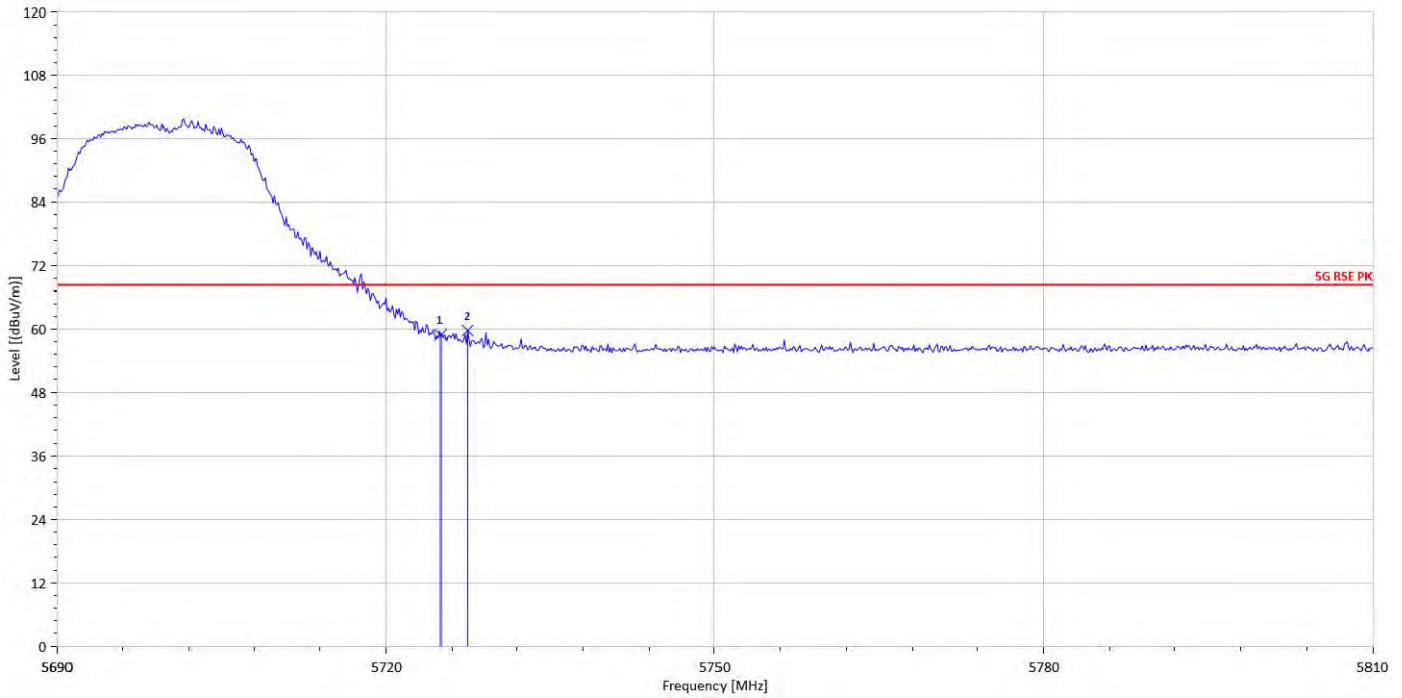

Freq. MHz	Note F/H/E/S	Detector Mode PK/QP/AV	Spectrum Reading Level dB μ V	Factor dB	Actual FS dB μ V/m	Limit @3m dB μ V/m	Margin dB
5457.80	S	Peak	45.36	14.50	59.86	74	-14.14
5457.80	S	Average	31.56	14.50	46.06	54	-7.94
5460.00	E	Peak	44.87	14.51	59.37	74	-14.63
5460.00	E	Average	31.65	14.51	46.16	54	-7.84

Unless otherwise stated the results shown in this test report refer only to the sample(s) tested and such sample(s) are retained for 90 days only.

除非另有說明，此報告結果僅對測試之樣品負責，同時此樣品僅保留90天。本報告未經本公司書面許可，不可部份複製。

This document is issued by the Company subject to its General Conditions of Service printed overleaf, available on request or accessible at www.sgs.com/terms_and_conditions.htm and, for electronic format documents, subject to Terms and Conditions for Electronic Documents at www.sgs.com/terms_e-document.htm. Attention is drawn to the limitation of liability, indemnification and jurisdiction issues defined therein. Any holder of this document is advised that information contained hereon reflects the Company's findings at the time of its intervention only and within the limits of Client's instructions, if any. The Company's sole responsibility is to its Client and this document does not exonerate parties to a transaction from exercising all their rights and obligations under the transaction documents. This document cannot be reproduced except in full, without prior written approval of the Company. Any unauthorized alteration, forgery or falsification of the content or appearance of this document is unlawful and offenders may be prosecuted to the fullest extent of the law.

SGS Taiwan Ltd.

No. 134, WuKungRoad, New Taipei Industrial Park, Wuku District, New Taipei City, Taiwan 24803 / 新北市五股區新北產業園區五工路 134 號

台灣檢驗科技股份有限公司

t (886-2) 2299-3279

f (886-2) 2298-0488

www.tw.sgs.com

Member of SGS Group

Operation Mode :	802.11a	Test Date :	2017/7/13
Fundamental Frequency :	5500 MHz	Temp. / Humi. :	22.7deg_C/57RH
Operation Band :	BE CH Low RSE	Test Engineer :	Ashton
EUT Pol. :	H	Measurement Antenna Pol. :	Vertical

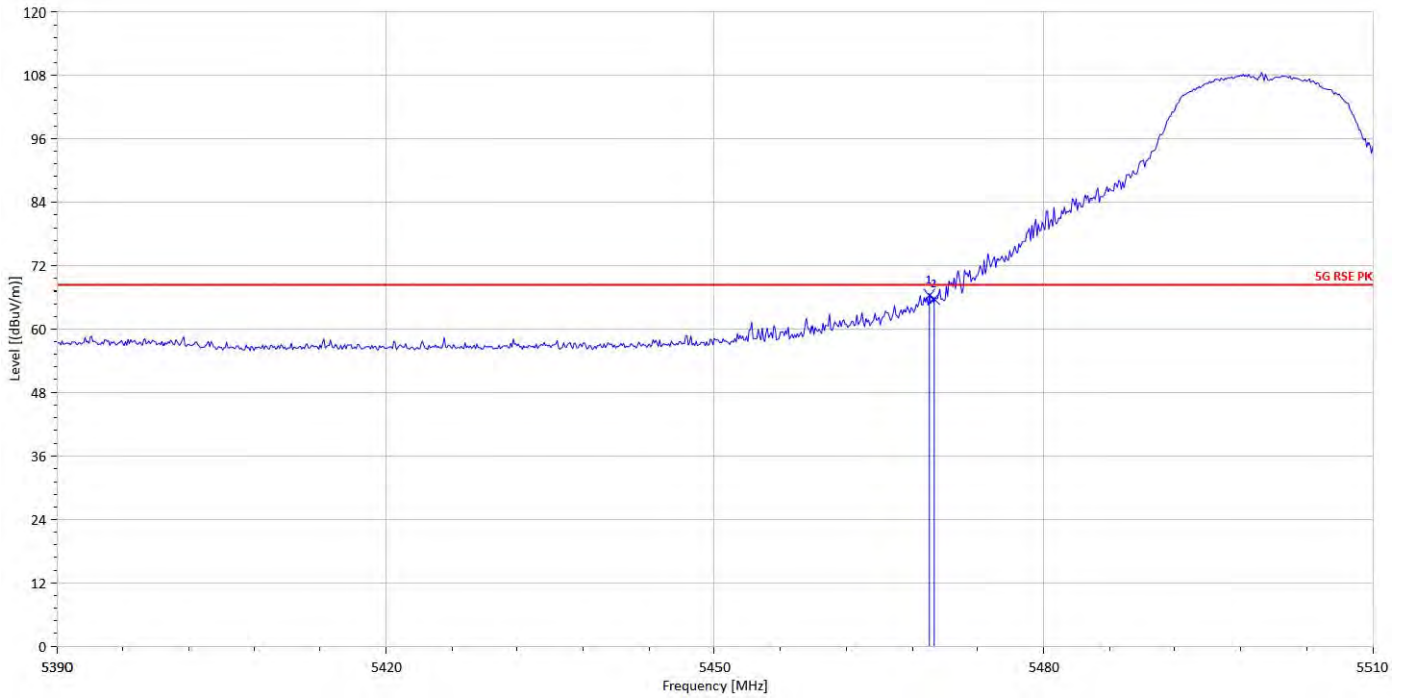

Freq. MHz	Note F/H/E/S	Detector Mode PK/QP/AV	Spectrum Reading Level dBuV	Factor dB	Actual FS dBuV/m	Limit @3m dBuV/m	Margin dB
5469.56	S	Peak	51.93	14.51	66.44	68.3	-1.86
5470.00	E	Peak	51.27	14.51	65.79	68.3	-2.51

Unless otherwise stated the results shown in this test report refer only to the sample(s) tested and such sample(s) are retained for 90 days only.

除非另有說明，此報告結果僅對測試之樣品負責，同時此樣品僅保留90天。本報告未經本公司書面許可，不可部份複製。

This document is issued by the Company subject to its General Conditions of Service printed overleaf, available on request or accessible at www.sgs.com/terms_and_conditions.htm and, for electronic format documents, subject to Terms and Conditions for Electronic Documents at www.sgs.com/terms_e-document.htm. Attention is drawn to the limitation of liability, indemnification and jurisdiction issues defined therein. Any holder of this document is advised that information contained hereon reflects the Company's findings at the time of its intervention only and within the limits of Client's instructions, if any. The Company's sole responsibility is to its Client and this document does not exonerate parties to a transaction from exercising all their rights and obligations under the transaction documents. This document cannot be reproduced except in full, without prior written approval of the Company. Any unauthorized alteration, forgery or falsification of the content or appearance of this document is unlawful and offenders may be prosecuted to the fullest extent of the law.

SGS Taiwan Ltd.

No. 134, WuKungRoad, New Taipei Industrial Park, Wuku District, New Taipei City, Taiwan 24803/新北市五股區新北產業園區五工路 134 號

台灣檢驗科技股份有限公司

t (886-2) 2299-3279

f (886-2) 2298-0488

www.tw.sgs.com

Member of SGS Group

Operation Mode :	802.11a	Test Date :	2017/7/13
Fundamental Frequency :	5500 MHz	Temp. / Humi. :	22.7deg_C/57RH
Operation Band :	BE CH Low RSE	Test Engineer :	Ashton
EUT Pol. :	H	Measurement Antenna Pol. :	Horizontal

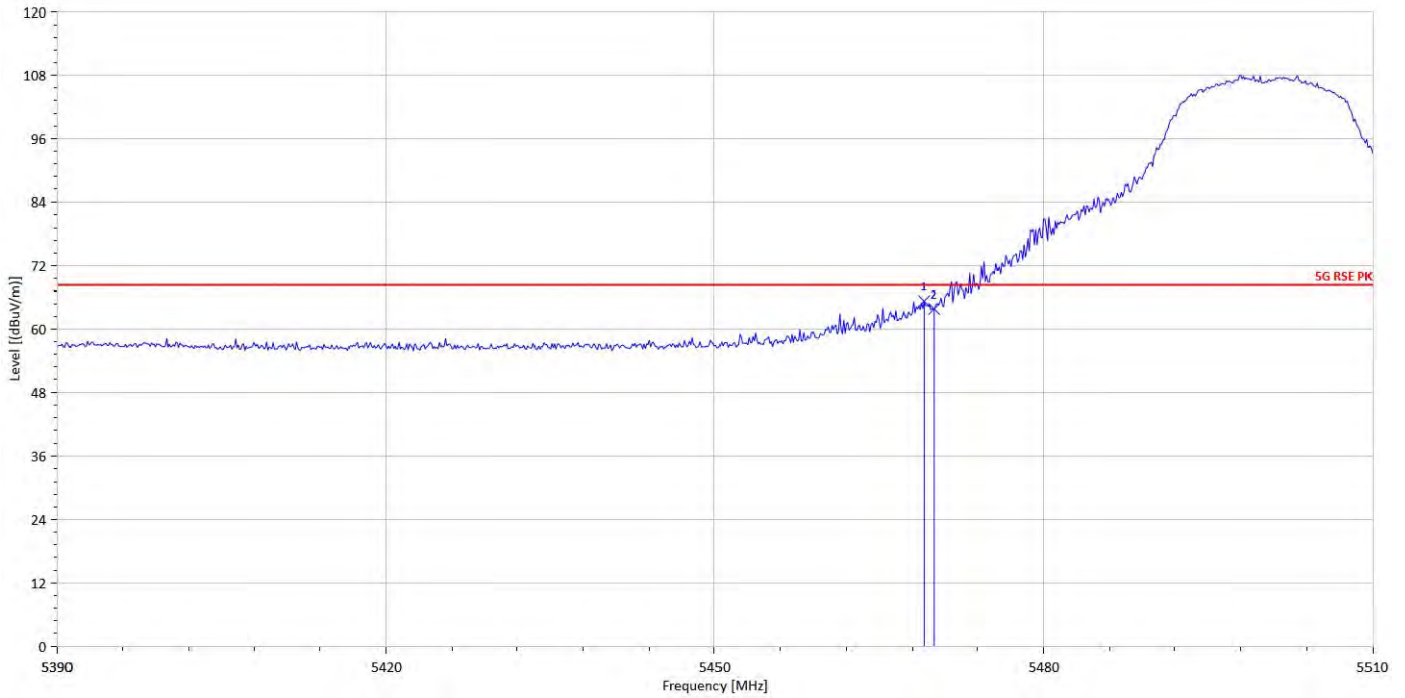

Freq. MHz	Note F/H/E/S	Detector Mode PK/QP/AV	Spectrum Reading Level dBuV	Factor dB	Actual FS dBuV/m	Limit @3m dBuV/m	Margin dB
5469.08	S	Peak	50.81	14.51	65.32	68.3	-2.98
5470.00	E	Peak	49.34	14.51	63.85	68.3	-4.45

Unless otherwise stated the results shown in this test report refer only to the sample(s) tested and such sample(s) are retained for 90 days only.

除非另有說明，此報告結果僅對測試之樣品負責，同時此樣品僅保留90天。本報告未經本公司書面許可，不可部份複製。

This document is issued by the Company subject to its General Conditions of Service printed overleaf, available on request or accessible at www.sgs.com/terms_and_conditions.htm and, for electronic format documents, subject to Terms and Conditions for Electronic Documents at www.sgs.com/terms_e-document.htm. Attention is drawn to the limitation of liability, indemnification and jurisdiction issues defined therein. Any holder of this document is advised that information contained hereon reflects the Company's findings at the time of its intervention only and within the limits of Client's instructions, if any. The Company's sole responsibility is to its Client and this document does not exonerate parties to a transaction from exercising all their rights and obligations under the transaction documents. This document cannot be reproduced except in full, without prior written approval of the Company. Any unauthorized alteration, forgery or falsification of the content or appearance of this document is unlawful and offenders may be prosecuted to the fullest extent of the law.

SGS Taiwan Ltd.

No. 134, WuKungRoad, New Taipei Industrial Park, Wuku District, New Taipei City, Taiwan 24803/新北市五股區新北產業園區五工路 134 號

台灣檢驗科技股份有限公司

t (886-2) 2299-3279

f (886-2) 2298-0488

www.tw.sgs.com

Member of SGS Group

Operation Mode :	802.11a	Test Date :	2017/7/13
Fundamental Frequency :	5700 MHz	Temp. / Humi. :	22.7deg_C/57RH
Operation Band :	BE CH High	Test Engineer :	Ashton
EUT Pol. :	H	Measurement Antenna Pol. :	Vertical

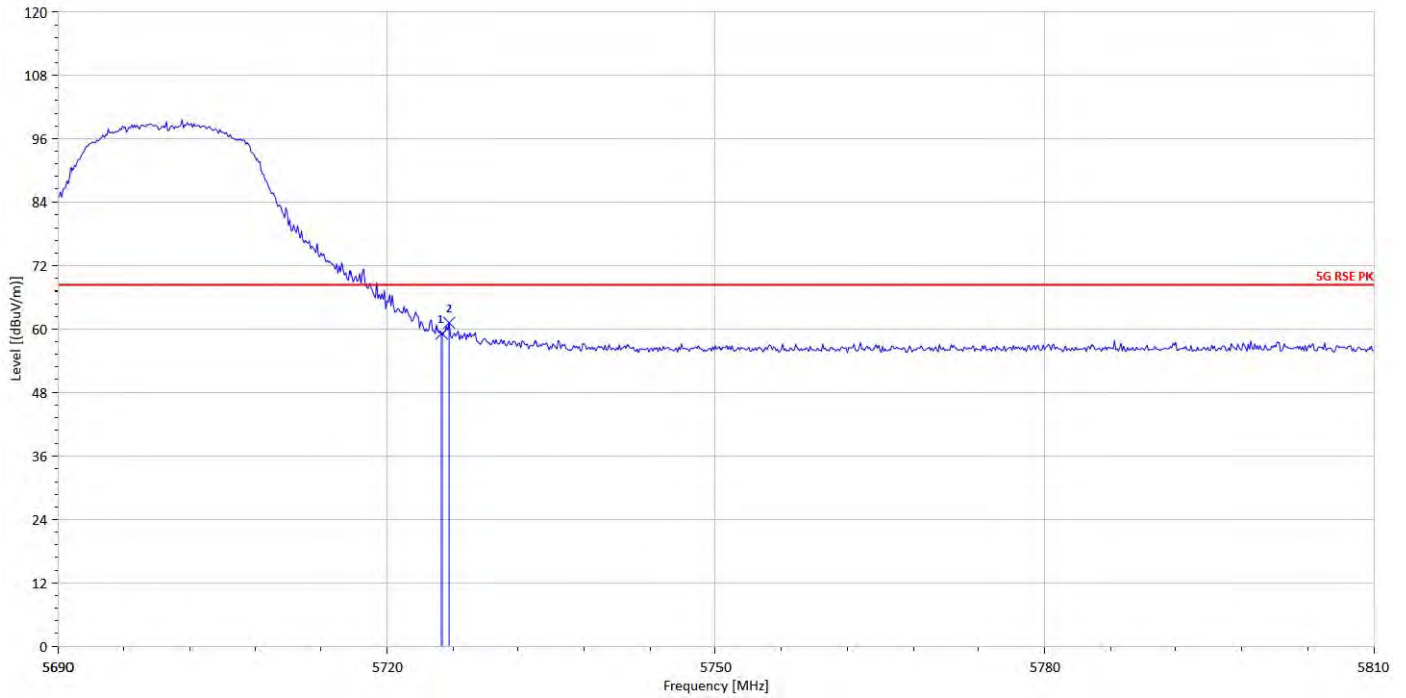

Freq. MHz	Note F/H/E/S	Detector Mode PK/QP/AV	Spectrum Reading Level dBuV	Factor dB	Actual FS dBuV/m	Limit @3m dBuV/m	Margin dB
5725.00	E	Peak	44.11	15.03	59.13	68.3	-9.17
5725.64	S	Peak	46.19	15.03	61.22	68.3	-7.08

Unless otherwise stated the results shown in this test report refer only to the sample(s) tested and such sample(s) are retained for 90 days only.

除非另有說明，此報告結果僅對測試之樣品負責，同時此樣品僅保留90天。本報告未經本公司書面許可，不可部份複製。

This document is issued by the Company subject to its General Conditions of Service printed overleaf, available on request or accessible at www.sgs.com/terms_and_conditions.htm and, for electronic format documents, subject to Terms and Conditions for Electronic Documents at www.sgs.com/terms_e-document.htm. Attention is drawn to the limitation of liability, indemnification and jurisdiction issues defined therein. Any holder of this document is advised that information contained hereon reflects the Company's findings at the time of its intervention only and within the limits of Client's instructions, if any. The Company's sole responsibility is to its Client and this document does not exonerate parties to a transaction from exercising all their rights and obligations under the transaction documents. This document cannot be reproduced except in full, without prior written approval of the Company. Any unauthorized alteration, forgery or falsification of the content or appearance of this document is unlawful and offenders may be prosecuted to the fullest extent of the law.

SGS Taiwan Ltd.

No. 134, WuKungRoad, New Taipei Industrial Park, Wuku District, New Taipei City, Taiwan 24803/新北市五股區新北產業園區五工路 134 號

台灣檢驗科技股份有限公司

t (886-2) 2299-3279

f (886-2) 2298-0488

www.tw.sgs.com

Member of SGS Group

Operation Mode :	802.11a	Test Date :	2017/7/13
Fundamental Frequency :	5700 MHz	Temp. / Humi. :	22.7deg_C/57RH
Operation Band :	BE CH High	Test Engineer :	Ashton
EUT Pol. :	H	Measurement Antenna Pol. :	Horizontal

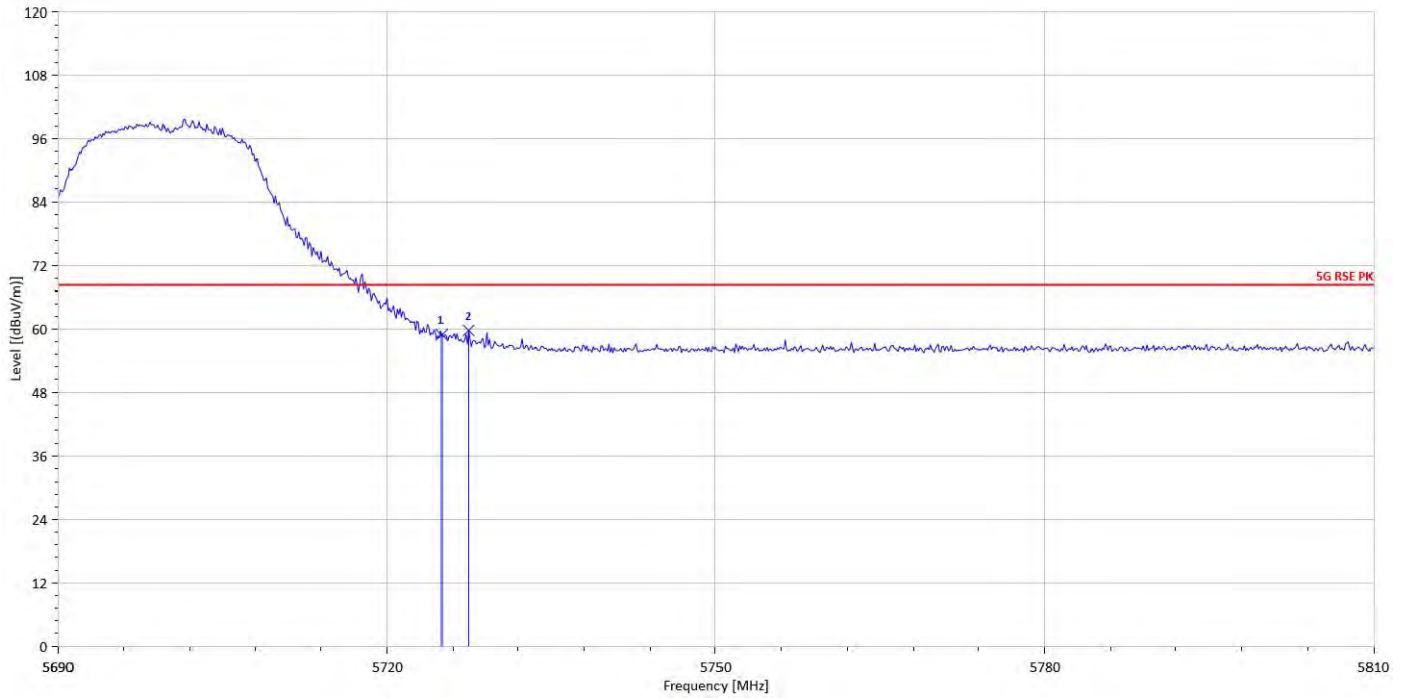

Freq. MHz	Note F/H/E/S	Detector Mode PK/QP/AV	Spectrum Reading Level dBμV	Factor dB	Actual FS dBμV/m	Limit @3m dBμV/m	Margin dB
5725.00	E	Peak	43.92	15.03	58.95	68.3	-9.35
5727.44	S	Peak	44.73	15.03	59.76	68.3	-8.54

Unless otherwise stated the results shown in this test report refer only to the sample(s) tested and such sample(s) are retained for 90 days only.

除非另有說明，此報告結果僅對測試之樣品負責，同時此樣品僅保留90天。本報告未經本公司書面許可，不可部份複製。

This document is issued by the Company subject to its General Conditions of Service printed overleaf, available on request or accessible at www.sgs.com/terms_and_conditions.htm and, for electronic format documents, subject to Terms and Conditions for Electronic Documents at www.sgs.com/terms_e-document.htm. Attention is drawn to the limitation of liability, indemnification and jurisdiction issues defined therein. Any holder of this document is advised that information contained hereon reflects the Company's findings at the time of its intervention only and within the limits of Client's instructions, if any. The Company's sole responsibility is to its Client and this document does not exonerate parties to a transaction from exercising all their rights and obligations under the transaction documents. This document cannot be reproduced except in full, without prior written approval of the Company. Any unauthorized alteration, forgery or falsification of the content or appearance of this document is unlawful and offenders may be prosecuted to the fullest extent of the law.

SGS Taiwan Ltd.

No.134,WuKungRoad,NewTaipeiIndustrialPark,WukuDistrict,NewTaipeiCity,Taiwan24803/新北市五股區新北產業園區五工路 134 號

台灣檢驗科技股份有限公司

t (886-2) 2299-3279

f (886-2) 2298-0488

www.tw.sgs.com

Member of SGS Group

Operation Mode :	802.11a	Test Date :	2017/7/14
Fundamental Frequency :	5745 MHz	Temp. / Humi. :	22.7deg_C/57RH
Operation Band :	BE CH Low	Test Engineer :	Ashton
EUT Pol. :	H	Measurement Antenna Pol. :	Vertical

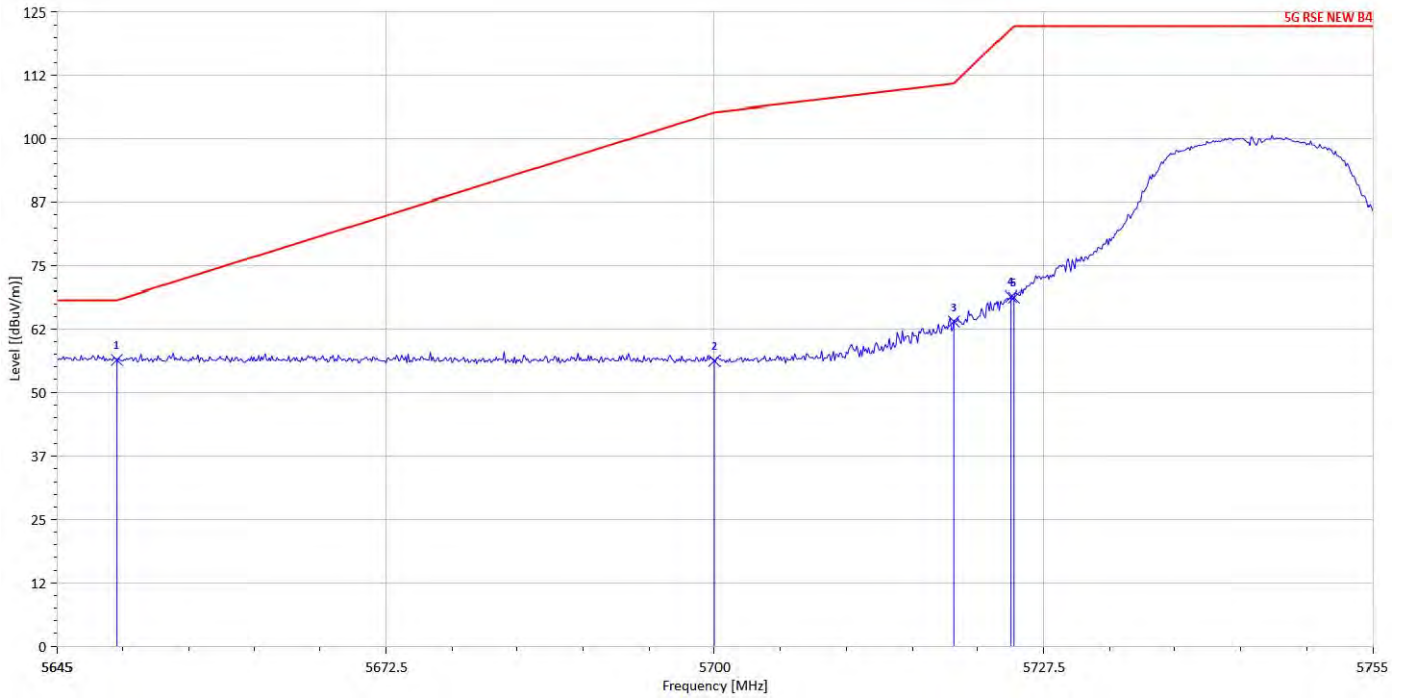

Freq. MHz	Note F/H/E/S	Detector Mode PK/QP/AV	Spectrum Reading Level dB μ V	Factor dB	Actual FS dB μ V/m	Limit @3m dB μ V/m	Margin dB
5650.00	S	Peak	41.52	14.86	56.38	68.23	-11.85
5700.00	S	Peak	41.23	14.97	56.20	105.23	-49.03
5720.00	S	Peak	49.01	15.02	64.02	110.83	-46.81
5724.75	S	Peak	53.92	15.03	68.95	121.66	-52.71
5725.00	E	Peak	53.75	15.03	68.77	122.23	-53.46

Unless otherwise stated the results shown in this test report refer only to the sample(s) tested and such sample(s) are retained for 90 days only.

除非另有說明，此報告結果僅對測試之樣品負責，同時此樣品僅保留90天。本報告未經本公司書面許可，不可部份複製。

This document is issued by the Company subject to its General Conditions of Service printed overleaf, available on request or accessible at www.sgs.com/terms_and_conditions.htm and, for electronic format documents, subject to Terms and Conditions for Electronic Documents at www.sgs.com/terms_e-document.htm. Attention is drawn to the limitation of liability, indemnification and jurisdiction issues defined therein. Any holder of this document is advised that information contained hereon reflects the Company's findings at the time of its intervention only and within the limits of Client's instructions, if any. The Company's sole responsibility is to its Client and this document does not exonerate parties to a transaction from exercising all their rights and obligations under the transaction documents. This document cannot be reproduced except in full, without prior written approval of the Company. Any unauthorized alteration, forgery or falsification of the content or appearance of this document is unlawful and offenders may be prosecuted to the fullest extent of the law.

SGS Taiwan Ltd.

No.134,WuKungRoad,NewTaipeiIndustrialPark,WukuDistrict,NewTaipeiCity,Taiwan24803/新北市五股區新北產業園區五工路 134 號

台灣檢驗科技股份有限公司

t (886-2) 2299-3279

f (886-2) 2298-0488

www.tw.sgs.com

Member of SGS Group

Operation Mode : 802.11a Test Date : 2017/7/14
 Fundamental Frequency : 5745 MHz Temp. / Humi. : 22.7deg_C/57RH
 Operation Band : BE CH Low Test Engineer : Ashton
 EUT Pol. : H Measurement Antenna Pol. : Horizontal

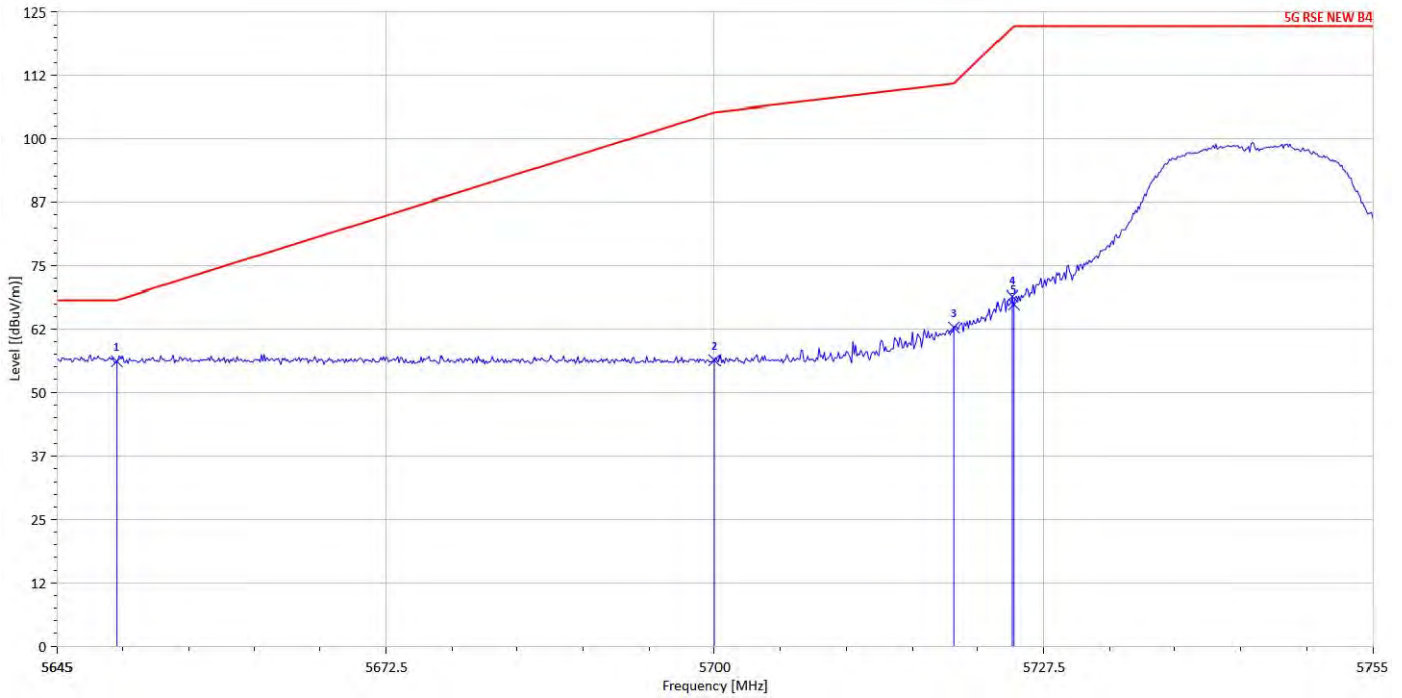

Freq. MHz	Note F/H/E/S	Detector Mode PK/QP/AV	Spectrum Reading Level dB μ V	Factor dB	Actual FS dB μ V/m	Limit @3m dB μ V/m	Margin dB
5650.00	S	Peak	41.23	14.86	56.09	68.23	-12.14
5700.00	S	Peak	41.35	14.97	56.32	105.23	-48.91
5720.00	S	Peak	47.82	15.02	62.84	110.83	-47.99
5724.86	S	Peak	54.00	15.03	69.03	121.9105	-52.88
5725.00	E	Peak	52.39	15.03	67.42	122.23	-54.81

Unless otherwise stated the results shown in this test report refer only to the sample(s) tested and such sample(s) are retained for 90 days only.

除非另有說明，此報告結果僅對測試之樣品負責，同時此樣品僅保留90天。本報告未經本公司書面許可，不可部份複製。

This document is issued by the Company subject to its General Conditions of Service printed overleaf, available on request or accessible at www.sgs.com/terms_and_conditions.htm and, for electronic format documents, subject to Terms and Conditions for Electronic Documents at www.sgs.com/terms_e-document.htm. Attention is drawn to the limitation of liability, indemnification and jurisdiction issues defined therein. Any holder of this document is advised that information contained hereon reflects the Company's findings at the time of its intervention only and within the limits of Client's instructions, if any. The Company's sole responsibility is to its Client and this document does not exonerate parties to a transaction from exercising all their rights and obligations under the transaction documents. This document cannot be reproduced except in full, without prior written approval of the Company. Any unauthorized alteration, forgery or falsification of the content or appearance of this document is unlawful and offenders may be prosecuted to the fullest extent of the law.

SGS Taiwan Ltd.

No.134,WuKungRoad,NewTaipeiIndustrialPark,WukuDistrict,NewTaipeiCity,Taiwan24803/新北市五股區新北產業園區五工路 134 號

台灣檢驗科技股份有限公司

t (886-2) 2299-3279

f (886-2) 2298-0488

www.tw.sgs.com

Member of SGS Group

Operation Mode : 802.11a Test Date : 2017/7/14
 Fundamental Frequency : 5825 MHz Temp. / Humi. : 22.7deg_C/57RH
 Operation Band : BE CH High Test Engineer : Ashton
 EUT Pol. : H Measurement Antenna Pol. : Vertical

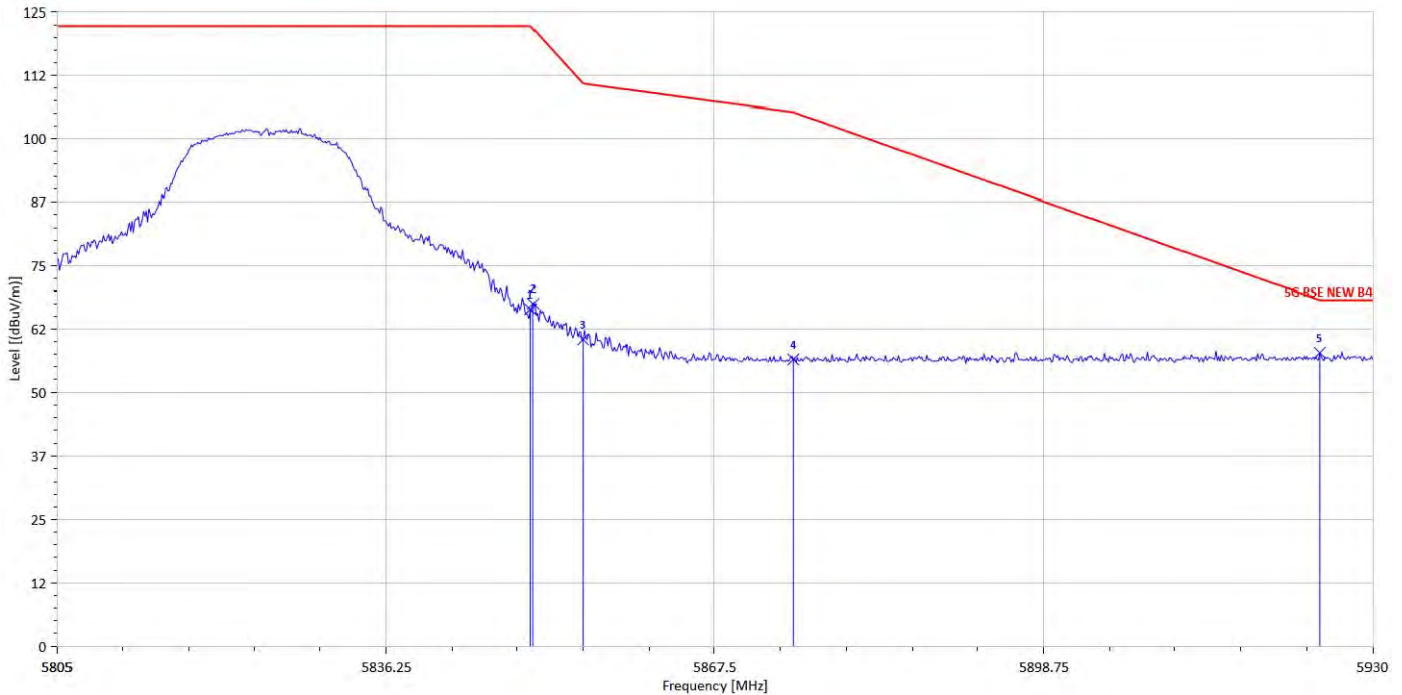

Freq. MHz	Note F/H/E/S	Detector Mode PK/QP/AV	Spectrum Reading Level dBμV	Factor dB	Actual FS dBμV/m	Limit @3m dBμV/m	Margin dB
5850.00	E	Peak	51.11	15.33	66.44	122.23	-55.79
5850.25	S	Peak	52.22	15.33	67.54	121.66	-54.12
5855.00	S	Peak	45.11	15.34	60.45	110.83	-50.38
5875.00	S	Peak	41.08	15.39	56.47	105.23	-48.76
5925.00	S	Peak	42.28	15.52	57.80	68.23	-10.43

Unless otherwise stated the results shown in this test report refer only to the sample(s) tested and such sample(s) are retained for 90 days only.

除非另有說明，此報告結果僅對測試之樣品負責，同時此樣品僅保留90天。本報告未經本公司書面許可，不可部份複製。

This document is issued by the Company subject to its General Conditions of Service printed overleaf, available on request or accessible at www.sgs.com/terms_and_conditions.htm and, for electronic format documents, subject to Terms and Conditions for Electronic Documents at www.sgs.com/terms_e-document.htm. Attention is drawn to the limitation of liability, indemnification and jurisdiction issues defined therein. Any holder of this document is advised that information contained hereon reflects the Company's findings at the time of its intervention only and within the limits of Client's instructions, if any. The Company's sole responsibility is to its Client and this document does not exonerate parties to a transaction from exercising all their rights and obligations under the transaction documents. This document cannot be reproduced except in full, without prior written approval of the Company. Any unauthorized alteration, forgery or falsification of the content or appearance of this document is unlawful and offenders may be prosecuted to the fullest extent of the law.

SGS Taiwan Ltd.

No.134,WuKungRoad,NewTaipeiIndustrialPark,WukuDistrict,NewTaipeiCity,Taiwan24803/新北市五股區新北產業園區五工路 134 號

台灣檢驗科技股份有限公司

t (886-2) 2299-3279

f (886-2) 2298-0488

www.tw.sgs.com

Member of SGS Group

Operation Mode : 802.11a Test Date : 2017/7/14
 Fundamental Frequency : 5825 MHz Temp. / Humi. : 22.7deg_C/57RH
 Operation Band : BE CH High Test Engineer : Ashton
 EUT Pol. : H Measurement Antenna Pol. : Horizontal

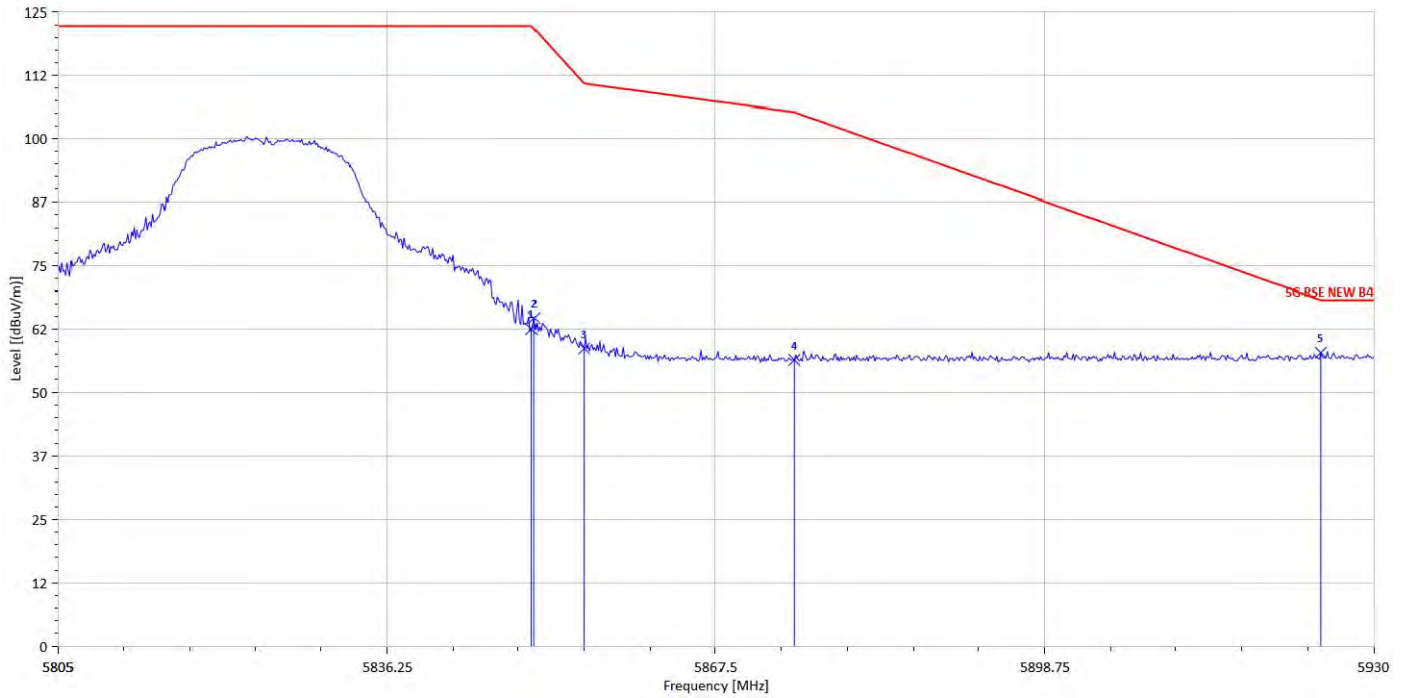

Freq. MHz	Note F/H/E/S	Detector Mode PK/QP/AV	Spectrum Reading Level dBμV	Factor dB	Actual FS dBμV/m	Limit @3m dBμV/m	Margin dB
5850.00	E	Peak	47.19	15.33	62.51	122.23	-59.72
5850.25	S	Peak	49.38	15.33	64.71	121.66	-56.95
5855.00	S	Peak	43.33	15.34	58.67	110.83	-52.16
5875.00	S	Peak	40.99	15.39	56.37	105.23	-48.86
5925.00	S	Peak	42.29	15.52	57.81	68.23	-10.42

Unless otherwise stated the results shown in this test report refer only to the sample(s) tested and such sample(s) are retained for 90 days only.

除非另有說明，此報告結果僅對測試之樣品負責，同時此樣品僅保留90天。本報告未經本公司書面許可，不可部份複製。

This document is issued by the Company subject to its General Conditions of Service printed overleaf, available on request or accessible at www.sgs.com/terms_and_conditions.htm and, for electronic format documents, subject to Terms and Conditions for Electronic Documents at www.sgs.com/terms_e-document.htm. Attention is drawn to the limitation of liability, indemnification and jurisdiction issues defined therein. Any holder of this document is advised that information contained hereon reflects the Company's findings at the time of its intervention only and within the limits of Client's instructions, if any. The Company's sole responsibility is to its Client and this document does not exonerate parties to a transaction from exercising all their rights and obligations under the transaction documents. This document cannot be reproduced except in full, without prior written approval of the Company. Any unauthorized alteration, forgery or falsification of the content or appearance of this document is unlawful and offenders may be prosecuted to the fullest extent of the law.

SGS Taiwan Ltd.

No.134,WuKungRoad,NewTaipeiIndustrialPark,WukuDistrict,NewTaipeiCity,Taiwan24803/新北市五股區新北產業園區五工路 134 號

台灣檢驗科技股份有限公司

t (886-2) 2299-3279

f (886-2) 2298-0488

www.tw.sgs.com

Member of SGS Group

802.11n20 HT mode

Operation Mode :	802.11n20	Test Date :	2017/7/14
Fundamental Frequency :	5180 MHz	Temp. / Humi. :	22.7deg_C/57RH
Operation Band :	BE CH Low	Test Engineer :	Ashton
EUT Pol. :	H	Measurement Antenna Pol. :	Vertical

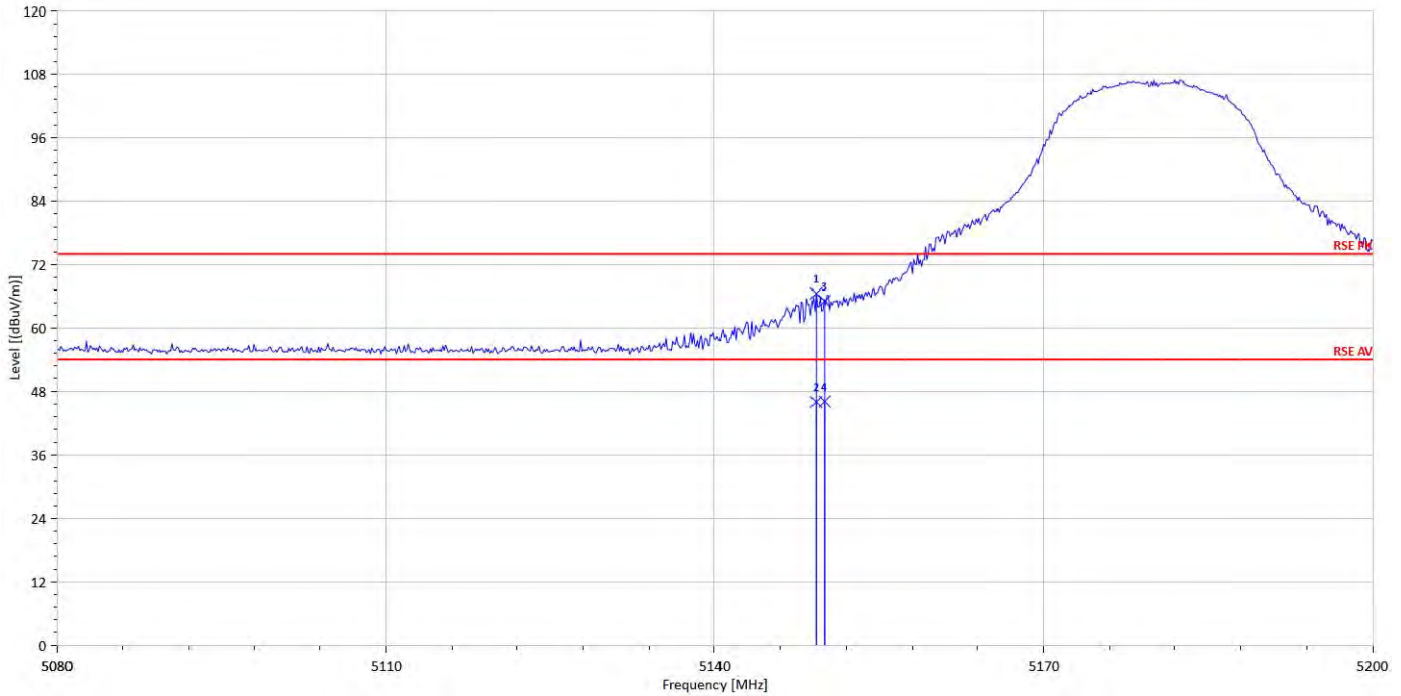

Freq. MHz	Note F/H/E/S	Detector Mode PK/QP/AV	Spectrum Reading Level dB μ V	Factor dB	Actual FS dB μ V/m	Limit @3m dB μ V/m	Margin dB
5149.24	S	Peak	52.24	14.31	66.56	74	-7.44
5149.24	S	Average	31.76	14.31	46.07	54	-7.93
5150.00	E	Peak	50.83	14.32	65.14	74	-8.86
5150.00	E	Average	31.86	14.32	46.18	54	-7.82

Unless otherwise stated the results shown in this test report refer only to the sample(s) tested and such sample(s) are retained for 90 days only.

除非另有說明，此報告結果僅對測試之樣品負責，同時此樣品僅保留90天。本報告未經本公司書面許可，不可部份複製。

This document is issued by the Company subject to its General Conditions of Service printed overleaf, available on request or accessible at www.sgs.com/terms_and_conditions.htm and, for electronic format documents, subject to Terms and Conditions for Electronic Documents at www.sgs.com/terms_e-document.htm. Attention is drawn to the limitation of liability, indemnification and jurisdiction issues defined therein. Any holder of this document is advised that information contained hereon reflects the Company's findings at the time of its intervention only and within the limits of Client's instructions, if any. The Company's sole responsibility is to its Client and this document does not exonerate parties to a transaction from exercising all their rights and obligations under the transaction documents. This document cannot be reproduced except in full, without prior written approval of the Company. Any unauthorized alteration, forgery or falsification of the content or appearance of this document is unlawful and offenders may be prosecuted to the fullest extent of the law.

SGS Taiwan Ltd.

No.134,WuKungRoad,NewTaipeiIndustrialPark,WukuDistrict,NewTaipeiCity,Taiwan24803/新北市五股區新北產業園區五工路 134 號

台灣檢驗科技股份有限公司

t (886-2) 2299-3279

f (886-2) 2298-0488

www.tw.sgs.com

Member of SGS Group

Operation Mode :	802.11n20	Test Date :	2017/7/14
Fundamental Frequency :	5180 MHz	Temp. / Humi. :	22.7deg_C/57RH
Operation Band :	BE CH Low	Test Engineer :	Ashton
EUT Pol. :	H	Measurement Antenna Pol. :	Horizontal

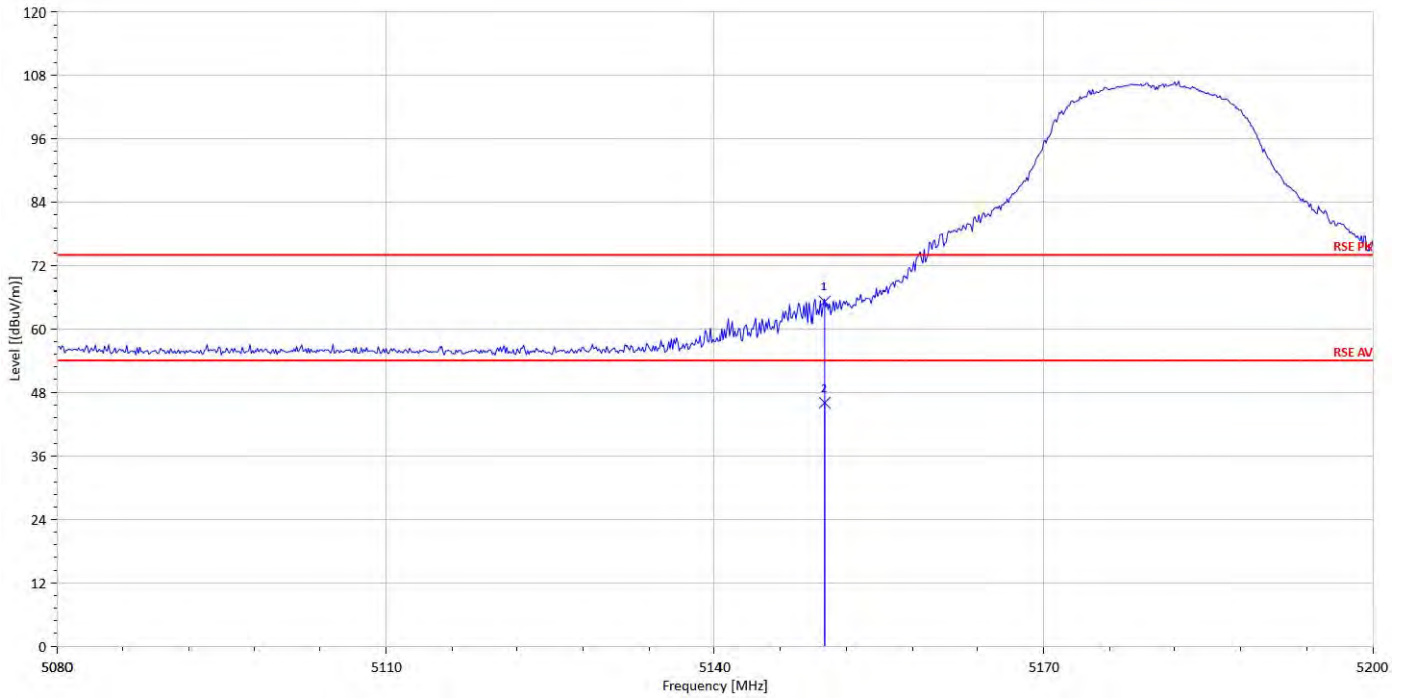

Freq. MHz	Note F/H/E/S	Detector Mode PK/QP/AV	Spectrum Reading Level dBµV	Factor dB	Actual FS dBµV/m	Limit @3m dBµV/m	Margin dB
5150.00	E	Peak	50.96	14.32	65.28	74	-8.72
5150.00	E	Average	31.83	14.32	46.15	54	-7.86

Unless otherwise stated the results shown in this test report refer only to the sample(s) tested and such sample(s) are retained for 90 days only.

除非另有說明，此報告結果僅對測試之樣品負責，同時此樣品僅保留90天。本報告未經本公司書面許可，不可部份複製。

This document is issued by the Company subject to its General Conditions of Service printed overleaf, available on request or accessible at www.sgs.com/terms_and_conditions.htm and, for electronic format documents, subject to Terms and Conditions for Electronic Documents at www.sgs.com/terms_e-document.htm. Attention is drawn to the limitation of liability, indemnification and jurisdiction issues defined therein. Any holder of this document is advised that information contained hereon reflects the Company's findings at the time of its intervention only and within the limits of Client's instructions, if any. The Company's sole responsibility is to its Client and this document does not exonerate parties to a transaction from exercising all their rights and obligations under the transaction documents. This document cannot be reproduced except in full, without prior written approval of the Company. Any unauthorized alteration, forgery or falsification of the content or appearance of this document is unlawful and offenders may be prosecuted to the fullest extent of the law.

SGS Taiwan Ltd.

No. 134, WuKungRoad, New Taipei Industrial Park, Wuku District, New Taipei City, Taiwan 24803/新北市五股區新北產業園區五工路 134 號

台灣檢驗科技股份有限公司

t (886-2) 2299-3279

f (886-2) 2298-0488

www.tw.sgs.com

Member of SGS Group

Operation Mode : 802.11n20 Test Date : 2017/7/14
 Fundamental Frequency : 5320 MHz Temp. / Humi. : 22.7deg_C/57RH
 Operation Band : BE CH High Test Engineer : Ashton
 EUT Pol. : H Measurement Antenna Pol. : Vertical

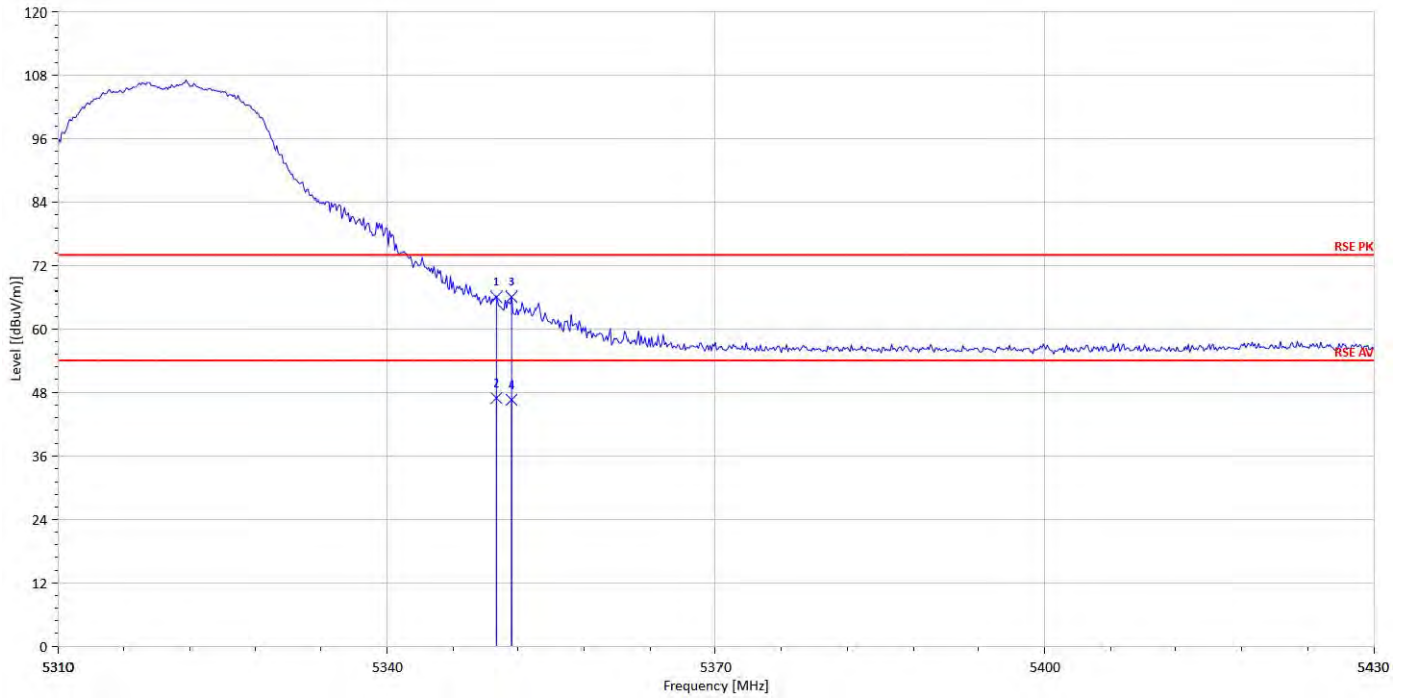

Freq. MHz	Note F/H/E/S	Detector Mode PK/QP/AV	Spectrum Reading Level dBμV	Factor dB	Actual FS dBμV/m	Limit @3m dBμV/m	Margin dB
5350.00	E	Peak	51.69	14.44	66.13	74	-7.87
5350.00	E	Average	32.59	14.44	47.03	54	-6.97
5351.40	S	Peak	51.72	14.44	66.16	74	-7.84
5351.40	S	Average	32.26	14.44	46.70	54	-7.30

Unless otherwise stated the results shown in this test report refer only to the sample(s) tested and such sample(s) are retained for 90 days only.

除非另有說明，此報告結果僅對測試之樣品負責，同時此樣品僅保留90天。本報告未經本公司書面許可，不可部份複製。

This document is issued by the Company subject to its General Conditions of Service printed overleaf, available on request or accessible at www.sgs.com/terms_and_conditions.htm and, for electronic format documents, subject to Terms and Conditions for Electronic Documents at www.sgs.com/terms_e-document.htm. Attention is drawn to the limitation of liability, indemnification and jurisdiction issues defined therein. Any holder of this document is advised that information contained hereon reflects the Company's findings at the time of its intervention only and within the limits of Client's instructions, if any. The Company's sole responsibility is to its Client and this document does not exonerate parties to a transaction from exercising all their rights and obligations under the transaction documents. This document cannot be reproduced except in full, without prior written approval of the Company. Any unauthorized alteration, forgery or falsification of the content or appearance of this document is unlawful and offenders may be prosecuted to the fullest extent of the law.

SGS Taiwan Ltd.

No. 134, WuKungRoad, New Taipei Industrial Park, Wuku District, New Taipei City, Taiwan 24803 / 新北市五股區新北產業園區五工路 134 號

台灣檢驗科技股份有限公司

t (886-2) 2299-3279

f (886-2) 2298-0488

www.tw.sgs.com

Member of SGS Group

Operation Mode :	802.11n20	Test Date :	2017/7/14
Fundamental Frequency :	5320 MHz	Temp. / Humi. :	22.7deg_C/57RH
Operation Band :	BE CH High	Test Engineer :	Ashton
EUT Pol. :	H	Measurement Antenna Pol. :	Horizontal

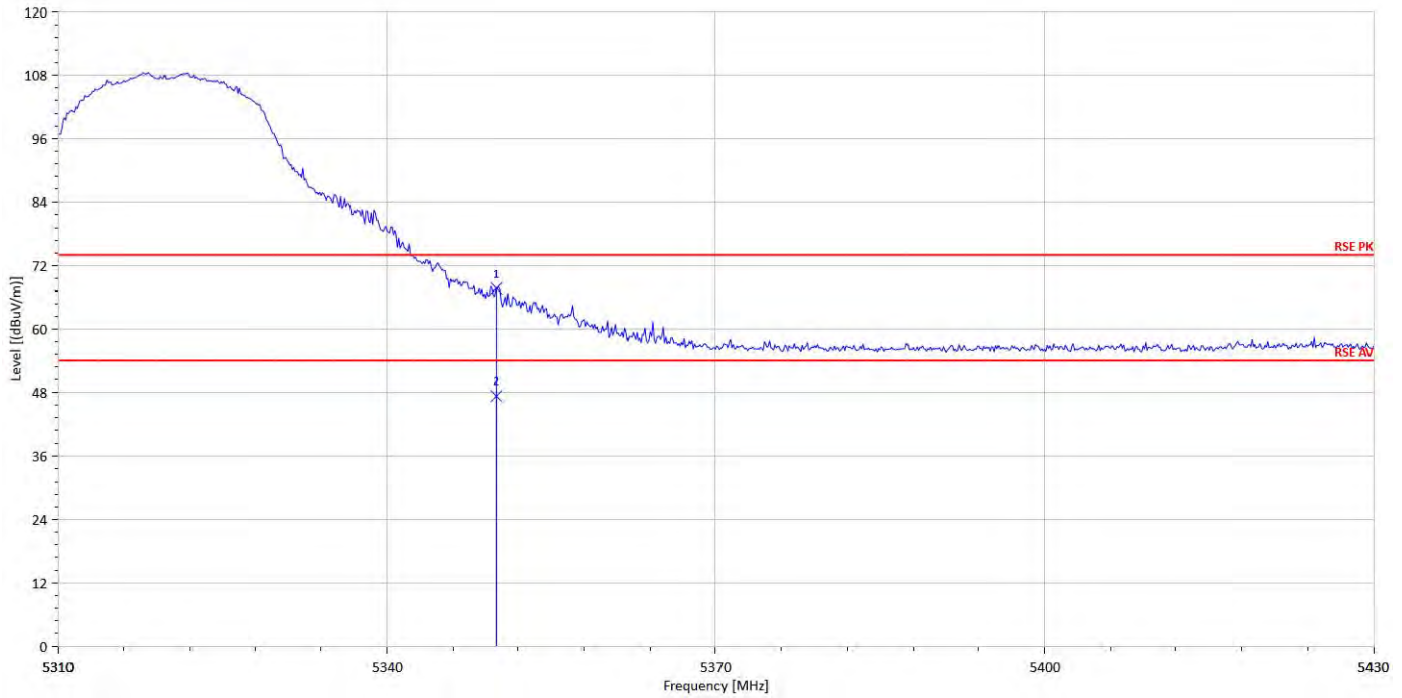

Freq. MHz	Note F/H/E/S	Detector Mode PK/QP/AV	Spectrum Reading Level dBuV	Factor dB	Actual FS dBuV/m	Limit @3m dBuV/m	Margin dB
5350.00	E	Peak	53.27	14.44	67.71	74	-6.29
5350.00	E	Average	32.93	14.44	47.37	54	-6.63

Unless otherwise stated the results shown in this test report refer only to the sample(s) tested and such sample(s) are retained for 90 days only.

除非另有說明，此報告結果僅對測試之樣品負責，同時此樣品僅保留90天。本報告未經本公司書面許可，不可部份複製。

This document is issued by the Company subject to its General Conditions of Service printed overleaf, available on request or accessible at www.sgs.com/terms_and_conditions.htm and, for electronic format documents, subject to Terms and Conditions for Electronic Documents at www.sgs.com/terms_e-document.htm. Attention is drawn to the limitation of liability, indemnification and jurisdiction issues defined therein. Any holder of this document is advised that information contained hereon reflects the Company's findings at the time of its intervention only and within the limits of Client's instructions, if any. The Company's sole responsibility is to its Client and this document does not exonerate parties to a transaction from exercising all their rights and obligations under the transaction documents. This document cannot be reproduced except in full, without prior written approval of the Company. Any unauthorized alteration, forgery or falsification of the content or appearance of this document is unlawful and offenders may be prosecuted to the fullest extent of the law.

SGS Taiwan Ltd.

No. 134, WuKungRoad, NewTaipeiIndustrialPark, WukuDistrict, New Taipei City, Taiwan 24803/新北市五股區新北產業園區五工路 134 號

台灣檢驗科技股份有限公司

t (886-2) 2299-3279

f (886-2) 2298-0488

www.tw.sgs.com

Member of SGS Group

Operation Mode :	802.11n20	Test Date :	2017/7/14
Fundamental Frequency :	5500 MHz	Temp. / Humi. :	22.7deg_C/57RH
Operation Band :	BE CH Low	Test Engineer :	Ashton
EUT Pol. :	H	Measurement Antenna Pol. :	Vertical

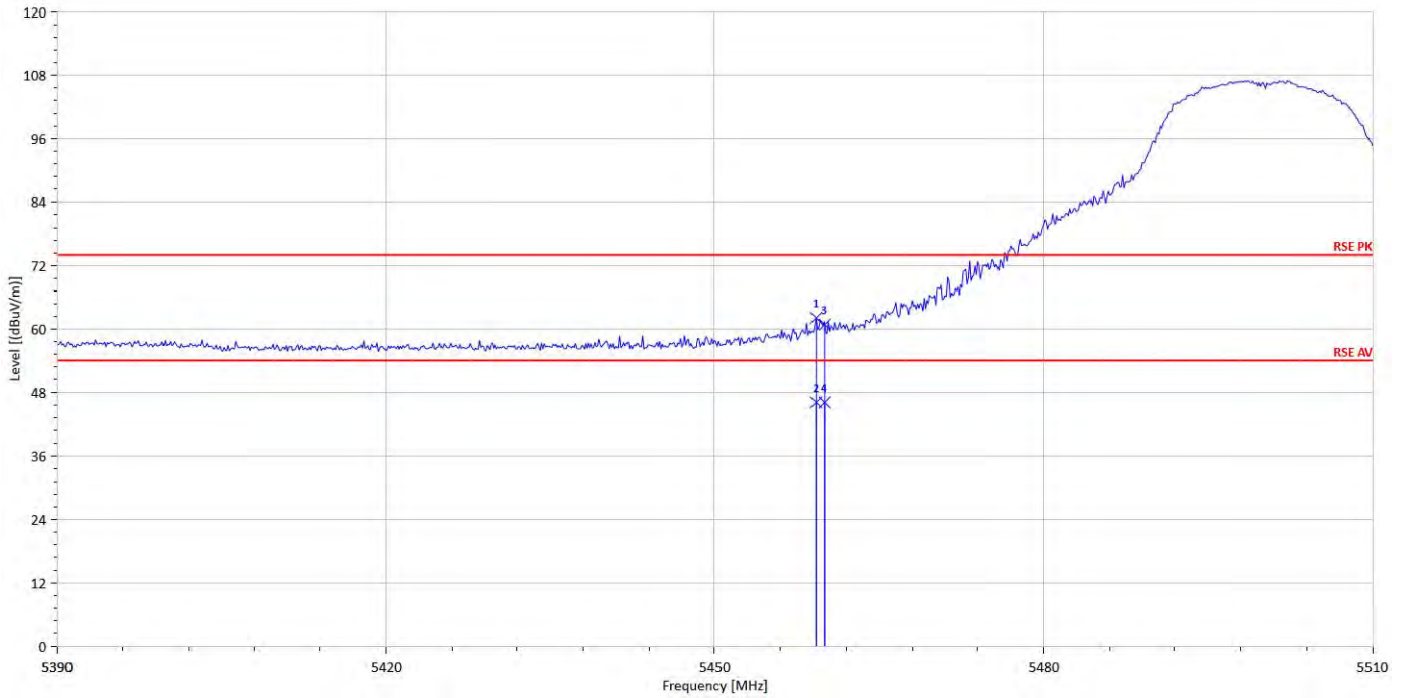

Freq. MHz	Note F/H/E/S	Detector Mode PK/QP/AV	Spectrum Reading Level dBμV	Factor dB	Actual FS dBμV/m	Limit @3m dBμV/m	Margin dB
5459.24	S	Peak	47.64	14.51	62.14	74	-11.86
5459.24	S	Average	31.68	14.51	46.19	54	-7.81
5460.00	E	Peak	46.35	14.51	60.85	74	-13.15
5460.00	E	Average	31.69	14.51	46.20	54	-7.80

Unless otherwise stated the results shown in this test report refer only to the sample(s) tested and such sample(s) are retained for 90 days only.

除非另有說明，此報告結果僅對測試之樣品負責，同時此樣品僅保留90天。本報告未經本公司書面許可，不可部份複製。

This document is issued by the Company subject to its General Conditions of Service printed overleaf, available on request or accessible at www.sgs.com/terms_and_conditions.htm and, for electronic format documents, subject to Terms and Conditions for Electronic Documents at www.sgs.com/terms_e-document.htm. Attention is drawn to the limitation of liability, indemnification and jurisdiction issues defined therein. Any holder of this document is advised that information contained hereon reflects the Company's findings at the time of its intervention only and within the limits of Client's instructions, if any. The Company's sole responsibility is to its Client and this document does not exonerate parties to a transaction from exercising all their rights and obligations under the transaction documents. This document cannot be reproduced except in full, without prior written approval of the Company. Any unauthorized alteration, forgery or falsification of the content or appearance of this document is unlawful and offenders may be prosecuted to the fullest extent of the law.

SGS Taiwan Ltd.

No.134,WuKungRoad,NewTaipeiIndustrialPark,WukuDistrict,NewTaipeiCity,Taiwan24803/新北市五股區新北產業園區五工路 134 號

台灣檢驗科技股份有限公司

t (886-2) 2299-3279

f (886-2) 2298-0488

www.tw.sgs.com

Member of SGS Group

Operation Mode :	802.11n20	Test Date :	2017/7/14
Fundamental Frequency :	5500 MHz	Temp. / Humi. :	22.7deg_C/57RH
Operation Band :	BE CH Low	Test Engineer :	Ashton
EUT Pol. :	H	Measurement Antenna Pol. :	Horizontal

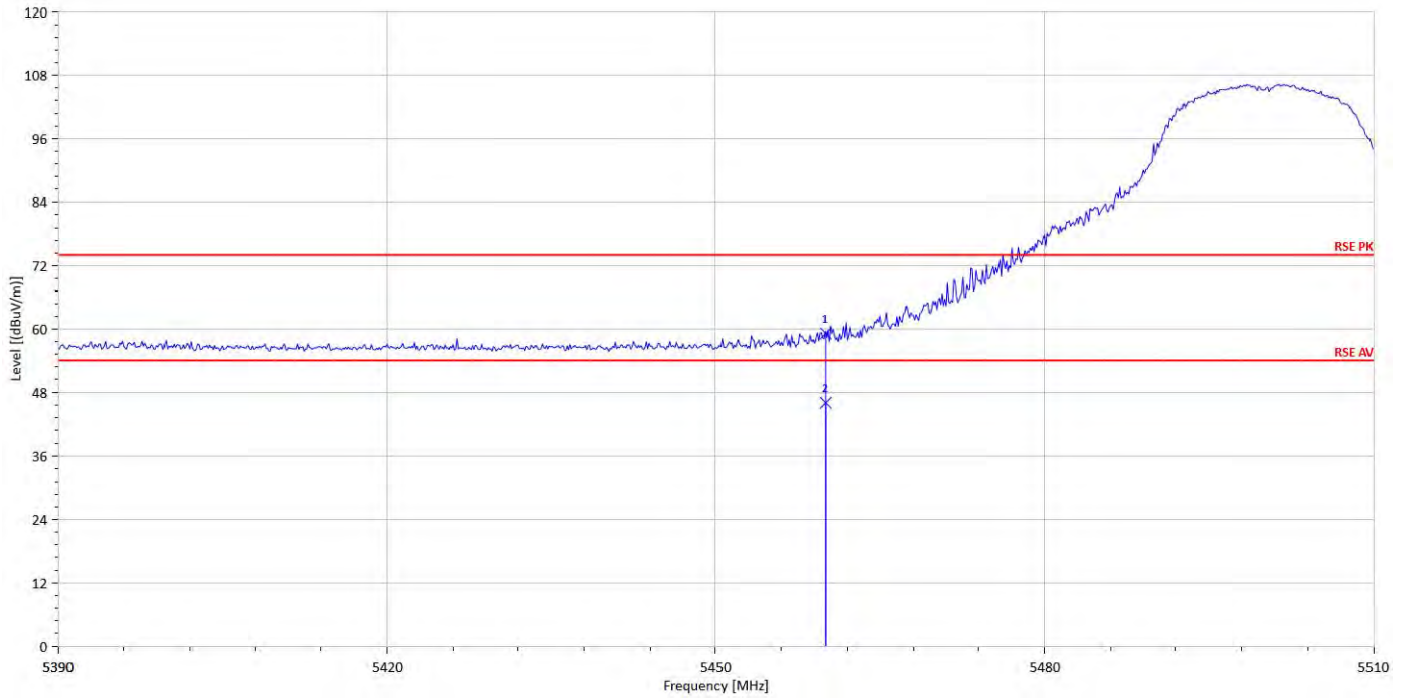

Freq. MHz	Note F/H/E/S	Detector Mode PK/QP/AV	Spectrum Reading Level dBuV	Factor dB	Actual FS dBuV/m	Limit @3m dBuV/m	Margin dB
5460.00	E	Peak	44.68	14.51	59.19	74	-14.81
5460.00	E	Average	31.62	14.51	46.13	54	-7.87

Unless otherwise stated the results shown in this test report refer only to the sample(s) tested and such sample(s) are retained for 90 days only.

除非另有說明，此報告結果僅對測試之樣品負責，同時此樣品僅保留90天。本報告未經本公司書面許可，不可部份複製。

This document is issued by the Company subject to its General Conditions of Service printed overleaf, available on request or accessible at www.sgs.com/terms_and_conditions.htm and, for electronic format documents, subject to Terms and Conditions for Electronic Documents at www.sgs.com/terms_e-document.htm. Attention is drawn to the limitation of liability, indemnification and jurisdiction issues defined therein. Any holder of this document is advised that information contained hereon reflects the Company's findings at the time of its intervention only and within the limits of Client's instructions, if any. The Company's sole responsibility is to its Client and this document does not exonerate parties to a transaction from exercising all their rights and obligations under the transaction documents. This document cannot be reproduced except in full, without prior written approval of the Company. Any unauthorized alteration, forgery or falsification of the content or appearance of this document is unlawful and offenders may be prosecuted to the fullest extent of the law.

SGS Taiwan Ltd.

No. 134, WuKungRoad, New Taipei Industrial Park, Wuku District, New Taipei City, Taiwan 24803 / 新北市五股區新北產業園區五工路 134 號

台灣檢驗科技股份有限公司

t (886-2) 2299-3279

f (886-2) 2298-0488

www.tw.sgs.com

Member of SGS Group

Operation Mode :	802.11n20	Test Date :	2017/7/14
Fundamental Frequency :	5500 MHz	Temp. / Humi. :	22.7deg_C/57RH
Operation Band :	BE CH Low RSE	Test Engineer :	Ashton
EUT Pol. :	H	Measurement Antenna Pol. :	Vertical

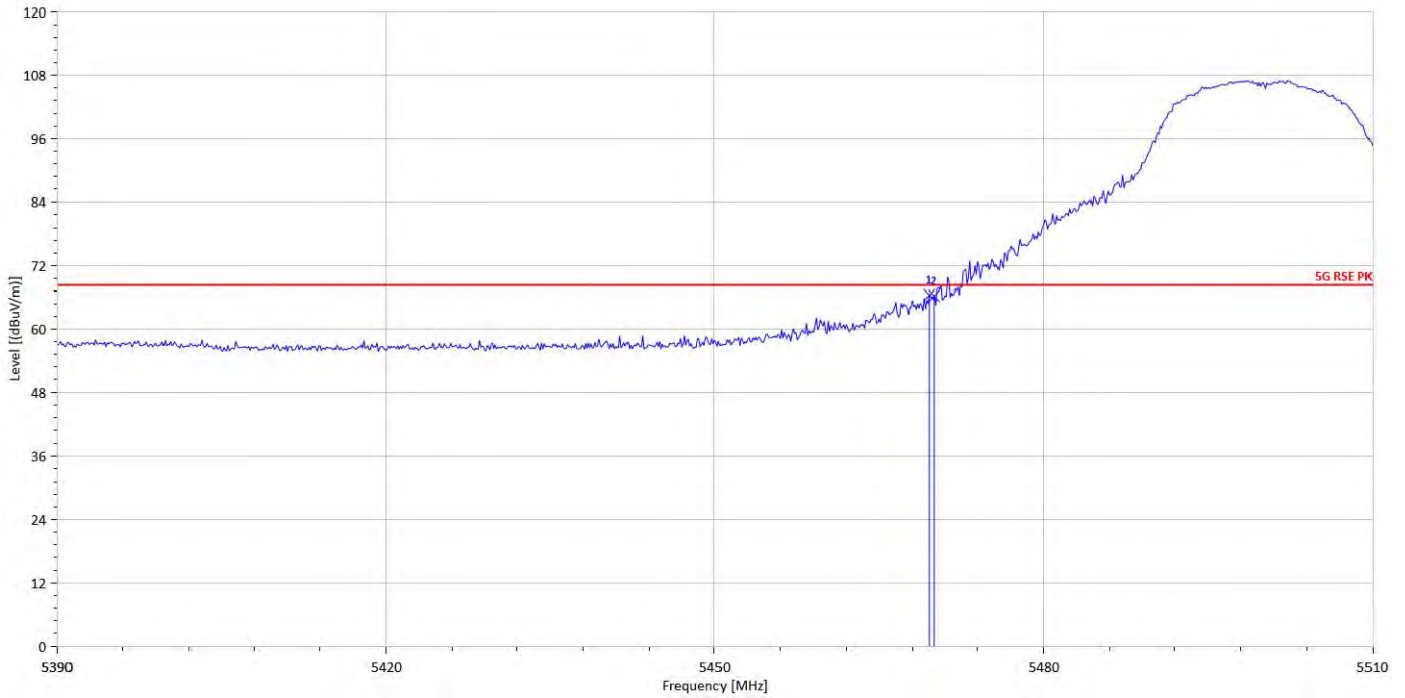

Freq. MHz	Note F/H/E/S	Detector Mode PK/QP/AV	Spectrum Reading Level dBuV	Factor dB	Actual FS dBuV/m	Limit @3m dBuV/m	Margin dB
5469.56	S	Peak	51.93	14.51	66.44	68.3	-1.86
5470.00	E	Peak	51.76	14.51	66.27	68.3	-2.03

Unless otherwise stated the results shown in this test report refer only to the sample(s) tested and such sample(s) are retained for 90 days only.

除非另有說明，此報告結果僅對測試之樣品負責，同時此樣品僅保留90天。本報告未經本公司書面許可，不可部份複製。

This document is issued by the Company subject to its General Conditions of Service printed overleaf, available on request or accessible at www.sgs.com/terms_and_conditions.htm and, for electronic format documents, subject to Terms and Conditions for Electronic Documents at www.sgs.com/terms_e-document.htm. Attention is drawn to the limitation of liability, indemnification and jurisdiction issues defined therein. Any holder of this document is advised that information contained hereon reflects the Company's findings at the time of its intervention only and within the limits of Client's instructions, if any. The Company's sole responsibility is to its Client and this document does not exonerate parties to a transaction from exercising all their rights and obligations under the transaction documents. This document cannot be reproduced except in full, without prior written approval of the Company. Any unauthorized alteration, forgery or falsification of the content or appearance of this document is unlawful and offenders may be prosecuted to the fullest extent of the law.

SGS Taiwan Ltd.

No. 134, WuKungRoad, New Taipei Industrial Park, Wuku District, New Taipei City, Taiwan 24803/新北市五股區新北產業園區五工路 134 號

台灣檢驗科技股份有限公司

t (886-2) 2299-3279

f (886-2) 2298-0488

www.tw.sgs.com

Member of SGS Group

Operation Mode :	802.11n20	Test Date :	2017/7/14
Fundamental Frequency :	5500 MHz	Temp. / Humi. :	22.7deg_C/57RH
Operation Band :	BE CH Low RSE	Test Engineer :	Ashton
EUT Pol. :	H	Measurement Antenna Pol. :	Horizontal

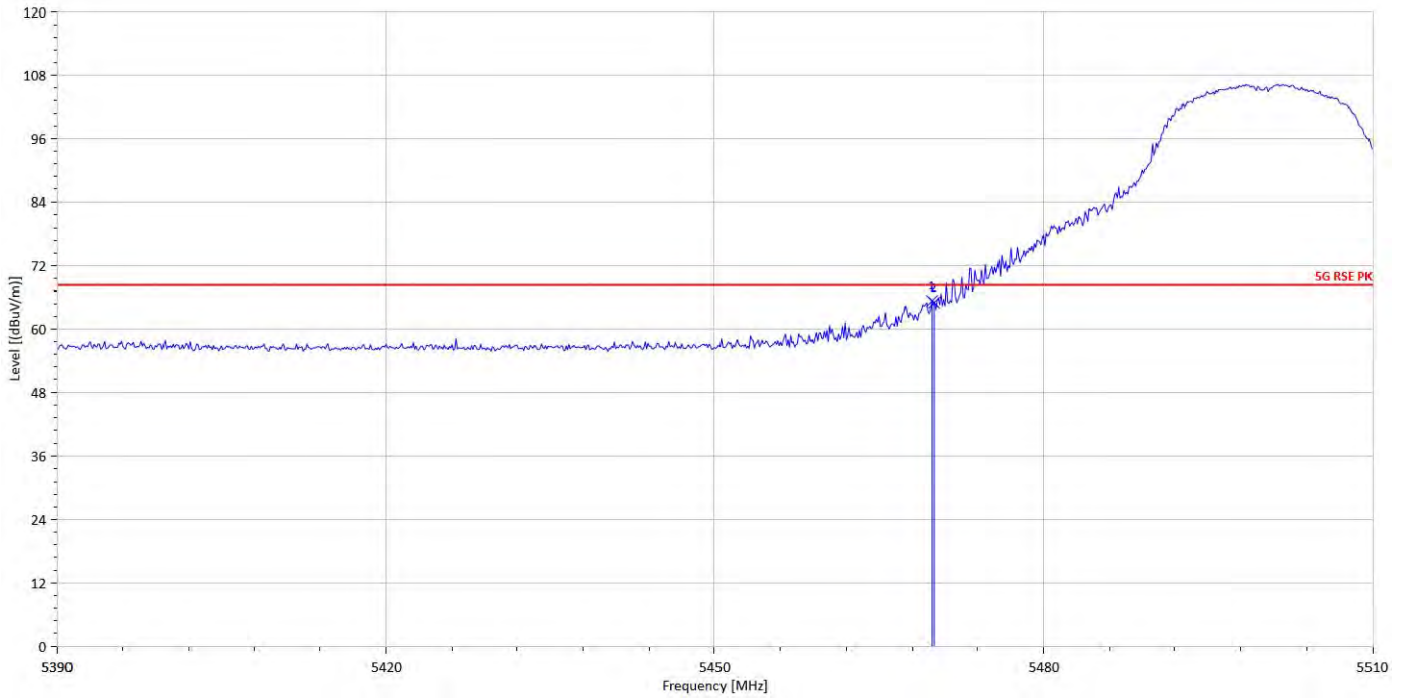

Freq. MHz	Note F/H/E/S	Detector Mode PK/QP/AV	Spectrum Reading Level dBμV	Factor dB	Actual FS dBμV/m	Limit @3m dBμV/m	Margin dB
5469.80	S	Peak	50.85	14.51	65.36	68.3	-2.94
5470.00	E	Peak	50.54	14.51	65.06	68.3	-3.24

Unless otherwise stated the results shown in this test report refer only to the sample(s) tested and such sample(s) are retained for 90 days only.

除非另有說明，此報告結果僅對測試之樣品負責，同時此樣品僅保留90天。本報告未經本公司書面許可，不可部份複製。

This document is issued by the Company subject to its General Conditions of Service printed overleaf, available on request or accessible at www.sgs.com/terms_and_conditions.htm and, for electronic format documents, subject to Terms and Conditions for Electronic Documents at www.sgs.com/terms_e-document.htm. Attention is drawn to the limitation of liability, indemnification and jurisdiction issues defined therein. Any holder of this document is advised that information contained hereon reflects the Company's findings at the time of its intervention only and within the limits of Client's instructions, if any. The Company's sole responsibility is to its Client and this document does not exonerate parties to a transaction from exercising all their rights and obligations under the transaction documents. This document cannot be reproduced except in full, without prior written approval of the Company. Any unauthorized alteration, forgery or falsification of the content or appearance of this document is unlawful and offenders may be prosecuted to the fullest extent of the law.

SGS Taiwan Ltd.

No. 134, WuKungRoad, New Taipei Industrial Park, Wuku District, New Taipei City, Taiwan 24803/新北市五股區新北產業園區五工路 134 號

台灣檢驗科技股份有限公司

t (886-2) 2299-3279

f (886-2) 2298-0488

www.tw.sgs.com

Member of SGS Group

Operation Mode :	802.11n20	Test Date :	2017/7/14
Fundamental Frequency :	5700 MHz	Temp. / Humi. :	22.7deg_C/57RH
Operation Band :	BE CH High	Test Engineer :	Ashton
EUT Pol. :	H	Measurement Antenna Pol. :	Vertical

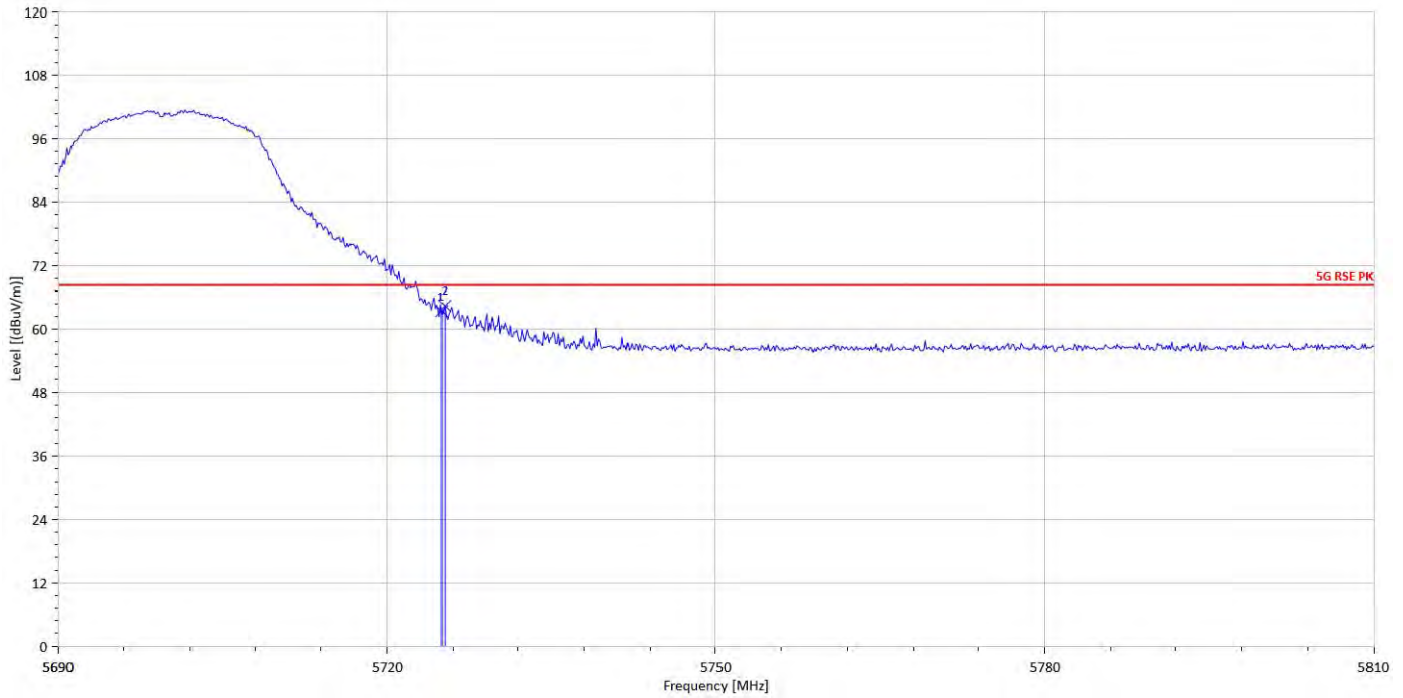

Freq. MHz	Note F/H/E/S	Detector Mode PK/QP/AV	Spectrum Reading Level dBμV	Factor dB	Actual FS dBμV/m	Limit @3m dBμV/m	Margin dB
5725.00	E	Peak	48.39	15.03	63.42	68.3	-4.88
5725.28	S	Peak	49.40	15.03	64.43	68.3	-3.87

Unless otherwise stated the results shown in this test report refer only to the sample(s) tested and such sample(s) are retained for 90 days only.

除非另有說明，此報告結果僅對測試之樣品負責，同時此樣品僅保留90天。本報告未經本公司書面許可，不可部份複製。

This document is issued by the Company subject to its General Conditions of Service printed overleaf, available on request or accessible at www.sgs.com/terms_and_conditions.htm and, for electronic format documents, subject to Terms and Conditions for Electronic Documents at www.sgs.com/terms_e-document.htm. Attention is drawn to the limitation of liability, indemnification and jurisdiction issues defined therein. Any holder of this document is advised that information contained hereon reflects the Company's findings at the time of its intervention only and within the limits of Client's instructions, if any. The Company's sole responsibility is to its Client and this document does not exonerate parties to a transaction from exercising all their rights and obligations under the transaction documents. This document cannot be reproduced except in full, without prior written approval of the Company. Any unauthorized alteration, forgery or falsification of the content or appearance of this document is unlawful and offenders may be prosecuted to the fullest extent of the law.

SGS Taiwan Ltd.

No. 134, WuKungRoad, New Taipei Industrial Park, Wuku District, New Taipei City, Taiwan 24803/新北市五股區新北產業園區五工路 134 號

台灣檢驗科技股份有限公司

t (886-2) 2299-3279

f (886-2) 2298-0488

www.tw.sgs.com

Member of SGS Group

Operation Mode :	802.11n20	Test Date :	2017/7/14
Fundamental Frequency :	5700 MHz	Temp. / Humi. :	22.7deg_C/57RH
Operation Band :	BE CH High	Test Engineer :	Ashton
EUT Pol. :	H	Measurement Antenna Pol. :	Horizontal

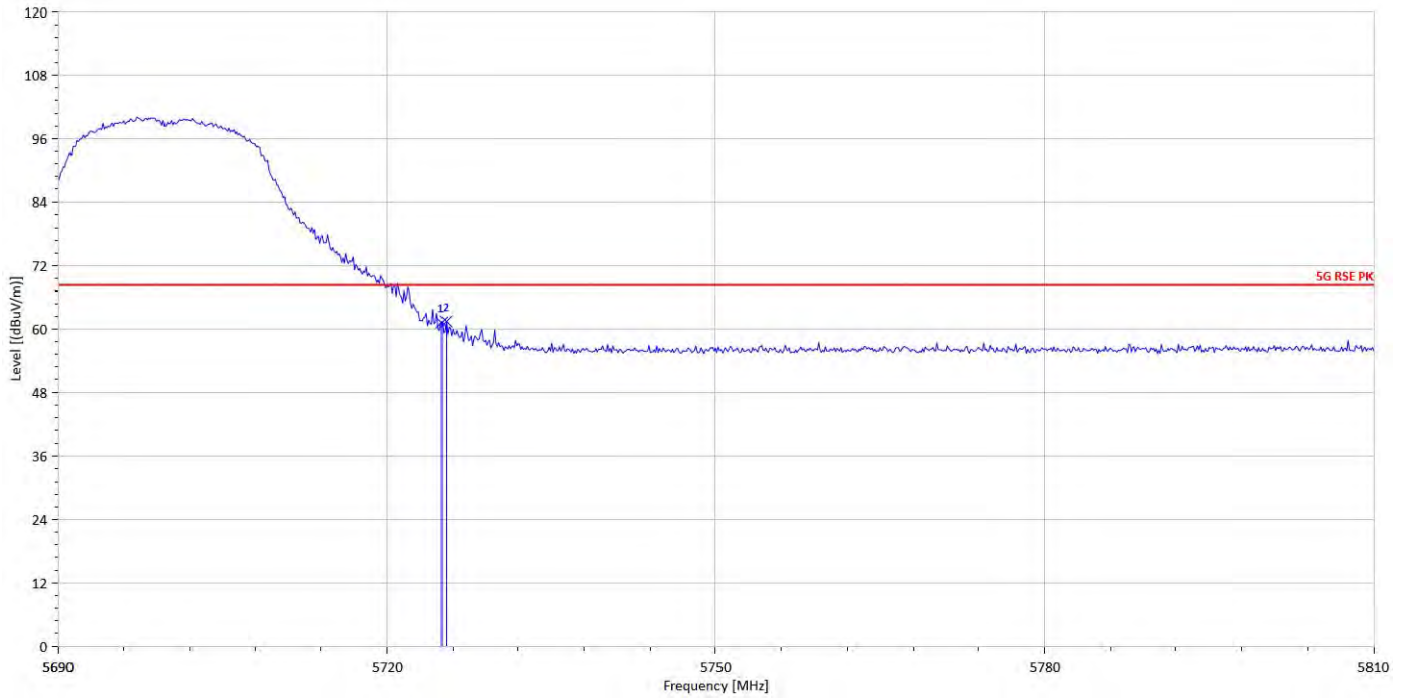

Freq. MHz	Note F/H/E/S	Detector Mode PK/QP/AV	Spectrum Reading Level dBuV	Factor dB	Actual FS dBuV/m	Limit @3m dBuV/m	Margin dB
5725.00	E	Peak	46.25	15.03	61.27	68.3	-7.03
5725.40	S	Peak	46.42	15.03	61.45	68.3	-6.85

Unless otherwise stated the results shown in this test report refer only to the sample(s) tested and such sample(s) are retained for 90 days only.

除非另有說明，此報告結果僅對測試之樣品負責，同時此樣品僅保留90天。本報告未經本公司書面許可，不可部份複製。

This document is issued by the Company subject to its General Conditions of Service printed overleaf, available on request or accessible at www.sgs.com/terms_and_conditions.htm and, for electronic format documents, subject to Terms and Conditions for Electronic Documents at www.sgs.com/terms_e-document.htm. Attention is drawn to the limitation of liability, indemnification and jurisdiction issues defined therein. Any holder of this document is advised that information contained hereon reflects the Company's findings at the time of its intervention only and within the limits of Client's instructions, if any. The Company's sole responsibility is to its Client and this document does not exonerate parties to a transaction from exercising all their rights and obligations under the transaction documents. This document cannot be reproduced except in full, without prior written approval of the Company. Any unauthorized alteration, forgery or falsification of the content or appearance of this document is unlawful and offenders may be prosecuted to the fullest extent of the law.

SGS Taiwan Ltd.

No.134,WuKungRoad,NewTaipeiIndustrialPark,WukuDistrict,NewTaipeiCity,Taiwan24803/新北市五股區新北產業園區五工路 134 號

台灣檢驗科技股份有限公司

t (886-2) 2299-3279

f (886-2) 2298-0488

www.tw.sgs.com

Member of SGS Group

Operation Mode : 802.11n20 Test Date : 2017/7/14
 Fundamental Frequency : 5745 MHz Temp. / Humi. : 22.7deg_C/57RH
 Operation Band : BE CH Low Test Engineer : Ashton
 EUT Pol. : H Measurement Antenna Pol. : Vertical

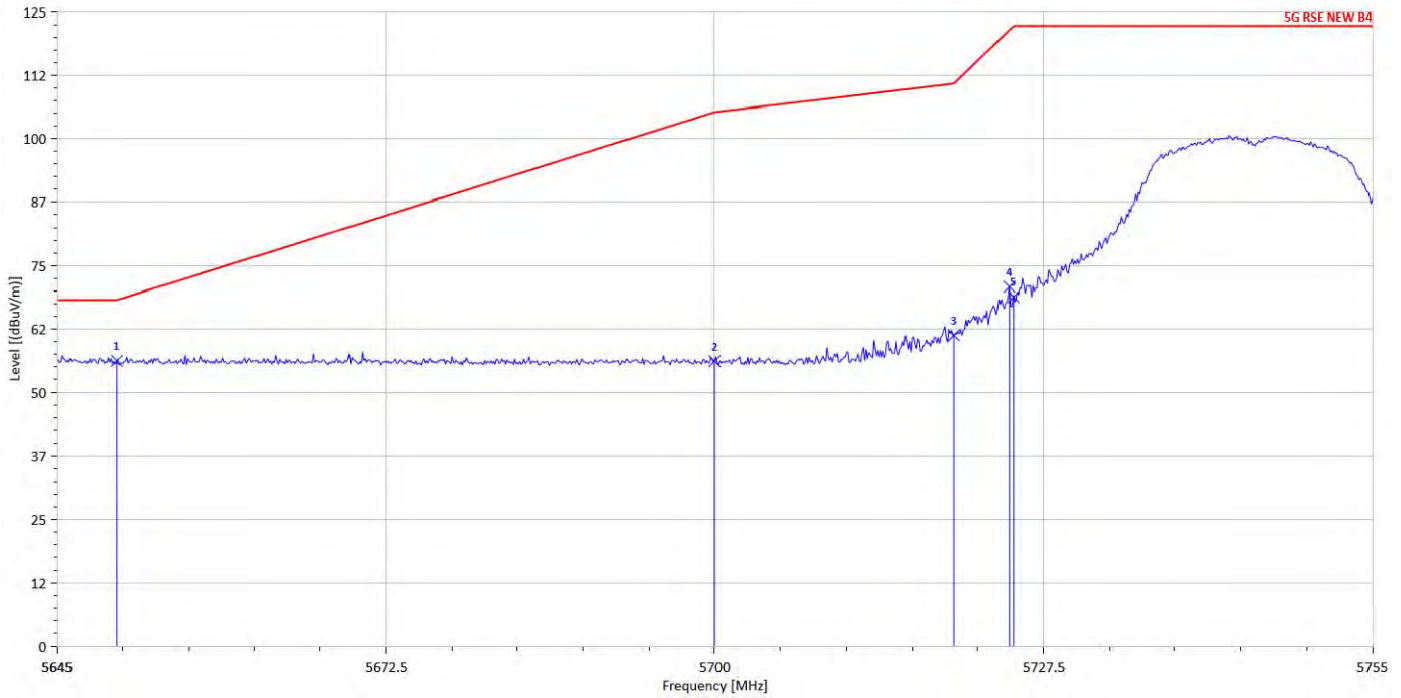

Freq. MHz	Note F/H/E/S	Detector Mode PK/QP/AV	Spectrum Reading Level dB μ V	Factor dB	Actual FS dB μ V/m	Limit @3m dB μ V/m	Margin dB
5650.00	S	Peak	41.34	14.86	56.20	68.23	-12.03
5700.00	S	Peak	41.16	14.97	56.13	105.23	-49.10
5720.00	S	Peak	46.24	15.02	61.26	110.83	-49.57
5724.64	S	Peak	55.80	15.03	70.83	121.4095	-50.58
5725.00	E	Peak	53.79	15.03	68.82	122.23	-53.41

Unless otherwise stated the results shown in this test report refer only to the sample(s) tested and such sample(s) are retained for 90 days only.

除非另有說明，此報告結果僅對測試之樣品負責，同時此樣品僅保留90天。本報告未經本公司書面許可，不可部份複製。

This document is issued by the Company subject to its General Conditions of Service printed overleaf, available on request or accessible at www.sgs.com/terms_and_conditions.htm and, for electronic format documents, subject to Terms and Conditions for Electronic Documents at www.sgs.com/terms_e-document.htm. Attention is drawn to the limitation of liability, indemnification and jurisdiction issues defined therein. Any holder of this document is advised that information contained hereon reflects the Company's findings at the time of its intervention only and within the limits of Client's instructions, if any. The Company's sole responsibility is to its Client and this document does not exonerate parties to a transaction from exercising all their rights and obligations under the transaction documents. This document cannot be reproduced except in full, without prior written approval of the Company. Any unauthorized alteration, forgery or falsification of the content or appearance of this document is unlawful and offenders may be prosecuted to the fullest extent of the law.

SGS Taiwan Ltd.

No.134,WuKungRoad,NewTaipeiIndustrialPark,WukuDistrict,NewTaipeiCity,Taiwan24803/新北市五股區新北產業園區五工路 134 號

台灣檢驗科技股份有限公司

t (886-2) 2299-3279

f (886-2) 2298-0488

www.tw.sgs.com

Member of SGS Group

Operation Mode : 802.11n20 Test Date : 2017/7/14
 Fundamental Frequency : 5745 MHz Temp. / Humi. : 22.7deg_C/57RH
 Operation Band : BE CH Low Test Engineer : Ashton
 EUT Pol. : H Measurement Antenna Pol. : Horizontal

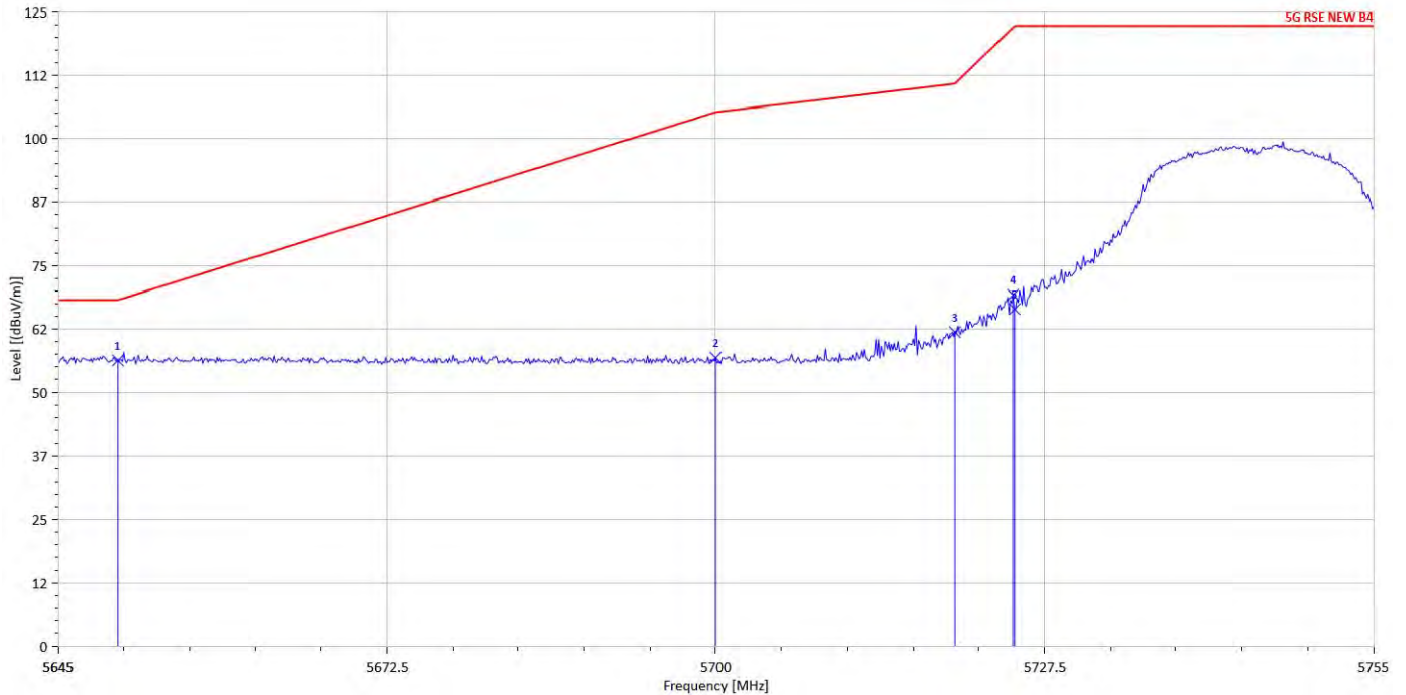

Freq. MHz	Note F/H/E/S	Detector Mode PK/QP/AV	Spectrum Reading Level dB μ V	Factor dB	Actual FS dB μ V/m	Limit @3m dB μ V/m	Margin dB
5650.00	S	Peak	41.42	14.86	56.28	68.23	-11.95
5700.00	S	Peak	41.84	14.97	56.81	105.23	-48.42
5720.00	S	Peak	46.86	15.02	61.88	110.83	-48.95
5724.86	S	Peak	54.18	15.03	69.21	121.9105	-52.70
5725.00	E	Peak	51.39	15.03	66.41	122.23	-55.82

Unless otherwise stated the results shown in this test report refer only to the sample(s) tested and such sample(s) are retained for 90 days only.

除非另有說明，此報告結果僅對測試之樣品負責，同時此樣品僅保留90天。本報告未經本公司書面許可，不可部份複製。

This document is issued by the Company subject to its General Conditions of Service printed overleaf, available on request or accessible at www.sgs.com/terms_and_conditions.htm and, for electronic format documents, subject to Terms and Conditions for Electronic Documents at www.sgs.com/terms_e-document.htm. Attention is drawn to the limitation of liability, indemnification and jurisdiction issues defined therein. Any holder of this document is advised that information contained hereon reflects the Company's findings at the time of its intervention only and within the limits of Client's instructions, if any. The Company's sole responsibility is to its Client and this document does not exonerate parties to a transaction from exercising all their rights and obligations under the transaction documents. This document cannot be reproduced except in full, without prior written approval of the Company. Any unauthorized alteration, forgery or falsification of the content or appearance of this document is unlawful and offenders may be prosecuted to the fullest extent of the law.

SGS Taiwan Ltd.

No.134,WuKungRoad,NewTaipeiIndustrialPark,WukuDistrict,NewTaipeiCity,Taiwan24803/新北市五股區新北產業園區五工路 134 號

台灣檢驗科技股份有限公司

t (886-2) 2299-3279

f (886-2) 2298-0488

www.tw.sgs.com

Member of SGS Group

Operation Mode : 802.11n20 Test Date : 2017/7/14
 Fundamental Frequency : 5825 MHz Temp. / Humi. : 22.7deg_C/57RH
 Operation Band : BE CH High Test Engineer : Ashton
 EUT Pol. : H Measurement Antenna Pol. : Vertical

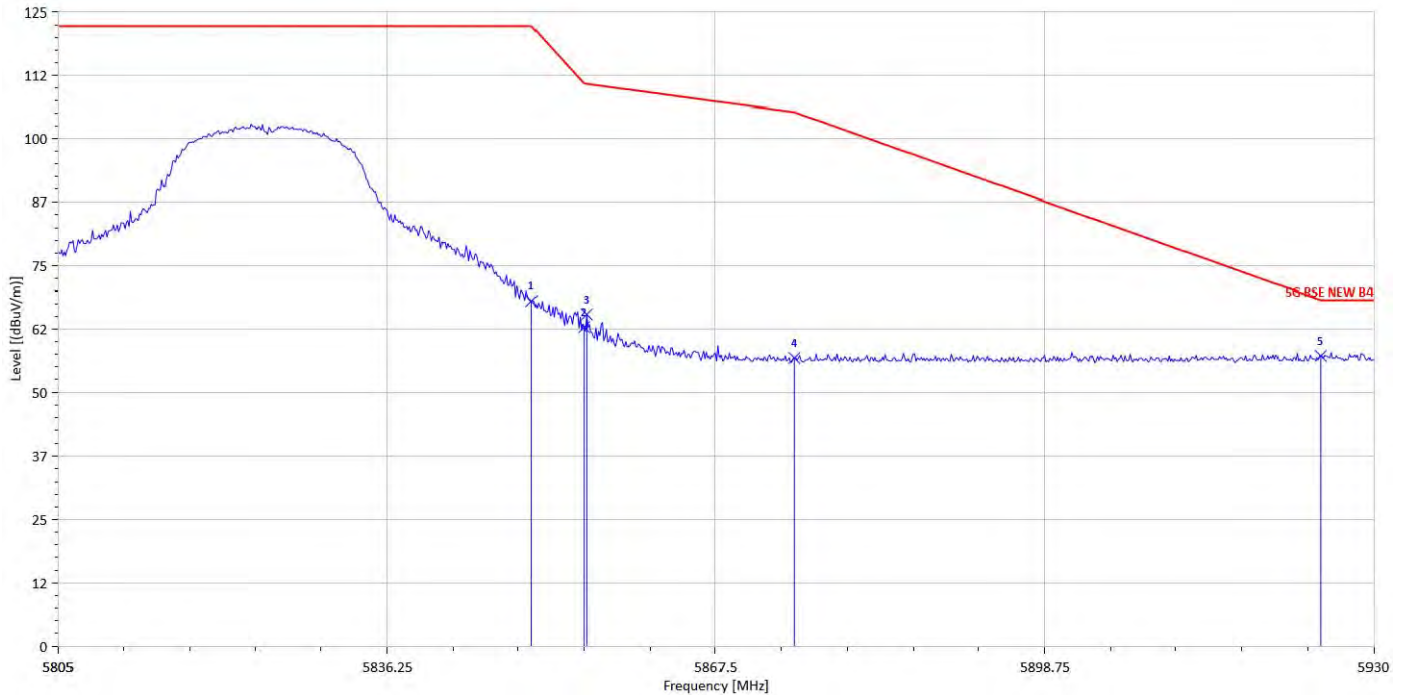

Freq. MHz	Note F/H/E/S	Detector Mode PK/QP/AV	Spectrum Reading Level dBµV	Factor dB	Actual FS dBµV/m	Limit @3m dBµV/m	Margin dB
5850.00	E	Peak	52.73	15.33	68.05	122.23	-54.18
5855.00	S	Peak	47.56	15.34	62.90	110.83	-47.93
5855.25	S	Peak	50.09	15.34	65.42	110.76	-45.34
5875.00	S	Peak	41.37	15.39	56.76	105.23	-48.47
5925.00	S	Peak	41.65	15.52	57.18	68.23	-11.05

Unless otherwise stated the results shown in this test report refer only to the sample(s) tested and such sample(s) are retained for 90 days only.

除非另有說明，此報告結果僅對測試之樣品負責，同時此樣品僅保留90天。本報告未經本公司書面許可，不可部份複製。

This document is issued by the Company subject to its General Conditions of Service printed overleaf, available on request or accessible at www.sgs.com/terms_and_conditions.htm and, for electronic format documents, subject to Terms and Conditions for Electronic Documents at www.sgs.com/terms_e-document.htm. Attention is drawn to the limitation of liability, indemnification and jurisdiction issues defined therein. Any holder of this document is advised that information contained hereon reflects the Company's findings at the time of its intervention only and within the limits of Client's instructions, if any. The Company's sole responsibility is to its Client and this document does not exonerate parties to a transaction from exercising all their rights and obligations under the transaction documents. This document cannot be reproduced except in full, without prior written approval of the Company. Any unauthorized alteration, forgery or falsification of the content or appearance of this document is unlawful and offenders may be prosecuted to the fullest extent of the law.

SGS Taiwan Ltd.

No.134,WuKungRoad,NewTaipeiIndustrialPark,WukuDistrict,NewTaipeiCity,Taiwan24803/新北市五股區新北產業園區五工路 134 號

台灣檢驗科技股份有限公司

t (886-2) 2299-3279

f (886-2) 2298-0488

www.tw.sgs.com

Member of SGS Group

Operation Mode :	802.11n20	Test Date :	2017/7/14
Fundamental Frequency :	5825 MHz	Temp. / Humi. :	22.7deg_C/57RH
Operation Band :	BE CH High	Test Engineer :	Ashton
EUT Pol. :	H	Measurement Antenna Pol. :	Horizontal

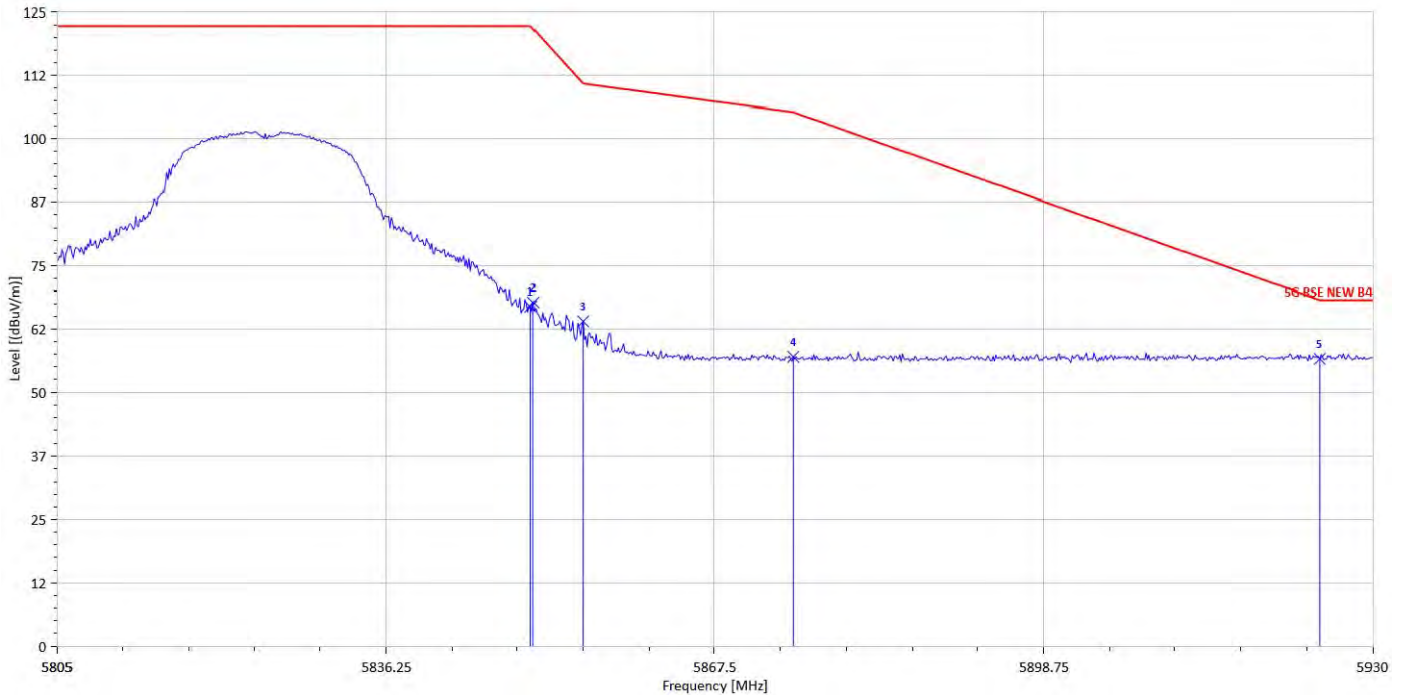

Freq. MHz	Note F/H/E/S	Detector Mode PK/QP/AV	Spectrum Reading Level dBuV	Factor dB	Actual FS dBuV/m	Limit @3m dBuV/m	Margin dB
5850.00	E	Peak	51.62	15.33	66.95	122.23	-55.28
5850.25	S	Peak	52.47	15.33	67.80	121.66	-53.86
5855.00	S	Peak	48.71	15.34	64.04	110.83	-46.79
5875.00	S	Peak	41.62	15.39	57.01	105.23	-48.22
5925.00	S	Peak	41.06	15.52	56.58	68.23	-11.65

Unless otherwise stated the results shown in this test report refer only to the sample(s) tested and such sample(s) are retained for 90 days only.

除非另有說明，此報告結果僅對測試之樣品負責，同時此樣品僅保留90天。本報告未經本公司書面許可，不可部份複製。

This document is issued by the Company subject to its General Conditions of Service printed overleaf, available on request or accessible at www.sgs.com/terms_and_conditions.htm and, for electronic format documents, subject to Terms and Conditions for Electronic Documents at www.sgs.com/terms_e-document.htm. Attention is drawn to the limitation of liability, indemnification and jurisdiction issues defined therein. Any holder of this document is advised that information contained hereon reflects the Company's findings at the time of its intervention only and within the limits of Client's instructions, if any. The Company's sole responsibility is to its Client and this document does not exonerate parties to a transaction from exercising all their rights and obligations under the transaction documents. This document cannot be reproduced except in full, without prior written approval of the Company. Any unauthorized alteration, forgery or falsification of the content or appearance of this document is unlawful and offenders may be prosecuted to the fullest extent of the law.

SGS Taiwan Ltd.

No. 134, WuKungRoad, New Taipei Industrial Park, Wuku District, New Taipei City, Taiwan 24803 / 新北市五股區新北產業園區五工路 134 號

台灣檢驗科技股份有限公司

t (886-2) 2299-3279

f (886-2) 2298-0488

www.tw.sgs.com

Member of SGS Group

12 TRANSMISSION IN THE ABSENCE OF DATA

12.1 Standard Applicable

According to §15.407(c)

The device shall automatically discontinue transmission in case of either absence of information to transmit or operational failure. These provisions are not intended to preclude the transmission of control or signaling information or the use of repetitive codes used by certain digital technologies to complete frame or burst intervals. Applicants shall include in their application for equipment authorization a description of how this requirement is met.

12.2 Result

No non-compliance noted:

While the EUT is not transmitting any information, the EUT can automatically discontinue transmission and become standby mode for power saving. the EUT can detect the controlling signal of ASK message transmitting from remote device and verify whether it shall resend or discontinue transmission.

Unless otherwise stated the results shown in this test report refer only to the sample(s) tested and such sample(s) are retained for 90 days only.

除非另有說明，此報告結果僅對測試之樣品負責，同時此樣品僅保留90天。本報告未經本公司書面許可，不可部份複製。

This document is issued by the Company subject to its General Conditions of Service printed overleaf, available on request or accessible at www.sgs.com/terms_and_conditions.htm and, for electronic format documents, subject to Terms and Conditions for Electronic Documents at www.sgs.com/terms_e-document.htm. Attention is drawn to the limitation of liability, indemnification and jurisdiction issues defined therein. Any holder of this document is advised that information contained hereon reflects the Company's findings at the time of its intervention only and within the limits of Client's instructions, if any. The Company's sole responsibility is to its Client and this document does not exonerate parties to a transaction from exercising all their rights and obligations under the transaction documents. This document cannot be reproduced except in full, without prior written approval of the Company. Any unauthorized alteration, forgery or falsification of the content or appearance of this document is unlawful and offenders may be prosecuted to the fullest extent of the law.

SGS Taiwan Ltd.

No. 134, WuKungRoad, NewTaipeiIndustrialPark, WukuDistrict, New Taipei City, Taiwan 24803/新北市五股區新北產業園區五工路 134 號

台灣檢驗科技股份有限公司

t (886-2) 2299-3279

f (886-2) 2298-0488

www.tw.sgs.com

Member of SGS Group

13 FREQUENCY STABILITY

13.1 Standard Applicable

Manufacturers of U-NII devices are responsible for ensuring frequency stability such that an emission is maintained within the band of operation under all conditions of normal operation as specified in the user's manual.

13.2 Measurement Procedure

1. The EUT was placed inside temperature chamber and powered and powered by nominal DC voltage.
2. Set EUT as normal operation.
3. Turn the EUT on and couple its output to spectrum.
4. Turn the EUT off and set the chamber to the highest temperature specified.
5. Allow sufficient time (approximately 30 min) for the temperature of the chamber to stabilize, turn the EUT and measure the operating frequency.
6. Repeat step with the temperature chamber set to the lowest temperature.

13.3 Test SET-UP

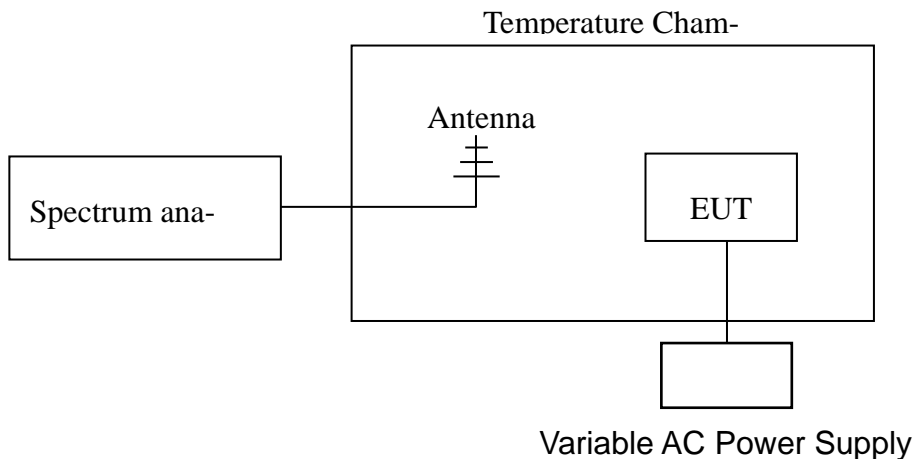

13.4 Measurement Equipment Used

Conducted Emission Test Site					
EQUIPMENT TYPE	MFR	MODEL NUMBER	SERIAL NUMBER	LAST CAL.	CAL DUE.
Spectrum Analyzer	KEYSIGHT	N9010A	MY51440113	06/20/2017	06/19/2018
DC Block	PASTERNAK	PE8210	RF29	12/12/2016	12/11/2017
Coaxial Cable 30cm	WOKEN	00100A1F1A1 95C	RF01	12/12/2016	12/11/2017
Attenuator	WOKEN	218FS-10	RF23	12/12/2016	12/11/2017
DC Power Supply	Agilent	E3640A	MY53140006	05/02/2017	05/01/2018
Temperature Chamber	TERCHY	MHK-120LK	1020582	06/13/2017	06/12/2018

Unless otherwise stated the results shown in this test report refer only to the sample(s) tested and such sample(s) are retained for 90 days only.

除非另有說明，此報告結果僅對測試之樣品負責，同時此樣品僅保留90天。本報告未經本公司書面許可，不可部份複製。

This document is issued by the Company subject to its General Conditions of Service printed overleaf, available on request or accessible at www.sgs.com/terms_and_conditions.htm and, for electronic format documents, subject to Terms and Conditions for Electronic Documents at www.sgs.com/terms_e-document.htm. Attention is drawn to the limitation of liability, indemnification and jurisdiction issues defined therein. Any holder of this document is advised that information contained hereon reflects the Company's findings at the time of its intervention only and within the limits of Client's instructions, if any. The Company's sole responsibility is to its Client and this document does not exonerate parties to a transaction from exercising all their rights and obligations under the transaction documents. This document cannot be reproduced except in full, without prior written approval of the Company. Any unauthorized alteration, forgery or falsification of the content or appearance of this document is unlawful and offenders may be prosecuted to the fullest extent of the law.

SGS Taiwan Ltd.

No. 134, WuKungRoad, NewTaipeiIndustrialPark, WukuDistrict, New TaipeiCity, Taiwan24803/新北市五股區新北產業園區五工路 134 號

台灣檢驗科技股份有限公司

t (886-2) 2299-3279

f (886-2) 2298-0488

www.tw.sgs.com

Member of SGS Group

13.5 Measurement Result

Operation Mode	802.11 a	Test Date	2017.07.18
Temperature	:23 °C	Test By	Enzo
Humidity	:62 %		

Test Temp.	Test Voltage	Channel	Measured Frequency (MHz)	Spectrum Frequency (MHz)	ΔFrequency (MHz)
-40 °C	13.2V	36	5180	5,179.99878	0.00000024
		44	5220	5,219.90899	0.00001743
		48	5240	5,239.92433	0.00001444
		52	5260	5,259.95962	0.00000768
		60	5300	5,299.99024	0.00000184
		64	5320	5,319.92685	0.00001375
		100	5500	5,499.98747	0.00000228
		116	5580	5,579.95922	0.00000731
		140	5700	5,699.93525	0.00001136
		149	5745	5,744.90207	0.00001705
		157	5785	5,784.97530	0.00000427
		165	5825	5,824.97172	0.00000485
	10.8V	36	5180	5,179.90025	0.00001926
		44	5220	5,219.90466	0.00001826
		48	5240	5,239.98531	0.00000280
		52	5260	5,259.94390	0.00001067
		60	5300	5,299.97041	0.00000558
		64	5320	5,319.96637	0.00000632
		100	5500	5,499.94548	0.00000991
		116	5580	5,579.92384	0.00001365
		140	5700	5,699.96500	0.00000614
		149	5745	5,744.98770	0.00000214
		157	5785	5,784.92771	0.00001250
		165	5825	5,824.90413	0.00001646

Unless otherwise stated the results shown in this test report refer only to the sample(s) tested and such sample(s) are retained for 90 days only.

除非另有說明，此報告結果僅對測試之樣品負責，同時此樣品僅保留90天。本報告未經本公司書面許可，不可部份複製。

This document is issued by the Company subject to its General Conditions of Service printed overleaf, available on request or accessible at www.sgs.com/terms_and_conditions.htm and, for electronic format documents, subject to Terms and Conditions for Electronic Documents at www.sgs.com/terms_e-document.htm. Attention is drawn to the limitation of liability, indemnification and jurisdiction issues defined therein. Any holder of this document is advised that information contained hereon reflects the Company's findings at the time of its intervention only and within the limits of Client's instructions, if any. The Company's sole responsibility is to its Client and this document does not exonerate parties to a transaction from exercising all their rights and obligations under the transaction documents. This document cannot be reproduced except in full, without prior written approval of the Company. Any unauthorized alteration, forgery or falsification of the content or appearance of this document is unlawful and offenders may be prosecuted to the fullest extent of the law.

SGS Taiwan Ltd.

No.134,WuKungRoad,NewTaipeiIndustrialPark,WukuDistrict,NewTaipeiCity,Taiwan24803/新北市五股區新北產業園區五工路 134 號

台灣檢驗科技股份有限公司

t (886-2) 2299-3279

f (886-2) 2298-0488

www.tw.sgs.com

Member of SGS Group

25 °C	12V	36	5180	5,179.92355	0.00001476
		44	5220	5,219.95822	0.00000800
		48	5240	5,239.92093	0.00001509
		52	5260	5,259.98346	0.00000314
		60	5300	5,299.92698	0.00001378
		64	5320	5,319.97745	0.00000424
		100	5500	5,499.93471	0.00001187
		116	5580	5,579.99756	0.00000044
		140	5700	5,699.92290	0.00001353
		149	5745	5,744.91574	0.00001467
		157	5785	5,784.95152	0.00000838
		165	5825	5,824.90124	0.00001695

85 °C	13.2V	36	5180	5,179.94050	0.00001149
		44	5220	5,219.95118	0.00000935
		48	5240	5,239.96648	0.00000640
		52	5260	5,259.93553	0.00001226
		60	5300	5,299.94333	0.00001069
		64	5320	5,319.98679	0.00000248
		100	5500	5,499.93563	0.00001170
		116	5580	5,579.97509	0.00000446
		140	5700	5,699.98428	0.00000276
		149	5745	5,744.90439	0.00001664
		157	5785	5,784.93328	0.00001153
		165	5825	5,824.95237	0.00000818
	10.8V	36	5180	5,179.94672	0.00001029
		44	5220	5,219.98704	0.00000248
		48	5240	5,239.99695	0.00000058
		52	5260	5,259.94711	0.00001006
		60	5300	5,299.93966	0.00001138
		64	5320	5,319.99672	0.00000062
		100	5500	5,499.91882	0.00001476
		116	5580	5,579.91739	0.00001480
		140	5700	5,699.97035	0.00000520
		149	5745	5,744.99938	0.00000011
		157	5785	5,784.98774	0.00000212
		165	5825	5,824.91460	0.00001466

Unless otherwise stated the results shown in this test report refer only to the sample(s) tested and such sample(s) are retained for 90 days only.

除非另有說明，此報告結果僅對測試之樣品負責，同時此樣品僅保留90天。本報告未經本公司書面許可，不可部份複製。

This document is issued by the Company subject to its General Conditions of Service printed overleaf, available on request or accessible at www.sgs.com/terms_and_conditions.htm and, for electronic format documents, subject to Terms and Conditions for Electronic Documents at www.sgs.com/terms_e-document.htm. Attention is drawn to the limitation of liability, indemnification and jurisdiction issues defined therein. Any holder of this document is advised that information contained hereon reflects the Company's findings at the time of its intervention only and within the limits of Client's instructions, if any. The Company's sole responsibility is to its Client and this document does not exonerate parties to a transaction from exercising all their rights and obligations under the transaction documents. This document cannot be reproduced except in full, without prior written approval of the Company. Any unauthorized alteration, forgery or falsification of the content or appearance of this document is unlawful and offenders may be prosecuted to the fullest extent of the law.

SGS Taiwan Ltd.

No.134,WuKungRoad,NewTaipeiIndustrialPark,WukuDistrict,NewTaipeiCity,Taiwan24803/新北市五股區新北產業園區五工路 134 號

台灣檢驗科技股份有限公司

t (886-2) 2299-3279

f (886-2) 2298-0488

www.tw.sgs.com

Member of SGS Group

Operation Mode	802.11 n_HT20	Test Date	2017.07.18
Temperature	:23 °C	Test By	Enzo
Humidity	:62 %		

Test Temp.	Test Voltage	Channel	Measured Frequency (MHz)	Spectrum Frequency (MHz)	ΔFrequency (MHz)
-40 °C	13.2V	38	5190	5,189.94820	0.00000998
		46	5230	5,229.91749	0.00001578
		54	5270	5,269.92147	0.00001490
		62	5310	5,309.92063	0.00001495
		102	5510	5,509.95155	0.00000879
		110	5550	5,549.99087	0.00000165
		134	5670	5,669.95315	0.00000826
		151	5755	5,754.94274	0.00000995
		159	5795	5,794.97165	0.00000489
	10.8V	38	5190	5,189.97259	0.00000528
		46	5230	5,229.99652	0.00000067
		54	5270	5,269.99689	0.00000059
		62	5310	5,309.95063	0.00000930
		102	5510	5,509.94135	0.00001064
		110	5550	5,549.91261	0.00001575
		134	5670	5,669.91214	0.00001550
		151	5755	5,754.91226	0.00001525
		159	5795	5,794.97168	0.00000489

Unless otherwise stated the results shown in this test report refer only to the sample(s) tested and such sample(s) are retained for 90 days only.

除非另有說明，此報告結果僅對測試之樣品負責，同時此樣品僅保留90天。本報告未經本公司書面許可，不可部份複製。

This document is issued by the Company subject to its General Conditions of Service printed overleaf, available on request or accessible at www.sgs.com/terms_and_conditions.htm and, for electronic format documents, subject to Terms and Conditions for Electronic Documents at www.sgs.com/terms_e-document.htm. Attention is drawn to the limitation of liability, indemnification and jurisdiction issues defined therein. Any holder of this document is advised that information contained hereon reflects the Company's findings at the time of its intervention only and within the limits of Client's instructions, if any. The Company's sole responsibility is to its Client and this document does not exonerate parties to a transaction from exercising all their rights and obligations under the transaction documents. This document cannot be reproduced except in full, without prior written approval of the Company. Any unauthorized alteration, forgery or falsification of the content or appearance of this document is unlawful and offenders may be prosecuted to the fullest extent of the law.

SGS Taiwan Ltd.

No.134,WuKungRoad,NewTaipeiIndustrialPark,WukuDistrict,NewTaipeiCity,Taiwan24803/新北市五股區新北產業園區五工路 134 號

台灣檢驗科技股份有限公司

t (886-2) 2299-3279

f (886-2) 2298-0488

www.tw.sgs.com

Member of SGS Group

25 °C	12V	38	5190	5,189.91014	0.00001731
		46	5230	5,229.99890	0.00000021
		54	5270	5,269.93055	0.00001318
		62	5310	5,309.99046	0.00000180
		102	5510	5,509.94904	0.00000925
		110	5550	5,549.91077	0.00001608
		134	5670	5,669.97732	0.00000400
		151	5755	5,754.93540	0.00001123
		159	5795	5,794.97821	0.00000376
85 °C	13.2V	38	5190	5,189.90098	0.00001908
		46	5230	5,229.98025	0.00000378
		54	5270	5,269.94063	0.00001127
		62	5310	5,309.94123	0.00001107
		102	5510	5,509.97007	0.00000543
		110	5550	5,549.98681	0.00000238
		134	5670	5,669.96304	0.00000652
		151	5755	5,754.90345	0.00001678
		159	5795	5,794.95881	0.00000711
	10.8V	38	5190	5,189.91085	0.00001718
		46	5230	5,229.94563	0.00001040
		54	5270	5,269.90483	0.00001806
		62	5310	5,309.99847	0.00000029
		102	5510	5,509.99418	0.00000106
		110	5550	5,549.96259	0.00000674
		134	5670	5,669.91543	0.00001492
		151	5755	5,754.93427	0.00001142
		159	5795	5,794.99846	0.00000027

~ End of Report ~

Unless otherwise stated the results shown in this test report refer only to the sample(s) tested and such sample(s) are retained for 90 days only.

除非另有說明，此報告結果僅對測試之樣品負責，同時此樣品僅保留90天。本報告未經本公司書面許可，不可部份複製。

This document is issued by the Company subject to its General Conditions of Service printed overleaf, available on request or accessible at www.sgs.com/terms_and_conditions.htm and, for electronic format documents, subject to Terms and Conditions for Electronic Documents at www.sgs.com/terms_e-document.htm. Attention is drawn to the limitation of liability, indemnification and jurisdiction issues defined therein. Any holder of this document is advised that information contained hereon reflects the Company's findings at the time of its intervention only and within the limits of Client's instructions, if any. The Company's sole responsibility is to its Client and this document does not exonerate parties to a transaction from exercising all their rights and obligations under the transaction documents. This document cannot be reproduced except in full, without prior written approval of the Company. Any unauthorized alteration, forgery or falsification of the content or appearance of this document is unlawful and offenders may be prosecuted to the fullest extent of the law.

SGS Taiwan Ltd.

No.134,WuKungRoad,NewTaipeiIndustrialPark,WukuDistrict,NewTaipeiCity,Taiwan24803/新北市五股區新北產業園區五工路 134 號

台灣檢驗科技股份有限公司

t (886-2) 2299-3279

f (886-2) 2298-0488

www.tw.sgs.com

Member of SGS Group