



FCC Radio Test Report

FCC ID: ACJ-EAH-AZ100R

This report concerns: Original Grant

Project No. : 2408C031
Equipment : Digital Wireless Stereo Earphones
Brand Name : Technics
Test Model : EAH-AZ100
Series Model : N/A
Applicant : Panasonic Corporation of North America
Address : Two Riverfront Plaza, Newark, New Jersey 07102-5490 United States
Manufacturer : Panasonic Entertainment & Communication Co., Ltd.
Address : 1-10-12 Yagumo-higashi-machi, Moriguchi City, Osaka 570-0021, Japan
Factory : Panasonic System Networks Malaysia Sdn. Bhd.
Address : PLO No.1, Kawasan Perindustrian Senai, K B No. 104, 81400 Senai, Johor Darul Takzim. Malaysia
Date of Receipt : Aug. 16, 2024
Date of Test : Aug. 19, 2024 ~ Sep. 19, 2024
Issued Date : Oct. 12, 2024
Report Version : R00
Test Sample : Engineering Sample No.: DG2024081627
Standard(s) : FCC CFR Title 47, Part 15, Subpart C

The above equipment has been tested and found compliance with the requirement of the relative standards by BTL Inc.

Prepared by : Evan Yang
Evan Yang

Approved by : Chay. Cai
Chay Cai

Room 108, Building 2, No.1, Yile Road, Songshan Lake Zone, Dongguan City, Guangdong, People's Republic of China.

Tel: +86-769-8318-3000 Web: www.newbtl.com Service mail: btl_qa@newbtl.com

Declaration

BTL represents to the client that testing is done in accordance with standard procedures as applicable and that test instruments used has been calibrated with standards traceable to international standard(s) and/or national standard(s).

BTL's reports apply only to the specific samples tested under conditions. It is manufacture's responsibility to ensure that additional production units of this model are manufactured with the identical electrical and mechanical components. **BTL** assumes no responsibility for the data provided by the customer, any statements, inferences or generalizations drawn by the customer or others from the reports issued by **BTL**. The report must not be used by the client to claim product certification, approval, or endorsement by A2LA or any agency of the U.S. Government.

This report is the confidential property of the client. As a mutual protection to the clients, the public and ourselves, the test report shall not be reproduced, except in full, without our written approval.

BTL's laboratory quality assurance procedures are in compliance with the ISO/IEC 17025: 2017 requirements, and accredited by the conformity assessment authorities listed in this test report.

BTL is not responsible for the sampling stage, so the results only apply to the sample as received.

The information, data and test plan are provided by manufacturer which may affect the validity of results, so it is manufacturer's responsibility to ensure that the apparatus meets the essential requirements of applied standards and in all the possible configurations as representative of its intended use.

Limitation

For the use of the authority's logo is limited unless the Test Standard(s)/Scope(s)/Item(s) mentioned in this test report is (are) included in the conformity assessment authorities acceptance respective.

Please note that the measurement uncertainty is provided for informational purpose only and are not use in determining the Pass/Fail results.

Table of Contents	Page
REPORT ISSUED HISTORY	6
1 . APPLICABLE STANDARDS	7
2 . SUMMARY OF TEST RESULTS	7
2.1 TEST FACILITY	8
2.2 MEASUREMENT UNCERTAINTY	8
2.3 TEST ENVIRONMENT CONDITIONS	9
3 . GENERAL INFORMATION	10
3.1 GENERAL DESCRIPTION OF EUT	10
3.2 DESCRIPTION OF TEST MODES	12
3.3 PARAMETERS OF TEST SOFTWARE	13
3.4 BLOCK DIAGRAM SHOWING THE CONFIGURATION OF SYSTEM TESTED	14
3.5 SUPPORT UNITS	15
3.6 CUSTOMER INFORMATION DESCRIPTION	15
4 . AC POWER LINE CONDUCTED EMISSIONS	16
4.1 LIMIT	16
4.2 TEST PROCEDURE	16
4.3 DEVIATION FROM TEST STANDARD	16
4.4 TEST SETUP	17
4.5 EUT OPERATING CONDITIONS	17
4.6 TEST RESULTS	17
5 . RADIATED EMISSIONS	18
5.1 LIMIT	18
5.2 TEST PROCEDURE	19
5.3 DEVIATION FROM TEST STANDARD	20
5.4 TEST SETUP	20
5.5 EUT OPERATING CONDITIONS	22
5.6 TEST RESULTS - 9 KHZ TO 30 MHZ	22
5.7 TEST RESULTS - 30 MHZ TO 1000 MHZ	22
5.8 TEST RESULTS - ABOVE 1000 MHZ	22
6 . NUMBER OF HOPPING FREQUENCY	23
6.1 LIMIT	23
6.2 TEST PROCEDURE	23

Table of Contents	Page
6.3 DEVIATION FROM STANDARD	23
6.4 TEST SETUP	23
6.5 EUT OPERATION CONDITIONS	23
6.6 TEST RESULTS	23
7 . AVERAGE TIME OF OCCUPANCY	24
7.1 LIMIT	24
7.2 TEST PROCEDURE	24
7.3 DEVIATION FROM STANDARD	24
7.4 TEST SETUP	24
7.5 EUT OPERATION CONDITIONS	24
7.6 TEST RESULTS	24
8 . HOPPING CHANNEL SEPARATION	25
8.1 LIMIT	25
8.2 TEST PROCEDURE	25
8.3 DEVIATION FROM STANDARD	25
8.4 TEST SETUP	25
8.5 EUT OPERATION CONDITIONS	25
8.6 TEST RESULTS	25
9 . BANDWIDTH	26
9.1 LIMIT	26
9.2 TEST PROCEDURE	26
9.3 DEVIATION FROM STANDARD	26
9.4 TEST SETUP	26
9.5 EUT OPERATION CONDITIONS	26
9.6 TEST RESULTS	26
10 . MAXIMUM OUTPUT POWER	27
10.1 LIMIT	27
10.2 TEST PROCEDURE	27
10.3 DEVIATION FROM STANDARD	27
10.4 TEST SETUP	27
10.5 EUT OPERATION CONDITIONS	27
10.6 TEST RESULTS	27
11 . CONDUCTED SPURIOUS EMISSION	28
11.1 LIMIT	28

Table of Contents	Page
11.2 TEST PROCEDURE	28
11.3 DEVIATION FROM STANDARD	28
11.4 TEST SETUP	28
11.5 EUT OPERATION CONDITIONS	28
11.6 TEST RESULTS	28
12 . MEASUREMENT INSTRUMENTS LIST	29
13 . EUT TEST PHOTO	31
APPENDIX A - AC POWER LINE CONDUCTED EMISSIONS	38
APPENDIX B - RADIATED EMISSION - 9 KHZ TO 30 MHZ	41
APPENDIX C - RADIATED EMISSION - 30 MHZ TO 1000 MHZ	46
APPENDIX D - RADIATED EMISSION - ABOVE 1000 MHZ	49
APPENDIX E - NUMBER OF HOPPING FREQUENCY	64
APPENDIX F - AVERAGE TIME OF OCCUPANCY	66
APPENDIX G - HOPPING CHANNEL SEPARATION	71
APPENDIX H - BANDWIDTH	73
APPENDIX I - MAXIMUM OUTPUT POWER	75
APPENDIX J - CONDUCTED SPURIOUS EMISSION	78
APPENDIX K - DECLARATION FOR BLUETOOTH DEVICE	83

REPORT ISSUED HISTORY

Report No.	Version	Description	Issued Date	Note
BTL-FCCP-2-2408C031	R00	Original Report.	Oct. 12, 2024	Valid

1. APPLICABLE STANDARDS

According to the specifications of the manufacturer, the EUT must comply with the requirements of the following standards:

ANSI C63.10-2013

The following reference test guidance is not within the scope of accreditation of A2LA:

KDB 558074 D01 15.247 Meas Guidance v05r02

2. SUMMARY OF TEST RESULTS

Test procedures according to the technical standard(s):

FCC CFR Title 47, Part 15, Subpart C				
Standard(s) Section	Test Item	Test Result	Judgment	Remark
15.207	AC Power Line Conducted Emissions	APPENDIX A	PASS	-----
15.247(d) 15.205(a) 15.209(a)	Radiated Emission	APPENDIX B APPENDIX C APPENDIX D	PASS	-----
15.247 (a)(1)(iii)	Number of Hopping Frequency	APPENDIX E	PASS	-----
15.247 (a)(1)(iii)	Average Time of Occupancy	APPENDIX F	PASS	-----
15.247(a)(1)	Hopping Channel Separation	APPENDIX G	PASS	-----
15.247(a)(1)	Bandwidth	APPENDIX H	PASS	-----
15.247(a)(1)	Maximum Output Power	APPENDIX I	PASS	-----
15.247(d)	Conducted Spurious Emission	APPENDIX J	PASS	-----
15.203	Antenna Requirement	-----	PASS	Note(2)

Note:

(1) "N/A" denotes test is not applicable in this test report

(2) The device what use a permanently attached antenna were considered sufficient to comply with the provisions of 15.203.

2.1 TEST FACILITY

The test facilities used to collect the test data in this report is at the location of No.3, Jinshagang 1st Road, Dalang, Dongguan City, Guangdong People's Republic of China.

BTL's Registration Number for FCC: 747969

BTL's Designation Number for FCC: CN1377

2.2 MEASUREMENT UNCERTAINTY

ISO/IEC 17025 requires that an estimate of the measurement uncertainties associated with the emissions test results be included in the report. The measurement uncertainties given below are based on a 95.45% confidence level (based on a coverage factor (k=2))

The BTL measurement uncertainty as below table:

A. AC power line conducted emissions test:

Test Site	Method	Measurement Frequency Range	U,(dB)
DG-C02	CISPR	150kHz ~ 30MHz	2.88

B. Radiated emissions test:

Test Site	Method	Measurement Frequency Range	U,(dB)
DG-CB01	CISPR	9kHz ~ 30MHz	2.36

Test Site	Method	Measurement Frequency Range	Ant. H / V	U,(dB)
DG-CB03 (3m)	CISPR	30MHz ~ 200MHz	V	4.40
		30MHz ~ 200MHz	H	3.62
		200MHz ~ 1,000MHz	V	4.58
		200MHz ~ 1,000MHz	H	3.98

Test Site	Method	Measurement Frequency Range	U,(dB)
DG-CB03 (3m)	CISPR	1GHz ~ 6GHz	4.08
		6GHz ~ 18GHz	4.62

Test Site	Method	Measurement Frequency Range	U,(dB)
DG-CB03 (1m)	CISPR	18 ~ 26.5 GHz	3.36

C. Other Measurement:

Test Item	Uncertainty
Conducted Spurious Emission	1.9 dB
Maximum Output Power	1.3 dB
Bandwidth	0.90 %
Temperature	0.8 °C
Humidity	2.2 %

Note: Unless specifically mentioned, the uncertainty of measurement has not been taken into account to declare the compliance or non-compliance to the specification.

2.3 TEST ENVIRONMENT CONDITIONS

Test Item	Temperature	Humidity	Test Voltage	Tested By	Test Date
AC Power Line Conducted Emissions	25°C	50%	AC 120V/60Hz	Hayden Chen	Aug. 21, 2024
Radiated Emissions-9 kHz to 30 MHz	25°C	46%	DC 5V	Hayden Chen	Aug. 22, 2024
Radiated Emissions-30 MHz to 1000 MHz	24°C	53%	DC 5V	Chen Mo	Aug. 21, 2024
Radiated Emissions-Above 1000 MHz	24°C	53%	DC 5V	Chen Mo	Aug. 20, 2024
	24°C	54%	DC 5V	Calvin Wen	Sep. 04, 2024
Number of Hopping Frequency	22-24°C	53-54%	DC 5V	Jaylan Li	Aug. 22, 2024- Sep. 19, 2024
Average Time of Occupancy	22-24°C	53-54%	DC 5V	Jaylan Li	Aug. 22, 2024- Sep. 19, 2024
Hopping Channel Separation	22-24°C	53-54%	DC 5V	Jaylan Li	Aug. 22, 2024- Sep. 19, 2024
Bandwidth	22-24°C	53-54%	DC 5V	Jaylan Li	Aug. 22, 2024- Sep. 19, 2024
Maximum Output Power	22-24°C	53-54%	DC 5V	Jaylan Li	Aug. 22, 2024- Sep. 19, 2024
Conducted Spurious Emission	22-24°C	53-54%	DC 5V	Jaylan Li	Aug. 22, 2024- Sep. 19, 2024

3. GENERAL INFORMATION

3.1 GENERAL DESCRIPTION OF EUT

Equipment	Digital Wireless Stereo Earphones
Brand Name	Technics
Test Model	EAH-AZ100
Series Model	N/A
Model Difference(s)	N/A
Hardware Version	Engineering Prototype
Software Version	SW0.098[JNZ1ZA]
Earphone	Right Earphone
Power Source	<p>For Earphones: 1# Supplied from charging case. 2# Supplied from battery. Model: 1454</p> <p>For Charging Case: 1# Supplied from USB port. 2# Supplied from battery. Model: 941832 3# Supplied from wireless charging base</p>
Power Rating	<p>For Earphones: 1# 5V$\overline{=}$0.09A x 2 2# DC 3.7V 85mAh 0.32Wh</p> <p>For Charging Case: 1# 5V$\overline{=}$2.5W 2# DC 3.7V 550mAh 2.035Wh 3# DC 5V</p>
Operation Frequency	2402 MHz ~ 2480 MHz
Modulation Type	GFSK, $\pi/4$ -DQPSK, 8-DPSK
Bit Rate of Transmitter	1Mbps, 2Mbps, 3Mbps
Max. Output Power	3Mbps: 8.85 dBm (0.0077 W)

Note:

1. For a more detailed features description, please refer to the manufacturer's specifications or the user's manual.

2. Channel List:

Channel	Frequency (MHz)	Channel	Frequency (MHz)	Channel	Frequency (MHz)
00	2402	27	2429	54	2456
01	2403	28	2430	55	2457
02	2404	29	2431	56	2458
03	2405	30	2432	57	2459
04	2406	31	2433	58	2460
05	2407	32	2434	59	2461
06	2408	33	2435	60	2462
07	2409	34	2436	61	2463
08	2410	35	2437	62	2464
09	2411	36	2438	63	2465
10	2412	37	2439	64	2466
11	2413	38	2440	65	2467
12	2414	39	2441	66	2468
13	2415	40	2442	67	2469
14	2416	41	2443	68	2470
15	2417	42	2444	69	2471
16	2418	43	2445	70	2472
17	2419	44	2446	71	2473
18	2420	45	2447	72	2474
19	2421	46	2448	73	2475
20	2422	47	2449	74	2476
21	2423	48	2450	75	2477
22	2424	49	2451	76	2478
23	2425	50	2452	77	2479
24	2426	51	2453	78	2480
25	2427	52	2454		
26	2428	53	2455		

3. Table for Filed Antenna:

Ant.	Brand	Model Name	Antenna Type	Connector	Gain (dBi)
1	N/A	N/A	FPC	N/A	-2

3.2 DESCRIPTION OF TEST MODES

The test system was pre-tested based on the consideration of all possible combinations of EUT operation mode.

Pretest Mode	Description
Mode 1	TX Mode_1Mbps Channel 00/39/78
Mode 2	TX Mode_2Mbps Channel 00/39/78
Mode 3	TX Mode_3Mbps Channel 00/39/78
Mode 4	TX Mode_3Mbps Channel 00

Following mode(s) was (were) found to be the worst case(s) and selected for the final test.

AC power line conducted emissions test	
Final Test Mode	Description
Mode 4	TX Mode_3Mbps Channel 00

Radiated emissions test - Below 1GHz	
Final Test Mode	Description
Mode 4	TX Mode_3Mbps Channel 00

Radiated emissions test - Above 1GHz	
Final Test Mode	Description
Mode 1	TX Mode_1Mbps Channel 00/39/78
Mode 3	TX Mode_3Mbps Channel 00/39/78

Maximum Output Power	
Final Test Mode	Description
Mode 1	TX Mode_1Mbps Channel 00/39/78
Mode 2	TX Mode_2Mbps Channel 00/39/78
Mode 3	TX Mode_3Mbps Channel 00/39/78

Other Conducted test	
Final Test Mode	Description
Mode 1	TX Mode_1Mbps Channel 00/39/78
Mode 3	TX Mode_3Mbps Channel 00/39/78

Note:

- (1) The measurements for Output Power were tested with DH1/3/5 during 1Mbps, 2Mbps and 3Mbps, the worst case were 1Mbps (DH5) and 3Mbps (3DH5), only worst case were documented for other test items except Average Time of Occupancy.
- (2) For radiated emission above 1 GHz test, the spurious points of 1GHz~26.5GHz have been pre-tested and in this report only recorded the worst case. The remaining spurious points are all below the limit value of 20dB.
- (3) This product has the mode of BT AFH, which was considered during testing. 800/20/X(X = 2 of DH1, X = 4 of DH3 or X = 6 of DH5) with 20, 10 or 6.67 hops per second in a channel, and then multiply 0.4*20 (20 # of hopping). But this mode is not the worst case mode as duration of the packet is same, and this report only shows the worst case mode.
- (4) For AC power line conducted emissions and radiated spurious emissions below 1 GHz test, the 3Mbps Channel 00 is found to be the worst case and recorded.
- (5) For radiated emission above 1GHz test, both Vertical and Horizontal are evaluated, only the worst case is recorded.
- (6) For radiated emission Harmonic 18-26.5GHz test, only tested the worst case and recorded.

3.3 PARAMETERS OF TEST SOFTWARE

During testing, channel & power controlling software provided by the customer was used to control the operating channel as well as the output power level.

Test Software Version	AB158x_Airoha_Tool_Kit(ATK)_v3.10.0.6		
Frequency (MHz)	2402	2441	2480
1Mbps	47	47	48
2Mbps	47	47	48
3Mbps	47	47	48

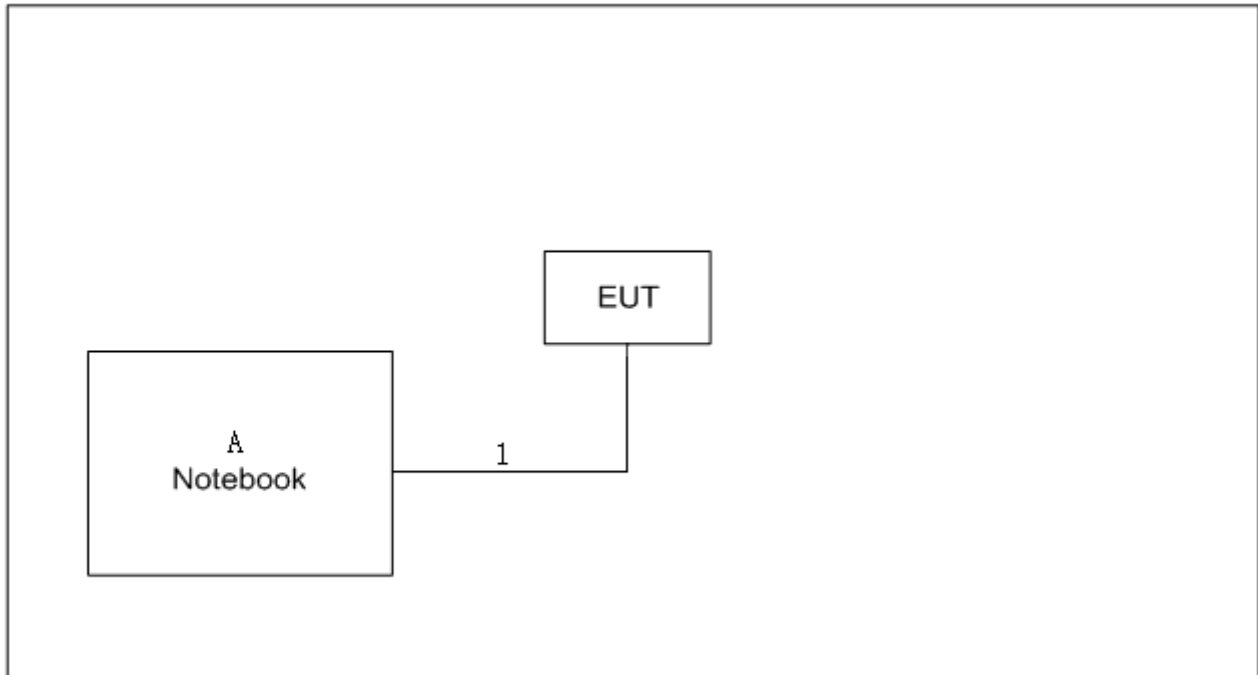
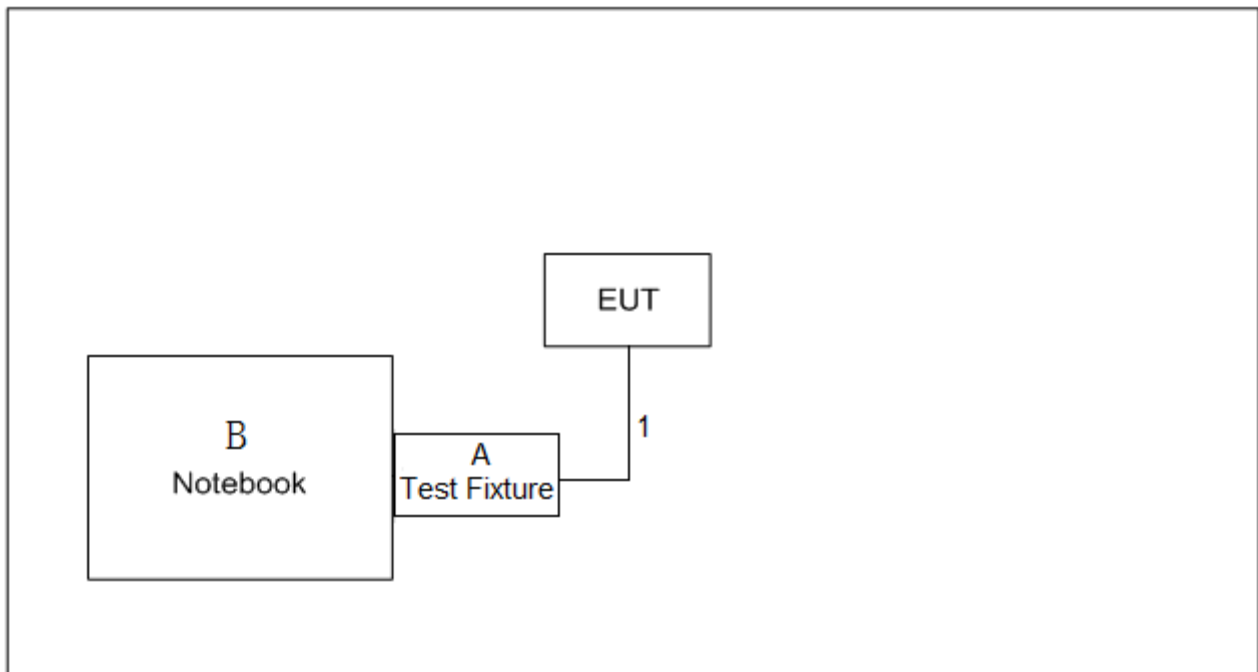
3.4 BLOCK DIAGRAM SHOWING THE CONFIGURATION OF SYSTEM TESTED**AC power line conducted emissions & Radiated Emissions - 9 kHz to 30 MHz****Radiated Emissions - Above 30 MHz**

3.5 SUPPORT UNITS

AC power line conducted emissions & Radiated Emissions - 9 kHz to 30 MHz

Item	Equipment	Brand	Model No.	Series No.	Note
A	Notebook	Lenovo	Pro 13	N/A	AC power line conducted emissions
		Apple	A1990	N/A	Radiated Emissions – 9 kHz to 30 MHz

Item	Cable Type	Shielded Type	Ferrite Core	Length
1	USB Cable	NO	NO	0.2m

Radiated Emissions - Above 30 MHz

Item	Equipment	Brand	Model No.	Series No.	Note
A	Test Fixture	N/A	N/A	N/A	-
B	Notebook	HUAWEI	WFH9	N/A	Radiated Emissions – Below 18GHz
		HONOR	NBLK-WAX9X	N/A	Radiated Emissions – Above 18GHz

Item	Cable Type	Shielded Type	Ferrite Core	Length
1	Data Cable	NO	NO	0.2m

3.6 CUSTOMER INFORMATION DESCRIPTION

- 1) The antenna gain is provided by the manufacturer.
- 2) Except for AC power line conducted emissions and radiated emissions, the results of all test items include cable losses. Part of the cable losses (0.5dB) are provided by the manufacturer, while the other parts of the cable losses are provided by the testing laboratory.

4. AC POWER LINE CONDUCTED EMISSIONS

4.1 LIMIT

Frequency of Emission (MHz)	Limit (dB μ V)	
	Quasi-peak	Average
0.15 - 0.5	66 to 56*	56 to 46*
0.5 - 5.0	56	46
5.0 - 30.0	60	50

Note:

- (1) The tighter limit applies at the band edges.
- (2) The limit of " * " marked band means the limitation decreases linearly with the logarithm of the frequency in the range.

4.2 TEST PROCEDURE

- a. The EUT was placed 0.8 meters from the horizontal ground plane with EUT being connected to the power mains through a line impedance stabilization network (LISN). All other support equipment powered from additional LISN(s). The LISN provide 50 Ohm/ 50uH of coupling impedance for the measuring instrument.
- b. Interconnecting cables that hang closer than 40 cm to the ground plane shall be folded back and forth in the center forming a bundle 30 to 40 cm long.
- c. I/O cables that are not connected to a peripheral shall be bundled in the center. The end of the cable may be terminated, if required, using the correct terminating impedance. The overall length shall not exceed 1 m.
- d. LISN at least 80 cm from nearest part of EUT chassis.
- e. For the actual test configuration, please refer to the related Item –EUT Test Photos.

The following table is the setting of the receiver:

Receiver Parameters	Setting
Start Frequency	0.15 MHz
Stop Frequency	30 MHz
IF Bandwidth	9 kHz

4.3 DEVIATION FROM TEST STANDARD

No deviation.

4.4 TEST SETUP

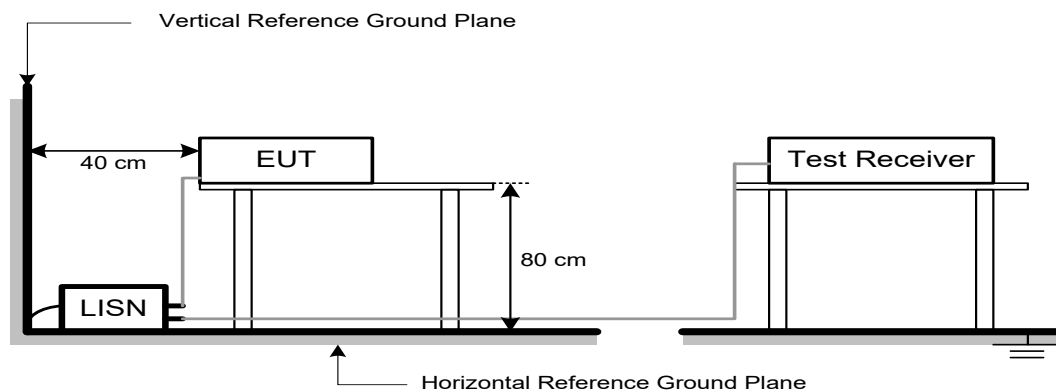

4.5 EUT OPERATING CONDITIONS

The EUT was configured for testing in a typical function (as a customer would normally use it), EUT was programmed to be in continuously transmitting data or hopping on mode.

4.6 TEST RESULTS

Please refer to the APPENDIX A.

Remark:

- (1) All readings are QP Mode value unless otherwise stated AVG in column of [Note] . If the QP Mode Measured value compliance with the QP Limits and lower than AVG Limits, the EUT shall be deemed to meet both QP & AVG Limits and then only QP Mode was measured, but AVG Mode didn't perform in this case, a "*" marked in AVG Mode column of Interference Voltage Measured.
- (2) Measuring frequency range from 150 kHz to 30 MHz.

5. RADIATED EMISSIONS

5.1 LIMIT

In case the emission fall within the restricted band specified on 15.205(a), then the 15.209(a) limit in the table below has to be followed.

LIMITS OF RADIATED EMISSION MEASUREMENT (9 kHz-1000 MHz)

Frequency (MHz)	Field Strength (microvolts/meter)	Measurement Distance (meters)
0.009-0.490	2400/F(kHz)	300
0.490-1.705	24000/F(kHz)	30
1.705-30.0	30	30
30-88	100	3
88-216	150	3
216-960	200	3
Above 960	500	3

LIMITS OF RADIATED EMISSION MEASUREMENT (Above 1000 MHz)

Frequency (MHz)	Band edge/ Harmonic at 3m (dB μ V/m)		Harmonic at 1m (dB μ V/m)	
	Peak	Average	Peak	Average
Above 1000	74	54	83.5 (Note 4)	63.5 (Note 4)

Note:

- (1) The limit for radiated test was performed according to FCC CFR Title 47, Part 15, Subpart C.
- (2) The tighter limit applies at the band edges.
- (3) Emission level (dBuV/m)=20log Emission level (uV/m).
- (4)

$$FS_{\text{limit}} = FS_{\text{max}} - 20 \log \left(\frac{d_{\text{limit}}}{d_{\text{measure}}} \right)$$

$20 \log (d_{\text{limit}}/d_{\text{measure}}) = 20 \log (3/1) = 9.5 \text{ dB}$.

FS_{limit} : Harmonic at 3m Peak and Average limit.

FS_{max} : Harmonic at 1m Peak and Average Maximum value.

d_{limit} : Harmonic at 3m test distance.

d_{measure} : Harmonic Actual test distance.

5.2 TEST PROCEDURE

- a. The measuring distance of 3 m shall be used for measurements. The EUT was placed on the top of a rotating table 0.8 meter above the ground at a 3 meter semi-anechoic chamber. The table was rotated 360 degrees to determine the position of the highest radiation.(below 1 GHz)
- b. The measuring distance of 3 m or 1m shall be used for measurements. The EUT was placed on the top of a rotating table 1.5 meter above the ground at a 3 meter semi-anechoic chamber. The table was rotated 360 degrees to determine the position of the highest radiation.(above 1GHz)
- c. The height of the equipment or of the substitution antenna shall be 0.8m or 1.5m; the height of the test antenna shall vary between 1 m to 4 m. Both horizontal and vertical polarizations of the antenna are set to make the measurement.
- d. For each suspected emission, the EUT was arranged to its worst case and then the antenna was tuned to heights find the maximum reading (used Bore sight function).
- e. The receiver system was set to peak and average detect function and specified bandwidth with maximum hold mode when the test frequency is above 1 GHz.
- f. The initial step in collecting radiated emission data is a receiver peak detector mode pre-scanning the measurement frequency range. Significant peaks are then marked and then Quasi Peak detector mode re-measured.
- g. All readings are Peak unless otherwise stated QP in column of Note. Peak denotes that the Peak reading compliance with the QP Limits and then QP Mode measurement didn't perform.
(below 1 GHz)
- h. All readings are Peak Mode value unless otherwise stated AVG in column of Note. If the Peak Mode Measured value compliance with the Peak Limits and lower than AVG Limits, the EUT shall be deemed to meet both Peak & AVG Limits and then only Peak Mode was measured, but AVG Mode didn't perform. (above 1 GHz)
- i. For the actual test configuration, please refer to the related Item –EUT Test Photos.

The following table is the setting of the receiver:

Spectrum Parameters	Setting
Start ~ Stop Frequency	9 kHz~150 kHz for RBW 200 Hz
Start ~ Stop Frequency	0.15 MHz~30 MHz for RBW 9 kHz
Start ~ Stop Frequency	30 MHz~1000 MHz for RBW 100 kHz

Spectrum Parameters	Setting
Start Frequency	1000 MHz
Stop Frequency	10th carrier harmonic
RBW / VBW (Emission in restricted band)	1 MHz / 3 MHz for PK value 1 MHz / 1/T Hz for AVG value

Spectrum Parameters	Setting
Start ~ Stop Frequency	9 kHz~90 kHz for PK/AVG detector
Start ~ Stop Frequency	90 kHz~110 kHz for QP detector
Start ~ Stop Frequency	110 kHz~490 kHz for PK/AVG detector
Start ~ Stop Frequency	490 kHz~30 MHz for QP detector
Start ~ Stop Frequency	30 MHz~1000 MHz for QP detector
Start ~ Stop Frequency	1 GHz~26.5 GHz for PK/AVG detector

5.3 DEVIATION FROM TEST STANDARD

No deviation.

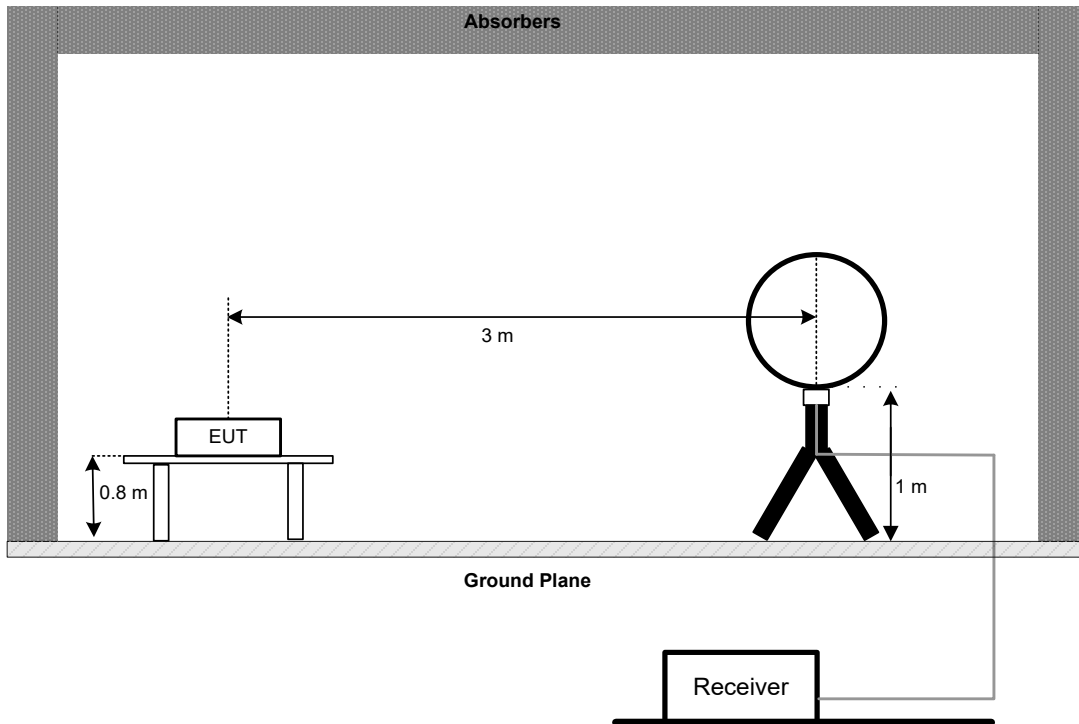
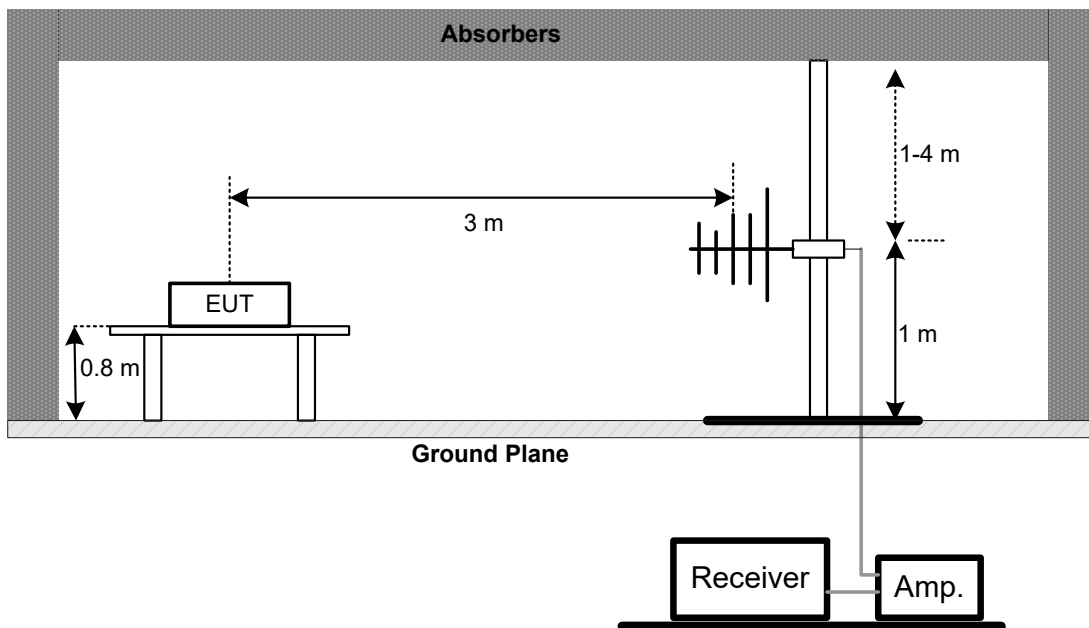
5.4 TEST SETUP**9 kHz to 30 MHz****30 MHz to 1 GHz**

**Above 1 GHz
Band edge & Harmonic (1 GHz to 18 GHz)**

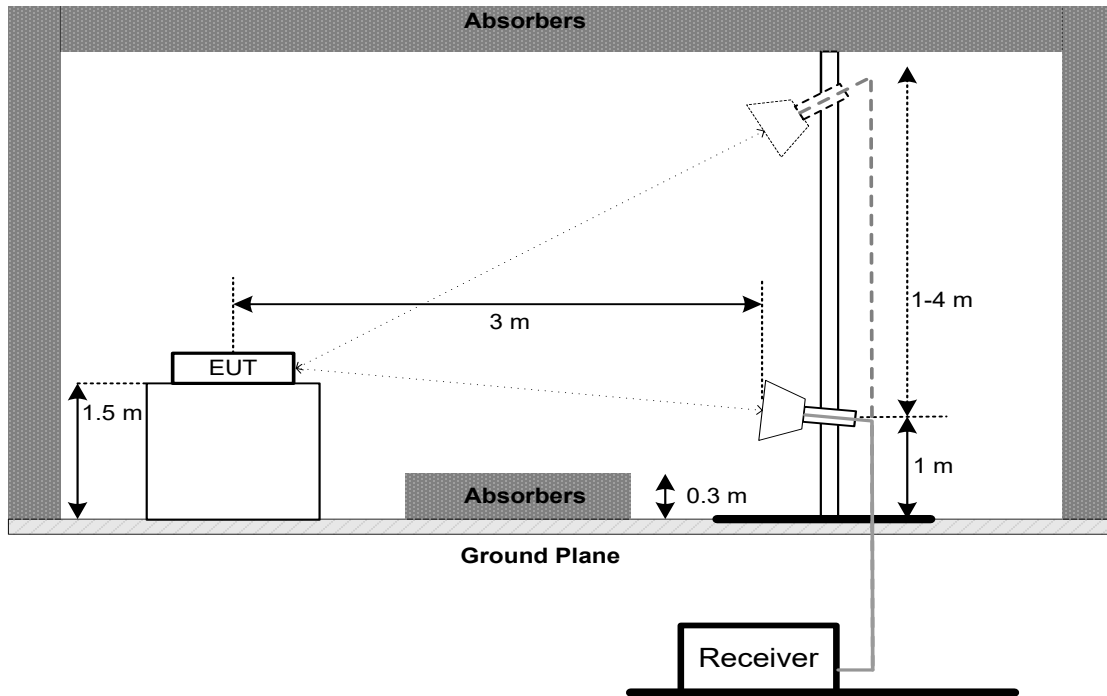

Harmonic (18 GHz to 26.5 GHz)

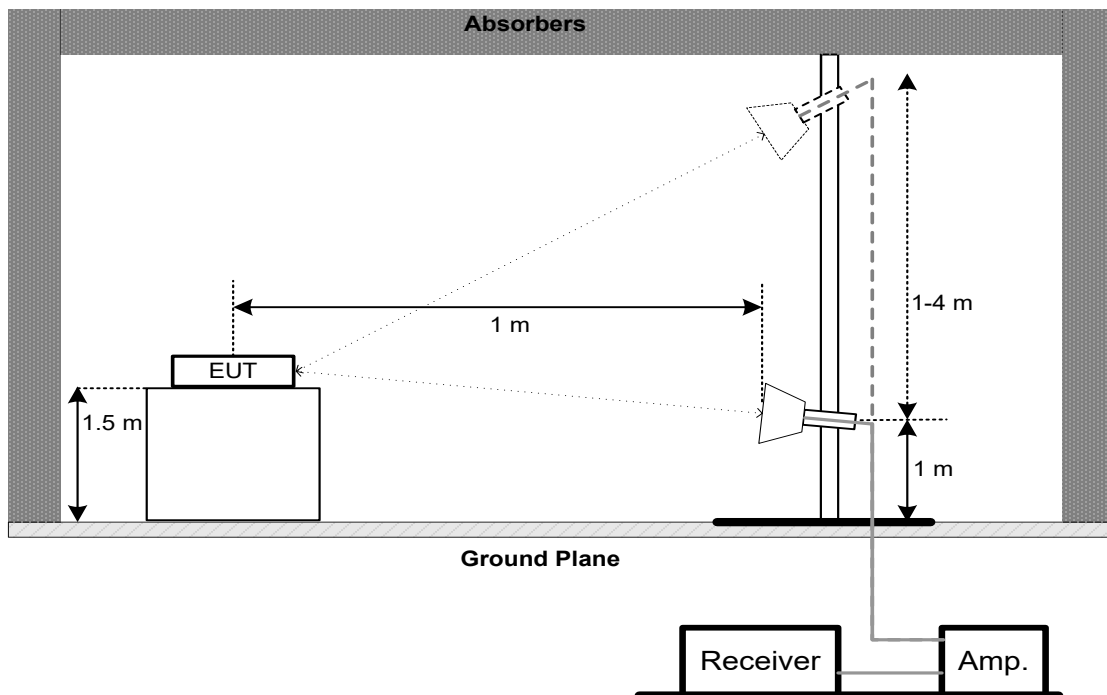

5.5 EUT OPERATING CONDITIONS

The EUT was programmed to be in continuously transmitting mode.

5.6 TEST RESULTS - 9 kHz TO 30 MHz

Please refer to the APPENDIX B.

Remark:

- (1) Distance extrapolation factor = $40 \log (\text{specific distance} / \text{test distance})$ (dB).
- (2) Limit line = specific limits (dBuV) + distance extrapolation factor.

5.7 TEST RESULTS - 30 MHz TO 1000 MHz

Please refer to the APPENDIX C.

5.8 TEST RESULTS - ABOVE 1000 MHz

Please refer to the APPENDIX D.

Remark:

- (1) No limit: This is fundamental signal, the judgment is not applicable.
For fundamental signal judgment was referred to Peak output test.

6. NUMBER OF HOPPING FREQUENCY

6.1 LIMIT

Section	Test Item	Limit
FCC 15.247(a)(1)(iii)	Number of Hopping Frequency	15

6.2 TEST PROCEDURE

- The EUT was directly connected to the spectrum analyzer and antenna output port as show in the block diagram below.
- The following table is the setting of the spectrum analyzer:

Spectrum Parameters	Setting
Span Frequency	> Operating Frequency Range
RBW	100 kHz
VBW	100 kHz
Detector	Peak
Trace	Max Hold
Sweep Time	Auto

6.3 DEVIATION FROM STANDARD

No deviation.

6.4 TEST SETUP



6.5 EUT OPERATION CONDITIONS

The EUT was programmed to be in continuously transmitting mode.

6.6 TEST RESULTS

Please refer to the APPENDIX E.

7. AVERAGE TIME OF OCCUPANCY

7.1 LIMIT

Section	Test Item	Limit
FCC 15.247(a)(1)(iii)	Average Time of Occupancy	0.4sec

7.2 TEST PROCEDURE

- Set the EUT for DH1, DH3 and DH5 packet transmitting.
- Measure the maximum time duration of one single pulse.
- DH1 Packet permit maximum $1600 / 79 / 2 = 10.12$ hops per second in each channel (1 time slot TX, 1 time slot RX). So, the dwell time is the time duration of the pulse times $10.12 \times 31.6 = 320$ within 31.6 seconds.
- DH3 Packet permit maximum $1600 / 79 / 4 = 5.06$ hops per second in each channel (3 time slots TX, 1 time slot RX). So, the dwell time is the time duration of the pulse times $5.06 \times 31.6 = 160$ within 31.6 seconds.
- DH5 Packet permit maximum $1600 / 79 / 6 = 3.37$ hops per second in each channel (5 time slots TX, 1 time slot RX). So, the dwell time is the time duration of the pulse times $3.37 \times 31.6 = 106.6$ within 31.6 seconds.
- The EUT was directly connected to the spectrum analyzer and antenna output port as show in the block diagram below.
- The following table is the setting of the spectrum analyzer:

Spectrum Parameters	Setting
Span Frequency	0 MHz
RBW	1 MHz
VBW	1 MHz
Detector	Peak
Trace	Max Hold
Sweep Time	As necessary to capture the entire dwell time per hopping channel

7.3 DEVIATION FROM STANDARD

No deviation.

7.4 TEST SETUP



7.5 EUT OPERATION CONDITIONS

The EUT was programmed to be in continuously transmitting mode.

7.6 TEST RESULTS

Please refer to the APPENDIX F.

8. HOPPING CHANNEL SEPARATION

8.1 LIMIT

Frequency hopping systems operating in the 2400-2483.5 MHz band may have hopping channel carrier frequencies that are separated by 25 kHz or two-thirds of the 20 dB bandwidth of the hopping channel, whichever is greater, provided the systems operate with an output power no greater than 125 mW.

8.2 TEST PROCEDURE

- a. The EUT was directly connected to the spectrum analyzer and antenna output port as show in the block diagram below.
- b. The following table is the setting of the spectrum analyzer:

Spectrum Parameters	Setting
Span Frequency	Wide enough to capture the peaks of two adjacent channels
RBW	30 kHz
VBW	100 kHz
Detector	Peak
Trace	Max Hold
Sweep Time	Auto

8.3 DEVIATION FROM STANDARD

No deviation.

8.4 TEST SETUP



8.5 EUT OPERATION CONDITIONS

The EUT was programmed to be in continuously transmitting mode.

8.6 TEST RESULTS

Please refer to the APPENDIX G.

9. BANDWIDTH

9.1 LIMIT

Section	Test Item
FCC 15.247(a)(1)	Bandwidth

9.2 TEST PROCEDURE

- The EUT was directly connected to the spectrum analyzer and antenna output port as show in the block diagram below.
- The following table is the setting of the spectrum analyzer:

Spectrum Parameters	Setting
Span Frequency	> Measurement Bandwidth
RBW	30 kHz
VBW	100 kHz
Detector	Peak
Trace	Max Hold
Sweep Time	Auto

9.3 DEVIATION FROM STANDARD

No deviation.

9.4 TEST SETUP



9.5 EUT OPERATION CONDITIONS

The EUT was programmed to be in continuously transmitting mode.

9.6 TEST RESULTS

Please refer to the APPENDIX H.

10. MAXIMUM OUTPUT POWER

10.1 LIMIT

Section	Test Item	Limit
FCC 15.247(a)(1)	Maximum Output Power	0.1250 Watt or 20.97 dBm

Note: Frequency hopping systems operating in the 2400-2483.5 MHz band may have hopping channel carrier frequencies that are separated by 25 kHz or two-thirds of the 20 dB bandwidth of the hopping channel, whichever is greater, provided the systems operate with an output power no greater than 125 mW.

10.2 TEST PROCEDURE

- The EUT was directly connected to the spectrum analyzer and antenna output port as show in the block diagram below.
- The following table is the setting of the spectrum analyzer:

Spectrum Parameters	Setting
Span Frequency	Approximately five times the 20 dB bandwidth, centered on a hopping channel.
RBW	3 MHz
VBW	3 MHz
Detector	Peak
Trace	Max Hold
Sweep Time	Auto

10.3 DEVIATION FROM STANDARD

No deviation.

10.4 TEST SETUP

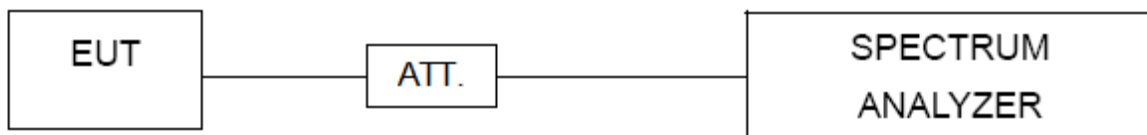

10.5 EUT OPERATION CONDITIONS

The EUT was programmed to be in continuously transmitting mode.

10.6 TEST RESULTS

Please refer to the APPENDIX I.

11. CONDUCTED SPURIOUS EMISSION

11.1 LIMIT

In any 100 kHz bandwidth outside the frequency band in which the spread spectrum or digitally modulated intentional radiator is operating, the radio frequency power that is produced by the intentional radiator shall be at least 20 dB below that in the 100 kHz bandwidth within the band that contains the highest level of the desired power, based on either an RF conducted or a radiated measurement, provided the transmitter demonstrates compliance with the peak Output Power limits. If the transmitter complies with the Output Power limits based on the use of RMS averaging over a time interval, as permitted under paragraph (b)(3) of this section, the attenuation required under this paragraph shall be 30 dB instead of 20 dB. Attenuation below the general limits specified in Section 15.209(a) is not required.

11.2 TEST PROCEDURE

- a. The EUT was directly connected to the spectrum analyzer and antenna output port as show in the block diagram below.
- b. The following table is the setting of the spectrum analyzer:

Spectrum Parameters	Setting
Start Frequency	30 MHz
Stop Frequency	26.5 GHz
RBW	100 kHz
VBW	100 kHz
Detector	Peak
Trace	Max Hold
Sweep Time	Auto

11.3 DEVIATION FROM STANDARD

No deviation.

11.4 TEST SETUP



11.5 EUT OPERATION CONDITIONS

The EUT was programmed to be in continuously transmitting mode.

11.6 TEST RESULTS

Please refer to the APPENDIX J.

12. MEASUREMENT INSTRUMENTS LIST

AC Power Line Conducted Emissions					
Item	Kind of Equipment	Manufacturer	Type No.	Serial No.	Calibrated until
1	EMI TEST RECEIVER	R&S	ESCI	100382	Dec. 22, 2024
2	TWO-LINE V-NETWORK	R&S	ENV216	101447	Dec. 22, 2024
3	Measurement Software	Farad	EZ-EMC Ver.NB-03A1-01	N/A	N/A
4	Cable	N/A	SFT205-NMNM-9M -001	9M	Nov. 27, 2024
5	643 Shield Room	ETS	6*4*3	N/A	N/A

Radiated Emissions - 9 kHz to 30 MHz					
Item	Kind of Equipment	Manufacturer	Type No.	Serial No.	Calibrated until
1	Active Loop Antenna	Schwarzbeck	FMZB 1513-60B	1513-60 B-034	Mar. 30, 2025
2	MXE EMI Receiver	Keysight	N9038A	MY56400091	Dec. 22, 2024
3	Cable	N/A	RW2350-3.8A-NMB M-1.5M	N/A	Jun. 09, 2025
4	Cable	N/A	RG 213/U	N/A	Jun. 09, 2025
5	Measurement Software	Farad	EZ-EMC Ver.NB-03A1-01	N/A	N/A
6	966 Chamber room	ETS	9*6*6	N/A	May 16, 2025

Radiated Emissions - 30 MHz to 1 GHz					
Item	Kind of Equipment	Manufacturer	Type No.	Serial No.	Calibrated until
1	Trilog-Broadband Antenna	Schwarzbeck	VULB 9168	1462	Dec. 13, 2024
2	Attenuator	EMC INSTRUMENT	EMCI-N-6-06	AT-06009	Dec. 13, 2024
3	Preamplifier	EMC INSTRUMENT	EMC001330	980998	Nov. 17, 2024
4	Cable	RegalWay	LMR400-NMNM-12 .5m	N/A	Jun. 06, 2025
5	Cable	RegalWay	LMR400-NMNM-3 m	N/A	Jun. 06, 2025
6	Cable	RegalWay	LMR400-NMNM-0. 5m	N/A	Jun. 06, 2025
7	Receiver	Agilent	N9038A	MY52130039	Dec. 22, 2024
8	Positioning Controller	MF	MF-7802	N/A	N/A
9	Measurement Software	Farad	EZ-EMC Ver.NB-03A1-01	N/A	N/A
10	966 Chamber room	CM	9*6*6	N/A	May 16, 2025

Radiated Emissions - Above 1 GHz					
Item	Kind of Equipment	Manufacturer	Type No.	Serial No.	Calibrated until
1	Receiver	Agilent	N9038A	MY52130039	Dec. 22, 2024
2	Preamplifier	EMC INSTRUMENT	EMC118A45SE	980888	Nov. 17, 2024
3	Double Ridged Guide Antenna	ETS	3115	75789	Jun. 15, 2025
4	Cable	RegalWay	RWLP50-4.0A-SMSM-12.5M	N/A	Jul. 03, 2025
5	Cable	RegalWay	RWLP50-4.0A-NMRA SM-2.5M	N/A	Jul. 03, 2025
6	Cable	RegalWay	RWLP50-4.0A-NMRA SMRA-0.8M	N/A	Jul. 03, 2025
7	966 Chamber room	CM	9*6*6	N/A	May 19, 2025
8	Attenuator	Talent Microwave	TA10A2-S-18	N/A	N/A
9	Filter	STI	STI15-9912	N/A	May. 31, 2025
10	Positioning Controller	MF	MF-7802	N/A	N/A
11	Measurement Software	Farad	EZ-EMC Ver.NB-03A1-01	N/A	N/A
12	Low Noise Amplifier	CONNPHY	CLN-18G40G-4330-K	619413	Jul. 17, 2025
13	Cable	RegalWay	RWLP50-2.6A-2.92M 2.92M-1.1M	N/A	Jul. 25, 2025
14	Cable	Tonscend	HF160-KMKM-3M	N/A	Jul. 25, 2025
15	Broad-Band Horn Antenna	Schwarzbeck	BBHA9170(3m)	9170-319	Jun. 16, 2025

Number of Hopping Frequency & Average Time of Occupancy & Hopping Channel Separation & Bandwidth & Maximum Output Power & Conducted Spurious Emission					
Item	Kind of Equipment	Manufacturer	Type No.	Serial No.	Calibrated until
1	Spectrum Analyzer	R&S	FSP38	100852	May 31, 2025
2	Measurement Software	BTL	BTL Conducted Test	N/A	N/A
3	Isolation attenuator	Z-Link	ASMA-16-18-2W	N/A	N/A

Remark "N/A" denotes no model name, serial no. or calibration specified.

All calibration period of equipment list is one year.

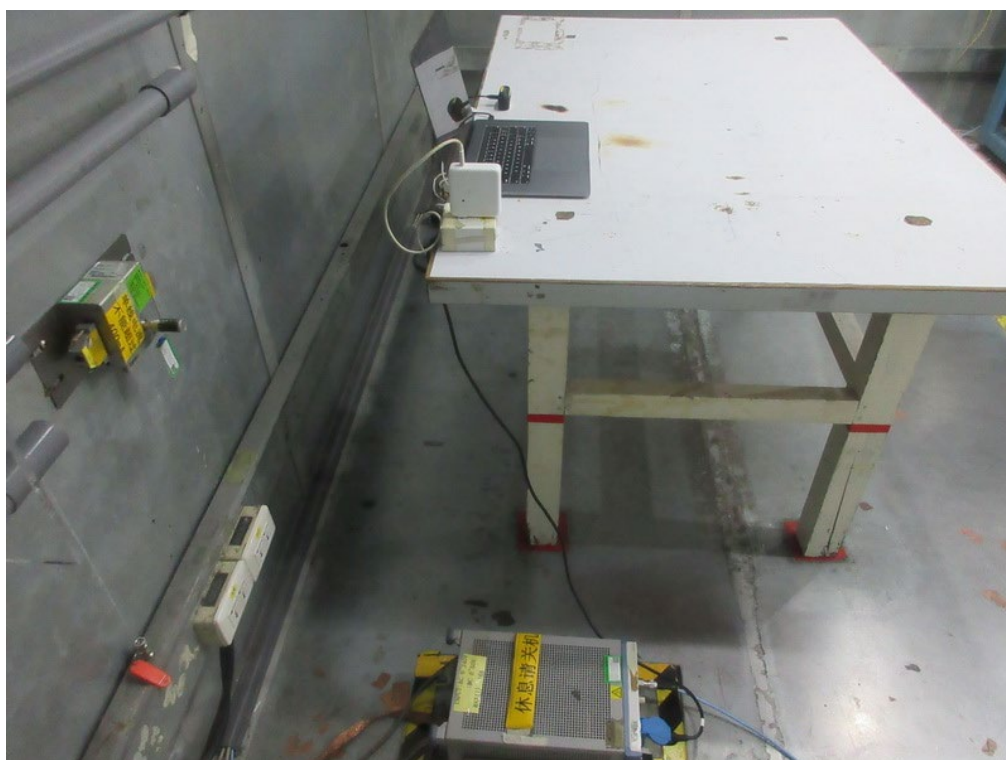
13. EUT TEST PHOTO**AC Power Line Conducted Emissions Test Photos**

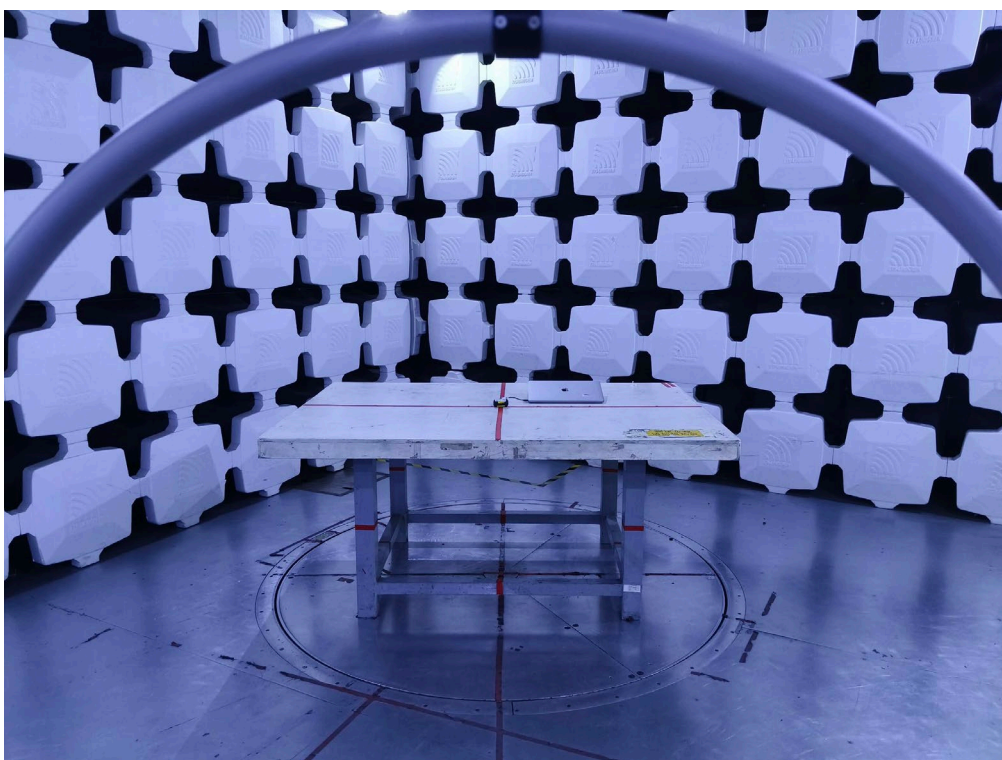
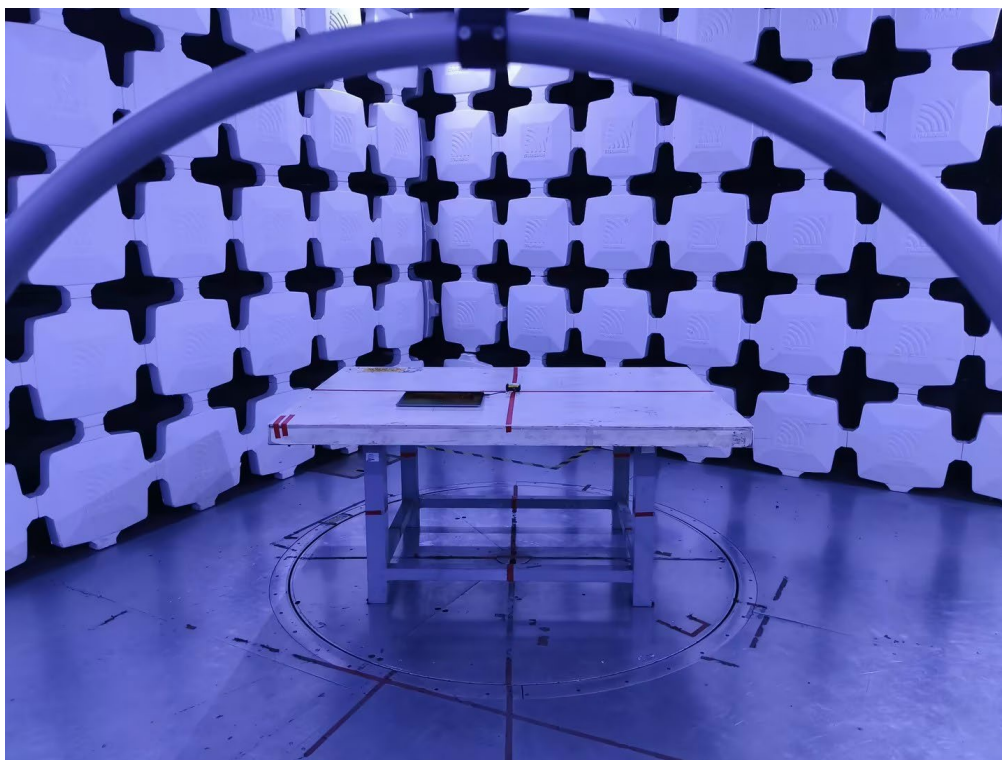
Radiated Emissions Test Photos**9 kHz to 30 MHz**

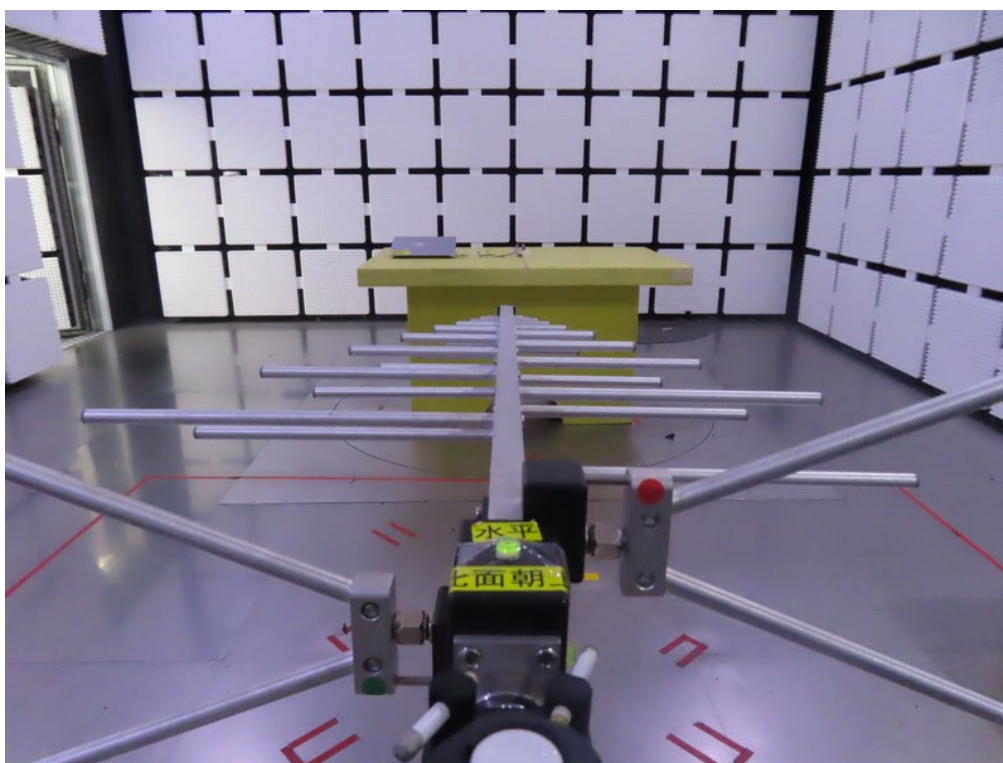
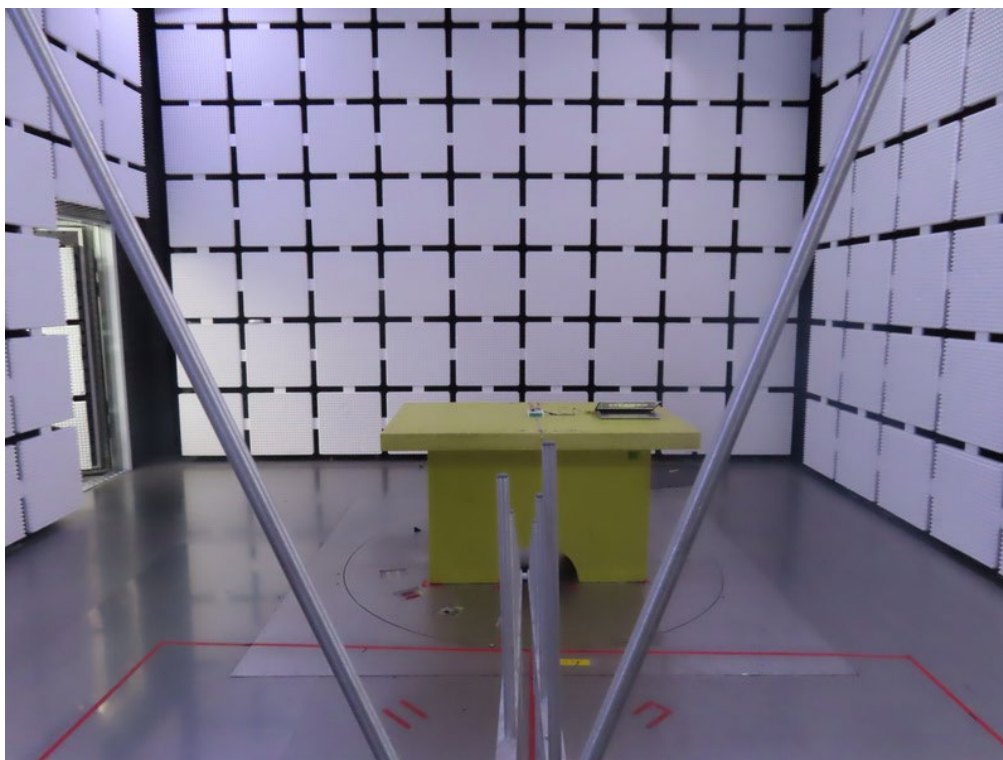
Radiated Emissions Test Photos**30 MHz to 1000 MHz**

Radiated Emissions Test Photos
Above 1 GHz
Band edge & Harmonic (1 GHz to 18 GHz)

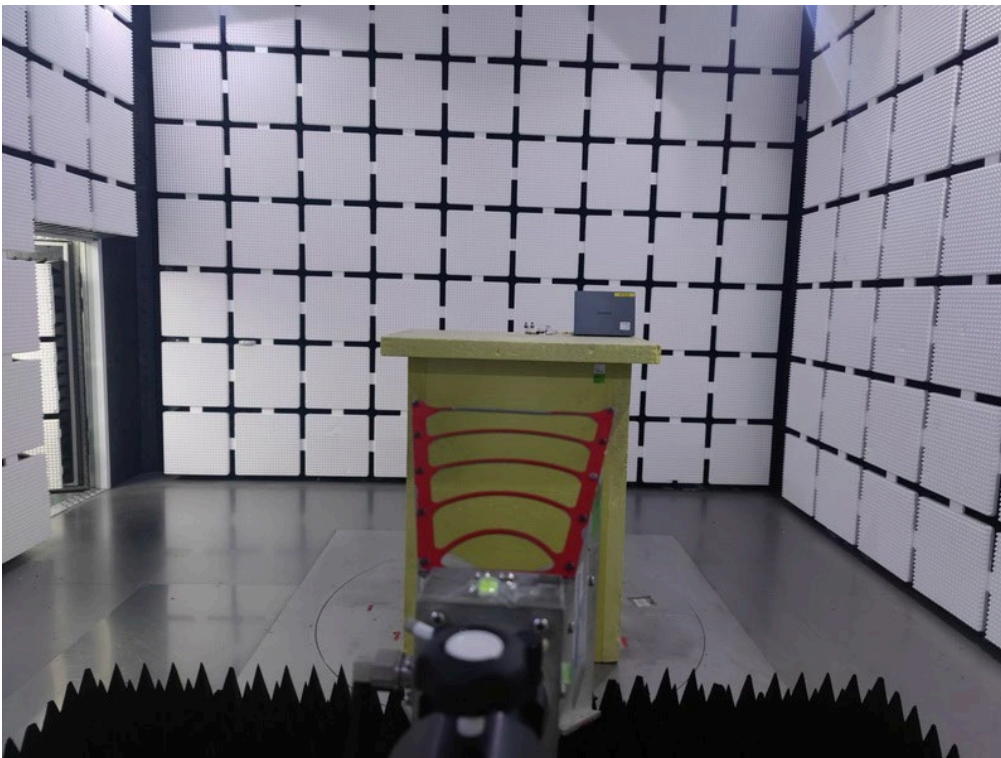
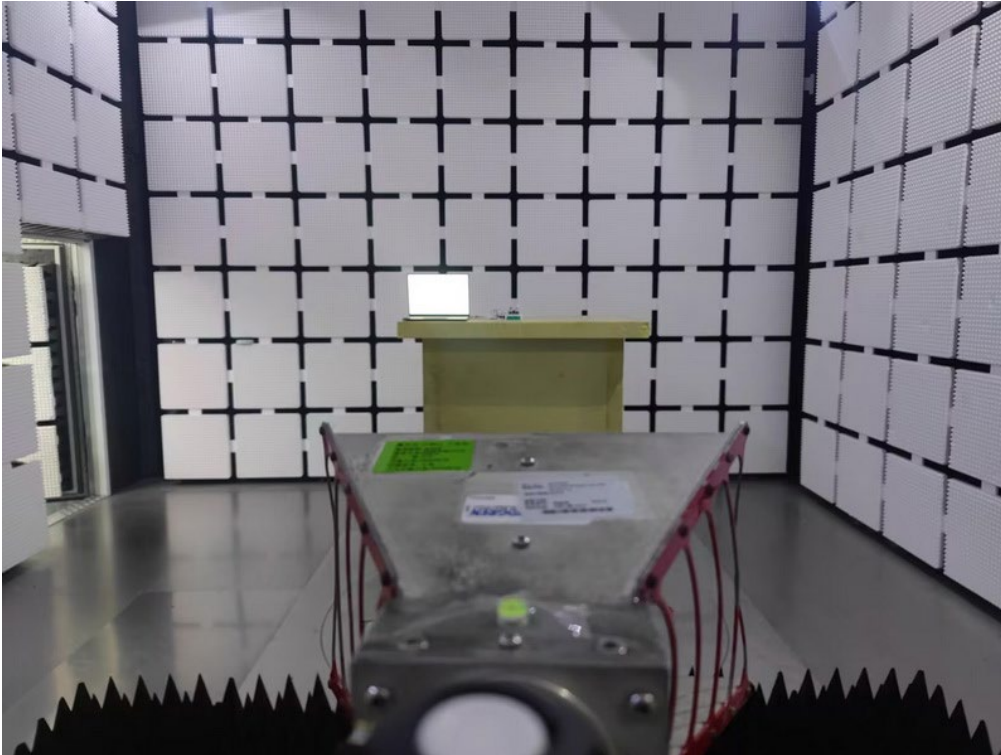

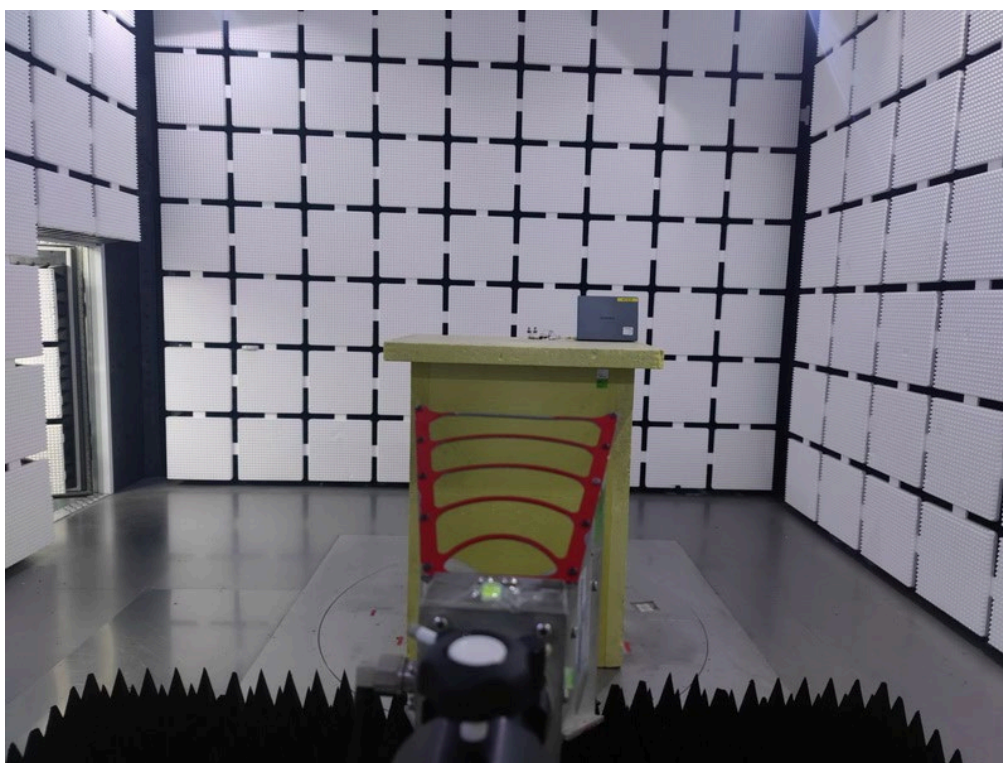
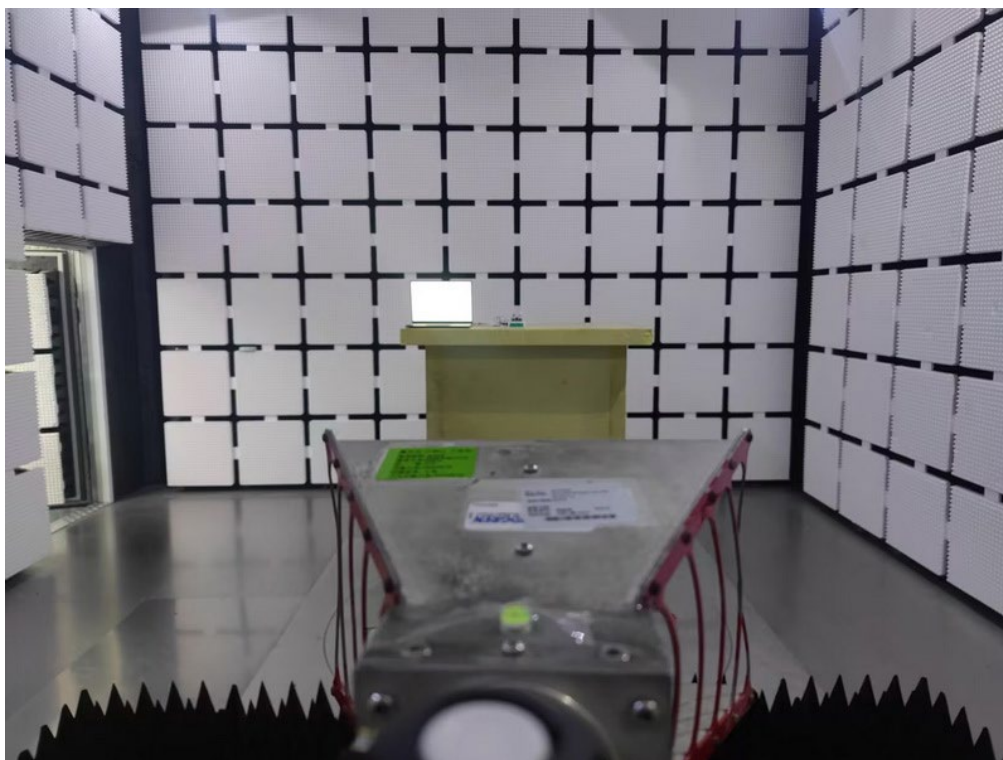
Radiated Emissions Test Photos**Above 1 GHz
Harmonic (Above 18 GHz)**

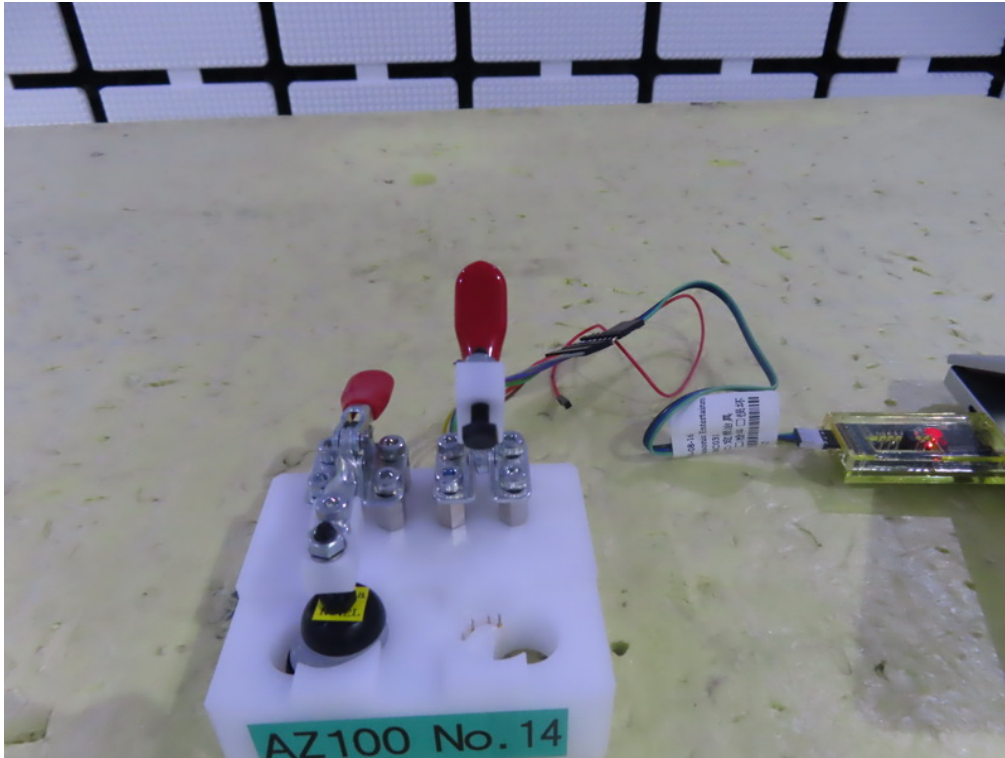

Conducted Test Photos

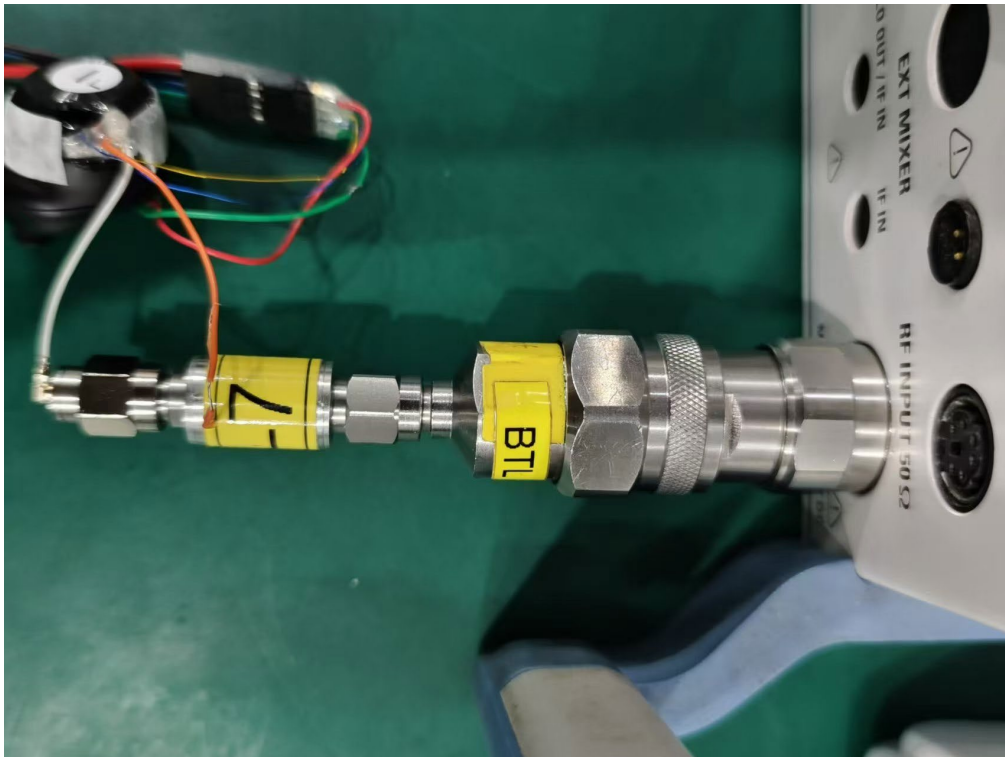
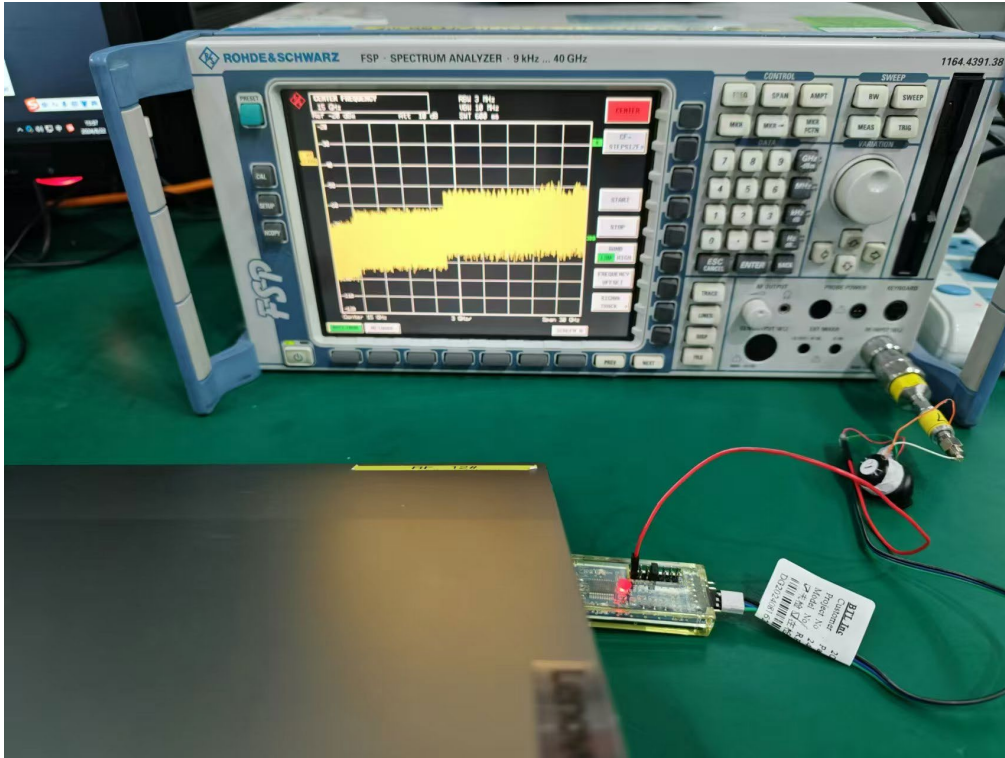

APPENDIX A - AC POWER LINE CONDUCTED EMISSIONS

Test Mode	TX Mode_3Mbps Channel 00	Phase	Line
-----------	--------------------------	-------	------

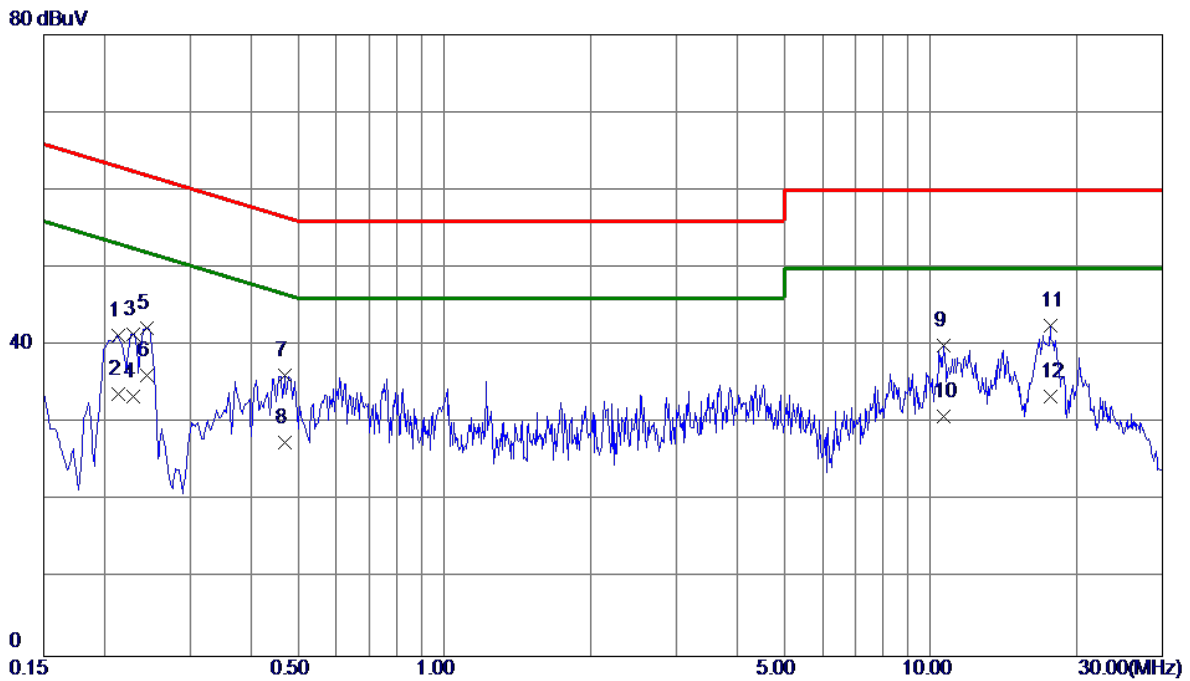

No.	Freq. MHz	Reading Level dBuV	Correct Factor dB	Measure ment dBuV	Limit dBuV	Margin dB	Detector	Comment
1	0.2130	31.34	10.00	41.34	63.09	-21.75	QP	
2	0.2130	23.70	10.00	33.70	53.09	-19.39	AVG	
3	0.2292	31.40	10.03	41.43	62.48	-21.05	QP	
4	0.2292	23.40	10.03	33.43	52.48	-19.05	AVG	
5	0.2445	32.23	10.06	42.29	61.94	-19.65	QP	
6 *	0.2445	26.09	10.06	36.15	51.94	-15.79	AVG	
7	0.4695	25.54	10.56	36.10	56.52	-20.42	QP	
8	0.4695	16.90	10.56	27.46	46.52	-19.06	AVG	
9	10.6350	27.81	12.21	40.02	60.00	-19.98	QP	
10	10.6350	18.71	12.21	30.92	50.00	-19.08	AVG	
11	17.6505	28.86	13.76	42.62	60.00	-17.38	QP	
12	17.6505	19.61	13.76	33.37	50.00	-16.63	AVG	

REMARKS:

- (1) Measurement Value = Reading Level + Correct Factor.
- (2) Margin Level = Measurement Value - Limit Value.

Test Mode	TX Mode_3Mbps Channel 00	Phase	Neutral
-----------	--------------------------	-------	---------

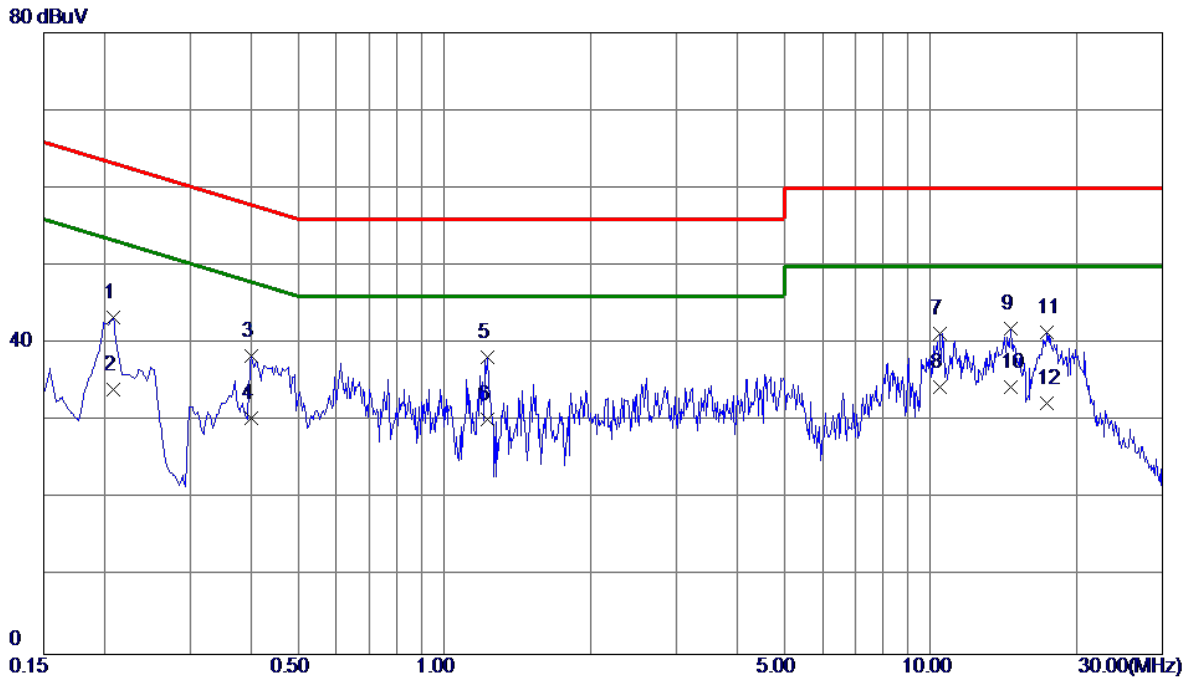

No.	Freq. MHz	Reading Level dBuV	Correct Factor dB	Measure ment dBuV	Limit dBuV	Margin dB	Detector	Comment
1	0.2085	33.48	9.95	43.43	63.26	-19.83	QP	
2	0.2085	24.10	9.95	34.05	53.26	-19.21	AVG	
3	0.4020	28.09	10.36	38.45	57.81	-19.36	QP	
4	0.4020	20.10	10.36	30.46	47.81	-17.35	AVG	
5	1.2255	26.95	11.27	38.22	56.00	-17.78	QP	
6	1.2255	18.90	11.27	30.17	46.00	-15.83	AVG	
7	10.4730	29.09	12.14	41.23	60.00	-18.77	QP	
8	10.4730	22.29	12.14	34.43	50.00	-15.57	AVG	
9	14.5995	29.18	12.74	41.92	60.00	-18.08	QP	
10 *	14.5995	21.71	12.74	34.45	50.00	-15.55	AVG	
11	17.3985	27.88	13.62	41.50	60.00	-18.50	QP	
12	17.3985	18.69	13.62	32.31	50.00	-17.69	AVG	

REMARKS:

- (1) Measurement Value = Reading Level + Correct Factor.
- (2) Margin Level = Measurement Value - Limit Value.

APPENDIX B - RADIATED EMISSION - 9 KHZ TO 30 MHZ

Test Mode	TX Mode_3Mbps Channel 00	Polarization	Ant 0°
-----------	--------------------------	--------------	--------

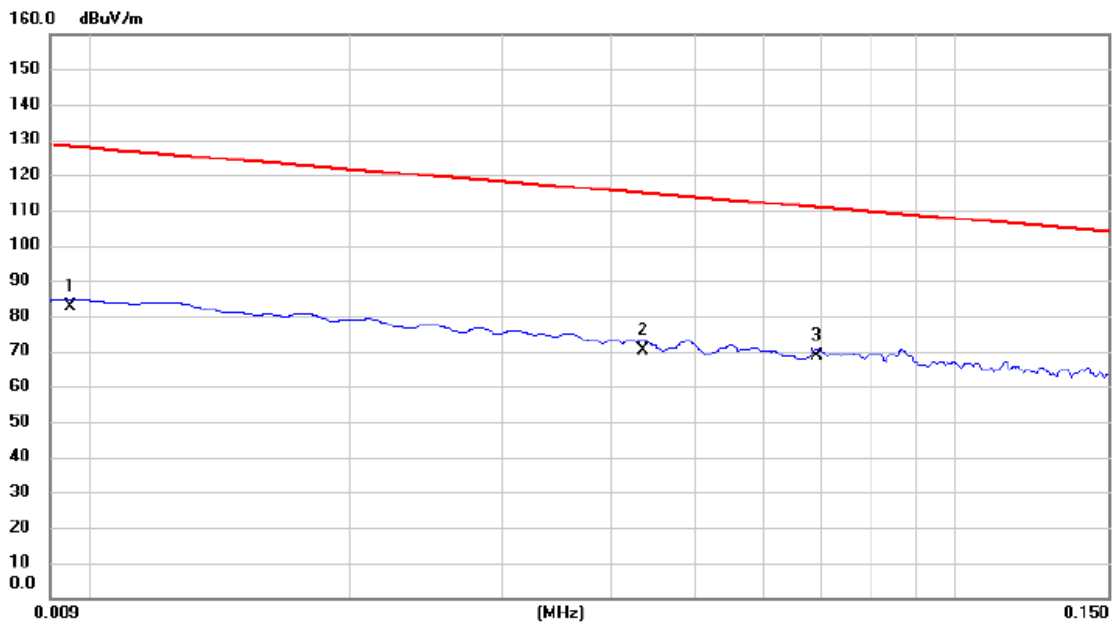

No.	Mk.	Freq. MHz	Reading Level dBuV	Correct Factor dB	Measure- ment dBuV/m	Limit dBuV/m	Margin dB	Detector	Comment
1		0.0095	62.17	20.45	82.62	128.05	-45.43	AVG	
2		0.0435	49.11	21.17	70.28	114.84	-44.56	AVG	
3	*	0.0692	47.32	21.26	68.58	110.80	-42.22	AVG	

REMARKS:

- (1) Measurement Value = Reading Level + Correct Factor.
- (2) Margin Level = Measurement Value - Limit Value.

Test Mode	TX Mode_3Mbps Channel 00	Polarization	Ant 0°
-----------	--------------------------	--------------	--------

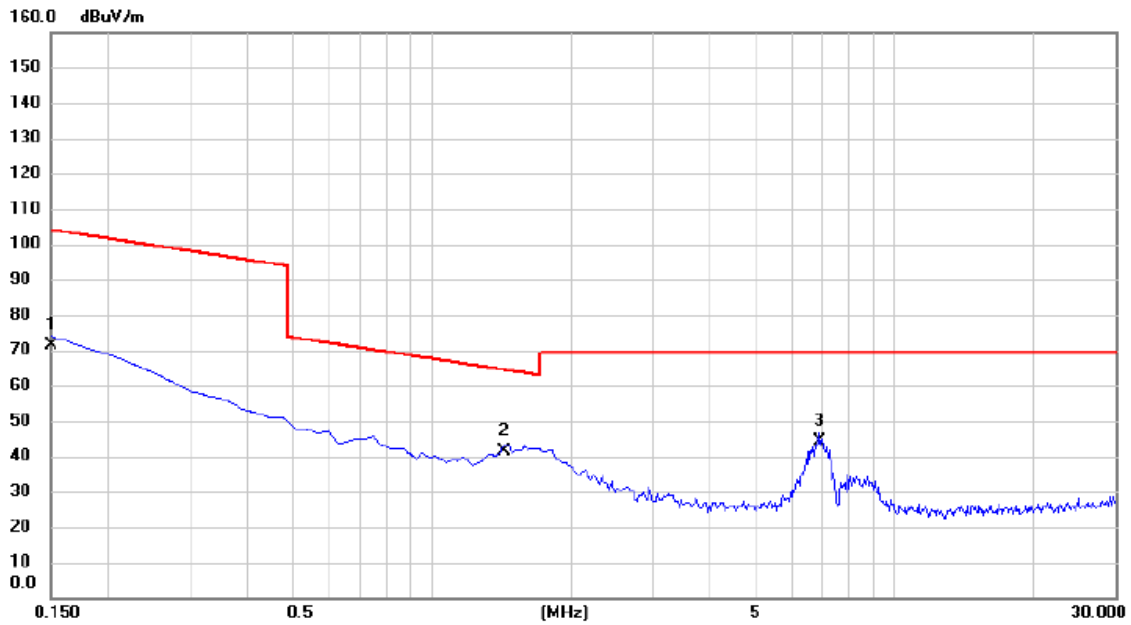

No.	Mk.	Freq. MHz	Reading Level dBuV	Correct Factor dB	Measure- ment dBuV/m	Limit dBuV/m	Margin dB	Detector	Comment
1		0.1500	50.13	21.27	71.40	104.09	-32.69	AVG	
2	*	1.4335	20.40	21.15	41.55	64.48	-22.93	QP	
3		6.8960	23.11	21.19	44.30	69.54	-25.24	QP	

REMARKS:

(1) Measurement Value = Reading Level + Correct Factor.

(2) Margin Level = Measurement Value - Limit Value.

Test Mode	TX Mode_3Mbps Channel 00	Polarization	Ant 90°
-----------	--------------------------	--------------	---------

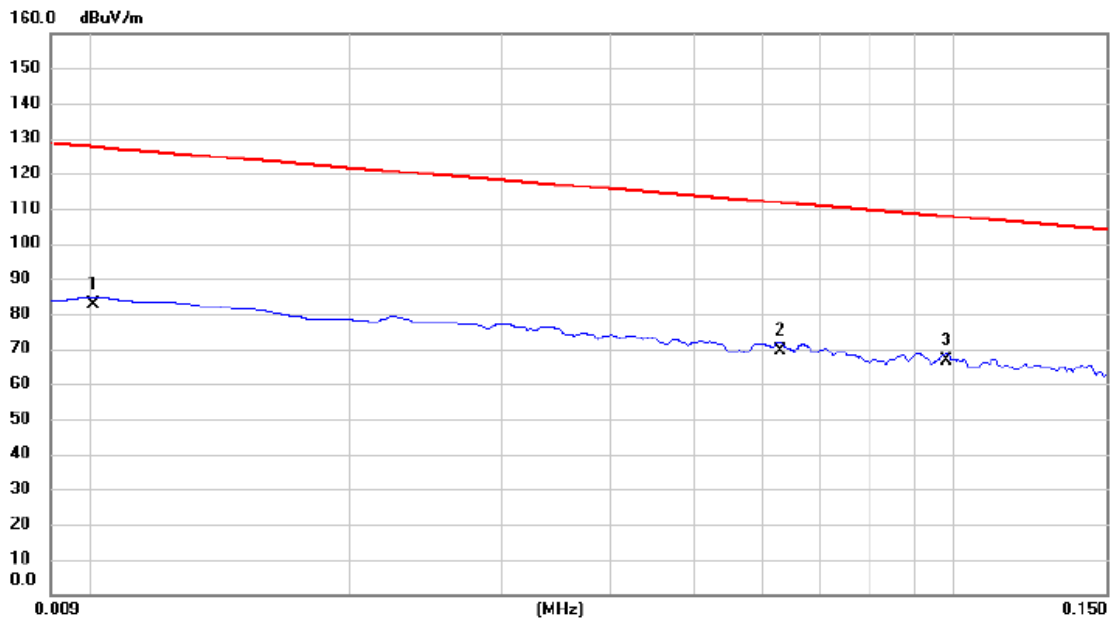

No.	Mk.	Freq.	Reading Level	Correct Factor	Measurement	Limit	Margin	Detector	Comment
		MHz	dBuV	dB	dBuV/m	dBuV/m	dB		
1		0.0101	62.16	20.50	82.66	127.52	-44.86	AVG	
2		0.0630	48.23	21.24	69.47	111.62	-42.15	AVG	
3	*	0.0980	45.25	21.33	66.58	107.78	-41.20	AVG	

REMARKS:

- (1) Measurement Value = Reading Level + Correct Factor.
- (2) Margin Level = Measurement Value - Limit Value.

Test Mode	TX Mode_3Mbps Channel 00	Polarization	Ant 90°
-----------	--------------------------	--------------	---------

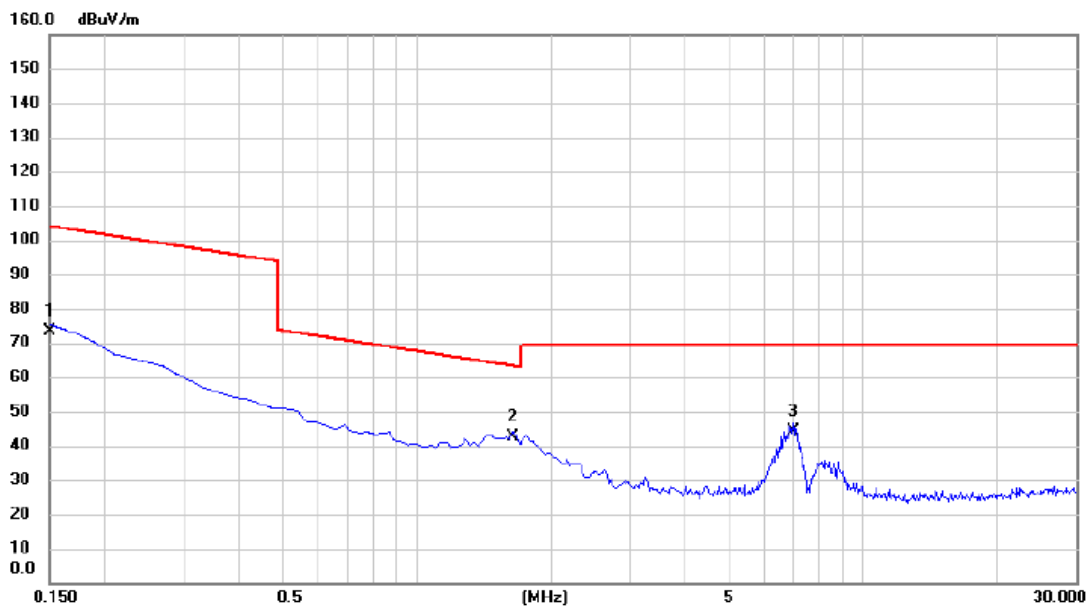

No. Mk.	Freq. MHz	Reading Level dBuV	Correct Factor dB	Measurement dBuV/m	Limit dBuV/m	Margin dB	Detector	Comment
1	0.1500	52.13	21.27	73.40	104.09	-30.69	AVG	
2 *	1.6425	21.27	21.14	42.41	63.29	-20.88	QP	
3	6.9557	23.10	21.19	44.29	69.54	-25.25	QP	

REMARKS:

- (1) Measurement Value = Reading Level + Correct Factor.
- (2) Margin Level = Measurement Value - Limit Value.

APPENDIX C - RADIATED EMISSION - 30 MHZ TO 1000 MHZ

Test Mode	TX Mode_3Mbps Channel 00	Polarization	Vertical
-----------	--------------------------	--------------	----------

80 dBuV/m

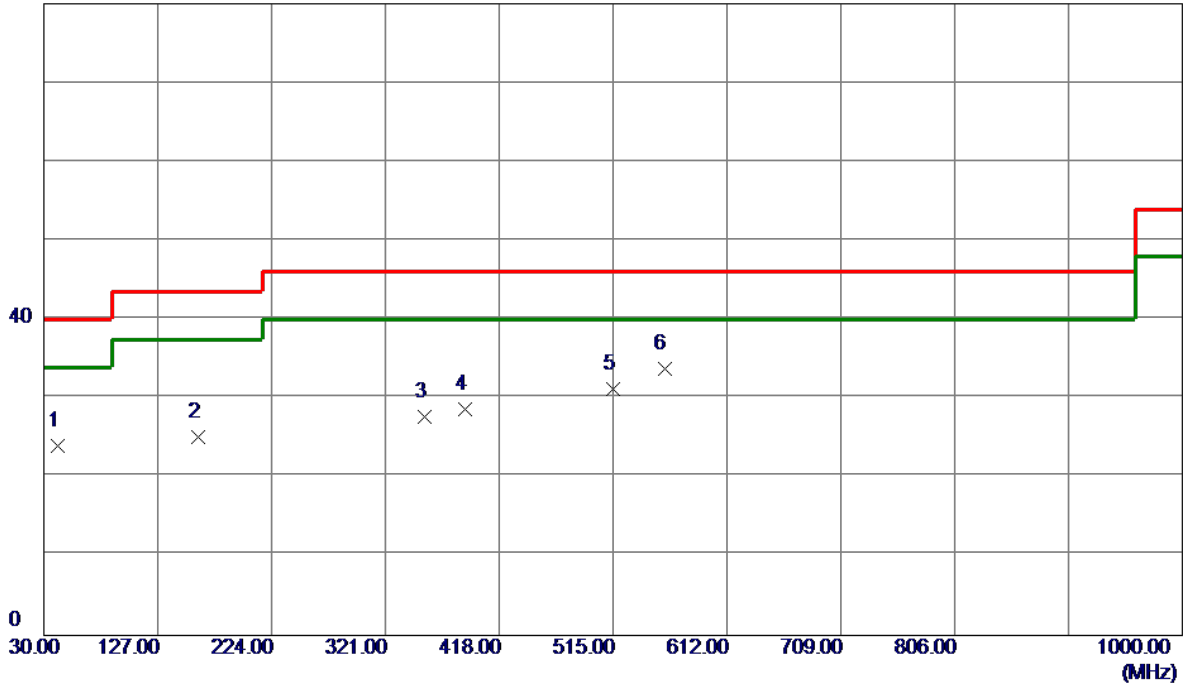

No.	Freq. MHz	Reading Level dBuV/m	Correct Factor dB	Measure ment dBuV/m	Limit dBuV/m	Margin dB	Detector	Comment
1	42.1250	35.59	-11.56	24.03	40.00	-15.97	Peak	
2	161.9200	36.06	-10.92	25.14	43.52	-18.38	Peak	
3	354.4650	37.09	-9.41	27.68	46.02	-18.34	Peak	
4	388.4150	36.93	-8.30	28.63	46.02	-17.39	Peak	
5	515.4850	36.94	-5.70	31.24	46.02	-14.78	Peak	
6 *	558.6500	38.57	-4.75	33.82	46.02	-12.20	Peak	

REMARKS:

- (1) Measurement Value = Reading Level + Correct Factor.
- (2) Margin Level = Measurement Value - Limit Value.

Test Mode	TX Mode_3Mbps Channel 00	Polarization	Horizontal
-----------	--------------------------	--------------	------------

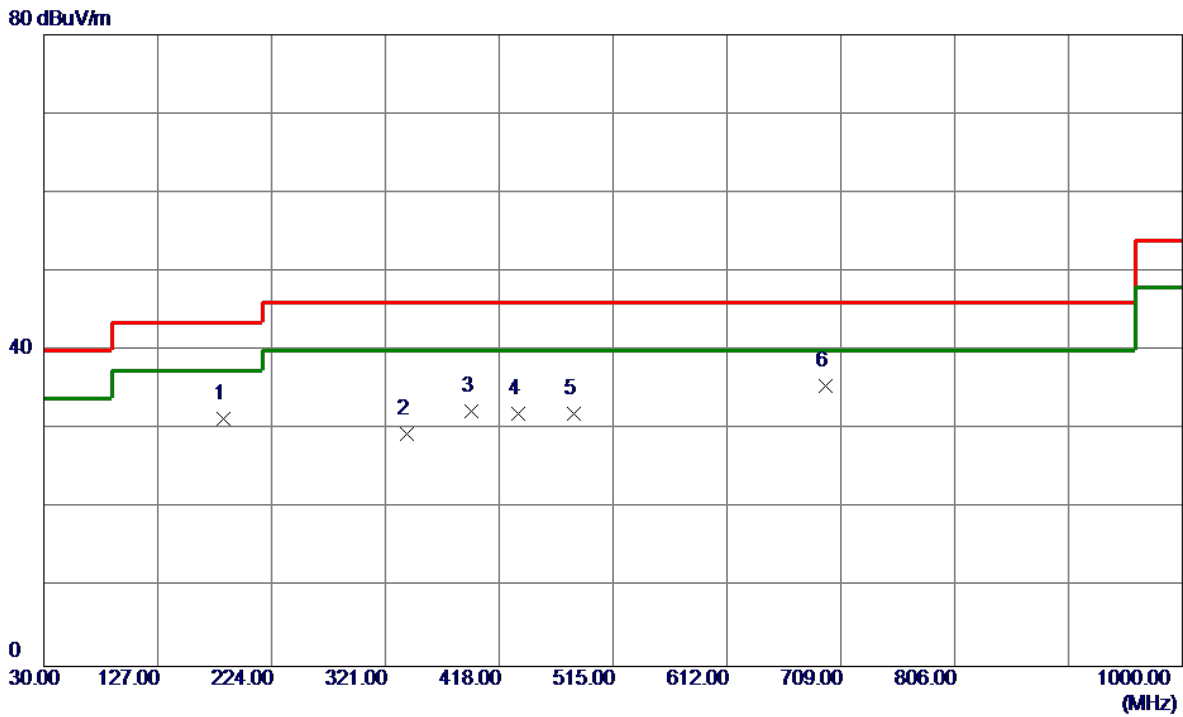

No.	Freq. MHz	Reading Level dBuV/m	Correct Factor dB	Measurement dBuV/m	Limit dBuV/m	Margin dB	Detector	Comment
1	183.2600	44.10	-12.79	31.31	46.02	-14.71	Peak	
2	339.4300	38.99	-9.54	29.45	46.02	-16.57	Peak	
3	394.2349	40.47	-8.15	32.32	46.02	-13.70	Peak	
4	434.4900	39.10	-7.17	31.93	46.02	-14.09	Peak	
5	481.5350	38.37	-6.30	32.07	46.02	-13.95	Peak	
6 *	695.9050	37.80	-2.35	35.45	46.02	-10.57	Peak	

REMARKS:

- (1) Measurement Value = Reading Level + Correct Factor.
- (2) Margin Level = Measurement Value - Limit Value.

APPENDIX D - RADIATED EMISSION - ABOVE 1000 MHZ

Test Mode	TX 2402 MHz_CH00_1Mbps	Polarization	Vertical
-----------	------------------------	--------------	----------

100 dBuV/m

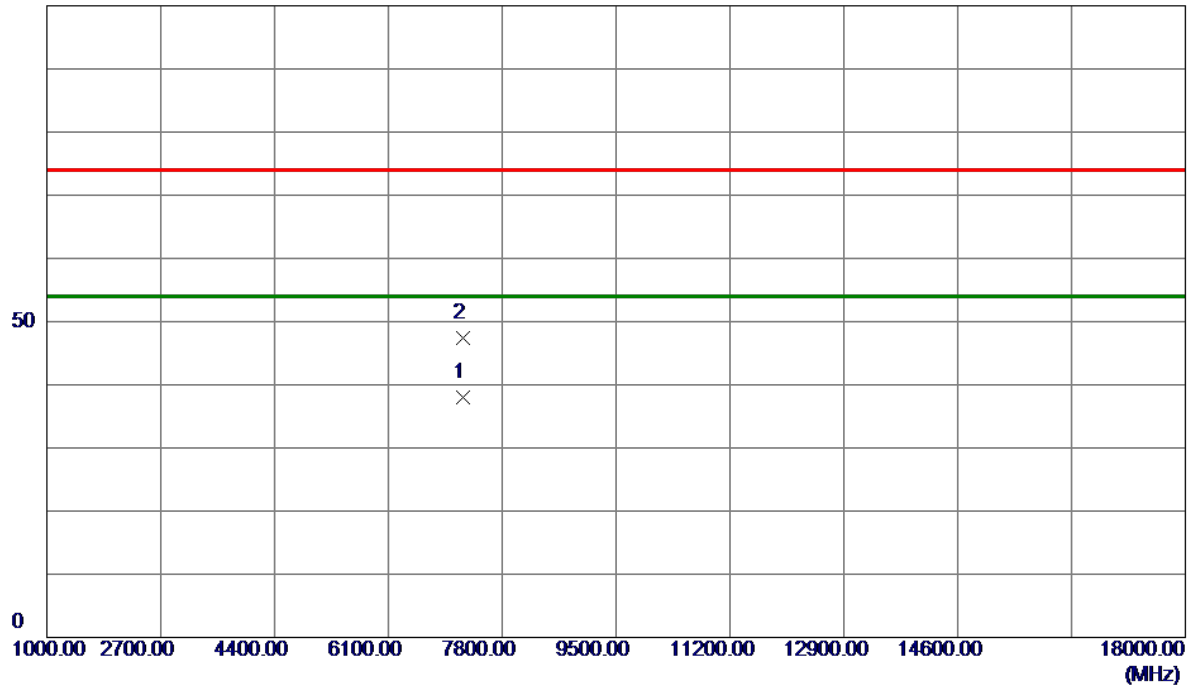

No.	Freq. MHz	Reading Level dBuV/m	Correct Factor dB	Measure ment dBuV/m	Limit dBuV/m	Margin dB	Detector	Comment
1 *	7205.9980	29.79	8.30	38.09	54.00	-15.91	AVG	
2	7206.1050	39.16	8.30	47.46	74.00	-26.54	Peak	

REMARKS:

- (1) Measurement Value = Reading Level + Correct Factor.
- (2) Margin Level = Measurement Value - Limit Value.

Test Mode	TX 2402 MHz_CH00_1Mbps	Polarization	Horizontal
-----------	------------------------	--------------	------------

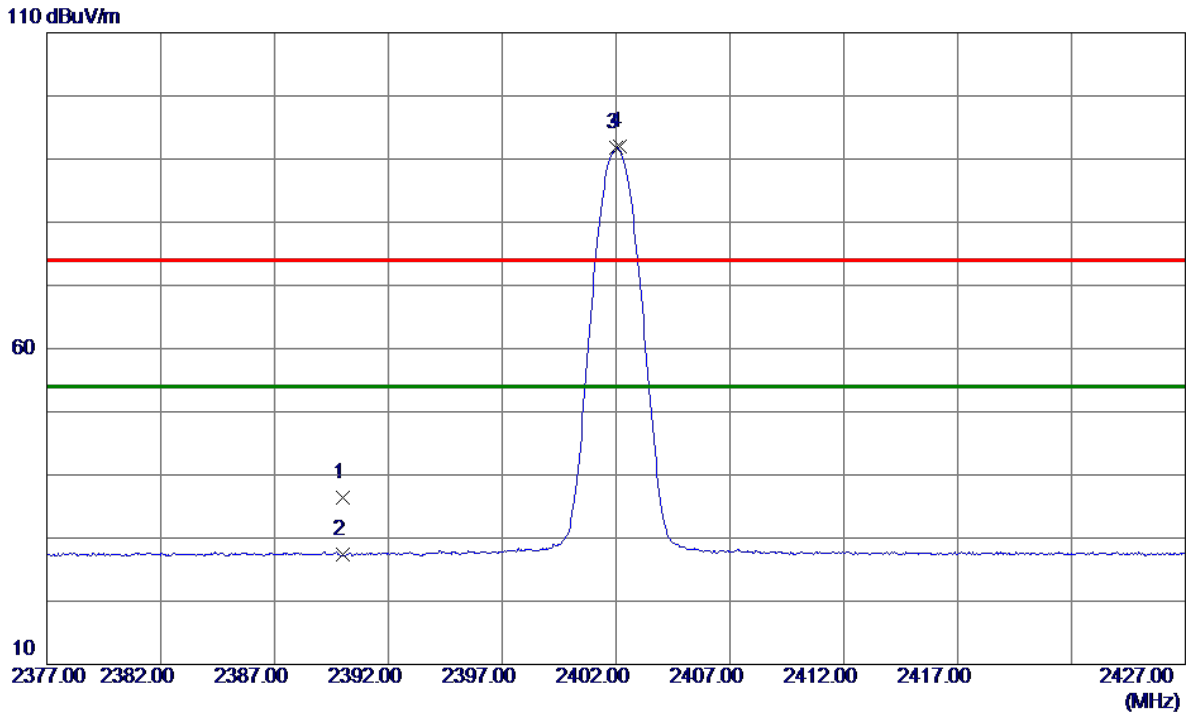

No.	Freq. MHz	Reading Level dBuV/m	Correct Factor dB	Measure ment dBuV/m	Limit dBuV/m	Margin dB	Detector	Comment
1	2390.0000	38.75	-2.30	36.45	74.00	-37.55	Peak	
2	2390.0000	29.61	-2.30	27.31	54.00	-26.69	AVG	
3 *	2402.0250	94.02	-2.29	91.73	54.00	37.73	AVG	No Limit
4	2402.1750	94.32	-2.29	92.03	74.00	18.03	Peak	No Limit

REMARKS:

- (1) Measurement Value = Reading Level + Correct Factor.
- (2) Margin Level = Measurement Value - Limit Value.

Test Mode	TX 2441 MHz _CH39_1Mbps	Polarization	Vertical
-----------	-------------------------	--------------	----------

100 dBuV/m

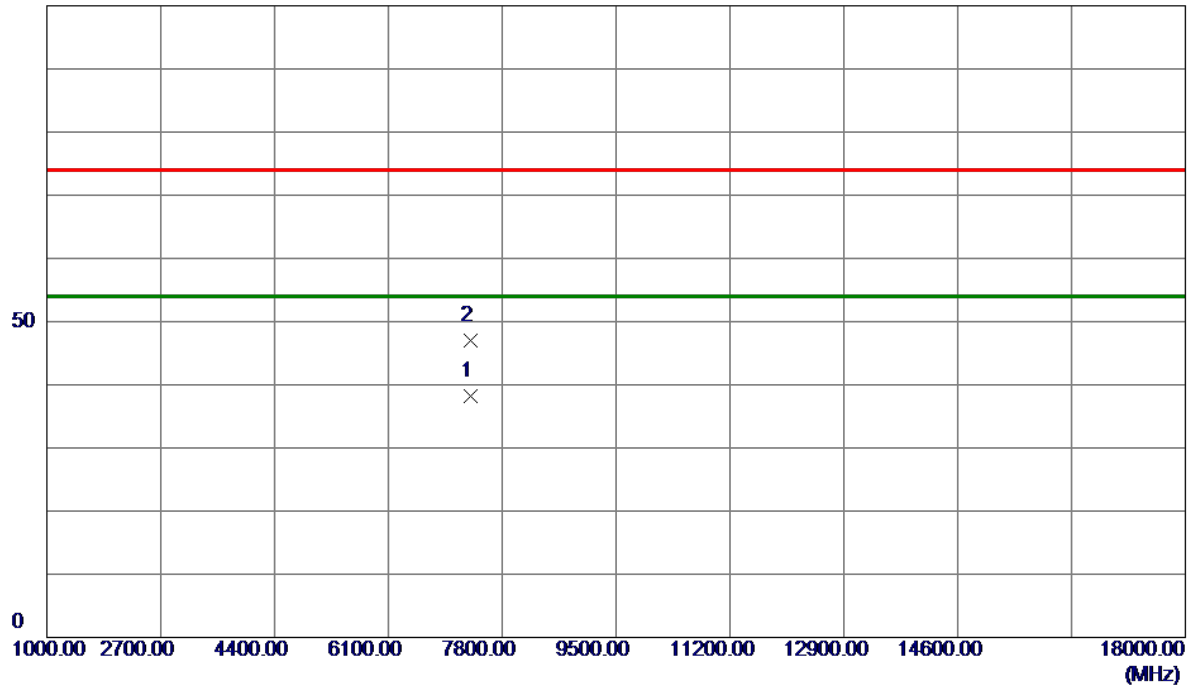

No.	Freq. MHz	Reading Level dBuV/m	Correct Factor dB	Measure ment dBuV/m	Limit dBuV/m	Margin dB	Detector	Comment
1 *	7323.0300	29.83	8.31	38.14	54.00	-15.86	AVG	
2	7323.1150	38.74	8.31	47.05	74.00	-26.95	Peak	

REMARKS:

- (1) Measurement Value = Reading Level + Correct Factor.
- (2) Margin Level = Measurement Value - Limit Value.

Test Mode	TX 2441 MHz _CH39_1Mbps	Polarization	Horizontal
-----------	-------------------------	--------------	------------

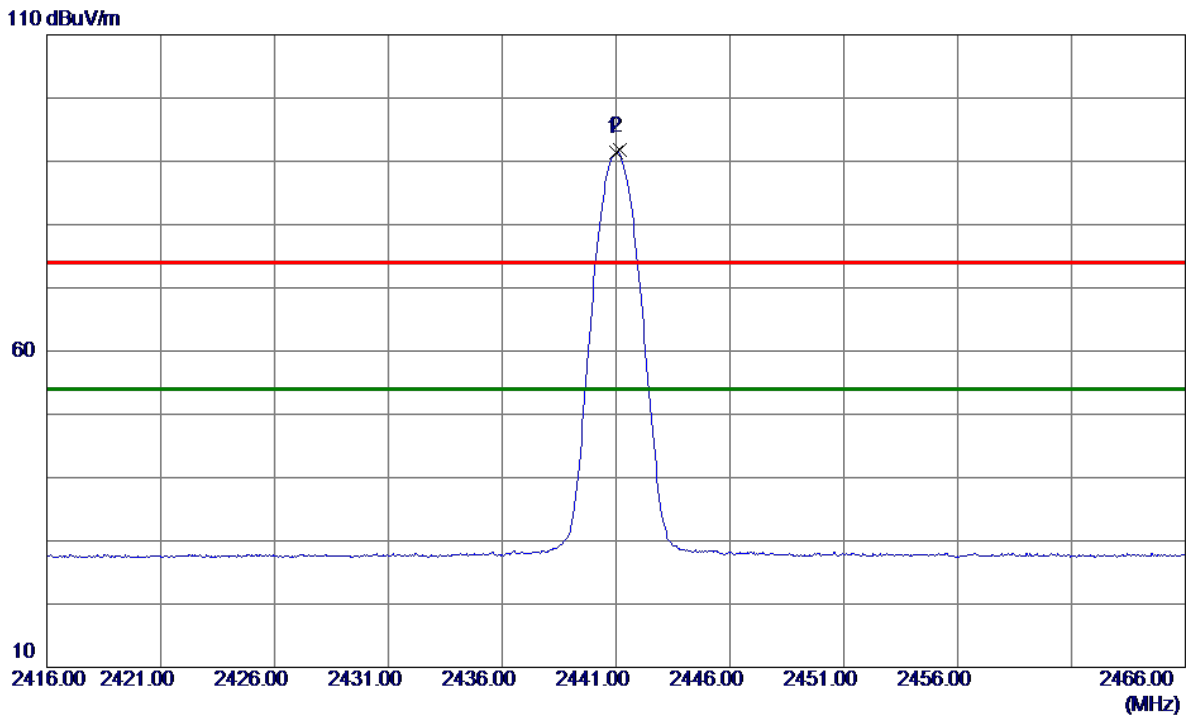

No.	Freq. MHz	Reading Level dBuV/m	Correct Factor dB	Measure ment dBuV/m	Limit dBuV/m	Margin dB	Detector	Comment
1 *	2441.0250	93.67	-2.24	91.43	54.00	37.43	AVG	No Limit
2	2441.1500	93.94	-2.24	91.70	74.00	17.70	Peak	No Limit

REMARKS:

- (1) Measurement Value = Reading Level + Correct Factor.
- (2) Margin Level = Measurement Value - Limit Value.

Test Mode	TX 2480 MHz _CH78_1Mbps	Polarization	Vertical
-----------	-------------------------	--------------	----------

100 dBuV/m

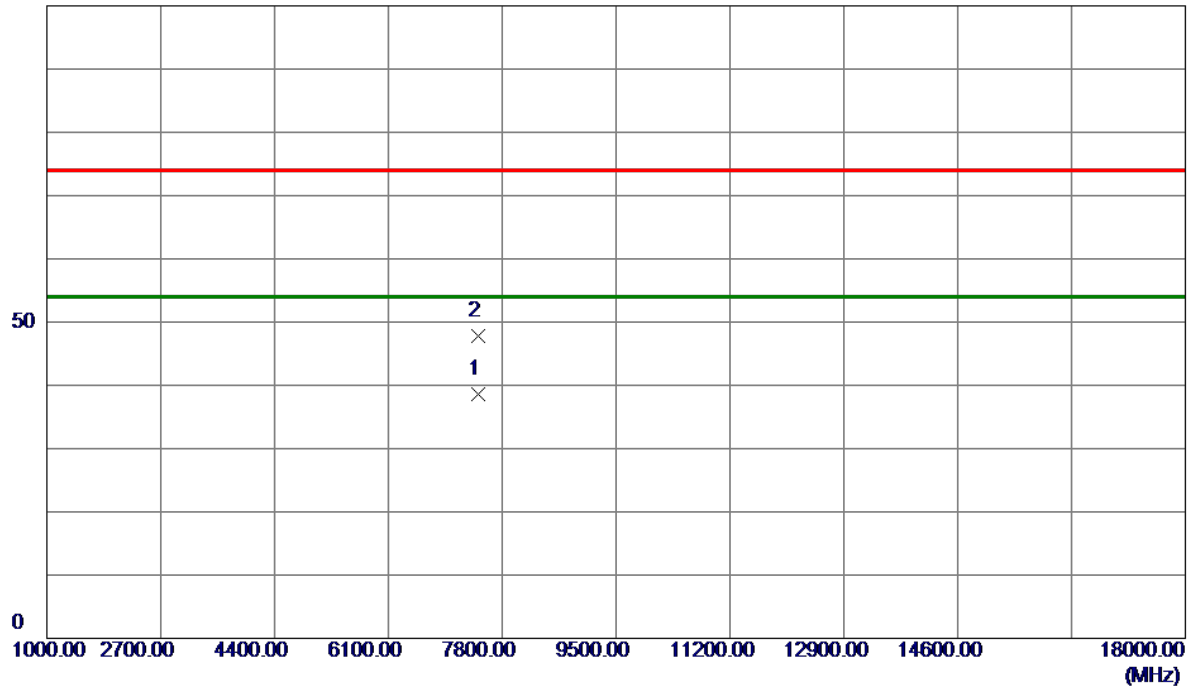

No.	Freq. MHz	Reading Level dBuV/m	Correct Factor dB	Measure ment dBuV/m	Limit dBuV/m	Margin dB	Detector	Comment
1 *	7440.0050	30.34	8.32	38.66	54.00	-15.34	AVG	
2	7440.1880	39.52	8.32	47.84	74.00	-26.16	Peak	

REMARKS:

- (1) Measurement Value = Reading Level + Correct Factor.
- (2) Margin Level = Measurement Value - Limit Value.

Test Mode	TX 2480 MHz _CH78_1Mbps	Polarization	Horizontal
-----------	-------------------------	--------------	------------

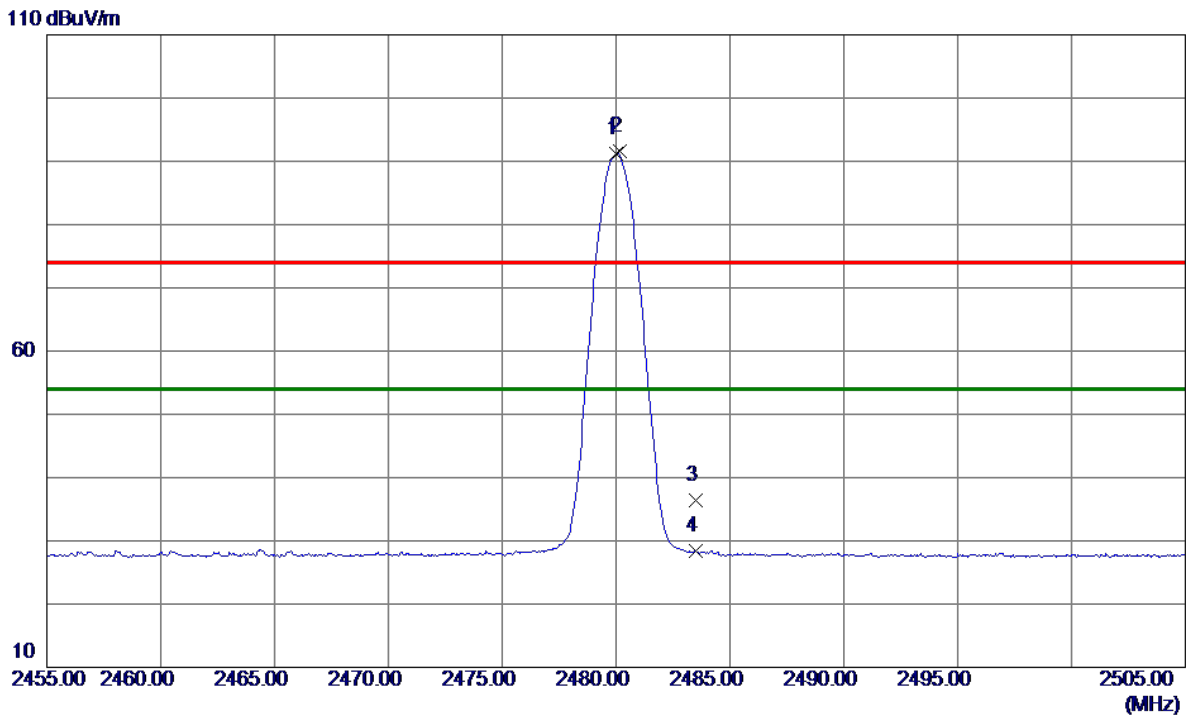

No.	Freq. MHz	Reading Level dBuV/m	Correct Factor dB	Measure ment dBuV/m	Limit dBuV/m	Margin dB	Detector	Comment
1 *	2480.0000	93.42	-2.19	91.23	54.00	37.23	AVG	No Limit
2	2480.1750	93.72	-2.19	91.53	74.00	17.53	Peak	No Limit
3	2483.5000	38.65	-2.19	36.46	74.00	-37.54	Peak	
4	2483.5000	30.52	-2.19	28.33	54.00	-25.67	AVG	

REMARKS:

- (1) Measurement Value = Reading Level + Correct Factor.
- (2) Margin Level = Measurement Value - Limit Value.

Test Mode	TX 2402 MHz_CH00_3Mbps	Polarization	Vertical
-----------	------------------------	--------------	----------

100 dBuV/m

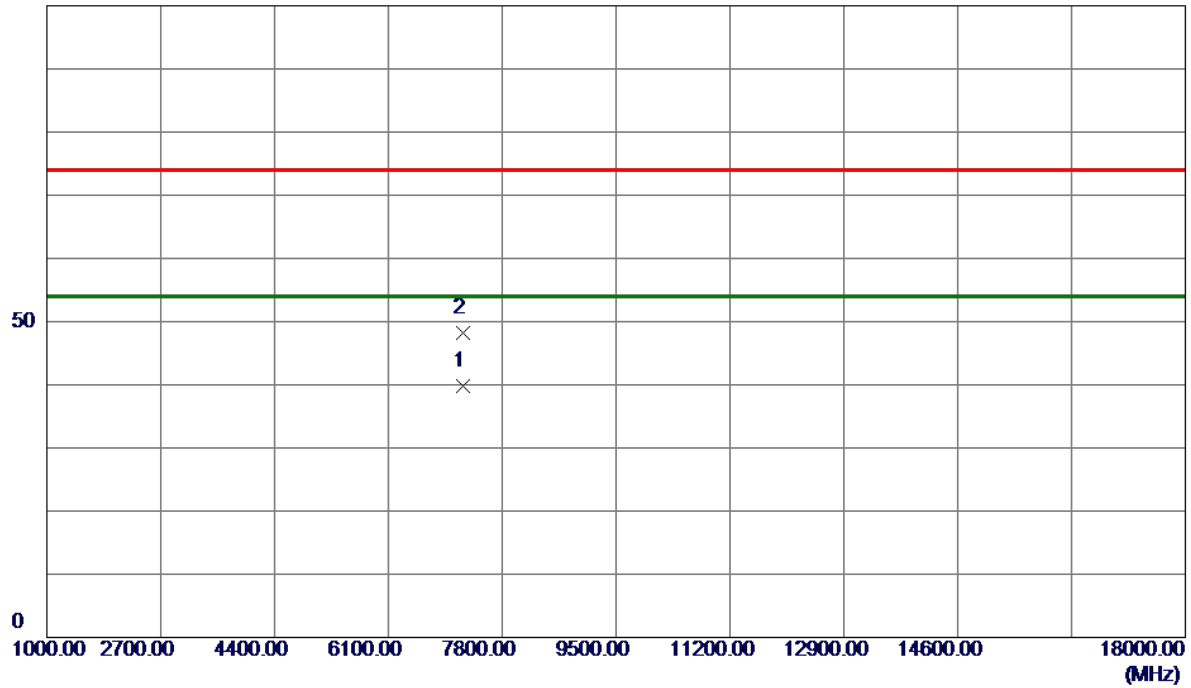

No.	Freq. MHz	Reading Level dBuV/m	Correct Factor dB	Measure ment dBuV/m	Limit dBuV/m	Margin dB	Detector	Comment
1 *	7205.1200	31.44	8.30	39.74	54.00	-14.26	AVG	
2	7206.9430	39.81	8.30	48.11	74.00	-25.89	Peak	

REMARKS:

- (1) Measurement Value = Reading Level + Correct Factor.
- (2) Margin Level = Measurement Value - Limit Value.

Test Mode	TX 2402 MHz_CH00_3Mbps	Polarization	Horizontal
-----------	------------------------	--------------	------------

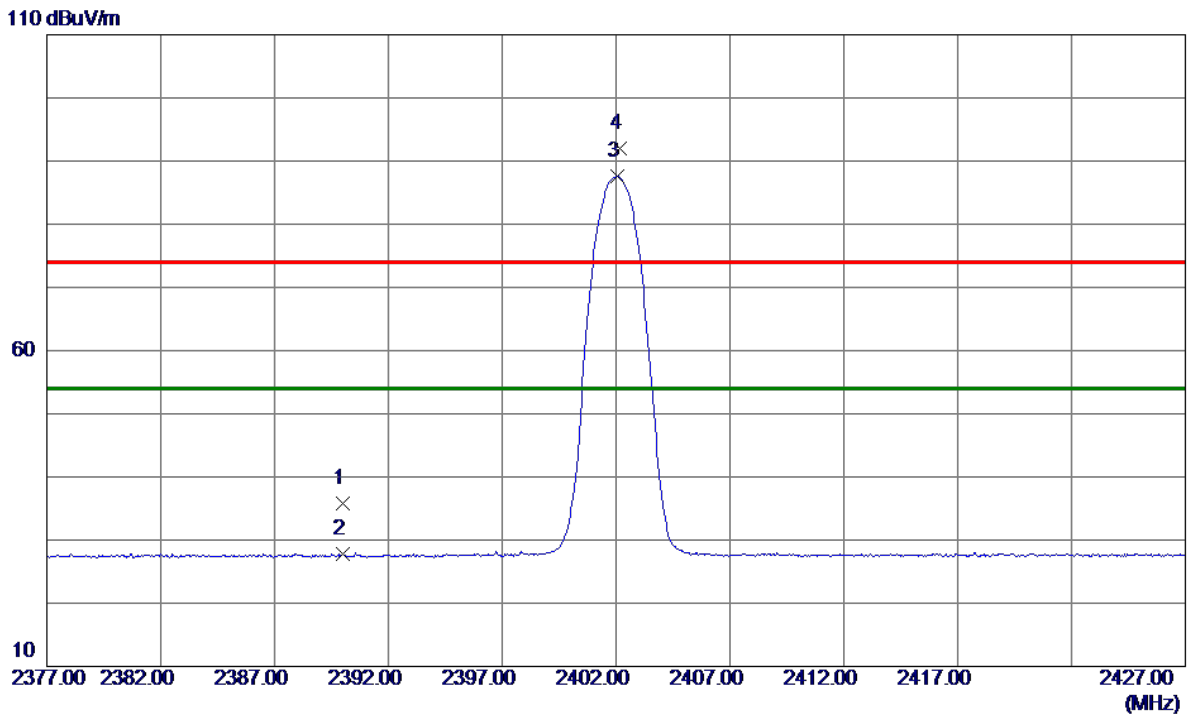

No.	Freq. MHz	Reading Level dBuV/m	Correct Factor dB	Measure ment dBuV/m	Limit dBuV/m	Margin dB	Detector	Comment
1	2390.0000	38.12	-2.30	35.82	74.00	-38.18	Peak	
2	2390.0000	30.02	-2.30	27.72	54.00	-26.28	AVG	
3 *	2402.0500	89.84	-2.29	87.55	54.00	33.55	AVG	No Limit
4	2402.1750	94.29	-2.29	92.00	74.00	18.00	Peak	No Limit

REMARKS:

- (1) Measurement Value = Reading Level + Correct Factor.
- (2) Margin Level = Measurement Value - Limit Value.

Test Mode	TX 2441 MHz _CH39_3Mbps	Polarization	Vertical
-----------	-------------------------	--------------	----------

100 dBuV/m

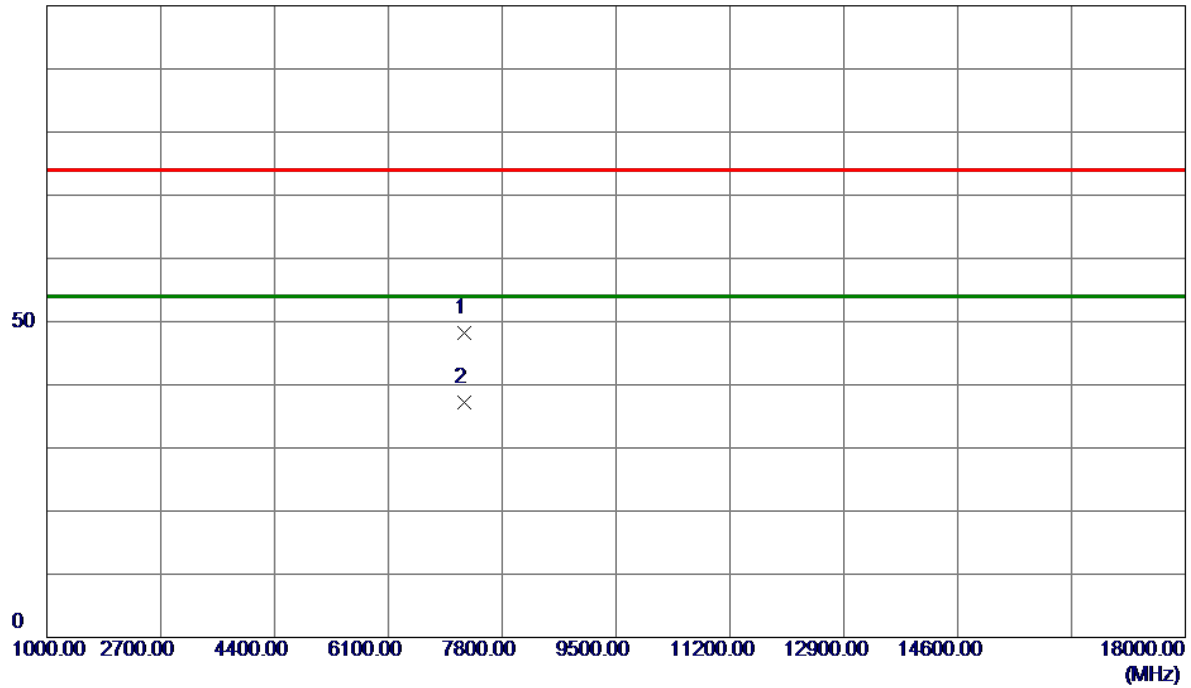

No.	Freq. MHz	Reading Level dBuV/m	Correct Factor dB	Measure ment dBuV/m	Limit dBuV/m	Margin dB	Detector	Comment
1	7233.1720	39.84	8.30	48.14	74.00	-25.86	Peak	
2 *	7233.1820	28.91	8.30	37.21	54.00	-16.79	AVG	

REMARKS:

- (1) Measurement Value = Reading Level + Correct Factor.
- (2) Margin Level = Measurement Value - Limit Value.

Test Mode	TX 2441 MHz _CH39_3Mbps	Polarization	Horizontal
-----------	-------------------------	--------------	------------

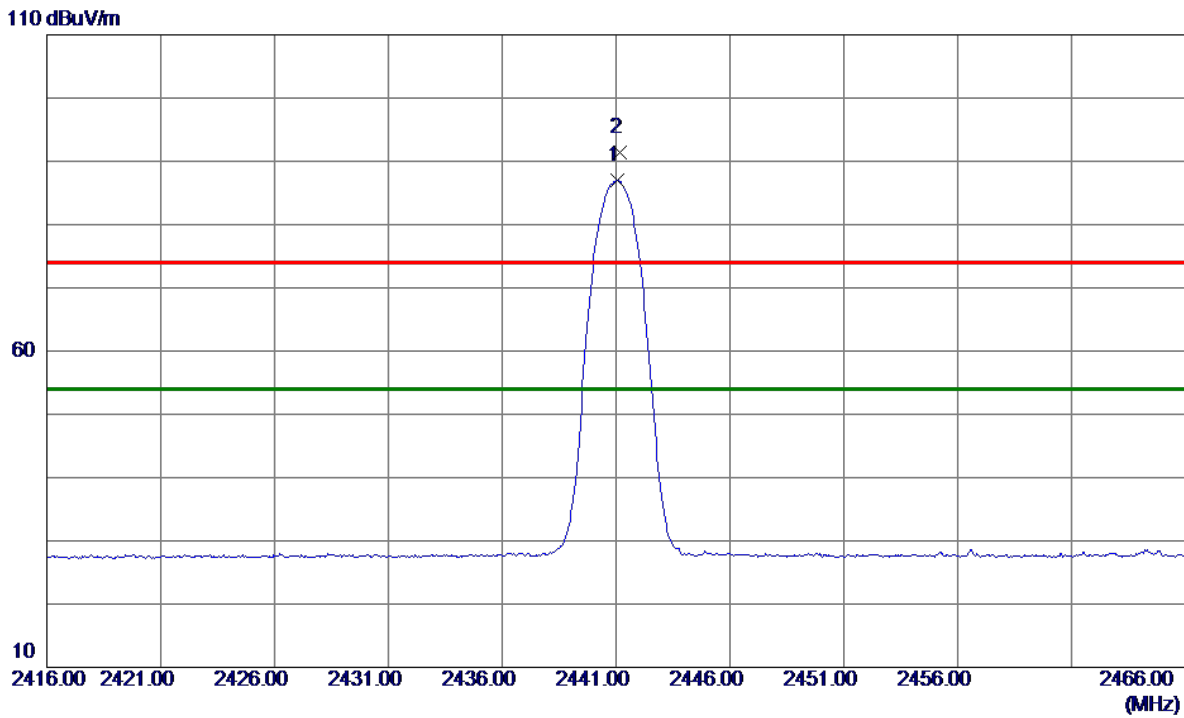

No.	Freq. MHz	Reading Level dBuV/m	Correct Factor dB	Measure ment dBuV/m	Limit dBuV/m	Margin dB	Detector	Comment
1 *	2441.0500	89.19	-2.24	86.95	54.00	32.95	AVG	No Limit
2	2441.1500	93.66	-2.24	91.42	74.00	17.42	Peak	No Limit

REMARKS:

- (1) Measurement Value = Reading Level + Correct Factor.
- (2) Margin Level = Measurement Value - Limit Value.

Test Mode	TX 2480 MHz _CH78_3Mbps	Polarization	Vertical
-----------	-------------------------	--------------	----------

100 dBuV/m

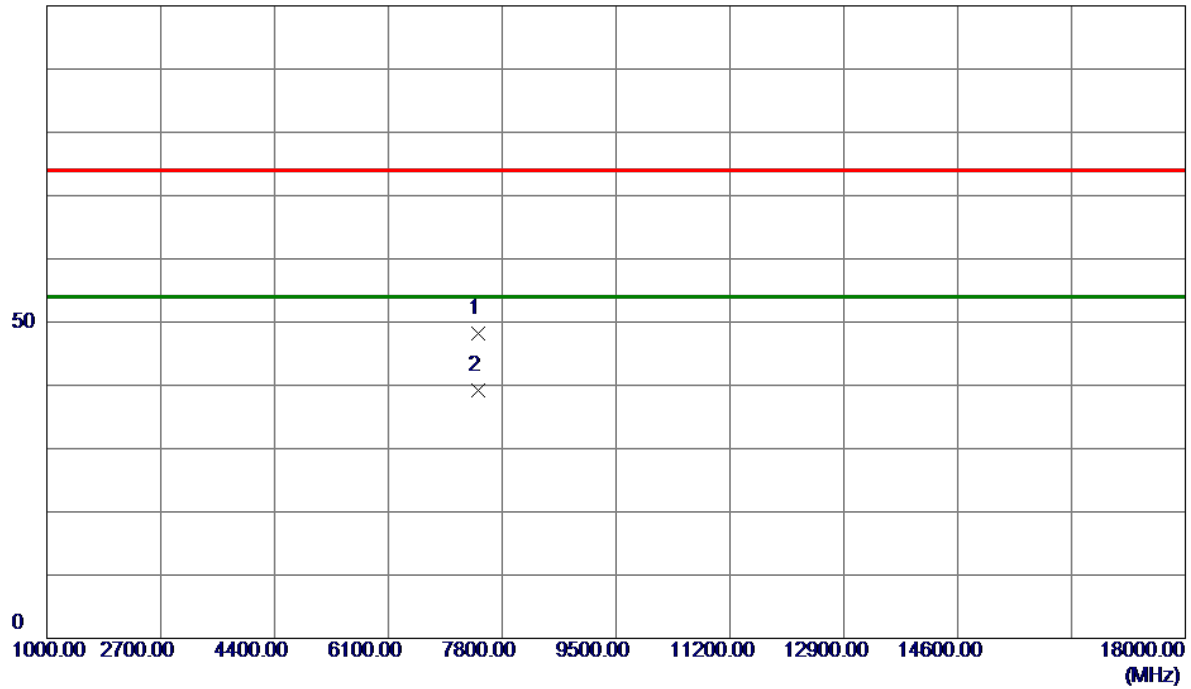

No.	Freq. MHz	Reading Level dBuV/m	Correct Factor dB	Measure ment dBuV/m	Limit dBuV/m	Margin dB	Detector	Comment
1	7442.1320	39.91	8.32	48.23	74.00	-25.77	Peak	
2 *	7442.4880	30.86	8.32	39.18	54.00	-14.82	AVG	

REMARKS:

- (1) Measurement Value = Reading Level + Correct Factor.
- (2) Margin Level = Measurement Value - Limit Value.

Test Mode	TX 2480 MHz _CH78_3Mbps	Polarization	Horizontal
-----------	-------------------------	--------------	------------

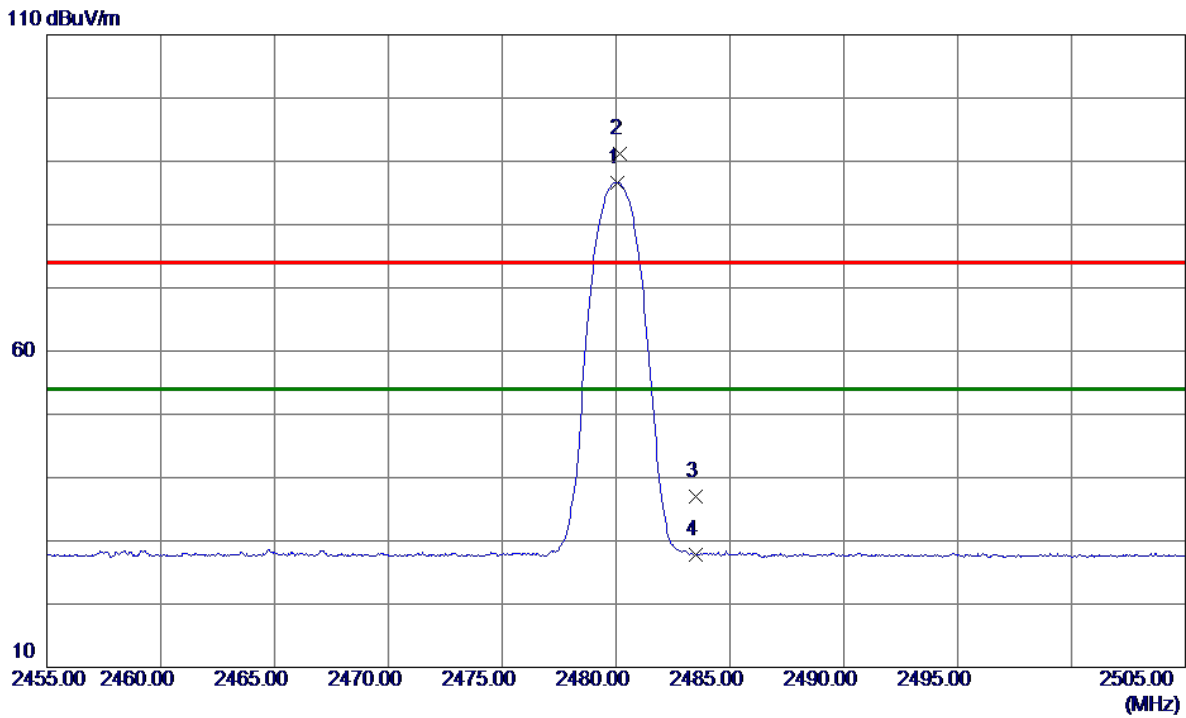

No.	Freq. MHz	Reading Level dBuV/m	Correct Factor dB	Measure ment dBuV/m	Limit dBuV/m	Margin dB	Detector	Comment
1 *	2480.0500	88.87	-2.19	86.68	54.00	32.68	AVG	No Limit
2	2480.1750	93.32	-2.19	91.13	74.00	17.13	Peak	No Limit
3	2483.5000	39.21	-2.19	37.02	74.00	-36.98	Peak	
4	2483.5000	29.95	-2.19	27.76	54.00	-26.24	AVG	

REMARKS:

- (1) Measurement Value = Reading Level + Correct Factor.
- (2) Margin Level = Measurement Value - Limit Value.

Test Mode	TX 2402 MHz_CH00_3Mbps	Polarization	Vertical
-----------	------------------------	--------------	----------

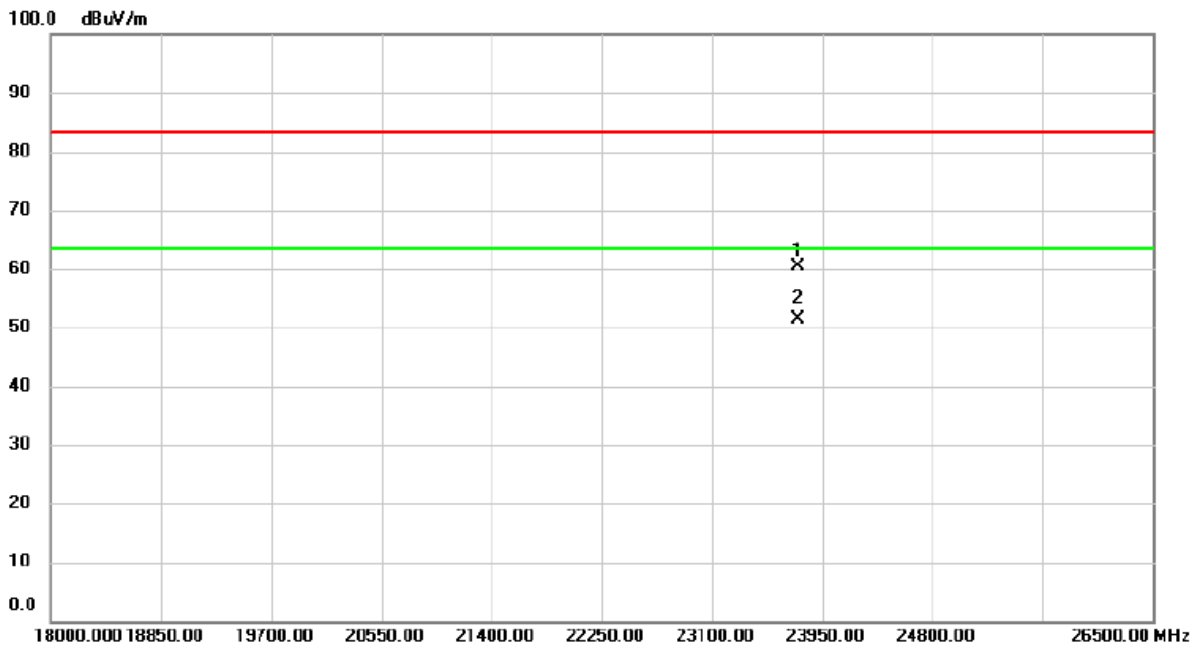

No.	Mk.	Freq. MHz	Reading Level dBuV	Correct Factor dB	Measure- ment dBuV/m	Limit dBuV/m	Margin dB	Detector	Comment
1		23767.25	49.71	10.62	60.33	83.50	-23.17	peak	
2	*	23767.25	40.85	10.62	51.47	63.50	-12.03	AVG	

REMARKS:

- (1) Measurement Value = Reading Level + Correct Factor.
- (2) Margin Level = Measurement Value - Limit Value.

Test Mode	TX 2402 MHz_CH00_3Mbps	Polarization	Horizontal
-----------	------------------------	--------------	------------

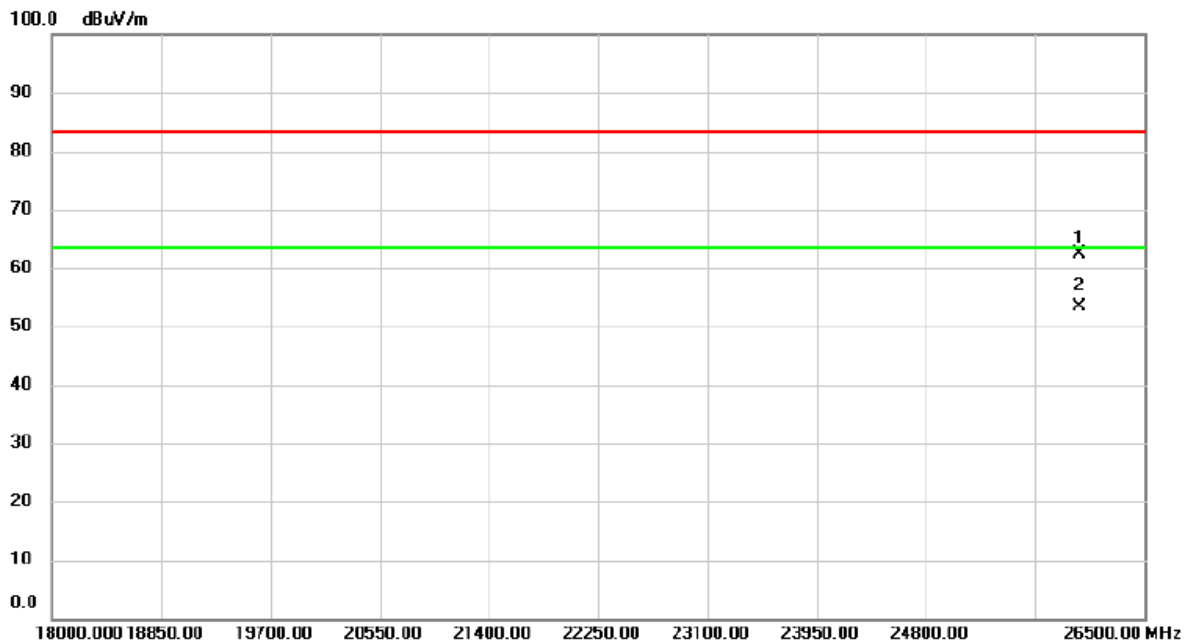

No.	Mk.	Freq. MHz	Reading Level dBuV	Correct Factor dB	Measure- ment dBuV/m	Limit dBuV/m	Margin dB	Detector	Comment
1		25998.50	50.14	12.28	62.42	83.50	-21.08	peak	
2	*	25998.50	41.15	12.28	53.43	63.50	-10.07	AVG	

REMARKS:

- (1) Measurement Value = Reading Level + Correct Factor.
- (2) Margin Level = Measurement Value - Limit Value.

APPENDIX E - NUMBER OF HOPPING FREQUENCY

Test Mode:	TX Mode_1Mbps
------------	---------------

Test Mode	Hopping Mode_1Mbps	Limit	Test Result
Number of Hopping Frequency	79	15	Pass

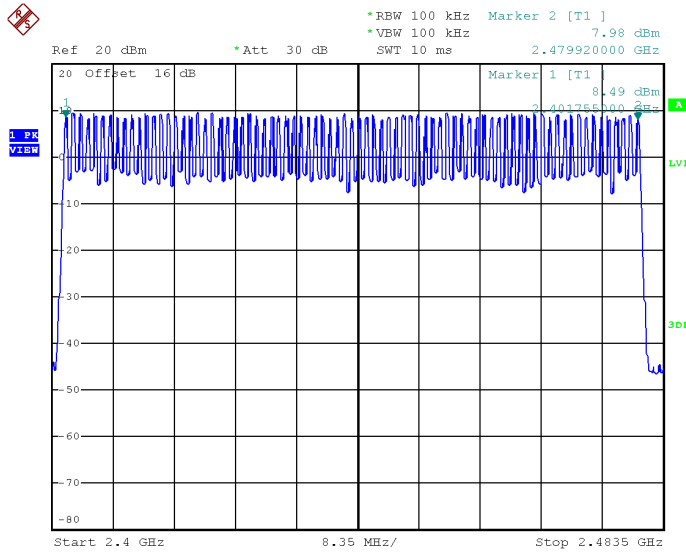

Date: 22.AUG.2024 11:20:03

Test Mode:	TX Mode_3Mbps
------------	---------------

Test Mode	Hopping Mode_3Mbps	Limit	Test Result
Number of Hopping Frequency	79	15	Pass

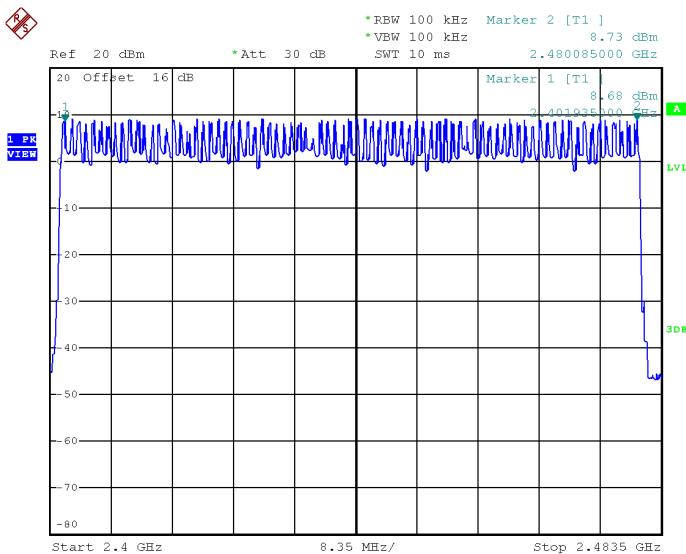

Date: 22.AUG.2024 11:36:31

APPENDIX F - AVERAGE TIME OF OCCUPANCY

Test Mode	Hopping Mode_1Mbps
-----------	--------------------

Data Packet	Frequency (MHz)	Pulse Duration (ms)	Dwell Time (s)	Limits (s)	Test Result
DH1	2402	0.3750	0.1200	0.4000	Pass
DH3	2402	1.6400	0.2624	0.4000	Pass
DH5	2402	2.8800	0.3072	0.4000	Pass
DH1	2441	0.3750	0.1200	0.4000	Pass
DH3	2441	1.6400	0.2624	0.4000	Pass
DH5	2441	2.8800	0.3072	0.4000	Pass
DH1	2480	0.3750	0.1200	0.4000	Pass
DH3	2480	1.6400	0.2624	0.4000	Pass
DH5	2480	2.9200	0.3115	0.4000	Pass

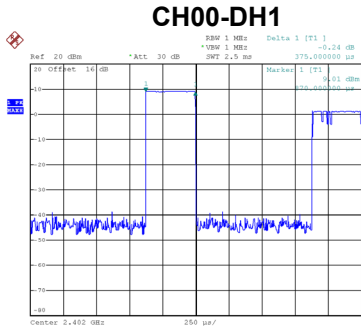

Date: 22.AUG.2024 11:14:03

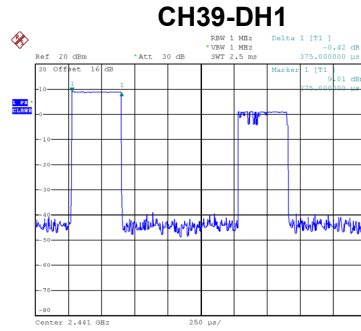

Date: 22.AUG.2024 11:14:27

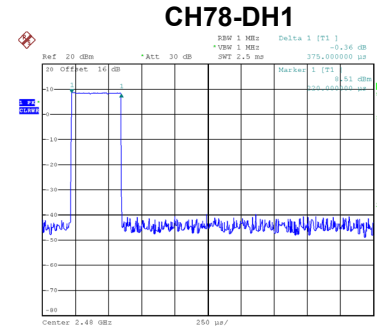

Date: 22.AUG.2024 11:14:49

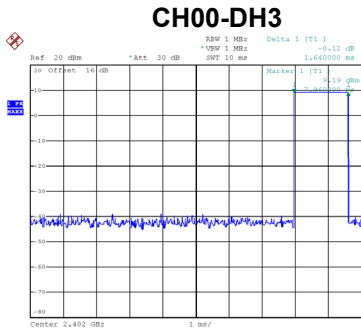

Date: 22.AUG.2024 11:21:44

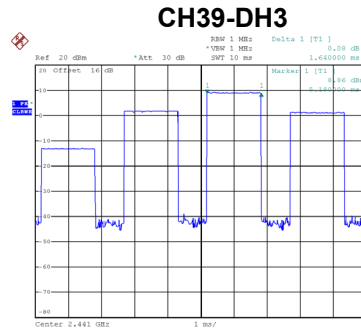

Date: 22.AUG.2024 11:22:07

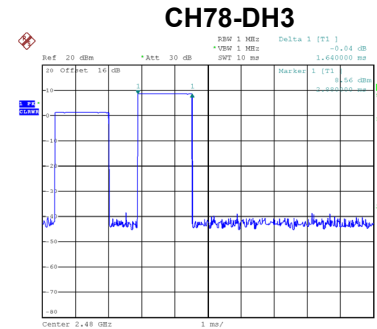

Date: 22.AUG.2024 11:22:14

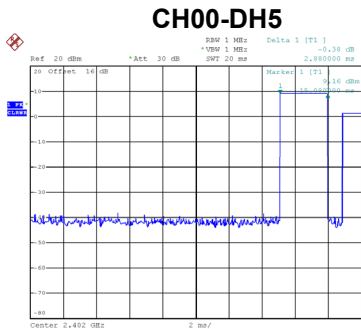

Date: 22.AUG.2024 11:22:26

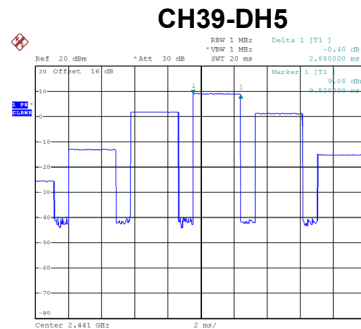

Date: 22.AUG.2024 11:22:32

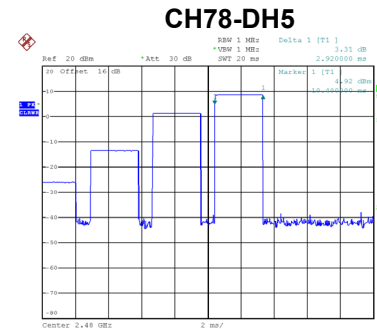

Date: 22.AUG.2024 11:22:36

Test Mode	Hopping Mode_3Mbps
-----------	--------------------

Data Packet	Frequency (MHz)	Pulse Duration (ms)	Dwell Time (s)	Limits (s)	Test Result
3DH1	2402	0.3800	0.1216	0.4000	Pass
3DH3	2402	1.6400	0.2624	0.4000	Pass
3DH5	2402	2.8800	0.3072	0.4000	Pass
3DH1	2441	0.3800	0.1216	0.4000	Pass
3DH3	2441	1.6400	0.2624	0.4000	Pass
3DH5	2441	2.8800	0.3072	0.4000	Pass
3DH1	2480	0.3850	0.1232	0.4000	Pass
3DH3	2480	1.6400	0.2624	0.4000	Pass
3DH5	2480	2.8800	0.3072	0.4000	Pass

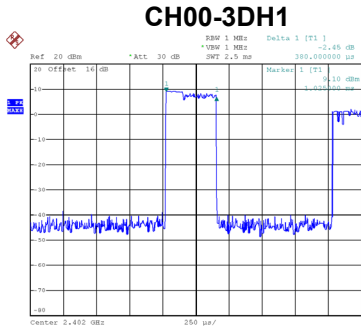

Date: 22.AUG.2024 11:30:54

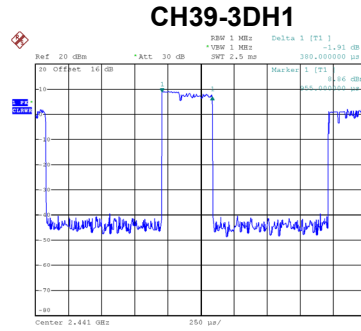

Date: 22.AUG.2024 11:30:59

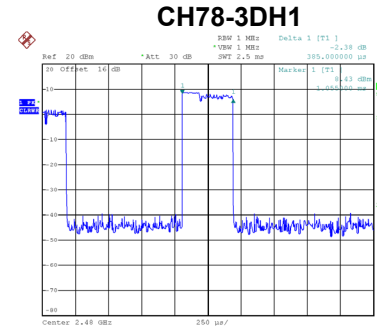

Date: 22.AUG.2024 11:31:23

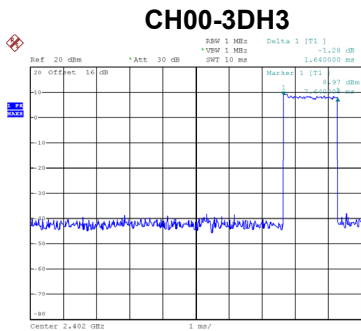

Date: 22.AUG.2024 11:38:10

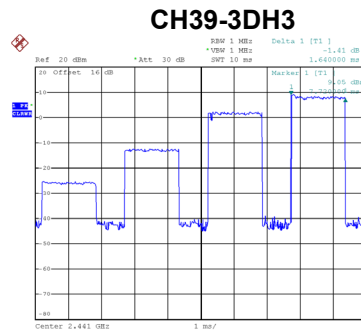

Date: 22.AUG.2024 11:38:19

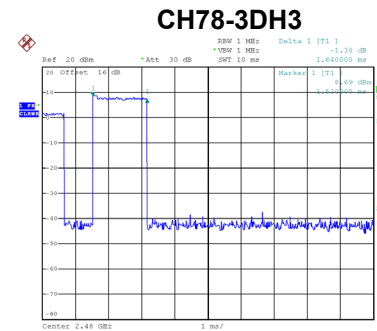

Date: 22.AUG.2024 11:38:43

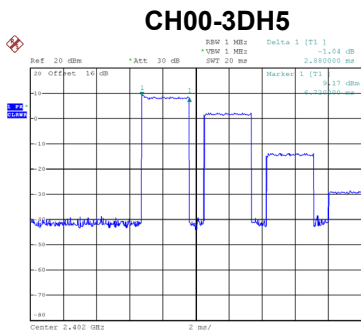

Date: 22.AUG.2024 11:38:56

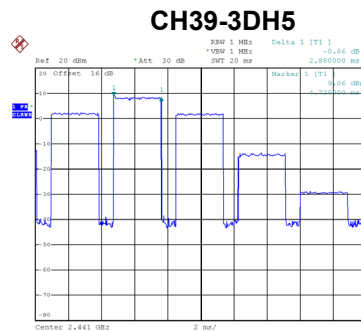

Date: 22.AUG.2024 11:39:03

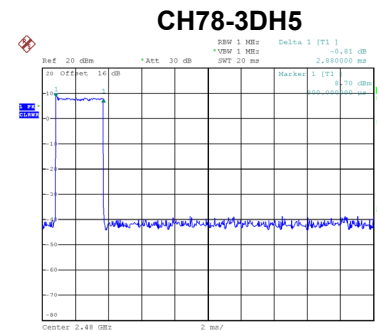

Date: 22.AUG.2024 11:39:10

APPENDIX G - HOPPING CHANNEL SEPARATION

Test Mode	Hopping Mode_1Mbps
-----------	--------------------

Channel	Frequency (MHz)	Channel Separation (MHz)	2/3 of 20 dB Bandwidth (MHz)	Test Result
00	2402	1.017	0.633	Pass
39	2441	0.990	0.637	Pass
78	2480	0.846	0.640	Pass

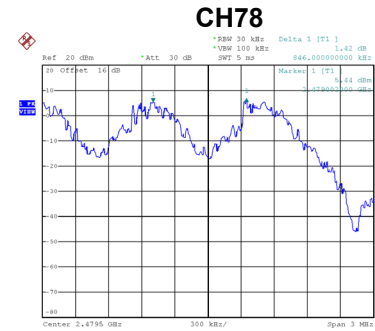
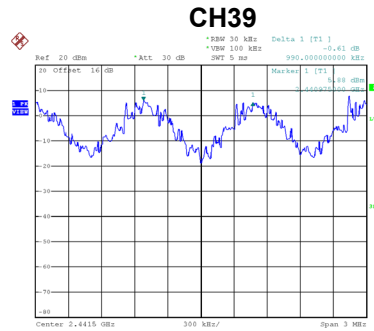
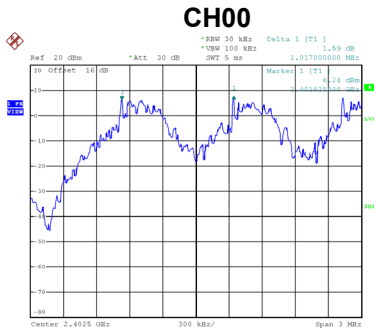

Test Mode	Hopping Mode_3Mbps
-----------	--------------------

Channel	Frequency (MHz)	Channel Separation (MHz)	2/3 of 20 dB Bandwidth (MHz)	Test Result
00	2402	1.197	0.843	Pass
39	2441	0.970	0.857	Pass
78	2480	1.014	0.857	Pass

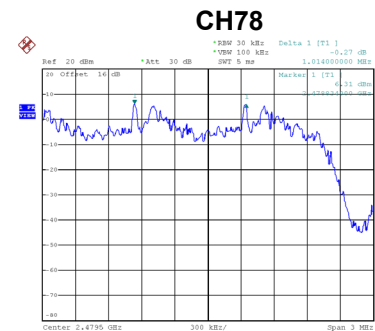
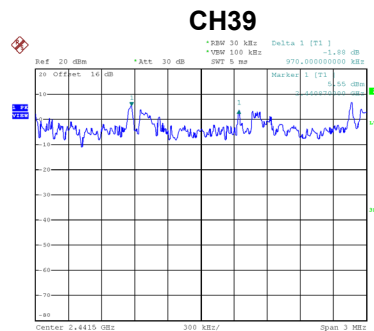
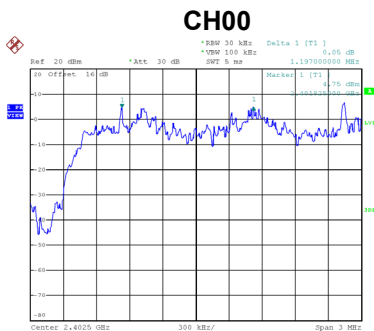

APPENDIX H - BANDWIDTH

Test Mode	TX Mode _1Mbps
-----------	----------------

Channel	Frequency (MHz)	20 dB Bandwidth (MHz)	99 % Occupied Bandwidth (MHz)
00	2402	0.950	0.892
39	2441	0.955	0.884
78	2480	0.960	0.888

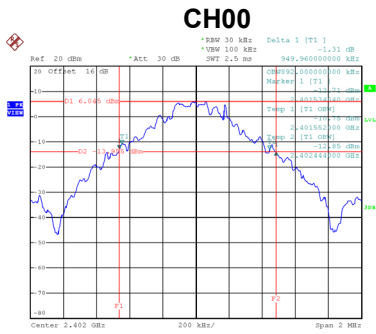

Date: 22.AUG.2024 11:07:33

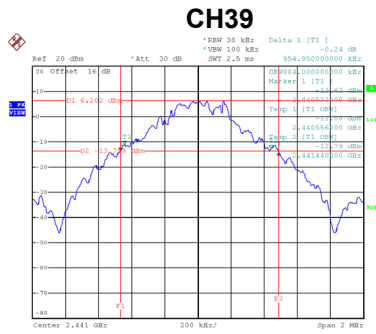

Date: 22.AUG.2024 11:10:40

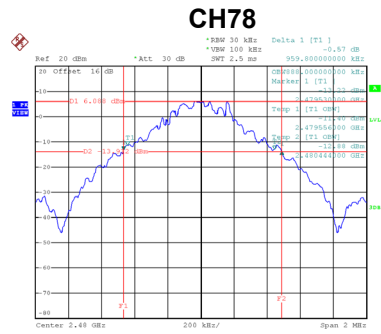

Date: 22.AUG.2024 11:12:37

Test Mode	TX Mode _3Mbps
-----------	----------------

Channel	Frequency (MHz)	20 dB Bandwidth (MHz)	99 % Occupied Bandwidth (MHz)
00	2402	1.264	1.192
39	2441	1.286	1.168
78	2480	1.286	1.180

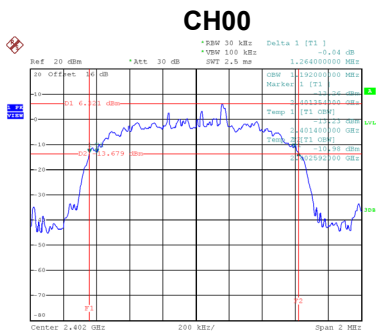

Date: 22.AUG.2024 11:26:21

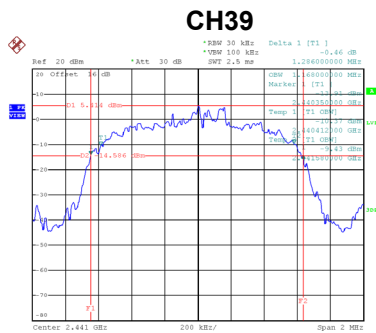

Date: 22.AUG.2024 11:28:09

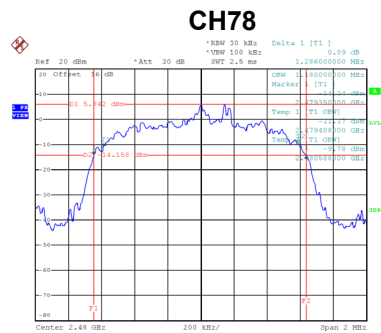

Date: 22.AUG.2024 11:29:28

APPENDIX I - MAXIMUM OUTPUT POWER

Test Mode	TX Mode _1Mbps
-----------	----------------

Channel	Frequency (MHz)	Output Power (dBm)	Max. Limit (dBm)	Max. Limit (W)	Test Result
00	2402	8.65	20.97	0.1250	Pass
39	2441	8.55	20.97	0.1250	Pass
78	2480	8.48	20.97	0.1250	Pass

Note: Output power = Measure result + Cable loss

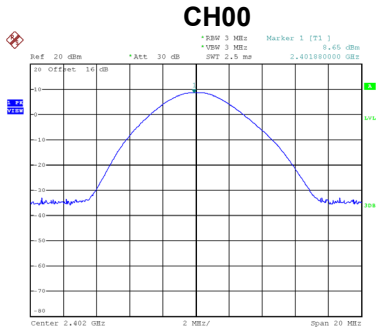

Date: 22_AUG.2024 11:03:43

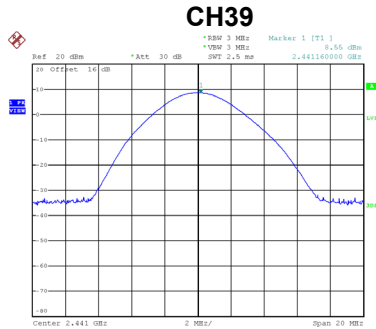

Date: 22_AUG.2024 11:04:18

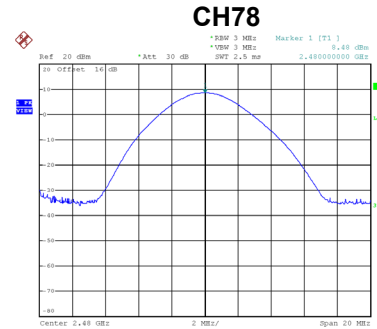

Date: 22_AUG.2024 11:05:03

Test Mode	TX Mode _2Mbps
-----------	----------------

Channel	Frequency (MHz)	Output Power (dBm)	Max. Limit (dBm)	Max. Limit (W)	Test Result
00	2402	8.81	20.97	0.1250	Pass
39	2441	8.73	20.97	0.1250	Pass
78	2480	8.81	20.97	0.1250	Pass

Note: Output power = Measure result + Cable loss

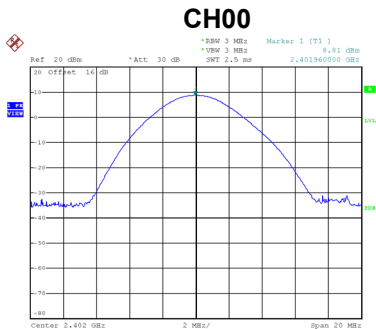

Date: 22_AUG.2024 11:23:42

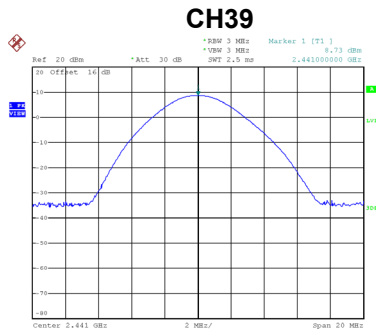

Date: 22_AUG.2024 11:24:26

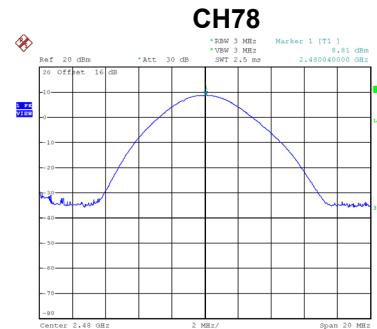

Date: 22_AUG.2024 11:24:47

Test Mode	TX Mode_3Mbps
-----------	---------------

Channel	Frequency (MHz)	Output Power (dBm)	Max. Limit (dBm)	Max. Limit (W)	Test Result
00	2402	8.85	20.97	0.1250	Pass
39	2441	8.69	20.97	0.1250	Pass
78	2480	8.84	20.97	0.1250	Pass

Note: Output power = Measure result + Cable loss

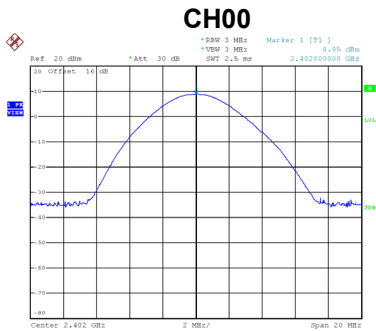

Date: 22.AUG.2024 11:41:03

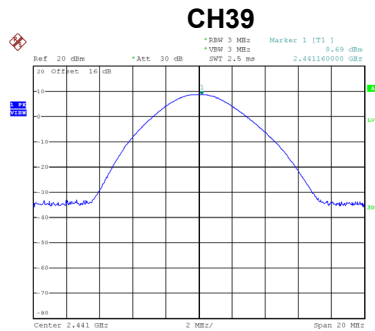

Date: 22.AUG.2024 11:41:58

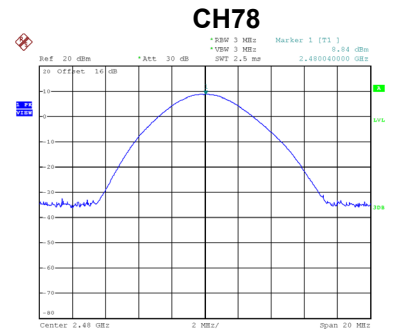

Date: 22.AUG.2024 11:42:40

APPENDIX J - CONDUCTED SPURIOUS EMISSION

Test Mode TX Mode _ 1Mbps

Bandedge CH00 (Lower)

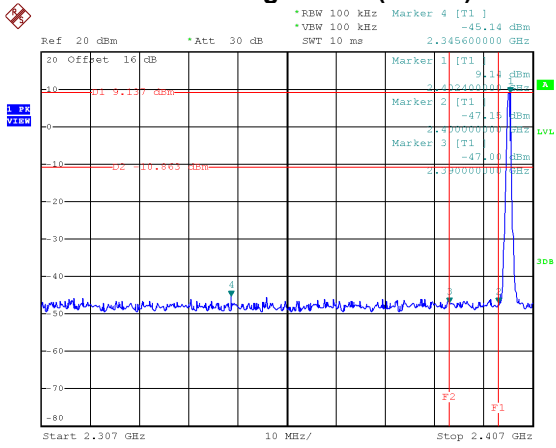

Date: 22.AUG.2024 11:07:00

Bandedge CH78 (Upper)

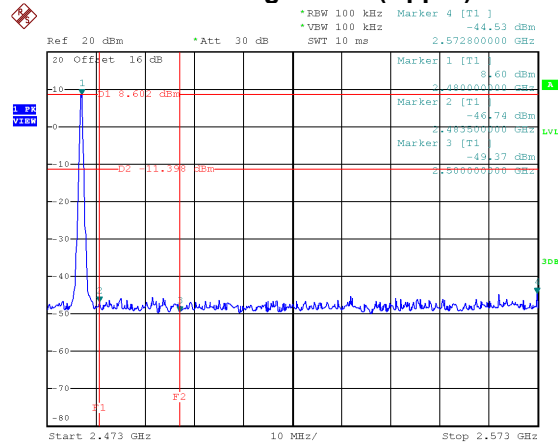

Date: 22.AUG.2024 11:11:54

Hopping on mode (Lower)

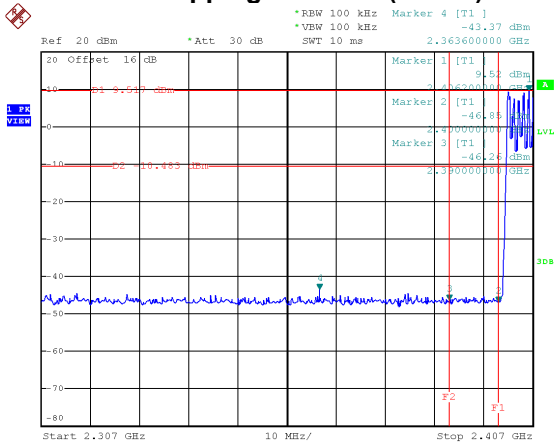

Date: 22.AUG.2024 11:20:37

Hopping on mode (Upper)

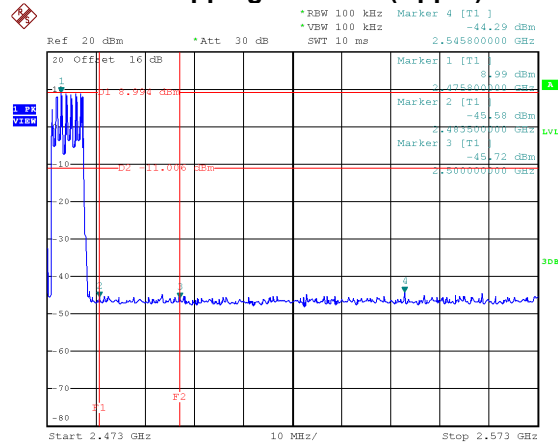

Date: 22.AUG.2024 11:21:11

CH00 – 10th Harmonic of the fundamental frequency

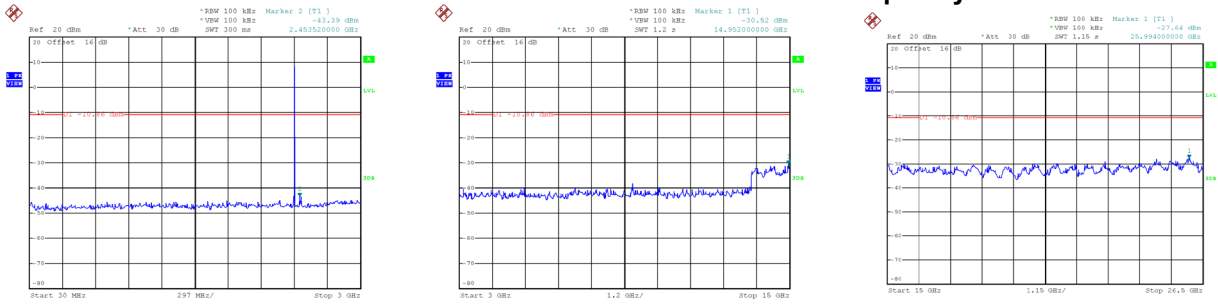

Date: 22.AUG.2024 11:07:46

Date: 22.AUG.2024 11:07:53

Date: 22.AUG.2024 11:08:01

CH39 – 10th Harmonic of the fundamental frequency

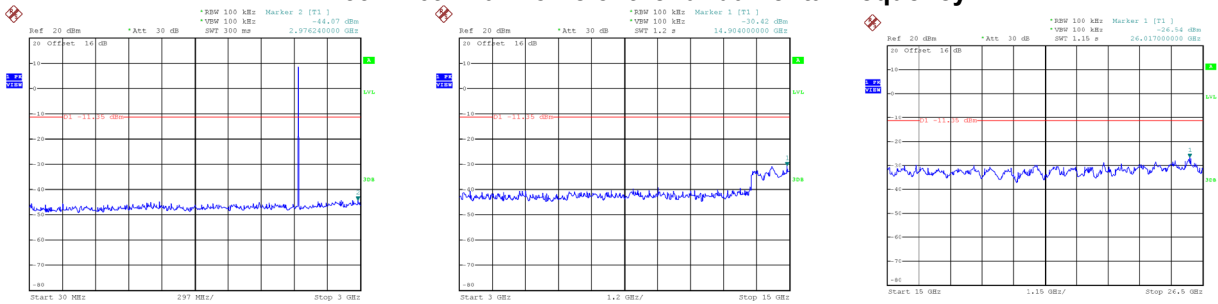

Date: 22.AUG.2024 11:09:53

Date: 22.AUG.2024 11:10:00

Date: 22.AUG.2024 11:10:07

CH78 – 10th Harmonic of the fundamental frequency

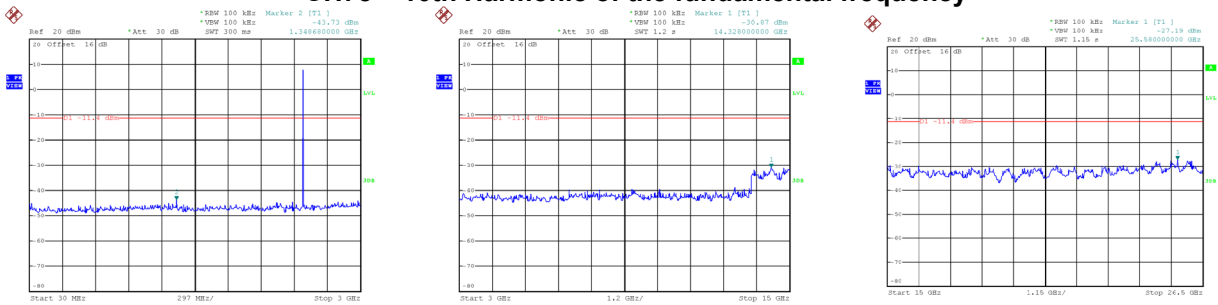

Date: 22.AUG.2024 11:12:50

Date: 22.AUG.2024 11:12:57

Date: 22.AUG.2024 11:13:04

Test Mode TX Mode_3Mbps

Bandedge CH00 (Lower)

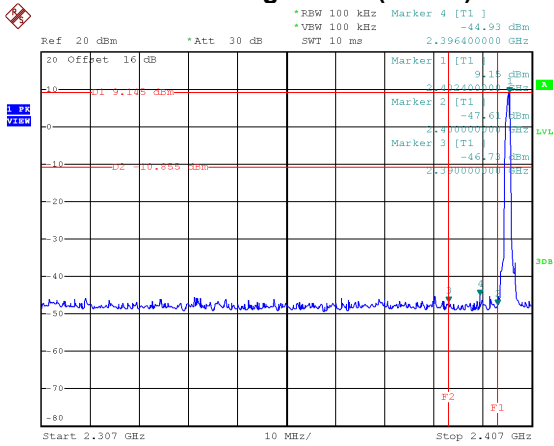

Date: 22.AUG.2024 11:25:55

Bandedge CH78 (Upper)

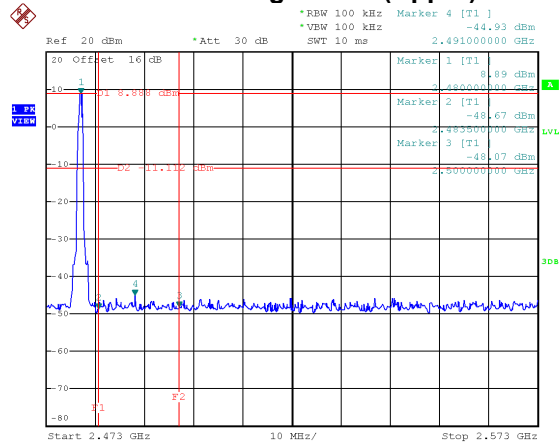

Date: 22.AUG.2024 11:28:57

Hopping on mode (Lower)

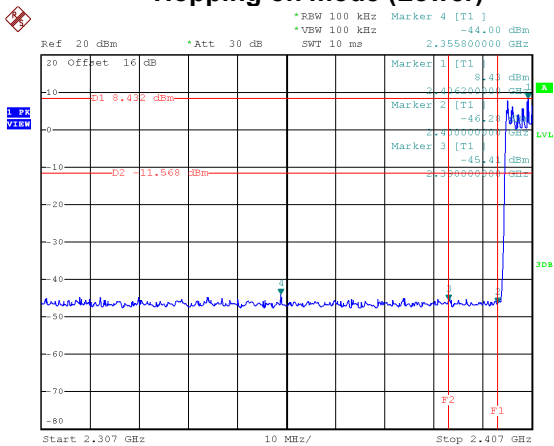

Date: 22.AUG.2024 11:37:05

Hopping on mode (Upper)

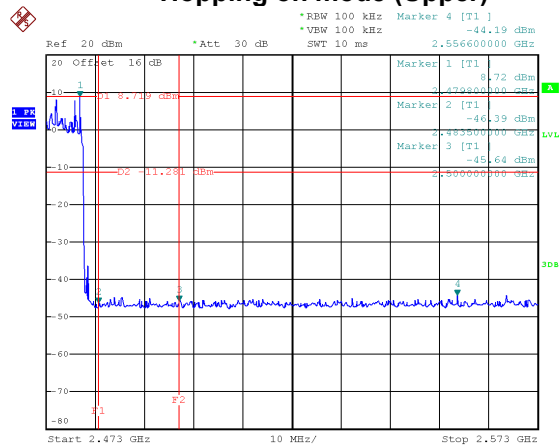

Date: 22.AUG.2024 11:37:56

CH00 – 10th Harmonic of the fundamental frequency

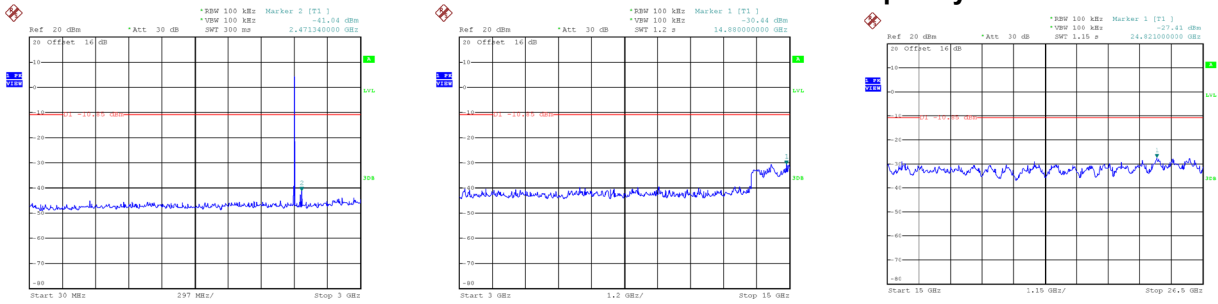

Date: 22.AUG.2024 11:26:35

Date: 22.AUG.2024 11:26:42

Date: 22.AUG.2024 11:26:49

CH39 – 10th Harmonic of the fundamental frequency

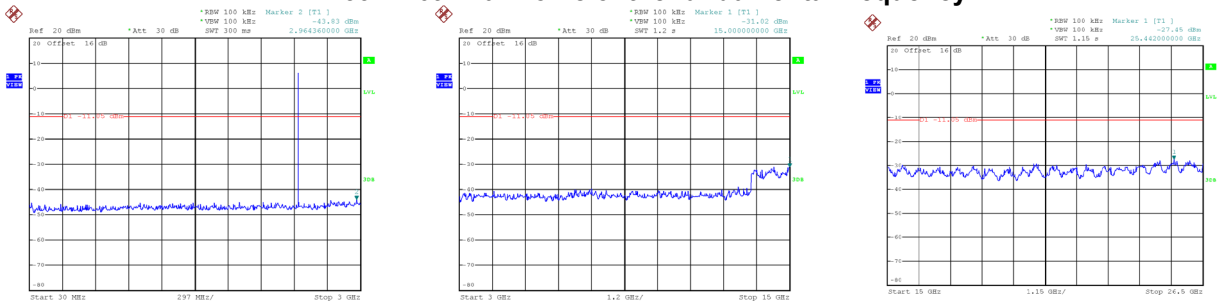

Date: 22.AUG.2024 11:27:29

Date: 22.AUG.2024 11:27:37

Date: 22.AUG.2024 11:27:44

CH78 – 10th Harmonic of the fundamental frequency

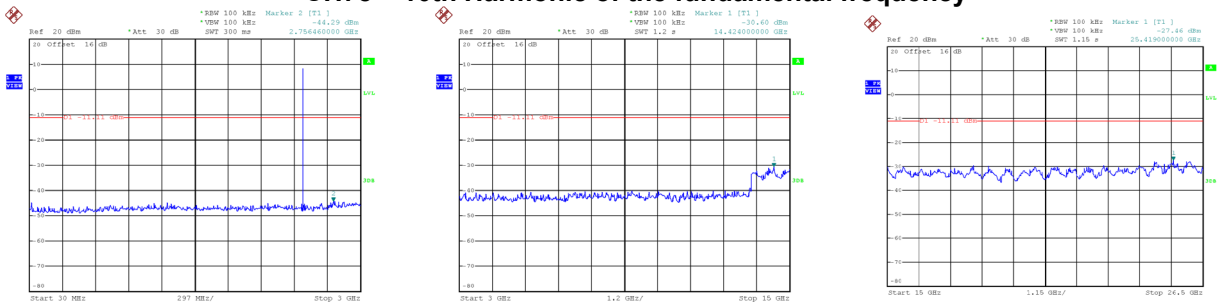

Date: 22.AUG.2024 11:29:42

Date: 22.AUG.2024 11:29:49

Date: 22.AUG.2024 11:29:56

APPENDIX K - DECLARATION FOR BLUETOOTH DEVICE

1. Output power and channel separation of a Bluetooth device in the different operating modes:

The different operating modes (data-mode, acquisition-mode) of a Bluetooth device has no influence on the output power and the channel spacing. There is only one transmitter which is driven by identical input parameters concerning these two parameters.
Only a different hopping sequence will be used. For this reason the check of these RF parameters in one op-mode is sufficient.

2. Frequency range of a Bluetooth device:

Hereby we declare that the maximum frequency of this device is: 2402 - 2480MHz. This is according to the Bluetooth Core Specification (+ critical errata) for devices which will be operated in the USA. This was checked during the Bluetooth Qualification tests (Test Case: TRM/CA/04-E). Other frequency ranges (e.g. for Spain, France, Japan) which are allowed according the Core Specification are not supported by this device.

3. Co-ordination of the hopping sequence in data mode to avoid simultaneous occupancy by multiple transmitters:

Bluetooth units which want to communicate with other units must be organised in a structure called piconet. This piconet consist of max. 8 Bluetooth units. One unit is the master the other seven are the slaves. The master co-ordinates frequency occupation in this piconet for all units. As the master hop sequence is derived from its BD address which is unique for each Bluetooth device, additional masters intending to establish new piconets will always use different hop sequences.

4. Example of a hopping sequence in data mode:

Example of a 79 hopping sequence in data mode:
40, 21, 44, 23, 42, 53, 46, 55, 48, 33, 52, 35, 50, 65, 54, 67, 56, 37, 60, 39, 58, 69, 62, 71, 64, 25, 68, 27, 66, 57, 70, 59, 72, 29, 76, 31, 74, 61, 78, 63, 01, 41, 05, 43, 03, 73, 07, 75, 09, 45, 13, 47, 11, 77, 15, 00, 64, 49, 66, 53, 68, 02, 70, 06, 01, 51, 03, 55, 05, 04

5. Equally average use of frequencies in data mode and behaviour for short transmissions:

The generation of the hopping sequence in connection mode depends essentially on two input values:

- a) LAP/UAP of the master of the connection.
- b) Internal master clock.

The LAP (lower address part) are the 24 LSB's of the 48 BD_ADDRESS. The BD_ADDRESS is an unambiguous number of every Bluetooth unit. The UAP (upper address part) are the 24 MSB's of the 48 BD_ADDRESS.

The internal clock of a Bluetooth unit is derived from a free running clock which is never adjusted and is never turned off. For synchronisation with other units only offset are used. It has no relation to the time of the day. Its resolution is at least half the RX/TX slot length of 312.5 μ s. The clock has a cycle of about one day (23h30). In most case it is implemented as 28 bit counter. For the deriving of the hopping sequence the entire.

LAP (24 bits), 4 LSB's (4 bits) (Input 1) and the 27 MSB's of the clock (Input 2) are used. With this input values different mathematical procedures (permutations, additions, XOR- operations) are performed to generate the sequence. This will be done at the beginning of every new transmission.

Regarding short transmissions the Bluetooth system has the following behaviour:

The first connection between the two devices is established, a hopping sequence was generated. For transmitting the wanted data the complete hopping sequence was not used. The connection ended. The second connection will be established. A new hopping sequence is generated. Due to the fact that the Bluetooth clock has a different value, because the period between the two transmission is longer (and it cannot be shorter) than the minimum resolution of the clock (312.5 μ s). The hopping sequence will always differ from the first one.

6. Receiver input bandwidth and behaviour for repeated single or multiple packets:

The input bandwidth of the receiver is 1 MHz. In every connection one Bluetooth device is the master and the other one is the slave. The master determines the hopping sequence (see chapter 5). The slave follows this sequence. Both devices shift between RX and TX time slot according to the clock of the master.

Additionally the type of connection (e.g. single or multislot packet) is set up at the beginning of the connection. The master adapts its hopping frequency and its TX/RX timing according to the packet type of the connection. Also the slave of the connection will use these settings.

Repeating of a packet has no influence on the hopping sequence. The hopping sequence generated by the master of the connection will be followed in any case. That means, a repeated packet will not be send on the same frequency, it is send on the next frequency of the hopping sequence.

End of Test Report