

Report on Test Measurements for FCC ID ABZ99FT3095B, HVIN SLR 8000-VHFB per FCC 47 CFR 90 and IC RSS-119.

Measurements Report

The measurement report shows compliance information against applicable standards. Each parameter is measured generally at the low end, middle, and at the high end of the applicable frequency band.

Each section of the report contains either verbiage or graphs which show compliance to applicable standards as required, explains testing method used, and indicates what the applicable specification is.

Test setup details and certification signoff page are included at the end of the measurement report.

INDEX

<u>EXHIBIT</u>	<u>DESCRIPTION</u>
E1-1	Tested Unit Details
E1-2	Measurement Uncertainties
E1-3	Test Results Summary
E1-4	RF Output Power
E1-5	Occupied Bandwidth
E1-6	Conducted Spurious Emissions
E1-7	Radiated Spurious Emissions
E1-8	Frequency Stability
E1-9	Frequency Transient Behavior
E1-10	Audio Frequency Response – Modulation Characteristics
E1-11	Audio Modulation Limiting – Modulation Characteristics
E1-12	Test Setup Details
E1-13	Statement of Certification

APPLICANT: MOTOROLA SOLUTIONS

EQUIPMENT TYPE: ABZ99FT3095B

109AB-99FT3095B

**Report on Test Measurements for FCC ID ABZ99FT3095B, HVIN SLR 8000-VHFB per FCC
47 CFR 90 and IC RSS-119.**

E1-1 Tested Unit Details

Model Under Test	SLR 8000
Serial Number	433IYY0565
Firmware Version	D20.22.03.09
Codeplug Version	226303
Bootloader Version	R01.01.00
Manufacturer	Motorola Solutions 2540 Galvin Drive, Elgin, IL 60124

Report on Test Measurements for FCC ID ABZ99FT3095B, HVIN SLR 8000-VHFB per FCC 47 CFR 90 and IC RSS-119.

E1-2: Measurement Uncertainty

Measurement	Frequency	Expanded Uncertainty
RF Power Output	50MHz-10GHz	+/-0.132dB
Carrier Frequency Stability	9kHz-13GHz	+/-0.368Hz
Occupied Bandwidth	9kHz-13GHz	+/-0.52dB
Transmitter Conducted Spurious Emissions	9kHz-13GHz	+/-0.64dB
Transient Frequency Behavior	9kHz-13GHz	+/-2.04dB
Modulation Characteristics	100-5000Hz	+/-0.40dB
Radiated Emissions	30MHz-1000MHz	4.3dB
Radiated Emissions	1GHz-6GHz	3.1dB

Report on Test Measurements for FCC ID ABZ99FT3095B, HVIN SLR 8000-VHFB per FCC 47 CFR 90 and IC RSS-119.

E1.3: Test Results Summary

Test	47 CFR Reference	RSS-119 Reference	Results
RF Output Power	2.1046	4.1,5.4	Pass
Occupied Bandwidth	2.1049	5.5	Pass
Conducted Spurious Emissions	2.1051	4.2,5.8	Pass
Radiated Spurious Emissions	2.1053	4.2,5.8	Pass
Frequency Stability	2.1055	5.3	Pass
Frequency Transient Behavior	90.214	5.9	Pass
Modulation Characteristics	2.1047		Pass

Test Standards:

Title 47 Part 2 of Code of Federal Regulations

Title 47 Part 90 of Code of Federal Regulations

RSS-119 Land Mobile and Fixed Equipment Operating in the Frequency Range 27.41-960 MHz

ANSI C63.26-2015 American National Standard for Compliance Testing of Transmitters

Used in Licensed Radio Services

ANSI C63.4-2014 American National Standard for Methods of Measurement of Radio-Noise

Emissions from Low-Voltage Electrical and Electronic Equipment in the Range 9 kHz to 40 Ghz

Report on Test Measurements for FCC ID ABZ99FT3095B, HVIN SLR 8000-VHFB per FCC 47 CFR 90 and IC RSS-119.

E1-4 RF Power Output Data per CFR 47 2.1046 and RSS-119 5.4

The RF power output was measured with the indicated voltage applied to and current into the final RF amplifying device(s). The DC current indicated is the total for the final RF amplifier stage.

Analog Voice (FM) and Digital MOTOTRBO™ 4-Level Frequency Modulation (4FSK)

	<u>136MHz</u>	<u>138MHz</u>	<u>155MHz</u>	<u>174MHz</u>	
Measured RF output	110	110	110	110	Watts
DC Voltage, final RF amplifier stage/stages	15.75	15.75	15.75	15.75	Volts
DC Current, final RF amplifier stage/stages	18.3	18.3	17	16.5	Amps
Input power for final RF amplifying device(s)	288	288	268	260	Watts
Primary Radio Input Supply Voltage	120	120	120	120	VAC
Minimum Measured RF output	1	1	1	1	Watts
DC Voltage, final RF amplifier stage/stages	15.75	15.75	15.75	15.75	Volts
Normal DC Current	2.7	2.7	2.6	2.6	Amps
Input power for final RF amplifying device(s)	43	43	41	41	Watts
Primary Radio Input Supply Voltage	120	120	120	120	VAC

**Report on Test Measurements for FCC ID ABZ99FT3095B, HVIN SLR 8000-VHFB per FCC
47 CFR 90 and IC RSS-119.****E1-5 Occupied bandwidth per CFR 47 2.1051 and RSS-119 5.5**Occupied Bandwidth – MOTOTRBO™ Digital Modulation, 12.5 kHz Channel Spacing

MOTOTRBO™ Digital Modulation can be used in a system configuration based upon channel usage as described in Exhibit B. The 'F7E' and 'FXE' emission designators provide usage for telephony, the 'F7D' and 'FXD' designators provide usage for data / telecommand, and the 'F7W' designator provides for usage as a combination of telephony and telecommand. All are spectrally identical. The occupied bandwidth chart references the following setup and specification requirements.

Modulation Type: MOTOTRBO™ Digital Modulation

Emission Designator: 7K60F7W, 7K60F7D, 7K60F7E, 7K60FXD, 7K60FXE

Channelization: 12.5 kHz

Power Setting: 110 Watts

Specification Requirement 47 CFR §90.210(d) and IC RSS-119 section 5.8.3 - Emission Limits –
“D-Mask”:

Emission Mask D. For transmitters designed to operate with a 12.5 kHz channel bandwidth, any emission must be attenuated below the power (P) of the highest emission contained within the authorized bandwidth as follows:

(1) On any frequency from the center of the authorized bandwidth (f_0) to 5.625 kHz removed from f_0 : *Zero dB*

(2) On any frequency removed from the center of the authorized bandwidth by a displacement frequency (f_d in kHz) of more than 5.625 kHz but no more than 12.5 kHz:
*At least $7.27 * (f_d - 2.88 \text{ kHz}) \text{ dB}$*

(3) On any frequency removed from the center of the authorized bandwidth by a displacement frequency (f_d in kHz) of more than 12.5 kHz:
At least $50 \text{ plus } 10 \log_{10}(P) \text{ dB}$ or 70 dB , whichever is the lesser attenuation.

(4) The reference level for showing compliance with the emission mask shall be established using a resolution bandwidth sufficiently wide to capture the true peak emission of the equipment under test. In order to show compliance with the emissions mask up to and including 50 kHz removed from the edge of the authorized bandwidth, adjust the resolution bandwidth to 100 Hz with the measuring instrument in a peak hold mode. A sufficient number of sweeps must be measured to ensure that the emission profile is developed.

Report on Test Measurements for FCC ID ABZ99FT3095B, HVIN SLR 8000-VHFB per FCC 47 CFR 90 and IC RSS-119.

Necessary Bandwidth Calculation:

The necessary bandwidth of the modulation per the formulas defined in 47 CFR §2.202(g) / TRC-43 section 8 is as follows:

Four Level Frequency Modulation is used to modulate a carrier with a digital bit stream: Data Rate: R = 9600 bps; Bits per Symbol: S=2; Modulation rate in baud = B = 9600 / 2 = 4800; Max Modulation Frequency = M = 1/2 * B = 2400 Hz; Deviation at the outer symbols is 1.944 kHz; A square root raised cosine filter is implemented for the modulation low pass filter with the following magnitude response, |F(f)|:

|F(f)|: 1 for |f| ≤ 1920Hz

|F(f)|: |cos(πf/1920)| for 1920Hz ≤ f ≤ 2880Hz

|F(f)|: 0 for |f| > 2880Hz

where f = frequency in hertz.

Max Mod Freq, M= 1/2B	Max Deviation, D	2M+2DK (K=.72)	Nec BW
2.4 kHz	1.944 kHz	7.60 kHz	7K60

Measurement Procedure and Instrument Settings:

Emission Measurement Analyzer Settings		Measured Occupied Bandwidth
Horizontal: 12.5 kHz per Division	Resolution BW: 100 Hz	Resolution BW: 100 Hz
Vertical: 10 dB per Division	Video BW: 10 kHz	Span: 125 kHz
Sweep Time: 72 Seconds (<2 kHz/Sec)	Span: 125 kHz	Number of Points: 6401
Detector: Peak		Integration Time: 34.16 ms

Test Procedure:

- 1) Adjust the spectrum analyzer per the values specified in the Emission Measurement Analyzer Settings.
- 2) Modulate the transmitter with the appropriate signaling pattern, (pseudorandom data) and key the transmitter at the full power rating. Use the analyzer controls to set this signal to the full-scale reference line. Allow the analyzer to sweep fully and store the sweep.
- 3) Use the band power marker function of the spectrum analyzer to measure the power of the carrier.
- 4) Use the carrier power value from the previous step to generate the emission mask limit.
- 5) Plot the resulting analyzer trace and the emission mask limit, add text and labeling as appropriate.
- 6) Adjust the signal analyzer resolution BW and span as indicated above, use the Occupied Bandwidth function to record the value.

APPLICANT: MOTOROLA SOLUTIONS

EQUIPMENT TYPE: ABZ99FT3095B

109AB-99FT3095B

**Report on Test Measurements for FCC ID ABZ99FT3095B, HVIN SLR 8000-VHFB per FCC
47 CFR 90 and IC RSS-119.**

EXHIBIT	DESCRIPTION	Meas Occ BW
E1-5.1	Occupied Bandwidth – MOTOTRBO™ Digital Modulation, 136.0125 MHz	7.51kHz
E1-5.2	Occupied Bandwidth – MOTOTRBO™ Digital Modulation, 138.0125 MHz	7.47kHz
E1-5.3	Occupied Bandwidth – MOTOTRBO™ Digital Modulation, 155.0125 MHz	7.59kHz
E1-5.4	Occupied Bandwidth – MOTOTRBO™ Digital Modulation, 173.9875 MHz	7.38 kHz

Report on Test Measurements for FCC ID ABZ99FT3095B, HVIN SLR 8000-VHFB per FCC 47 CFR 90 and IC RSS-119.

Occupied Bandwidth – Analog Voice Frequency Modulation, 25 kHz Channel Spacing

The exhibits in this section show occupied bandwidth plots for analog voice modulation. Data is shown with the modulating audio tone itself, the tone plus Private Line (PL) sub-audible tone signaling, and tone plus Digital Private Line (DPL) sub-audible signaling. PL is a Continuous Tone Coded Squelch System (CTCSS), a method of using low frequency sub audible tones to share a single radio channel among multiple users. DPL is a digital version of Private Line.

The occupied bandwidth charts reference the following setup and specification requirements.

Modulation Type: Analog Voice
 Emission Designator: 16K0F3E
 Channelization: 25 kHz
 Deviation Limit: ±5.0 kHz Max
 Power Setting: 110 Watts

Specification Requirement 47 CFR §90.210(b) and IC RSS-119 section 5.8.1 - Emission Limits – “B-Mask”:

For transmitters equipped with an audio low pass filter and designed to operate with a 25 kHz channel spacing (authorized bandwidth 20 kHz), the power of any emission must be below the unmodulated carrier power (P) as follows:

On any frequency removed from the assigned frequency by a displacement frequency (Fd in kHz) of:

- a) >10 kHz up to and including 20 kHz At least 25 dB;
- b) >20 kHz up to and including 50 kHz At least 35 dB;
- c) >50 kHz at least $43 + 10 * \text{Log}_{10}(P)$ dB.

Necessary Bandwidth Calculation:

The necessary bandwidth of the modulation per the formulas defined in 47 CFR §2.202(g) / TRC-43 section 8 is as follows:

Max Mod Freq, M	Max Deviation, D	$2*(M+D)$	Nec BW
3 kHz	5 kHz	16 kHz	16K0

Measurement Procedure and Instrument Settings:

<u>Emission Measurement Analyzer Settings</u>		<u>Measured Occupied Bandwidth</u>
Horizontal: 2.5 kHz per Division	Resolution BW: 300 Hz	Resolution BW: 300 Hz
Vertical: 0 dB per Division	Video BW: 10 kHz	Span: 30 kHz
Sweep Time: 72 Seconds (<2 kHz/Sec)	Span: 125 kHz	Number of Points: 1001
Detector: Peak		Integration Time: 7.4 ms

Report on Test Measurements for FCC ID ABZ99FT3095B, HVIN SLR 8000-VHFB per FCC 47 CFR 90 and IC RSS-119.

Test Procedure:

- 1) Key the station with no modulation to obtain the unmodulated carrier reference level on the analyzer. Use the analyzer controls to set this reference to a full-scale reference line. Store this analyzer trace in trace A.
- 2) Modulate the transmitter with a 2500 Hz sine wave at an input level 16 dB greater than that necessary to produce 50% of rated system deviation.
- 3) Allow the analyzer to sweep, and record the resultant emission levels in trace B.
- 4) Plot the resulting analyzer trace. The occupied bandwidth mask is then added along with additional labeling as appropriate.
- 5) Adjust the signal analyzer resolution BW and span as indicated above, use the Occupied Bandwidth function to record the value.

<u>EXHIBIT</u>	<u>DESCRIPTION</u>	<u>Meas Occ BW: No PL</u>	<u>PL</u>	<u>DPL</u>
E1-5.5,6,7	Occupied Bandwidth, Analog, 25 kHz Channels, 136.0125 MHz	15.05, 12.02, 11.95 kHz		
E1-5.8,9,10	Occupied Bandwidth, Analog, 25 kHz Channels, 138.0125 MHz	15.05, 11.97, 11.97 kHz		
E1-5.11,12,13	Occupied Bandwidth, Analog, 25 kHz Channels, 155.0125 MHz	15.05, 12.69, 12.62 kHz		
E1-5.14,15,16	Occupied Bandwidth, Analog, 25 kHz Channels, 173.9875 MHz	15.06, 13.39, 13.30 kHz		

Report on Test Measurements for FCC ID ABZ99FT3095B, HVIN SLR 8000-VHFB per FCC 47 CFR 90 and IC RSS-119.

Occupied Bandwidth – Analog Voice Frequency Modulation, 12.5 kHz Channel Spacing

The exhibits in this section show occupied bandwidth plots for analog voice modulation. Data is shown with the modulating audio tone itself, the tone plus Private Line (PL) sub-audible tone signaling, and tone plus Digital Private Line (DPL) sub-audible signaling. PL is a Continuous Tone Coded Squelch System (CTCSS), a method of using low frequency sub audible tones to share a single radio channel among multiple users. DPL is a digital version of Private Line.

The occupied bandwidth charts reference the following setup and specification requirements.

Modulation Type: Analog Voice
 Emission Designator: 11K0F3E
 Channelization: 12.5 kHz
 Deviation Limit: ±2.5 kHz Max
 Power Setting: 110 Watts

Specification Requirement 47 CFR §90.210(d) and IC RSS-119 section 5.8.3 - Emission Limits – “D-Mask”:

Emission Mask D. For transmitters designed to operate with a 12.5 kHz channel bandwidth, any emission must be attenuated below the power (P) of the highest emission contained within the authorized bandwidth as follows:

- (1) On any frequency from the center of the authorized bandwidth (f0) to 5.625 kHz removed from f0: Zero dB
- (2) On any frequency removed from the center of the authorized bandwidth by a displacement frequency (fd in kHz) of more than 5.625 kHz but no more than 12.5 kHz: At least $7.27 * (fd - 2.88 \text{ kHz}) \text{ dB}$
- (3) On any frequency removed from the center of the authorized bandwidth by a displacement frequency (fd in kHz) of more than 12.5 kHz: At least 50 plus $10 \log_{10}(P) \text{ dB}$ or 70 dB,
 whichever is the lesser attenuation.

(4) The reference level for showing compliance with the emission mask shall be established using a resolution bandwidth sufficiently wide to capture the true peak emission of the equipment under test. In order to show compliance with the emissions mask up to and including 50 kHz removed from the edge of the authorized bandwidth, adjust the resolution bandwidth to 100 Hz with the measuring instrument in a peak hold mode. A sufficient number of sweeps must be measured to ensure that the emission profile is developed.

Necessary Bandwidth Calculation (Analog Emission):

Report on Test Measurements for FCC ID ABZ99FT3095B, HVIN SLR 8000-VHFB per FCC 47 CFR 90 and IC RSS-119.

The necessary bandwidth of the modulation signal per the formulas defined in 47 CFR 2.202 (b) is as follows:

Max Mod Freq, M	Max Deviation, D	2*(M+D)	Nec BW
3 kHz	2.5 kHz	11 kHz	11K0

Measurement Procedure and Instrument Settings:

Emission Measurement Analyzer Settings		Measured Occupied Bandwidth	
Horizontal:12.5 kHz per Division	Resolution BW:100 Hz	Resolution BW:150 Hz	
Vertical:10 dB per Division	Video BW:10 kHz	Span: 15 kHz	
Sweep Time:72 Seconds (<2 kHz/Sec)	Span:125 kHz	Number of Points:	1601
Detector:Peak		Integration Time:	14.8 ms

Test Procedure (Analog Voice):

- 1) Key the station with no modulation to obtain the unmodulated carrier reference level on the analyzer. Use the analyzer controls to set this reference to a full-scale reference line. Store this analyzer trace in trace A.
- 2) Modulate the transmitter with a 2500 Hz sine wave at an input level 16 dB greater than that necessary to produce 50% of rated system deviation.
- 3) Allow the analyzer to sweep, and record the resultant emission levels in trace B.
- 4) Plot the resulting analyzer trace. The occupied bandwidth mask is then added along with additional labeling as appropriate.
- 5) Adjust the signal analyzer resolution BW and span as indicated above, use the Occupied Bandwidth function to record the value.

EXHIBIT	DESCRIPTION	Meas Occ BW:	No PL	PL	DPL
E1-5.17,18,19	Occupied Bandwidth, Analog, 12.5 kHz Channels, 136.0125 MHz	10.00,	9.26,	9.16	kHz
E1-5.20,21,22	Occupied Bandwidth, Analog, 12.5 kHz Channels, 138.0125 MHz	10.00,	9.26,	9.16	kHz
E1-5.23,24,25	Occupied Bandwidth, Analog, 12.5 kHz Channels, 155.0125 MHz	10.00,	9.26,	9.17	kHz
E1-5.26,27,28	Occupied Bandwidth, Analog, 12.5 kHz Channels, 173.9875 MHz	10.00,	9.29,	9.18	kHz

Report on Test Measurements for FCC ID ABZ99FT3095B, HVIN SLR 8000-VHFB per FCC 47 CFR 90 and IC RSS-119.

E1-5.1 Occupied Bandwidth – MOTOTRBO™ Digital Modulation, 136.0125 MHz

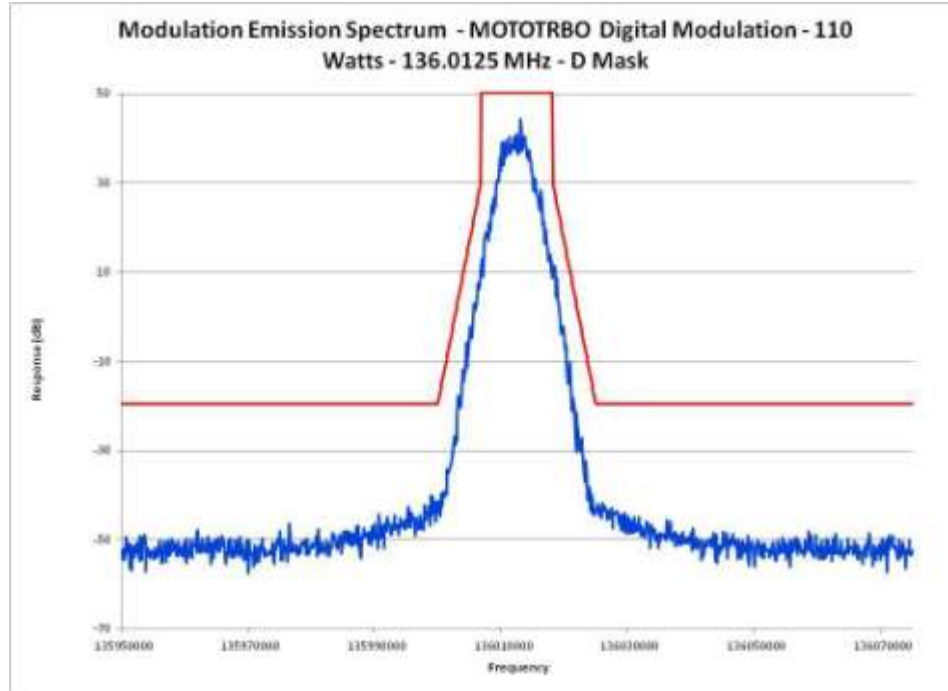

E1-5.2 Occupied Bandwidth – MOTOTRBO™ Digital Modulation, 138.0125 MHz

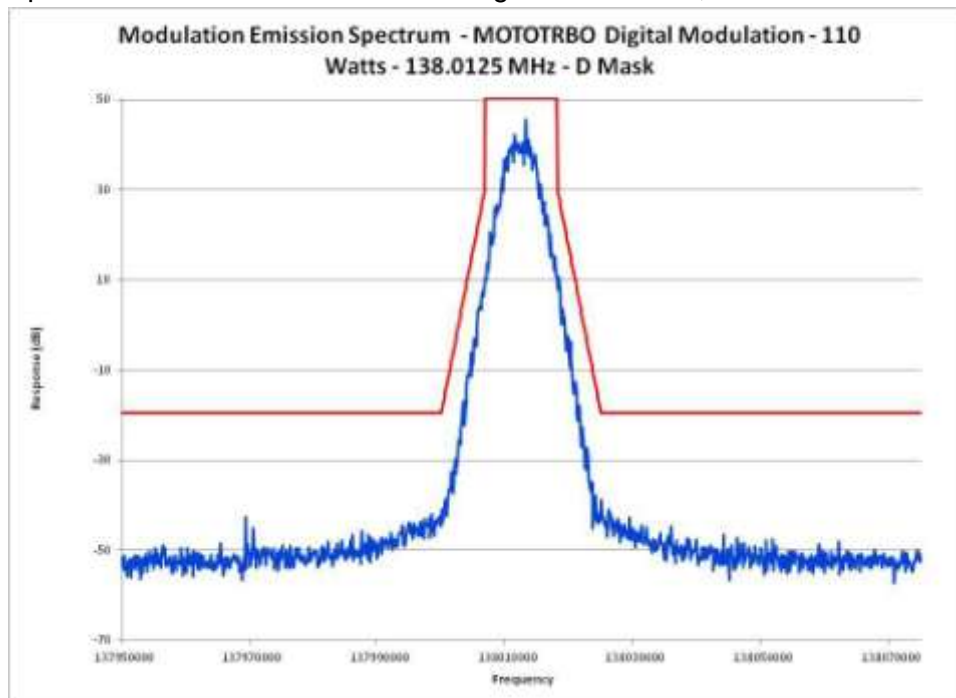

Report on Test Measurements for FCC ID ABZ99FT3095B, HVIN SLR 8000-VHFB per FCC 47 CFR 90 and IC RSS-119.

E1-5.3 Occupied Bandwidth – MOTOTRBO™ Digital Modulation, 155.0125 MHz

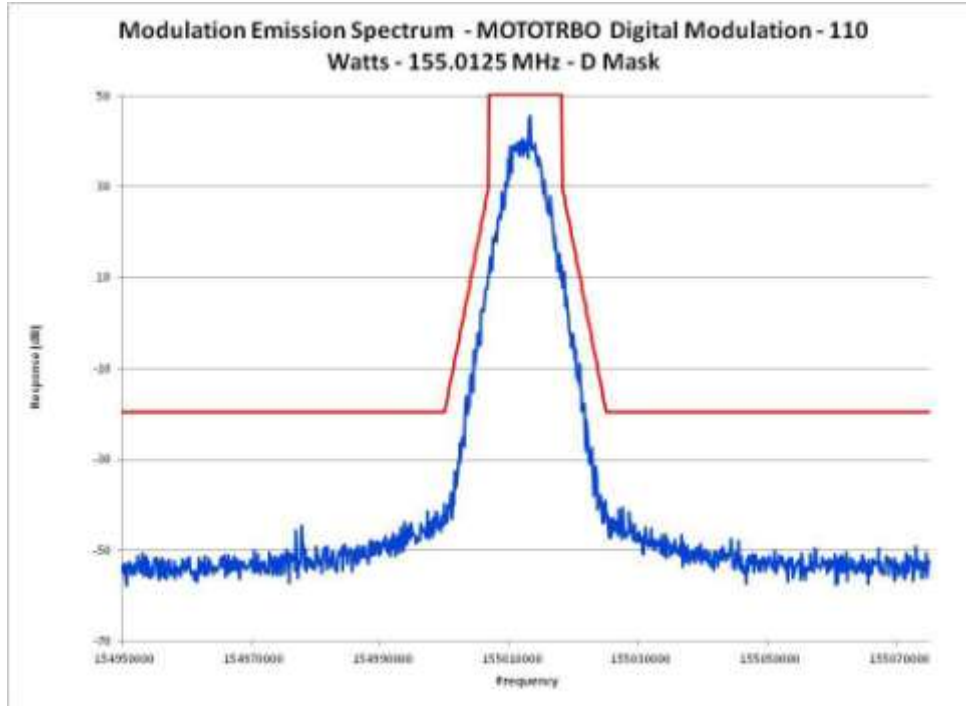

E1-5.4 Occupied Bandwidth – MOTOTRBO™ Digital Modulation, 173.9875 MHz

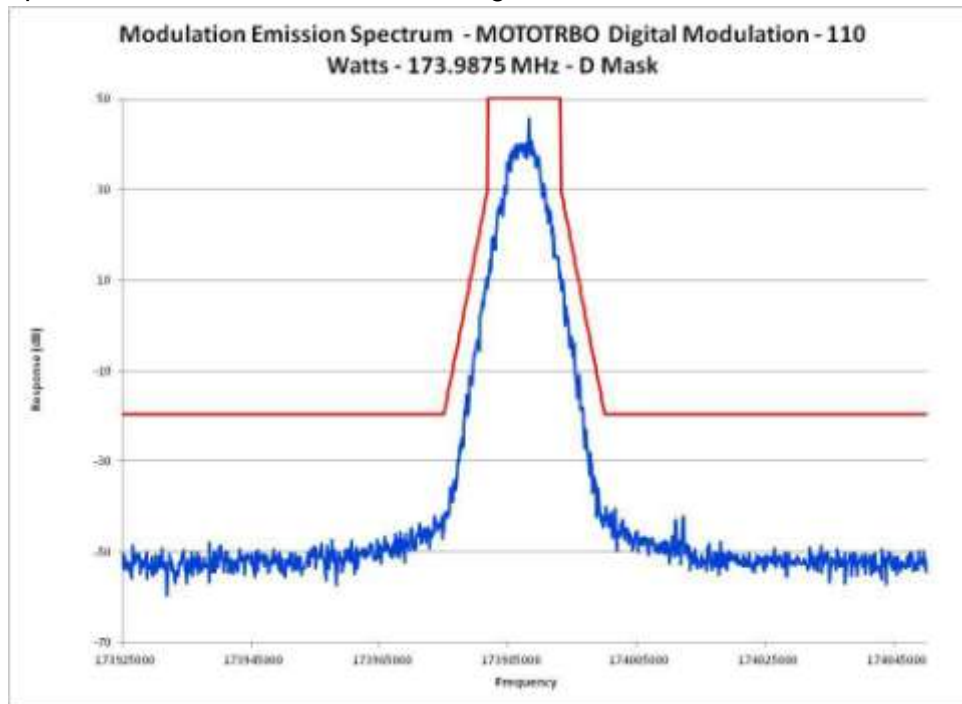

Report on Test Measurements for FCC ID ABZ99FT3095B, HVIN SLR 8000-VHFB per FCC 47 CFR 90 and IC RSS-119.

E1-5.5 Occupied Bandwidth, Analog, 25 kHz Channels, 136.0125 MHz

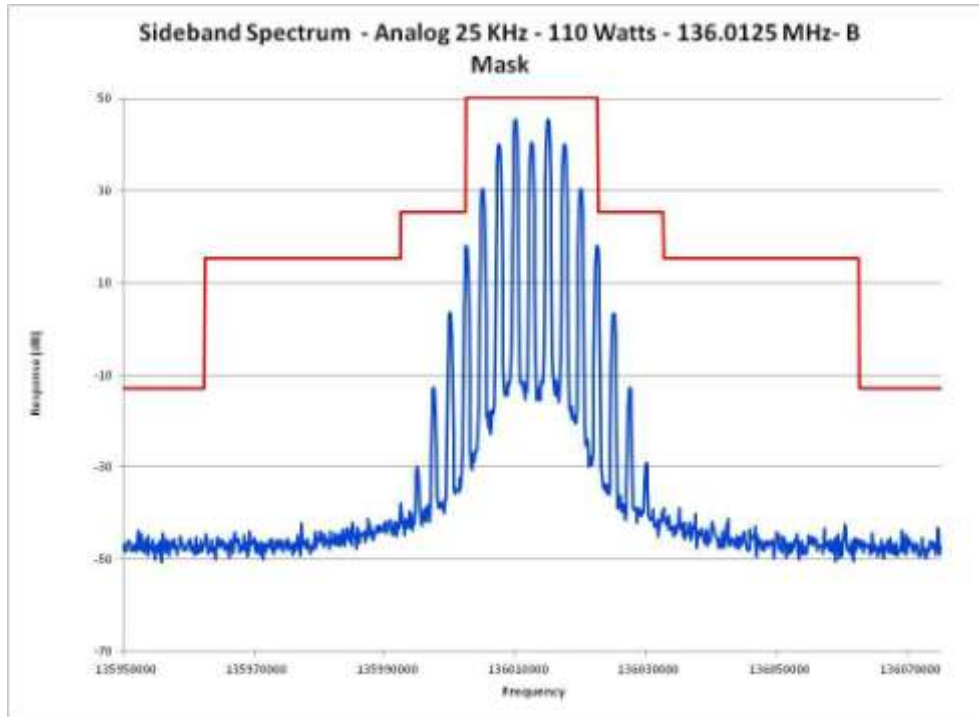

E1-5.6 Occupied Bandwidth, Analog, 25 kHz Channels, 136.0125 MHz PL

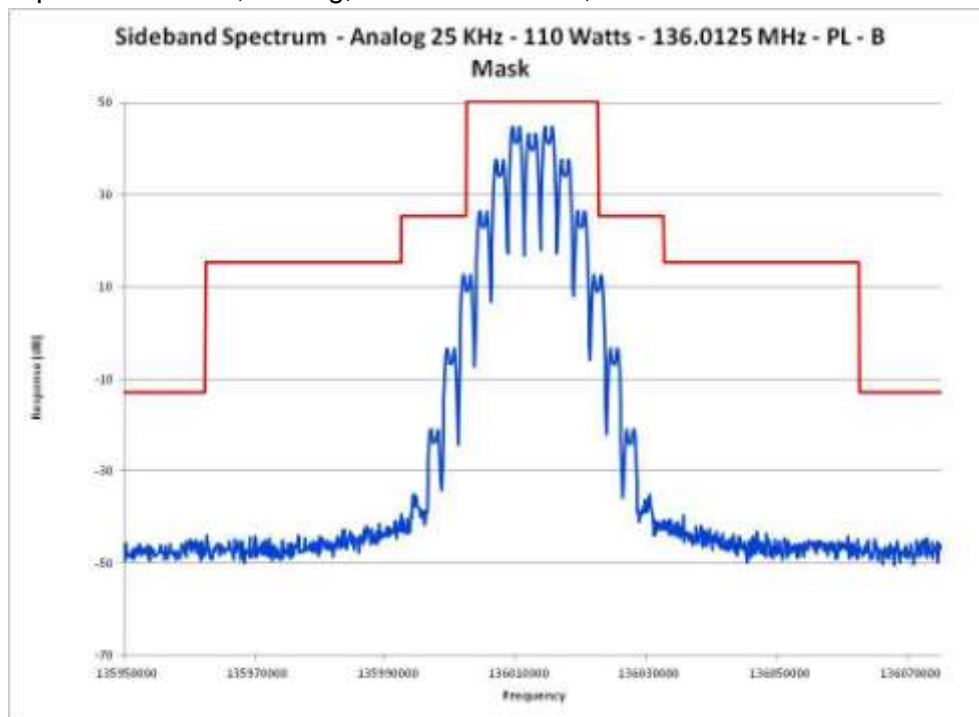

Report on Test Measurements for FCC ID ABZ99FT3095B, HVIN SLR 8000-VHFB per FCC 47 CFR 90 and IC RSS-119.

E1-5.7 Occupied Bandwidth, Analog, 25 kHz Channels, 136.0125 MHz DPL

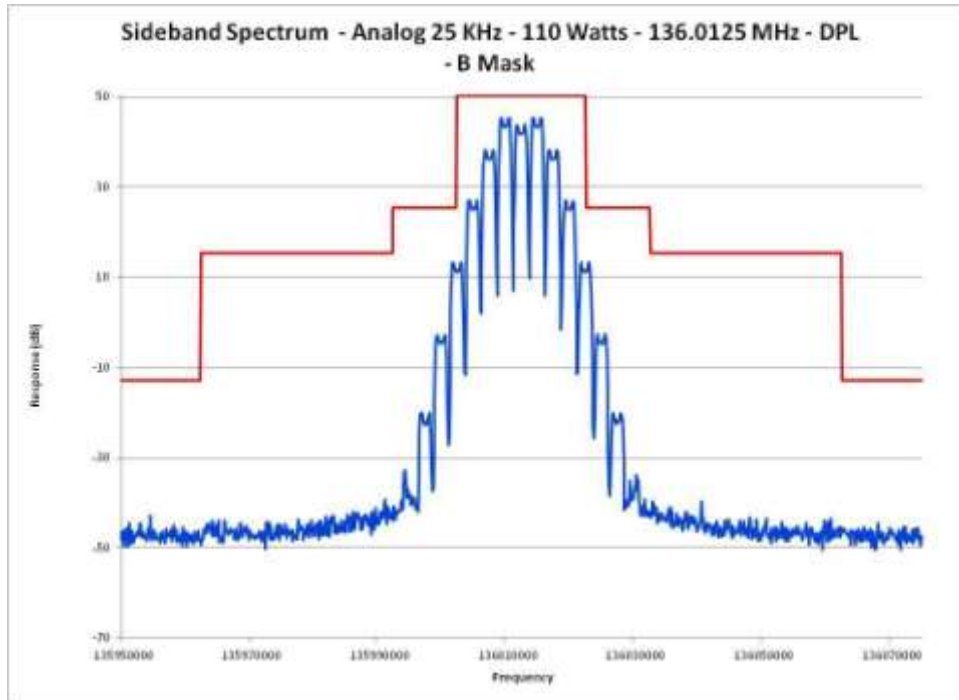

E1-5.8 Occupied Bandwidth, Analog, 25 kHz Channels, 138.0125 MHz

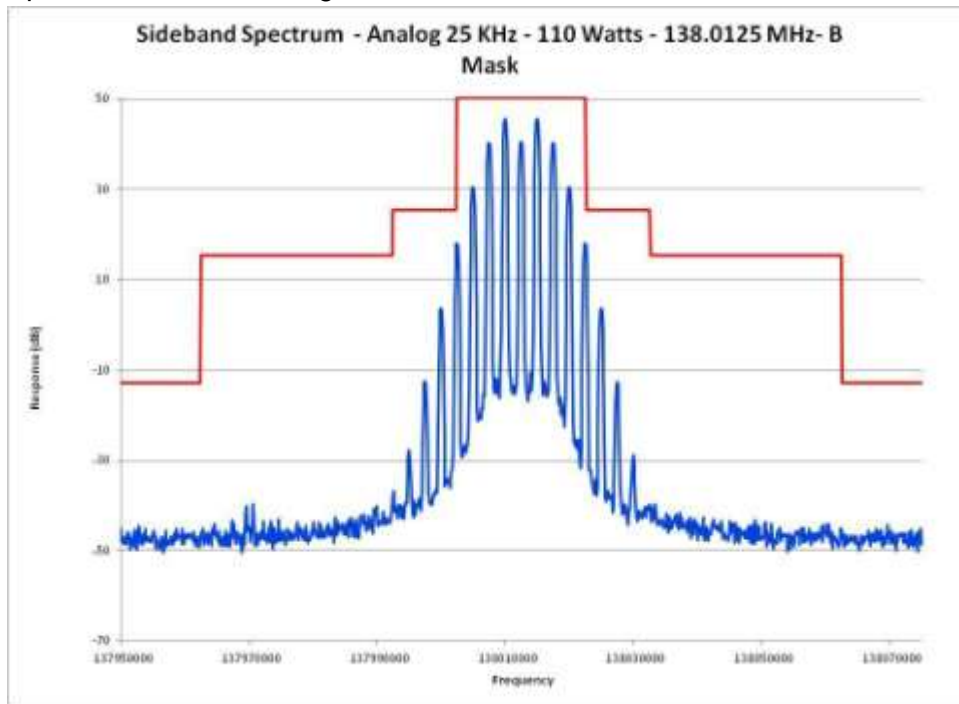

Report on Test Measurements for FCC ID ABZ99FT3095B, HVIN SLR 8000-VHFB per FCC 47 CFR 90 and IC RSS-119.

E1-5.9 Occupied Bandwidth, Analog, 25 kHz Channels, 138.0125 MHz PL

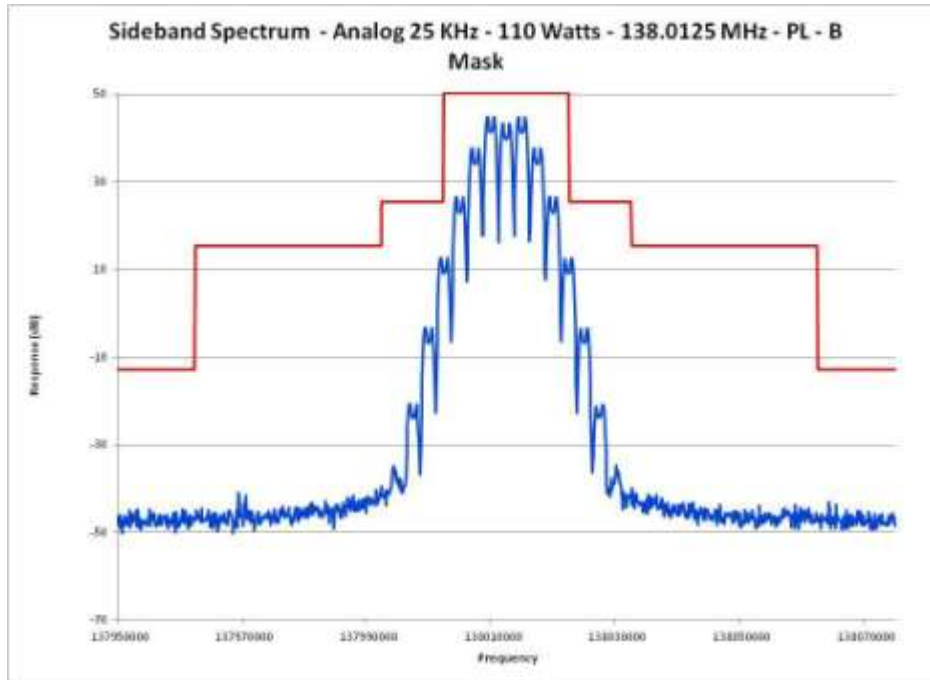

E1-5.10 Occupied Bandwidth, Analog, 25 kHz Channels, 138.0125 MHz DPL

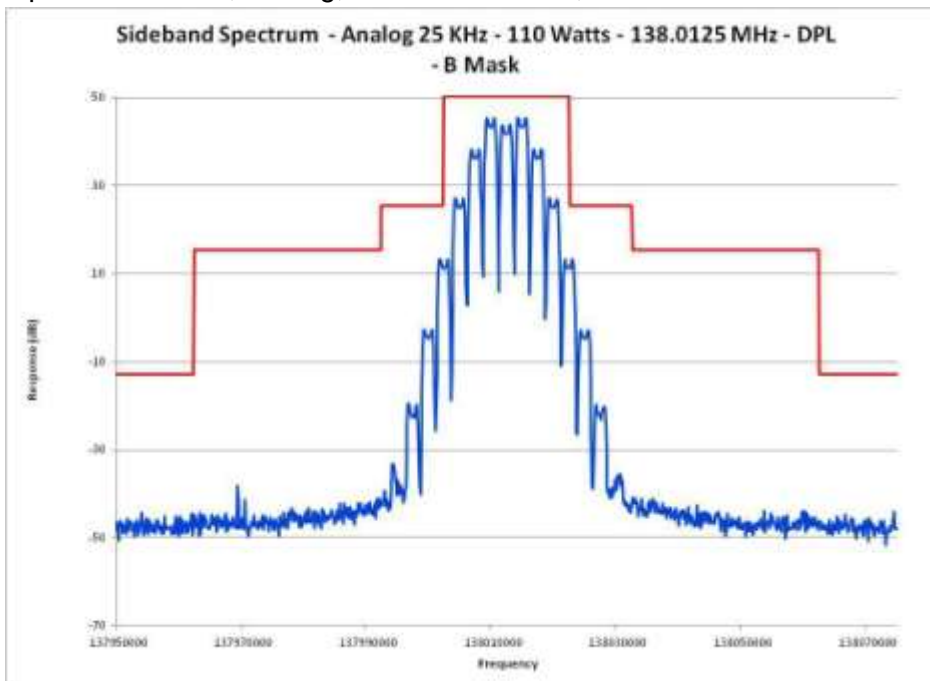

Report on Test Measurements for FCC ID ABZ99FT3095B, HVIN SLR 8000-VHFB per FCC 47 CFR 90 and IC RSS-119.

E1-5.11 Occupied Bandwidth, Analog, 25 kHz Channels, 155.0125 MHz

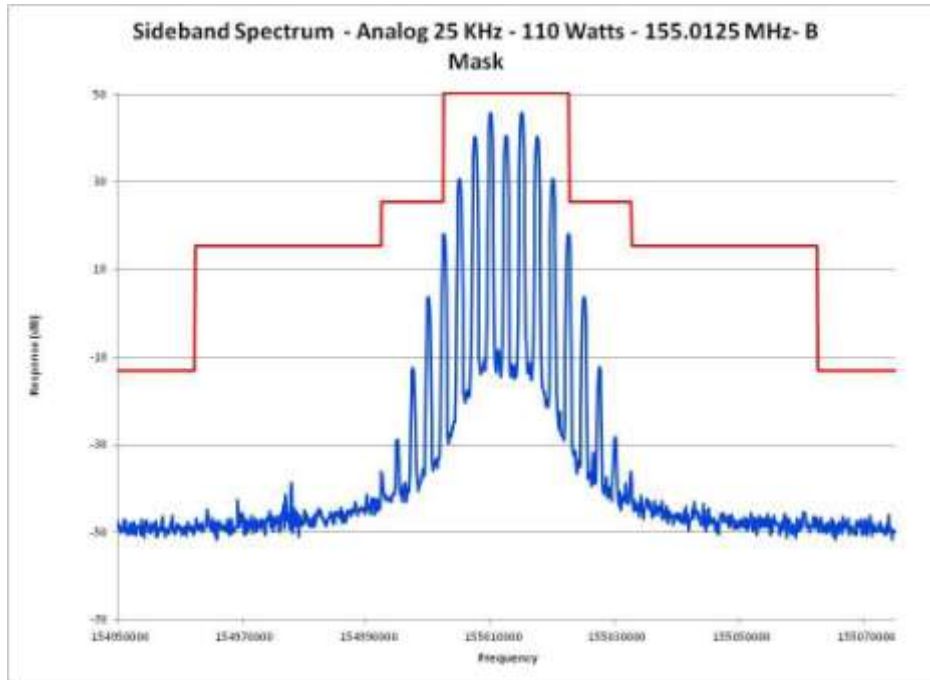

E1-5.12 Occupied Bandwidth, Analog, 25 kHz Channels, 155.0125 MHz PL

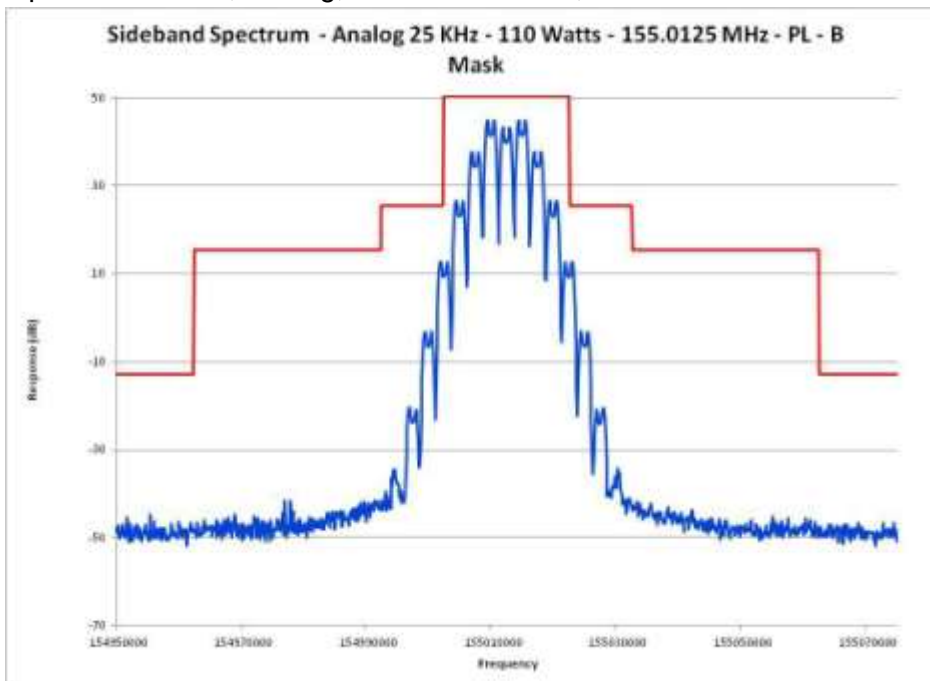

Report on Test Measurements for FCC ID ABZ99FT3095B, HVIN SLR 8000-VHFB per FCC 47 CFR 90 and IC RSS-119.

E1-5.13 Occupied Bandwidth, Analog, 25 kHz Channels, 155.0125 MHz DPL

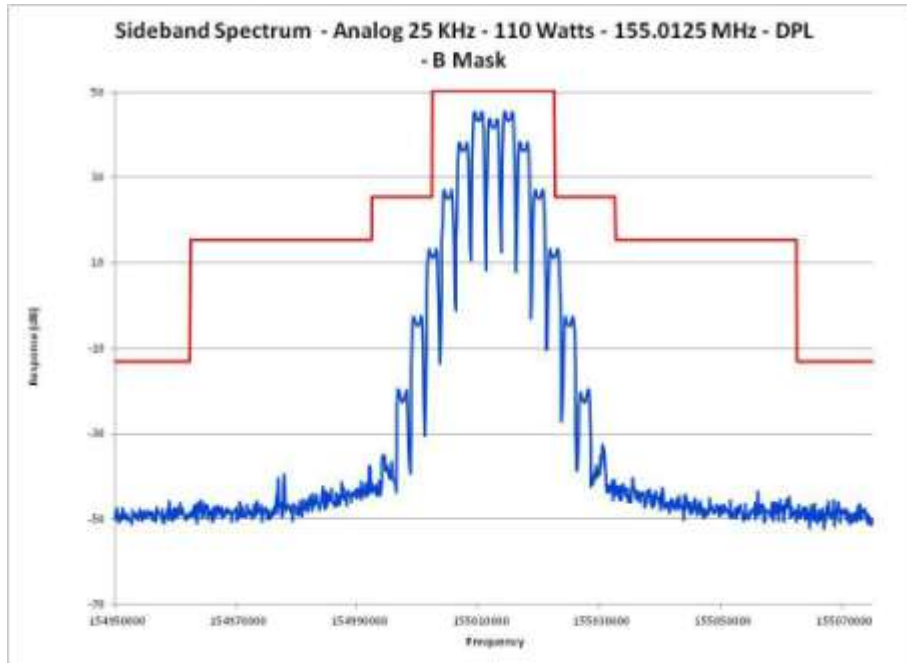

E1-5.14 Occupied Bandwidth, Analog, 25 kHz Channels, 173.9875 MHz

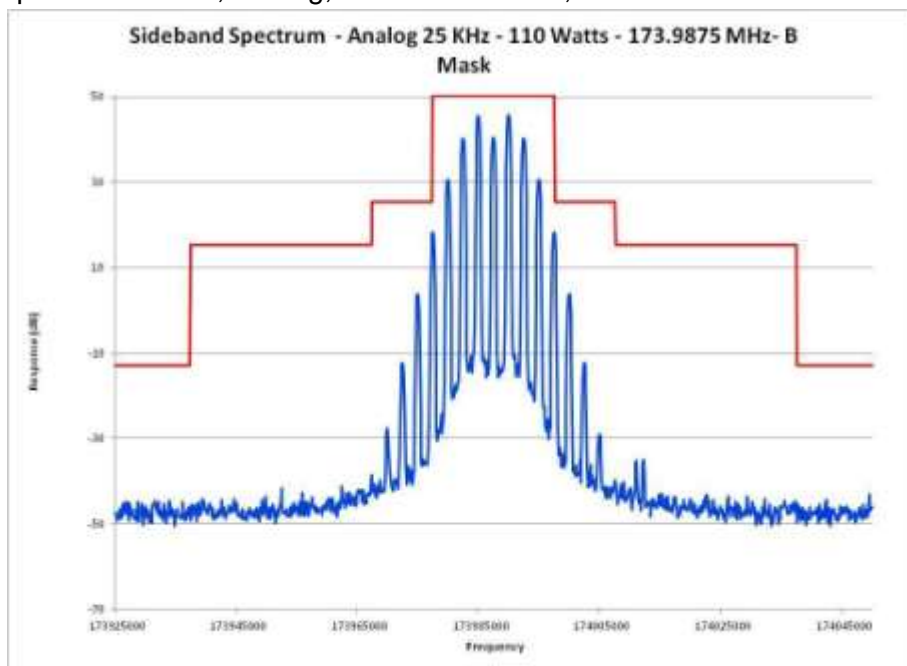

Report on Test Measurements for FCC ID ABZ99FT3095B, HVIN SLR 8000-VHFB per FCC 47 CFR 90 and IC RSS-119.

E1-5.15 Occupied Bandwidth, Analog, 25 kHz Channels, 173.9875 MHz PL

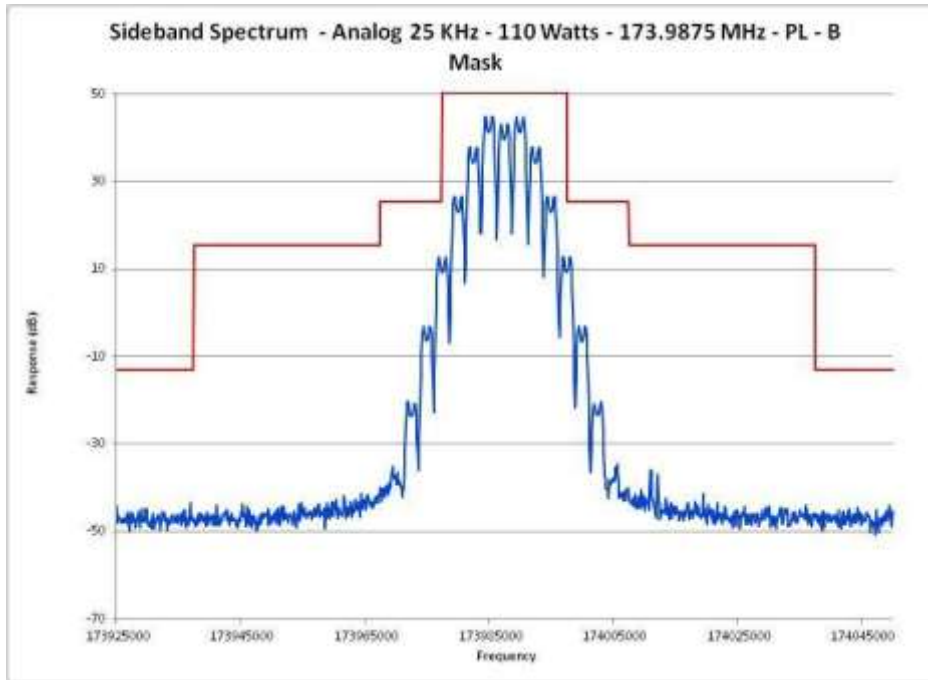

E1-5.16 Occupied Bandwidth, Analog, 25 kHz Channels, 173.9875 MHz DPL

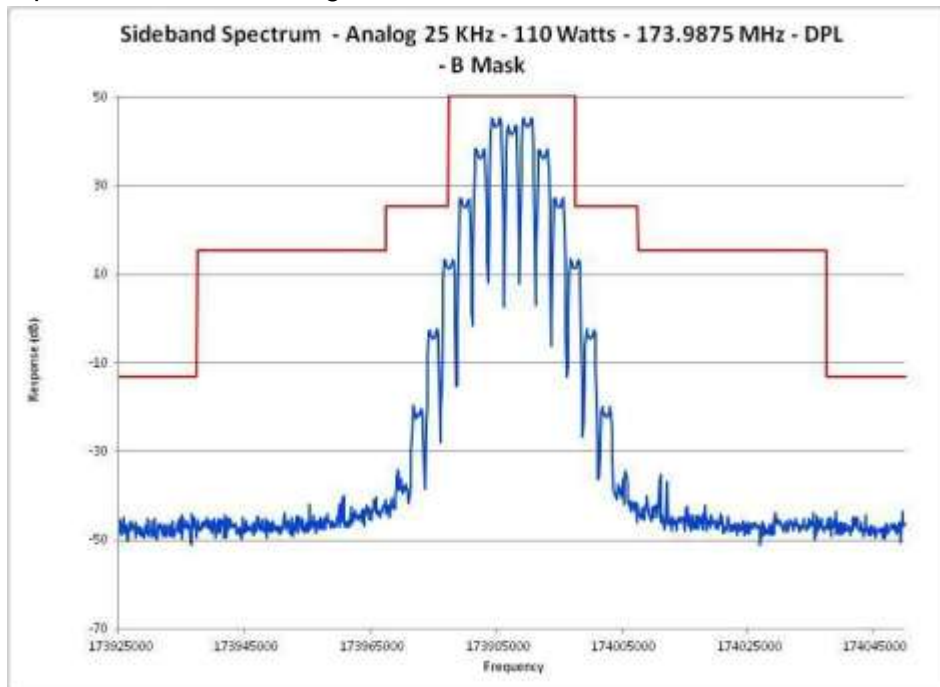

Report on Test Measurements for FCC ID ABZ99FT3095B, HVIN SLR 8000-VHFB per FCC 47 CFR 90 and IC RSS-119.

E1-5.17 Occupied Bandwidth, Analog, 12.5 kHz Channels, 136.0125 MHz

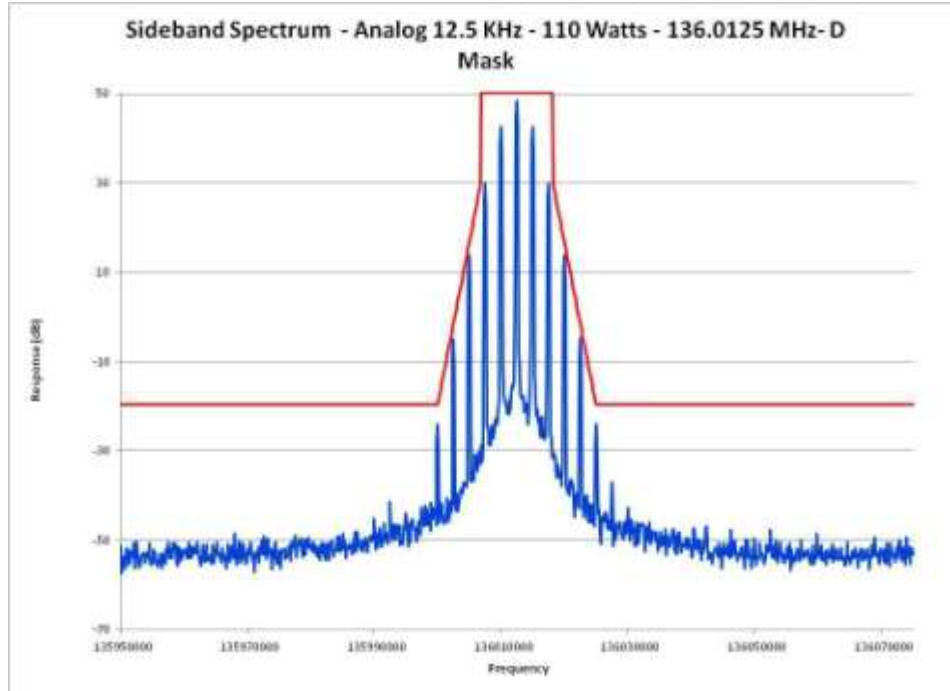

E1-5.18 Occupied Bandwidth, Analog, 12.5 kHz Channels, 136.0125 MHz PL

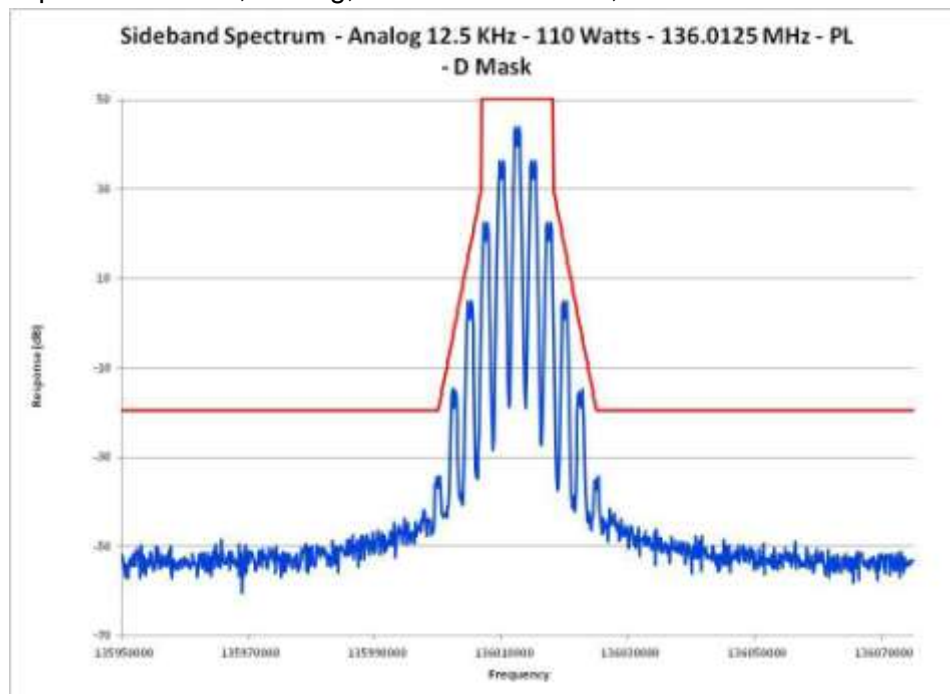

Report on Test Measurements for FCC ID ABZ99FT3095B, HVIN SLR 8000-VHFB per FCC 47 CFR 90 and IC RSS-119.

E1-5.19 Occupied Bandwidth, Analog, 12.5 kHz Channels, 136.0125 MHz DPL

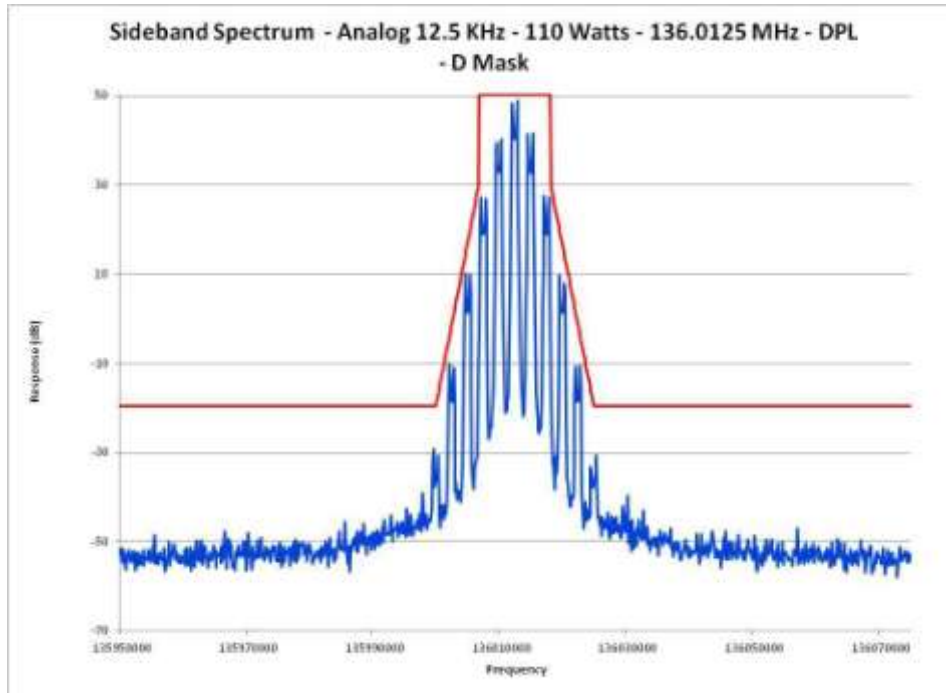

E1-5.20 Occupied Bandwidth, Analog, 12.5 kHz Channels, 138.0125 MHz

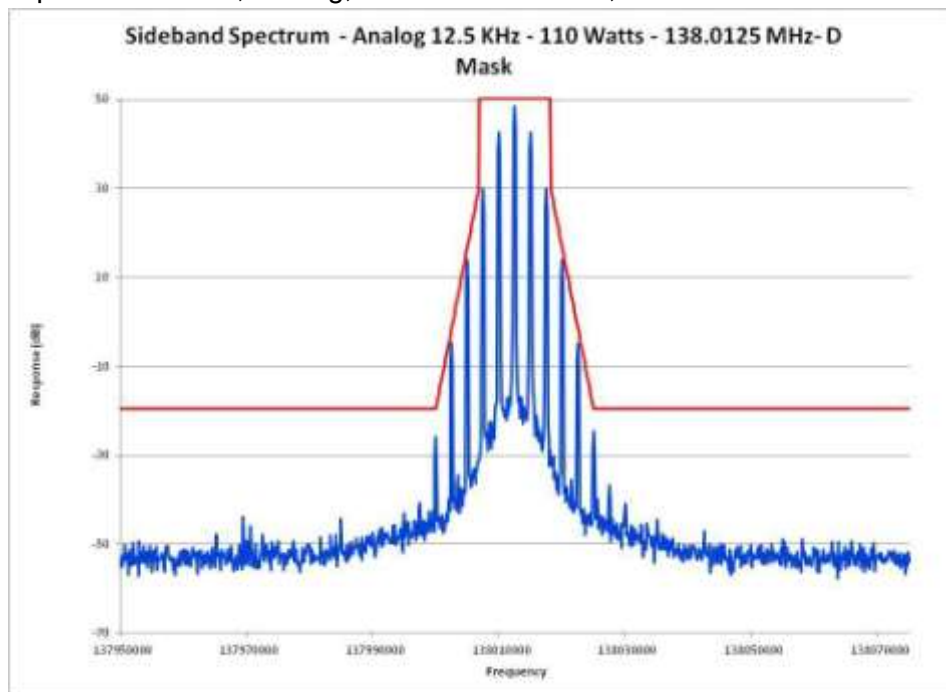

Report on Test Measurements for FCC ID ABZ99FT3095B, HVIN SLR 8000-VHFB per FCC 47 CFR 90 and IC RSS-119.

E1-5.21 Occupied Bandwidth, Analog, 12.5 kHz Channels, 138.0125 MHz PL

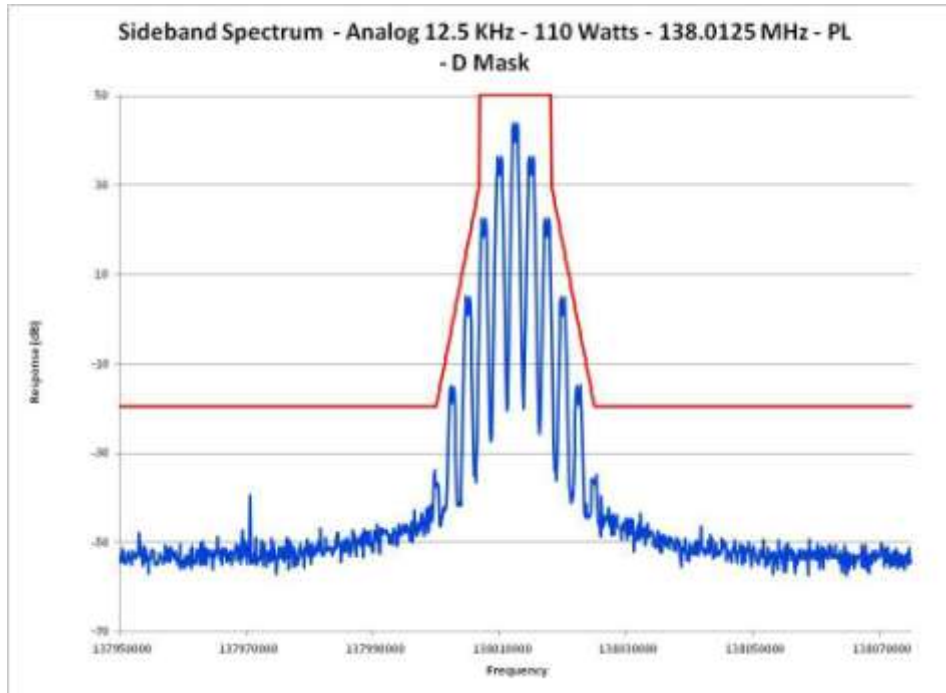

E1-5.22 Occupied Bandwidth, Analog, 12.5 kHz Channels, 138.0125 MHz DPL

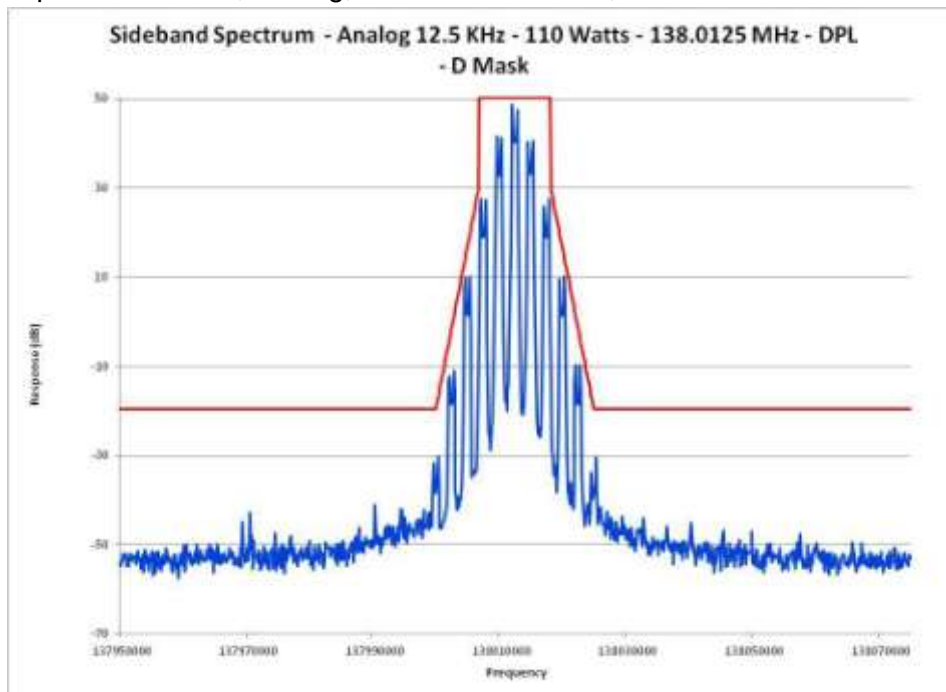

Report on Test Measurements for FCC ID ABZ99FT3095B, HVIN SLR 8000-VHFB per FCC 47 CFR 90 and IC RSS-119.

E1-5.23 Occupied Bandwidth, Analog, 12.5 kHz Channels, 155.0125 MHz

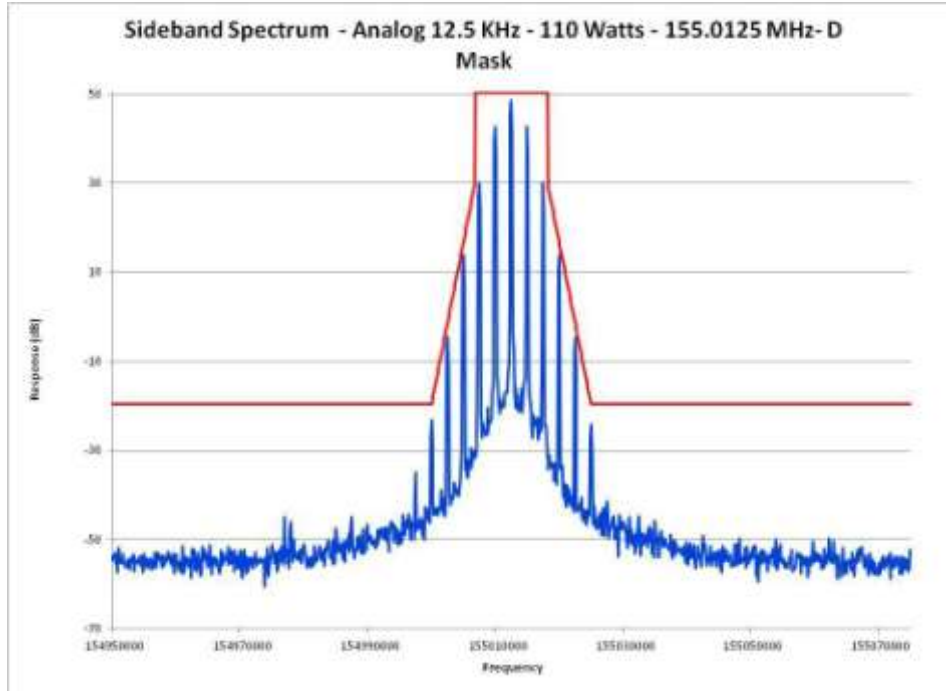

E1-5.24 Occupied Bandwidth, Analog, 12.5 kHz Channels, 155.0125 MHz PL

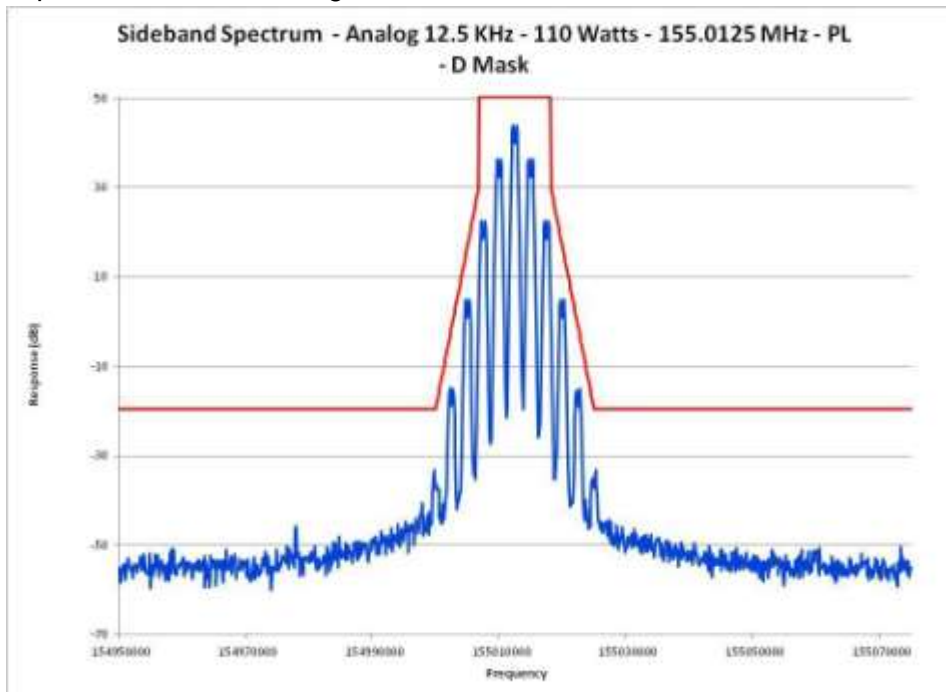

Report on Test Measurements for FCC ID ABZ99FT3095B, HVIN SLR 8000-VHFB per FCC 47 CFR 90 and IC RSS-119.

E1-5.25 Occupied Bandwidth, Analog, 12.5 kHz Channels, 155.0125 MHz DPL

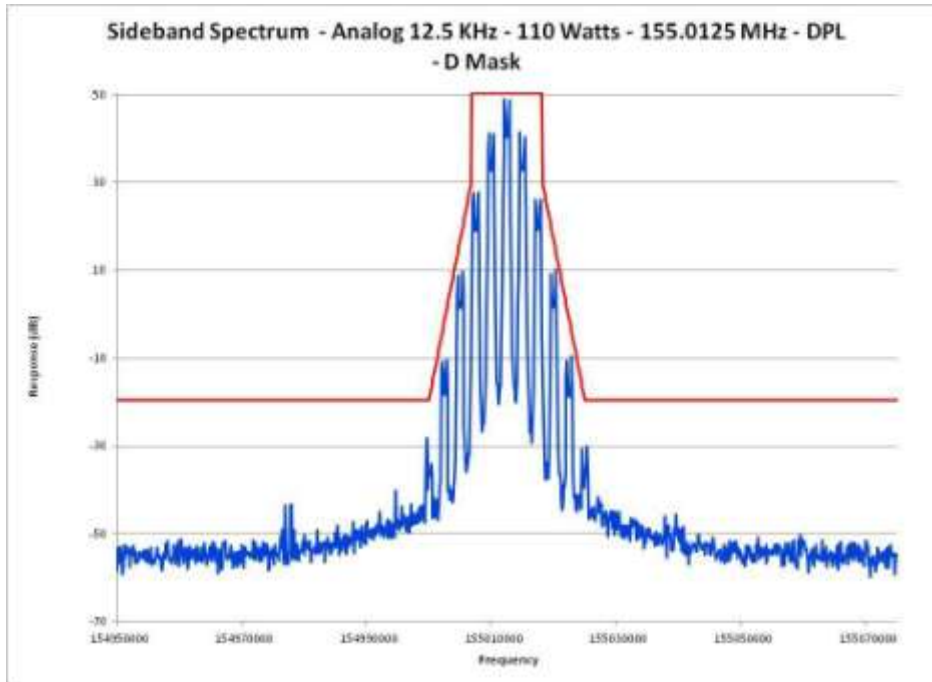

E1-5.26 Occupied Bandwidth, Analog, 12.5 kHz Channels, 173.9875 MHz

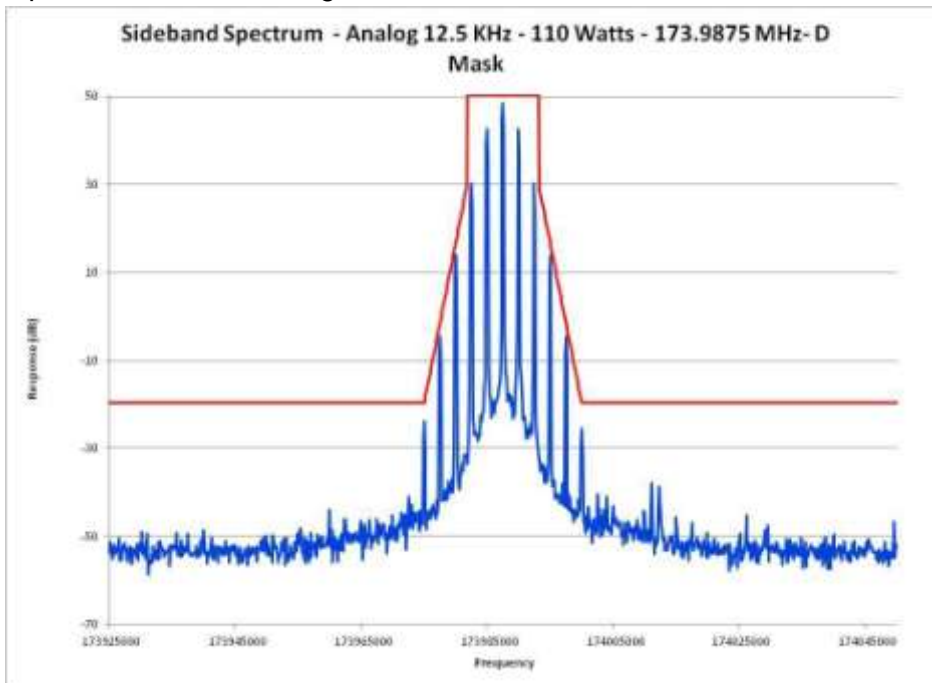

Report on Test Measurements for FCC ID ABZ99FT3095B, HVIN SLR 8000-VHFB per FCC 47 CFR 90 and IC RSS-119.

E1-5.27 Occupied Bandwidth, Analog, 12.5 kHz Channels, 173.9875 MHz PL

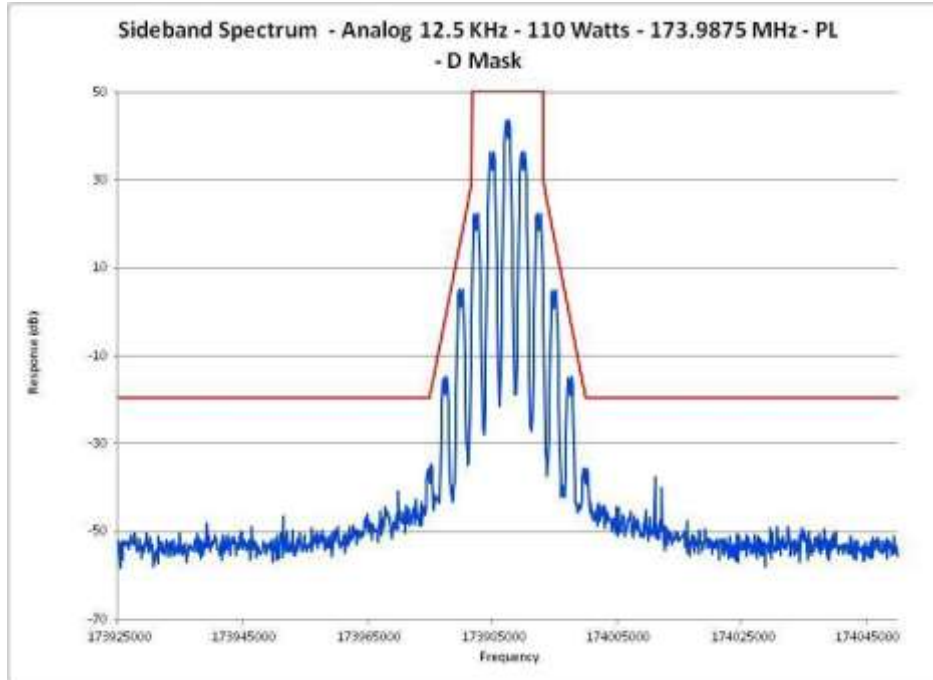

E1-5.28 Occupied Bandwidth, Analog, 12.5 kHz Channels, 173.9875 MHz DPL

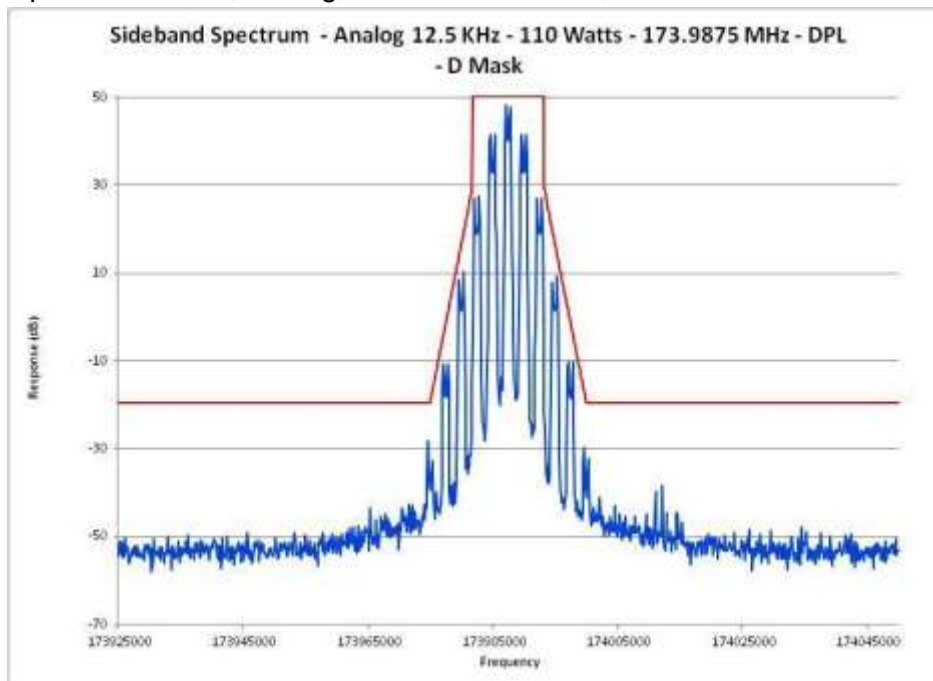

Report on Test Measurements for FCC ID ABZ99FT3095B, HVIN SLR 8000-VHFB per FCC 47 CFR 90 and IC RSS-119.

E1-6 Conducted Spurious Emissions – Harmonics and Emission Spectrum

Specification Requirement 47 CFR §90.210(b) and IC RSS-119 section 5.8.1 - Emission Limits – “B-Mask”:

For transmitters equipped with an audio low pass filter and designed to operate with a 25 kHz channel spacing (authorized bandwidth 20 kHz), the power of any emission must be below the unmodulated carrier power (P) as follows:

On any frequency removed from the assigned frequency by a displacement frequency (Fd in kHz) of: c) >50 kHz at least $43 + 10 * \text{Log}_{10}(P)$ dB.

Specification Requirement 47 CFR §90.210(d) and IC RSS-119 section 5.8.3 - Emission Limits – “D-Mask”:

Emission Mask D: For transmitters designed to operate with a 12.5 kHz channel bandwidth, any emission must be attenuated below the power (P) of the highest emission contained within the authorized bandwidth as follows:

(3) On any frequency removed from the center of the authorized bandwidth by a displacement frequency (fd in kHz) of more than 12.5 kHz:

At least 50 plus $10 \log_{10}(P)$ dB or 70 dB, whichever is the lesser attenuation.

Modulation: Analog Frequency Modulation – this is also representative of the performance of MOTOTRBO™ Digital Modulation, which is 4-level frequency modulation of the carrier.

Carrier Frequencies: Carrier frequencies of 136.0125, 138.0125, 155.0125, 173.9875 MHz were measured for conducted carrier harmonics.

Carrier frequencies of 136.0125, 138.0125, 155.0125, 173.9875 MHz were measured for conducted spurious emission measurements

These frequencies represent the low end, center, and high end of the band, and are representative of the full 136-174 operating band.

Report on Test Measurements for FCC ID ABZ99FT3095B, HVIN SLR 8000-VHFB per FCC 47 CFR 90 and IC RSS-119.

<u>EXHIBIT</u>	<u>DESCRIPTION</u>
E1-6.1	Conducted Spurious Harmonic Emissions, Power Output 110 Watts The specification limit is -70.0 dBc
E1-6.2	Conducted Spurious Harmonic Emissions, Power Output 1 Watt The specification limit is -50.0 dBc
E1-6.3	Conducted Spurious Emission Spectrum, 200 MHz Span, Power 110 Watts, 136.0125 MHz
E1-6.4	Conducted Spurious Emission Spectrum, 200 MHz Span, Power 110 Watts, 138.0125 MHz
E1-6.5	Conducted Spurious Emission Spectrum, 200 MHz Span, Power 110 Watts, 155.0125 MHz
E1-6.6	Conducted Spurious Emission Spectrum, 200 MHz Span, Power 110 Watts, 173.9875 MHz

Report on Test Measurements for FCC ID ABZ99FT3095B, HVIN SLR 8000-VHFB per FCC 47 CFR 90 and IC RSS-119.

E1-6.1 Conducted Spurious Harmonic Emissions, Power Output 110 Watts

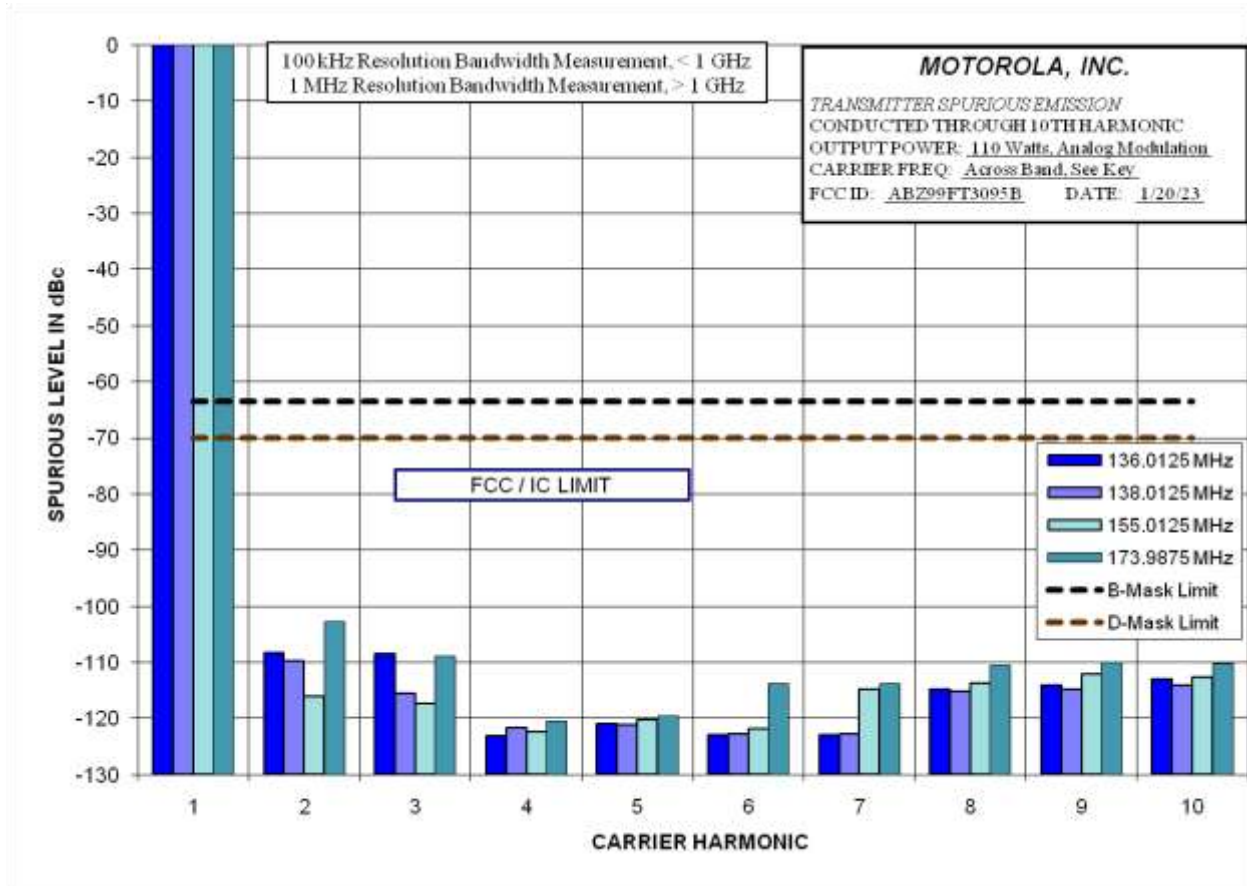

Report on Test Measurements for FCC ID ABZ99FT3095B, HVIN SLR 8000-VHFB per FCC 47 CFR 90 and IC RSS-119.

E1-6.2 Conducted Spurious Harmonic Emissions, Power Output 1 Watt

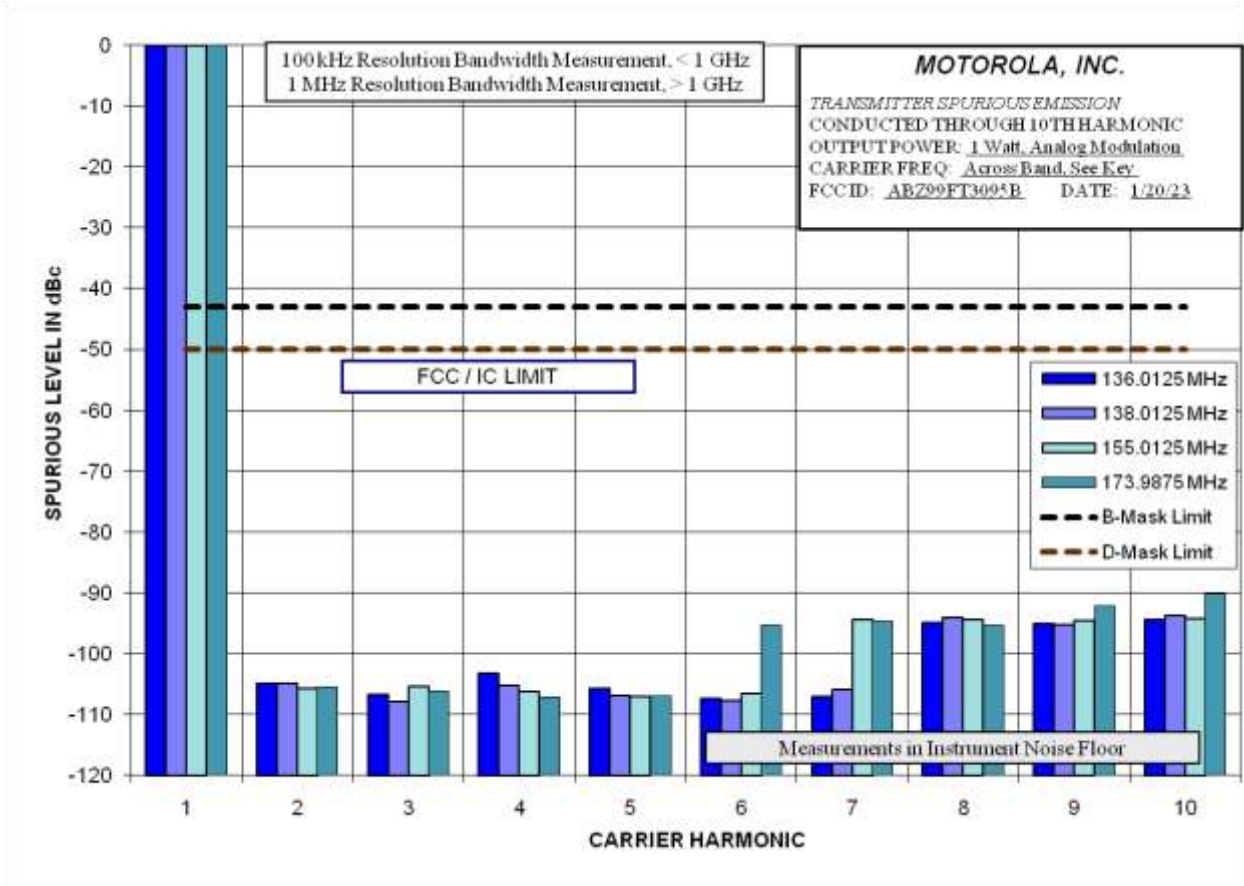

Report on Test Measurements for FCC ID ABZ99FT3095B, HVIN SLR 8000-VHFB per FCC 47 CFR 90 and IC RSS-119.

E1-6.3 Conducted Spurious Emission Spectrum, 200 MHz Span, Power 110 Watts, 136.0125MHz

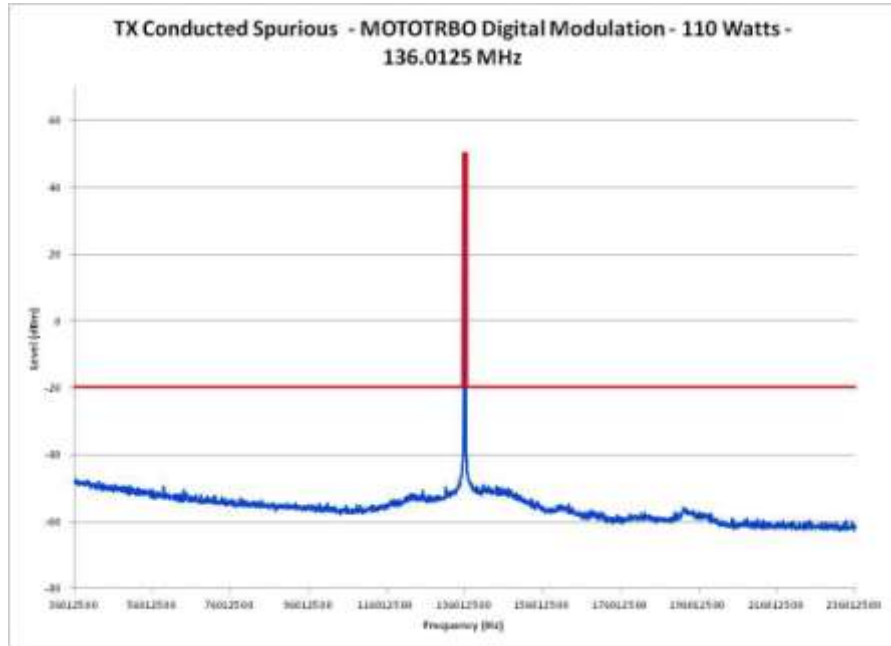

E1-6.4 Conducted Spurious Emission Spectrum, 200 MHz Span, Power 110 Watts, 138.0125MHz

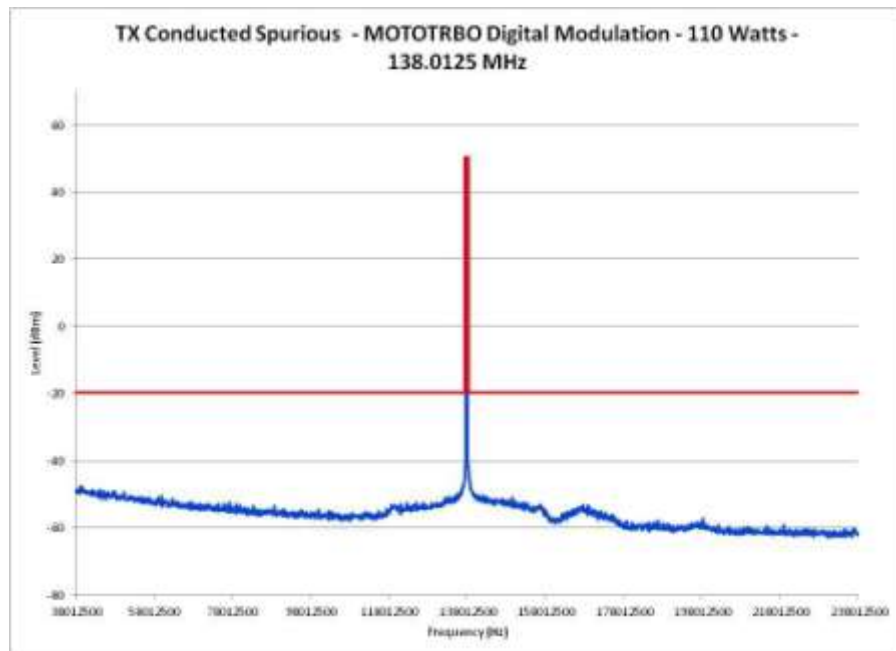

Report on Test Measurements for FCC ID ABZ99FT3095B, HVIN SLR 8000-VHFB per FCC 47 CFR 90 and IC RSS-119.

E1-6.5 Conducted Spurious Emission Spectrum, 200 MHz Span, Power 110 Watts, 155.0125MHz

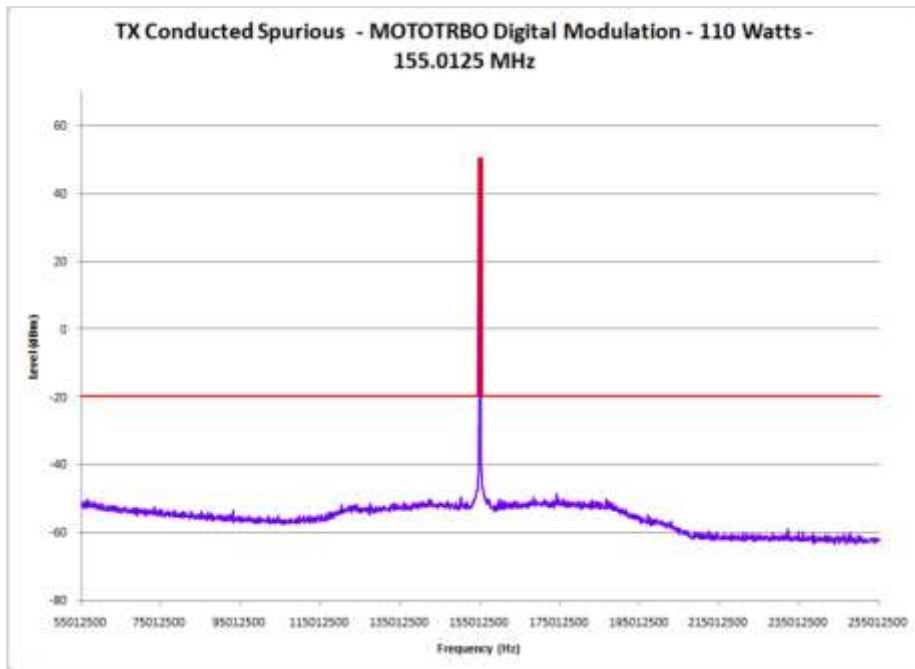

E1-6.6 Conducted Spurious Emission Spectrum, 200 MHz Span, Power 110 Watts, 173.9875MHz

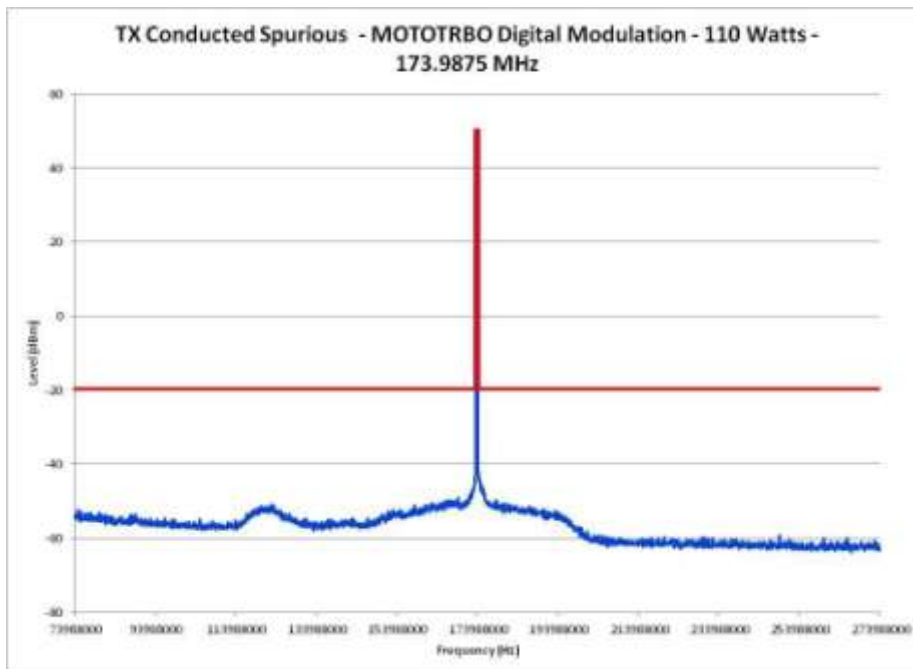

Report on Test Measurements for FCC ID ABZ99FT3095B, HVIN SLR 8000-VHFB per FCC 47 CFR 90 and IC RSS-119.

E1-7 Radiated Spurious Emissions, Harmonics

Specification Requirement 47 CFR §90.210(b) and IC RSS-119 section 5.8.1 - Emission Limits – “B-Mask”:

For transmitters equipped with an audio low pass filter and designed to operate with a 25 kHz channel spacing (authorized bandwidth 20 kHz), the power of any emission must be below the unmodulated carrier power (P) as follows:

On any frequency removed from the assigned frequency by a displacement frequency (F_d in kHz) of: c) >50 kHz *at least $43 + 10 * \text{Log}_{10}(P)$ dB.*

Specification Requirement 47 CFR §90.210(d) and IC RSS-119 section 5.8.3 - Emission Limits – “D-Mask”:

Emission *Mask D*: For transmitters designed to operate with a 12.5 kHz channel bandwidth, any emission must be attenuated below the power (P) of the highest emission contained within the authorized bandwidth as follows:

(3) On any frequency removed from the center of the authorized bandwidth by a displacement frequency (f_d in kHz) of more than 12.5 kHz:

At least 50 plus $10 \log_{10}(P)$ dB or 70 dB, whichever is the lesser attenuation.

Carrier Frequencies: Carrier frequencies of 136.0125, 138.0125, 155.0125, 173.9875 MHz were measured for radiated carrier harmonics at the high and low rated power. These frequencies represent the low end, center, and high end of the 136-174 MHz band and the low end, center, and high end of the 138-174 MHz band, and are representative of the full operating band.

:

EXHIBIT	DESCRIPTION
E1-7.1	Radiated Spurious Harmonic Emissions, Power Output 1 Watt, 136.0125 MHz
E1-7.2	Radiated Spurious Harmonic Emissions, Power Output 110 Watts, 136.0125 MHz
E1-7.3	Radiated Spurious Harmonic Emissions, Power Output 1 Watt, 138.0125 MHz
E1-7.4	Radiated Spurious Harmonic Emissions, Power Output 110 Watts, 138.0125 MHz
E1-7.5	Radiated Spurious Harmonic Emissions, Power Output 1 Watt, 155.0125 MHz

APPLICANT: MOTOROLA SOLUTIONS

EQUIPMENT TYPE: ABZ99FT3095B

109AB-99FT3095B

**Report on Test Measurements for FCC ID ABZ99FT3095B, HVIN SLR 8000-VHFB per FCC
47 CFR 90 and IC RSS-119.**

- E1-7.6 Radiated Spurious Harmonic Emissions, Power Output 110 Watts,
155.0125 MHz
- E1-7.7 Radiated Spurious Harmonic Emissions, Power Output 1 Watt,
173.9875 MHz
- E1-7.8 Radiated Spurious Harmonic Emissions, Power Output 110 Watts,
173.9875 MHz

Report on Test Measurements for FCC ID ABZ99FT3095B, HVIN SLR 8000-VHFB per FCC 47 CFR 90 and IC RSS-119.

Test Details	
Manufacturer	Motorola Solutions Inc.
EUT	VHF 110W Repeater
Model No.	SLR8000
Serial No.	433IYY0565
Mode	Transmit
Frequency Tested	136.0125MHz
Notes	1W Power
Date Tested	January 26, 2023 through January 30, 2023

Freq (MHz)	Ant Pol	Meter Reading (dBµV)	Ambient	Matched Sig Gen Reading (dBm)	Equivalent Antenna Gain (dB)	Cable Loss (dB)	ERP (dBm)	Attenuation Below Output Power (dB)	Minimum Attenuation (dB)
272.0250	H	13.9		-67.0	0.0	0.9	-67.9	97.9	50.0
	V	11.4		-64.0	0.0	0.9	-64.9	94.9	50.0
408.0375	H	5.3	Ambient	-70.5	0.0	1.1	-71.6	101.6	50.0
	V	5.2	Ambient	-68.0	0.0	1.1	-69.1	99.1	50.0
544.0500	H	5.2	Ambient	-70.6	0.0	1.3	-71.9	101.9	50.0
	V	5.4	Ambient	-71.4	0.0	1.3	-72.7	102.7	50.0
680.0625	H	29.5		-43.7	0.0	1.4	-45.1	75.1	50.0
	V	24.3		-45.2	0.0	1.4	-46.6	76.6	50.0
816.0750	H	5.0	Ambient	-65.5	0.0	1.5	-67.1	97.1	50.0
	V	4.8	Ambient	-63.1	0.0	1.5	-64.6	94.6	50.0
952.0875	H	5.4	Ambient	-62.8	0.0	1.7	-64.4	94.4	50.0
	V	5.4	Ambient	-61.1	0.0	1.7	-62.8	92.8	50.0
1088.1000	H	14.4	Ambient	-52.1	0.5	1.8	-53.4	83.4	50.0
	V	14.7	Ambient	-51.2	0.5	1.8	-52.5	82.5	50.0
1224.1125	H	14.4	Ambient	-51.0	0.2	1.9	-52.7	82.7	50.0
	V	14.3	Ambient	-50.2	0.2	1.9	-51.9	81.9	50.0
1360.1250	H	14.4	Ambient	-50.9	1.3	2.0	-51.6	81.6	50.0
	V	14.3	Ambient	-51.1	1.3	2.0	-51.8	81.8	50.0

E1-7.1 Radiated Spurious Harmonic Emissions, Power Output 1 Watt, 136.0125 MHz

Report on Test Measurements for FCC ID ABZ99FT3095B, HVIN SLR 8000-VHFB per FCC 47 CFR 90 and IC RSS-119.

Test Details	
Manufacturer	Motorola Solutions Inc.
EUT	VHF 110W Repeater
Model No.	SLR8000
Serial No.	433IYY0565
Mode	Transmit
Frequency Tested	136.0125MHz
Notes	110W Power
Date Tested	January 26, 2023 through January 30, 2023

Freq (MHz)	Ant Pol	Meter Reading (dBµV)	Ambient	Matched Sig Gen Reading (dBm)	Equivalent Antenna Gain (dB)	Cable Loss (dB)	ERP (dBm)	Attenuation Below Output Power (dB)	Minimum Attenuation (dB)
272.0250	H	19.8		-60.8	0.0	0.9	-61.7	112.1	70.0
	V	17.6		-57.8	0.0	0.9	-58.7	109.1	70.0
408.0375	H	5.7	Ambient	-70.1	0.0	1.1	-71.2	121.7	70.0
	V	5.2	Ambient	-68.0	0.0	1.1	-69.1	119.5	70.0
544.0500	H	9.0		-66.8	0.0	1.3	-68.1	118.5	70.0
	V	7.9		-68.8	0.0	1.3	-70.1	120.5	70.0
680.0625	H	15.0		-58.6	0.0	1.4	-60.0	110.4	70.0
	V	17.9		-52.0	0.0	1.4	-53.4	103.8	70.0
816.0750	H	5.2	Ambient	-65.3	0.0	1.5	-66.9	117.3	70.0
	V	4.9	Ambient	-63.0	0.0	1.5	-64.5	115.0	70.0
952.0875	H	5.0	Ambient	-63.2	0.0	1.7	-64.8	115.2	70.0
	V	5.5	Ambient	-61.0	0.0	1.7	-62.7	113.1	70.0
1088.1000	H	14.7	Ambient	-51.8	0.5	1.8	-53.1	103.5	70.0
	V	14.4	Ambient	-51.5	0.5	1.8	-52.8	103.2	70.0
1224.1125	H	14.3	Ambient	-51.1	0.2	1.9	-52.8	103.2	70.0
	V	14.2	Ambient	-50.3	0.2	1.9	-52.0	102.4	70.0
1360.1250	H	14.4	Ambient	-50.9	1.3	2.0	-51.6	102.0	70.0
	V	14.9	Ambient	-50.5	1.3	2.0	-51.2	101.6	70.0

E1-7.2 Radiated Spurious Harmonic Emissions, Power Output 110 Watts, 136.0125 MHz

Report on Test Measurements for FCC ID ABZ99FT3095B, HVIN SLR 8000-VHFB per FCC 47 CFR 90 and IC RSS-119.

Test Details	
Manufacturer	Motorola Solutions Inc.
EUT	VHF 110W Repeater
Model No.	SLR8000
Serial No.	433IYY0565
Mode	Transmit
Frequency Tested	138.0125MHz
Notes	1W
Date Tested	January 26, 2023 through January 30, 2023

Freq (MHz)	Ant Pol	Meter Reading (dBµV)	Ambient	Matched Sig Gen Reading (dBm)	Equivalent Antenna Gain (dB)	Cable Loss (dB)	ERP (dBm)	Attenuation Below Output Power (dB)	Minimum Attenuation (dB)
276.0250	H	15.6		-65.0	0.0	0.9	-65.9	95.9	50.0
	V	11.6		-63.0	0.0	0.9	-63.9	93.9	50.0
414.0375	H	5.4	Ambient	-70.2	0.0	1.1	-71.4	101.4	50.0
	V	5.3	Ambient	-67.8	0.0	1.1	-68.9	98.9	50.0
552.0500	H	5.0	Ambient	-67.9	0.0	1.3	-69.2	99.2	50.0
	V	6.2	Ambient	-64.7	0.0	1.3	-66.0	96.0	50.0
690.0625	H	5.2	Ambient	-66.5	0.0	1.4	-67.9	97.9	50.0
	V	5.0	Ambient	-64.1	0.0	1.4	-65.5	95.5	50.0
828.0750	H	5.9	Ambient	-64.7	0.0	1.6	-66.2	96.2	50.0
	V	5.7	Ambient	-62.1	0.0	1.6	-63.7	93.7	50.0
966.0875	H	5.0	Ambient	-62.9	0.0	1.7	-64.6	94.6	50.0
	V	5.7	Ambient	-60.7	0.0	1.7	-62.4	92.4	50.0
1104.1000	H	14.7	Ambient	-51.6	0.4	1.8	-53.0	83.0	50.0
	V	14.4	Ambient	-51.2	0.4	1.8	-52.6	82.6	50.0
1242.1125	H	14.3	Ambient	-51.1	0.3	1.9	-52.7	82.7	50.0
	V	14.6	Ambient	-50.0	0.3	1.9	-51.6	81.6	50.0
1380.1250	H	14.8	Ambient	-50.5	1.6	2.1	-51.0	81.0	50.0
	V	14.5	Ambient	-51.0	1.6	2.1	-51.4	81.4	50.0

E1-7.3 Radiated Spurious Harmonic Emissions, Power Output 1 Watt, 138.0125 MHz

Report on Test Measurements for FCC ID ABZ99FT3095B, HVIN SLR 8000-VHFB per FCC 47 CFR 90 and IC RSS-119.

Test Details	
Manufacturer	Motorola Solutions Inc.
EUT	VHF 110W Repeater
Model No.	SLR8000
Serial No.	433IYY0565
Mode	Transmit
Frequency Tested	138.0125MHz
Notes	110W
Date Tested	January 26, 2023 through January 30, 2023

Freq (MHz)	Ant Pol	Meter Reading (dBµV)	Ambient	Matched Sig Gen Reading (dBm)	Equivalent Antenna Gain (dB)	Cable Loss (dB)	ERP (dBm)	Attenuation Below Output Power (dB)	Minimum Attenuation (dB)
276.0250	H	18.4		-61.9	0.0	0.9	-62.8	113.2	70.0
	V	18.7		-56.0	0.0	0.9	-56.9	107.3	70.0
414.0375	H	6.4	Ambient	-69.2	0.0	1.1	-70.4	120.8	70.0
	V	5.9	Ambient	-67.2	0.0	1.1	-68.3	118.7	70.0
552.0500	H	6.4	Ambient	-66.5	0.0	1.3	-67.8	118.2	70.0
	V	5.6	Ambient	-65.3	0.0	1.3	-66.6	117.0	70.0
690.0625	H	5.5	Ambient	-66.2	0.0	1.4	-67.6	118.0	70.0
	V	4.9	Ambient	-64.2	0.0	1.4	-65.6	116.0	70.0
828.0750	H	4.6	Ambient	-66.0	0.0	1.6	-67.5	117.9	70.0
	V	5.6	Ambient	-62.2	0.0	1.6	-63.8	114.2	70.0
966.0875	H	5.6	Ambient	-62.3	0.0	1.7	-64.0	114.4	70.0
	V	5.6	Ambient	-60.8	0.0	1.7	-62.5	112.9	70.0
1104.1000	H	14.0	Ambient	-52.3	0.4	1.8	-53.7	104.1	70.0
	V	14.5	Ambient	-51.1	0.4	1.8	-52.5	102.9	70.0
1242.1125	H	14.6	Ambient	-50.8	0.3	1.9	-52.4	102.8	70.0
	V	14.8	Ambient	-49.8	0.3	1.9	-51.4	101.8	70.0
1380.1250	H	14.3	Ambient	-51.0	1.6	2.1	-51.5	101.9	70.0
	V	14.6	Ambient	-50.9	1.6	2.1	-51.3	101.8	70.0

E1-7.4 Radiated Spurious Harmonic Emissions, Power Output 110 Watts, 138.0125 MHz

Report on Test Measurements for FCC ID ABZ99FT3095B, HVIN SLR 8000-VHFB per FCC 47 CFR 90 and IC RSS-119.

Test Details	
Manufacturer	Motorola Solutions Inc.
EUT	VHF 110W Repeater
Model No.	SLR8000
Serial No.	433IYY0565
Mode	Transmit
Frequency Tested	155.0125MHz
Notes	1W
Date Tested	January 26, 2023 through January 30, 2023

Freq (MHz)	Ant Pol	Meter Reading (dBµV)	Ambient	Matched Sig Gen Reading (dBm)	Equivalent Antenna Gain (dB)	Cable Loss (dB)	ERP (dBm)	Attenuation Below Output Power (dB)	Minimum Attenuation (dB)
310.0250	H	6.8	Ambient	-72.8	0.0	1.0	-73.8	103.8	50.0
	V	5.8	Ambient	-70.6	0.0	1.0	-71.6	101.6	50.0
465.0375	H	5.7	Ambient	-68.9	0.0	1.2	-70.0	100.0	50.0
	V	5.8	Ambient	-66.8	0.0	1.2	-67.9	97.9	50.0
620.0500	H	5.2	Ambient	-68.2	0.0	1.4	-69.6	99.6	50.0
	V	5.2	Ambient	-65.3	0.0	1.4	-66.7	96.7	50.0
775.0625	H	5.7	Ambient	-64.8	0.0	1.5	-66.3	96.3	50.0
	V	5.2	Ambient	-63.2	0.0	1.5	-64.7	94.7	50.0
930.0750	H	5.4	Ambient	-63.7	0.0	1.7	-65.3	95.3	50.0
	V	5.8	Ambient	-60.9	0.0	1.7	-62.5	92.5	50.0
1085.0875	H	15.0	Ambient	-51.5	0.5	1.8	-52.9	82.9	50.0
	V	14.1	Ambient	-51.8	0.5	1.8	-53.2	83.2	50.0
1240.1000	H	14.6	Ambient	-50.8	0.3	1.9	-52.4	82.4	50.0
	V	14.0	Ambient	-50.6	0.3	1.9	-52.2	82.2	50.0
1395.1125	H	15.1	Ambient	-50.2	1.8	2.1	-50.5	80.5	50.0
	V	14.9	Ambient	-50.7	1.8	2.1	-51.0	81.0	50.0
1550.1250	H	15.1	Ambient	-52.2	3.9	2.2	-50.5	80.5	50.0
	V	15.2	Ambient	-51.7	3.9	2.2	-50.0	80.0	50.0

E1-7.5 Radiated Spurious Harmonic Emissions, Power Output 1 Watt, 155.0125 MHz

Report on Test Measurements for FCC ID ABZ99FT3095B, HVIN SLR 8000-VHFB per FCC 47 CFR 90 and IC RSS-119.

Test Details	
Manufacturer	Motorola Solutions Inc.
EUT	VHF 110W Repeater
Model No.	SLR8000
Serial No.	433IYY0565
Mode	Transmit
Frequency Tested	155.0125MHz
Notes	110W
Date Tested	January 26, 2023 through January 30, 2023

Freq (MHz)	Ant Pol	Meter Reading (dBµV)	Ambient	Matched Sig Gen Reading (dBm)	Equivalent Antenna Gain (dB)	Cable Loss (dB)	ERP (dBm)	Attenuation Below Output Power (dB)	Minimum Attenuation (dB)
310.0250	H	13.9		-66.0	0.0	1.0	-67.0	117.4	70.0
	V	10.3		-67.0	0.0	1.0	-68.0	118.4	70.0
465.0375	H	6.0	Ambient	-68.6	0.0	1.2	-69.7	120.1	70.0
	V	5.4	Ambient	-67.2	0.0	1.2	-68.3	118.7	70.0
620.0500	H	16.8		-57.8	0.0	1.4	-59.2	109.6	70.0
	V	12.5		-59.8	0.0	1.4	-61.2	111.6	70.0
775.0625	H	5.0	Ambient	-65.5	0.0	1.5	-67.0	117.4	70.0
	V	5.3	Ambient	-63.1	0.0	1.5	-64.6	115.0	70.0
930.0750	H	5.3	Ambient	-63.8	0.0	1.7	-65.4	115.8	70.0
	V	5.2	Ambient	-61.5	0.0	1.7	-63.1	113.5	70.0
1085.0875	H	14.0	Ambient	-52.5	0.5	1.8	-53.9	104.3	70.0
	V	14.5	Ambient	-51.4	0.5	1.8	-52.8	103.2	70.0
1240.1000	H	14.5	Ambient	-50.9	0.3	1.9	-52.5	102.9	70.0
	V	14.4	Ambient	-50.2	0.3	1.9	-51.8	102.2	70.0
1395.1125	H	14.9	Ambient	-50.4	1.8	2.1	-50.7	101.1	70.0
	V	14.9	Ambient	-50.7	1.8	2.1	-51.0	101.4	70.0
1550.1250	H	14.8	Ambient	-52.5	3.9	2.2	-50.8	101.2	70.0
	V	15.2	Ambient	-51.7	3.9	2.2	-50.0	100.4	70.0

E1-7.6 Radiated Spurious Harmonic Emissions, Power Output 110 Watts, 155.0125 MHz

Report on Test Measurements for FCC ID ABZ99FT3095B, HVIN SLR 8000-VHFB per FCC 47 CFR 90 and IC RSS-119.

Test Details	
Manufacturer	Motorola Solutions Inc.
EUT	VHF 110W Repeater
Model No.	SLR8000
Serial No.	433IYY0565
Mode	Transmit
Frequency Tested	173.9875MHz
Notes	1W
Date Tested	January 26, 2023 through January 30, 2023

Freq (MHz)	Ant Pol	Meter Reading (dBµV)	Ambient	Matched Sig Gen Reading (dBm)	Equivalent Antenna Gain (dB)	Cable Loss (dB)	ERP (dBm)	Attenuation Below Output Power (dB)	Minimum Attenuation (dB)
347.9750	H	10.7	Ambient	-68.8	0.0	1.0	-69.8	99.8	50.0
	V	6.0	Ambient	-70.3	0.0	1.0	-71.3	101.3	50.0
521.9625	H	5.9	Ambient	-69.6	0.0	1.2	-70.8	100.8	50.0
	V	5.7	Ambient	-69.3	0.0	1.2	-70.5	100.5	50.0
695.9500	H	5.0	Ambient	-66.9	0.0	1.4	-68.3	98.3	50.0
	V	7.9	Ambient	-61.3	0.0	1.4	-62.8	92.8	50.0
869.9375	H	5.4	Ambient	-64.4	0.0	1.6	-66.0	96.0	50.0
	V	5.0	Ambient	-62.0	0.0	1.6	-63.6	93.6	50.0
1043.9250	H	15.3	Ambient	-51.6	0.5	1.8	-52.9	82.9	50.0
	V	14.5	Ambient	-52.0	0.5	1.8	-53.3	83.3	50.0
1217.9125	H	14.6	Ambient	-50.8	0.2	1.9	-52.5	82.5	50.0
	V	15.2	Ambient	-49.2	0.2	1.9	-50.9	80.9	50.0
1391.9000	H	15.1	Ambient	-50.2	1.7	2.1	-50.5	80.5	50.0
	V	15.0	Ambient	-50.6	1.7	2.1	-50.9	80.9	50.0
1565.8875	H	14.9	Ambient	-52.6	4.0	2.2	-50.7	80.7	50.0
	V	15.1	Ambient	-51.9	4.0	2.2	-50.1	80.1	50.0
1739.8750	H	15.2	Ambient	-50.4	4.1	2.3	-48.6	78.6	50.0
	V	15.2	Ambient	-48.8	4.1	2.3	-46.9	76.9	50.0

E1-7.7 Radiated Spurious Harmonic Emissions, Power Output 1 Watt, 173.9875 MHz

Report on Test Measurements for FCC ID ABZ99FT3095B, HVIN SLR 8000-VHFB per FCC 47 CFR 90 and IC RSS-119.

Test Details	
Manufacturer	Motorola Solutions Inc.
EUT	VHF 110W Repeater
Model No.	SLR8000
Serial No.	433IYY0565
Mode	Transmit
Frequency Tested	173.9875MHz
Notes	110W
Date Tested	January 26, 2023 through January 30, 2023

Freq (MHz)	Ant Pol	Meter Reading (dBµV)	Ambient	Matched Sig Gen Reading (dBm)	Equivalent Antenna Gain (dB)	Cable Loss (dB)	ERP (dBm)	Attenuation Below Output Power (dB)	Minimum Attenuation (dB)
347.9750	H	10.7		-68.8	0.0	1.0	-69.8	120.2	70.0
	V	8.1		-68.2	0.0	1.0	-69.2	119.6	70.0
521.9625	H	17.9		-57.6	0.0	1.2	-58.8	109.3	70.0
	V	15.0		-60.6	0.0	1.2	-61.8	112.3	70.0
695.9500	H	4.9	Ambient	-67.0	0.0	1.4	-68.4	118.8	70.0
	V	5.1	Ambient	-64.1	0.0	1.4	-65.6	116.0	70.0
869.9375	H	5.2	Ambient	-64.6	0.0	1.6	-66.2	116.6	70.0
	V	5.5	Ambient	-61.5	0.0	1.6	-63.1	113.5	70.0
1043.9250	H	14.7	Ambient	-52.2	0.5	1.8	-53.5	103.9	70.0
	V	14.6	Ambient	-51.9	0.5	1.8	-53.2	103.6	70.0
1217.9125	H	15.5	Ambient	-49.9	0.2	1.9	-51.6	102.0	70.0
	V	14.6	Ambient	-49.8	0.2	1.9	-51.5	102.0	70.0
1391.9000	H	14.8	Ambient	-50.5	1.7	2.1	-50.8	101.2	70.0
	V	15.1	Ambient	-50.5	1.7	2.1	-50.8	101.2	70.0
1565.8875	H	15.0	Ambient	-52.5	4.0	2.2	-50.6	101.0	70.0
	V	14.3	Ambient	-52.7	4.0	2.2	-50.9	101.3	70.0
1739.8750	H	15.2	Ambient	-50.4	4.1	2.3	-48.6	99.0	70.0
	V	15.6	Ambient	-48.4	4.1	2.3	-46.5	97.0	70.0

E1-7.8 Radiated Spurious Harmonic Emissions, Power Output 110 Watts, 173.9875 MHz

Report on Test Measurements for FCC ID ABZ99FT3095B, HVIN SLR 8000-VHFB per FCC 47 CFR 90 and IC RSS-119.

E1-8 Oscillator Frequency Stability

Specification Requirement IC RSS-119 section 5.3:

Fixed and Base stations operating at 138-174 MHz and 12.5 kHz channel bandwidth must have a frequency stability of better than +/- 2.5 PPM, and those operating at 25 kHz / 30 kHz channel bandwidth must have a frequency stability of better than +/- 5.0 PPM.

Specification Requirement: Reference Part 90.213

Fixed and Base stations operating at 150-174 MHz and 12.5 kHz channel bandwidth must have a frequency stability of better than +/- 2.5 PPM.

Only the more stringent specification limit is shown on the frequency stability exhibits. Performance was measured at carrier frequencies across the operating band.

EXHIBIT	DESCRIPTION
E1-8.1	Frequency Stability Vs Temperature
E1-8.2	Frequency Stability Vs Voltage

Report on Test Measurements for FCC ID ABZ99FT3095B, HVIN SLR 8000-VHFB per FCC 47 CFR 90 and IC RSS-119.

E1-8.1 Frequency Stability Vs Temperature

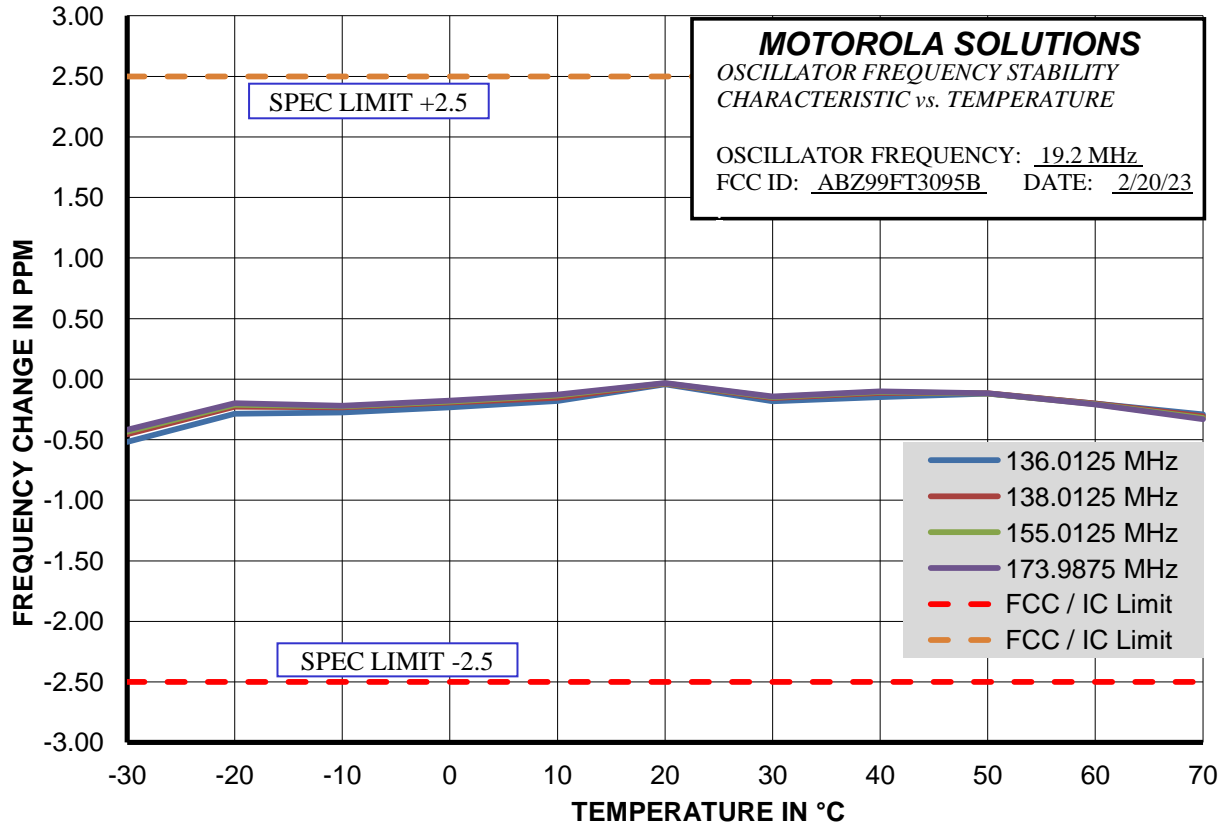

Report on Test Measurements for FCC ID ABZ99FT3095B, HVIN SLR 8000-VHFB per FCC 47 CFR 90 and IC RSS-119.

E1-11.2 Frequency Stability Vs Voltage

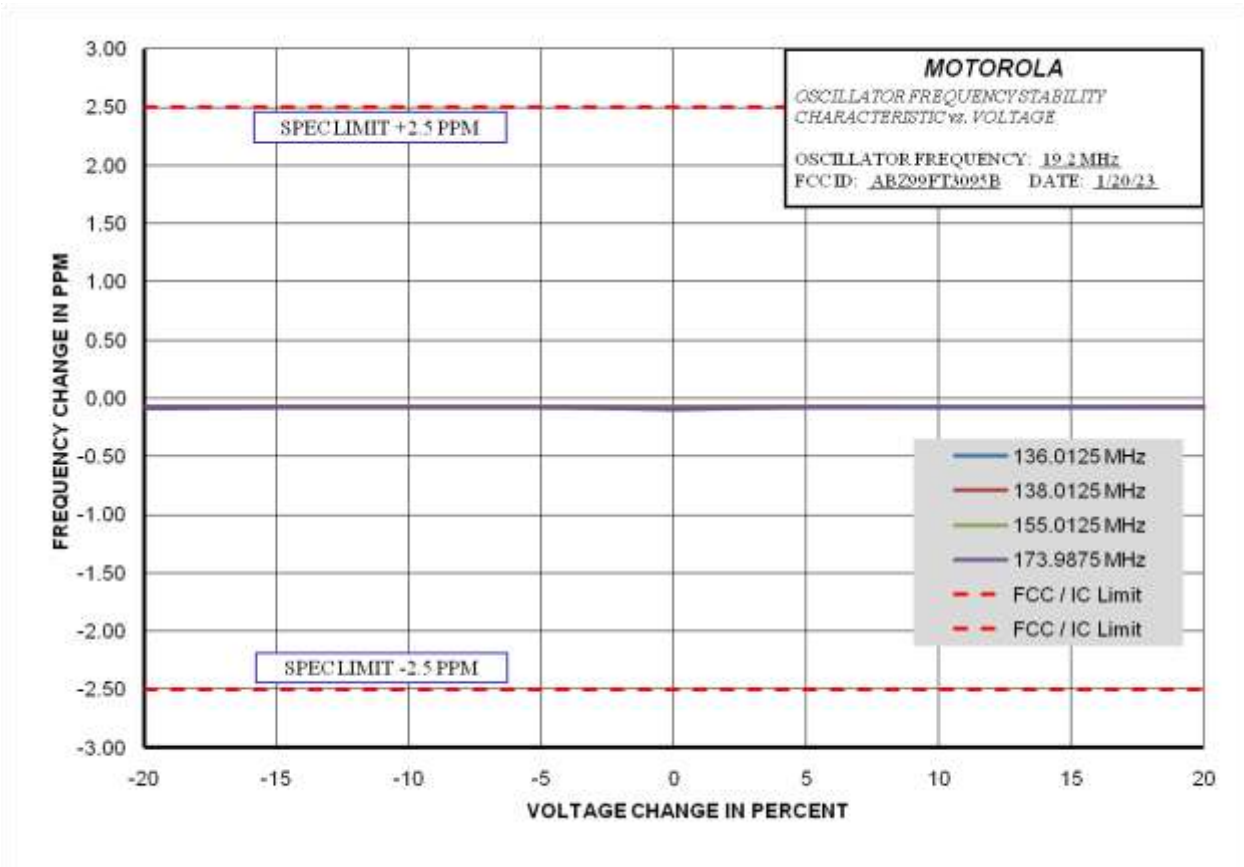

Report on Test Measurements for FCC ID ABZ99FT3095B, HVIN SLR 8000-VHFB per FCC 47 CFR 90 and IC RSS-119.

E1-9 Frequency Transient Behavior

Specification Requirement 47 CFR §90.214 and IC RSS-119 section 5.9:

Transmitters designed to operate in the 138-174 MHz (150-174 MHz for FCC) frequency band must maintain transient frequencies within the maximum frequency difference limits during the time intervals indicated below:

Transient Frequency Behavior 25 kHz Channels

For time intervals:

- a. t1 = 5 ms Maximum Frequency Difference ± 25 kHz
- b. t2 = 20 ms Maximum Frequency Difference ± 12.5 kHz
- c. t3 = 5 ms Maximum Frequency Difference ± 25 kHz

Transient Frequency Behavior 12.5 kHz Channels

For time intervals:

- a. t1 = 5 ms Maximum Frequency Difference ± 12.5 kHz
- b. t2 = 20 ms Maximum Frequency Difference ± 6.25 kHz
- c. t3 = 5 ms Maximum Frequency Difference ± 12.5 kHz

Where t1 and t2 are times immediately following when the transmitter is turned on, and t3 is the time from when the transmitter is turned off.

During the time from the end of t2 to the beginning of t3, the frequency difference must not exceed the limits specified in §90.213 / RSS-119 section 5.3.

Modulation: Analog Mode Frequency Modulation

Carrier Frequencies: Performance was measured at carrier frequencies at the low end, middle, and high end of the operating band.

<u>EXHIBIT</u>	<u>DESCRIPTION</u>
E1-9.1-9.4	Frequency Transient Behavior, 25 kHz Channel Key-Up
E1-9.5-9.8	Frequency Transient Behavior, 25 kHz Channel De-Key
E1-9.9-9.12	Frequency Transient Behavior, 12.5 kHz Channel Key-Up
E1-9.13-9.16	Frequency Transient Behavior, 12.5 kHz Channel De-key

Report on Test Measurements for FCC ID ABZ99FT3095B, HVIN SLR 8000-VHFB per FCC 47 CFR 90 and IC RSS-119.

E1-9.1 Frequency Transient Behavior, 25 kHz Channel Key-Up, 136.0125MHz

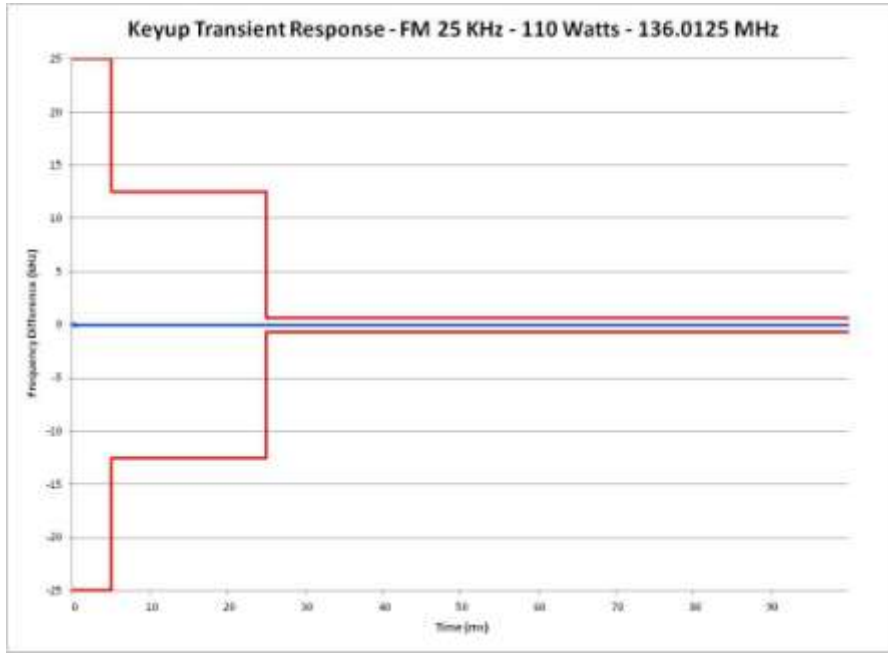

E1-9.2 Frequency Transient Behavior, 25 kHz Channel Key-Up, 138.0125MHz

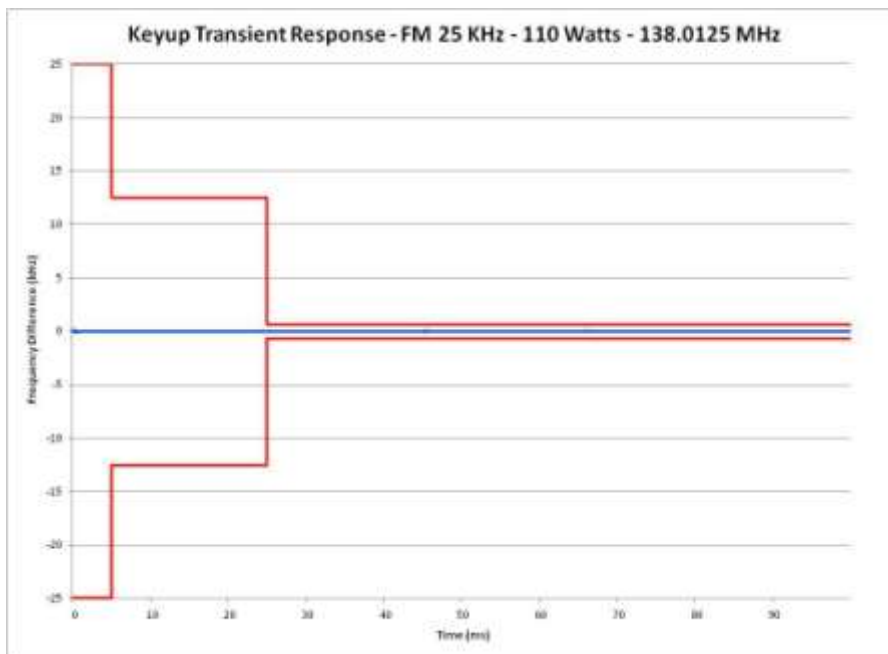

Report on Test Measurements for FCC ID ABZ99FT3095B, HVIN SLR 8000-VHFB per FCC 47 CFR 90 and IC RSS-119.

E1-9.3 Frequency Transient Behavior, 25 kHz Channel Key-Up, 155.0125MHz

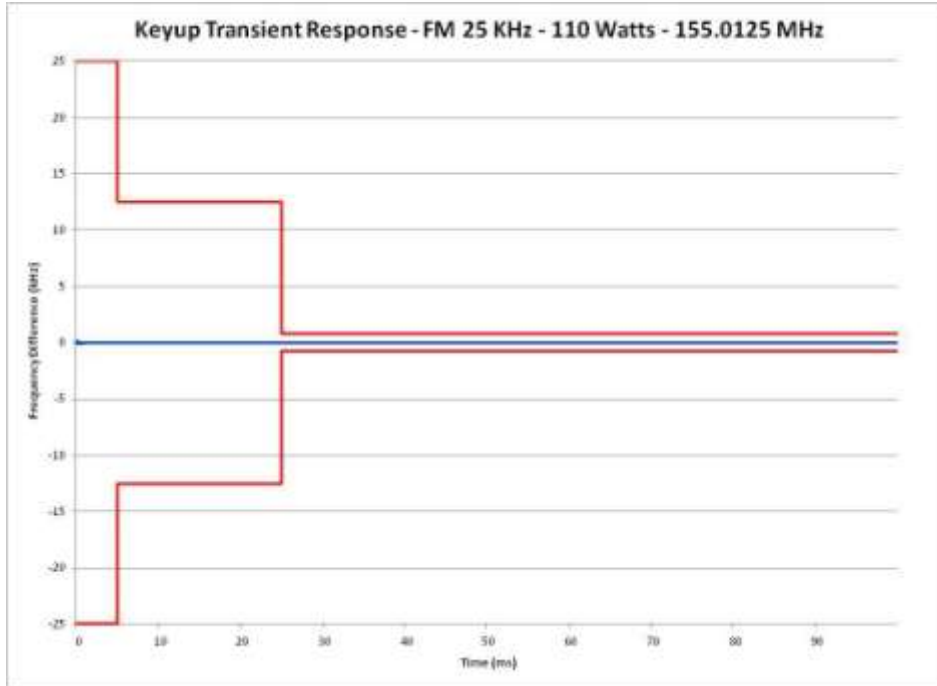

E1-9.4 Frequency Transient Behavior, 25 kHz Channel Key-Up, 173.9875 MHz

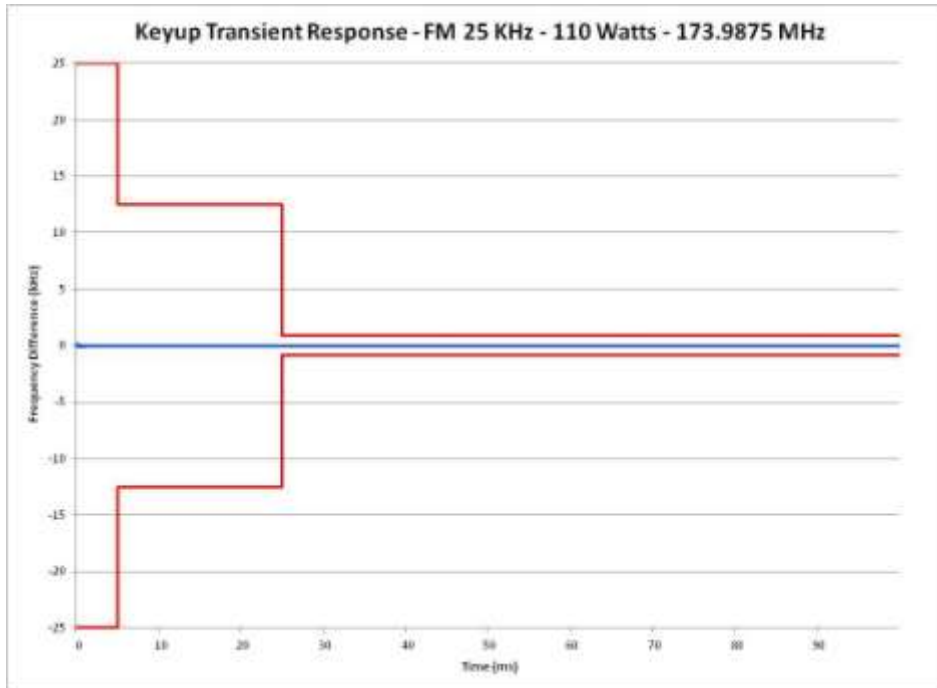

E1-9.5 Frequency Transient Behavior, 25 kHz Channel De-Key, 136.0125 MHz

Report on Test Measurements for FCC ID ABZ99FT3095B, HVIN SLR 8000-VHFB per FCC 47 CFR 90 and IC RSS-119.

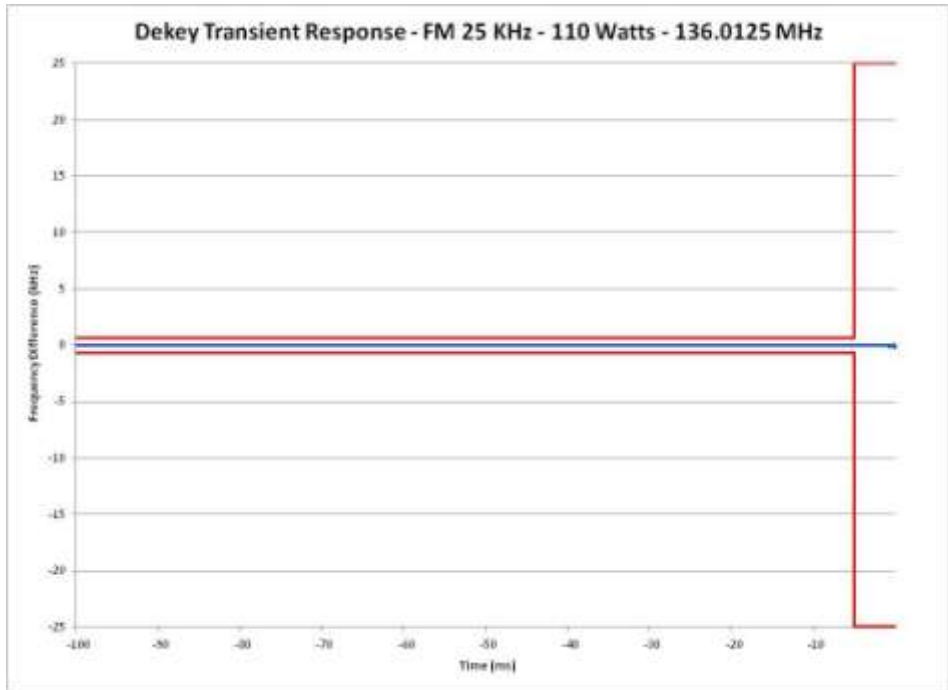

E1-9.6 Frequency Transient Behavior, 25 kHz Channel De-Key, 138.0125 MHz

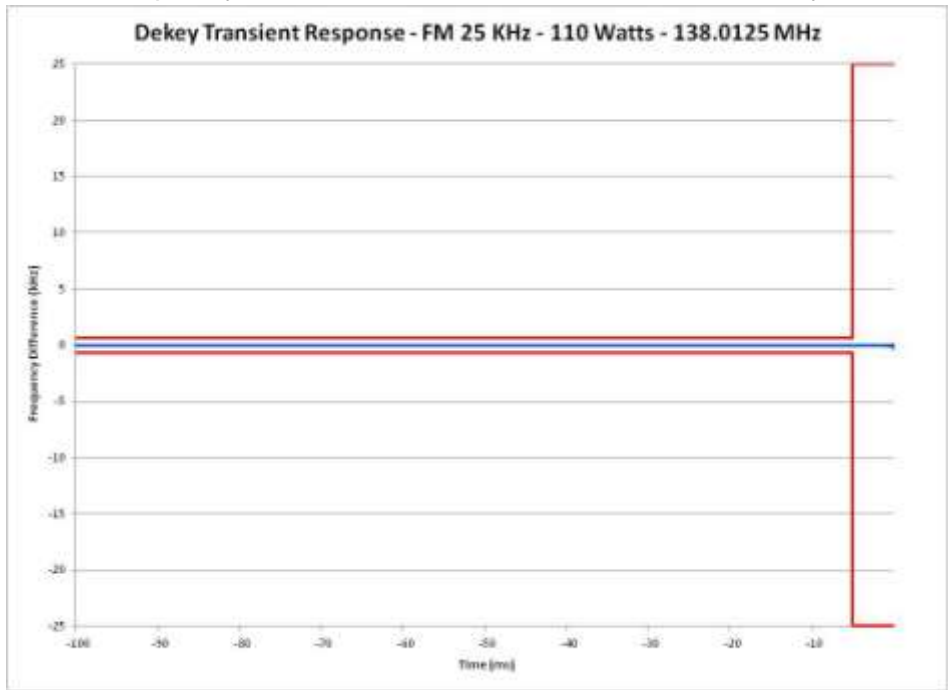

Report on Test Measurements for FCC ID ABZ99FT3095B, HVIN SLR 8000-VHFB per FCC 47 CFR 90 and IC RSS-119.

E1-9.7 Frequency Transient Behavior, 25 kHz Channel De-Key, 155.0125 MHz

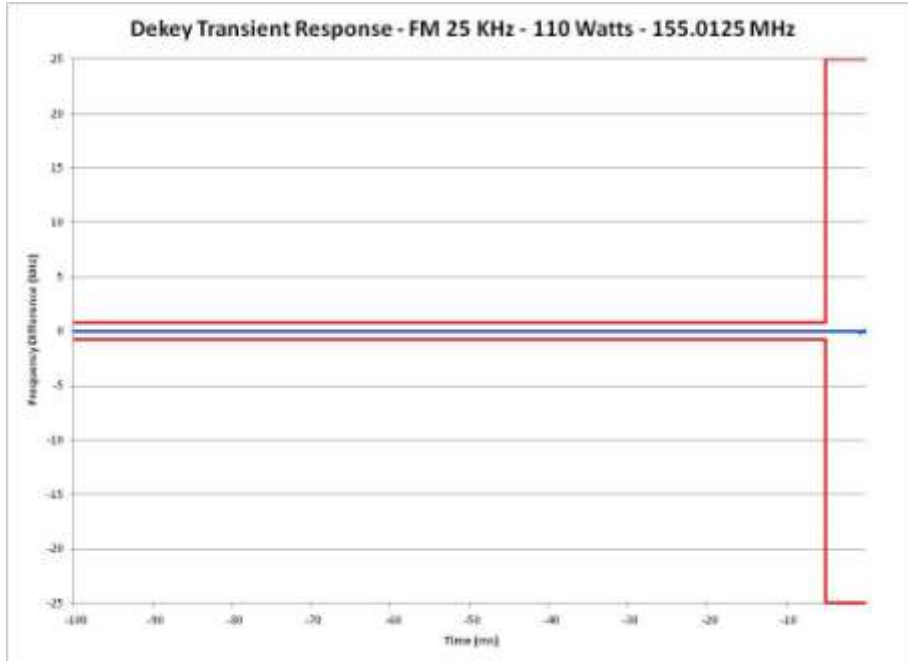

E1-9.8 Frequency Transient Behavior, 25 kHz Channel De-Key, 173.9875 MHz

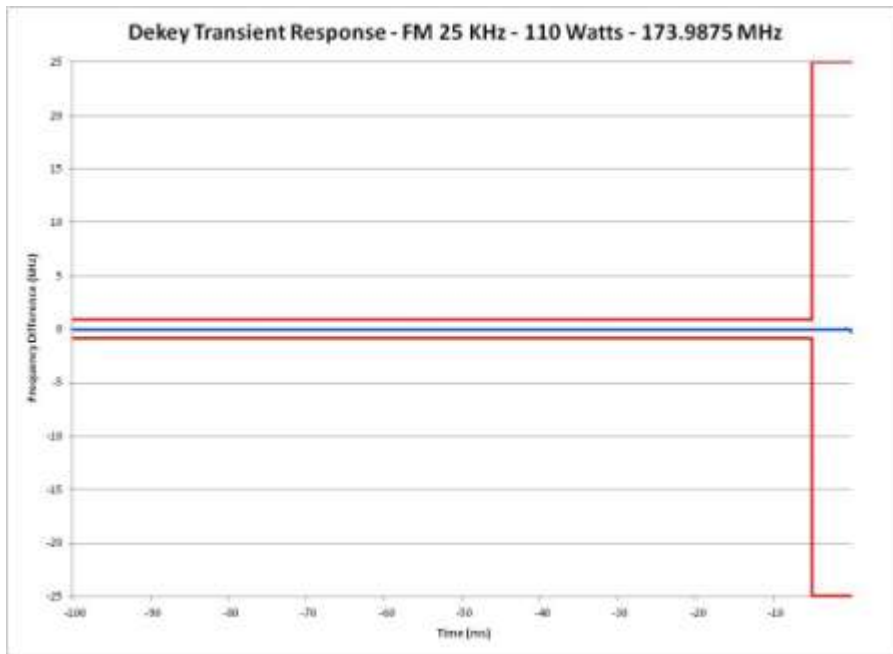

Report on Test Measurements for FCC ID ABZ99FT3095B, HVIN SLR 8000-VHFB per FCC 47 CFR 90 and IC RSS-119.

E1-9.9 Frequency Transient Behavior, 12.5 kHz Channel Key-Up, 136.0125 MHz

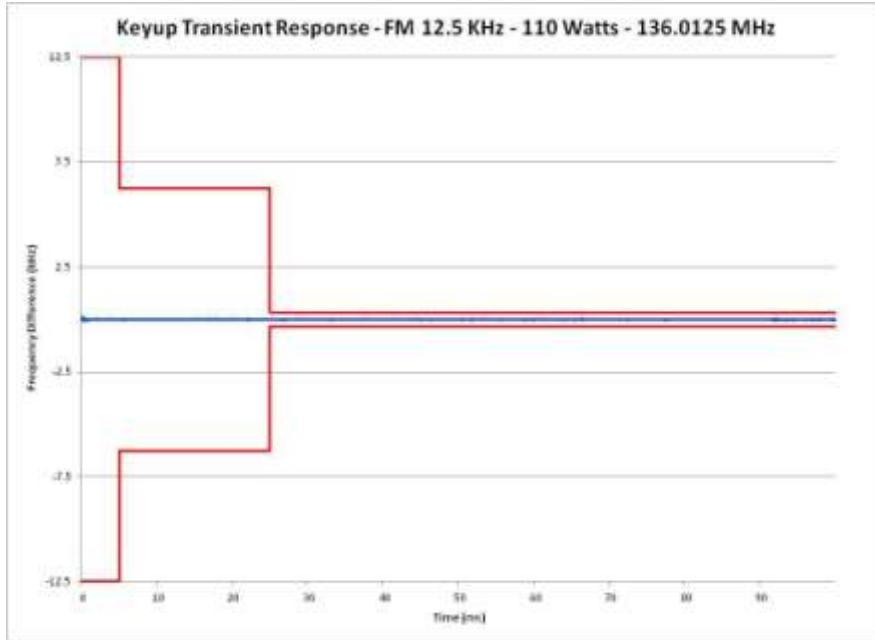

E1-9.10 Frequency Transient Behavior, 12.5 kHz Channel Key-Up, 138.0125 MHz

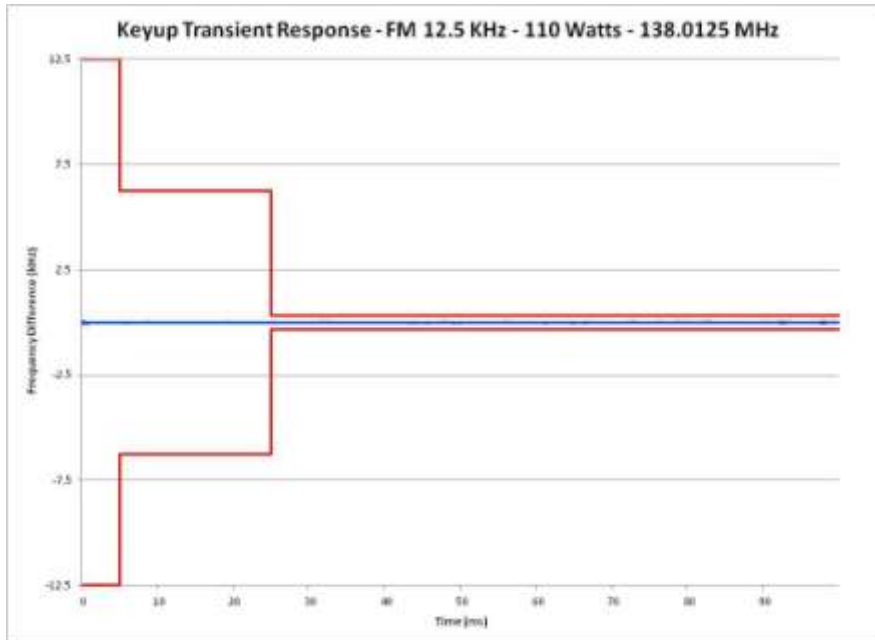

Report on Test Measurements for FCC ID ABZ99FT3095B, HVIN SLR 8000-VHFB per FCC 47 CFR 90 and IC RSS-119.

E1-9.11 Frequency Transient Behavior, 12.5 kHz Channel Key-Up, 155.0125 MHz

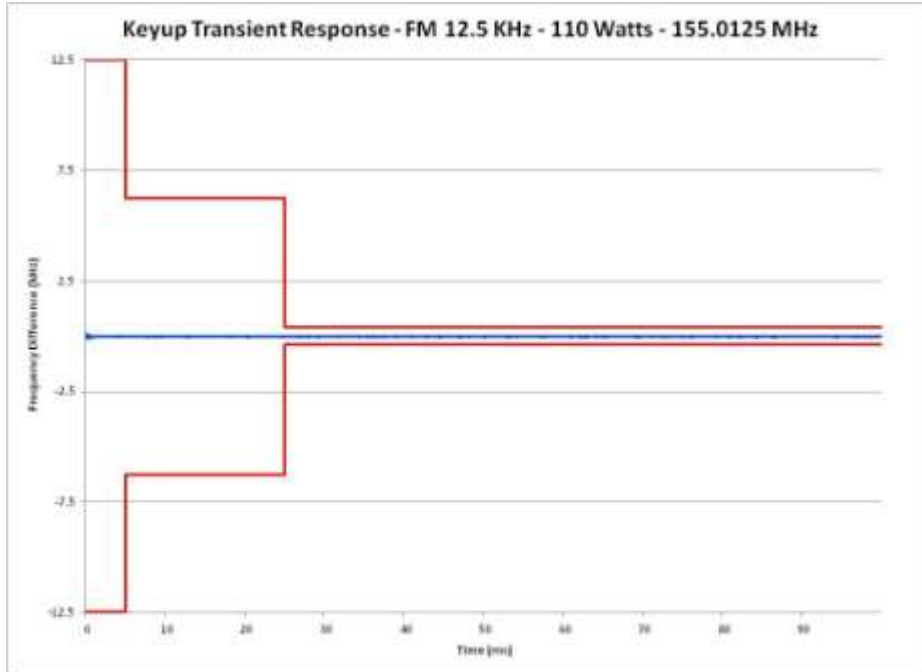

E1-9.12 Frequency Transient Behavior, 12.5 kHz Channel Key-Up, 173.9875 MHz

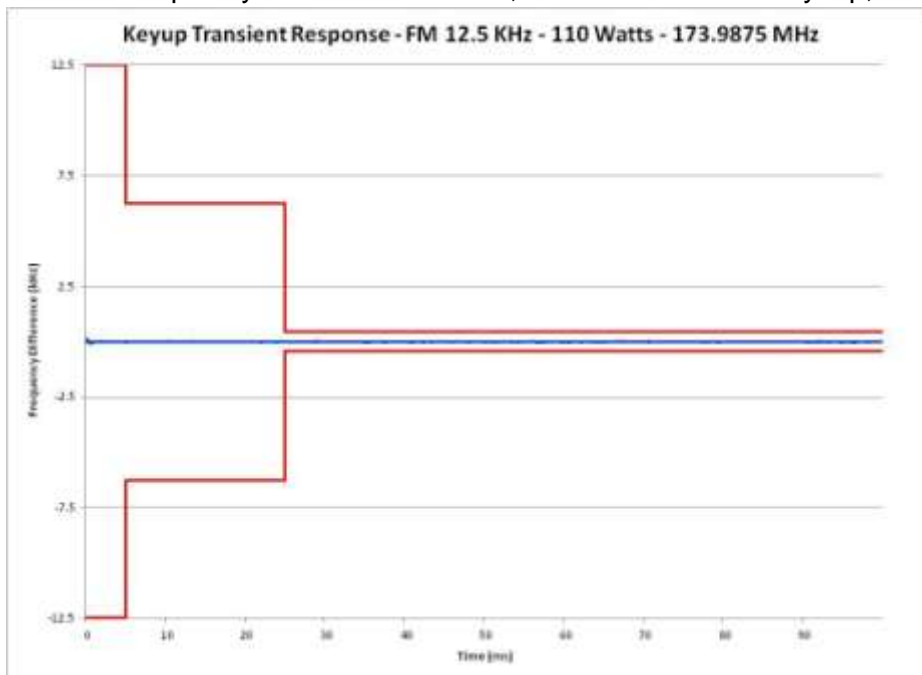

Report on Test Measurements for FCC ID ABZ99FT3095B, HVIN SLR 8000-VHFB per FCC 47 CFR 90 and IC RSS-119.

E1-9.13 Frequency Transient Behavior, 12.5 kHz Channel De-Key, 136.0125 MHz

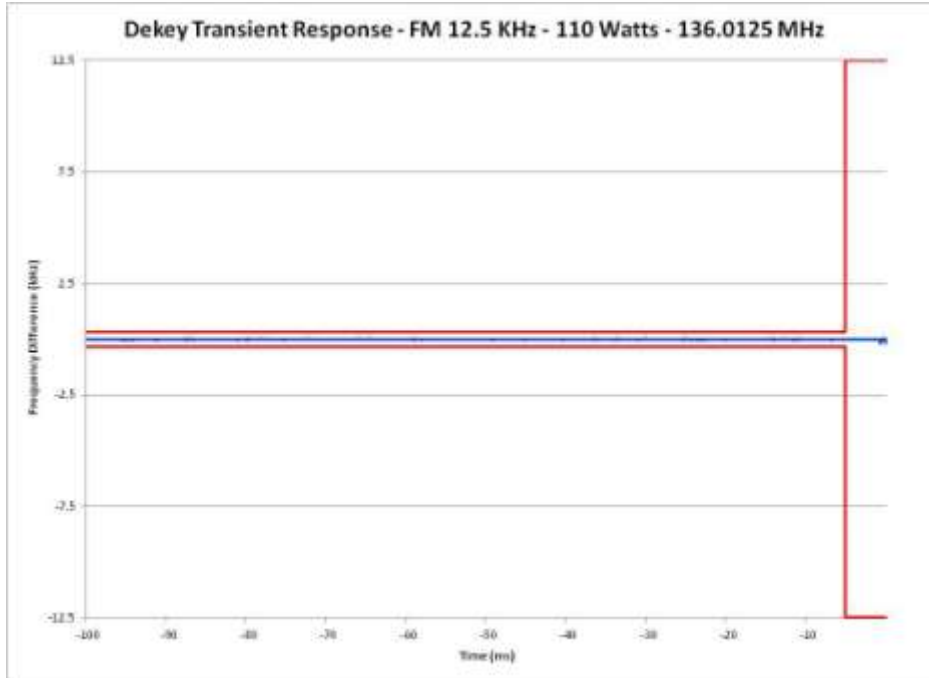

E1-9.14 Frequency Transient Behavior, 12.5 kHz Channel De-Key, 138.0125 MHz

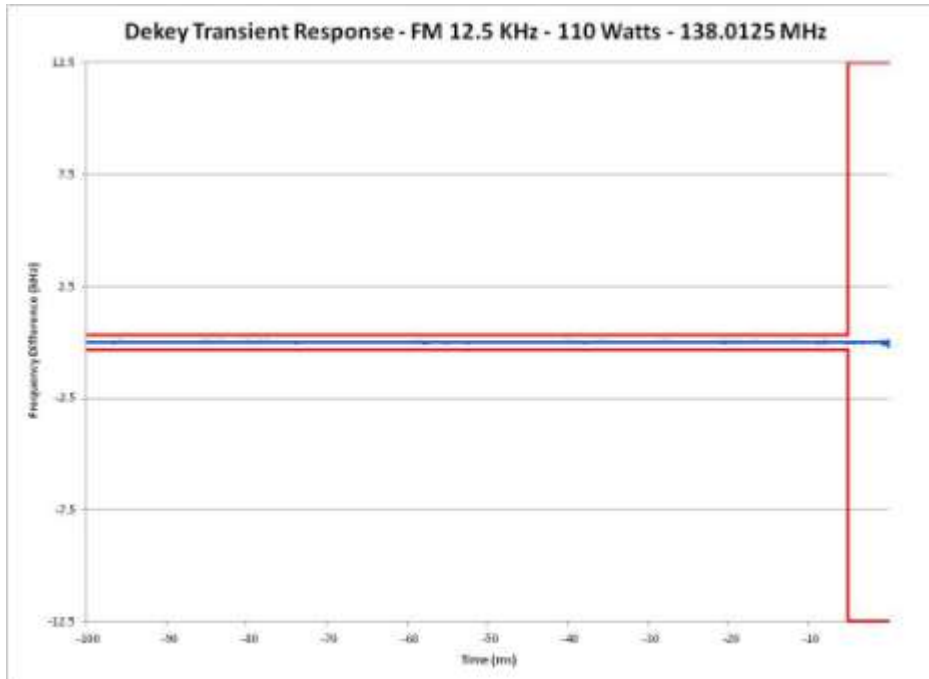

Report on Test Measurements for FCC ID ABZ99FT3095B, HVIN SLR 8000-VHFB per FCC 47 CFR 90 and IC RSS-119.

E1-9.15 Frequency Transient Behavior, 12.5 kHz Channel De-Key, 155.0125 MHz

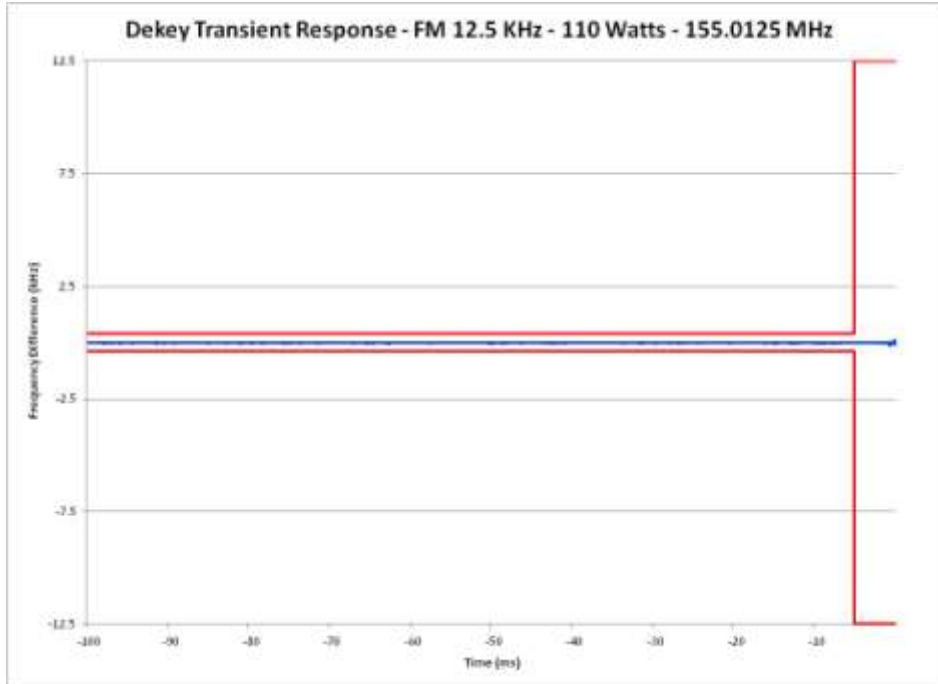

E1-9.16 Frequency Transient Behavior, 12.5 kHz Channel De-Key, 173.9875 MHz

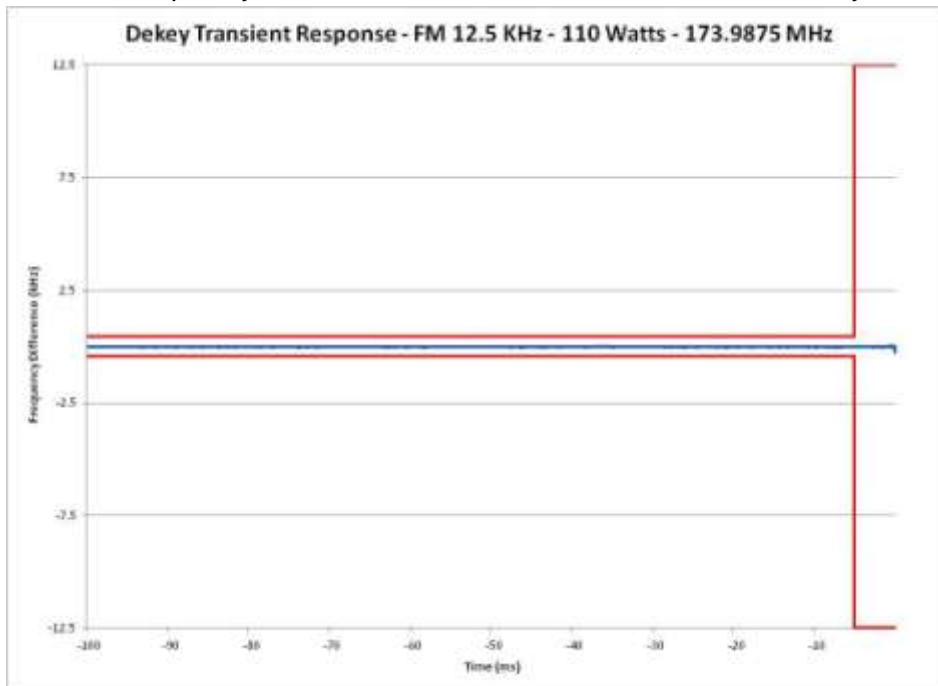

Report on Test Measurements for FCC ID ABZ99FT3095B, HVIN SLR 8000-VHFB per FCC 47 CFR 90 and IC RSS-119.

E1-10 Audio Frequency Response

Specification Requirement per TIA 603:

Audio Frequency Response, 25 kHz Channels: The audio frequency response from 300 Hz to 3000 Hz shall not vary more than +1 dB or -3 dB from a true 6 dB per octave pre-emphasis characteristic as referenced to the 1000 Hz level, with an additional 6 dB per octave attenuation allowed from 500 Hz to 300 Hz, and an additional 6 dB per octave attenuation is allowed from 2500 Hz to 3000 Hz in equipment operating in the 25 MHz to 869 MHz range.

Audio Frequency Response, 12.5 kHz Channels: The audio frequency response from 300 Hz to 3000 Hz shall not vary more than +1 dB or -3 dB from a true 6 dB per octave pre-emphasis characteristic as referenced to the 1000 Hz level, with an additional 6 dB per octave attenuation allowed from 500 Hz to 300 Hz. An additional 6 dB per octave rolloff is allowed from 2300 Hz to 2700 Hz, and an additional 12 dB per octave is allowed from 2700 Hz to 3000 Hz in equipment operating in the 896 MHz to 940 MHz range or for 12.5 kHz channel operation.

Modulation: Audio Test Tone

Carrier Frequency: Performance was measured at carrier frequencies at the low end, middle, and high end of the operating band..

Specification: The specification limit is shown on the response plots

<u>EXHIBIT</u>	<u>DESCRIPTION</u>
E1-10.1	Audio Frequency Response – Modulation Characteristics, 25 kHz Channels – 136.0125 MHz
E1-10.2	Audio Frequency Response – Modulation Characteristics, 25 kHz Channels – 138.0125 MHz
E1-10.3	Audio Frequency Response – Modulation Characteristics, 25 kHz Channels – 155.0125 MHz
E1-10.4	Audio Frequency Response – Modulation Characteristics, 25 kHz Channels – 173.9875 MHz
E1-10.5	Audio Frequency Response – Modulation Characteristics, 12.5 kHz Channels – 136.0125 MHz
E1-10.6	Audio Frequency Response – Modulation Characteristics, 12.5 kHz Channels – 138.0125 MHz
E1-10.7	Audio Frequency Response – Modulation Characteristics, 12.5 kHz Channels – 155.0125 MHz
E1-10.8	Audio Frequency Response – Modulation Characteristics, 12.5 kHz Channels – 173.9875 MHz

Report on Test Measurements for FCC ID ABZ99FT3095B, HVIN SLR 8000-VHFB per FCC 47 CFR 90 and IC RSS-119.

E1-10.1 Audio Frequency Response – Modulation Characteristics, 25 kHz Channels – 136.0125 MHz

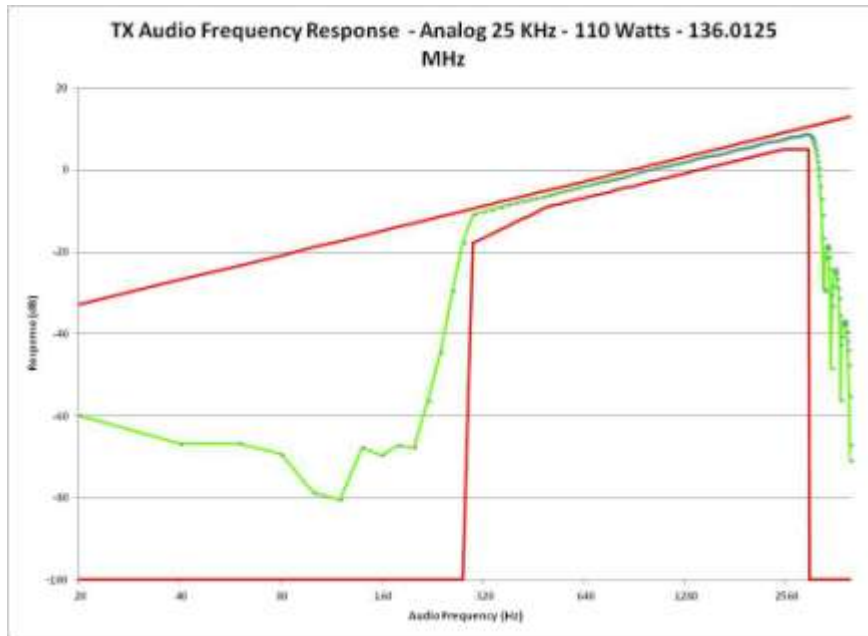

E1-10.2 Audio Frequency Response – Modulation Characteristics, 25 kHz Channels – 138.0125 MHz

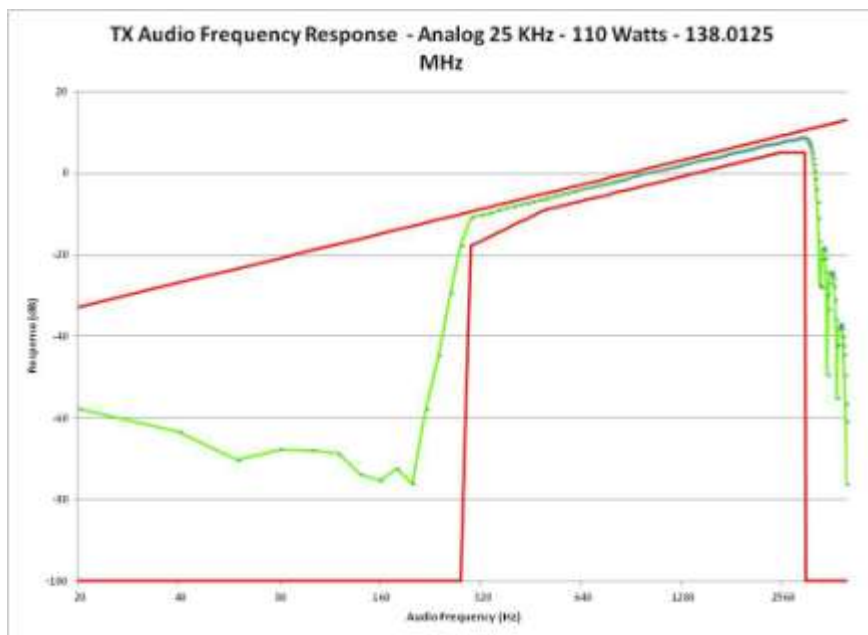

Report on Test Measurements for FCC ID ABZ99FT3095B, HVIN SLR 8000-VHFB per FCC 47 CFR 90 and IC RSS-119.

E1-10.3 Audio Frequency Response – Modulation Characteristics, 25 kHz Channels – 155.0125 MHz

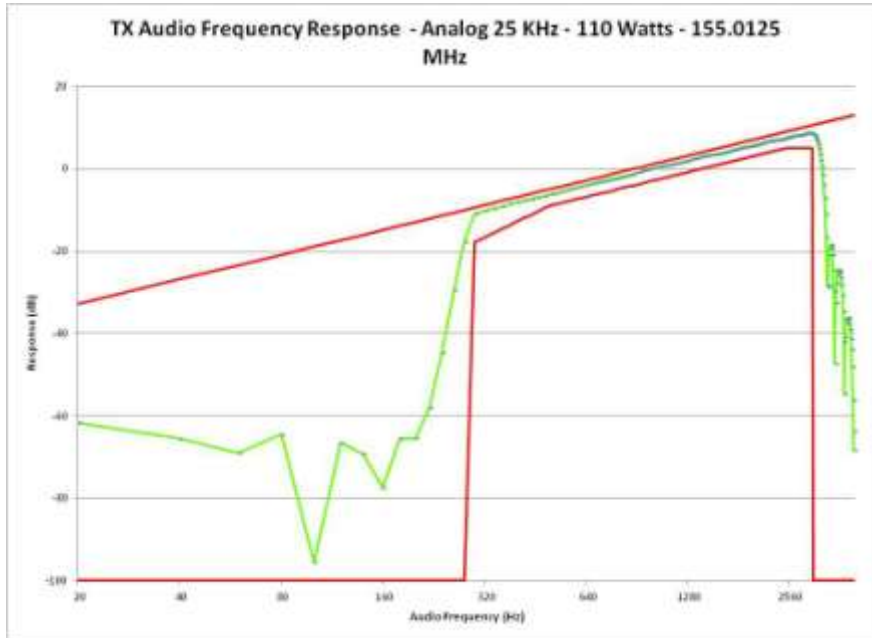

E1-10.4 Audio Frequency Response – Modulation Characteristics, 25 kHz Channels – 173.9875 MHz

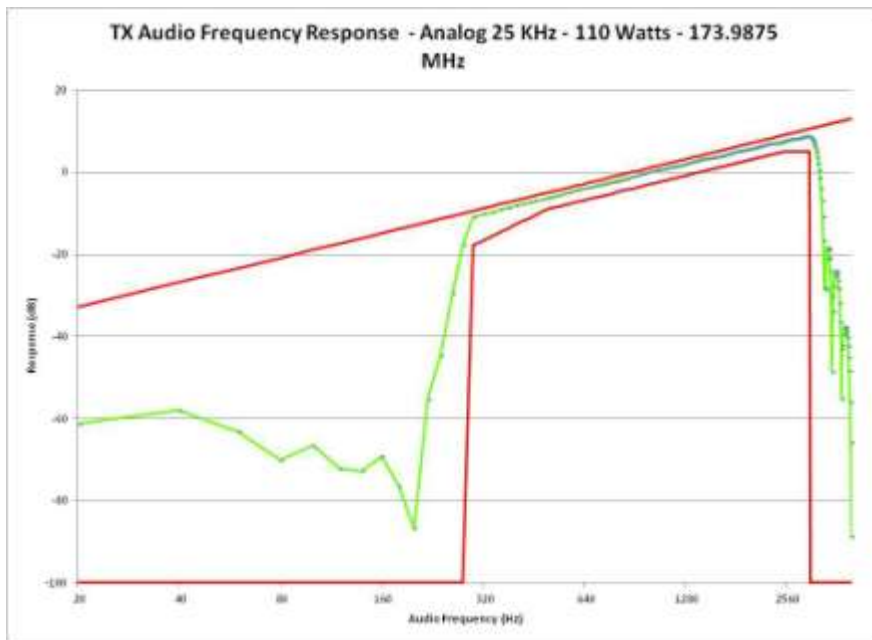

Report on Test Measurements for FCC ID ABZ99FT3095B, HVIN SLR 8000-VHFB per FCC 47 CFR 90 and IC RSS-119.

E1-10.5 Audio Frequency Response – Modulation Characteristics, 12.5 kHz Channels – 136.0125 MHz

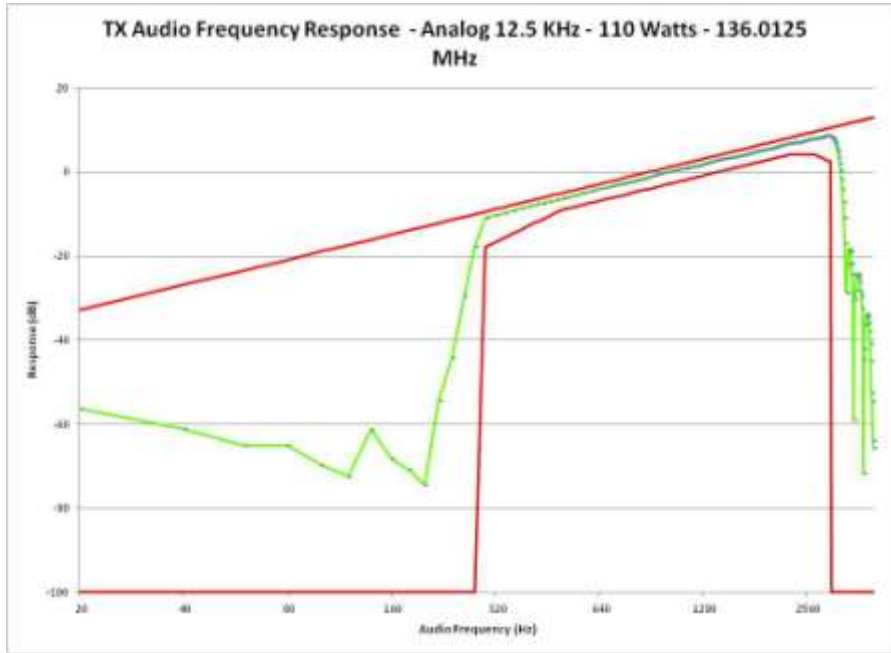

E1-10.6 Audio Frequency Response – Modulation Characteristics, 12.5 kHz Channels – 138.0125 MHz

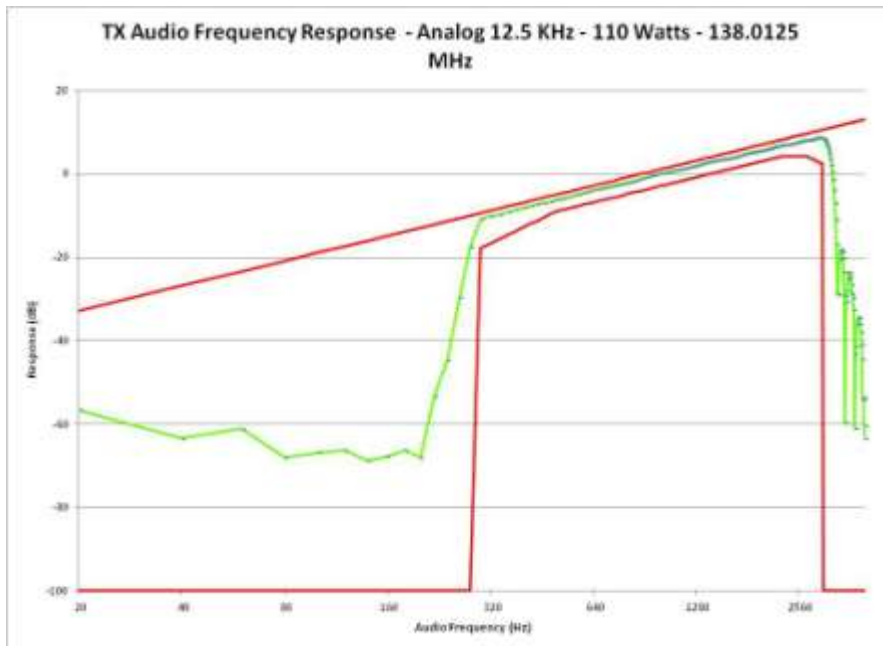

Report on Test Measurements for FCC ID ABZ99FT3095B, HVIN SLR 8000-VHFB per FCC 47 CFR 90 and IC RSS-119.

E1-10.7 Audio Frequency Response – Modulation Characteristics, 12.5 kHz Channels – 155.0125 MHz

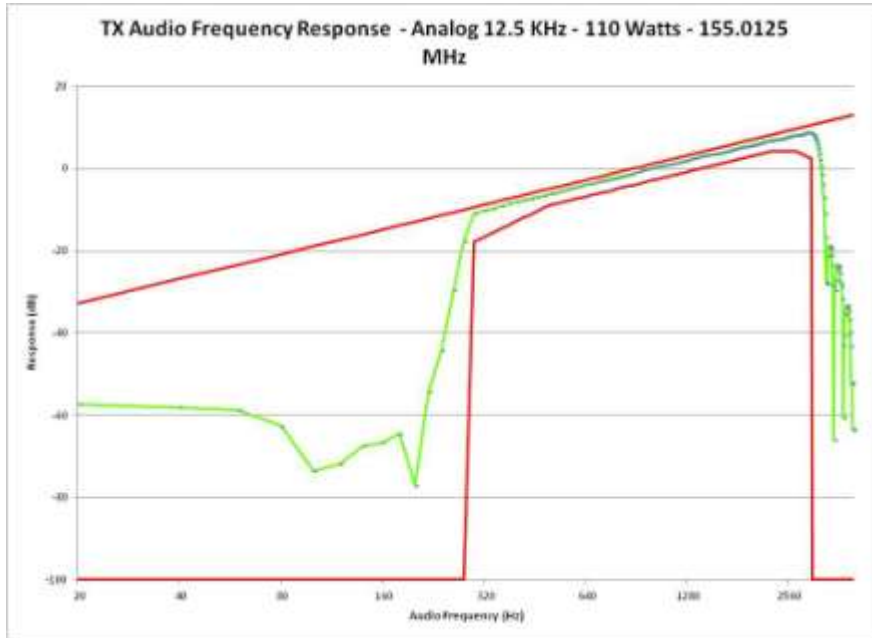

E1-10.8 Audio Frequency Response – Modulation Characteristics, 12.5 kHz Channels – 173.9875 MHz

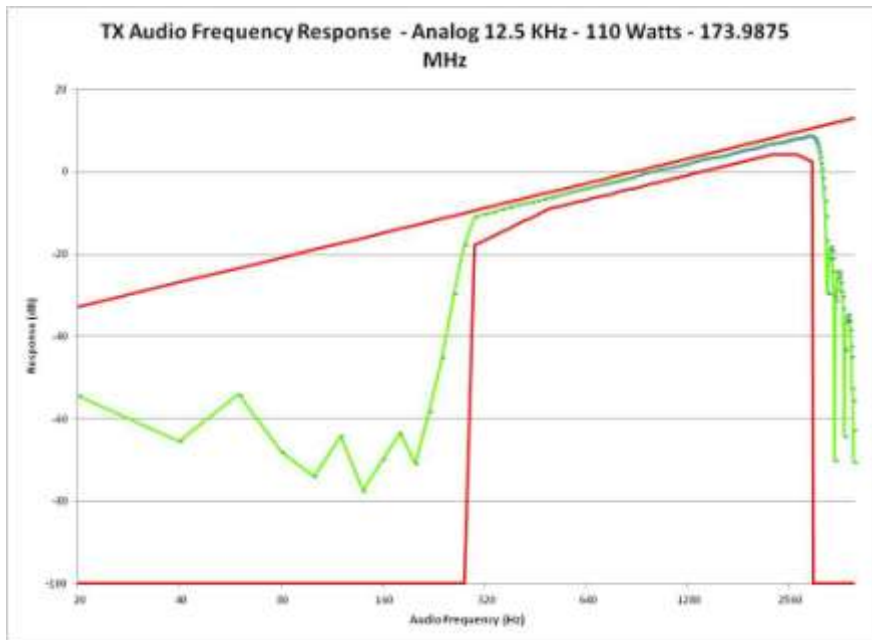

Report on Test Measurements for FCC ID ABZ99FT3095B, HVIN SLR 8000-VHFB per FCC 47 CFR 90 and IC RSS-119.

E1-11 Modulation Limiting

Specification Requirement per TIA 603:

Modulation Limiting, 25 kHz Channels: The maximum instantaneous peak and steady state deviations shall not exceed the rated system deviation of +/- 5 kHz at any audio frequency or change in level as specified in the method of measurement.

The minimum value of modulation limiting shall be at least 60% of the rated system deviation, or 3 kHz.

Modulation Limiting, 12.5 kHz Channels: The maximum instantaneous peak and steady state deviations shall not exceed the rated system deviation of +/- 2.5 kHz at any audio frequency or change in level as specified in the method of measurement.

The minimum value of modulation limiting shall be at least 60% of the rated system deviation, or 1.5 kHz..

Modulation: Audio Test Tone, Varying Frequency between 300 Hz and 3000 Hz
 Carrier Frequency: Performance was measured at carrier frequencies at the low end, middle, and high end of the operating band.

Modulation Limiting Response Plots:

EXHIBIT	DESCRIPTION
E1-11.1	Audio Modulation Limiting – Modulation Characteristics, 25 kHz Channels – 136.0125 MHz
E1-11.2	Audio Modulation Limiting – Modulation Characteristics, 25 kHz Channels – 138.0125 MHz
E1-11.3	Audio Modulation Limiting – Modulation Characteristics, 25 kHz Channels – 155.0125 MHz
E1-11.4	Audio Modulation Limiting – Modulation Characteristics, 25 kHz Channels – 173.9875 MHz
E1-11.5	Audio Modulation Limiting – Modulation Characteristics, 12.5 kHz Channels – 136.0125 MHz
E1-11.6	Audio Modulation Limiting – Modulation Characteristics, 12.5 kHz Channels – 138.0125 MHz
E1-11.7	Audio Modulation Limiting – Modulation Characteristics, 12.5 kHz Channels – 155.0125 MHz

APPLICANT: MOTOROLA SOLUTIONS

EQUIPMENT TYPE: ABZ99FT3095B

109AB-99FT3095B

**Report on Test Measurements for FCC ID ABZ99FT3095B, HVIN SLR 8000-VHFB per FCC
47 CFR 90 and IC RSS-119.**

E1-11.8

Audio Modulation Limiting – Modulation Characteristics, 12.5 kHz
Channels – 173.9875 MHz

Report on Test Measurements for FCC ID ABZ99FT3095B, HVIN SLR 8000-VHFB per FCC 47 CFR 90 and IC RSS-119.

E1-11.1 Audio Modulation Limiting – Modulation Characteristics, 25 kHz Channels – 136.0125 MHz

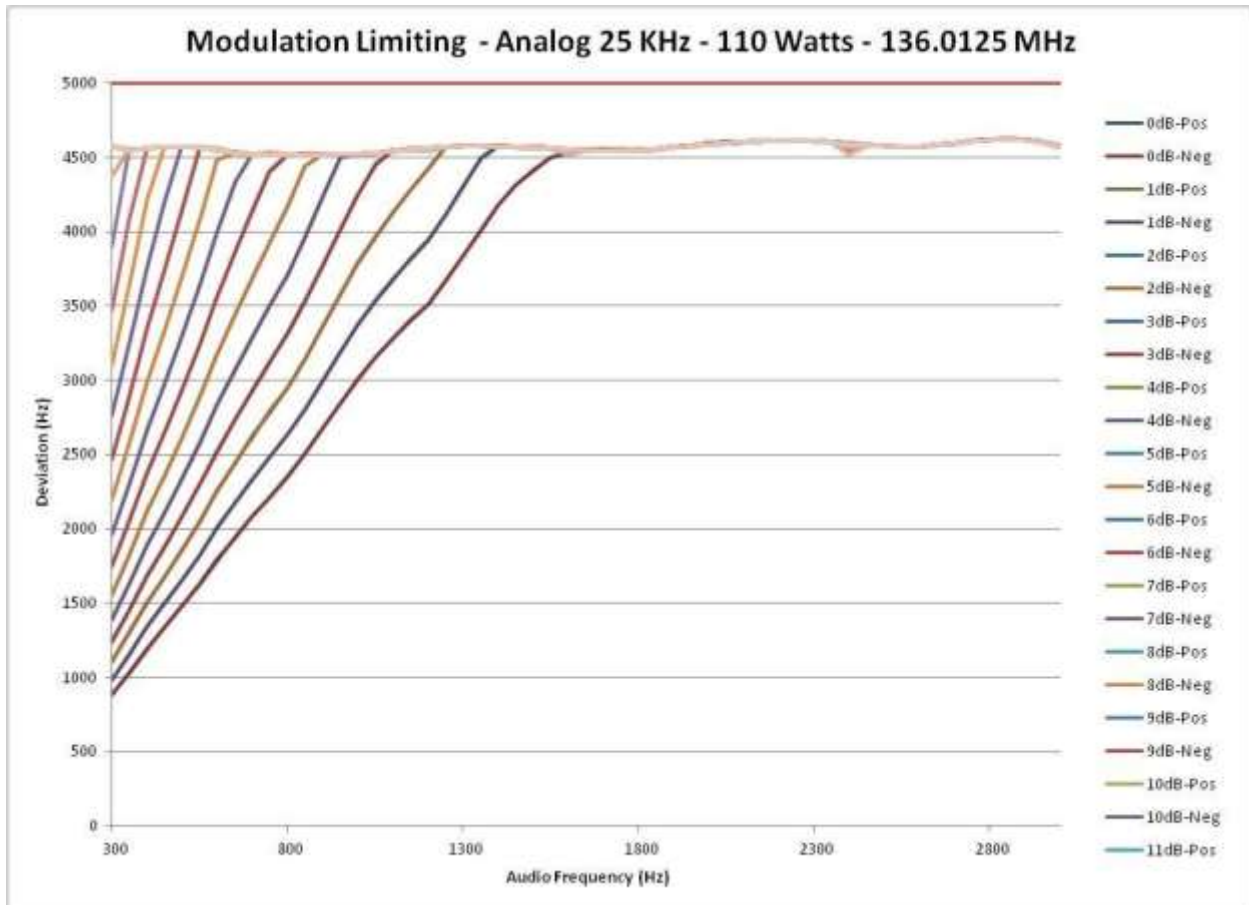

Report on Test Measurements for FCC ID ABZ99FT3095B, HVIN SLR 8000-VHFB per FCC 47 CFR 90 and IC RSS-119.

E1-11.2 Audio Modulation Limiting – Modulation Characteristics, 25 kHz Channels – 138.0125 MHz



Report on Test Measurements for FCC ID ABZ99FT3095B, HVIN SLR 8000-VHFB per FCC 47 CFR 90 and IC RSS-119.

E1-11.3 Audio Modulation Limiting – Modulation Characteristics, 25 kHz Channels – 155.0125 MHz

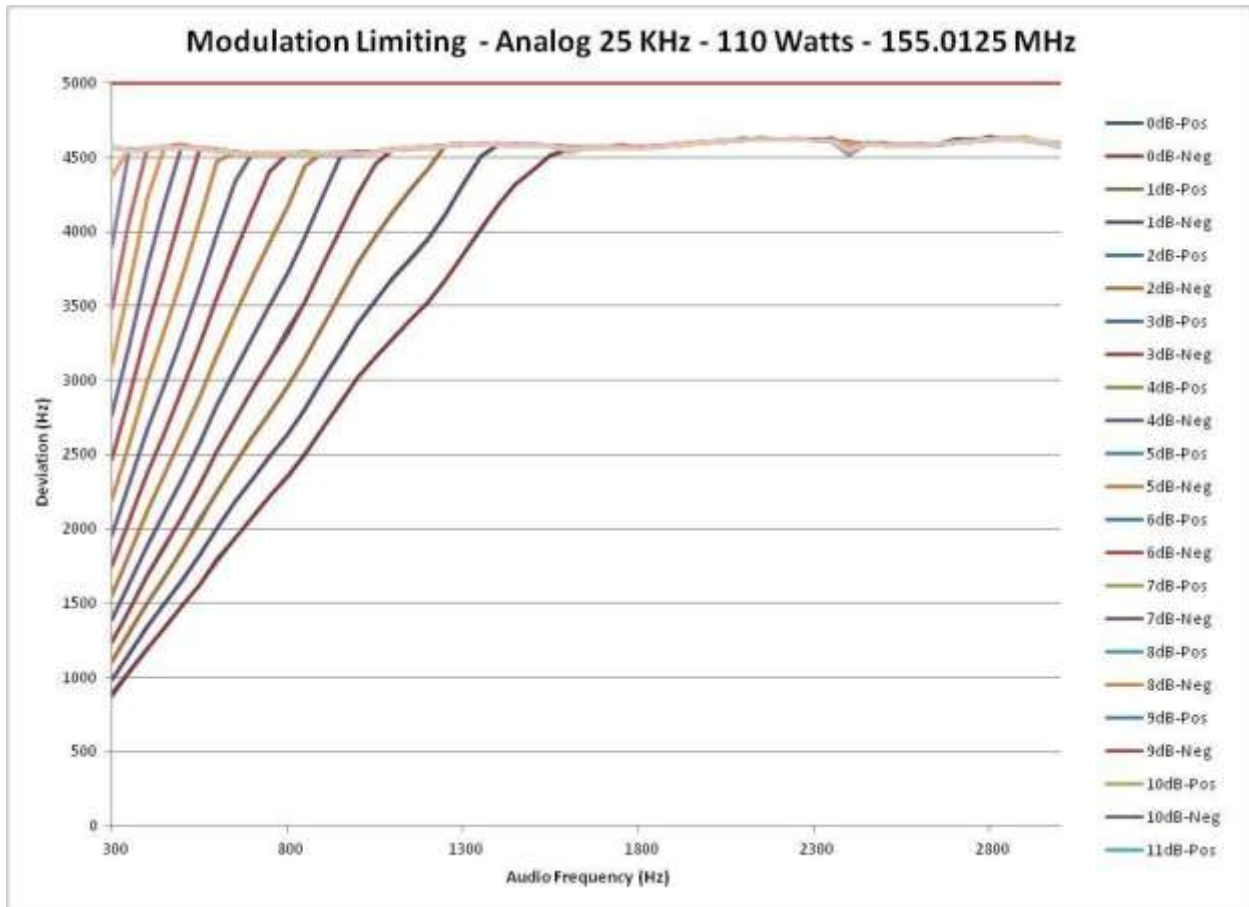

Report on Test Measurements for FCC ID ABZ99FT3095B, HVIN SLR 8000-VHFB per FCC 47 CFR 90 and IC RSS-119.

E1-11.4 Audio Modulation Limiting – Modulation Characteristics, 25 kHz Channels – 173.9875 MHz

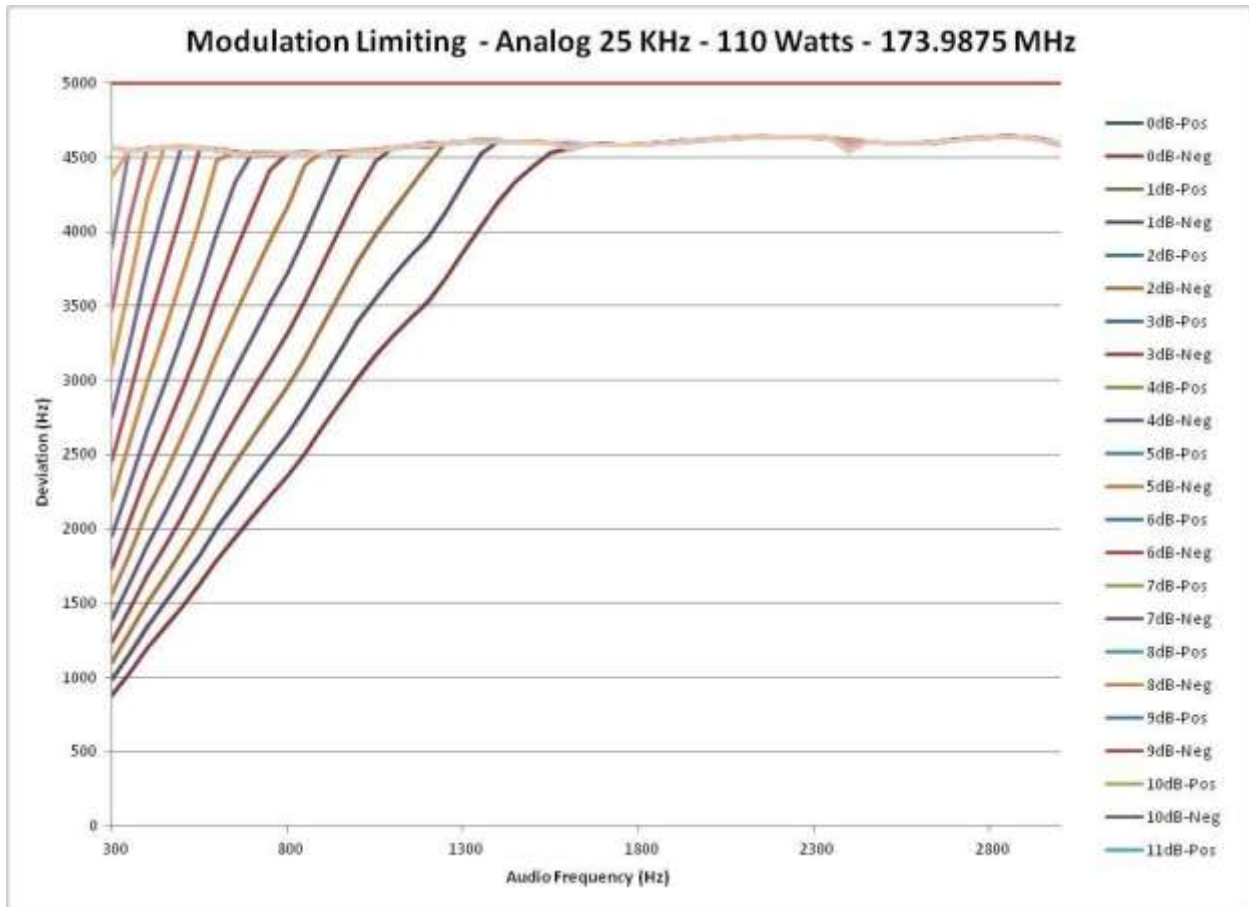

Report on Test Measurements for FCC ID ABZ99FT3095B, HVIN SLR 8000-VHFB per FCC 47 CFR 90 and IC RSS-119.

E1-11.5 Audio Modulation Limiting – Modulation Characteristics, 12.5 kHz Channels – 136.0125 MHz

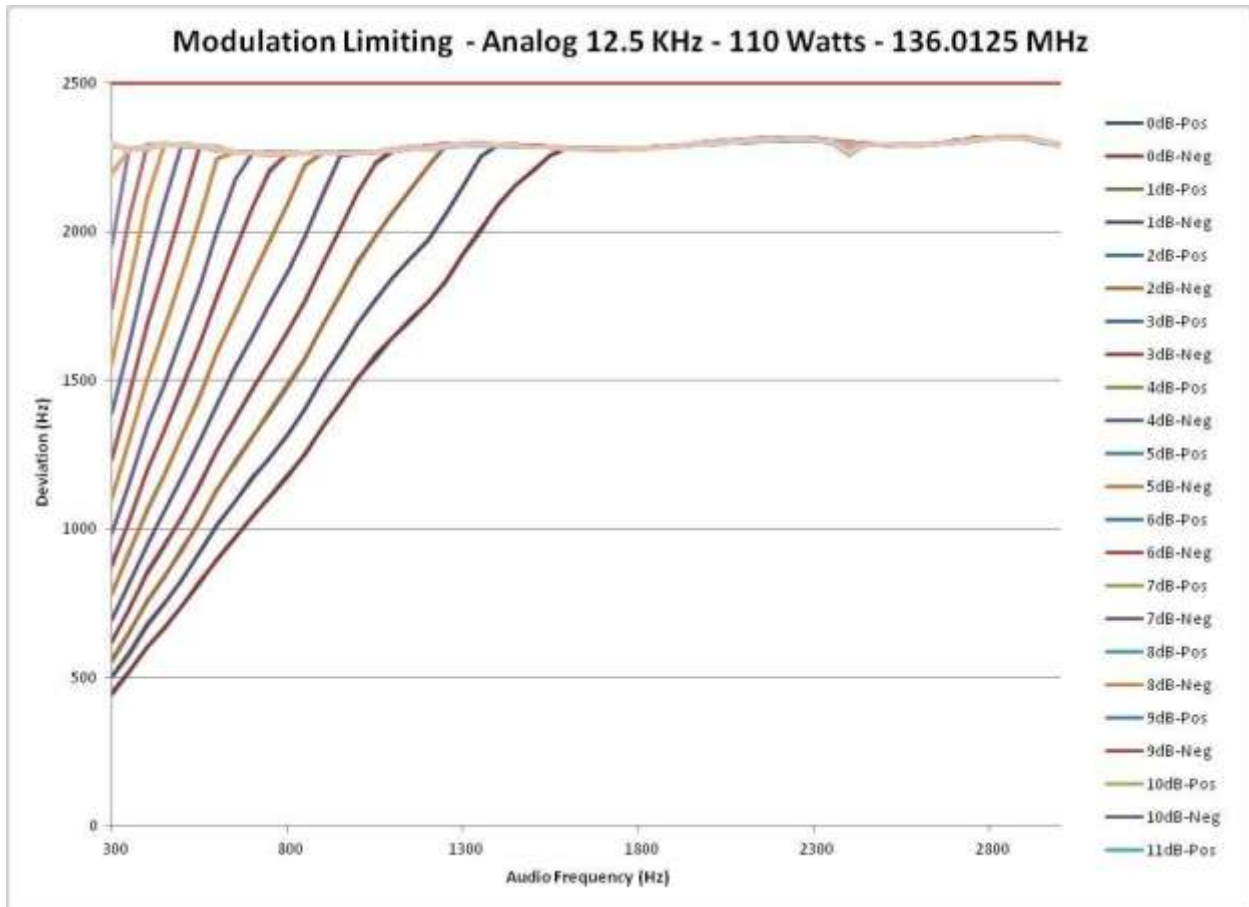

Report on Test Measurements for FCC ID ABZ99FT3095B, HVIN SLR 8000-VHFB per FCC 47 CFR 90 and IC RSS-119.

E1-11.6 Audio Modulation Limiting – Modulation Characteristics, 12.5 kHz Channels – 138.0125 MHz

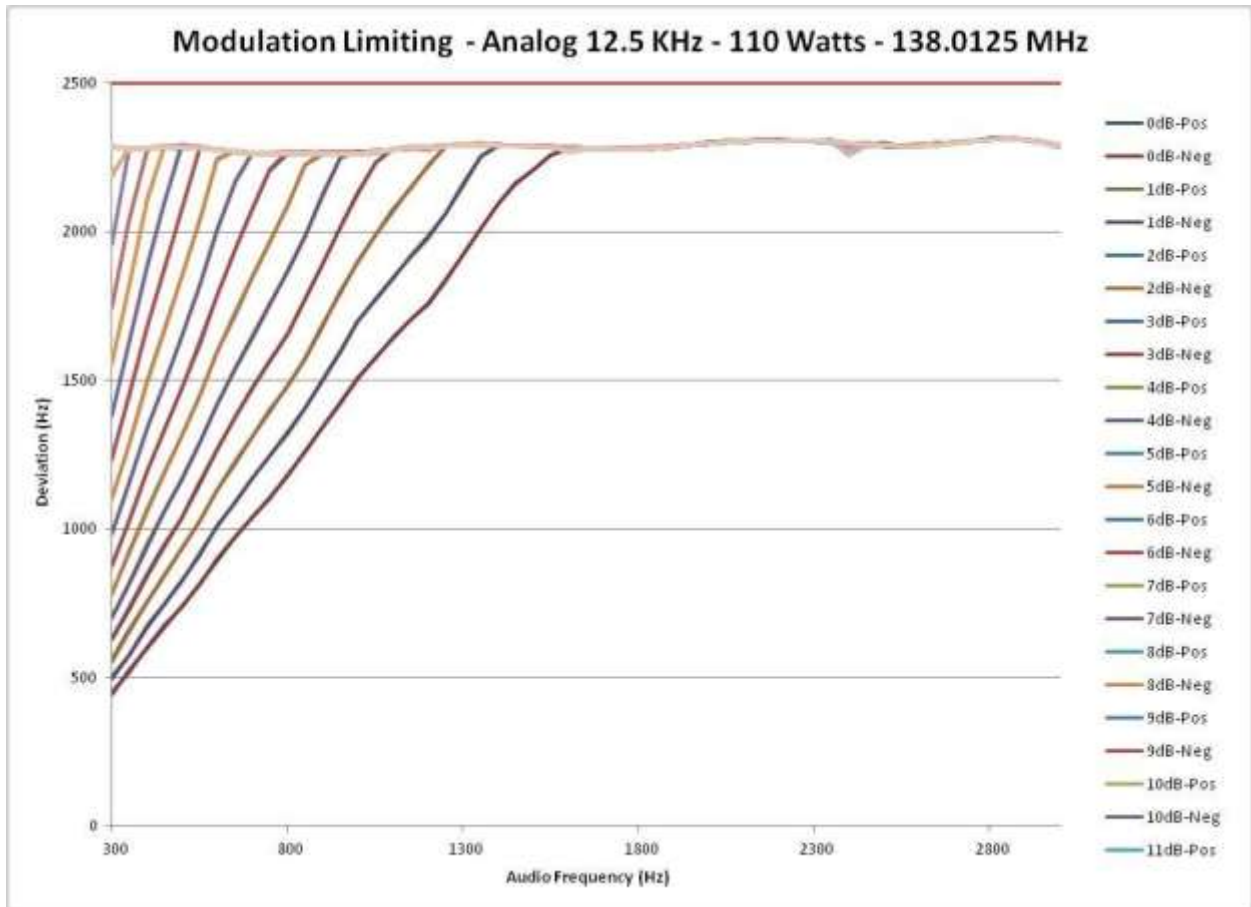

Report on Test Measurements for FCC ID ABZ99FT3095B, HVIN SLR 8000-VHFB per FCC 47 CFR 90 and IC RSS-119.

E1-11.7 Audio Modulation Limiting – Modulation Characteristics, 12.5 kHz Channels – 155.0125 MHz

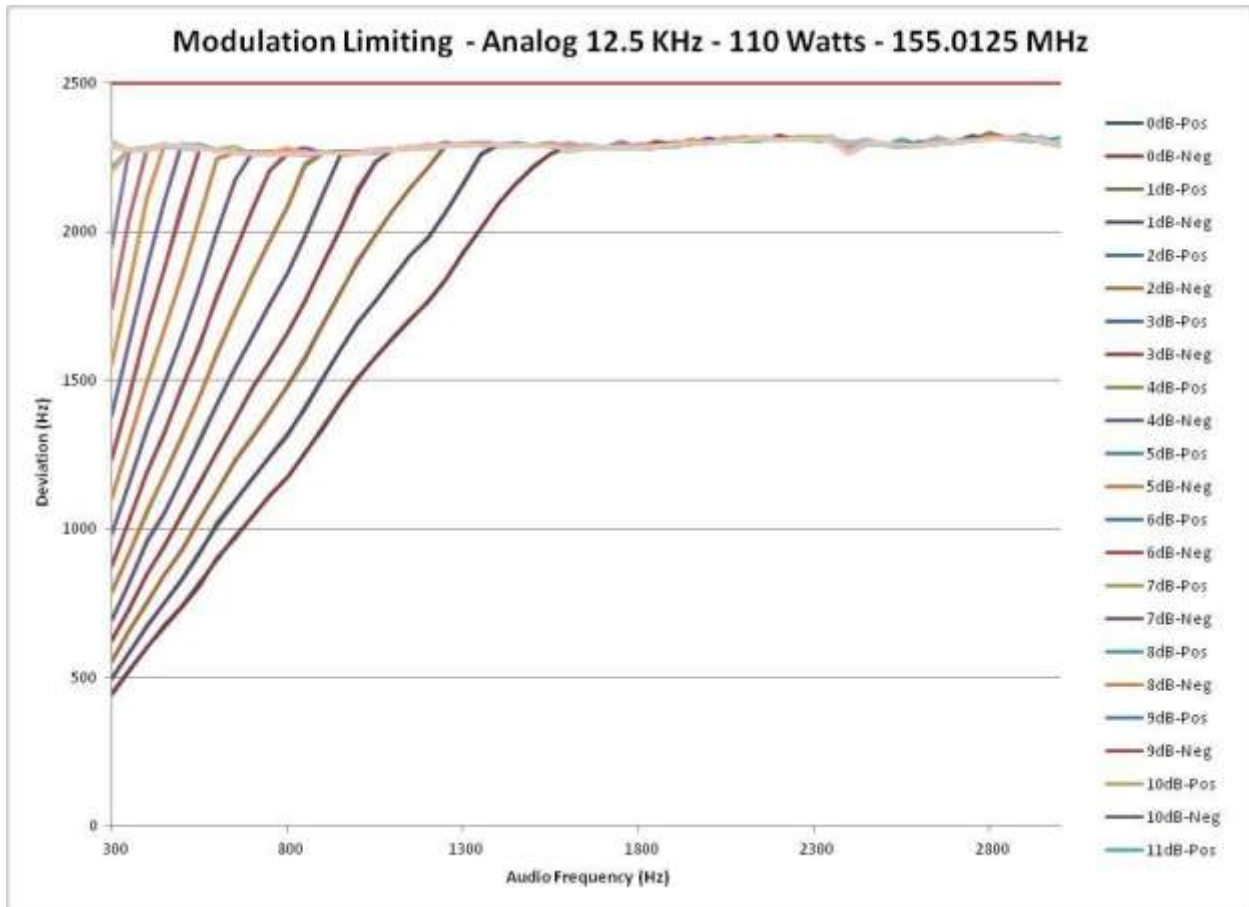

Report on Test Measurements for FCC ID ABZ99FT3095B, HVIN SLR 8000-VHFB per FCC 47 CFR 90 and IC RSS-119.

E1-11.8 Audio Modulation Limiting – Modulation Characteristics, 12.5 kHz Channels – 173.9875 MHz

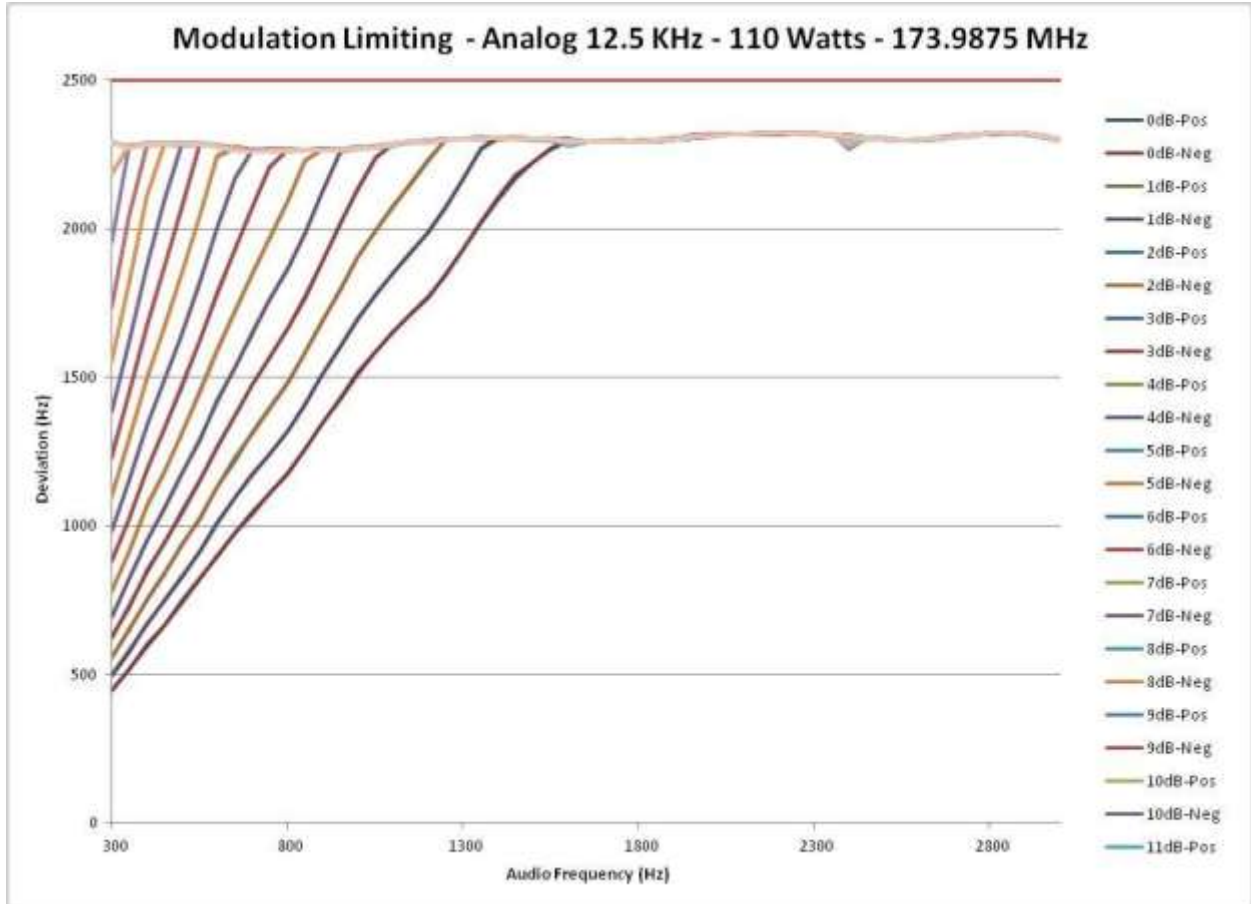

APPLICANT: MOTOROLA SOLUTIONS

EQUIPMENT TYPE: ABZ99FT3095B

109AB-99FT3095B

**Report on Test Measurements for FCC ID ABZ99FT3095B, HVIN SLR 8000-VHFB per FCC
47 CFR 90 and IC RSS-119.**

E1-12 Test Setup Details

Test Location:

(for all tests except radiated emissions)

Motorola Solutions, Inc., Schaumburg Lab

2000 Progress Parkway, Schaumburg, IL 60196

FCC Registration Number 786245

IC CAB Identifier US0220

Test Engineer Matt Nawrocki

(for radiated emissions)

Elite Electronic Engineering Inc.

1516 Centre Circle Dr., Downers Grove, IL 60515

FCC Registration Number 269750

IC Registration Number 2987A

IC CAB Identifier US0107

Test Engineer Mark E. Longinotti

APPLICANT: MOTOROLA SOLUTIONS

EQUIPMENT TYPE: ABZ99FT3095B

109AB-99FT3095B

Report on Test Measurements for FCC ID ABZ99FT3095B, HVIN SLR 8000-VHFB per FCC 47 CFR 90 and IC RSS-119.

Test Setup: Motorola Solutions

RF Output Power, Occupied Bandwidth, Frequency Stability, Frequency Transient Behavior, Modulation Characteristics

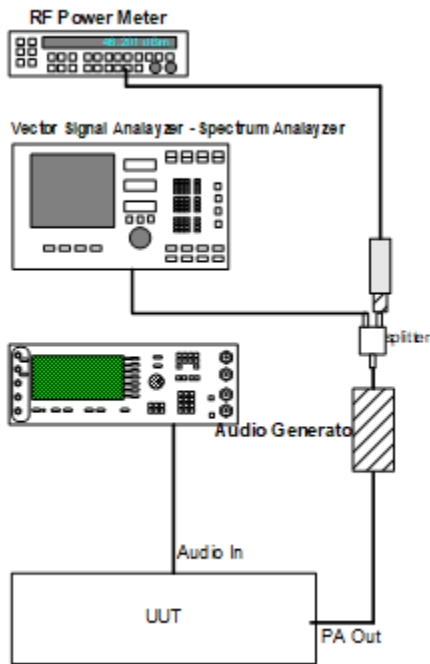

Report on Test Measurements for FCC ID ABZ99FT3095B, HVIN SLR 8000-VHFB per FCC 47 CFR 90 and IC RSS-119.

Conducted Spurious Emissions Close-in

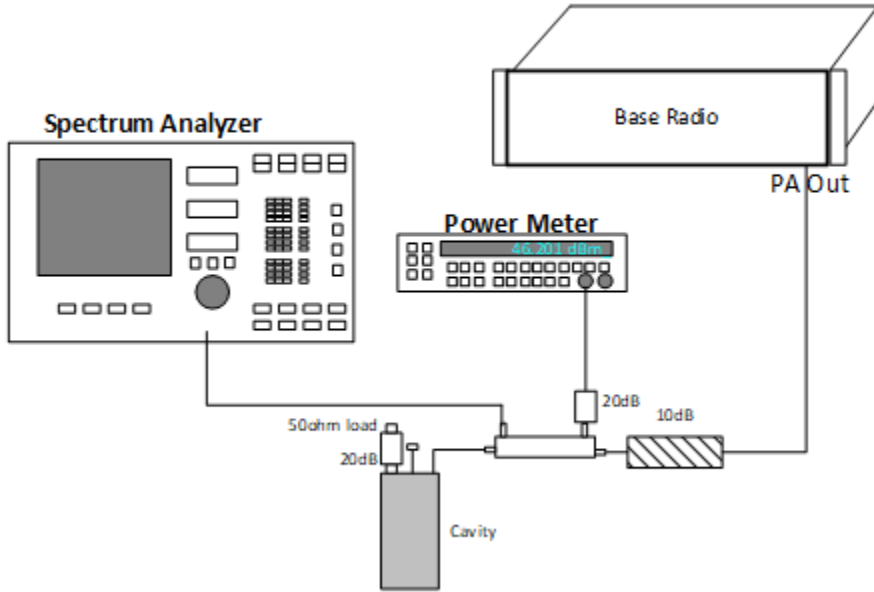

Conducted Harmonic Emissions

APPLICANT: MOTOROLA SOLUTIONS

EQUIPMENT TYPE: ABZ99FT3095B

109AB-99FT3095B

Report on Test Measurements for FCC ID ABZ99FT3095B, HVIN SLR 8000-VHFB per FCC 47 CFR 90 and IC RSS-119.

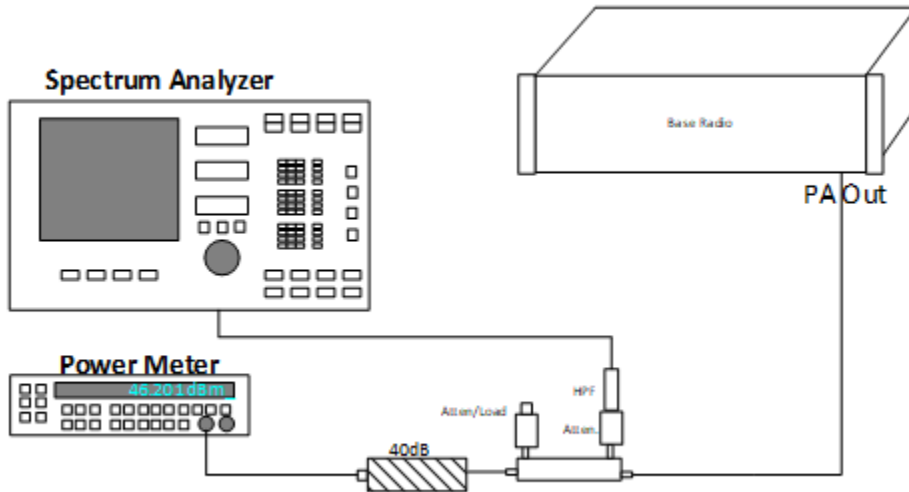

Report on Test Measurements for FCC ID ABZ99FT3095B, HVIN SLR 8000-VHFB per FCC 47 CFR 90 and IC RSS-119.

Test Setup: Elite

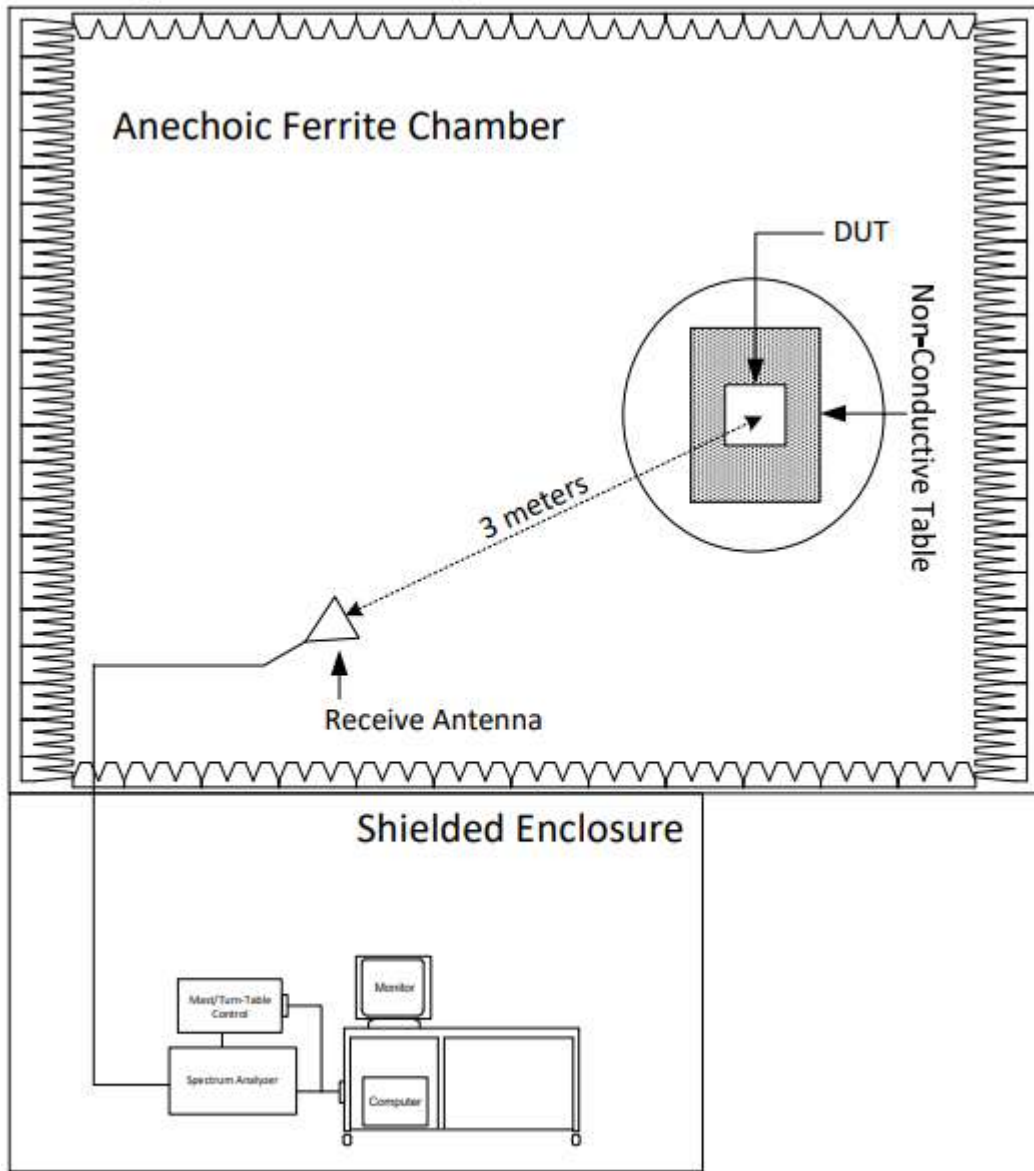

Radiated Measurements Test Setup

APPLICANT: MOTOROLA SOLUTIONS

EQUIPMENT TYPE: ABZ99FT3095B

109AB-99FT3095B

Report on Test Measurements for FCC ID ABZ99FT3095B, HVIN SLR 8000-VHFB per FCC 47 CFR 90 and IC RSS-119.



Report on Test Measurements for FCC ID ABZ99FT3095B, HVIN SLR 8000-VHFB per FCC 47 CFR 90 and IC RSS-119.



Test Setup for Spurious Radiated Emissions, 30MHz – 1GHz – Antenna Polarization Horizontal



Test Setup for Spurious Radiated Emissions, 30MHz – 1GHz – Antenna Polarization Vertical

Report on Test Measurements for FCC ID ABZ99FT3095B, HVIN SLR 8000-VHFB per FCC 47 CFR 90 and IC RSS-119.



Test Setup for Spurious Radiated Emissions, Above 1GHz – Antenna Polarization Horizontal



Test Setup for Spurious Radiated Emissions, Above 1GHz – Antenna Polarization Vertical

Report on Test Measurements for FCC ID ABZ99FT3095B, HVIN SLR 8000-VHFB per FCC 47 CFR 90 and IC RSS-119.

Test Equipment List – Motorola Solutions

Manufacturer	Model	Serial Number	Description	Last Cal	Interval
Keysight/Agilent/HP	N9030A	MY53310751	PXA Signal Analyzer, 3 Hz to 50 GHz	09-07-2022	09-07-2024
Keysight/Agilent/HP	U8903A	my50500002	Audio Analyzer, 10 Hz to 100 kHz	09-04-2022	09-04-2023
Rohde & Schwarz	NRP-Z11	101590	Power Sensor	08-31-2022	8-31-2024
Rohde & Schwarz	SMU200A	101350	Signal Generator / Power Meter	12-30-2021	12-29-2024
Keysight/Agilent/HP	34401A	3146A59752	Digital Multimeter	08-29-2022	08-29-2026
Keysight/Agilent/HP	8482a	gg00004032	Power Sensor	08-30-2022	08-30-2023
Keysight/Agilent/HP	E5071C	MY46316134	ENA Series Network analyzer	08-31-2022	09-31-2023
Thermotron	WS-120-CHM-15-15	52516	Temperature Chamber	03-07-2022	03-07-2024
Keysight/Agilent/HP	E4440A	my46185813	PSA Spectrum Analyzer 3 Hz - 26.5 GHz	09-06-2022	09-06-2024

Report on Test Measurements for FCC ID ABZ99FT3095B, HVIN SLR 8000-VHFB per FCC 47 CFR 90 and IC RSS-119.

Test Equipment List – Elite

Eq ID	Equipment Description	Manufacturer	Model No.	Serial No.	Frequency Range	Cal Date	Due Date
APW14	PREAMPLIFIER	PLANAR	PE2-35-120-5RD-10-12-SFF	PL22671	1-20GHZ	9/21/2022	9/21/2023
CDZ4	LAB WORKSTATION	ELITE	LWS-10		WINDOWS 10	CNR	
GRE1	SIGNAL GENERATOR	AGILENT	E4438C	MY42081749	250KHZ-6GHZ	3/7/2022	3/7/2023
NDP1	TUNED DIPOLE ANTENNA	EMCO	3121C-DB3	313	140-400MHZ	9/14/2022	9/14/2024
NDQ1	TUNED DIPOLE ANTENNA	EMCO	3121C-DB4	313	400-1000MHZ	9/14/2022	9/14/2024
NTA4	BILOG ANTENNA	TESEQ	6112D	46660	20-2000GHZ	10/26/2022	10/26/2024
NWQ0	DOUBLE RIDGED WAVEGUIDE ANTENNA	ETS LINDGREN	3117	66657	1GHZ-18GHZ	6/13/2022	6/13/2023
NWQ1	DOUBLE RIDGED WAVEGUIDE ANTENNA	ETS-LINDGREN	3117	66655	1GHZ-18GHZ	5/26/2022	5/26/2024
RBG3	EMI ANALYZER	ROHDE & SCHWARZ	ESW44	101592	2HZ-44GHZ	4/7/2022	4/7/2023
VBV2	CISPR EN FCC ICES RE.EXE	ELITE	CISPR EN FCC ICES RE.EXE	---	---	N/A	

N/A: Not Applicable

IO: Initial Only

CNR: Calibration Not Required

NOTE 1: For the purpose of this test, the equipment was calibrated over the specified frequency range, pulse rate, or modulation prior to the test or monitored by a calibrated instrument.

APPLICANT: MOTOROLA SOLUTIONS

EQUIPMENT TYPE: ABZ99FT3095B

109AB-99FT3095B

**Report on Test Measurements for FCC ID ABZ99FT3095B, HVIN SLR 8000-VHFB per FCC
47 CFR 90 and IC RSS-119.**

E1-13 Statement of Certification

The technical data supplied with this application, having been taken under my supervision is hereby duly certified. The following is a statement of my qualifications:

College Degree: BSEE, Northern Illinois University, DeKalb, Illinois, USA

22 years of Development and Test experience in the field of two-way radio communication.

NAME: Matthew Nawrocki

SIGNATURE: _____



DATE: 2/17/23

POSITION: Principal Staff Engineer

I hereby certify that the above application was prepared under my direction and that to the best of my knowledge and belief, the facts set forth in the application and accompanying technical data are true and correct:

NAME: Robert Sarocka

SIGNATURE: _____



DATE: 2/17/23

POSITION: Technical Manager

REPORT END