 <p>CERTIFICATE 2518.08</p> <p>MS ISO/IEC 17025 TESTING SAMM NO. 0825</p>
<p><b>MOTOROLA PENANG ADV. COMM. LABORATORY</b> Motorola Solutions Malaysia SDN BHD, Plot 2A, Medan Bayan Lepas, Mukim 12 S.W.D, 11900 Bayan Lepas, Penang, Malaysia.</p>	<p><b>FCC/ISED TEST REPORT</b> <b>Report Revision : Rev.B</b></p>
<p><b>Date/s Tested</b> : 12-MAY-2022 - 21-MAY-2022 <b>Report Issue Date</b> : 22-JUN-2022 <b>Manufacturer</b> : Motorola Solutions Malaysia SDN BHD <b>Manufacturer Address</b> : Plot 2A, Medan Bayan Lepas, Mukim 12 SWD, 11900 Bayan Lepas, Penang, Malaysia <b>Requestor</b> : TAI, WEN QI <b>Product Type</b> : Vehicle Mounted <b>Product Version (PMN)</b> : XPR 2500 <b>Model Number (HVIN)</b> : AAM02JQH9JA1AN <b>Frequency Band</b> : 136-174 MHz <b>Max RF Output Power</b> : 54 Watts <b>Applicant Name</b> : Motorola Solutions Inc <b>Applicant Address</b> : 8000 West Sunrise Boulevard, Fort Lauderdale, Florida 33322</p> <p><b>ISED Registrations</b> : MY0001 <b>FCC Registrations</b> : 461337 <b>Firmware Version (FVIN)</b> : D02.22.01.0128</p> <p><b>The equipment was tested accordance to the requirement listed below:</b></p> <p>(LMR) FCC 47 CFR Part 22 / 74 / 90 <b>PASS</b> ISED RSS- Gen Issue 5 / 119 Issue 12</p>	
<p>This report shall not be reproduced without written approval from an officially designated representative of the Motorola Penang Adv. Comm. Laboratory. The results and statements contained in this report pertain only to the device(s) evaluated.</p>	
<p>Prepared By:</p>  <hr/> <p><b>Putri Nur Sarah Sofia</b> Test Personnel</p>	<p>Approved Signatory:</p> <hr/> <p><b>Soon Oi May</b> Responsible Engineer</p>

## Table of Contents

Report Revision History .....	3
1.0 General Information.....	4
2.0 Summary of Test Results.....	5
3.0 Measurement Uncertainty.....	6
4.0 Equipment List.....	7
5.0 Test Condition.....	10
5.1. Transmitter Test Conditions .....	10
6.0 Transmitter Test Parameters .....	11
6.1. RF Output Power .....	11
6.1.1. Test Setup.....	11
6.1.2. Test Result .....	11
6.2. Frequency Stability .....	12
6.2.1. Test Setup.....	12
6.2.2. Test Result .....	13
6.2.3. Test Limit.....	14
6.3. Modulation Characteristics .....	15
6.3.1. Test Setup.....	15
6.3.2. Test Result .....	16
6.3.3. Test Limit.....	17
6.4. Modulation Limiting.....	18
6.4.1. Test Setup.....	18
6.4.2. Test Result .....	19
6.4.3. Test Limit.....	19
6.5. Occupied Bandwidth.....	20
6.5.1. Test Setup (Analog) .....	20
6.5.2. Test Result (Analog).....	21
6.5.3. Test Setup (Digital).....	22
6.5.4. Test Result (Digital).....	28
6.5.5. Test Limit.....	35
6.6. Band Edge Conducted Spurious Emission (Part 22) .....	36
6.6.1. Test Setup (Analog) .....	36
6.6.2. Test Result (Analog).....	37
6.6.3. Test Setup (Digital).....	38
6.6.4. Test Result (Digital).....	39
6.6.5. Test Limit.....	39
6.7. Transient Frequency Behavior.....	40
6.7.1. Test Setup.....	40
6.7.2. Test Result .....	41
6.7.3. Test Limit.....	42
6.8. Adjacent Channel Power.....	44
6.8.1. Test Setup (Analog) .....	44
6.8.2. Test Result .....	44
6.8.3. Test Setup (Digital).....	45

6.8.4. Test Result ..... 45  
 6.8.5. Test Limit..... 46  
 6.9. Conducted Spurious Emission ..... 48  
     6.9.1. Test Setup..... 48  
     6.9.2. Test Result (Analog)..... 49  
     6.9.3. Test Result (Digital)..... 55  
     6.9.4. Test Limit..... 61  
 6.10. Radiated Spurious Emission ..... 62  
     6.10.1. Test Setup..... 62  
     6.10.2. Test Result (Analog)..... 63  
     6.10.3. Test Result (Digital)..... 69  
     6.10.4. Test Limit..... 75  
 6.11. Effective Radiated Power (ERP) ..... 76  
     6.11.1. Test Setup..... 76  
     6.11.2. Test Result ..... 76  
     6.11.3. Test Limit..... 76  
 6.12. GNSS (EIRP for 1559 - 1610MHz)..... 77  
     6.12.1. Test Setup..... 77  
     6.12.1. Test Result ..... 77  
     6.12.2. Test Limit..... 77

**Report Revision History**

<b>Revision History</b>	<b>Description</b>	<b>Date</b>	<b>Originator</b>
Rev. A	Initial Report	13-Jun-2022	Putri
Rev. B	Updated test end date Add the FXE and FXD into the OBW summary table Update worst case emission for RSE in summary table.	1-Sep-2022	Putri

## 1.0 General Information

### EUT Description:

<b>Technologies</b>	Land Mobile Radio (LMR)
<b>Modulation Type</b>	Analog, 4FSK

The EUT contains following accessory devices and data cable:

<b>Item</b>	<b>Brand</b>	<b>Model or P/N</b>
COMPACT MICROPHONE WITH CLIP	MOTOROLA	PMMN4090A
ANTENNA VHF 132-174MHz	MOTOROLA	HAD4022A

### General Description of Applied Standards

The EUT is a RF Product. According to the specifications of the manufacturer, the EUT is to comply with the requirements of the following standards:

#### **ANSI C63.26-2015**

No modifications were done to the UUT to facilitate the tests in this report.

### **Deviation from standard**

Not applicable as no deviation from standard test method

### **Antenna gain disclaimer**

Antenna gain information is provided by customer. The validity of the results is dependent upon this information. The lab will not be held accountable in the event the supplied information affects compliance.

### **Test configuration of EUT**

All relevant configurations involving radio models and accessories (including chargers, batteries, and antennas) were assessed. Only worst case configurations will be included in this report.

## 2.0 Summary of Test Results

FCC General Rules Part (47CFR)	ISED General Rules Part	Test Item	Result	Remarks	Serial number tested
2.1046(a), 22.565(f), 74.461	RSS-Gen, RSS-119	RF Power Output	Pass		776TYH0074
2.1055, 22.355, 74.464, 90.213	-	Frequency Stability	Pass		776TYH0074
2.1047, 80.213, 90.213	RSS-Gen, RSS-119	Audio Frequency Response	Pass		776TYH0074
2.1047, 80.213, 90.213	RSS-Gen, RSS-119	Audio Low Pass Filter Response	Pass		776TYH0074
2.1047, 90.213, 80.213,	RSS-Gen, RSS-119	Modulation limiting	Pass		776TYH0074
2.1049, 22.359, 90.21, 74.462	RSS-Gen, RSS-119	Occupied Bandwidth	Pass	16K0F3E- 14.9959kHz 11K0F3E- 9.8506kHz 7K60F1D/FXD- 7.4083kHz 7K60F1E/FXE- 7.4648kHz 7K60F1W- 7.4941kHz	776TYH0074
2.1051, 22.359 (a), (b)	RSS-119	Band Edge Conducted Spurious Emission	Pass		776TYH0074
90.214	RSS-119	Transient Frequency Behavior	Pass		776TYH0074
-	-	Adjacent Channel Power	NA		
2.1051, 22.359, 90.210 74.462(c)	RSS-Gen, RSS-119	Conducted Spurious Emissions	Pass	Worst Case - -39.04dBm	776TYH0074
2.1051, 22.359, 90.210 74.462(c)	RSS-Gen, RSS-119	Radiated Spurious Emission	Pass	Worst Case- -58.074dBm Margin: 38.074dB (Noise Floor)	776TYH0079
-	-	GNSS (EIRP for 1559 – 1610MHz)	NA		
-	-	Effective Radiated Power (ERP)	NA		

NA → Not Applicable

### 3.0 Measurement Uncertainty

Measurement	Frequency	Expanded Uncertainty (k=1.96) (±)
AC Power Line Conducted Spurious Emission	150KHz ~ 30MHz	3.48 dB
Radiated Emissions up to 1 GHz dB $\mu$ V/m (Field Strength)	30MHz ~ 1000MHz	5.88 dB
Radiated Emissions above 1 GHz dB $\mu$ V/m (Field Strength)	1GHz ~ 18GHz	5.84 dB
	18GHz ~ 40GHz	6.02 dB
Radiated Emissions dBm (ERP/EiRP)	30MHz ~ 18GHz	4.03 dB
Conducted Spurious Emissions	9kHz ~ 12.75GHz	2.82 dB
Frequency Stability	9kHz ~ 12.75GHz	0.0085 ppm
Audio Frequency Response / Low Pass Filter Response	300Hz – 20kHz	4.09 %
Modulation Limiting	300Hz – 3kHz	1.15 %
Occupied Bandwidth	9kHz ~ 12.75GHz	2.82 dB
Band Edge Conducted Spurious Emission	9kHz ~ 12.75GHz	2.82 dB
Transient Frequency Behavior	9kHz ~ 12.75GHz	5.4 ms
Adjacent Channel Power	9kHz ~ 12.75GHz	2.82 dB

#### 4.0 Equipment List

##### FCC Analog ATE#1: (SW version: FCC\_Analog\_v2.5.0)

Description	Model	Serial Number	Calibration Date	Calibration Due Date
CHAMBER	SH-641	92009188	21-Mar-22	21-Mar-23
POWER SENSOR	E4412A	MY41502652	09-Sep-21	09-Sep-22
POWER SUPPLY	6031A	3018A01915	29-Sep-21	29-Sep-22
POWER METER	E4416A	MY45101705	04-Mar-22	04-Mar-23
MODULATION ANALYZER	8901B	3403A04974	06-Sep-21	06-Sep-22
AUDIO ANALYZER	U8903B	MY61340003	21-Mar-22	21-Mar-23
CXA SIGNAL ANALYZER	N9000B	MY60250694	14-Dec-21	14-Dec-22
N to N RF Cable # 1	M17/128-RG400	NA	NA	NA
BNC to N RF Cable # 1	RG 58	NA	NA	NA
BNC to BNC RF Cable # 1	RG 58	NA	NA	NA
BNC to BNC RF Cable # 2	RG 58	NA	NA	NA
BNC to BNC RF Cable # 3	RG 58	NA	NA	NA
BNC to BNC RF Cable # 4	RG 58	NA	NA	NA
BNC to BNC RF Cable # 5	RG 58	NA	NA	NA
BNC to BNC RF Cable # 6	RG 58	NA	NA	NA
BNC to BNC RF Cable # 7	RG 58	NA	NA	NA
N to SMA RF Cable # 1	RG 58	NA	NA	NA
N to SMA RF Cable # 2	RG 58	NA	NA	NA
N to SMA RF Cable # 3	RG 58	NA	NA	NA
Aeroflex Attenuator 30dB	49-30-34-LIM	NA	NA	NA

**FCC Transient ATE #1: (SW version: FCC Transient ATE\_R1.1.4)**

Description	Model	Serial Number	Calibration Date	Calibration Due Date
SWITCH CONTROL UNIT	3488A	2719A36210	CNR	CNR
ATTENUATOR / SWITCH DRIVER	11713A	2508A10141	CNR	CNR
POWER SENSOR	E9301B	MY50180003	29-Jul-21	29-Jul-22
SIGNAL GENERATOR	8657A	3315U04973	03-Sep-21	03-Sep-22
AUDIO ANALYZER	8903B	3011A10318	01-Nov-21	01-Nov-22
POWER METER	E4416A	GB41293240	14-Mar-22	14-Mar-23
STEP ATTENUATOR	8494G	MY42145194	12-Sep-21	12-Sep-22
POWER SUPPLY	6033A	3004A04987	08-Jul-21	08-Jul-22
ANALYZER SPECTRUM	E4445A	MY45301089	11-Oct-21	11-Oct-22
ATTENUATOR/110DB	8496G	MY42143970	12-Sep-21	12-Sep-22
AUDIO ANALYZER	8903B	3413A14586	13-Sep-21	13-Sep-22
ANALYZER MODULATION	8901B	2619A00845	30-Sep-21	30-Sep-22
AUDIO ANALYZER	8903B	3011A12488	13-Sep-21	13-Sep-22
N to N RF Cable # 1	SF126/11N/11N	NA	NA	NA
N to N RF Cable # 1	SF126/11N/11N	NA	NA	NA
N to N RF Cable # 2	M17/128-RG400	NA	NA	NA
N to N RF Cable # 3	M17/128-RG400	NA	NA	NA
N to N RF Cable # 4	M17/128-RG400	NA	NA	NA
N to N RF Cable # 5	M17/128-RG400	NA	NA	NA
N to N RF Cable # 6	M17/128-RG400	NA	NA	NA
N to N RF Cable # 7	M17/128-RG400	NA	NA	NA
N to N RF Cable # 8	M17/128-RG400	NA	NA	NA
N to N RF Cable # 9	M17/128-RG400	NA	NA	NA
BNC to BNC RF Cable # 1	RG 58	NA	NA	NA
BNC to BNC RF Cable # 2	RG 58	NA	NA	NA
BNC to BNC RF Cable # 3	RG 58	NA	NA	NA
BNC to BNC RF Cable # 4	RG 58	NA	NA	NA
BNC to BNC RF Cable # 5	RG 58	NA	NA	NA
BNC to BNC RF Cable # 6	RG 58	NA	NA	NA
BNC to N RF Cable # 1	RG 58	NA	NA	NA
Aeroflex Attenuator 10dB	49-10-43-LIM	NA	NA	NA
Aeroflex Attenuator 10dB	33-10-34-LIM	NA	NA	NA



**FCC CONDUCTED SPUR EMISSION ATE # 1 (SW version: Conducted Spur ATE\_rev 1.23.03)**

Description	Model	Serial Number	Calibration Date	Calibration Due Date
SWITCH CONTROL UNIT	3488A	2719A32735	CNR	CNR
ANALYZER SPECTRUM	E4440A	MY48250517	21-Dec-21	21-Dec-22
POWER SUPPLY	6033A	3506A08076	10-Jan-22	10-Jan-23
INTERFACE BOX - FILTER	CNR	CS001	06-Jul-21	06-Jul-22
N to N RF Cable # 1	SF126/11N/11N	NA	NA	NA
N to N RF Cable # 2	SF126/11N/11N	NA	NA	NA
BNC to BNC RF Cable # 1	RG 58	NA	NA	NA
Aeroflex Attenuator 30dB	49-30-43-LIM	NA	NA	NA
Aeroflex Attenuator 10dB	33-10-34-LIM	NA	NA	NA

**EMC Chamber 1**

DESCRIPTION	MODEL	SERIAL NUMBER	CALIBRATION DATE	CALIBRATION DUE DATE
DRG HORN FREQ.	SAS-571	720	06-Apr-21	06-Apr-23
DRG HORN FREQ.	SAS-571	719	13-Sep-21	13-Sep-22
POWER SUPPLY	N7976A	MY53410110	24-May-21	24-May-22
SIGNAL GENERATOR	SMB 100A	182511	4-Jun-21	4-Jun-24
EMI TEST RECEIVER	ESW44	101731	5-Nov-21	5-Nov-22
5m SEMI-ANECHOIC CHAMBER	S800-HX	J2308	No Cal. Req'd	No Cal. Req'd
BILOG ANTENNA	CBL6112D	55546	06-Jun-21	06-Jun-22
BILOG ANTENNA	CBL6112D	30991	05-Oct-21	05-Oct-22
DATA LOGGER	SDL500	A.016785	24-Jun-21	24-Jun-22
SYSTEM CONTROLLER	SC104V	050806-1	No Cal. Req'd	No Cal. Req'd
TURNTABLE FLUSH MOUNT 2M	FM2011	NA	No Cal. Req'd	No Cal. Req'd
ANTENNA POSITIONING TOWER	TLT2	NA	No Cal. Req'd	No Cal. Req'd
BROAD-BAND HORN ANTENNA	BBHA9170	BBHA9170143	3-Aug-21	3-Aug-22
PREAMPLIFIER 18-40GHz	BBV9721	9721-007	No Cal. Req'd	No Cal. Req'd
PREAMPLIFIER	PAM-0118P	361	11-Sep-20	11-Sep-23
LOOP ANTENNA	6502	00208416	8-Oct-21	8-Oct-22
TEST SOFTWARE	EMC_FCC_IC_BLUETOOTH_RE_TEST			
VERSION	EMC_FCC_RE_v1.6.4			

## 5.0 Test Condition

### 5.1. Transmitter Test Conditions

Test Item, (Channel Spacing)	Power (W)	Modulation	Test Frequency (MHz)	Tested By	Environmental conditions
RF Output Power	Low & Max	Analog	138.0125, 158.55, 161.7, 173.3875	Putri	23.4°C, 50%RH
Frequency Stability	Max	Analog	158.55	Putri	25.1°C, 54.3%RH, 60.3°C, 50%RH, -30.1°C, 51.2%RH
Modulation Characteristic (12.5kHz / 25kHz)	Max	Analog	158.55	Putri	23.4°C, 50%RH
Modulation limiting (12.5kHz / 25kHz)	Max	Analog	158.55	Putri	23.4°C, 50%RH
Occupied Bandwidth (12.5kHz / 20kHz / 25kHz)	Max	Analog, 4FSK	138.0125, 158.55, 161.7, 173.9875, 173.3875	Putri	23.4°C, 50%RH
Band Edge Conducted Spurious Emissions (Part 22) (12.5kHz / 20kHz / 25kHz)	Max	Analog, 4FSK	157.77, 158.67	Putri	23.4°C, 50%RH
Transient Frequency Behavior (UHF & VHF Band) (12.5kHz / 25kHz)	Max	Analog	158.55	Putri	23.4°C, 50%RH
Adjacent Channel Power (700MHz Band) (12.5kHz / 25kHz)	Max	Analog, 4FSK	NA		
Conducted Spurious Emissions- (12.5kHz / 25kHz)	Low / Max	Analog, 4FSK	138.0125, 158.55, 161.7, 173.9875, 173.3875	Putri	23.4°C, 50%RH
Radiated Spurious Emission (12.5kHz / 25kHz)	Low / Max	Analog, 4FSK	138.0125, 158.55, 161.7, 173.9875, 173.3875	Nazrin&Qawiman	23.8°C, 69.8%RH
GNSS (EIRP for 1559 - 1610MHz) (12.5kHz / 25kHz)	Max	Analog	NA		
Effective Radiated Power (ERP) (12.5kHz / 25kHz)	Max	Analog	NA		

NA → Not Applicable

## 6.0 Transmitter Test Parameters

### 6.1. RF Output Power

#### 6.1.1. Test Setup

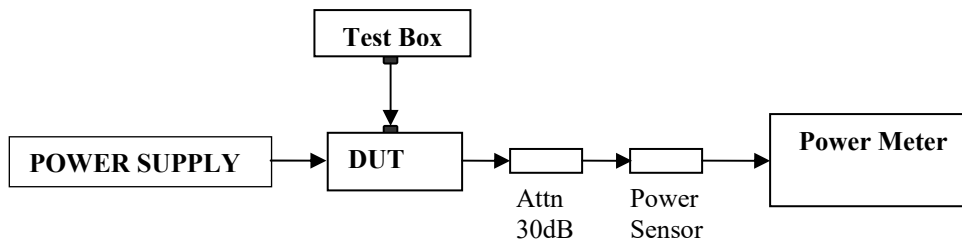

- 1) The DUT transmitter connected to Power Meter using the 30 dB attenuator and power sensor with above setup.
- 2) Path loss for the measurement included.
- 3) All the measurement was done at low, mid, high frequency for each band.
- 4) Record the power into the test report.

#### 6.1.2. Test Result

Temperature	25°C				REMARK
Voltage (V)	13.6V				
Frequency (MHz)	Low Power (W)	Current (A)	Max Power (W)	Current (A)	
138.01250	24.40	5.80	53.10	8.46	Not for FCC review
158.55000	24.40	5.14	52.60	7.48	
161.70000	24.70	5.15	52.50	7.33	
173.38750	24.70	6.11	53.80	8.79	

## 6.2. Frequency Stability

### 6.2.1. Test Setup

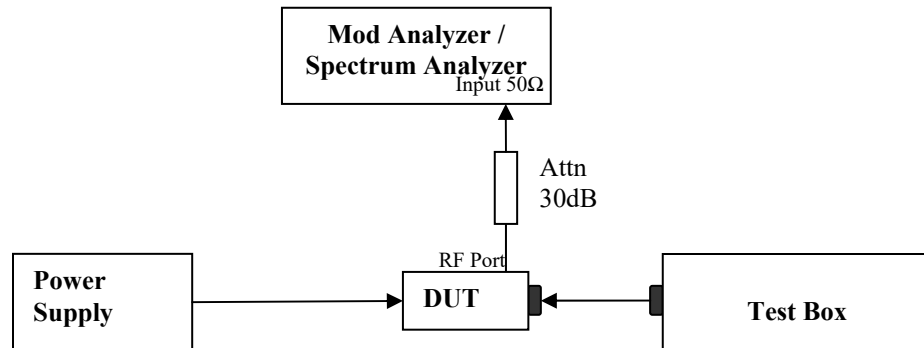

- 1) The DUT transmitter output port was connected to Modulation / Spectrum Analyzer.
- 2) Path loss for the measurement included.
- 3) Transmit the DUT and record the freq in  $MCF_{MHz}$ .
- 4) Test in 2 conditions:
  - Temperature: The frequency of the transmitter was measured from  $-30^{\circ}C$  to  $50^{\circ}C$ .
  - Supply Voltage:
    - Mobile: The frequency of the transmitter was measured from 85% to 115% of the nominal operating input voltage.
    - Portable: The frequency of the transmitter was measured from nominal  $\pm x\%$  as specified by the manufacturer
- 5) Calculate the ppm frequency error by the following:

$$ppm\ error = \left( \frac{MCF_{MHz}}{ACF_{MHz}} - 1 \right) * 10^6$$

Where:  $MCF_{MHz}$  is the Measured Carrier Frequency in MHz  
 $ACF_{MHz}$  is the Assigned Carrier Frequency in MHz

**6.2.2. Test Result**

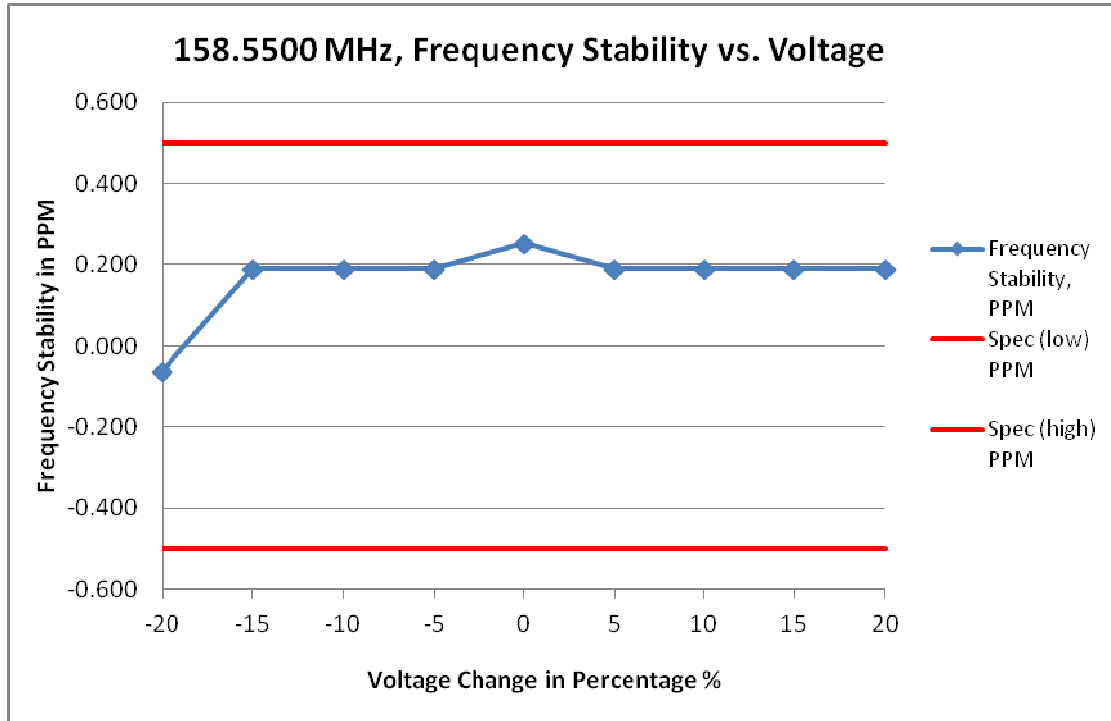

(i) Frequency Stability VS Voltage

Frequency / Channel Spacing	158.5500 MHz / 12.5 kHz				
Temperature, °C	25				
Voltage %	Voltage, V	Frequency, MHz	Frequency Stability, PPM	Spec (low) PPM	Spec (high) PPM
-20	10.880	158.549990	-0.063	-0.500	0.500
-15	11.560	158.550030	0.189	-0.500	0.500
-10	12.240	158.550030	0.189	-0.500	0.500
-5	12.920	158.550030	0.189	-0.500	0.500
0	13.600	158.550040	0.252	-0.500	0.500
5	14.280	158.550030	0.189	-0.500	0.500
10	14.960	158.550030	0.189	-0.500	0.500
15	15.640	158.550030	0.189	-0.500	0.500
20	16.320	158.550030	0.189	-0.500	0.500

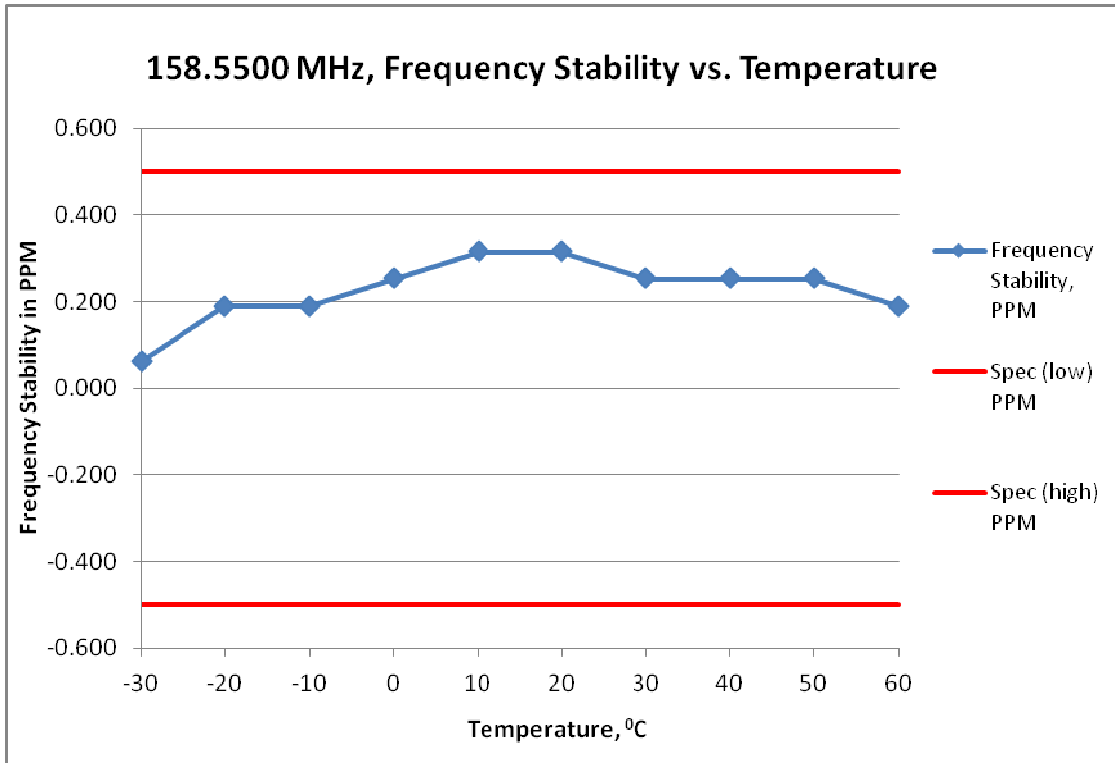

(ii) Frequency Stability VS temperature

Frequency / Channel Spacing	158.5500 MHz / 12.5 kHz			
Voltage, V	13.6			
Temperature, °C	Frequency, MHz	Frequency Stability, PPM	Spec (low) PPM	Spec (high) PPM
-30	158.550010	0.063	-0.500	0.500
-20	158.550030	0.189	-0.500	0.500
-10	158.550030	0.189	-0.500	0.500
0	158.550040	0.252	-0.500	0.500
10	158.550050	0.315	-0.500	0.500
20	158.550050	0.315	-0.500	0.500
30	158.550040	0.252	-0.500	0.500
40	158.550040	0.252	-0.500	0.500
50	158.550040	0.252	-0.500	0.500
60	158.550030	0.189	-0.500	0.500

**6.2.3. Test Limit**

As per manufacturer declared spec +/- 0.5ppm

### 6.3. Modulation Characteristics

#### 6.3.1. Test Setup

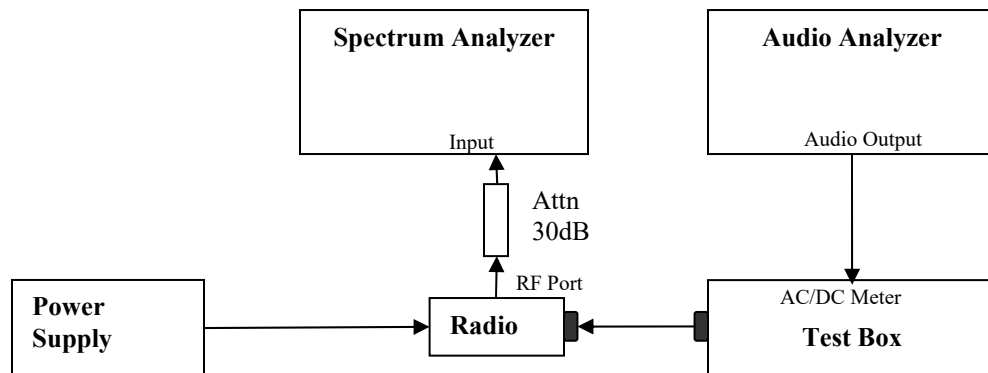

- 1) The DUT transmitter output port was connected to Modulation Analyzer.
- 2) Path loss for the measurement included.
- 3) Set the audio bandwidth filter to 15 kHz and 50 kHz.
- 4) Transmit the radio and set the audio analyzer to 1 kHz audio frequency and 20% of the Full rated system deviation.
- 5) On audio analyzer, set the rated level as 0dB reference
- 6) Vary the audio frequency from 300 Hz to 20 kHz. Record the change in modulation in reference to step 5.

### 6.3.2. Test Result

Not for FCC review

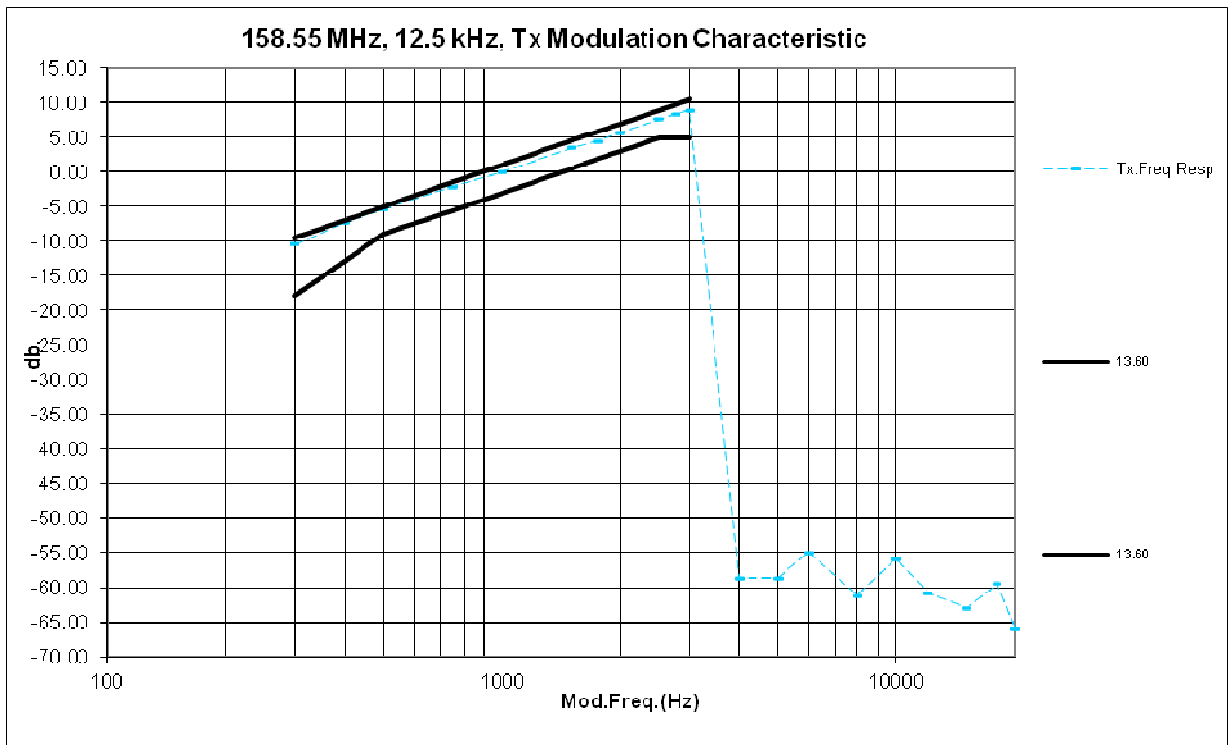
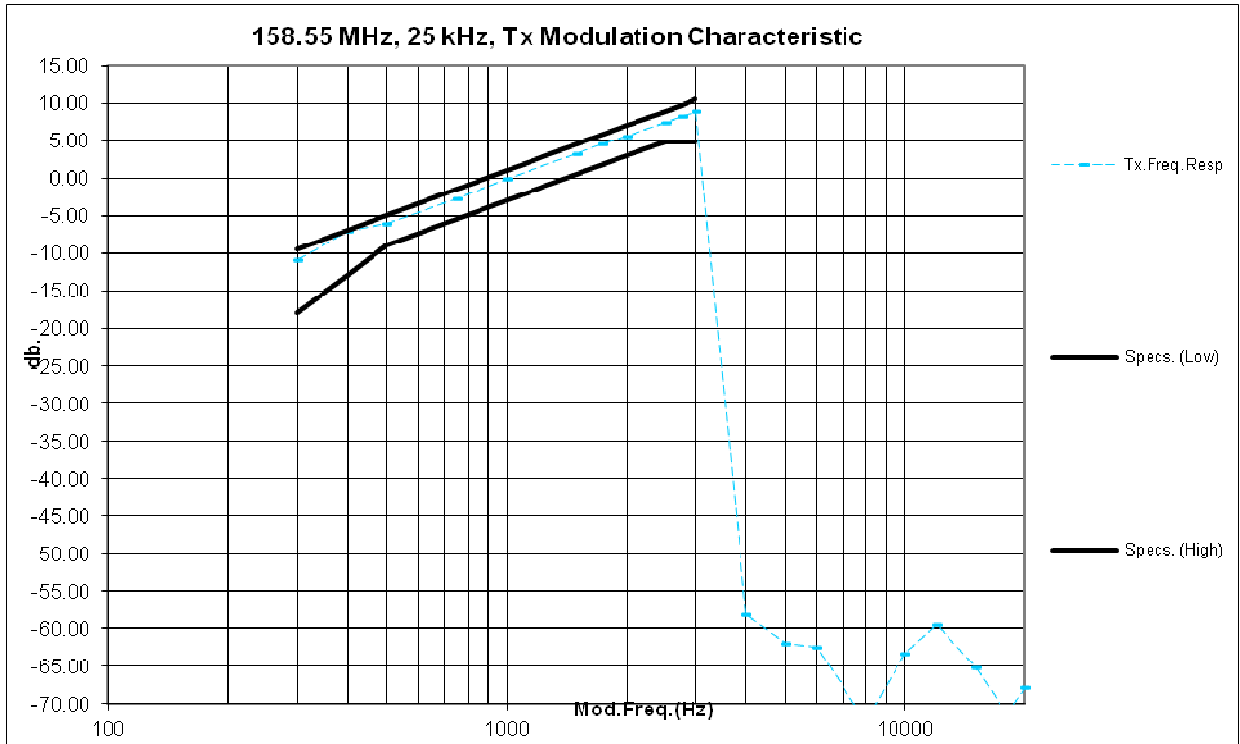



### 6.3.3. Test Limit

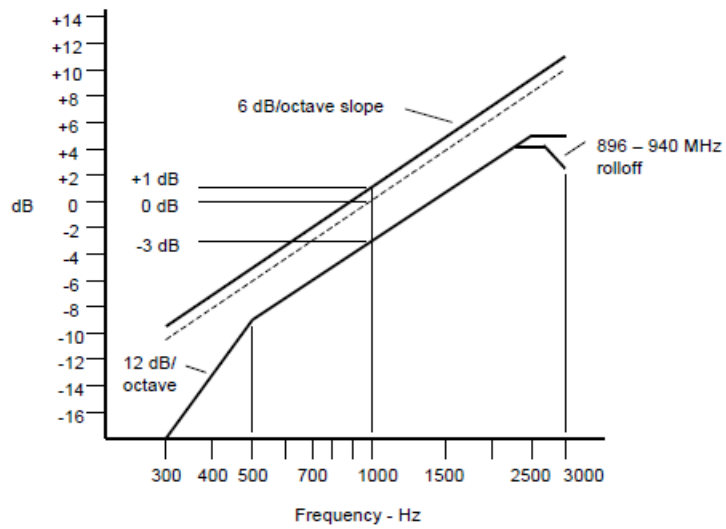

Note:

- o There are additional 6 dB per octave attenuation is allowed from 2.5KHz to 3KHz in equipment 25MHz to 869MHz radio.
- o Additional 6 dB per octave attenuation is allowed from 2.3KHz to 2.7KHz & additional 12 dB per octave attenuation is allowed from 2.7KHz to 3KHz in equipment 896MHz to 940MHz radio.

## 6.4. Modulation Limiting

### 6.4.1. Test Setup

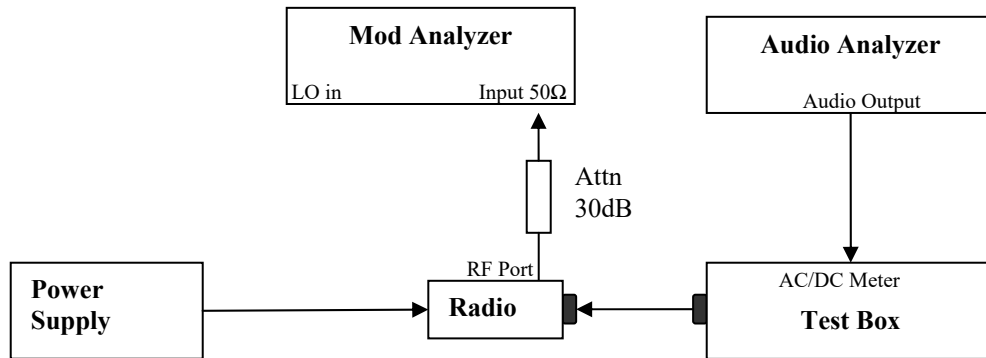

- 1) The DUT transmitter output port was connected to Modulation Analyzer.
- 2) Path loss for the measurement included.
- 3) Set the audio bandwidth filter to 15 kHz.
- 4) Transmit the radio and set the audio analyzer to 1 kHz audio frequency and 60% of the Full rated system deviation.
- 5) Record the frequency deviation as 0dB input level at 1kHz audio frequency.
- 6) Repeat the step and record the frequency deviation from -20 dB to 20dB by 5 dB increments and different audio freq 300 Hz, 2.5 kHz and 3 kHz.

### 6.4.2. Test Result

Not for FCC review

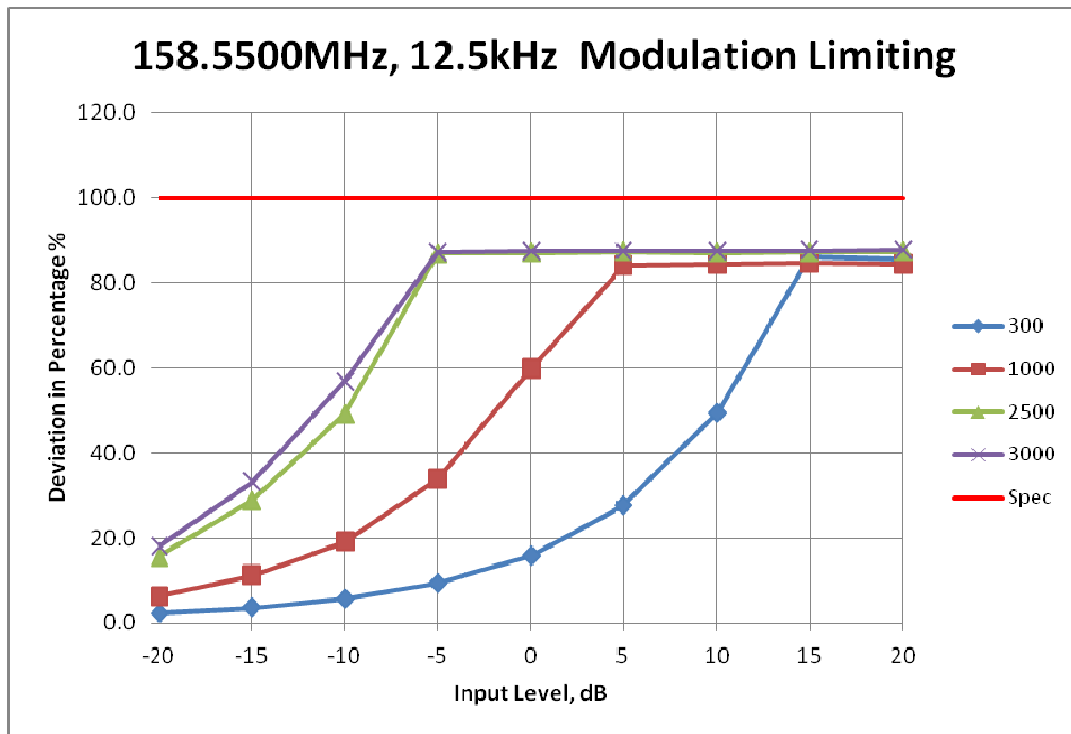
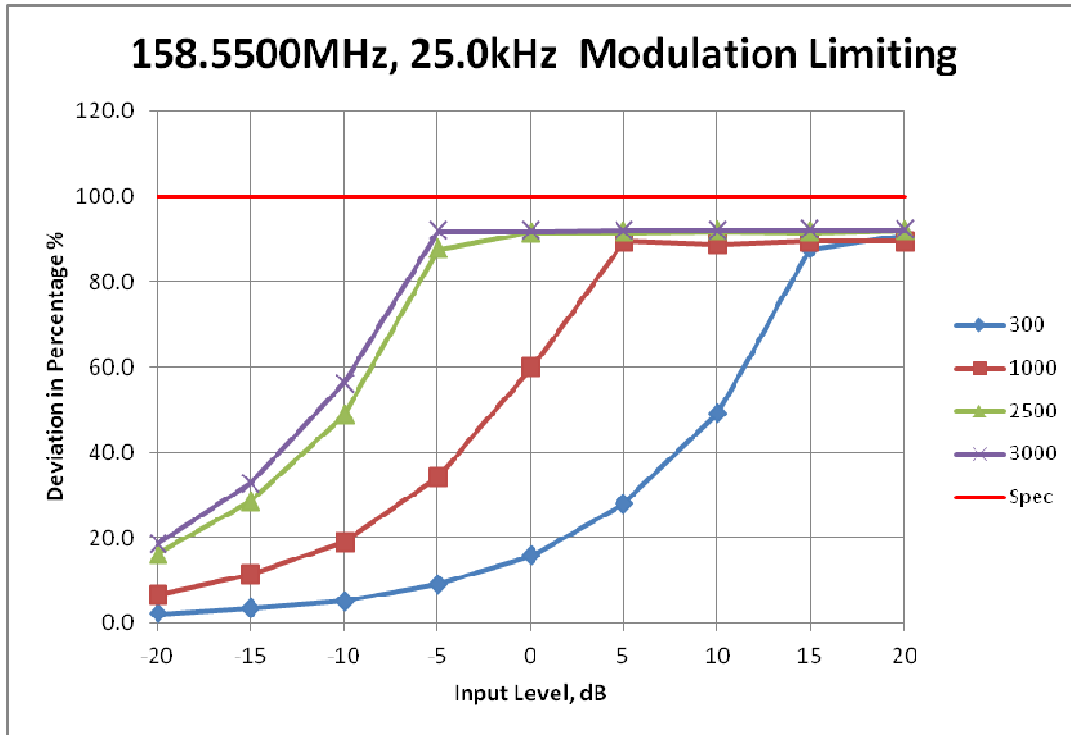

### 6.4.3. Test Limit

Modulation Limiting shall not exceed 100 percent.

## 6.5. Occupied Bandwidth

### 6.5.1. Test Setup (Analog)

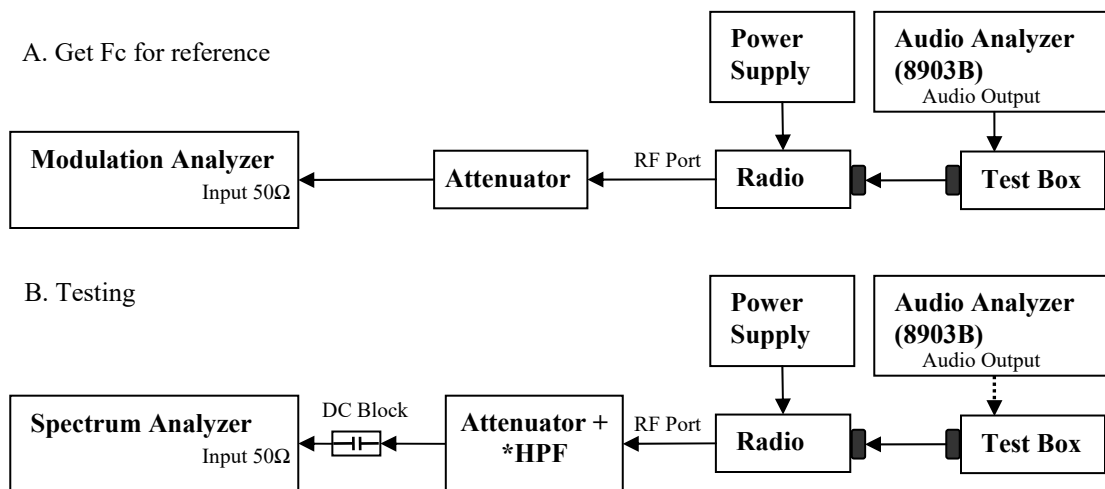

- 1) The DUT transmitter output port was connected to Modulation Analyzer.
- 2) Set the audio bandwidth filter to 15 kHz low pass filter and 50 kHz high pass filter.
- 3) Transmit the radio and set the audio analyzer to 2.5 kHz audio frequency and 50% of the rated deviation. Up the amplitude by 16 dB. Dekey the DUT.
- 4) Path loss for the measurement included.
- 5) Select the Occupied Bandwidth measurement for 99% Emissions Bandwidth Measurement.
- 6) Key in the Fc and Resolution Bandwidth (1 ~ 5 % of emission designator).
- 7) Transmit the DUT and record the occupied Bandwidth frequency.
- 8) Preset the spectrum analyzer for sideband spectrum measurement.
- 9) Set the span and Resolution Bandwidth (according to FCC/ ISED standard).
- 10) Save the screen shot as modulated signal
- 11) Remove the audio tone from audio analyzer to capture unmodulated signal.

\* Only HPF added for Mask 80.211 measurement with attenuator.

\* 99% Bandwidth measurement is computed by the spectrum analyzer and is consistent with the C63.26 5.4.4 method.

### **6.5.2. Test Result (Analog)**

Standard Audio Modulation (25 kHz Channelization, Analog Voice):  
Emission Designator 16K0F3E

In this case, the maximum modulating frequency is 3 kHz with a 5 kHz deviation.

$BW = 2(M+D) = 2*(3 \text{ kHz} + 5 \text{ kHz}) = 16 \text{ kHz} = 16K0$   
F3E portion of the designator indicates voice.

Therefore, the entire designator for 25 kHz channelization analog voice is 16K0F3E.

Standard Audio Modulation (12.5 kHz Channelization, Analog Voice):  
Emission Designator 11K0F3E

In this case, the maximum modulating frequency is 3.0 kHz with a 2.5 kHz deviation.

$BW = 2(M+D) = 2*(3.0 \text{ kHz} + 2.5 \text{ kHz}) = 11 \text{ kHz} = 11K0$   
F3E portion of the designator indicates voice.

Therefore, the entire designator for 12.5 kHz channelization analog voice is 11K0F3E.

Not for FCC review

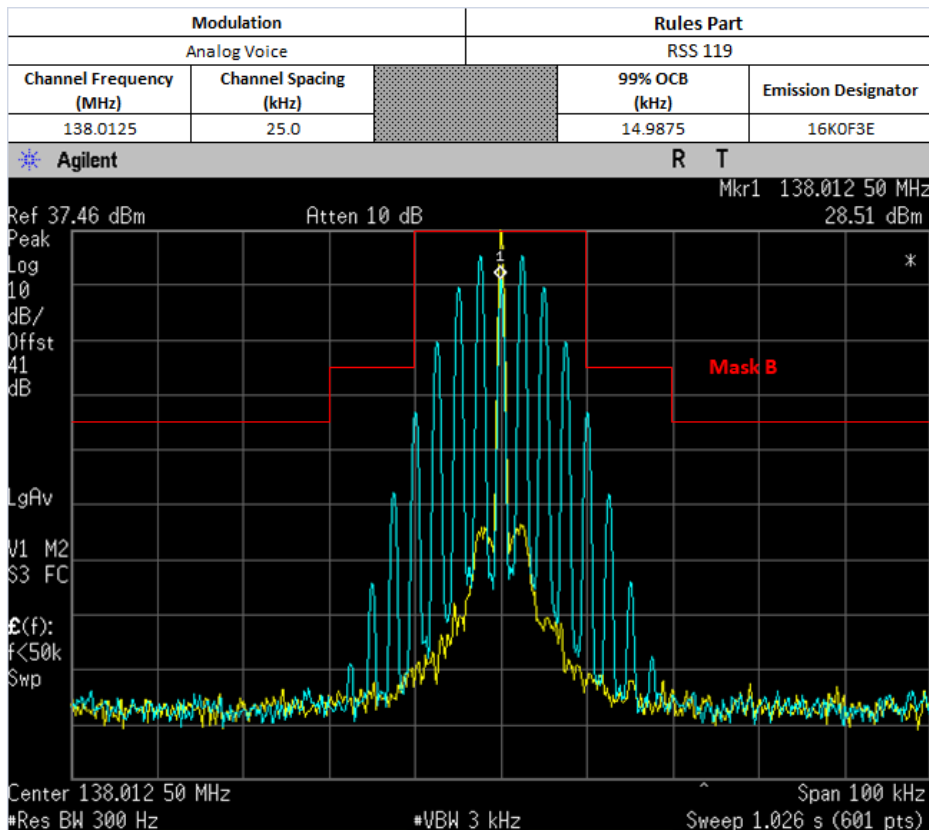

Not for FCC review

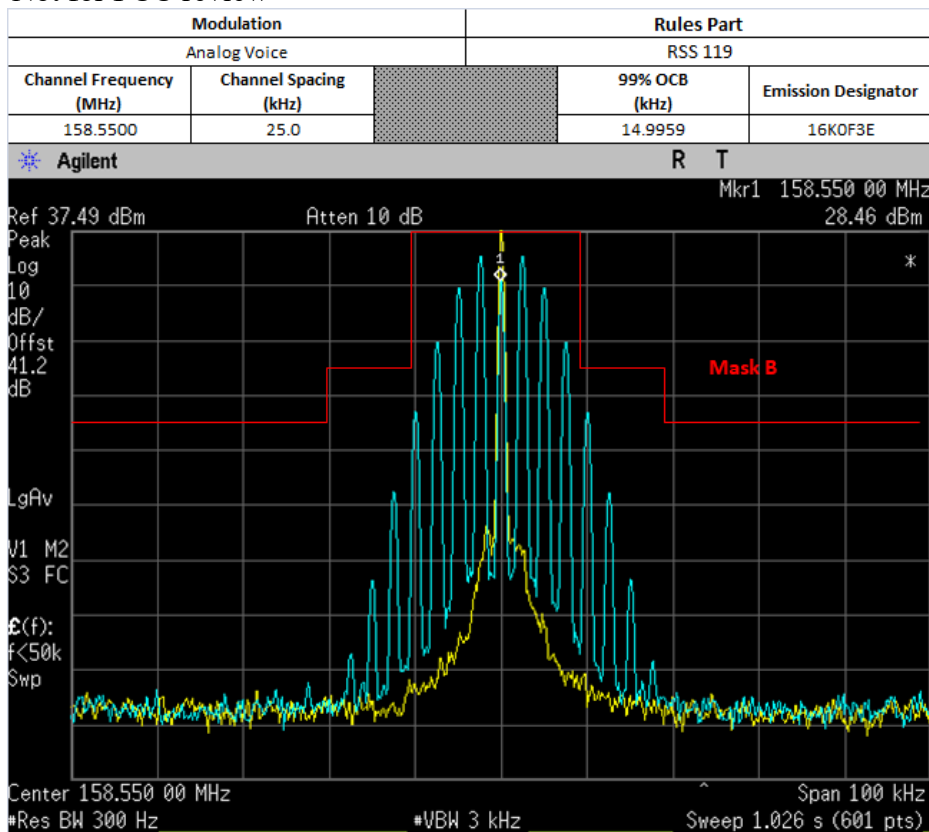

For Part 74

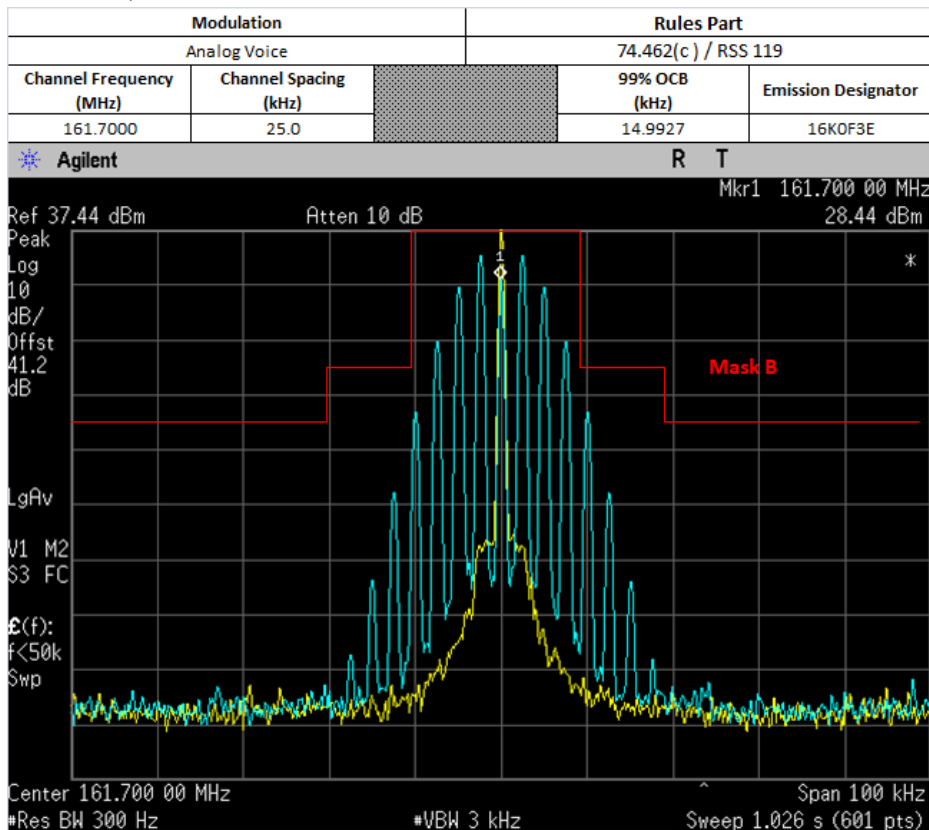

Not for FCC review

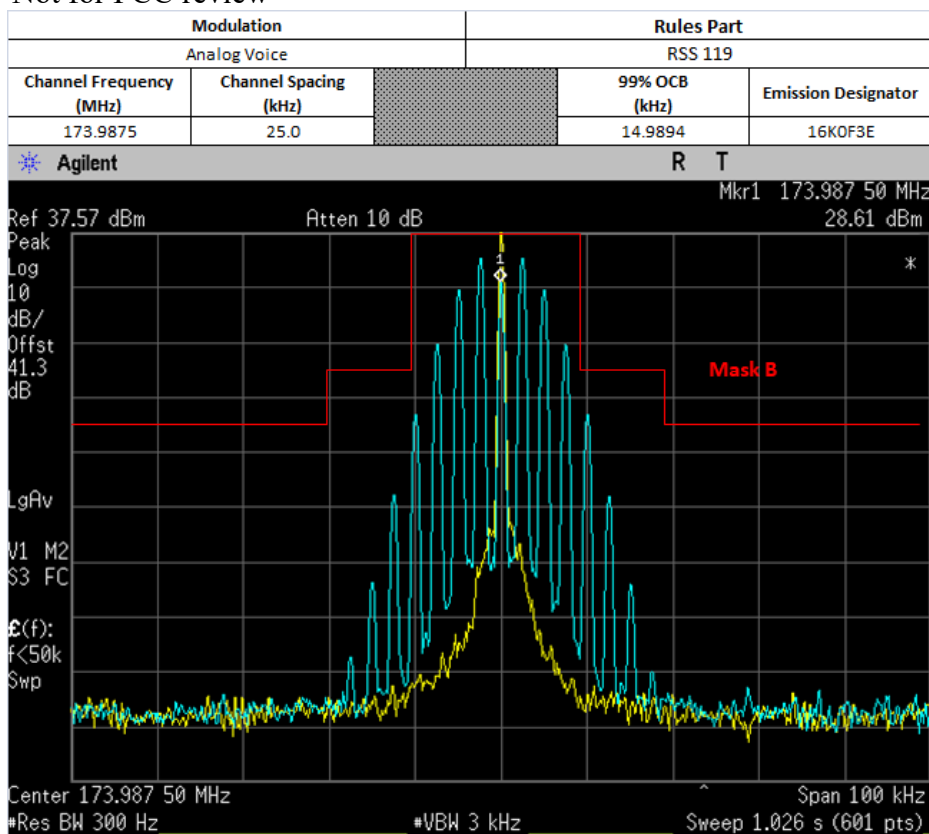

Not for FCC review

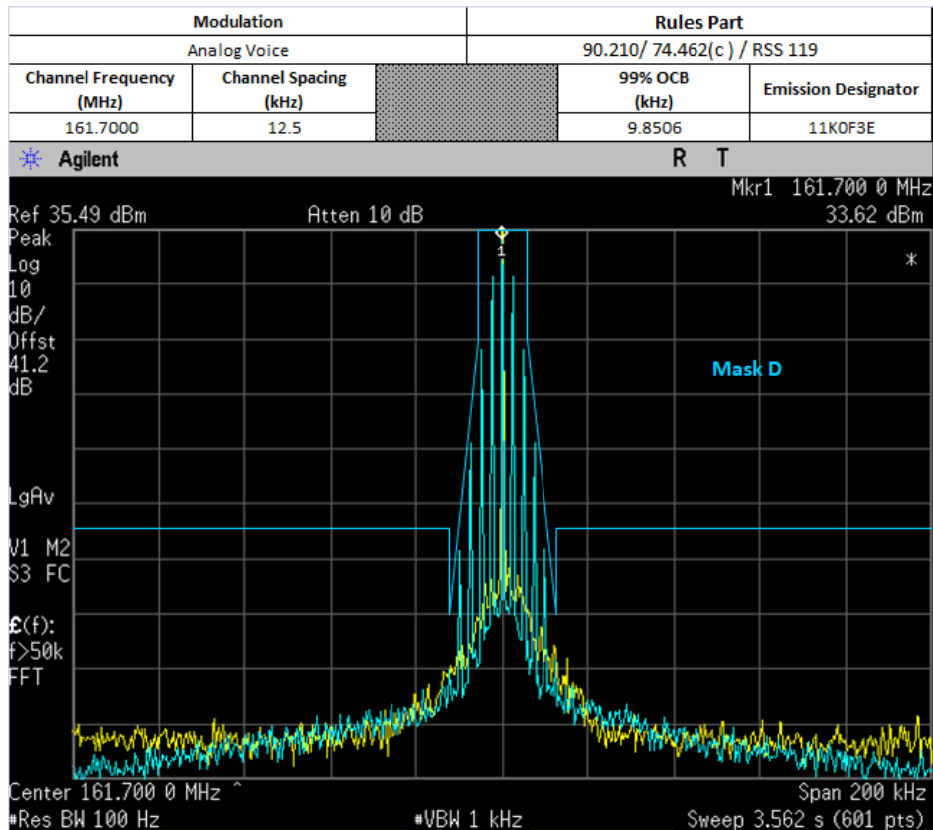
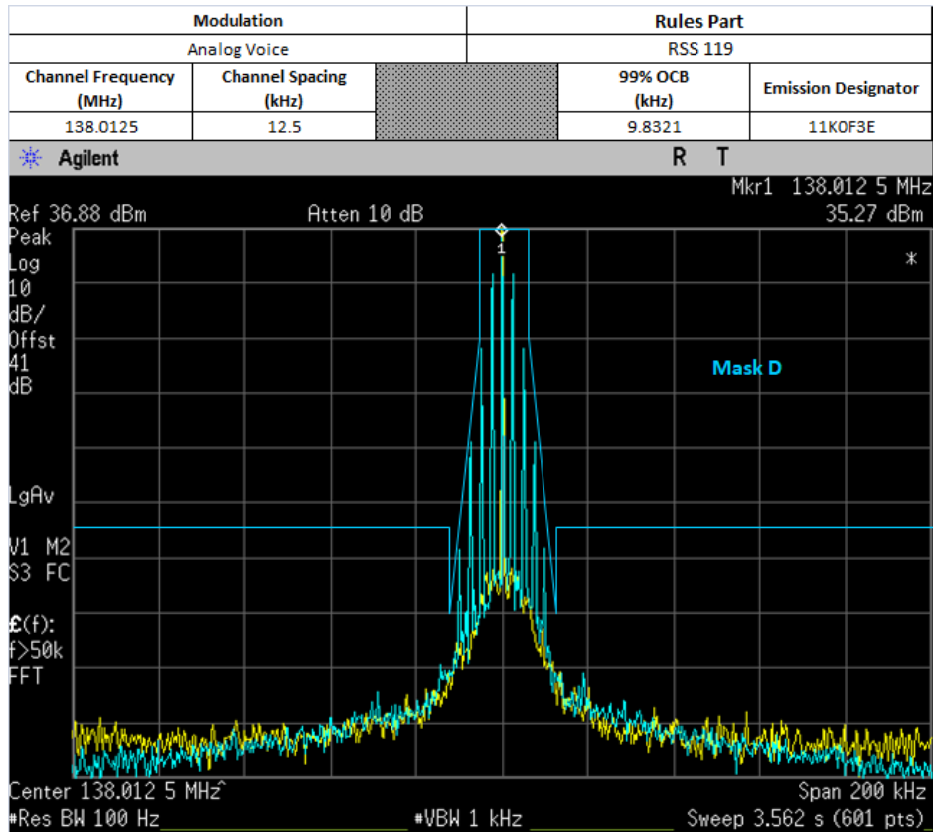



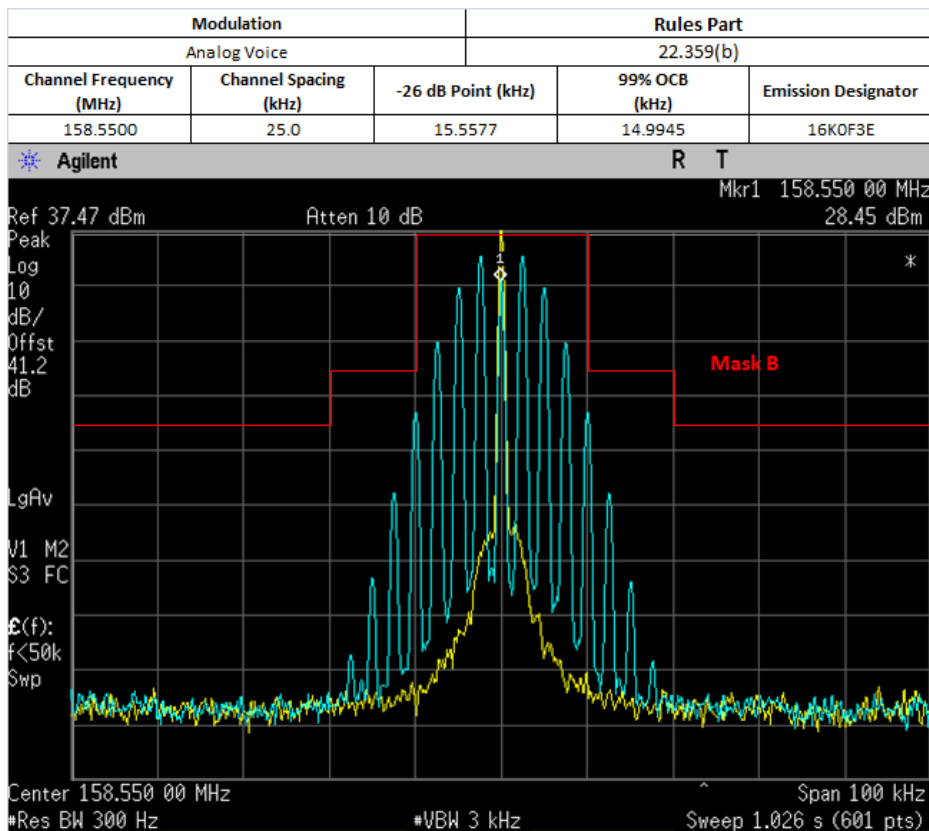
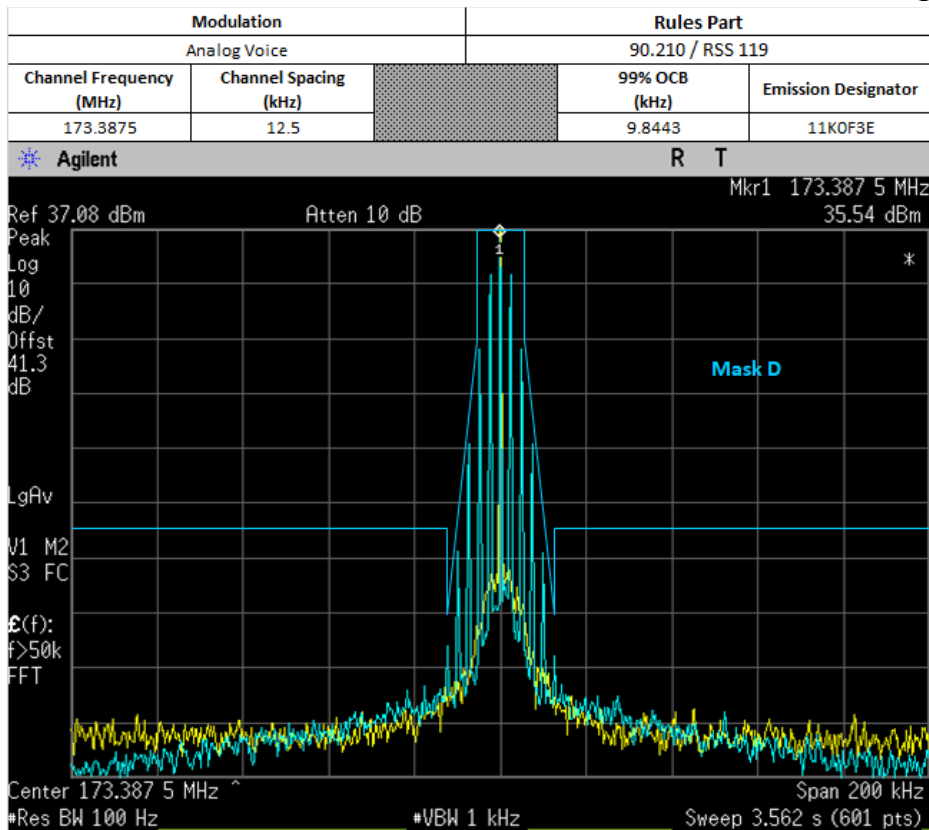

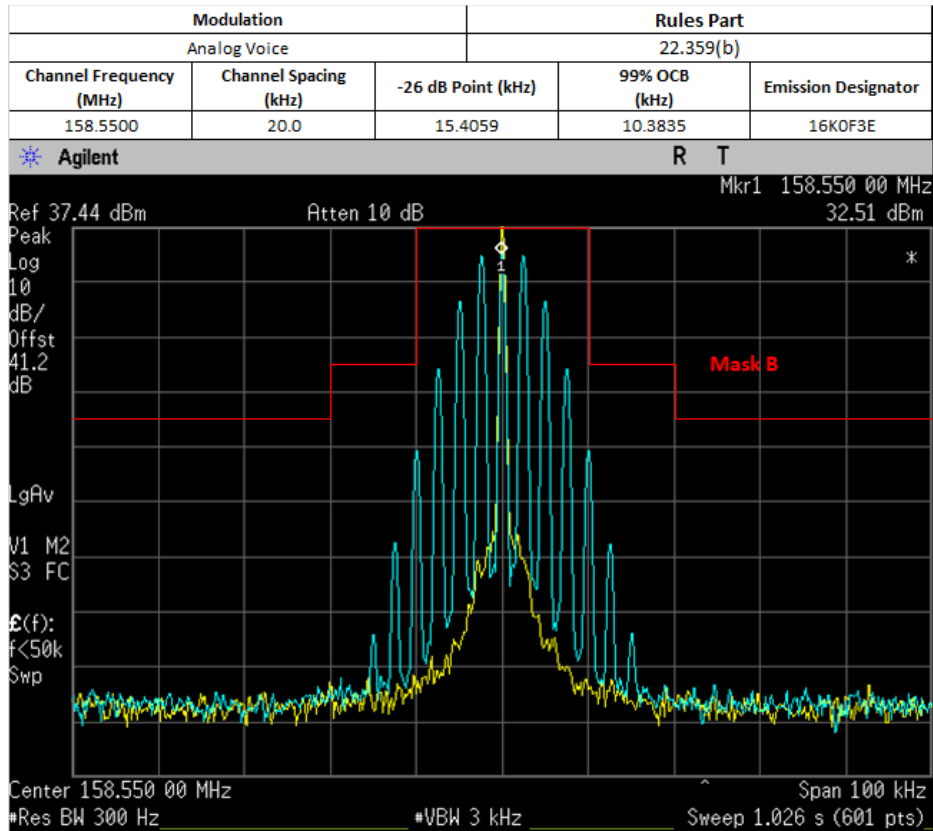

### 6.5.3. Test Setup (Digital)

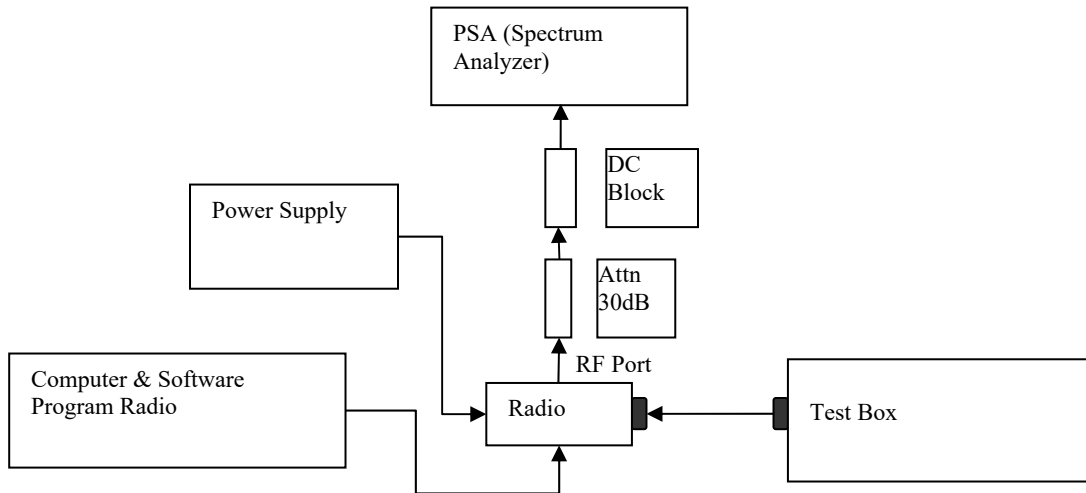

- 1) Program and set radio to operate in desire test frequency and digital mode with modulation. (\*4FSK, C4FM or other digital modulation form).
- 2) Path loss for the measurement included.
- 3) Select the Occupied Bandwidth measurement for 99% Emissions Bandwidth Measurement.
- 4) Key in the Fc and Resolution Bandwidth (1 ~ 5 % of emission designator).
- 5) Transmit the DUT and record the occupied Bandwidth frequency.
- 6) Preset the spectrum analyzer for modulation emission spectrum measurement.
- 7) Set the span and Resolution Bandwidth (according to FCC/ ISED standard).
- 8) Capture the screen shot as modulated signal.

\* 99% Bandwidth measurement is computed by the spectrum analyzer and is consistent with the C63.26 5.4.4 method.

\*Note:

- For Digital Modulation, 12.5 kHz Data F1D & FXD would be the same. Therefore only measurements with F1D modulation shown below.
- For Digital Modulation, 12.5 kHz Data F1E & FXE would be the same. Therefore only measurements with F1E modulation shown below.

#### **6.5.4. Test Result (Digital)**

Digital (12.5 kHz Channelization, Digital Voice/Data/Voice+Data):  
Emission Designator 7K60F1E/D/W

The 99% energy rule (title 47CFR 2.989) was used for digital mode and is more accurate than Carson's rule. It basically states that 99% of the modulation energy falls within X kHz, in this case, 7.60 kHz. Measurements were performed in accordance with TIA/EIA TSB102.CAAB Section 2.2.5.2. The emission mask was obtained from 47CFR 90.210(d).

F1E/D/W portion of the designator indicates digital voice/data/voice+data.

Therefore, the entire designator for 12.5 kHz channelization digital voice is 7K60F1E/D/W.

Not for FCC review

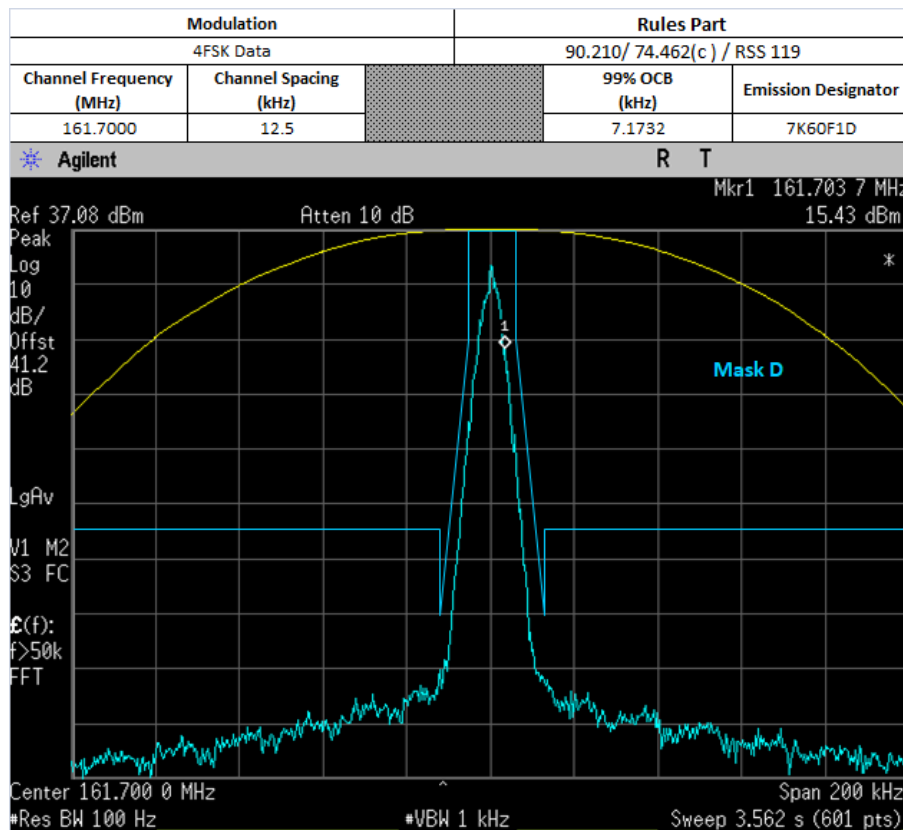
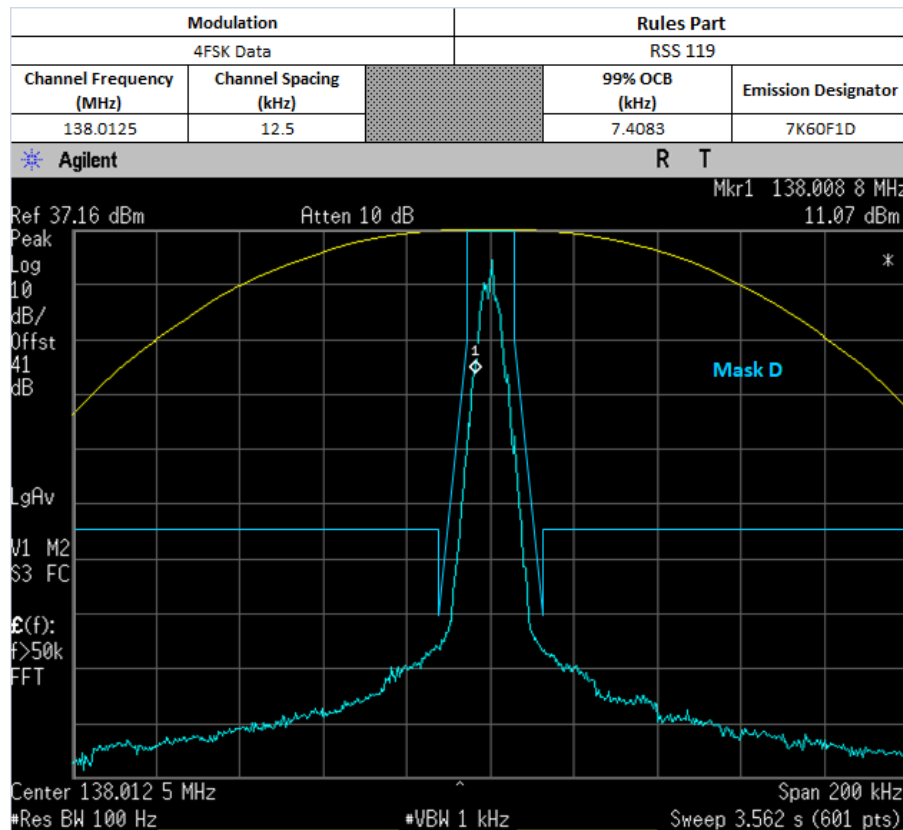

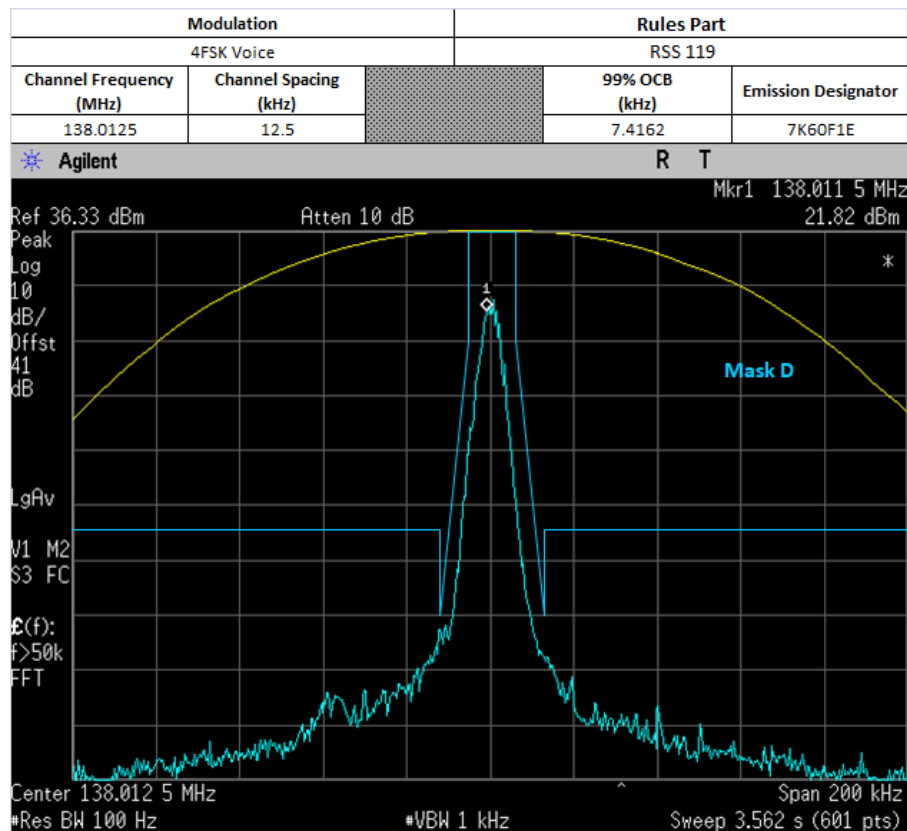
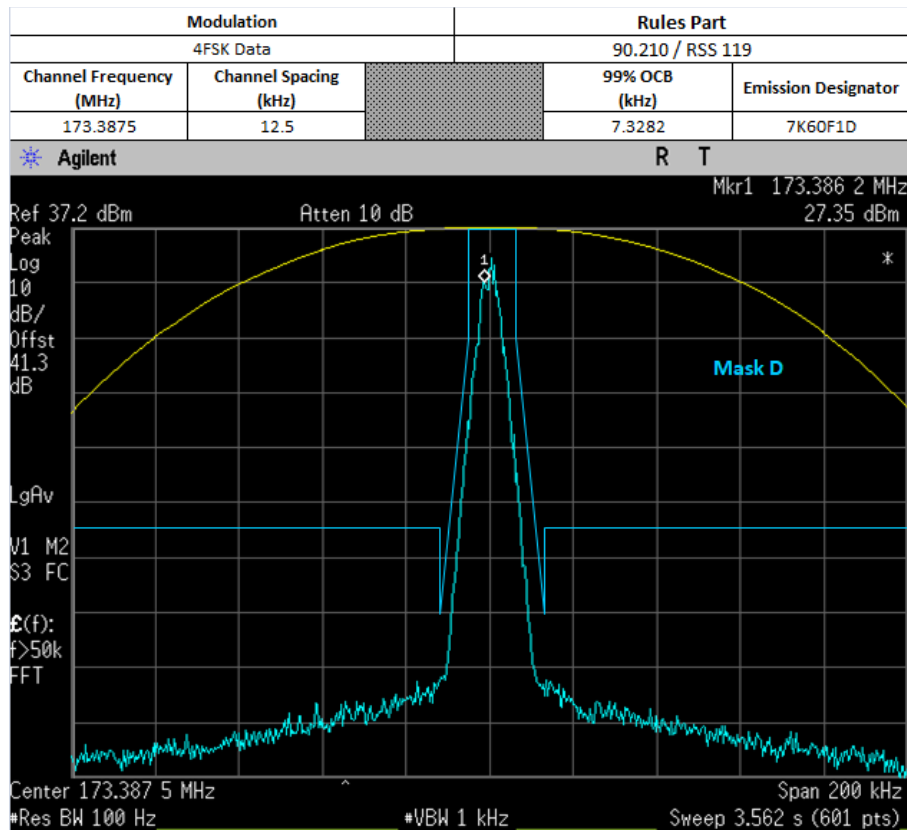

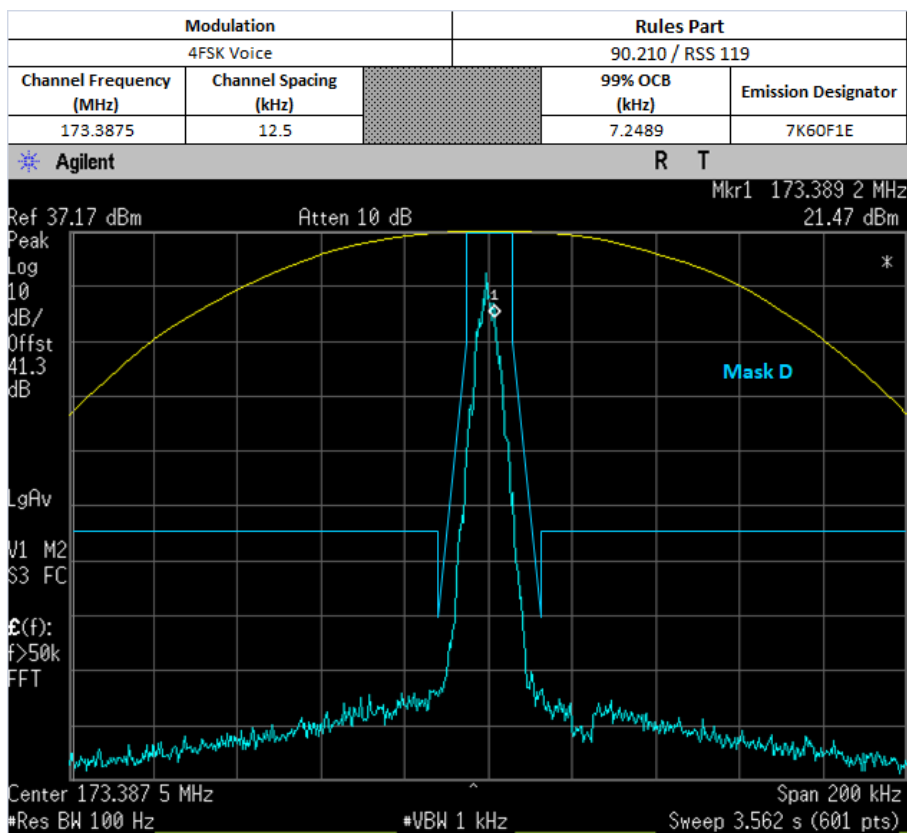
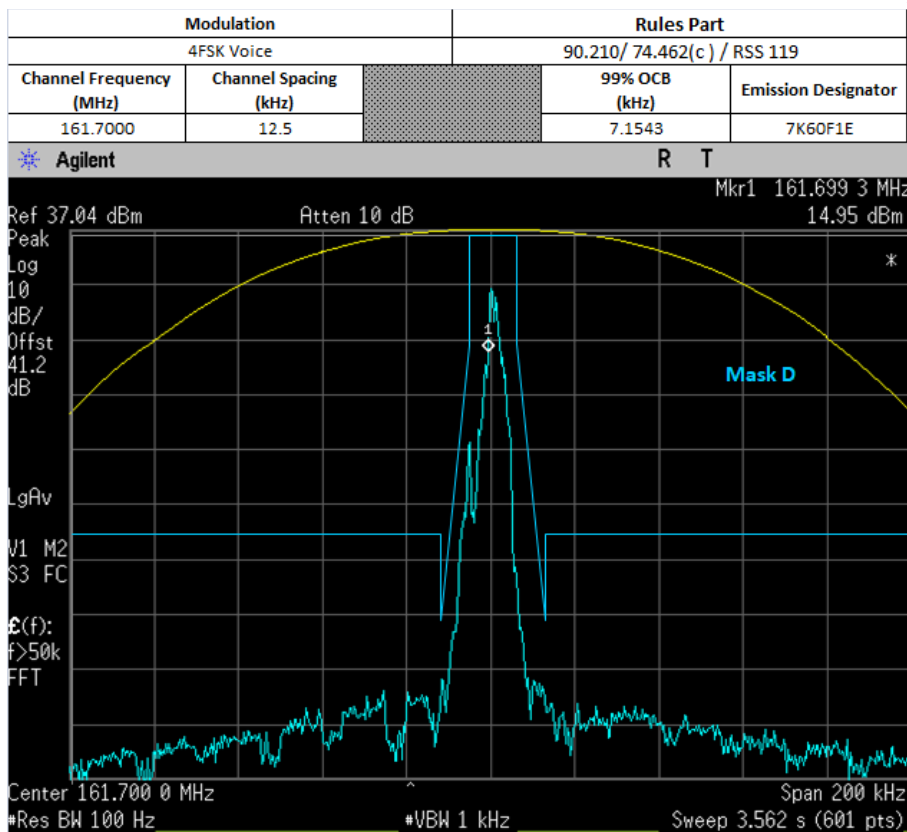

Not for FCC review

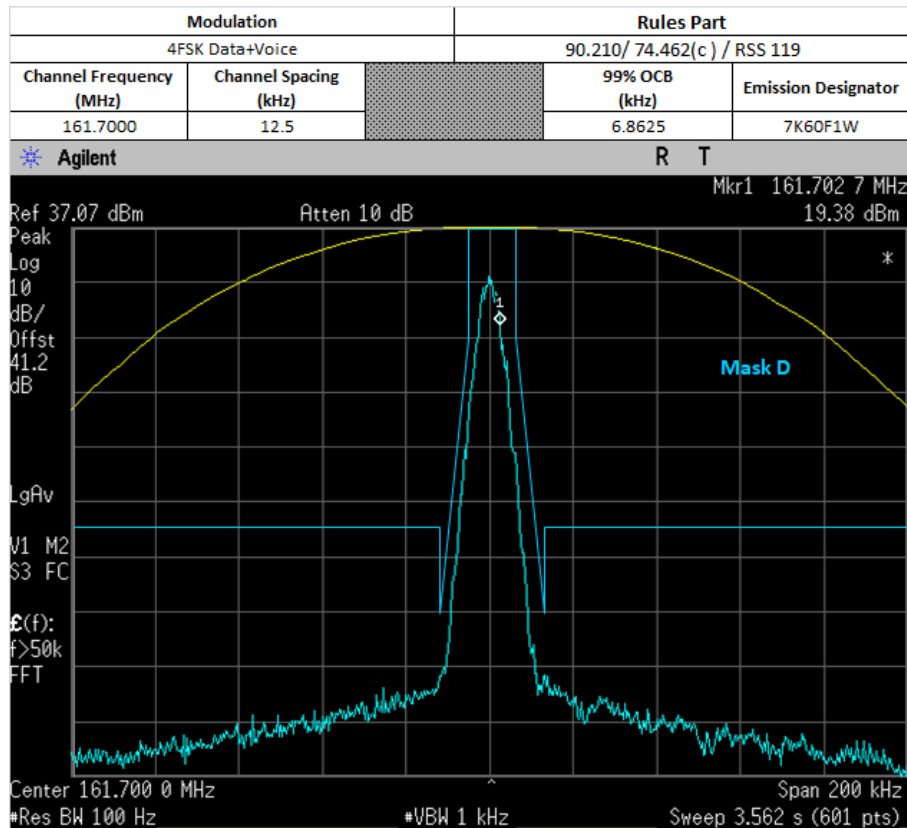
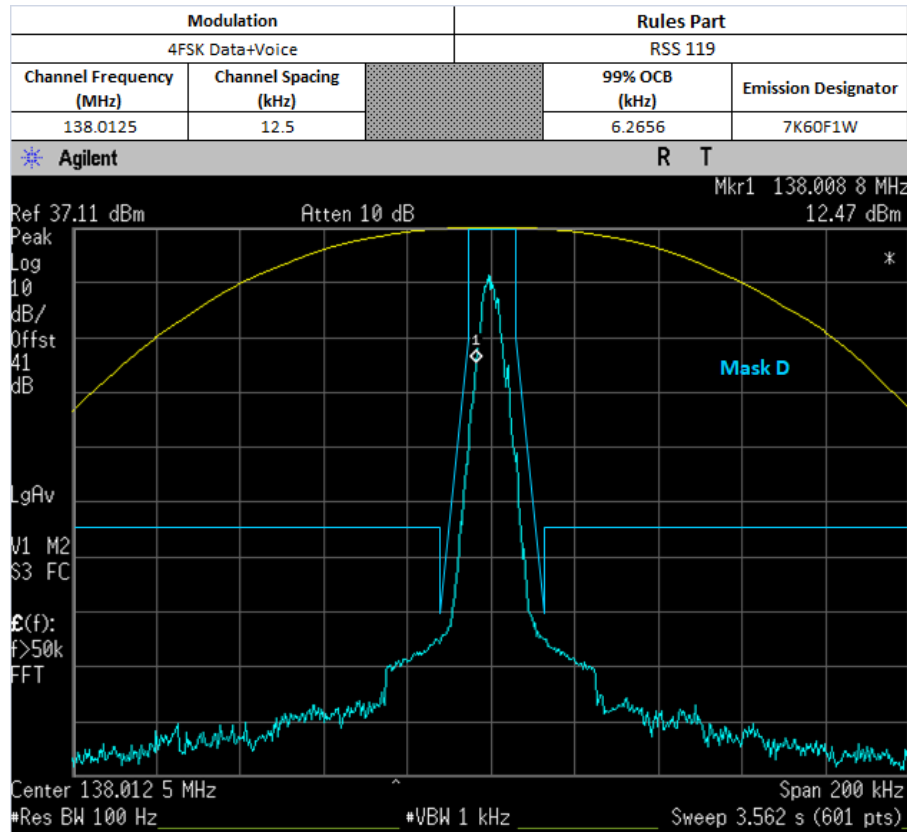



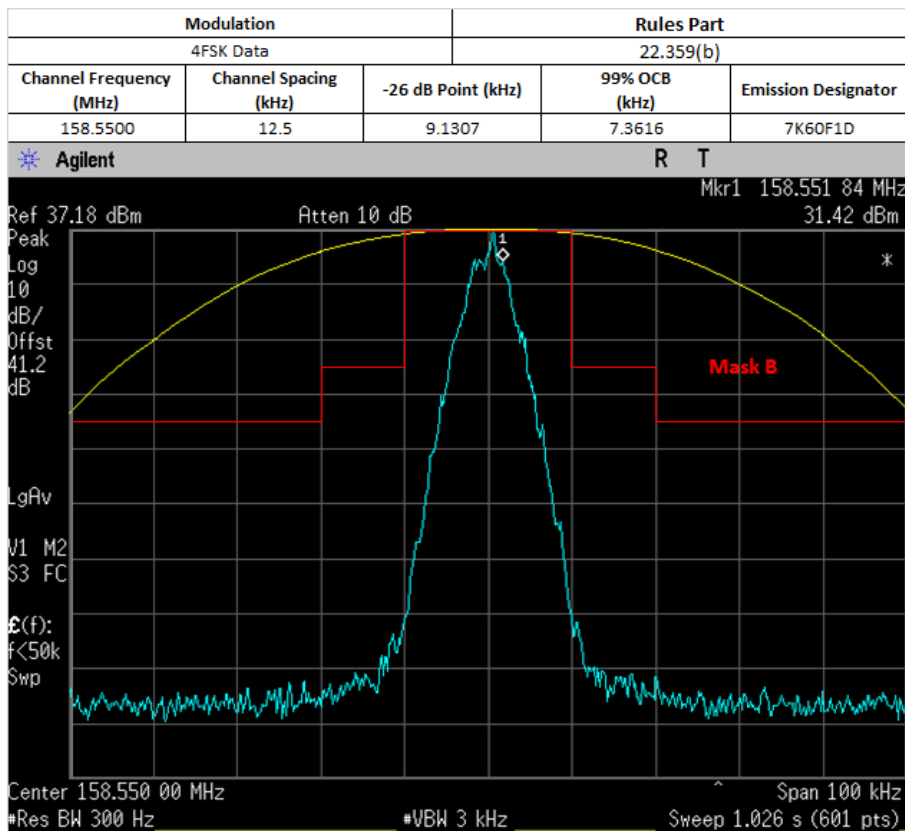
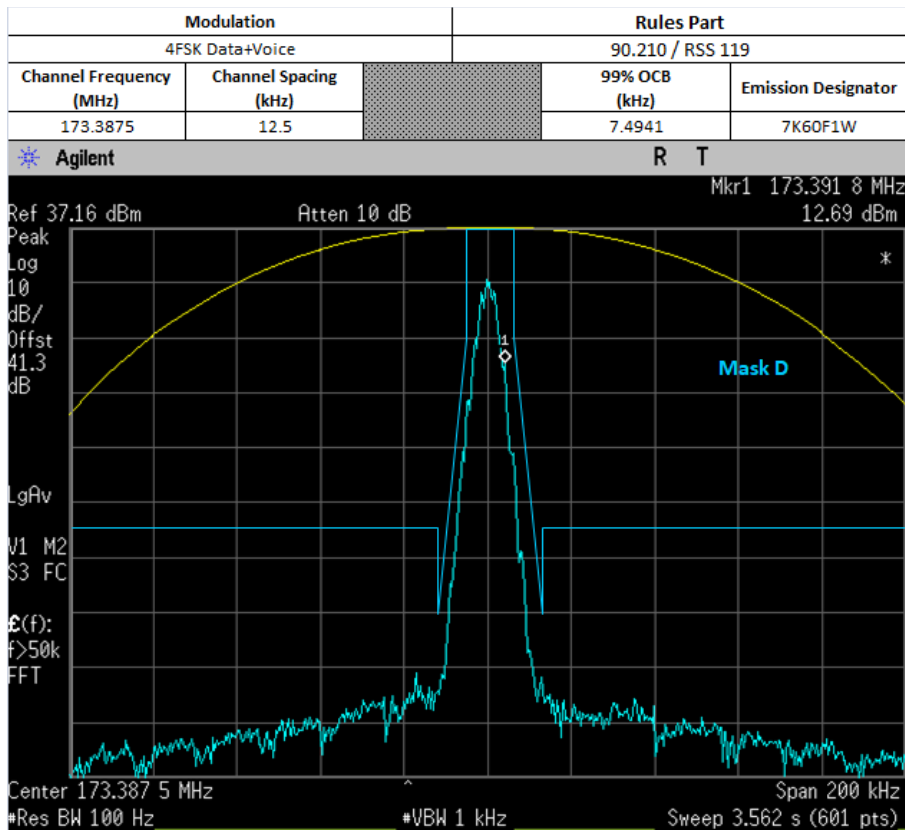

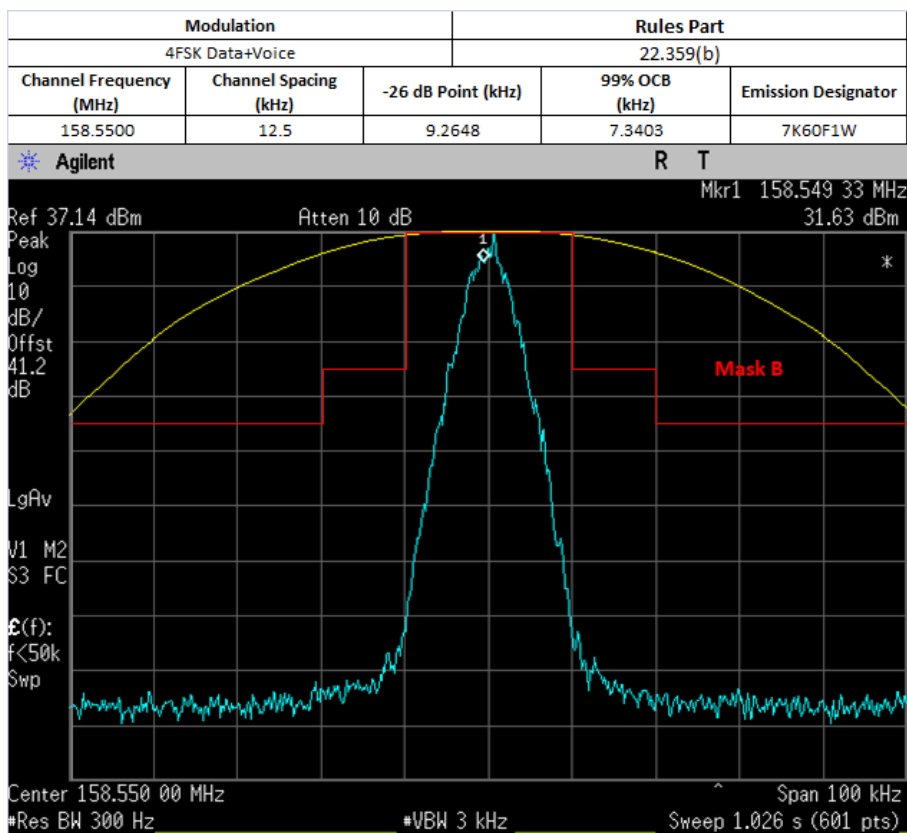
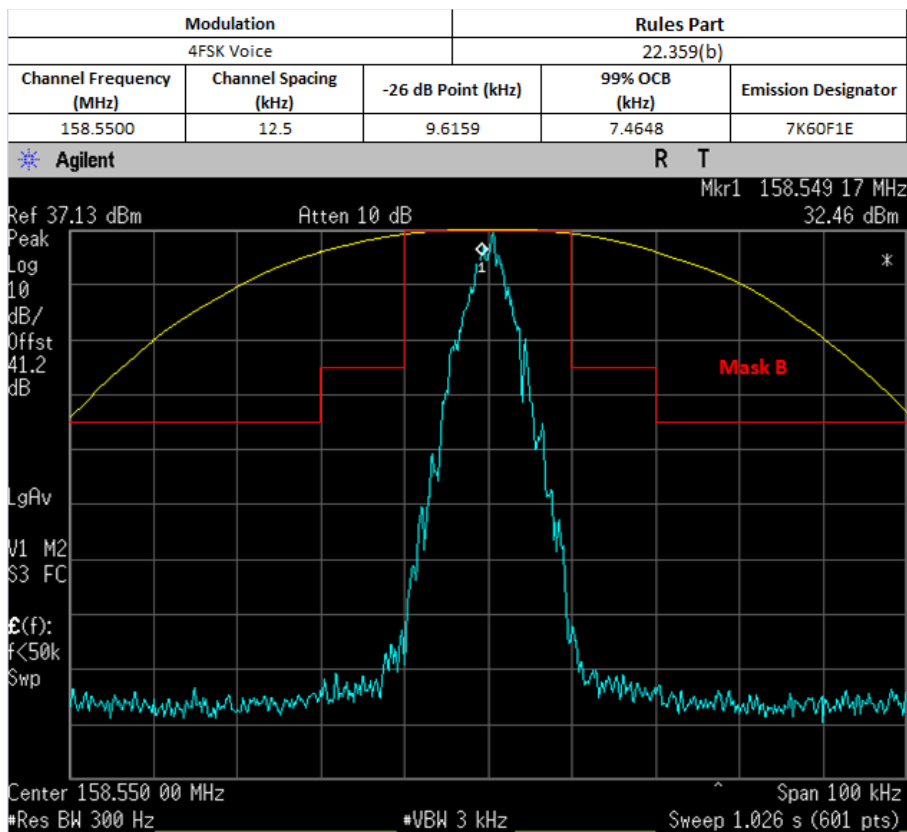

**6.5.5. Test Limit**

The 99% occupied bandwidth is the width of a frequency band such that, below the lower and above the upper frequency limits, the mean powers emitted are each equal to a specified percentage 0.5% of the total mean transmitted power.

## 6.6. Band Edge Conducted Spurious Emission (Part 22)

### 6.6.1. Test Setup (Analog)

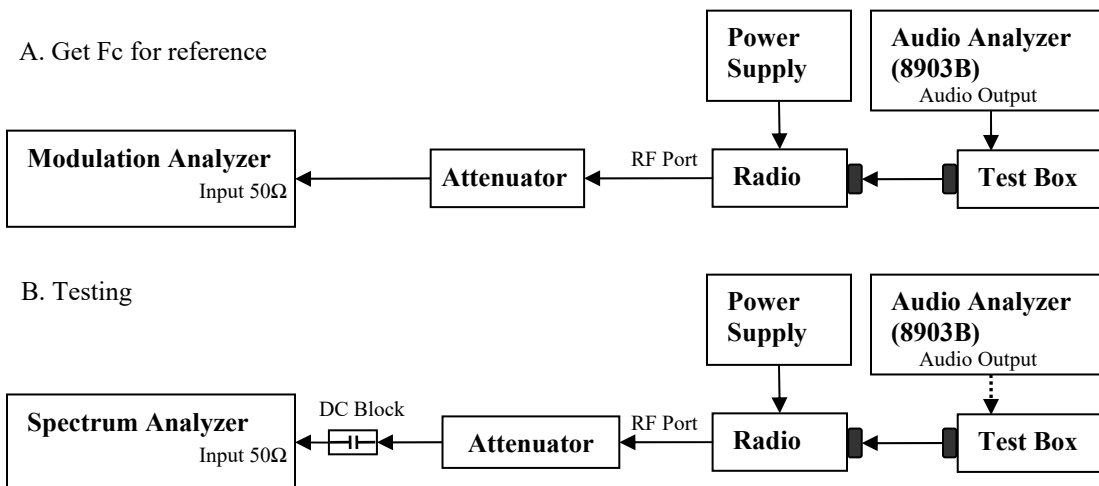

- 1) The DUT transmitter output port was connected to Modulation Analyzer.
- 2) Set the audio bandwidth filter to 15 kHz low pass filter and 50 kHz high pass filter.
- 3) Transmit the radio and set the audio analyzer to 2.5 kHz audio frequency and 50% of the rated deviation. Up the amplitude by 16 dB. Dekey the DUT.
- 4) Path loss for the measurement included.
- 5) Select the Occupied Bandwidth measurement for 99% and 26dB Emissions Bandwidth Measurement.
- 6) Key in the Fc and Resolution Bandwidth.
- 7) Transmit the DUT and record the occupied Bandwidth frequencies.
- 8) Preset the spectrum analyzer for band edge measurement.
- 9) The band edges of lowest and highest channels were measured.
- 10) Key in the Lowest and highest channel frequency, span is 60 kHz and Resolution Bandwidth is at least 1% of Emission Bandwidth.
- 11) Save the screen shot as modulated signal.
- 12) Remove the audio tone from audio analyzer to capture unmodulated signal.

\*Note:

- For emission designator ending with F3E, 16K0F3E is the worst case and therefore only 16K0F3E will be shown.

### 6.6.2. Test Result (Analog)

#### MAX POWER

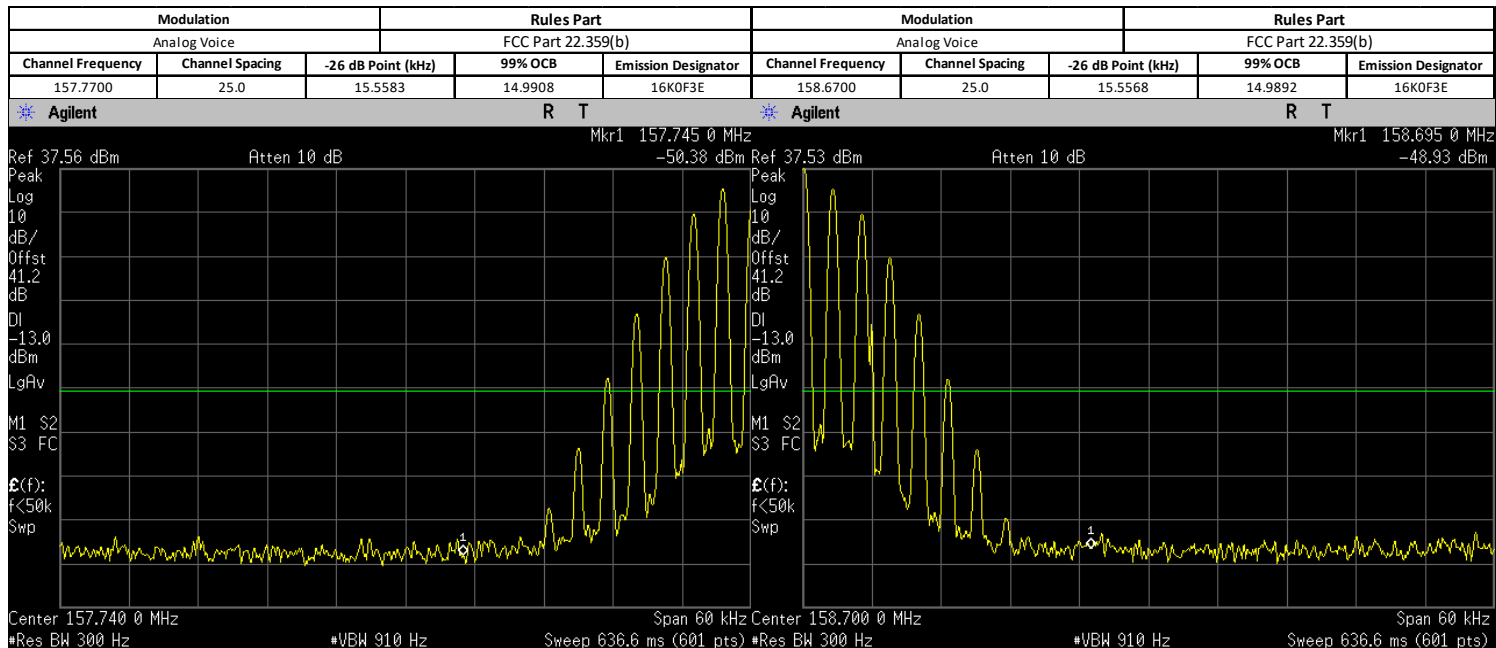

#### LOW POWER

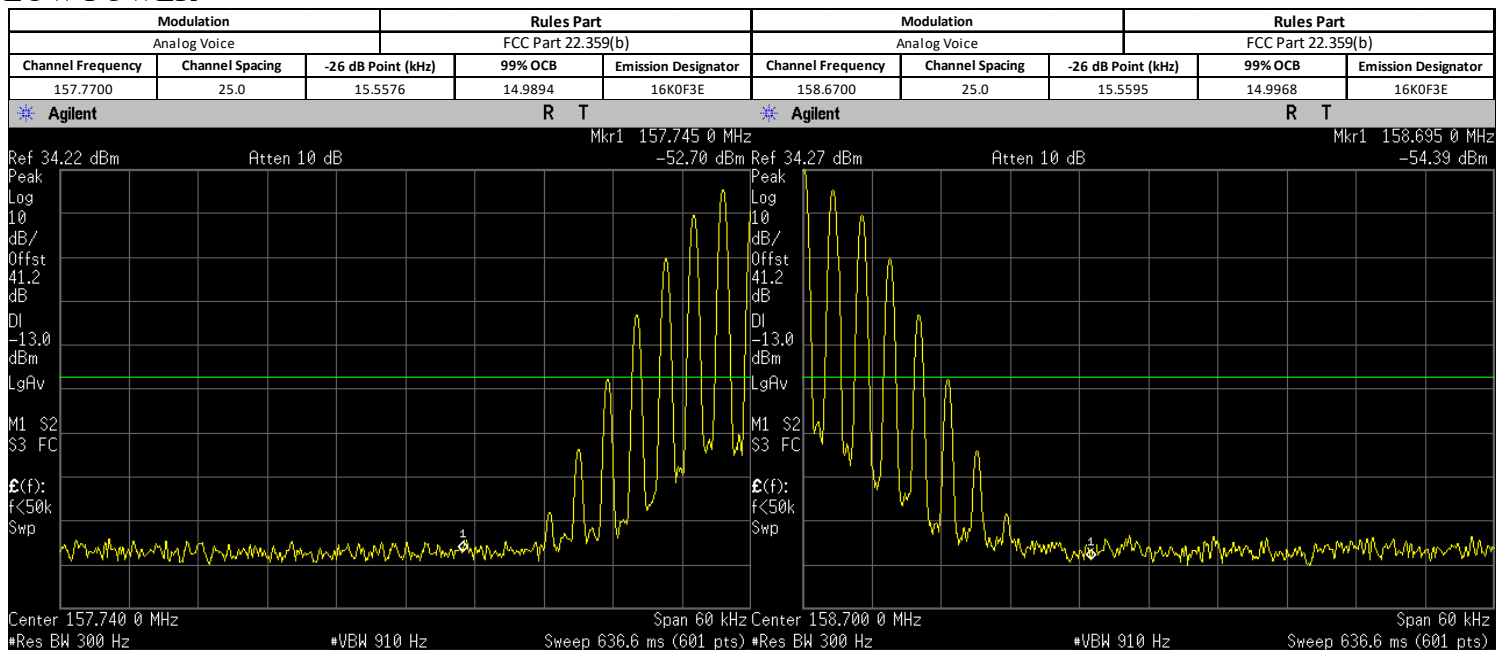

### 6.6.3. Test Setup (Digital)

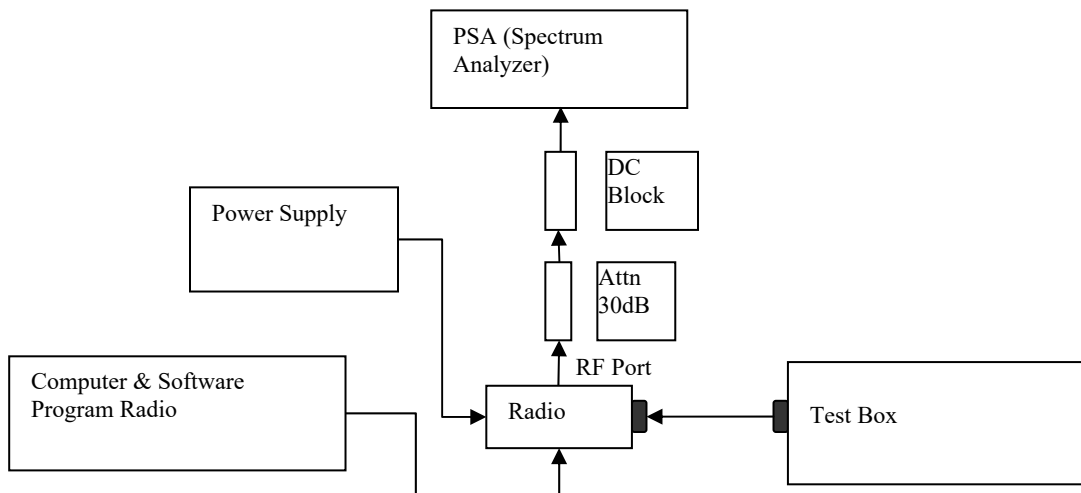

- 1) Program and set radio to operate in desire test frequency and digital mode with modulation. (\*4FSK, C4FM or other digital modulation form).
- 2) Path loss for the measurement included.
- 3) Select the Occupied Bandwidth measurement for 99% and 26dB Emissions Bandwidth Measurement.
- 4) Key in the Fc and Resolution Bandwidth.
- 5) Transmit radio record the occupied Bandwidth frequencies.
- 6) Preset the spectrum analyzer for band edge measurement.
- 7) Key in the lowest and highest channels frequency, span is 60 kHz and Resolution Bandwidth is at least 1% of Emission Bandwidth.
- 8) Save the screen shot.

\*Note:

- For Digital Modulation, 12.5 kHz Data F1D & FXD would be the same. Therefore only measurements with F1D modulation shown below.
- For Digital Modulation, 12.5 kHz Data F1E & FXE would be the same. Therefore only measurements with F1E modulation shown below.

### 6.6.4. Test Result (Digital)

#### MAX POWER

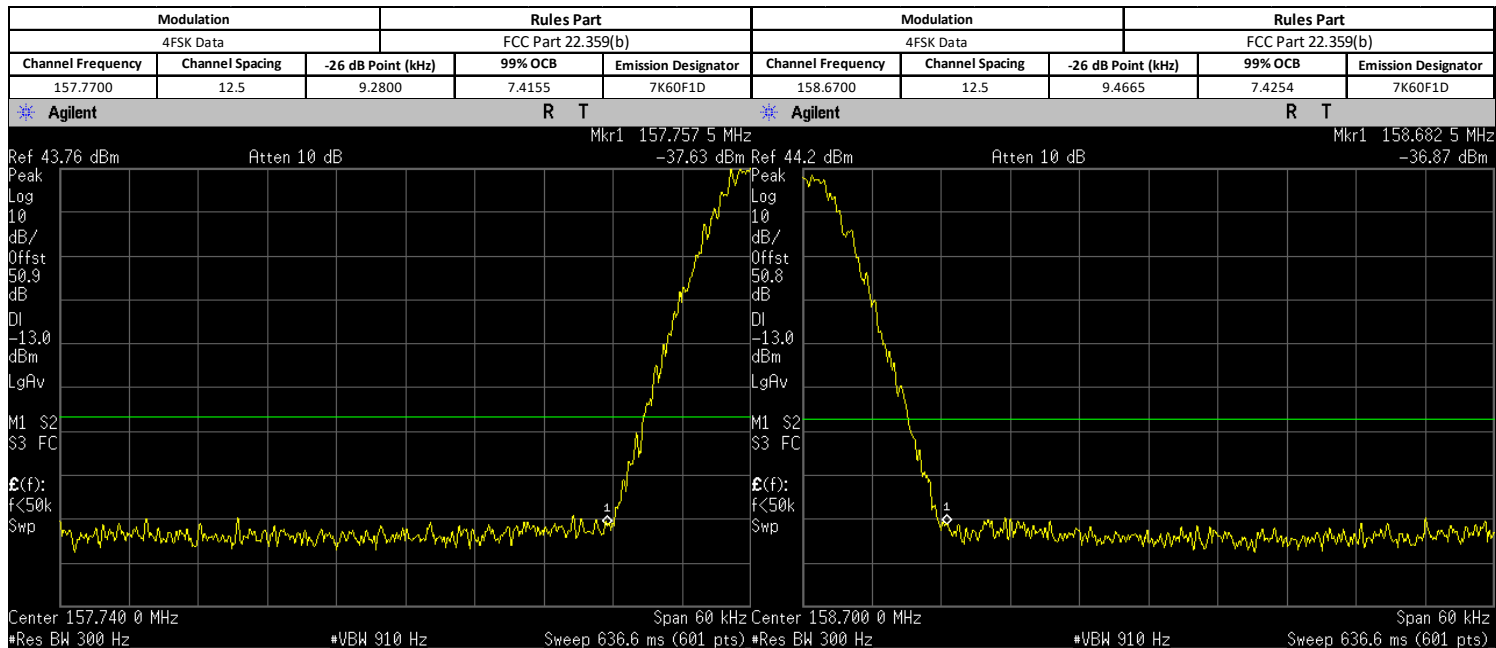

#### LOW POWER

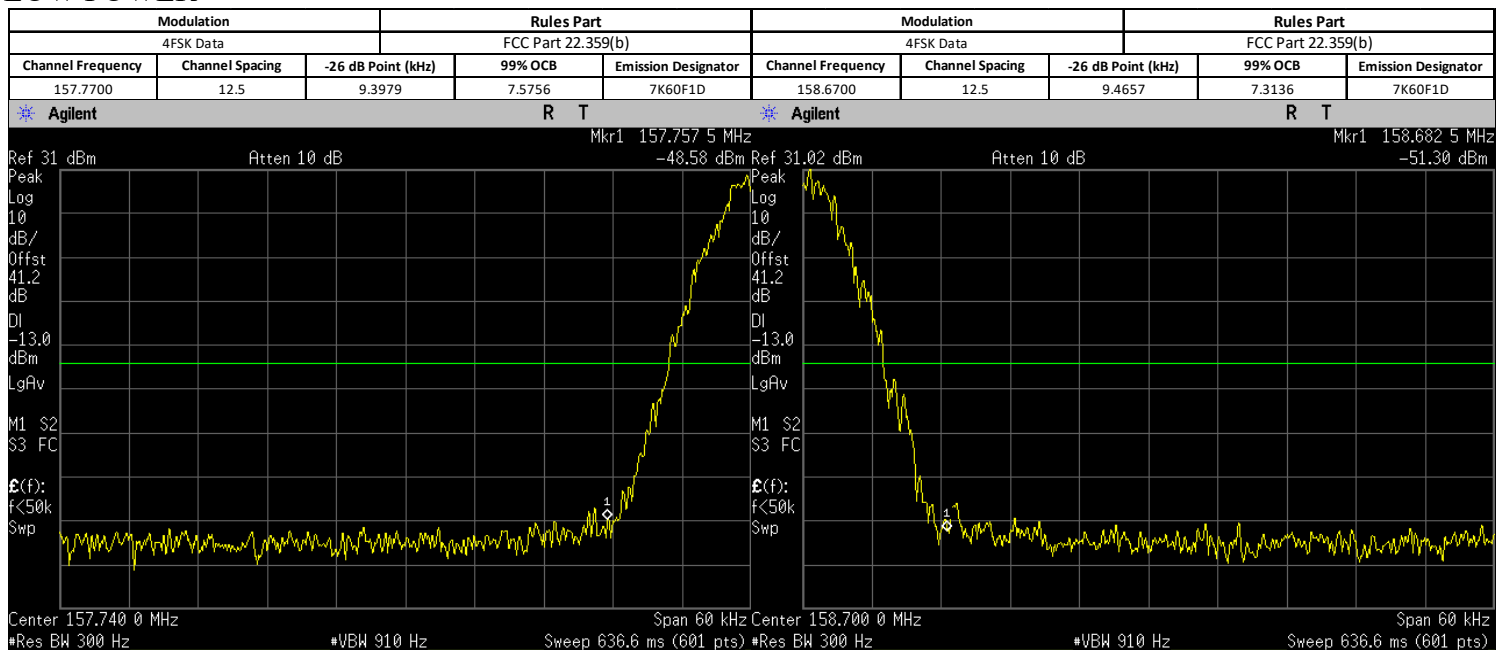

### 6.6.5. Test Limit

The power of any emission outside of the authorized operating frequency ranges must be attenuated below the transmitting power (P) by a factor of at least  $43 + 10 \log(P)$  dB.

## 6.7. Transient Frequency Behavior

### 6.7.1. Test Setup

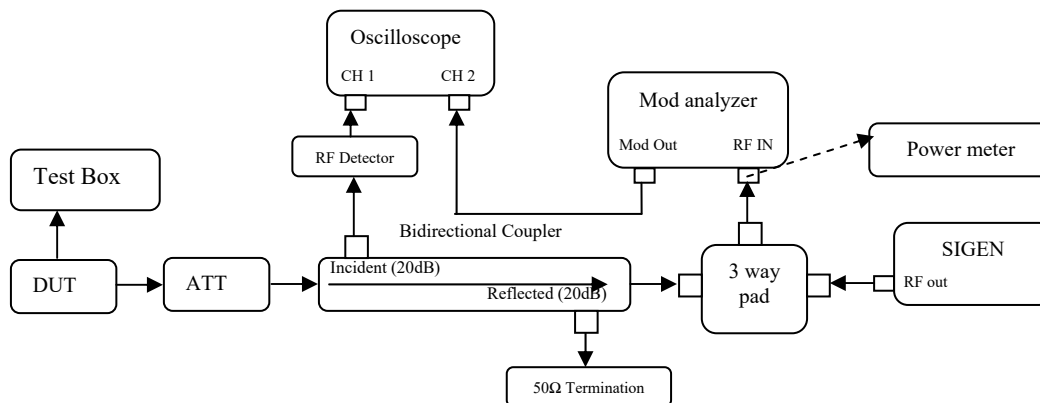

- 1) Connect the setup as figure above.
- 2) Path loss for the measurement included.
- 3) Set on Sigen with the assigned center frequency, internal 1 kHz FM tone.  
FM Deviation: Analog 25kHz Channel Spacing = 25 kHz  
Analog 12.5 kHz Channel Spacing = 12.5 kHz  
C4FM = 12.5 kHz
- 4) Turn on 50 kHz high pass filter and 15 kHz low pass filter on modulation analyzer.
- 5) Supply sufficient attenuation ATT to provide the output power of  $\leq -11\text{dBm}$  into power meter when DUT is keying up.
- 6) Note the power level on power meter and dekey the DUT.
- 7) Adjust the amplitude of the signal generator to the level power meter, maintained the amplitude throughout the rest of the measurement.
- 8) Connect the output to modulation analyzer.
- 9) Reduce 30dB attenuation and transmit the radio to get the trigger line.
- 10) Capture the screen shot for key-up (rising edge) and de-key (falling edge) mode.



### 6.7.2. Test Result

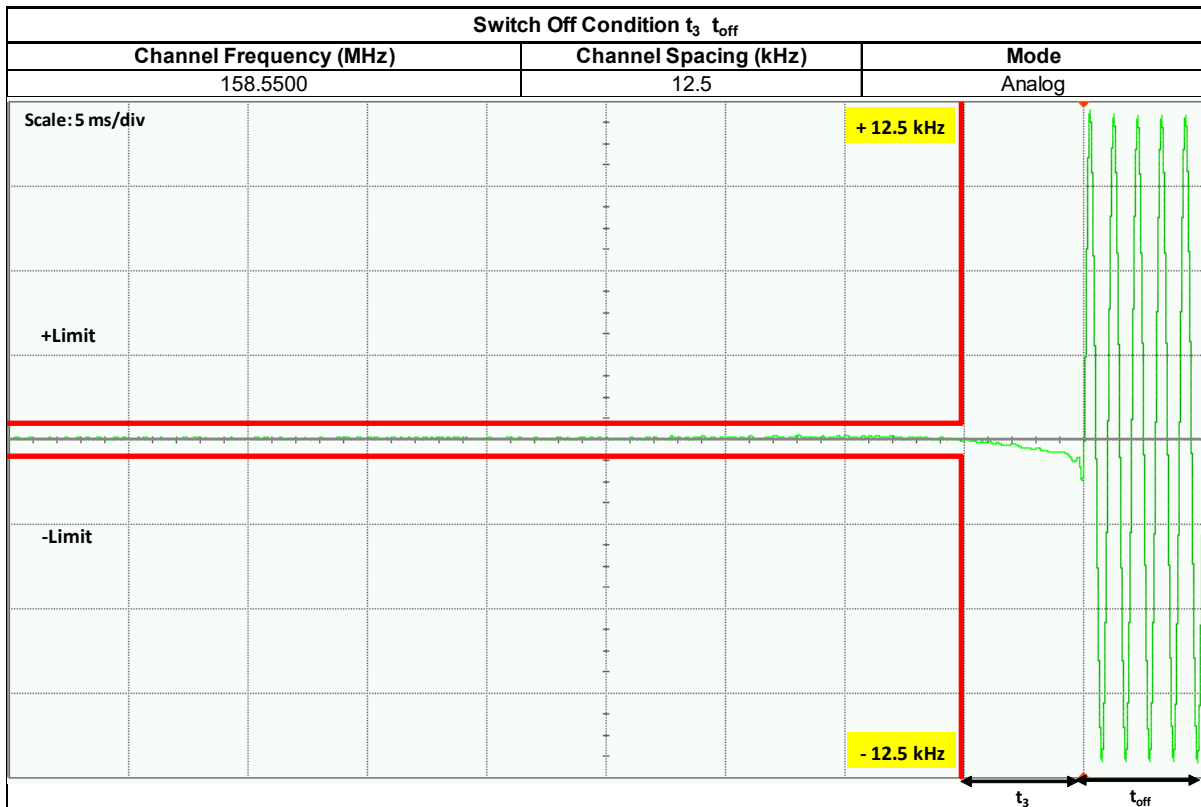
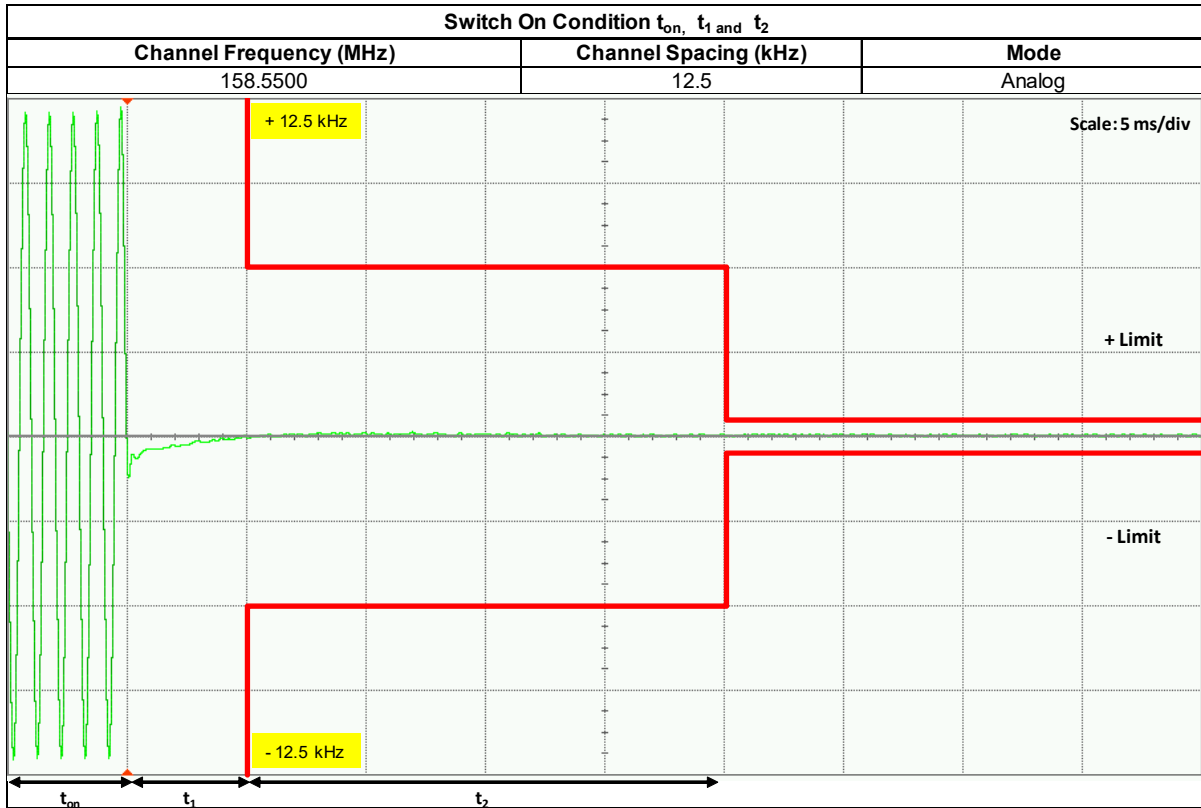

Not for FCC review

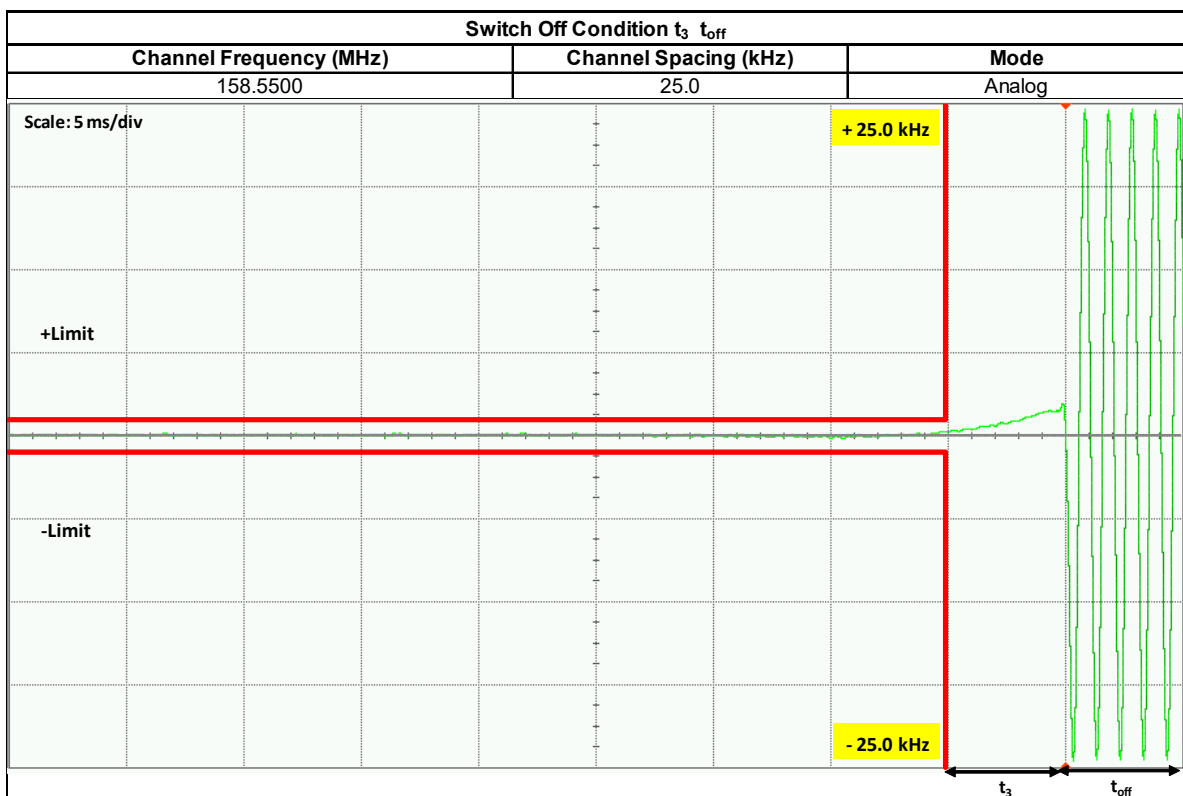
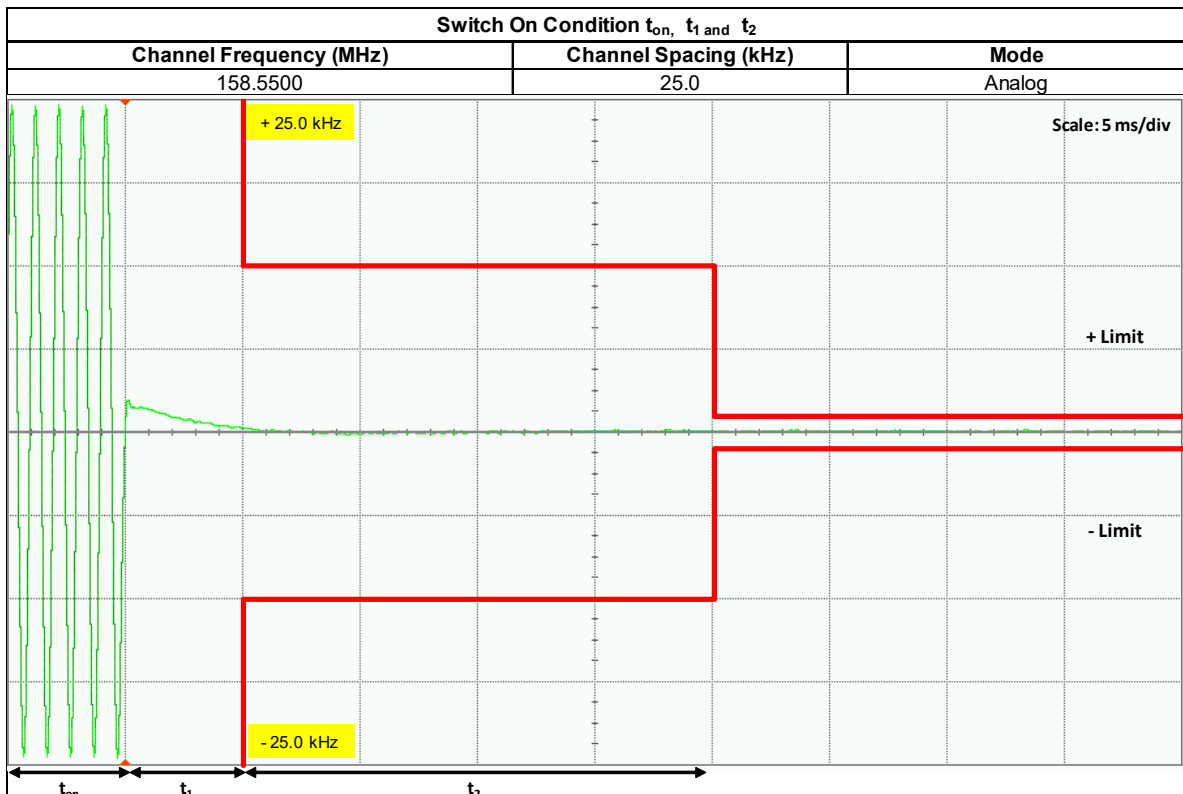

### 6.7.3. Test Limit

Transmitters designed to operate in the 150-174 MHz and 421-512 MHz frequency bands must maintain transient frequencies within the maximum frequency difference limits during the time intervals indicated:

Time intervals <sup>1 2</sup>	Maximum frequency difference <sup>3</sup>	All equipment	
		150 to 174 MHz	421 to 512 MHz
Transient Frequency Behavior for Equipment Designed to Operate on 25 kHz Channels			
t <sub>1</sub> <sup>4</sup>	±25.0 kHz	5.0 ms	10.0 ms
t <sub>2</sub>	±12.5 kHz	20.0 ms	25.0 ms
t <sub>3</sub> <sup>4</sup>	±25.0 kHz	5.0 ms	10.0 ms
Transient Frequency Behavior for Equipment Designed to Operate on 12.5 kHz Channels			
t <sub>1</sub> <sup>4</sup>	±12.5 kHz	5.0 ms	10.0 ms
t <sub>2</sub>	±6.25 kHz	20.0 ms	25.0 ms
t <sub>3</sub> <sup>4</sup>	±12.5 kHz	5.0 ms	10.0 ms
Transient Frequency Behavior for Equipment Designed to Operate on 6.25 kHz Channels			
t <sub>1</sub> <sup>4</sup>	±6.25 kHz	5.0 ms	10.0 ms
t <sub>2</sub>	±3.125 kHz	20.0 ms	25.0 ms
t <sub>3</sub> <sup>4</sup>	±6.25 kHz	5.0 ms	10.0 ms

<sup>1</sup> t<sub>on</sub> is the instant when a 1 kHz test signal is completely suppressed, including any capture time due to phasing.

t<sub>1</sub> is the time period immediately following t<sub>on</sub>.

t<sub>2</sub> is the time period immediately following t<sub>1</sub>.

t<sub>3</sub> is the time period from the instant when the transmitter is turned off until t<sub>off</sub>.

t<sub>off</sub> is the instant when the 1 kHz test signal starts to rise.

<sup>2</sup> During the time from the end of t<sub>2</sub> to the beginning of t<sub>3</sub>, the frequency difference must not exceed the limits specified in §90.213.

<sup>3</sup> Difference between the actual transmitter frequency and the assigned transmitter frequency.

<sup>4</sup> If the transmitter carrier output power rating is 6 watts or less, the frequency difference during this time period may exceed the maximum frequency difference for this time period.

## 6.8. Adjacent Channel Power

### 6.8.1. Test Setup (Analog)

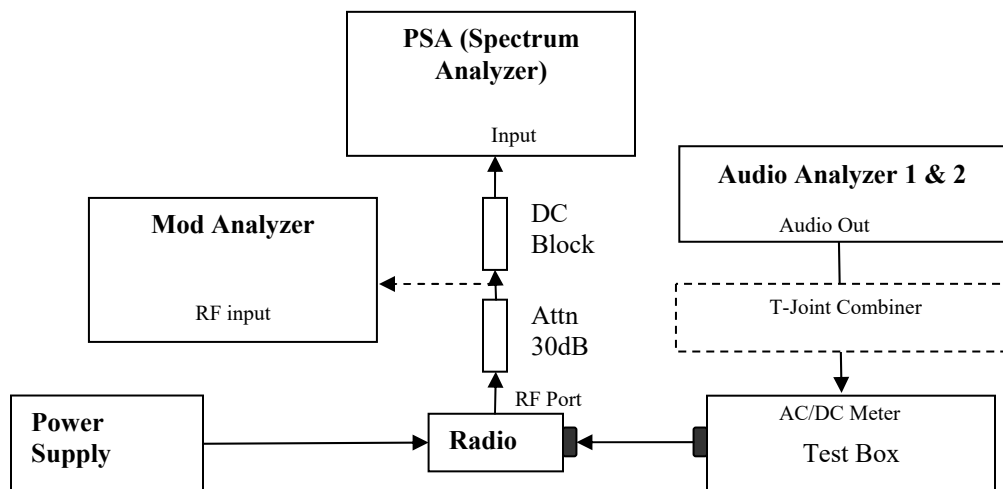

- 1) The DUT transmitter output port was connected to modulation analyzer.
- 2) Transmit the radio and turn on 1<sup>st</sup> audio analyzer with audio frequency 650Hz, 50% rated deviation, and record the amplitude value as AmpT1.
- 3) Turn off Audio analyzer 1 and turn on audio analyzer 2, set the audio frequency to 2.2 kHz and 50% deviation. Record the amplitude as AmpT2.
- 4) Turn both audio analyzers ON and up 10dB amplitude level.
- 5) Connect the output to PSA and set to assigned center frequency.
- 6) Set Span, Resolution Bandwidth and Video Bandwidth per rules part.
- 7) Transmit the radio and record the Adjacent Channel Power value in dBc.

### 6.8.2. Test Result

**Not Applicable.**

### 6.8.3. Test Setup (Digital)

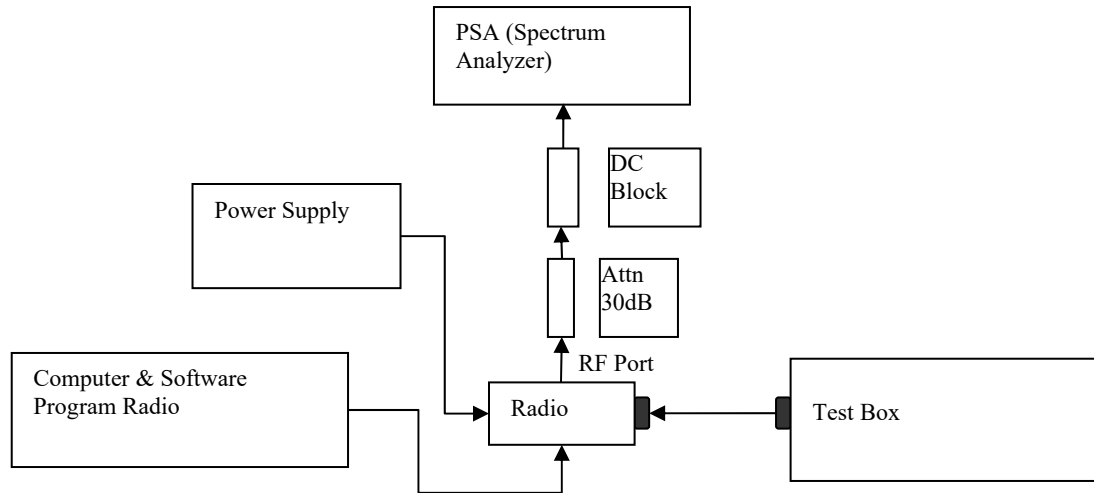

- 1) Program and set radio to operate in desire test frequency and digital mode with modulation. (4FSK, C4FM or other digital modulation form).
- 2) Prepare setup as per picture.
- 3) Turn on the ACP Measurement – Press Measure, ACP.
- 4) Set Span, Resolution Bandwidth and Video Bandwidth as per rules part.
- 5) Transmit the radio and record the Adjacent Channel Power value in dBc.

### 6.8.4. Test Result

**Not Applicable.**

### 6.8.5. Test Limit

#### 12.5 kHz MOBILE TRANSMITTER ACP REQUIREMENTS

Offset from center frequency (kHz)	Measurement bandwidth (kHz)	Maximum ACP relative (dBc)
9.375	6.25	-40
15.625	6.25	-60
21.875	6.25	-60
37.50	25.00	-60
62.50	25.00	-65
87.50	25.00	-65
150.00	100	-65
250.00	100	-65
350.00	100	-65
>400 to 12 MHz	30 (s)	-75
12 MHz to paired receive band	30 (s)	-75
In the paired receive band	30 (s)	-100

#### 25 kHz MOBILE TRANSMITTER ACP REQUIREMENTS

Offset from center frequency (kHz)	Measurement bandwidth (kHz)	Maximum ACP relative (dBc)
15.625	6.25	-40
21.875	6.25	-60
37.50	25	-60
62.50	25	-65
87.50	25	-65
150.00	100	-65
250.00	100	-65
350.00	100	-65
>400 kHz to 12 MHz	30 (s)	-75
12 MHz to paired receive band	30 (s)	-75
In the paired receive band	30 (s)	-100

**12.5 kHz BASE TRANSMITTER ACP REQUIREMENTS**

Offset from center frequency (kHz)	Measurement bandwidth (kHz)	Maximum ACP (dBc)
9.375	6.25	-40
15.625	6.25	-60
21.875	6.25	-60
37.5	25	-60
62.5	25	-65
87.5	25	-65
150	100	-65
250	100	-65
350.00	100	-65
>400 kHz to 12 MHz	30 (s)	-80
12 MHz to paired receive band	30 (s)	-80
In the paired receive band	30 (s)	-85

**25 kHz BASE TRANSMITTER ACP REQUIREMENTS**

Offset from center frequency (kHz)	Measurement bandwidth (kHz)	Maximum ACP (dBc)
15.625	6.25	-40
21.875	6.25	-60
37.5	25	-60
62.5	25	-65
87.5	25	-65
150	100	-65
250	100	-65
350	100.00	-65
>400 kHz to 12 MHz	30 (s)	-80
12 MHz to paired receive band	30 (s)	-80
In the paired receive band	30 (s)	-85

## 6.9. Conducted Spurious Emission

### 6.9.1. Test Setup

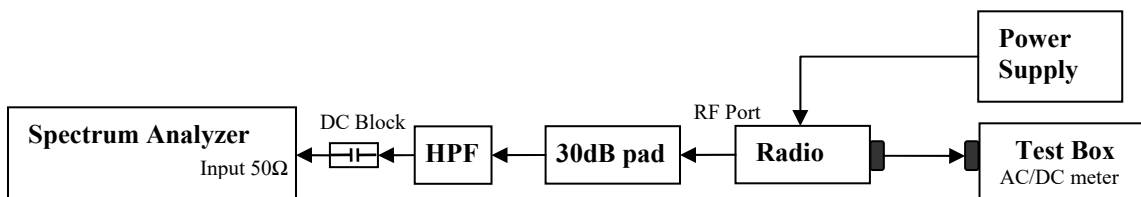

- 1) The DUT transmitter output port was connected to Spectrum Analyzer with above setup.
- 2) Program and set radio to operate in desire test frequency and mode. (Analog / digital modulation form).
- 3) Path loss for the measurement included.
- 4) Set the PSA Resolution Bandwidth as per rules part.
- 5) Set the Ref offset from the pathloss offset calibration file.
- 6) Adjust the center frequency of the spectrum analyzer for incremental coverage of the range from:
  - a. 9 KHz to  $F_c - \text{Test Bandwidth}$
  - b.  $F_c + \text{Test Bandwidth}$  to  $2F_c - 5\text{MHz}$ .
- 7) Key up the DUT, Peak Search the highest Spur and record the levels of spurious emissions
- 8) Dekey the DUT.
- 9) Turn On High Pass Filter path and Key up the DUT.
- 10) Adjust the PSA Freq for incremental coverage of range from  $2F_c$  to  $10F_c$
- 11) Key up the DUT and record the highest spur levels of spurious emissions.



### 6.9.2. Test Result (Analog)

**Analog: 138.0125 MHz, 25.kHz Channel Spacing, Max. Power**  
 Not for FCC review

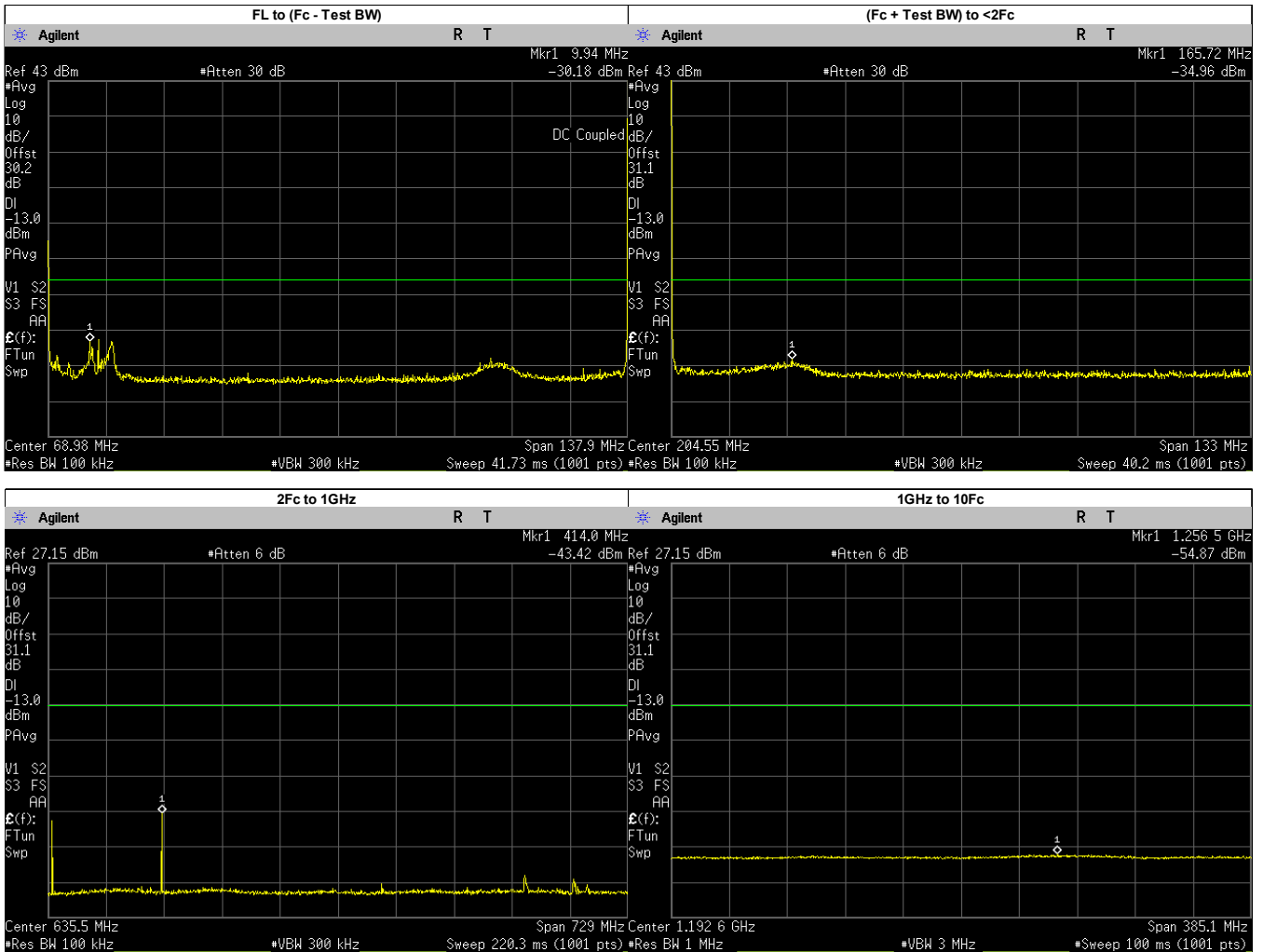

Frequency Range	Highest Spur Frequency (MHz)	Spurious Level (dBm)	Failing Limit (dBm)	Results
FL to (Fc - Test BW)	9.9400	-30.1840	-13.00	PASS
(Fc + Test BW) to <2Fc	165.7232	-34.9600	-13.00	PASS
2Fc to 1GHz	414.0000	-43.4200	-13.00	PASS
	276.0250	-48.3683	-13.00	PASS
	552.0500	-65.7954	-13.00	PASS
	690.0625	-63.6182	-13.00	PASS
	828.0750	-65.5066	-13.00	PASS
	966.0875	-65.4533	-13.00	PASS
1GHz to 10Fc	1256.4930	-54.8700	-13.00	PASS
	1104.1000	-55.7435	-13.00	PASS
	1242.1120	-55.5309	-13.00	PASS
	1380.1250	-55.6354	-13.00	PASS

**Analog: 158.55 MHz, 25.kHz Channel Spacing, Max. Power  
 For Part 22**

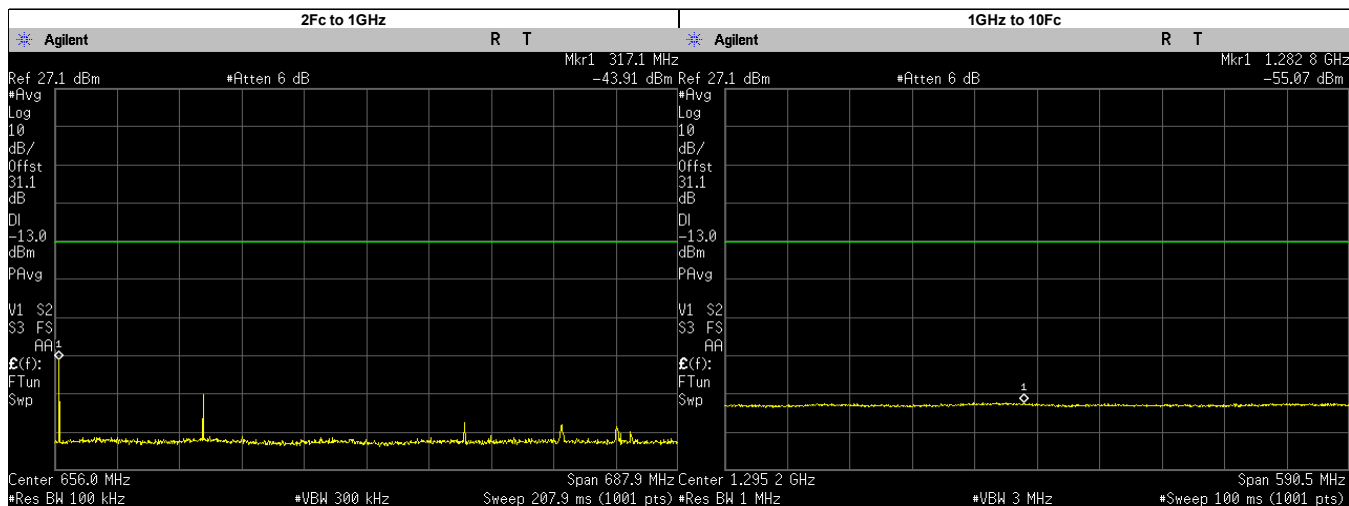
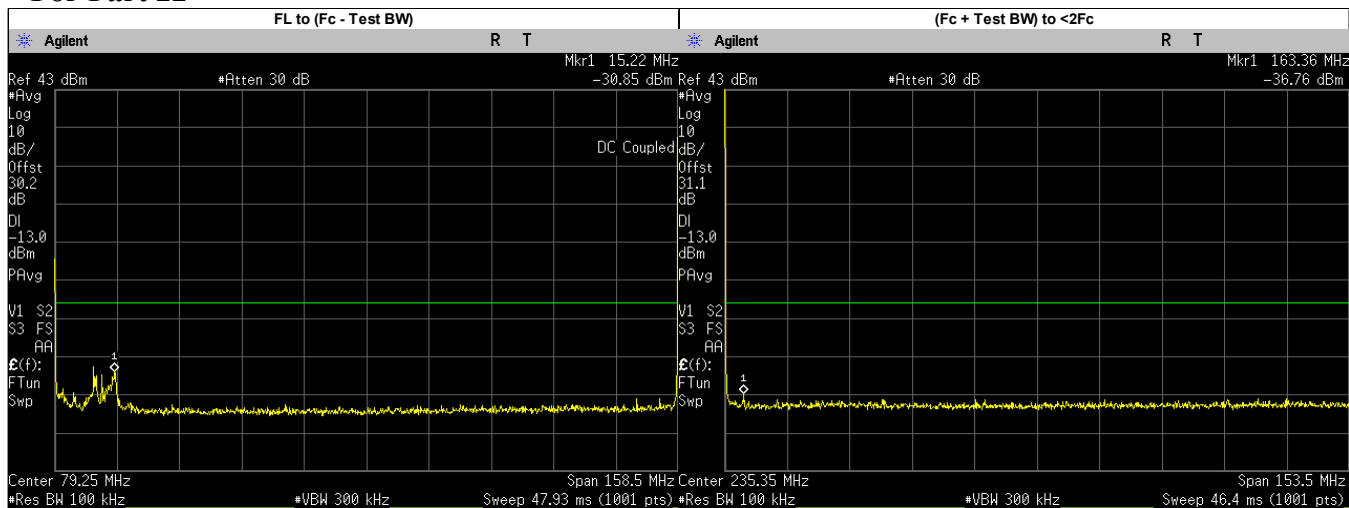

Frequency Range	Highest Spur Frequency (MHz)	Spurious Level (dBm)	Failing Limit (dBm)	Results
FL to (Fc - Test BW)	15.2200	-30.8460	-13.00	PASS
(Fc + Test BW) to <2Fc	163.3640	-36.7600	-13.00	PASS
2Fc to 1GHz	317.1000	-43.9100	-13.00	PASS
	475.6500	-56.1437	-13.00	PASS
	634.2000	-65.3894	-13.00	PASS
	792.7500	-64.2363	-13.00	PASS
	951.3000	-65.5152	-13.00	PASS
1GHz to 10Fc	1282.8500	-55.0700	-13.00	PASS
	1109.8500	-55.7214	-13.00	PASS
	1268.4000	-55.3954	-13.00	PASS
	1426.9500	-55.7018	-13.00	PASS
	1585.5000	-55.6630	-13.00	PASS

**Analog: 158.55 MHz, 25.kHz Channel Spacing, Low. Power  
 For Part 22**

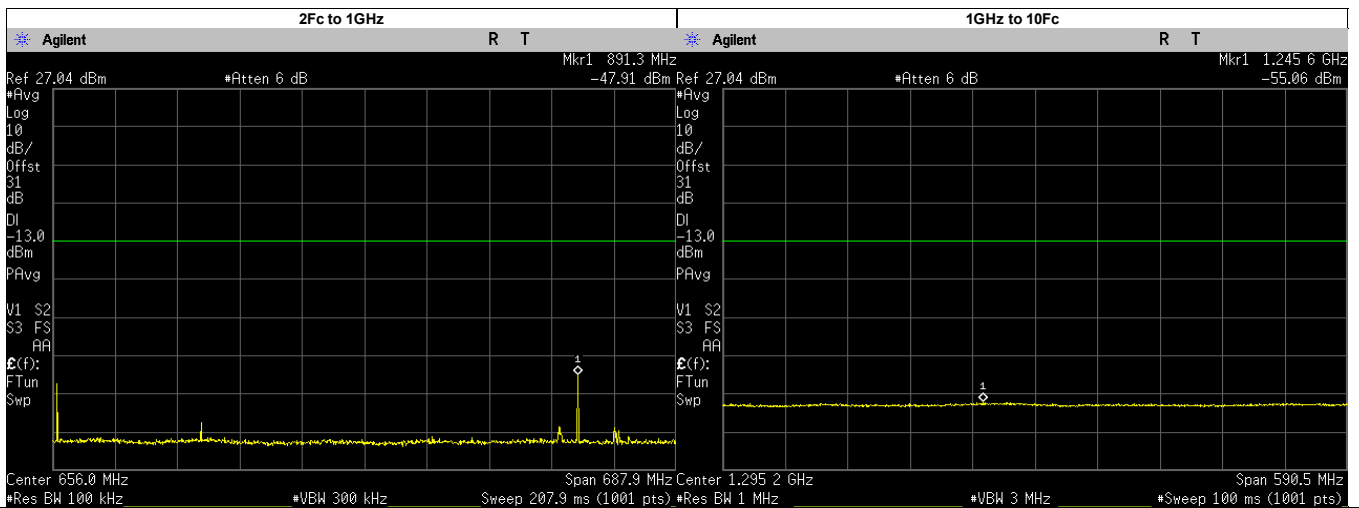
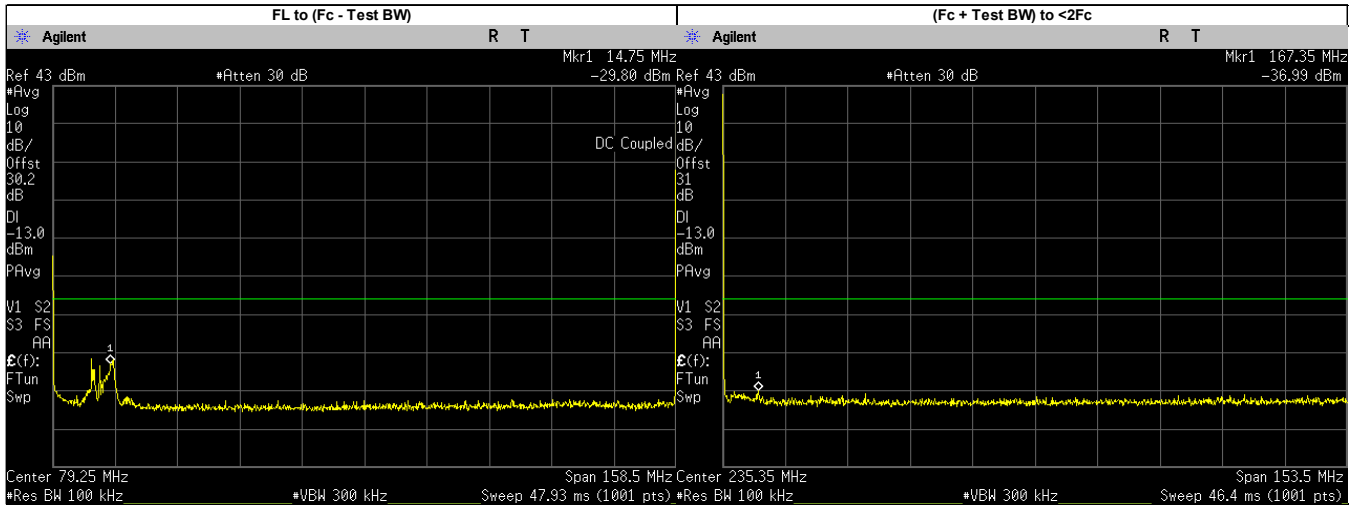

Frequency Range	Highest Spur Frequency (MHz)	Spurious Level (dBm)	Failing Limit (dBm)	Results
FL to (Fc - Test BW)	14.7500	-29.7950	-13.00	PASS
(Fc + Test BW) to <2Fc	167.3548	-36.9900	-13.00	PASS
2Fc to 1GHz	891.3118	-47.9100	-13.00	PASS
	317.1000	-54.3177	-13.00	PASS
	475.6500	-61.4566	-13.00	PASS
	634.2000	-65.7775	-13.00	PASS
	792.7500	-65.6733	-13.00	PASS
	951.3000	-65.4204	-13.00	PASS
1GHz to 10Fc	1245.6480	-55.0600	-13.00	PASS
	1109.8500	-55.6771	-13.00	PASS
	1268.4000	-55.5021	-13.00	PASS
	1426.9500	-55.9605	-13.00	PASS
	1585.5000	-55.7226	-13.00	PASS

**Analog: 161.7 MHz, 25.kHz Channel Spacing, Max. Power  
 For Part 74**

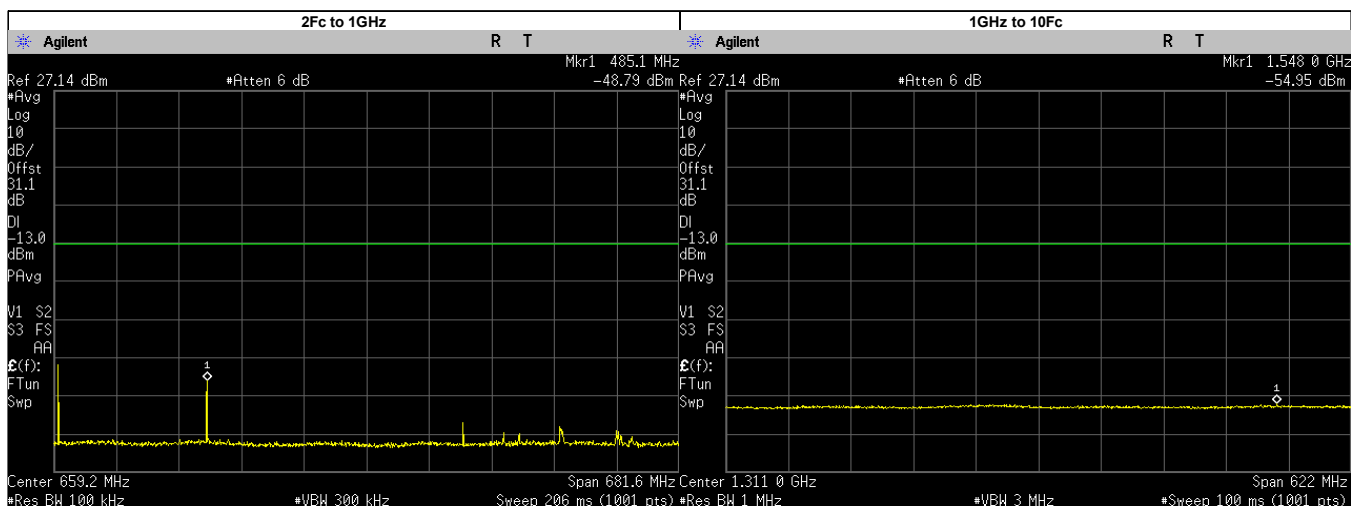
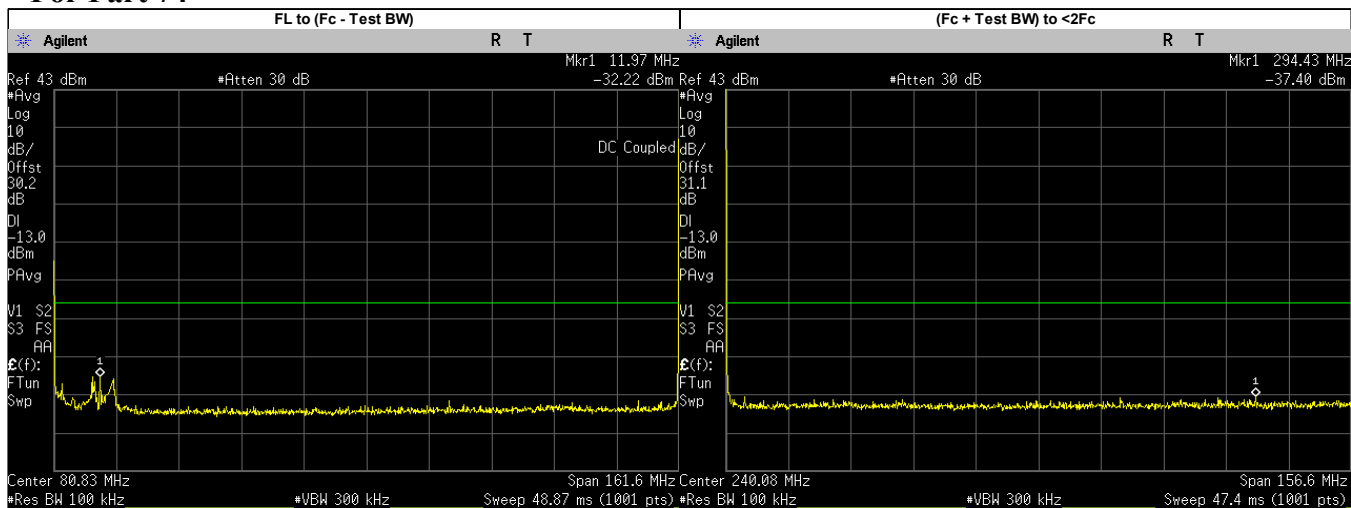

Frequency Range	Highest Spur Frequency (MHz)	Spurious Level (dBm)	Failing Limit (dBm)	Results
FL to (Fc - Test BW)	11.9700	-32.2220	-13.00	PASS
(Fc + Test BW) to <2Fc	294.4334	-37.4000	-13.00	PASS
2Fc to 1GHz	485.1000	-48.7900	-13.00	PASS
	323.4000	-51.2597	-13.00	PASS
	646.8000	-65.0957	-13.00	PASS
	808.5000	-62.4928	-13.00	PASS
	970.2000	-65.4557	-13.00	PASS
1GHz to 10Fc	1547.9820	-54.9500	-13.00	PASS
	1131.9000	-55.4593	-13.00	PASS
	1293.6000	-55.6937	-13.00	PASS
	1455.3000	-55.7831	-13.00	PASS
	1617.0000	-55.7682	-13.00	PASS

**Analog: 161.7 MHz, 25.kHz Channel Spacing, Low. Power  
 For Part 74**

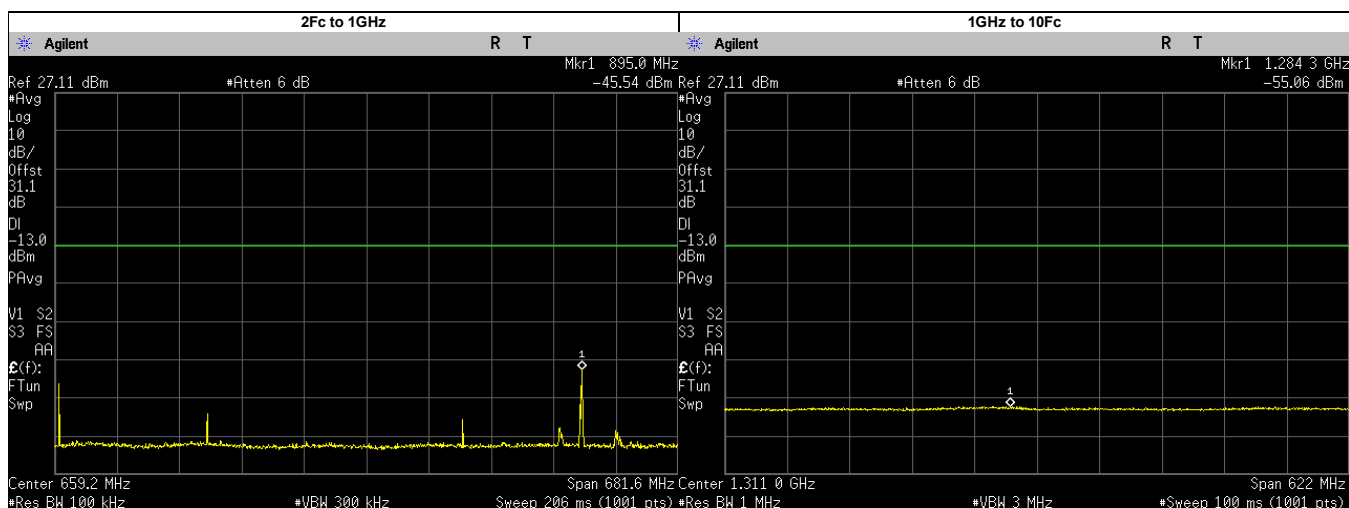
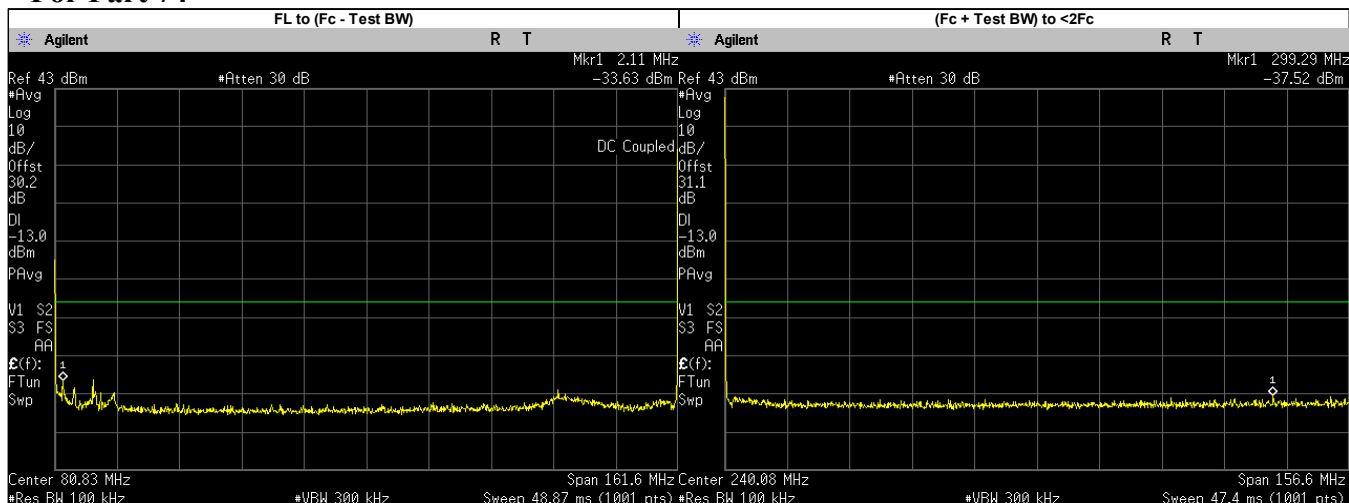

Frequency Range	Highest Spur Frequency (MHz)	Spurious Level (dBm)	Failing Limit (dBm)	Results
FL to (Fc - Test BW)	2.1100	-33.6300	-13.00	PASS
(Fc + Test BW) to <2Fc	299.2894	-37.5200	-13.00	PASS
2Fc to 1GHz	895.0336	-45.5400	-13.00	PASS
	323.4000	-54.5130	-13.00	PASS
	485.1000	-58.5975	-13.00	PASS
	646.8000	-65.7949	-13.00	PASS
	808.5000	-64.6600	-13.00	PASS
	970.2000	-65.5994	-13.00	PASS
1GHz to 10Fc	1284.2540	-55.0600	-13.00	PASS
	1131.9000	-55.7104	-13.00	PASS
	1293.6000	-55.7072	-13.00	PASS
	1455.3000	-55.8643	-13.00	PASS
	1617.0000	-55.7647	-13.00	PASS

**Analog: 173.9875 MHz, 25.kHz Channel Spacing, Max. Power**  
 Not for FCC review

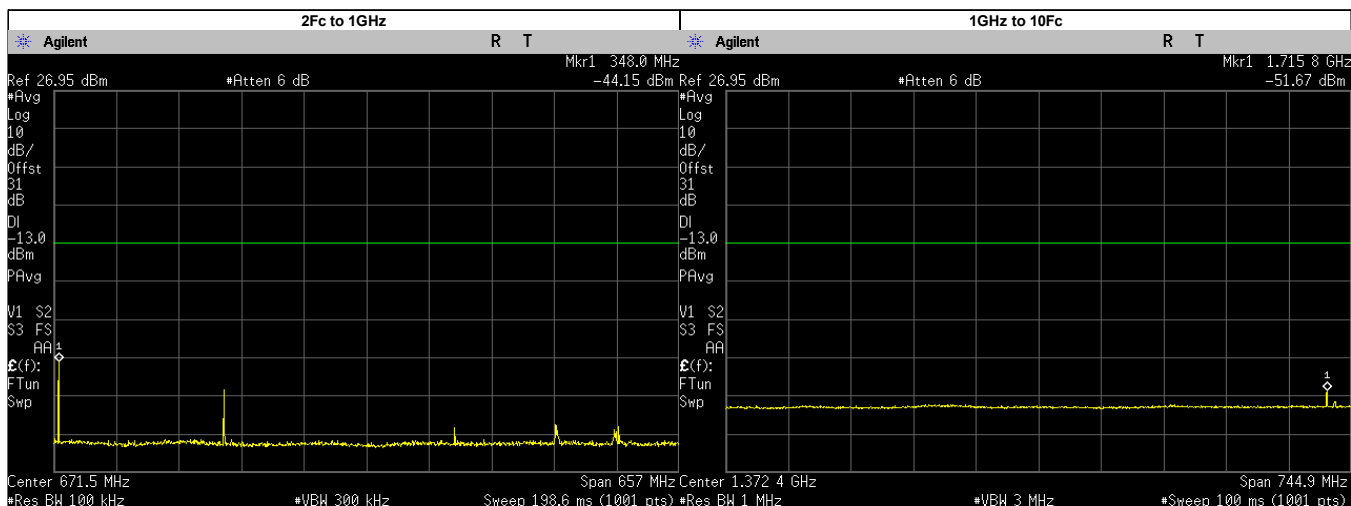
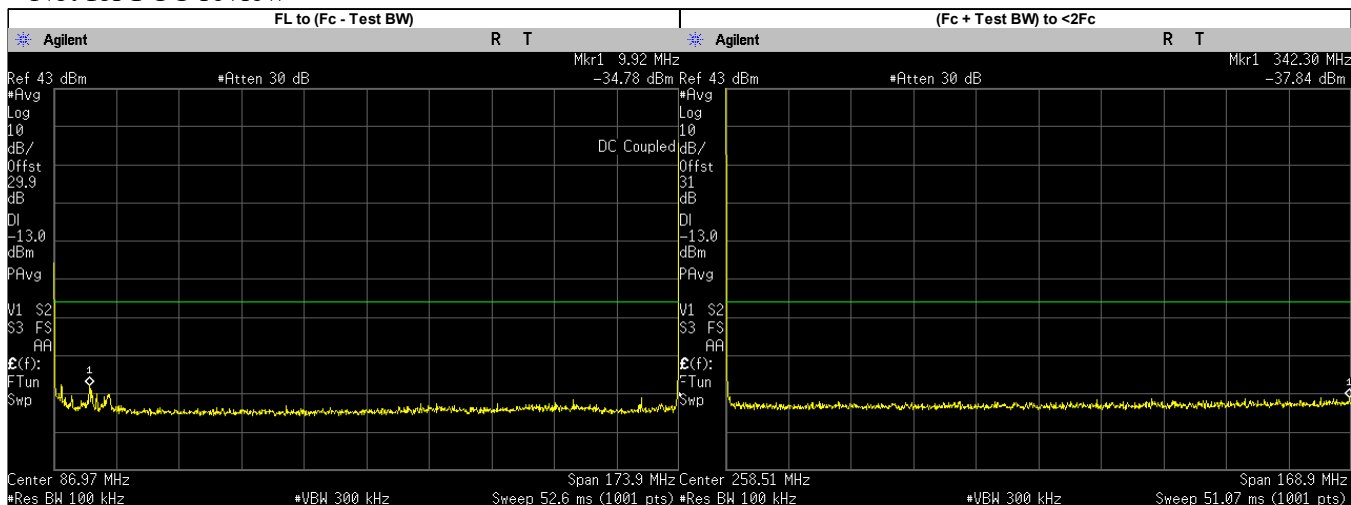

Frequency Range	Highest Spur Frequency (MHz)	Spurious Level (dBm)	Failing Limit (dBm)	Results
FL to (Fc - Test BW)	9.9200	-34.7810	-13.00	PASS
(Fc + Test BW) to <2Fc	342.2993	-37.8400	-13.00	PASS
2Fc to 1GHz	348.0000	-44.1500	-13.00	PASS
	347.9750	-47.9020	-13.00	PASS
	521.9625	-55.7661	-13.00	PASS
	695.9500	-65.9425	-13.00	PASS
	869.9375	-60.6493	-13.00	PASS
1GHz to 10Fc	1715.8250	-51.6700	-13.00	PASS
	1043.9250	-56.2150	-13.00	PASS
	1217.9120	-55.7652	-13.00	PASS
	1391.9000	-55.9985	-13.00	PASS
	1565.8880	-55.6019	-13.00	PASS
	1739.8750	-55.7775	-13.00	PASS

### 6.9.3. Test Result (Digital)

**Digital: 138.0125. MHz, 12.5 kHz Channel Spacing, Max. Power**  
 Not for FCC review

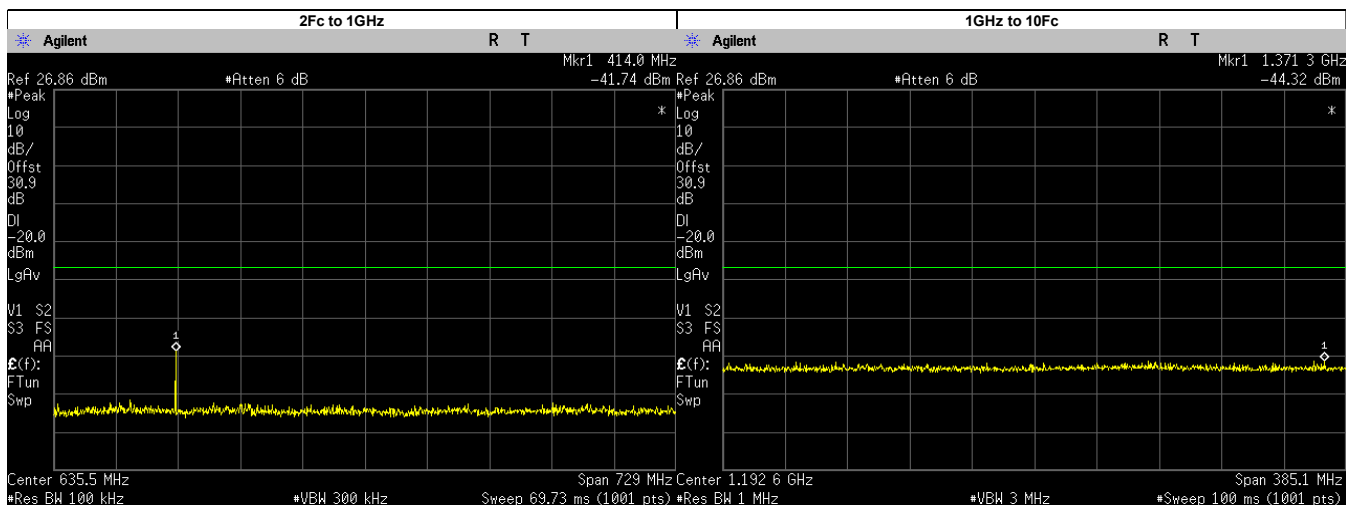
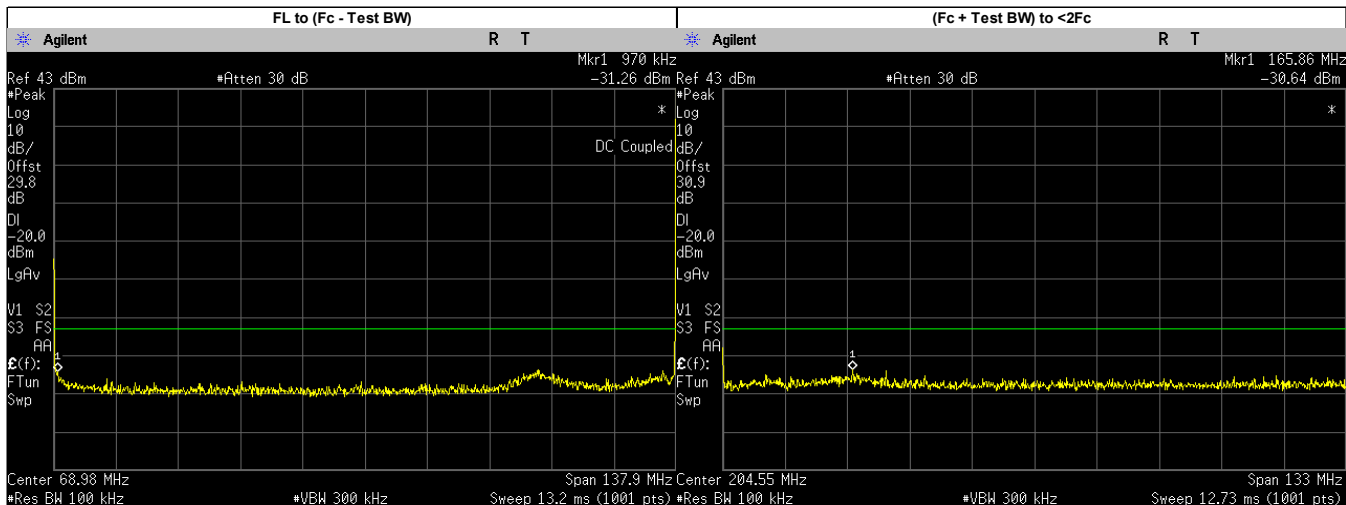

Frequency Range	Highest Spur Frequency (MHz)	Spurious Level (dBm)	Failing Limit (dBm)	Results
FL to (Fc - Test BW)	0.9700	-31.2640	-20.00	PASS
(Fc + Test BW) to <2Fc	165.8561	-30.6400	-20.00	PASS
2Fc to 1GHz	414.0000	-41.7400	-20.00	PASS
	276.0250	-55.9709	-20.00	PASS
	552.0500	-57.8016	-20.00	PASS
	690.0625	-57.1895	-20.00	PASS
	828.0750	-57.5928	-20.00	PASS
	966.0875	-57.8069	-20.00	PASS
1GHz to 10Fc	1371.2610	-44.3200	-20.00	PASS
	1104.1000	-46.4228	-20.00	PASS
	1242.1120	-45.8747	-20.00	PASS
	1380.1250	-46.2092	-20.00	PASS

### Digital: 158.55. MHz, 12.5 kHz Channel Spacing, Max. Power

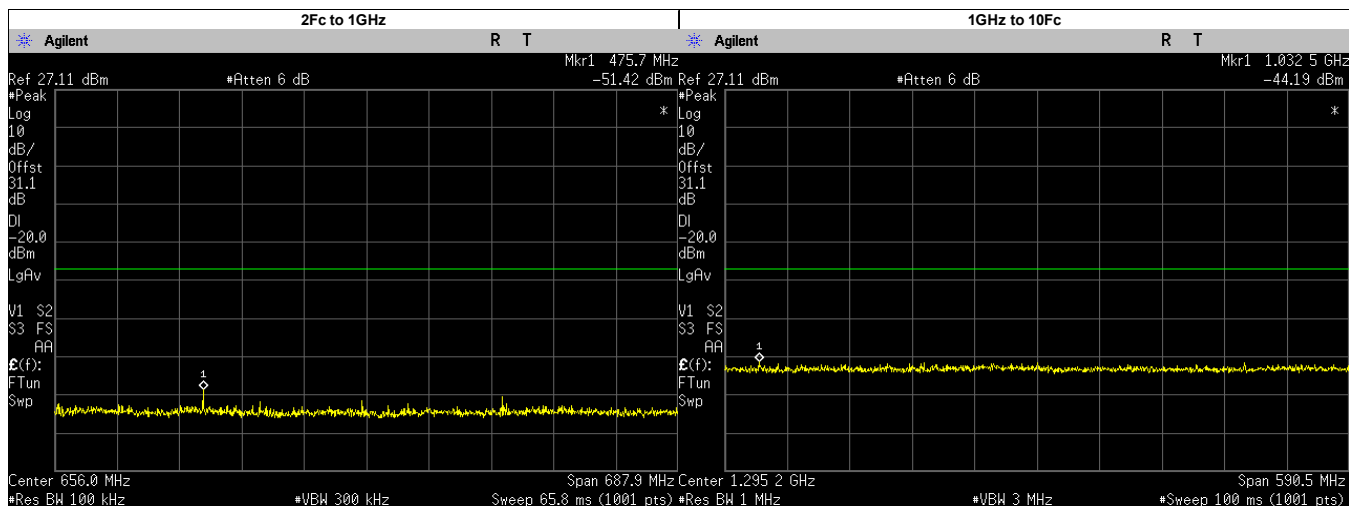
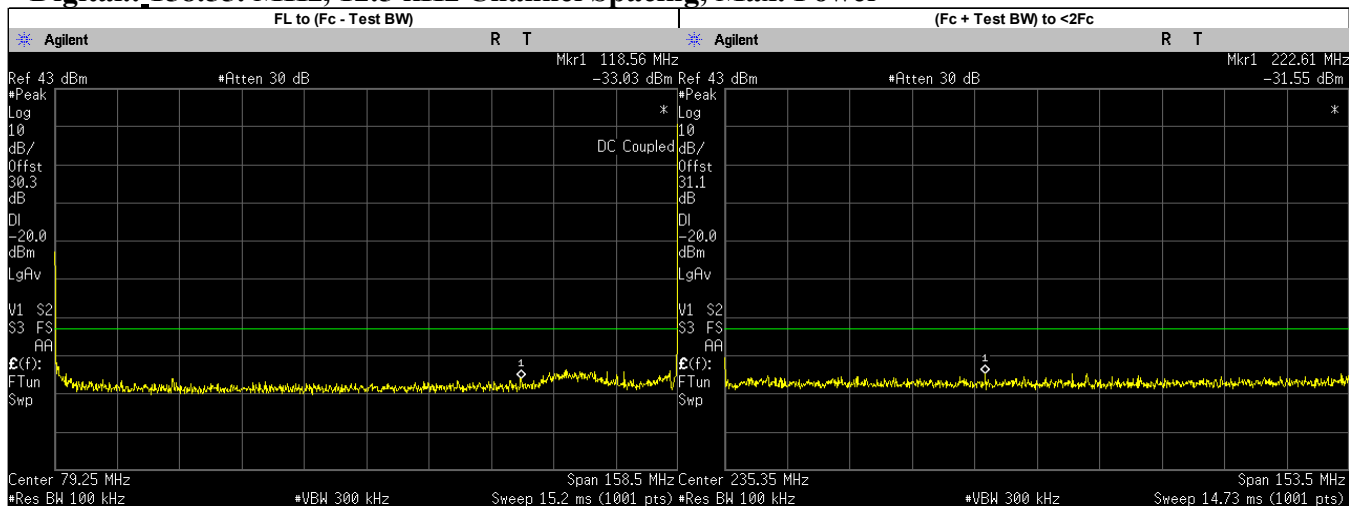

Frequency Range	Highest Spur Frequency (MHz)	Spurious Level (dBm)	Failing Limit (dBm)	Results
FL to (Fc - Test BW)	118.5600	-33.0310	-20.00	PASS
(Fc + Test BW) to <2Fc	222.6128	-31.5500	-20.00	PASS
2Fc to 1GHz	475.7000	-51.4200	-20.00	PASS
	317.1000	-55.6902	-20.00	PASS
	634.2000	-57.5043	-20.00	PASS
	792.7500	-57.0944	-20.00	PASS
	951.3000	-57.5678	-20.00	PASS
1GHz to 10Fc	1032.4770	-44.1900	-20.00	PASS
	1109.8500	-46.0804	-20.00	PASS
	1268.4000	-45.7273	-20.00	PASS
	1426.9500	-46.1683	-20.00	PASS
	1585.5000	-46.0690	-20.00	PASS



**Digital: 158.55. MHz, 12.5 kHz Channel Spacing, Low. Power**

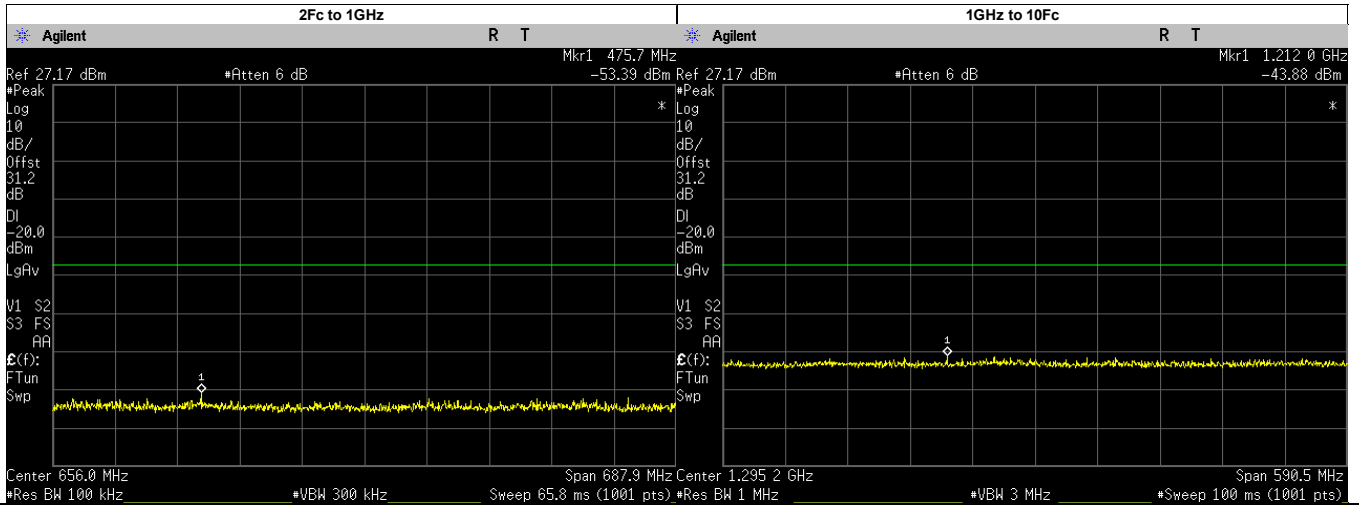
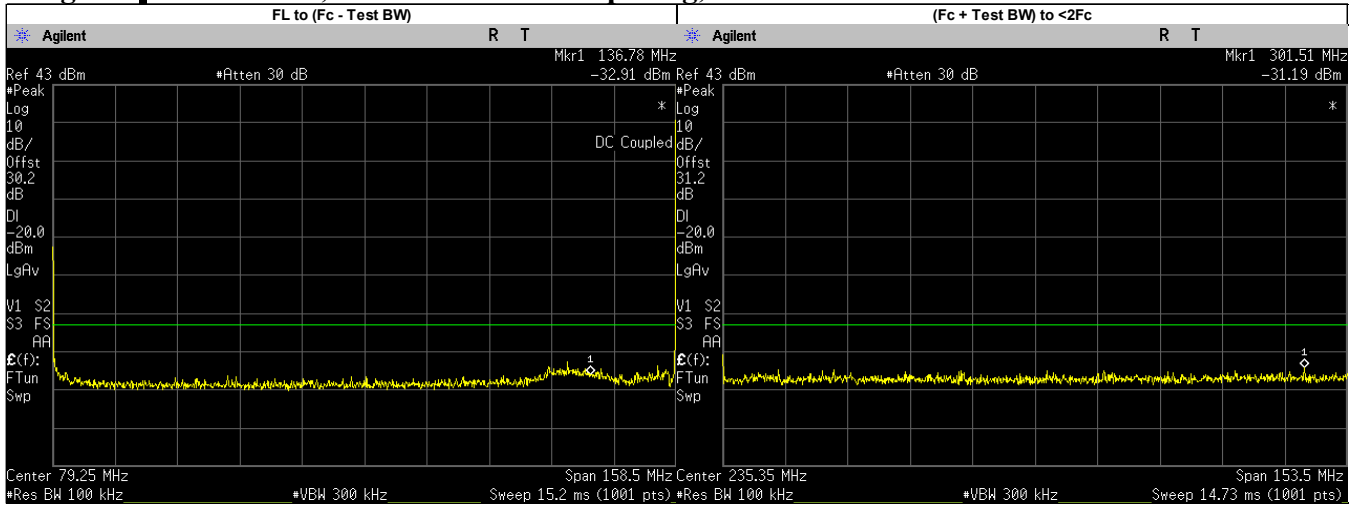

Frequency Range	Highest Spur Frequency (MHz)	Spurious Level (dBm)	Failing Limit (dBm)	Results
FL to (Fc - Test BW)	136.7800	-32.9140	-20.00	PASS
(Fc + Test BW) to <2Fc	301.5089	-31.1900	-20.00	PASS
2Fc to 1GHz	475.7000	-53.3900	-20.00	PASS
	317.1000	-56.4753	-20.00	PASS
	634.2000	-57.2774	-20.00	PASS
	792.7500	-56.9798	-20.00	PASS
	951.3000	-57.8028	-20.00	PASS
1GHz to 10Fc	1211.9890	-43.8800	-20.00	PASS
	1109.8500	-46.1064	-20.00	PASS
	1268.4000	-46.1701	-20.00	PASS
	1426.9500	-45.1297	-20.00	PASS
	1585.5000	-45.9289	-20.00	PASS

### Digital: 161.7. MHz, 12.5 kHz Channel Spacing, Max. Power

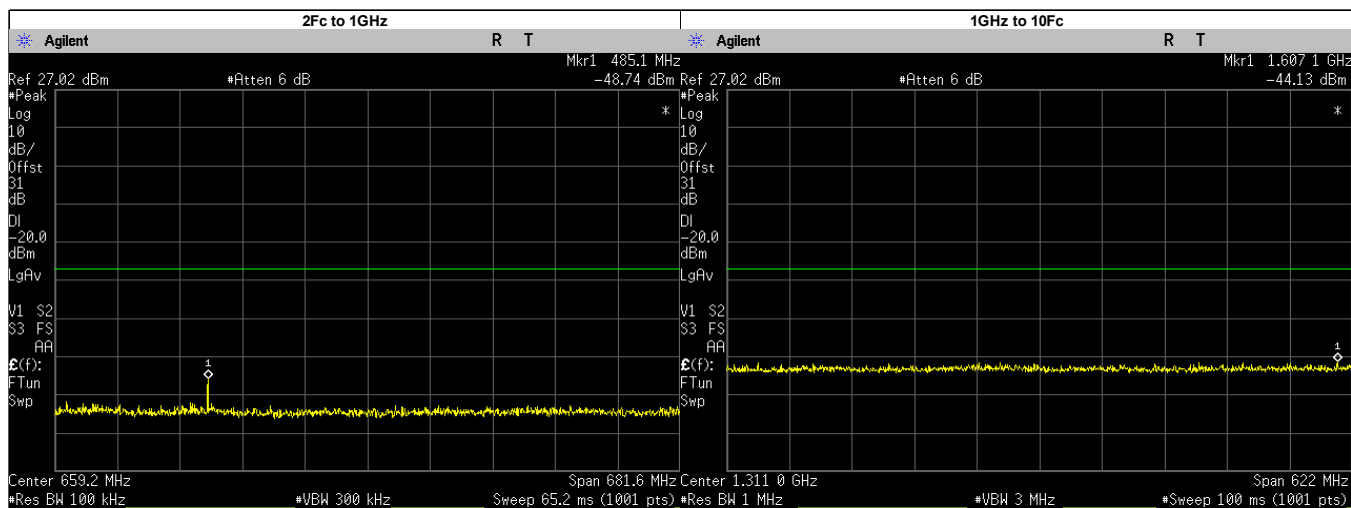
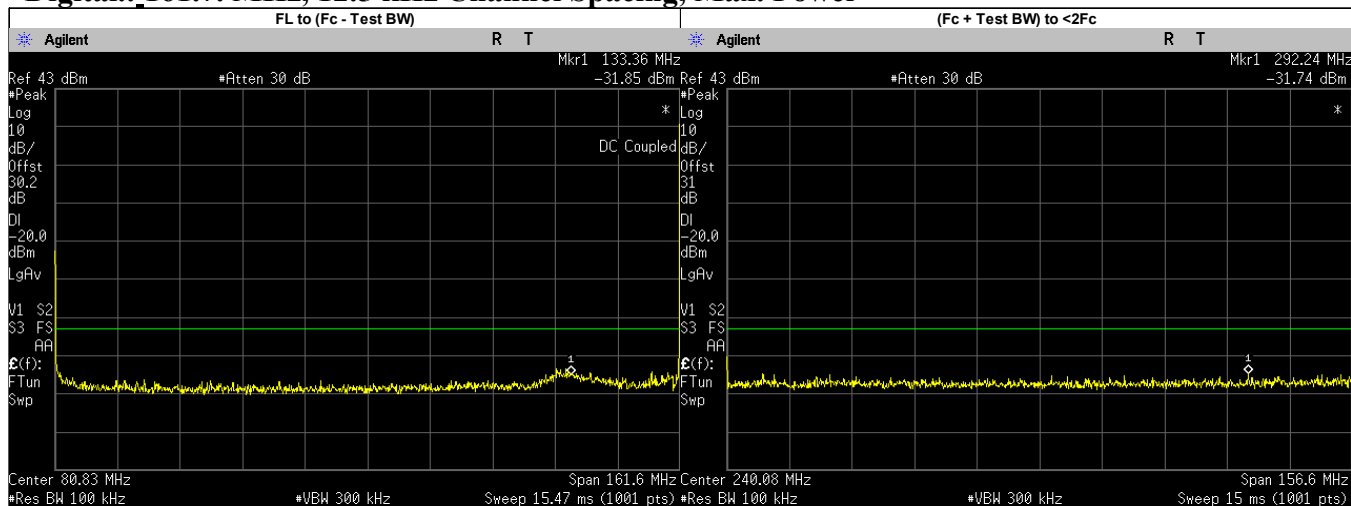

Frequency Range	Highest Spur Frequency (MHz)	Spurious Level (dBm)	Failing Limit (dBm)	Results
FL to (Fc - Test BW)	133.3600	-31.8550	-20.00	PASS
(Fc + Test BW) to <2Fc	292.2404	-31.7400	-20.00	PASS
2Fc to 1GHz	485.1000	-48.7400	-20.00	PASS
	323.4000	-57.0394	-20.00	PASS
	646.8000	-57.0049	-20.00	PASS
	808.5000	-57.2133	-20.00	PASS
	970.2000	-57.2335	-20.00	PASS
1GHz to 10Fc	1607.0720	-44.1300	-20.00	PASS
	1131.9000	-46.7718	-20.00	PASS
	1293.6000	-46.5185	-20.00	PASS
	1455.3000	-46.4549	-20.00	PASS
	1617.0000	-46.1223	-20.00	PASS

**Digital: 161.7. MHz, 12.5 kHz Channel Spacing, Low. Power**

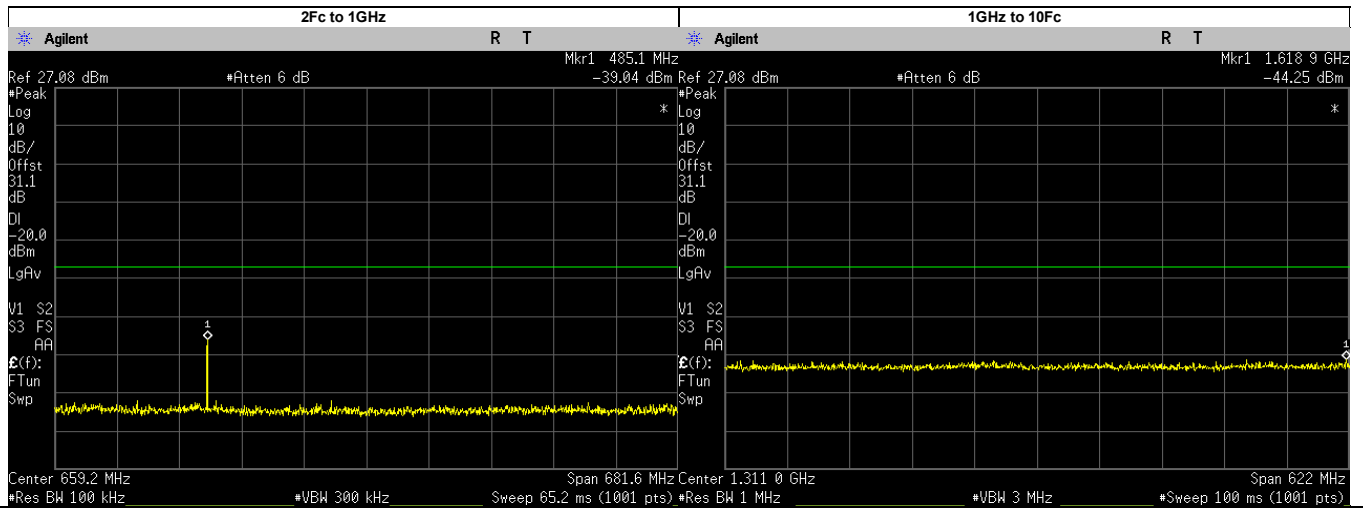
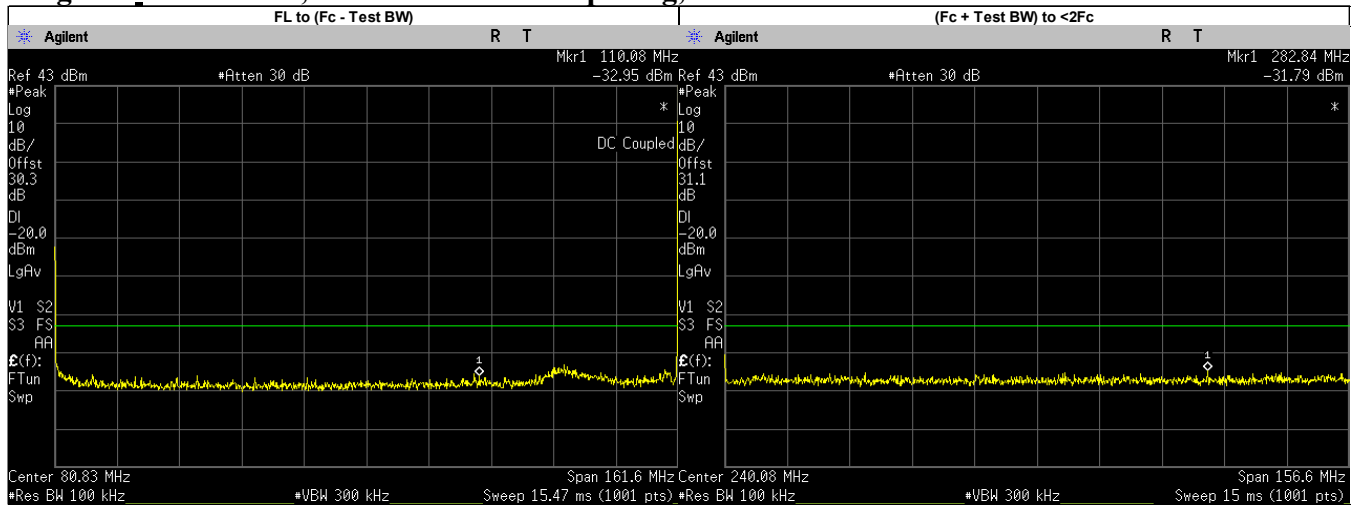

Frequency Range	Highest Spur Frequency (MHz)	Spurious Level (dBm)	Failing Limit (dBm)	Results
FL to (Fc - Test BW)	110.0800	-32.9530	-20.00	PASS
(Fc + Test BW) to <2Fc	282.8417	-31.7900	-20.00	PASS
2Fc to 1GHz	485.1000	-39.0400	-20.00	PASS
	323.4000	-56.8889	-20.00	PASS
	646.8000	-57.5468	-20.00	PASS
	808.5000	-57.7269	-20.00	PASS
	970.2000	-56.7738	-20.00	PASS
1GHz to 10Fc	1618.8900	-44.2500	-20.00	PASS
	1131.9000	-46.0336	-20.00	PASS
	1293.6000	-45.8695	-20.00	PASS
	1455.3000	-46.3526	-20.00	PASS
	1617.0000	-45.5252	-20.00	PASS

**Digital: 173.3875. MHz, 12.5 kHz Channel Spacing, Max. Power**

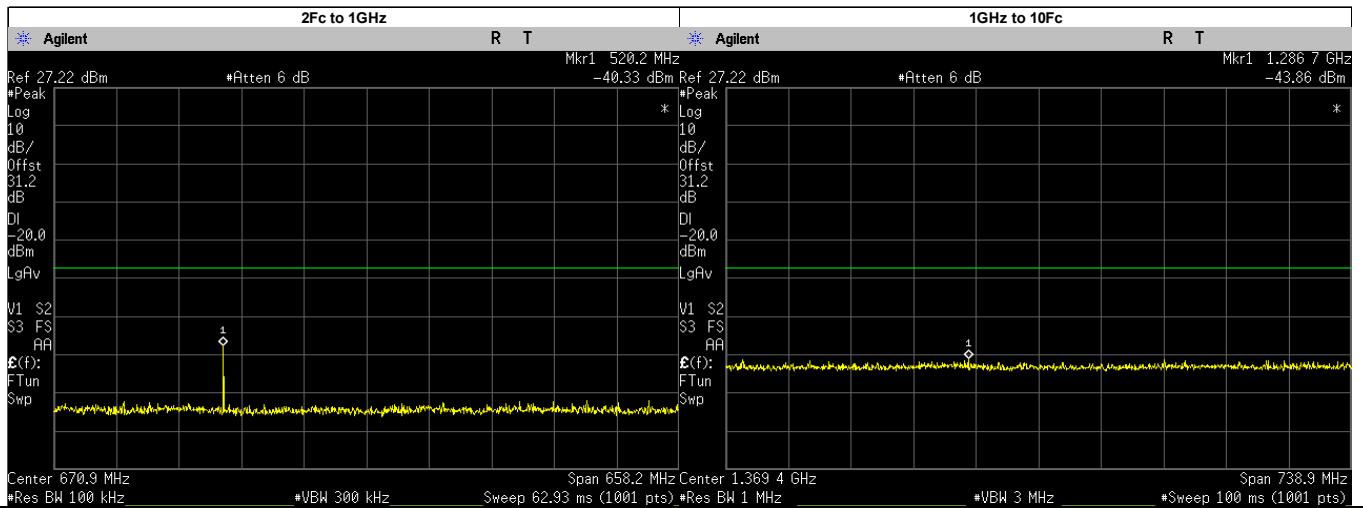
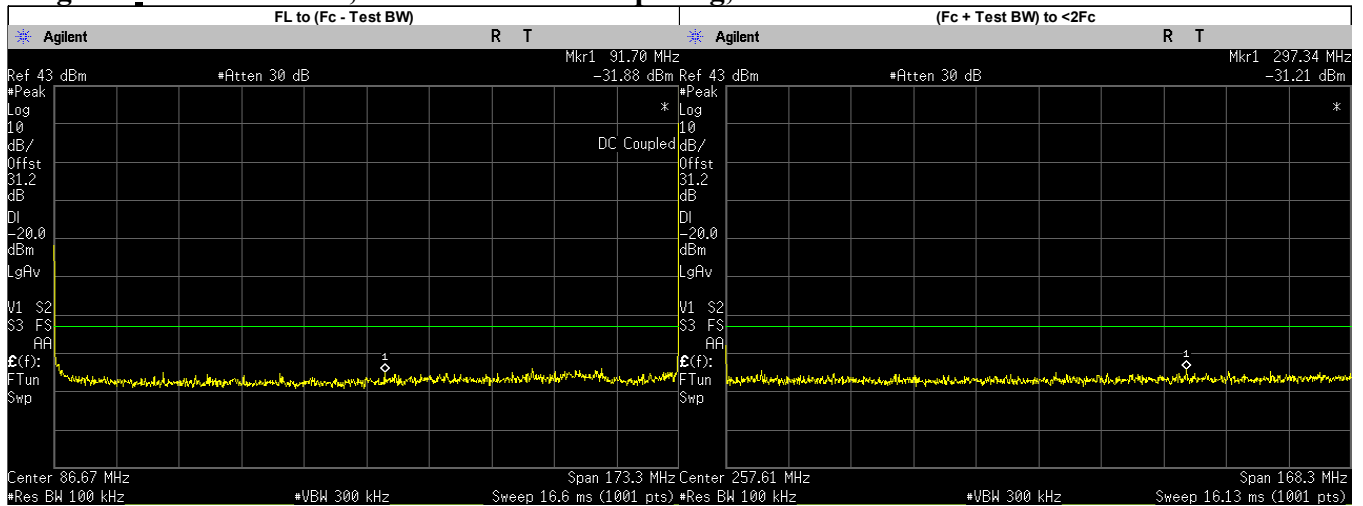

Frequency Range	Highest Spur Frequency (MHz)	Spurious Level (dBm)	Failing Limit (dBm)	Results
FL to (Fc - Test BW)	91.7000	-31.8760	-20.00	PASS
(Fc + Test BW) to <2Fc	297.3354	-31.2100	-20.00	PASS
2Fc to 1GHz	520.2000	-40.3300	-20.00	PASS
	346.7750	-56.5345	-20.00	PASS
	693.5500	-57.1935	-20.00	PASS
	866.9375	-55.4168	-20.00	PASS
1GHz to 10Fc	1286.6840	-43.8600	-20.00	PASS
	1040.3250	-46.1613	-20.00	PASS
	1213.7130	-46.0501	-20.00	PASS
	1387.1000	-45.1506	-20.00	PASS
	1560.4870	-46.0755	-20.00	PASS
	1733.8750	-45.0081	-20.00	PASS

### 6.9.4. Test Limit

Table below summarized the power of any emission outside a licensee’s frequency block shall be attenuated below the transmitter power (P) by at least

Channel Spacing	Part 22	Part 24D	Part 74	Part 80	Part 90 (UHF, VHF, 800, 900)	Part 90 (700)
12.5kHz	43 + log <sub>10</sub> (P) (-13 dBm)	43 + log <sub>10</sub> (P) (-13 dBm)	43 + log <sub>10</sub> (P) (-13 dBm)	Not Applicable	50 + log <sub>10</sub> (P) (-20 dBm)	43 + log <sub>10</sub> (P) (-13 dBm)
25kHz		Not Applicable		43 + log <sub>10</sub> (P) (-13 dBm)	43 + log <sub>10</sub> (P) (-13 dBm)	43 + log <sub>10</sub> (P) (-13 dBm)

Channel Spacing	RSS 134	RSS 182	RSS 119 (UHF, VHF, 800, 900)	RSS 119 (700)
12.5kHz	43 + log <sub>10</sub> (P) (-13 dBm)	Not Applicable	50 + log <sub>10</sub> (P) (-20 dBm)	43 + log <sub>10</sub> (P) (-13 dBm)
25kHz	Not Applicable	43 + log <sub>10</sub> (P) (-13 dBm)	43 + log <sub>10</sub> (P) (-13 dBm)	43 + log <sub>10</sub> (P) (-13 dBm)

## 6.10. Radiated Spurious Emission

### 6.10.1. Test Setup

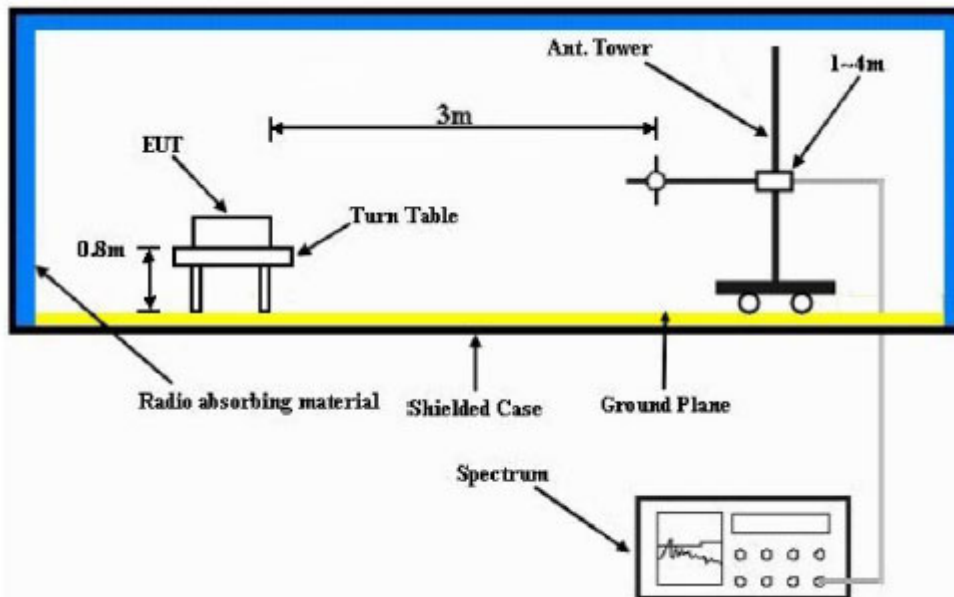

- 1) The Resolution Bandwidth for scanning Radiated Emission below 1 GHz is 100 kHz with Video Bandwidth = 300 kHz and Resolution Bandwidth for above 1 GHz is 1 MHz with Video Bandwidth = 3 MHz. Detector mode is positive peak.
- 2) In the semi- anechoic chamber, setup as illustrated above the DUT placed on the 0.8m height (for  $F_c < 1\text{GHz}$ ) or 1.5m height (for  $F_c > 1\text{GHz}$ ) of Turn Table, rotated the table around 360 degrees to search the maximum radiation power and receiver antenna shall be rotated vertical and horizontal polarization and moved height from 1m to 4m to find the maximum polar radiated power. The “Read Value” is the spectrum reading the maximum power value.
- 3) The substitution antenna is substituted for DUT at the same position and signals generator (S.G) export the CW signal to the substitution antenna via a TX cable. The receiver antenna shall be rotated vertical and horizontal polarization and moved height from 1m to 4m to find the maximum radiation power. Record the power level of maximum radiation power from spectrum. So, the measured substitution value = Ref level of S.G + TX cables loss – Substituted Antenna Gain.
- 4) Final Radiated Spurious Emission = “Read Value” + Measured substitution value.

### 6.10.2. Test Result (Analog)

**Model Number: AAM02JQH9JA1AN**      **SAC Transmitter Radiated Emission:**      **SR:32947-EMC-00006**  
**Battery Part No: NA**      **S/N: 776TYH0079**      **Accy Part No: PMMN4090A-CF3, HKN4191B-C2**  
**Test Mode: TX Analog**      **25 kHz**      **54.000 Watt(s) /Max Power**  
**138.012500 MHz (Not for FCC review)**

Frequency (MHz)	Limit	Horizontal Measured Emission Equip Pwr Into Ideal Dipole (dBm)	Vertical Measured Emission Equip Pwr Into ideal Dipole (dBm)
276.0250	-13.0000	-84.3343 **	-84.3469 **
414.0375	-13.0000	-81.2396 **	-80.5764 **
552.0500	-13.0000	-76.0604 **	-77.1461 **
690.0625	-13.0000	-77.1776 **	-77.2454 **
828.0750	-13.0000	-75.4418 **	-75.7753 **
966.0875	-13.0000	-74.6525 **	-75.0640 **
1104.1000	-13.0000	-61.1232 **	-61.5460 **
1242.1125	-13.0000	-60.6470 **	-60.5368 **
1380.1250	-13.0000	-59.6105 **	-59.6197 **

**RADIATED SPURIOUS EMISSIONS**

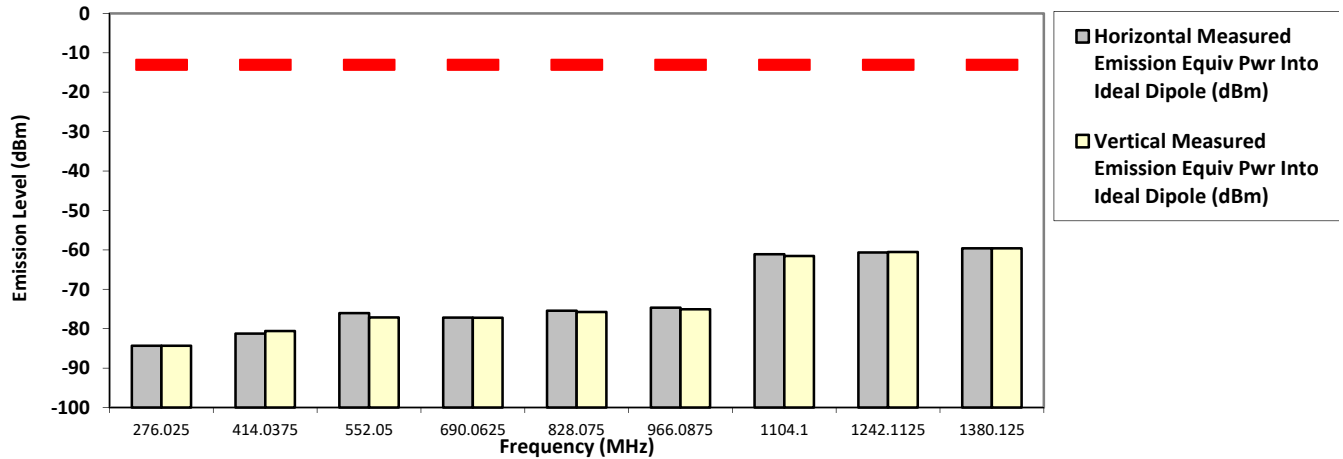

The data presented here was taken using the substitution method as found in the ANSI C63.26-2015 document.  
 Motorola Penang EMC Lab - Test Performed by: Qawiman&Nazrin      Sat, 21 May, 2022

Remarks: \*\* Indicates the spurious emission could not be detected due to noise limitations or ambient.  
 \*Pursuant to CFR 47 Part 2.1057 ( c ), emissions attenuated more than 20 dB below the permissible limit are not reported  
 Temp(Deg): 23.8 Hum(%RH): 70.1

Remarks: Passed Results Marginal Results Failed Results

**Model Number: AAM02JQH9JA1AN**      **SAC Transmitter Radiated Emission:**      **S/N: 776TYH0079**      **SR:32947-EMC-00006**  
**Battery Part No: NA**      **Accy Part No: PMMN4090A-CF3, HKN4191B-C2**  
**158.550000 MHz (For Part 22)**      **Test Mode: TX Analog**      **25 kHz**      **54.000 Watt(s) /Max Power**

Frequency (MHz)	Limit	Horizontal Measured Emission Equip Pwr Into Ideal Dipole (dBm)	Vertical Measured Emission Equip Pwr Into ideal Dipole (dBm)
317.1000	-13.0000	-83.0978 **	-83.7582 **
475.6500	-13.0000	-79.8838 **	-79.8895 **
634.2000	-13.0000	-77.7827 **	-77.4091 **
792.7500	-13.0000	-75.8282 **	-76.1981 **
951.3000	-13.0000	-74.3547 **	-74.5923 **
1109.8500	-13.0000	-61.1256 **	-61.0427 **
1268.4000	-13.0000	-60.3976 **	-60.8024 **
1426.9500	-13.0000	-59.9904 **	-58.5127 **
1585.5000	-13.0000	-59.6679 **	-59.0795 **

**RADIATED SPURIOUS EMISSIONS**

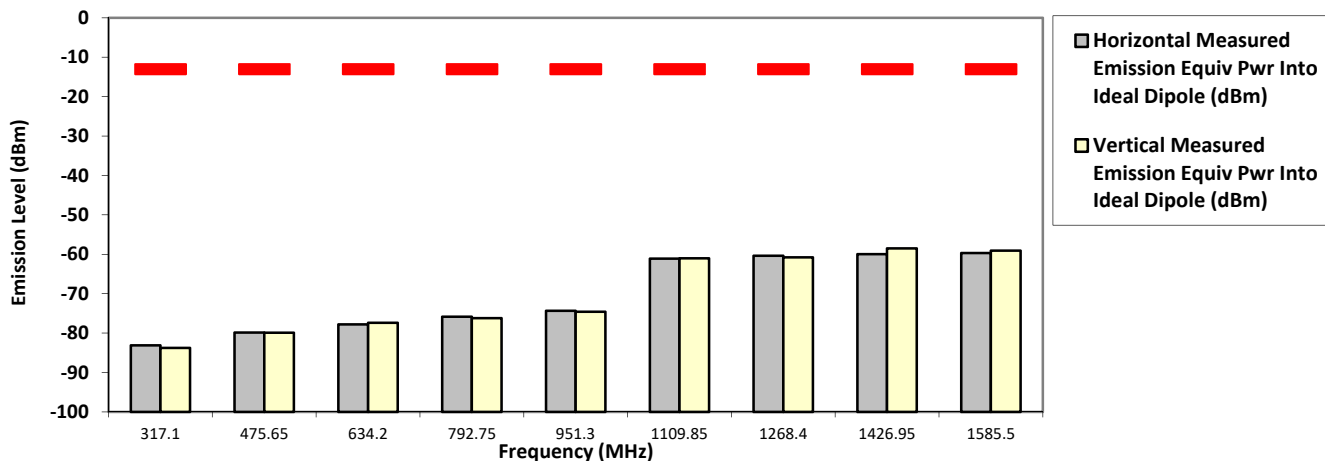

The data presented here was taken using the substitution method as found in the ANSI C63.26-2015 document.  
 Motorola Penang EMC Lab - Test Performed by: Qawiman&Nazrin      Sat, 21 May, 2022

Remarks: \*\* Indicates the spurious emission could not be detected due to noise limitations or ambient.  
 \*Pursuant to CFR 47 Part 2.1057 ( c ), emissions attenuated more than 20 dB below the permissible limit are not reported  
 Temp(Deg): 23.8 Hum(%RH): 70.1

Remarks: Passed Results Marginal Results Failed Results



**Model Number: AAM02JQH9JA1AN**      **SAC Transmitter Radiated Emission:**      **S/N: 776TYH0079**      **SR:32947-EMC-00006**  
**Battery Part No: NA**      **Accy Part No: PMMN4090A-CF3, HKN4191B-C2**  
**158.550000 MHz (For Part 22)**      **Test Mode: TX Analog**      **25 kHz**      **25.000 Watt(s) /Low Power**

Frequency (MHz)	Limit	Horizontal Measured Emission Equiv Pwr Into Ideal Dipole (dBm)	Vertical Measured Emission Equiv Pwr Into ideal Dipole (dBm)
317.1000	-13.0000	-83.8827 **	-83.8696 **
475.6500	-13.0000	-80.1805 **	-78.0837 **
634.2000	-13.0000	-78.6761 **	-77.9205 **
792.7500	-13.0000	-74.9034 **	-75.8987 **
951.3000	-13.0000	-75.1937 **	-74.5534 **
1109.8500	-13.0000	-61.1604 **	-60.2906 **
1268.4000	-13.0000	-60.2796 **	-59.8007 **
1426.9500	-13.0000	-59.7321 **	-60.1273 **
1585.5000	-13.0000	-58.5935 **	-59.5697 **

**RADIATED SPURIOUS EMISSIONS**

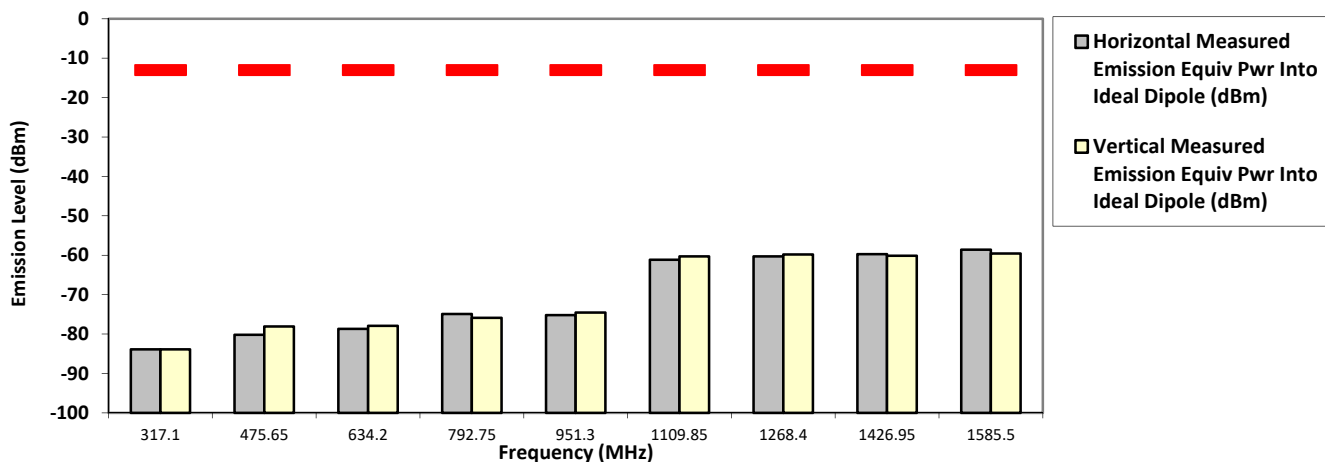

The data presented here was taken using the substitution method as found in the ANSI C63.26-2015 document.  
 Motorola Penang EMC Lab - Test Performed by: Qawiman&Nazrin      Sat, 21 May, 2022

Remarks: \*\* Indicates the spurious emission could not be detected due to noise limitations or ambient.  
 \*Pursuant to CFR 47 Part 2.1057 ( c ), emissions attenuated more than 20 dB below the permissible limit are not reported  
 Temp(Deg): 23.8 Hum(%RH): 70.1

Remarks: Passed Results Marginal Results Failed Results

Model Number: AAM02JQH9JA1AN  
 Battery Part No: NA

SAC Transmitter Radiated Emission:

S/N: 776TYH0079

SR:32947-EMC-00006

Accy Part No: PMMN4090A-CF3, HKN4191B-C2

Test Mode: TX Analog

161.700000 MHz (For Part 74)

25 kHz

54.000 Watt(s) /Max Power

Frequency (MHz)	Limit	Horizontal Measured Emission Equip Pwr Into Ideal Dipole (dBm)	Vertical Measured Emission Equip Pwr Into ideal Dipole (dBm)
323.4000	-13.0000	-81.6776 **	-84.0009 **
485.1000	-13.0000	-78.7858 **	-79.9241 **
646.8000	-13.0000	-77.7894 **	-78.2868 **
808.5000	-13.0000	-76.1149 **	-76.1955 **
970.2000	-13.0000	-74.5566 **	-74.4544 **
1131.9000	-13.0000	-61.7548 **	-60.6134 **
1293.6000	-13.0000	-60.1263 **	-60.1483 **
1455.3000	-13.0000	-59.5872 **	-59.6377 **
1617.0000	-13.0000	-58.4568 **	-59.0407 **

**RADIATED SPURIOUS EMISSIONS**

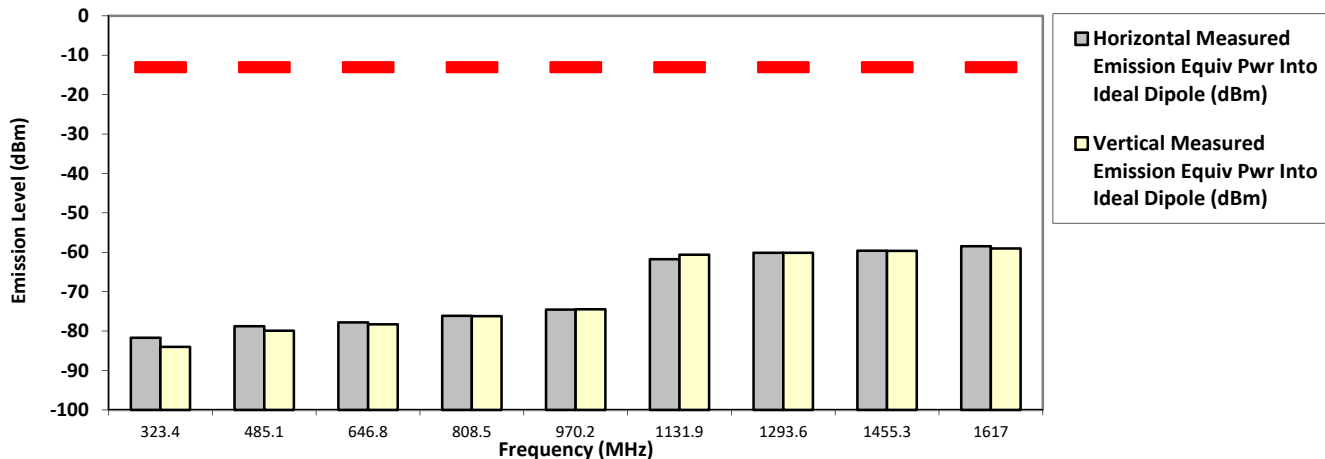

The data presented here was taken using the substitution method as found in the ANSI C63.26-2015 document.  
 Motorola Penang EMC Lab - Test Performed by: Qawiman&Nazrin Sat, 21 May, 2022

Remarks: \*\* Indicates the spurious emission could not be detected due to noise limitations or ambient.

\*Pursuant to CFR 47 Part 2.1057 ( c ), emissions attenuated more than 20 dB below the permissible limit are not reported  
 Temp(Deg): 23.8 Hum(%RH): 70.1

Remarks: Passed Results Marginal Results Failed Results

Model Number: AAM02JQH9JA1AN  
 Battery Part No: NA

SAC Transmitter Radiated Emission:

S/N: 776TYH0079

SR:32947-EMC-00006

Accy Part No: PMMN4090A-CF3, HKN4191B-C2

Test Mode: TX Analog

161.700000 MHz (For Part 74)

25 kHz

25.000 Watt(s) /Low Power

Frequency (MHz)	Limit	Horizontal Measured Emission Equip Pwr Into Ideal Dipole (dBm)	Vertical Measured Emission Equip Pwr Into ideal Dipole (dBm)
323.4000	-13.0000	-84.4478 **	-84.1643 **
485.1000	-13.0000	-80.4640 **	-78.7424 **
646.8000	-13.0000	-77.4230 **	-78.2751 **
808.5000	-13.0000	-75.3636 **	-76.1093 **
970.2000	-13.0000	-73.7989 **	-73.4625 **
1131.9000	-13.0000	-60.9977 **	-61.4512 **
1293.6000	-13.0000	-60.6281 **	-58.5740 **
1455.3000	-13.0000	-60.1322 **	-59.8984 **
1617.0000	-13.0000	-58.3345 **	-58.7118 **

**RADIATED SPURIOUS EMISSIONS**

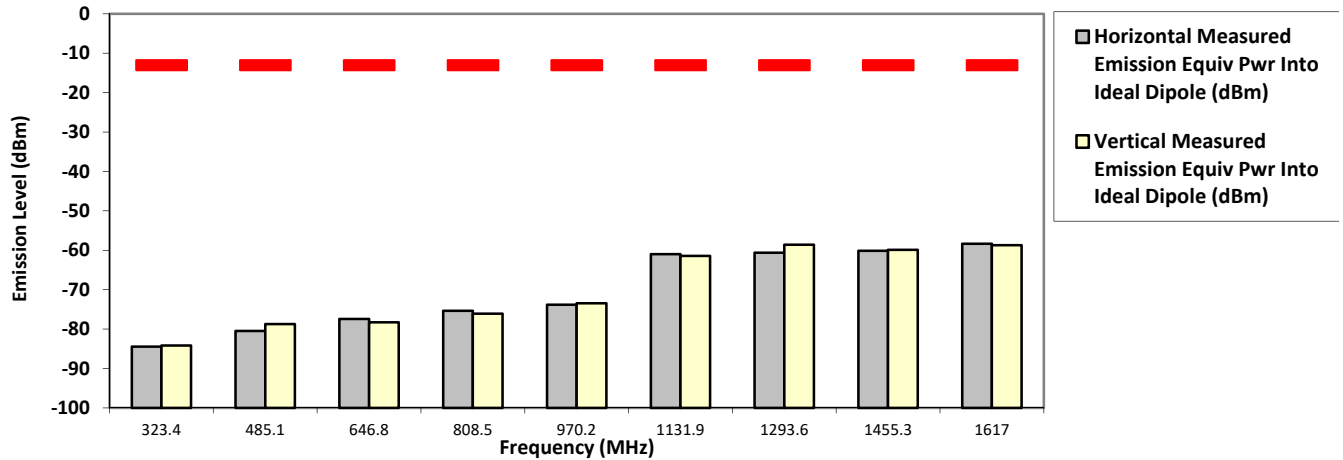

The data presented here was taken using the substitution method as found in the ANSI C63.26-2015 document.  
 Motorola Penang EMC Lab - Test Performed by: Qawiman&Nazrin Sat, 21 May, 2022

Remarks: \*\* Indicates the spurious emission could not be detected due to noise limitations or ambient.  
 \*Pursuant to CFR 47 Part 2.1057 ( c ), emissions attenuated more than 20 dB below the permissible limit are not reported  
 Temp(Deg): 23.8 Hum(%RH): 70.1

Remarks: Passed Results Marginal Results Failed Results

**Model Number: AAM02JQH9JA1AN**      **SAC Transmitter Radiated Emission:**      **S/N: 776TYH0079**      **SR:32947-EMC-00006**  
**Battery Part No: NA**      **Accy Part No: PMMN4090A-CF3, HKN4191B-C2**  
**Test Mode: TX Analog**  
**173.987500 MHz (Not for FCC review)**      **25 kHz**      **54.000 Watt(s) /Max Power**

Frequency (MHz)	Limit	Horizontal Measured Emission Equip Pwr Into Ideal Dipole (dBm)	Vertical Measured Emission Equip Pwr Into ideal Dipole (dBm)
347.9750	-13.0000	-82.4657 **	-83.7816 **
521.9625	-13.0000	-78.7003 **	-78.9485 **
695.9500	-13.0000	-78.1223 **	-77.3992 **
869.9375	-13.0000	-75.6709 **	-75.6589 **
1043.9250	-13.0000	-61.5459 **	-60.5240 **
1217.9125	-13.0000	-60.7039 **	-60.7189 **
1391.9000	-13.0000	-60.1139 **	-59.8417 **
1565.8875	-13.0000	-59.7966 **	-59.5424 **
1739.8750	-13.0000	-58.6887 **	-58.6505 **

**RADIATED SPURIOUS EMISSIONS**

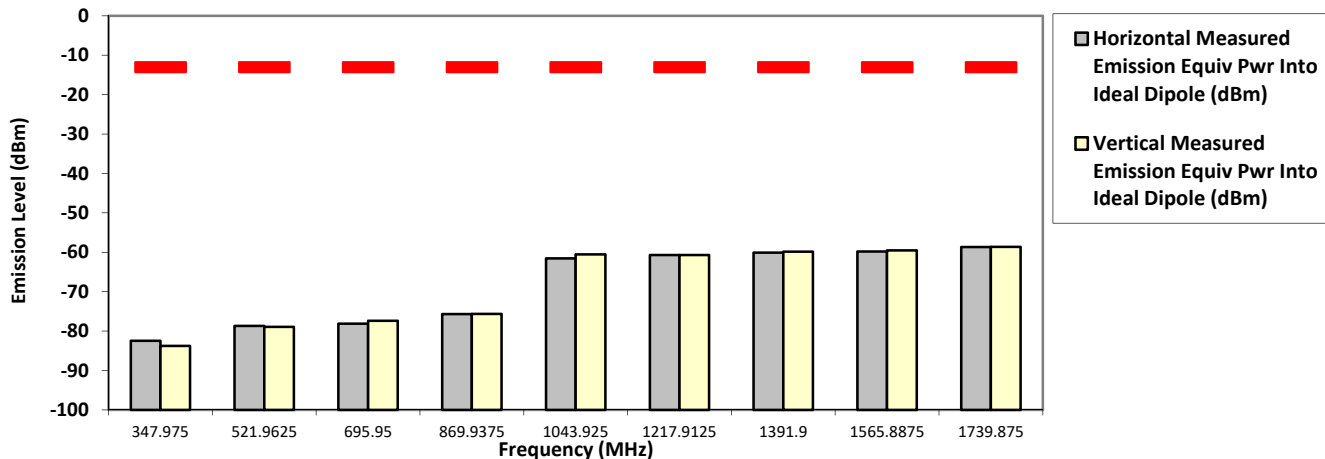

The data presented here was taken using the substitution method as found in the ANSI C63.26-2015 document.  
 Motorola Penang EMC Lab - Test Performed by: Qawiman&Nazrin      Sat, 21 May, 2022

Remarks: \*\* Indicates the spurious emission could not be detected due to noise limitations or ambient.  
 \*Pursuant to CFR 47 Part 2.1057 ( c ), emissions attenuated more than 20 dB below the permissible limit are not reported  
 Temp(Deg): 23.8 Hum(%RH): 70.1

Remarks: Passed Results Marginal Results Failed Results

### 6.10.3. Test Result (Digital)

SAC Transmitter Radiated Emission:

Model Number: AAM02JQH9JA1AN  
 Battery Part No: NA

S/N: 776TYH0079  
 Accy Part No: PMMN4090A-CF3, HKN4191B-C2

SR:32947-EMC-00006

Test Mode: TX Digital  
 12.5 kHz

138.012500 MHz (Not for FCC review)

54.000 Watt(s) /Max Power

Frequency (MHz)	Limit	Horizontal Measured Emission Equip Pwr Into Ideal Dipole (dBm)	Vertical Measured Emission Equip Pwr Into ideal Dipole (dBm)
276.0250	-20.0000	-83.8478 **	-83.1528 **
414.0375	-20.0000	-80.8332 **	-81.6951 **
552.0500	-20.0000	-77.0402 **	-76.5852 **
690.0625	-20.0000	-78.5017 **	-77.7732 **
828.0750	-20.0000	-75.3307 **	-74.5070 **
966.0875	-20.0000	-73.8747 **	-72.8602 **
1104.1000	-20.0000	-61.5476 **	-62.4269 **
1242.1125	-20.0000	-60.2765 **	-60.3367 **
1380.1250	-20.0000	-58.9858 **	-58.7723 **

RADIATED SPURIOUS EMISSIONS

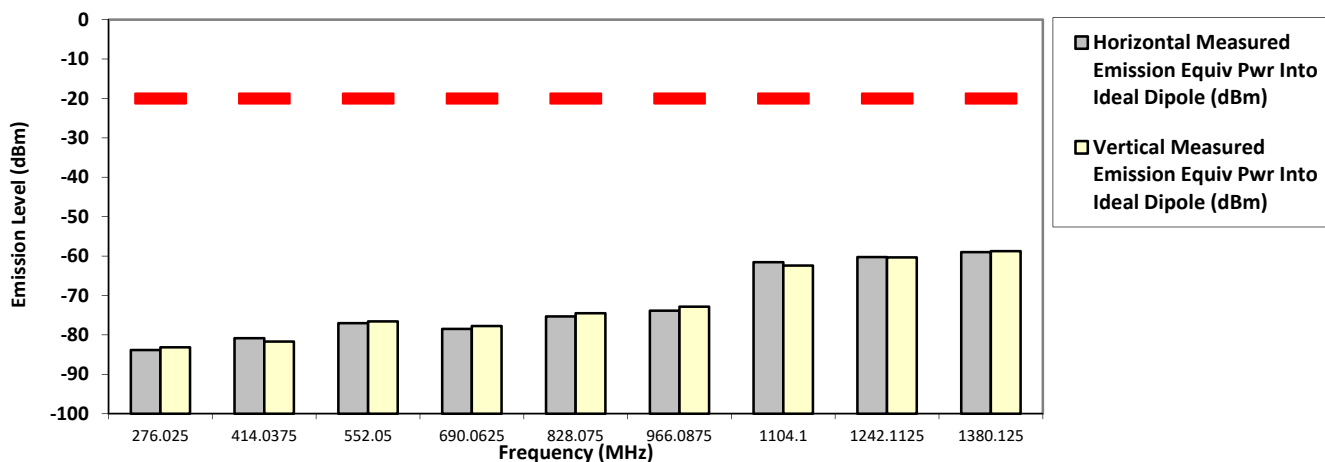

The data presented here was taken using the substitution method as found in the ANSI C63.26-2015 document.  
 Motorola Penang EMC Lab - Test Performed by: Qawiman&Nazrin Sat, 21 May, 2022

Remarks: \*\* Indicates the spurious emission could not be detected due to noise limitations or ambient.

\*Pursuant to CFR 47 Part 2.1057 ( c ), emissions attenuated more than 20 dB below the permissible limit are not reported  
 Temp(Deg): 23.8 Hum(%RH): 70.1

Remarks: Passed Results Marginal Results Failed Results

Model Number: AAM02JQH9JA1AN  
 Battery Part No: NA

SAC Transmitter Radiated Emission:

S/N: 776TYH0079  
 Accy Part No: PMMN4090A-CF3, HKN4191B-C2

SR:32947-EMC-00006

158.550000 MHz

12.5 kHz

54.000 Watt(s) /Max Power

Frequency (MHz)	Limit	Horizontal Measured Emission Equip Pwr Into Ideal Dipole (dBm)	Vertical Measured Emission Equip Pwr Into ideal Dipole (dBm)
317.1000	-20.0000	-83.8860 **	-83.3918 **
475.6500	-20.0000	-79.3361 **	-78.6954 **
634.2000	-20.0000	-77.0823 **	-78.2153 **
792.7500	-20.0000	-76.4007 **	-76.4104 **
951.3000	-20.0000	-74.7536 **	-74.9736 **
1109.8500	-20.0000	-62.3436 **	-61.3990 **
1268.4000	-20.0000	-60.0289 **	-61.3286 **
1426.9500	-20.0000	-58.7961 **	-59.6165 **
1585.5000	-20.0000	-58.3695 **	-59.4594 **

**RADIATED SPURIOUS EMISSIONS**

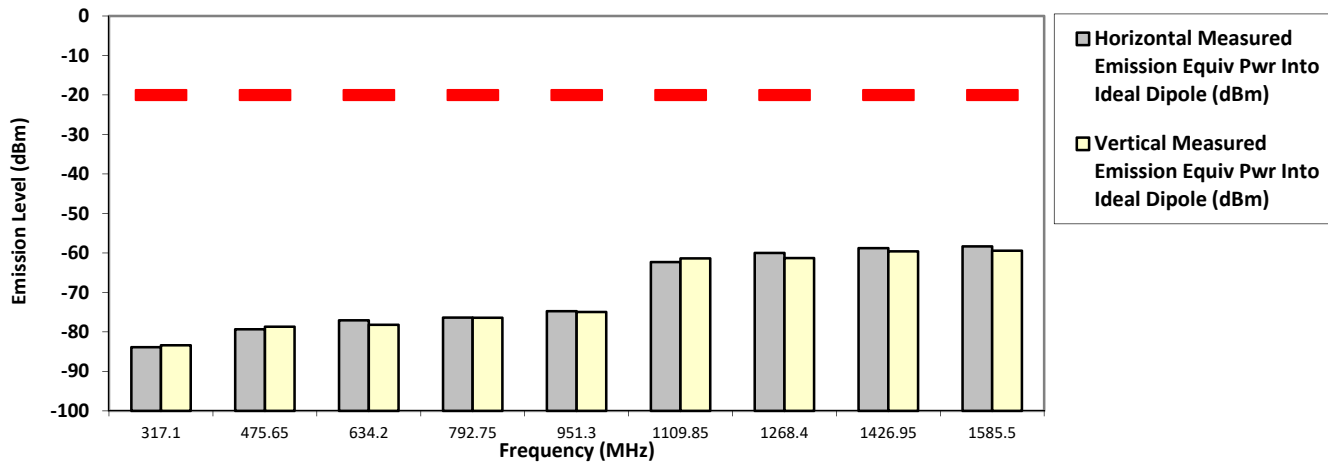

The data presented here was taken using the substitution method as found in the ANSI C63.26-2015 document.  
 Motorola Penang EMC Lab - Test Performed by: Qawiman&Nazrin Sat, 21 May, 2022

Remarks: \*\* Indicates the spurious emission could not be detected due to noise limitations or ambient.

\*Pursuant to CFR 47 Part 2.1057 ( c ), emissions attenuated more than 20 dB below the permissible limit are not reported  
 Temp(Deg): 23.8 Hum(%RH): 70.1

Remarks:

Passed Results	Marginal Results	Failed Results
----------------	------------------	----------------

Model Number: AAM02JQH9JA1AN  
 Battery Part No: NA

SAC Transmitter Radiated Emission:

S/N: 776TYH0079

SR:32947-EMC-00006

Accy Part No: PMMN4090A-CF3, HKN4191B-C2

Test Mode: TX Digital

158.550000 MHz

12.5 kHz

25.000 Watt(s) /Low Power

Frequency (MHz)	Limit	Horizontal Measured Emission Equip Pwr Into Ideal Dipole (dBm)	Vertical Measured Emission Equip Pwr Into ideal Dipole (dBm)
317.1000	-20.0000	-84.1295 **	-82.8648 **
475.6500	-20.0000	-80.1983 **	-79.6646 **
634.2000	-20.0000	-77.8706 **	-77.1372 **
792.7500	-20.0000	-75.4465 **	-75.1707 **
951.3000	-20.0000	-74.6333 **	-74.5198 **
1109.8500	-20.0000	-60.2681 **	-61.2286 **
1268.4000	-20.0000	-60.7280 **	-60.4171 **
1426.9500	-20.0000	-59.3534 **	-59.5303 **
1585.5000	-20.0000	-58.4632 **	-59.1801 **

**RADIATED SPURIOUS EMISSIONS**

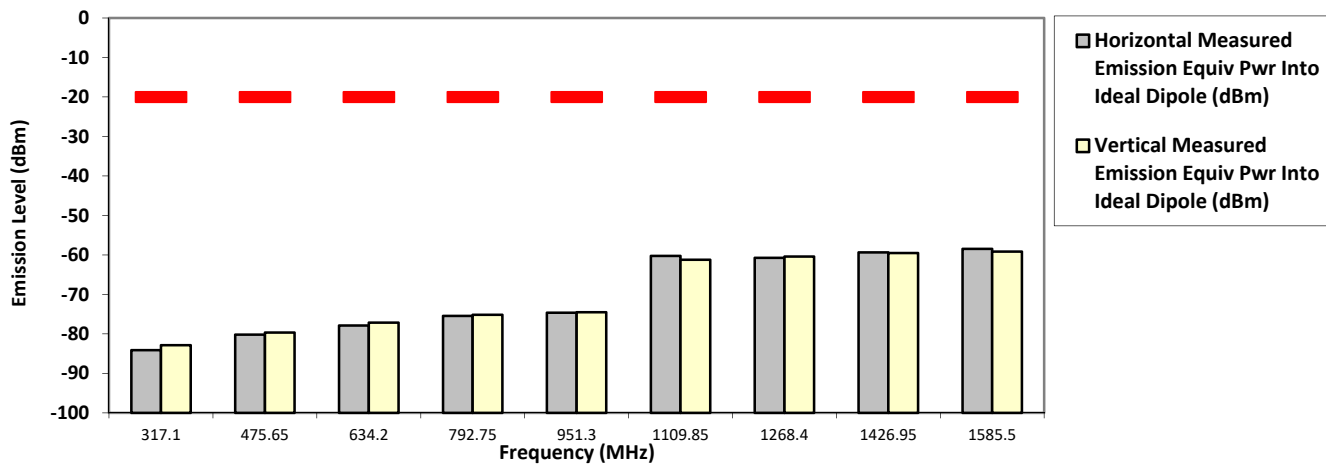

The data presented here was taken using the substitution method as found in the ANSI C63.26-2015 document.  
 Motorola Penang EMC Lab - Test Performed by: Qawiman&Nazrin Sat, 21 May, 2022

Remarks: \*\* Indicates the spurious emission could not be detected due to noise limitations or ambient.

\*Pursuant to CFR 47 Part 2.1057 ( c ), emissions attenuated more than 20 dB below the permissible limit are not reported  
 Temp(Deg): 23.8 Hum(%RH): 70.1

Remarks:

Passed Results	Marginal Results	Failed Results
----------------	------------------	----------------

Model Number: AAM02JQH9JA1AN  
 Battery Part No: NA

SAC Transmitter Radiated Emission:

S/N: 776TYH0079

SR:32947-EMC-00006

Accy Part No: PMMN4090A-CF3, HKN4191B-C2

Test Mode: TX Digital

161.700000 MHz

12.5 kHz

54.000 Watt(s) /Max Power

Frequency (MHz)	Limit	Horizontal Measured Emission Equip Pwr Into Ideal Dipole (dBm)	Vertical Measured Emission Equip Pwr Into ideal Dipole (dBm)
323.4000	-20.0000	-84.4164 **	-83.6129 **
485.1000	-20.0000	-78.4310 **	-78.9295 **
646.8000	-20.0000	-77.6450 **	-78.1119 **
808.5000	-20.0000	-76.5335 **	-75.6481 **
970.2000	-20.0000	-73.8271 **	-74.7615 **
1131.9000	-20.0000	-62.1970 **	-61.2519 **
1293.6000	-20.0000	-60.0431 **	-59.6957 **
1455.3000	-20.0000	-60.1676 **	-59.2585 **
1617.0000	-20.0000	-59.6954 **	-58.8079 **

**RADIATED SPURIOUS EMISSIONS**

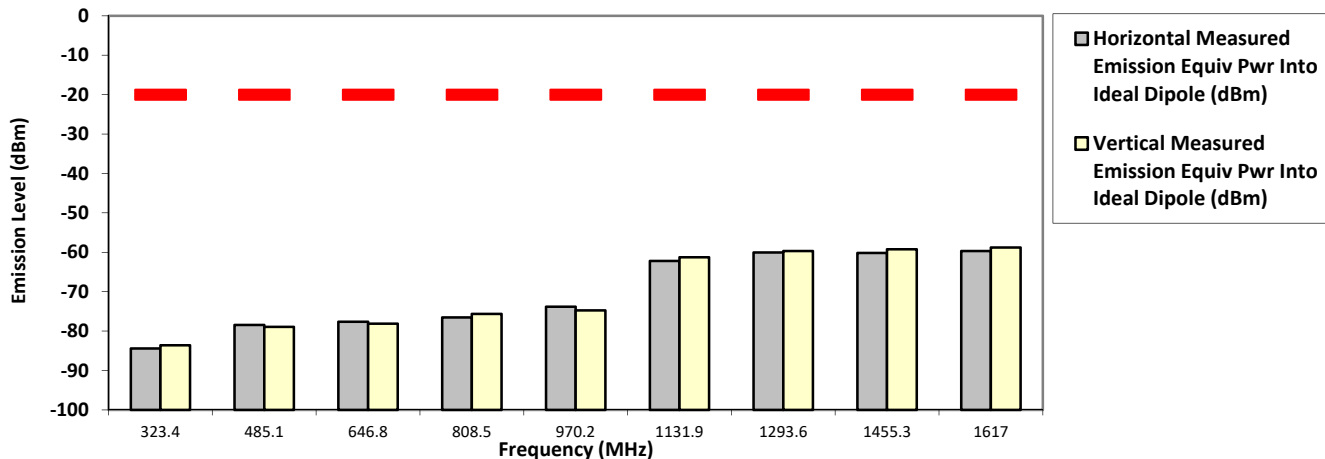

The data presented here was taken using the substitution method as found in the ANSI C63.26-2015 document.  
 Motorola Penang EMC Lab - Test Performed by: Qawiman&Nazrin Sat, 21 May, 2022

Remarks: \*\* Indicates the spurious emission could not be detected due to noise limitations or ambient.

\*Pursuant to CFR 47 Part 2.1057 ( c ), emissions attenuated more than 20 dB below the permissible limit are not reported  
 Temp(Deg): 23.8 Hum(%RH): 70.1

Remarks:

Passed Results	Marginal Results	Failed Results
----------------	------------------	----------------



Model Number: AAM02JQH9JA1AN  
 Battery Part No: NA

SAC Transmitter Radiated Emission:

S/N: 776TYH0079  
 Accy Part No: PMMN4090A-CF3, HKN4191B-C2

SR:32947-EMC-00006

161.700000 MHz

12.5 kHz

25.000 Watt(s) /Low Power

Frequency (MHz)	Limit	Horizontal Measured Emission Equip Pwr Into Ideal Dipole (dBm)	Vertical Measured Emission Equip Pwr Into ideal Dipole (dBm)
323.4000	-20.0000	-83.6820 **	-83.7324 **
485.1000	-20.0000	-79.8746 **	-79.6334 **
646.8000	-20.0000	-78.3158 **	-78.2654 **
808.5000	-20.0000	-75.4289 **	-76.0313 **
970.2000	-20.0000	-73.8008 **	-73.5773 **
1131.9000	-20.0000	-61.1135 **	-60.1415 **
1293.6000	-20.0000	-59.5814 **	-59.2247 **
1455.3000	-20.0000	-58.8257 **	-59.9975 **
1617.0000	-20.0000	-58.2497 **	-59.3293 **

**RADIATED SPURIOUS EMISSIONS**

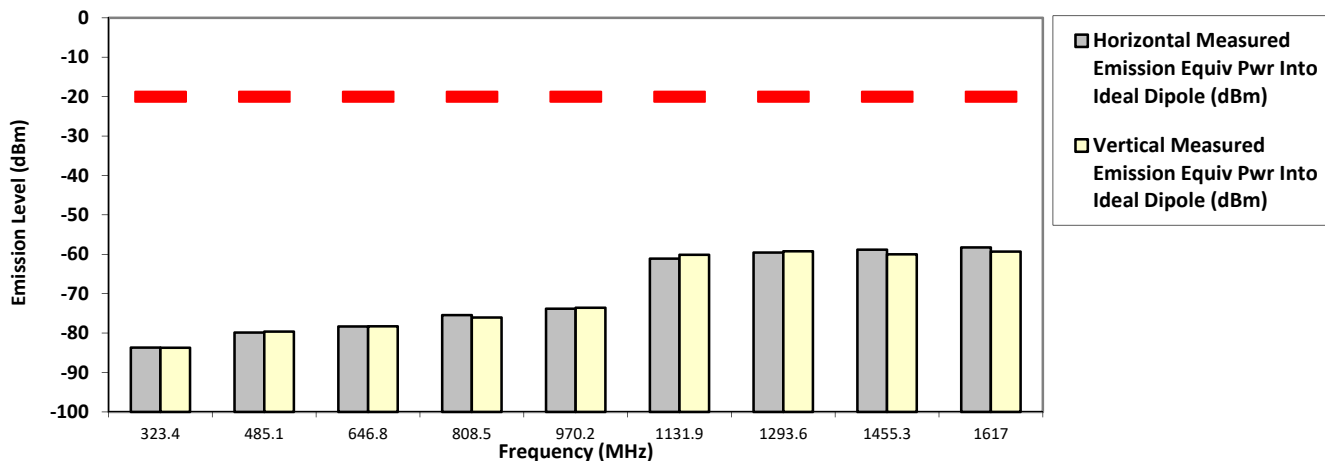

The data presented here was taken using the substitution method as found in the ANSI C63.26-2015 document.  
 Motorola Penang EMC Lab - Test Performed by: Qawiman&Nazrin Sat, 21 May, 2022

Remarks: \*\* Indicates the spurious emission could not be detected due to noise limitations or ambient.  
 \*Pursuant to CFR 47 Part 2.1057 ( c ), emissions attenuated more than 20 dB below the permissible limit are not reported  
 Temp(Deg): 23.8 Hum(%RH): 70.1

Remarks: Passed Results Marginal Results Failed Results

Model Number: AAM02JQH9JA1AN  
 Battery Part No: NA

SAC Transmitter Radiated Emission:

S/N: 776TYH0079

SR:32947-EMC-00006

Accy Part No: PMMN4090A-CF3, HKN4191B-C2

Test Mode: TX Digital

173.387500 MHz

12.5 kHz

54.000 Watt(s) /Max Power

Frequency (MHz)	Limit	Horizontal Measured Emission Equip Pwr Into Ideal Dipole (dBm)	Vertical Measured Emission Equip Pwr Into ideal Dipole (dBm)
346.7750	-20.0000	-83.1439 **	-83.7914 **
520.1625	-20.0000	-79.1577 **	-79.0290 **
693.5500	-20.0000	-76.7131 **	-77.2901 **
866.9375	-20.0000	-75.5700 **	-75.0346 **
1040.3250	-20.0000	-61.7065 **	-60.3972 **
1213.7125	-20.0000	-59.7880 **	-60.2623 **
1387.1000	-20.0000	-58.8189 **	-59.4044 **
1560.4875	-20.0000	-58.9615 **	-58.9904 **
1733.8750	-20.0000	-58.0740 **	-58.5242 **

**RADIATED SPURIOUS EMISSIONS**

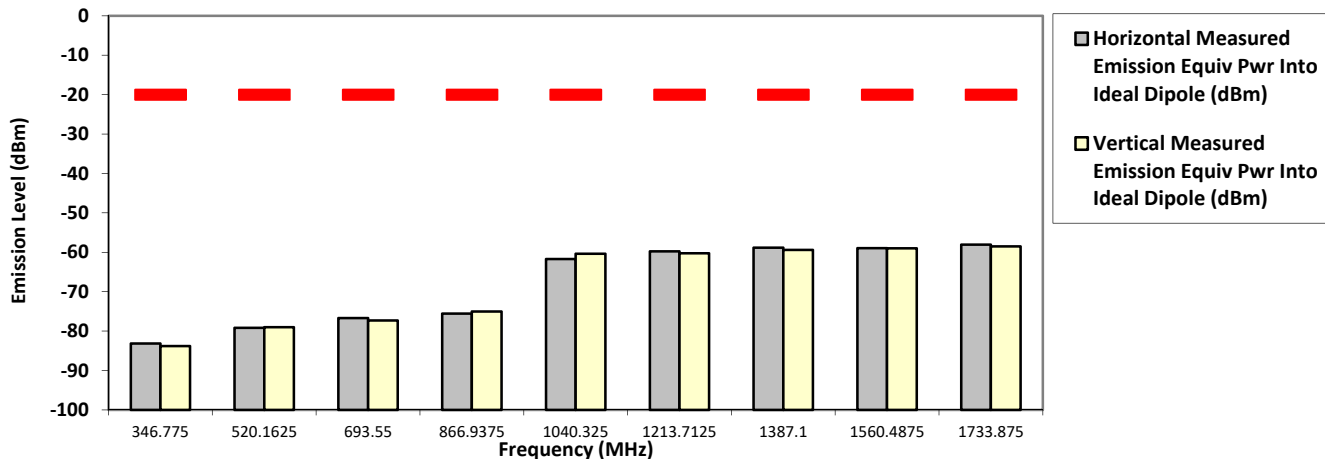

The data presented here was taken using the substitution method as found in the ANSI C63.26-2015 document.  
 Motorola Penang EMC Lab - Test Performed by: Qawiman&Nazrin Sat, 21 May, 2022

Remarks: \*\* Indicates the spurious emission could not be detected due to noise limitations or ambient.

\*Pursuant to CFR 47 Part 2.1057 ( c ), emissions attenuated more than 20 dB below the permissible limit are not reported  
 Temp(Deg): 23.8 Hum(%RH): 70.1

Remarks:

Passed Results	Marginal Results	Failed Results
----------------	------------------	----------------

**6.10.4. Test Limit**

Table below summarized the power of any emission outside a licensee’s frequency block shall be attenuated below the transmitter power (P) by at least

Channel Spacing	Part 22	Part 24D	Part 74	Part 80	Part 90 (UHF, VHF, 800, 900)	Part 90 (700)
12.5kHz	43 + log <sub>10</sub> (P) (-13 dBm)	43 + log <sub>10</sub> (P) (-13 dBm)	43 + log <sub>10</sub> (P) (-13 dBm)	Not Applicable	50 + log <sub>10</sub> (P) (-20 dBm)	43 + log <sub>10</sub> (P) (-13 dBm)
25kHz		Not Applicable		43 + log <sub>10</sub> (P) (-13 dBm)	43 + log <sub>10</sub> (P) (-13 dBm)	43 + log <sub>10</sub> (P) (-13 dBm)

Channel Spacing	RSS 134	RSS 182	RSS 119 (UHF, VHF, 800, 900)	RSS 119 (700)
12.5kHz	43 + log <sub>10</sub> (P) (-13 dBm)	Not Applicable	50 + log <sub>10</sub> (P) (-20 dBm)	43 + log <sub>10</sub> (P) (-13 dBm)
25kHz	Not Applicable	43 + log <sub>10</sub> (P) (-13 dBm)	43 + log <sub>10</sub> (P) (-13 dBm)	43 + log <sub>10</sub> (P) (-13 dBm)

## 6.11. Effective Radiated Power (ERP)

### 6.11.1. Test Setup

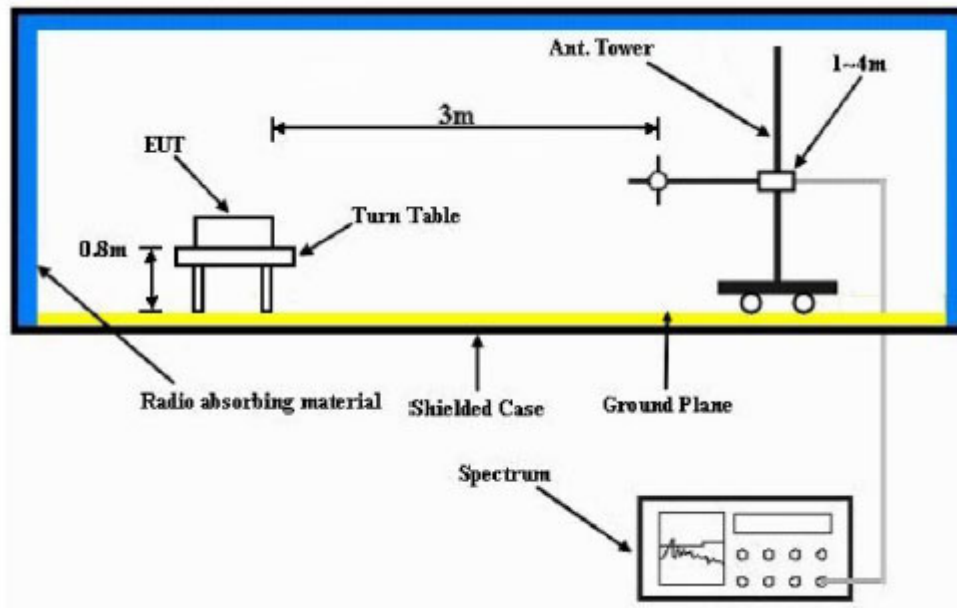

- 1) The Resolution Bandwidth for Equivalent Radiated Power (ERP) below 1 GHz is 100 kHz with Video Bandwidth = 300 kHz and Resolution Bandwidth for EIRP above 1 GHz is 1 MHz with Video Bandwidth = 3 MHz. Detector Mode is RMS.
- 2) In the semi-anechoic chamber, setup as illustrated above the DUT placed on the 0.8m height (for  $f_c < 1\text{GHz}$ ) or 1.5m (for  $f_c > 1\text{GHz}$ ) of Turn Table, rotated the table 45 degree each interval to search the maximum radiation power and receiver antenna shall be rotated vertical and horizontal polarization and moved height from 1m to 4m to find the maximum polar radiated power for each degree interval. The “Read Value” is the spectrum reading of maximum power value.
- 3) The substitution antenna is substituted for DUT at the same position and signals generator (S.G) export the CW signal to the substitution antenna via a TX cable. The receiver antenna shall be rotated vertical and horizontal polarization and moved height from 1m to 4m to find the maximum radiation power. Record the power level of maximum radiation power from spectrum. So, the Measured substitution value = Ref level of S.G + TX cables loss – Substituted Antenna Gain.

### 6.11.2. Test Result

**Not Applicable.**

### 6.11.3. Test Limit

The maximum output power of the transmitter for mobile stations is 100 watts (20 dB). Power is given in terms of effective radiated power (ERP).

## 6.12. GNSS (EIRP for 1559 - 1610MHz)

### 6.12.1. Test Setup

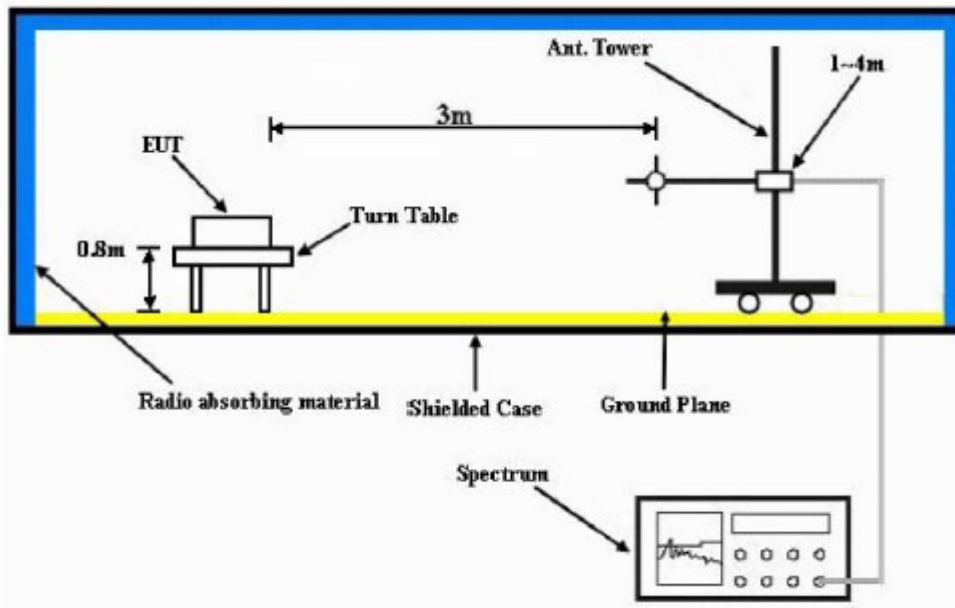

- 4) The Resolution Bandwidth for Equivalent Isotropically Radiated Power (EIRP) below 1 GHz is 100 kHz with Video Bandwidth = 300 kHz and Resolution Bandwidth for EIRP above 1 GHz is 1 MHz with Video Bandwidth = 3 MHz. Detector Mode is RMS.
- 5) In the semi-anechoic chamber, setup as illustrated above the DUT placed on the 0.8m height of Turn Table, rotated the table 45 degree each interval to search the maximum radiation power and receiver antenna shall be rotated vertical and horizontal polarization and moved height from 1m to 4m to find the maximum polar radiated power for each degree interval. The “Read Value” is the spectrum reading of maximum power value.
- 6) The substitution antenna is substituted for DUT at the same position and signals generator (S.G) export the CW signal to the substitution antenna via a TX cable. The receiver antenna shall be rotated vertical and horizontal polarization and moved height from 1m to 4m to find the maximum radiation power. Record the power level of maximum radiation power from spectrum. So, the Measured substitution value = Ref level of S.G + TX cables loss – Substituted Antenna Gain.
- 7)  $EIRP = \text{“Read Value”} + \text{Measured substitution value} + 2.15$ .

### 6.12.1. Test Result

**Not Applicable.**

### 6.12.2. Test Limit

For operations in the 758-775 MHz and 788-805 MHz bands, all emissions including harmonics in the band 1559-1610 MHz shall be limited to  $-70$  dBW/MHz equivalent isotropically radiated power (EIRP) for wideband signals, and  $-80$  dBW EIRP for discrete emissions of less than 700 Hz bandwidth.

**~ End of Test Report ~**