



EXHIBIT 2A

Radio Test Report

Applicant: Northern Telecom Ltd.



For Certification on:

AB6S8000

FCC Part 24/Part22 Test Report for S8000 Indoor and Outdoor Base stations FCC ID#AB6S8000

Document number:	PCS/BTS/DJD/005945
Document issue:	V01.01/EN
Document status:	Approved
Date:	29/01/2003

**RF Tests concerning FCC Part are performed by RF GSM Department
In laboratory 007 – Nortel Networks, 38 Bd Paul Cezanne, 78280 Guyancourt - France.**

<i>Author:</i>	A. CAILLE	
<i>Approved by:</i>	R. JACQUES	

Copyright© 2000 Nortel Matra Cellular and Nortel Networks, All Rights Reserved

Printed in France

NORTEL NETWORKS AND NORTEL MATRA CELLULAR CONFIDENTIAL:

The information contained in this document is the property of Nortel Networks. Except as specifically authorized in writing by Nortel Networks, the holder of this document shall keep the information contained herein confidential and shall protect same in whole or in part from disclosure and dissemination to third parties and use same for evaluation, operation and maintenance purposes only.

The content of this document is provided for information purposes only and is subject to modification. It does not constitute any representation or warranty from Nortel Networks as to the content or accuracy of the information contained herein, including but not limited to the suitability and performances of the product or its intended application.

The following are trademarks of Nortel Networks: *NORTEL NETWORKS, the NORTEL NETWORKS corporate logo, the NORTEL Globemark, HOW THE WORLD SHARES IDEAS, UNIFIED NETWORKS. The information in this document is subject to change without notice. Nortel Networks assumes no responsibility for errors that might appear in this document.

All other brand and product names are trademarks or registered trademarks of their respective holders.

PUBLICATION HISTORY

29/Jan/2003

Issue V01.01 / EN

Status: Approved

Creation

Nuno OLIVEIRA, Alain CAILLE

CONTENTS

1.	INTRODUCTION.....	5
1.1.	OBJECT.....	5
1.2.	SCOPE.....	6
1.3.	PRODUCT CONFIGURATIONS.....	6
2.	RELATED DOCUMENTS	7
2.1.	APPLICABLE DOCUMENTS.....	7
2.2.	REFERENCE DOCUMENTS	7
3.	ABBREVIATIONS & DEFINITIONS.....	9
3.1.	ABBREVIATIONS.....	9
3.2.	DEFINITIONS.....	10
4.	EXHIBIT 1 : TEST REPORT - HEPA PCS1900.....	11
4.1.	INTRODUCTION.....	11
4.2.	MEASUREMENT RESULTS	11
4.3.	NAME OF TEST: RF POWER OUTPUT	12
	4.3.1. FCC REQUIREMENTS – FCC PART 24.232	12
	4.3.2. TEST RESULTS	12
	4.3.3. Test procedure	15
4.4.	NAME OF TEST : OCCUPIED BANDWIDTH.....	16
	4.4.1. FCC REQUIREMENTS.....	16
	4.4.2. TEST RESULTS	16
	4.4.3. Test procedure	17
4.5.	NAME OF TEST: SPURIOUS EMISSIONS AT ANTENNA TERMINALS	19
	4.5.1. FCC requirements LIMITS – FCC Part 24.238.....	19
	4.5.2. Test results with Duplexer Configuration.....	20
	4.5.3. Test results with H2D Duplexer Configuration.....	30
	4.5.4. Test results with H4D Duplexer Configuration.....	35
	4.5.5. CONCLUSION.....	40
	4.5.6. Test procedure	41
4.6.	NAME OF TEST: FREQUENCY STABILITY.....	43
5.	EXHIBIT 2 : TEST REPORT FOR PCS900 PA 30W.....	45
5.1.	INTRODUCTION.....	45
5.2.	MEASUREMENT RESULTS	45

**FCC Part 24/Part 22 Test Report for S8000 Indoor and Outdoor Base stations FCC
ID#AB6S8000**

5.3.	NAME OF TEST : 2.1046 RF POWER OUTPUT	46
	<i>Test results</i>	46
5.4.	NAME OF TEST : 2.1049 OCCUPIED BANDWIDTH	47
	<i>Test results</i>	47
5.5.	SPURIOUS EMISSIONS AT ANTENNA TERMINALS	49
	<i>Test results</i>	49
5.6.	NAME OF TEST : 2.1055 FREQUENCY STABILITY	61
	<i>Test results:</i>	61
	<i>Test procedure</i>	62
6.	EXHIBIT 3: TEST REPORT - PA30W GSM850.....	64
6.1.	INTRODUCTION.....	64
6.2.	MEASUREMENTS RESULTS	64
6.3.	NAME OF TEST: 2.1046 RF POWER OUTPUT	65
	<i>fcc requirements</i>	65
	<i>test results</i>	65
	<i>test procedure</i>	66
6.4.	NAME OF TEST: 2.1049 OCCUPIED BANDWIDTH.....	67
	<i>fcc requirements</i>	67
	<i>test results</i>	67
	<i>test procedure</i>	68
6.5.	NAME OF TEST: 2.1051 SPURIOUS EMISSIONS AT ANTENNA TERMINALS	69
	<i>fcc requirements</i>	69
	<i>test results</i>	70
	<i>test procedure</i>	81
6.6.	NAME OF TEST: 2.1055 FREQUENCY STABILITY.....	83
	<i>fcc requirements</i>	83
	<i>test results</i>	83
7.	MEASUREMENT EQUIPMENT LIST.....	85
8.	EXHIBIT 2 : UPDATED EQUIPMENT LIST.....	86

1. INTRODUCTION

1.1. OBJECT

This report presents the test data in accordance with FCC Part 24 Subpart E for the S8000 Indoor and Outdoor Basestations in PCS1900 band configured with:

- a new module introduction : HePA (GMSK 60W / Edge 45W) 1900 .
- existing configuration with PA (GMSK 30W / Edge 30W) 1900 Band only

These results can be applied for mixed BTS configuration 1900 Band PA (GMSK 30W / Edge 30W) and HePA (GMSK 60W / Edge 45W)

This report presents also the test data in accordance with FCC Part 22, Subpart H , for the S8000 Indoor and Outdoor Basestations in 850 Band configured with:

- 850 Band only - PA (GMSK 30W / Edge 30W)

These results can be applied for 1900 / 850 Dual Band BTS configuration :

- 1900/ 850 Dual Band - PA (GMSK 30W / Edge 30W)
- 1900 Band HePA (GMSK 60W / Edge 45W) mixed with 850 Band PA (GMSK 30W / Edge 30W)

This report presents test data for GMSK modulation and 8PSK modulation (EDGE functionality).

1.2. SCOPE

This document applies to the S8000 BTS GSM 1900/850 Outdoor and Indoor versions.

S8000 BTS can integrate a maximum of 6 HePA modules.

Some RF Tests have been performed in the worst case of BTS configuration: S12000 BTS (equipped with 8HePA).

As we use same modules eDRX, HePA and duplexer in S8000 BTS and S12000 BTS , measurements available in this document done with S12000 BTS can be applied to S8000 BTS.

1.3. PRODUCT CONFIGURATIONS

Some Tests were conducted on the Outdoor S12000 BTS with a worst case configuration of 8 HePA modules. As the RF transmit paths are identical in both the Outdoor system and Indoor system, testing has been conducted on the Outdoor version only.

Measurements were taken with all available coupling configurations including with duplexer involves the compliance with H2D (two input coupler with 3dB loss coupling associated with duplexer) and the H4D configuration (four input coupler with 7dB loss coupling associated with duplexer).

The systems use both GMSK modulation and 8PSK, testing was done with both modulation types.

2. RELATED DOCUMENTS

2.1. APPLICABLE DOCUMENTS

- | | | |
|------|------------------|---|
| [A1] | CFR 47 - Part 2 | FREQUENCY ALLOCATIONS AND RADIO TREATY MATTERS; GENERAL RULES AND REGULATIONS |
| [A2] | CFR 47 - Part 24 | PERSONAL COMMUNICATIONS SERVICES |

2.2. REFERENCE DOCUMENTS

- | | | |
|------|------------------|--|
| [R1] | PE/BTS/DJD/0222 | FCC Part 24 Type Acceptance Filing for Nortel's S8000 Outdoor BTS AB6OUDS8000 |
| [R2] | PCS/BTS/DJD/0234 | AB6OUDS8000: FCC Part 24 Class II Permissive Change Application : S8000 Indoor BTS |
| [R3] | PCS/BTS/DJD/0730 | AB6OUDS8000: FCC Part 24 Class II Permissive Change Application : S8000 Indoor BTS |
| [R4] | PCS/BTS/DJD/0743 | S8000 Outdoor and Indoor BTS GSM 1900 : FCC Part 24 Class II Permissive Change Application AB6OUDS8000 |
| [R5] | PCS/BTS/DJD/0746 | S8000 Outdoor and Indoor BTS GSM 1900 : FCC Part 24 Class II Permissive Change Application AB6OUDS8000 |

- [R6] PCS/BTS/DJD/04574 S8000 Outdoor and Indoor BTS GSM 1900 : FCC Part 24 Class II Permissive Change Application AB6OUDS8000
- [R7] PE/BTS/DJD/002630 S8000 Outdoor and Indoor BTS eGSM 850 FCC Part 22 : exhibits documents
- [R8] PE/BTS/DJD/4233 S12000 Indoor BTS GSM 850 / PCS 1900: FCC Part 22 / FCC Part 24 Certification Filing for Nortel AB6INDS12000 exhibits document
- [R9] PE/BTS/DJD/4248 S12000 Outdoor BTS GSM 850 / PCS 1900: FCC Part 22 / FCC Part 24 Certification Filing for Nortel AB6OUTS12000 exhibits document

3. ABBREVIATIONS & DEFINITIONS

3.1. ABBREVIATIONS

DRX	Driver Receiver Unit
e-DRX	EDGE DRX
BCF	Base Common Function
BTS	Base Transceiving Station
GSM	Global System for Mobile Communications
GPRS	General Packet Radio Service
EDGE	Enhanced Data for GSM Evolution
PDTCH	Packet Data Logical Channel
PA	Power Amplifier
e-SCPA	EDGE Single Carrier PA
HePA	Edge High Power Amplifier
LNA	Low Noise Amplifier
OMC	Operation and Maintenance Center
TCU	Trans-Coding Unit
MSC	Mobile Switching Center
RF	Radio Frequency
Tx	Transmitter

4. EXHIBIT 1 : TEST REPORT - HEPA PCS1900

4.1. INTRODUCTION

The following information is submitted for update of the type acceptance of a Broadband PCS Base Station for Northern Telecom, Inc., in accordance with FCC Part 24, Subpart E and Part 2, Subpart J of the FCC Rules and Regulations.

The measurement procedures were in accordance with the requirements of Part 2.

4.2. MEASUREMENT RESULTS

Table 1 is a summary of the measurement results for this update.

Table 1 : Measurement Results Summary

FCC Measurement Specification	IC Limit Specification	Description	Result	Note
2.1046(a), 2.1033(c)(8) 24.232	6.2	RF Power Output	Complies	
2.1049		Occupied Bandwidth	Complies	
2.1051, 2.1057 24.238	6.3 6.4	Spurious Emissions at Antenna Terminals	Complies	
2.1055 24.235	7.0	Frequency Stability	Complies	

4.3. NAME OF TEST: RF POWER OUTPUT

4.3.1. FCC REQUIREMENTS – FCC PART 24.232

Base stations are limited to 1640 watts peak equivalent isotropically radiated power (e.i.r.p.) with an antenna height up to 300 meters HAAT. See 24.53 for HAAT calculation method. Base station antenna heights may exceed 300 meters with a corresponding reduction in power. In no case may the peak output power of a base station transmitter exceed 100 watts.

4.3.2. TEST RESULTS

Table 2 shows the test results of RF Output Power for **GMSK modulation** with several coupling configurations :

Radio Channel	Frequency (MHz)	Duplexer Power (dBm)	H2D Power (dBm)	H4D Power (dBm)	HePA Output Power (dBm)	Limit (dBm)
512	1930,2	45.8	42.2	39.3	GMSK (60W) 47.8 dBm +/- 0.5 dB	50 dBm
548	1937,4	46.1	42.4	39.6		
585	1944,8	46.3	42.6	39.8		
587	1945,2	46.3	42.6	39.8		
598	1947,4	46.2	42.6	39.8		
610	1949,8	46.3	42.6	39.8		
612	1950,2	46.3	42.6	39.8		
648	1957,4	46.5	42.9	39.9		
685	1964,8	46.5	42.8	39.9		
687	1965,2	46.5	42.8	39.9		
698	1967,4	46.5	42.9	39.9		
710	1969,8	46.5	42.9	39.9		
712	1970,2	46.5	42.9	39.9		
723	1972,4	46.5	42.8	39.9		
735	1974,8	46.5	42.8	39.8		
737	1975,2	46.5	42.8	39.8		
773	1982,4	46.5	42.7	39.9		
810	1989,8	46.6	42.9	39.9		

Table 3 shows the test results of RF Output Power for **8PSK modulation** supported by eDRX/HePA 1900 with several coupling configurations :

Radio Channel	Frequency (MHz)	Duplexer Power (dBm)	H2D Power (dBm)	H4D Power (dBm)	HePA Output Power (dBm)	Limit (dBm)
512	1930,2	45	41.9	38.5	8PSK (45W) 46.5 dBm +/- 0.5 dB	50 dBm
548	1937,4	45.3	41.6	38.8		
585	1944,8	45.5	41.8	39		
587	1945,2	45.5	41.8	39		
598	1947,4	45.4	41.8	39		
610	1949,8	45.5	41.8	39		
612	1950,2	45.5	41.8	39		
648	1957,4	45.7	42	39.1		
685	1964,8	45.7	42	39.1		
687	1965,2	45.7	42	39.1		
698	1967,4	45.7	42	39.1		
710	1969,8	45.7	42	39.1		
712	1970,2	45.7	42	39.1		
723	1972,4	45.7	42	39.1		
735	1974,8	45.7	42	39		
737	1975,2	45.7	42	39.1		
773	1982,4	45.7	41.9	39.1		
810	1989,8	45.8	42.1	39.2		

Table 4 shows the HePA Output RF Power reduction available

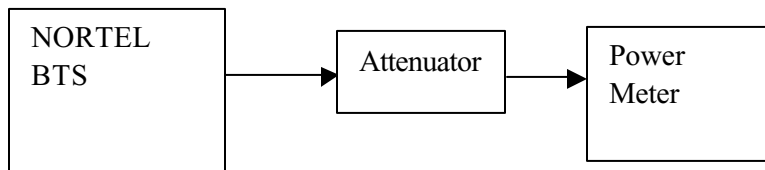
- For GMSK modulation
- For 8PSK modulation supported by eDRX/HePA 1900

Power reduction available	HePA (60W) output Power for GMSK modulation (dBm)	HePA (45W) output Power for 8PSK modulation (dBm)
Pmax <i>Pmax - 1dB</i>	47.8	46.5
Pmax - 2 dB <i>Pmax - 3dB</i>	45.8	44.5
Pmax - 4 dB <i>Pmax - 5dB</i>	43.8	42.5
Pmax - 6 dB <i>Pmax - 7dB</i>	41.8	40.5

4.3.3. TEST PROCEDURE

The equipment was configured as shown in schematic 1.

Schematic 1: Test configuration for RF Output Power



The BTS was configured to transmit at maximum power (static level 0) :

- for GMSK modulation, in mode GMSK no synchro,
- for 8PSK modulation, in mode logical PDCH, Type GPRS, coding MCS5.

Measurements were made at frequencies which are the bottom, middle and top of each of the licensed blocks.

The output power was measured using the power meter which has the following settings :

Mode :	Average
Reference Level Offset :	Corrected to account for cable(s) and attenuator losses

4.4. NAME OF TEST : OCCUPIED BANDWIDTH

4.4.1. FCC REQUIREMENTS

The occupied bandwidth is defined as the width of the signal between two points, one below the carrier center frequency and one above the carrier center frequency, outside of which all emissions are attenuated at least 26 dB below the transmitter power.

4.4.2. TEST RESULTS

The maximum occupied bandwidth was found to be:
320 kHz, measured on channel 661, $f=1960$ MHz in GMSK modulation,
317 kHz, measured on channel 661, $f=1960$ MHz in 8PSK modulation.

Figure 1: Sample plot for occupied bandwidth in GMSK modulation

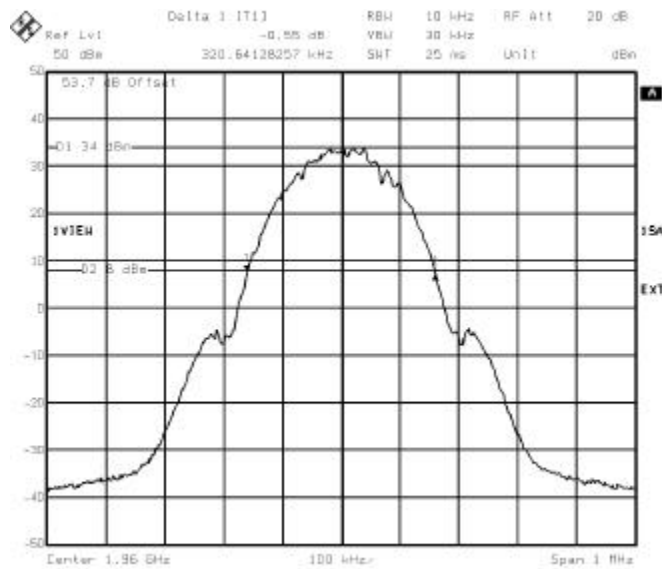
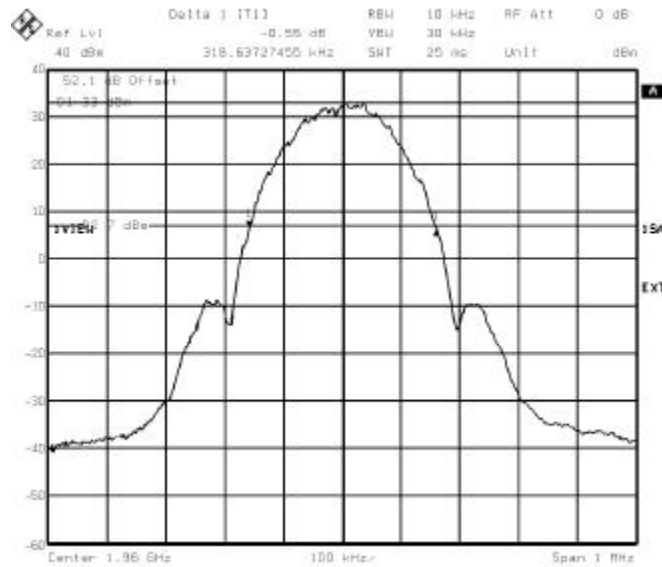


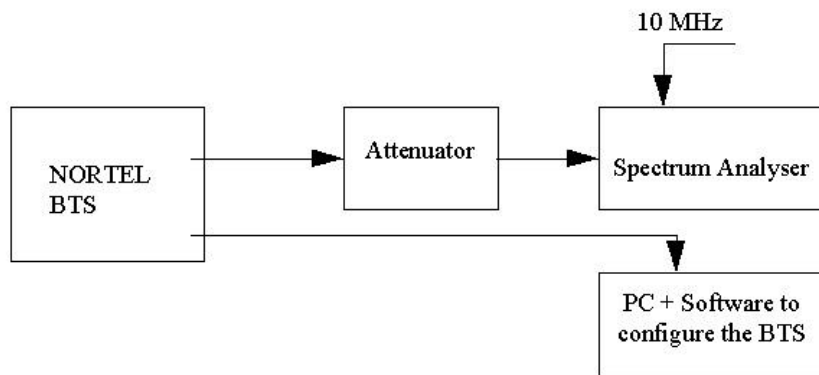
Figure 2: Sample plot for occupied bandwidth in 8PSK modulation



4.4.3. TEST PROCEDURE

The equipment was configured as shown in schematic 2.

Schematic 2 : Test configuration for Occupied bandwidth



The BTS was configured to transmit at maximum power (static level 0) :

- for GMSK modulation, in mode GMSK no synchro,
- for 8PSK modulation, in mode logical PDCH, Type GPRS, coding MCS5.

The occupied bandwidth was measured by determining the bandwidth out of which all emissions are attenuated at least 26 dB below the transmitter power.

The spectrum analyzer had the following settings :

Detector :	Sample
Trace :	Average
Resolution bandwidth :	10 kHz
Video bandwidth :	30 kHz
Span :	1 MHz
Reference Level Offset :	Corrected to account for cable(s) and attenuator losses
Level range :	100 dB
Sweep time :	25 ms

4.5. NAME OF TEST: SPURIOUS EMISSIONS AT ANTENNA TERMINALS

4.5.1. FCC REQUIREMENTS LIMITS – FCC PART 24.238

- (a) On any frequency outside a licensee's frequency block, the power of any emission shall be attenuated below the transmitter power (P) by at least $43 + 10 \log (P)$ dB.
- (b) Compliance with these provisions is based on the use of measurement instrumentation employing a resolution bandwidth of 1 MHz or greater. However, in the 1 MHz bands immediately outside and adjacent to the frequency block a resolution bandwidth of at least one percent of the emission bandwidth of the fundamental emission of the transmitter may be employed. The emission bandwidth is defined as the width of the signal between two points, one below the carrier center frequency and one above the carrier center frequency, outside of which all emissions are attenuated at least 26 dB below the transmitter power.
- (c) When measuring the emission limits, the nominal carrier frequency shall be adjusted as close to the licensee's frequency block edges, both upper and lower, as the design permits.
- (d) The measurements of emission power can be expressed in peak or average values, provided they are expressed in the same parameters as the transmitter power.

4.5.2. TEST RESULTS WITH DUPLEXER CONFIGURATION

The reference level for spurious emissions at the antenna terminals is taken from the measured output power (46.3 dBm = 42.63 Watts).

Therefore the spurious emissions must be attenuated by at least $43 + 10 * \text{Log}(42.63) = 59.3\text{dB}$
 The measured output power was 46.3 dBm ; therefore the limit is $46.3 - 59.3 = -13 \text{ dBm}$.

Spurious measurement is performed with the worst configuration with Duplexer coupling and 60W High Power amplifier .

The Nominal power at antenna connector : PD max =46.5 dBm.

The test compliance with duplexer involves the compliance with H2D (two input coupler with 3dB loss coupling associated with duplexer) and the compliance with H4D configuration (four input coupler with 7dB loss coupling associated with duplexer).

Tables 5 and 6 show the results for Spurious Emissions at Antenna Terminals.

Table 5 : Spurious emissions with the duplexer for GMSK modulation

	Channel	Power emission level	Spurious emissions level (dBm)	Limit (dB)	Margin (dB)
A	512	Pmax-4	-16.2	-13	3.2
A	585	Pmax-4	-14.7	-13	1.7
D	587	Pmax-4	-15.4	-13	2.4
D	610	Pmax-4	-14.3	-13	1.3
B	612	Pmax-4	-15.1	-13	2.1
B	685	Pmax-4	-14.1	-13	1.1
E	687	Pmax-4	-15	-13	2
E	710	Pmax-4	-14.6	-13	1.6
F	712	Pmax-4	-15.2	-13	2.2
F	735	Pmax-4	-14.5	-13	1.5
C	737	Pmax-4	-14.6	-13	1.6
C	810	Pmax-4	-13.9	-13	0.9

Tables 6: Spurious emissions with the diplexer for 8PSK modulation

	Channel	Power emission level	Spurious emissions level (dBm)	Limit (dB)	Margin (dB)
A	512	Pmax-2	-16.3	-13	3.3
A	585	Pmax-2	-16.8	-13	3.8
D	587	Pmax-2	-15.8	-13	2.8
D	610	Pmax-2	-16.2	-13	3.2
B	612	Pmax-2	-15.4	-13	2.4
B	685	Pmax-2	-15.8	-13	2.8
E	687	Pmax-2	-15.2	-13	2.2
E	710	Pmax-2	-16	-13	3
F	712	Pmax-2	-14.6	-13	1.6
F	735	Pmax-2	-16.1	-13	3.1
C	737	Pmax-2	-15.3	-13	2.3
C	810	Pmax-2	-15.2	-13	2.2

Notes :

GMSK modulation measurements :

Figures from 3 to 6 show sample plots for the case when the transmitter was tuned with the power reduced by 4 dB in diplexer configuration for different Edge Channel 512 , 585, 737, 810.

8PSK modulation measurements:

Figures from 7 to 10 show sample plots for the case when the transmitter was tuned at the power reduced by 2dB in diplexer configuration.

Out of band measurement in GMSK modulation:

Figures from 11 to 20 show sample plots for frequency spans from 0 to 20 GHz with emission on channel 810 at maximum power with diplexer configuration.

Figure 3 :
-1 MHz adjacent band (Channel 512, Pmax-4),
Diplexer only, GMSK modulation

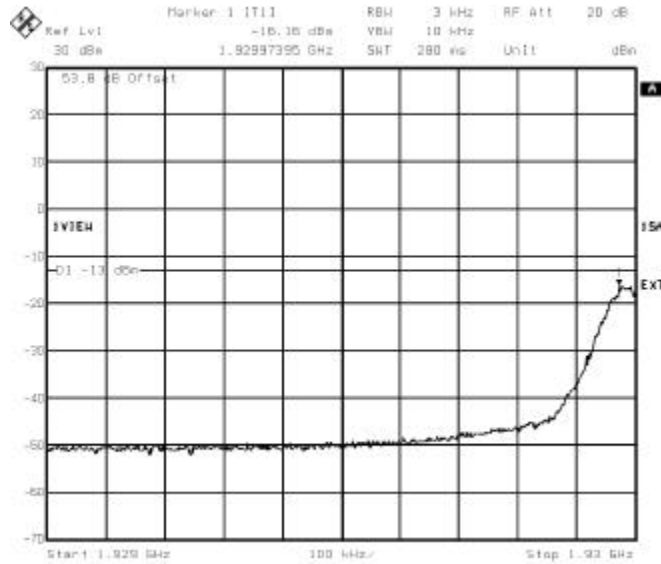


Figure 4 :
+1 MHz adjacent band (Channel 585, Pmax-4),
Diplexer only, GMSK modulation

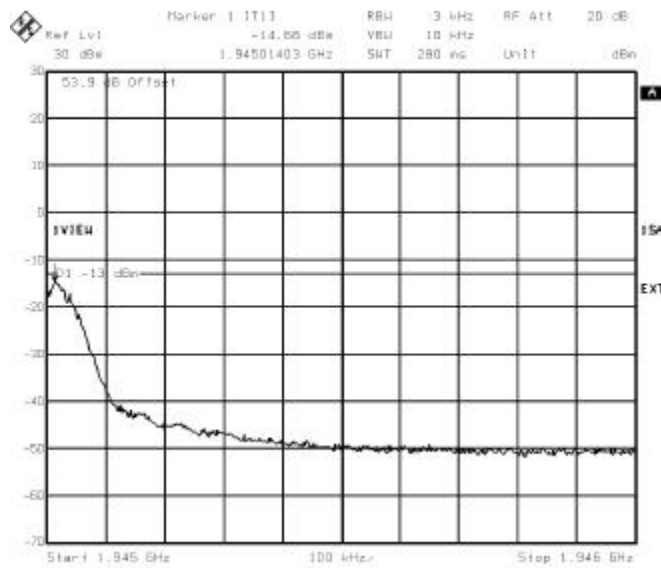


Figure 5 :
 -1 MHz adjacent band (Channel 737, Pmax-4),
 Diplexer only, GMSK modulation

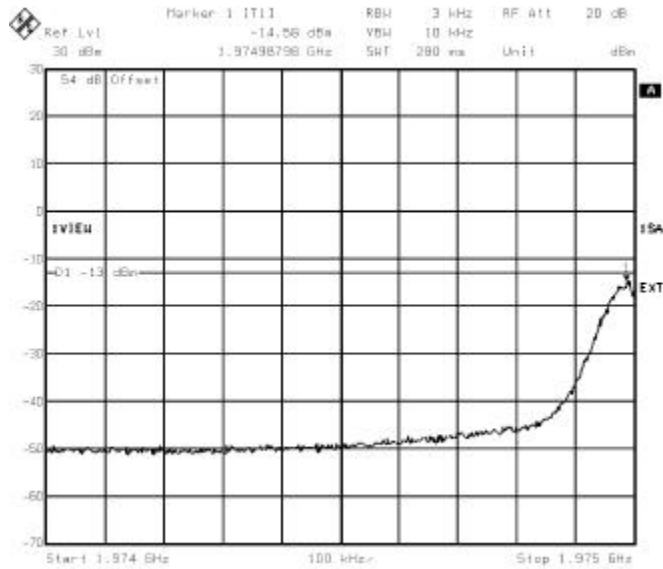


Figure 6:
 +1 MHz adjacent band (Channel 810, Pmax-4),
 Diplexer only, GMSK modulation

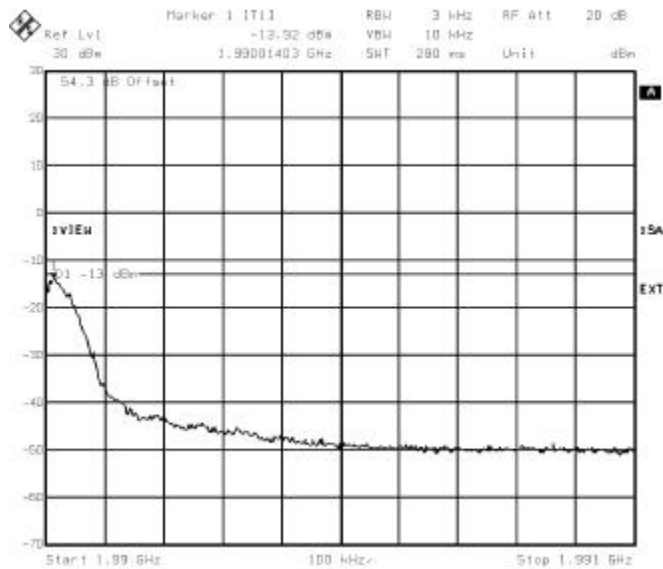


Figure 7:

-1 MHz adjacent band (Channel 512, Pmax-2),
Diplexer only, 8PSK modulation

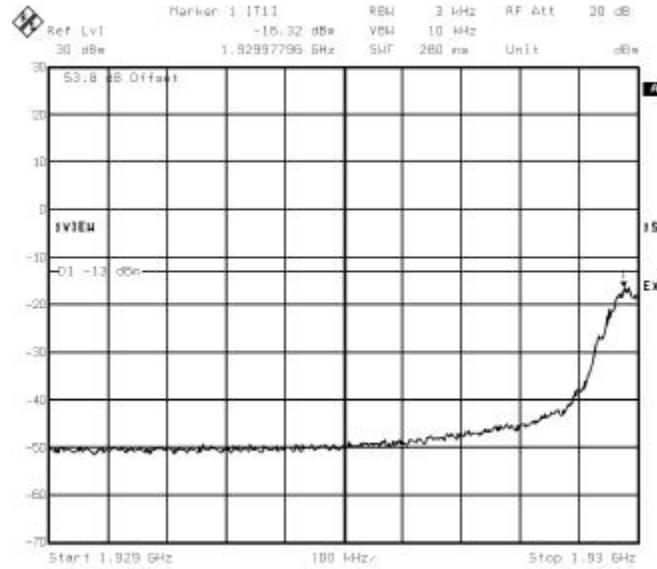


Figure 8:

+1 MHz adjacent band (Channel 585, Pmax-2),
Diplexer only, 8PSK modulation

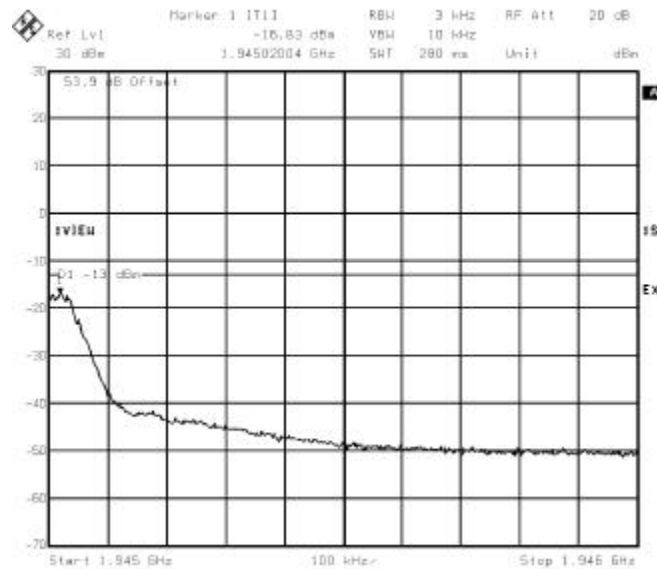


Figure 9:
-1 MHz adjacent band (Channel 737, Pmax-2),
Diplexer only, 8PSK modulation

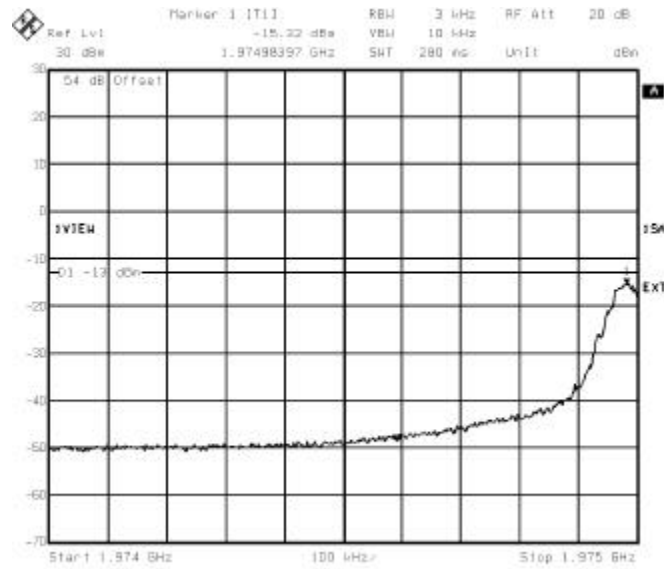
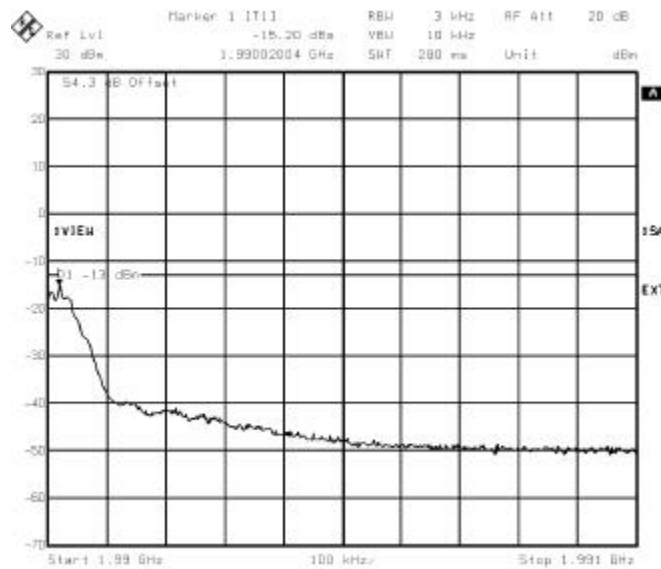


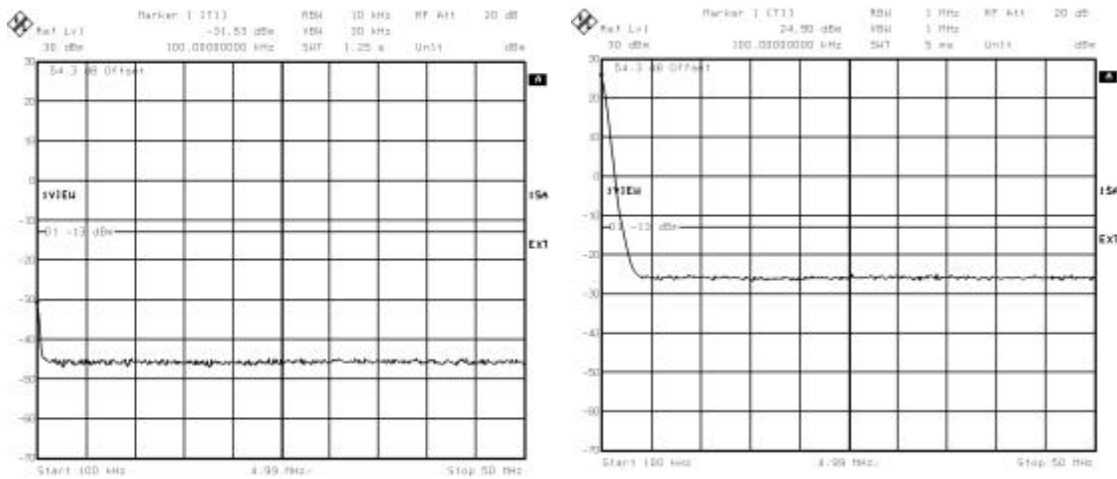
Figure 10:
+1 MHz adjacent band (Channel 810, Pmax-2),
Diplexer only, 8PSK modulation



**Out-of-block emissions (Channel 810, Pmax),
Diplexer, GMSK modulation**

Figure 11:

100 kHz – 50 MHz

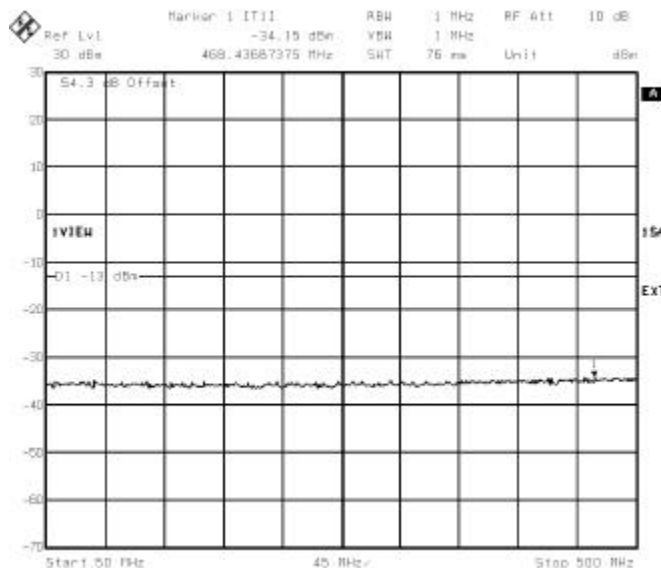


RBW=10 kHz

RBW=1 MHz (*)

(*) Note: spectrum line at 100 kHz is internal DC spectrum line of analyser

Figure 12:
50 MHz – 500 MHz



**Out-of-block emissions (Channel 810, Pmax),
Diplexer, GMSK modulation**

Figure 13 : 500 MHz – 1970.2 MHz

Figure 14 : 1970.2 – 1974 MHz

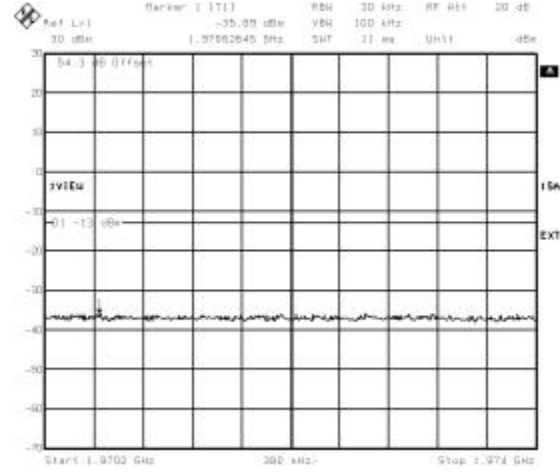
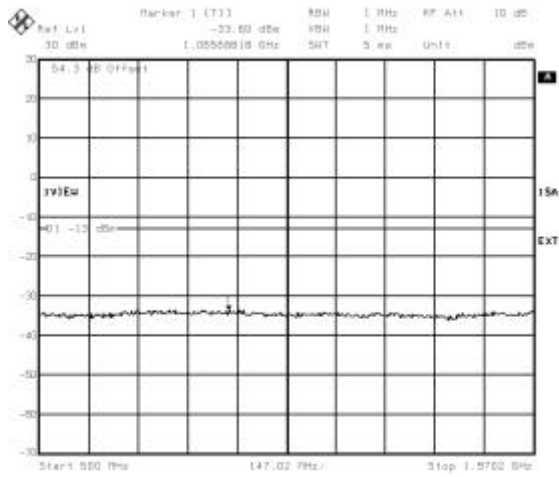
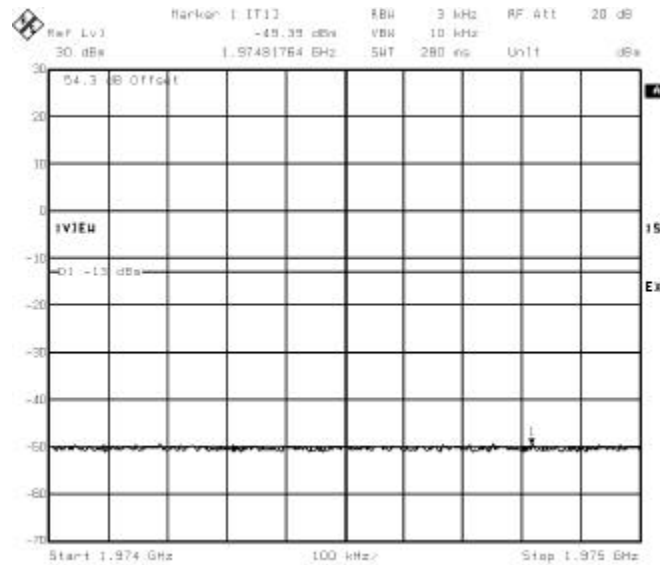


Figure 15 : 1974 – 1975 MHz



**Out-of-block emissions (Channel 810, Pmax),
Diplexer, GMSK modulation**

Figure 16 : 1991 – 1994.8 MHz

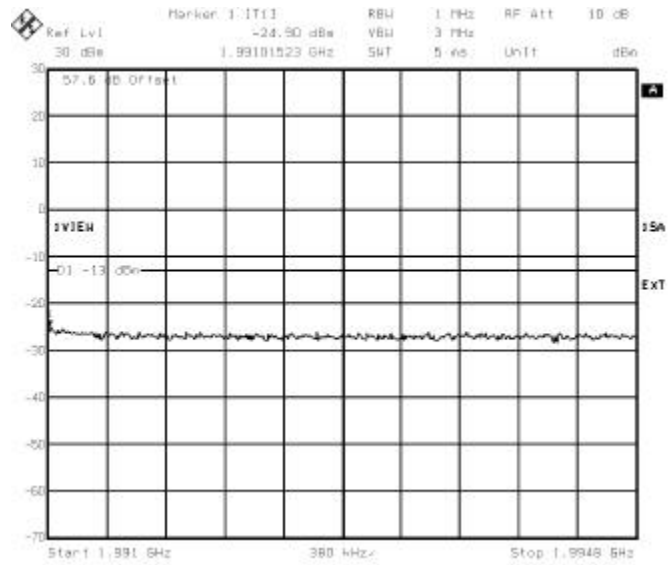
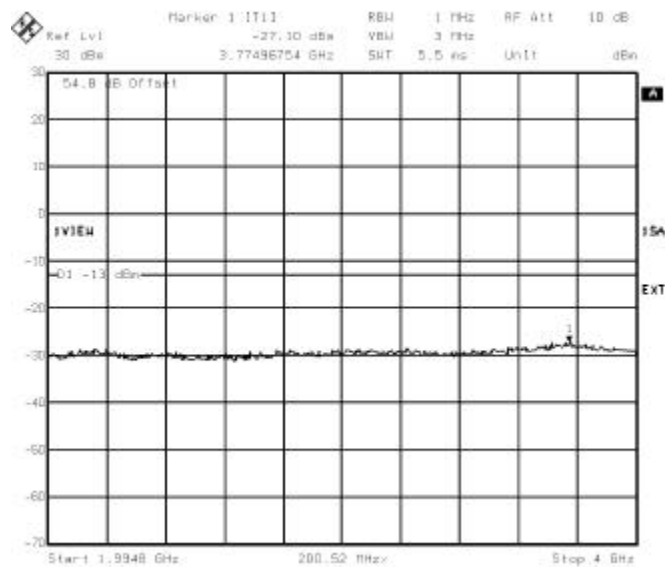


Figure 17 : 1994.8 MHz – 4 GHz



Out-of-block emissions (Channel 810, Pmax),
Diplexer, GMSK modulation

Figure 18 : 4 – 8 GHz

Figure 19 : 8 – 12 GHz

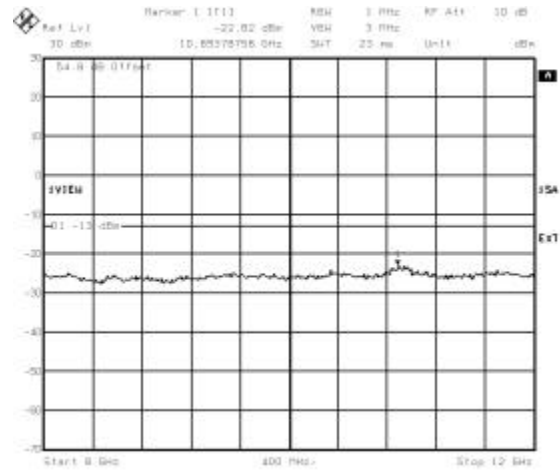
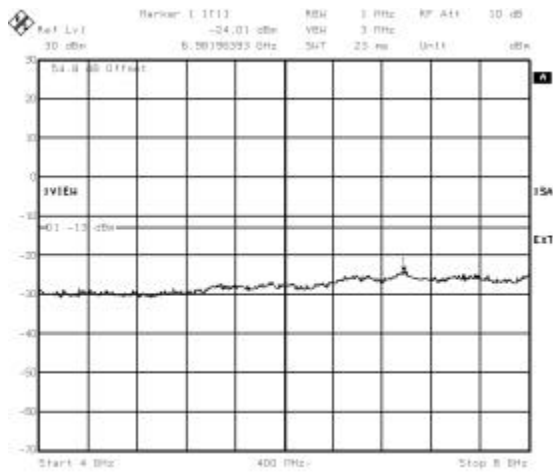
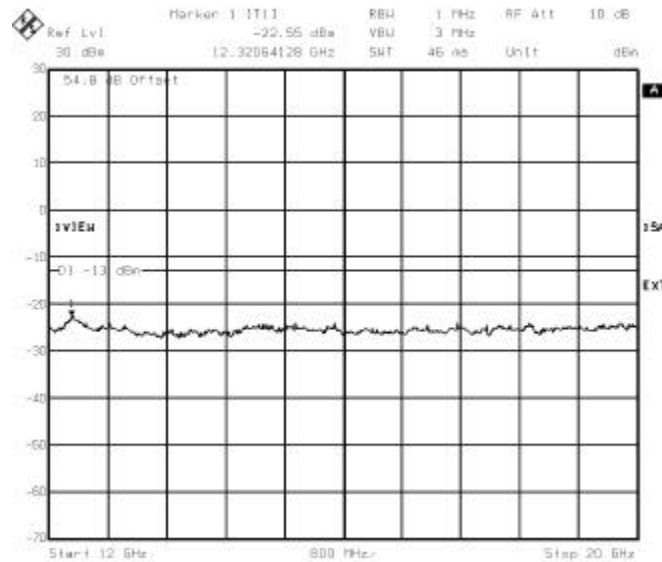


Figure 20 : 12 – 20 GHz



4.5.3. TEST RESULTS WITH H2D DUPLEXER CONFIGURATION

Table 7: Spurious emissions with the H2D for GMSK modulation

	Channel	Power level	Spurious emissions level (dBm)	Limit (dB)	Margin (dB)
A	512	Pmax	-15.1	-13	2.1
A	585	Pmax	-14.1	-13	1.1
D	587	Pmax	-14.9	-13	1.9
D	610	Pmax	-14.1	-13	1.1
B	612	Pmax	-15.2	-13	2.2
B	685	Pmax	-13.7	-13	0.7
E	687	Pmax	-14.4	-13	1.4
E	710	Pmax	-14.1	-13	1.1
F	712	Pmax	-14.4	-13	1.4
F	735	Pmax	-13.9	-13	0.9
C	737	Pmax	-14.3	-13	1.3
C	810	Pmax	-13.5	-13	0.5

GMSK modulation measurements:

Figures from 21 to 24 show sample plots for the case when the transmitter was tuned with the maximum power in H2D diplexer configuration for different Edge Channel 512 , 585, 737, 810.

Table 8: Spurious emissions with the H2D for 8PSK modulation

	Channel	Power level	Spurious emissions level (dBm)	Limit (dB)	Margin (dB)
A	512	Pmax	-16.9	-13	3.9
A	585	Pmax	-17.7	-13	4.7
D	587	Pmax	-16.5	-13	3.5
D	610	Pmax	-17.2	-13	4.2
B	612	Pmax	-16.8	-13	3.8
B	685	Pmax	-17	-13	4
E	687	Pmax	-16.2	-13	3.2
E	710	Pmax	-17.4	-13	4.4
F	712	Pmax	-16.2	-13	3.2
F	735	Pmax	-17.1	-13	4.1
C	737	Pmax	-16.2	-13	3.2
C	810	Pmax	-16.5	-13	3.5

8PSK modulation measurements:

Figures from 25 to 28 show sample plots for the case when the transmitter was tuned at the maximum power in H2D diplexer configuration.

Figure 21:

-1 MHz adjacent band (Channel 512, Pmax),
H2D, GMSK modulation

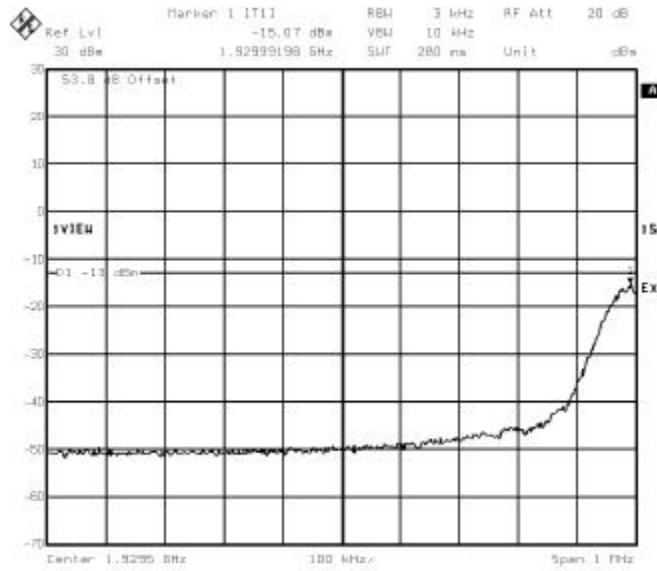


Figure 22 :

+1 MHz adjacent band (Channel 585, Pmax),
H2D, GMSK modulation

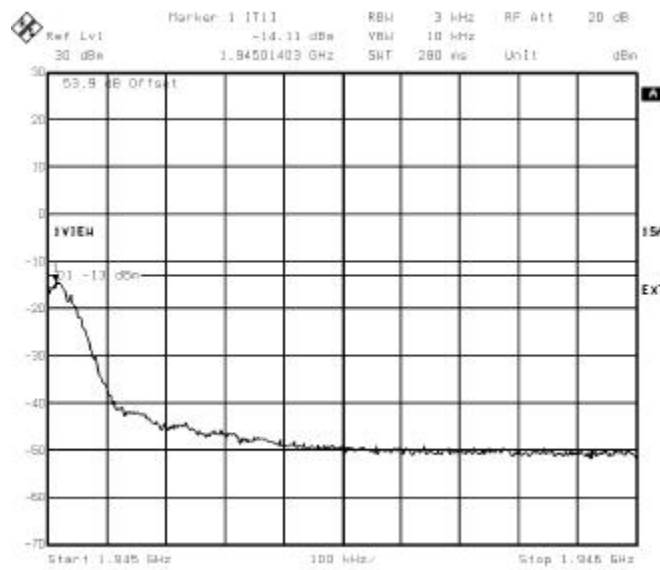


Figure 23 :
-1 MHz adjacent band (Channel 737, Pmax),
H2D, GMSK modulation

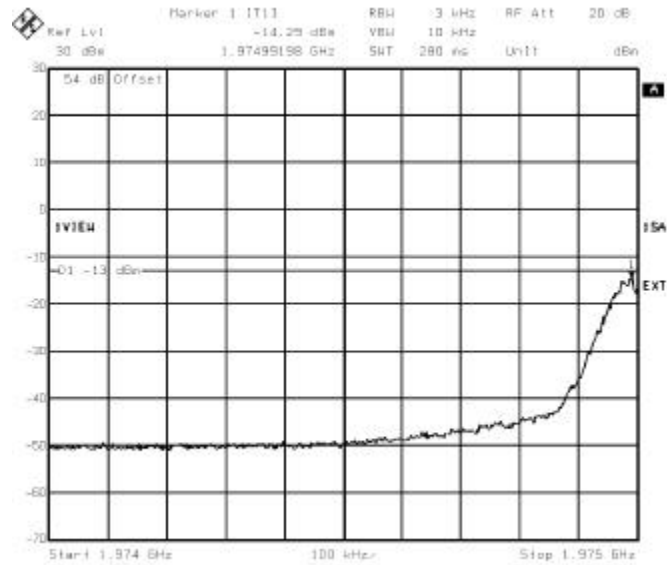


Figure 24 :
+1 MHz adjacent band (Channel 810, Pmax),
H2D, GMSK modulation

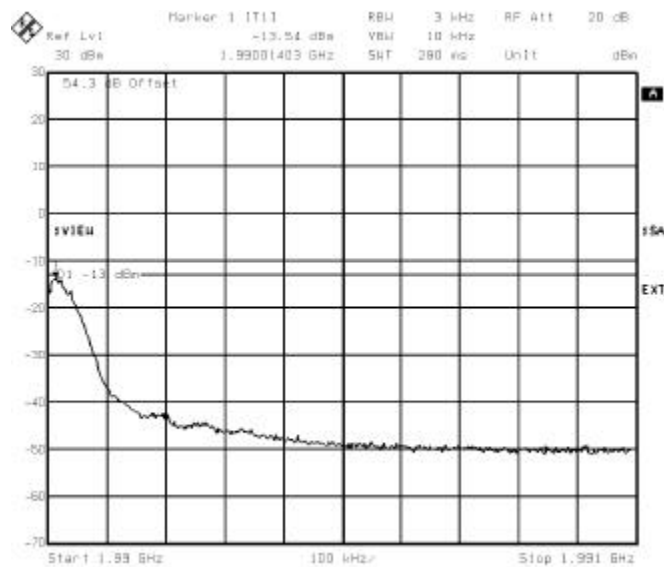


Figure 25 :
-1 MHz adjacent band (Channel 512, Pmax),
H2D, 8PSK modulation

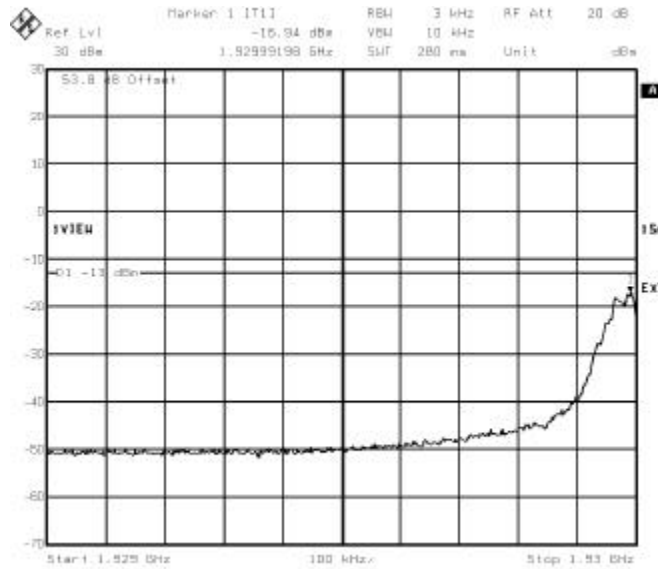


Figure 26 :
+1 MHz adjacent band (Channel 585, Pmax),
H2D, 8PSK modulation

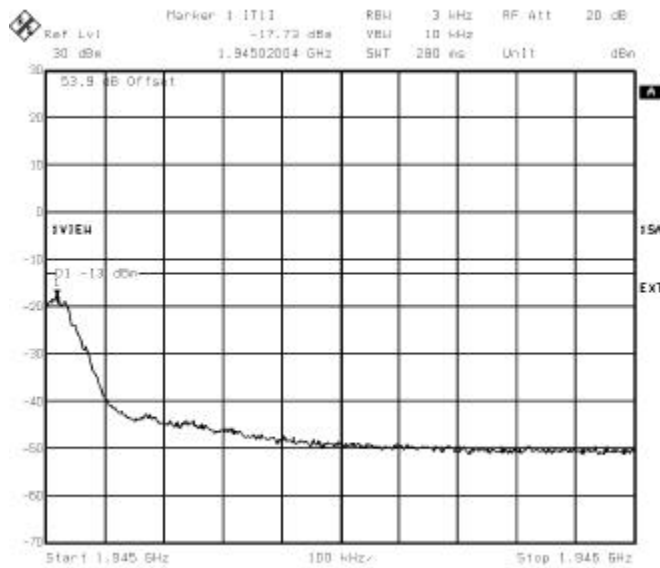


Figure 27 :
-1 MHz adjacent band (Channel 737, Pmax),
H2D, 8PSK modulation

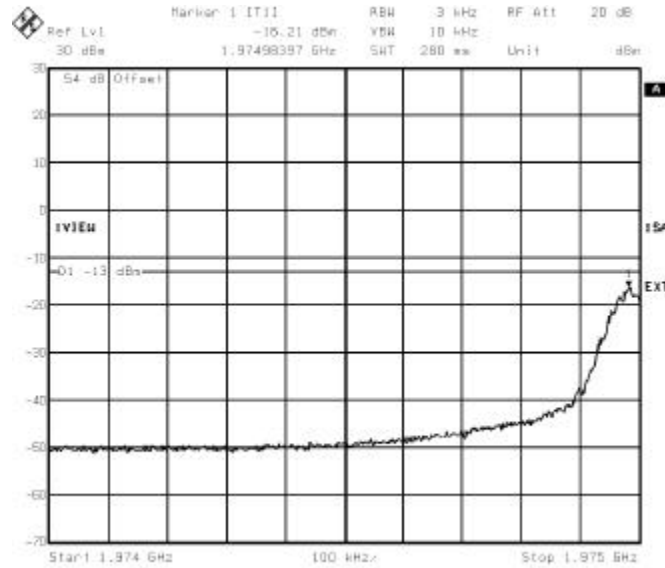
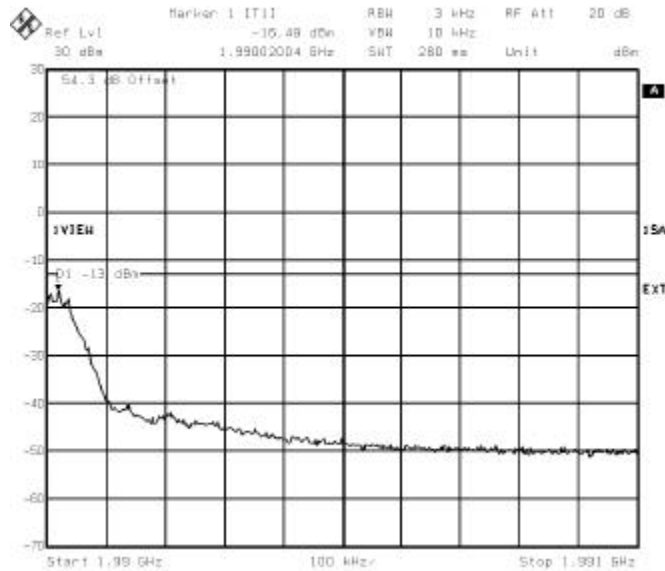


Figure 28 :
+1 MHz adjacent band (Channel 810, Pmax),
H2D, 8PSK modulation



4.5.4. TEST RESULTS WITH H4D DUPLEXER CONFIGURATION

Table 9: Spurious emissions with the H4D for GMSK modulation

	Channel	Power level	Spurious emissions level (dBm)	Limit (dB)	Margin (dB)
A	512	Pmax	-17.8	-13	4.8
A	585	Pmax	-17.1	-13	4.1
D	587	Pmax	-18	-13	5
D	610	Pmax	-16.3	-13	3.3
B	612	Pmax	-18.1	-13	5.1
B	685	Pmax	-16.4	-13	3.4
E	687	Pmax	-17.6	-13	4.6
E	710	Pmax	-16.6	-13	3.6
F	712	Pmax	-17.1	-13	4.1
F	735	Pmax	-16.6	-13	3.6
C	737	Pmax	-17.7	-13	4.7
C	810	Pmax	-16.3	-13	3.3

GMSK modulation measurements:

Figures from 29 to 32 show sample plots for the case when the transmitter was tuned with the maximum power in H4D diplexer configuration for different Edge Channel 512 , 585, 737, 810.

Table 10: spurious emissions with the H4D for 8PSK modulation

	Channel	Power level	Spurious emissions level (dBm)	Limit (dB)	Margin (dB)
A	512	Pmax	-20.2	-13	7.2
A	585	Pmax	-20.3	-13	7.3
D	587	Pmax	-19.2	-13	6.2
D	610	Pmax	-20.5	-13	7.5
B	612	Pmax	-18.9	-13	5.9
B	685	Pmax	-20.1	-13	7.1
E	687	Pmax	-18.8	-13	5.8
E	710	Pmax	-20	-13	7
F	712	Pmax	-19	-13	6
F	735	Pmax	-19.9	-13	6.9
C	737	Pmax	-19.4	-13	6.4
C	810	Pmax	-19.9	-13	6.9

8PSK modulation measurements:

Figures from 33 to 36 show sample plots for the case when the transmitter was tuned at the maximum power in H4D diplexer configuration.

Figure 29:
-1 MHz adjacent band (Channel 512, Pmax),
H4D, GMSK modulation

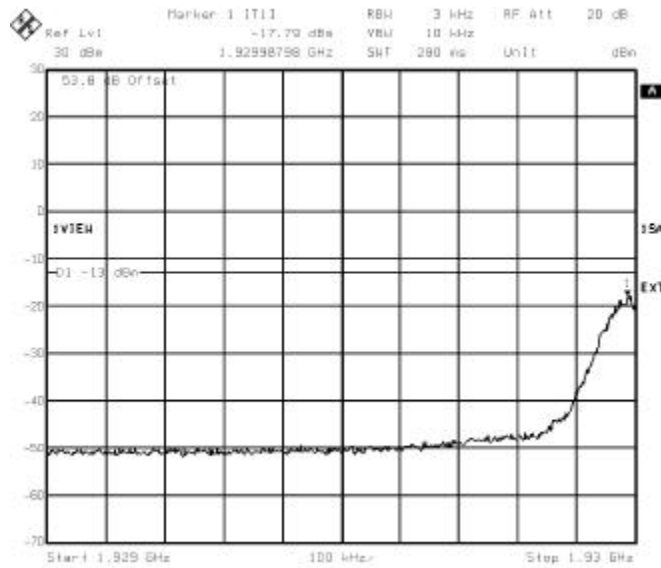


Figure 30 :
+1 MHz adjacent band (Channel 585, Pmax),
H4D, GMSK modulation

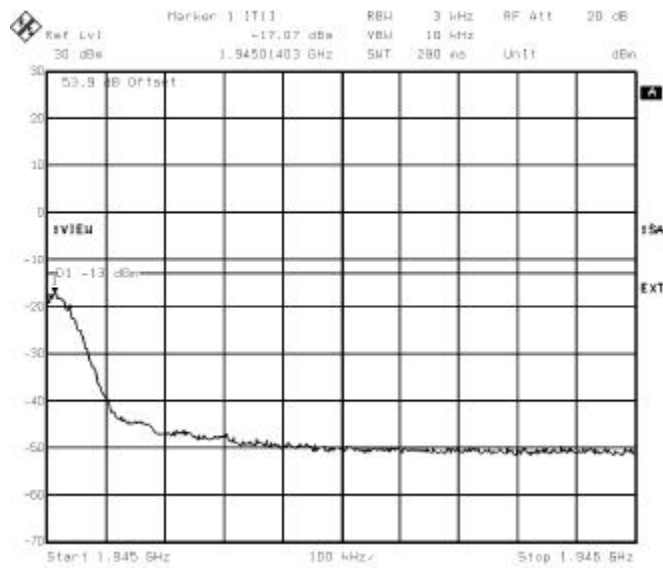


Figure 31 :
 -1 MHz adjacent band (Channel 737, Pmax),
 H4D, GMSK modulation

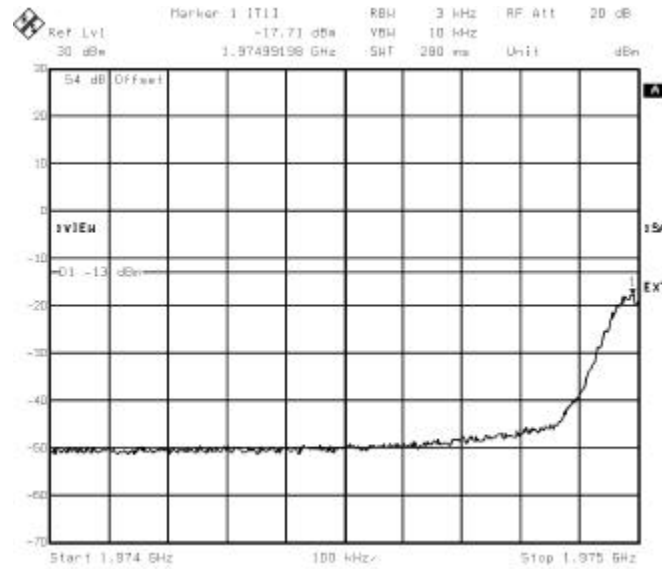


Figure 32 :
 +1 MHz adjacent band (Channel 810, Pmax),
 H4D, GMSK modulation

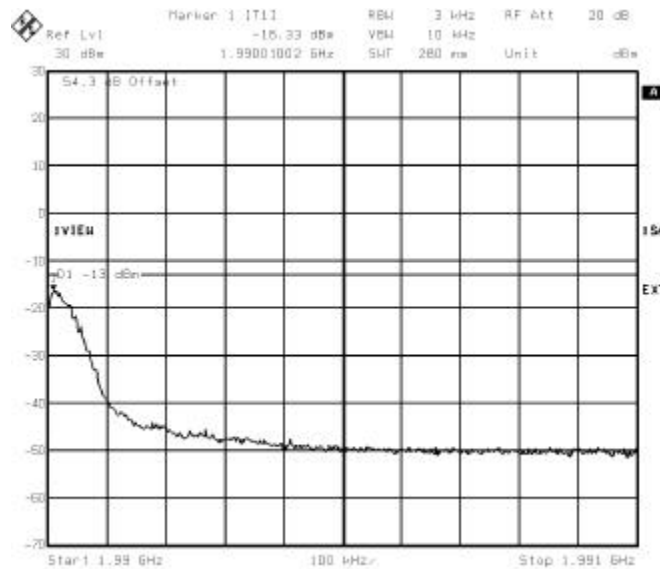


Figure 33:
-1 MHz adjacent band (Channel 512, Pmax),
H4D, 8PSK modulation

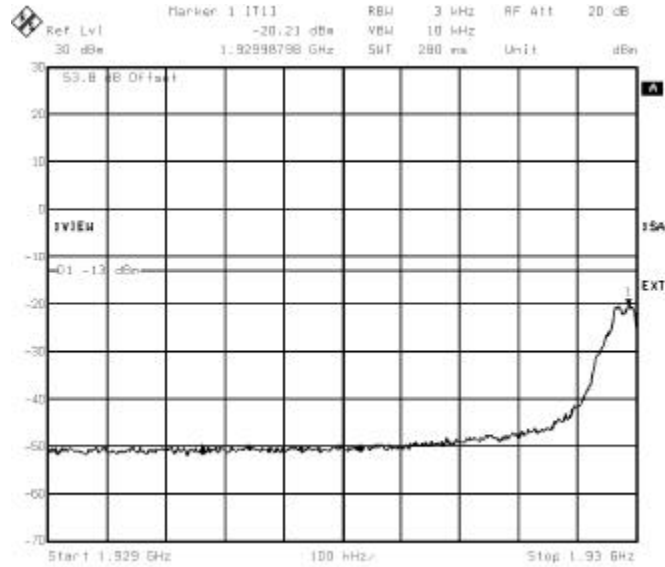


Figure 34 :
+1 MHz adjacent band (Channel 585, Pmax),
H4D, 8PSK modulation

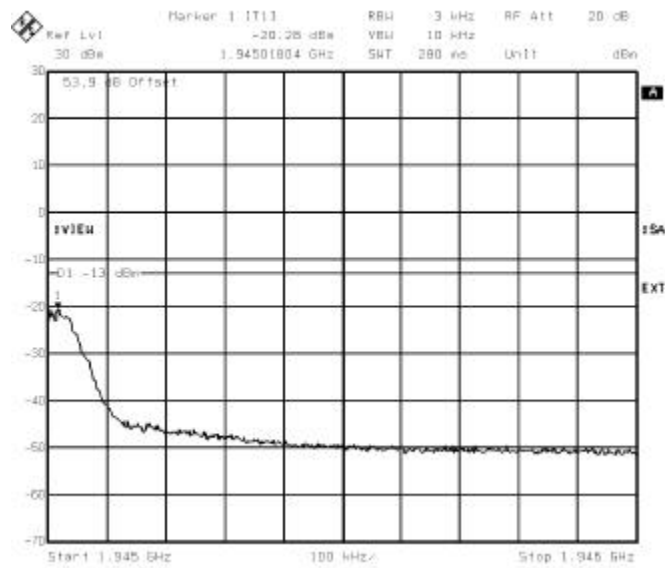


Figure 35:
-1 MHz adjacent band (Channel 737, Pmax),
H4D, 8PSK modulation

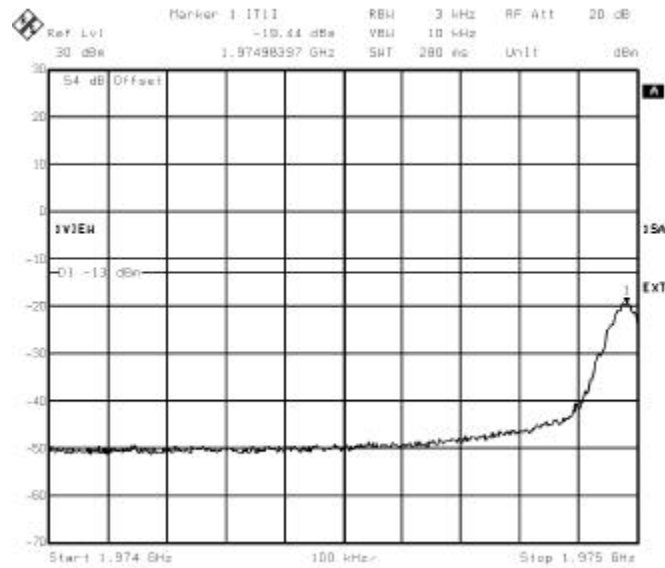
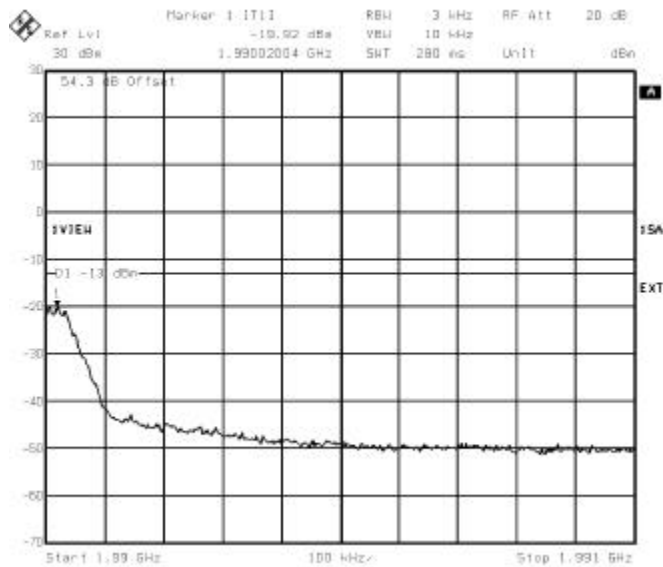


Figure 36 :
+1 MHz adjacent band (Channel 810, Pmax),
H4D, 8PSK modulation



4.5.5. CONCLUSION

▪ **GMSK modulation:**

Coupling Configuration	Antenna Output power (dBm)	Power reduction Measurement (qualification modules)	System Power limitation GMSK modulation
Diplexer	46.5	$P_{max} - 4 \text{ dB} = 42.5 \text{ dBm}$	$P_{max} - 6 \text{ dB} = 40.5 \text{ dBm}$
H2D	43	$P_{max} = 43 \text{ dBm}$	$P_{max} - 2 \text{ dB} = 41 \text{ dBm}$
H4D	40	$P_{max} = 40 \text{ dBm}$	$P_{max} = 40 \text{ dBm}$

For system limit, 2dB power reduction margin is taken to ensure the compliance for the case of diplexer and H2D due to eDRX/HePA products tolerances.

In order to comply with the emission limits in the 1 MHz bands immediately outside and adjacent to the frequency block, the absolute transmit power level of the block edge channels has been done at **$P_{max} - 6 \text{ dB} = 40.5 \text{ dBm}$** for the worst case in diplexer configuration.

▪ **8PSK modulation:**

eDRX and HePA 1900 support 8 PSK modulation.

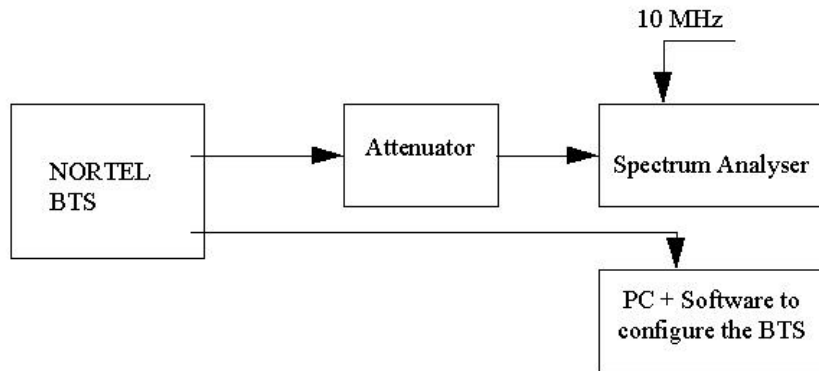
Coupling	Antenna port Output power (dBm)	Power reduction measurement	System Power limitation 8 PSK modulation
Diplexer	45.8	$P_{max} - 2 \text{ dB} = 43.8 \text{ dBm}$	$P_{max} - 2 \text{ dB} = 43.8 \text{ dBm}$
H2D	42	$P_{max} = 42 \text{ dBm}$	$P_{max} = 42 \text{ dBm}$
H4D	39	$P_{max} = 39 \text{ dBm}$	$P_{max} = 39 \text{ dBm}$

In the worst configuration (Diplexer) , the maximum power emission with 2dB reduced (**$P_{max} - 2 \text{ dB}$**) allows to be compliant with the spurious emission limits (-13 dBm) in the 1 MHz bands immediately outside and adjacent to the frequency block for 8PSK modulation .

4.5.6. TEST PROCEDURE

The equipment was configured as shown in schematic 3 .

Schematic 3 : Test configuration for Spurious emissions at antenna terminals



For adjacent channels emissions, the BTS nominal carrier frequency was adjusted to each block edge channel.

Channels 512 and 810 are those channels which are at the lower and upper edges of the PCS band respectively.

The BTS was configured to transmit at maximum power (static level 0) or a reduced power :

- for GMSK modulation, in mode GMSK no synchro
- for 8PSK modulation, in mode logical PDCH, Type GPRS, coding MCS5 .

For these measurements, the resolution bandwidth of the spectrum analyzer was set to at least 1% of the emission bandwidth. In this case the emission bandwidth measured was closed to 300 kHz. Therefore, the resolution bandwidth was set to 3 kHz.

The spectrum analyzer had the following settings for adjacent band:

Resolution bandwidth :	3 kHz
Video bandwidth :	10 kHz
Span :	1 MHz
Reference Level Offset :	Corrected to account for cable(s), filter and attenuator losses
Level range :	100 dB
Sweep time :	Coupled
Detector :	Sample
Trace :	Average
Sweep count :	200

For all other measurements the BTS carrier frequency was adjusted to Channel 810.

The spectrum analyzer had the following settings for out of block emissions.

Resolution bandwidth :	1 MHz
Video bandwidth :	1 MHz

The emissions were investigated up to the tenth harmonic of the fundamental emission (20 GHz).

The measured level of the emissions was recorded and compared to the -13 dBm limit.

4.6. NAME OF TEST: FREQUENCY STABILITY

Frequency stability has been tested in worst BTS configuration (BTS S12000) case for PCS 1900 HePA introduction.

This BTS S12000 compliance ensures the frequency stability compliance for BTS S8000.

Table 6 shows the Frequency Stability for channel 661 (F=1960 MHz) in BTS 12000 OUTDOOR configuration (8 HePA) under extreme conditions.

Table 11: Frequency Stability in BTS S12000 Outdoor configuration – Channel661

Temperature (°C)	Maximum Carrier Frequency Deviation (Hz)		
	85% Nominal Supply voltage 195 V AC	Nominal Supply voltage 230V AC	115% Nominal Supply voltage 264 V AC
-30	50.3	56.8	47.4
-20	56.9	56.5	45.4
-10	57.7	56.6	43.7
0	62.3	49.2	61.5
10	49.7	54.6	48.0
20	49.2	58.7	56.3
30	56.5	49.4	53.9
40	58.7	71.0	63.0
50	60.7	61.0	56.6

The maximum frequency deviation allowed is 90 Hz.

The maximum deviation measured (71Hz) is sufficient to ensure that the fundamental emission stays within the authorized frequency block.

The S12000 Outdoor BTS complies with the requirement which involves the compliance for BTS S8000.

TEST CONFIGURATION :

Thermal tests have been performed with OUTDOOR BTS S12000.

The BTS S12000 must operate under the following external extreme temperatures:

- BTS S12000 Outdoor : - 30°C / + 50 °C

Frequency stability test is performed under following extreme conditions:

- Temperature from -30°C to +50°C at intervals of 10 degrees.
- With AC power supply variations: 195 VAC , 230 VAC, 264 VAC.

All Modules (eDRX and HePA) run with nominal power regulation at maximum power (60W) in GMSK modulation. The eDRX/HePA were configured to transmit at maximum power (Static level 0).

BTS S12000 is equipped with eDRX/HePA in slots 0, 1, 2, 3, 6, 7, 8, 9 with following emission configuration :

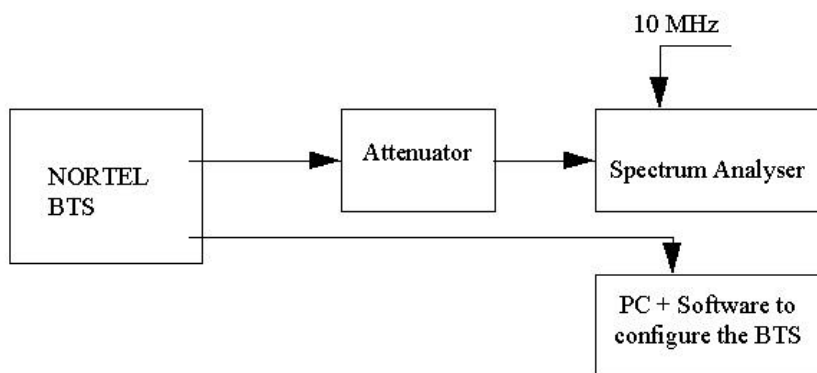
slot 0 : BCCH →	C542	slot 6 : BCCH →	C632
slot 1 : TCH →	C661	slot 7 : BCCH →	C692
slot 2 : BCCH →	C572	slot 8 : BCCH →	C722
slot 3 : BCCH →	C602	slot 9 : BCCH →	C752

Frequency deviation is measured in slot 1 on channel C661.

A period of at least one hour was allowed prior to measurement to ensure that all the components of the oscillator circuit was stabilized at each temperature.

The equipment was configured as shown in figure 16.

Figure 16: Test configuration for Frequency Stability



5. EXHIBIT 2 : TEST REPORT FOR PCS900 PA 30 W

5.1. INTRODUCTION

The following information is submitted for update of the type acceptance of a Broadband PCS Base Station for Northern Telecom, Inc., in accordance with FCC Part 24, Subpart E and Part 2, Subpart J of the FCC Rules and Regulations.

The measurement procedures were in accordance with the requirements of Part 2.

5.2. MEASUREMENT RESULTS

Table 1 is a summary of the measurement results for this update.

Table 1 : Measurement Results Summary

FCC Measurement Specification	IC Limit Specification	Description	Result	Note
2.1046(a), 2.1033(c)(8) 24.232	6.2	RF Power Output	Complies	Refer to [R2]
2.1049		Occupied Bandwidth	Complies	[R5]
2.1051, 2.1057 24.238	6.3 6.4	Spurious Emissions at Antenna Terminals	Complies	[R6]
2.1055 24.235	7.0	Frequency Stability	Complies	

5.3. NAME OF TEST : 2.1046 RF POWER OUTPUT

TEST RESULTS

Table 2 shows the test results for RF Output Power with the diplexer configuration :

- For GMSK modulation
- For 8PSK modulation supported by eDRX/eSCPA 1900.

Band	Radio Channel	Frequency (MHz)	Measured RF Output Power (dBm) GMSK	Measured RF Output Power (dBm) 8PSK	Limit (dBm)
A	512	1930,2	43.8	43.9	50
A	548	1937,4	43.9	44.2	50
A	585	1944,8	44	44.3	50
D	587	1945,2	44	44.2	50
D	598	1947,4	44	44.3	50
D	610	1949,8	44	44.3	50
B	612	1950,2	44	44.3	50
B	648	1957,4	44.1	44.3	50
B	685	1964,8	44.1	44.3	50
E	687	1965,2	44.1	44.3	50
E	698	1967,4	44.1	44.3	50
E	710	1969,8	44.1	44.1	50
F	712	1970,2	44.1	44.1	50
F	723	1972,4	44	44.1	50
F	735	1974,8	44	44.1	50
C	737	1975,2	44	44.2	50
C	773	1982,4	44	44	50
C	810	1989,8	43.8	44	50

5.4. NAME OF TEST : 2.1049 OCCUPIED BANDWIDTH

TEST RESULTS

The occupied bandwidth is defined as the width of the signal between two points, one below the carrier center frequency and one above the carrier center frequency, outside of which all emissions are attenuated at least 26 dB below the transmitter power.

The maximum occupied bandwidth was found to be:

- 320 kHz , measured on channel 661, f = 1960.0 MHz GMSK modulation.
- 318 kHz , measured on channel 661, f = 1960.0 MHz 8PSK modulation.

Figure 1: Sample plot for occupied bandwidth . GMSK modulation

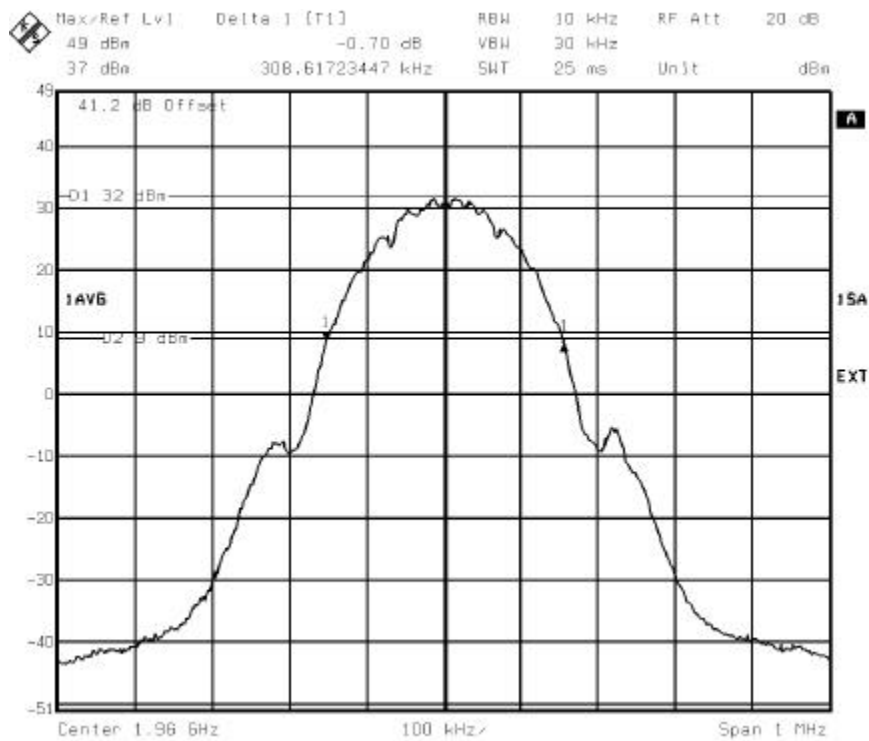
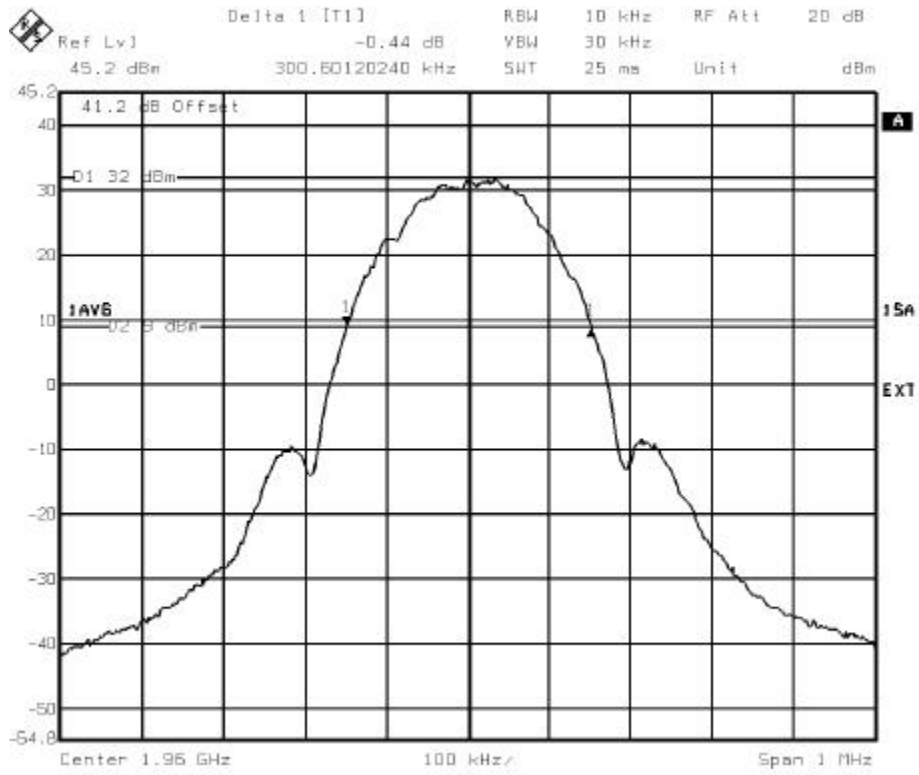


Figure 2 : Sample plot for occupied bandwidth . 8PSK modulation



5.5. SPURIOUS EMISSIONS AT ANTENNA TERMINALS

TEST RESULTS

The reference level for spurious emissions at the antenna terminals is taken from the measured output power (43.9 dBm = 24.5 Watts).

Therefore the spurious emissions must be attenuated by at least $43 + 10 \cdot \log(24.5) = 56.9$ dB. The measured output power was 43.9 dBm ; therefore the limit is $43.9 - 56.9 = -13$ dBm.

Spurious measurement is performed with the worst configuration with Duplexer coupling and 30W Power amplifier .

The Nominal power at antenna connector : PD max =44dBm.

The test compliance with duplexer involves the compliance with H2D (two input coupler with 3dB loss coupling associated with duplexer) and the compliance with H4D configuration (four input coupler with 7dB loss coupling associated with duplexer).

Tables 3 and 4 show the results for Spurious Emissions at Antenna Terminals.

Table 3 : Test results for Spurious Emissions at Antenna Terminals with the duplexer for GMSK modulation.

	Channel	Power emission level	Spurious Emissions Level (dBm)	Limit (dBm)	Margin (dB)
A	512	Pmax - 4 dB	-16.6	-13	3.6
A	585	Pmax - 4 dB	-14.1	-13	1.1
D	587	Pmax - 4 dB	-16.9	-13	3.9
D	610	Pmax - 4 dB	-14.5	-13	1.5
B	612	Pmax - 4 dB	-17.5	-13	4.5
B	685	Pmax - 4 dB	-14.1	-13	1.1
E	687	Pmax - 4 dB	-17.2	-13	4.2
E	710	Pmax - 4 dB	-14.9	-13	1.9
F	712	Pmax - 4 dB	-17.2	-13	4.2
F	735	Pmax - 4 dB	-14.5	-13	1.5
C	737	Pmax - 4 dB	-17.1	-13	4.1
C	810	Pmax - 4 dB	-14.4	-13	1.4

Table 4 : Test re sults for Spurious Emissions at Antenna Terminals with the diplexer for 8PSK modulation

	Channel	Power emission level	Spurious Emissions Level (dBm)	Limit (dBm)	Margin (dB)
A	512	P max	-14.9	-13	1.9
A	585	P max	-13.3	-13	0.3
D	587	P max	-15.1	-13	2.1
D	610	P max	-13.8	-13	0.8
B	612	P max	-14.9	-13	1.9
B	685	P max	-13.3	-13	0.3
E	687	P max	-14.6	-13	1.6
E	710	P max	-13.5	-13	0.5
F	712	P max	-14.5	-13	1.5
F	735	P max	-13.8	-13	0.8
C	737	P max	-14.6	-13	1.6
C	810	P max	-14.1	-13	1.1

Table 5 : Test results for Spurious Emissions at Antenna Terminals with diplexer for GMSK modulation.

Frequency (MHz)	Spurious Emissions Level (dBm)	Limit (dBm)	Margin (dB)
50	-36	-13	23
68	-44.4	-13	31.4
1231	-41	-13	28
1972.5	-47.1	-13	34.1
1974.8	-58	-13	45
1991	-39.8	-13	26.8
3750.8	-32	-13	19
6966	-28.4	-13	15.4
10926	-27.7	-13	14.7
12337	-27.2	-13	14.2

Notes :

GMSK modulation measurements :

Figures from 3 to 4 show sample plots for the case when the transmitter was tuned with the power reduced by 4 dB in diplexer configuration for different Edge Channel 512 , 585, 737, 810.

8PSK modulation measurements:

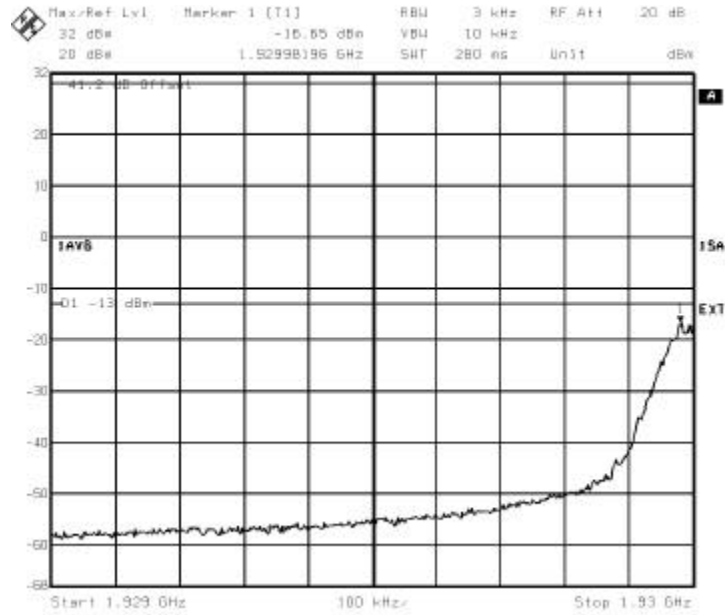
Figures from 5 to 6 show sample plots for the case when the transmitter was tuned at maximum power in diplexer configuration.

Out of band measurement in GMSK modulation:

Figures from 7 to 10 show sample plots for frequency spans from 0 to 20 GHz with emission on channel 810 at maximum power with diplexer configuration.

Figure 3 :

**-1 MHz adjacent band (Channel 512, Pmax - 4 dB)
Diplexer only, GMSK modulation**



**+1 MHz adjacent band (Channel 585, Pmax - 4 dB)
Diplexer only, GMSK modulation**



Figure 4 :

**-1 MHz adjacent band (Channel 737, Pmax - 4 dB)
Diplexer only, GMSK modulation**



**+1 MHz adjacent band (Channel 810, Pmax - 4 dB)
Diplexer only, GMSK modulation**

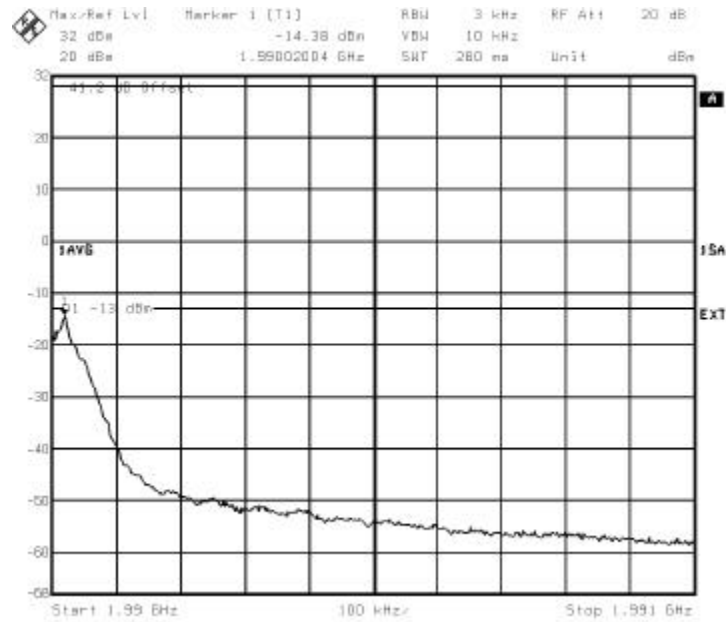
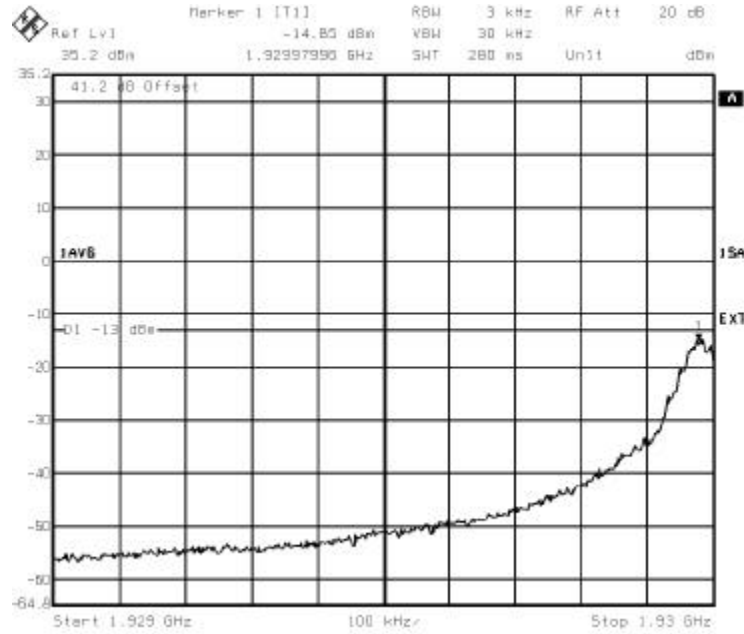


Figure 5:

**- 1 MHz adjacent band (Channel 512, Pmax)
Diplexer only, 8PSK modulation.**



**+ 1 MHz adjacent band (Channel 585, Pmax)
Diplexer only, 8PSK modulation.**

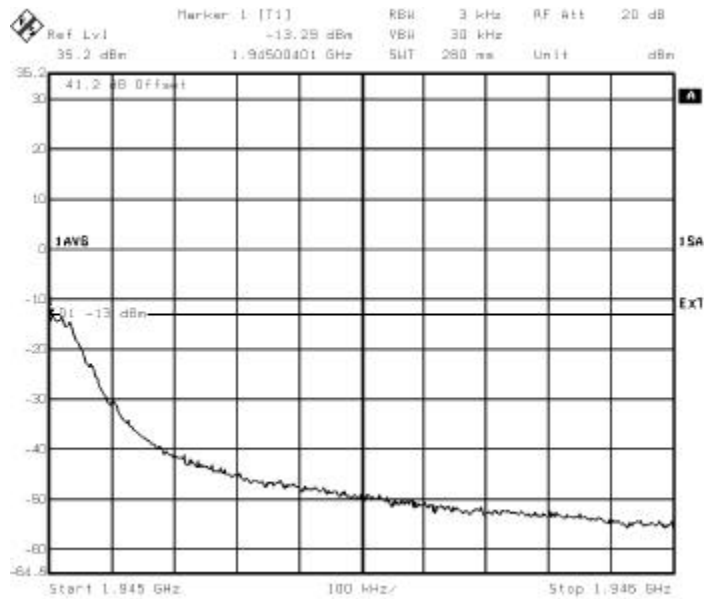
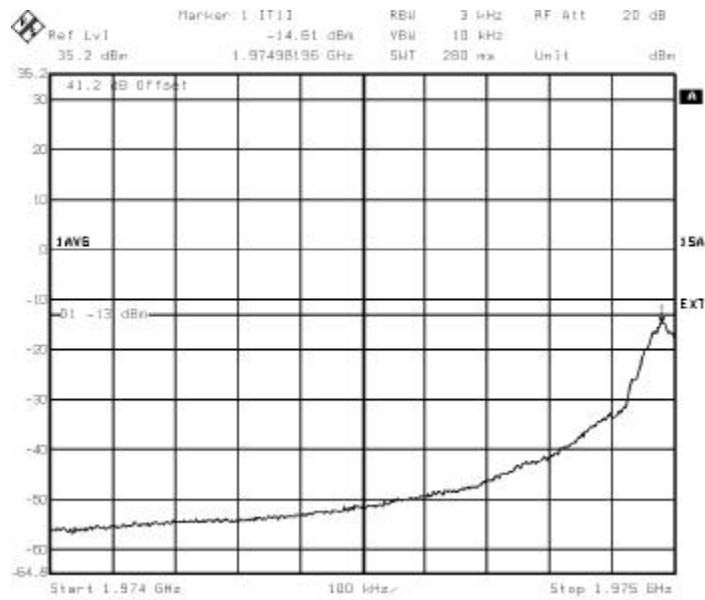


Figure 6 :

**- 1 MHz adjacent band (Channel 737, Pmax)
Diplexer only, 8PSK modulation.**



**+ 1 MHz adjacent band (Channel 810, Pmax)
Diplexer only, 8PSK modulation.**

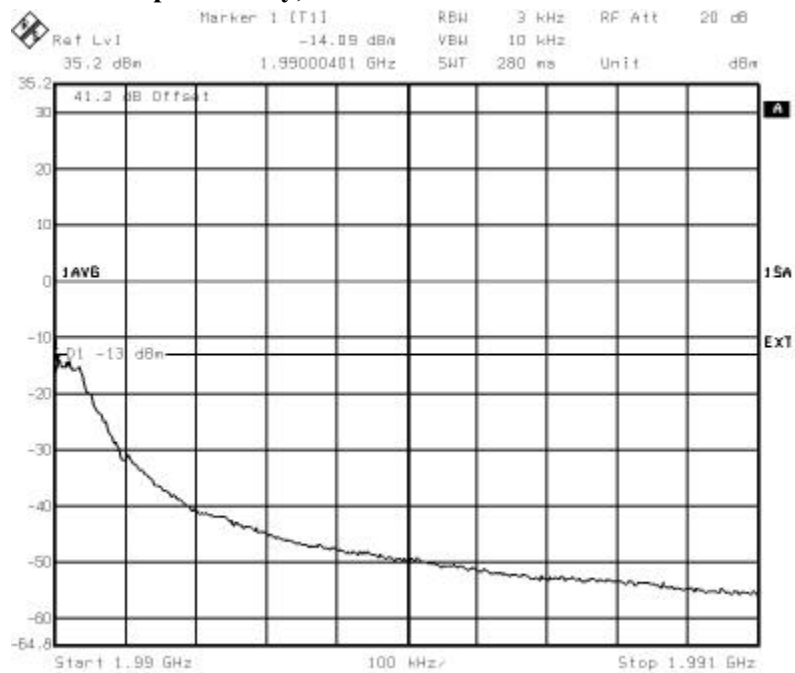
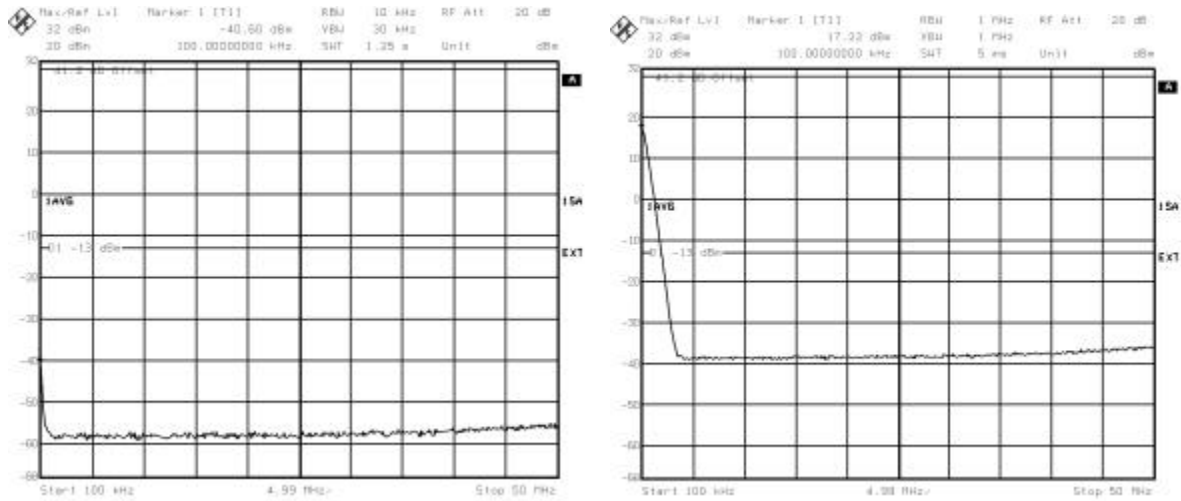


Figure 7: Out of block emissions (Channel 810, Pmax)

GMSK modulation

Band 100kHz – 50 MHz



RBW = 10 kHz

RBW = 1 MHz (*)

(*) Note : spectrum lines at 100 kHz is internal DC spectrum line of analyzer.

Band 50 MHz – 500MHz

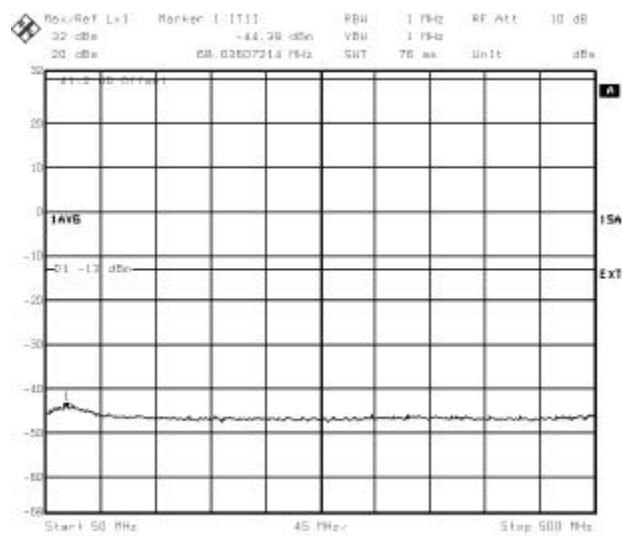
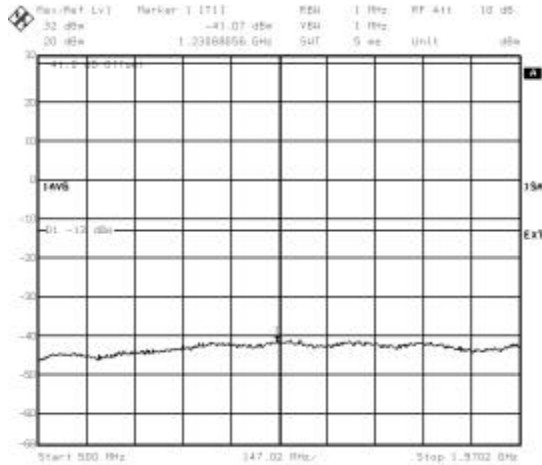
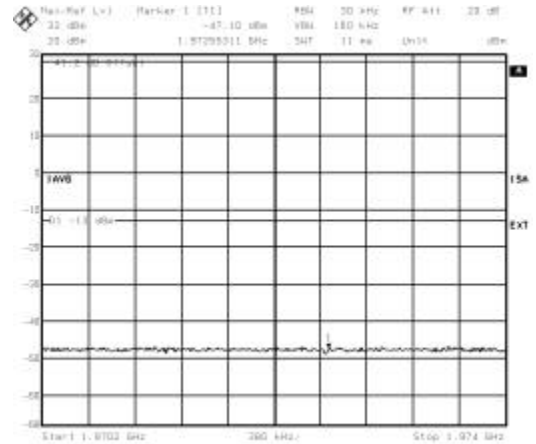


Figure 8 : Out of block emissions (Channel 810, Pmax)
GMSK modulation

Band 500 MHz- 1970.2 MHz



Band 1970.2 – 1974 MHz



Band 1974 MHz - 1975 MHz

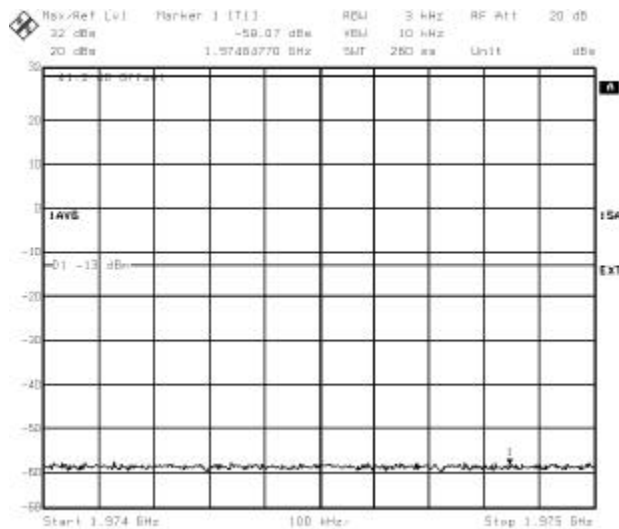


Figure 9: Out of block emissions (Channel 810, Pmax)
GMSK modulation

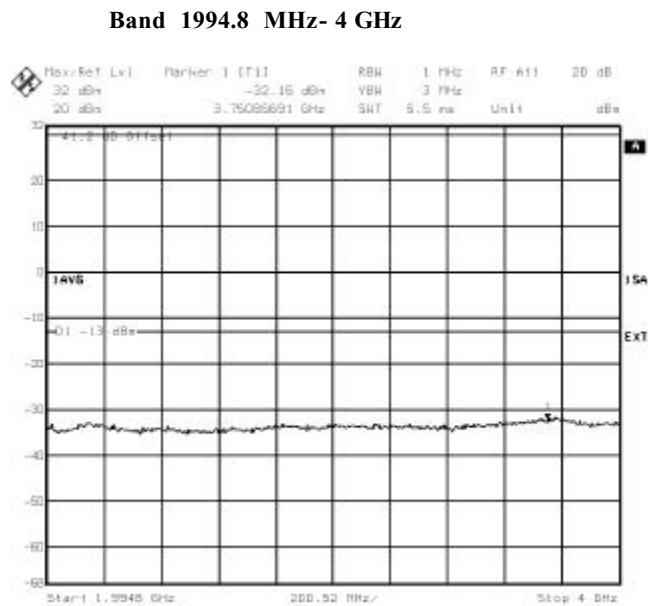
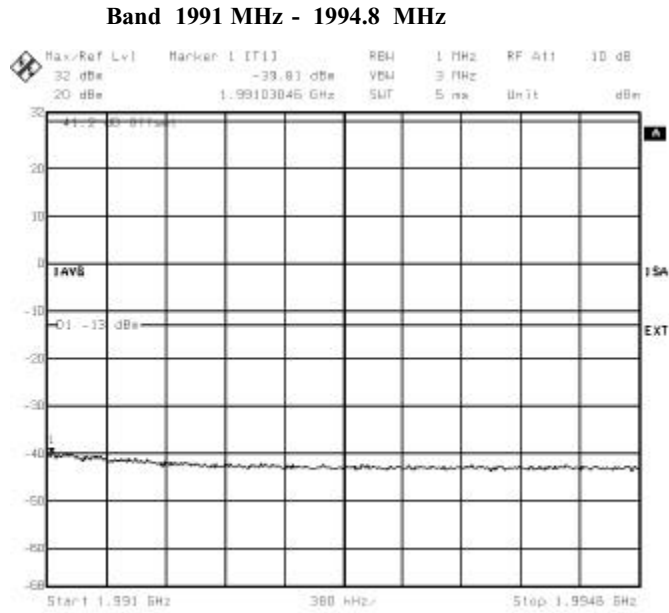
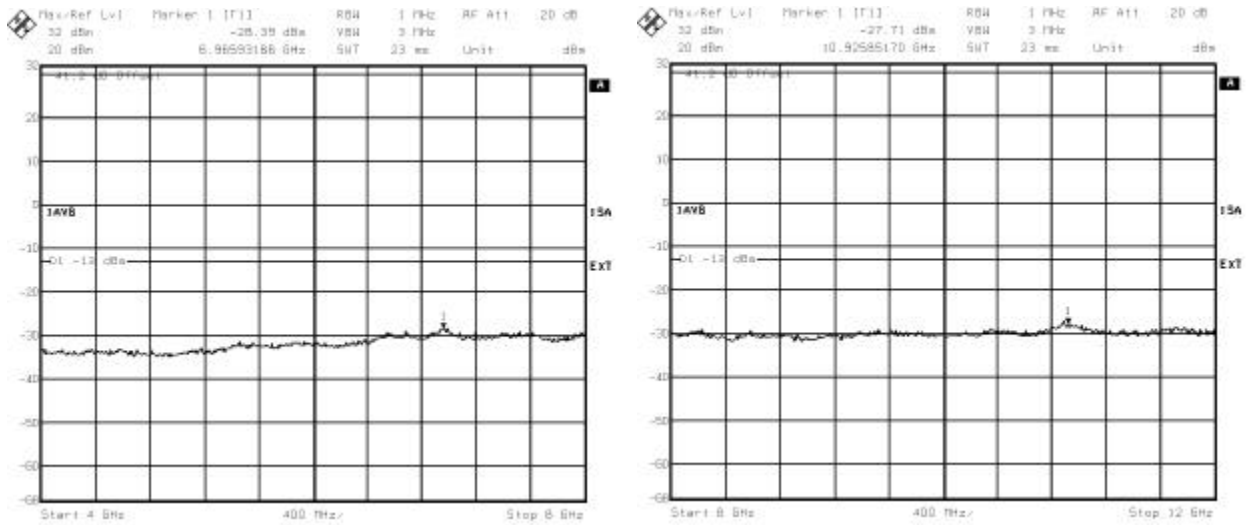
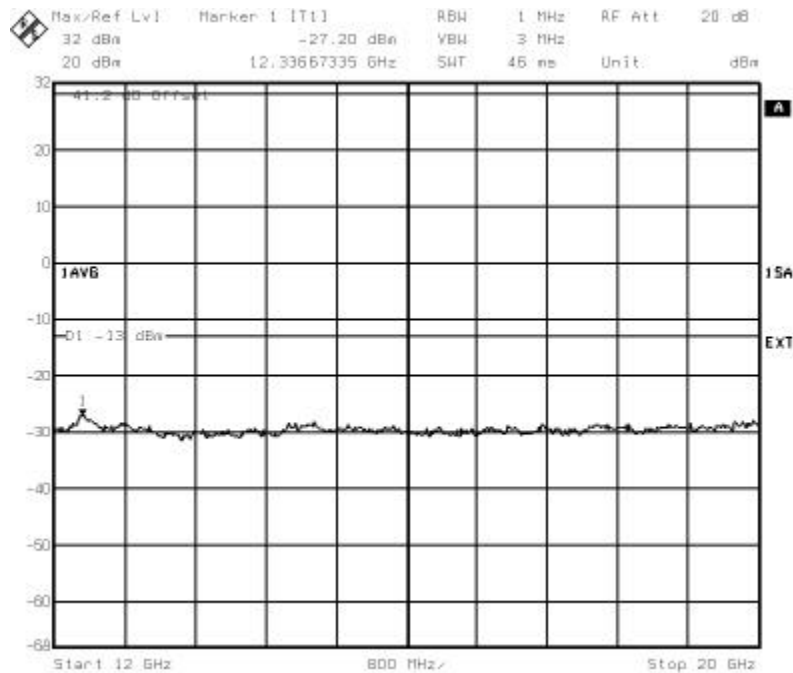


Figure 10: Out of block emissions (Channel 810, Pmax)
GMSK modulation

Band 4 – 12 GHz



Band 12 - 20 GHz



Conclusion :

Table 6 : Edge channel Power limitation for PCS1900 30W emission.

Coupling configuration	System Power limitation GMSK modulation	System Power limitation 8 PSK modulation (If 8PSK is supported by modules)
Duplexer Tx Filter	Power Limitation : Pmax – 4 dB = 40 dBm	Pmax= 44 dBm
H2D	Pmax = 41 dBm	Pmax= 41 dBm
H4D	Pmax = 37 dBm	Pmax = 37 dBm

▪ **GMSK modulation:**

The worst case is the Duplexer configuration and emission power has been done at PD max - 4dB = 40 dBm

In order to comply with the emission limits in the 1 MHz bands immediately outside and adjacent to the frequency block, the absolute transmit power level of the block edge channels is set to **40 dBm** for GMSK modulation.

▪ **8PSK modulation:**

eDRX and eSCPA 1900 support 8 PSK modulation.

In the worst configuration (Duplexer) , **maximum emission power P=44 dBm** allows to be compliant with the spurious emission limits (-13 dBm) in the 1 MHz bands immediately outside and adjacent to the frequency block for 8PSK modulation.

5.6. NAME OF TEST : 2.1055 FREQUENCY STABILITY

The frequency stability shall be sufficient to ensure that the fundamental emission stays within the authorized frequency block.

TEST RESULTS:

Table 7 shows frequency stability checked during DRX New Design introduction [R2].

Table 7 : Frequency Stability in BTS S8000 Outdoor configuration – Channel 661

Temperature (°C)	Maximum Carrier Frequency Deviation (Hz)		
	85% Nominal Supply voltage 195 V AC	Nominal Supply voltage 230V AC	115% Nominal Supply voltage 264 V AC
-30	-66	64	-61
-20	67	45	+48
-10	89	68	+51
0	-49	62	+65
10	+66	73	-68
20	+56	67	+53
30	+65	-64	+48
40	-39	+42	+35
50	+25	-42	+42

Tables 8 shows the frequency Stability during eDRX/eSCPA1900 introduction in quick test bench configuration in extreme conditions .

Table 8: Frequency Stability in quick test bench configuration – Channel 661

External BTS temperature		Module Temperature (°C)	Maximum Carrier Frequency Deviation (Hz) in quick test bench configuration		
BTS S8000 Indoor	BTS S8000 Outdoor		DC Supply Voltage DRX -40V PA -36V	DC Supply Voltage DRX -48V PA -48V	DC Supply Voltage DRX -57V PA -60V
-5		-5	13.88	14.08	10.78
5	-40 to 0	5	14.33	12.40	13.30
15	5	15	12.79	12.98	14.14
25	15	25	-13.50	-16.98	13.17
35	25	35	-13.69	12.46	12.40
45	35	45	14.21	12.46	12.79
	45	55	12.79	-12.46	14.01
	50	65	-13.17	-17.18	-15.95

The maximum frequency deviation allowed is 89 Hz.

The maximum deviation measured 73Hz is more than sufficient to ensure that the fundamental emission stays within the authorized frequency block.

The S8000 Outdoor/Indoor BTS still complies with the requirement.

TEST PROCEDURE

Thermal tests has been performed with modules eDRX with eSCPA inside BTS8000 .

These tests have shown that thermal features of eDRX/eSCPA were equivalent or better than old DRX and PA versions inside BTS S8000 in extreme conditions.

The BTS S8000 must operate in following external extreme temperatures:

- BTS S8000 Indoor : - 5°C / +45 °C
- BTS S8000 Outdoor : -40°C / +50°C

These external temperature ranges involve the extreme temperature range from -5°C to +65°C on eDRX and eSCPA modules .

Frequency stability are checked in BTS S8000 Indoor at ambient temperature.

Frequency stability test is also performed with a quick test bench for module configuration in following extreme conditions :

- Temperature from -5 to +65 centigrade at intervals of 10 centigrades
- With DC power supply variations eSCPA (-36V/-60V) and eDRX (-40V/-57V)

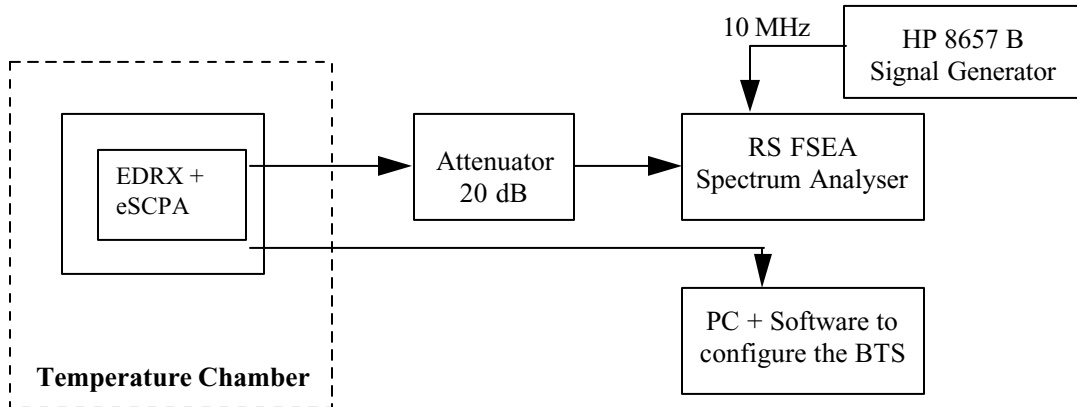
Modules (eDRX – eSCPA) run with nominal power regulation at maximum power (30W) in GMSK modulation.

The eDRX/eSCPA was configured to transmit at maximum power (Static level 0).

A period of at least one hour was allowed prior to measurement to ensure that all of the components of the oscillator circuit had stabilized at each temperature.

The equipment was configured as shown in figure 11.

Figure 12 : Test configuration for Frequency Stability



6. EXHIBIT 3: TEST REPORT - PA30W GSM850

6.1. INTRODUCTION

The following information is submitted for update of the type acceptance of a Broadband GSM Base Station for Nortel Networks, in accordance with FCC Part 22, Subpart H and Part 2, Subpart J of the FCC Rules and Regulations. The measurement procedures were in accordance with the requirements of Part 2.999.

6.2. MEASUREMENTS RESULTS

Table 1 is a summary of the measurement results for this update.

Table 1 : Measurement Results Summary

FCC Measurement Specification	IC Limit Specification RSS 128 Section	Description	Result
2.1046	7.1	RF Power Output	Complies
2.1047	7.2	Modulation characteristics	Complies
2.1049		Occupied Bandwidth	Complies
2.1051	7.4 , 7.5	Spurious Emissions at Antenna Terminals	Complies
2.1055	8.1 , 8.2	Frequency Stability	Complies

Measurements in GSMK modulation for GSM 850 Band are available in document [R7].

Additional GSMK tests are performed for the Edge channel of sub-band A”, A, B, A’, B’.

Additional Tests are also performed in 8PSK modulation.

6.3. NAME OF TEST: 2.1046 RF POWER OUTPUT

FCC REQUIREMENTS

4.3.1.1. FCC PART 22.913

- (a) Base stations are limited to 1640 watts peak equivalent isotropically radiated power (e.i.r.p.) with an antenna height up to 300 meters HAAT. See 24.53 for HAAT calculation method. Base station antenna heights may exceed 300 meters with a corresponding reduction in power. In no case may the peak output power of a base station transmitter exceed 500 watts.
- (b) Peak transmit power must be measured over any interval of continuous transmission using instrumentation calibrated in terms of an rms-equivalent voltage. The measurement results shall be properly adjusted for any instrument limitations, such as detector response times, limited resolution bandwidth capability when compared to the emission bandwidth, sensitivity, etc., so as to obtain a true peak measurement for the emission in question over the full bandwidth of the channel.

TEST RESULTS

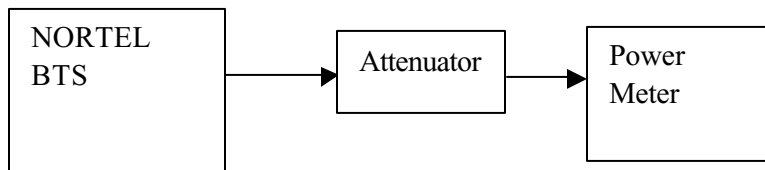
Table 2 shows the test results for RF Output Power.

Radio Channel	Frequency (MHz)	RF Output Power (dBm) GMSK modulation	RF Output Power (dBm) 8PSK modulation	Maximum Rated Power (dBm)	Limit (dBm)
128	869.2	43.4	44.2	44,8 (30 W)	50
131	869.8	43.4	44.3		
133	870.2	43.4	44.3		
181	879.8	43.7	44.5		
183	880.2	43.6	44.5		
231	889.8	43.5	44.4		
233	890.2	43.5	44.4		
238	891.2	43.5	44.3		
241	891.8	43.5	44.4		
251	893.8	43.5	44.2		

TEST PROCEDURE

The equipment was configured as shown in schematic 1.

Schematic 1: Test configuration for RF Output Power



The BTS was configured to transmit at maximum power (static level 0) :

- for GMSK modulation, in mode GMSK no synchro,
- for 8PSK modulation, in mode logical PDCH, Type GPRS, coding MCS5.

Measurements were made at frequencies which are the bottom and top of each of the licensed blocks.

The output power was measured using the power meter which has the following settings :

Mode :	Average
Reference Level Offset :	Corrected to account for cable(s) and attenuator losses

6.4. NAME OF TEST: 2.1049 OCCUPIED BANDWIDTH

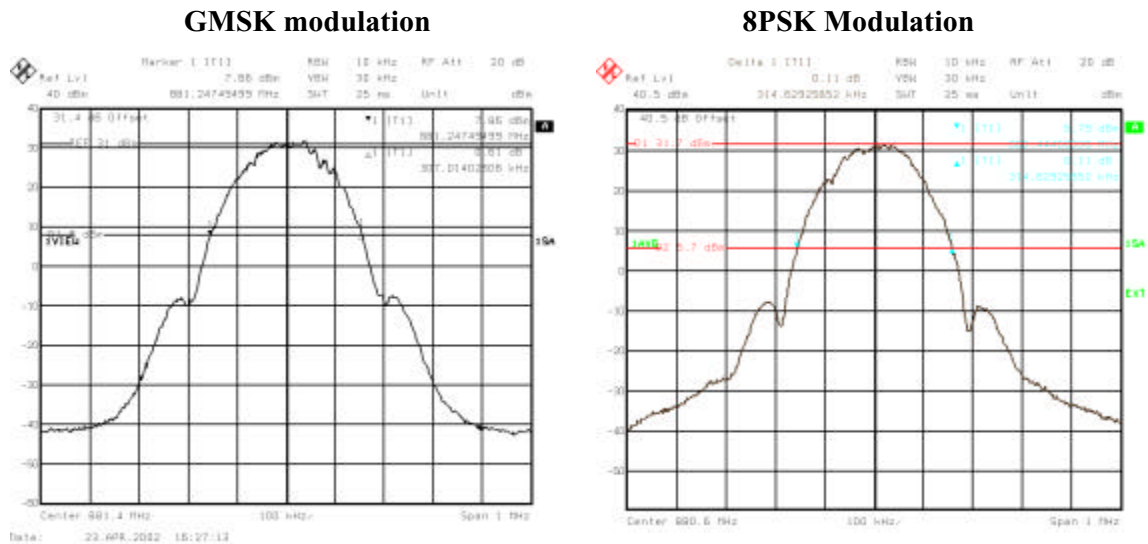
FCC REQUIREMENTS

4.4.1.1. FCC PART 2.1049

The occupied bandwidth is defined as the width of the signal between two points, one below the carrier center frequency and one above the carrier center frequency, outside of which all emissions are attenuated at least 26 dB below the transmitter power.

TEST RESULTS

Figure 1: sample plot for occupied bandwidth



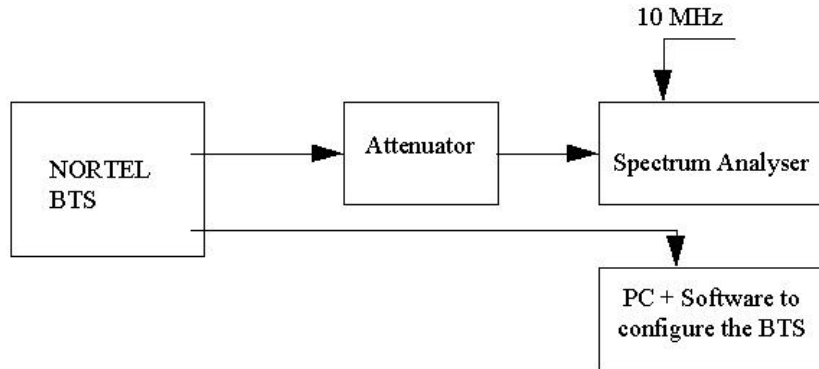
The maximum occupied bandwidth was found 320 kHz for GMSK modulation

The maximum occupied bandwidth was found 314 kHz for 8PSK modulation

TEST PROCEDURE

The equipment was configured as shown in schematic 2.

Schematic 2: Test configuration for Occupied bandwidth



The BTS was configured to transmit at maximum power (Static Level 0). Measurements were made at frequencies which were at the bottom and top of the transmit band.

The occupied bandwidth was measured by determining the bandwidth out of which all emissions are attenuated at least 26 dB below the transmitter power.

The spectrum analyzer had the following settings :

Resolution bandwidth :	10 kHz
Video bandwidth :	30 kHz
Span :	1 MHz and 2.2 MHz
Reference level:	40 dBm
Reference Level Offset :	Corrected to account for cable(s) and attenuator losses
Level range :	90 dB
Sweep time :	25 ms

6.5. NAME OF TEST: 2.1051 SPURIOUS EMISSIONS AT ANTENNA TERMINALS

FCC REQUIREMENTS

- (c) On any frequency outside a licensee's frequency block, the power of any emission shall be attenuated below the transmitter power (P) by at least $43 + 10 \log (P)$ dB.
- (d) Compliance with these provisions is based on the use of measurement instrumentation employing a resolution bandwidth of 1 MHz or greater. However, in the 1 MHz bands immediately outside and adjacent to the frequency block a resolution bandwidth of at least one percent of the emission bandwidth of the fundamental emission of the transmitter may be employed. The emission bandwidth is defined as the width of the signal between two points, one below the carrier center frequency and one above the carrier center frequency, outside of which all emissions are attenuated at least 26 dB below the transmitter power.
- (e) When measuring the emission limits, the nominal carrier frequency shall be adjusted as close to the licensee's frequency block edges, both upper and lower, as the design permits.
- (f) The measurements of emission power can be expressed in peak or average values, provided they are expressed in the same parameters as the transmitter power.

TEST RESULTS

The reference level for spurious emissions at the antenna terminals is taken from the measured output power (43.9 dBm = 24.5 Watts).

Therefore the spurious emissions must be attenuated by at least $43 + 10 \cdot \text{Log}(24.5) = 56.9$ dB. The measured output power was 43.9 dBm ; therefore the limit is $43.9 - 56.9 = -13$ dBm.

Spurious measurement is performed in the following coupling configuration with 30W Power amplifier and with duplexer .

The nominal power at antenna connector : $P_{\text{duplexer max}} = 44\text{dBm}$

Tables 3 and 4 show the results for Spurious Emissions at Antenna Terminals.

Table 3 : Test results For GMSK Modulation

	Channel	Power emission level	Spurious Emissions Level (dBm)	Limit (dBm)	Margin (dB)
A''	128	Pmax – 2 dB	-13.4	-13	0.4
A''	131	Pmax – 2 dB	-13.4	-13	0.4
A	133	Pmax – 2 dB	-13.6	-13	0.6
A	181	Pmax – 2 dB	-13.2	-13	0.2
B	183	Pmax – 2 dB	-13.9	-13	0.9
B	231	Pmax – 2 dB	-13.7	-13	0.7
A'	233	Pmax – 2 dB	-14.3	-13	1.3
A'	238	Pmax	-35.8	-13	22.8
B'	241	Pmax	-34	-13	21
B'	251	Pmax – 2 dB	-13.5	-13	0.5

Table 4: Test results For 8PSK Modulation

	Channel	Power emission level	Spurious Emissions Level (dBm)	Limit (dBm)	Margin (dB)
A''	128	Pmax – 2 dB	-14.8	-13	1.8
A''	131	Pmax – 2 dB	-14.9	-13	1.9
A	133	Pmax – 2 dB	-14.0	-13	1.0
A	181	Pmax – 2 dB	-14.9	-13	1.9
B	183	Pmax – 2 dB	-14.4	-13	1.4
B	231	Pmax – 2 dB	-14.8	-13	1.8
A'	233	Pmax – 2 dB	-14.3	-13	1.3
A'	238	Pmax	-31.5	-13	18.5
B'	241	Pmax	-33.6	-13	20.6
B'	251	Pmax – 2 dB	-14.8	-13	1.8

Table 5 : Test results for Spurious Emissions at Antenna Terminals

Frequency MHz	Spurious Emissions Level Duplexer (dBm)	Margin (dB) Duplexer
100 kHz - 50 MHz	-33.7	20.7
50 MHz – 500 MHz	-32.5	19.5
500 MHz – 880.2 MHz	-25.5	12.5
882.6 MHz –1994.8 MHz	-33	20
1994.8 MHz – 4 GHz	-27.3	14.3
4 GHz - 12 GHz	-22.5	9.5
12 GHz -20 GHz	-23	10

Notes :

Figures 2,3,4 show sample plots for the case when the transmitter was respectively tuned to edge channels in Tx band for GMSK modulation.

Figures 5,6,7 show sample plots for the case when the transmitter was respectively tuned to edge channels in Tx band for 8PSK modulation.

Figure 8,9,10 show sample plots for frequency spans from 0 to 20 GHz with emission on channel 189 at Pmax = 44 dBm with Duplexer module.

Conclusion :

For both modulation GMSK and 8PSK, the worst case is the Duplexer configuration and it has been done at $P_D \text{ max} - 2\text{dB} = 42 \text{ dBm}$.

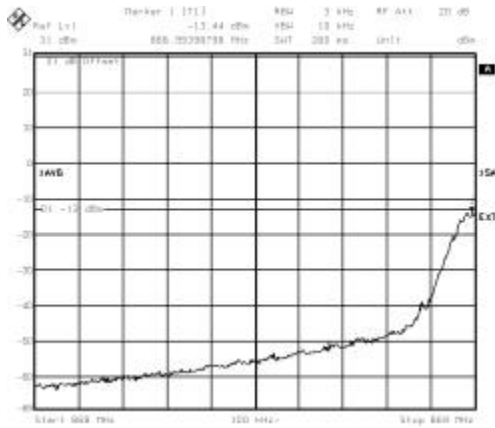
For Edge Channel ARFCN 128, 131, 133, 181, 183, 231, 233, 251, power has to be reduced by 2dB in order to meet spurious emission requirement.

For Edge Channel ARFCN 238, 241, the maximum power (44dBm) has allowed to meet spurious emission requirement.

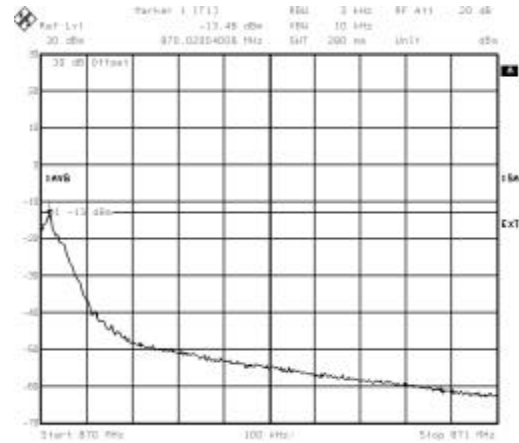
The H2D configuration has been done at maximum power $P_{H2D\text{max}} = 44 \text{ dBm}$.

**Figure 2 : 1 MHz adjacent band
GMSK MODULATION – Duplexer configuration
Power limitation :Pmax - 2 dB**

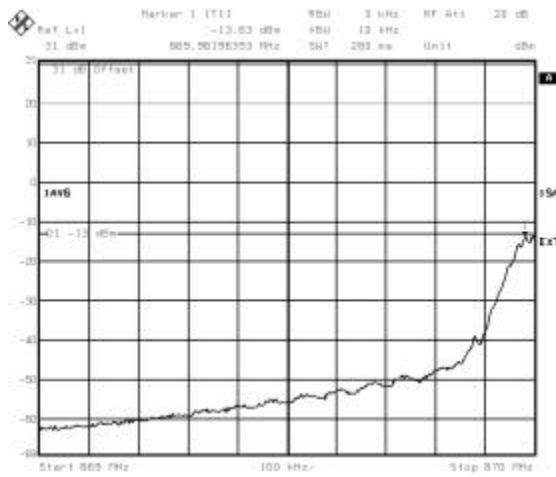
Channel 128



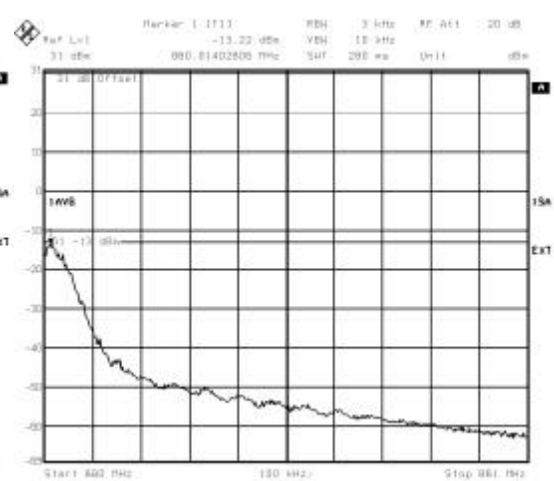
Channel 131



Channel 133

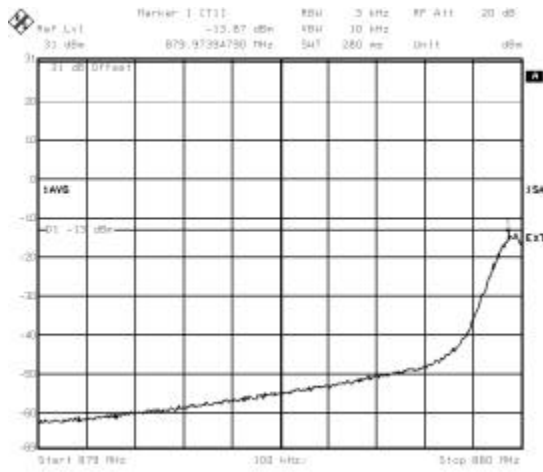


Channel 181

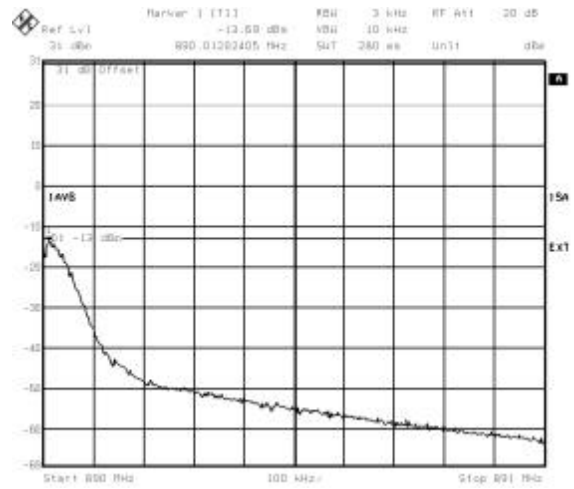


**Figure 3 : 1 MHz adjacent band
GMSK MODULATION – Duplexer configuration
Power limitation :Pmax - 2 dB**

Channel 183



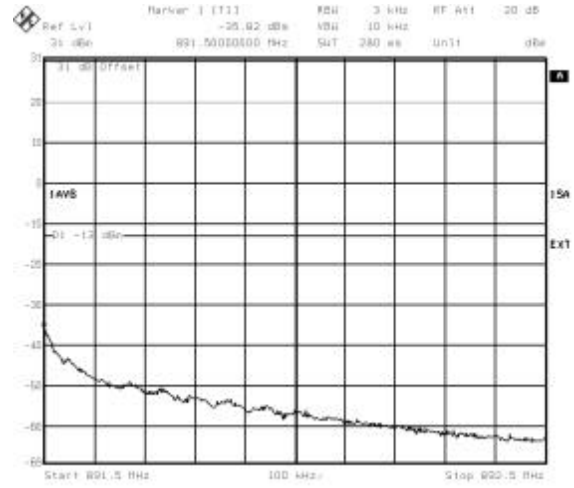
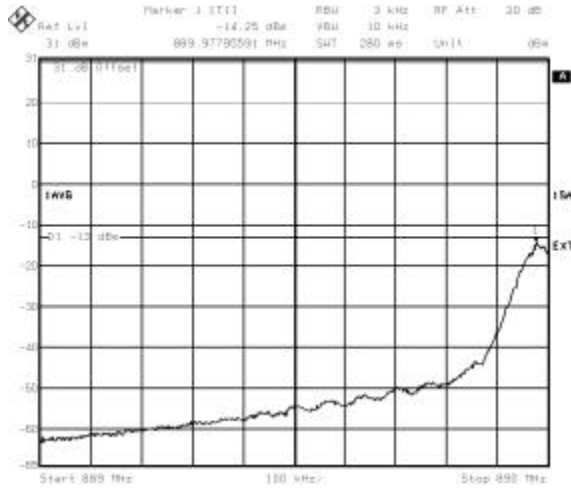
Channel 231



**Figure 4 : 1 MHz adjacent band
GMSK MODULATION – Duplexer configuration**

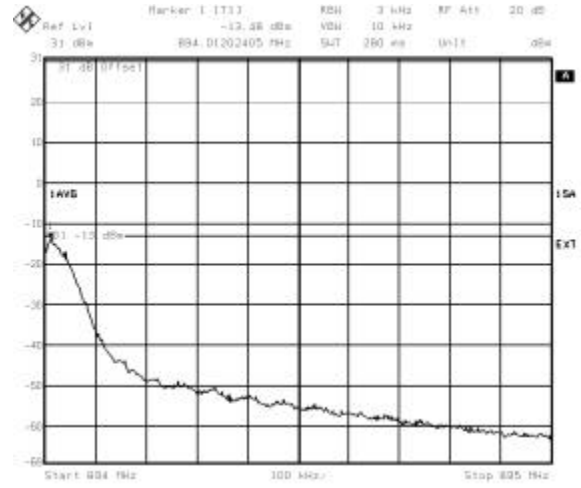
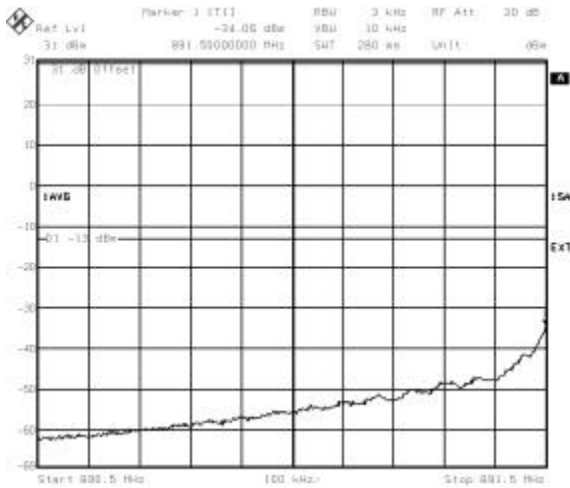
Channel 233
-1 MHz adjacent band,
Power limitation Pmax –2dB

Channel 238
+1 MHz adjacent band
Power limitation: Pmax



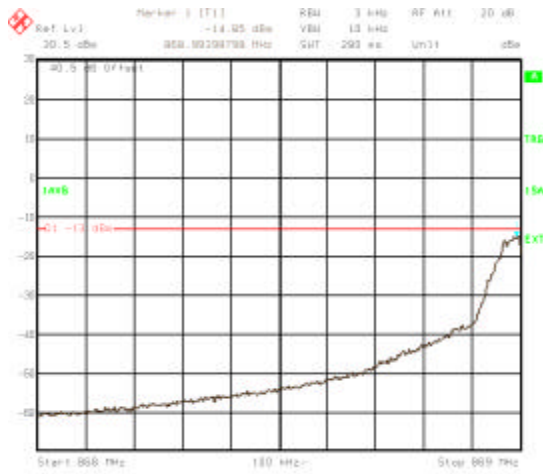
**-1MHz adjacent band
Channel 241
Power limitation P Max**

**+ 1MHz adjacent band
Channel 251
Pmax –2dB**

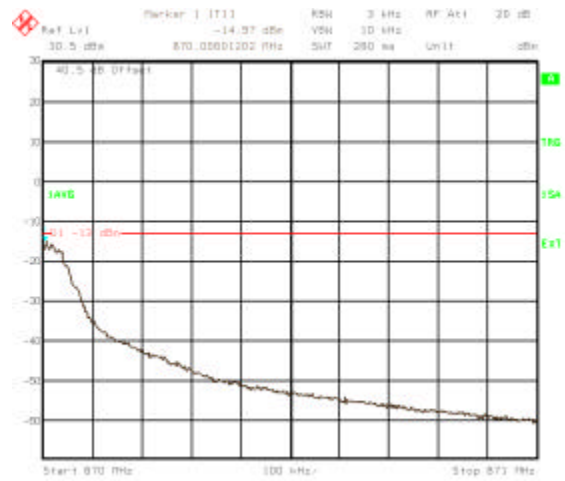


**Figure5 : 1 MHz adjacent band
8PSK MODULATION – Duplexer configuration
Power limitation :Pmax - 2 dB**

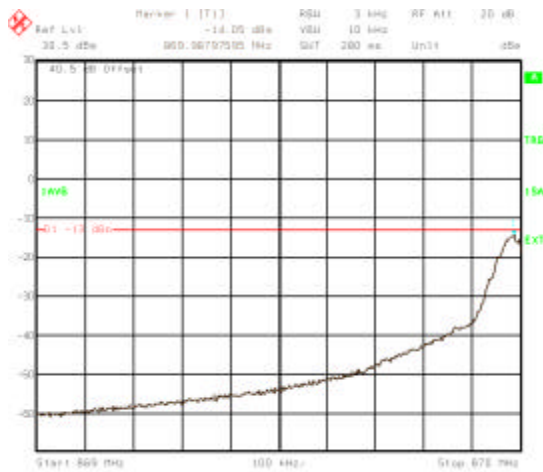
Channel 128



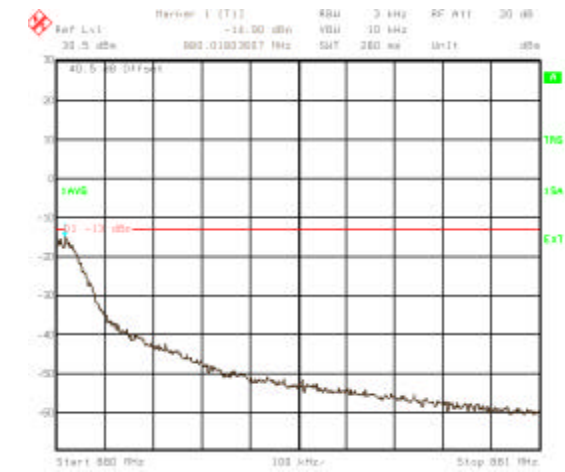
Channel 131



Channel 133

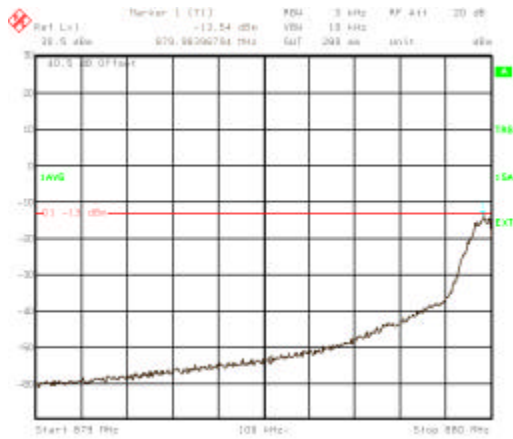


Channel 181

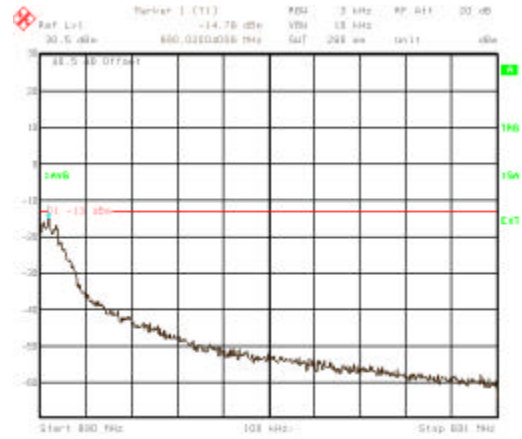


**Figure 6 : 1 MHz adjacent band
8PSK MODULATION – Duplexer configuration
Power limitation :Pmax - 2 dB**

Channel 183

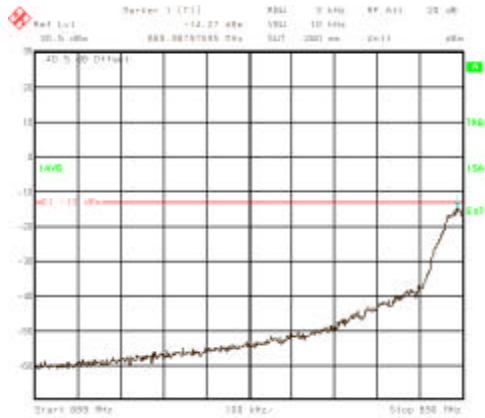


Channel 231

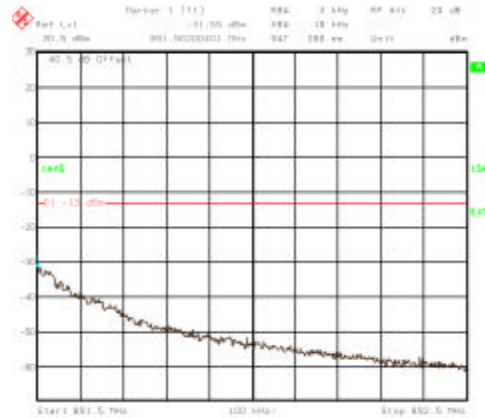


**Figure 7 : 1 MHz adjacent band
8PSK MODULATION – Duplexer configuration**

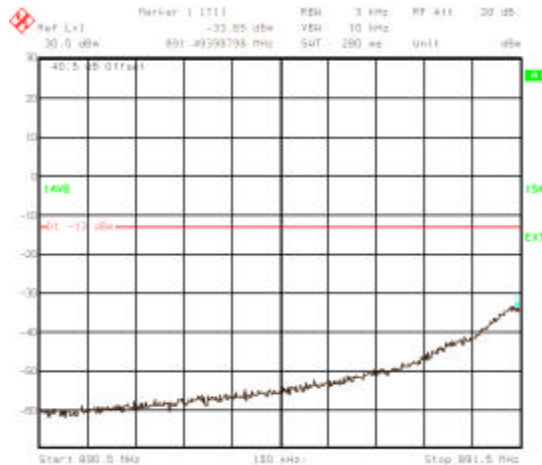
Channel 233
-1 MHz adjacent band,
Power limitation Pmax –2dB



Channel 238
+1 MHz adjacent band
Power limitation: Pmax



**-1MHz adjacent band
Channel 241
Power limitation P Max**



**+ 1MHz adjacent band
Channel 251
Pmax –2dB**

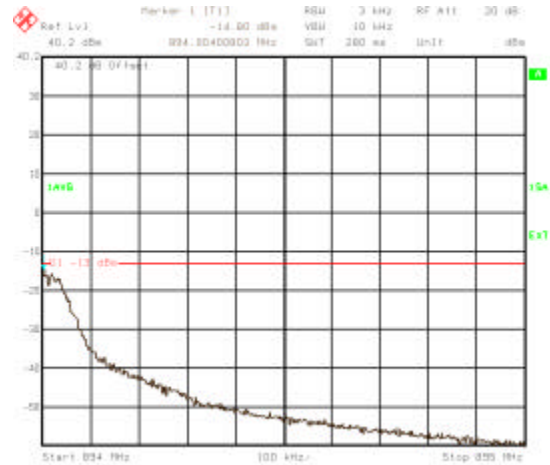
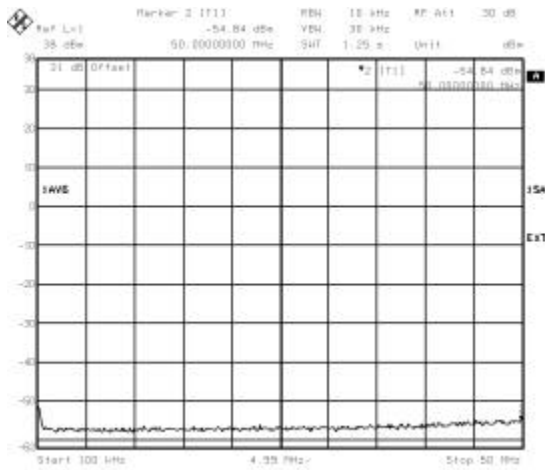
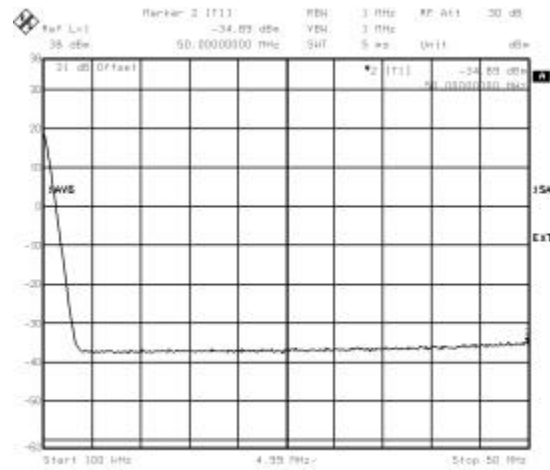


Figure 8 : Out of block emissions (channel 189, Pmax) with Duplexer GMSK modulation

Band 100 kHz – 50 Mhz



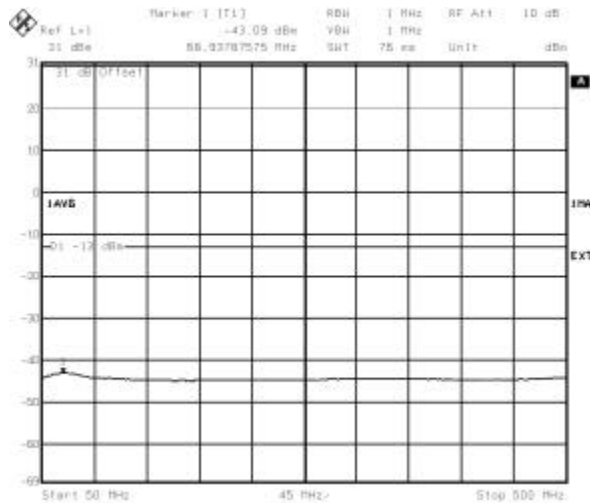
RBW = 10 kHz



RBW = 1 MHz

Note: spectrum lines at 100 kHz are internal DC spectrum line of Analyser

Band 50 Mhz – 500 MHz



Band 500 Mhz – 880.2 MHz

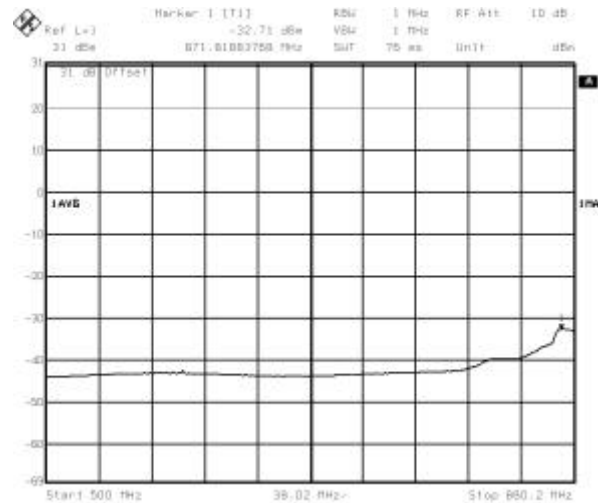
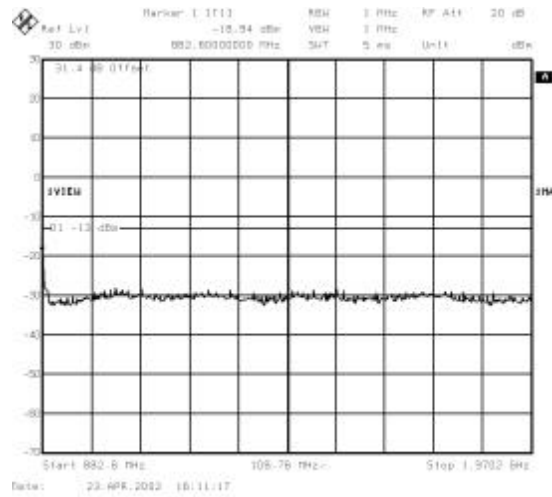
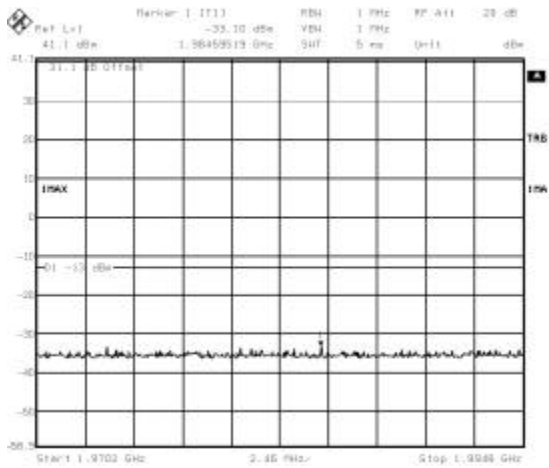


Figure9 : Out of block emissions (channel189, Pmax) with Duplexer GSMK modulation

Band 882.6 Mhz – 1970.2 MHz



Band 1970.2 Mhz – 1994.8 MHz



Band 1994.8 Mhz – 4 GHz

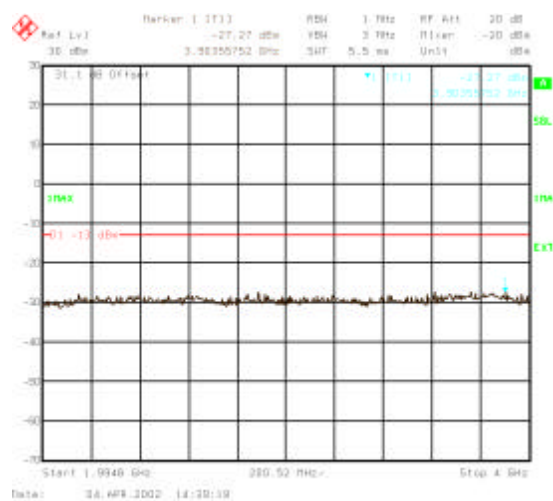
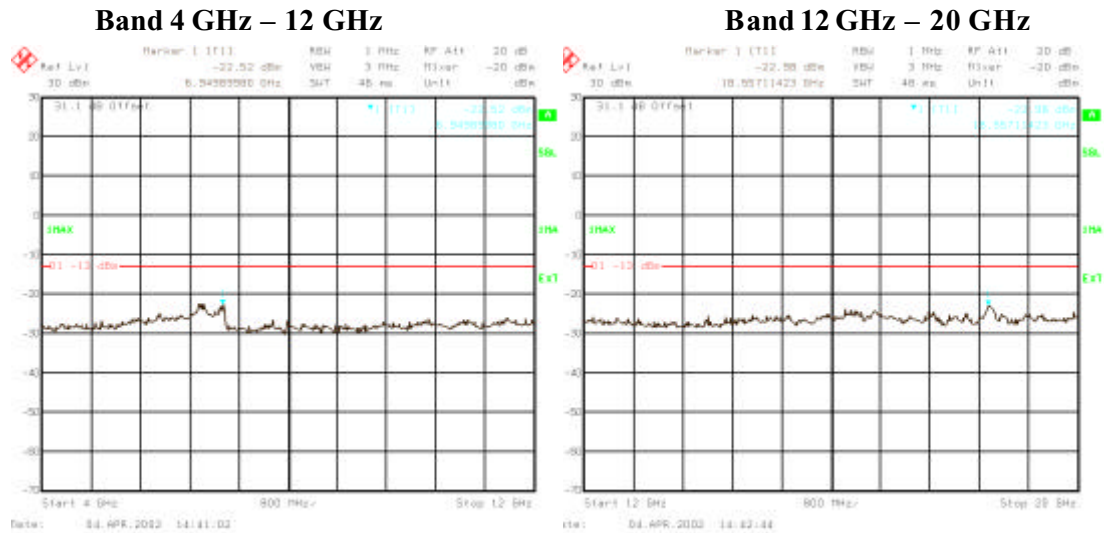


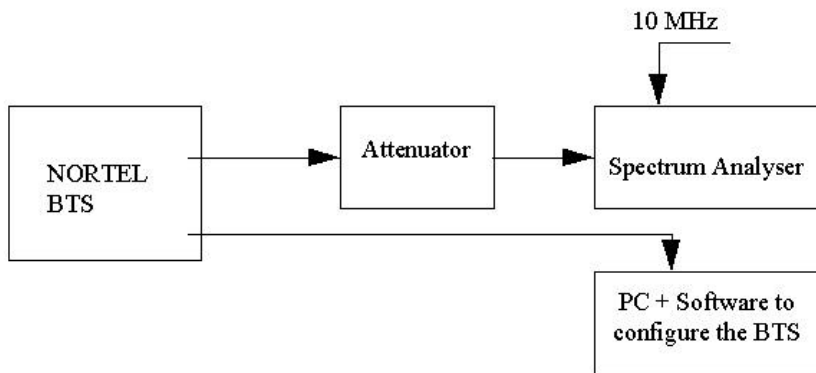
Figure 10 : Out of block emissions (channel 189, Pmax) with Duplexer GSMK modulation



TEST PROCEDURE

The equipment was configured as shown in schematic3.

Schematic3: Test configuration for Spurious emissions at antenna terminals



For adjacent channels emissions, the BTS nominal carrier frequency was adjusted to each block edge channel.

Channels 128 and 251 are those channels which are at the lower and upper edges of the eGSM 850 band respectively.

The BTS was configured to transmit at maximum power (static level 0) or a reduced power :

- for GMSK modulation, in mode GMSK no synchro
- for 8PSK modulation, in mode logical PDCH, Type GPRS, coding MCS5 .

Initially the transmitter was set to operate to maximum power. Then in case of out of limits, the power has been decreased by 2 dB.

For these measurements, the resolution bandwidth of the spectrum analyzer was set to at least 1% of the emission bandwidth. In this case the emission bandwidth measured was closed to 300 kHz. Therefore, the resolution bandwidth was set to 3 kHz.

The spectrum analyzer had the following settings for adjacent band:

Resolution bandwidth :	3 kHz
Video bandwidth :	10 kHz
Span :	1 MHz
Reference level:	30 dBm
Reference Level Offset :	Corrected to account for cable(s), filter and attenuator losses
Level range :	100 dB
Sweep time :	Coupled
Detector:	Sample
Trace:	Average
Sweep count:	200

The spectrum analyzer had the following settings for out of block emissions.

Resolution bandwidth :	1 MHz
Video bandwidth :	1 MHz

The emissions were investigated up to the twentieth harmonic of the fundamental emission (20 GHz).

The measured level of the emissions was recorded and compared to the -13 dBm limit.

6.6. NAME OF TEST: 2.1055 FREQUENCY STABILITY

FCC REQUIREMENTS

The frequency stability shall be sufficient to ensure that the fundamental emission stays within the authorized frequency block.

TEST RESULTS

Table 6 shows Frequency Stability for channel 189 (f=881.4MHz) in Quick Test Bench configuration in extreme conditions

Table 7 shows Frequency Stability in BTS S8000 Outdoor at ambient temperature for channels B,M,T.

Table 6: Frequency Stability in quick test bench configuration – Channel 189

Module Temperature (°C)	Maximum Carrier Frequency Deviation (Hz) in quick test bench configuration		
	DC Supply Voltage DRX - 40V PA - 36V	DC Supply Voltage DRX - 48V PA - 48V	DC Supply Voltage DRX - 57V PA - 60V
-5	-6.91	6.91	5.94
5	-7.75	-9.3	-7.17
15	8.85	7.1	-9.1
25	-7.81	-9.17	8.14
35	-9.04	-7.81	-9.43
45	-7.68	-7.49	8.52
55	-8.78	-7.43	-6.84
65	-8.52	-9.88	-7.68

Table 7 : Frequency Stability in BTS S8000 Outdoor at ambient temperature

	Maximum Carrier Frequency Deviation (Hz) in BTS Configuration Ambient temperature		
Channel	C128 (f=869.2 MHz)	C189 (f=881.4 MHz)	C251 (f= 893.8 MHz)
	-9	-11	+9

The maximum frequency deviation allowed is 90 Hz.

The maximum deviation measured (-11Hz) is more than sufficient to ensure that the fundamental emission stays within the authorized frequency block.

The S8000 Indoor BTS still complies with the requirement.

TEST PROCEDURE

The BTS S8000 must operate in following external extreme temperatures:

- BTS S8000 Indoor: - 5°C / + 45 °C
- BTS S8000 Outdoor: - 40°C / + 50°C

These external temperature ranges involve the extreme temperature range from - 5°C to +65°C on eDRX and eSCPA modules.

Frequency stability are checked in BTS S8000 Outdoor at ambient temperature.

Frequency stability test is performed with a Quick Test Bench for module configuration in following extreme conditions:

- Temperature from -5 to +65 centigrades at intervals of 10 centigrades
- With DC power supply variations eSCPA (-36V/-60V) and eDRX (-40V/-57V)

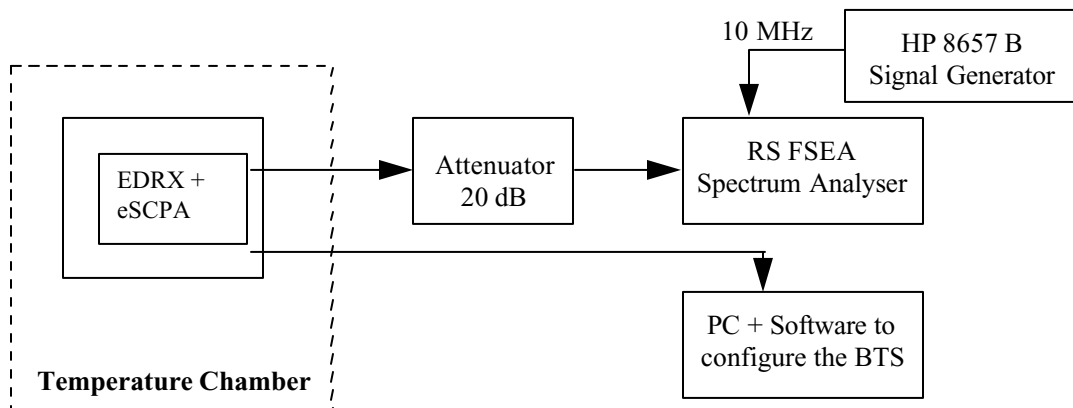
Modules (eDRX and eSCPA) run with nominal power regulation at maximum power (30W) in GMSK modulation.

The eDRX/eSCPA were configured to transmit at maximum power (Static level 0).

A period of at least one hour was allowed prior to measurement to ensure that all of the components of the oscillator circuit had stabilized at each temperature.

The equipment was configured as shown in schematic 4 .

Schematic4: Test configuration for Frequency Stability



7. MEASUREMENT EQUIPMENT LIST

List of all of the measurement equipment used in this report.

Equipment description	Manufacturer	Model	Serial No.	V/A date
Power Meter	Giga-tronics	8542C	515956	04/2003
Programmable AC source	Chroma	Model 6590	57220073	04/2004
Programmable DC source	LAMBDA	Model LLS9060	ELC08493	03/03
Programmable DC source	LAMBDA	Model LLS9060	500222	03/03
Spectrum Analyser	R&S	FSEA	509455	12/2003
Spectrum Analyser	R&S	FSEM	525495	07/2003
Signal Generator	R&S	SMT 03	509922	03/2003
30 dB attenuator 100 W	Spinner		25483	
20 dB attenuator 80 W	Radiall		R417720118	

8. EXHIBIT 2 : UPDATED EQUIPMENT LIST

Description	Hardware code	Comment
Base Cabinet		
CPCMI T1	NTQA66AA	
CMCF	NTQA66CB	
CBCF	NTQA66GA	

- PCS 1900 Radio Modules used with the 60W High Power Amplifier configuration**

Radio Modules GSM 1900		
GSM 1900 eDRX	NTQA88PA	EDRX PCS1900 (GMSK / 8PSK)
GSM 1900 High Power Amplifier	NTQA50RA	HePA (60 W GMSK / 45W 8PSK)
GSM 1900 Duplexer	NTQA51DA NTQA51FA	Without TOS meter With TOS meter
GSM1900 Tx Filter	NTQA52CA NTQA52CB	Without TOS meter With TOS meter
GSM 1900 Two Ways Hybrid Duplexer (60W Power handling)	NTQA38KA NTQA38LA	Without TOS meter With TOS meter
GSM 1900 Four Ways Hybrid Duplexer	NTQA52BA NTQA52BB	Without TOS meter With TOS meter
GSM 1900 Splitter	NTQA10AA	Rx Splitter for Rx way only

Power limitation to comply to Adjacent Band spurious at antenna connector :

Coupling configuration	System Power limitation	System Power limitation
	GMSK modulation	8 PSK modulation
Diplexer Tx Filter	Power Limitation : Pmax – 6 dB = 40.5 dBm	Power Limitation : Pmax – 2 dB = 43.8 dBm
H2D	Power Limitation : Pmax – 2 dB = 41 dBm	Pmax = 42 dBm
H4D	Pmax = 40 dBm	Pmax = 39 dBm

• **PCS1900 Radio Modules used with 30W Power Amplifier configuration**

Description	Hardware code	Comment
Radio Modules GSM 1900		
GSM 1900 DRX	NTQA01DA	DRX ND PCS1900 (GMSK only)
GSM 1900 Power Amplifier	NTQA50DB	PA GMSK 30W
GSM 1900 eDRX	NTQA88PA	EDRX PCS1900 (GMSK / 8PSK)
GSM 1900 Power Amplifier	NTQA50GA	eSCPA (GMSK / 8PSK) 30W
GSM 1900 Diplexer	NTQA51DA NTQA51FA	Without TOS meter With TOS meter
GSM1900 Tx Filter	NTQA52CA NTQA52CB	Without TOS meter With TOS meter
GSM 1900 Two Ways Hybrid Duplexer	NTQA51AA NTQA51BA	Without TOS meter With TOS meter
GSM 1900 Four Ways Hybrid Duplexer	NTQA52BA NTQA52BB	Without TOS meter With TOS meter
GSM 1900 Splitter	NTQA10AA	Rx Splitter for Rx way only

Power limitation to comply to Adjacent Band spurious at antenna connector :

Coupling configuration	System Power limitation GMSK modulation	System Power limitation 8 PSK modulation (If 8PSK is supported by modules)
Diplexer Tx Filter	Power Limitation : Pmax – 4 dB = 40 dBm	Pmax = 44 dBm
H2D	Pmax = 41 dBm	Pmax= 41 dBm
H4D	Pmax = 37 dBm	Pmax = 37 dBm

• **GSM850 Radio Modules used with 30W Power Amplifier configuration**

Description	Hardware code	Comment
Radio Modules GSM 850		
GSM 850 DRX	NTQA88HA	eDRX
GSM 850 Splitter	NTQA88XA	
GSM 850 Power Amplifier	NTQA37AA	eSCPA
Full Band coupling (Tx Band 869-894 MHz)		
GSM 850 Duplexer	NTQA38GA	Without TOS meter
	NTQA38FA	With TOS meter
GSM 850 Tx Filter	NTQA39CA	Without TOS meter
	NTQA39DA	With TOS meter
GSM 850 Two Ways Hybrid Duplexer	NTQA38JA	Without TOS meter
	NTQA38HA	With TOS meter
Part Band coupling (Tx Band 869-891.5 MHz)		
GSM 850 Duplexer	NTQA38CA	Without TOS meter
	NTQA38DA	With TOS meter
GSM 850 Tx Filter	NTQA39AA	Without TOS meter
	NTQA39BA	With TOS meter
GSM 850 Two Ways Hybrid Duplexer	NTQA38BA	Without TOS meter
	NTQA38AA	With TOS meter

Power limitation to comply to Adjacent Band spurious at antenna connector :

Coupling configuration	System Power limitation GMSK modulation	System Power limitation 8 PSK modulation (If 8PSK is supported by modules)
Diplexer Tx Filter	Power Limitation : Pmax – 2 dB = 42 dBm Except ARFCN 238 , 241 : Pmax	Power Limitation : Pmax – 2 dB = 42 dBm Except ARFCN 238 , 241 : Pmax
H2D	Pmax = 41 dBm	Pmax= 41 dBm

For Edge Channel ARFCN 128, 131, 133, 181, 183, 231, 233, 251, power has to be reduced by 2dB in order to meet spurious emission requirement.

For Edge Channel ARFCN 238, 241, maximum power (44dBm) has allowed to meet spurious emission requirement.

∞ End of DOCUMENT ∞