

## 1.0 Introduction

---

This report is a certification application of the Northern Telecom Transmit Receive Unit (FCCID: AB6NTAW99AAE3)

The TRUIII is modified version of another transceiver which received a grant of authorization under the AB6NTAW99AA FCCID (March 1998).

The modifications done on the TRUIII include; i) demodulization of RX-RXM1-800 module into discrete components (transistor, RF SAW, mixer), ii) demodulization of CIF1A into discrete transistors, iii) demodulization of TXM1B into discrete components (Tx IF SAW, TXIC1C, RF BPF ceramic, HP RF MMIC amp, Tx RF SAW), iv) replacement of EMI rope gasket with sheet metal gasket; and in the BB board: v) removal of inductive filters for the ribbon cable between RF and BB boards, vi) replacement of the oscillator with another which has same the frequency. All those changes are documented in the schematics which are part of this application. The basic modulating circuits, the maximum power, and the field strength ratings have not been changed.

The test that have been repeated include; - RF Power Output

- Occupied Bandwidth
- Spurious Emissions at Antenna Terminals
- Field Strength of Spurious and Harmonic Radiation

Frequency stability wasn't repeated since none of the modifications affect the frequency determination or stabilization characteristics of the TRU.

This transceiver (TRU) is intended for use in the Domestic Public Cellular Radio Telecommunications Service and is designed in accordance with the following standards:

- CFR 47, Part 22, Subpart H, *Domestic Public Cellular Radio Telecommunications Service*
- CFR 47, Part 2, Subpart J, Equipment Authorization Procedures - Certification
- *TDMA Cellular/PCS - Radio Interface - Minimum Performance Standards for Base Stations*, TIA/EIA/IS-138-A, July 1996

## 2.0 Engineering Declaration

---

The Transmit Receive Unit (NTAW99AA) has been tested in accordance with the requirements contained in the Federal Communications Rules and Regulations Parts 2, and 22. To the best of my knowledge, these tests were performed in accordance with good engineering practices using measurement procedures consistent with industry or commission standards and demonstrate that this equipment complies with the appropriate standards. All tests were conducted on a representative sample of the equipment for which certification is sought.

April 20, 1999

---

Denis Lalonde  
Radio Compatibility Engineer  
Nortel Networks  
Kanata, Ontario, Canada

April 20, 1999

---

Steve Cassidy  
Radio Compatibility Engineer  
Nortel Networks  
Kanata, Ontario, Canada

## **3.0 Certification Application Requirements**

---

### **3.1 Name of applicant**

The applicant is Northern Telecom Incorporated.

### **3.2 Identification of Equipment**

The equipment in this application is referred to as the Transmit Receive Unit (TRU). The Model Number for the terminal is NTAW99AA.

### **3.3 Quantity Production**

The Transmit Receive Unit (NTAW99AA) will be produced in quantity.

### **3.4 Technical Description**

Same as original filing (March 1998).

### **3.5 Type or types of emission.**

30K0GXW - TDMA mode.

### **3.6 Frequency range**

The Transmit Receive Unit (NTAW99AA) will operate in the 824 to 894 MHz band, using 869-894 MHz for the transmitter and 824-849 MHz for the receiver. The channel separation is 30 kHz.

### **3.7 Range of operating power**

Same as original filing (March 1998).

### **3.8 Maximum power rating**

The maximum RF power output is 0.5 W. Same as original filing (March 1998).

### **3.9 Final RF amplifying device power consumption**

At maximum RF output power (0.5W), the applied voltages to the final RF amplifying stage (all voltages with respect to ground) are 10 VDC (drain) and 0 VDC (source). The gate voltage is dynamically adjusted to maintain a normal 320 mA current.

### **3.10 Function of each active circuit device**

Same as original filing (March 1998).

### **3.11 Complete circuit diagrams**

This application contains schematics of devices incorporated in the Transmit Receive Unit (NTAW99AA).

### **3.12 User and Maintenance Manual**

Same as original filing (March 1998).

### **3.13 Tune-up procedure**

Same as original filing (March 1998).

### **3.14 Circuit description for frequency determining and stabilizing**

Same as original filing (March 1998).

### **3.15 Circuit description for suppression of spurious radiation**

Same as original filing (March 1998).

### **3.16 Circuit description for limiting modulation**

Same as original filing (March 1998).

### **3.17 Circuit description for limiting power**

Same as original filing (March 1998).

### **3.18 Photographs**

New pictures are included.

### **3.19 Standard Test Conditions and Test Equipment**

The Transmit Receive Unit (NTAW99AA) was tested under the following standard test conditions unless otherwise noted:

Ambient Temperature: 20 - 35°C

Ambient Humidity: 20 to 40%

### 3.20 Test Equipment List

**Table 1: Test Equipment**

<b>Description</b>	<b>Manufacturer</b>	<b>Model</b>	<b>Serial Number</b>	<b>Cal Due Date</b>
Spectrum Analyzer	Rhode & Schwarz	FSEM	Z0076245	25 Jun. 2000
Spectrum Analyzer	Rhode & Schwarz	FSB	L0544288	23 Apr. 2000
Power Meter	HP	438A	L0044910	23 Apr. 2000
Power Sensor	HP	8482A	3318A23688	22 Jul. 1999
Audio Analyzer	HP	8903B	Z0077109	21 Jul. 1999

## 4.0 Transmitter Test and Measurement Results

---

### 4.1 RF Power Output

#### **Standard:**

#### **RF Power Output Requirements (FCC Sec. 2.1046)**

*(a) For transmitters other than single sideband, independent sideband and controlled carrier radiotelephone, power output shall be measured at the RF output terminals when the transmitter is adjusted in accordance with the tune-up procedure to give the values of current and voltage on the circuit elements specified in 2.1033(c)(8). The electrical characteristics of the radio frequency load attached to the output terminals when this test is made shall be stated.*

#### **FCC Limit (Sec. 22.913)**

*The maximum effective radiated power (ERP) of base transmitters and cellular transmitters must not exceed 500 Watts.*

#### **Equipment:**

Transmit Receive Unit (NTAW99AA)

#### **Test Method:**

In digital mode, the antenna connector of the TRU was connected directly to a power meter. The TRU was set to transmit at maximum transmit power. The loss from the measurement RF cable/attenuator was calibrated. The power output was measured on 3 channels, (one at the middle, top, and bottom of the cellular band). The input impedances of the RF cable, RF attenuator, and the power meter are all 50 ohms.

#### **Test Setup:**

#### DIGITAL MODE

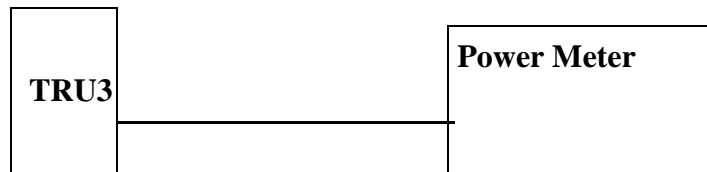

**Results:**

**Conforms.**

The maximum rated RF power output is 27.0 dBm.

	<b>Digital Mode</b>
<b>Channel</b>	<b>Max. RF Power (dBm)</b>
991 (low end of band)	26.8
367 (middle of band)	26.8
799 (top of band)	27.0

## 4.2 Occupied Bandwidth

### **Standard:**

#### **FCC Part 2, Para. 2.1049**

*The OBW, that is the frequency bandwidth such that, below its lower and above its upper frequency limits, the mean powers radiated are each equal to 0.5 percent of the total mean power radiated by a given emission shall be measured under the following conditions as applicable:*

*(g) Transmitter in which the modulating baseband comprises not more than three independent channels - when modulated by the full complement of signals for which the transmitter is rated. The level of modulation for each channel should be set to that prescribed in rule parts applicable to the services for which the transmitter is intended. If specific modulation levels are not set forth in the rules, the tests should provide the manufacturer's maximum rated condition.*

*(h) Transmitters employing digital modulation techniques - when modulated by an input signal such that its amplitude and symbol rate represent the maximum rated conditions under which the equipment will be operated. The signal shall be applied through any filter networks, pseudo-random generators or other devices required in normal service. Additionally, the occupied bandwidth shall be shown for operation with any devices used for modifying the spectrum when such devices are optional at discretion of the user.*

#### **IS-138-A Minimum Standard**

*The emission power in either adjacent channel, centered +/-30kHz from the carrier frequency, shall not exceed a level of 26dB below the mean output power.*

*The emission power in either alternate channel, centered +/-60kHz from the carrier frequency, shall not exceed a level of 45dB below the mean output power.*

*The emission power in either second alternate channel, centered +/-90kHz from the carrier frequency, shall not exceed a level of 45dB below the mean output power or -13 dBm, whichever is the lower power.*

### **Equipment:**

Transmit Receive Unit (NTAW99AA)

### **Measurements:**

The 99% occupied bandwidth for the LAU was measured on three channels (991, 367, and 799) using the 99% occupied bandwidth measurement feature of the FSEM spectrum analyzer from Rohde & Schwarz. The resolution bandwidth of the spectrum analyzer was 300 Hz. The TRU-III was modulated with pseudo random data stream on all time slots.

Test results are shown on Table 2. Figure 1 is a plot which demonstrate how the 99% occupied bandwidth was measured.



**Table:2 99% Occupied bandwidth**

Channel	99% Occupied BW (KHz)
991	27.8
367	28.2
799	28.2

**Figure 1: Measurement of 99% Occupied Bandwidth**

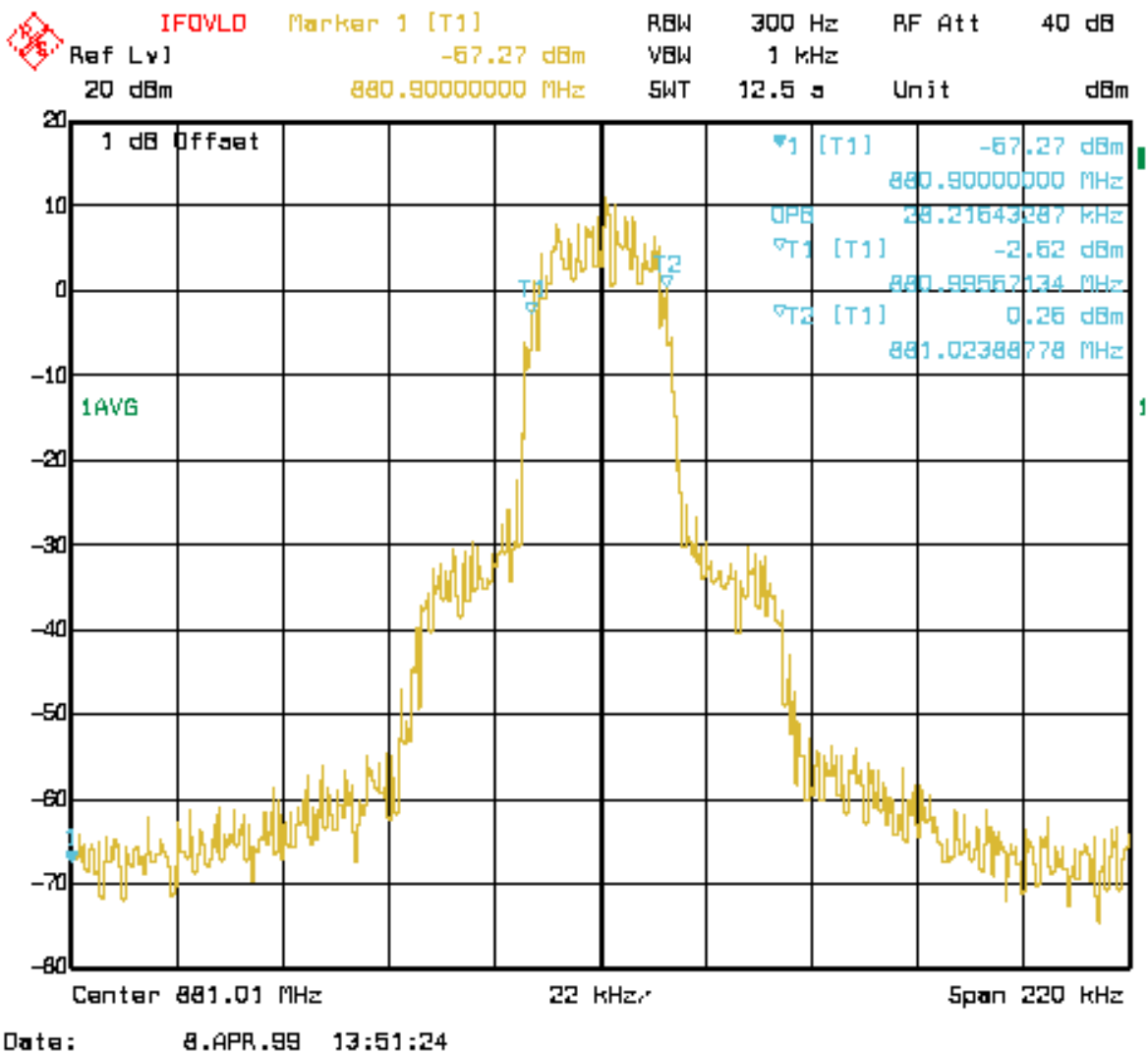

For the adjacent channel power measurement, the TX output of the TRU-III was directly coupled to the Spectrum Analyzer via a 6dB attenuator. The insertion loss between the output of the TRU-III and the input of the spectrum analyzer was measured and taken into account in the final readings. The TRU-III was modulated with pseudo random data stream on all time slots. The TRU-III was set to transmit on channel 991 with the output power set to 27dBm (max). The emission power at frequency offsets of +/-30kHz (adjacent channel), +/-60kHz (alternate channel) and +/-90kHz (second alternate channel) was measured. The procedure was repeated for channels 367 and 799.

**Test Setup:**

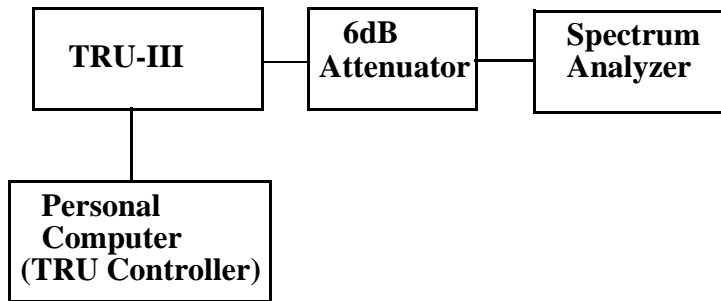

**Results:**

**Conforms.**

The occupied bandwidth in digital mode is shown in Table 3, Figure 2, Figure 3, and Figure 4.

**Table:3 Adjacent Channel Power (digital)**

Center frequency offset (kHz)	Channel 991 Power (dBc)	Channel 367 Power (dBc)	Channel 799 Power (dBc)	Limit (dBc)
-90	-70.6	-70.6	-70.6	-45
-60	-64.6	-65.3	-65.7	-45
-30	-32.4	-32.7	-33.9	-26
30	-33.3	-33.8	-34.5	-26
60	-62.2	-63.2	-63.8	-45
90	-70.6	-70.7	-70.5	-45

**Figure 2: Adjacent Channel Power for Channel 991 (Digital)**

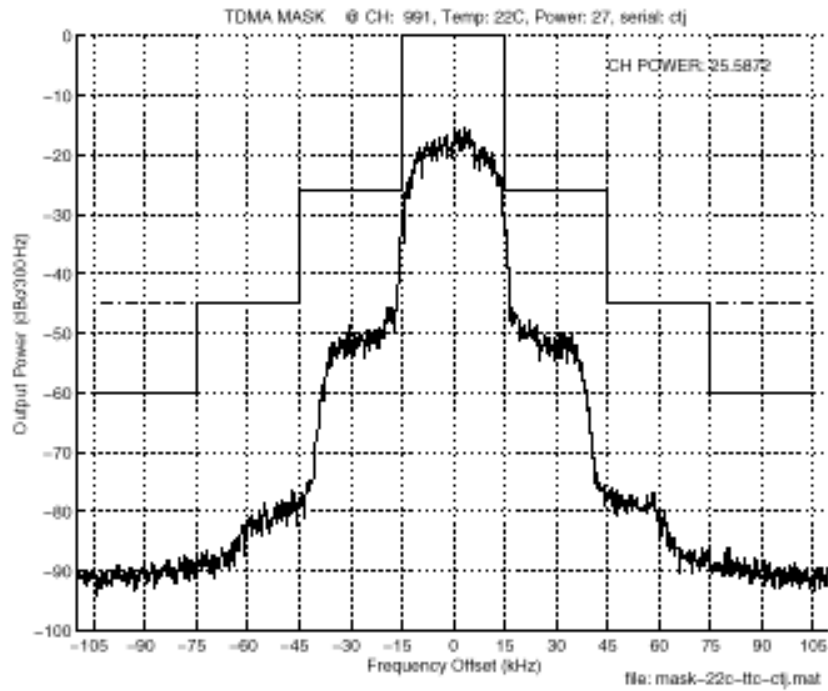

**Figure 3: Adjacent Channel Power for Channel 367 (Digital)**

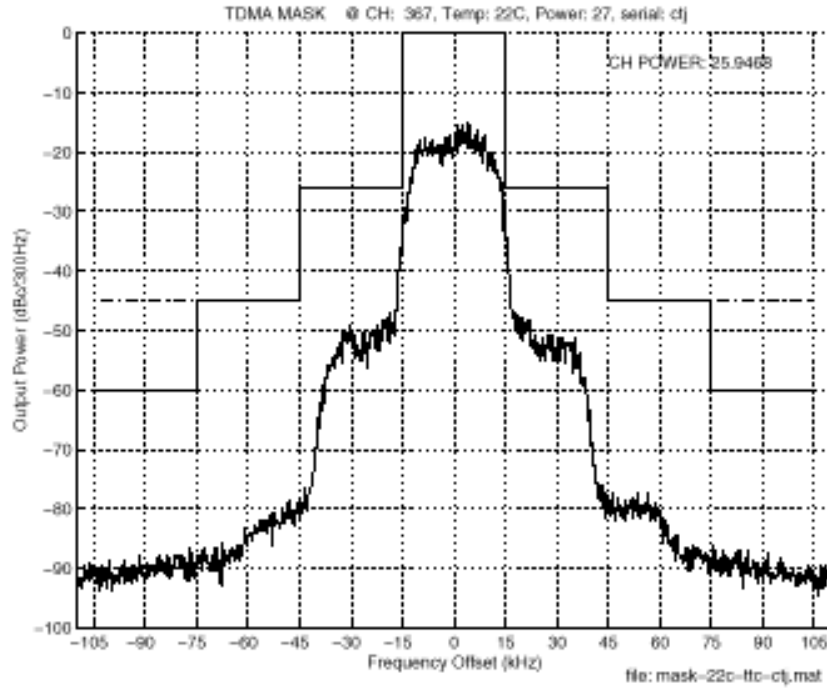

**Figure 4: Adjacent Channel Power for Channel 799 (Digital)**

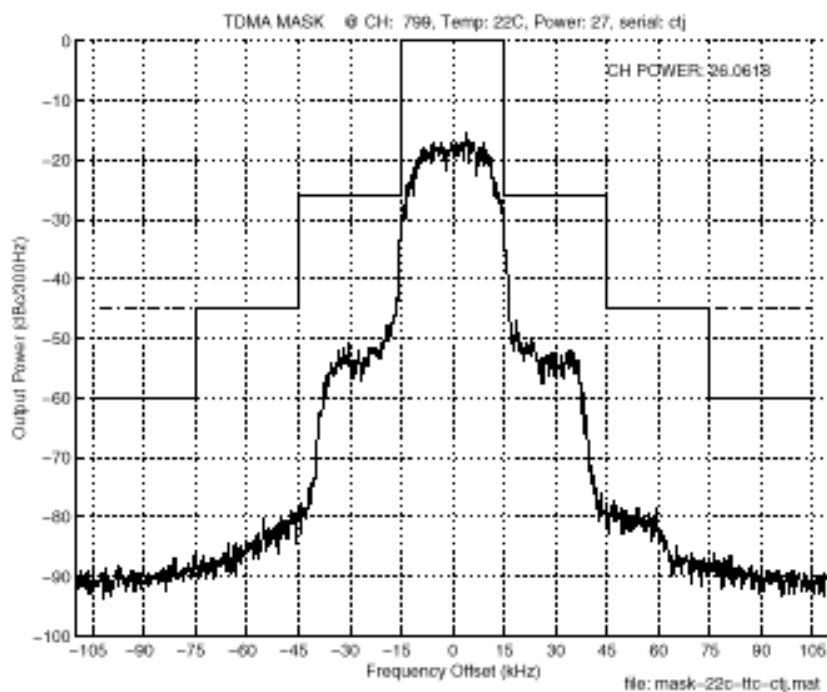

### 4.3 Spurious Emissions at Antenna Terminals

**Standard:**

**Spurious Emissions at Antenna Terminals (FCC Sec 2.1051 & 22.917)**

*The peak power level of conducted spurious emissions shall not exceed -13 dBm.*

**Equipment:**

Transmit Receive Unit (NTAW99AA)

**Measurements:**

The transmitter was operated under the standard test conditions. The TRU was set to transmit pseudo-random data bits. The harmonic and spurious emissions were measured from 100 kHz to 9 GHz. A 30 kHz resolution bandwidth was used with peak hold.

**Test Setup:**

The diagram below shows the test setup used to measure the emissions.

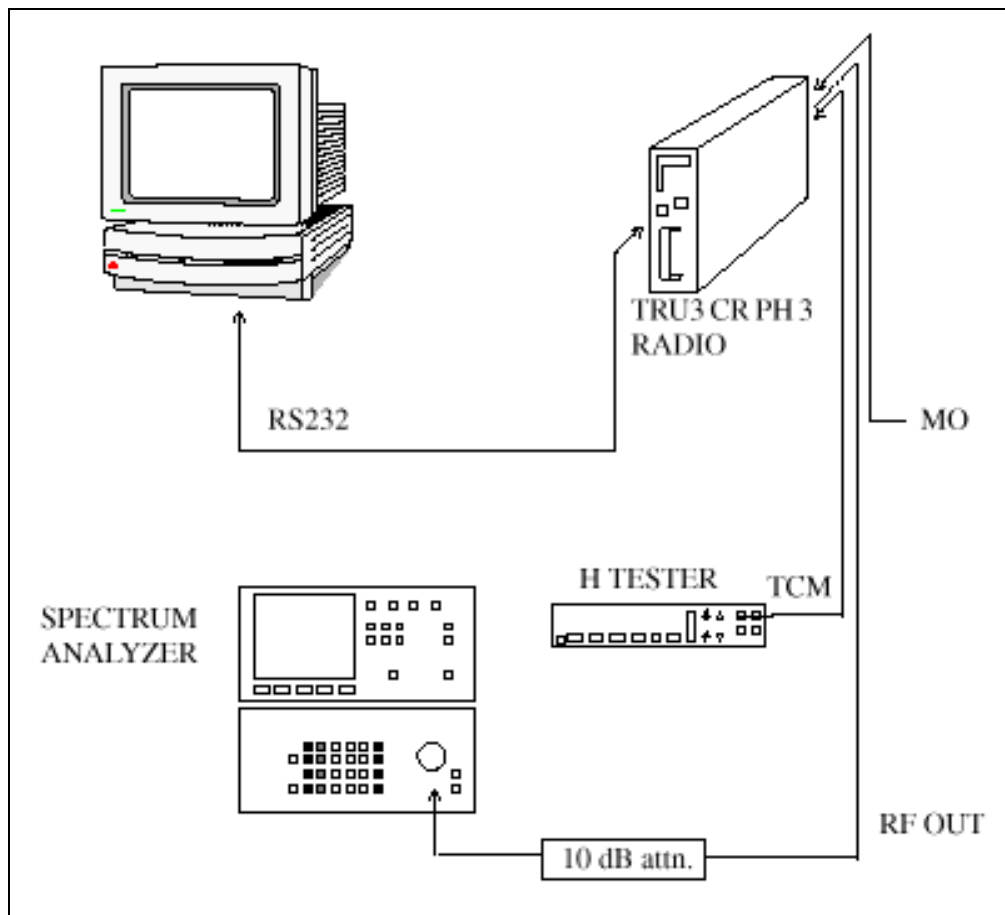

**Results:**

**Transmitter emissions**

**Conforms.**

The test was performed on channel 991, 367, and 799 from 100 KHz to 9 GHz. Result shown are from the channel that produced the highest emission levels. Table 3 identifies the frequencies where the emission are within 20 dB of the limit. Figure 5 shows a plot of the emissions up to 5 GHz.

**Table 4: Transmitter Spurious Emissions**

<b>Frequency (MHz)</b>	<b>Emission Level (dBm)</b>	<b>Limit</b>
738.48	-22.2	-13
874.02	-26.9	-13
1011.57	-32.4	-13
1738.08	-11.5 (Note 1.)	-13
2607.12	-19.7	-13
3476.16	-22.7	-13
4405.05	-30.5	-13

**Note 1.** As described in this product's last certification report, the TRUIII when installed in a cellular base station will always meet the -13 dBm limit at 1738 MHz by margin greater than 20 dB since duplexer/combiner units with rejection much higher than 22.5 dB are always present between the TRUIII and the transmitting antenna. The insertion loss characteristics from duplexer/combiner units used with the TRUIII are shown in Figure 6 and Figure 7.

**Figure 5: Spurious Emissions up to 5GHz**

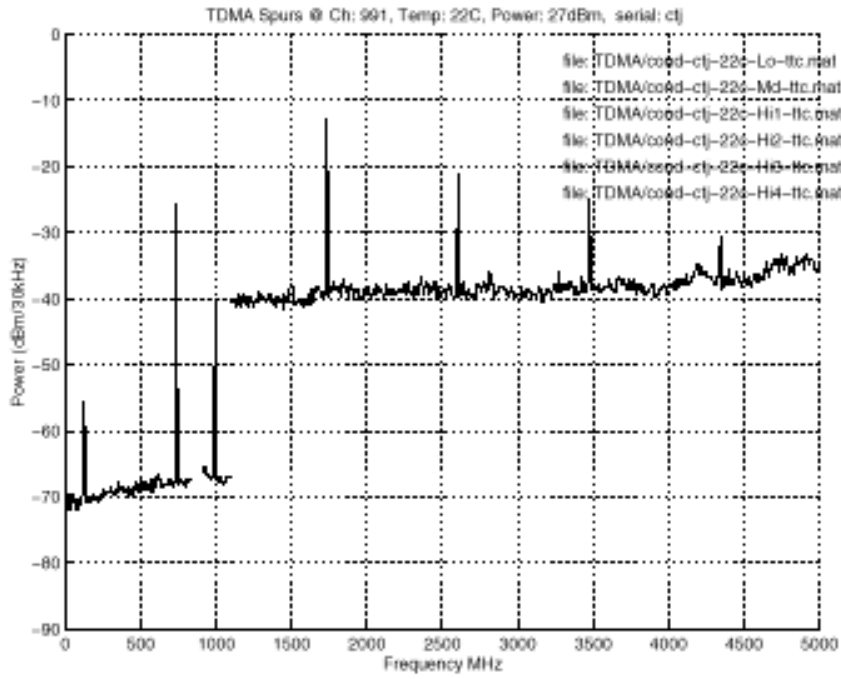



**Figure 6: Insertion loss of Cellwave 16 combiner/duplexer**

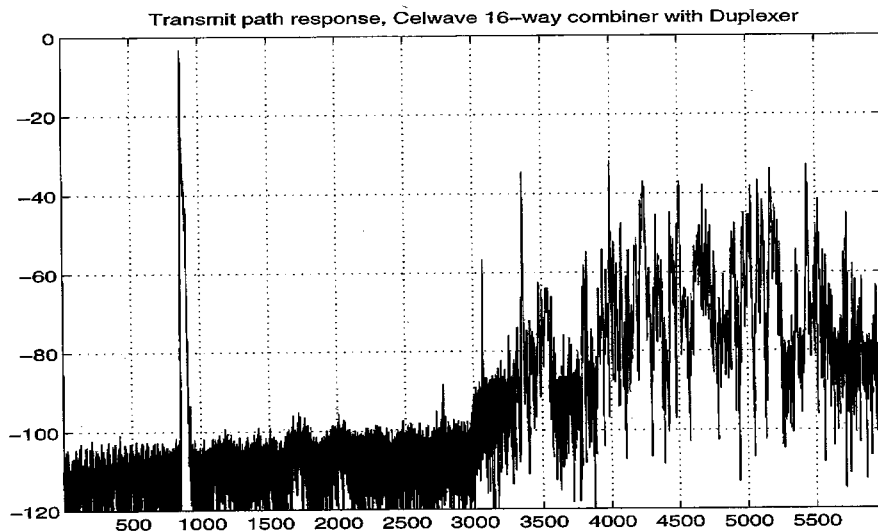
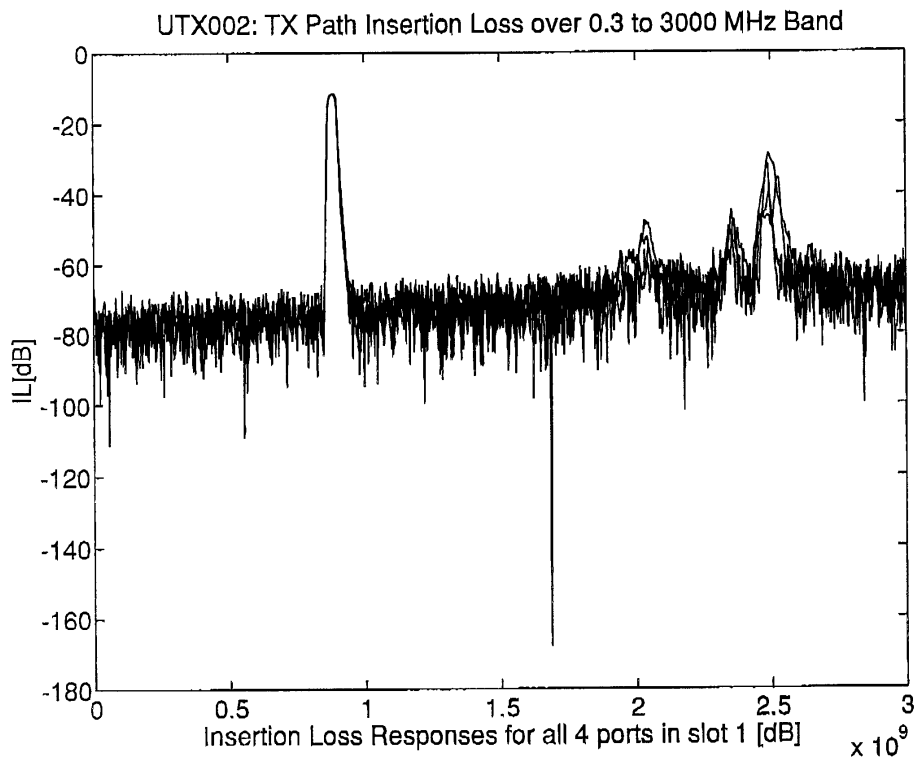

Figure 49 Tx RF Path out of band response

**Figure 7: Insertion loss of Microcell antenna matrix Y**



---

## 5.0 Field Strength of Spurious and Harmonic Radiation

---

### **Standard:**

#### **Field Strength of Spurious and Harmonic Radiation FCC Sec.2.1053**

*(a) Measurements shall be made to detect spurious emissions that may be radiated directly from the cabinet, control circuits, power leads, or intermediate circuit elements under normal conditions of installation and operation. Curves or equivalent data shall be supplied showing the magnitude of each harmonic and other spurious emission. For this test, single sideband, independent sideband, and controlled carrier transmitters shall be modulated under the conditions specified in paragraph (c) of 2.1049, as appropriate. For equipment operating on frequencies below 890 MHz, an open field test is normally required, with the measuring instrument antenna located in the far-field at all test frequencies. In the event it is either impractical or impossible to make open field measurements (e.g., a broadcast transmitter installed in a building) measurements will be accepted of the equipment as installed. Such measurements must be accompanied by a description of the site where the measurements were made showing the location of any possible source of reflections which might distort the field strength measurements. Information submitted shall include the relative radiated power of each spurious emission with reference to the rated power output of the transmitter, assuming all emissions are radiated from half-wave dipole antennas.*

*(b) The measurements specified in paragraph (a) of this section shall be made for the following equipment:*

- (1) Those in which the spurious emission are required to be 60 dB or more below the mean power of the transmitter.*
- (2) All equipment operating on frequencies higher than 25 MHz.*
- (3) All equipment where the antenna is an integral part of, and attached directly to the transmitter.*
- (4) Other types of equipment as required, when deemed necessary by the Commission.*

### **5.1 Description of Equipment Under Test**

#### **5.1.1 Equipment Under Test (EUT)**

The EUT is a Transmit Receive Unit (NTAW99AA).

#### **5.1.2 System Clocks**

The following table lists the clock sources (e.g. discrete crystals and VCXOs) used in the configurations under test

**Table:5 Clock Frequencies.**

Fundamental Frequencies (Crystal/VCXO) (MHz)	Fundamental Frequencies (Crystal/VCXO) (MHz)
0.00972	32.0
0.03	81.0
0.0486	82.2
0.12	84.96
0.155	85.56
0.48	130.56
0.6	738.4 to 763.5
1.2	786.8 to 811.8
2.561	824.0 to 849.0
3.1104	869.0 to 894.0
3.6864	
4.8	
6.2208	
10.0	
10.244	
12.4416	
20.0	
25.0	
27.0	

### 5.1.3 System Cables

Cables were organized in position on the cross-arms supports to be most representative of a typical cell site installation.

## **5.2 General Test Conditions**

### **5.2.1 Test Sites**

Radiated emission tests were performed at Northern Telecom's Open Area Test Site (1500 Peter Robinson Road, Almonte, Ontario, Canada).

### **5.2.2 Test Configuration**

A NT800-DR cell site system was put together using 8 TRUII (NTAX98AA) and 8 TRUIII (NTAW99AA). The eight TRUIII (NTAW99AA) were programmed to transmit at maximum power and on different channels.

**Table:6 Cellular System Configuration**

Slot No.	Description	Model No.	Serial No.
1	TRUIII transceiver	NTAX99AA	NNTM532KPD92
2	TRUII transceiver	NTAX98AA	NNTM532KPDG9
3	TRUIII transceiver	NTAX99AA	NNTM532KPD70
4	TRUII transceiver	NTAX98AA	NNTM532KPME
5	TRUIII transceiver	NTAX99AA	NNTM532KPD81
6	TRUII transceiver	NTAX98AA	NNTM532KPDQH
7	TRUIII transceiver	NTAX99AA	NNTM532M2VD2
8	TRUII transceiver	NTAX98AA	NNTM532KPDPG
9	TRUIII transceiver	NTAX99AA	NNTM532KPD5X
10	TRUII transceiver	NTAX98AA	NNTM532KPKDC
11	TRUIII transceiver	NTAX99AA	NNTM532KPD6Y
12	TRUII transceiver	NTAX98AA	NNTM532KPDNF
13	TRUIII transceiver	NTAX99AA	NNTM532M2WLA
14	TRUII transceiver	NTAX98AA	NNTM532KPDHA
15	TRUIII transceiver	NTAX99AA	NNTM532KPDF8
16	TRUII transceiver	NTAX98AA	NNTM532KPDE7
1	PA	NTHX51AA	NNTM74501HM2
2	PA	NTHX51AA	NNTM530Q1FQ0
3	PA	NTHX51AA	NNTM61012RL3
4	PA	NTHX51AA	NNTM530Q1FPY
5	PA	NTHX51AA	NNTM530Q1R7R
6	PA	NTHX51AA	NNTM61000332
7	PA	NTHX51AA	NNTM61012PPM
8	PA	NTHX51AA	NNTM74S01HME
9	PA	NTHX51AA	NNTM74S01HMF
10	PA	NTHX51AA	NNTM61000316
11	PA	QCPA-0914	NNTM61000308
12	PA	NTHX51AA	NNTM61000349

Slot No.	Description	Model No.	Serial No.
13	PA	QCPA-0914	NNTM61000301
14	PA	NTHX51AA	NNTM530Q1QWE
15	PA	NTHX51AA	NNTM74S01HMR
16	PA	NTHX51AA	NNTM61000335
	RF FRAME	NT3P21GE	
	RIP	NT3P	
	SPLITTERS	NTXR1A	10-94-B446
	COMBINER	81186	5925
	COMBINER	81186	5955
	COMBINER	81186	5897
	COMBINER	81186	5956
	CE FRAME	NT3P20BC	
	RIP	NT3P20BC	
	HSM OSCILLATOR	NT3P20HP	14778-043

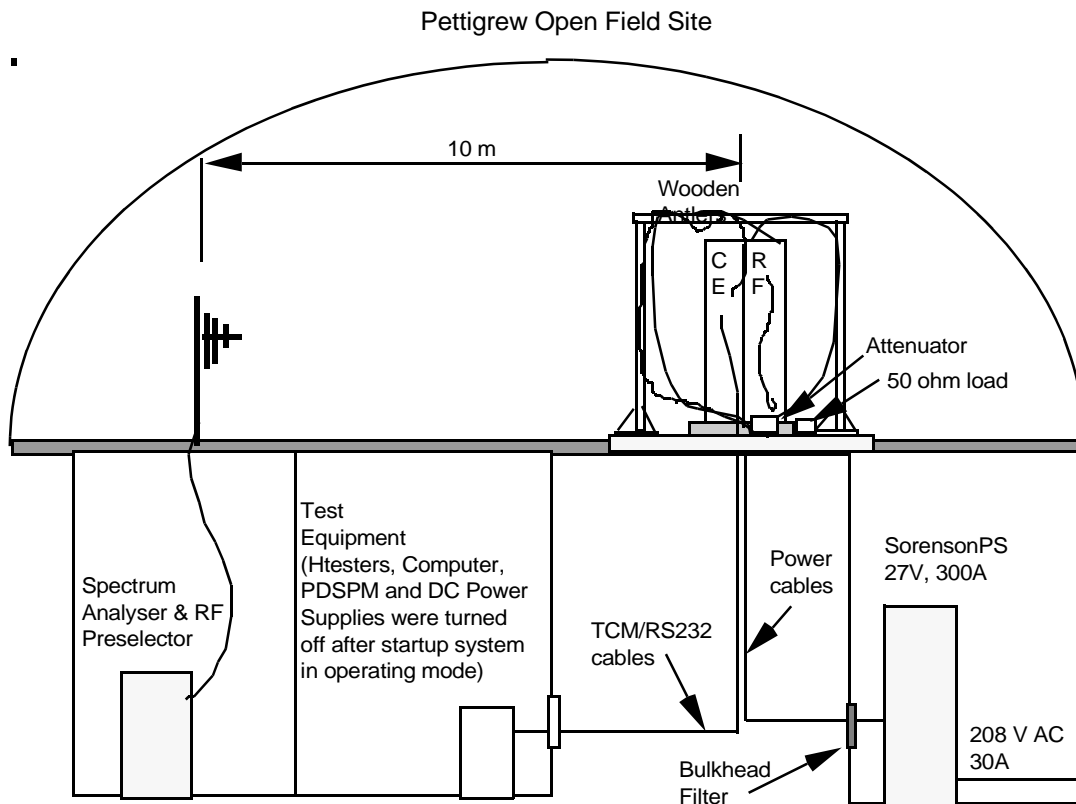

**Figure 1: Test Setup For Radiated Emissions at Open Field Site**

### 5.3 Radiated Emissions Measurements

#### 5.3.1 Test Procedure

Test equipment & site verification is performed prior to the installation of test sample as an ISO9000 procedure. The test system uses a broadband antenna positioned at 3 or 10 meters from the test sample. For this test, measurements were performed at 10 meters from the test sample. The test sample is rotated in azimuth over 360 degrees and antenna varied from 1 to 4 meters by increments of no less than 10 degrees and 50 cm, respectively. The azimuth, height and measured signal levels of the maximum emissions for all frequencies of the system clock harmonics are recorded. Cables are placed on the cross-arm to maximize emissions during the test. These procedures apply to both horizontal and vertical polarization of the search antenna. Final measurements are taken with tuned dipole antennae up to 1 GHz and a double ridged horn for above 1 GHz. All measurements are done by an automated program called AEMS, which is NORTEL proprietary software being developed for automated Open Field Tests.

The bandwidth used on the spectrum analyzer is 100 kHz unless otherwise noted. For broadband scans, the detector mode is video averaging of three scans. For measurements at discrete frequen-

cies the detector mode is always quasi-peak except above 1 GHz where 1 MHz resolution bandwidth and average detection (video bandwidth of 100 Hz) are used. The frequency range investigated is 30 to 10000 MHz.

### **5.3.2 Measurement Instrumentation**

The measurement instrumentation conforms to American National Standard Specification for Electromagnetic Interference and Field Strength Instrumentation 100 Hz - 22 GHz, ANSI C63.4 (1992) and CISPR publication 16.

Calibration of the measurement instrumentation is maintained in accordance with the supplier's recommendations, or as necessary to ensure its accuracy.

## **5.4 Test Results**

### **5.4.1 Radiated Emission Results**

#### **Conforms**

Measurement of the transmit harmonics of the transceiver were carried on various channels. Emissions with levels which were less than 20 dB from the limit are shown in Table 7.



**Table:7 Radiated Emission Results**

Frequency (MHz)	Description	Measured Level (dBuV)	Correction Factor (dB)	Field Strength (dBuV/m)	Limit (dBuV/m)	Margin (dB)
2618.46	3rd Tx Harm.	64.1	-1	63.1	73.9	10.8
2638.89	3rd Tx Harm.	56.6	-1	55.6	73.9	18.3
3476.16	4th Tx Harm.	64.2	0.8	65	73.9	8.9
3486.24	4th Tx Harm.	65.6	0.9	66.5	73.9	7.4
3491.28	4th Tx Harm.	61.2	0.9	62.1	73.9	11.8
3523.56	4th Tx Harm.	57.3	0.9	58.2	73.9	15.7
3528.6	4th Tx Harm.	58.8	0.9	59.7	73.9	14.2
4357.8	5th Tx Harm.	61.2	4.8	66	73.9	7.9
4364.1	5th Tx Harm.	49.4	4.8	54.2	73.9	19.7
4404.45	5th Tx Harm.	54.6	4.8	59.4	73.9	14.5
4410.75	5th Tx Harm.	54.4	4.8	59.2	73.9	14.7
4417.05	5th Tx Harm.	61.3	4.8	66.1	73.9	7.8
5229.36	6th Tx Harm.	56	6.4	62.4	73.9	11.5
5236.92	6th Tx Harm.	59.8	6.6	66.4	73.9	7.5
5285.34	6th Tx Harm.	48.2	6.6	54.8	73.9	19.1
6100.92	7th Tx Harm.	46.6	8	54.6	73.9	19.3
6175.05	7th Tx Harm.	57.4	8.1	65.5	73.9	8.4
6183.87	7th Tx Harm.	55.8	8.1	63.9	73.9	10

All measurements < 1 GHz were performed with a Quasi-peak detector.

All measurements > 1 GHz were performed with a peak detector.

### 5.5 Mathematical Calculations of Compliance Limit and Margin

FCC Part 22 states that harmonics must be suppressed  $43 + 10 \log P$  below the transmitter power level in order to comply.

#### Calculation of Part 22 Limit @ 3m (dBuV/m)

Emission limit = **-13 dBm**

To determine the field-strength limit at 3 meters, we use the gain of a half-wave dipole antenna:

$$E_{\text{limit}} = (1/R) * \text{SQRT}(30 * P_t * G_t)$$

where  $G_t = 1.65$  for an half-wave dipole antenna,  $R = 3$  meters,  $P_t = -13$  dBm  $\sim 50.1 \mu\text{W}$

$$E_{\text{limit}} = (1/10) * \text{SQRT}(30 * 50.1\mu\text{W} * 1.65)$$

$$E_{\text{limit}} = 0.00498 \text{ V/m}$$

$$E_{\text{limit}} = 20 \log(0.00498\text{V}) = -46.1 \text{ dBV} = 73.9 \text{ dB}\mu\text{V/m} = \text{E-Field Limit @ 10 meters}$$

**Calculation of Field Strength @ 10m (dBμV/m)**

To calculate the E-field measured by the horn antenna, the following calculations were used:

Data sample: 3486.24 MHz, Measured value = 65.6 dBμV

Antenna factor + Cable loss - Pre-Amplifier Gain at 3.3531 GHz = 0.9 dB

Field strength measured (dBμV/m) = Measured Level (dBμV) + Correction Factor (dB)

$$= 65.6 \text{ dB}\mu\text{V} + 0.9 \text{ dB}$$

$$= 66.5 \text{ dB}\mu\text{V/m}$$

Therefore, the margin for this example is  $73.9 - 66.5 = 7.4$  dB.

**5.6 Test Equipment List**

**Table 8: Test Equipment List for Radiated Emissions Test**

MANUFACTURE/TYPE	MODEL NO.	SERIAL NO.	CAL. DUE
HP QUASI-PEAK DETECTOR	85650A	2043A00159	30 MAR. 99
HP SPECTRUM ANALYZER	85660B	3014A07256	30 MAR. 99
HP SPECTRUM ANALYZER DISPLAY	85662A	3026A20026	30 MAR. 99
HP RF PRESELECTOR	85685A	3010A01085	30 MAR. 99
CHASE BILOG ANTENNA	CBL 6111	1011	30 DEC. 98
HP SPECTRUM ANALYZER	8593E	3308A00587	23 MAY 98
EMCO HORN ANTENNA	3115	4690	27 OCT.99
CABLE / SUCOFLEX		2867	FEB. 99
CABLE / SUCOFLEX		1705/4PB	SEP. 99