



Test Report for FCC Equipment Authorization

FCC ID AB6NT3030VBTS CDMA BTS 3030 800MHz

Document:	AB6NT3030VBTS
Stream:	01
Issue:	00
Document Status:	Approved
Issue Date:	April 24, 2006
Security Status:	Nortel Networks Confidential
Author:	Fabian Wong

© 2006 Nortel Networks Limited

Disclaimer

The master of this document is stored on an electronic database and "write protected". The protection can be altered by authorized persons only. Viewing of the master document electronically ensures access to the current issue. Any hardcopies must be regarded as uncontrolled copies.

Security Warning

The information disclosed herein is proprietary to Nortel Networks and not to be used by or disclosed by unauthorized persons without the written consent of Nortel Networks. The recipient of this document shall respect the security status of the information.

PAGE INTENTIONALLY LEFT BLANK

Publication History

The latest controlled release of this document is located in Livelink at the following location:

<http://livelink2.ca.nortel.com/livelink/livelink.exe?func=ll&objId=16522182&objAction=browse&sort=namenull>

All other soft and hard copies are uncontrolled. It is the responsibility of the reader to ensure that the latest release of this document is being used.

List of Consultants

The following people have reviewed this document prior to its release and have recommended its approval:

Printed Name	Function	Department
Thomas Wong	CDMA/TDMA Regulatory Prime	2U40
Brad Carlson	Systems Manager	2U41

Decision Ratifier

The release of this document has been reviewed and approved for distribution and use by the following:

Ratifier's Name	Signature	Date
Brad Carlson		

Revision History

Stream/Issue	Revision Date	Reason for Change	Author
00/0.01	24/04/2006	Initial release of test Report	Fabian Wong

Change bars will not be used in this document.

Acronyms and Abbreviations

BPF	Bandpass Filter
BTS	Base Station Transceiver Subsystem
BW	Bandwidth
CDMA	Code Division Multiple Access
CEM	Channel Enhancement Module
CM	Control Module
CR	Cost Reduced
DE	Digital Encloser
DPM	Duplexer Preselector Module
FAM	Fan and Alarm Module
GPSTM	Global Position System Timing Module
LO	Local Oscillator
PA	Power Amplifier
RBW	Resolution BandWidth
RM	Radio Module
RMS	Root Mean Square
RF	Radio Frequency
SA	Spectrum Analyzer
TBD	To Be Determined

Table of Contents

Publication History	3
List of Consultants	3
Decision Ratifier	3
.....	4
Revision History	4
Acronyms and Abbreviations	5
1 Introduction.....	15
1.1 Required Tests	15
2 Engineering Declaration.....	17
3 Equipment Authorization Application Requirements	18
3.1 Standard Test Conditions and Test Equipment.....	18
3.2 EUT Identification List	18
3.3 Test Equipment List.....	19
4 Transmitter Tests.....	21
4.1 RF Power Output	21
4.1.1 RF Power Output Requirements	21
4.1.2 Test Method	21
4.1.3 Test Setup	21
4.1.4 Test Result	21
4.1.5 Test Method	22
4.1.6 Test Setup	22
4.1.7 IS-97.....	22
4.1.8 DOM	23
4.1.9 Noise Floor	23
4.1.10 RF Output Power Test Results.....	24
4.2 Occupied Bandwidth.....	26
4.2.1 Occupied Bandwidth Requirements	26
4.2.2 Test Method	26
4.2.3 Test Setup	26
4.2.4 Test Result	27
4.3 Spurious Emissions at Antenna Terminals	29
4.3.1 Spurious Emissions Requirements.....	29
4.3.2 Test Method	30
4.3.2.1 Adjacent 1MHz to indicated cellular band (Upper and Lower)	30
4.3.2.2 All other Spurious Emissions up to 10 GHz.....	31
4.3.3 Test Requirements	31
4.3.4 Test Setup	32
4.3.5 Test Results	33
4.4 Transmitter Tests (CDMA Mode)	36
4.4.1 Test Method	36
4.4.1.1 Adjacent 1MHz to indicated cellular band (Upper and Lower)	37

4.4.2 Test Setup	38
4.4.3 Test Results	39
4.5 Frequency Stability	42
4.5.1 Frequency Stability Requirements	42
4.5.2 Test Procedure	43
4.5.3 Frequency Results	43
5 Appendix A - Single Carrier Spurious Emission	45
6 Appendix B - Two Carriers Spurious Emission.....	62
7 Appendix C - Three Carrier Spurious Emission	80
References.....	97

List of Figures

Figure 1 : Test Setup for PA DC current draw measurement	21
Figure 2 : Test Setup for RF Power Output Measurement	23
Figure 3 : Test Setup for Occupied Bandwidth Measurement.....	27
Figure 4 : Test Setup for Spurious Emissions Measurement.....	32
Figure 5 : Test Setup for Spurious Emissions Measurement.....	38
Figure 6 : Test configuration for Frequency Stability	43
Figure 7 : 1 Carrier - Occupied Bandwidth Channel 1015	45
Figure 8 : 1 Carrier - Lower Adjacent Channel 1MHz Channel 1015.....	46
Figure 9 : One Carrier - Ch1015 IS95 Lower A” Band Adjacent to outside edge 12.5kHz band Channel Power	47
Figure 10 : 1 Carrier - Upper Adjacent Channel 1MHz Channel 308.....	48
Figure 11 : One Carrier - Ch 308 Upper A Band adjacent to outside edge 12.5 kHz band Channel power	49
Figure 12 : One Carrier - A Band Spurious emissions 50-400 MHz Channel 308	50
Figure 13 : One Carrier - A Band Spurious emissions 400 MHz to Lower Band Emissions Channel 308	51
Figure 14 : One Carrier - A Band Spurious Emissions Upper Band Emissions to 1GHz Channel 308	52
Figure 15 : One Carrier - A Band Spurious emissions 1000-2000 MHz Channel 308	53
Figure 16 : One Carrier - A Band Spurious emissions 2000-3000 MHz Channel 308	54
Figure 17 : One Carrier - A Band Spurious emissions 3000-4000 MHz Channel 308	55
Figure 18 : One Carrier - A Band Spurious emissions 4000-5000 MHz Channel 308	56
Figure 19 : One Carrier - A Band Spurious emissions 5000-6000 MHz Channel 308	57
Figure 20 : One Carrier - A Band Spurious emissions 6000-7000 MHz Channel 308	58
Figure 21 : One Carrier - A Band Spurious emissions 7000-8000 MHz Channel 308	59
Figure 22 : One Carrier - A Band Spurious emissions 8000-9000 MHz Channel 308	60
Figure 23 : One Carrier - A Band Spurious emissions 9000-10000 MHz Channel 308	61
Figure 24 : Two Carriers - Occupied Bandwidth Ch 358, 399 Band B.....	62
Figure 25 : Two Carriers - Lower Adjacent Channel 1 MHz Channel 358, 399.....	63
Figure 26 : Two Carriers - Ch 358, 399 Lower B Band Adjacent to outside edge 25kHz band Channel Power	64
Figure 27 : Two Carriers Upper Adjacent Channel 1MHz Channel 601, 642	65

Figure 28 : Two Carriers - Ch 601, 642 Upper B Band adjacent to outside edge 25.0 kHz band Channel power	66
Figure 29 : Two Carriers - B Band Spurious emission 50 - 400MHz Channel 601, 642	67
Figure 30 : Two Carriers - Spurious emissions 400 MHz to Lower Band Emissions Channel 601, 642	68
Figure 31 : Two Carriers - Upper Band Emissions to 1 GHz Channel 601, 642	69
Figure 32 : Two Carriers - B Band Spurious emissions 1000-2000 MHz Channel 601, 642	70
Figure 33 : Two Carriers - B Band Spurious emissions 1000-2000 MHz Channel 601, 642	71
Figure 34 : Two Carriers - B Band Spurious emissions 2000-3000 MHz Channel 601, 642	72
Figure 35 : Two Carriers - B Band Spurious emissions 3000-4000 MHz Channel 601, 642	73
Figure 36 : Two Carriers - B Band Spurious emissions 4000-5000 MHz Channel 601, 642	74
Figure 37 : Two Carriers - B Band Spurious emissions 5000-6000 MHz Channel 601, 642	75
Figure 38 : Two Carriers - B Band Spurious emissions 6000-7000 MHz Channel 601, 642	76
Figure 39 : Two Carriers - B Band Spurious emissions 7000-8000 MHz Channel 601, 642	77
Figure 40 : Two Carriers - B Band Spurious emissions 8000-9000 MHz Channel 601, 642	78
Figure 41 : Two Carriers - B Band Spurious emissions 9000-10000 MHz Channel 601, 642	79
Figure 42 : Three Carriers - Occupied Bandwidth Ch 1015, 33, 74 A”	80
Figure 43 : Three Carriers - Lower Adjacent Channel 1MHz Channel 1015, 33, 74.....	81
Figure 44 : Three Carriers - Ch 1015, 33, 74 Lower A” Band Adjacent to outside edge 37.5kHz band Channel Power	82
Figure 45 : Three Carriers - Upper Adjacent Channel 1MHz Channel 226, 267, 308	83
Figure 46 : Three Carriers - Ch 226, 267, 308 Upper A Band adjacent to outside edge 37.5 kHz band Channel power	84
Figure 47 : Three Carriers - A Band Spurious emissions 50-400 MHz Ch 226, 267, 308.....	85
Figure 48 : Three Carriers - A Band Spurious emissions 400 MHz to Lower Band Emissions Ch 226, 267, 308	86
Figure 49 : Three Carriers - A Band Spurious Emissions Upper Band Emissions to 1 GHz Ch 226, 267, 308	87
Figure 50 : Three Carriers - A Band Spurious emissions 1000-2000 MHz Ch 226, 267, 308.....	88
Figure 51 : Three Carriers - A Band Spurious emissions 2000-3000 MHz Ch 226, 267, 308.....	89
Figure 52 : Three Carriers - A Band Spurious emissions 3000-4000 MHz Ch 226, 267, 308.....	90
Figure 53 : Three Carriers - A Band Spurious emissions 4000-5000 MHz Ch 226, 267, 308.....	91
Figure 54 : Three Carriers - A Band Spurious emissions 5000-6000 MHz Ch 226, 267, 308.....	92
Figure 55 : Three Carriers - A Band Spurious emissions 6000-7000 MHz Ch 226, 267, 308.....	93

Figure 56 : Three Carriers - A Band Spurious emissions 7000-8000 MHz Ch 226, 267, 308.....94

Figure 57 : Three Carriers - A Band Spurious emissions 8000-9000 MHz Ch 226, 267, 308.....95

Figure 58 : Three Carriers - A Band Spurious emissions 9000-10000 MHz Ch 226, 267, 308...96

List of Tables

Table 1 : Required Tests	15
Table 2 : EUT Identification List.....	18
Table 3 : Test Equipment List.....	19
Table 5 : Spectrum Analyzer Noise Floor	23
Table 6 : RF Output Power BTS3030 800 MHz 1-Carrier IS-97 and IS-864	24
Table 7 : RF Output Power BTS3030 800 MHz 2-Carrier IS-864.....	24
Table 9 : Measured Occupied Bandwidth BTS3030 800 MHz 1-Carrier IS-97 and IS-864.....	27
Table 10 : Measured Occupied Bandwidth BTS3030 800 MHz 2-Carrier IS-864.....	27
Table 11 : Measured Occupied Bandwidth of BTS3030 800 MHz 3-Carrier IS-97 and IS-864.28	
Table 13 : All other Emission Spectrum Analyze Settings	31
Table 14 : Spurious Emissions Requirements	31
Table 15 : Spurious Emissions at the BTS3030 800 MHz Ant. Port one carrier IS-97 and IS-864 33	
Table 16 : Spurious Emissions at the BTS3030 800 MHz Ant. Port Two Carrier IS-864	34
Table 17 : Spurious Emissions at the BTS3030 800 MHz Ant. Port Three Carrier IS-97 and IS- 864	35
Table 19 : Industry Canada Suppression inside cellular band BTS3030 800 MHz Antenna Port 1 Carrier band A''	39
Table 20 : Industry Canada Suppression inside cellular band BTS3030 800 MHz Antenna Port IS97, 3 Carrier band A'' and A.....	40
Table 21 : Industry Canada Suppression inside cellular band BTS3030 800 MHz Antenna Port, 1 Carrier band B'	41
Table 22 : Test results for Frequency Stability versus Power supply Voltage at 25C	43
Table 23 : Test results for Frequency Stability versus Temperature at -48V operation.....	44

1 Introduction

This test report supports FCC filing for the BTS 3030 800 MHz. This test report will be used as a filing for FCC part 22. This filing includes single, two and three carrier modes for the 800MHz cellular band. The following test results include; RF Power Output, Occupied Bandwidth, Spurious Emissions at Antenna Terminals, and Transmitter Test (CDMA Mode Transmitter). Frequency stability over voltage and temperature test results are included. Emissions testing was conducted at -48VDC at room temperature. The IS97 and IS864 modulation schemes will be included in this report.

This test report is submitted in accordance with the FCC Rules and Regulations, Part 2, Subpart J, Sections 2.1046 through 2.1057 for equipment authorization of Nortel Networks BTS 3030 800 MHz.

The BTS3030 800 MHz is intended for use in the Domestic Public Cellular Radio Telecommunications Service and is designed in accordance with the following standards:

- *CFR 47, Part 22, Subpart H, Cellular Radiotelephone Service [1]*
- *CFR 47, Part 2, Subpart J, Equipment Authorization Procedures - Equipment Authorization[2]*
- *IC RSS-129, Issue 2, 800 MHz Dual-Mode CDMA Cellular Telephones [3]*
- *TIA/EIA-97-F, Recommended Minimum Performance Standards for Base Stations Supporting Dual Mode Spread Spectrum Systems [4]*

1.1 Required Tests

Table 1 summarizes the required tests for the BTS3030 800 MHz.

Table 1 : Required Tests

FCC Measurement Specification	FCC Limit Specification	Description	Test to be Performed?
2.1033		PA DC Current Draw	Yes
2.1046	22.913	RF Power Output	Yes
2.1049	22.917	Occupied Bandwidth	Yes
2.1051, 2.1057	22.917	Spurious Emissions at Antenna Terminals	Yes
2.1053, 2.1057	22.917	Field Strength of Spurious Emissions	Yes ^a
2.1055	22.355	Frequency Stability	Yes

-
- a. Field strength of spurious emissions testing will be performed by Sanmina-SCI Canada, Calgary.

2 Engineering Declaration

The CDMA BTS3030 800 MHz has been tested in accordance with the requirements contained in the Federal Communications Commission Rules and Regulations Part 2 and 22.

To the best of my knowledge, these tests were performed in accordance with good engineering practices using measurement procedures consistent with industry or commission standards or previous Commission correspondence or guidance and demonstrate that this equipment complies with the appropriate standards. All tests were conducted on a representative sample of the equipment for which equipment authorization is sought.

Tested by:
Fabian Wong
Systems Test Prime
Nortel Networks
Calgary Canada

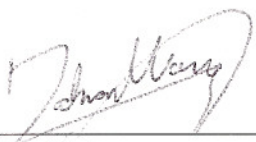

Signature

APR 28TH, 2006

Date

Reviewed by:
Thomas Wong
CDMA/TDMA Regulatory
Emissions Prime
Nortel Networks
Calgary Canada

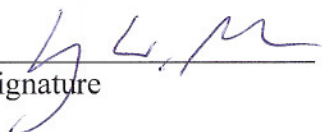

Signature

April 28, 2006

Date

Approved by:
Brad Carlson
Systems Manager
Nortel Networks
Calgary Canada



Signature

April 28, 2006

Date

3 Equipment Authorization Application Requirements

3.1 Standard Test Conditions and Test Equipment

The BTS3030 800 MHz Radio will be tested under the following standard test conditions unless otherwise noted:

- Ambient Temperature: 20 to 35 degrees C
- Ambient Humidity: 20 to 40%
- DC Supply Voltage: -48 Vdc (nominal)
- Input modulation IS-97 and IS-864

3.2 EUT Identification List

Table 2 shows the identification of the components required for testing.

Table 2 : EUT Identification List

Equipment Description	Model / Part Number	Release Number	Serial Number
Radio Module	NTDV30BA	P3	NNTM536G3MP8
Digital Module	NTDV25BA	P2	NNTM7860CL8B
Fan Module	NTDV22AA	N2	NNTM7860CKGP
A-Band Duplexer	NTDV40AA	P2	000006
B-Band Duplexer	NTDV40BA	01	000196
Customer Alarm Module	NTDV21BA	P1	NNTM536G3NCX
XCEM 192 ^a	NTRZ80BA	17	NNTM74X101GJ
XCEM 64 ^a	NTRZ80AA	N1	NNTM74X0LR6D
DOM 0 ^b	NTBW99D0	40	ARVN44556054
DOM 0	NTBW99D0	42	ARVN51750197

Notes: ^a One carrier used channel element in Digital Module. Three XCEM carriers: One carrier used channel element in digital module while the other two carriers used external XCEM.

Notes: ^b One carrier used channel element in DOM (external slot). Three mixed carriers: One carrier used channel element in digital module while the other two carriers used external DOMs.

3.3 Test Equipment List

Table 3 shows the identification of the test equipment required.

Table 3 : Test Equipment List

Description	Manufacturer	Model	Serial Number	Cal. Due Date
9kHz to 40 GHz Spectrum Analyzer	Rohde&Schwarz	FSEK-30	DE25178	28 Oct 2006
RF Power Meter	Agilent	E4419B	US39250565	21 Oct 2007
RF Power Sensor Head	Agilent	8482A	1-64464488	18 Jun 2006
30dB Attenuator (150W)	Narda	769-30	06583	n/a
10dB Attenuator (150W)	Narda	769-10	04458	n/a
RF Cable 1	Andrew	A0359685	n/a	n/a
RF Cable 2	Micro-Coax	201B-1-0720-70X70	n/a	n/a

4 Transmitter Tests

4.1 RF Power Output

4.1.1 RF Power Output Requirements

FCC Part 2.1033 Application for certification.

(c) Applications for equipment other than that operating under parts 15 and 18 of the rules shall be accompanied by a technical report containing the following information:

(8) The dc voltages applied to and dc currents into the several elements of the final radio frequency amplifying device for normal operation over the power range.

4.1.2 Test Method

The BTS3030 was setup to blossom at maximum power. The RF output power was measured using the power meter. The softfail current registers were read with the BTS controller when the BTS3030 was fully blossomed.

4.1.3 Test Setup

The set-up used for the BTS PA DC current draw test is illustrated in Figure 1. RF output power measurements were referenced to the BTS PA output.

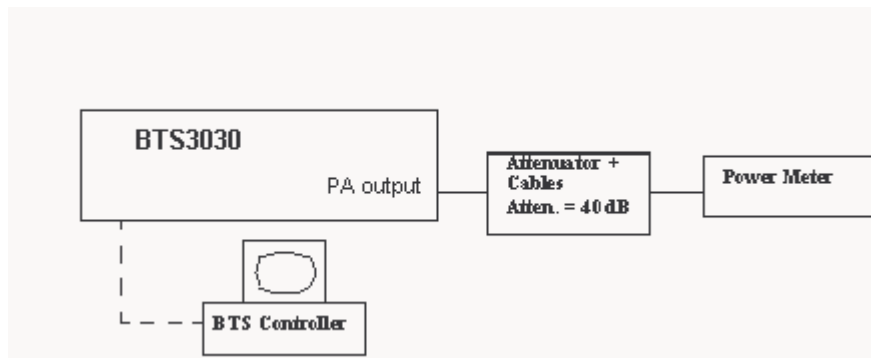

Figure 1 : Test Setup for PA DC current draw measurement

4.1.4 Test Result

The final amplifying dc voltage is 27.0 Vdc. The final dc current is shown in Table 4.

Table 4: Average Current Values @ Pout = 48.75dBm

	Average Current Values @ Pout = 48.75dBm (mean Ampere)
Q5	4.00
Q6	4.00

FCC Part 2.1046 Measurements required: RF power output

§(a) For transmitters other than single sideband, independent sideband and controlled carrier radiotelephone, power output shall be measured at the RF output terminals when the transmitter is adjusted in accordance with the tune-up procedure to give the values of current and voltage on the circuit elements specified in §2.1033(c)(8). The electrical characteristics of the radio frequency load attached to the output terminals when this test is made shall be stated.

(c) For measurements conducted pursuant to paragraphs (a) and (b) of this section, all calculations and methods used by the applicant for determining carrier power or peak envelope power, as appropriate, on the basis of measured power in the radio frequency load attached to the transmitter output terminals shall be shown. Under the test conditions specified, no components of the emission spectrum shall exceed the limits specified in the applicable rule parts as necessary for meeting occupied bandwidth or emission limitations.

4.1.5 Test Method

Setup the BTS controller to enable the BTS3030 800 MHz Radio to transmit at the rated MAXIMUM power for each of the carrier configurations one, two and three carrier in the Baseband modulation formats IS-97 and IS-864. Measurements will be made on channels at the bottom and top of the operator bands with the BTS3030 MHz Radio operating with -48Vdc. The RF output power will be measured using the power meter.

4.1.6 Test Setup

The set-up required for the BTS3030 800 MHz Radio RF output power test is illustrated in Figure 2. RF output power measurements will be referenced to the antenna port of the Duplexer.

4.1.7 IS-97

The RF power output of the BTS3030 800 MHz were tested at RATED maximum power. Transmitters operating with IS97 were tested at +47.8 dBm.

4.1.8 DOM

The RF power output of the BTS3030 800 MHz, with IS-864 waveforms were tested at RATED maximum power. Transmitters operating with IS864 were tested at +47.8 dBm.

4.1.9 Noise Floor

Table 4 lists the noise floor of the measurement system with no signal present.

Table 5 : Spectrum Analyzer Noise Floor

Start (MHz)	Stop (MHz)	Peak (dBm)	RBW kHz
50	400	-39.45	100
50	1000	-38.87	100
1000	2000	-36.22	100
2000	3000	-34.36	100
3000	4000	-34.75	100
4000	5000	-34.47	100
5000	6000	-32.01	100
6000	7000	-28.74	100
7000	8000	-29.07	100
8000	9000	-25.84	100
9000	10000	-22.61	100

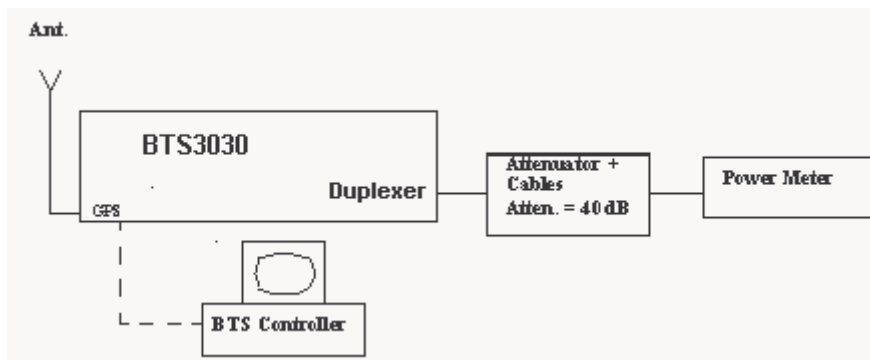

Figure 2 : Test Setup for RF Power Output Measurement

4.1.10 RF Output Power Test Results

Table 6 : RF Output Power BTS3030 800 MHz 1-Carrier IS-97 and IS-864

Channel Number (Band)	Modulation	Frequency (MHz)	Measured RF Output Power (dBm)	Typical Maximum Rated Power (dBm)
1015 (A'')	QPSK	869.76	47.71	47.8
308 (A)	QPSK	879.24	47.73	47.8
358 (B)	8PSK	880.74	47.65	47.8
642 (B)	8PSK	889.26	47.68	47.8
692 (A')	IS-97	890.76	47.73	47.8
742 (B')	16QAM	892.26	47.65	47.8
775 (B')	16QAM	893.25	47.69	47.8

Table 7 : RF Output Power BTS3030 800 MHz 2-Carrier IS-864

Channel Number (Band)	Modulation	Frequency (MHz)	Measured RF Output Power (dBm)	Typical Maximum Rated Power (dBm)
358, 399 (B)	16QAM	880.74, 881.97,	47.65	47.8
601, 642 (B)	16QAM	886.8, 888.03	47.65	47.8

Table 8: RF Output Power of BTS3030 800 MHz 3-Carrier IS-97 and IS-864

Channel Number (Band)	Modulation	Frequencies (MHz)	Measured RF Output Power (dBm)	Typical Maximum Rated Power (dBm)
1015, 33, 74 (A''&A)	IS-97 and 2 8PSK	869.76, 870.99, 872.22	47.65	47.8
226, 267, 308 (A)	IS-97 and 2 8PSK	876.78, 878.01, 879.24	47.68	47.8

Table 8: RF Output Power of BTS3030 800 MHz 3-Carrier IS-97 and IS-864

Channel Number (Band)	Modulation	Frequencies (MHz)	Measured RF Output Power (dBm)	Typical Maximum Rated Power (dBm)
358, 399, 440 (B)	IS-97 and 2 16QAM	880.74, 881.97, 883.20	47.64	47.8
560, 601, 642 (B)	IS-97 and 2 16QAM	886.8, 888.03, 889.26	47.65	47.8
358, 399, 440 (B)	3 IS-97	880.74, 881.97, 883.20	47.66	47.8
560, 601, 642 (B)	3 IS-97	886.8, 888.03, 889.26	47.66	47.8

4.2 Occupied Bandwidth

4.2.1 Occupied Bandwidth Requirements

FCC Part 2.1049

The OBW, that is the frequency bandwidth such that, below its lower and above its upper frequency limits, the mean powers radiated are each equal to 0.5 percent of the total mean power radiated by a given emission shall be measured under the following conditions as applicable:

(g) Transmitter in which the modulating baseband comprises not more than three independent channels - when modulated by the full complement of signals for which the transmitter is rated. The level of modulation for each channel should be set to that prescribed in rule parts applicable to the services for which the transmitter is intended. If specific modulation levels are not set forth in the rules, the tests should provide the manufacturer's maximum rated condition.

(h) Transmitters employing digital modulation techniques - when modulated by an input signal such that its amplitude and symbol rate represent the maximum rated conditions under which the equipment will be operated. The signal shall be applied through any filter networks, pseudo-random generators or other devices required in normal service. Additionally, the occupied bandwidth shall be shown for operation with any devices used for modifying the spectrum when such devices are optional at discretion of the user.

4.2.2 Test Method

Setup the BTS3030 to transmit at maximum rated power for each of the carrier configurations one, two and three carrier in the Baseband modulation formats IS-97 and IS-864. Measurements will be made on channels at the bottom and top of each of the operator bands. The occupied bandwidth was measured using the 99% channel power feature of the spectrum analyzer.

4.2.3 Test Setup

The set-up required for the BTS3030 800 MHz Occupied bandwidth test is illustrated in Figure 3.

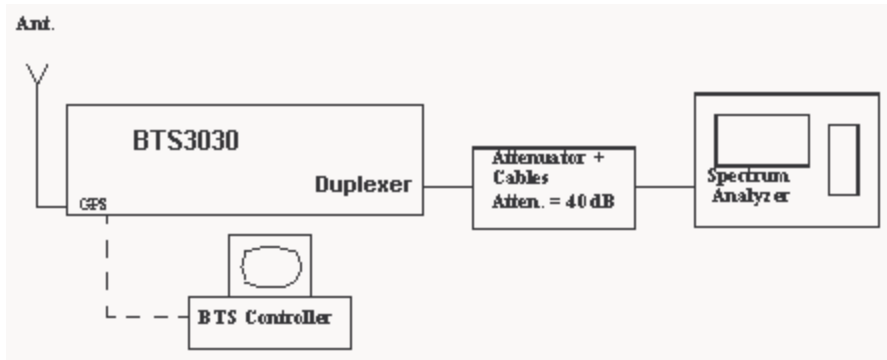

Figure 3 : Test Setup for Occupied Bandwidth Measurement

4.2.4 Test Result

Table 9 : Measured Occupied Bandwidth BTS3030 800 MHz 1-Carrier IS-97 and IS-864

Channel Number (Band)	Modulation	Frequency (MHz)	Measured Occupied Bandwidth (MHz) (1-Carrier)
1015 (A'')	QPSK	869.76	1.2665
308 (A)	QPSK	879.24	1.2625
358 (B)	8PSK	880.74	1.2625
642 (B)	8PSK	889.26	1.2625
692 (A')	IS-97	890.76	1.2625
742 (B')	16QAM	892.26	1.2625
775 (B')	16QAM	893.25	1.2705

Table 10 : Measured Occupied Bandwidth BTS3030 800 MHz 2-Carrier IS-864

Channel Number (Band)	Modulation	Frequency (MHz)	Measured Occupied Bandwidth (MHz)
358, 399(B)	16QAM	880.74, 881.97,	2.4609
601, 642 (B)	16QAM	888.03, 889.26	2.4769

Table 11 : Measured Occupied Bandwidth of BTS3030 800 MHz 3-Carrier IS-97 and IS-864

Channel Number (Band)	Modulation	Frequencies (MHz)	Measured Occupied Bandwidth (MHz)
1015, 33, 74 (A' & A)	IS-97 and 2 8PSK	869.76, 870.99, 872.22	3.6713
226, 267, 308 (A)	IS-97 and 2 8PSK	876.78, 878.01, 879.24	3.6713
358, 399, 440 (B)	IS-97 and 2 16QAM	880.74, 881.97, 883.20	3.6873
560, 601, 642 (B)	IS-97 and 2 16QAM	886.8, 888.03, 889.26	3.6713
358, 399, 440 (B)	3 IS-97	880.74, 881.97, 883.20	3.6873
560, 601, 642 (B)	3 IS-97	886.8, 888.03, 889.26	3.6713

4.3 Spurious Emissions at Antenna Terminals

4.3.1 Spurious Emissions Requirements

FCC Part 2.1051

The radio frequency voltage or powers generated within the equipment and appearing on a spurious frequency shall be checked at the equipment output terminals when properly loaded with a suitable artificial antenna. Curves or equivalent data shall show the magnitude of each harmonic and other spurious emission that can be detected when the equipment is operated under the conditions specified in 2.1049 as appropriate. The magnitude of spurious emissions which are attenuated more than 20 dB below the permissible value need not be specified.

FCC Part 2.1057 - Frequency Spectrum to be investigated

The spectrum should be investigated from the lowest radio frequency generated in the equipment up to at least the 10th harmonic of the carrier frequency or to the highest frequency practicable in the present state of the art of measuring techniques, whichever is lower. Particular attention should be paid to harmonics and subharmonics of the carrier frequency. Radiation at the frequencies of multiplier stages should be checked. The amplitude of spurious emissions which are attenuated more than 20 dB below the permissible value need not be reported.

FCC Part 22.917 Limit

Out of band emissions. The power of any emission outside of the authorized operating frequency ranges must be attenuated below the transmitting power (P) by a factor of at least $43 + 10 \log(P)$ dB.

Measurement procedure. Compliance with these rules is based on the use of measurement instrumentation employing a resolution bandwidth of 100 kHz or greater. In the 1 MHz bands immediately outside and adjacent to the frequency block a resolution bandwidth of at least one percent of the emission bandwidth of the fundamental emission of the transmitter may be employed. A narrower resolution bandwidth is permitted in all cases to improve measurement accuracy provided the measured power is integrated over the full required measurement bandwidth (i.e. 100 kHz or 1 percent of emission bandwidth, as specified). The emission bandwidth is defined as the width of the signal between two points, one below the carrier center frequency and one above the carrier center frequency, outside of which all emissions are attenuated at least 26 dB below the transmitter power.

Alternative out of band emission limit. Licensees in this service may establish an alternative out of band emission limit to be used at specified band edge(s) in specified geographical areas, in lieu of that set forth in this section, pursuant to a private contractual arrangement of all affected licensees and applicants. In this event, each party to such contract shall maintain a copy of the contract in their station files and disclose it to prospective assignees or transferees and, upon request, to the FCC.

Interference caused by out of band emissions. If any emission from a transmitter operating in this service results in interference to users of another radio service, the FCC may require a greater attenuation of that emission than specified in this section

4.3.2 Test Method

Configure the BTS3030 800 MHz to transmit at maximum rated power for each of the carrier configurations one, two and three carrier in the Baseband modulation formats IS-97 and IS-864. Measurements will be made on channels at the bottom and top of the operator bands. The following spectrum analyzer settings are to be used for the measurement of the antenna port (Duplexer) spurious emissions:

4.3.2.1 Adjacent 1MHz to indicated cellular band (Upper and Lower)

Table 12: Adjacent 1MHz Spectrum Analyze Settings

Setting	1 Carrier	2 Carrier	3 Carrier
Resolution Bandwidth ^a :	12.5 kHz	25 kHz	37.5 kHz
Video Bandwidth (3x RBW) ^b	(3x RBW)	(3x RBW)	(3x RBW)
Video Average	10 Averages	10 Averages	10 Averages
Span	Set accordingly	Set accordingly	Set accordingly
Detector	RMS	RMS	RMS
Attenuation ^c	20 dB	20 dB	20 dB
Ref. Level	35 dBm	35 dBm	35 dBm
Ref. Level Offset	41.1 dB	41.1 dB	41.1 dB

- If the spectrum analyze cannot be set to the specified RBW the next highest RBW should be used and all measurements corrected to the specified RBW
- If the spectrum analyze cannot be set to the specified Video Bandwidth the next highest Video Bandwidth should be used.
- The lowest value of attenuator should be used to improve measurement accuracy, without overdriving the Spectrum Analyzer.

4.3.2.2 All other Spurious Emissions up to 10 GHz

Table 13 : All other Emission Spectrum Analyze Settings

Setting	1 Carrier	2 Carrier	3 Carrier
Resolution Bandwidth	100 kHz	100 kHz	100 kHz
Video Bandwidth (3x RBW)	300 kHz	300 kHz	300 kHz
Video Average	10 Averages	10 Averages	10 Averages
Span	Set accordingly	Set accordingly	Set accordingly
Detector	RMS	RMS	RMS
Attenuation ^a	20 dB	20 dB	20 dB
Ref. Level	35 dBm	35 dBm	35 dBm
Ref. Level Offset	Variable	Variable	Variable

a. The lowest value of attenuator should be used to improve measurement accuracy, without overdriving the Spectrum Analyzer.

The emissions will be investigated up to 10 GHz (the 10th harmonic of the fundamental emission) for all carrier configurations (1, 2, 3) as per FCC Part 22.

4.3.3 Test Requirements

Table 14 : Spurious Emissions Requirements

Frequency Offset	1 Carrier	2 Carrier	3 Carrier
+/- 740 kHz	< -13 dBm/12.5KHz	< -13 dBm/25 KHz	< -13 dBm/37.5 KHz

4.3.4 Test Setup

The set-up required for the BTS3030 800 MHz Antenna Port (Duplexer) Spurious Emission test is illustrated in Figure 4.

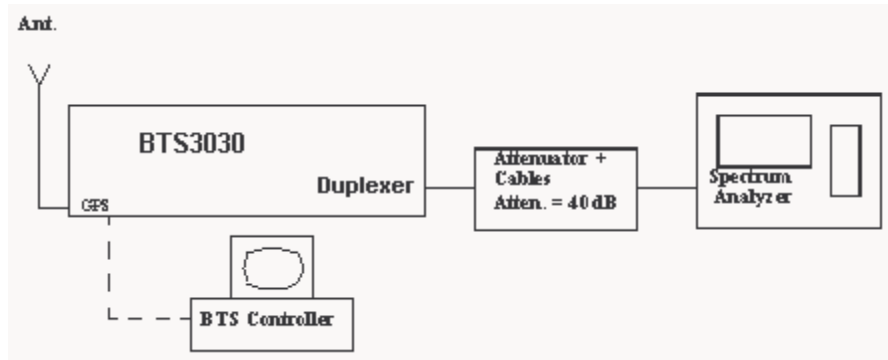

Figure 4 : Test Setup for Spurious Emissions Measurement

4.3.5 Test Results

Table 15 : Spurious Emissions at the BTS3030 800 MHz Ant. Port one carrier IS-97 and IS-864

Frequency (MHz)	Spurious Emissions Level (dBm)	Margin to FCC Limit of -13 dBm (dB)
	1Carrier	1Carrier
869 MHz (Lower edge of band A'') Ch 1015 (RBW=12.5 kHz)	-26.0	13.0
880 MHz (Upper edge of band A) Ch 308 (RBW=12.5 kHz)	-21.8	8.8
880 MHz (Lower edge of band B) Ch 358 (RBW=12.5kHz)	-26.8	13.8
890 MHz (Upper edge of band B) Ch 642 (RBW=12.5kHz)	-21.3	8.3
890 MHz (Lower edge of band A') Ch 692 (RBW=12.5kHz)	-18.8	5.8
891.5 MHz (upper edge of band A') Ch 692 (RBW=12.5kHz)	-16.8	3.8
891.5 MHz (lower edge of band B') Ch 742 (RBW=12.5kHz)	-24.1	11.1
894 MHz (upper edge of band B') Ch 775 (RBW=12.5kHz)	-27.7	14.7
0-1000 (RBW=100KHz) _a	-38.5	25.5
1000-2000 (RBW=100KHz) _a	-28.63	15.63
2000-3000 (RBW=100KHz) _a	-33.68	20.68
3000-4000 (RBW=100KHz) _a	-33.82	20.82
4000-5000 (RBW=100KHz) _a	-34.33	21.33
5000-6000 (RBW=100KHz) _a	-31.53	18.53
6000-7000 (RBW=100KHz) _a	-28.34	15.34
7000-8000 (RBW=100KHz) _a	-27.72	14.72
8000-9000 (RBW=100KHz) _a	-25.05	12.05
9000-10000 (RBW=100KHz) _a	-21.19	8.19

Notes: a Emission levels given in these ranges represents the worst case value over all the tested channels

Table 16 : Spurious Emissions at the BTS3030 800 MHz Ant. Port Two Carrier IS-864

Frequency (MHz)	Spurious Emissions Level (dBm)	Margin to FCC Limit of -13 dBm (dB)
	2Carrier IS-864	2Carrier
880 MHz (Lower edge of band B) Ch 358, 399 (RBW=25 kHz)	-18.4	5.4
890 MHz (Upper edge of band B) Ch 601, 642 (RBW=25 kHz)	-17.0	4.0
0-1000 (RBW=100KHz) _a	-37.16	24.16
1000-2000 (RBW=100KHz) _a	-32.14	19.14
2000-3000 (RBW=100KHz) _a	-34.99	21.99
3000-4000 (RBW=100KHz) _a	-34.8	21.8
4000-5000 (RBW=100KHz) _a	-34.66	21.66
5000-6000 (RBW=100KHz) _a	-32.08	19.08
6000-7000 (RBW=100KHz) _a	-28.4	15.4
7000-8000 (RBW=100KHz) _a	-28.78	15.78
8000-9000 (RBW=100KHz) _a	-25.34	12.34
9000-10000 (RBW=100KHz) _a	-22.4	9.4

Notes: a Emission levels given in these ranges represents the worst case value over all the tested channels

Table 17 : Spurious Emissions at the BTS3030 800 MHz Ant. Port Three Carrier IS-97 and IS-864

Frequency (MHz)	Spurious Emissions Level (dBm)	Margin to FCC Limit of -13 dBm (dB)
	3Carrier	3Carrier
869 MHz (Lower edge of band A'') Ch 1015, 33, 74 (RBW=37.5 kHz)	-19.8	6.8
880 MHz (Upper edge of band A) Ch 226, 267, 308 (RBW=37.5 kHz)	-19.0	6.0
880 MHz (Lower edge of band B) Ch 358, 399, 440 (RBW=37.5 kHz)	-18.8	5.8
890 MHz (Upper edge of band B) Ch 560, 601, 642 (RBW=37.5kHz)	-18.5	5.5
0-1000 (RBW=100KHz) _a	-37.8	24.8
1000-2000 (RBW=100KHz) _a	-32.23	19.23
2000-3000 (RBW=100KHz) _a	-33.8	20.8
3000-4000 (RBW=100KHz) _a	-33.36	20.36
4000-5000 (RBW=100KHz) _a	-33.84	20.84
5000-6000 (RBW=100KHz) _a	-31.35	18.35
6000-7000 (RBW=100KHz) _a	-27.81	14.81
7000-8000 (RBW=100KHz) _a	-28.43	15.43
8000-9000 (RBW=100KHz) _a	-24.88	11.88
9000-10000 (RBW=100KHz) _a	-21.68	8.68

Notes: a Emission levels given in these ranges represents the worst case value over all the tested channels

4.4 Transmitter Tests (CDMA Mode)

Unwanted Emissions

Unwanted emissions are emissions on a frequency or frequencies outside the necessary bandwidth which result from the modulation process, from spurious emissions and harmonics.

IC RSS-129

(1) Suppression inside cellular band: For all base station transmit frequencies allocated to the same operator system, the total spurious emissions in any 30 kHz band shall be attenuated below the mean output power level in accordance with the following schedule:

(a) for all offset frequencies greater than 750 kHz from the CDMA centre frequency, at least 45 dB. 800 MHz Dual-Mode CDMA Cellular Telephones RSS-129.

(b) for all offset frequencies greater than 1.98 MHz from the CDMA centre frequency, at least 60 dB.

(c) for all offset frequencies not allocated to the same operator system, at least 60 dB or -13 dBm, whichever is less stringent.

(2) In any 30 kHz outside the cellular band, the attenuation shall be at least $43+10 \log_{10}$ (mean output power in watts) or 70, dB, whichever is the less stringent.

4.4.1 Test Method

Configure the BTS3030 800 MHz to transmit at maximum rated power for each of the carrier configurations one, two and three carrier in the Baseband modulation formats IS-97 and IS-864. Measurements will be made on channels at the bottom and top of the duplexer band. The following spectrum analyzer settings are to be used for the measurement of the antenna port (Duplexer) spurious emissions:

4.4.1.1 Adjacent 1MHz to indicated cellular band (Upper and Lower)

Table 18: Adjacent 750 KHz and 1.98 MHz Spectrum Analyze Settings

Setting	1 Carrier	2 Carrier	3 Carrier
Resolution Bandwidth ^a :	30 kHz	30 kHz	30 kHz
Video Bandwidth (3x RBW)	100 kHz	100 kHz	100 kHz
Video Average	10 Averages	10 Averages	10 Averages
Span	Set accordingly	Set accordingly	Set accordingly
Detector	RMS	RMS	RMS
Attenuation	20 dB	20 dB	20 dB
Ref. Level	35 dBm	35 dBm	35 dBm
Ref. Level Offset	41.1 dB	41.1 dB	41.1 dB

a. If the spectrum analyze can not be set to the specified RBW the next highest RBW should be used and all measurements corrected to the specified RBW

4.4.2 Test Setup

The set-up required for the BTS3030 800 MHz Antenna Port (Duplexer) Spurious Emission test is illustrated in Figure 4.

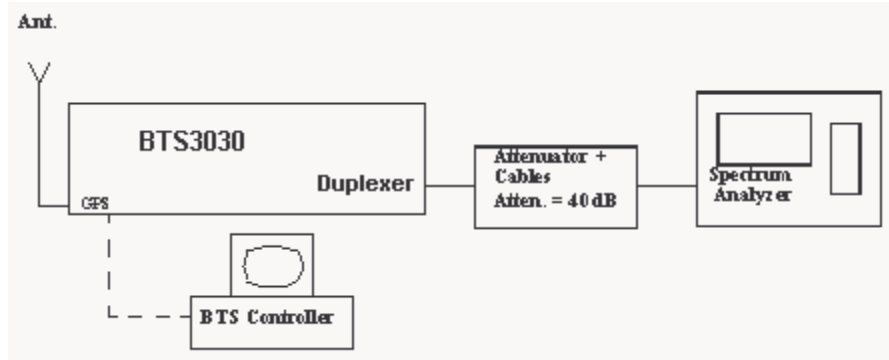

Figure 5 : Test Setup for Spurious Emissions Measurement

4.4.3 Test Results

Table 19 : Industry Canada Suppression inside cellular band BTS3030 800 MHz Antenna Port 1 Carrier band A”

Frequency (MHz)	Spurious Emissions Level (dBm)	Limit for 45 dBc/ 30KHz (dBm)	Margin to IC Limit of 45 dBc/ 30KHz (dB)
	1Carrier IS-95	1Carrier	1 Carrier
Ch1015 750KHz offset at lower side	-14.36	2.3	16.66
Ch1015 750KHz offset at upper side	-16.38	2.3	18.68
		Limit for 60 dBc/ 30KHz (dBm)	Margin to IC Limit of 60 dBc/ 30KHz (dB)
Ch1015 1.98MHz offset at lower side	-44.29	-12.7	31.59
Ch1015 1.98MHz offset at upper side	-43.81	-12.7	31.11

Table 20 : Industry Canada Suppression inside cellular band BTS3030 800 MHz Antenna Port IS97, 3 Carrier band A” and A

Frequency (MHz)	Spurious Emissions Level (dBm)	Limit for 45 dBc/ 30KHz (dBm)	Margin to IC Limit of 45 dBc/ 30KHz (dB)
	3Carrier IS-95	3Carrier	3Carrier
Ch1015, 33, 74 750KHz offset at lower side	-16.05	2.3	18.35
Ch1015, 33, 74 750KHz offset at upper side	-19.58	2.3	21.88
		Limit for 60 dBc/ 30KHz (dBm)	Margin to IC Limit of 60 dBc/ 30KHz (dB)
Ch1015, 33, 74 1.98MHz offset at lower side	-29.95	-12.7	17.25
Ch1015, 33, 74 1.98MHz offset at upper side	-33.22	-12.7	20.52

Table 21 : Industry Canada Suppression inside cellular band BTS3030 800 MHz Antenna Port, 1 Carrier band B'

Frequency (MHz)	Spurious Emissions Level (dBm)	Limit for 45 dBc/ 30KHz (dBm)	Margin to IC Limit of 45 dBc/ 30KHz (dB)
	1Carrier	1Carrier	1Carrier
Ch 742 750KHz offset at lower side	-16.41	2.3	18.71
Ch 742 750KHz offset at upper side	-18.13	2.3	20.43
		Limit for 60 dBc/ 30KHz (dBm)	Margin to IC Limit of 60 dBc/ 30KHz (dB)
Ch 742 1.98MHz offset at lower side	-38.17	-12.7	25.47
Ch 742 1.98MHz offset at upper side	-38.56	-12.7	25.86

4.5 Frequency Stability

4.5.1 Frequency Stability Requirements

FCC Part 2.1055

(a) The frequency stability shall be measured with variation of ambient temperature as follows:

(1) From -30 to +50 centigrade for all equipment except that specified in subparagraphs (2) and (3) of this paragraph.

(b) Frequency measurements shall be made at the extremes of the specified temperature range and at intervals of not more than 10 centigrade through the range. A period of time sufficient to stabilize all of the components of the oscillator circuit at each temperature level shall be allowed prior to frequency measurement. The short term transient effects on the frequency of the transmitter due to keying (except for broadcast transmitters) and any heating element cycling normally occurring at each ambient temperature level also shall be shown. Only the portion or portions of the transmitter containing the frequency determining and stabilizing circuitry need be subjected to the temperature variation test.

(d) The frequency stability shall be measured with variation of primary supply voltage as follows:

(1) Vary primary supply voltage from 85 to 115 percent of the nominal value for other than hand carried battery equipment.

(2) For hand carried, battery powered equipment, reduce primary supply voltage to the battery operating end point which shall be specified by the manufacturer.

(3) The supply voltage shall be measured at the input to the cable normally provided with the equipment, or at the power supply terminals if cables are not normally provided. Effects on frequency of transmitter keying (except for broadcast transmitters) and any heating element cycling at the nominal supply voltage and at each extreme also shall be shown.

(e) When deemed necessary, the Commission may require tests of frequency stability under conditions in addition to those specifically set out in paragraphs (a), (b), (c) and (d) of this section. (For example, measurements showing the effect of proximity to large metal objects, or of various types of antennas, may be required for portable equipment.)

FCC Part 22.355 Frequency Tolerance

The carrier frequency of each transmitter in the 821-896 MHz Frequency range, must be maintained within 1.5ppm tolerance, according to table C-1 of this section (22.355)

4.5.2 Test Procedure

The test equipment was configured as shown in figure 6.

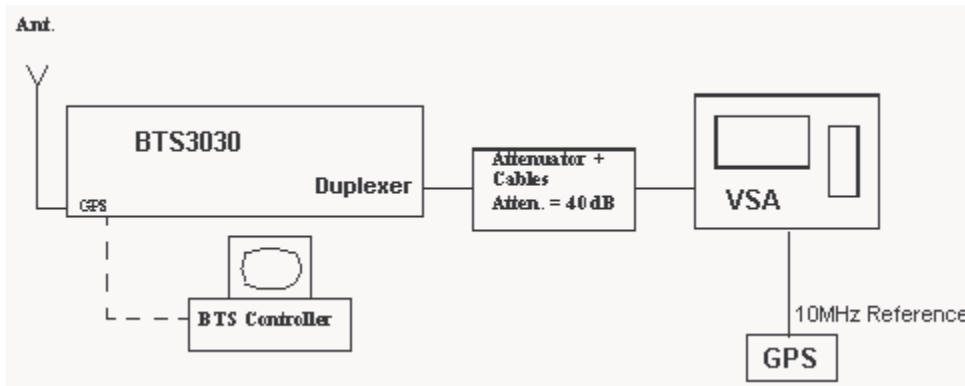

Figure 6 : Test configuration for Frequency Stability

4.5.3 Frequency Results

The frequency measured 871.74 MHz. Operating temperature for the BTS3030 800 MHz is from -5°C to +50°C as specified in the NTDV6001_SDS System Design Specification. The VSA set at

Table 22 : Test results for Frequency Stability versus Power supply Voltage at 25C

Voltage (Vdc)	Maximum Carrier Frequency Deviation (PPM)	Maximum Carrier Frequency Deviation (Hz)
40	0.00255	2.55
48 nominal	0.00264	2.64
56	0.00118	1.18

10 average, at each temperature 30 samples were collected.

Table 23 : Test results for Frequency Stability versus Temperature at -48V operation

Temperature (°C)	Maximum Carrier Frequency Deviation (PPM)	Maximum Carrier Frequency Deviation (Hz)
-10	0.00123	1.23
0	0.00368	3.68
10	0.00549	5.49
20	0.00125	1.25
30	0.00238	2.38
40	0.00658	6.58
50	0.0013	1.3

5 Appendix A - Single Carrier Spurious Emission

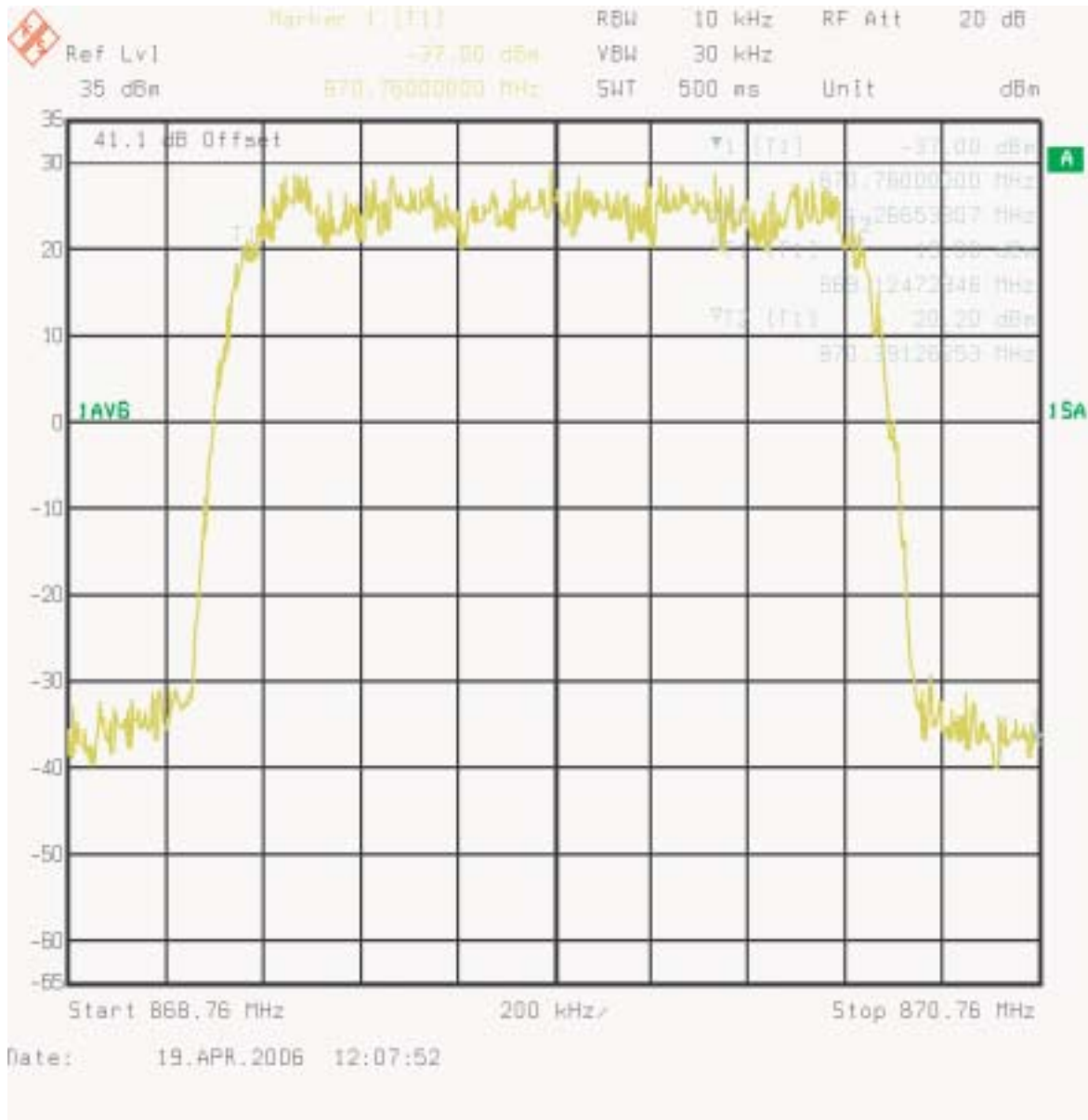

Figure 7 : 1 Carrier - Occupied Bandwidth Channel 1015

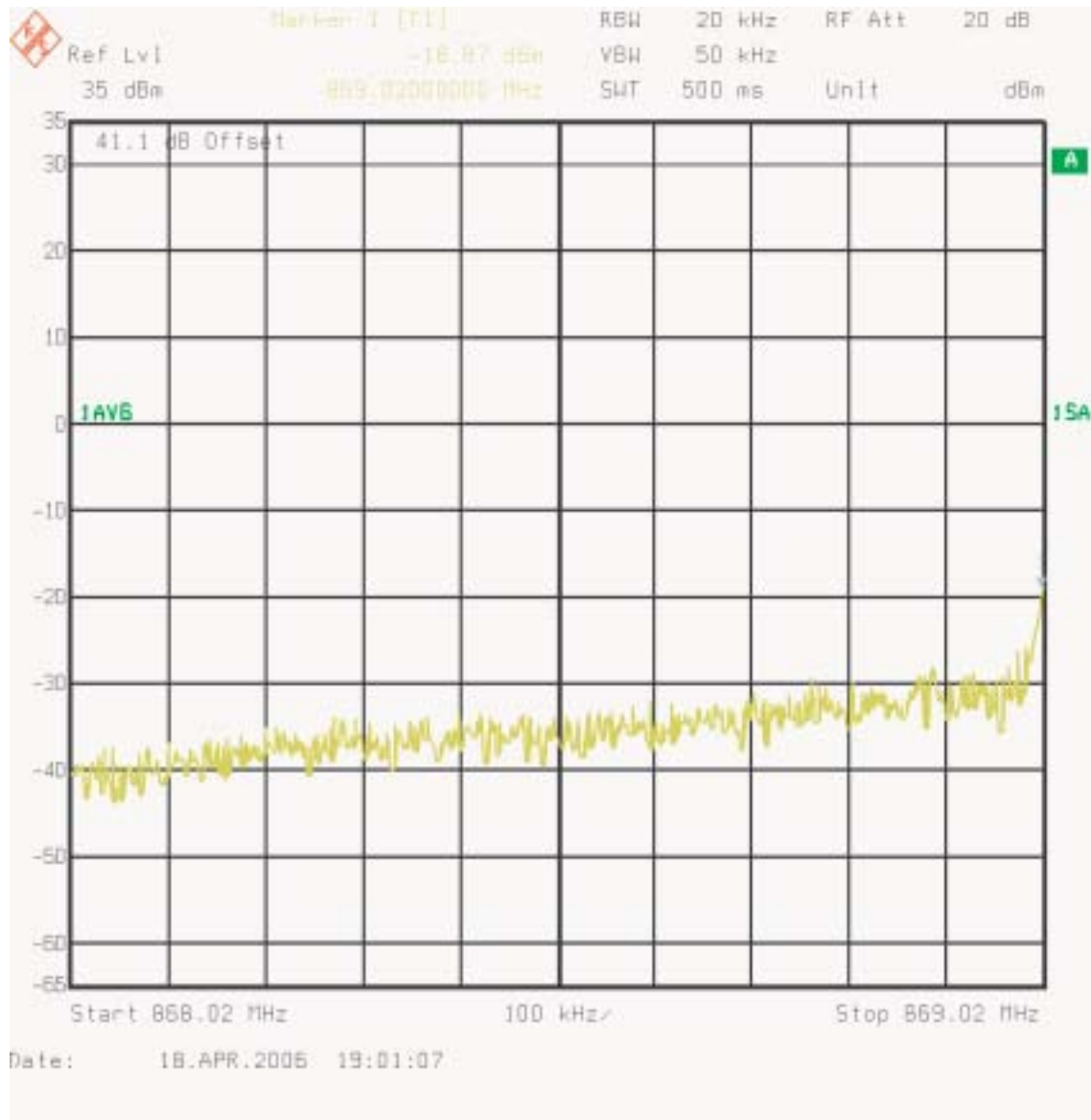

Figure 8 : 1 Carrier - Lower Adjacent Channel 1MHz Channel 1015



Figure 9 : One Carrier - Ch1015 IS95 Lower A" Band Adjacent to outside edge 12.5kHz band Channel Power



Figure 10 : 1 Carrier - Upper Adjacent Channel 1MHz Channel 308

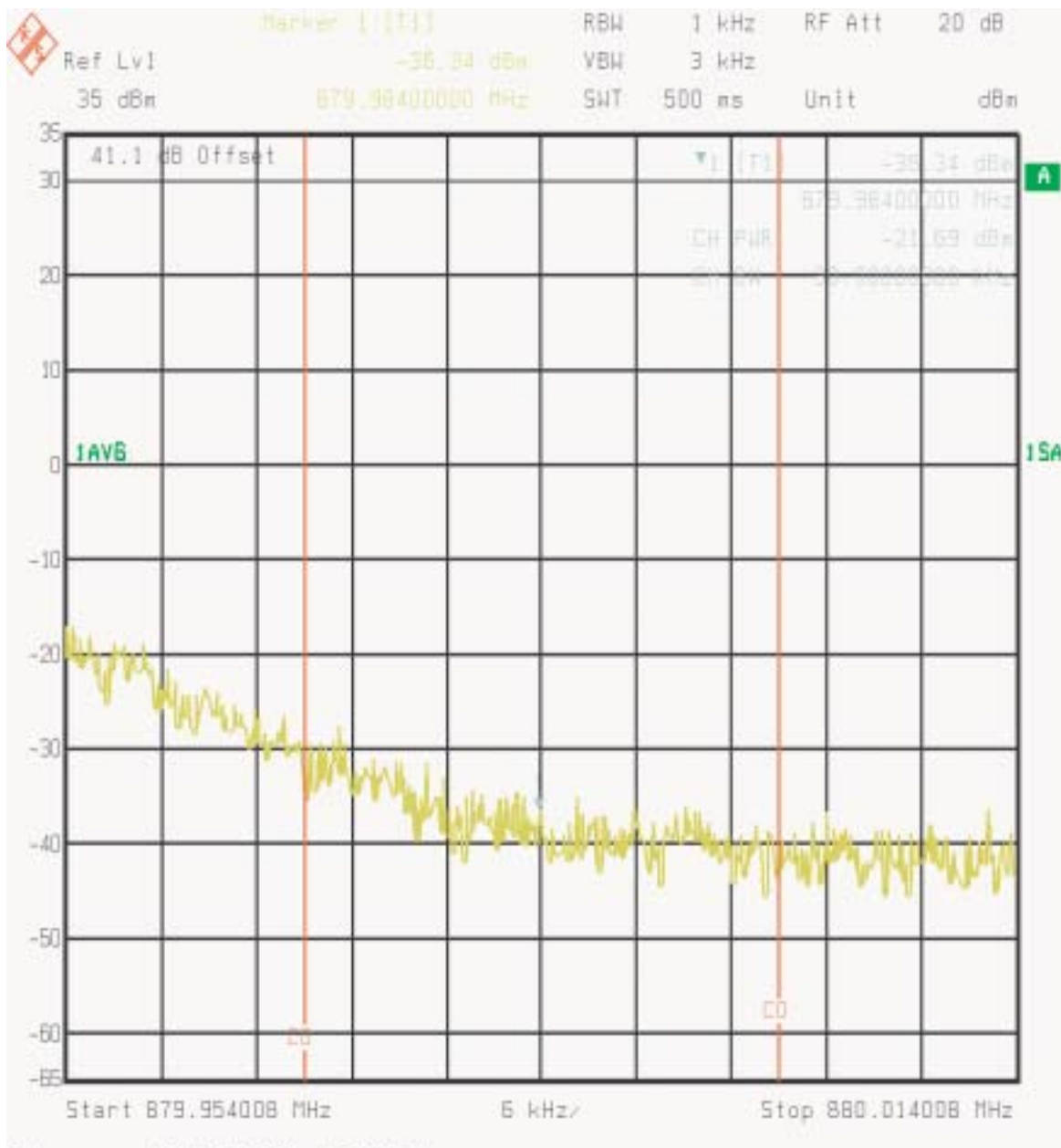

**Figure 11 : One Carrier - Ch 308 Upper A Band adjacent to outside edge 12.5 kHz band
Channel power**

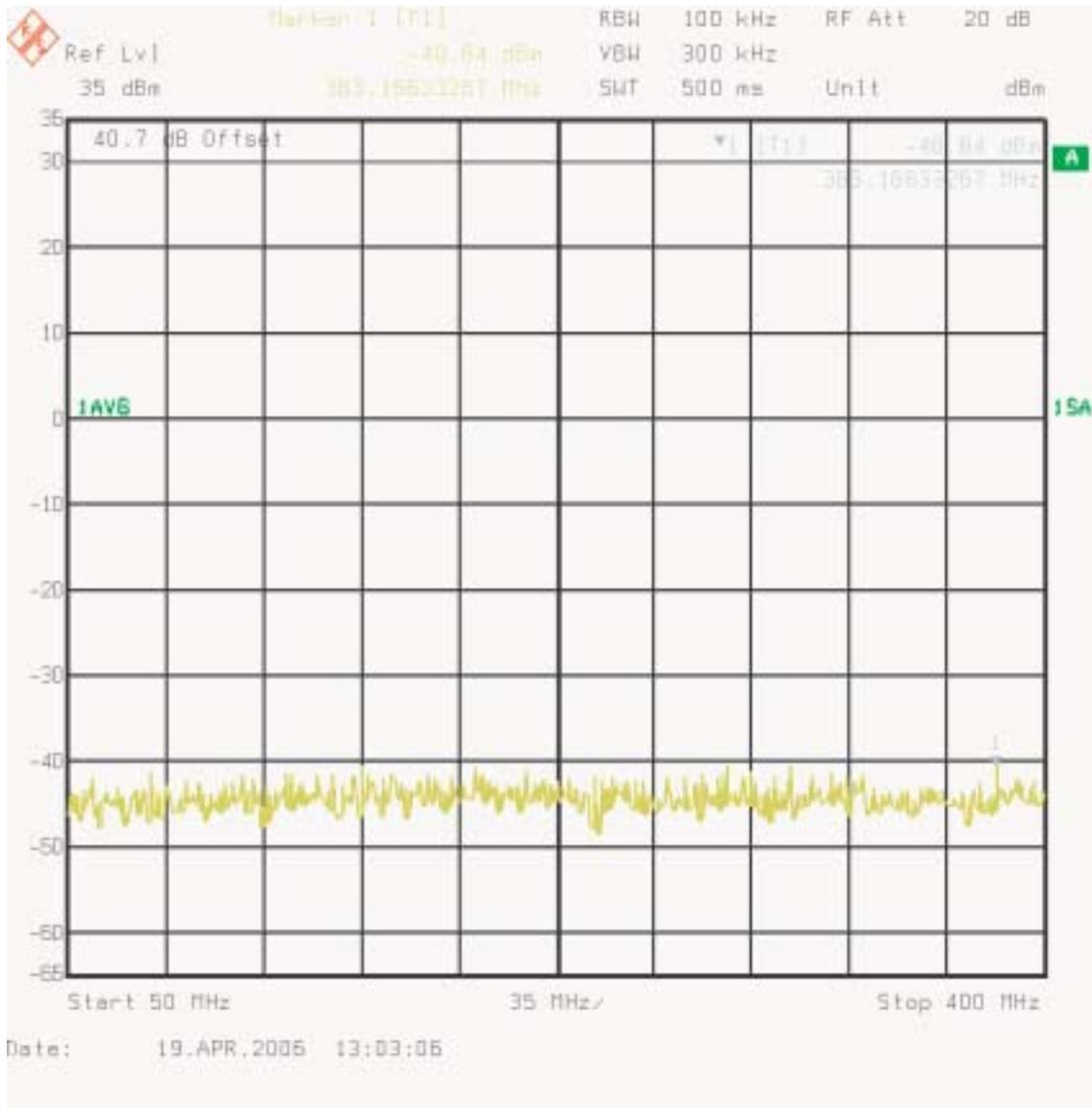

Figure 12 : One Carrier - A Band Spurious emissions 50-400 MHz Channel 308

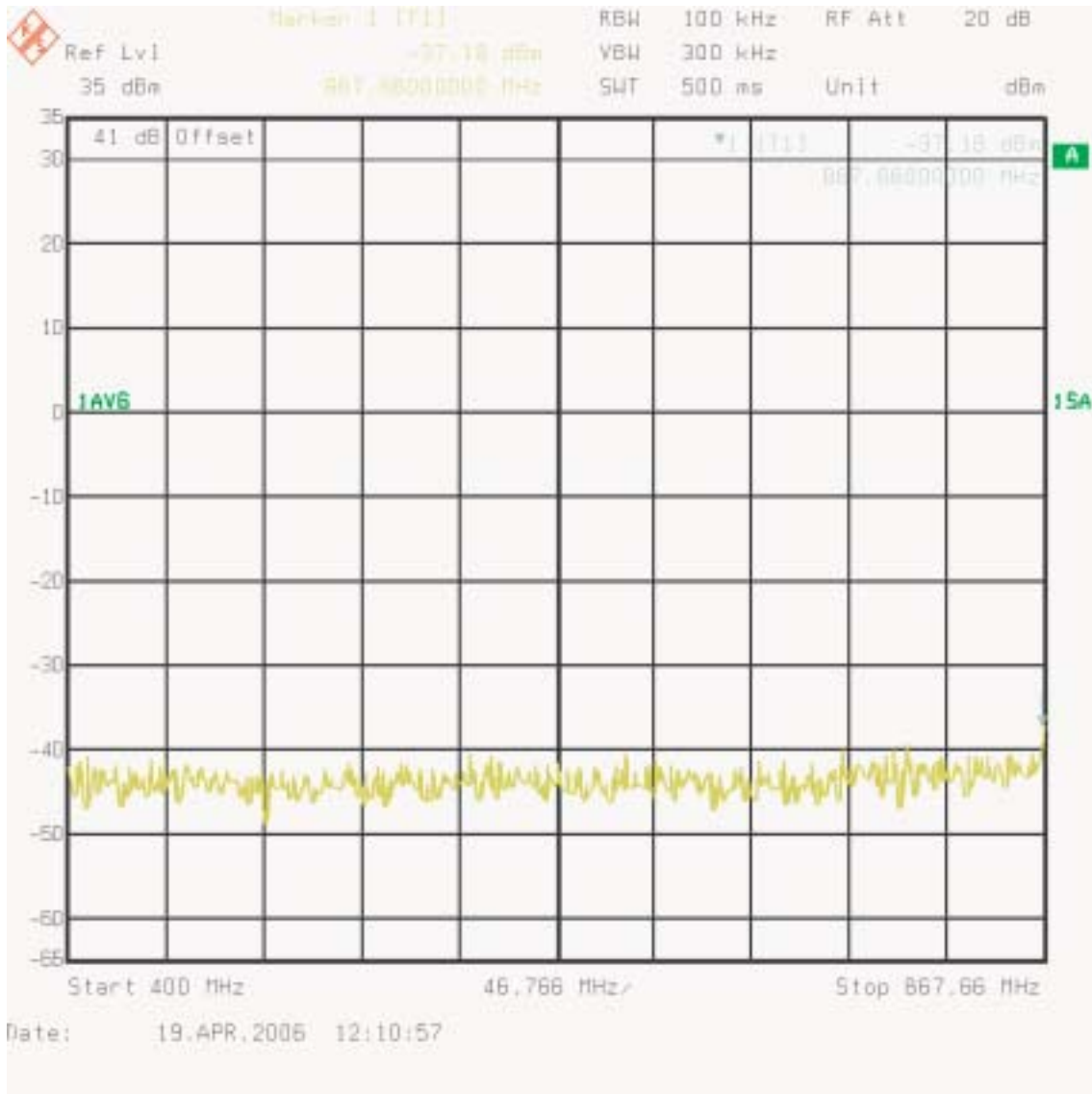

Figure 13 : One Carrier - A Band Spurious emissions 400 MHz to Lower Band Emissions Channel 308

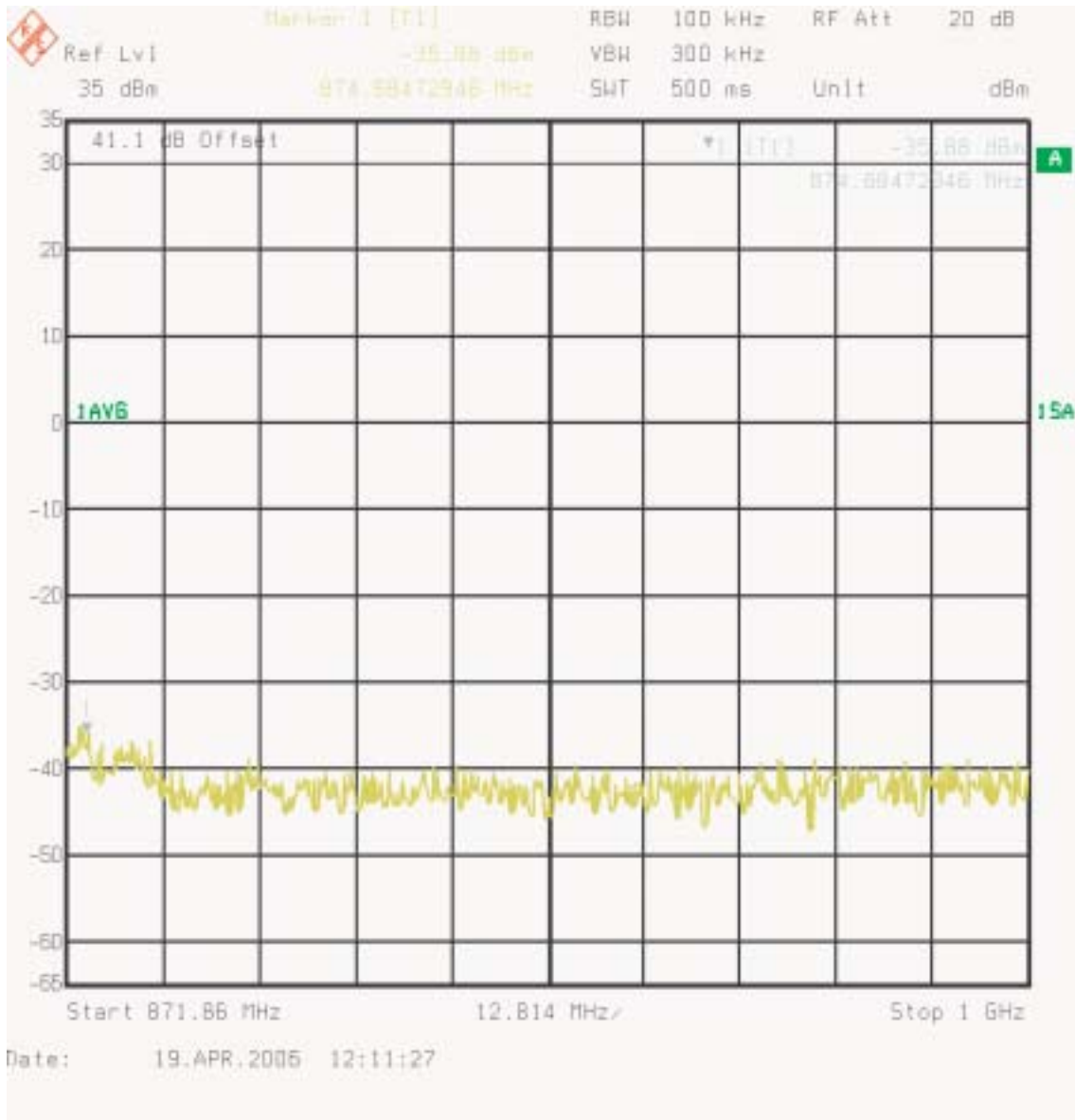

Figure 14 : One Carrier - A Band Spurious Emissions Upper Band Emissions to 1GHz Channel 308

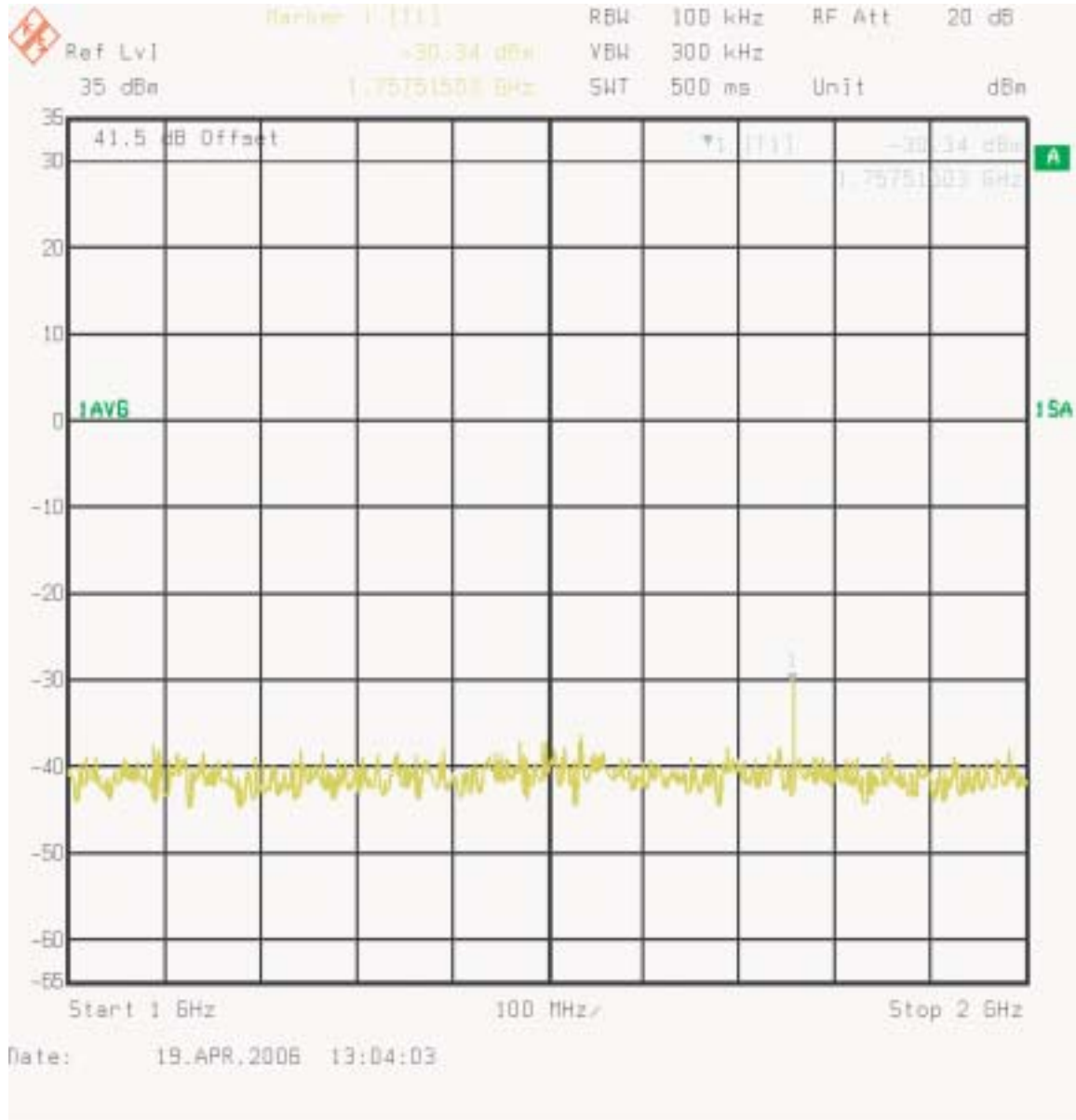

Figure 15 : One Carrier - A Band Spurious emissions 1000-2000 MHz Channel 308

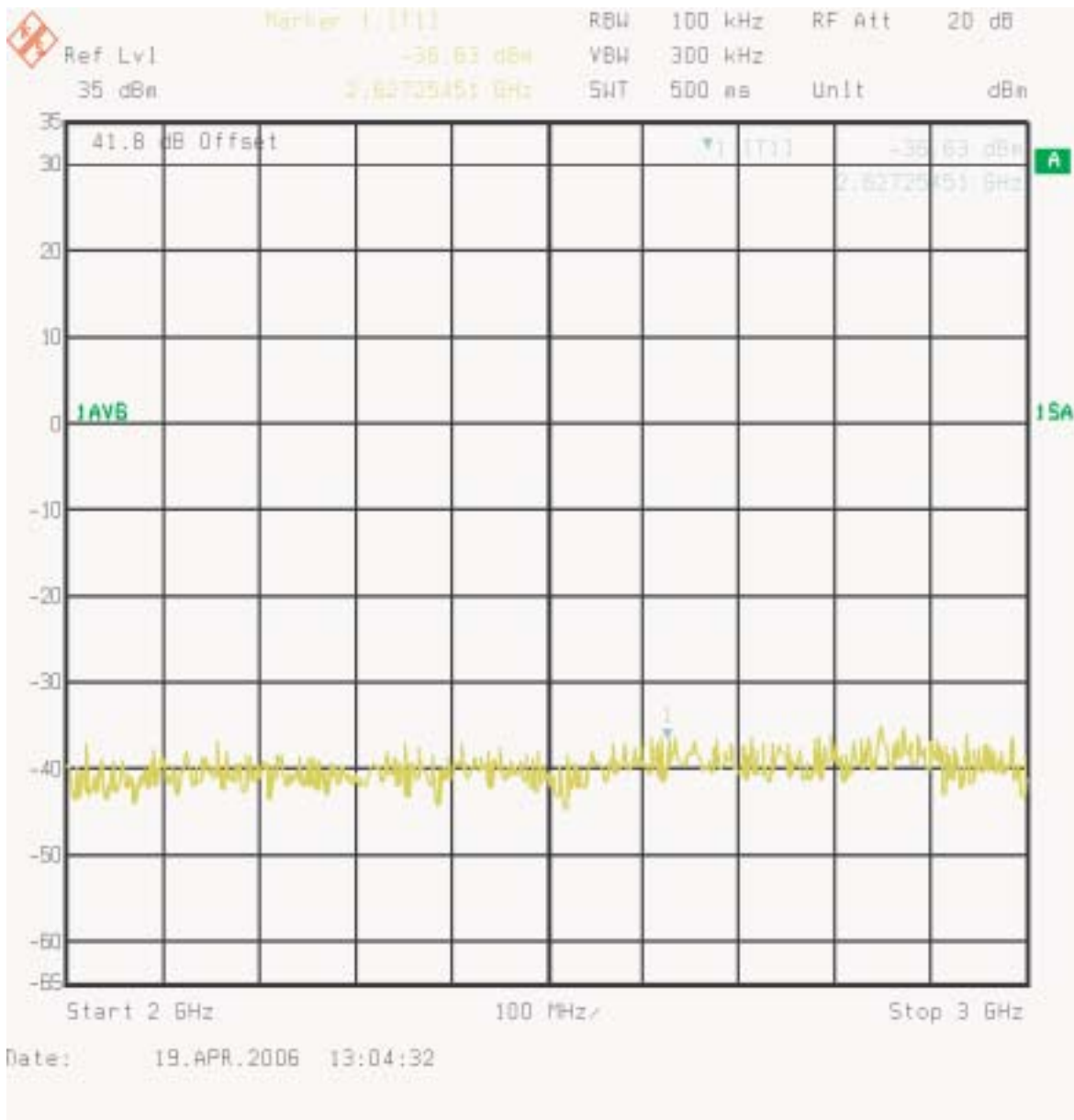

Figure 16 : One Carrier - A Band Spurious emissions 2000-3000 MHz Channel 308

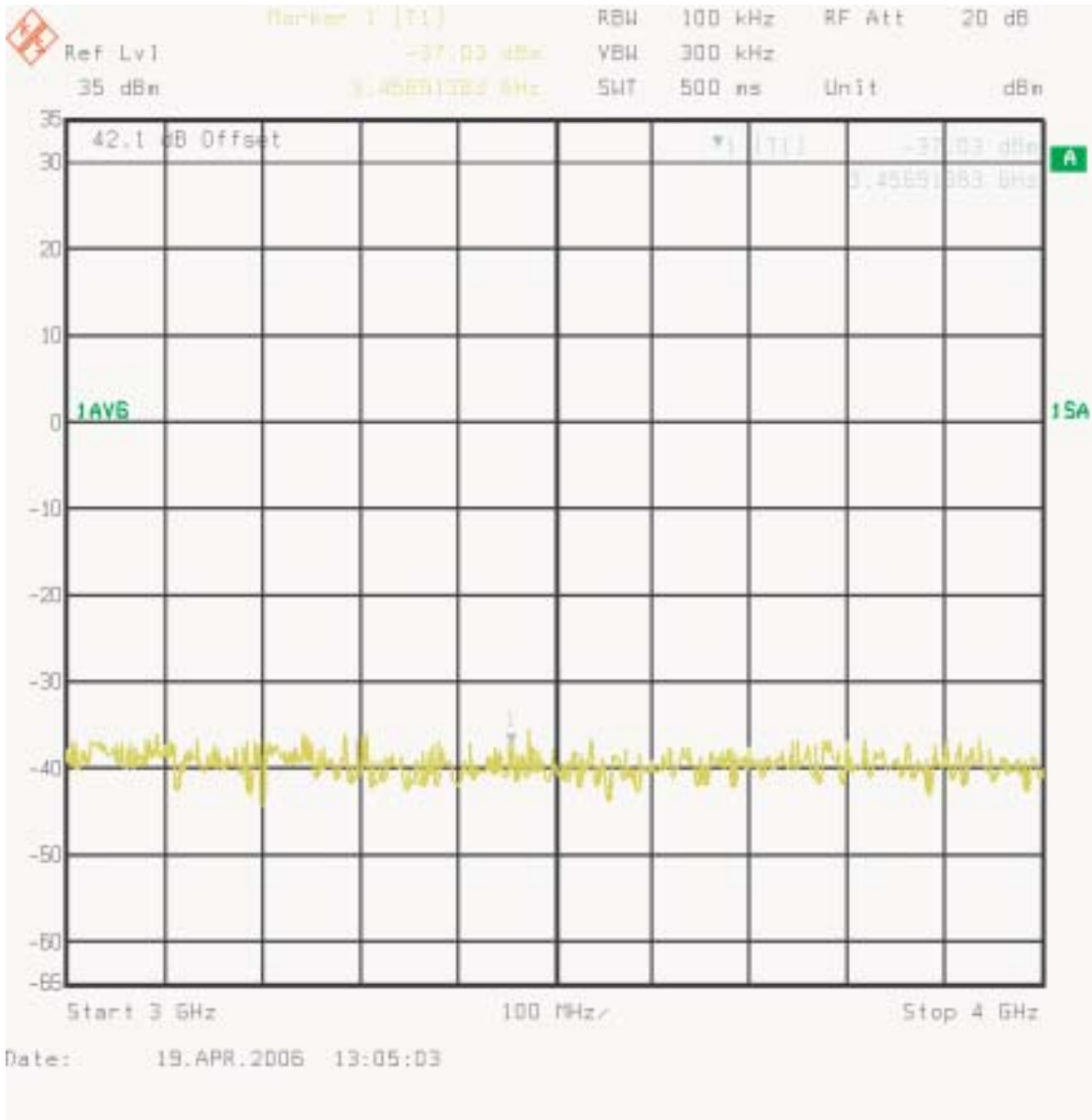

Figure 17 : One Carrier - A Band Spurious emissions 3000-4000 MHz Channel 308

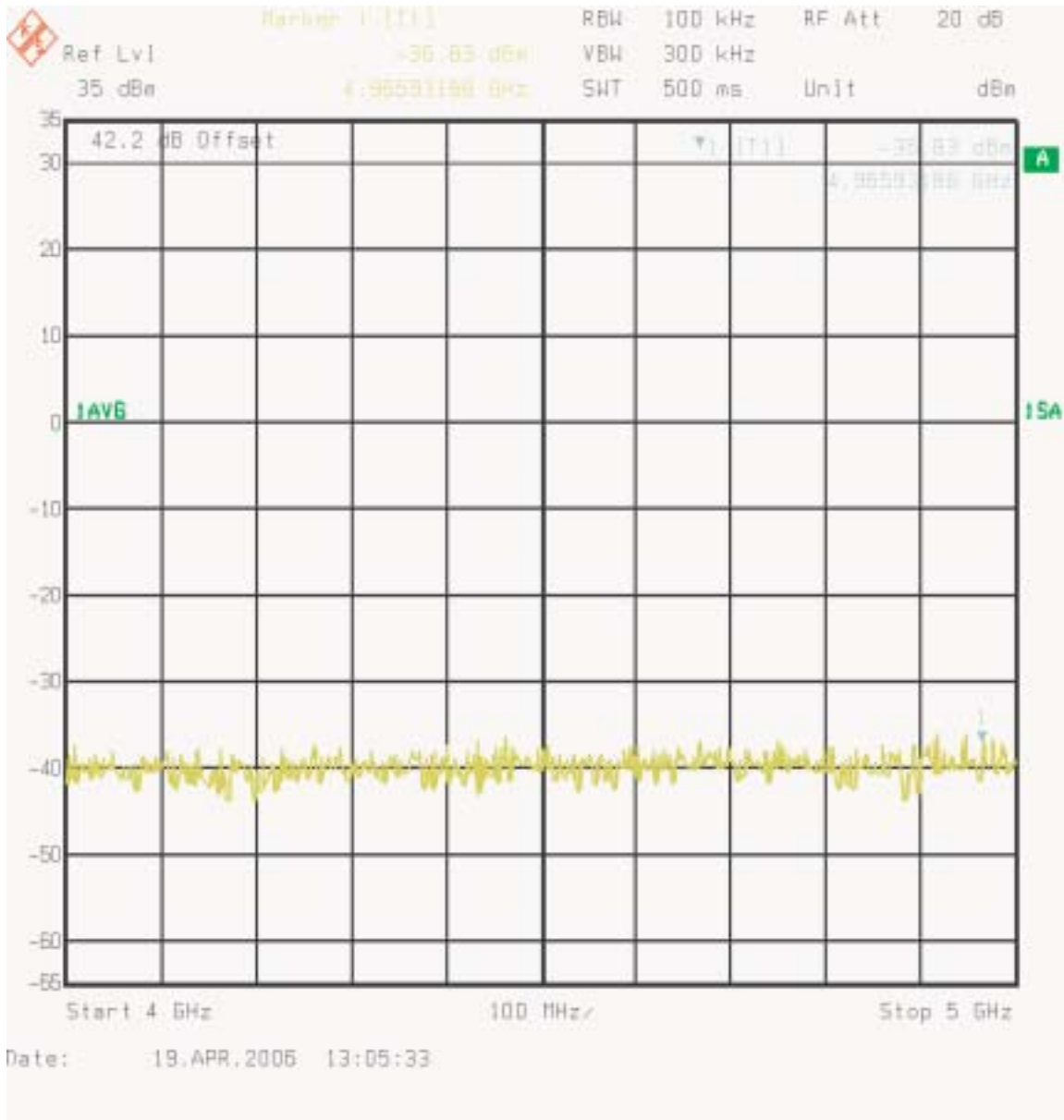

Figure 18 : One Carrier - A Band Spurious emissions 4000-5000 MHz Channel 308

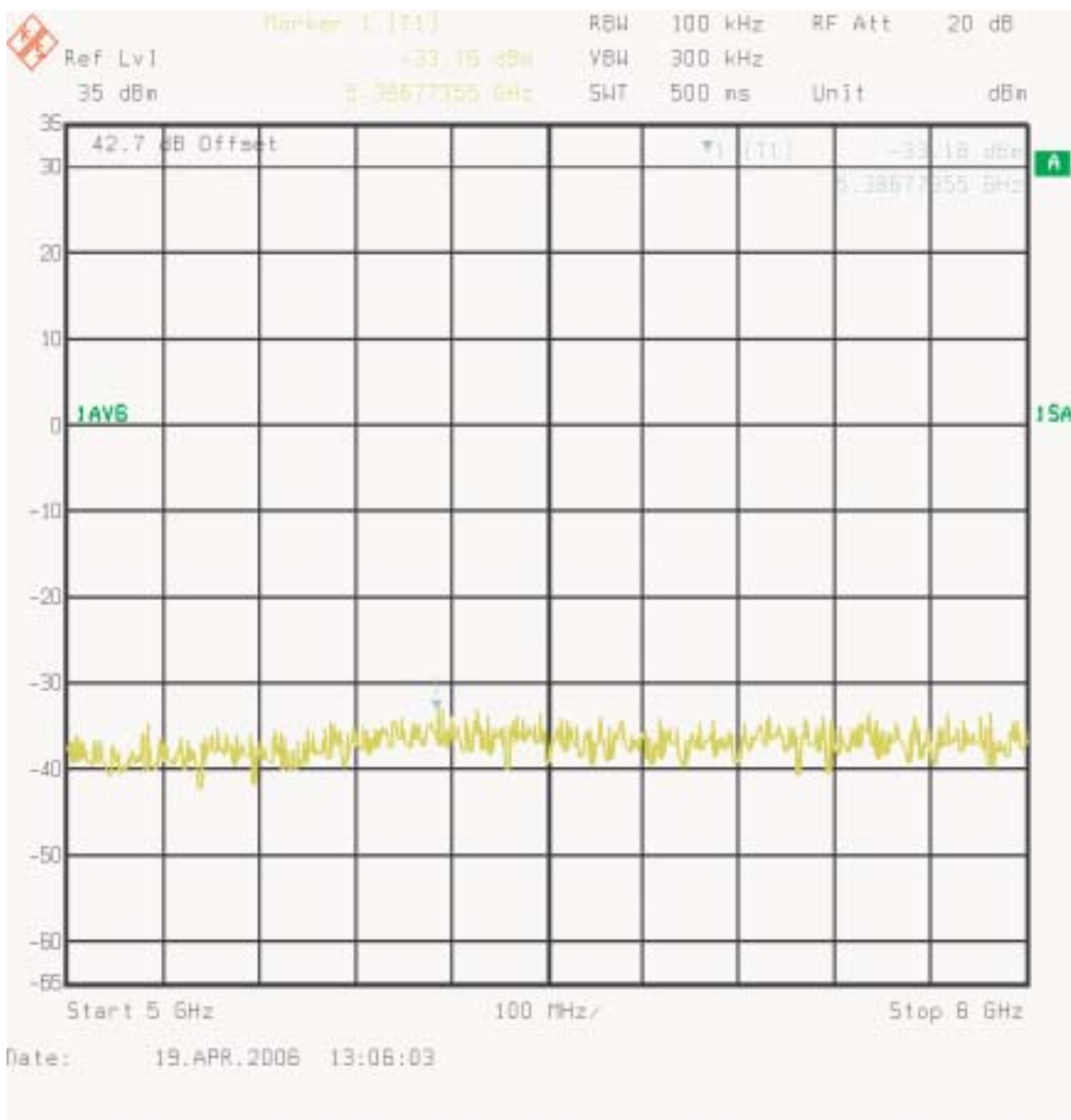

Figure 19 : One Carrier - A Band Spurious emissions 5000-6000 MHz Channel 308

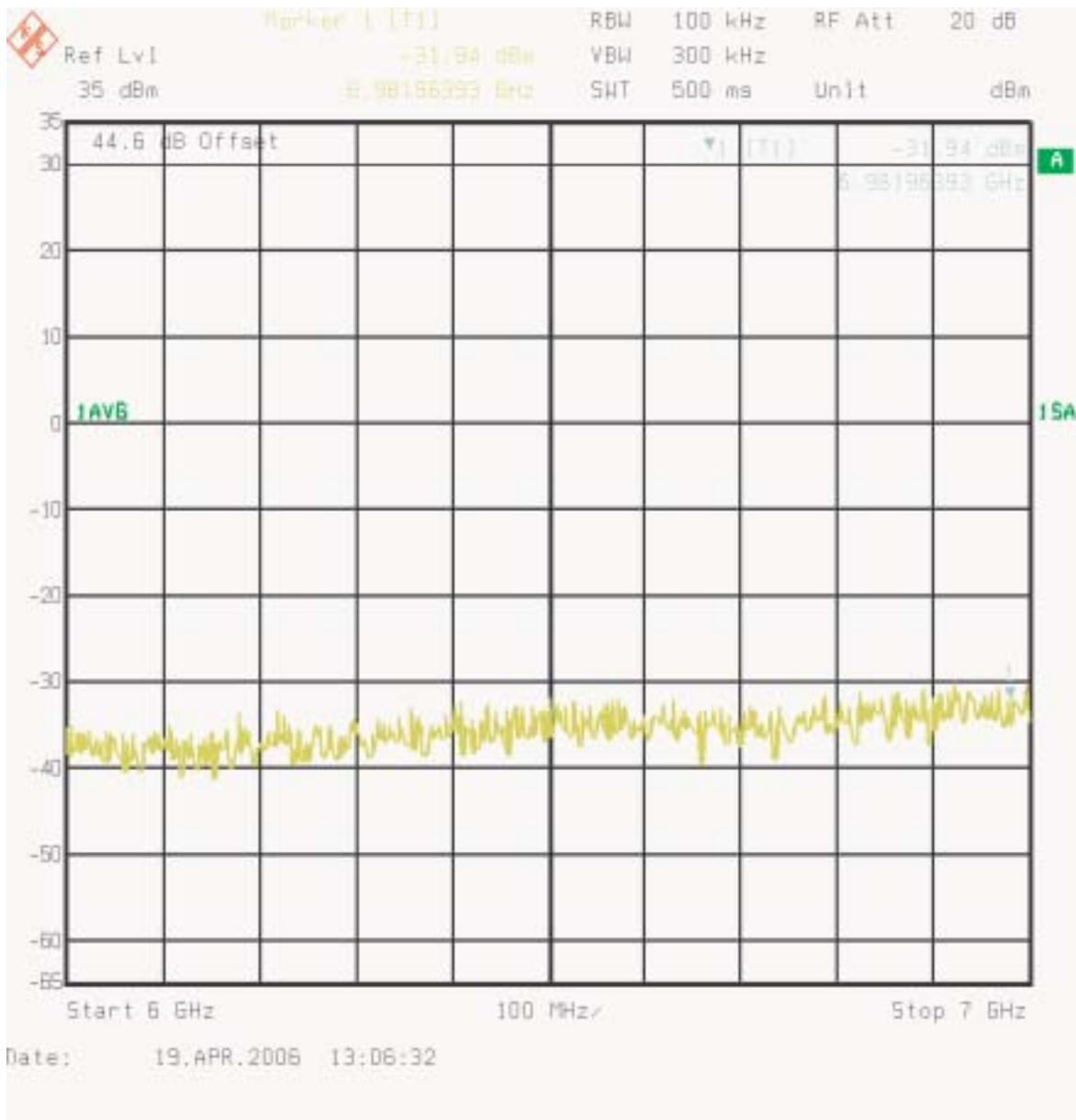

Figure 20 : One Carrier - A Band Spurious emissions 6000-7000 MHz Channel 308

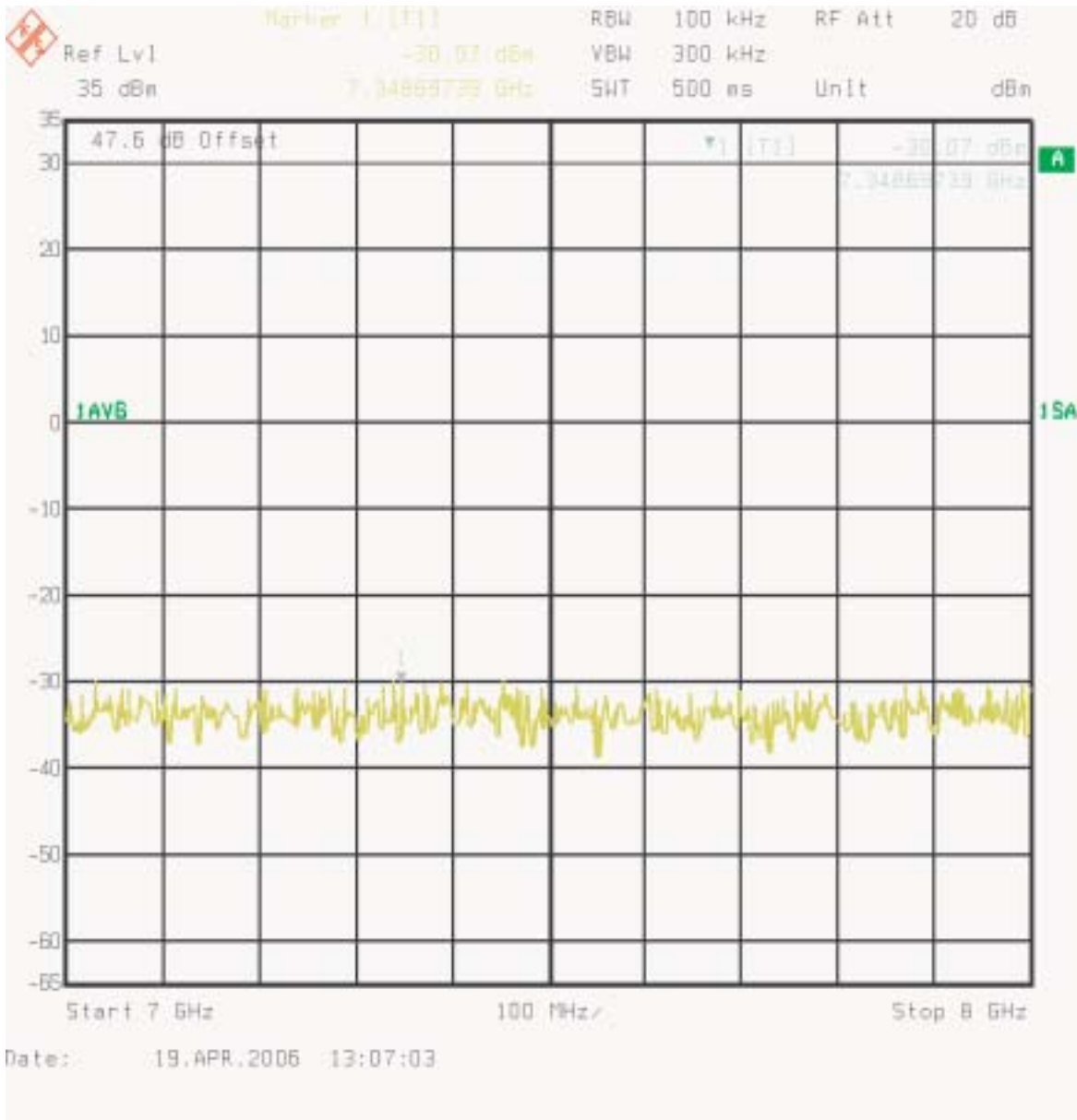

Figure 21 : One Carrier - A Band Spurious emissions 7000-8000 MHz Channel 308

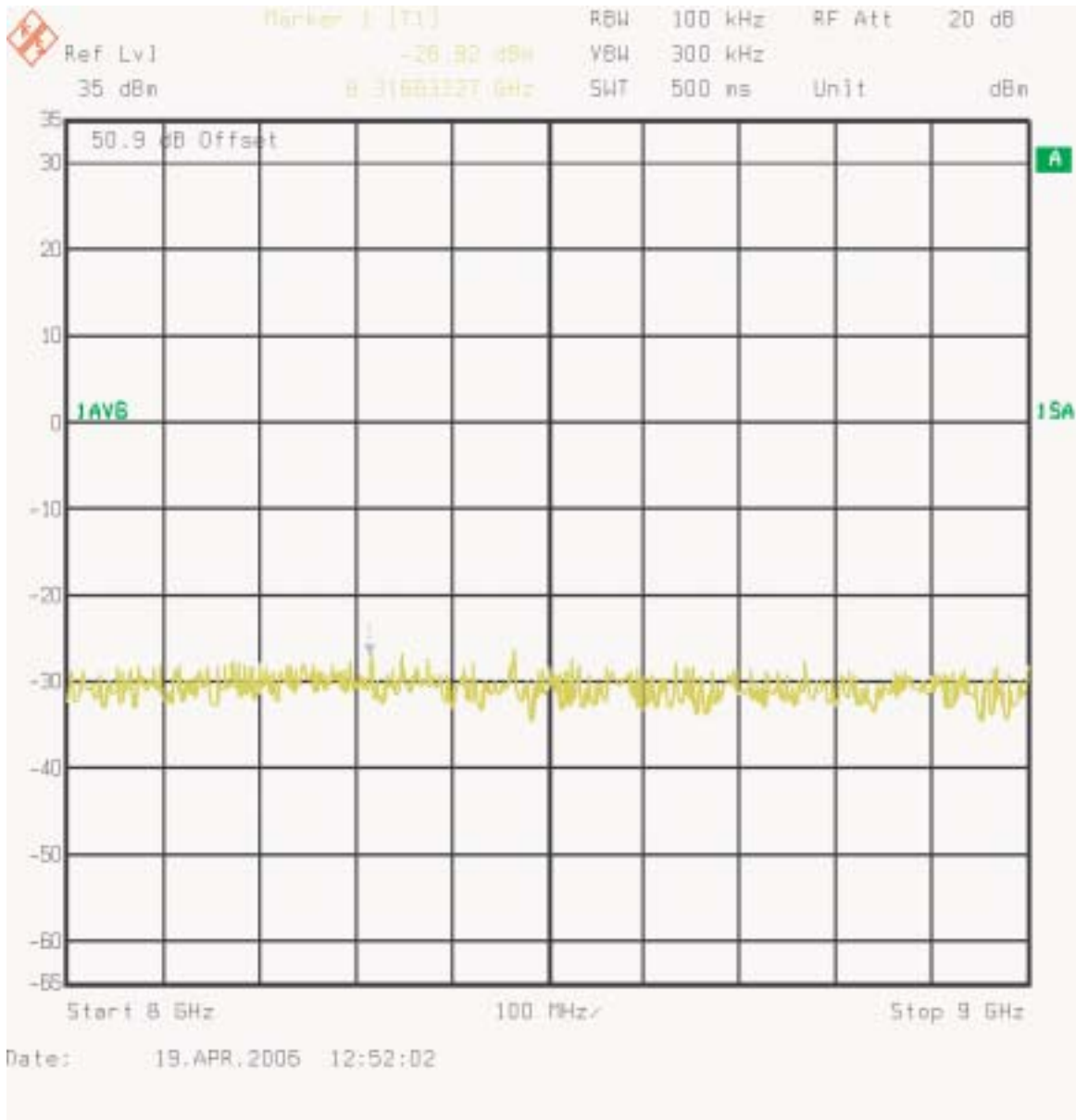

Figure 22 : One Carrier - A Band Spurious emissions 8000-9000 MHz Channel 308

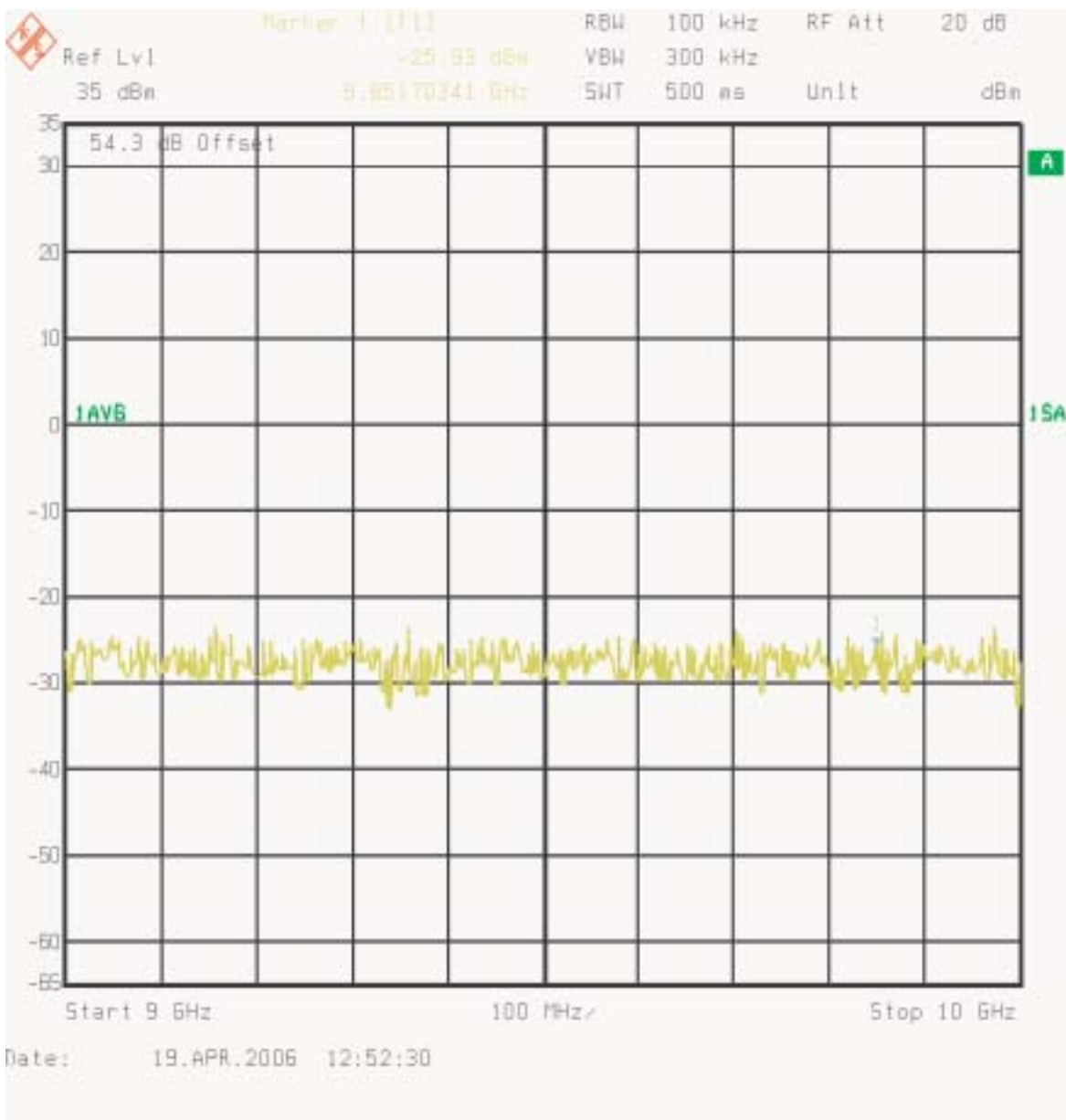

Figure 23 : One Carrier - A Band Spurious emissions 9000-10000 MHz Channel 308

6 Appendix B - Two Carriers Spurious Emission

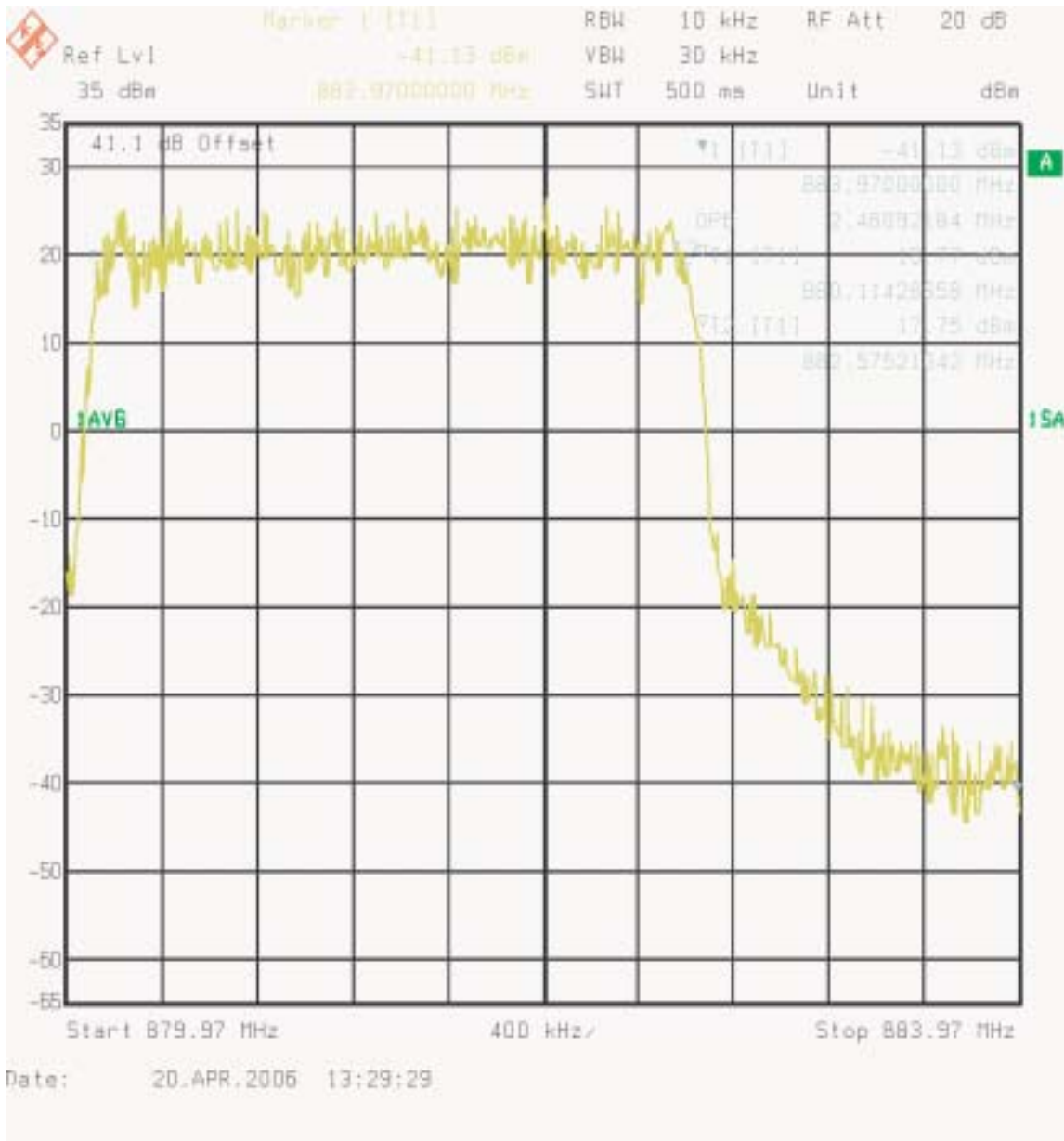

Figure 24 : Two Carriers - Occupied Bandwidth Ch 358, 399 Band B

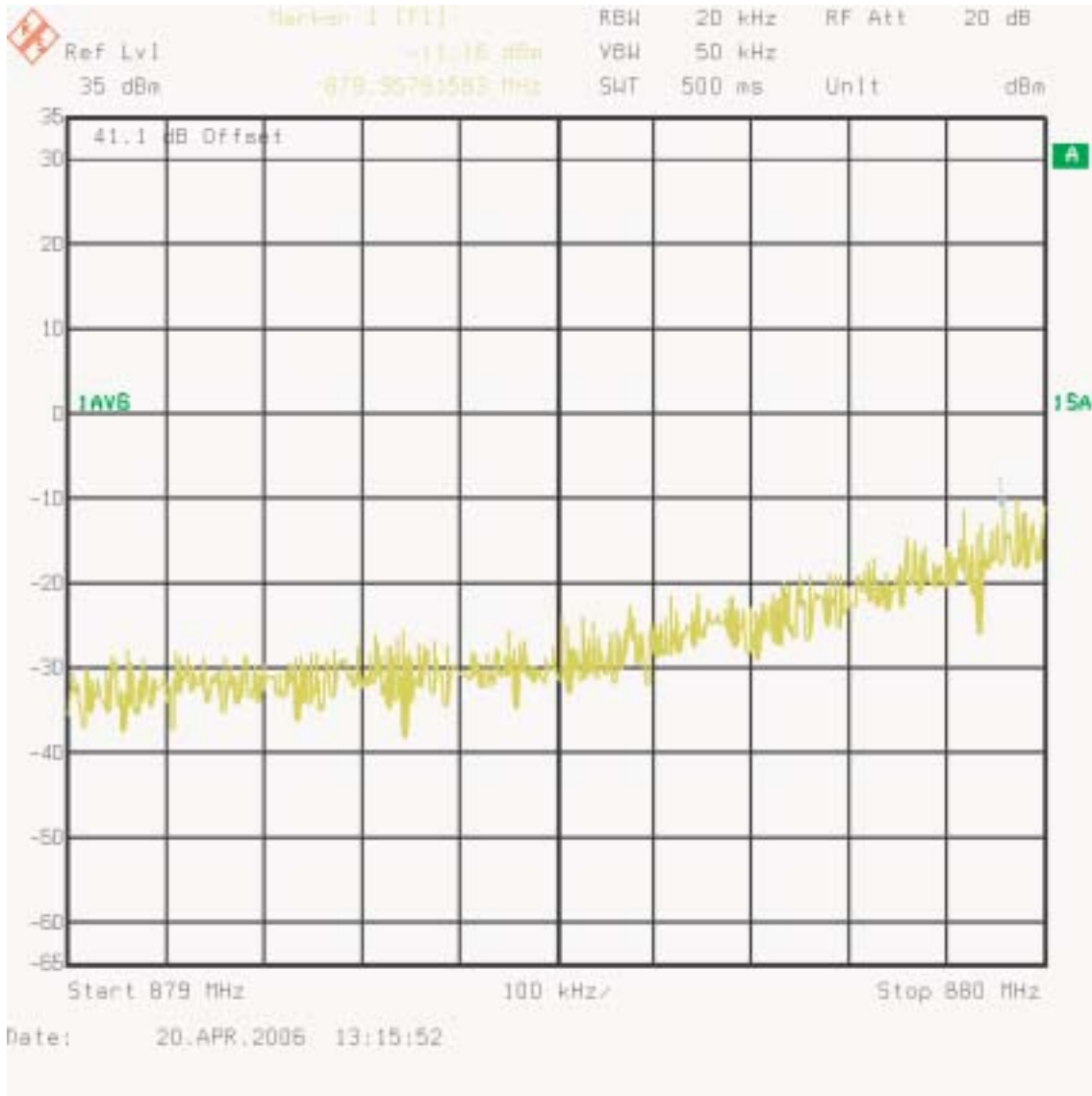

Figure 25 : Two Carriers - Lower Adjacent Channel 1 MHz Channel 358, 399

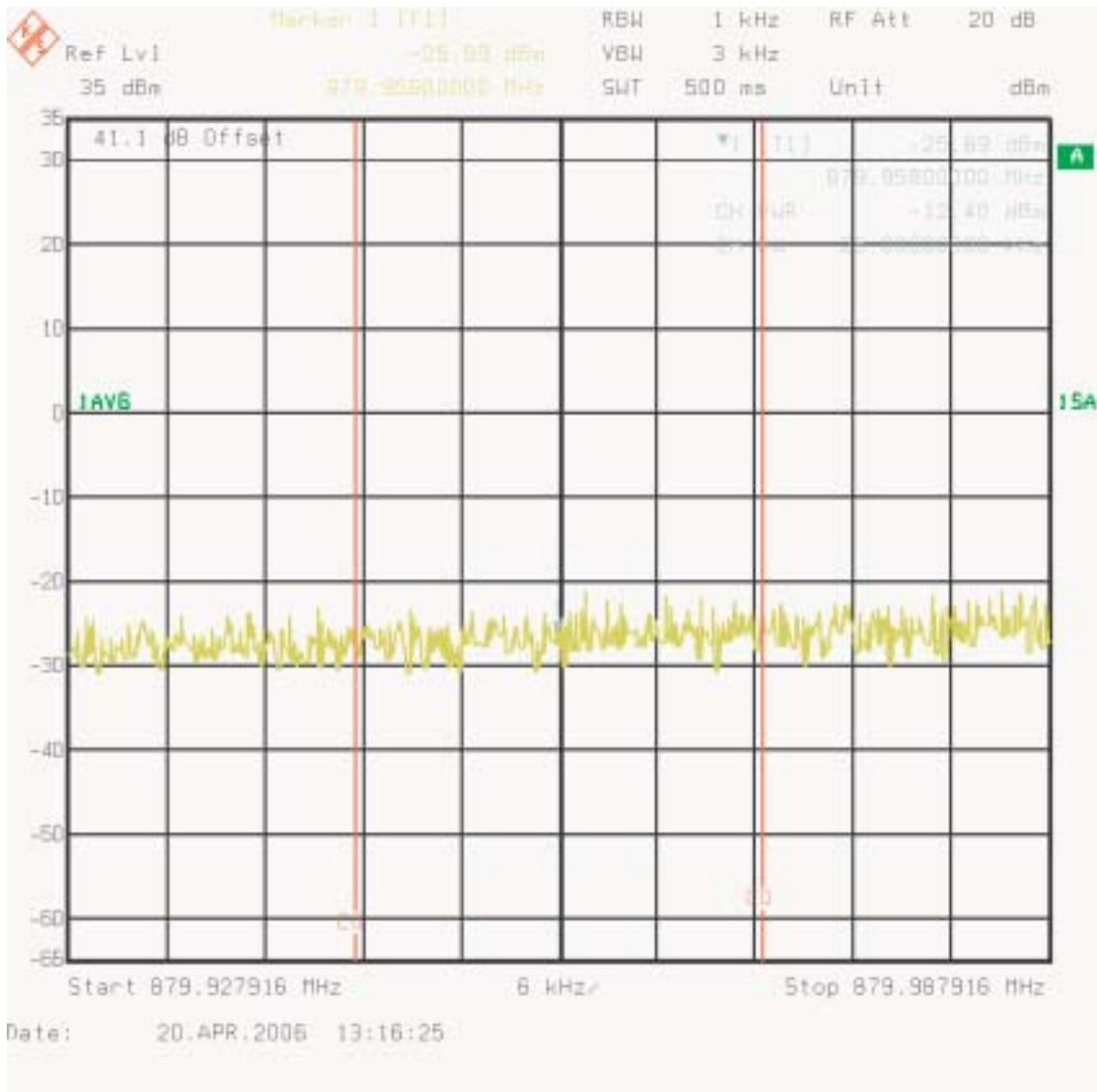

Figure 26 : Two Carriers - Ch 358, 399 Lower B Band Adjacent to outside edge 25kHz band Channel Power

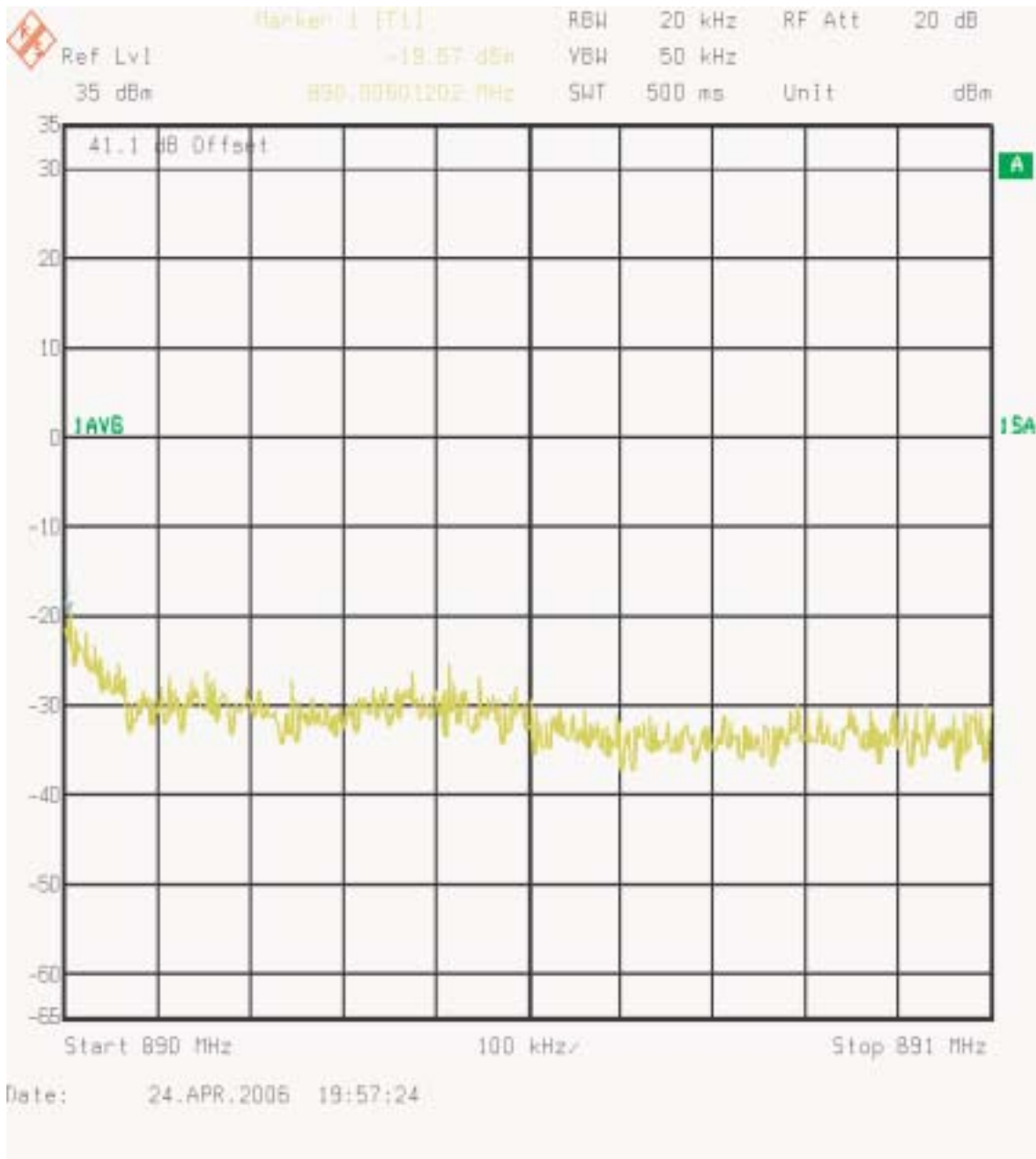

Figure 27 : Two Carriers Upper Adjacent Channel 1MHz Channel 601, 642

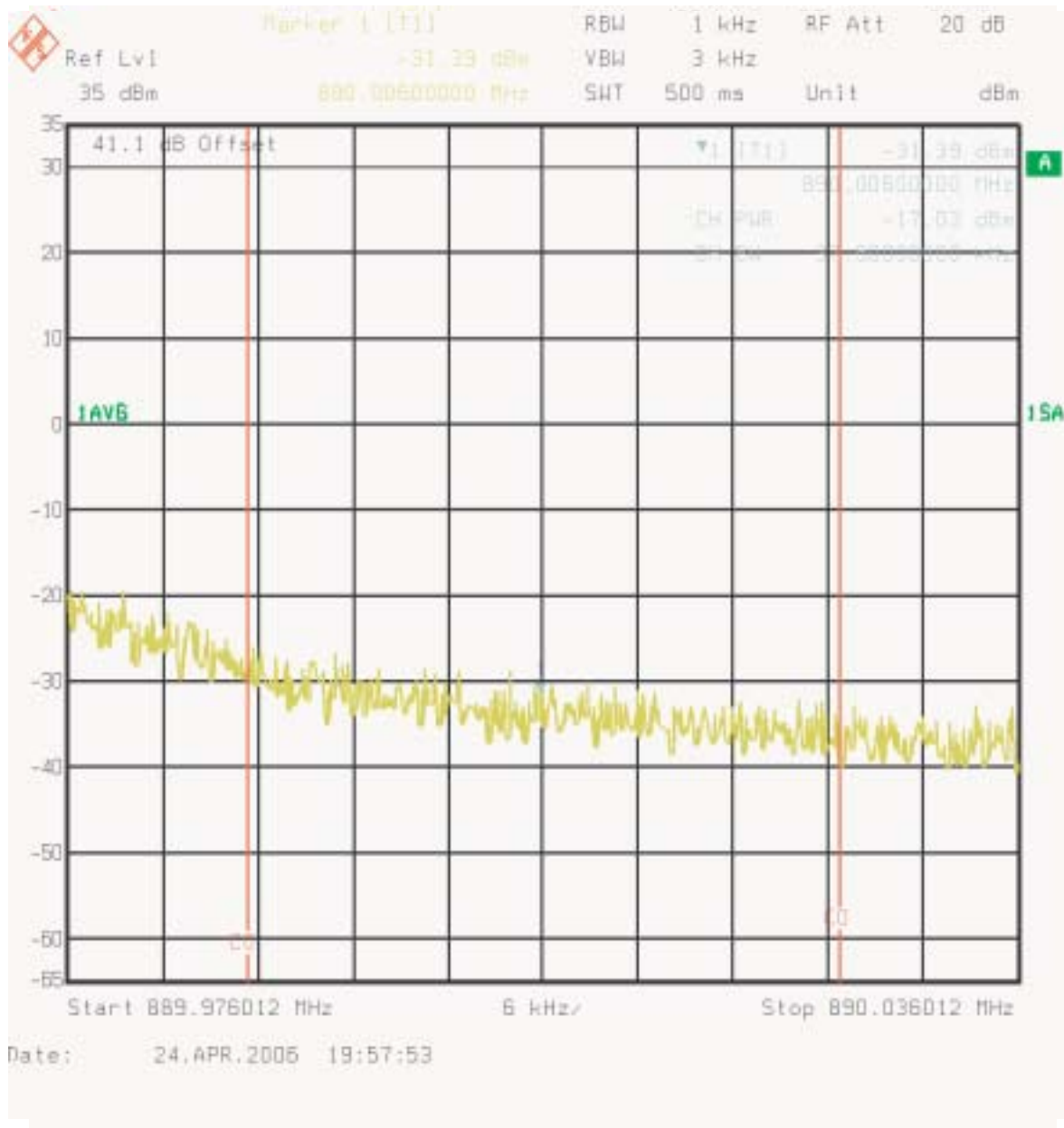

Figure 28 : Two Carriers - Ch 601, 642 Upper B Band adjacent to outside edge 25.0 kHz band Channel power

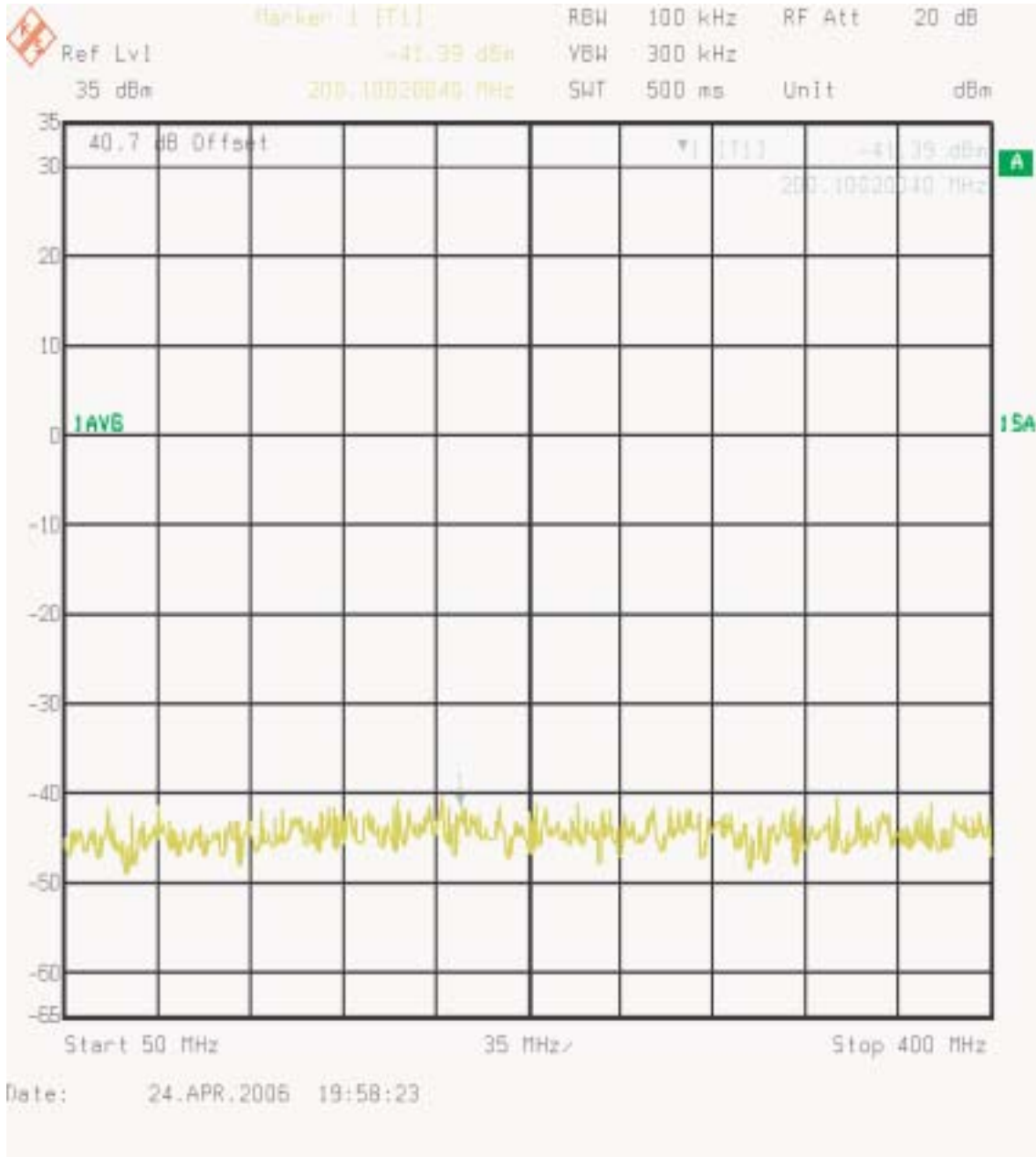

Figure 29 : Two Carriers - B Band Spurious emission 50 - 400MHz Channel 601, 642

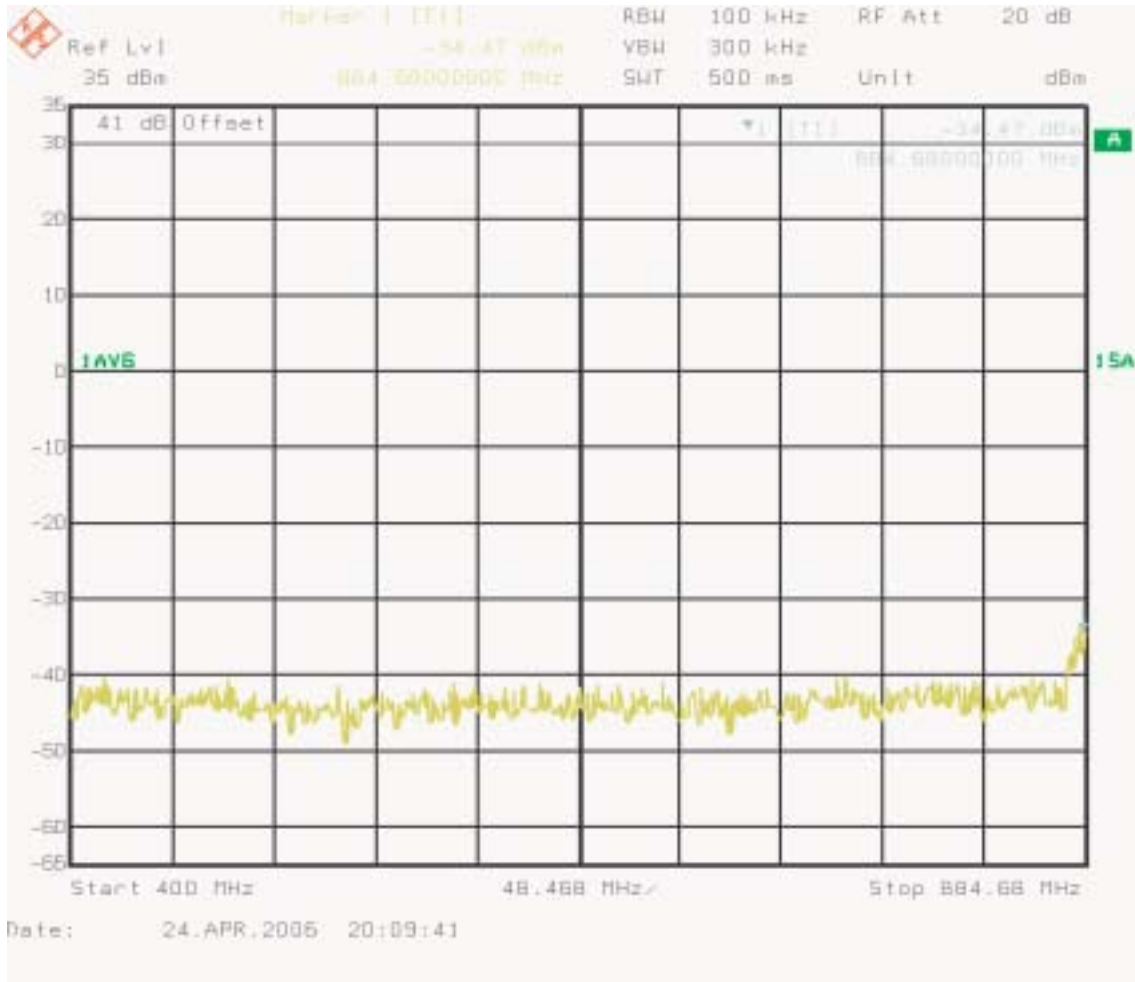

Figure 30 : Two Carriers - Spurious emissions 400 MHz to Lower Band Emissions Channel 601, 642

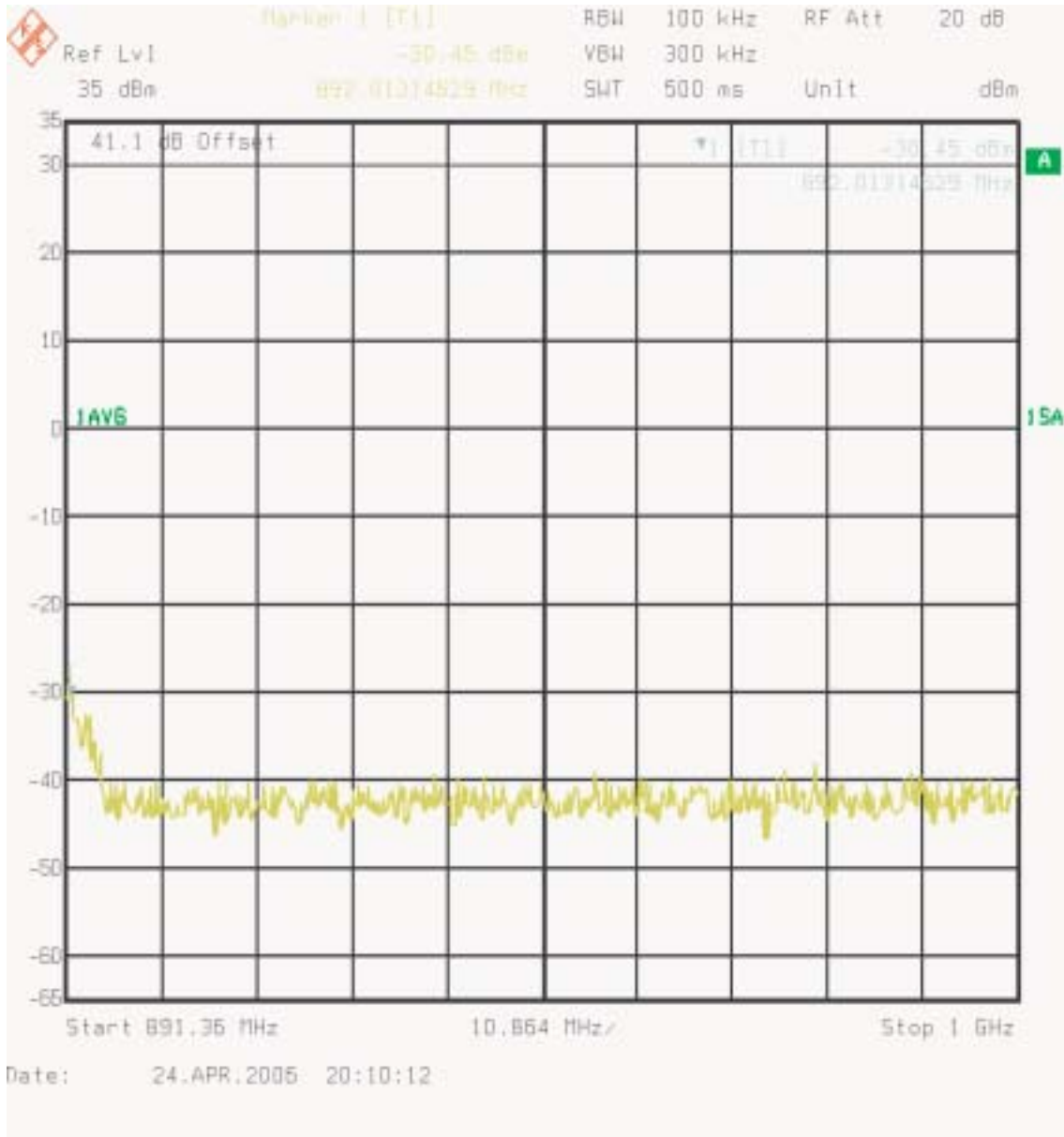

Figure 31 : Two Carriers - Upper Band Emissions to 1 GHz Channel 601, 642

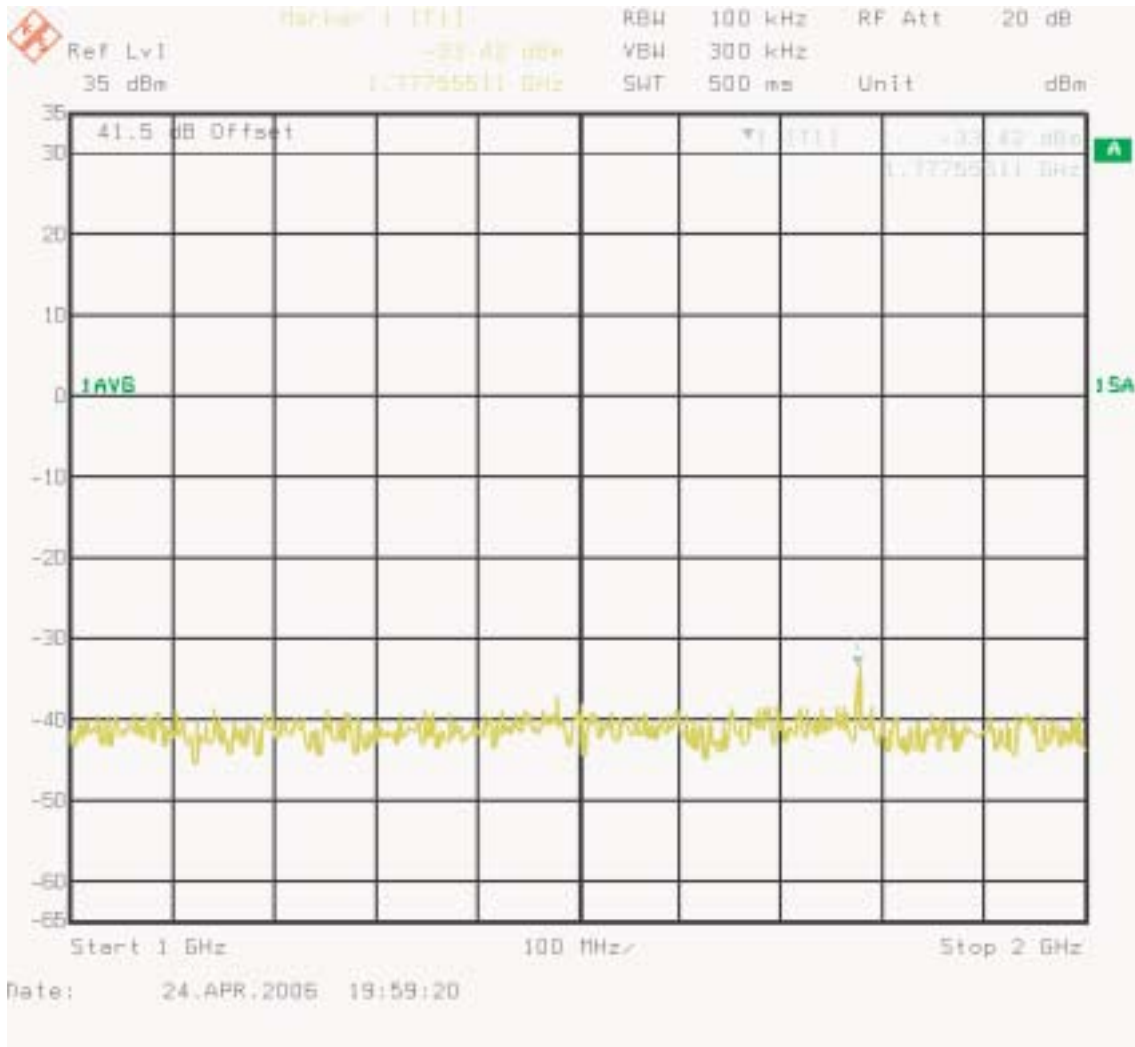

Figure 32 : Two Carriers - B Band Spurious emissions 1000-2000 MHz Channel 601, 642

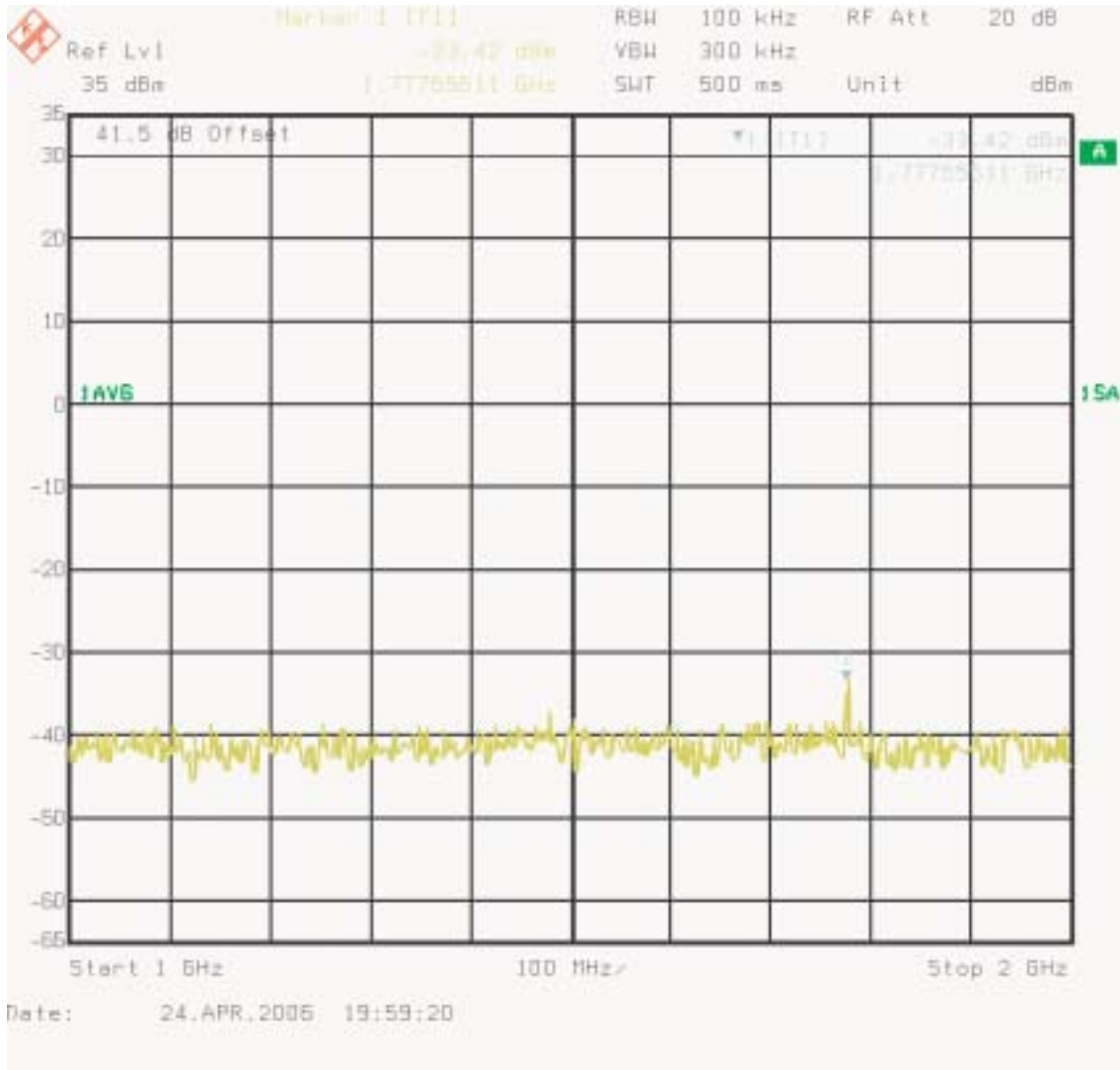

Figure 33 : Two Carriers - B Band Spurious emissions 1000-2000 MHz Channel 601, 642

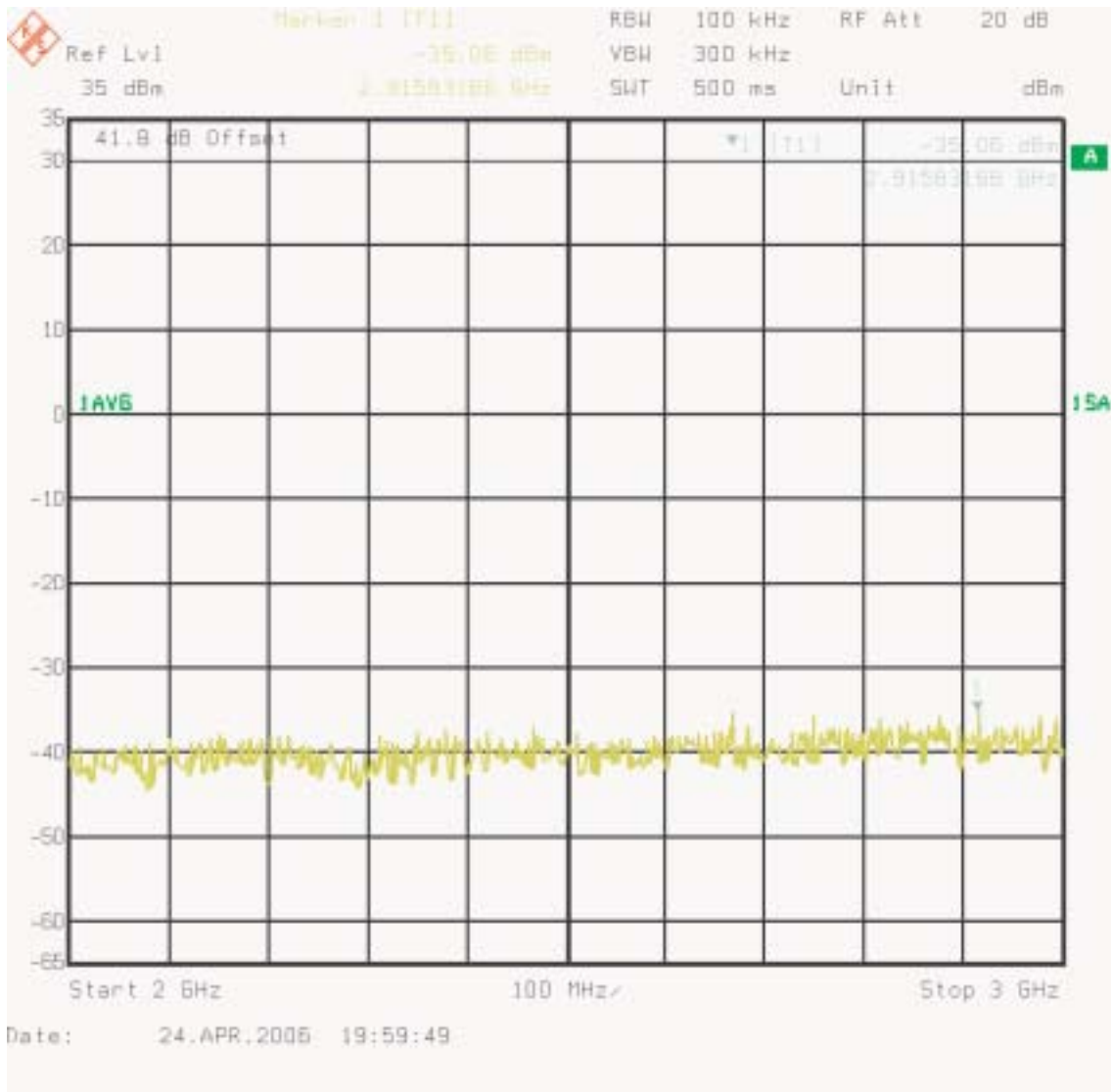

Figure 34 : Two Carriers - B Band Spurious emissions 2000-3000 MHz Channel 601, 642

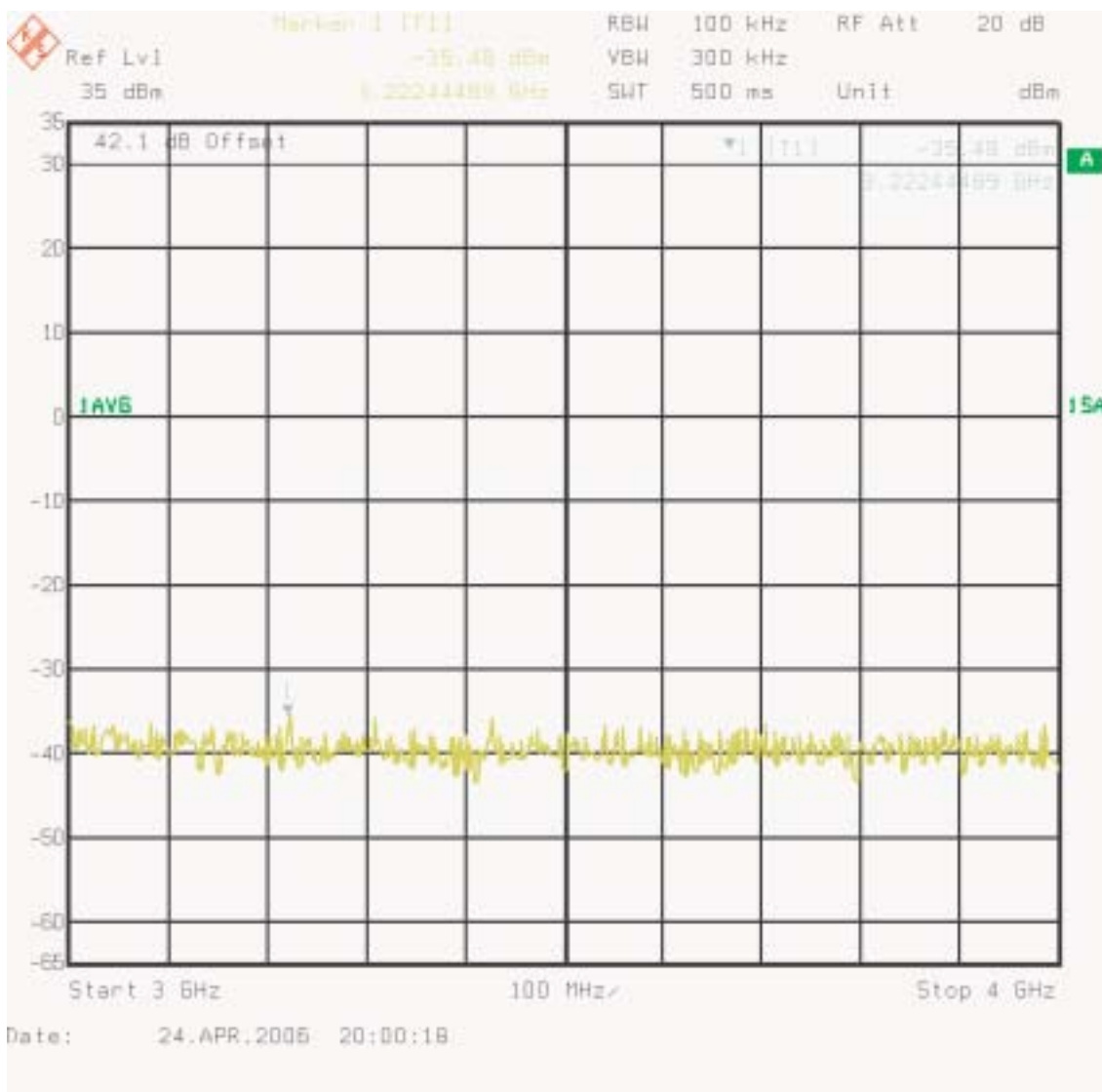

Figure 35 : Two Carriers - B Band Spurious emissions 3000-4000 MHz Channel 601, 642

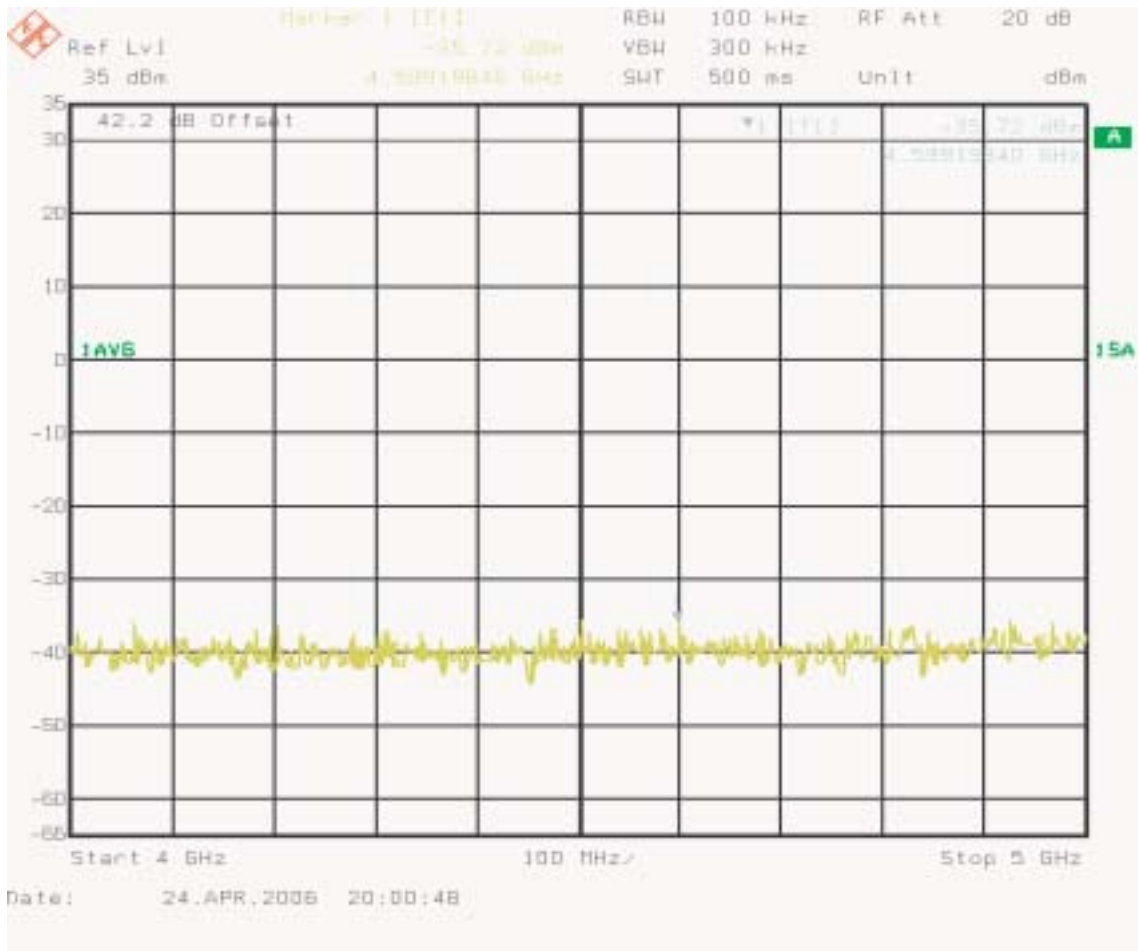

Figure 36 : Two Carriers - B Band Spurious emissions 4000-5000 MHz Channel 601, 642

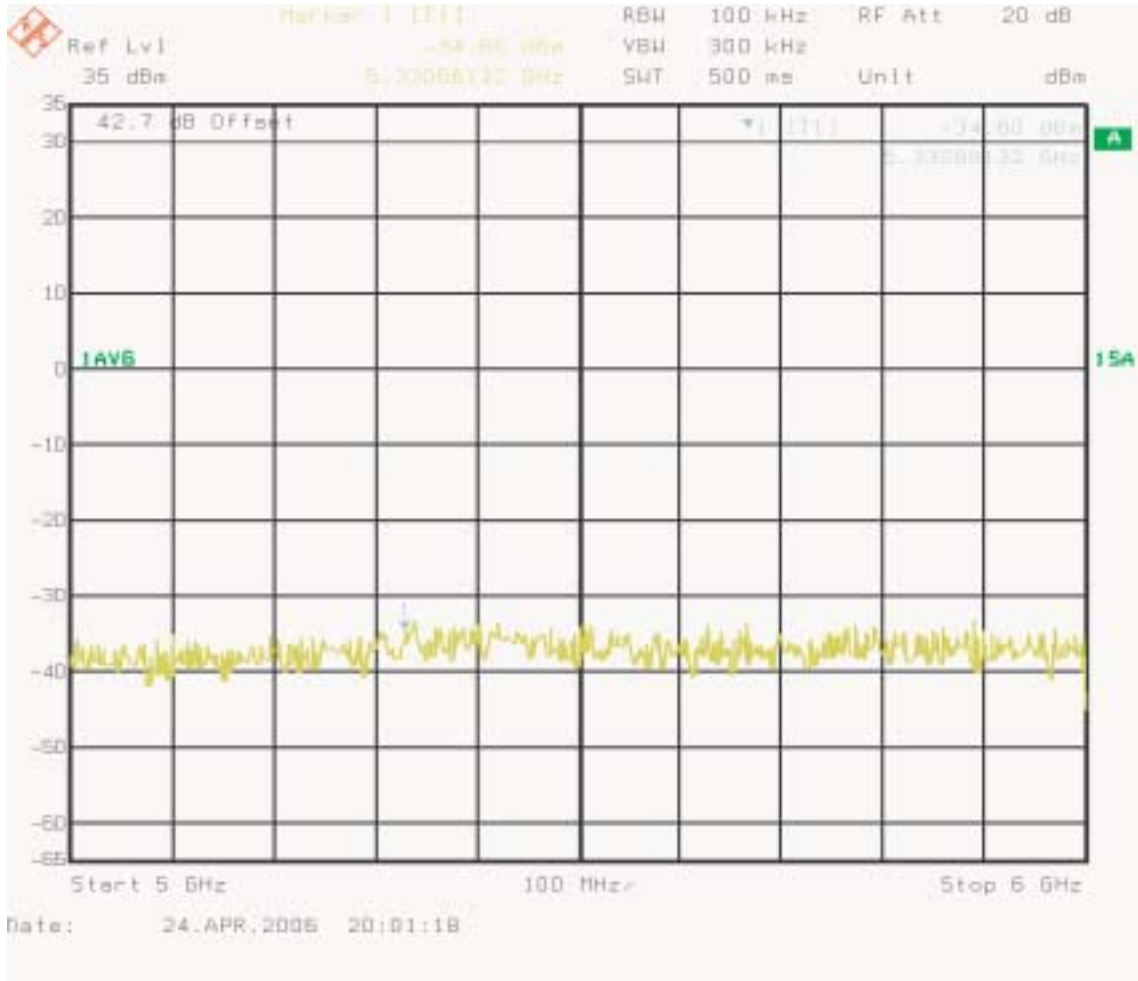

Figure 37 : Two Carriers - B Band Spurious emissions 5000-6000 MHz Channel 601, 642

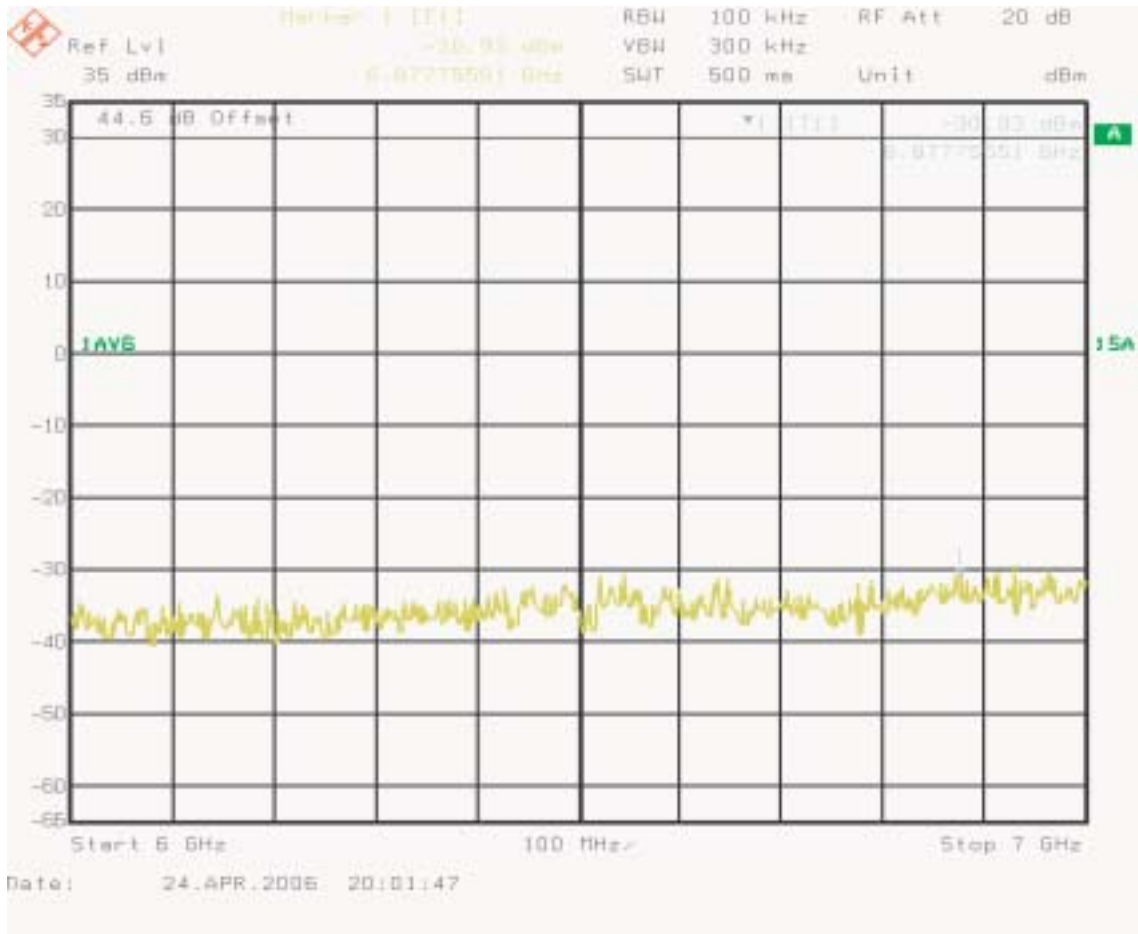

Figure 38 : Two Carriers - B Band Spurious emissions 6000-7000 MHz Channel 601, 642

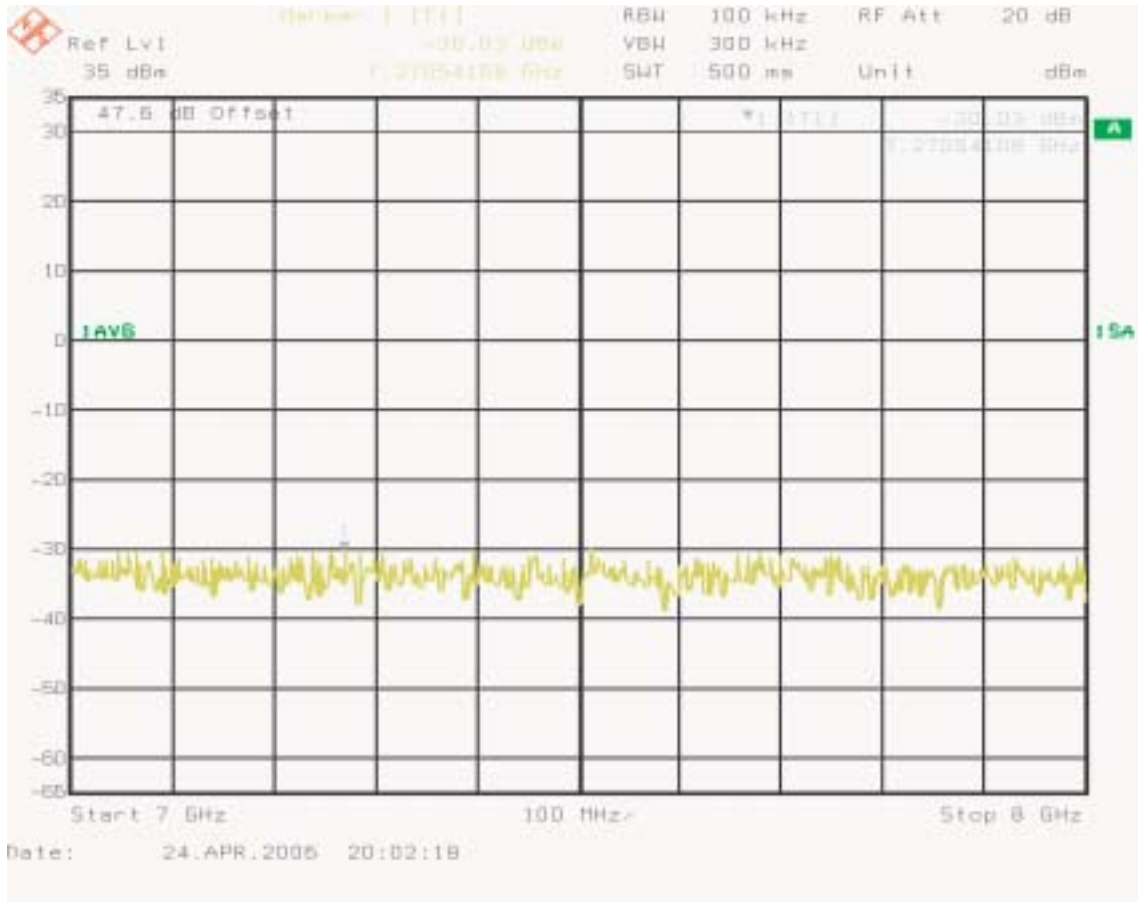

Figure 39 : Two Carriers - B Band Spurious emissions 7000-8000 MHz Channel 601, 642

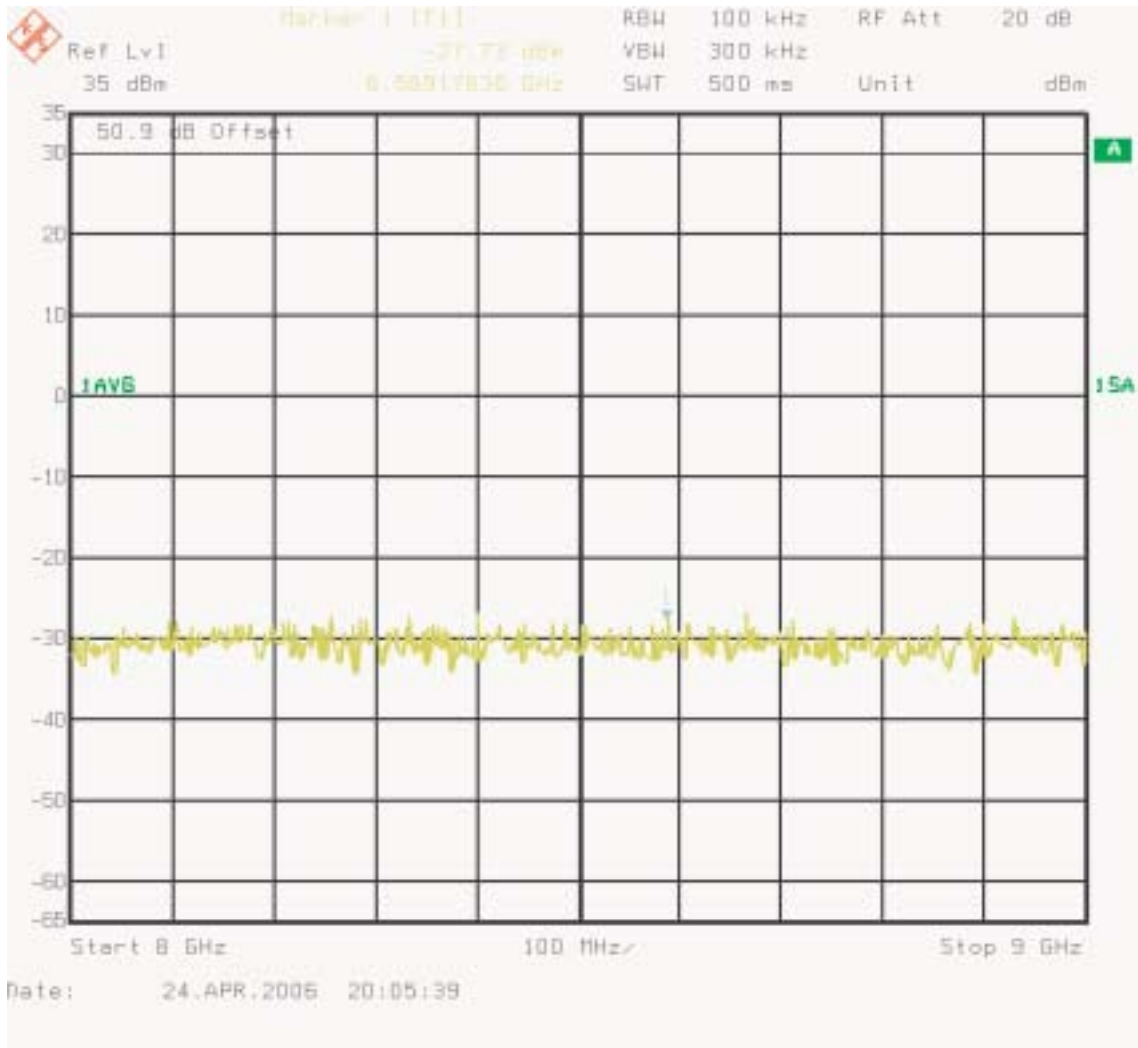

Figure 40 : Two Carriers - B Band Spurious emissions 8000-9000 MHz Channel 601, 642

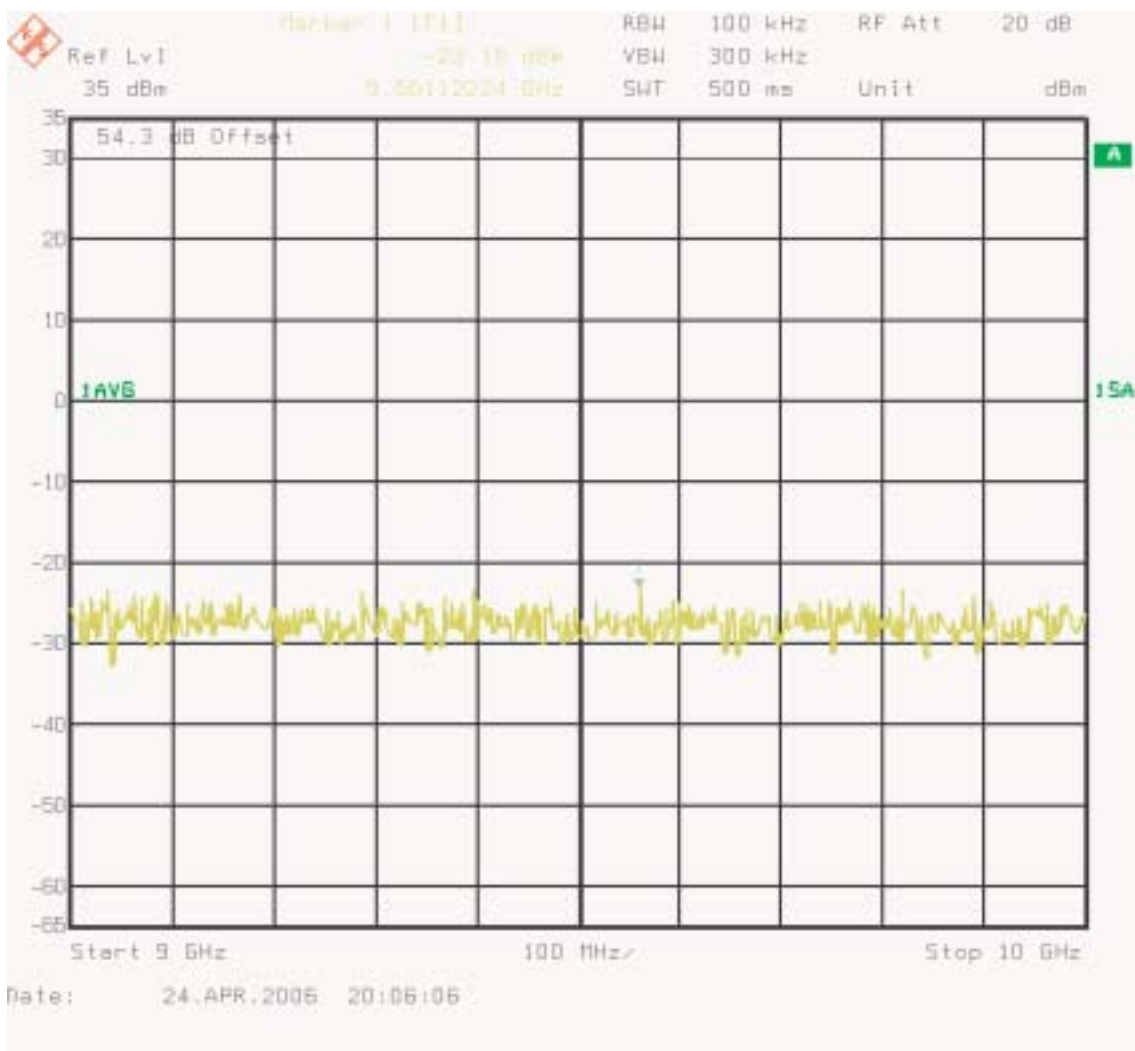

Figure 41 : Two Carriers - B Band Spurious emissions 9000-10000 MHz Channel 601, 642

7 Appendix C - Three Carrier Spurious Emission

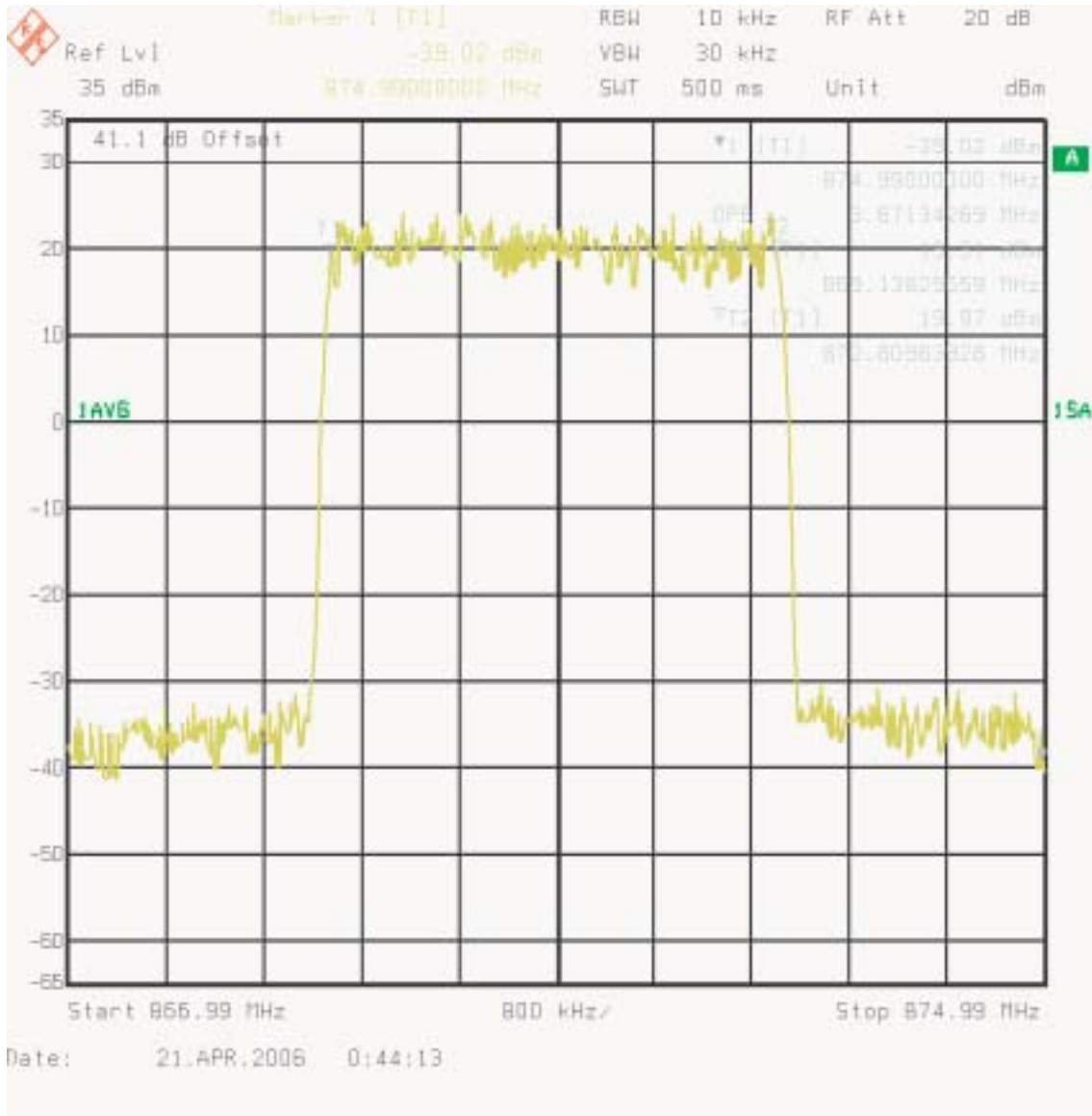

Figure 42 : Three Carriers - Occupied Bandwidth Ch 1015, 33, 74 A”

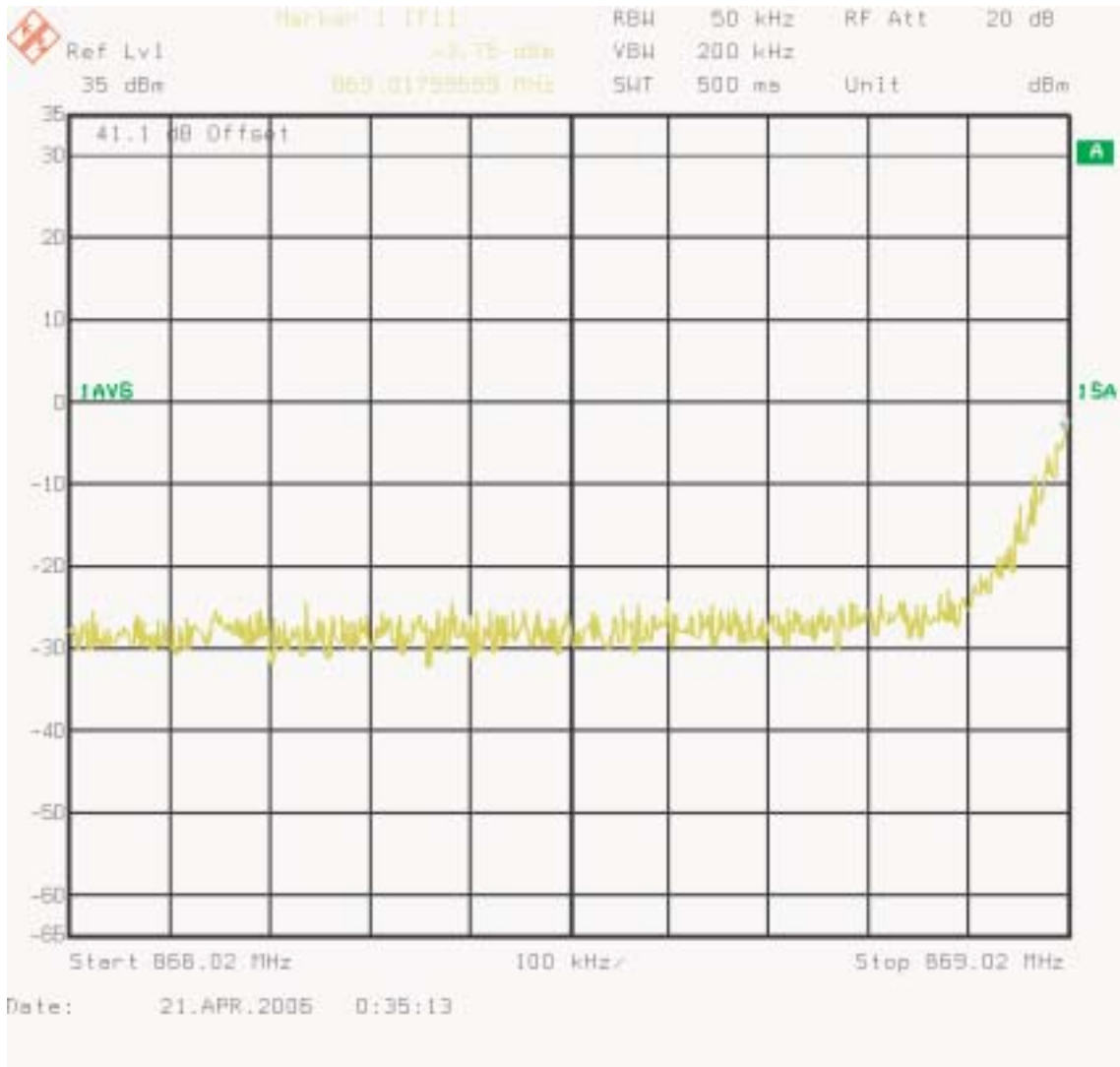

Figure 43 : Three Carriers - Lower Adjacent Channel 1MHz Channel 1015, 33, 74

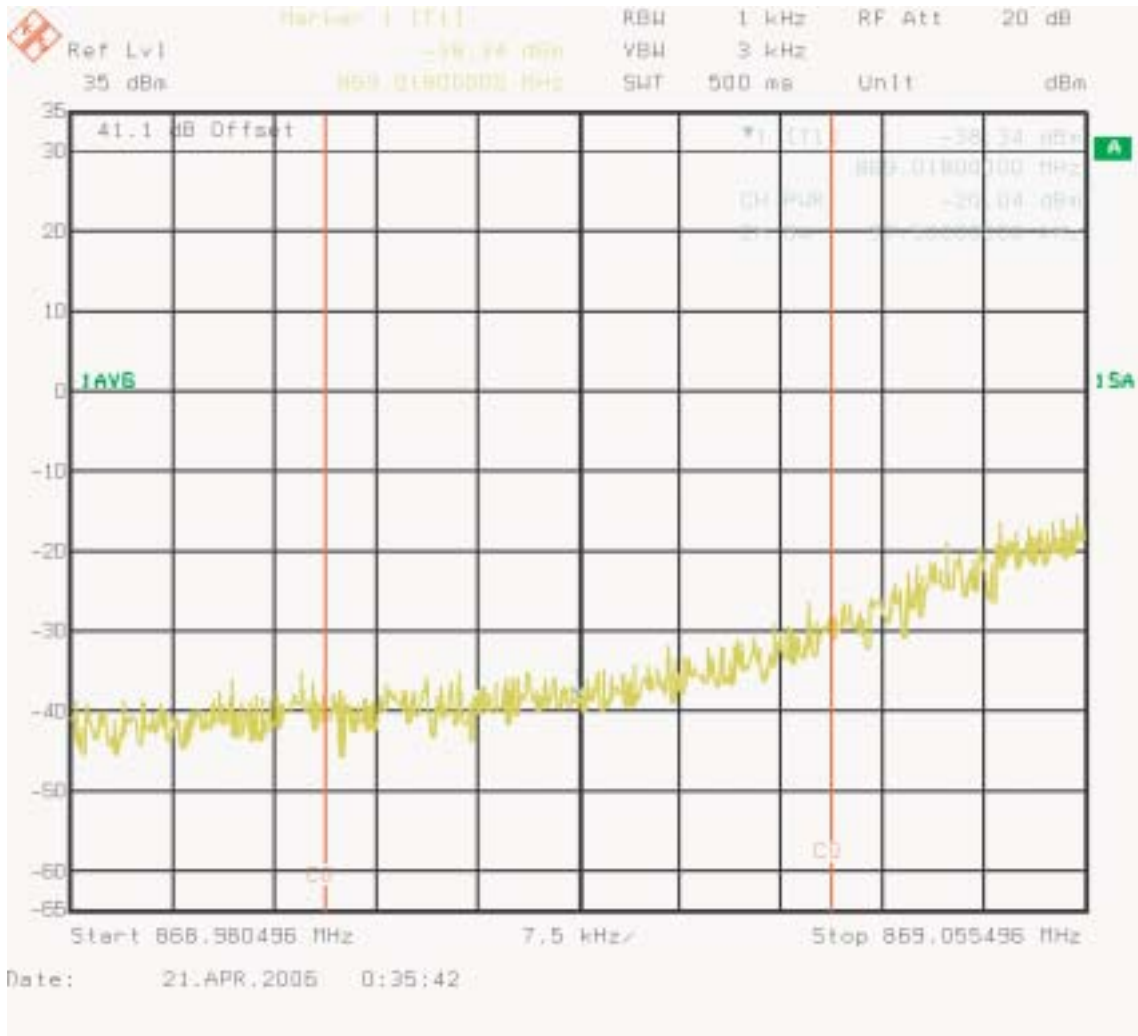

Figure 44 : Three Carriers - Ch 1015, 33, 74 Lower A” Band Adjacent to outside edge 37.5kHz band Channel Power

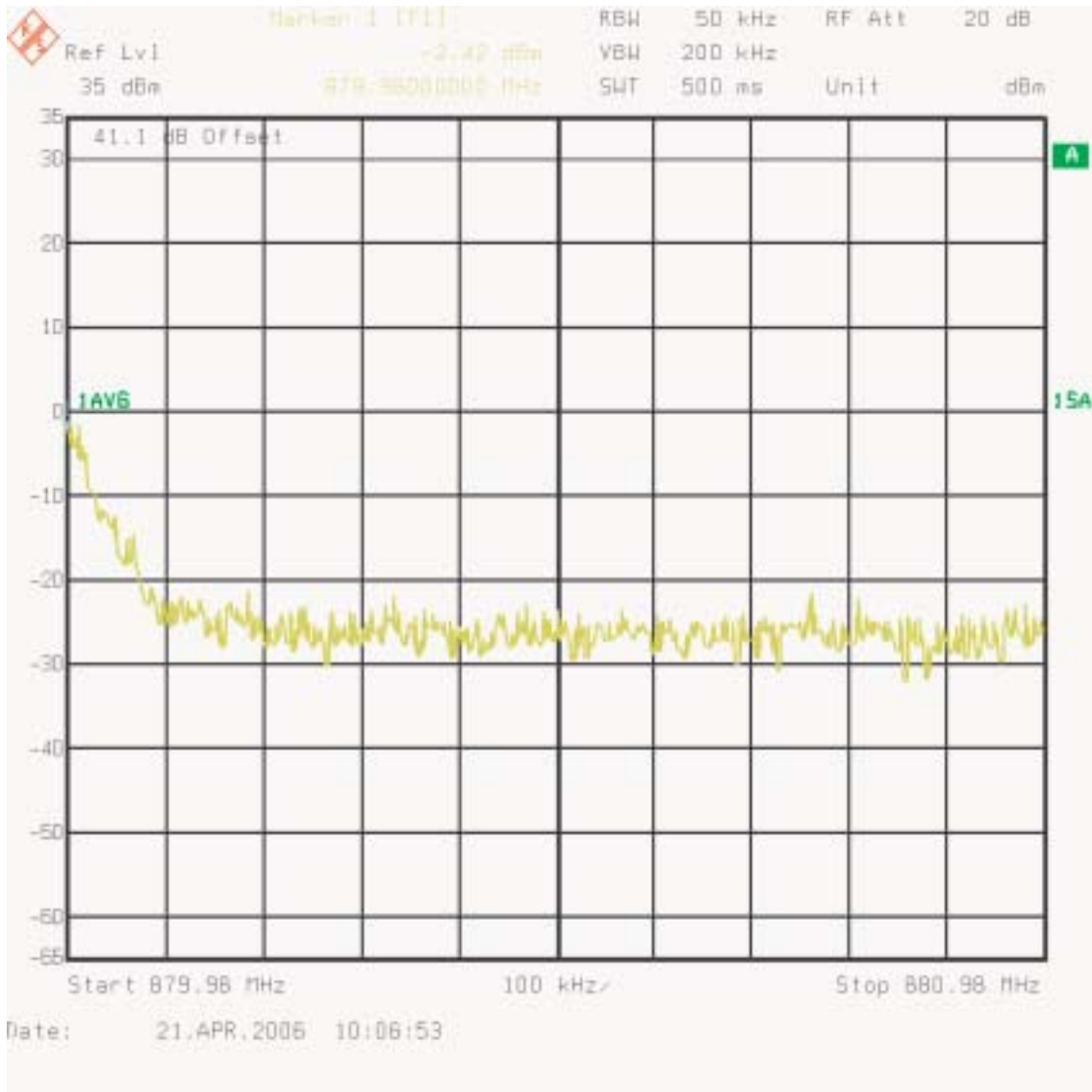

Figure 45 : Three Carriers - Upper Adjacent Channel 1MHz Channel 226, 267, 308

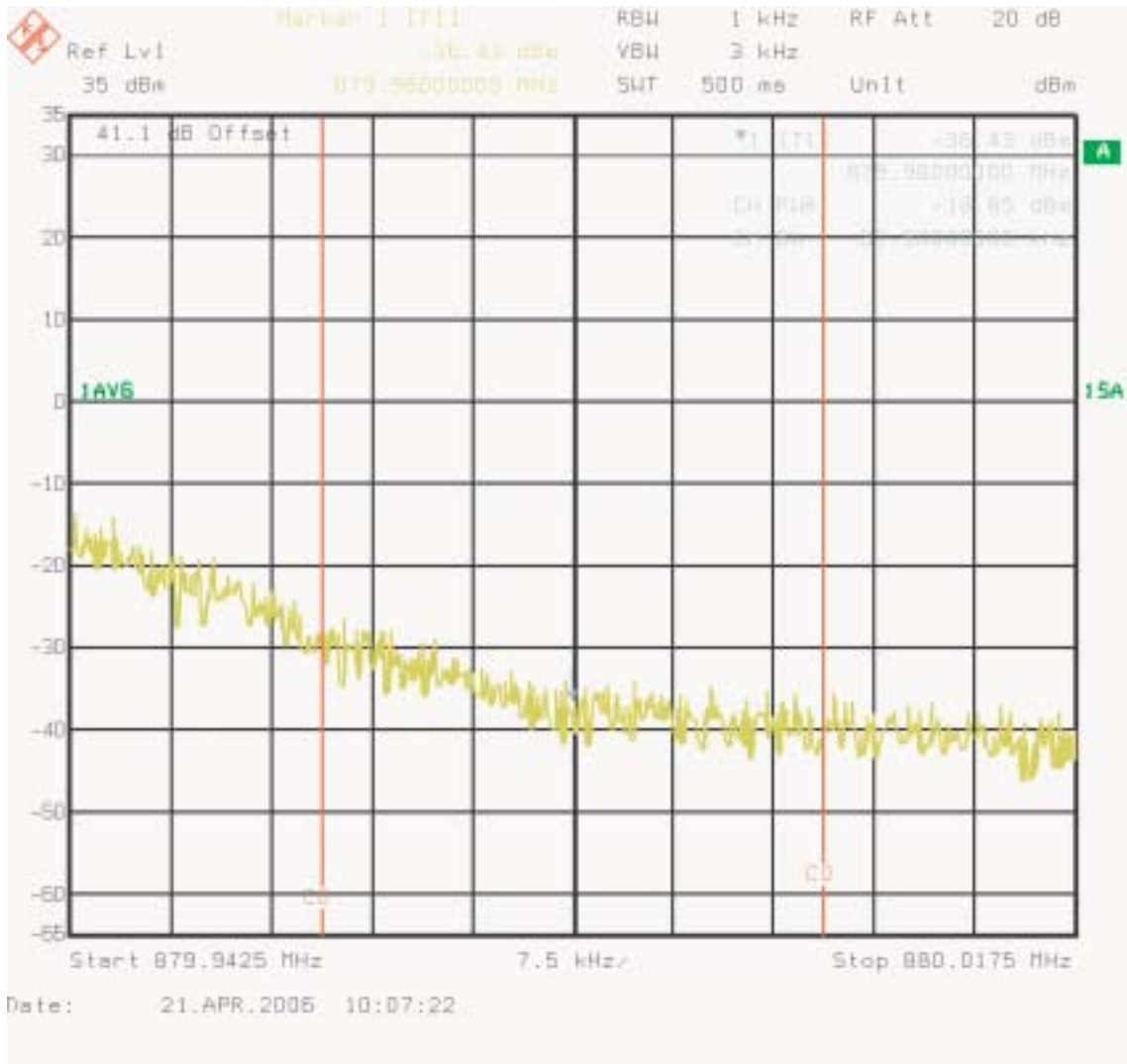

Figure 46 : Three Carriers - Ch 226, 267, 308 Upper A Band adjacent to outside edge 37.5 kHz band Channel power

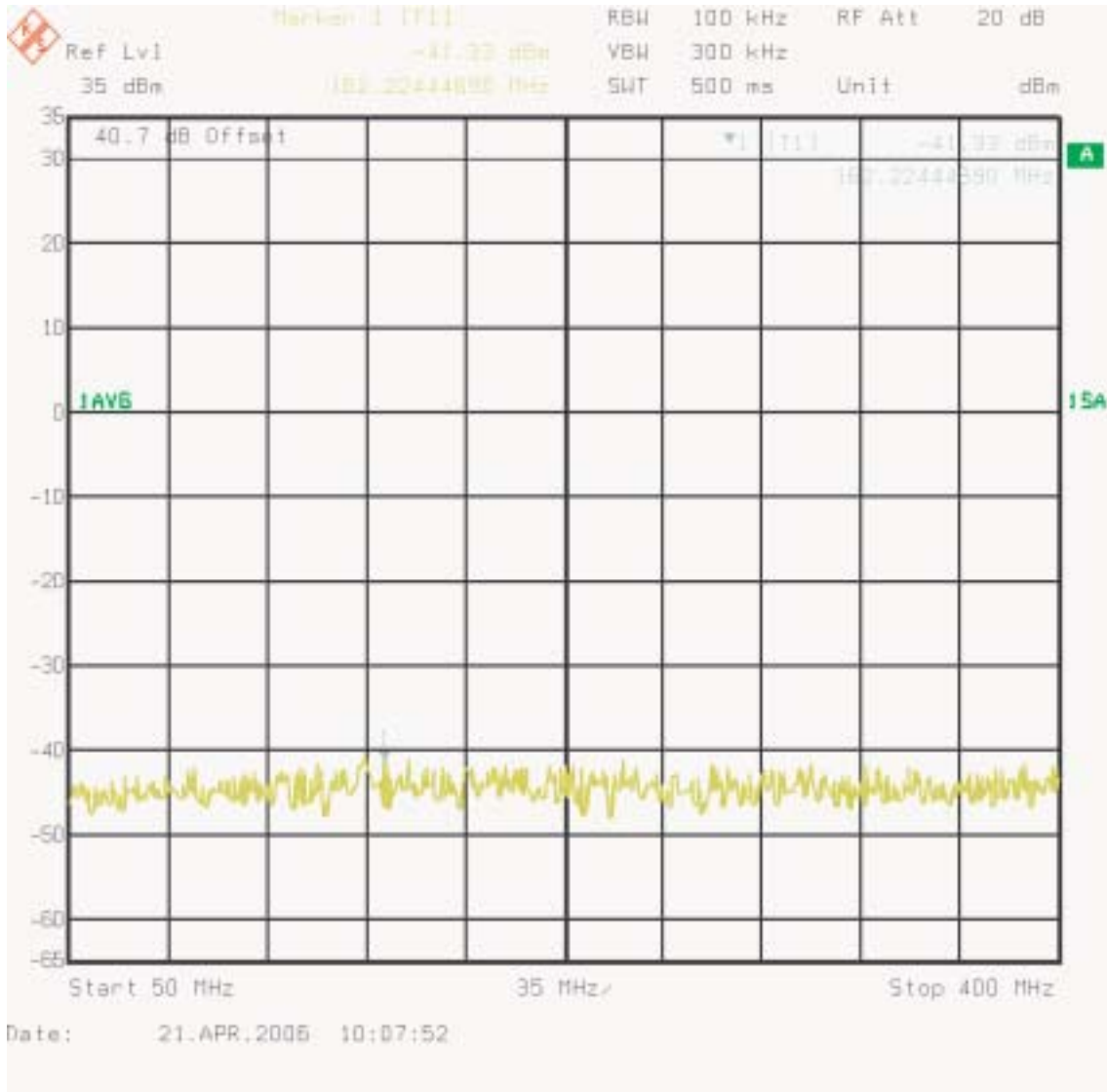

Figure 47 : Three Carriers - A Band Spurious emissions 50-400 MHz Ch 226, 267, 308

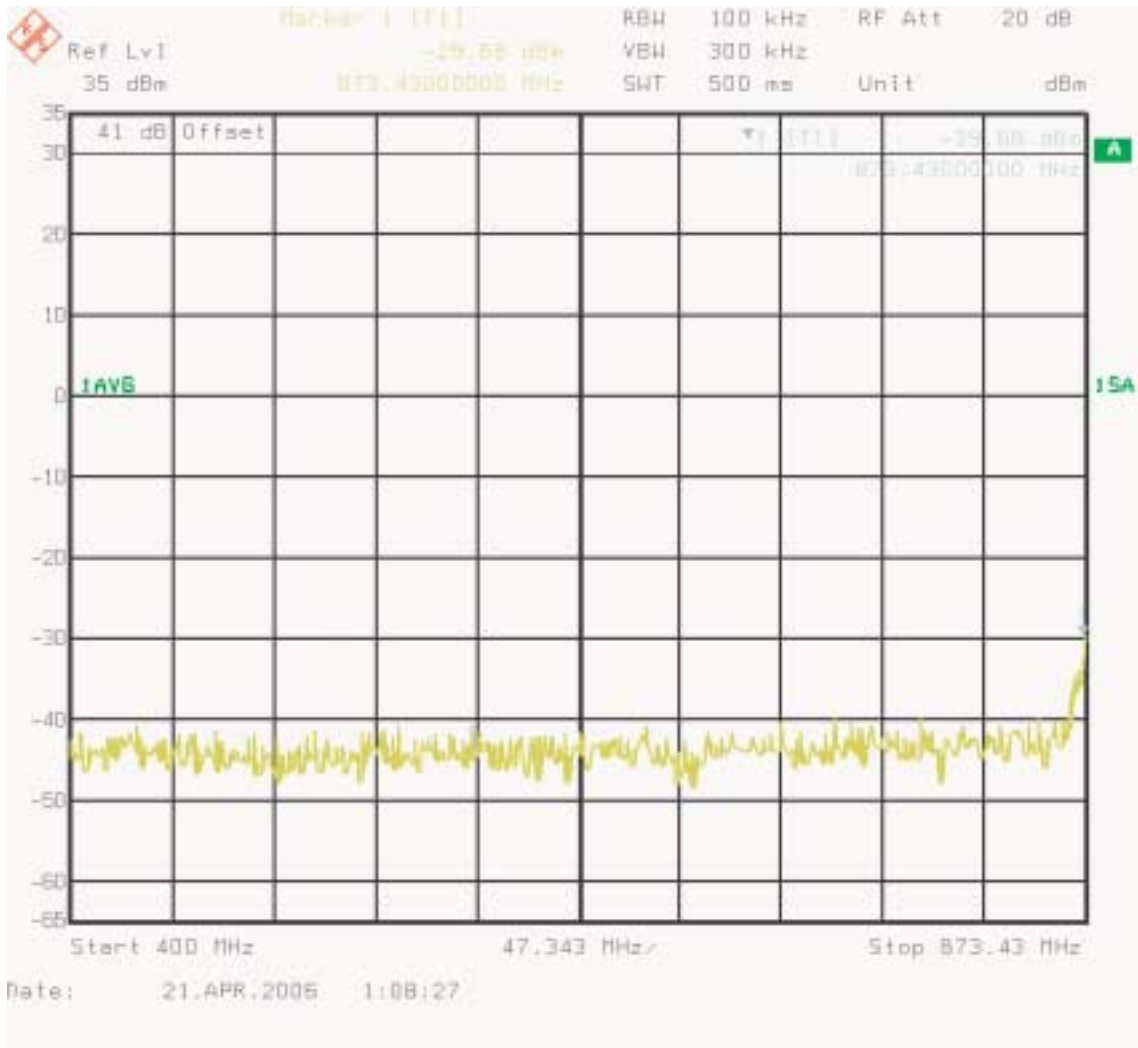
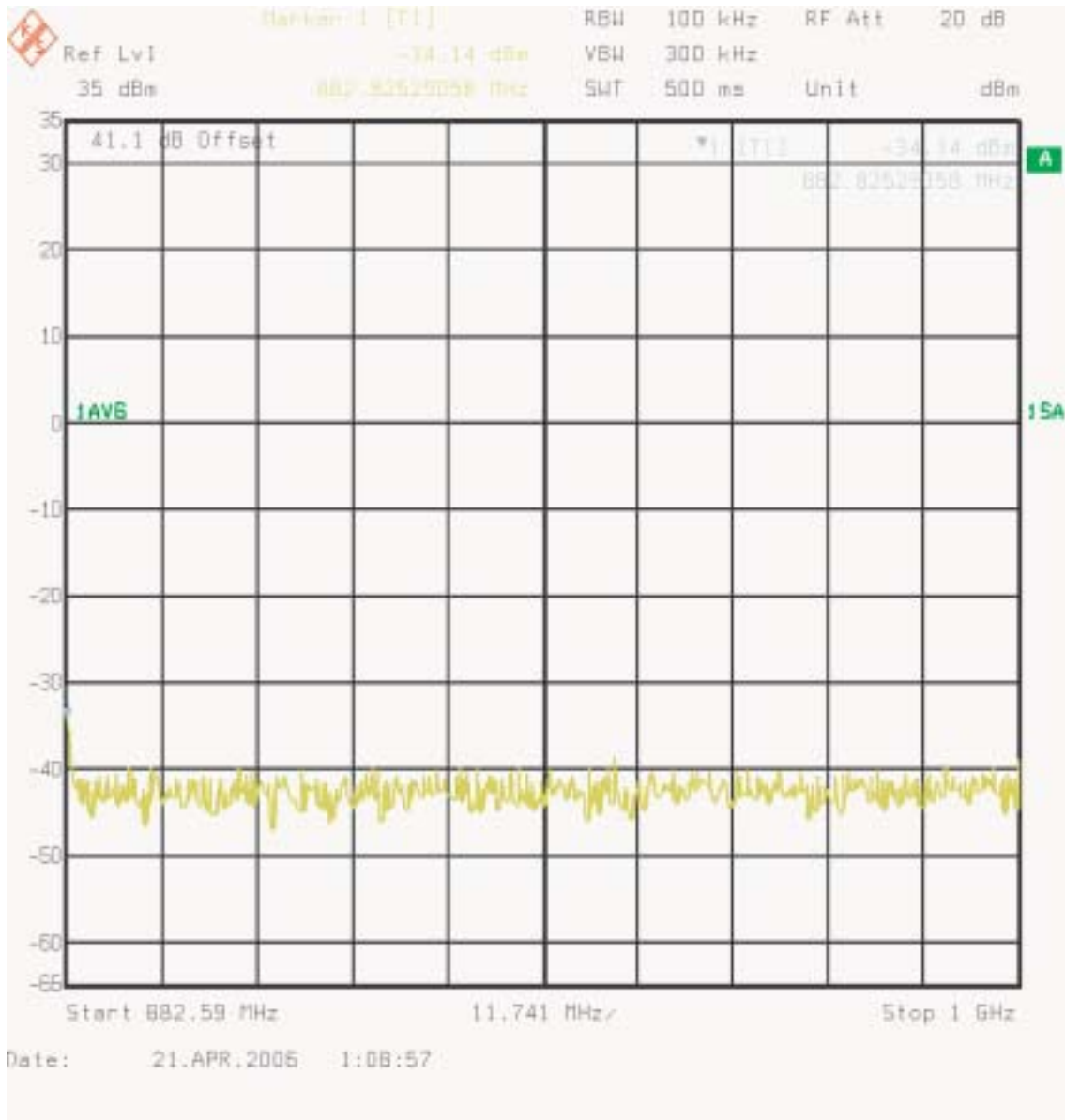

Figure 48 : Three Carriers - A Band Spurious emissions 400 MHz to Lower Band Emissions Ch 226, 267, 308



**Figure 49 : Three Carriers - A Band Spurious Emissions Upper Band Emissions to 1 GHz
Ch 226, 267, 308**

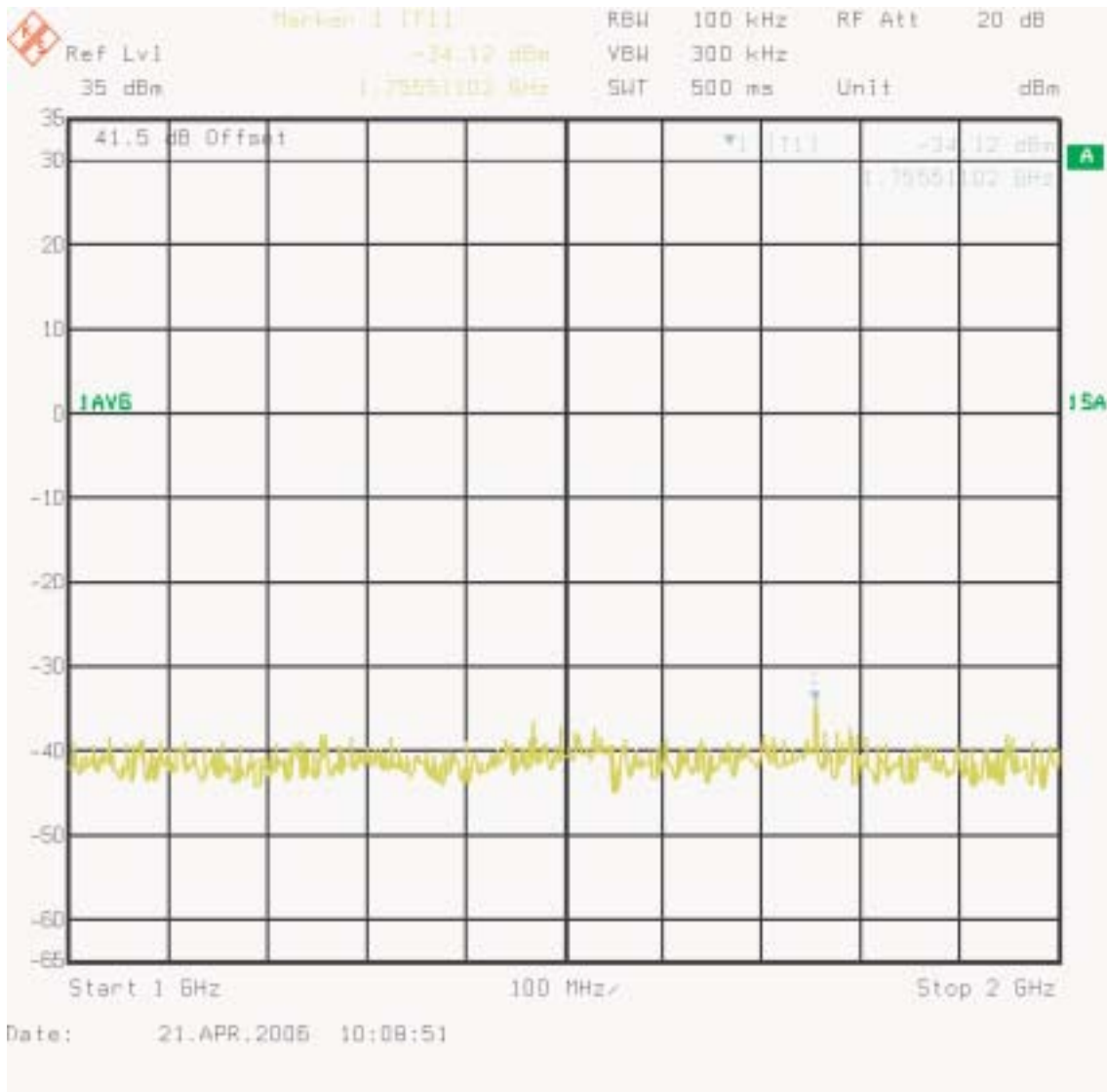

Figure 50 : Three Carriers - A Band Spurious emissions 1000-2000 MHz Ch 226, 267, 308

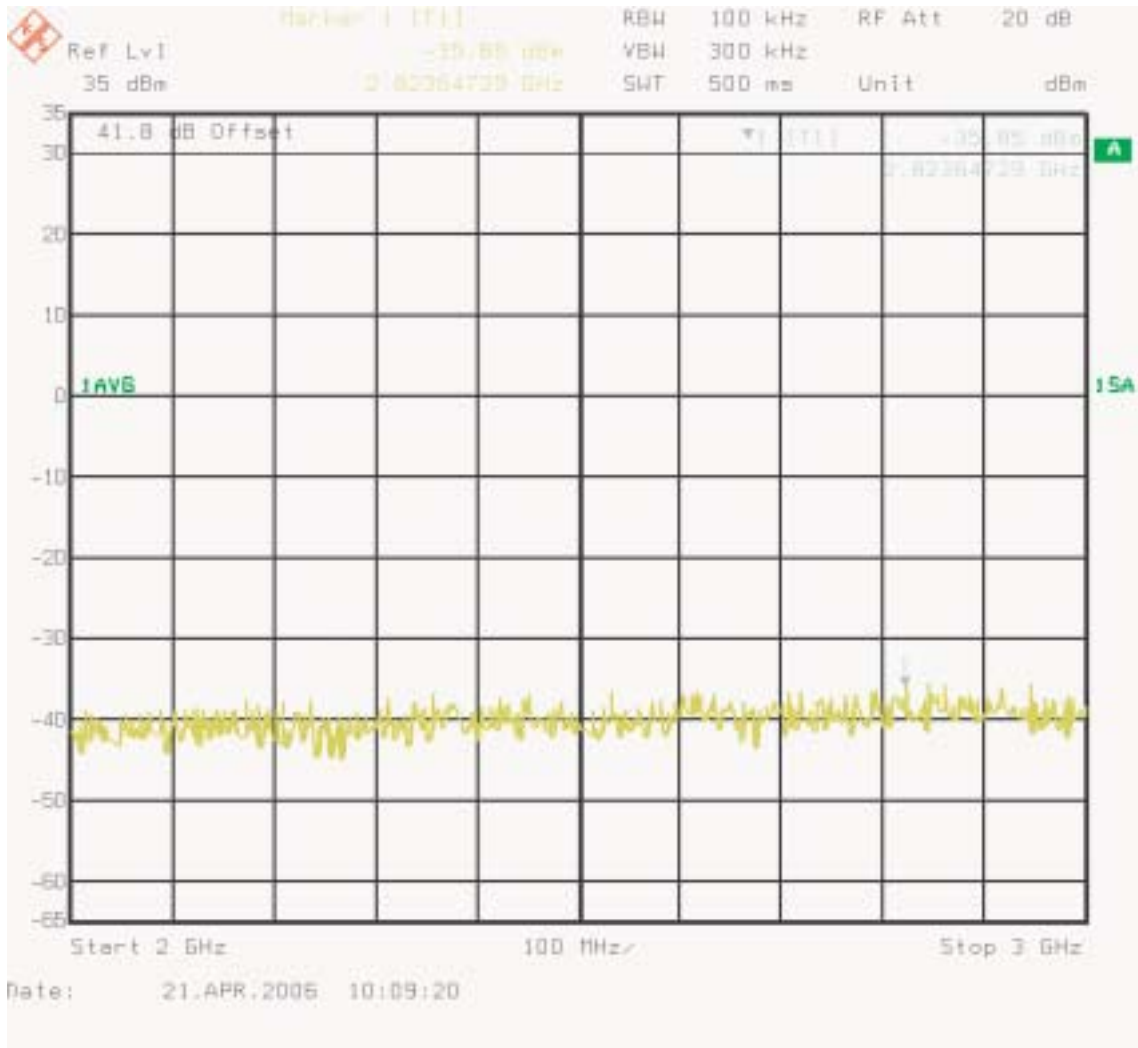

Figure 51 : Three Carriers - A Band Spurious emissions 2000-3000 MHz Ch 226, 267, 308

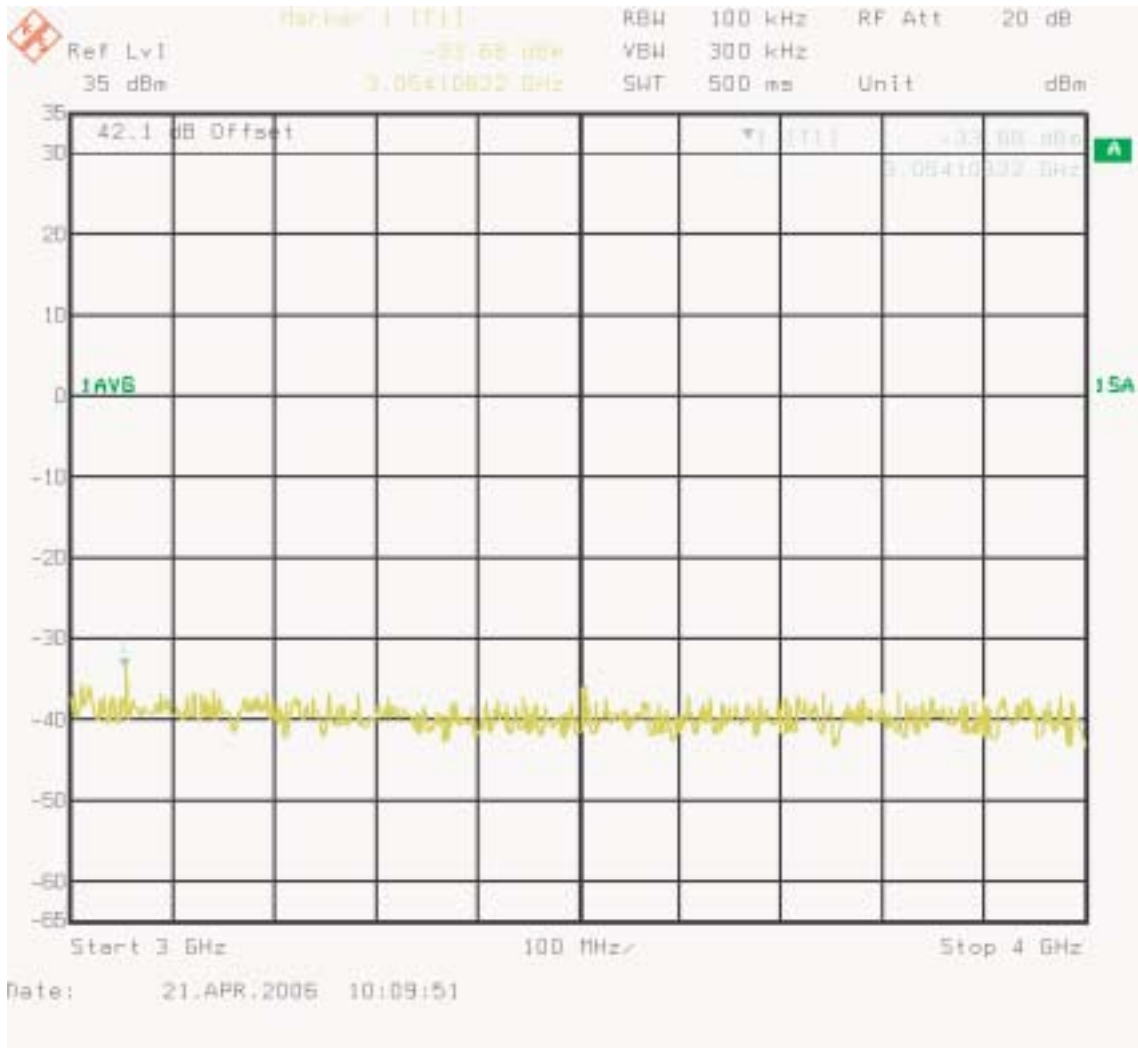

Figure 52 : Three Carriers - A Band Spurious emissions 3000-4000 MHz Ch 226, 267, 308

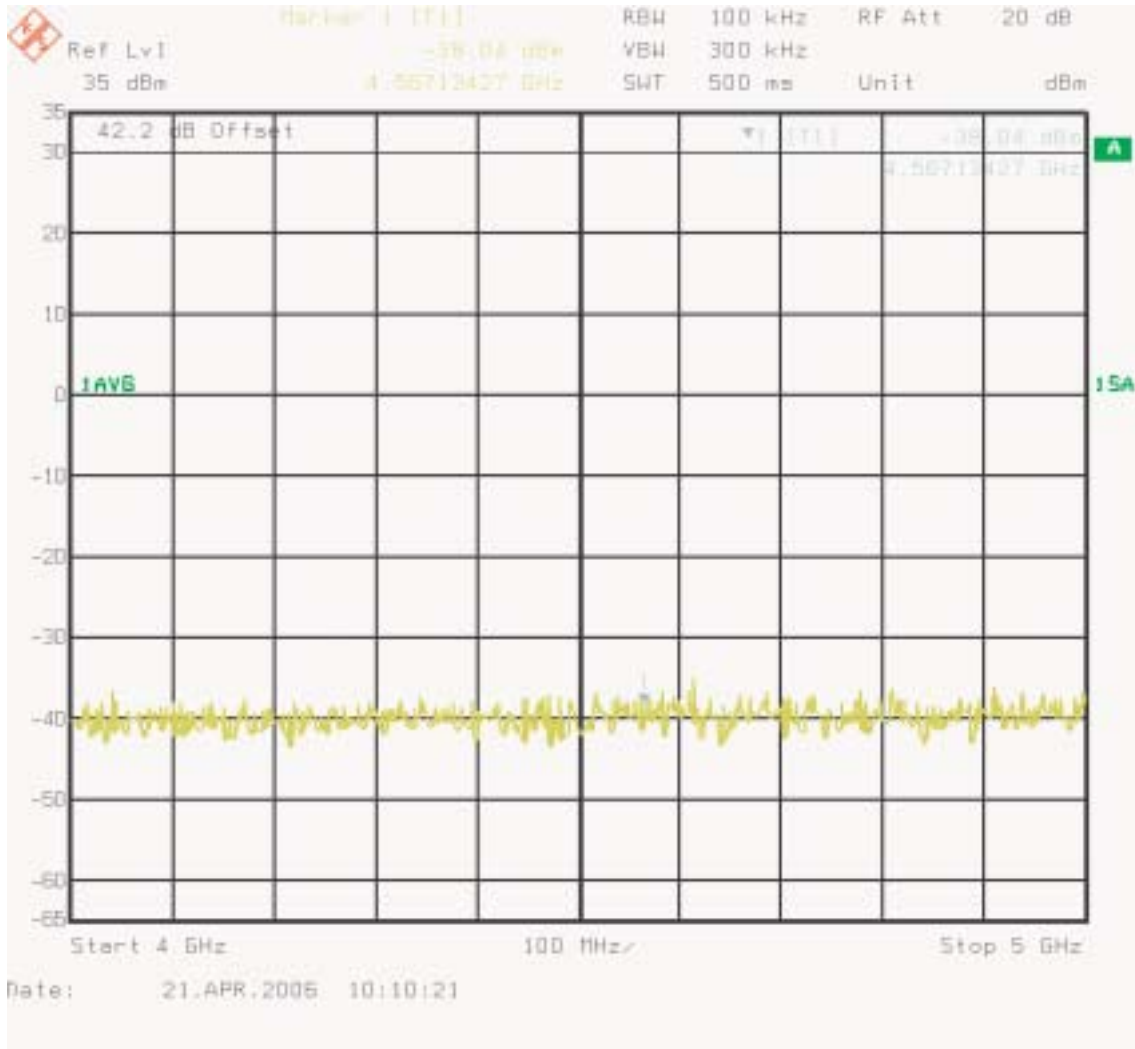

Figure 53 : Three Carriers - A Band Spurious emissions 4000-5000 MHz Ch 226, 267, 308

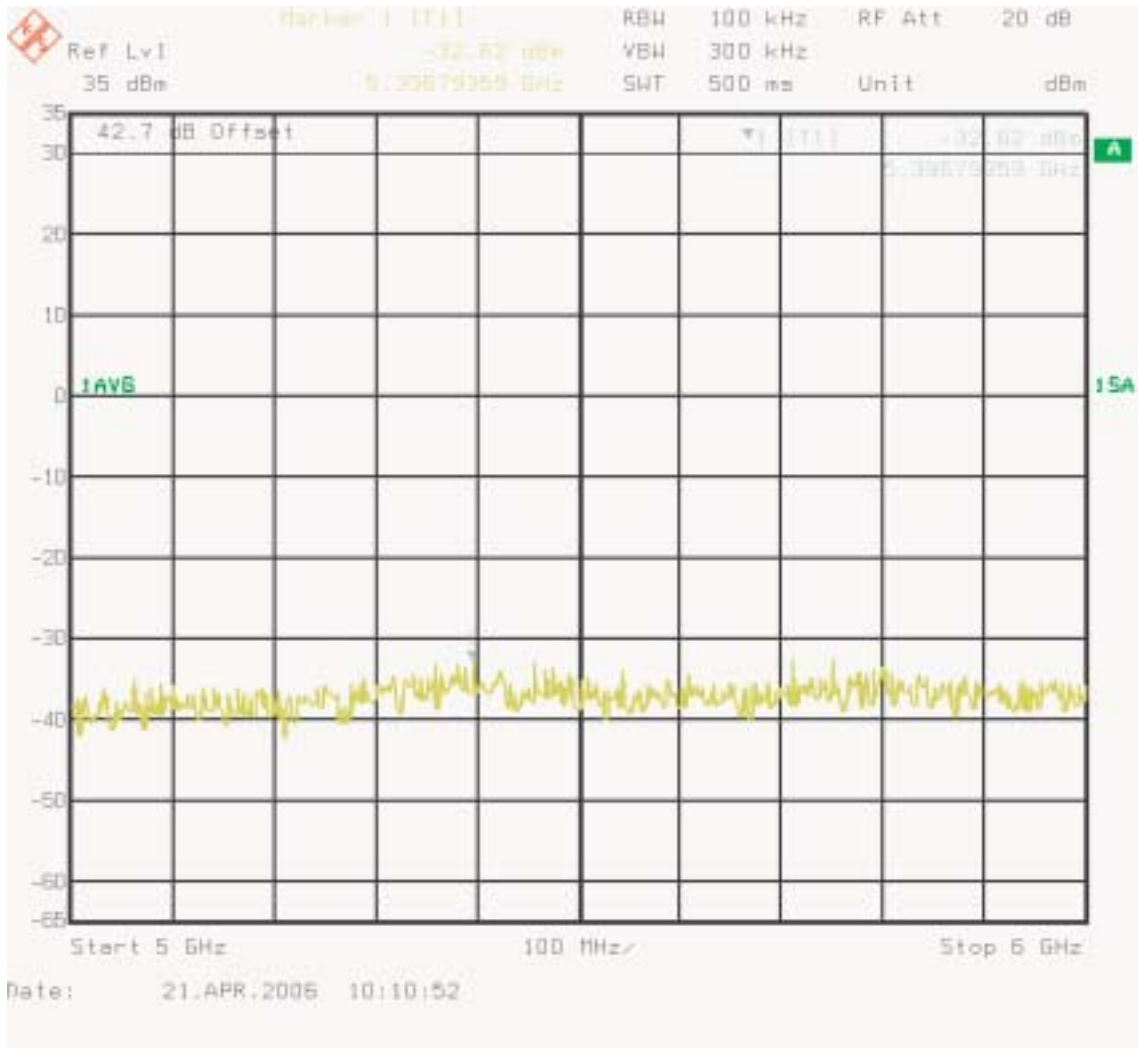

Figure 54 : Three Carriers - A Band Spurious emissions 5000-6000 MHz Ch 226, 267, 308

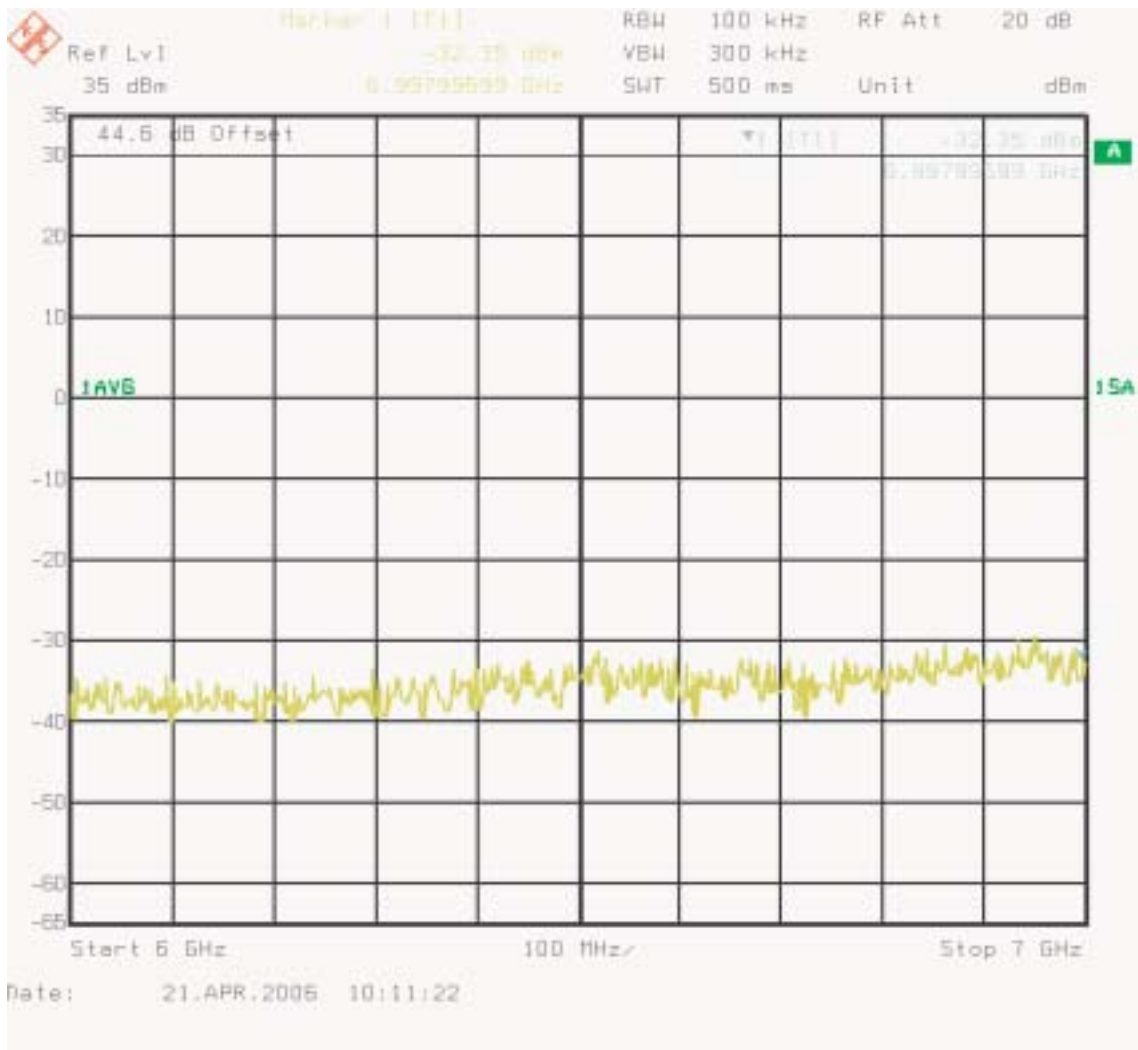

Figure 55 : Three Carriers - A Band Spurious emissions 6000-7000 MHz Ch 226, 267, 308

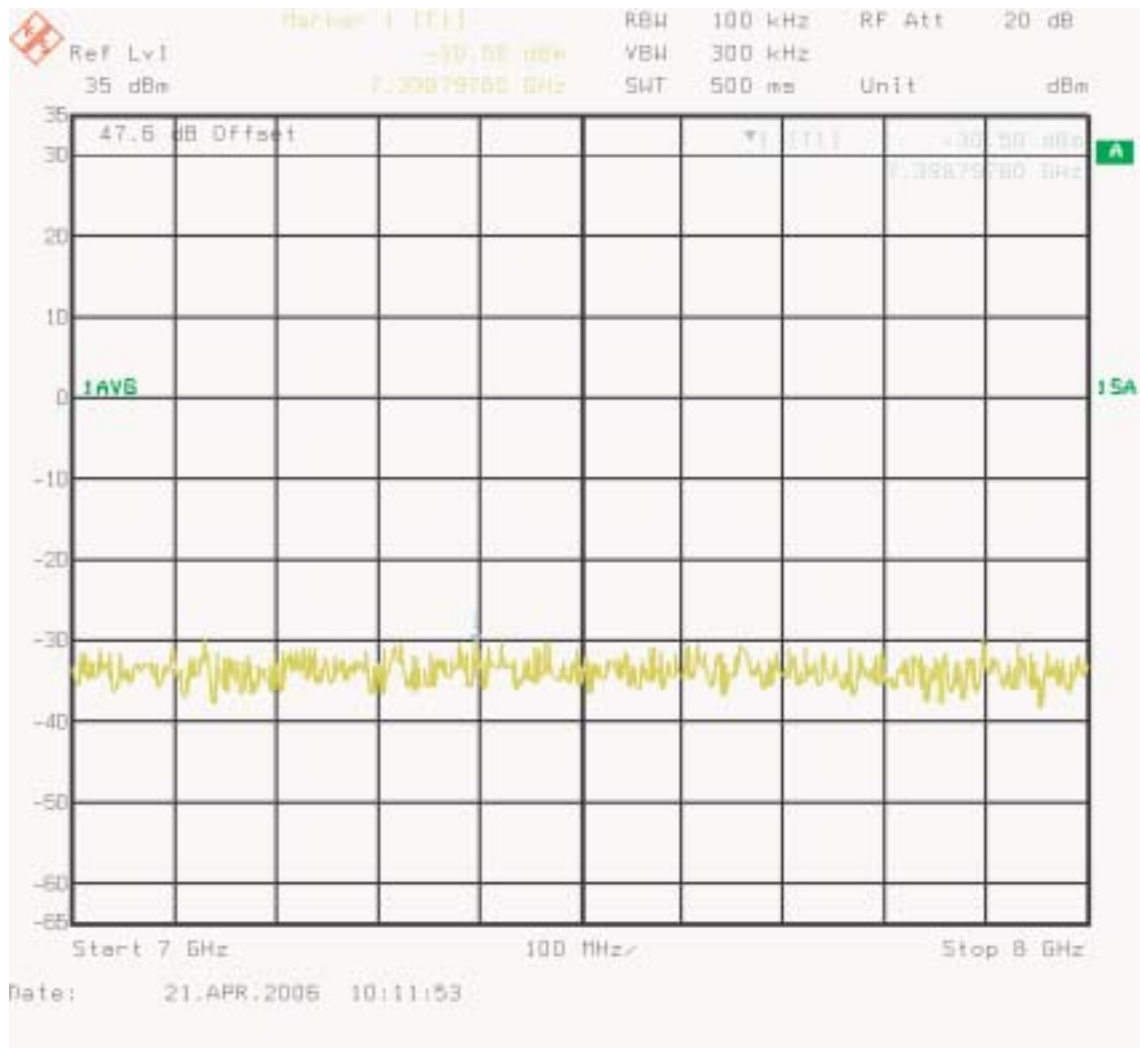

Figure 56 : Three Carriers - A Band Spurious emissions 7000-8000 MHz Ch 226, 267, 308

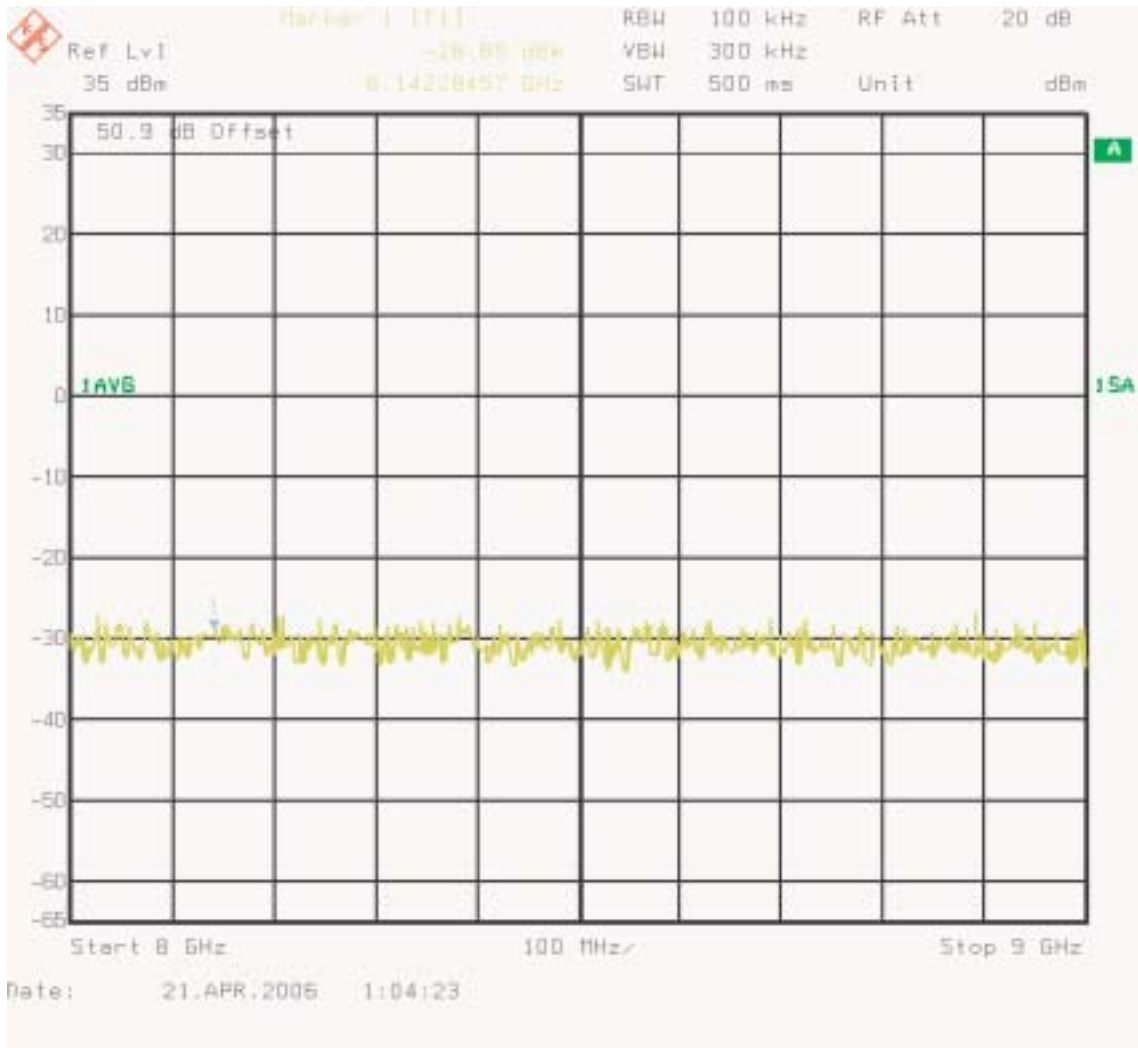

Figure 57 : Three Carriers - A Band Spurious emissions 8000-9000 MHz Ch 226, 267, 308

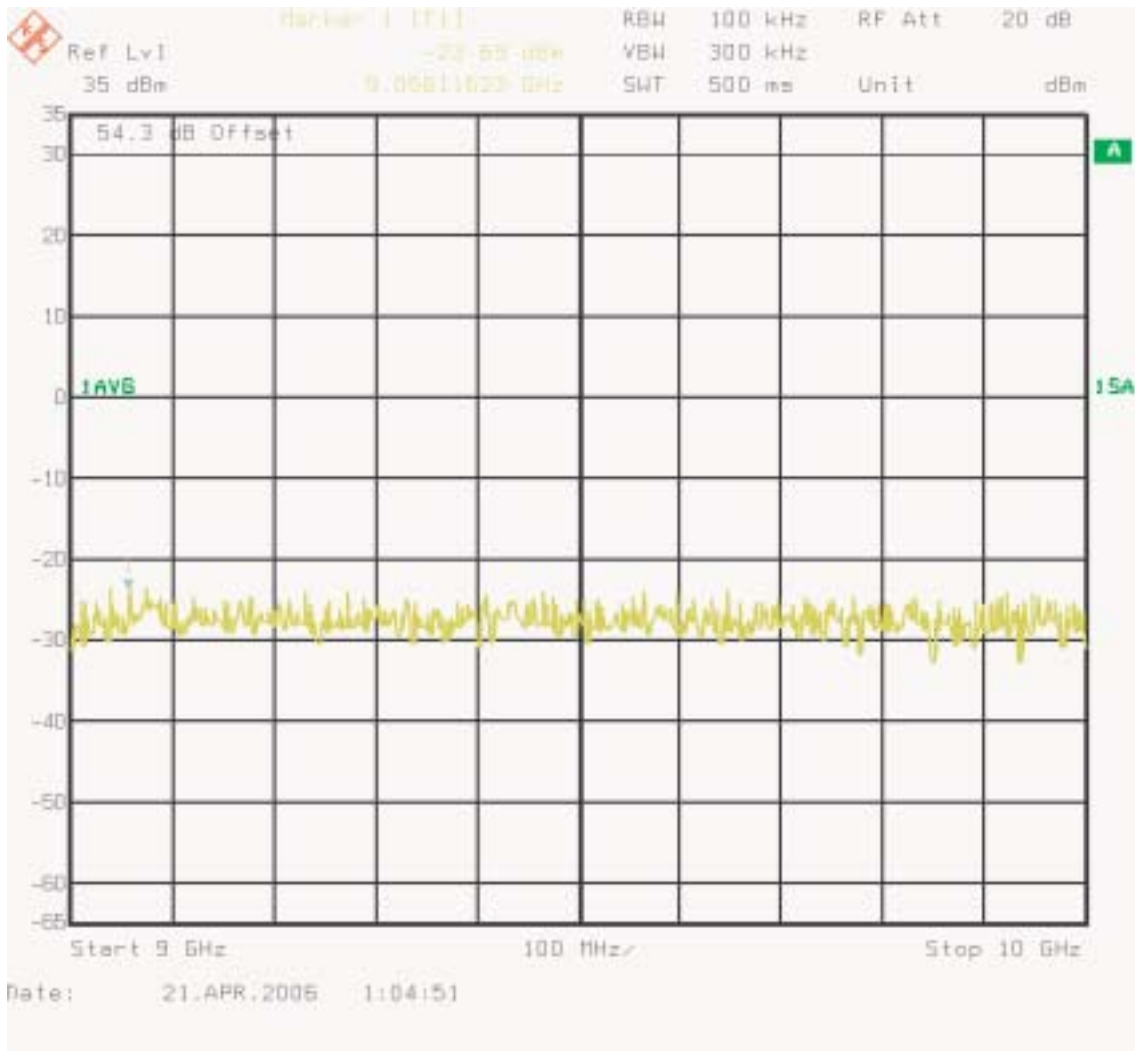

Figure 58 : Three Carriers - A Band Spurious emissions 9000-10000 MHz Ch 226, 267, 308

References

- [1] FCC Part 22 Subpart H, “Public Mobile Services”, http://www.access.gpo.gov/nara/cfr/waisidx_01/47cfr22_01.html
- [2] FCC Part 2 Subpart J, “Frequency allocations and radio treaty matters; general rules and regulations”, http://www.access.gpo.gov/nara/cfr/waisidx_01/47cfr2_01.html
- [3] Industry Canada RSS-129, “800 MHz Dual-Mode CDMA Cellular Telephones”, <http://strategis.ic.gc.ca/SSG/sf01324e.html>
- [4] TIA/EIA-97-D “Recommended Minimum Performance Standards for Base Stations Supporting Dual Mode Spread Spectrum Systems”, June 2001
- [5] Industry Canada “Information on the 99% Bandwidth measurement” Author Brain Kasper. [http://strategis.ic.gc.ca/epic/internet/inceb-bhst.nsf/vwapj/occupied-bandwidth.pdf/\\$FILE/occupied-bandwidth.pdf](http://strategis.ic.gc.ca/epic/internet/inceb-bhst.nsf/vwapj/occupied-bandwidth.pdf/$FILE/occupied-bandwidth.pdf)
- [6] CTP_AB6NT800MFRM2_8_and_9th_carrier. http://livelink-ott.ca.nortel.com/livelink.exe/8153812/FCC_22_8th_and_9th_carrier_Test_Plan.pdf?func=doc.Fetch&nodedid=8153812

END OF DOCUMENT