



Restricted

---

# Test Report for FCC Equipment Authorization

## FCC Test Report

Dataset Name: AB6NTAWSMFRM3

Document Status: Approved

Stream 00, Issue 1.0

Issue Date: 19 September 2007

Author: Igor Acimovic

Security Status: Nortel Confidential

---

The master of this document is stored on an electronic database and is “write protected”; it may be altered only by authorized persons. While copies may be printed, it is not recommended. Viewing of the master document electronically ensures access to the current issue. Any hardcopies must be regarded as uncontrolled copies.

© 2007 Nortel

The information disclosed herein is proprietary to Northern Telecom or others and is not to be used by or disclosed to unauthorized persons without the written consent of Northern Telecom. The recipient of this document shall respect the security status of the information.

---

**Blank Page**

---

## Table of Contents

<b>Publication History .....</b>	<b>11</b>
List of Consultants .....	11
Table 1: Decision Maker.....	11
Table 2: Decision Ratifier.....	11
Table 3: Revision History.....	12
<b>Acronyms and Abbreviations .....</b>	<b>13</b>
<b>1 Introduction.....</b>	<b>15</b>
1.1 Required Tests .....	15
<b>2 Engineering Declaration.....</b>	<b>16</b>
<b>3 Equipment Authorization Application Requirements .....</b>	<b>17</b>
3.1 Standard Test Conditions and Test Equipment.....	17
3.2 EUT Identification List.....	17
3.3 Test Equipment List.....	18
<b>4 Transmitter Tests.....</b>	<b>19</b>
4.1 Certification Requirements .....	19
4.1.1 Application for certification.....	19
4.1.1 FCC Part 2.1033 Application for certification.....	19
4.1.2 Test Method .....	19
4.1.3 Test Setup .....	19
4.1.4 Test Results.....	19
4.2 RF Power Output .....	20
4.2.1 RF Power Output Requirements .....	20
4.2.1 FCC Part 2.1046 .....	20
4.2.2 Test Method .....	20
4.2.3 Test Setup .....	20
4.2.4 DOM .....	20
4.2.5 RF Output Power Test Results .....	22
4.3 Occupied Bandwidth.....	24
4.3.1 Occupied Bandwidth Requirements .....	24
4.3.1 FCC Part 2.1049 .....	24
4.3.2 Test Method .....	24
4.3.3 Test Setup .....	24
4.3.4 Test Result .....	25
4.4 Spurious Emissions at Antenna Terminals .....	33
4.4.1 Spurious Emissions Requirements.....	33
4.4.1 FCC Part 2.1051 .....	33
4.4.1 FCC Part 2.1057 - Frequency Spectrum to be investigated.....	33
4.4.1 FCC Part 27.53 Limit.....	33
4.4.2 Test Method .....	34
4.4.2.1 Noise Floor .....	34
4.4.2.2 Adjacent 1MHz to indicated subband (Upper and Lower).....	34



---

4.4.2.3 All other Spurious Emissions up to 20 GHz.....	36
4.4.3 Test Setup .....	37
4.4.4 Test Results IS95 .....	38
4.4.5 Test Results IS856 .....	40
4.5 Frequency Stability .....	42
4.5.1 Frequency Stability Requirements.....	42
4.5.1 FCC Part 2.1055 .....	42
4.5.1 FCC Part 27.54 Limit.....	42
4.5.2 Test Procedure .....	43
4.5.3 Frequency Results.....	43
<b>References.....</b>	<b>47</b>

---

## List of Figures

Figure 1 : Test Setup for RF Power Output Measurement .....	21
Figure 2 : Test Setup for Occupied Bandwidth Measurement.....	25
Figure 3 : Occupied Bandwidth, Single Carrier, Channel 25 IS-95 .....	27
Figure 4 : Occupied Bandwidth, 2 Carrier, Channels 25, 50 IS-95 .....	28
Figure 5 : Occupied Bandwidth, 3 Carrier, Channels 25, 50, 75, IS-95 .....	29
Figure 6 : Occupied Bandwidth, 1 Carrier, Channels 25, IS-856 (QPSK) .....	30
Figure 7 : Occupied Bandwidth, 3 Carrier , Channels 25, 50, 75 , IS-856 (8PSK).....	31
Figure 8 : Occupied Bandwidth, 3 Carrier, Channels 25, 50 (IS-856 16QAM), & 75 (IS-95) ...	32
Figure 9 : Test Setup for Spurious Emissions Measurement.....	37
Figure 10 : Test configuration for Frequency Stability .....	43
Figure 11 : Conducted Spurious Emissions - 1 Carrier, Ch. 25, IS95 (9kHz to Lower Adjacent 1MHz).....	49
Figure 12 : Conducted Spurious Emissions - 1 Carrier, Ch. 25, IS95 (9kHz to Lower Adjacent 1MHz) Verification.....	50
Figure 13 : Conducted Spurious Emissions - 1 Carrier, Ch. 25, IS95 (Lower Adjacent 1MHz) .	51
Figure 14 : Conducted Spurious Emissions - 1 Carrier, Ch. 875, IS95 (Upper Adjacent 1MHz)	52
Figure 15 : Conducted Spurious Emissions - 1 Carrier, Ch. 875, IS95 (Upper Adjacent 1MHz to 5GHz).....	53
Figure 16 : Conducted Spurious Emissions - 1 Carrier, Ch. 875, IS95 (Upper Adjacent 1MHz to 5GHz) Verification .....	54
Figure 17 : Conducted Spurious Emissions - 1 Carrier, Ch. 875, IS95 (5GHz to 20GHz) .....	55
Figure 18 : Conducted Spurious Emissions - 2 Carrier, Ch. 25, 50, IS95 (9kHz to Lower Adjacent 1MHz).....	56
Figure 19 : Conducted Spurious Emissions - 2 Carrier, Ch. 25, 50, IS95 (9kHz to Lower Adjacent 1MHz) Verification.....	57
Figure 20 : Conducted Spurious Emissions - 2 Carrier, Ch. 25, 50, IS95 (Lower Adjacent 1MHz)	58
Figure 21 : Conducted Spurious Emissions - 2 Carrier, Ch. 850, 875 IS95 (Upper Adjacent 1MHz)	59
Figure 22 : Conducted Spurious Emissions - 2 Carrier, Ch. 850, 875, IS95 (Upper Adjacent 1MHz to 5GHz) .....	60
Figure 23 : Conducted Spurious Emissions - 2 Carrier, Ch. 850, 875, IS95 (Upper Adjacent 1MHz to 5GHz) Verification .....	61

Figure 24 : Conducted Spurious Emissions - 2 Carrier, Ch. 850, 875, IS95 (5GHz to 22GHz) ..	62
Figure 25 : Conducted Spurious Emissions - 3 Carrier, Ch. 25, 50, 75, IS95 (9kHz to Lower Adjacent 1MHz) .....	63
Figure 26 : Conducted Spurious Emissions - 3 Carrier, Ch. 25, 50, 75, IS95 (9kHz to Lower Adjacent 1MHz) Verification .....	64
Figure 27 : Conducted Spurious Emissions - 3 Carrier, Ch. 25, 50, 75, IS95 (Lower Adjacent 1MHz) .....	65
Figure 28 : Conducted Spurious Emissions - 3 Carrier, Ch. 825, 850, 875, IS95 (Upper Adjacent 1MHz) .....	66
Figure 29 : Conducted Spurious Emissions - 3 Carrier, Ch. 825, 850, 875, IS95 (Upper Adjacent 1MHz to 5GHz) .....	67
Figure 30 : Conducted Spurious Emissions - 3 Carrier, Ch. 825, 850, 875, IS95 (Upper Adjacent 1MHz to 5GHz) Verification .....	68
Figure 31 : Conducted Spurious Emissions - 3 Carrier, Ch. 825, 850, 875, IS95 (5GHz to 22GHz)	69
Figure 32 : Conducted Spurious Emissions - 1 Carrier, Ch. 25, QPSK (9kHz to Lower Adjacent 1MHz) .....	70
Figure 33 : Conducted Spurious Emissions - 1 Carrier, Ch. 25, QPSK (9kHz to Lower Adjacent 1MHz) Verification .....	71
Figure 34 : Conducted Spurious Emissions - 1 Carrier, Ch. 25, QPSK (Lower Adjacent 1MHz)...	72
Figure 35 : Conducted Spurious Emissions - 1 Carrier, Ch. 875, QPSK (Upper Adjacent 1MHz).	73
Figure 36 : Conducted Spurious Emissions - 1 Carrier, Ch. 875, QPSK (Upper Adjacent 1MHz to 5GHz) .....	74
Figure 37 : Conducted Spurious Emissions - 1 Carrier, Ch. 875, QPSK (Upper Adjacent 1MHz to 5GHz) Verification .....	75
Figure 38 : Conducted Spurious Emissions - 1 Carrier, Ch. 875, QPSK (5GHz to 22GHz) .....	76
Figure 39 : Conducted Spurious Emissions - 3 Carrier, Ch. 25, 50, 75, 8PSK (9kHz to Lower Adjacent 1MHz) .....	77
Figure 40 : Conducted Spurious Emissions - 3 Carrier, Ch. 25, 50, 75, 8PSK (9kHz to Lower Adjacent 1MHz) Verification .....	78
Figure 41 : Conducted Spurious Emissions - 3 Carrier, Ch. 25, 50, 75, 8PSK (Lower Adjacent 1MHz) .....	79
Figure 42 : Conducted Spurious Emissions - 3 Carrier, Ch. 825, 850, 875, 8PSK (Upper Adjacent 1MHz) .....	80
Figure 43 : Conducted Spurious Emissions - 3 Carrier, Ch. 825, 850, 875, 8PSK (Upper Adjacent 1MHz to 5GHz) .....	81

---

Figure 44 : Conducted Spurious Emissions - 3 Carrier, Ch. 825, 850, 875, 8PSK (Upper Adjacent 1MHz to 5GHz) Verification .....	82
Figure 45 : Conducted Spurious Emissions - 3 Carrier, Ch. 825, 850, 875, 8PSK (5GHz to 22GHz)	83
Figure 46 : Conducted Spurious Emissions - 3 Carrier, Ch. 25, 50, 16QAM Ch. 75, IS95 (9kHz to Lower Adjacent 1MHz) .....	84
Figure 47 : Conducted Spurious Emissions - 3 Carrier, Ch. 25, 50, 16QAM Ch. 75, IS95 (9kHz to Lower Adjacent 1MHz) Verification.....	85
Figure 48 : Conducted Spurious Emissions - 3 Carrier, Ch. 25, 50, 16QAM Ch. 75, IS95 (Lower Adjacent 1MHz) .....	86
Figure 49 : Conducted Spurious Emissions - 3 Carrier, Ch. 825, 850, 16QAM Ch. 875, IS95 (Upper Adjacent 1MHz) .....	87
Figure 50 : Conducted Spurious Emissions - 3 Carrier, Ch. 825, 850, 16QAM Ch. 875, IS95 (Upper Adjacent 1MHz to 5GHz).....	88
Figure 51 : Conducted Spurious Emissions - 3 Carrier, Ch. 825, 850, 16QAM Ch. 875, IS95 (Upper Adjacent 1MHz to 5GHz) Verification .....	89
Figure 52 : Conducted Spurious Emissions - 3 Carrier, Ch. 825, 850, 16QAM Ch. 875, IS95 (5GHz to 22GHz) .....	90





## List of Tables

Table 1:	Consultants	11
Table 2:	Decision maker	11
Table 3:	Ratifier	12
Table 4:	History	12
Table 5:	Required Tests	15
Table 6:	EUT Identification List	17
Table 7:	Test Equipment List	18
Table 8:	Average Current Values @ Pout = dBm	19
Table 9:	RF Output Power AWS MFRM3 1-Carrier IS95	22
Table 10:	RF Output Power AWS MFRM3 2-Carrier IS95	22
Table 11:	RF Output Power of AWS MFRM3 3-Carrier IS95	22
Table 12:	RF Output Power AWS MFRM3 1-Carrier IS856 (QPSK)	22
Table 13:	RF Output Power of AWS MFRM3 3-Carrier IS856 (8-PSK)	23
Table 14:	RF Output Power of 1900 MHz MFRM3 3-Carrier IS856 (16-QAM)	23
Table 15:	RF Output Power AWS MFRM3 Combination 3-Carrier: IS856 16-QAM and IS95	23
Table 16:	Measured Occupied Bandwidth AWS MFRM3 1-Carrier IS95	25
Table 17:	Measured Occupied Bandwidth AWS MFRM3 2-Carrier IS95	25
Table 18:	Measured Occupied Bandwidth of AWS MFRM3 3-Carrier IS95	26
Table 19:	Measured Occupied Bandwidth AWS MFRM3 1-Carrier IS856 QPSK	26
Table 20:	Measured Occupied Bandwidth AWS MFRM3 3-Carrier IS856 8PSK	26
Table 21:	Measured Occupied Bandwidth AWS MFRM3 3-Carrier IS856 16QAM IS95	26
Table 22:	Spectrum Analyzer Noise Floor Level	34
Table 23:	Adjacent 1MHZ Spectrum Analyze Settings	34
Table 24:	All other Emission Spectrum Analyzer Settings	36
Table 25:	Spurious Emissions at the AWS MFRM3 Ant. Port one Carrier IS95	38
Table 26:	Spurious Emissions at the AWS MFRM3 Ant. Port two Carrier IS95	38
Table 27:	Spurious Emissions at the AWS MFRM3 Ant. Port Three Carrier IS-95	38
Table 28:	Spurious Emissions at the AWS MFRM3 Ant. Port One Carrier Band IS856 (QPSK)	40
Table 29:	Spurious Emissions at the AWS MFRM3 Ant. Port Three Carrier IS856 (8PSK)	40
Table 30:	Spurious Emissions at the AWS MFRM3 Ant. Port Three Carrier Combined IS-95 & IS-856 (16QAM)	41
Table 31:	Test results for Frequency Stability versus Power supply Voltage	43
Table 32:	Test results for Frequency Stability versus Temperature at -48V operation	44
Table 33:	Test results for Frequency Stability versus Temperature at 24V operation	44



## Publication History

The latest controlled release of this document is located in Livelink at the following location:

<http://livelink-ott.ca.nortel.com/livelink/livelink.exe?func=ll&objId=25363032&objAction=browse&sort=name&viewType=1>

All other soft and hard copies are uncontrolled. It is the responsibility of the reader to ensure that the latest release of this document is being used.

## List of Consultants

The following people have reviewed this document prior to its release and have recommended its approval:

**Table 1: Consultants**

Printed Name	Function	Department
Rahim Nathoo	System Prime	2M40
Peter Goussev	System Design	2M40
James Loo	Systems Design	2M40
Igor Acimovic	Systems Design	2M40
Hossein Yektaii	Systems Design	2M40
Brian Racey	Systems Design	2M40
Yan Papernov	Systems Design	2M40
Marin Sampaleanu	CDMA/TDMA Regulatory Prime	2U20

## Decision Maker

**Table 2: Decision maker**

Ratifier's Name	Signature	Date
Marin Sampaleanu		

## Decision Ratifier

The release of this document has been reviewed and approved for distribution and use by the fol-

lowing:

**Table 3: Ratifier**

Ratifier's Name	Signature	Date
Mark Willetts		

## Revision History

**Table 4: History**

Stream/Issue	Revision Date	Reason for Change	Author (Dept.)
00/00	12 July 2007	First draft	Igor Acimovic (2M40)
00/1.0	19 Sep. 2007	Approval granted	Igor Acimovic (2M40)

---

## Acronyms and Abbreviations

ASIC	Application Specific Integrated Circuit
BBW	Breathing, Blossoming and Wilting
BPF	Bandpass Filter
BTS	Base Station Transceiver Subsystem
BW	Bandwidth
CDMA	Code Division Multiple Access
CR	Cost Reduced
dBFS	dB relative to Full Scale
DDS	Direct Digital Synthesizer
DPM	Duplexer Preselector Module
EEPROM	Electrically Erasable and Programmable ROM
EC	Engineering Change
ERLCE	Excess Reverse Link Capacity Estimate
HSSPC	High-Speed Serial Protocol Controller
HW	Hardware
IF	Intermediate Frequency
IIC	Inter-Integrated Circuit Bus
IS	Interim Standard
LO	Local Oscillator
LPF	Lowpass Filter
MFRM-3	Multi-Carrier Flexible Radio Module
NF	Noise Figure
OCNS	Orthogonal Channel Noise Source
OH	OverHead
PA	Power Amplifier
PC	Personal Computer
PPR	Peak Power Reduction
PSA	Product Specification Agreement
RBW	Resolution BandWidth
RF	Radio Frequency

---

Rx	Receive
SA	Spectrum Analyzer
SFRM	Single Carrier Flexible Radio Module
SW	Software
TBD	To Be Determined
TDM	Tri-sector Duplexer Module
TM	Triplexer Module
TPTL	Transmit Power Tracking Loop
TRM	Transmitter Receiver Module
Tx	Transmit

# 1 Introduction

This test report supports FCC filing for MFRM-3 AWS. This filing includes single, two, and three carrier modes for the 2100MHz AWS band. The following tests were performed: RF Power Output, Occupied Bandwidth, Spurious Emissions at Antenna Terminals, and Transmitter Test (CDMA Mode Transmitter). Frequency over voltage and temperature test results are included. Emissions testing was conducted at -48VDC at room temperature. Both IS95 and IS856 modulation schemes are included in this report.

This test report will be submitted in accordance with the FCC Rules and Regulations, Part 2, Subpart J, Sections 2.1046 through 2.1057 for equipment authorization of Nortel Networks' CDMA AWS Multi carrier Flexible Radio Module 3 (MFRM-3).

The AWS MFRM3 is intended for use in the Domestic Public Cellular Radio Telecommunications Service and is designed in accordance with the following standards:

- *CFR 47, Part 22, Subpart H, Cellular Radiotelephone Service [1]*
- *CFR 47, Part 2, Subpart J, Equipment Authorization Procedures - Equipment Authorization[2]*
- *TIA/EIA-97-E, Recommended Minimum Performance Standards for Base Stations Supporting Dual Mode Spread Spectrum Systems [4]*
- *Recommended Minimum Performance Standards for cdma2000 High Rate Packet Data Access Network C.S0032-0, Version 2.0 [7]*
- 

The MFRM3 is capable of transmitting simultaneously on three sectors. Data collected on all sectors are combined together.

## 1.1 Required Tests

Table summarizes the required tests for the CDMA AWS MFRM-3.

**Table 5: Required Tests**

FCC Measurement Specification	FCC Limit Specification	Description	Test to be Performed?
2.1033		PA current specification	Yes
2.1046		RF Power Output	Yes
2.1049		Occupied Bandwidth	Yes
2.1051, 2.1057	27.53	Spurious Emissions at Antenna Terminals	Yes

**Table 5: Required Tests**

FCC Measurement Specification	FCC Limit Specification	Description	Test to be Performed?
2.1053, 2.1057		Field Strength of Spurious Emissions	Yes
2.1055	27.54	Frequency Stability	Yes

## 2 Engineering Declaration

The CDMA 1900MHz Multi carrier Flexible Radio Module3 has been tested in accordance with the requirements contained in the Federal Communications Commission Rules and Regulations Part 2 and 27.

To the best of my knowledge, these tests were performed in accordance with good engineering practices using measurement procedures consistent with industry or commission standards or previous Commission correspondence or guidance and demonstrate that this equipment complies with the appropriate standards. All tests were conducted on a representative sample of the equipment for which equipment authorization is sought.

INSERT SIGNATURES HERE



### 3 Equipment Authorization Application Requirements

#### 3.1 Standard Test Conditions and Test Equipment

The MFRM3 was tested under the following standard test conditions unless otherwise noted:

- Ambient Temperature: 20 to 35 degrees C
- Ambient Humidity: 20 to 40%
- DC Supply Voltage: -48 Vdc (nominal)
- Input modulation: IS-95 and IS-856 (QPSK, 8PSK, 16QAM)

#### 3.2 EUT Identification List

Table shows the identification of the components required for testing.

**Table 6: EUT Identification List**

Equipment Description	Model / Part Number	Release Number	Serial Number
AWS Multi carrier Flexible Radio Module	NNTGZ70CAE5	B2	NNTMEEW0101Q
AWS TDPM	NTGZ83AAE6	N1	FING010EY001
AWS FAM3	NTGZ85AA	N2	NNTM84G027W3
DOM rel A Modem	NTBW89DA	01	NNTM536G3VRH
DOM rel A Modem	NTBW89DA	R7	NNTM536G3Y3X
DOM rel A Modem	NTBW89DA	01	NNTM536G4030
XCEM-192 Modem	NTRZ80BA	02	NNTM74X0VC6M
TDPM Power/Data Cable	NTGZ8000		N0043622
TDM / TDPM to Tx port Cable	NTGZ8042E6		N0081665

### 3.3 Test Equipment List

Table shows the identification of the test equipment required.

**Table 7: Test Equipment List**

Description	Manufacturer	Model	Serial Number	Cal. Due Date
9kHz to 26.5 GHz Spectrum Analyzer	Rhode & Schwarz	FSEM - 30	DE25141	12 July 2008
Vector Signal Analyser	Agilent	E4406A	US39480709	25 May 2008
RF Power Meter	Agilent	HP438A	3513U04169	19 Sep. 2007
RF Power Sensor Head	Agilent	8481A	3318A99057	05 Jan. 2008
30dB Attenuator (>100W)				
RF Cables				

## 4 Transmitter Tests

### 4.1 Certification Requirements

#### 4.1.1 Application for certification

##### FCC Part 2.1033 Application for certification.

*(c) Applications for equipment other than that operating under parts 15 and 18 of the rules shall be accompanied by a technical report containing the following information:*

*(8) The dc voltages applied to and dc currents into the several elements of the final radio frequency amplifying device for normal operation over the power range.*

#### 4.1.2 Test Method

This information required for this section is available from:

Title: MFRM-3 AWS (2.1GHz) Power Amplifier (PA) Assembly Verification Notice

Dataset Name: VPGZ74EA

Document Status: Draft

Stream: 00 Issue: 01

<http://livelink2.ca.nortel.com/livelink/livelink.exe?func=ll&objId=24807149&objAction=browse&viewType=>

#### 4.1.3 Test Setup

See above document.

#### 4.1.4 Test Results

The MFRM-3 AWS has three PA pallets. Each pallet has 2 transistors (connected in parallel) comprising the final gain block. The average current below is identical for all PA pallets.

**Table 8: Average Current Values @ Pout =48.67dBm**

Average Current Values @ Pout =48.67dBm		
	25 °C	
	Q1	Q2
Mean	5.2A	1.7A

---

## **4.2 RF Power Output**

### **4.2.1 RF Power Output Requirements**

#### **FCC Part 2.1046**

*(a) For transmitters other than single sideband, independent sideband and controlled carrier radiotelephone, power output shall be measured at the RF output terminals when the transmitter is adjusted in accordance with the tune-up procedure to give the values of current and voltage on the circuit elements specified in Sec. 2.1033(c)(8). The electrical characteristics of the radio frequency load attached to the output terminals when this test is made shall be stated.*

### **4.2.2 Test Method**

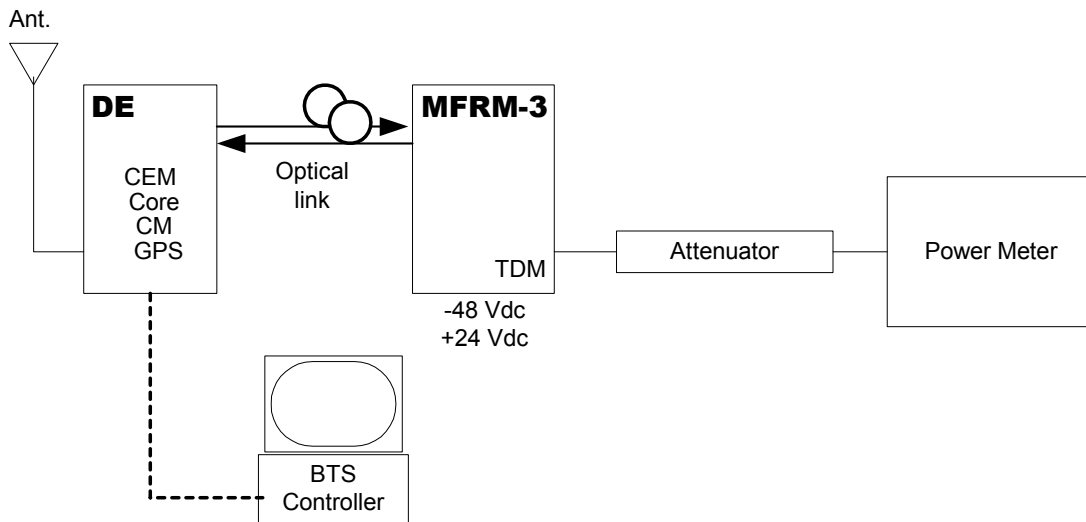
Setup the DE via the BTS controller to enable the MFRM3 to transmit at the rated power for each of the carrier configurations in each of the Baseband modulation formats IS-95 and IS-856. Measurements were made on channels at the bottom and top of the operator bands with the MFRM-3 operating at -48Vdc. The RF output power was measured using the power meter. The measured power was maintained within +/- 0.25 dB.

### **4.2.3 Test Setup**

The set-up required for the MFRM3 RF output power test is illustrated in Figure 1. RF output power measurements were referenced to the antenna port of the TDM / TDPM. The measured power represents composite RF power per sector.

### **4.2.4 DOM**

The conducted spurious emissions of the MFRM-3, with IS-856 (1xEVDO) waveforms were tested at maximum power. All supported modulations of EVDO (QPSK, 8-PSK, 16QAM) results are grouped together.



**Figure 1 : Test Setup for RF Power Output Measurement**

#### 4.2.5 RF Output Power Test Results (Composite sector power)

**Table 9: RF Output Power AWS MFRM3 1-Carrier IS95**

Channel Number	Frequency (MHz)	Measured RF Output Power (dBm)	Typical Maximum Rated Power (dBm)
25	2111.25	48.79	48.8
875	2153.75	48.85	48.8

**Table 10: RF Output Power AWS MFRM3 2-Carrier IS95**

Channel Number	Frequency (MHz)	Measured RF Output Power (dBm)	Typical Maximum Rated Power (dBm)
25, 50	2111.25, 2112.50	48.81	48.8
850, 875	2152.50, 2153.75	48.87	48.8

**Table 11: RF Output Power of AWS MFRM3 3-Carrier IS95**

Channel Number	Frequency (MHz) (centre channel)	Measured RF Output Power (dBm)	Typical Maximum Rated Power (dBm)
25, 50, 75	2112.50	48.83	48.8
825, 850, 875	2152.50	48.86	48.8

**Table 12: RF Output Power AWS MFRM3 1-Carrier IS856 (QPSK)**

Channel Number	Frequency (MHz)	Measured RF Output Power (dBm)	Typical Maximum Rated Power (dBm)
25	2111.25	48.86	48.8
875	2153.75	48.77	48.8

**Table 13: RF Output Power of AWS MFRM3 3-Carrier IS856 (8-PSK)**

Channel Number	Frequency (MHz) (centre channel)	Measured RF Output Power (dBm)	Typical Maximum Rated Power (dBm)
25, 50, 75	2112.50	48.79	48.8
825, 850, 875	2152.50	48.86	48.8

**Table 14: RF Output Power of AWS MFRM3 3-Carrier IS856 (16-QAM)**

Channel Number	Frequency (MHz) (centre channel)	Measured RF Output Power (dBm)	Typical Maximum Rated Power (dBm)
25, 50, 75	2112.50	48.82	48.8
825, 850, 875	2152.50	48.79	48.8

**Table 15: RF Output Power AWS MFRM3 Combination 3-Carrier: IS856 16-QAM and IS95**

Channel Number	Frequency (MHz) (centre channel)	Measured RF Output Power (dBm)	Typical Maximum Rated Power (dBm)
25, 50, 75*	2112.50	48.83	48.8
825, 850, 875*	2152.50	48.75	48.8

Note: First 2 channels in the 3X mode is configured with 16-QAM modulation. Third channel (\*) indicates carrier is configured with IS-95.

---

## 4.3 Occupied Bandwidth

### 4.3.1 Occupied Bandwidth Requirements

#### FCC Part 2.1049

*The OBW, that is the frequency bandwidth such that, below its lower and above its upper frequency limits, the mean powers radiated are each equal to 0.5 percent of the total mean power radiated by a given emission shall be measured under the following conditions as applicable:*

*(g) Transmitter in which the modulating baseband comprises not more than three independent channels - when modulated by the full complement of signals for which the transmitter is rated. The level of modulation for each channel should be set to that prescribed in rule parts applicable to the services for which the transmitter is intended. If specific modulation levels are not set forth in the rules, the tests should provide the manufacturer's maximum rated condition.*

*(h) Transmitters employing digital modulation techniques - when modulated by an input signal such that its amplitude and symbol rate represent the maximum rated conditions under which the equipment will be operated. The signal shall be applied through any filter networks, pseudo-random generators or other devices required in normal service. Additionally, the occupied bandwidth shall be shown for operation with any devices used for modifying the spectrum when such devices are optional at discretion of the user.*

### 4.3.2 Test Method

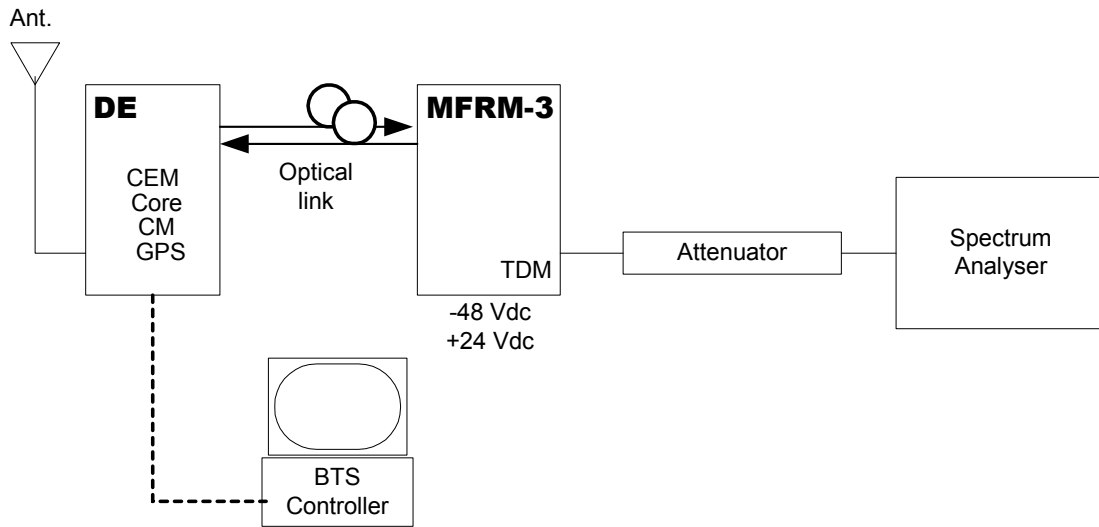
Setup the DE via the BTS controller to enable the MFRM3 to transmit at maximum rated power for each of the carrier configurations and in each of the Baseband modulation formats IS-95 and IS-856 (16 QAM). Measurements were made on channels at the bottom and top of each of the sub bands.

The Occupied Bandwidth was measured using the 99% channel power feature of the spectrum analyzer.

### 4.3.3 Test Setup

The set-up required for the MFRM3 Occupied bandwidth test is illustrated in Figure 2.





**Figure 2 : Test Setup for Occupied Bandwidth Measurement**

#### 4.3.4 Test Result

**Table 16: Measured Occupied Bandwidth AWS MFRM3 1-Carrier IS95**

Channel Number	Frequency (MHz)	Measured Occupied Bandwidth (MHz) (1-Carrier)
25	2111.25	1.267535
875	2153.75	1.267535

**Table 17: Measured Occupied Bandwidth AWS MFRM3 2-Carrier IS95**

Channel Number	Frequency (MHz)	Measured Occupied Bandwidth (MHz)
25, 50	2111.25, 2112.50	2.494989
850, 875	2152.50, 2153.75	2.494989

**Table 18: Measured Occupied Bandwidth of AWS MFRM3 3-Carrier IS95**

Channel Number	Frequency (MHz) (centre channel)	Measured Occupied Bandwidth (MHz)
25, 50, 75	2112.50	3.712425
825, 850, 875	2152.50	3.712425

**Table 19: Measured Occupied Bandwidth AWS MFRM3 1-Carrier IS856 QPSK**

Channel Number	Frequency (MHz)	Measured Occupied Bandwidth (MHz)
25	2111.25	1.267535
875	2153.75	1.267535

**Table 20: Measured Occupied Bandwidth AWS MFRM3 3-Carrier IS856 8PSK**

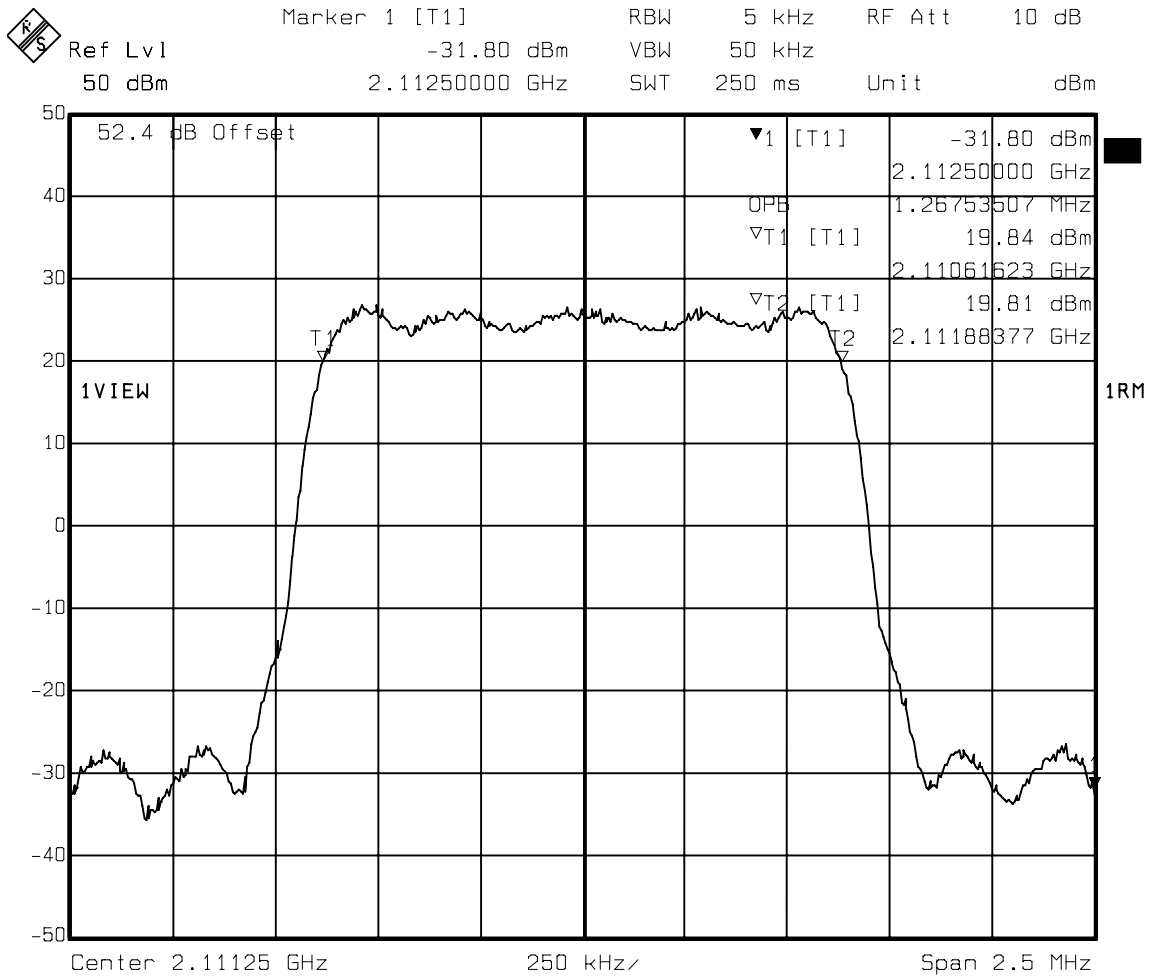
Channel Number	Frequency (MHz) (centre channel)	Measured Occupied Bandwidth (MHz)
25, 50, 75	2112.50	3.712425
825, 850, 875	2152.50	3.712425

**Table 21: Measured Occupied Bandwidth AWS MFRM3 3-Carrier IS856 16QAM IS95**

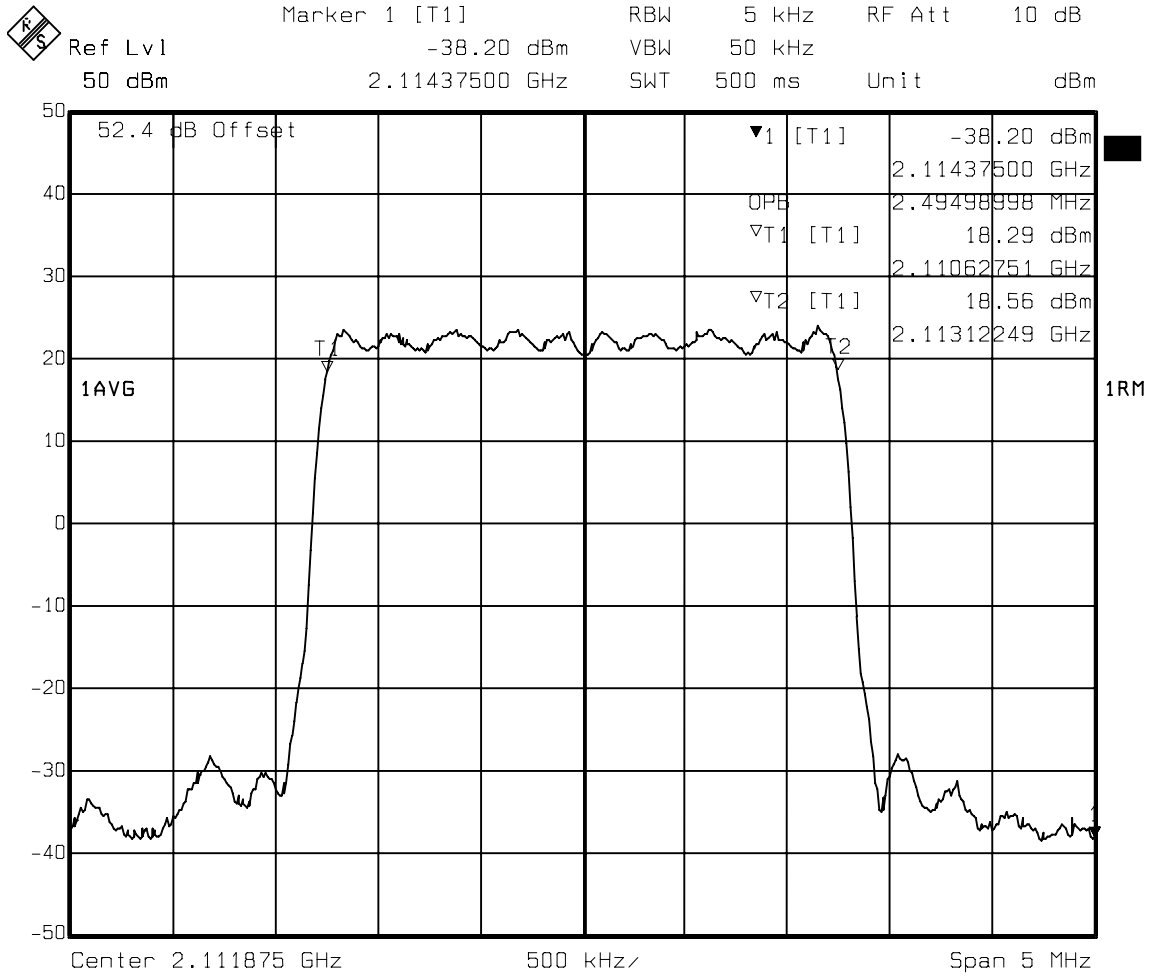
Channel Number	Frequency (MHz) (centre channel)	Measured Occupied Bandwidth (MHz)
25, 50, 75*	2112.50	3.712425
1125, 1150, 1175*	2152.50	3.712425

Note: First 2 channels in the 3X mode is configured with 16-QAM modulation. Third channel (\*) indicates carrier is configured with IS-95.

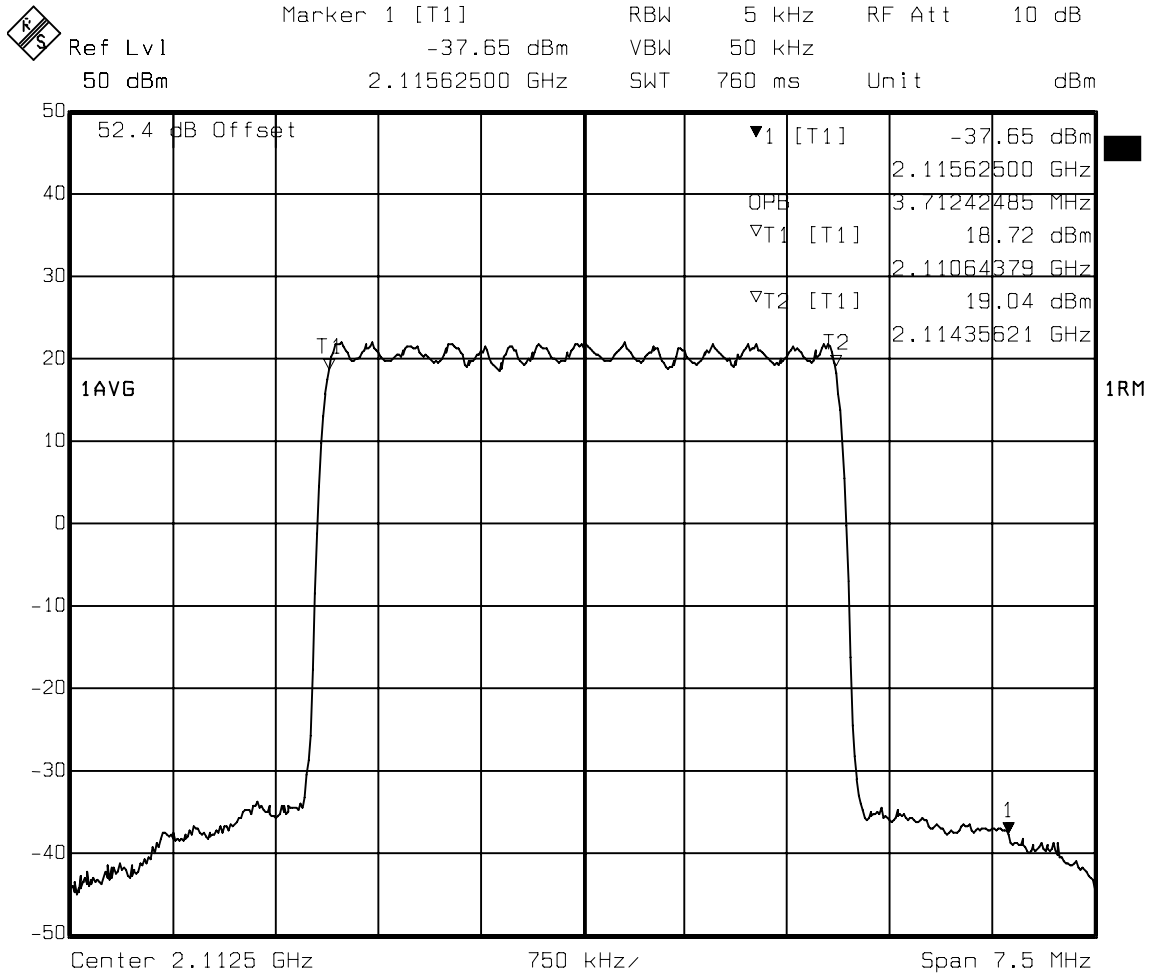
**Figure 3 : Occupied Bandwidth, Single Carrier, Channel 25 IS-95**



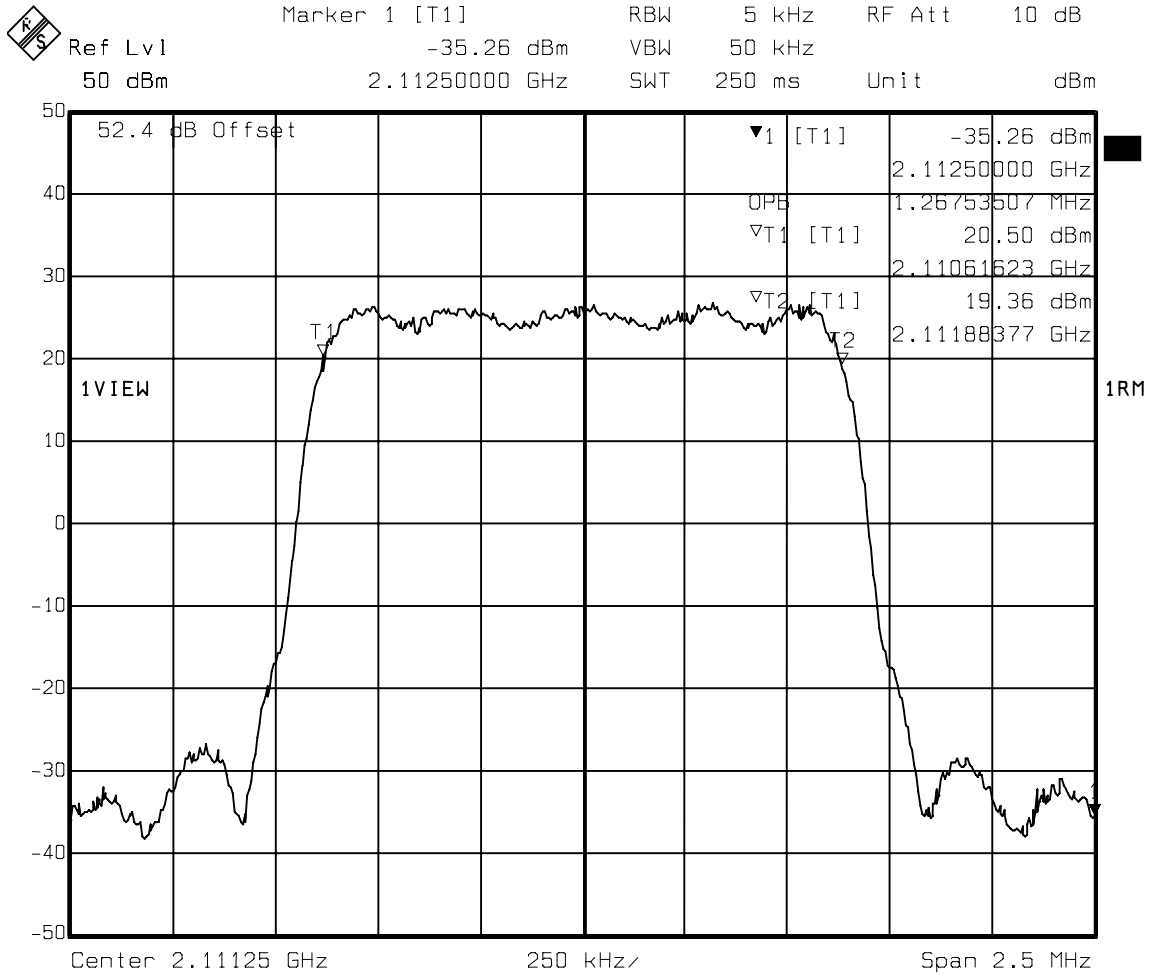
**Figure 4 : Occupied Bandwidth, 2 Carrier, Channels 25, 50 IS-95**



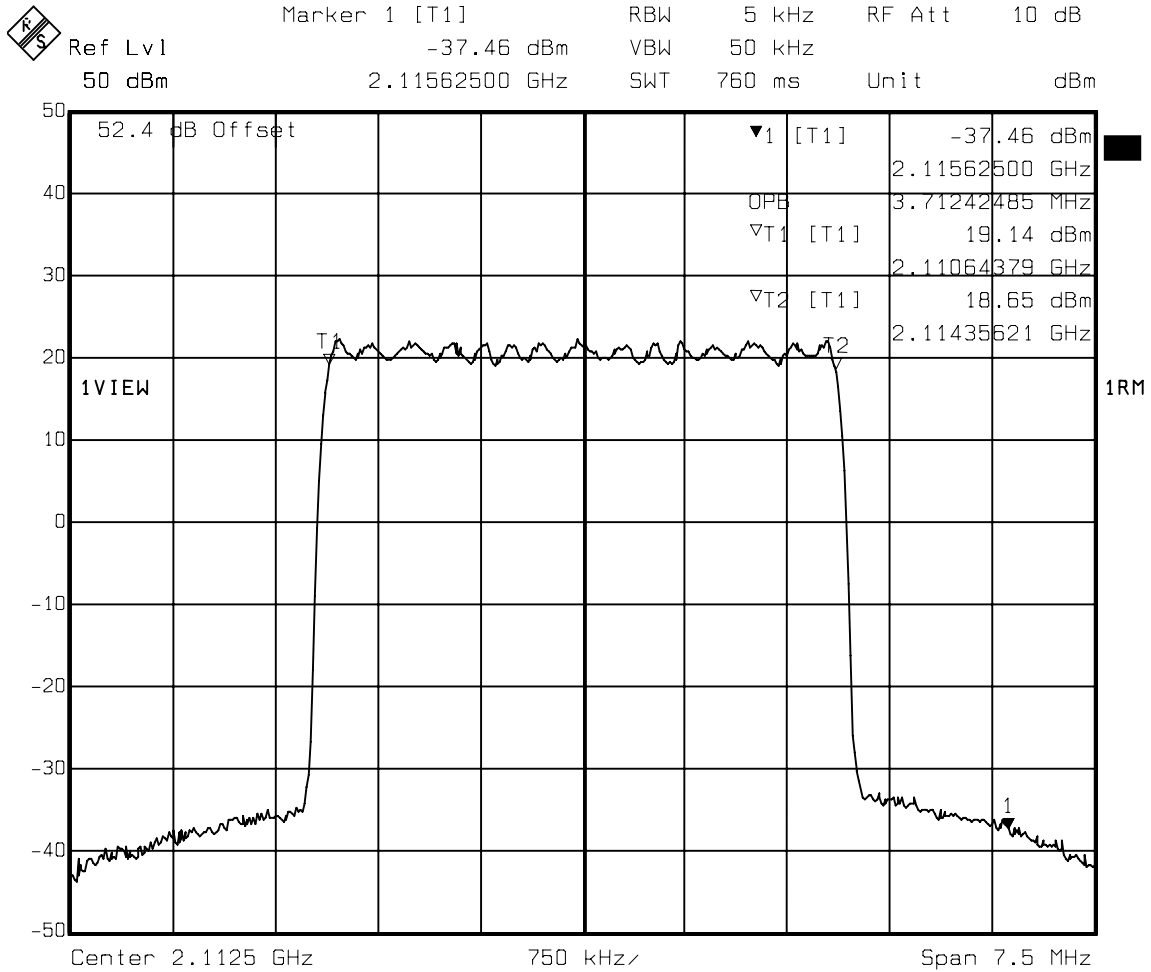
**Figure 5 : Occupied Bandwidth, 3 Carrier, Channels 25, 50, 75, IS-95**



**Figure 6 : Occupied Bandwidth, 1 Carrier, Channels 25, IS-856 (QPSK)**

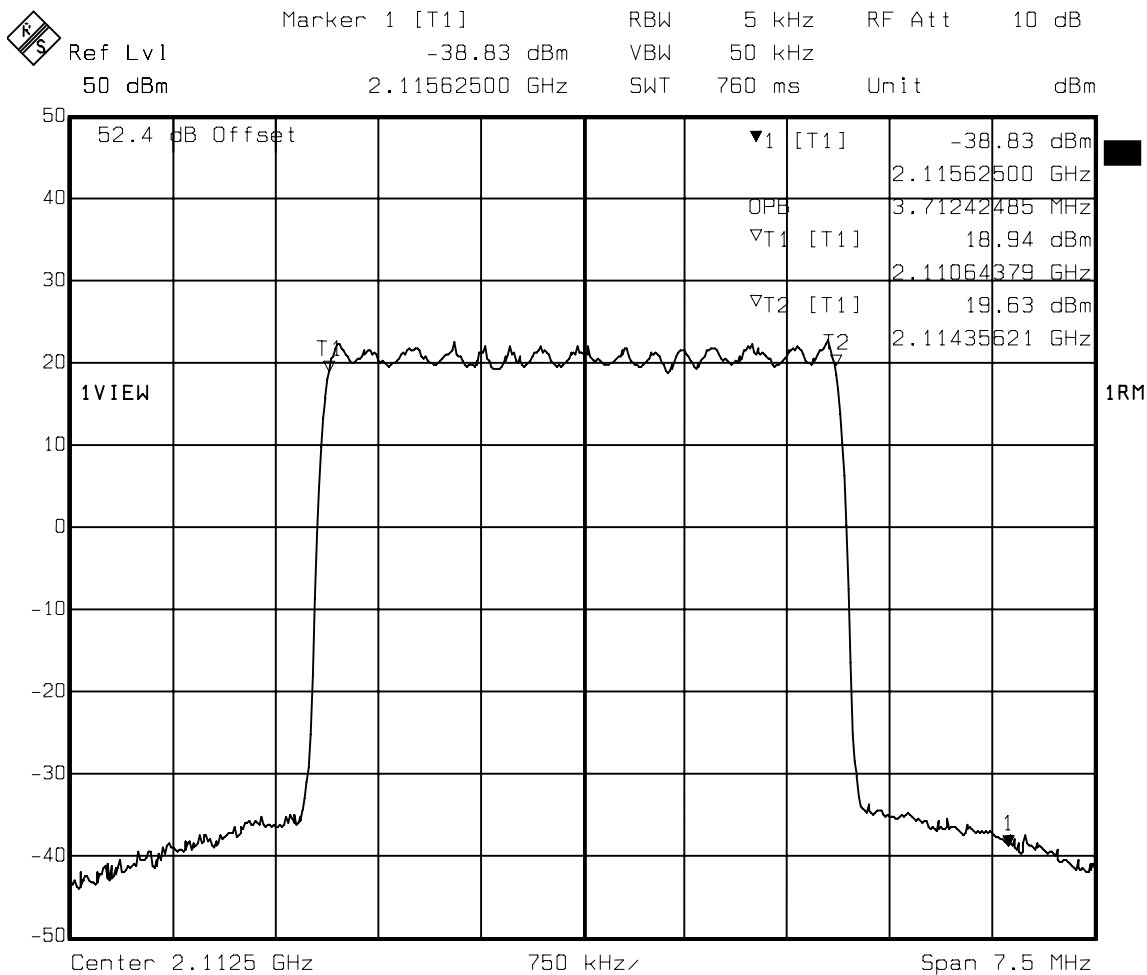


**Figure 7 : Occupied Bandwidth, 3 Carrier , Channels 25, 50, 75 , IS-856 (8PSK)**



Title: Occupied Bandwidth  
 Comment A: Temp C 25  
 Date: 27.JUL.2007 09:07:05

**Figure 8 : Occupied Bandwidth, 3 Carrier, Channels 25, 50 (IS-856 16QAM), & 75 (IS-95)**



Title: Occupied Bandwidth  
 Comment A: Temp C 25  
 Date: 27.JUL.2007 11:16:21



## 4.4 Spurious Emissions at Antenna Terminals

### 4.4.1 Spurious Emissions Requirements

#### FCC Part 2.1051

*The radio frequency voltage or powers generated within the equipment and appearing on a spurious frequency shall be checked at the equipment output terminals when properly loaded with a suitable artificial antenna. Curves or equivalent data shall show the magnitude of each harmonic and other spurious emission that can be detected when the equipment is operated under the conditions specified in Sec. 2.1049 as appropriate. The magnitude of spurious emissions which are attenuated more than 20 dB below the permissible value need not be specified.*

#### FCC Part 2.1057 - Frequency Spectrum to be investigated

*(a) In all of the measurements set forth in Sec. 2.1051, the spectrum shall be investigated from the lowest radio frequency signal generated in the equipment, without going below 9 kHz, up to at least the tenth harmonic of the highest fundamental frequency or to 40 GHz, whichever is lower.*

*(b) Particular attention should be paid to harmonics and subharmonics of the carrier frequency as well as to those frequencies removed from the carrier by multiples of the oscillator frequency. Radiation at the frequencies of multiplier stages should also be checked.*

*(c) The amplitude of spurious emissions which are attenuated more than 20 dB below the permissible value need not be reported.*

#### FCC Part 27.53 Limit

*(g) On any frequency outside a licensee's frequency block, the power of any emission shall be attenuated below the transmitter power ( $P$ ) by at least  $43 + 10 \log (P)$  dB.*

*(1) Compliance with these provisions is based on the use of measurement instrumentation employing a resolution bandwidth of 1 MHz or greater. However, in the 1 MHz bands immediately outside and adjacent to the frequency block a resolution bandwidth of at least one percent of the emission bandwidth of the fundamental emission of the transmitter may be employed. The emission bandwidth is defined as the width of the signal between two points, one below the carrier center frequency and one above the carrier center frequency, outside of which all emissions are attenuated at least 26 dB below the transmitter power.*

*(2) When measuring the emission limits, the nominal carrier frequency shall be adjusted as close to the licensee's frequency block edges, both upper and lower, as the design permits.*

*(3) The measurements of emission power can be expressed in peak or average values, provided they are expressed in the same parameters as the transmitter power.*

#### 4.4.2 Test Method

Configure the BTS via the BTS controller to enable the MFRM3 to transmit at maximum rated power for each of the carrier configurations and each of the Baseband modulation formats IS-95, and IS-856 (16 QAM). Measurements were made on channels at the bottom and top of the operator bands. The following spectrum analyzer settings were used for the measurement of the antenna port (DPM) spurious emissions:

##### 4.4.2.1 Noise Floor

Table 22 lists the noise floor of the measurement system with no signal present.

**Table 22: Spectrum Analyzer Noise Floor Level**

Frequency (Band)	Noise Floor Level (dBm)
9 kHz to lower adjacent 1MHz	-29.78
Lower adjacent 1 MHz	-46.20
Upper adjacent 1 MHz	-44.43
upper adjacent 1MHz to 5 GHz	-27.00
5 GHz to 22 GHz	-45.35

##### 4.4.2.2 Adjacent 1MHz to indicated subband (Upper and Lower)

**Table 23: Adjacent 1MHz Spectrum Analyze Settings**

Setting	1 Carrier (BW 1.25MHz)	2 Carrier (BW 2.5MHz)	3 Carrier (BW 3.75MHz)
Resolution Bandwidth <sup>a</sup> :	30 kHz	30 kHz	50 kHz
Video Bandwidth (3x RBW) <sup>b</sup>	(10x RBW)	(10x RBW)	(10x RBW)
Video Average	10 Averages	10 Averages	10 Averages
Span	Set accordingly	Set accordingly	Set accordingly
Detector	RMS	RMS	RMS
Attenuation <sup>c</sup>	10 dB	10 dB	10 dB
Ref. Level	0 dBm	0 dBm	0 dBm
Ref. Offset	52.4 dB	52.4 dB	52.4 dB

- 
- a. If the spectrum analyzer cannot be set to the specified RBW the next highest RBW should be used and all measurements corrected to the specified RBW
  - b. If the spectrum analyzer cannot be set to the specified Video Bandwidth the next highest Video Bandwidth should be used.
  - c. The lowest value of attenuator should be used to improve measurement accuracy, without overdriving the Spectrum Analyzer.

All spectrum analyzer settings were coupled as per the manufacturers recommendations to improve measurement time, without compromising data.

**4.4.2.3 All other Spurious Emissions up to 20 GHz**

**Table 24: All other Emission Spectrum Analyzer Settings**

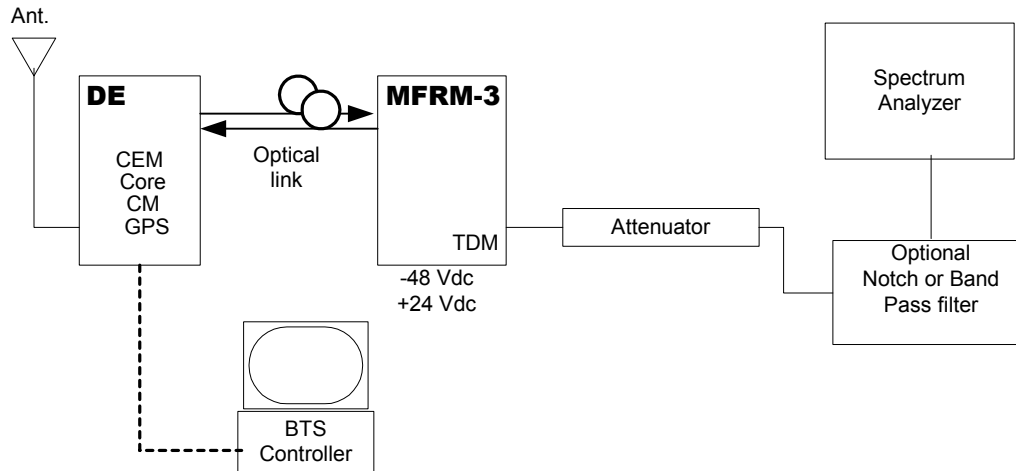
Setting	1 Carrier	2 Carrier	3 Carrier
Resolution Bandwidth	1 MHz	1 MHz	1 MHz
Video Bandwidth (3x RBW)	10 MHz	10 MHz	10 MHz
Video Average	10 Averages	10 Averages	10 Averages
Span	Set accordingly	Set accordingly	Set accordingly
Detector	RMS	RMS	RMS
Attenuation <sup>a</sup>	10 dB	10 dB	10 dB
Ref. Level	Set accordingly	Set accordingly	Set accordingly
Ref. Level Offset (9kHz to Lower Adjacent 1MHz)	52.4 dB	52.4 dB	52.4 dB
Ref. Level Offset (Upper Adjacent 1MHz to 5GHz)	54.2 dB	54.2 dB	54.2 dB
Ref. Level Offset (5GHz to 20GHz)	40.7 dB	40.7 dB	40.7 dB

a. The lowest value of attenuator should be used to improve measurement accuracy, without overdriving the Spectrum Analyzer.

The emissions will be investigated up to 22 GHz (the 10<sup>th</sup> harmonic of the fundamental emission) for all carrier configurations (1, 2, 3) as per FCC Part 27.

### 4.4.3 Test Setup

The set-up required for the MFRM3 Antenna Port Spurious Emission test is illustrated in Figure 9.



**Figure 9 : Test Setup for Spurious Emissions Measurement**

#### 4.4.4 Test Results IS95

**Table 25: Spurious Emissions at the AWS MFRM3 Ant. Port one Carrier IS95**

Frequency	Spurious Emissions Level (dBm)	Margin to FCC Limit of -13 dBm (dB)
2109 to 2110 MHz (lower adjacent 1 MHz); Channel 25	-25.82	12.82
2155 to 2156 MHz (upper adjacent 1 MHz); Channel 875	-24.51	11.51
9 kHz to lower adjacent 1MHz (RBW=1MHz)	-20.03	7.03
upper adjacent 1MHz to 5 GHz (RBW=1MHz)	-20.21	7.21
5 GHz to 22 GHz (RBW=1MHz)	-37.58	24.58

**Table 26: Spurious Emissions at the AWS MFRM3 Ant. Port two Carrier IS95**

Frequency (Band)	Spurious Emissions Level (dBm)	Margin to FCC Limit of -13 dBm (dB)
2109 to 2110 MHz (lower adjacent 1 MHz); Channel 25, 50	-24.24	11.24
2155 to 2156 MHz (upper adjacent 1 MHz); Channel 850, 875	-22.89	9.89
9 kHz to lower adjacent 1MHz (RBW=1MHz)	-16.49	3.49
upper adjacent 1MHz to 5 GHz (RBW=1MHz)	-16.06	3.06
5 GHz to 22 GHz (RBW=1MHz)	-36.50	23.50

**Table 27: Spurious Emissions at the AWS MFRM3 Ant. Port Three Carrier IS-95**

Frequency (MHz)	Spurious Emissions Level (dBm)	Margin to FCC Limit of -13 dBm (dB)
2109 to 2110 MHz (lower adjacent 1 MHz); Channel 25, 50, 75	-24.19	11.19
2155 to 2156 MHz (upper adjacent 1 MHz); Channel 825, 850, 875	-24.67	11.67

**Table 27: Spurious Emissions at the AWS MFRM3 Ant. Port Three Carrier IS-95**

Frequency (MHz)	Spurious Emissions Level (dBm)	Margin to FCC Limit of -13 dBm (dB)
9 kHz to lower adjacent 1MHz (RBW=1MHz)	-16.35	3.35
upper adjacent 1MHz to 5 GHz (RBW=1MHz)	-16.71	3.71
5 GHz to 22 GHz (RBW=1MHz)	-44.33	31.33

#### 4.4.5 Test Results IS856

**Table 28: Spurious Emissions at the AWS MFRM3 Ant. Port One Carrier Band IS856 (QPSK)**

Frequency (MHz)	Spurious Emissions Level (dBm)	Margin to FCC Limit of -13 dBm (dB)
2109 to 2110 MHz (lower adjacent 1 MHz); Channel 25	-27.84	14.84
2155 to 2156 MHz (upper adjacent 1 MHz); Channel 875	-25.82	12.82
9 kHz to lower adjacent 1MHz (RBW=1MHz)	-18.55	5.55
upper adjacent 1MHz to 5 GHz (RBW=1MHz)	-20.54	7.54
5 GHz to 22 GHz (RBW=1MHz)	-37.44	24.44

**Table 29: Spurious Emissions at the AWS MFRM3 Ant. Port Three Carrier IS856 (8PSK)**

Frequency (MHz)	Spurious Emissions Level (dBm)	Margin to FCC Limit of -13 dBm (dB)
	3Carrier 8PSK	3Carrier
2109 to 2110 MHz (lower adjacent 1 MHz); Channel 25, 50, 75	-23.22	10.22
2155 to 2156 MHz (upper adjacent 1 MHz); Channel 825, 850, 875	-21.75	8.75
9 kHz to lower adjacent 1MHz (RBW=1MHz)	-15.16	2.16
upper adjacent 1MHz to 5 GHz (RBW=1MHz)	-16.20	3.20
5 GHz to 22 GHz (RBW=1MHz)	-38.19	25.18



**Table 30: Spurious Emissions at the AWS MFRM3 Ant. Port Three Carrier Combined IS-95 & IS-856 (16QAM)**

Frequency (MHz)	Spurious Emissions Level (dBm)	Margin to FCC Limit of -13 dBm (dB)
	3Carrier 16QAM IS95	3Carrier
2109 to 2110 MHz (lower adjacent 1 MHz); Channel 25, 50, 75	-25.22	12.22
2155 to 2156 MHz (upper adjacent 1 MHz); Channel 825, 850, 875	-21.69	8.69
9 kHz to lower adjacent 1MHz (RBW=1MHz)	-15.18	2.18
upper adjacent 1MHz to 5 GHz (RBW=1MHz)	-16.43	3.43
5 GHz to 22 GHz (RBW=1MHz)	-37.75	24.75

---

## 4.5 Frequency Stability

### 4.5.1 Frequency Stability Requirements

#### FCC Part 2.1055

*(a) The frequency stability shall be measured with variation of ambient temperature as follows:*

*(1) From -30 to +50 centigrade for all equipment except that specified in subparagraphs (2) and (3) of this paragraph.*

*(b) Frequency measurements shall be made at the extremes of the specified temperature range and at intervals of not more than 10 centigrade through the range. A period of time sufficient to stabilize all of the components of the oscillator circuit at each temperature level shall be allowed prior to frequency measurement. The short term transient effects on the frequency of the transmitter due to keying (except for broadcast transmitters) and any heating element cycling normally occurring at each ambient temperature level also shall be shown. Only the portion or portions of the transmitter containing the frequency determining and stabilizing circuitry need be subjected to the temperature variation test.*

*(d) The frequency stability shall be measured with variation of primary supply voltage as follows:*

*(1) Vary primary supply voltage from 85 to 115 percent of the nominal value for other than hand carried battery equipment.*

*(2) For hand carried, battery powered equipment, reduce primary supply voltage to the battery operating end point which shall be specified by the manufacturer.*

*(3) The supply voltage shall be measured at the input to the cable normally provided with the equipment, or at the power supply terminals if cables are not normally provided. Effects on frequency of transmitter keying (except for broadcast transmitters) and any heating element cycling at the nominal supply voltage and at each extreme also shall be shown.*

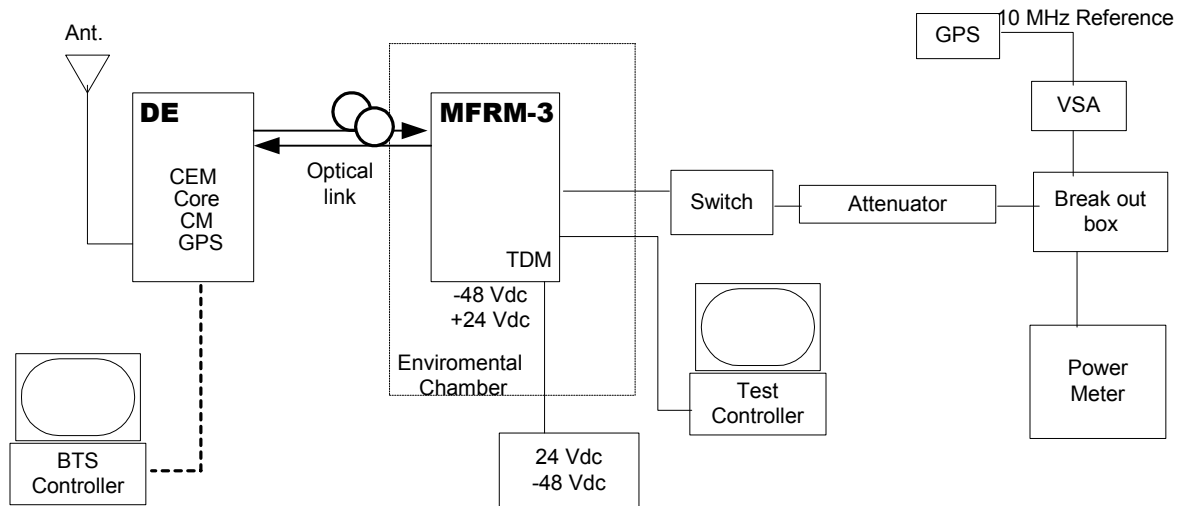
*(e) When deemed necessary, the Commission may require tests of frequency stability under conditions in addition to those specifically set out in paragraphs (a), (b), (c) and (d) of this section. (For example, measurements showing the effect of proximity to large metal objects, or of various types of antennas, may be required for portable equipment.)*

#### FCC Part 27.54 Limit

*The frequency stability shall be sufficient to ensure that the fundamental emission stays within the authorized frequency block.*

### 4.5.2 Test Procedure

The test equipment was configured as shown in figure 11.



**Figure 10 : Test configuration for Frequency Stability**

### 4.5.3 Frequency Results

The test results for Frequency stability provided in this section were measured with the BTS configured with channels 425, 450, 475. All carriers were IS-95 modulated. The BTS was configured to transmit at maximum transmit power.

**Table 31: Test results for Frequency Stability versus Power supply Voltage**

Voltage (Vdc)	Maximum Carrier Frequency Deviation (PPM)	Maximum Carrier Frequency Deviation (Hz)
-40	0.00142	3.019
-48 nominal	0.00121	2.557
-56	0.00170	3.623
20	0.00170	3.619

**Table 31: Test results for Frequency Stability versus Power supply Voltage**

Voltage (Vdc)	Maximum Carrier Frequency Deviation (PPM)	Maximum Carrier Frequency Deviation (Hz)
24 nominal	0.00135	2.885
28	0.00137	2.930

**Table 32: Test results for Frequency Stability versus Temperature at -48V operation**

Temperature (°C)	Maximum Carrier Frequency Deviation (PPM)	Maximum Carrier Frequency Deviation (Hz)
-40	0.00162	3.452
-30	0.00391	8.337
-20	0.00212	4.524
-10	0.00231	4.926
0	0.00150	3.205
10	0.00147	3.172
20	0.00108	2.302
30	0.00152	3.234
40	0.00095	2.022
50	0.00118	2.518

**Table 33: Test results for Frequency Stability versus Temperature at 24V operation**

Temperature (°C)	Maximum Carrier Frequency Deviation (PPM)	Maximum Carrier Frequency Deviation (Hz)
-40	0.00234	4.991

**Table 33: Test results for Frequency Stability versus Temperature at 24V operation**

Temperature (°C)	Maximum Carrier Frequency Deviation (PPM)	Maximum Carrier Frequency Deviation (Hz)
-30	0.00202	4.297
-20	0.00191	4.066
-10	0.00173	3.693
0	0.00120	2.567
10	0.00149	3.185
20	0.00130	2.781
30	0.00194	4.139
40	0.00161	3.431
50	0.00154	3.289



---

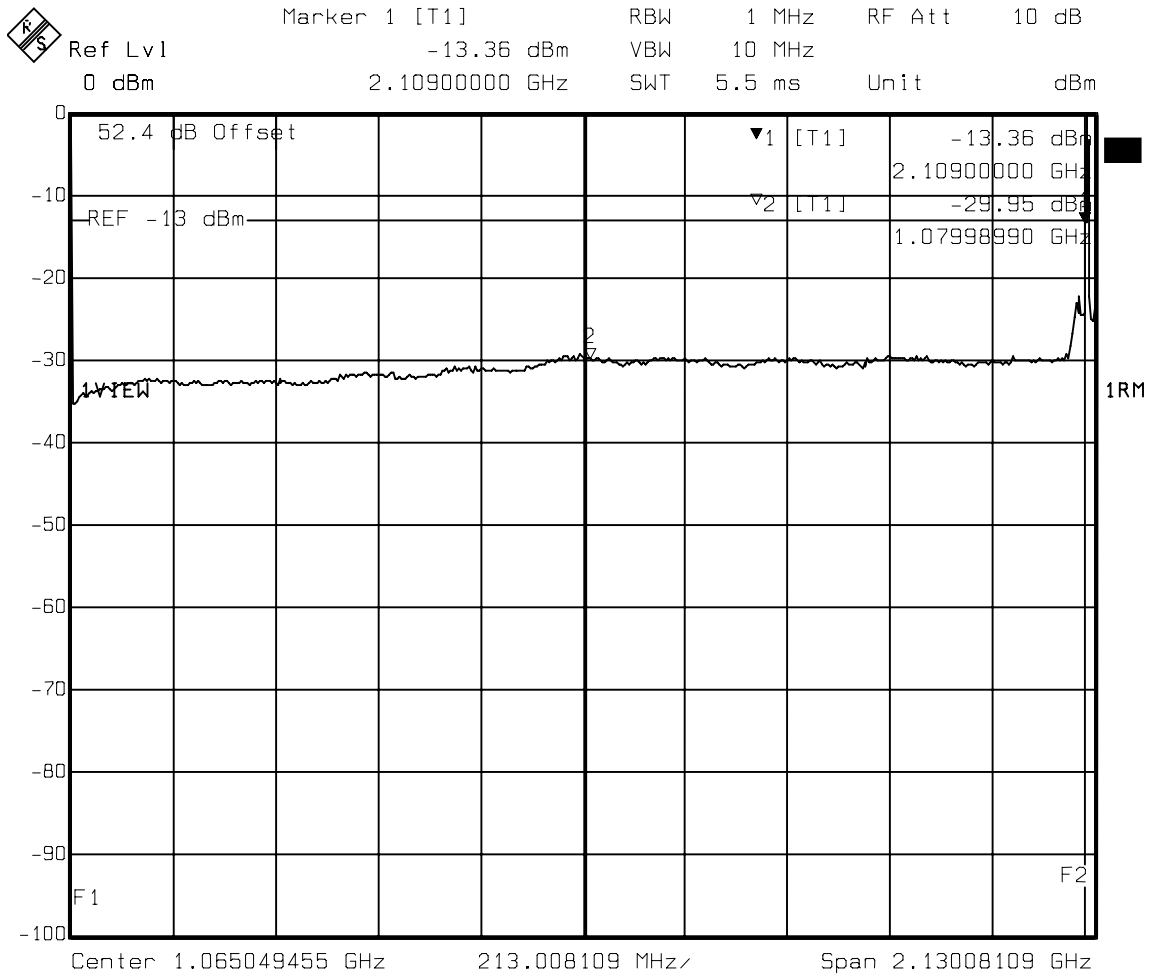
## References

- [1] FCC Part 22 Subpart H, “Public Mobile Service”, [http://www.access.gpo.gov/nara/cfr/waisidx\\_01/47cfr22\\_01.html](http://www.access.gpo.gov/nara/cfr/waisidx_01/47cfr22_01.html)
- [2] FCC Part 2 Subpart J, “Frequency allocations and radio treaty matters; general rules and regulations”, [http://www.access.gpo.gov/nara/cfr/waisidx\\_01/47cfr2\\_01.html](http://www.access.gpo.gov/nara/cfr/waisidx_01/47cfr2_01.html)
- [3] Industry Canada RSS-129, “800 MHz Dual-Mode CDMA Cellular Telephones”, <http://www.strategis.ic.gc.ca/epic/site/smt-gst.nsf/en/sf01324e.html>
- [4] TIA/EIA-97-E “Recommended Minimum Performance Standards for Base Stations Supporting Dual Mode Spread Spectrum Systems”,
- [5] Industry Canada “Information on the 99% Bandwidth measurement” Author Brian Kasper. [http://strategis.ic.gc.ca/epic/internet/inceb-bhst.nsf/vwapj/occupied-bandwidth.pdf/\\$FILE/occupied-bandwidth.pdf](http://strategis.ic.gc.ca/epic/internet/inceb-bhst.nsf/vwapj/occupied-bandwidth.pdf/$FILE/occupied-bandwidth.pdf)
- [6] CDMA BTS Development, MFRM-2 800 MHz Power Amplifier Assembly Beta Cycle Verification Report, Dataset Name: NTGY37AA, Document Status: Ratified, Stream: 02 Issue: 02, Issue Date: March 12, 2003, Document Prime: Neil Claxton, 2M23
- [7] Recommended Minimum Performance Standards for cdma2000 High Rate Packet Data Access Network, C.S0032-0, Version 2.0, 12 December 2003

APPENDIX PLOTS

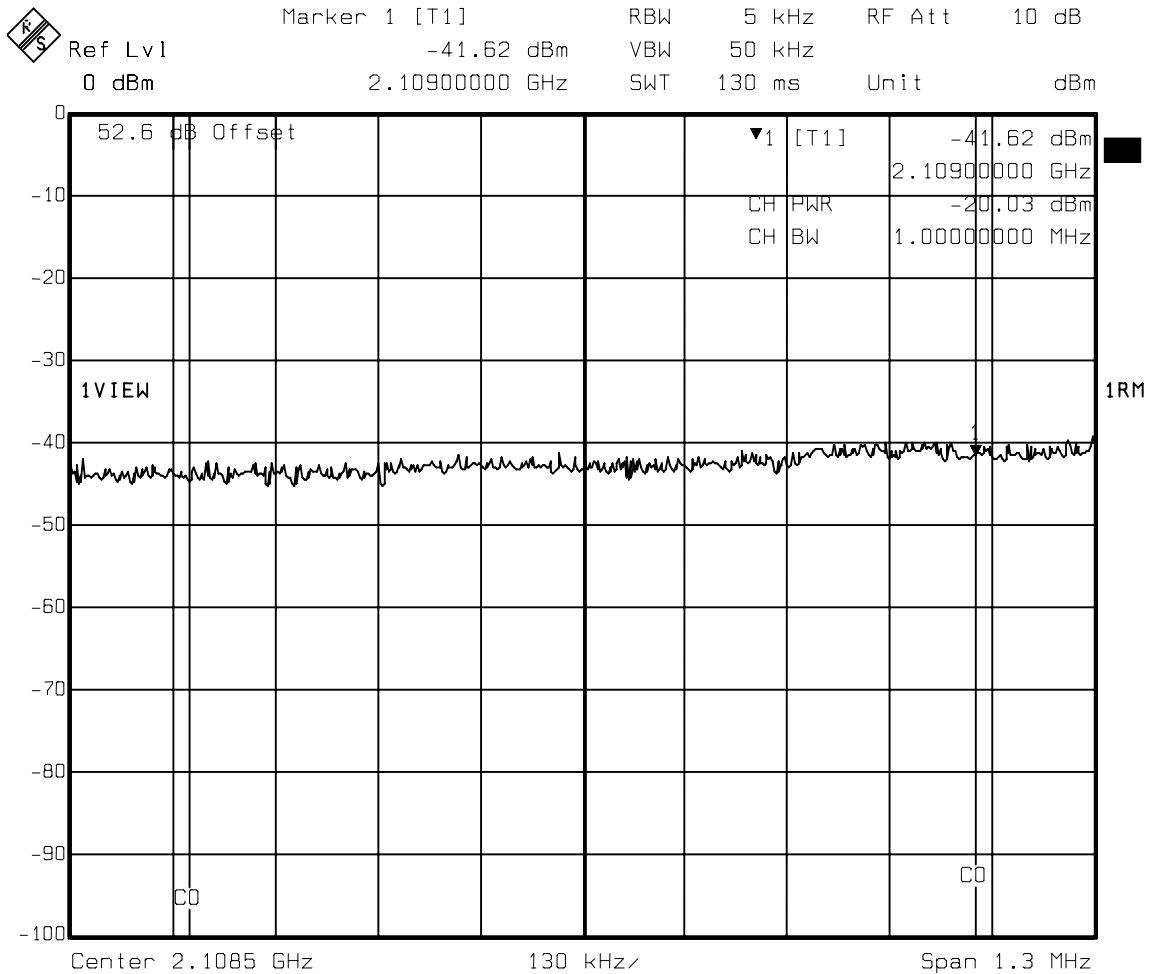


**Figure 11 : Conducted Spurious Emissions - 1 Carrier, Ch. 25, IS95 (9kHz to Lower Adjacent 1MHz)**



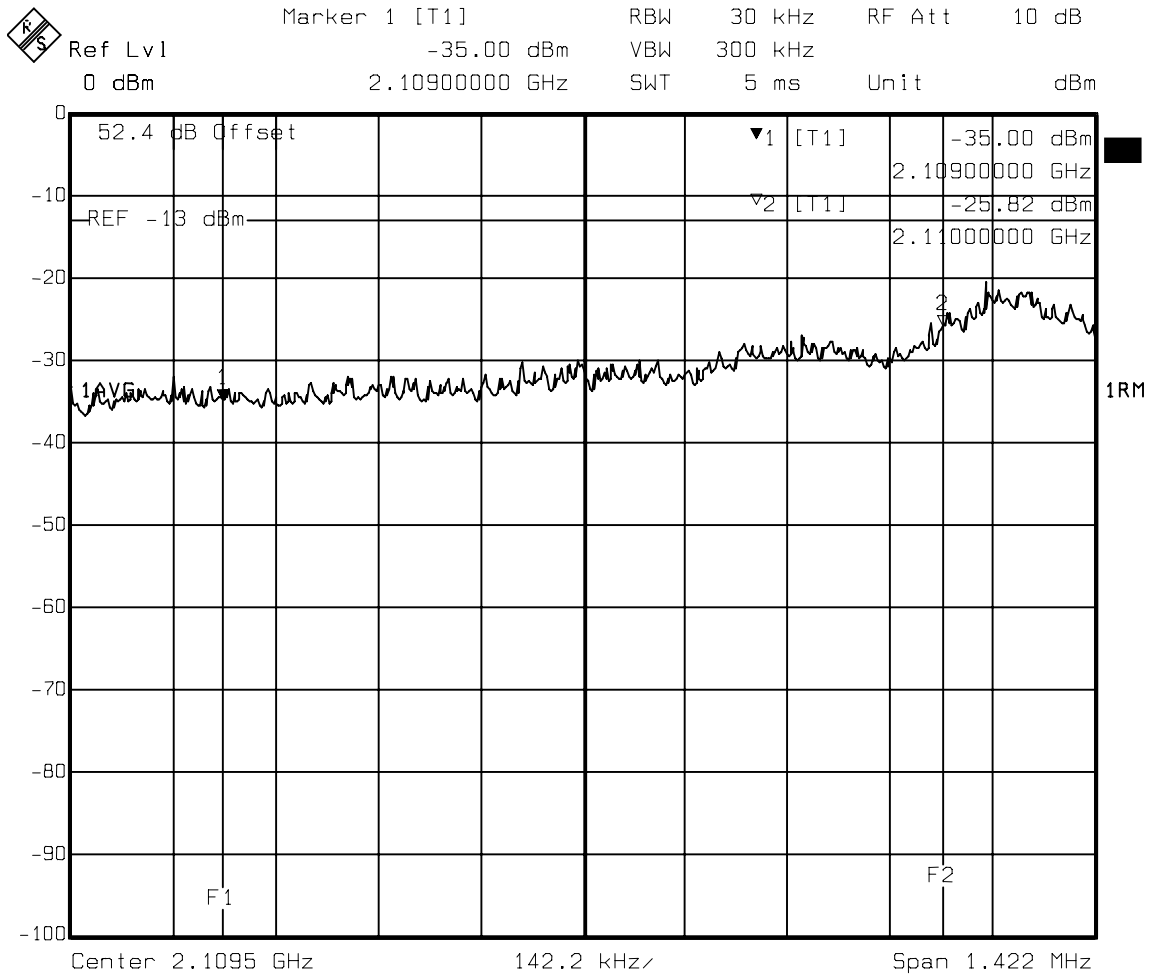
Title: 9kHz (Low edge-1.0MHz)  
 Comment A: Temp C 25  
 Date: 24.JUL.2007 16:27:07

**Figure 12 : Conducted Spurious Emissions - 1 Carrier, Ch. 25, IS95 (9kHz to Lower Adjacent 1MHz) Verification**



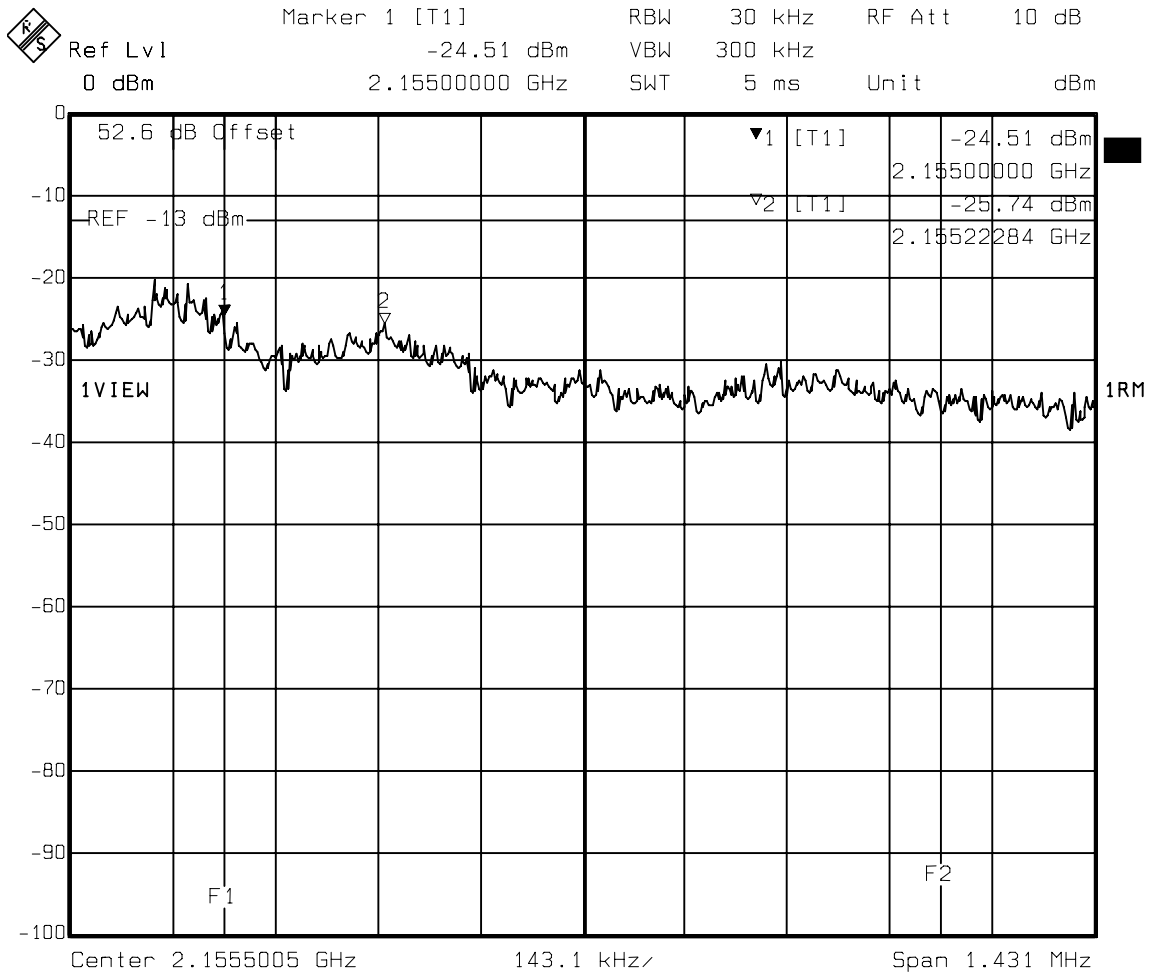
Title: 2MHz\_1MHz Low adj channel, verification  
 Comment A: Temp C 25  
 Date: 24.JUL.2007 16:28:56

**Figure 13 : Conducted Spurious Emissions - 1 Carrier, Ch. 25, IS95 (Lower Adjacent 1MHz)**



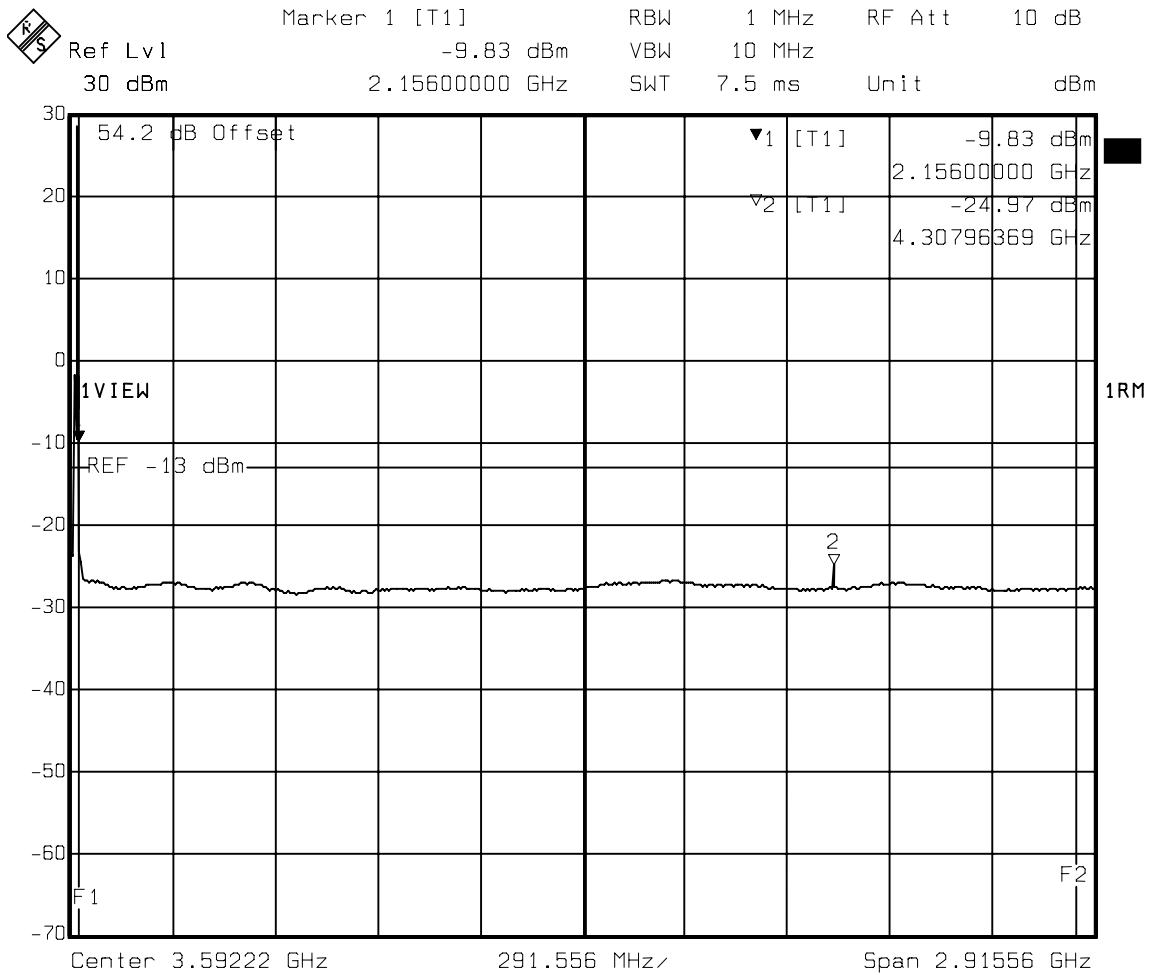
Title: (Low edge-1.0MHz) to Low edge  
 Comment A: Temp C 25  
 Date: 24.JUL.2007 16:45:32

**Figure 14 : Conducted Spurious Emissions - 1 Carrier, Ch. 875, IS95 (Upper Adjacent 1MHz)**



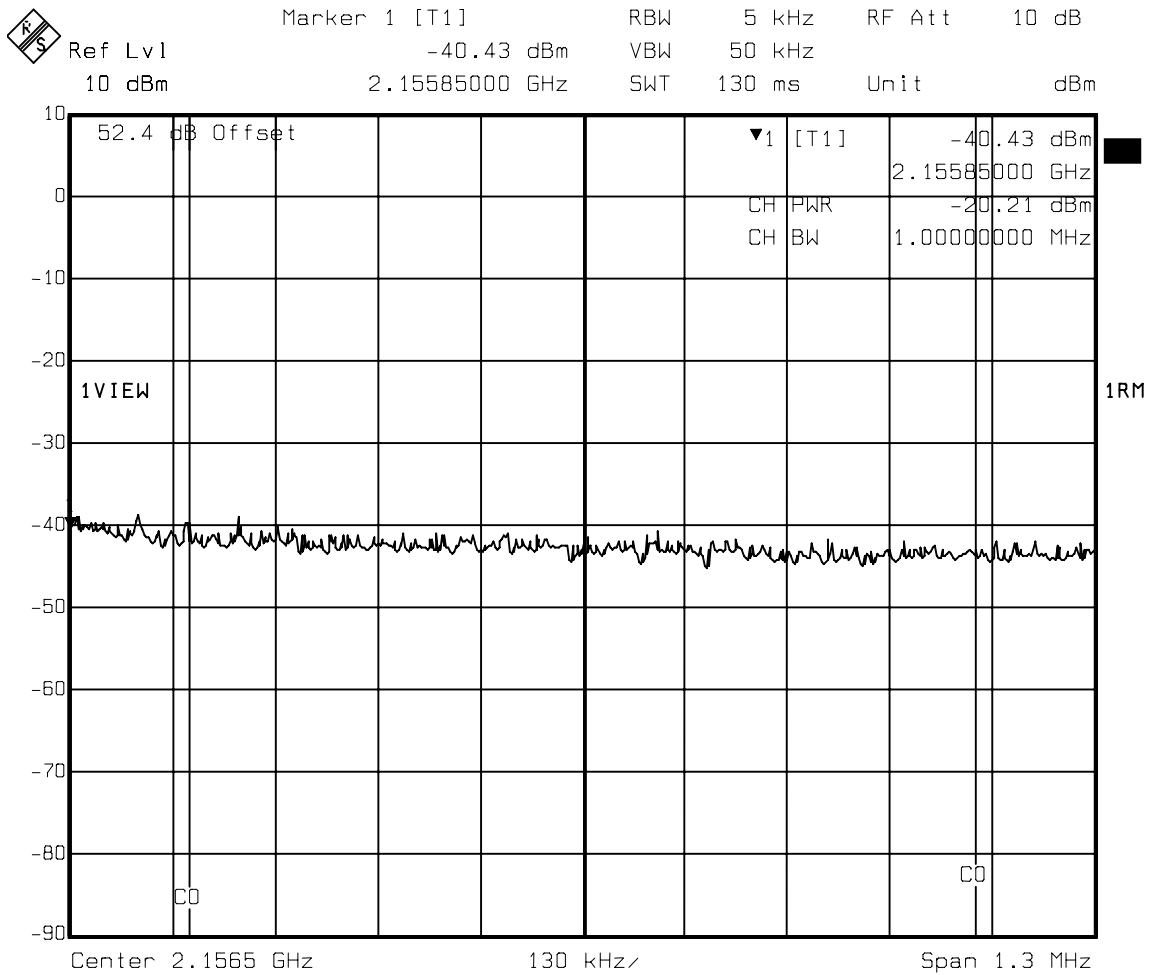
Title: Upper edge to (Upper edge + 1 MHz)  
 Comment A: Temp C 25  
 Date: 24.JUL.2007 13:10:07

**Figure 15 : Conducted Spurious Emissions - 1 Carrier, Ch. 875, IS95 (Upper Adjacent 1MHz to 5GHz)**



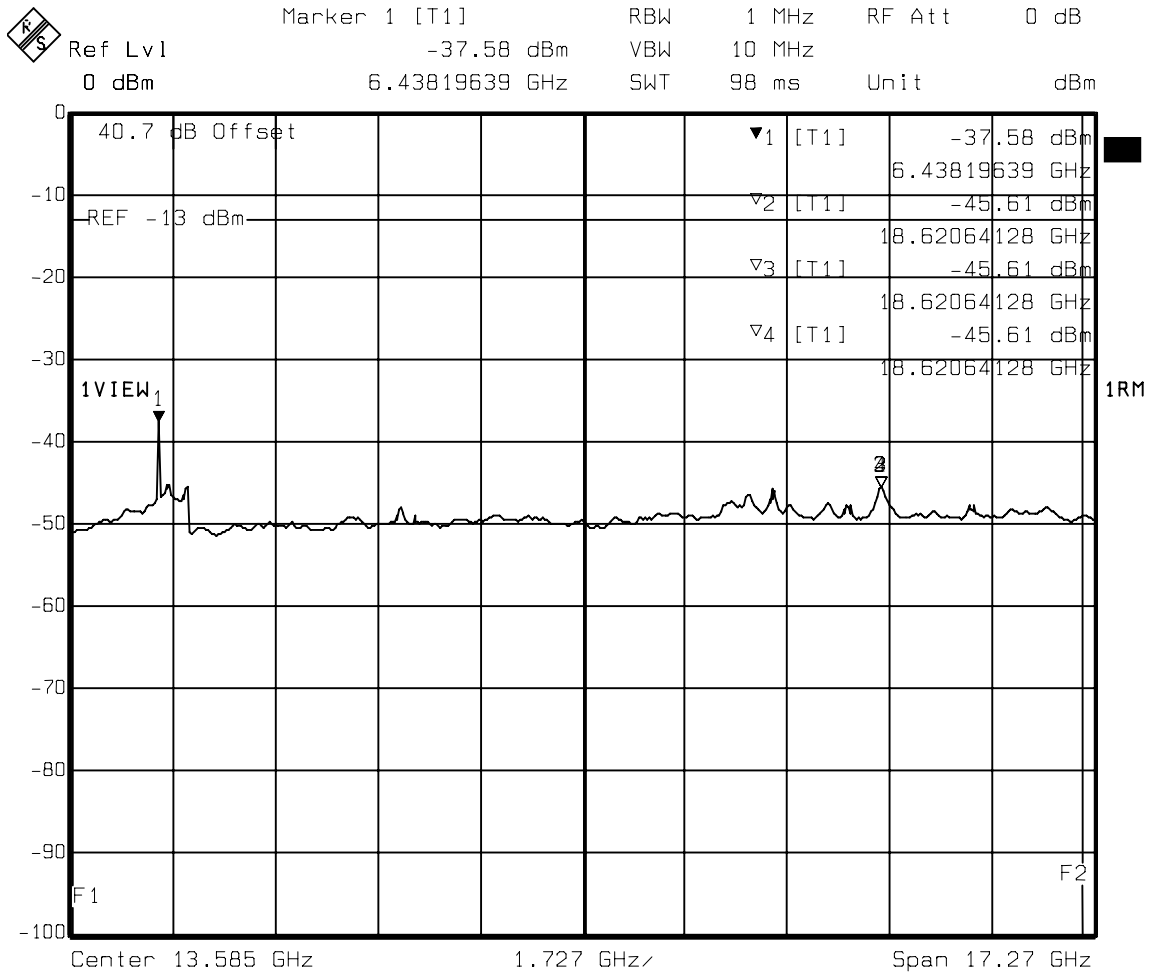
Title: (Upper edge + 1 MHz) to 5 GHz  
 Comment A: Temp C 25  
 Date: 24.JUL.2007 13:13:16

**Figure 16 : Conducted Spurious Emissions - 1 Carrier, Ch. 875, IS95 (Upper Adjacent 1MHz to 5GHz) Verification**



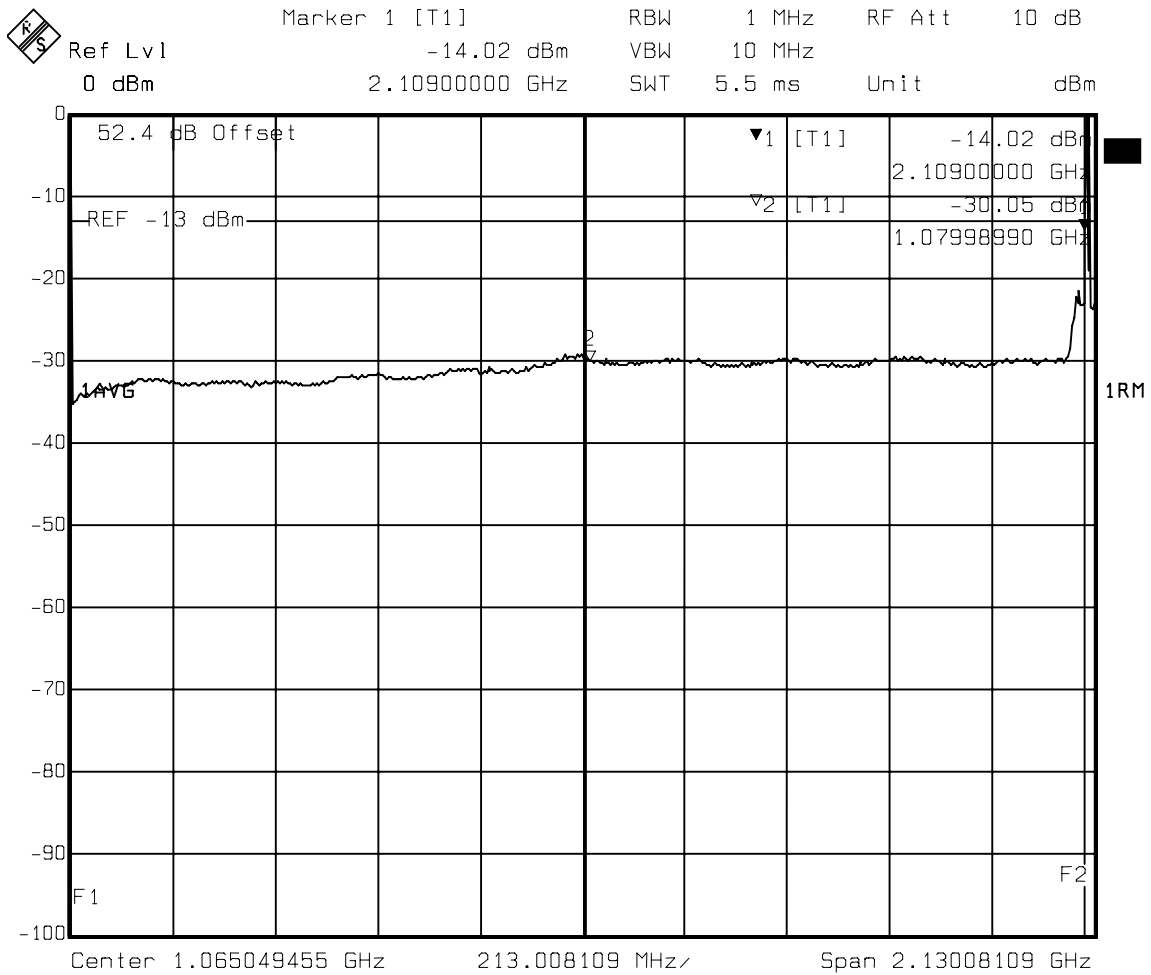
Title: 2MHz\_1MHz Upper adj channel, verification  
 Comment A: Temp C 25  
 Date: 24.JUL.2007 13:15:40

**Figure 17 : Conducted Spurious Emissions - 1 Carrier, Ch. 875, IS95 (5GHz to 20GHz)**



Title: 5 GHz to 22 GHz  
 Comment A: Temp C 25  
 Date: 23.JUL.2007 17:02:57

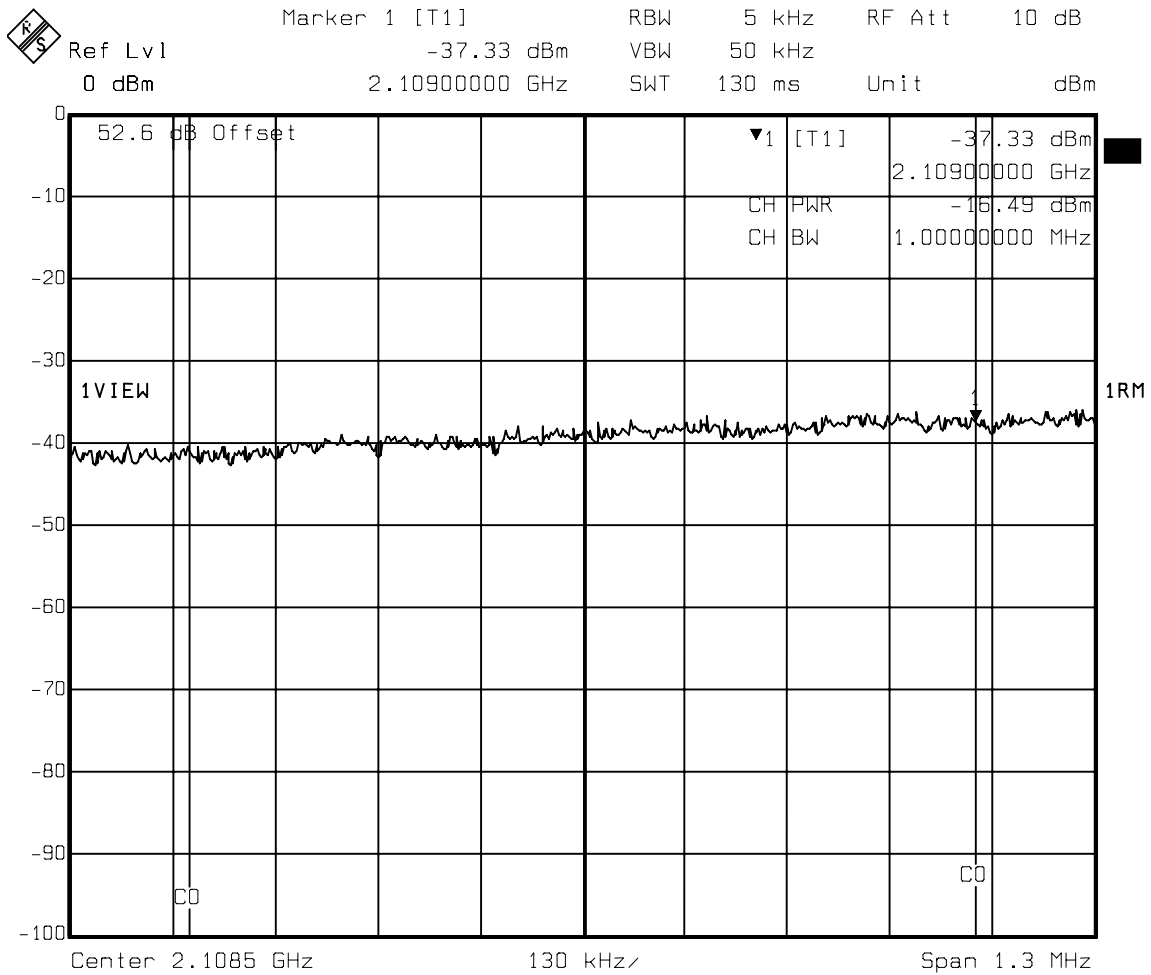
**Figure 18 : Conducted Spurious Emissions - 2 Carrier, Ch. 25, 50, IS95 (9kHz to Lower Adjacent 1MHz)**



Title: 9kHz (Low edge-1.0MHz)  
 Comment A: Temp C 25  
 Date: 24.JUL.2007 17:06:00

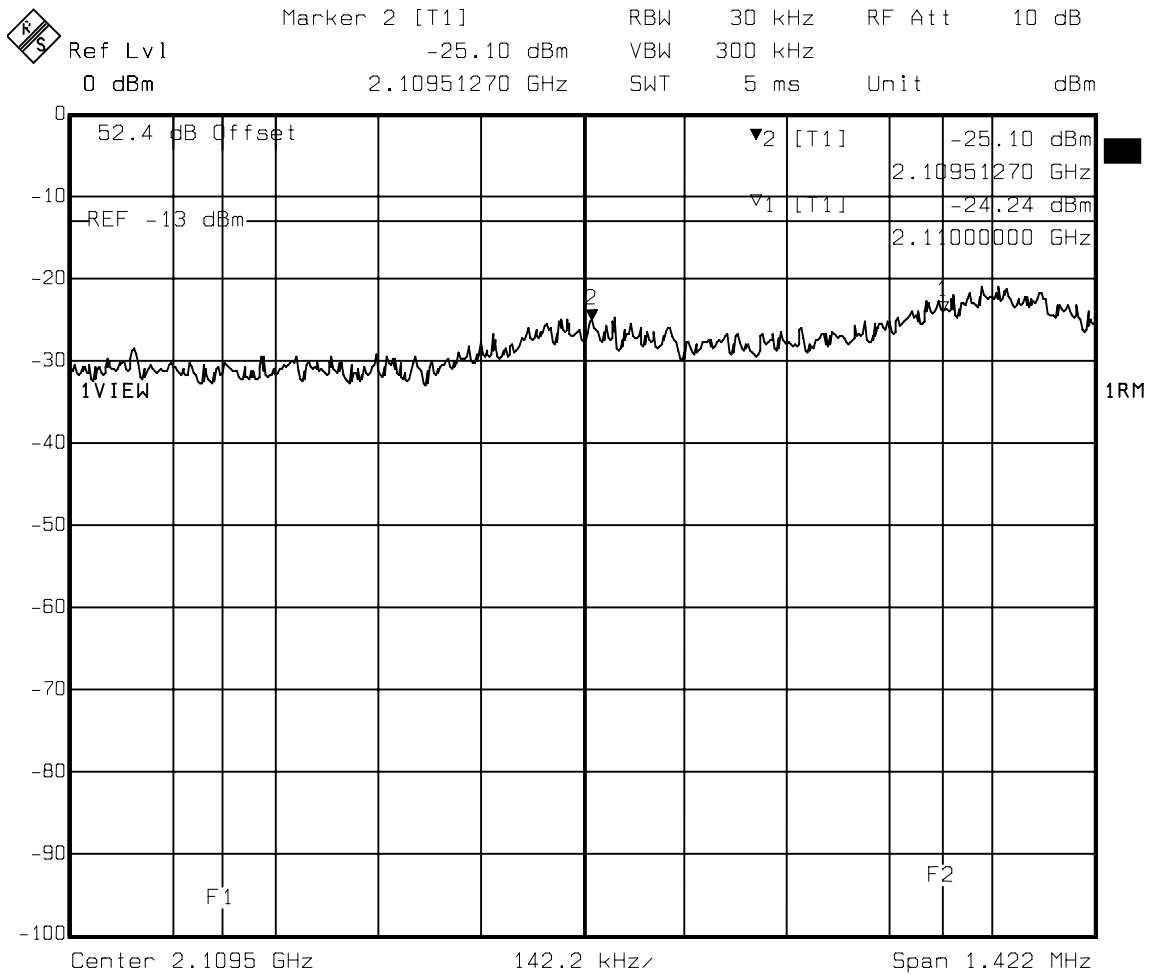


**Figure 19 : Conducted Spurious Emissions - 2 Carrier, Ch. 25, 50, IS95 (9kHz to Lower Adjacent 1MHz) Verification**



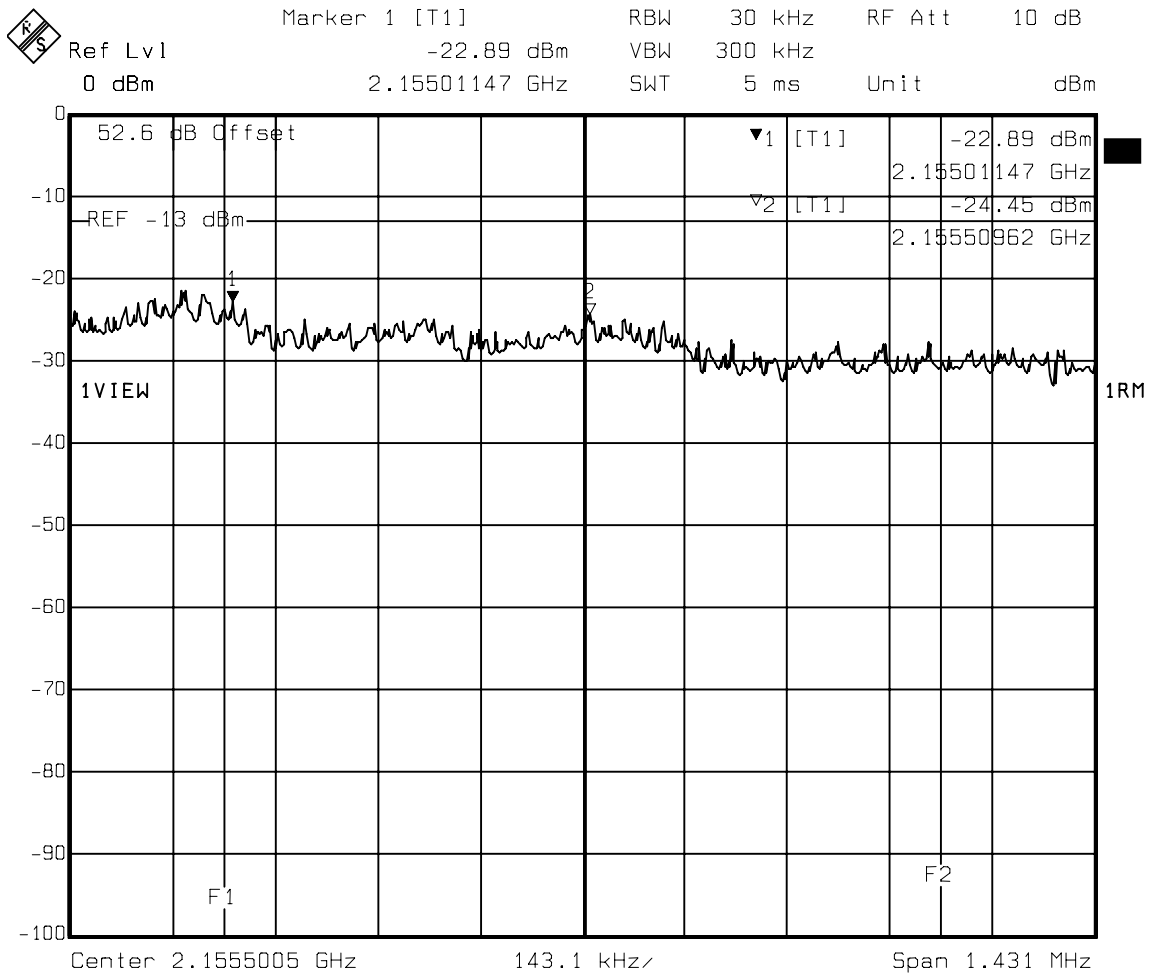
Title: 2MHz\_1MHz Low adj channel, verification  
 Comment A: Temp C 25  
 Date: 24.JUL.2007 17:09:49

**Figure 20 : Conducted Spurious Emissions - 2 Carrier, Ch. 25, 50, IS95 (Lower Adjacent 1MHz)**



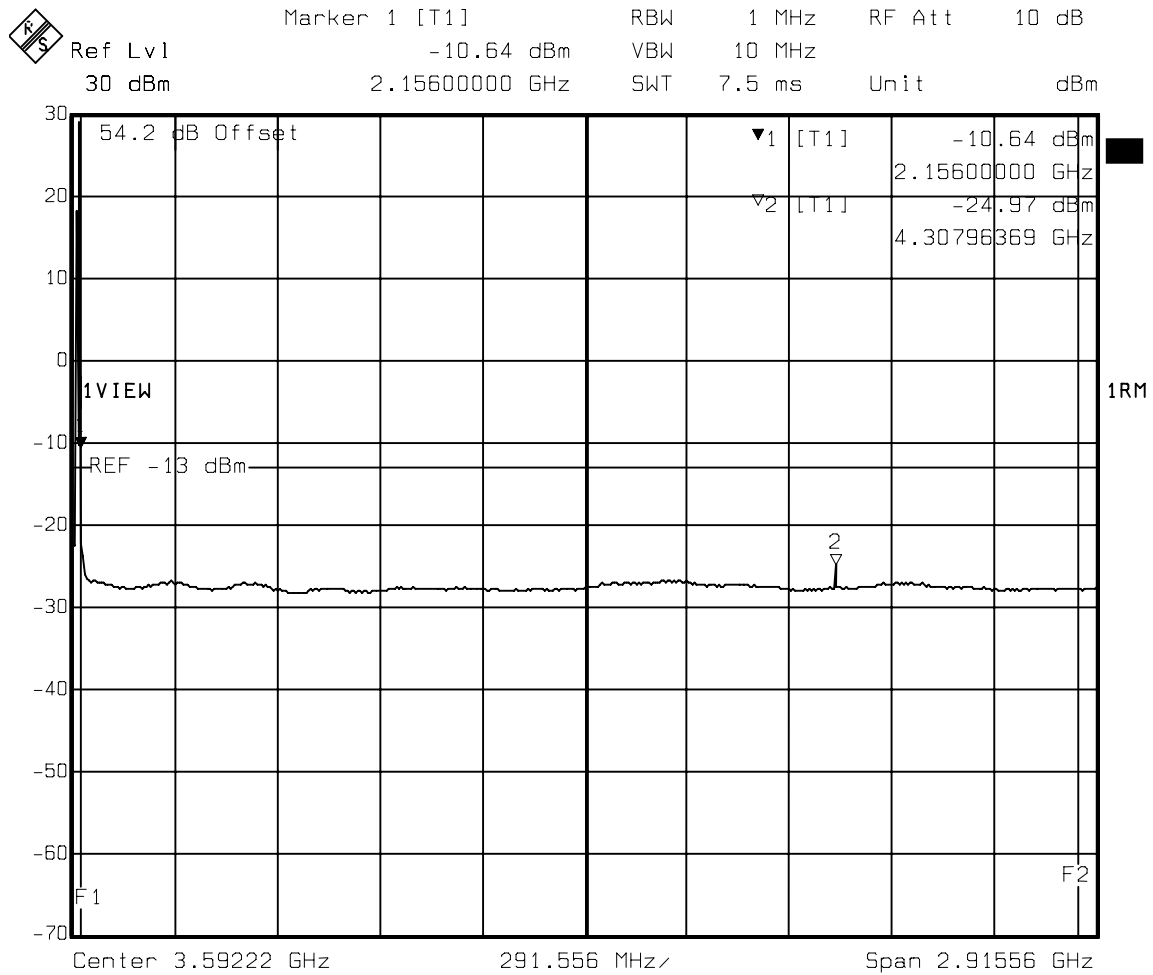
Title: (Low edge-1.0MHz) to Low edge  
 Comment A: Temp C 25  
 Date: 24.JUL.2007 17:08:08

**Figure 21 : Conducted Spurious Emissions - 2 Carrier, Ch. 850, 875 IS95 (Upper Adjacent 1MHz)**



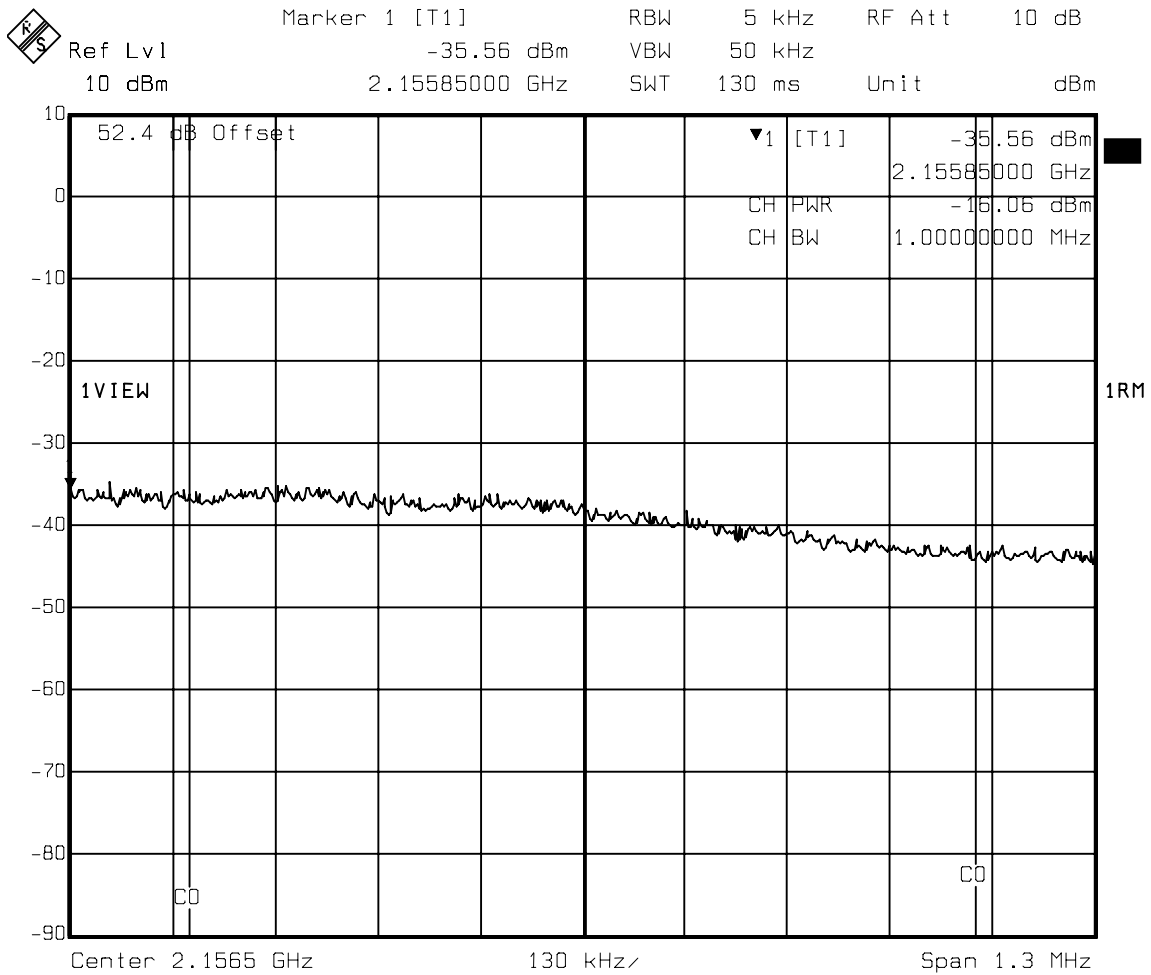
Title: Upper edge to (Upper edge + 1 MHz)  
 Comment A: Temp C 25  
 Date: 24.JUL.2007 12:49:04

**Figure 22 : Conducted Spurious Emissions - 2 Carrier, Ch. 850, 875, IS95 (Upper Adjacent 1MHz to 5GHz)**



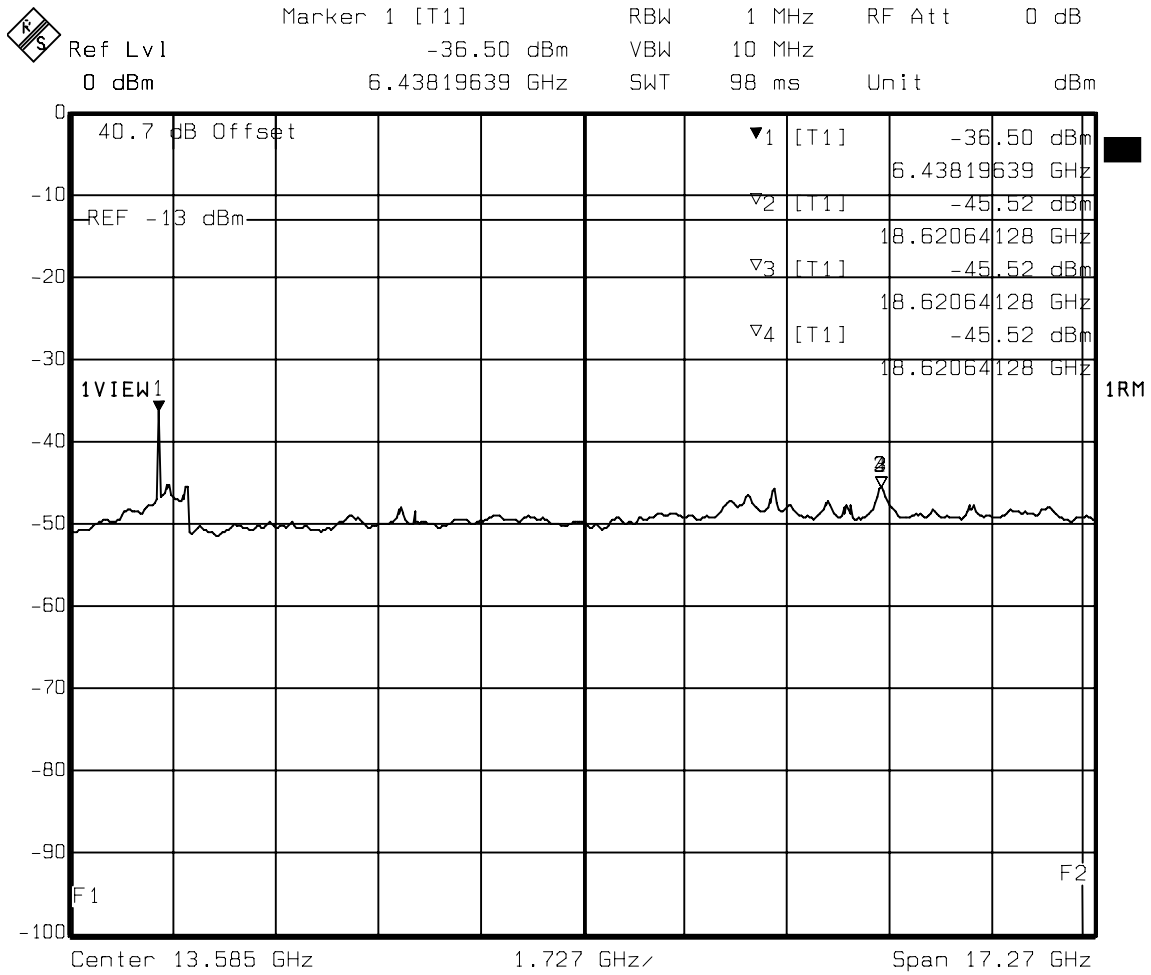
Title: (Upper edge + 1 MHz) to 5 GHz  
 Comment A: Temp C 25  
 Date: 24.JUL.2007 12:52:56

**Figure 23 : Conducted Spurious Emissions - 2 Carrier, Ch. 850, 875, IS95 (Upper Adjacent 1MHz to 5GHz) Verification**



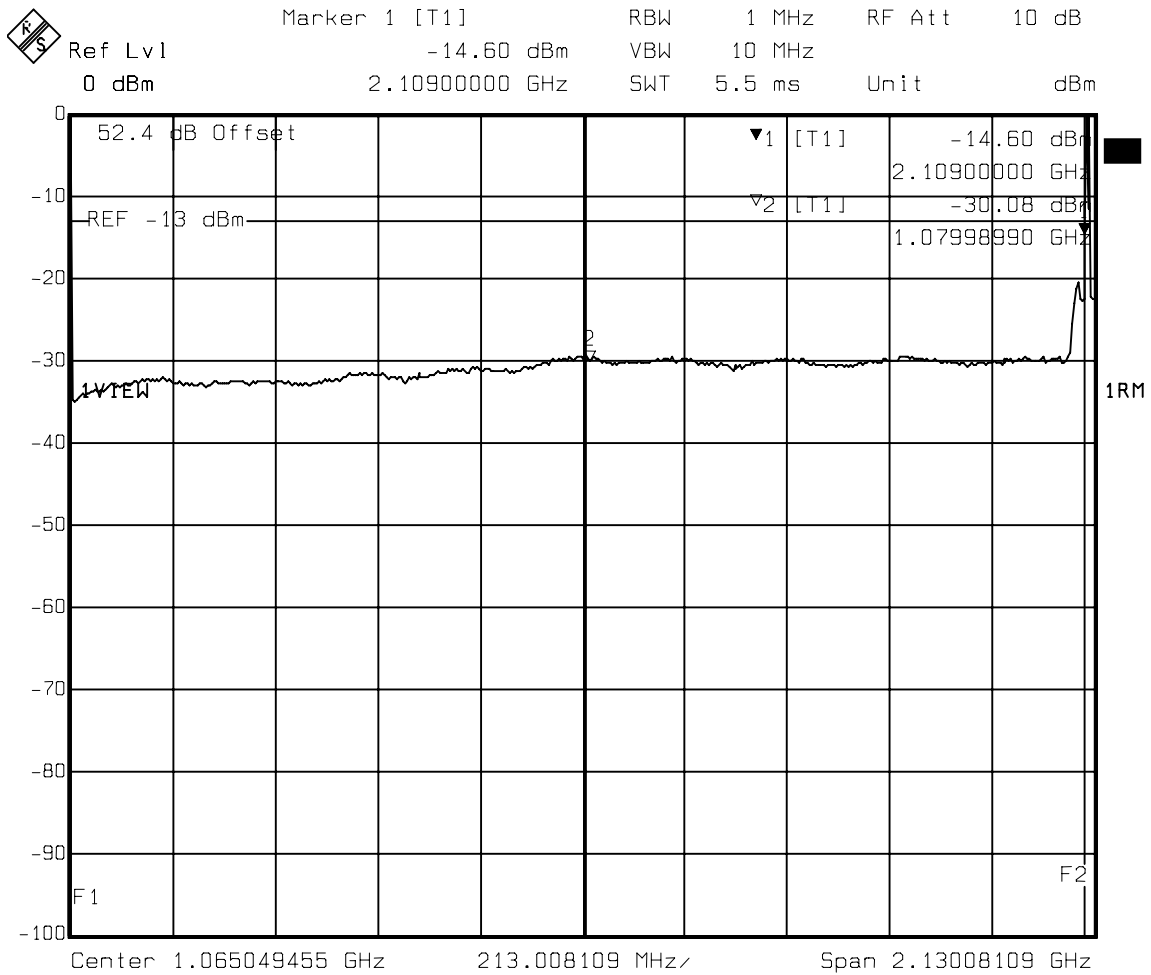
Title: 2MHz\_1MHz Upper adj channel, verification  
 Comment A: Temp C 25  
 Date: 24.JUL.2007 12:56:57

**Figure 24 : Conducted Spurious Emissions - 2 Carrier, Ch. 850, 875, IS95 (5GHz to 22GHz)**



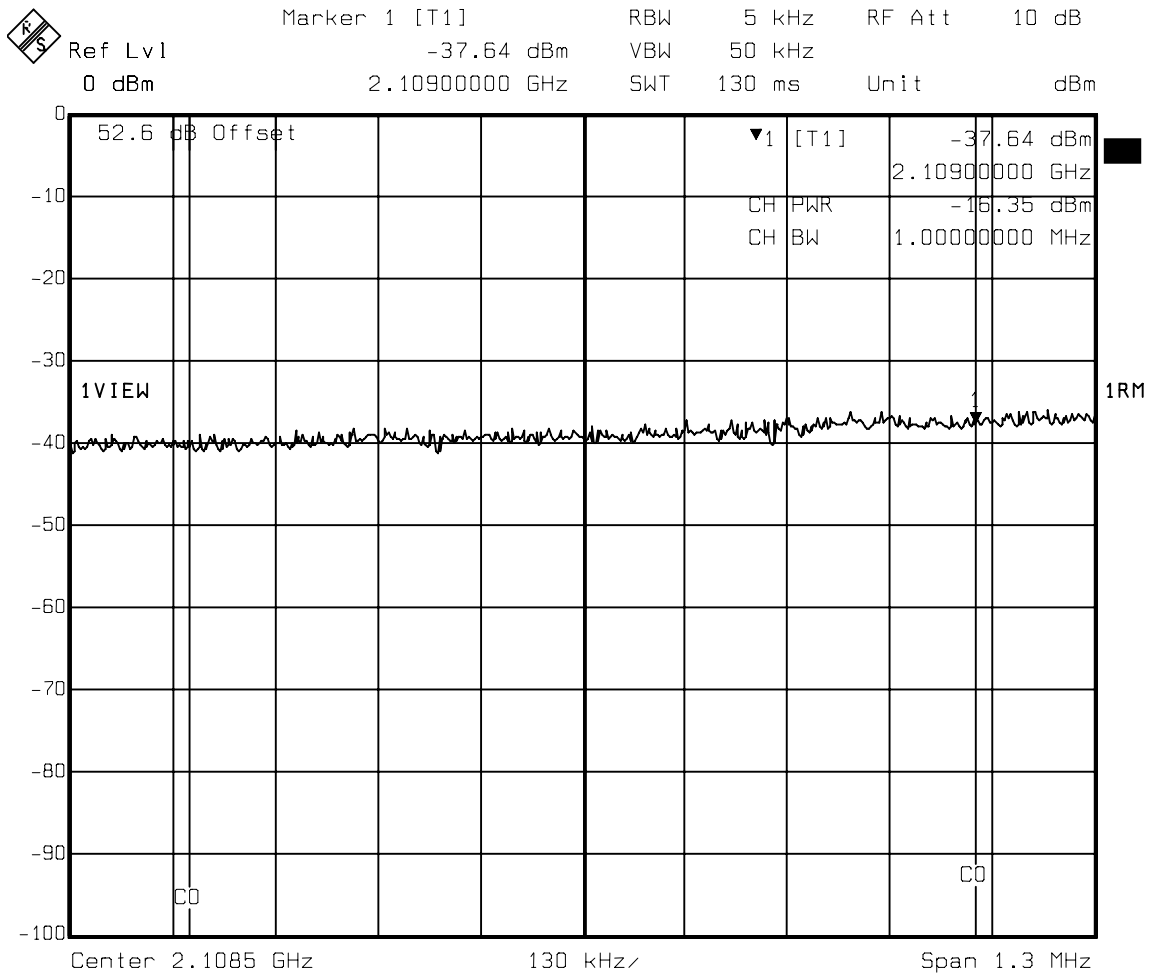
Title: 5 GHz to 22 GHz  
 Comment A: Temp C 25  
 Date: 23.JUL.2007 17:21:29

**Figure 25 : Conducted Spurious Emissions - 3 Carrier, Ch. 25, 50, 75, IS95 (9kHz to Lower Adjacent 1MHz)**



Title: 9kHz (Low edge-1.0MHz)  
 Comment A: Temp C 25  
 Date: 24.JUL.2007 17:46:11

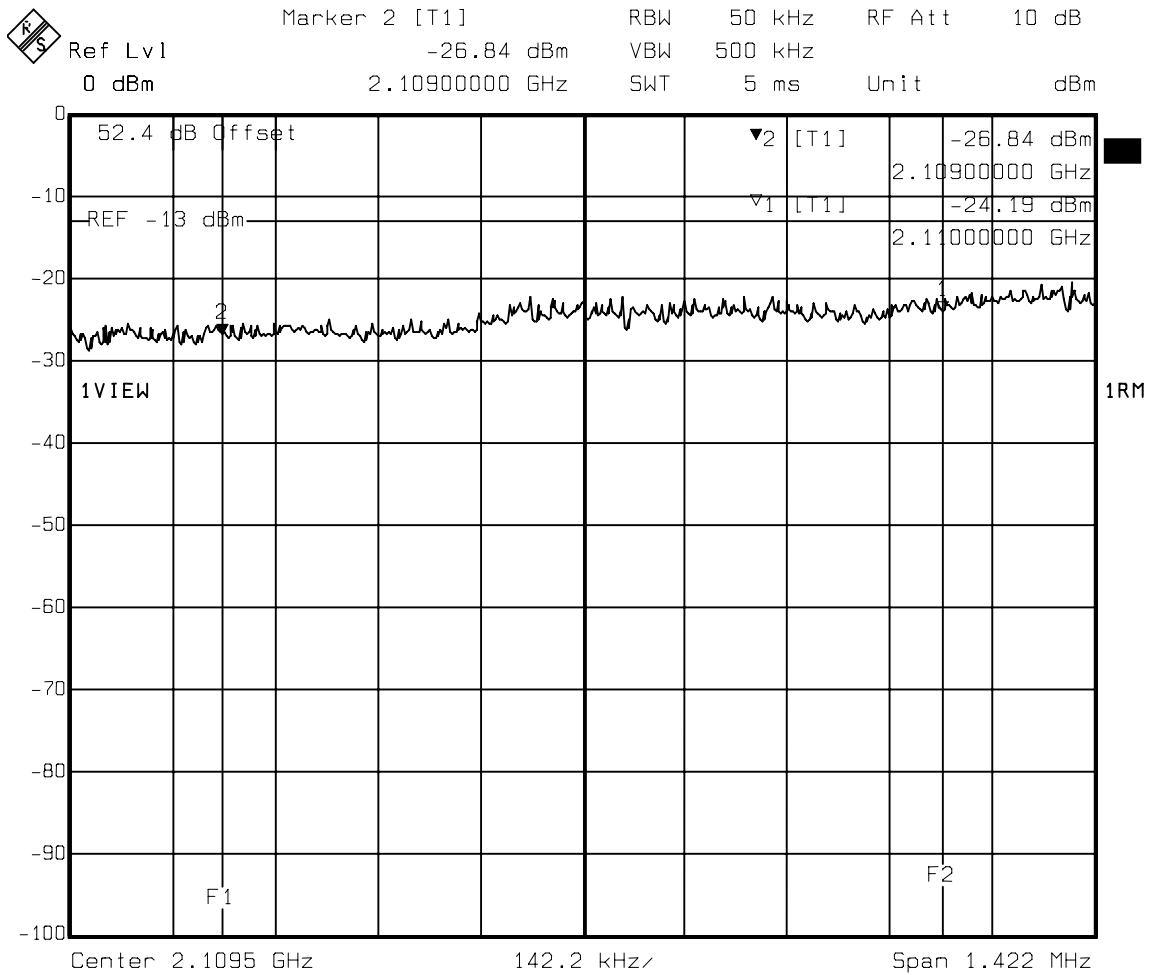
**Figure 26 : Conducted Spurious Emissions - 3 Carrier, Ch. 25, 50, 75, IS95 (9kHz to Lower Adjacent 1MHz) Verification**



Title: 2MHz\_1MHz Low adj channel, verification  
 Comment A: Temp C 25  
 Date: 24.JUL.2007 17:48:28

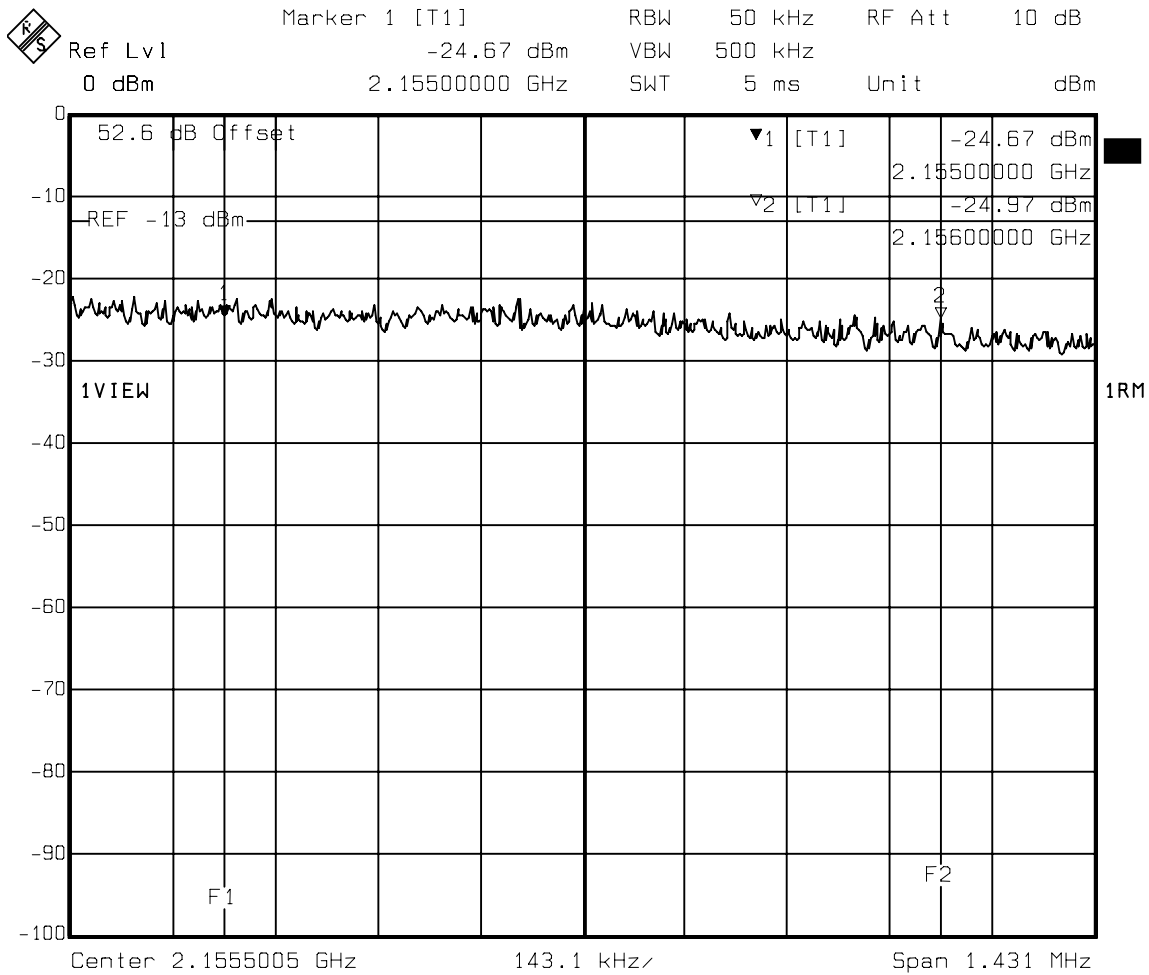


**Figure 27 : Conducted Spurious Emissions - 3 Carrier, Ch. 25, 50, 75, IS95 (Lower Adjacent 1MHz)**



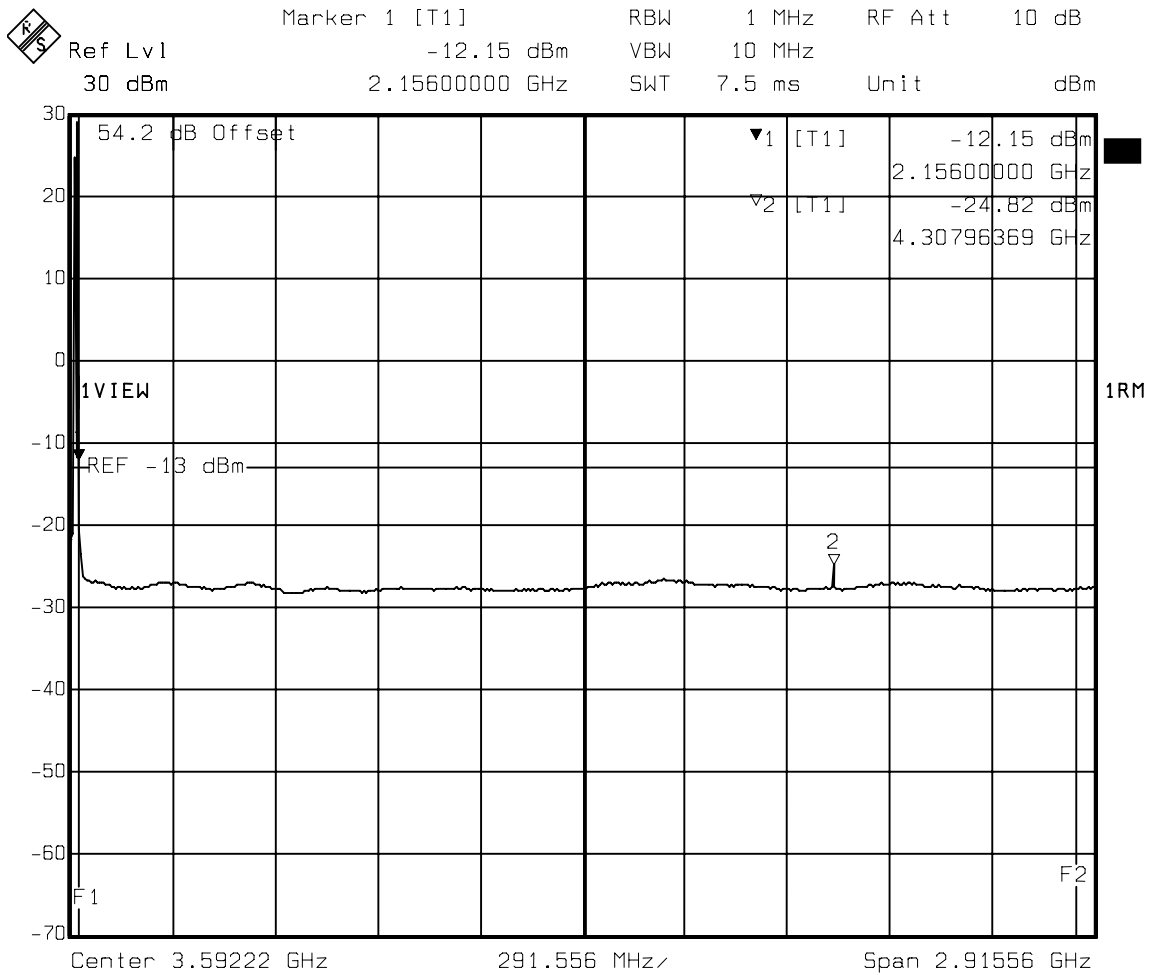
Title: (Low edge-1.0MHz) to Low edge  
 Comment A: Temp C 25  
 Date: 26.JUL.2007 18:57:48

**Figure 28 : Conducted Spurious Emissions - 3 Carrier, Ch. 825, 850, 875, IS95 (Upper Adjacent 1MHz)**



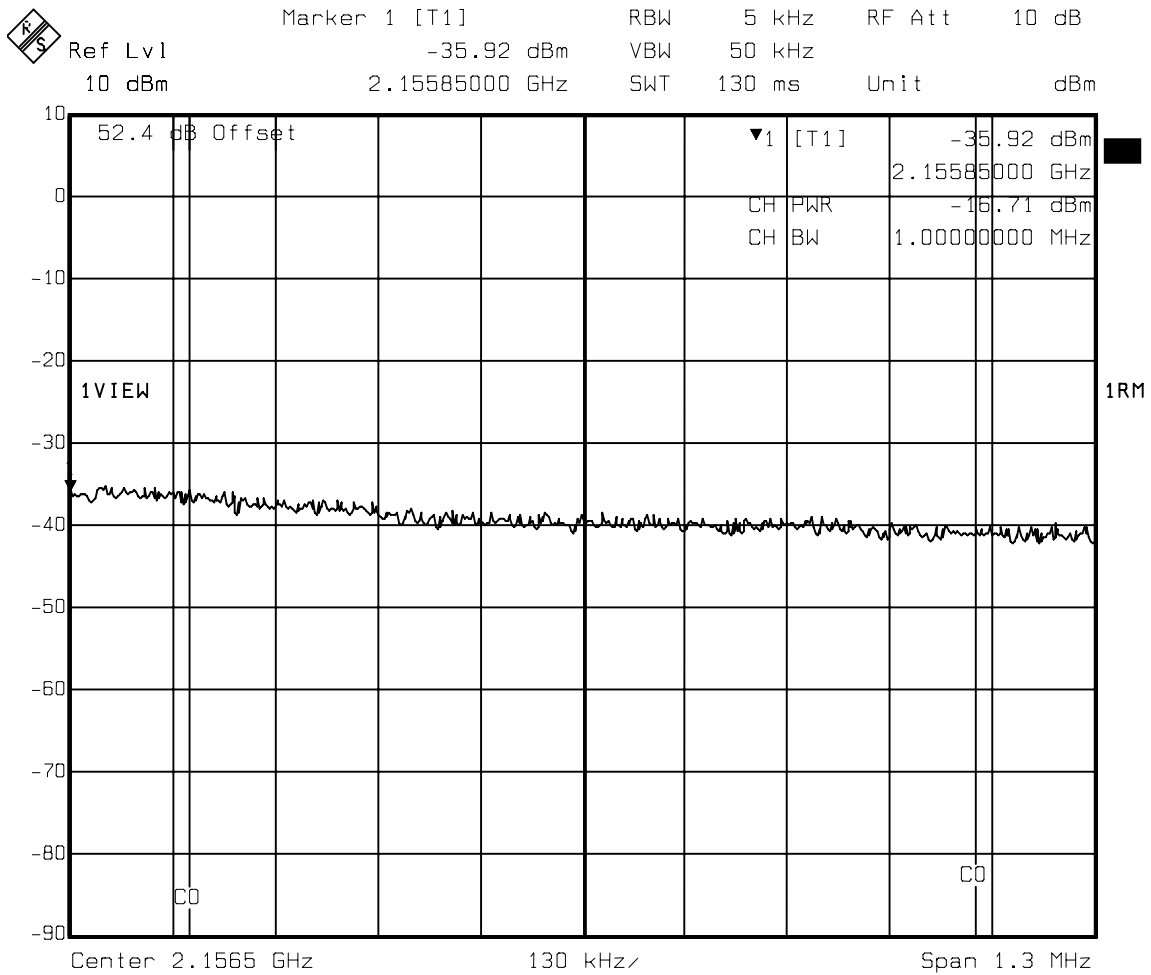
Title: Upper edge to (Upper edge + 1 MHz)  
 Comment A: Temp C 25  
 Date: 24.JUL.2007 09:34:29

**Figure 29 : Conducted Spurious Emissions - 3 Carrier, Ch. 825, 850, 875, IS95 (Upper Adjacent 1MHz to 5GHz)**



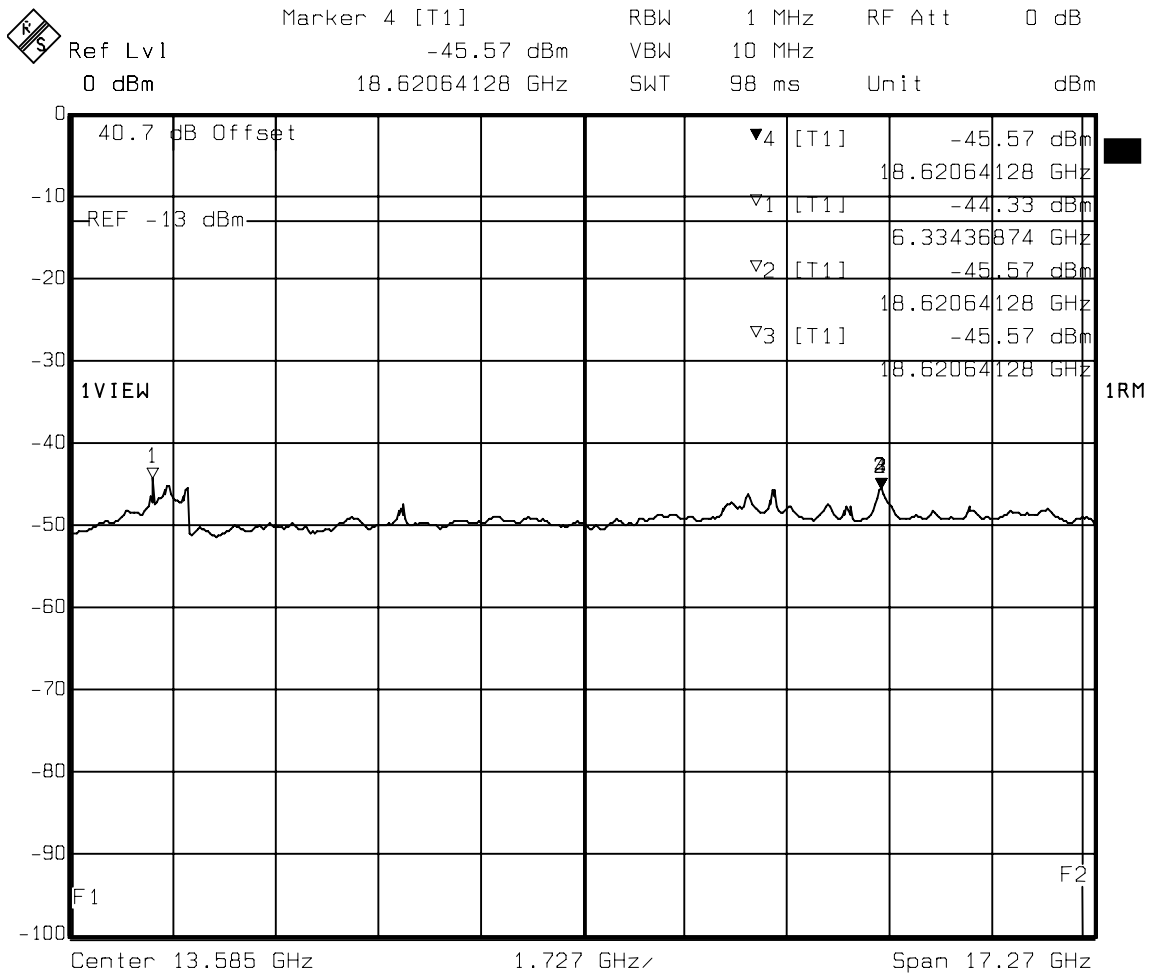
Title: (Upper edge + 1 MHz) to 5 GHz  
 Comment A: Temp C 25  
 Date: 24.JUL.2007 09:36:09

**Figure 30 : Conducted Spurious Emissions - 3 Carrier, Ch. 825, 850, 875, IS95 (Upper Adjacent 1MHz to 5GHz) Verification**



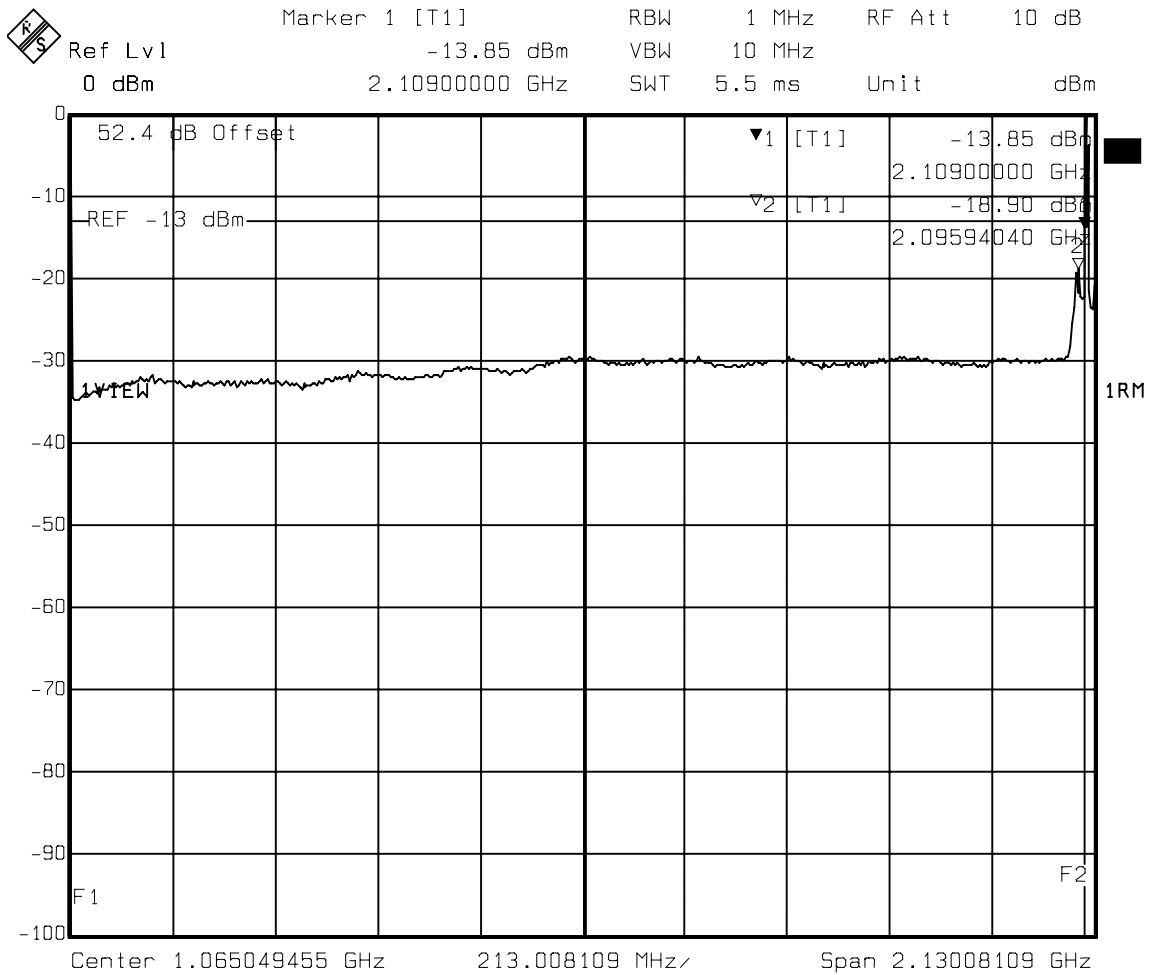
Title: 2MHz\_1MHz Upper adj channel, verification  
 Comment A: Temp C 25  
 Date: 24.JUL.2007 09:38:05

**Figure 31 : Conducted Spurious Emissions - 3 Carrier, Ch. 825, 850, 875, IS95 (5GHz to 22GHz)**



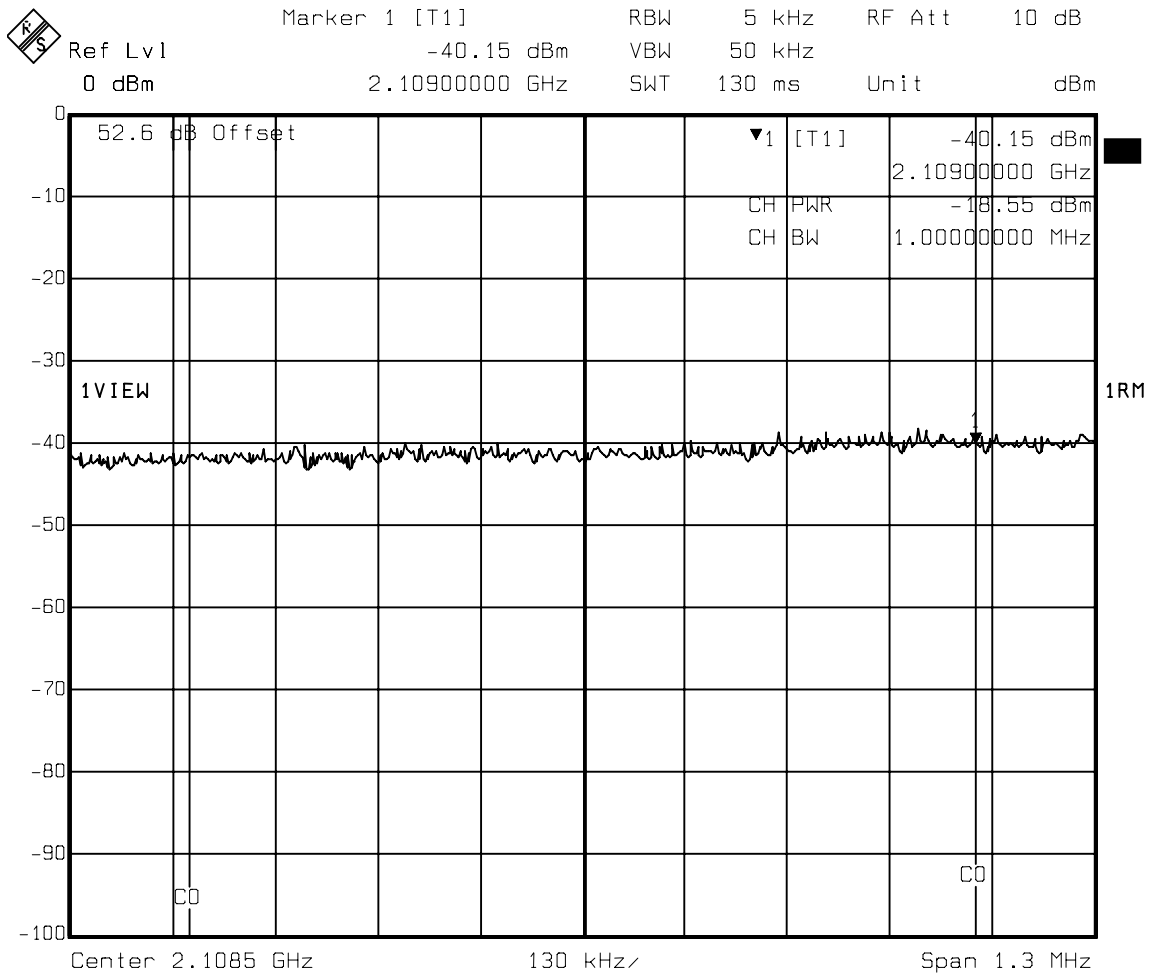
Title: 5 GHz to 22 GHz  
 Comment A: Temp C 25  
 Date: 23.JUL.2007 16:44:44

**Figure 32 : Conducted Spurious Emissions - 1 Carrier, Ch. 25, QPSK (9kHz to Lower Adjacent 1MHz)**



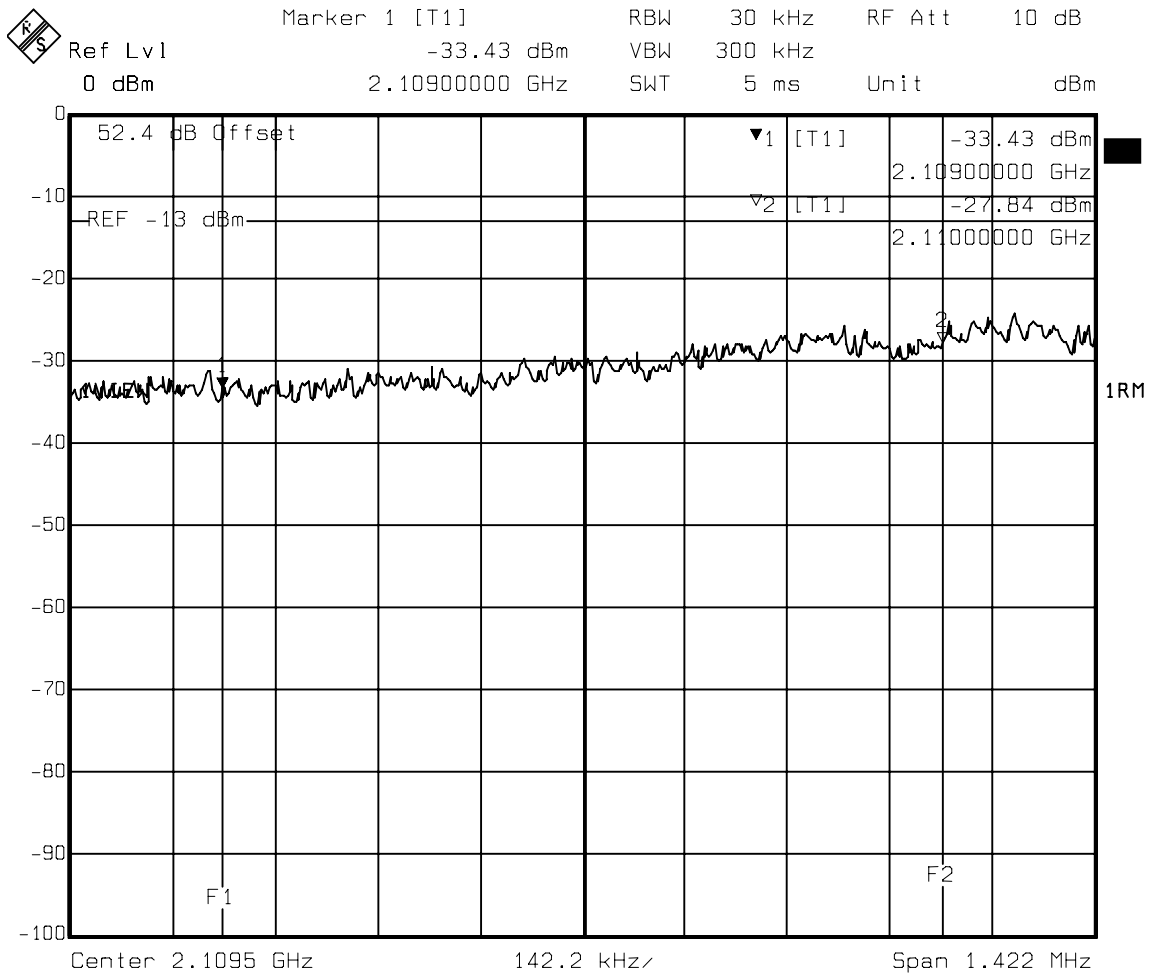
Title: 9kHz (Low edge-1.0MHz)  
 Comment A: Temp C 25  
 Date: 25.JUL.2007 13:40:59

**Figure 33 : Conducted Spurious Emissions - 1 Carrier, Ch. 25, QPSK (9kHz to Lower Adjacent 1MHz) Verification**



Title: 2MHz\_1MHz Low adj channel, verification  
 Comment A: Temp C 25  
 Date: 25.JUL.2007 13:43:45

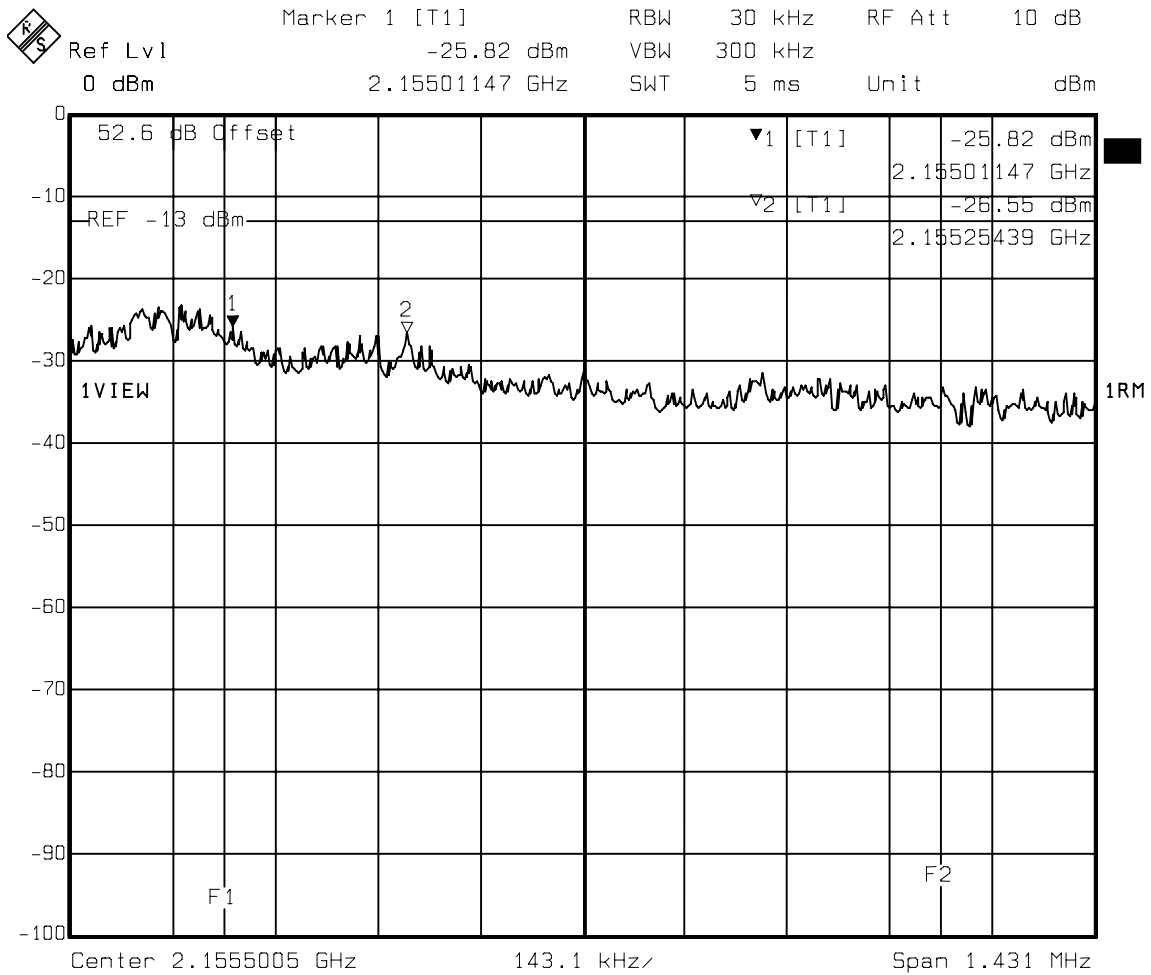
**Figure 34 : Conducted Spurious Emissions - 1 Carrier, Ch. 25, QPSK (Lower Adjacent 1MHz)**



Title: (Low edge-1.0MHz) to Low edge  
 Comment A: Temp C 25  
 Date: 25.JUL.2007 13:42:27

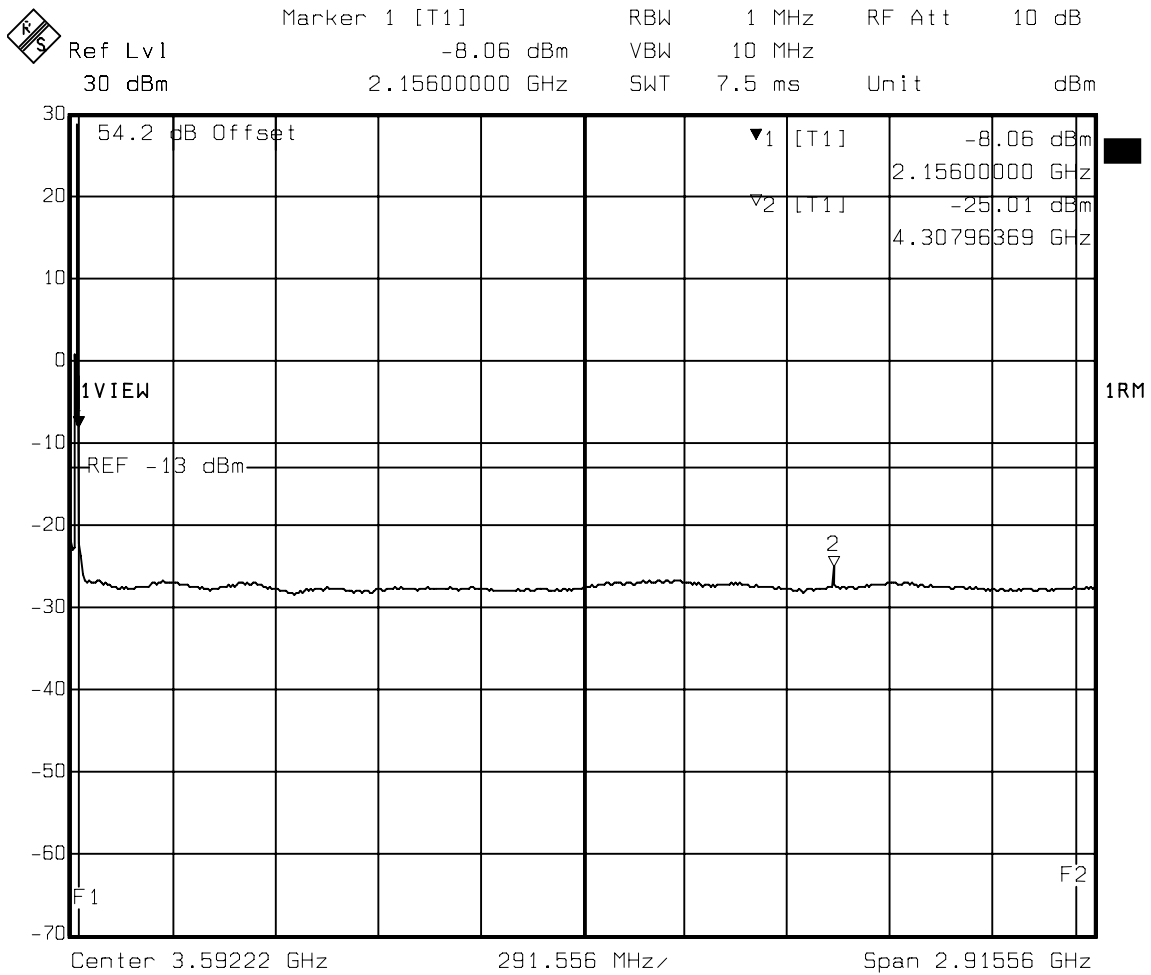


**Figure 35 : Conducted Spurious Emissions - 1 Carrier, Ch. 875, QPSK (Upper Adjacent 1MHz)**



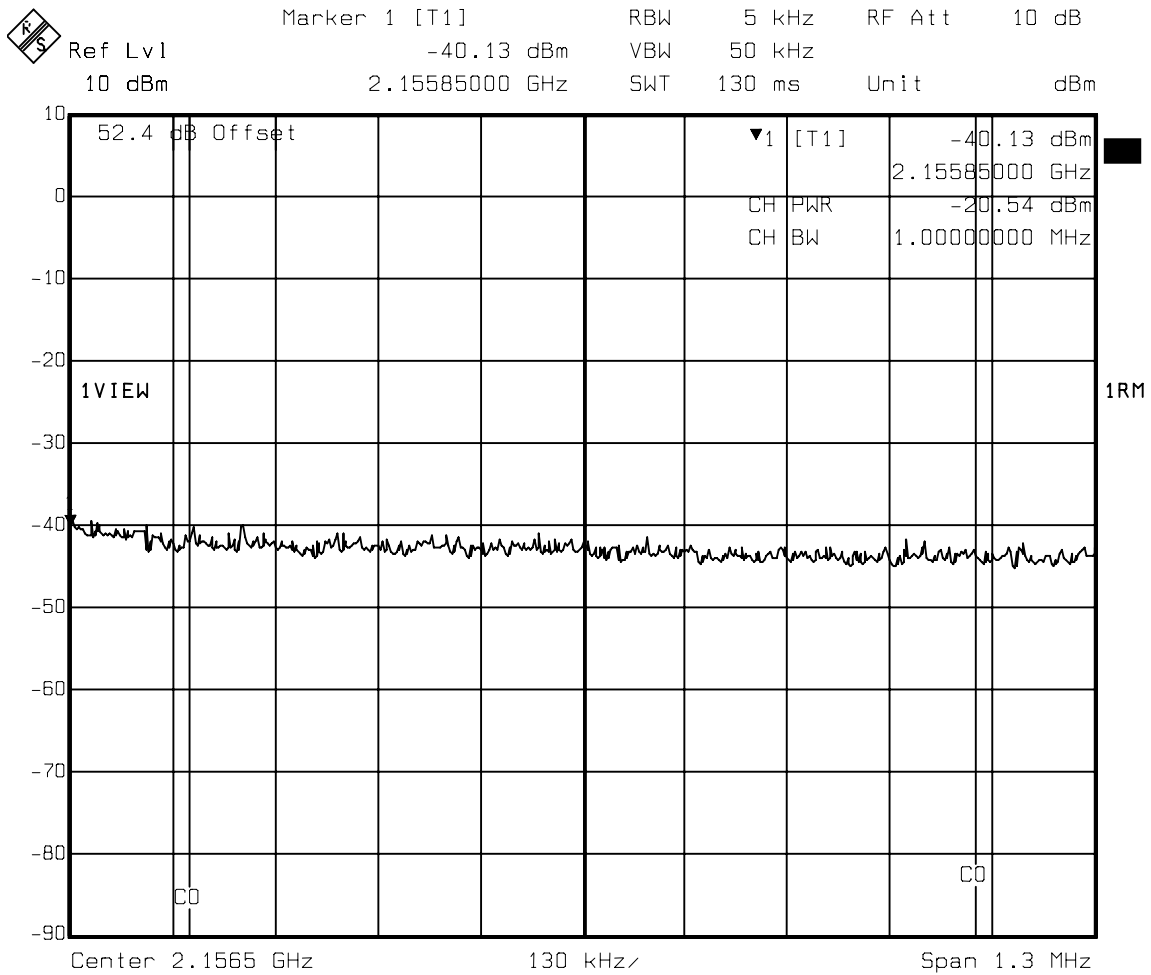
Title: Upper edge to (Upper edge + 1 MHz)  
 Comment A: Temp C 25  
 Date: 25.JUL.2007 14:31:41

**Figure 36 : Conducted Spurious Emissions - 1 Carrier, Ch. 875, QPSK (Upper Adjacent 1MHz to 5GHz)**



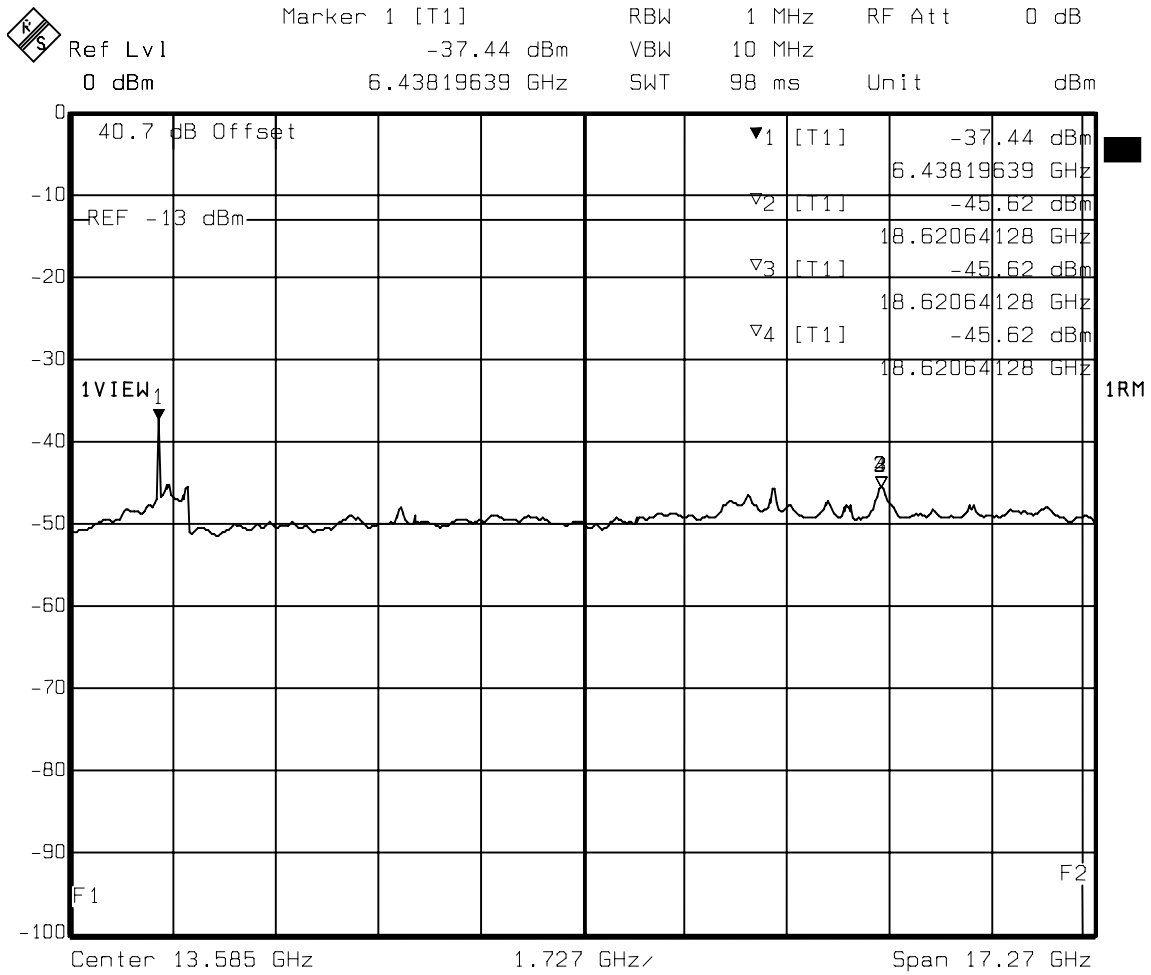
Title: (Upper edge + 1 MHz) to 5 GHz  
 Comment A: Temp C 25  
 Date: 25.JUL.2007 14:33:03

**Figure 37 : Conducted Spurious Emissions - 1 Carrier, Ch. 875, QPSK (Upper Adjacent 1MHz to 5GHz) Verification**



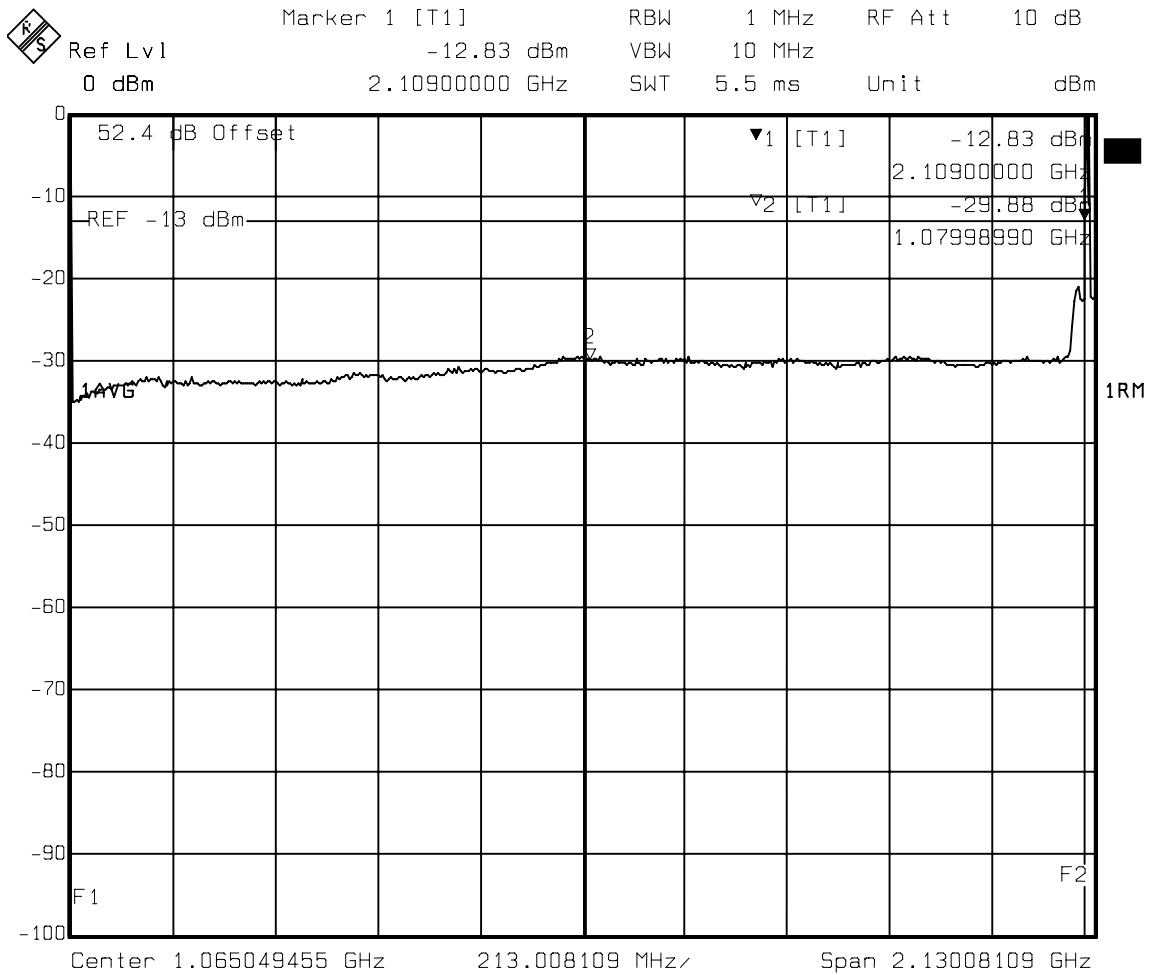
Title: 2MHz\_1MHz Upper adj channel, verification  
 Comment A: Temp C 25  
 Date: 25.JUL.2007 14:34:35

**Figure 38 : Conducted Spurious Emissions - 1 Carrier, Ch. 875, QPSK (5GHz to 22GHz)**



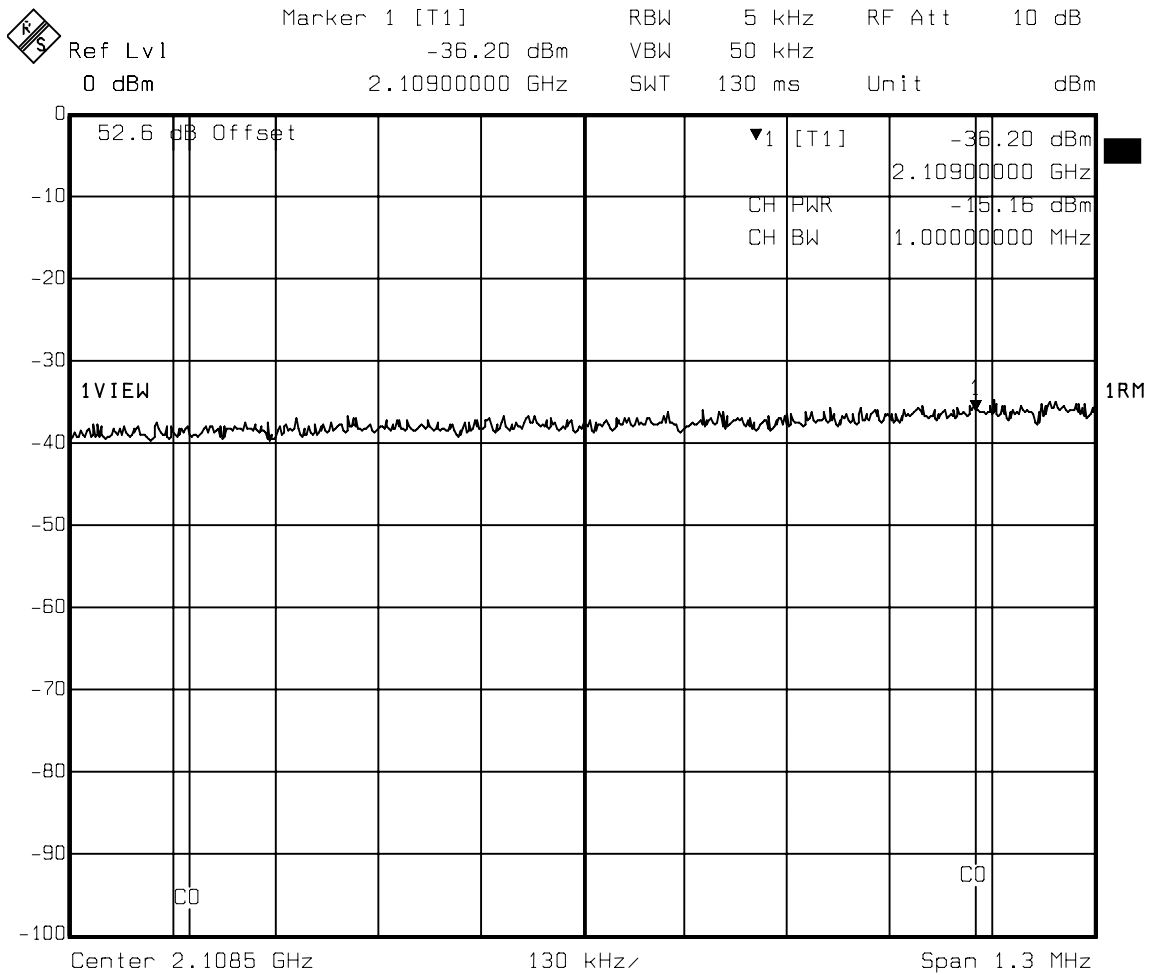
Title: 5 GHz to 22 GHz  
 Comment A: Temp C 25  
 Date: 23.JUL.2007 18:08:37

**Figure 39 : Conducted Spurious Emissions - 3 Carrier, Ch. 25, 50, 75, 8PSK (9kHz to Lower Adjacent 1MHz)**



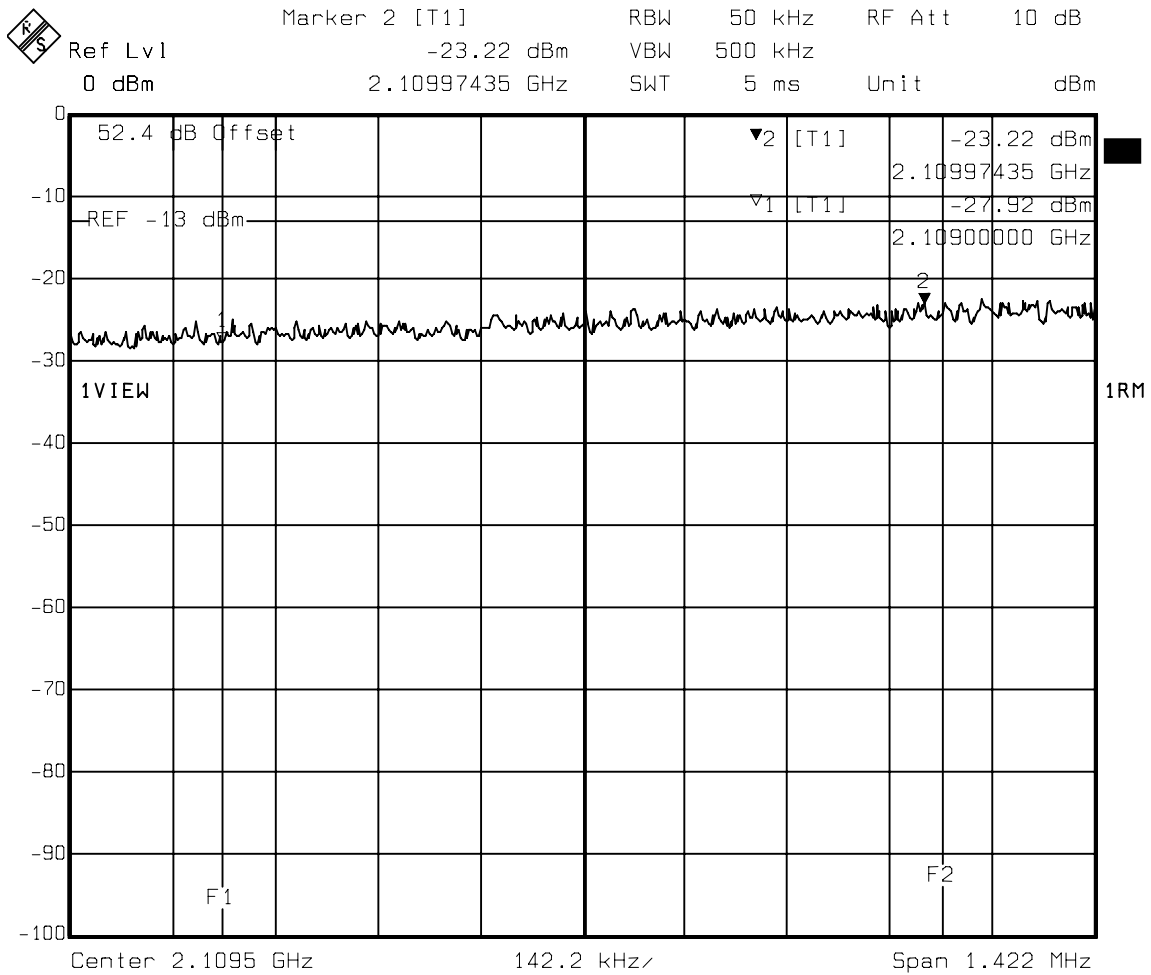
Title: 9kHz (Low edge-1.0MHz)  
 Comment A: Temp C 25  
 Date: 27.JUL.2007 09:02:29

**Figure 40 : Conducted Spurious Emissions - 3 Carrier, Ch. 25, 50, 75, 8PSK (9kHz to Lower Adjacent 1MHz) Verification**



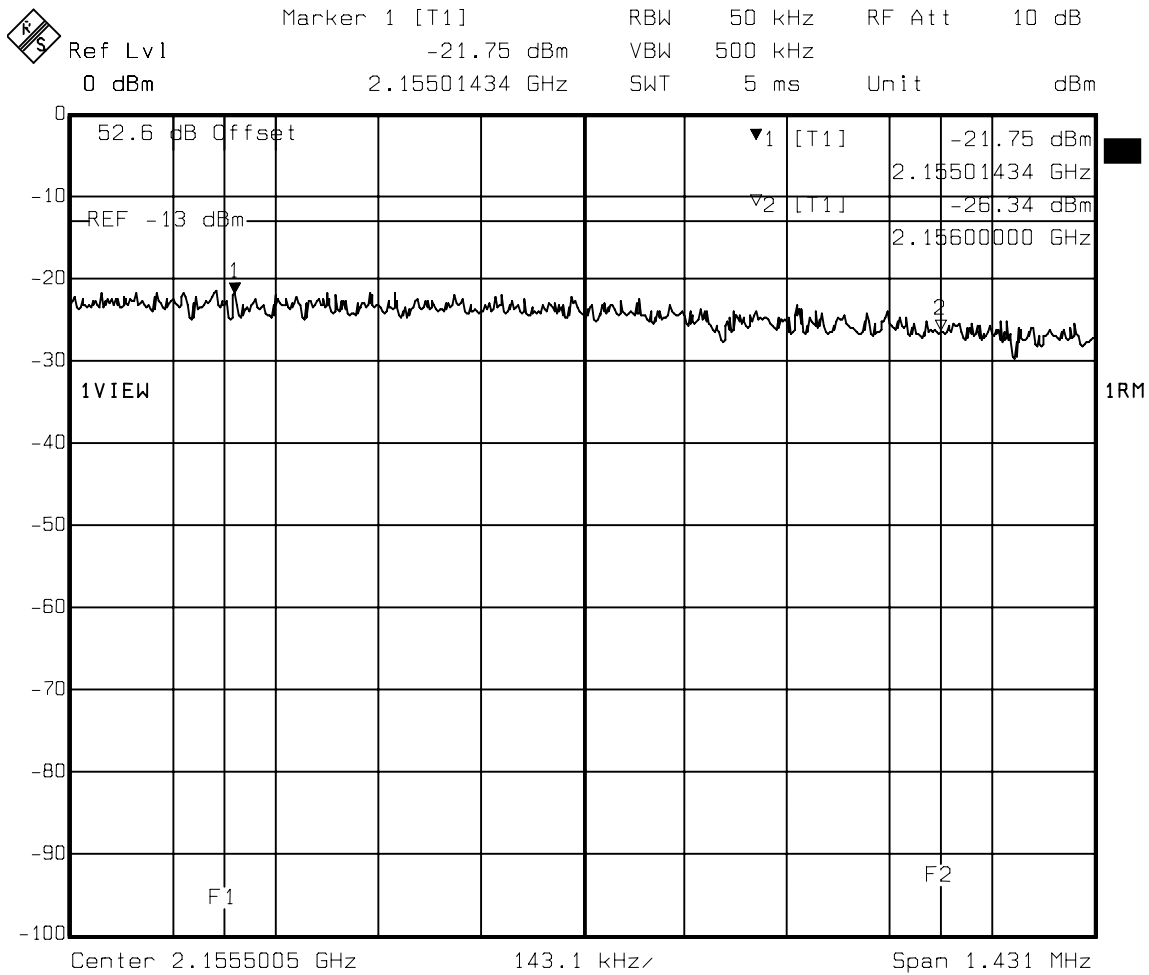
Title: 2MHz\_1MHz Low adj channel, verification  
 Comment A: Temp C 25  
 Date: 27.JUL.2007 09:05:42

**Figure 41 : Conducted Spurious Emissions - 3 Carrier, Ch. 25, 50, 75, 8PSK (Lower Adjacent 1MHz)**



Title: (Low edge-1.0MHz) to Low edge  
 Comment A: Temp C 25  
 Date: 27.JUL.2007 09:04:07

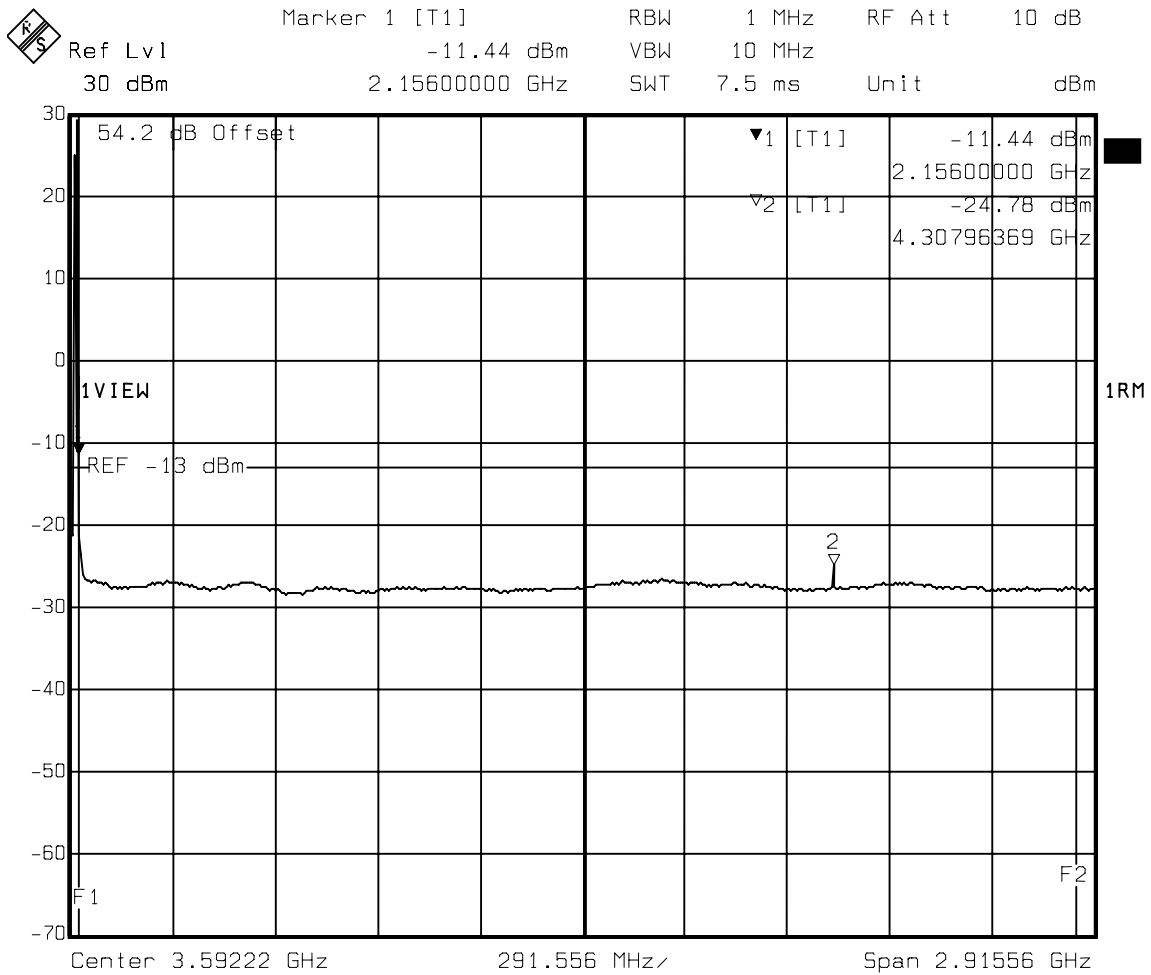
**Figure 42 : Conducted Spurious Emissions - 3 Carrier, Ch. 825, 850, 875, 8PSK (Upper Adjacent 1MHz)**



Title: Upper edge to (Upper edge + 1 MHz)  
 Comment A: Temp C 25  
 Date: 27.JUL.2007 10:02:55

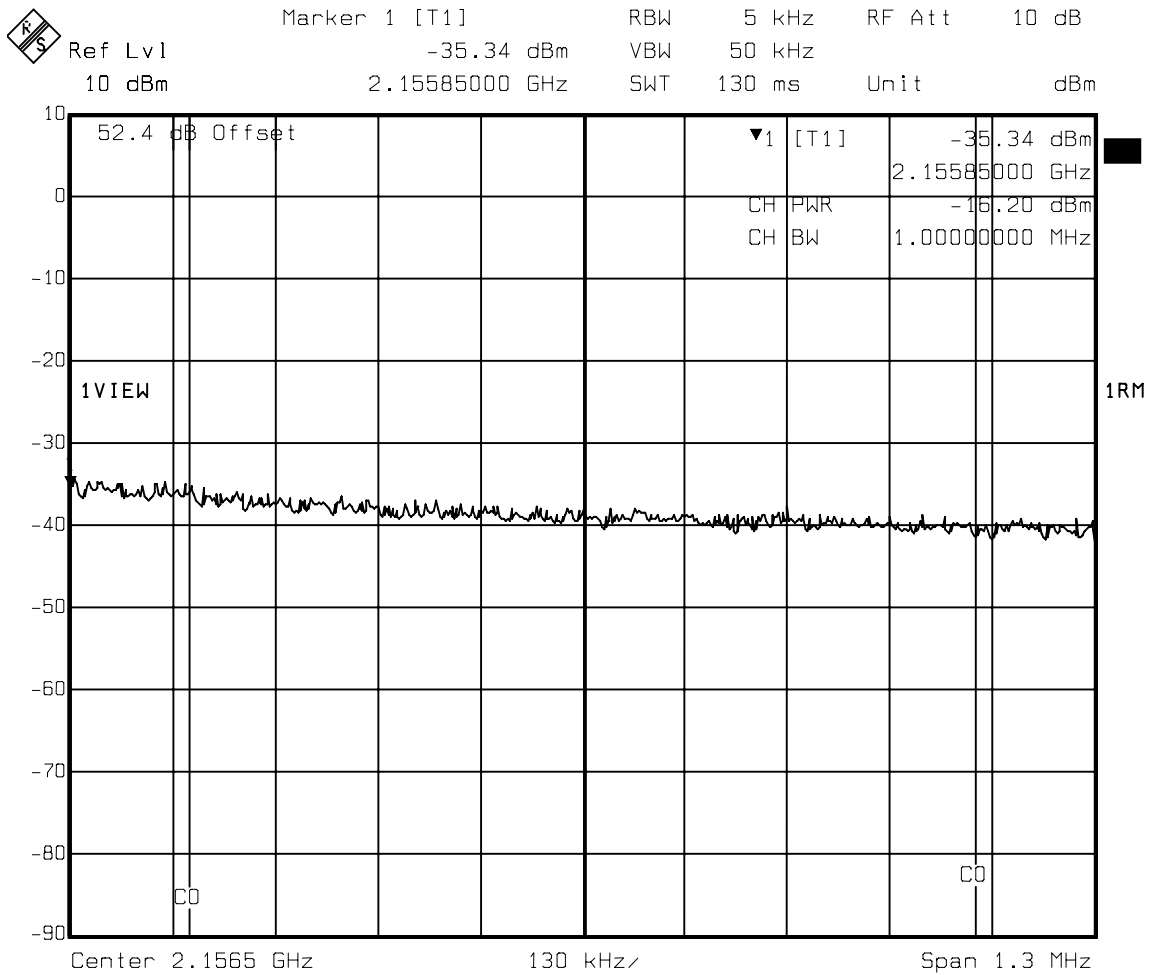


**Figure 43 : Conducted Spurious Emissions - 3 Carrier, Ch. 825, 850, 875, 8PSK (Upper Adjacent 1MHz to 5GHz)**



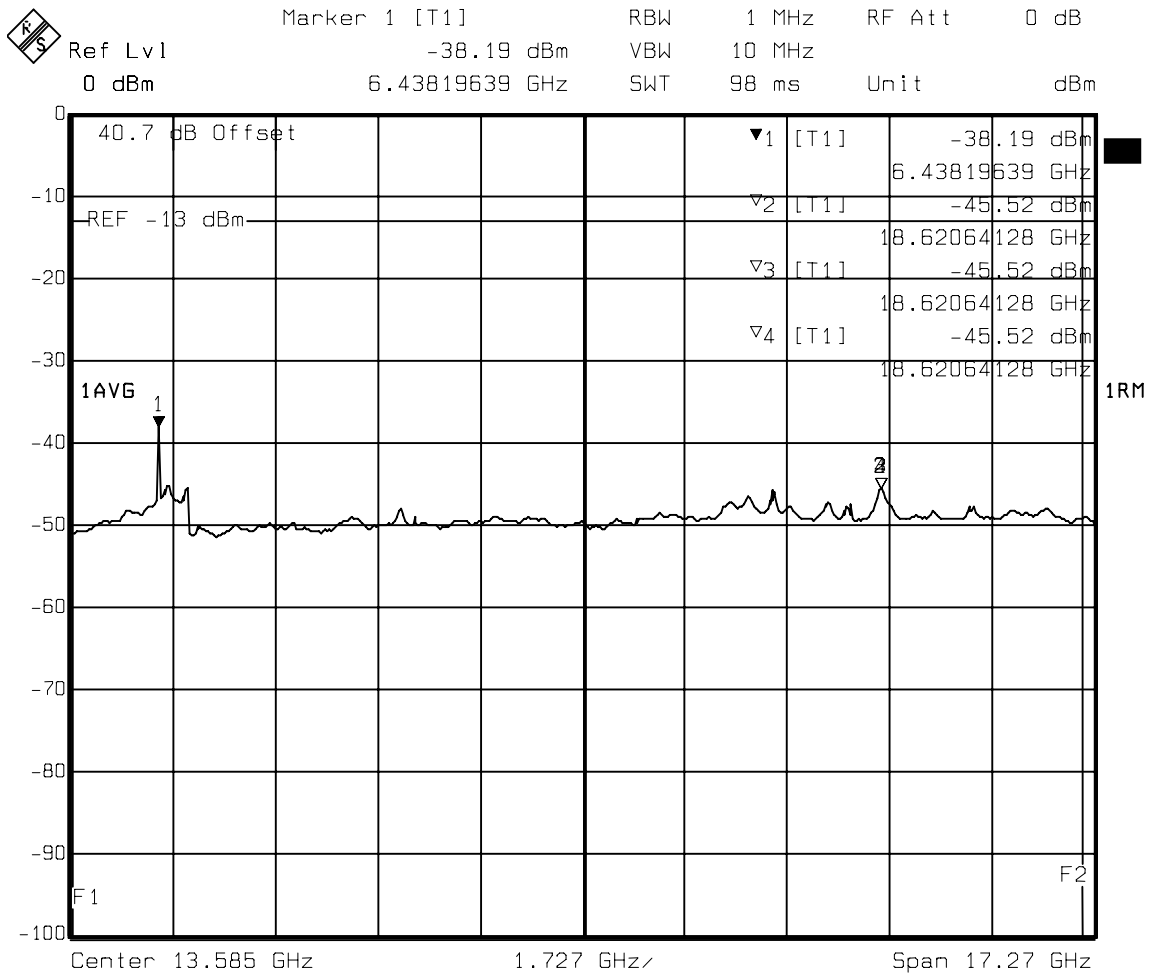
Title: (Upper edge + 1 MHz) to 5 GHz  
 Comment A: Temp C 25  
 Date: 27.JUL.2007 10:03:40

**Figure 44 : Conducted Spurious Emissions - 3 Carrier, Ch. 825, 850, 875, 8PSK (Upper Adjacent 1MHz to 5GHz) Verification**



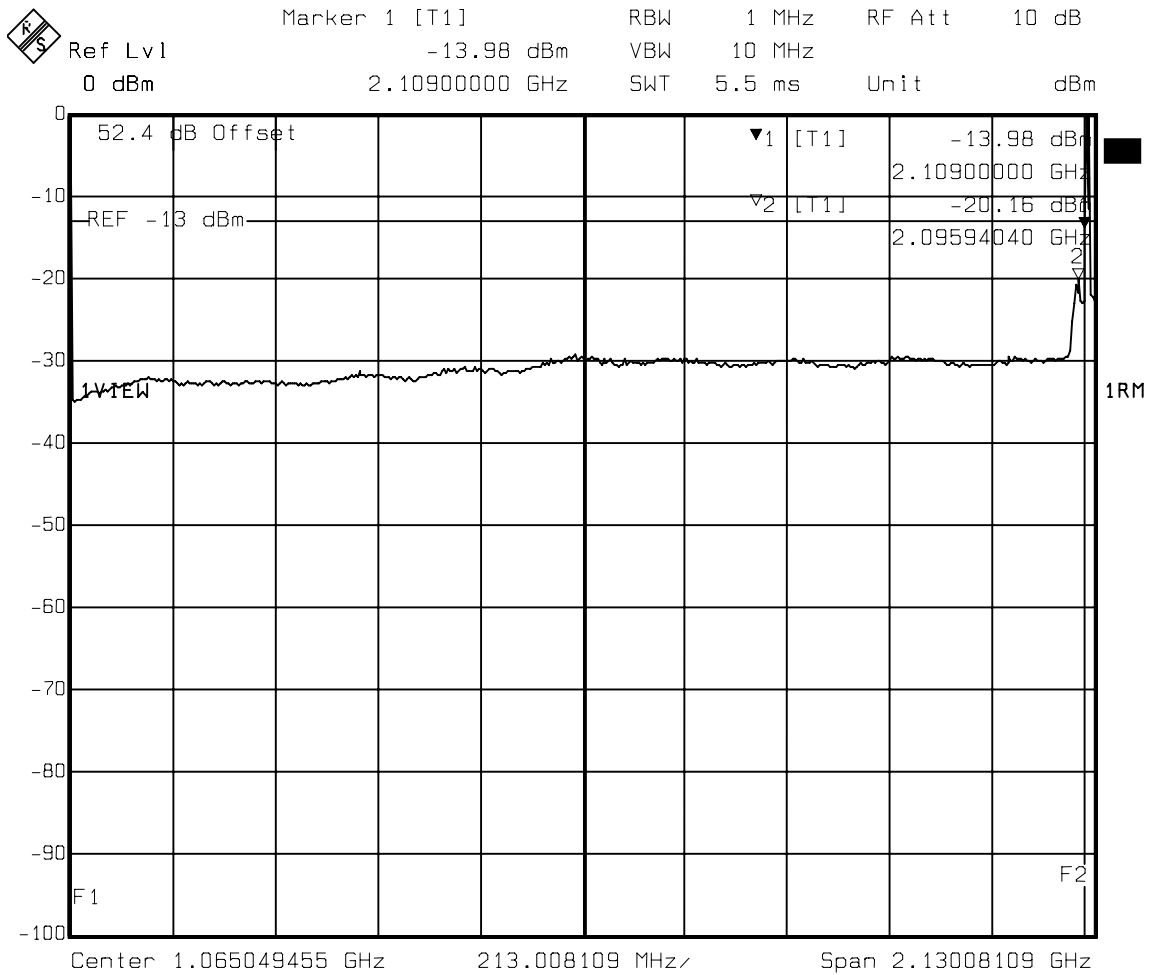
Title: 2MHz\_1MHz Upper adj channel, verification  
 Comment A: Temp C 25  
 Date: 27.JUL.2007 10:04:48

**Figure 45 : Conducted Spurious Emissions - 3 Carrier, Ch. 825, 850, 875, 8PSK (5GHz to 22GHz)**



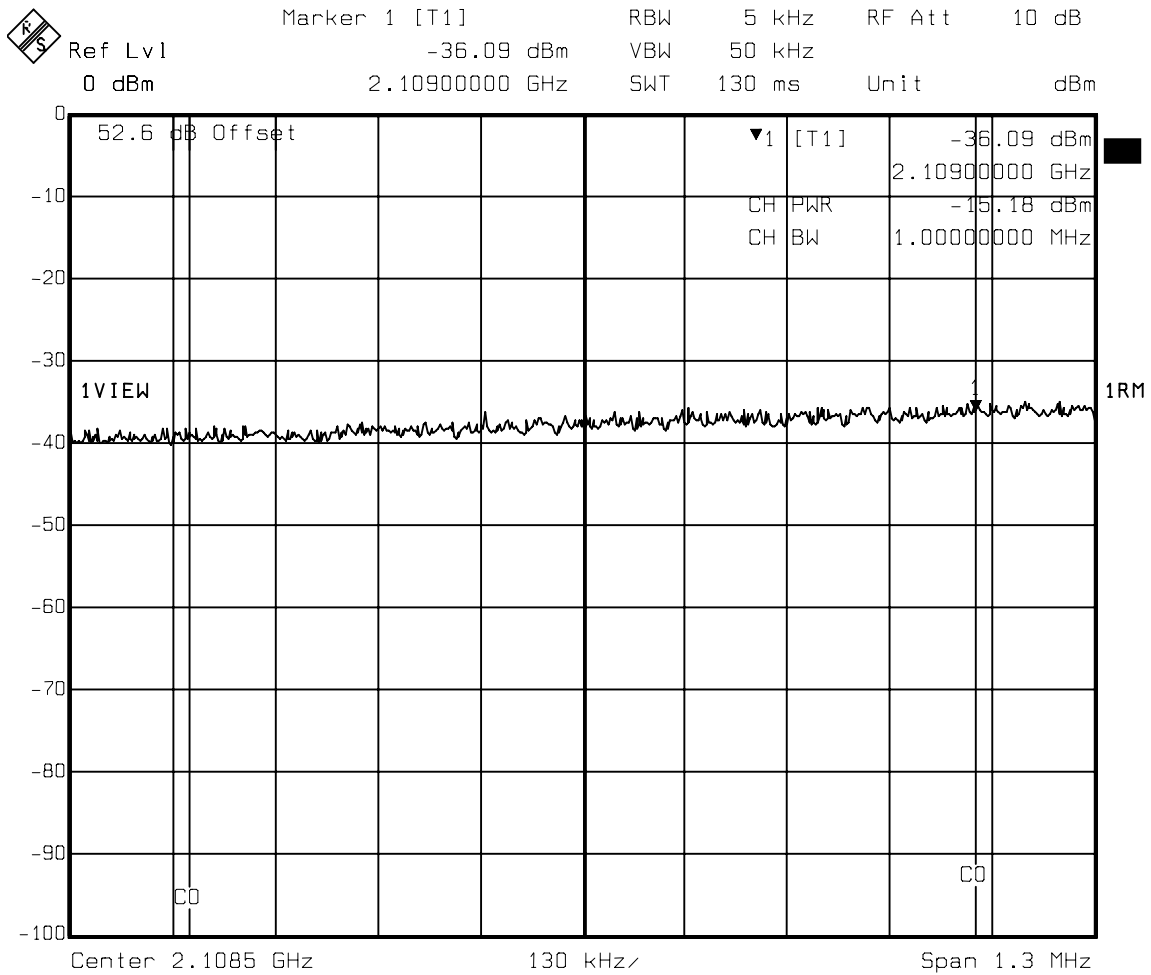
Title: 5 GHz to 22 GHz  
 Comment A: Temp C 25  
 Date: 23.JUL.2007 18:28:24

**Figure 46 : Conducted Spurious Emissions - 3 Carrier, Ch. 25, 50, 16QAM Ch. 75, IS95 (9kHz to Lower Adjacent 1MHz)**



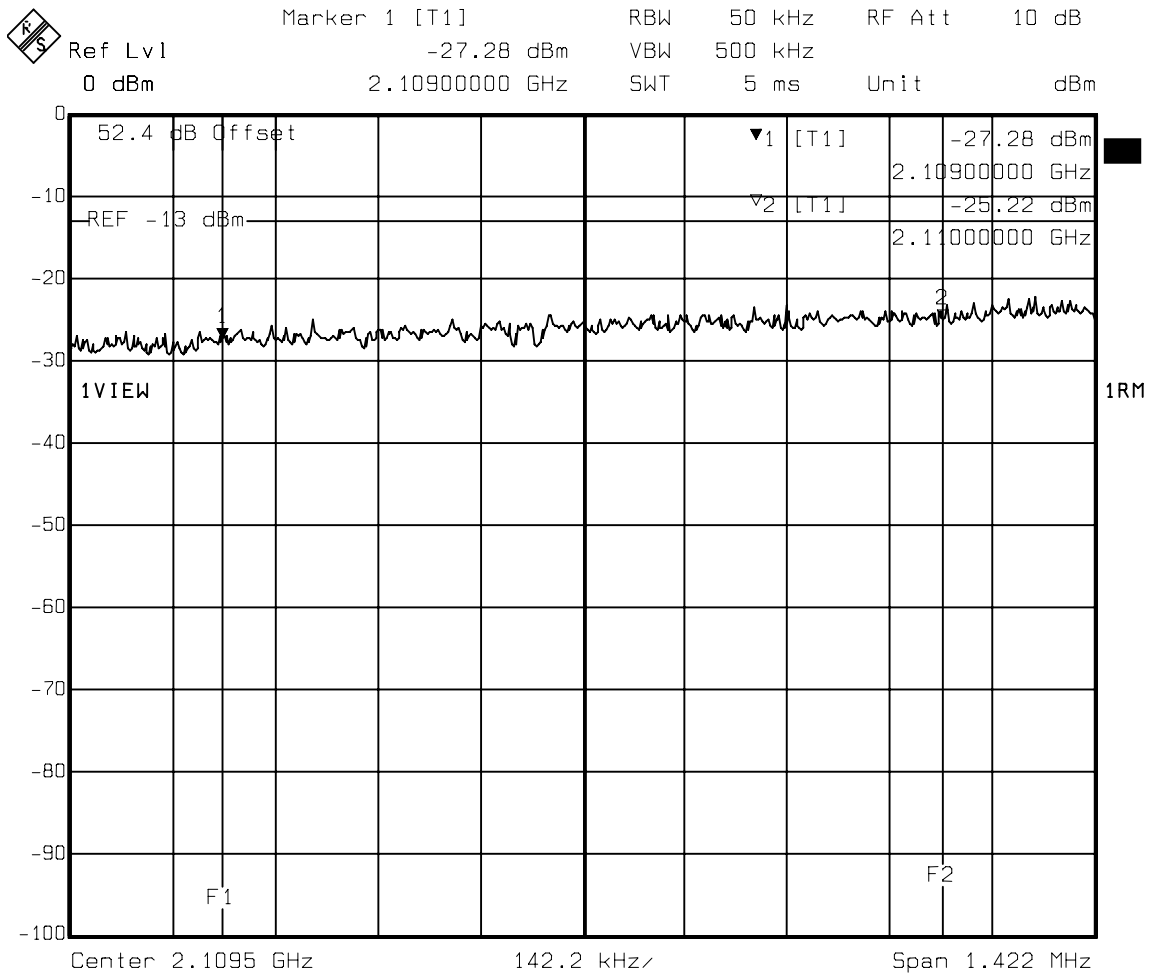
Title: 9kHz (Low edge-1.0MHz)  
 Comment A: Temp C 25  
 Date: 27.JUL.2007 11:13:11

**Figure 47 : Conducted Spurious Emissions - 3 Carrier, Ch. 25, 50, 16QAM Ch. 75, IS95 (9kHz to Lower Adjacent 1MHz) Verification**



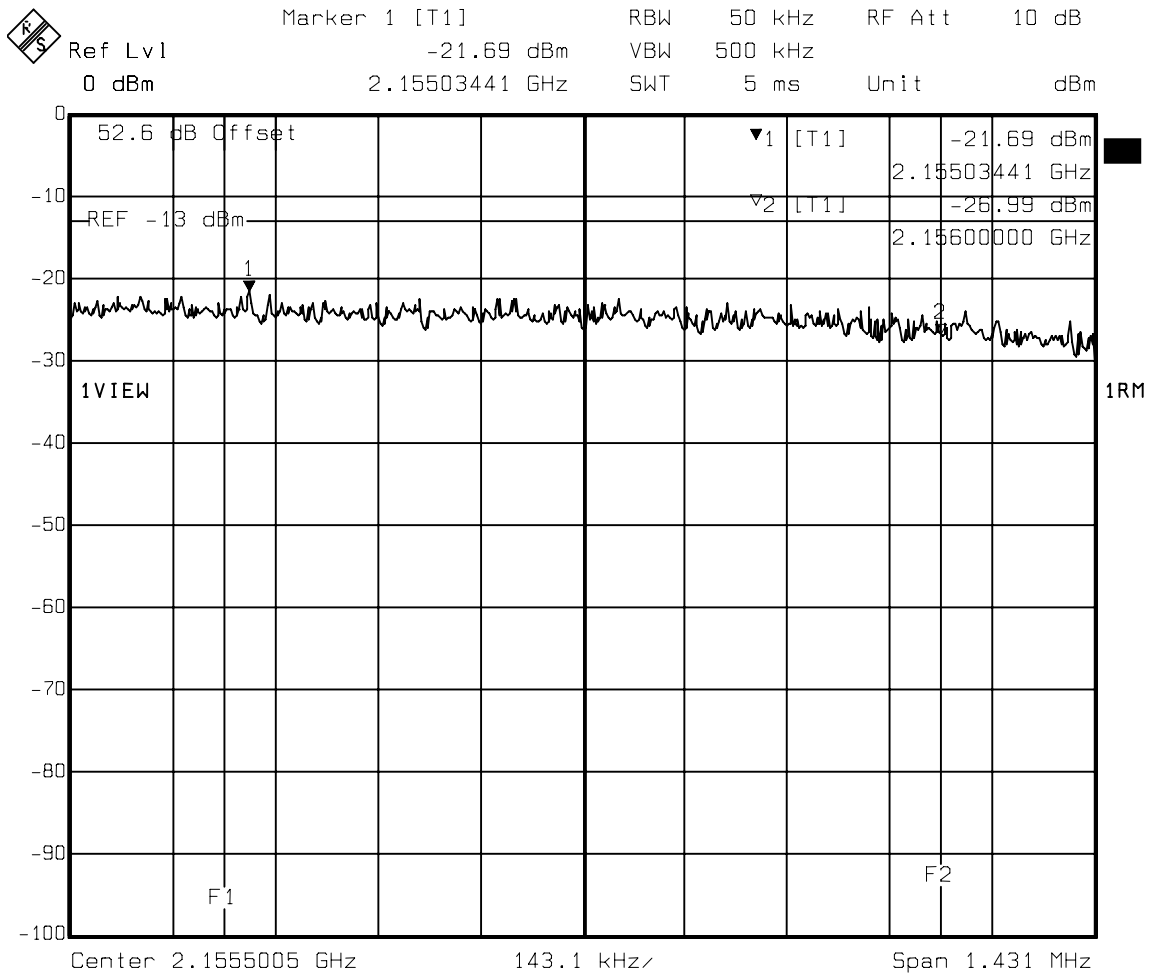
Title: 2MHz\_1MHz Low adj channel, verification  
 Comment A: Temp C 25  
 Date: 27.JUL.2007 11:15:02

**Figure 48 : Conducted Spurious Emissions - 3 Carrier, Ch. 25, 50, 16QAM Ch. 75, IS95 (Lower Adjacent 1MHz)**



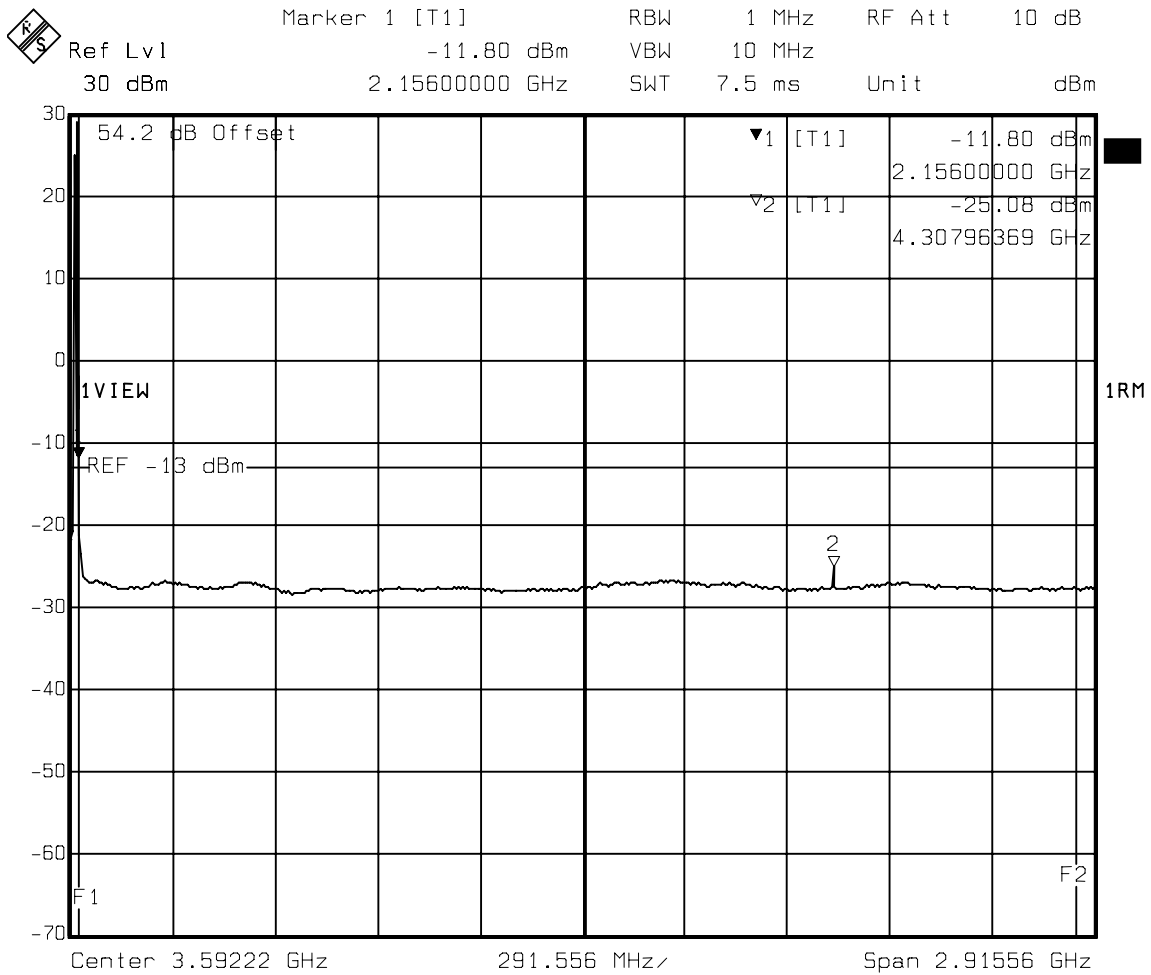
Title: (Low edge-1.0MHz) to Low edge  
 Comment A: Temp C 25  
 Date: 27.JUL.2007 11:14:14

**Figure 49 : Conducted Spurious Emissions - 3 Carrier, Ch. 825, 850, 16QAM Ch. 875, IS95 (Upper Adjacent 1MHz)**



Title: Upper edge to (Upper edge + 1 MHz)  
 Comment A: Temp C 25  
 Date: 27.JUL.2007 10:41:06

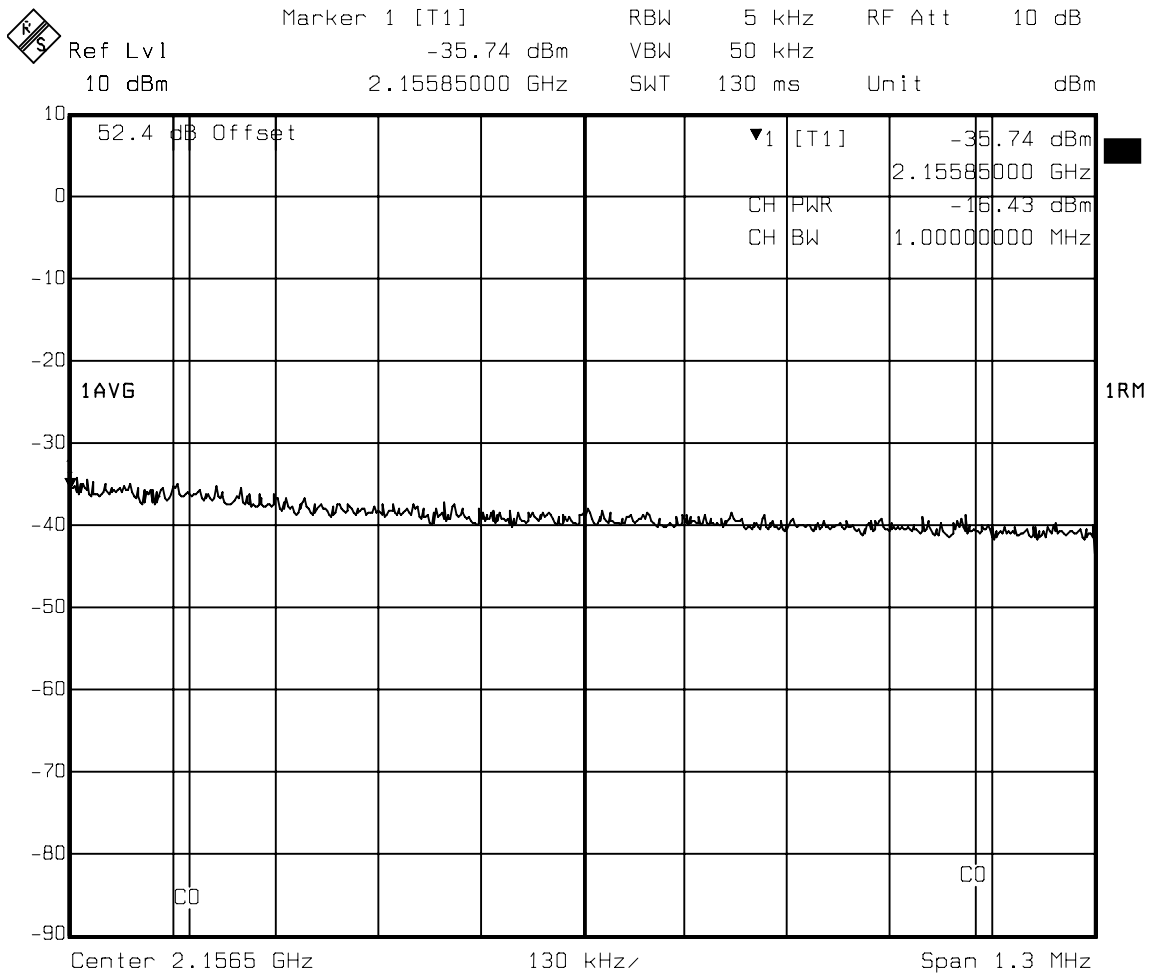
**Figure 50 : Conducted Spurious Emissions - 3 Carrier, Ch. 825, 850, 16QAM Ch. 875, IS95 (Upper Adjacent 1MHz to 5GHz)**



Title: (Upper edge + 1 MHz) to 5 GHz  
 Comment A: Temp C 25  
 Date: 27.JUL.2007 10:41:59

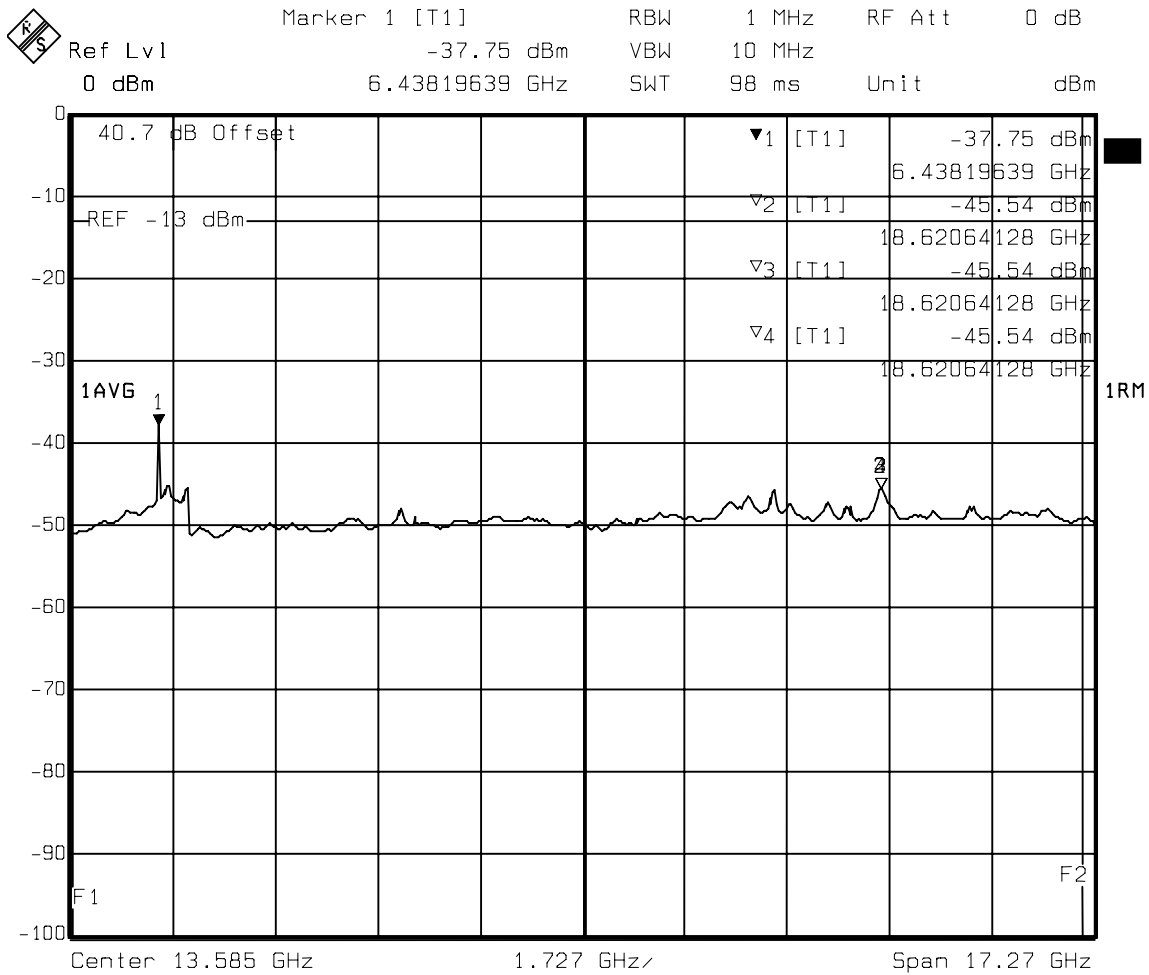


**Figure 51 : Conducted Spurious Emissions - 3 Carrier, Ch. 825, 850, 16QAM Ch. 875, IS95 (Upper Adjacent 1MHz to 5GHz) Verification**



Title: 2MHz\_1MHz Upper adj channel, verification  
 Comment A: Temp C 25  
 Date: 27.JUL.2007 10:42:53

**Figure 52 : Conducted Spurious Emissions - 3 Carrier, Ch. 825, 850, 16QAM Ch. 875, IS95 (5GHz to 22GHz)**



Title: 5 GHz to 22 GHz  
 Comment A: Temp C 25  
 Date: 23.JUL.2007 18:44:10