



Spurious Emissions Test Report for MFRM-2 FCC Part 24 and Industry Canada RSS-133

Document Number: KP000576-TR-RAD-01-02
Release Date: March 31, 2003

Prepared for: Nortel Networks
3500 Carling avenue
Ottawa, Ontario
Canada K1Y 8H9

Author: Denis Lalonde
Radio Compliance Discipline Leader

C-MAC Engineering Inc.
21 Richardson Side Road,
Kanata, Ontario, K2K 2C1
<http://www.engineering.cmac.com/>

© Copyright C-MAC Engineering Inc. March 31, 2003

The master of this document is stored on an electronic database and is “write-protected” and may be altered only by authorized persons at C-MAC Engineering Inc. Viewing of the master document electronically ensures access to the current issue. Any hard copies must be regarded as uncontrolled copies.





C-MAC Engineering Inc. accepts no liability for the content of this document except when it is reproduced in its entirety by a method acceptable to C-MAC Engineering Inc.

Release Control Record

This document is based on CEI document template KG000347-TR-EMC-03.

Release no.	Reason for change	Date released
01	Original version	March 6, 2003
02	Added substitution measurement data	March 31, 2003

Approvals

Function	Name	Job title	Signature
Document Release Approval	Real Perriard	Program Manager	 31MAR, 03
Tester	Denis Lalonde	Radio Compliance Discipline Leader	 March 31, 2003
Author	Denis Lalonde	Radio Compliance Discipline Leader	 March 31, 2003
Technical Reviewer	Horia Popovici	Radio Compliance Specialist	 Popovici, 31.03.2003

Accreditations

C-MAC Engineering EMC test facilities are accredited by the Standards Council of Canada (SCC) in accordance with the scope of accreditation outlined in <http://www.scc.ca/scopes/reg126-eng-s.pdf>.



Through a Mutual Recognition Agreement (MRA) between the National Voluntary Laboratory Accreditation Program (NVLAP) and SCC, the accreditation status of this facility is valid for the U.S.

The Federal Communications Commission (FCC) in the United States also recognizes these facilities to be compliant with the requirements of Section 2.948 of the FCC Rules, as outlined in a letter dated May 25, 1999 [2].

C-MAC Engineering is ISO 9001:2000 and ISO/IEC 17025 certified and its processes are documented in the C-MAC Engineering Quality Manual [3] and Lab Operations Manual [4].

Table of Contents

RELEASE CONTROL RECORD2

APPROVALS2

ACCREDITATIONS2

TABLE OF CONTENTS3

LIST OF FIGURES4

LIST OF TABLES4

1. EXECUTIVE SUMMARY.....6

2. SCOPE AND PURPOSE.....7

3. COMPLIANCE SUMMARY.....8

4. EQUIPMENT UNDER TEST (EUT)9

 4.1 PRODUCT FUNCTIONAL DESCRIPTION9

 4.2 MANUFACTURER INFORMATION9

 4.3 POWER REQUIREMENTS10

 4.4 GROUNDING REQUIREMENTS10

 4.5 CLOCKS / OSCILLATORS / SWITCHING POWER SUPPLY FREQUENCIES11

 4.6 SYSTEM COMPONENTS11

 4.7 EUT INTERFACES AND CABLES12

 4.8 SUPPORT EQUIPMENT13

 4.9 SYSTEM SET-UP AND TEST CONFIGURATIONS14

 4.10 EUT OPERATIONS AND SOFTWARE16

 4.11 SYSTEM MODIFICATIONS16

 4.12 SYSTEM INVENTORY LIST16

5. GENERAL TEST CONDITIONS18

 5.1 TEST FACILITY18

 5.2 MEASUREMENT INSTRUMENTATION18

6. E-FIELD RADIATED EMISSIONS19

 6.1 TEST SPECIFICATION19

 6.1.1 Limits19

 6.1.1.1 FCC Part 2.105319

 6.1.1.2 FCC Part 2.105719

 6.1.1.3 FCC Part 24.23819

 6.1.1.4 RSS-133 Section 6.320

 6.1.2 Field strength limit equivalent20

 6.2 TEST FACILITY INFORMATION21

The master of this document is stored on an electronic database and is "write-protected" and may be altered only by authorized persons at C-MAC Engineering Inc.. Viewing of the master document electronically ensures access to the current issue. Any hard copies must be regarded as uncontrolled copies.

6.3	TEST CONFIGURATIONS	21
6.4	TEST PROCEDURE	21
6.5	TEST RESULTS	22
6.6	MEASUREMENT UNCERTAINTIES	24
6.7	CALCULATION OF THE COMPLIANCE MARGIN	24
6.8	TEST CONCLUSION	24
6.9	TEST EQUIPMENT LIST	25
7.	REFERENCES	26
7.1	APPLICABLE DOCUMENTS	26
7.2	REFERENCE DOCUMENTS	26
8.	APPENDICES	27
8.1	APPENDIX A: GLOSSARY	27
8.2	APPENDIX B: TEST SET-UP PHOTOGRAPHS	29
8.3	APPENDIX C: RADIATED EMISSIONS PLOTS	30

List of Figures

FIGURE 4-1: MFRM-2 PICTURE.....	9
FIGURE 4-2: SYSTEM GROUNDING.....	10
FIGURE 4-3: HARDWARE SET-UP FOR EMISSIONS	15
FIGURE 4-4: EUT SHELF CONFIGURATION	16
FIGURE 8-1: MFRM-2 [RADIATED EMISSION] SET-UP.....	29
FIGURE 8-2: E-FIELD RADIATED EMISSIONS, 30 – 1000 MHz (CONFIGURATION No.1).....	30
FIGURE 8-3: E-FIELD RADIATED EMISSIONS, 1 GHz – 10 GHz (CONFIGURATION No.1)	31
FIGURE 8-4: E-FIELD RADIATED EMISSIONS, 10 GHz – 18 GHz (CONFIGURATION No.1)	32
FIGURE 8-5: E-FIELD RADIATED EMISSIONS, 18 GHz – 20 GHz (CONFIGURATION No.1)	33
FIGURE 8-6: E-FIELD RADIATED EMISSIONS, 30 – 1000 MHz (CONFIGURATION No.2).....	34
FIGURE 8-7: E-FIELD RADIATED EMISSIONS, 1 GHz – 10 GHz (CONFIGURATION No.2)	35
FIGURE 8-8: E-FIELD RADIATED EMISSIONS, 10 GHz – 18 GHz (CONFIGURATION No.2)	36
FIGURE 8-9: E-FIELD RADIATED EMISSIONS, 18 GHz – 20 GHz (CONFIGURATION No.2)	37

List of Tables

TABLE 3-1: COMPLIANCE RESULTS SUMMARY.....	8
TABLE 4-1: POWER REQUIREMENTS	10
TABLE 4-2: EUT FUNDAMENTAL FREQUENCIES	11



TABLE 4-3: SYSTEM COMPONENTS	11
TABLE 4-4: SYSTEM CABLES	12
TABLE 4-5 TEST BED	13
TABLE 4-6 SUPPORT EQUIPMENT	14
TABLE 4-7 MFRM-2 CONFIGURATION	15
TABLE 4-8: INVENTORY LIST	17
TABLE 6-1: E-FIELD RADIATED EMISSIONS REQUIREMENTS.....	19
TABLE 6-2: SPURIOUS EMISSIONS LIMITS FOR FCC PART 24 AND IC RSS-133	21
TABLE 6-3: E-FIELD RADIATED EMISSIONS TEST RESULTS	23
TABLE 6-4: TEST EQUIPMENT USED FOR E-FIELD RADIATED EMISSIONS	25

1. Executive Summary

The MFRM-2 is a 1-sector, 3 carrier product, similar to the MFRM except that the MPAM and MTRM from the MFRM are integrated into a single module for MFRM-2. The resulting new module, named the MFRM-2 Radio Module, consists of the following: a wide voltage range Power Entry Module (WR MPEM); a High Power Converter Assembly (WR HCPA); a Radio Power Supply Unit (PSU); a transceiver card; a power amplifier (PA); interface cables; and mechanical assemblies.

At the request of the Customer Development group, C-MAC Engineering Product Integrity has evaluated the system radiated spurious emissions. This report describes the test results of the FCC Part 24 and Industry Canada RSS-133 radiated emissions tests performed on the MFRM-2 system.

On the basis of measurements performed in January and February 2003, MFRM-2 is verified to be compliant with the radiated emissions requirements of FCC Part 24 (and Industry Canada RSS-133). The test data included in this report apply to the product titled above manufactured by Nortel Networks.

2. Scope and Purpose

At the request of the Customer Development group, C-MAC Engineering Product Integrity has evaluated the system radiated spurious emissions. This report describes the test results of the FCC Part 24 and Industry Canada RSS-133 radiated emissions tests performed on the MFRM-2 system.

3. Compliance Summary

This section summarizes all the measurements performed on MFRM-2 and its compliance to FCC Part 24 and Industry Canada RSS-133.

Table 3-1: Compliance Results Summary

Product Summary					
Product Name:	MFRM-2	Project Leader:	Real Perriard		
Product Code:		EMC Engineer:	Denis Lalonde		
Product Release:		Tester:	Alain Lavoie, Denis Lalonde		
Product Status:	GA	Date:	January, February , & March 2003		
Test Cases ¹					
Completed	Description	Specification	Test Results		Notes
			Pass	Fail	
■	Radiated Emissions (E-field)	FCC Part 24	■	<input type="checkbox"/>	Tested with both +24V & -48V
■	Radiated Emissions (E-field)	Industry Canada RSS-133	■	<input type="checkbox"/>	Tested with both +24V & -48V

1. All the emissions measurements were performed at C-MAC Engineering Inc., Kanata, Ontario.

4. Equipment Under Test (EUT)

4.1 Product Functional Description

The MFRM-2 is a 1-sector, 3 carrier product, similar to the MFRM except that the MPAM and MTRM from the MFRM are integrated into a single module for MFRM-2. The resulting new module, named the MFRM-2 Radio Module, consists of the following: a wide voltage range Power Entry Module (WR MPEM); a High Power Converter Assembly (WR HCPA); a Radio Power Supply Unit (PSU); a transceiver card; a power amplifier (PA); interface cables; and mechanical assemblies.

The MFRM-2 Radio Brick is shown in Figure 4-1.

Figure 4-1: MFRM-2 picture

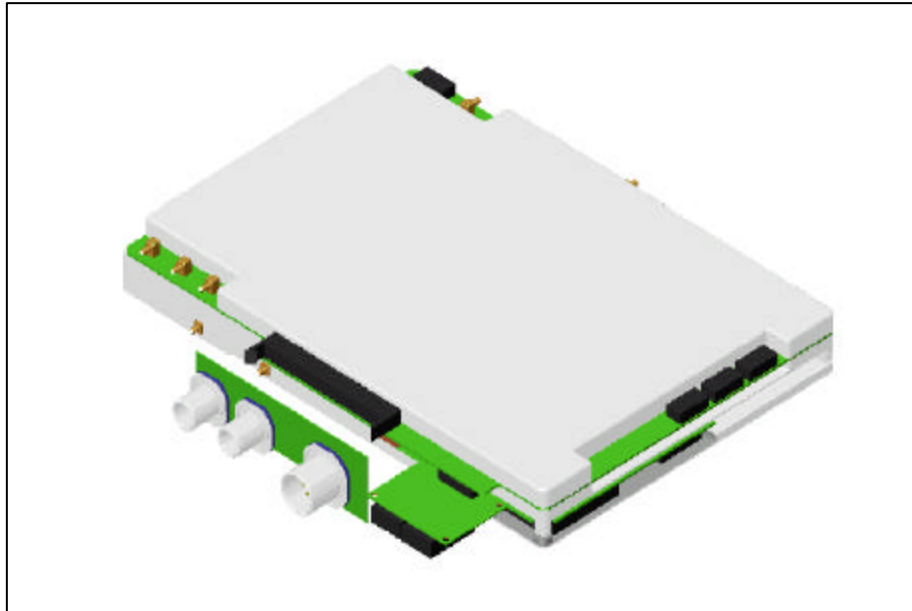

4.2 Manufacturer Information

Company Name	Nortel Networks
Mailing Address	3500 Carling avenue, Ottawa, Ontario, Canada K1Y 8H9
Product Name	MFRM-2
Primary Technical Contact	James Loo
Title	CDMA BTS RF Systems Development
Phone	613-765-2441
E-mail	James.Loo@nortelnetworks.com

4.3 Power Requirements

For the purposes of EMC testing, the power requirements were as follows:

Table 4-1: Power Requirements

Feed	Voltage	Current
A	-48 V DC	70 A max
B	+24 V DC	145 A max

4.4 Grounding Requirements

For the purposes of the EMC testing, the system was grounded in the same manner as its typical installation as shown in Figure 4-2.

Figure 4-2: System grounding

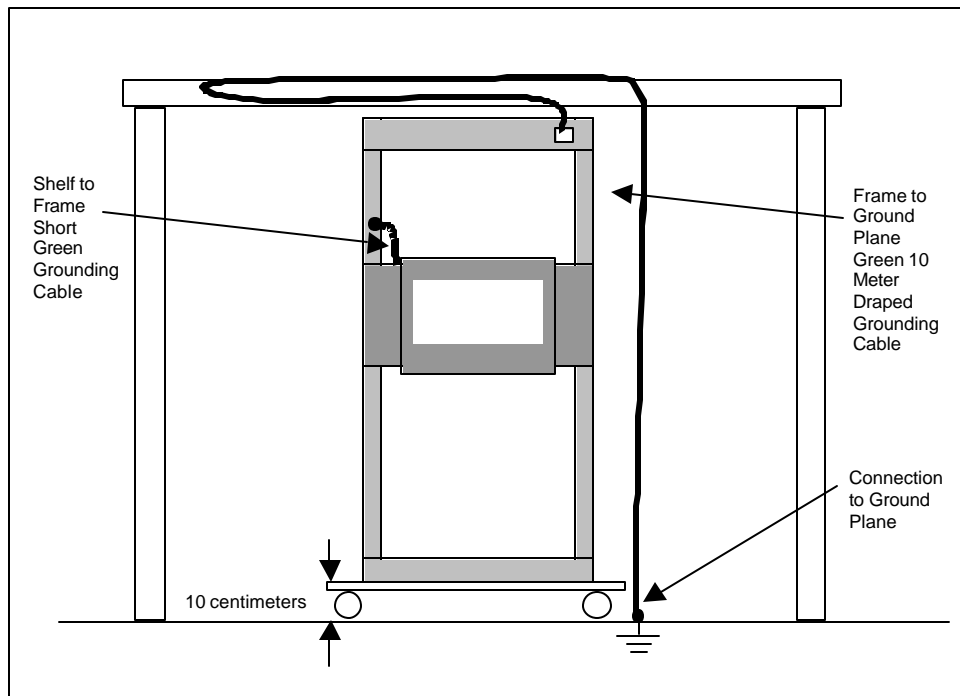

4.5 Clocks / Oscillators / Switching Power Supply Frequencies

Table 4-2 lists all the clock sources (e.g., discrete crystals and VCXOs) used in the configurations under test (and, where appropriate, the sub-multiples when clock division has been employed for distribution to other circuit packs).

Table 4-2: EUT Fundamental Frequencies

Circuit Pack	Fundamental Frequencies (MHz)
Digital clocks	24.0, 39.3216, 63.6976, 78.6432, 638.976
Radio signals	9.8304, 19.2, 88.5, Tx_Freq + 9.8303, Tx_Freq - 153.6

Note: The tests in this document were done with Tx_Freq = 1960.0 MHz

4.6 System Components

The system tested consists of the following units, as shown in Table 4-3 and Figure 4-1.

Table 4-3: System Components

Component	Code	Release	Quantity
MFRM-2	NTGY30BA	T2	1
MFRM-2	NTGY30BA	T3	5

4.7 EUT Interfaces and Cables

The system contained the following interfaces, as shown in Table 4-4:

Table 4-4: System Cables

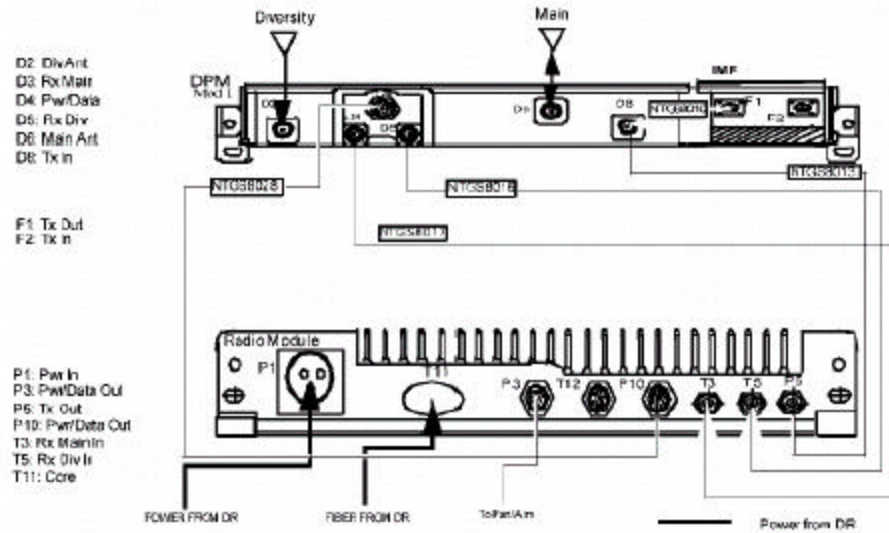

Note: Subsequent 800MHz configurations will be illustrated with the optional IMF installed. Use the following table to determine the provisional cable requirements.

CABLE TYPE	PEC	FROM CONNECTOR	TO CONNECTOR	NOTE
RF	NTGS8017	D3 - DPM - Rx Main out	T3 - Radio Module - Rx In	2
RF	NTGS8016	D5 - DPM - Rx Div out	T5 - Radio Module - Rx In	1
RF	NTGS8013	P5 - Radio Module - Tx out	D8 - DPM - Tx in (w/o IMF) or F2 - IMF - Tx in	1
RF	NTGS8010	F1 - IMF - Tx out	D8 - DPM - Tx in	*
Pwr/Data	NTGS8028	P10 - Radio Module - Pwr/Data out	D4 - DPM - Pwr/Data in	1

NOTE: * The IMF and NTGS8010 IMF jumper cable are to be provisioned together (optional).

1. This cable is part of the module assembly.
2. This cable is provisional.

4.8 Support Equipment

The support equipment is defined in Table 4-5 and Table 4-6.

Table 4-5 Test bed

Description	Model	Ser #	Cal Date	Notes
Cell Site Tester or VSA	Agilent E4406		06 July 2003	
Power Meter	HP 438A		11 April 2004	
Power Sensor	HP 8481A		09 April 2004	
Power Sensor	HP 8481D		22 Febr 2003	
Spectrum Analyzer	R&S FSEM		28 Febr 2003	
RS422 Converter				
PC	DELL GX200	1337086		
Power Supply	Xantrex 20-3			Used for mobile
Mobile	QCP 1960	2723331186A		

Table 4-6 Support equipment

Qty.	Description	Pec Code	Rel	Serial #	Where used
2	Metrocell AC Digital Rack	NTGS35AA			EMC/Safety
1	Metrocell Radio Rack	NTGS65AA			EMC
3	Mini-RE	NTGT30CA			EMC
3	Core Module	NTGS30AA		NNTM NNTM	EMC/Safety Safety
3	Control Module	NTGS40AA		NNTM NNTM	EMC/Safety Safety
2	GPSTM	NTGS50AA			EMC/Safety
9	XCEM	NTGS63BA			
12	MFRM mounting brackets	NTGS6570			EMC/Safety
9	1900MHz DPM	NTGS53KA		XX XXX XX XX XX XX	EMC/Safety EMC/Safety Safety Safety Safety Safety
9	Fiber Cables	NTGY5521			EMC/Safety
3	MFRM 1900 MHz	NTGY55KT			EMC/Safety
1	Metrocell Outdoor Radio Enclosure	NTGS03AA			Safety
1	INDOOR ALARM MDF CABLE	NTGS3518			ENC

4.9 System Set-up and Test Configurations

The configuration used for radiated emissions is presented in Table 4-7 and Figure 4-3.

The definition of configuration 1 is shown in Table 4-7, configuration 2 is the same except that the power supply voltage is -48 V.

Table 4-7 MFRM-2 configuration

Configuration	No. MFRM-2	HPCA	MPEM	Mode	RR/RE
RAD.1	MFRM-2 #1	Astec	GE-ACT	+24V	RR or RE
	MFRM-2 #2	Astec	GE-ACT	+24V	
	MFRM-2 #3	Astec	Spectrum	+24V	
	MFRM-2 #4	Acsom	Spectrum	+24V	
	MFRM-2 #5	Acsom	Spectrum	+24V	
	MFRM-2 #6	Acsom	GE-ACT	+24V	

Each MFRM-2 has its transmitter output connected to a 50 ohm load.

Figure 4-3: Hardware set-up for Emissions

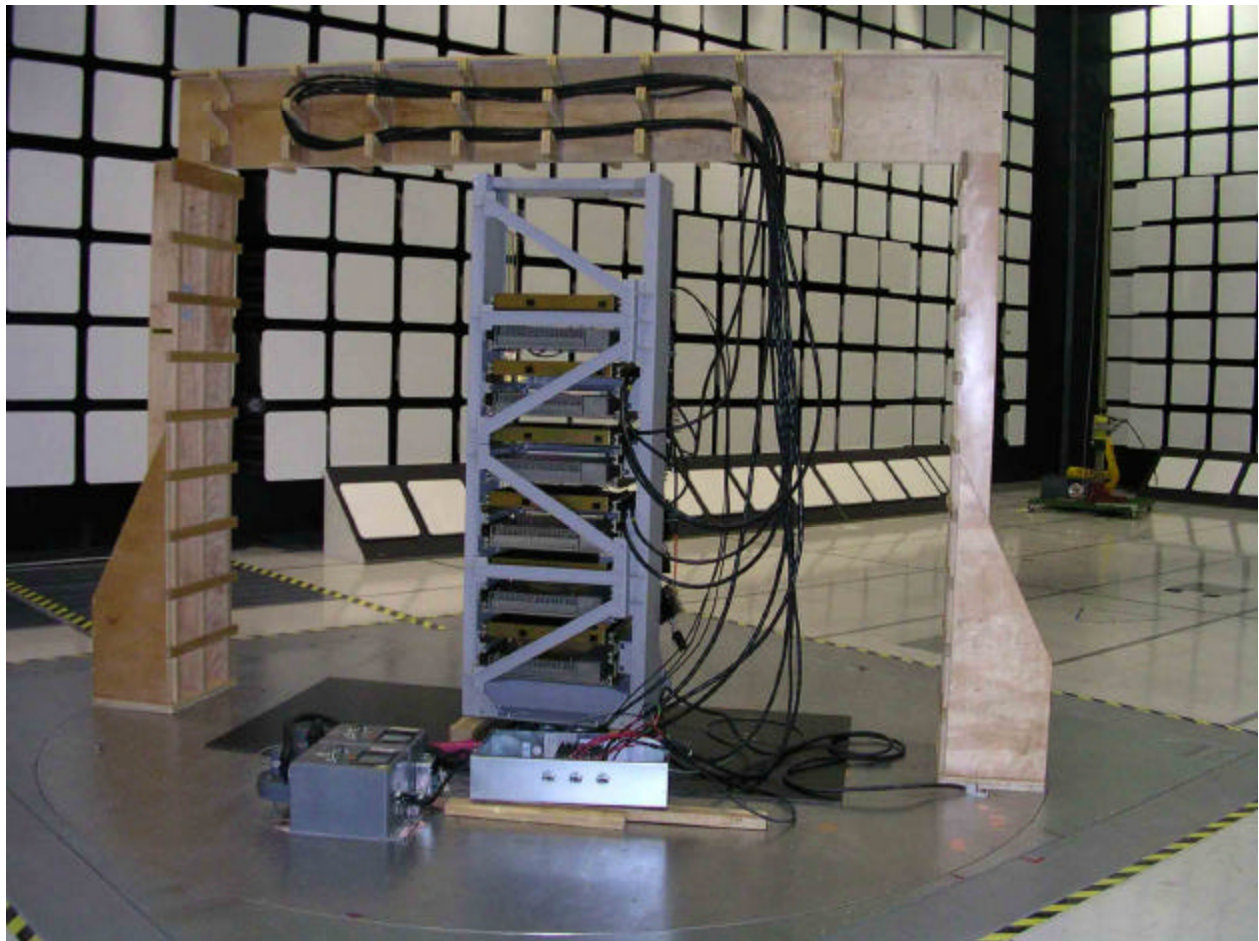

Photographs of all the test configurations used throughout this Test Report are presented in Appendix B: Test Set-up Photographs, on page 29.

4.10 EUT Operations and Software

The software used to operate the system consisted of a software load representative of the latest production.

All six radios were set to simultaneously transmit on 3 CDMA (1.25 MHz) channels. The channels were 575, 600, and 625. The center frequency of this 3 carrier signal was 1960 MHz.

The MFRM-2 is interconnected through the test interface box to the test equipment, which has the capability of producing/measuring any of the test conditions specified by the Pass/Fail criteria. The MFRM-2 is also connected to the Metro cell BTS. The BTS is required to provide the Base band data to the MFRM-2.

The BTS is configured via the control and data PC using the Nortel commissioning software tool Vortex. This PC is also used to configure the MFRM-2. Configuration, and control of the MFRM-2 is achieved by manipulating the base drivers provided by the software team. These software drivers used during the Beta cycle are the same drivers that will be used in the final application code.

4.11 System Modifications

No modifications to the EUT were necessary in order to comply with FCC Part 24 and IC RSS-133.

4.12 System Inventory List

The EUT configuration is presented in Figure 4-4 and described in Table 4-8.

Figure 4-4: EUT shelf configuration

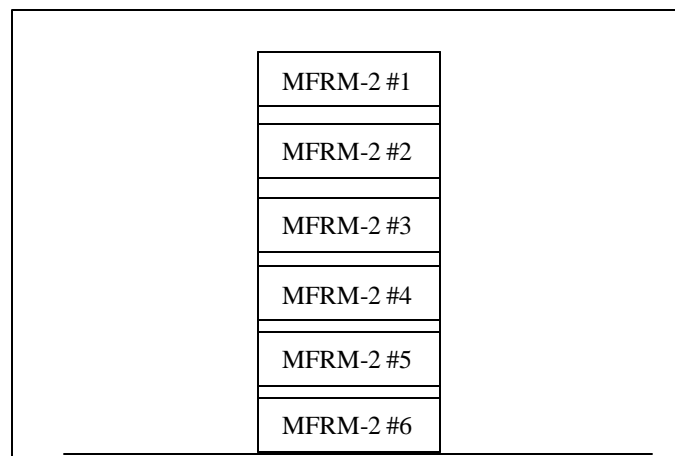



Table 4-8: Inventory List

Item	Component	Code	Release Number	Serial Number
1	MFRM-2	NTGY30BA	T2	NNTM533GRV3E
2	MFRM-2	NTGY30BA	T3	NNTM533GRWJX
3	MFRM-2	NTGY30BA	T3	NNTM533GRW8L
4	MFRM-2	NTGY30BA	T3	NNTM533GRWET
5	MFRM-2	NTGY30BA	T3	NNTM533GRW0C
6	MFRM-2	NTGY30BA	T3	NNTM533GRWKY

5. General Test Conditions

5.1 Test Facility

Radiated emissions testing was performed in a 10-meter Ambient Free Chamber (AFC). The AFC consists of a shielded room lined with ferrite tiles and anechoic material.

This test facility is accredited by the Standards Council of Canada (SCC) [2]. Through a Mutual Recognition Agreement (MRA) between the National Voluntary Laboratory Accreditation Program (NVLAP) and SCC, the accreditation status of this facility is valid for the U.S.

5.2 Measurement Instrumentation

The measurement instrumentation conforms to ANSI C63.2-1996 [7] and CISPR 16 [8]. Calibration of the measurement instrumentation is maintained in accordance with the supplier's recommendations, or as necessary to ensure its accuracy.

6. E-field Radiated Emissions

E-field Radiated Emissions tests are performed to assure that that the product does not produce excess amounts of radiated emissions that could interfere with licensed radiators.

6.1 Test Specification

The system was tested to the following requirements, listed in Table 6-1:

Table 6-1: E-field Radiated Emissions Requirements

Requirement	Country of Application
RSS-133	Canada
FCC Part 2.1053, 2.1057 FCC Part 24.238	USA

6.1.1 Limits

6.1.1.1 FCC Part 2.1053

Measurements shall be made to detect spurious emissions that may be radiated directly from the cabinet, control circuits, power leads, or intermediate circuit elements under normal conditions of installation and operation. Curves or equivalent data shall be supplied showing the magnitude of each harmonic and other spurious emissions. For this test, single sideband, independent sideband, and controlled carrier transmitters shall be modulated under the conditions specified in paragraph (c) of FCC 2.1049 [12], as appropriate.

Information submitted shall include the relative radiated power of each spurious emission with reference to the rated power output of the transmitter, assuming all emissions are radiated from half wave dipole antennas.

6.1.1.2 FCC Part 2.1057

The spectrum should be investigated from the lowest radio frequency signal generated in the equipment, without going below 9 kHz, up to at least the tenth harmonic of the highest fundamental frequency or to 40 GHz, whichever is lower. Particular attention should be paid to harmonics and sub harmonics of the carrier frequency as well as to those frequencies removed from the carrier by multiples of the oscillator frequency. Radiation at the frequencies of multiplier stages should also be checked. The amplitude of spurious emissions which are attenuated more than 20 dB below the permissible value need not be reported.

6.1.1.3 FCC Part 24.238

(a) On any frequency outside a licensee’s frequency block, the power of any emission shall be attenuated below the transmitter power (P) by at least $43 + 10 \log (P)$ dB.

6.1.1.4 RSS-133 Section 6.3

Out of Block Emissions

(i) In the first 1.0 MHz bands immediately outside and adjacent to the licensee's frequency block, the power of emissions (per 1% of the emission bandwidth) shall be attenuated below the transmitter output power P (in watts) by at least $43 + 10 \log_{10}(P)$, dB. It is only required to use the plots from (a) and (b) to demonstrate that the out of blocks A and C emissions are met. (ii) After the first 1.0 MHz, the power of emissions shall be attenuated below the transmitter output power by at least $43 + 10 \log_{10}(P)$, dB, per any MHz of bandwidth. (Note: If the test result using 1% of the emission bandwidth is used, then power integration over 1.0 MHz is required; alternatively, the spectrum analyzer resolution and video bandwidths can be increased to 1.0 MHz for this measurement). The search for these emissions shall be from the lowest frequency internally generated or used in the device (local oscillator, intermediate or carrier frequency), or 30 MHz, whichever is the lowest frequency, to the 5th harmonic of the highest frequency generated or used, without exceeding 40 GHz.

6.1.2 Field strength limit equivalent

The Prescan reference level for spurious radiation was taken with reference to an ideal dipole antenna excited by the rated output power according to the following relationship:

$$E\left(\frac{V}{m}\right) = \frac{1}{R(m)} \sqrt{30 \cdot P_t \cdot G}$$

Where,

E=Field Strength in Volts/meter,

R = Measurement distance in meters,

P_t = Transmitter Rated Power in Watts= 44.6 W

G = Gain of Ideal Dipole (linear)= 1.64

Therefore:

$$E\left(\frac{V}{m}\right) = \frac{1}{10} \sqrt{30 \cdot 44.6 \cdot 1.64}$$

$$E = 4.7 \text{ V/m} = 133.4 \text{ dB}\mu\text{V/m at 10 m}$$

The spurious emissions must be attenuated by at least $43 + 10 \log(44.6) = 59.5 \text{ dB}$

Therefore the field strength limit at 10 meters is:

$$E = 133.4 \text{ dB}\mu\text{V/m} - 59.5 \text{ dB} = 73.9 \text{ dB}\mu\text{V/m at 10m}$$

The limit at 3 meters is:

$$E = 84.4 \text{ dB}\mu\text{V/m}$$

The limit at 1m is:

$$E = 93.9 \text{ dB}\mu\text{V/m}$$

The specification levels in Table 6-2 are worst-case limits taken from all test specifications.

Table 6-2: Prescan Spurious emissions limits for FCC Part 24 and IC RSS-133

Frequency Range (MHz)	Measurement distance (m)	Field strength equivalent of -13 dBm ERP limit (dBuV/m)
30 - 1000	10	73.9
1000 - 10000	10	73.9
10000 - 18000	3	84.4
18000 - 20000	1	93.9

The worst emissions observed during prescan measurements were then evaluated using the substitution method.

6.2 Test Facility Information

Location: C-MAC AFC
Date tested: 20, 21, 22 January, 4 February and March 28, 2003
Tested by: Alain Lavoie, Rick Poirier, William Kwong, Glen Albert, D. Lalonde

6.3 Test Configurations

For radiated emissions test cases, the EUT hardware configuration/software load used is described in Sections 4.9 and 4.10.

6.4 Test Procedure

Verifications of the test equipment and AFC were performed prior to the installation of the EUT in accordance with the quality assurance procedures in KP000270-LP-EMC-01-DF [9]. The test was performed as per the relevant Test procedures: ANSI C63.4-1992 [5].

The system was tested in the following manner:

- The EUT was placed on a turntable inside the AFC and it was configured as in normal operation. The system and its cables were separated from the ground plane by an insulating support 10 mm in height. The system was connected to the grounding system, in accordance with its installation specifications. No additional grounding connections are allowed.
- For tests between 30 MHz and 1 GHz a broadband bilog antenna was placed at a 10 m distance; a horn antenna, placed also at 10 m distance from the EUT, was used for high

frequency measurements between 1 GHz and 10 GHz. The horn antenna was moved to a 3 m distance for measurements between 10 and 18 GHz. The measuring distance was further reduces to 1 m for measurements between 18 GHz and 20 GHz.

- A pre-scan was performed to find emissions (frequencies) requiring detail measurement. The pre-scan (using a peak detector) was performed by rotating the system 360 degrees while recording all emissions (frequency and amplitude). This procedure was repeated for antenna heights of 1 to 4 meters, in steps of 1 meter, and for horizontal and vertical polarizations of the receiving antenna (for measurements above 30 MHz).
- Prescan optimization was performed based on the pre-scan data. All frequencies, having emission levels within 10 dB of the specification(s) limits, were optimized. For each such frequency, the EUT was rotated in azimuth over 360 degrees and the direction of maximum emission was noted. Antenna height was then varied from 1 to 4 meters at this azimuth to obtain maximum emissions. The procedure was repeated for both horizontal and vertical polarizations of the search antenna. Then the maximum level measured was recorded.
- The frequency range investigated was 30 MHz to 20 GHz.
- Above 30 MHz and up to 1 GHz, a resolution bandwidth of 120 kHz was used.
- Above 1 GHz, a 1 MHz resolution bandwidth and 1 MHz video bandwidth were used.
- The highest emissions were evaluated using the substitution method. This is accomplished by replacing the EUT by a calibrated antenna, cable and signal generator. This equipment is used to transmit a signal that will generate a RF meter reading level identical to the one recorded when the EUT was present.

6.5 Test Results

This section presents the E-field radiated emissions results for all the test cases considered. These measurements were taken using a peak detector and compared to the specification limit lines.

Graphical representations of the measurements taken appear in Appendix C: Radiated Emissions Plots on page 30.

Note that a positive margin value in the “E-field Radiated Emissions Test Results” table below indicates a PASS and a negative margin value indicates a FAILURE.

Two configurations of the same equipment were evaluated; one using a +24 V power supply, the other with a -48 V power supply.

Table 6-3 lists the highest emissions measured, all other emission had more than 20 dB margin:

Table 6-3: Prescan E-field Radiated Emissions Test Results

Parameter		Unit	30 – 1000 MHz	1 – 10 GHz range		10 – 20 GHz range
			Conf. No. 2	Conf. No. 1	Conf. No. 2	Conf. 1 & 2
Frequency		(MHz)	215.6	3919.8	3918.72	18000
Antenna	Azimuth	(deg.)		0	2	
	Height	(cm)		142	100	
	Polarization		Horz.	Vert.	Vert.	Vert.
Meter Reading		(dBµV)	47.6	54.9	55.5	37.7
Detector			Peak	Peak	Peak	Peak
Gain / Loss Factor		(dB)	-25.4	-33.9	-33.9	-29.3
Transducer Factor		(dB)	11.8	32.2	32.2	48.6
Level		(dBµV/m)	34.0	53.2	53.8	57.0
Limit (approximate)		(dBµV/m)	73.9	73.9	73.9	84.4

Pre-scan plots of the radiated E-field emissions measured are included in Appendix C: Radiated Emissions Plots on page 30.

Table 6-4: Substitution Measurement Test Results

Freq. (MHz)	Signal generator level (dBm)	Cable loss (dB)	Pol	Antenna gain (dB)	Prescan meter reading (dBuV)	Substitution meter reading (dBuV)	ERP (dBm)	Limit (dBm)	Margin (dB)
(30–1000) range 215.6	-63	0.4	H	3.2	47.6	47.8	-60.2	-13	47.2
(1000-10000) range 3918.72	-31.6	1.6	V	6.0	55.5	55.5	-27.2	-13	14.2
(10000 – 20000) range 18000	-35.5	3.5	V	7.0	37.7	37.5	-32.0	-13	19.0

The master of this document is stored on an electronic database and is "write-protected" and may be altered only by authorized persons at C-MAC Engineering Inc.. Viewing of the master document electronically ensures access to the current issue. Any hard copies must be regarded as uncontrolled copies.

6.6 Prescan Measurement Uncertainties

The expanded measurement uncertainty (with a 95% level of confidence) on E-field radiated emissions measurements are: ± 5.0 dB between 30 MHz and 1 GHz and ± 5.6 dB between 1 GHz and 10 GHz.

Uncertainty evaluation has been calculated according to the method described in NAMAS NIS 81 (May 1994), "The Treatment of Uncertainty in EMC Measurements" [14].

6.7 Calculation of the Compliance Margin

The following illustrates the manner in which the compliance margin is calculated:

$$\text{ERP} = \text{Signal generator level} - \text{Cable losses} + \text{Antenna gain}$$

$$\text{Margin} = \text{Limit} - \text{ERP}$$

6.8 Test Conclusion

The worst-case margin is 14.2 dB at 3918.72 MHz to FCC Part 24 and Industry Canada RSS-133 spurious emissions requirements. This worst case margin was calculated using a substitution measurement.

Since all measured emissions indicate positive margins, it can be declared that the EUT has passed the radiated Spurious Emission tests with respect to FCC Part 24 and Industry Canada RSS-133 requirements.

6.9 Test Equipment List

Table 6-5: Test Equipment used for E-field Radiated Emissions

Category	Description	Make	Model Number	Serial Number	Cal. Due
Amplifier	Pre Amplifier	HP	8447D	2944A06919	31-Aug-03
Amplifier	Amplifier LNA 1-18GHz	BNR	LNA A7	LNA A7	22-Apr-03
Antenna	Double Ridge Guide Horn	EMCO	3115	9711-5314	19-Dec-03
Antenna	Bilog - 30MHz-1000MHz	A R	2420/A	1113	19-Dec-03
Cable-RF	Pre Amplifier out	HUBER & SUHNER	SUCO 104PEA	10246/4PEA	23-Oct-03
Cable-RF	AFC Bulkhead #2	SUCOFLEX	106/A	1060	18-Feb-04
Cable-RF	AFC Bulkhead #1	SUCOFLEX	106/A	1061	18-Feb-04
Software	EMI Software	UL	EMI Software	V 3.02	n/a
S A	(AFC#1) SA	HP	8566B	3014A07256	31-Aug-03
S A	(AFC#1) Display Unit	HP	8566B	3026A20026	31-Aug-03
S A	(AFC#1) RF Preselector	HP	85685A	3010A01085	31-Aug-03
S A	(AFC#1) QPA	HP	85650A	2043A00313	23-Apr-03
Mast & Turntable	Dual mast & turntable ctrl'r	Sunol Sciences	SC99V	120498-1	n/a
LISN	200A LISN	Solar Electronics	8616-50-TS-200N		18-Feb-04
LISN	200A LISN	Solar Electronics	8616-50-TS-200N		18-Feb-04
Antenna	Bilog - 30MHz-1000MHz	A R	2420/A	1174	04-Mar-04
Antenna	Double Ridge Guide Horn	EMCO	3115	2703	19-Feb-04
Signal generator	20 GHz max frequency	Wiltron	68247B	984004	16-Dec-03
Cable-RF	Signal generator output	HUBER & SUHNER	SUCO 104PEA	10241/4PEA	n/a

The measurement instrumentation conforms to ANSI C63.2-1996 [7] and CISPR 16 [8]. Calibration of the measurement instrumentation is maintained in accordance with the supplier's recommendations, or as necessary to ensure its accuracy.

7. References

7.1 Applicable documents

1. Nortel Networks 1900 MHz MFRM-2 Beta System Integrity Test Plan, Stream 00, Issue 04

7.2 Reference documents

2. Standards Council of Canada Scope of Accreditation Letter SCC 1003-15/163 dated 2001-02-16 (Scope of accreditation is effective until 2002-10-05 and includes FCC Part 15 and ICES-003).
3. Federal Communications Commission Letter dated May 25, 1999 (in response to submission EF-00049-99, Measurement facility located at Kanata Anechoic chamber (3 & 10 meters), FCC Registration Number 94326).
4. C-MAC Engineering Inc. Quality Manual, Document No. KG000347-QD-QM-01-04, Issue 04, December 2001.
5. C-MAC Engineering Inc. Lab Operations Manual, Document No. KG000347-QD-LAB-01-01, Issue 01, January 2002.
6. ANSI C63.4-1992, Methods of Measurement of Radio-Noise Emission from Low-Voltage Electrical and Electronic Equipment in the Range of 9 kHz to 40 GHz, 17 July 1992.
7. ANSI C63.2-1996, American National Standard for Electromagnetic Noise and Field Strength Instrumentation, 10 Hz to 40 GHz – Specifications.
8. CISPR 16-1, Specification for Radio Disturbance and Immunity Measuring Apparatus and Methods - Part 1: Radio Disturbance and Immunity Measuring Apparatus, Edition 2.0, 1999-10.
9. C-MAC Engineering Inc., EMC General Lab Test Procedure, KP000270-LP-EMC-01-DF Feb 2002.
10. Code of Federal Regulations (Washington, DC: Federal Communications Commission), Title 47, Chapter 1, Part 15.
11. Code of Federal Regulations (Washington, DC: Federal Communications Commission), Title 47, Chapter 1, Part 24.
12. Code of Federal Regulations (Washington, DC: Federal Communications Commission), Title 47, Chapter 1, Part 2.
13. 2 GHz Personal Communications Services, Industry Canada, RSS-133, Issue 2, Revision 1, November 6, 1999
14. NAMAS Publication NIS 81: “The Treatment of Uncertainty in EMC Measurements”, Edition 1, May 1994.

8. Appendices

8.1 Appendix A: Glossary

Included below are definitions and abbreviations of terms used in this document.

Term	Definition
AD	Average Detector
AE	Auxiliary Equipment
AFC	Ambient Free Chamber
AM	Amplitude modulation
ANSI	American National Standards Institute
CSA	Canadian Standards Association
dB	Decibel
DC	Direct Current
EMC	Electromagnetic Compatibility
EUT	Equipment Under Test
FCC	Federal Communications Commission, USA
GND	Ground
IC	Industry Canada
LISN	Line Impedance Stabilization Network
MU	Measurement Uncertainty
NA	Not Applicable
NAMAS	National Measurement Accreditation Service
NBS/ NIST	National Bureau of Standards / National Institute of Standards and Technology
PA	Broadband Power Amplifier
PK	Peak Detector
RBW	Resolution Bandwidth
RE	Radiated Emissions
RF	Radio-Frequency
RMS	Root-mean-square
RSS	Radio Standards Specification
SA	Spectrum Analyzer, the ANSI C63.2 Compliant EMI meter
SCC	Standards Council of Canada
T	50 Ω Coaxial Termination (conducted emissions / immunity)
UL	Underwriters Laboratories, Inc.
UUT	Unit Under Test

Term	Definition
VBW	Video Bandwidth
ERP	Effective Radiated Power
MFRM	Multi-carrier Flexible Radio Module
CDMA	Code Division Multiple Access
BTS	Base-station Transceiver System
WR MPEM	Wide voltage Range Power Entry Module
WR HCPA	Wide voltage Range High Power Converter Assembly
PSU	Power Supply Unit

8.2 Appendix B: Test Set-up Photographs

This appendix presents all the set-ups used to cover all the tests presented in this Test Report.

Figure 8-1: MFRM-2 [radiated emission] set-up

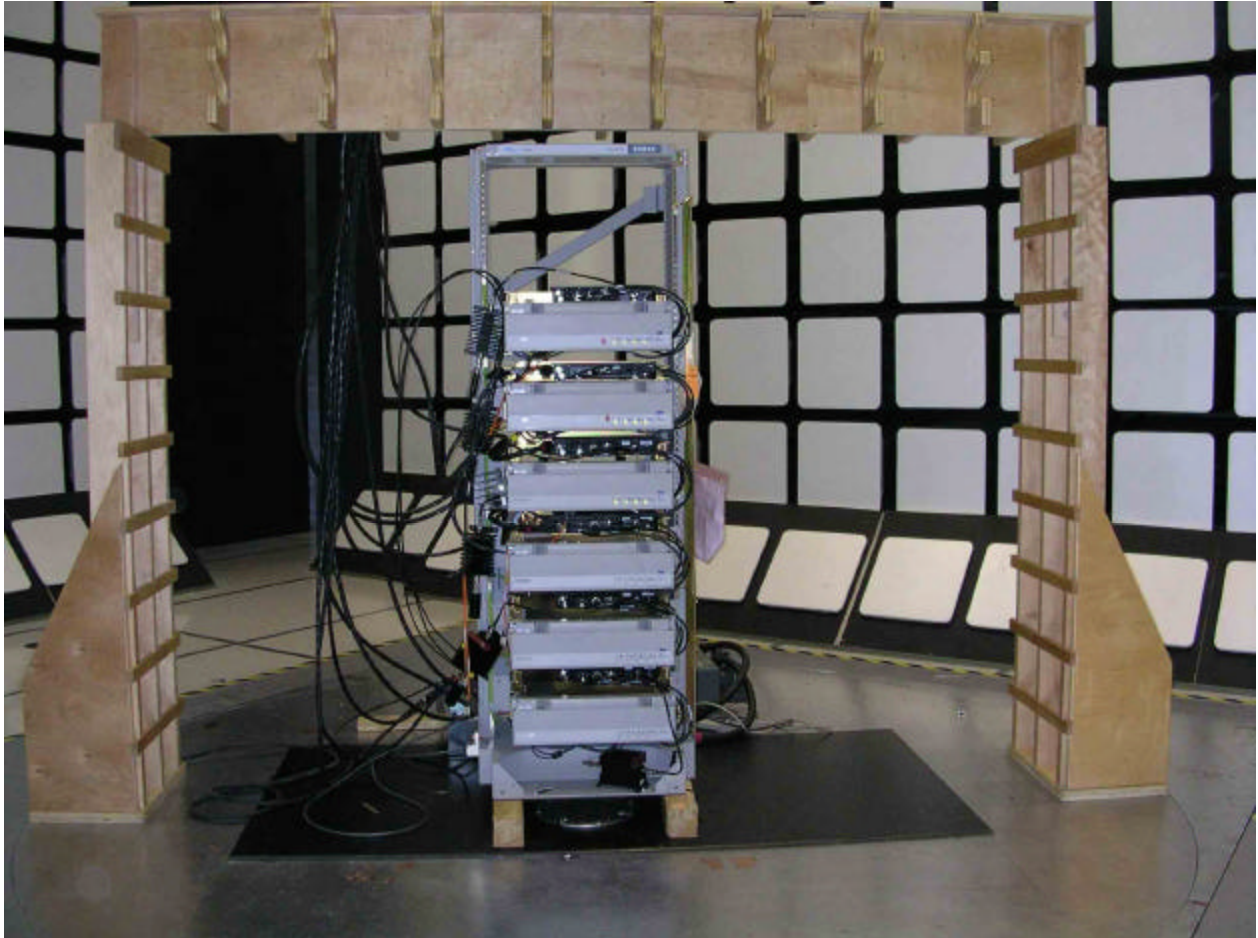

8.3 Appendix C: Radiated Emissions Plots

This appendix presents all radiated emissions plots for the test cases measured.

Figure 8-2: E-field Radiated Emissions, 30 – 1000 MHz (Configuration No.1)

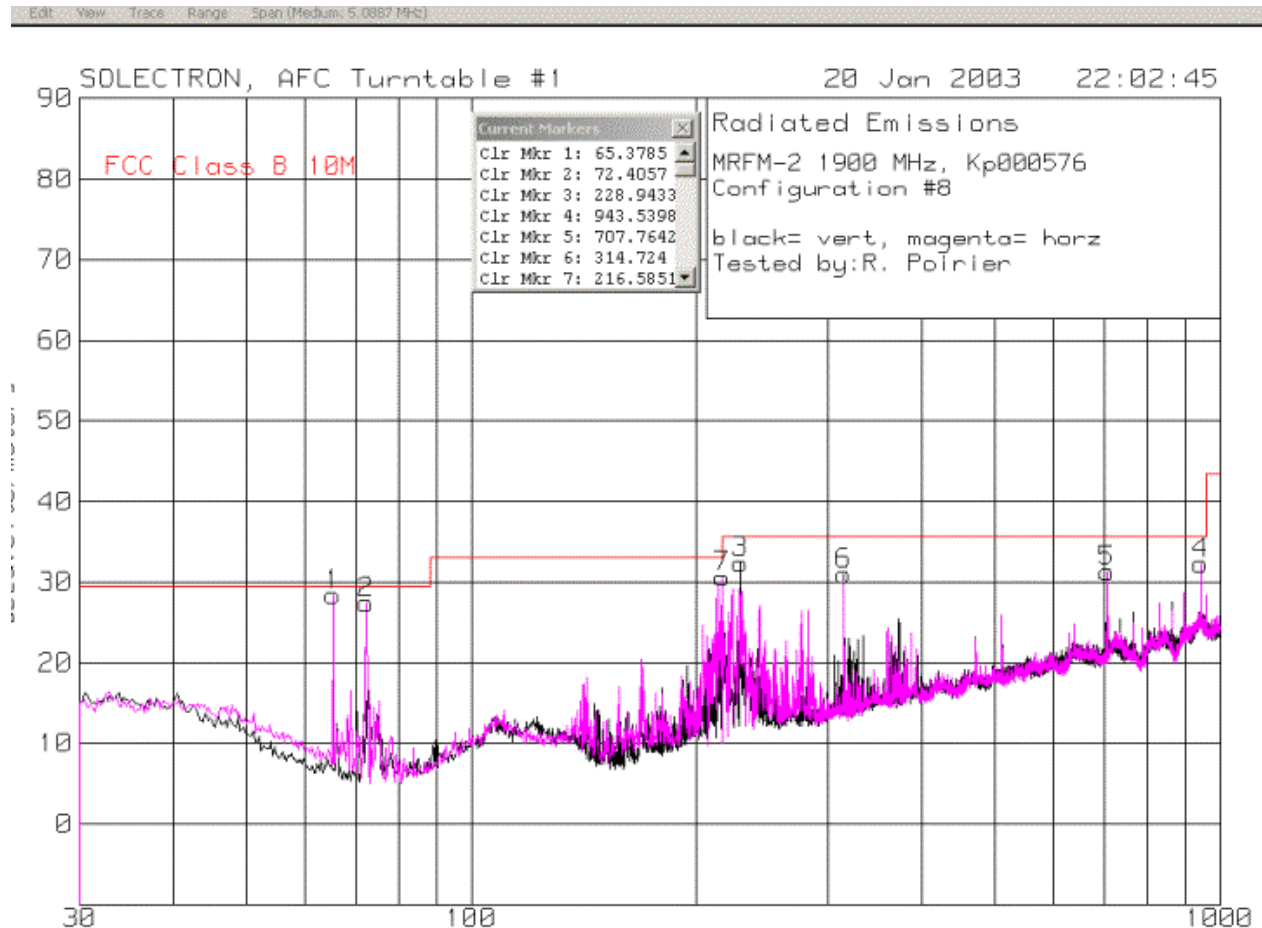

Note: the 2 emissions at 65 MHz and 72 MHz were intermittent signals. They disappeared when we reduced the span to observe them.

Figure 8-3: E-field Radiated Emissions, 1 GHz – 10 GHz (Configuration No.1)

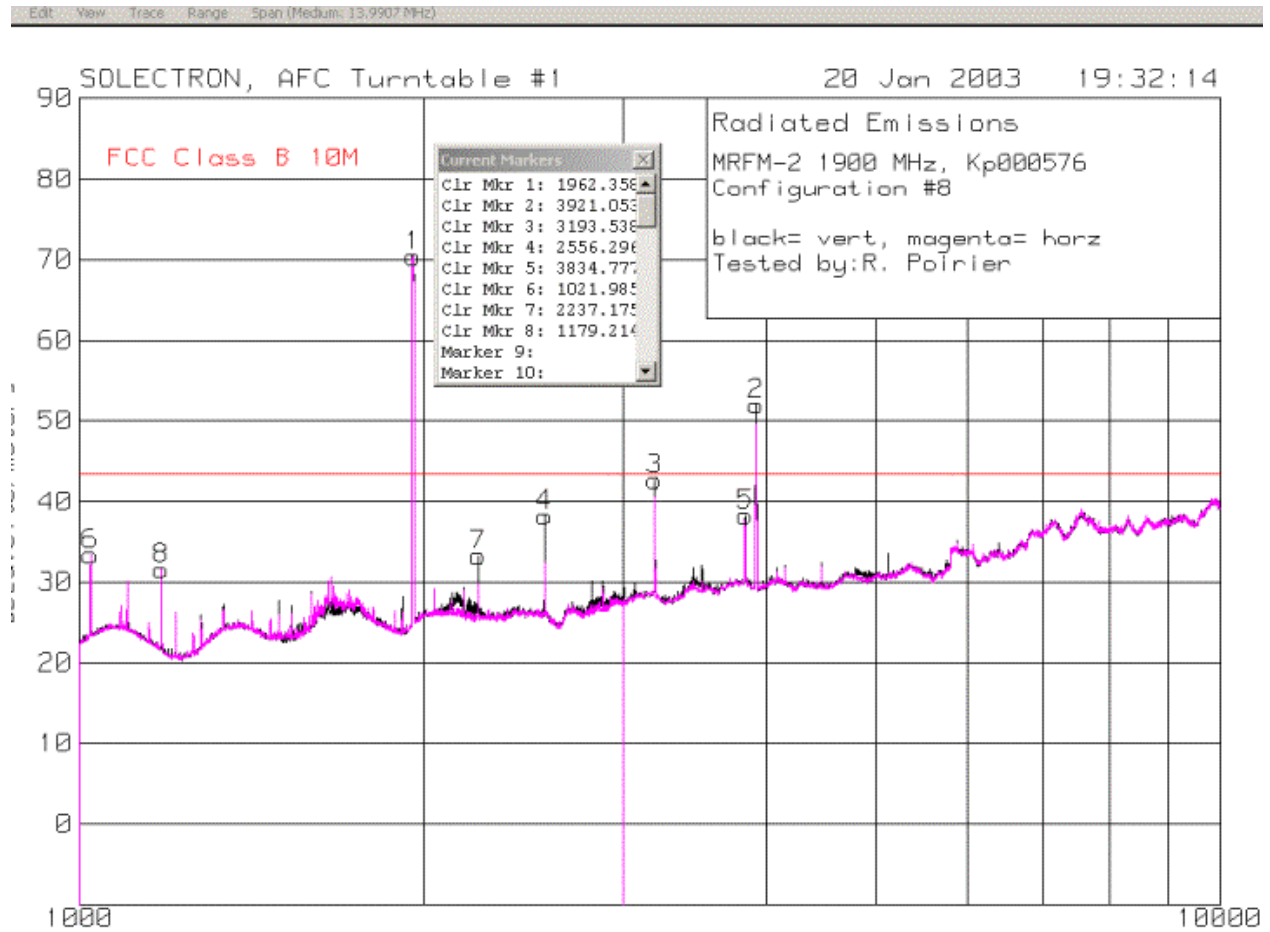

Note: the 1962.36 MHz emission is RF leakage of the transmitter signal from the six 50 ohms terminations.

Figure 8-4: E-field Radiated Emissions, 10 GHz – 18 GHz (Configuration No.1)

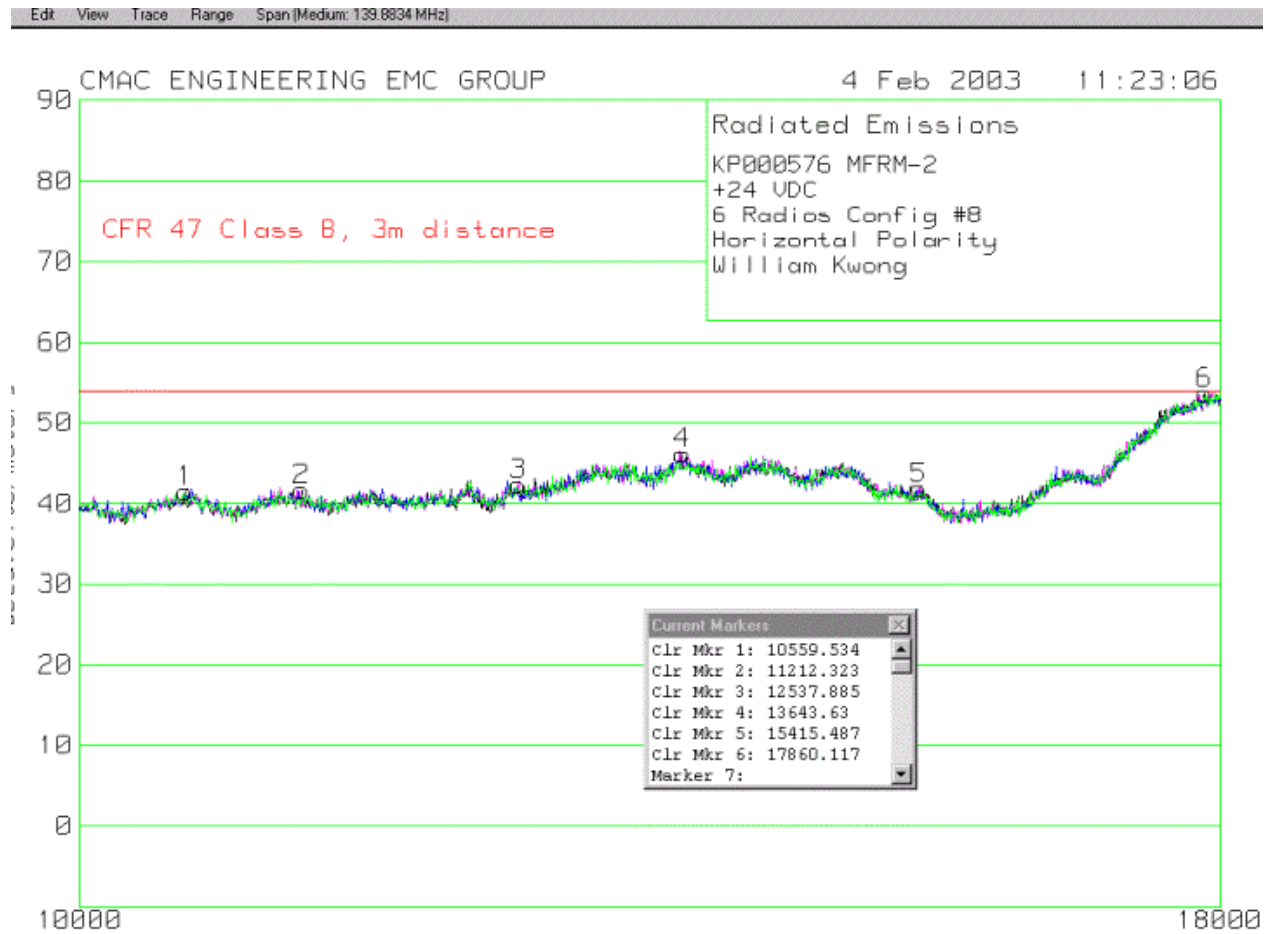

Note: this scan was repeated with vertical polarization with identical test results.

Figure 8-5: E-field Radiated Emissions, 18 GHz – 20 GHz (Configuration No.1)

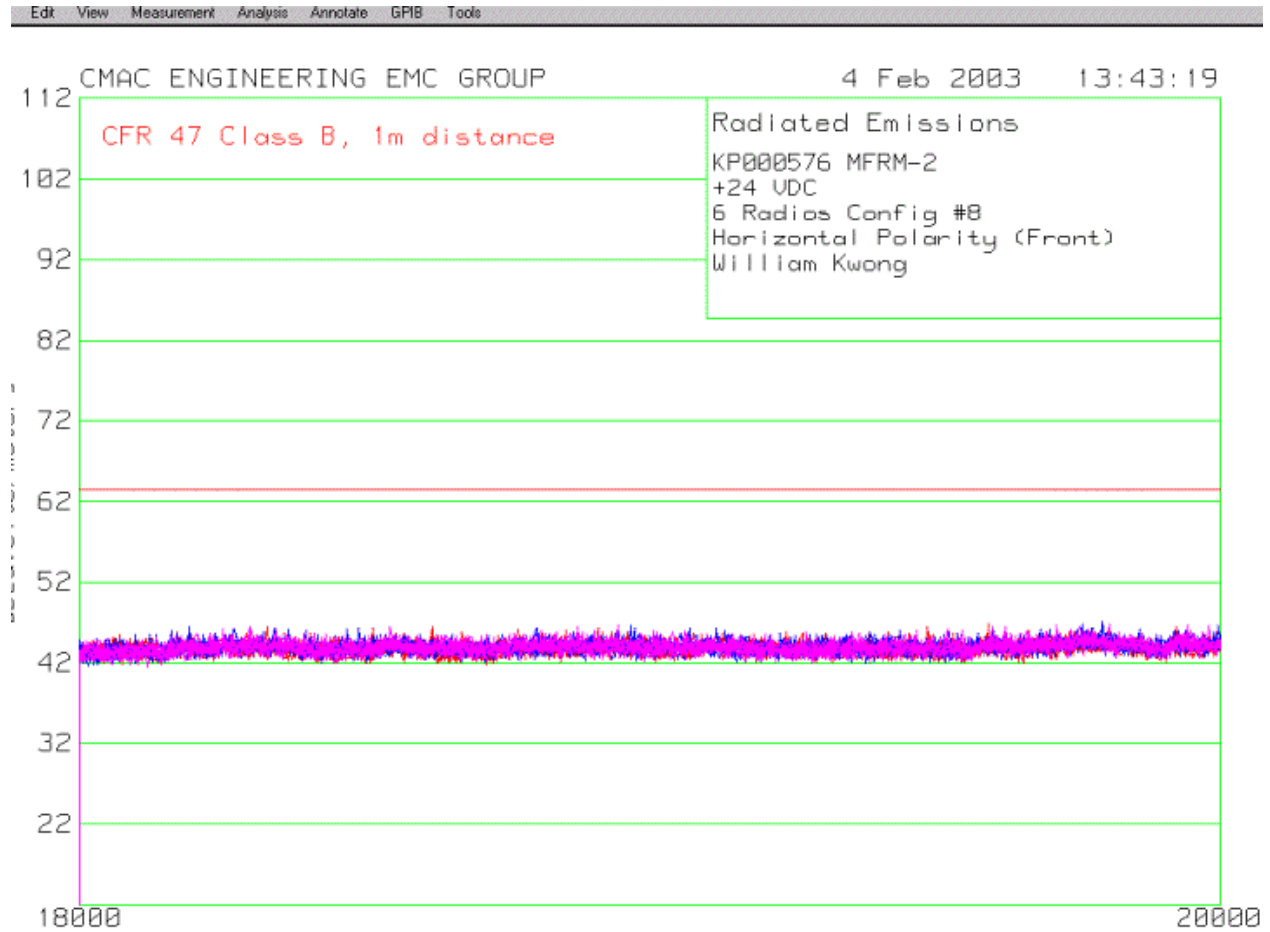

Note: this scan was repeated on the 4 sides of the EUT with both vertical and horizontal polarizations. Identical test results were observed.

Figure 8-6: E-field Radiated Emissions, 30 – 1000 MHz (Configuration No.2)

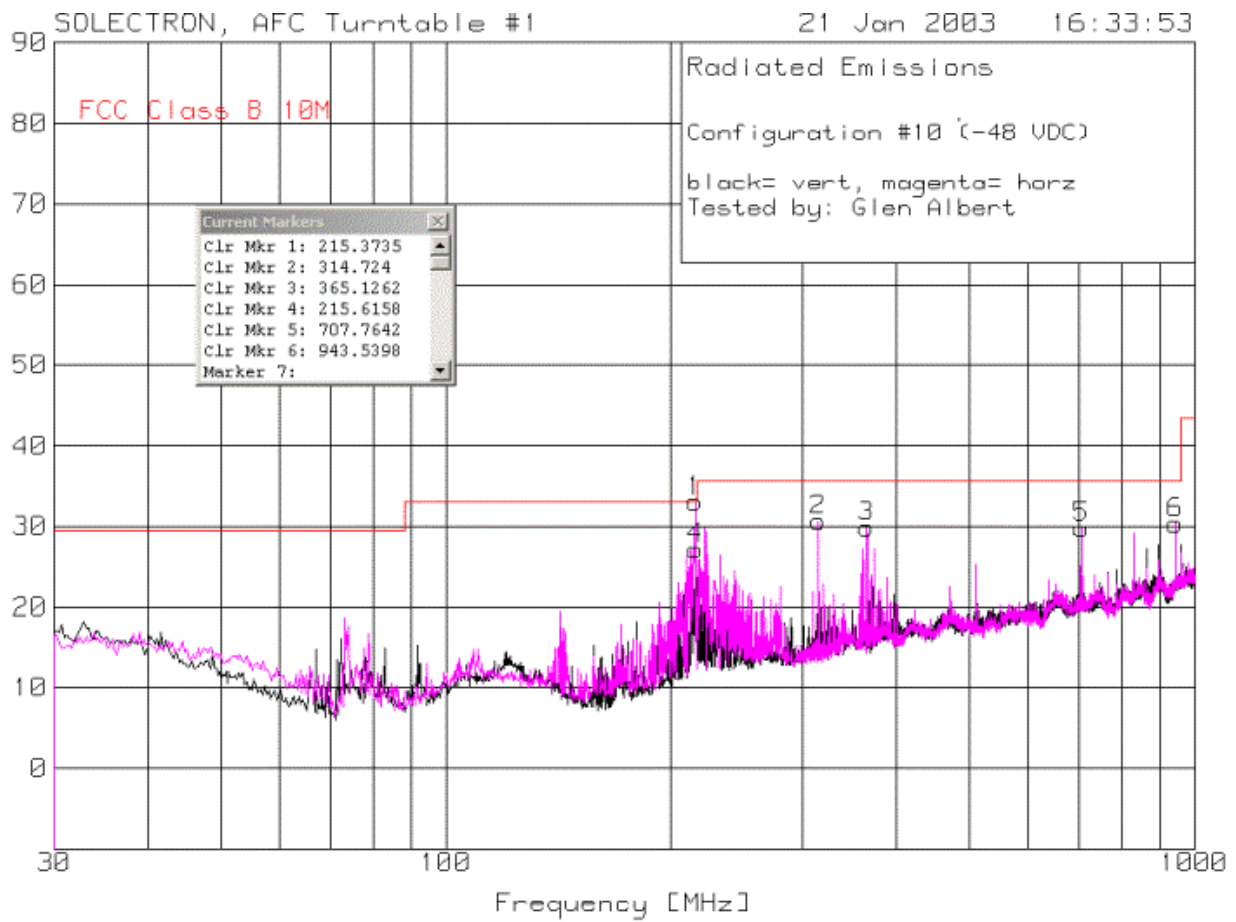
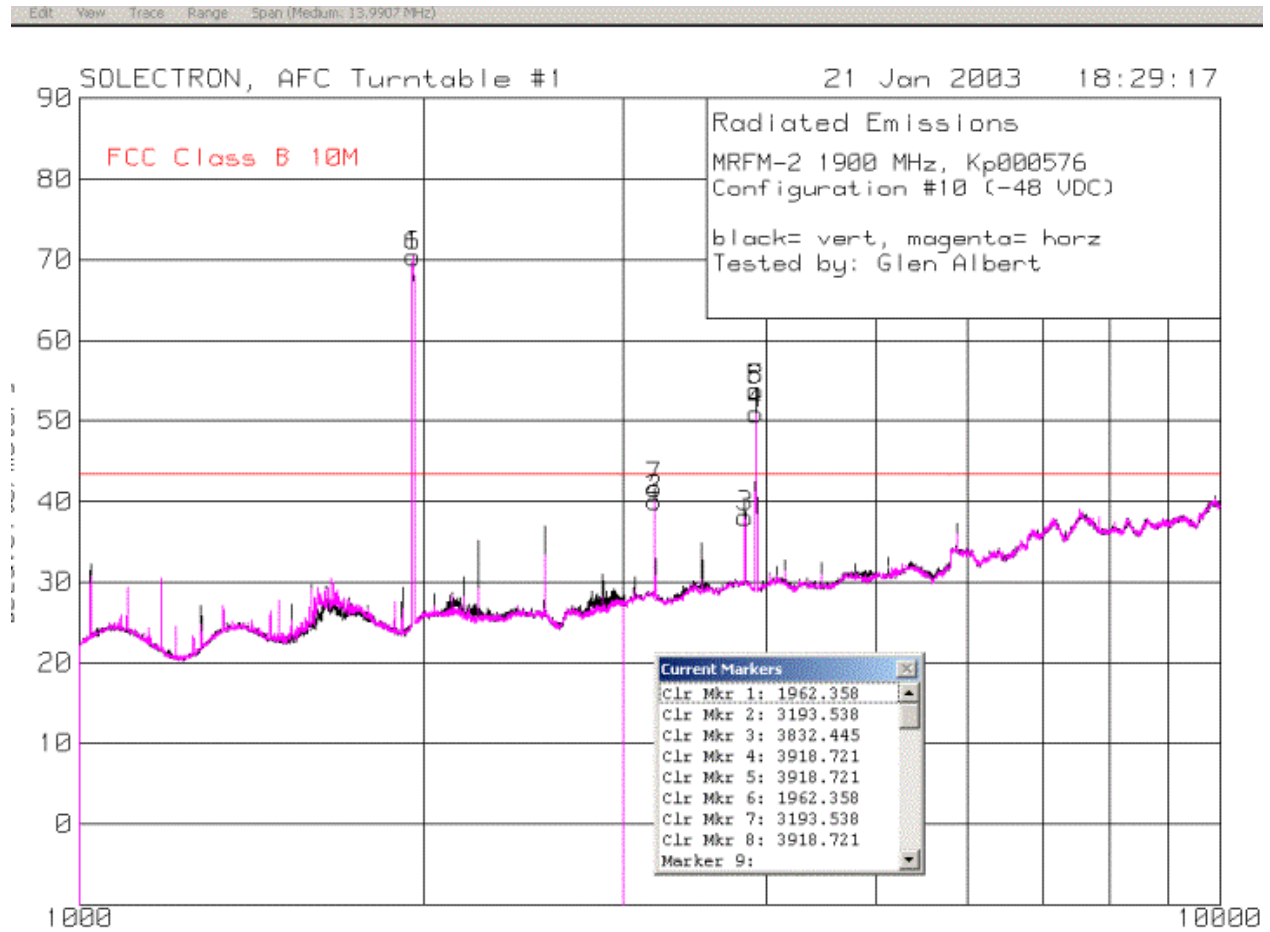
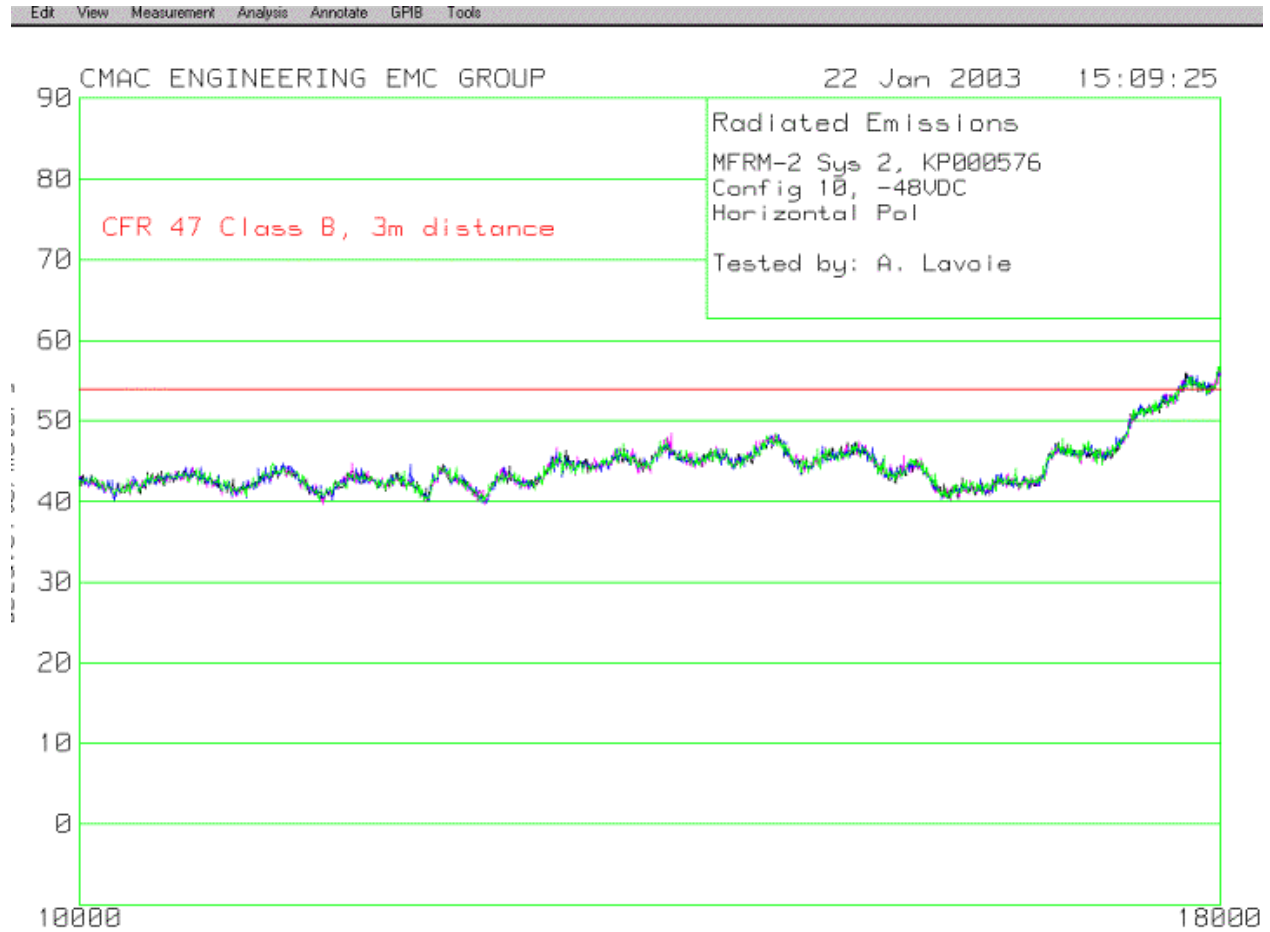

Figure 8-7: E-field Radiated Emissions, 1 GHz – 10 GHz (Configuration No.2)



Note: the 1962.36 MHz emission is RF leakage of the transmitter signal from the six 50 ohms terminations.

Figure 8-8: E-field Radiated Emissions, 10 GHz – 18 GHz (Configuration No.2)



Note: this scan was repeated with vertical polarization with identical test results.

Figure 8-9: E-field Radiated Emissions, 18 GHz – 20 GHz (Configuration No.2)

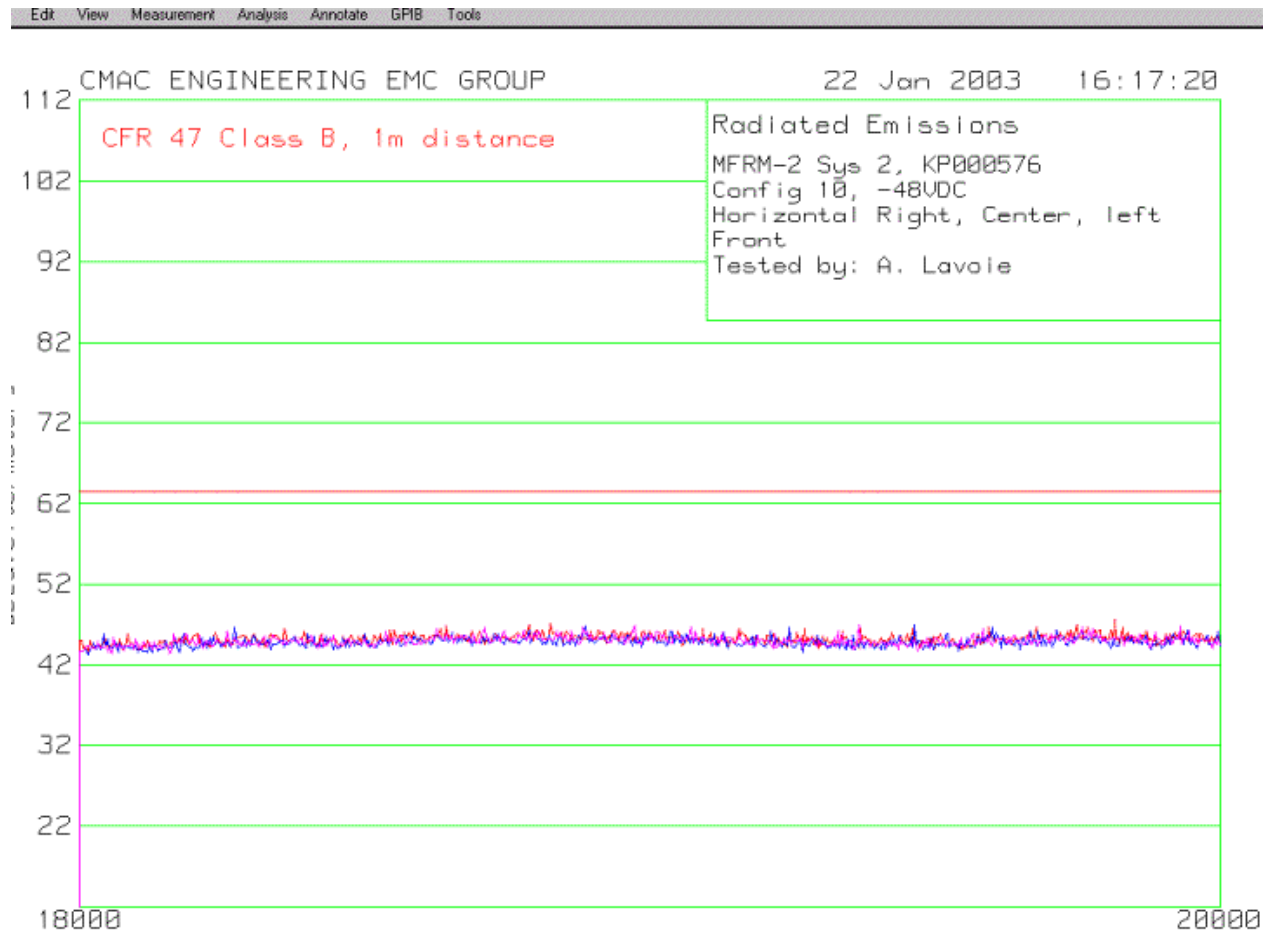

Note: this scan was repeated on the 4 sides of the EUT with both vertical and horizontal polarizations. Identical test results were observed.

C-MAC ENGINEERING INC.
Spurious Emissions Test Report for MFRM-2
FCC Part 24 and Industry Canada RSS-133

© Copyright C-MAC Engineering Inc. March 31, 2003

The master of this document is stored on an electronic database and is “write-protected” and may be altered only by authorized persons at C-MAC Engineering Inc. Viewing of the master document electronically ensures access to the current issue. Any hard copies must be regarded as uncontrolled copies.

C-MAC Engineering Inc. accepts no liability for the content of this document except when it is reproduced in its entirety by a method acceptable to C-MAC Engineering Inc.
