



EXHIBIT 2A

Test Report Provided By Nortel Networks

Applicant: Nortel Networks

For Certification on:

AB6NT1900MFRM



Test Report for FCC Equipment Authorization

FCC ID : AB6NT1900MFRM CDMA Metro Cell 1900MHz

Document: TR_AB6NT1900MFRM
Stream: 00
Issue: 02
Document Status: Approved
Issue Date: March 14, 2002
Security Status: Nortel Networks Confidential
Author: Rahim Nathoo

© 2001 Nortel Networks Limited

Disclaimer

The master of this document is stored on an electronic database and "write protected". The protection can be altered by authorized persons only. Viewing of the master document electronically ensures access to the current issue. Any hardcopies must be regarded as uncontrolled copies.

Security Warning

The information disclosed herein is proprietary to Nortel Networks and not to be used by or disclosed by unauthorized persons without the written consent of Nortel Networks. The recipient of this document shall respect the security status of the information.

PAGE INTENTIONALLY LEFT BLANK

Table of Contents

Publication History	9
List of Consultants	9
Decision Maker/Ratifier	9
Revision History	9
Acronyms and Abbreviations	11
1 Introduction.....	13
1.1 Test Result Summary	13
2 Engineering Declaration.....	14
3 Equipment Authorization Application Requirements	15
3.1 Standard Test Conditions and Test Equipment.....	15
3.2 EUT Identification List.....	15
3.3 Test Equipment List.....	15
4 Transmitter Test and Measurement Results.....	17
4.1 RF Power Output	17
4.1.1 RF Power Output Requirements	17
4.1.1 FCC Part 2.1046	17
4.1.1 FCC Limit (Part 24.232).....	17
4.1.2 Test Method	17
4.1.3 Test Setup	17
4.1.4 Test Results.....	18
4.2 Occupied Bandwidth.....	19
4.2.1 Occupied Bandwidth Requirements	19
4.2.1 FCC Part 2.1049	19
4.2.2 Test Method	20
4.2.3 Test Setup	20
4.2.4 Test Results.....	20
4.3 Spurious Emissions at Antenna Terminals	25
4.3.1 Spurious Emissions Requirements.....	25
4.3.1 FCC Part 2.1051	25
4.3.1 FCC Part 2.1057 - Frequency Spectrum to be investigated.....	25
4.3.1 FCC Part 24.238 Limit.....	25
4.3.2 Test Method	25
4.3.3 Test Setup	26
4.3.4 Test Results.....	27
4.4 Frequency Stability	43
4.4.1 Frequency Stability Requirements.....	43
4.4.1 FCC Part 2.1055	43
4.4.1 FCC Part 24.235 Limit.....	43
4.4.2 Results.....	44
References.....	45

List of Figures

Figure 1 : Test Setup for RF Power Output Measurement	17
Figure 2 : Test Setup for Occupied Bandwidth Measurement.....	20
Figure 3 : Occupied Bandwidth - Single Carrier, Channel 50.....	22
Figure 4 : Occupied Bandwidth - 2 Carrier, Channel 50, 75	23
Figure 5 : Occupied Bandwidth - 3 Carrier, Channel 25, 50, 75	24
Figure 6 : Test Setup for Spurious Emissions Measurement.....	26
Figure 7 : Conducted Spurious Emissions - 1 Carrier, Channel 775 (Lower adjacent 1 MHz)	28
Figure 8 : Conducted Spurious Emissions - 1 Carrier, Channel 775 (Upper adjacent 1 MHz).....	29
Figure 9 : Conducted Spurious Emissions - 1 Carrier, Channel 775 (10kHz - 2 GHz).....	30
Figure 10 : Conducted Spurious Emissions - 1 Carrier, Channel 775 (2 GHz - 7 GHz).....	31
Figure 11 : Conducted Spurious Emissions - 1 Carrier, Channel 775 (7 GHz - 20 GHz).....	32
Figure 12 : Conducted Spurious Emissions - 2 Carrier, Channels 650, 675 (Lower adjacent 1 MHz).....	33
Figure 13 : Conducted Spurious Emissions - 2 Carrier, Channels 650, 675 (Upper adjacent 1 MHz)	34
Figure 14 : Conducted Spurious Emissions - 2 Carrier, Channels 650, 675 (10 kHz - 2 GHz)	35
Figure 15 : Conducted Spurious Emissions - 2 Carrier, Channels 650, 675 (2 GHz - 7 GHz)	36
Figure 16 : Conducted Spurious Emissions - 2 Carrier, Channels 650, 675 (7 GHz - 20 GHz)	37
Figure 17 : Conducted Spurious Emissions - 3 Carrier, Channels 925, 950, 975 (Lower adjacent 1 MHz).....	38
Figure 18 : Conducted Spurious Emissions - 3 Carrier, Channels 925, 950, 975 (Upper adjacent 1 MHz)	39
Figure 19 : Conducted Spurious Emissions - 3 Carrier, Channels 925, 950, 975 (10 kHz - 2 GHz)	40
Figure 20 : Conducted Spurious Emissions - 3 Carrier, Channels 925, 950, 975 (2 GHz - 7 GHz)	41
Figure 21 : Conducted Spurious Emissions - 3 Carrier, Channels 925, 950, 975 (7 GHz - 20 GHz)	42

List of Tables

Table 1 : Test Results Summary	13
Table 2 : EUT Identification List.....	15
Table 3 : Test Equipment List.....	16
Table 4 : RF Output Power of 1900 MHz MFRM, 1 Carrier Mode.....	18
Table 5 : RF Output Power of 1900 MFRM, 2 Carrier Mode.....	18
Table 6 : RF Output Power 1900 MFRM, 3 Carrier Mode	19
Table 7 : Occupied Bandwidth, 1900 MFRM, Single Carrier Mode	20
Table 8 : Occupied Bandwidth, 1900 MFRM 2 Carrier Mode.....	21
Table 9 : Occupied Bandwidth, 1900 MFRM 3 Carrier Mode.....	21
Table 10 : Spurious Emissions at the 1900 MHz MFRM Antenna Port	27

Publication History

The latest controlled release of this document is located in an electronic database. **All other soft and hard copies are uncontrolled.** It is the responsibility of the reader to ensure that the latest release of this document is being used.

List of Consultants

The following people have reviewed this document prior to its release and have recommended its approval:

Printed Name	Function	Department
Mihai Parvan	CDMA BTS RF Systems	2M64
Hatem Tawfik	CDMA BTS RF Systems	2M64
Thomas Wong	Regulatory Prime	2U40

Decision Maker/Ratifier

The release of this document has been reviewed and approved for distribution and use by the following:

Ratifier's Name	Signature	Date
Radu Trandafir	via email	13 March, 2002

Revision History

Stream/issue	Revision Date	Reason for Change	Author
00/01	11/03/2002	Initial test report	Rahim Nathoo
00/02	14/03/2002	Minor changes as per reviewer comments Approved for release	Rahim Nathoo

Change bars are not used in this document.

Acronyms and Abbreviations

ASIC	Application Specific Integrated Circuit
BBW	Breathing, Blossoming and Wilting
BPF	Bandpass Filter
BTS	Base Station Transceiver Subsystem
BW	Bandwidth
CDMA	Code Division Multiple Access
dBFS	dB relative to Full Scale
DDS	Direct Digital Synthesizer
DPM	Duplexer Preselector Module
EEPROM	Electrically Erasable and Programmable ROM
EC	Engineering Change
ERLCE	Excess Reverse Link Capacity Estimate
HSSPC	High-Speed Serial Protocol Controller
HW	Hardware
IF	Intermediate Frequency
IIC	Inter-Integrated Circuit Bus
IS	Interim Standard
LO	Local Oscillator
LPF	Lowpass Filter
MCPA	Multi-Carrier Power Amplifier
MFRM	Multi-carrier Flexible Radio Module
NF	Noise Figure
OCNS	Orthogonal Channel Noise Source
OH	OverHead
PA	Power Amplifier
PC	Personal Computer
PPR	Peak Power Reduction
PSA	Product Specification Agreement
RBW	Resolution BandWidth
RF	Radio Frequency

Rx	Receive
SA	Spectrum Analyzer
SFRM	Single Carrier Flexible Radio Module
SW	Software
TBD	To Be Determined
TM	Triplexer Module
TPTL	Transmit Power Tracking Loop
TRM	Transmitter Receiver Module
Tx	Transmit
uP	Microprocessor
XCVR	Transceiver

1 Introduction

This test report is submitted in accordance with the FCC Rules and Regulations, Part 2, Subpart J, Sections 2.1046 through 2.1057 for equipment authorization of Northern Telecom's (Nortel Networks) CDMA 1900 MHz Multiple carrier Flexible Radio Module (MFRM).

The 1900 MHz MFRM is intended for use in the Domestic Public Cellular Radio Telecommunications Service and is designed in accordance with the following standards:

- *CFR 47, Part 24, Subpart E, Broadband Personal Communications Service [1]*
- *CFR 47, Part 2, Subpart J, Equipment Authorization Procedures - Equipment Authorization[2]*

1.1 Test Result Summary

Table 1 summarizes the measurement results¹ for the CDMA 1900 MHz MFRM.

Table 1 : Test Results Summary

FCC Measurement Specification	FCC Limit Specification	Description	Results
2.1046	24.232	RF Power Output	Compliant
2.1047		Modulation Characteristics	Not Applicable
2.1049		Occupied Bandwidth	OBW = 1.2725 MHz
2.1051, 2.1057	24.238	Spurious Emissions at Antenna Terminals	Compliant
2.1055	24.235	Frequency Stability	Compliant

1. This report presents measurement results for tests performed by Nortel Networks. Field Strength of Spurious Emissions measurement results along with requirements specified in 2.1033 are covered in a separate test report from Sanmina Canada.

1 Engineering Declaration

The CDMA 1900MHz Multiple carrier Flexible Radio Module has been tested in accordance with the requirements contained in the Federal Communications Commission Rules and Regulations Part 2 and 24.

To the best of my knowledge, these tests were performed in accordance with good engineering practices using measurement procedures consistent with industry or commission standards or previous Commission correspondence or guidance and demonstrate that this equipment complies with the appropriate standards. All tests were conducted on a representative sample of the equipment for which equipment authorization is sought.

Tested By:

Rahim Nathoo
Systems Designer
Nortel Networks
Ottawa, Canada

Signature

13 March, 2002
Date

Reviewed By:

Thomas Wong
Regulatory Prime
Nortel Networks
Calgary, Canada

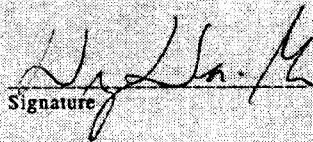
Signature

March 13, 2002
Date

Approved By:

Radu Trandafir
Systems Engineering Manage
Nortel Networks
Ottawa, Canada

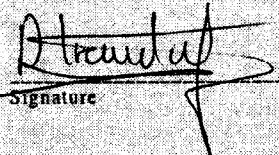
Signature

March 14, 2002
Date

3 Equipment Authorization Application Requirements

3.1 Standard Test Conditions and Test Equipment

The MFRM was tested under the following standard test conditions unless otherwise noted:

- Ambient Temperature: 20 to 35 degrees C
- Ambient Humidity: 20 to 40%
- DC Supply Voltage: -48 Vdc (nominal)

3.2 EUT Identification List

Table 2 shows the identification of the components tested in this report.

Table 2 : EUT Identification List

Equipment Description	Model / Part Number	Release Number	Serial Number
1900 MHz Multiple carrier Flexible Radio Module (comprised of the main modules below)	N/A	N/A	N/A
a) 1900 MTRM	NTGY10ZA	08	NNTM533GQ49U
b) 1900 MPAM	NTGY80AZ	P3	NNTM533BQP99
i) 1900 MCPA	NTGY811AB	03	NNTM74PC3M2R
c) A/D Band DPM	NTGS53JA	05	CLWVPP201RFW
d) B/E Band DPM	NTGS53KA	05	CLWVPP201KYV
e) C/F Band DPM	NTGS531LA	05	CLWVPP2025CJ

3.3 Test Equipment List

Table 3 shows the identification of the test equipment used in this report.

Table 3 : Test Equipment List

Description	Manufacturer	Model	Serial Number	Cal. Due Date
9kHz to 26.5 GHz Spectrum Analyzer	Rohde&Schwarz	FSEM-30	830843/006	Nov-23-02
RF Power Meter	HP	EPM442A	US37480249	Sept-24-02
RF Power Sensor Head	HP	8482A	US37294699	Nov-12-02
30dB Attenuator	Narda	776B-30	5280	Verified
20 dB Attenuator	Huber+Suhner	6820.17.B		Verified
10 dB Attenuator	Huber+Suhner	6810.17.B		Verified
RF Cable	Huber+Suhner	Sucoflex 104PE	2972/4PE	Verified
RF Cable	Andrew	FSJ4-50B		Verified

4 Transmitter Test and Measurement Results

4.1 RF Power Output

4.1.1 RF Power Output Requirements

FCC Part 2.1046

(a) For transmitters other than single sideband, independent sideband and controlled carrier radiotelephone, power output shall be measured at the RF output terminals when the transmitter is adjusted in accordance with the tune -up procedure to give the values of current and voltage on the circuit elements specified in 2.983(d)(5). The electrical characteristics of the radio frequency load attached to the output terminals when this test is made shall be stated.

FCC Limit (Part 24.232)

The maximum RF power from a base station must not exceed 100 Watts.

4.1.2 Test Method

The DE was setup via the BTS controller to enable the MFRM to transmit at maximum power. Measurements were made in one, two, and three carrier configurations. The RF output power was measured using the power meter.

4.1.3 Test Setup

The set-up used for the MFRM RF output power test is illustrated in Figure 1. RF output power measurements were referenced to the antenna port of the DPM.

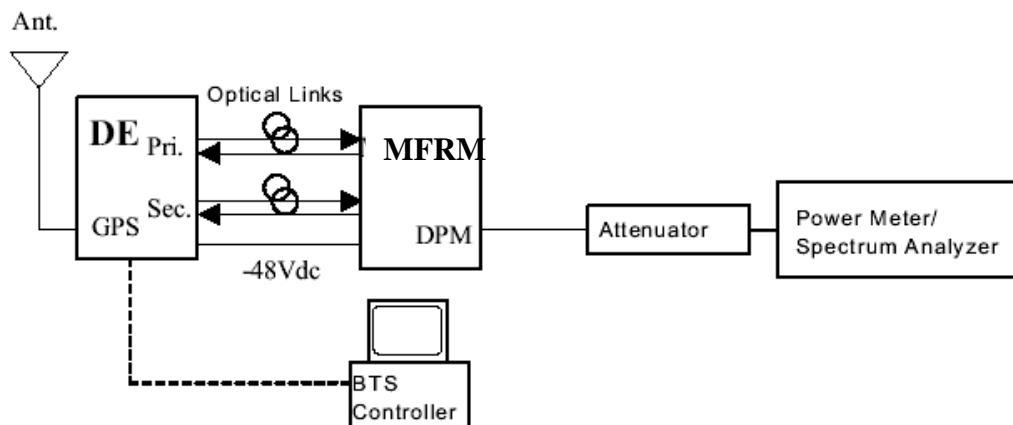

Figure 1 : Test Setup for RF Power Output Measurement

4.1.4 Test Results

The 1900 MHz MFRM complies with the requirement. The maximum measured RF output power from the MFRM was 46.0 dBm.

Table 4 : RF Output Power of 1900 MHz MFRM, 1 Carrier Mode

Channel Number (Band)	Frequency (MHz)	Measured RF Output Power (dBm)	Maximum Rated Power (dBm)	FCC Limit (dBm)
50 (A)	1932.5	45.74	46.0	50
250 (A)	1942.5	45.88	46.0	50
350 (D)	1947.5	45.97	46.0	50
450 (B)	1952.5	45.80	46.0	50
650 (B)	1962.5	45.95	46.0	50
750 (E)	1967.5	46.00	46.0	50
850 (F)	1972.5	45.90	46.0	50
950 (F)	1977.5	45.93	46.0	50
1150 (F)	1987.5	46.00	46.0	50

Table 5 : RF Output Power of 1900 MFRM, 2 Carrier Mode

Channel Number (Band)	Frequency (MHz)	Measured RF Output Power (dBm)	Maximum Rated Power (dBm)	FCC Limit (dBm)
50, 75 (A)	1932.5, 1933.75	45.81	46.0	50
650, 675	1962.5, 1963.75	45.94	46.0	50

Table 6 : RF Output Power 1900 MFRM, 3 Carrier Mode

Channel Number (Band)	Frequency (MHz) (centre channel)	Measured RF Output Power (dBm)	Maximum Rated Power (dBm)	FCC Limit (dBm)
25, 50, 75 (A)	1932.5	45.81	46.0	50
225, 250, 275 (A)	1942.5	45.91	46.0	50
325, 350, 375 (D)	1947.5	45.96	46.0	50
425, 450, 475 (B)	1952.5	45.78	46.0	50
625, 650, 675 (B)	1962.5	45.88	46.0	50
725, 750, 775 (E)	1967.5	45.85	46.0	50
825, 850, 875 (F)	1972.5	45.90	46.0	50
925, 950, 975 (C)	1977.5	45.99	46.0	50
1125, 1150, 1175 (C)	1987.5	46.00	46.0	50

4.2 Occupied Bandwidth

4.2.1 Occupied Bandwidth Requirements

FCC Part 2.1049

The OBW, that is the frequency bandwidth such that, below its lower and above its upper frequency limits, the mean powers radiated are each equal to 0.5 percent of the total mean power radiated by a given emission shall be measured under the following conditions as applicable:

(g) Transmitter in which the modulating baseband comprises not more than three independent channels - when modulated by the full complement of signals for which the transmitter is rated. The level of modulation for each channel should be set to that prescribed in rule parts applicable to the services for which the transmitter is intended. If specific modulation levels are not set forth in the rules, the tests should provide the manufacturer's maximum rated condition.

(h) Transmitters employing digital modulation techniques - when modulated by an input signal such that its amplitude and symbol rate represent the maximum rated conditions under which the equipment will be operated. The signal shall be applied through any filter networks, pseudo-random generators or other devices required in normal service. Additionally, the occupied bandwidth shall be shown for operation with any devices used for modifying the spectrum when such devices are optional at discretion of the user.

4.2.2 Test Method

The DE was setup via the BTS controller to enable the MFRM to transmit at maximum power. The occupied bandwidth was measured using the 99% channel power feature of the spectrum analyzer.

4.2.3 Test Setup

The set-up used for the MFRM Occupied bandwidth test is illustrated in Figure 2.

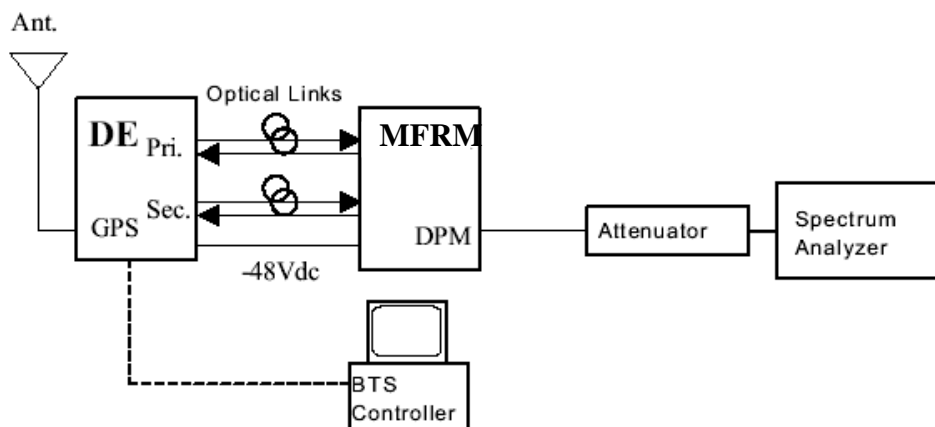

Figure 2 : Test Setup for Occupied Bandwidth Measurement

4.2.4 Test Results

The 1900 MHz MFRM complies with the requirement. The occupied bandwidth measured in one, two, and three carrier configurations for each licensed band is shown in Table 7. The plots that follow show the occupied bandwidth in one, two, and three carrier configurations. (Although plots were recorded for all channels tested, only one sample plot per carrier configuration is provided reduce the number of figures).

Table 7 : Occupied Bandwidth, 1900 MFRM, Single Carrier Mode

Channel Number (Band)	Frequency (MHz)	Measured Occupied Bandwidth (kHz)
50 (A)	1932.5	1272.5
250 (A)	1942.5	1272.5
350 (D)	1947.5	1262.5
450 (B)	1952.5	1262.5

Channel Number (Band)	Frequency (MHz)	Measured Occupied Bandwidth (kHz)
650 (B)	1962.5	1262.5
750 (E)	1967.5	1262.5
850 (F)	1972.5	1272.5
950 (C)	1977.5	1272.5
1150 (C)	1987.5	1262.5

Table 8 : Occupied Bandwidth, 1900 MFRM 2 Carrier Mode

Channel Number (Band)	Frequency (MHz)	Measured Occupied Bandwidth (kHz)
50, 75 (A)	1932.5, 1933.75	2494.9
650, 675 (A)	1962.5, 1963.75	2484.9

Table 9 : Occupied Bandwidth, 1900 MFRM 3 Carrier Mode

Channel Number (Band)	Frequency (MHz) (centre channel)	Measured Occupied Bandwidth (kHz)
25, 50, 75 (A)	1932.5	3747.5
225, 250, 275 (A)	1942.5	3747.5
325, 350, 375 (D)	1947.5	3747.5
425, 450, 475 (B)	1952.5	3727.5
625, 650, 675 (B)	1962.5	3727.5
725, 750, 775 (E)	1967.5	3747.5
825, 850, 875 (F)	1972.5	3747.5
925, 950, 975 (C)	1977.5	3727.5
1125, 1150, 1175 (C)	1987.5	3727.5

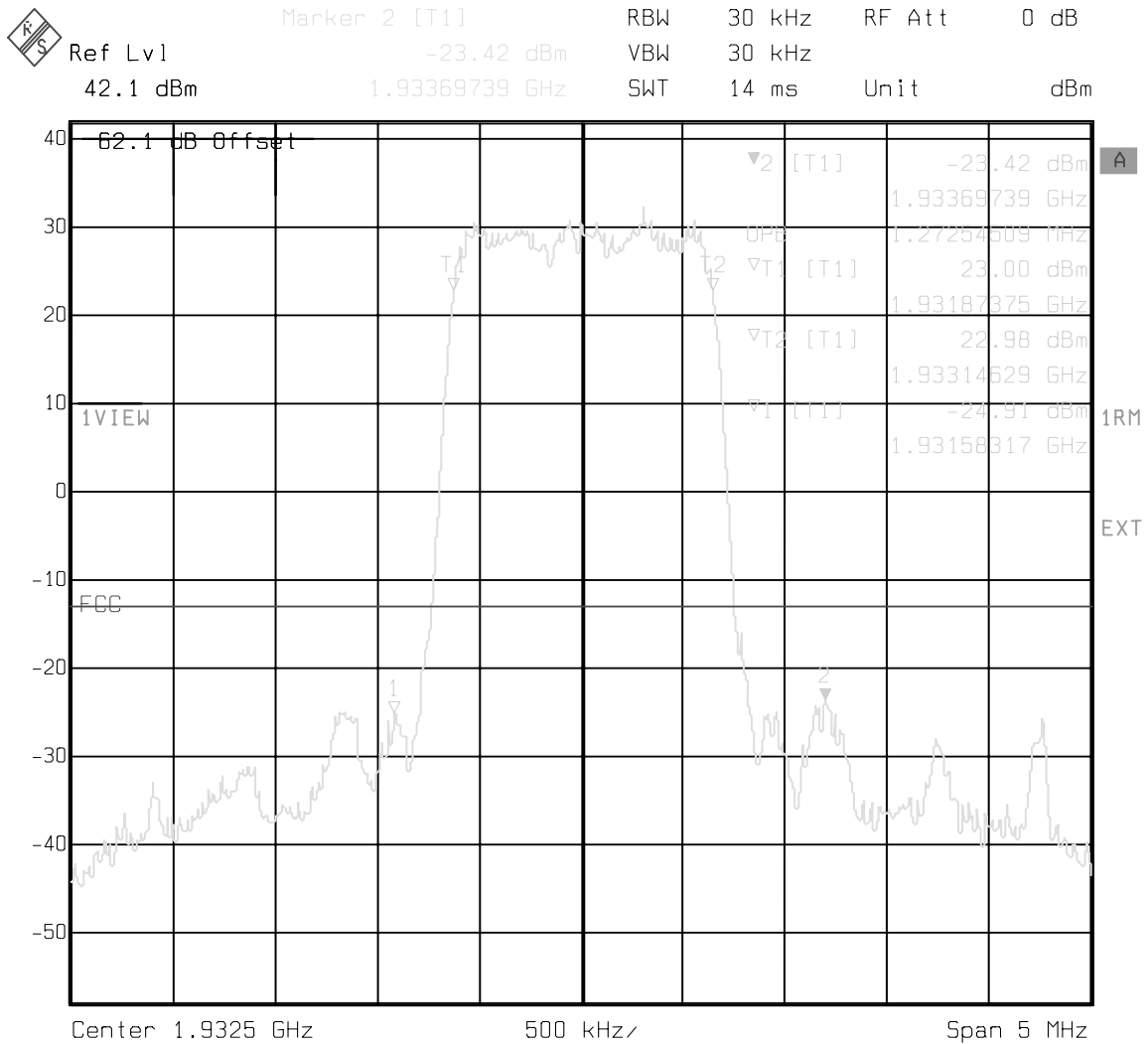

Title: OCCUPIED BANDWIDTH
 Comment A: FCC ID: AB6NT1900MFRM. CDMA 1900 MFRM CHANNEL 50
 Date: 4.MAR.2002 10:28:40

Figure 3 : Occupied Bandwidth - Single Carrier, Channel 50

Figure 4 : Occupied Bandwidth - 2 Carrier, Channel 50, 75

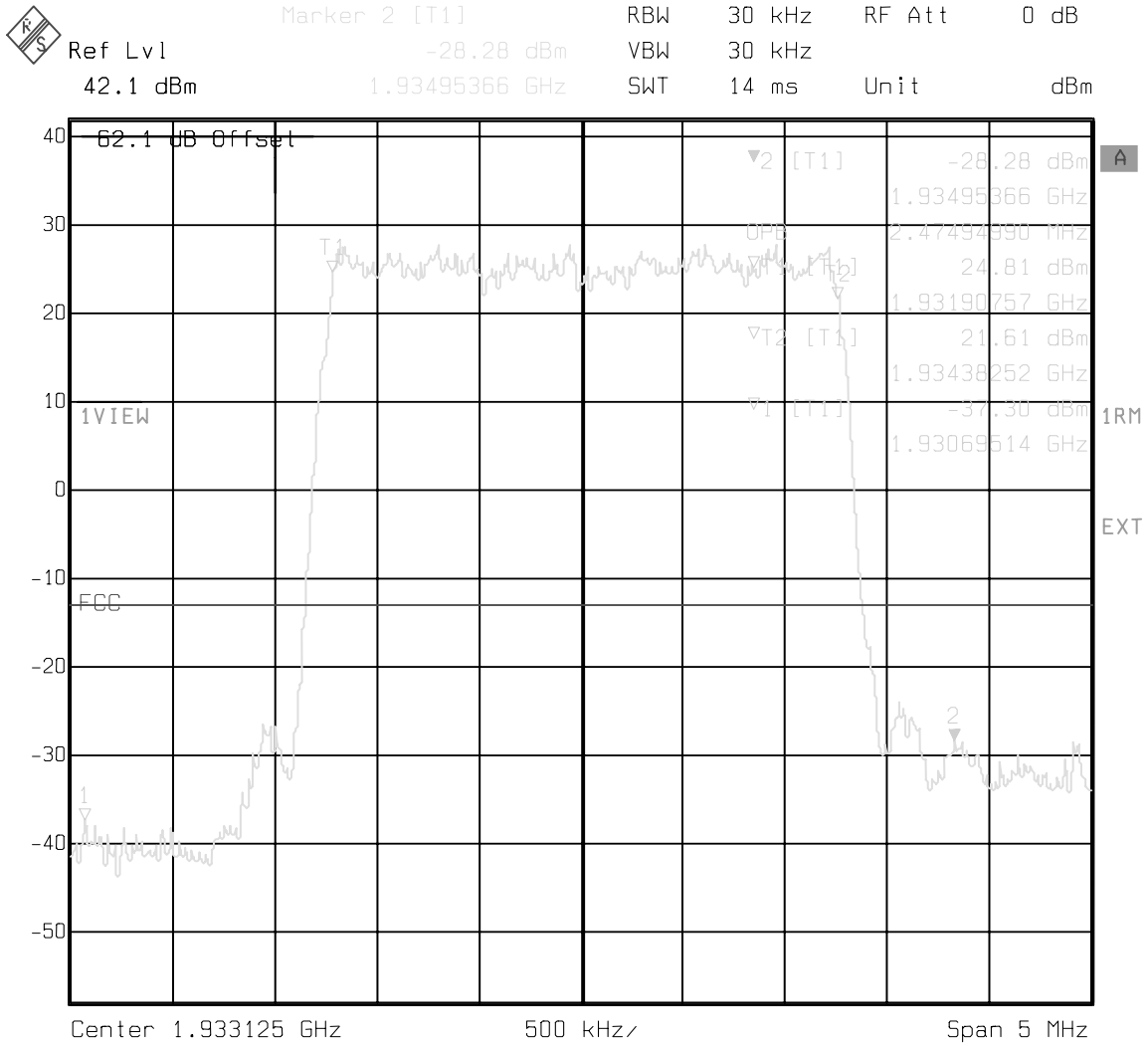

Title: OCCUPIED BANDWIDTH
 Comment A: FCC ID: AB6NT1900MFRM. CDMA 1900 MFRM CHANNEL 50 75
 Date: 25.FEB.2002 11:38:53

Figure 5 : Occupied Bandwidth - 3 Carrier, Channel 25, 50, 75

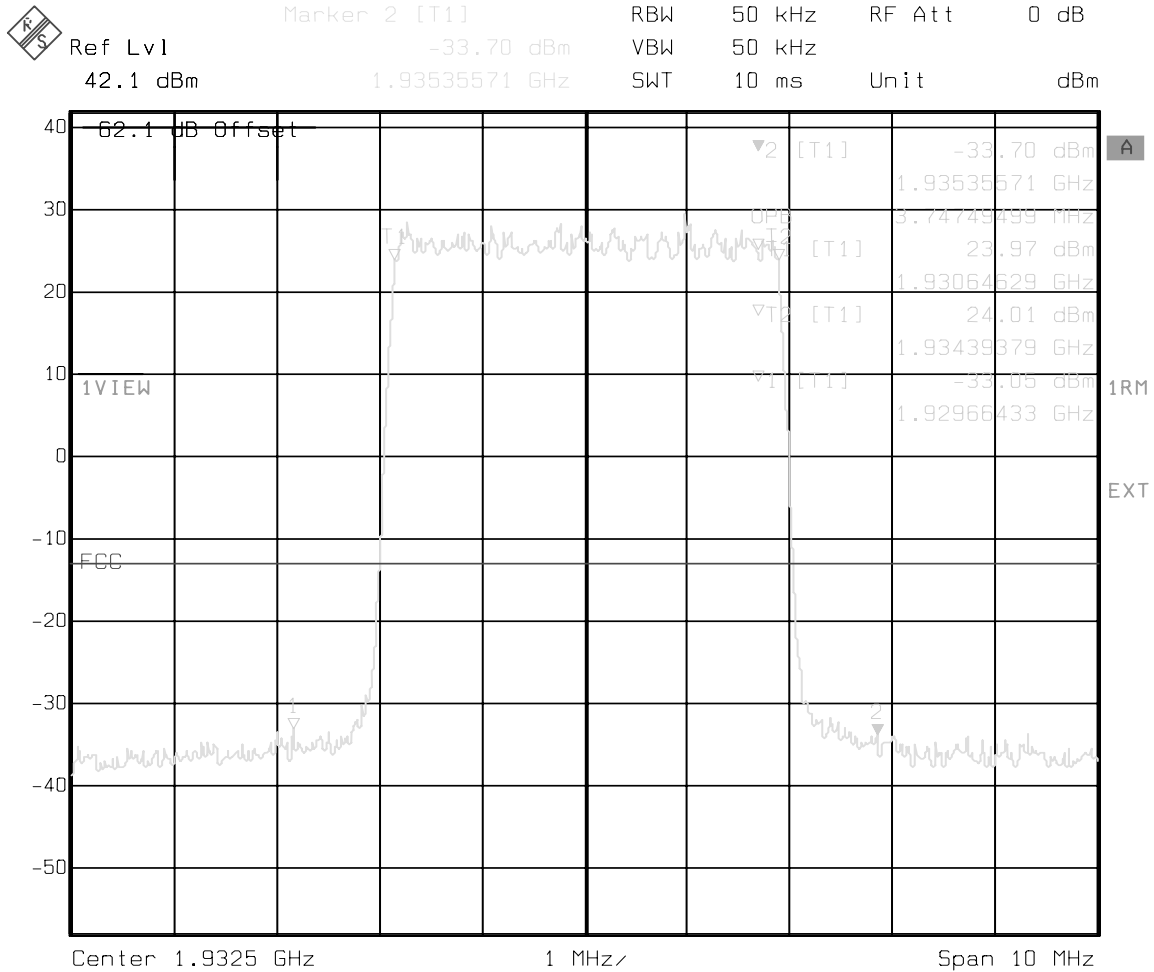

Title: OCCUPIED BANDWIDTH
 Comment A: FCC ID: AB6NT1900MFRM. CDMA 1900 MFRM CHANNEL 25 50 75
 Date: 25.FEB.2002 14:30:22

4.3 Spurious Emissions at Antenna Terminals

4.3.1 Spurious Emissions Requirements

FCC Part 2.1051

The radio frequency voltage or powers generated within the equipment and appearing on a spurious frequency shall be checked at the equipment output terminals when properly loaded with a suitable artificial antenna. Curves or equivalent data shall show the magnitude of each harmonic and other spurious emission that can be detected when the equipment is operated under the conditions specified in 2.1049 as appropriate. The magnitude of spurious emissions which are attenuated more than 20 dB below the permissible value need not be specified.

FCC Part 2.1057 - Frequency Spectrum to be investigated

The spectrum should be investigated from the lowest radio frequency generated in the equipment up to at least the 10th harmonic of the carrier frequency or to the highest frequency practicable in the present state of the art of measuring techniques, whichever is lower. Particular attention should be paid to harmonics and subharmonics of the carrier frequency. Radiation at the frequencies of multiplier stages should be checked. The amplitude of spurious emissions which are attenuated more than 20 dB below the permissible value need not be reported.

FCC Part 24.238 Limit

(a) On any frequency outside a licensee's frequency block, the power of any emission shall be attenuated below the transmit power (P) by at least $43 + 10 \log (P)$ dB.

(b) Compliance with these provisions is based on the use of measurement instrumentation employing a resolution bandwidth of 1 MHz or greater. However, in the 1 MHz bands immediately outside and adjacent to the frequency block a resolution bandwidth of at least one percent of the emission bandwidth of the fundamental emission of the transmitter may be employed. The emission bandwidth is defined as the width of the signal between two points, one below the carrier center frequency and one above the carrier center frequency, outside of which all emissions are attenuated at least 26 dB below the transmitter power.

(c) When measuring the emission limits, the nominal carrier frequency shall be adjusted as close to the licensee's frequency block edges, both upper and lower, as the design permits.

(d) The measurements of emission power can be expressed in peak or average values, provided they are expressed in the same parameters as the transmitter power.

4.3.2 Test Method

The BTS digital enclosure was configured via the BTS controller to enable the MFRM to transmit

at maximum power. Measurements were made on channels at the bottom and top of the licensed sub-bands in one, two and three carrier configurations. The following spectrum analyzer settings were used for the measurement of the antenna port spurious emissions:

Adjacent 1MHz to indicated cellular band (Upper and Lower)

Resolution Bandwidth:	30 kHz (1 carrier, 2 carrier), 50 kHz (3 carrier)
Video Bandwidth:	30 kHz (1 carrier, 2 carrier), 50 kHz (3 carrier)
Video Average:	10 Averages
Span:	1 MHz
Attenuation:	0 dB
Ref. Level:	42.1 dBm
Ref. Level Offset:	61.2 dB

All spectrum analyzer settings were coupled as per the manufacturers recommendations to improve measurement time, without compromising data.

All other Spurious Emissions up to 20 GHz

Resolution Bandwidth:	1 MHz (1 carrier, 2 carrier, 3 carrier)
Video Bandwidth:	1 MHz (1 carrier, 2 carrier, 3 carrier)
Video Average:	10 Averages
Span:	Set accordingly
Attenuation:	0 dB
Ref. Level:	42.1 dBm
Ref. Level Offset:	61.2 dB

4.3.3 Test Setup

The set-up used for the MFRM Antenna Port Spurious Emission test is illustrated in Figure 6.

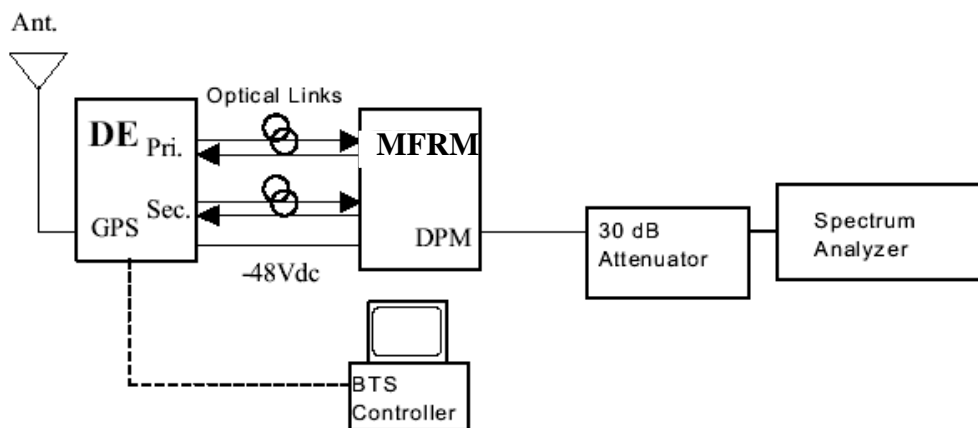

Figure 6 : Test Setup for Spurious Emissions Measurement

4.3.4 Test Results

The frequency spectrum from 1 MHz to 20 GHz was scanned for emissions using the spectrum analyzer settings outlined in the test method (Section 4.3.2). The MFRM complies with the limit of -13 dBm. Table 10 shows the spurious emissions at the antenna port of the MFRM for 1 , 2 and 3 carrier modes. The plots that follow show the spurious emissions in one, two, and three carrier configuration. (For each configuration, only one sample is shown to reduce the number of figures).

Table 10 : Spurious Emissions at the 1900 MHz MFRM Antenna Port

Frequency (MHz)	Spurious Emissions Level (dBm)			Margin to FCC Limit of -13 dBm (dB)		
	1 carrier (30 kHz RBW)	2 carrier (30 kHz RBW)	3 carrier (50 kHz RBW)	1 carrier	2 carrier	3 carrier
1930.00 (lower edge of band A)	-30.10	-39.92	-29.98	17.1	26.9	17.0
1944.95 (upper edge of band A)	-24.91		-31.45	11.9		18.5
1945.00 (lower edge of band D)	-29.22		-32.48	16.2		19.5
1949.95 (upper edge of band D)	-24.41		-30.92	11.4		17.9
1950.00 (lower edge of band B)	-29.08	-35.81	-32.45	16.1	22.81	19.5
1964.95 (upper edge of band B)	-23.05	-22.85	-31.60	10.1	9.9	18.6
1965.00 (lower edge of band E)	-27.68		-31.34	14.7		18.3
1969.95 (upper edge of band E)	-23.48		-32.11	10.5		19.1
1970.00 (lower edge of band F)	-27.46		-30.43	14.5		17.4
1974.95 (upper edge of band F)	-24.41		-32.00	11.4		19.0
1975.00 (lower edge of band C)	-26.96		-29.91	14.0		16.9
1989.95 (upper edge of band C)	-26.90		-30.94	13.9		17.9
0 - 2000 ^a (RBW=1 MHz)	-28.64	-28.83	-28.59	15.6	15.8	15.6
2000 - 7000 ^a (RBW=1 MHz)	-23.02	-22.99	-22.94	10.0	10.0	9.9
7000 - 20000 ^a (RBW=1 MHz)	-24.98	-24.99	-24.97	12.0	12.0	12.0

Notes: a Emission levels given in these ranges represents the worst case value over all the tested channels

Figure 7 : Conducted Spurious Emissions - 1 Carrier, Channel 775 (Lower adjacent 1 MHz)

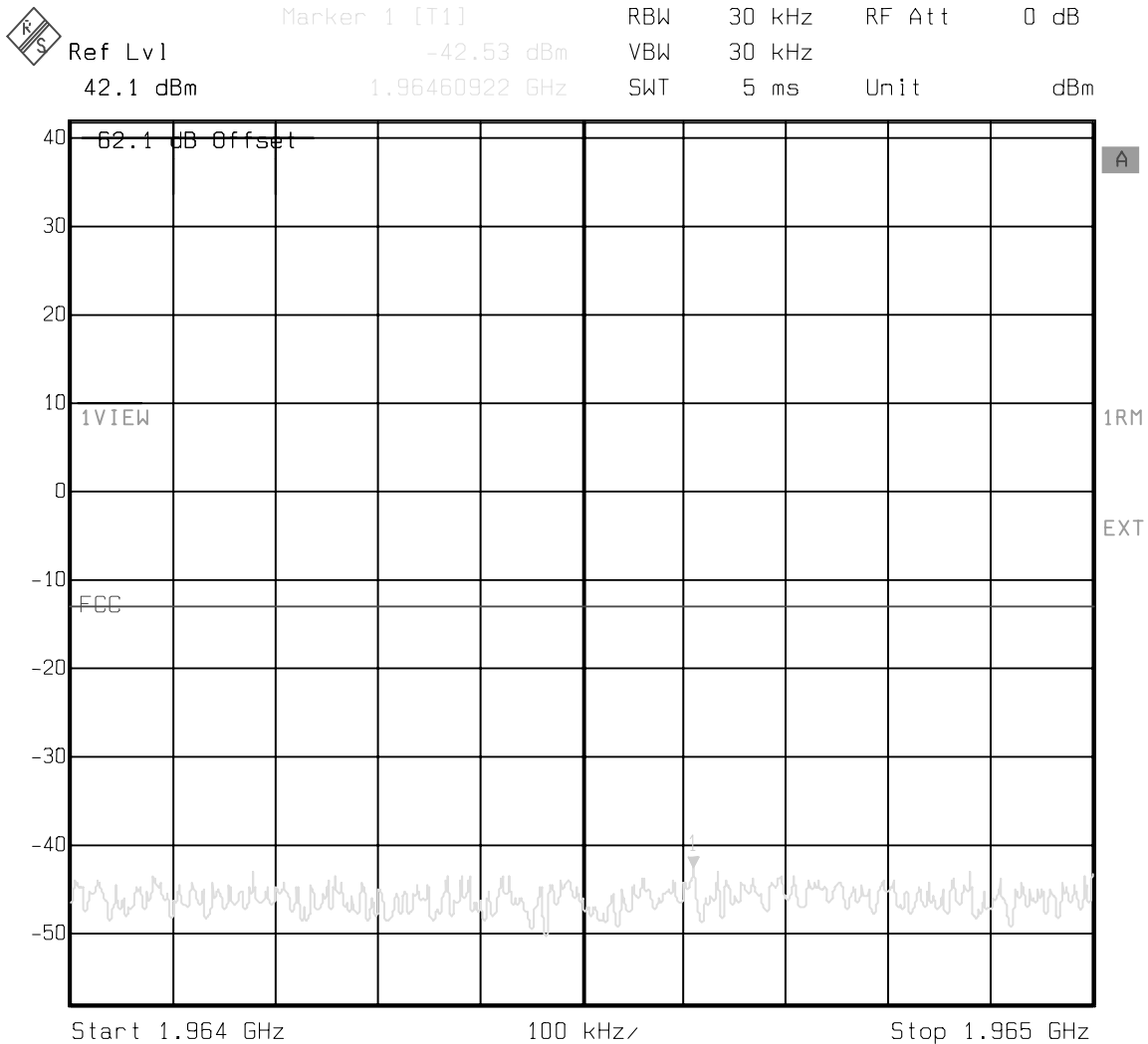

Title: SPURIOUS EMISSIONS AT ANTENNA PORT
Comment A: FCC ID: AB6NT1900MFRM. CDMA 1900 MFRM CHANNEL 775
Date: 5.MAR.2002 16:27:42

Figure 8 : Conducted Spurious Emissions - 1 Carrier, Channel 775 (Upper adjacent 1 MHz)

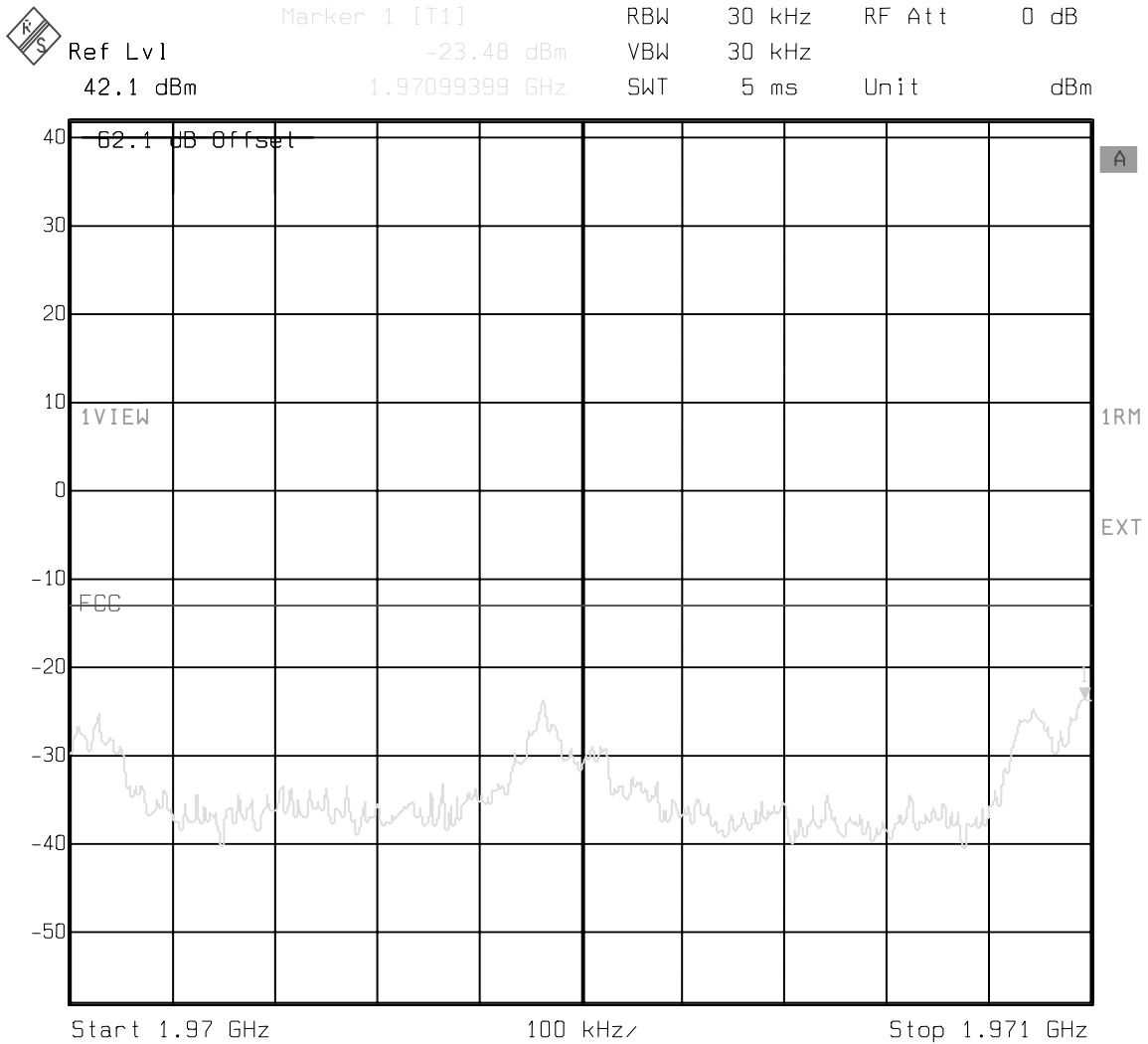

Title: SPURIOUS EMISSIONS AT ANTENNA PORT
 Comment A: FCC ID: AB6NT1900MFRM. CDMA 1900 MFRM CHANNEL 775
 Date: 5.MAR.2002 16:28:01

Figure 9 : Conducted Spurious Emissions - 1 Carrier, Channel 775 (10kHz - 2 GHz)

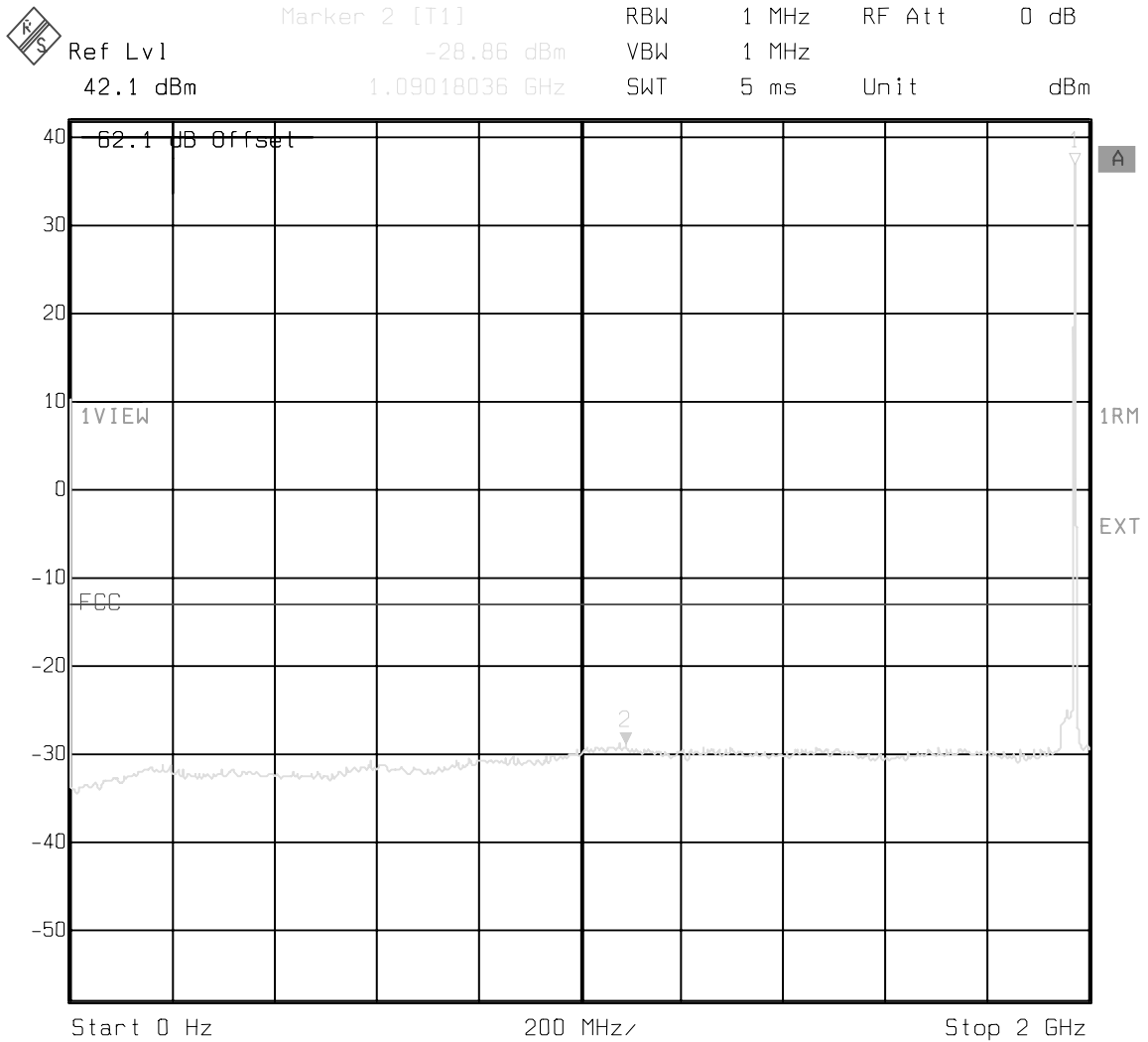

Title: SPURIOUS EMISSIONS AT ANTENNA PORT
Comment A: FCC ID: AB6NT1900MFRM. CDMA 1900 MFRM CHANNEL 775
Date: 5.MAR.2002 16:26:48

Figure 10 : Conducted Spurious Emissions - 1 Carrier, Channel 775 (2 GHz - 7 GHz)

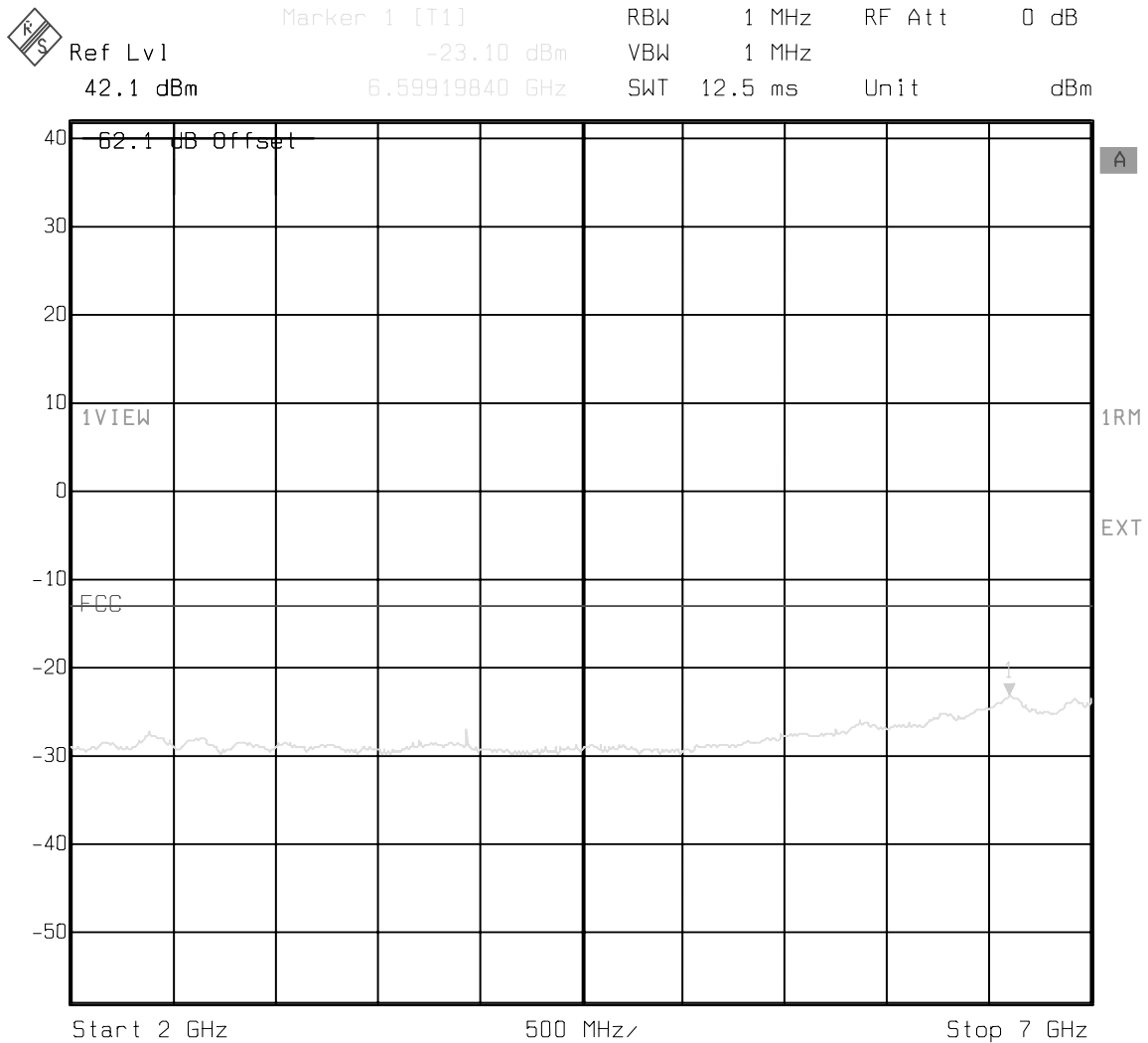

Title: SPURIOUS EMISSIONS AT ANTENNA PORT
 Comment A: FCC ID: AB6NT1900MFRM. CDMA 1900 MFRM CHANNEL 775
 Date: 5.MAR.2002 16:27:06

Figure 11 : Conducted Spurious Emissions - 1 Carrier, Channel 775 (7 GHz - 20 GHz)

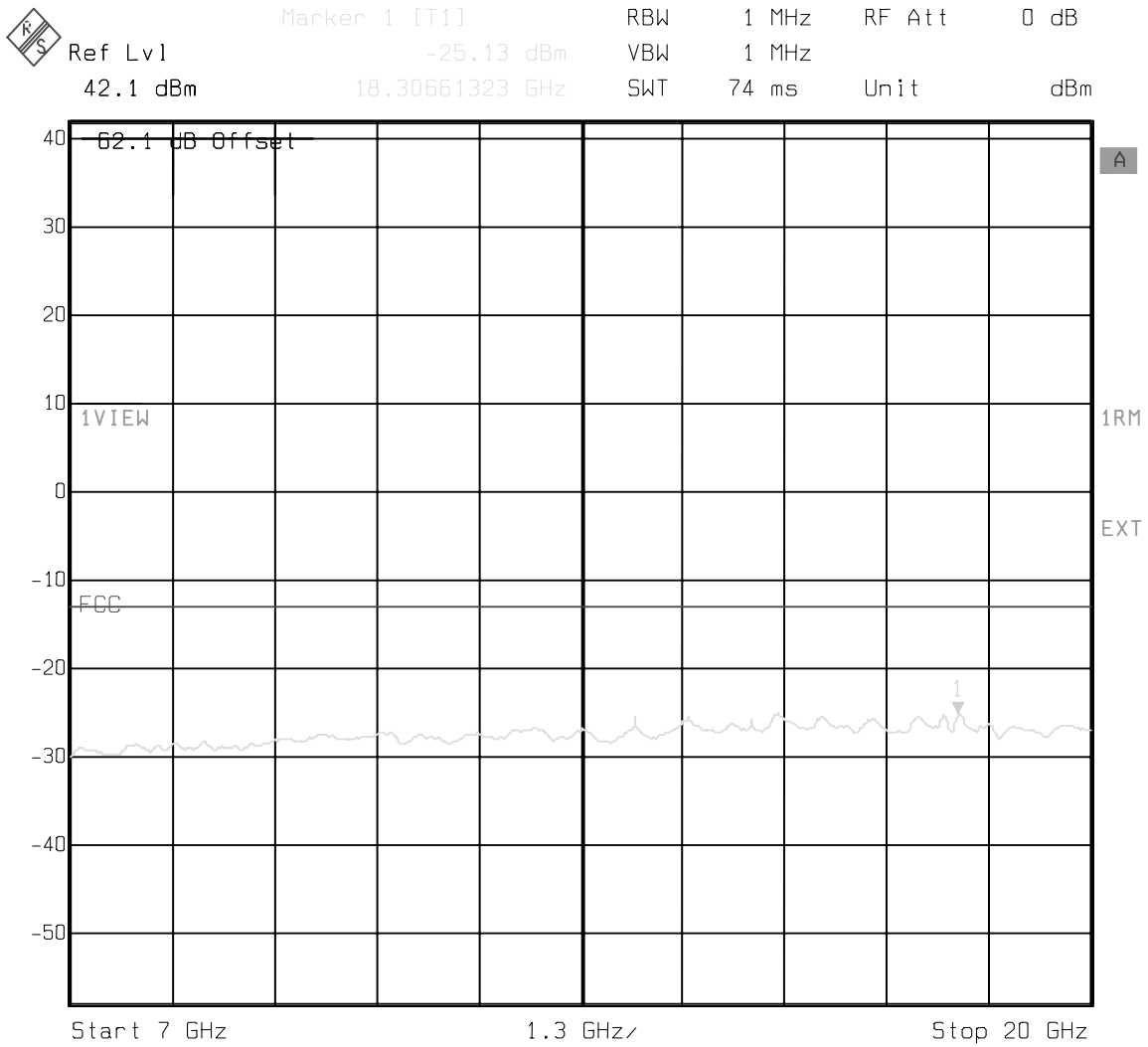

Title: SPURIOUS EMISSIONS AT ANTENNA PORT
 Comment A: FCC ID: AB6NT1900MFRM, CDMA 1900 MFRM CHANNEL 775
 Date: 5.MAR.2002 16:27:24

Figure 12 : Conducted Spurious Emissions - 2 Carrier, Channels 650, 675 (Lower adjacent 1 MHz)

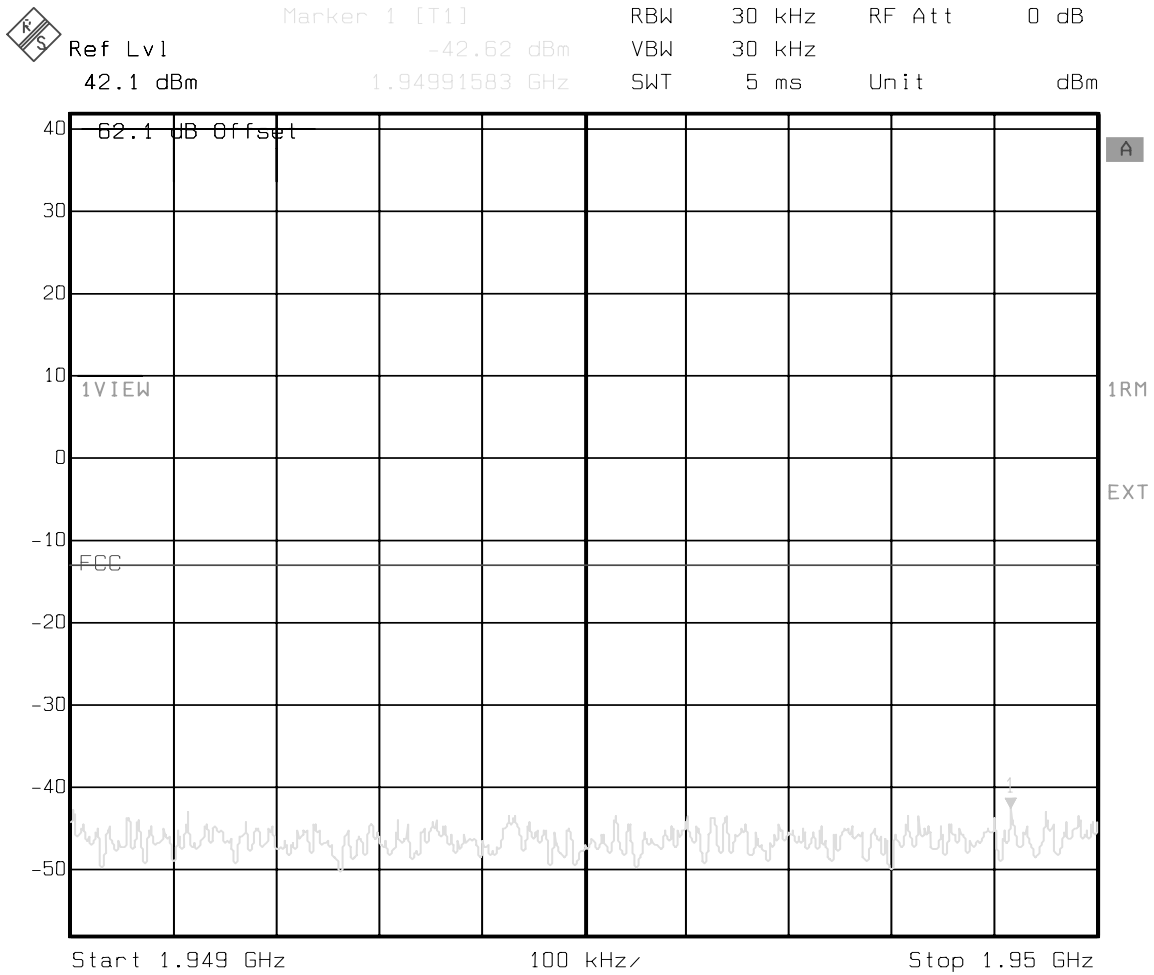

Title: SPURIOUS EMISSIONS AT ANTENNA PORT
 Comment A: FCC ID: AB6NT1900MFRM. CDMA 1900 MFRM CHANNEL 650, 675
 Date: 5.MAR.2002 16:45:28

Figure 13 : Conducted Spurious Emissions - 2 Carrier, Channels 650, 675 (Upper adjacent 1 MHz)

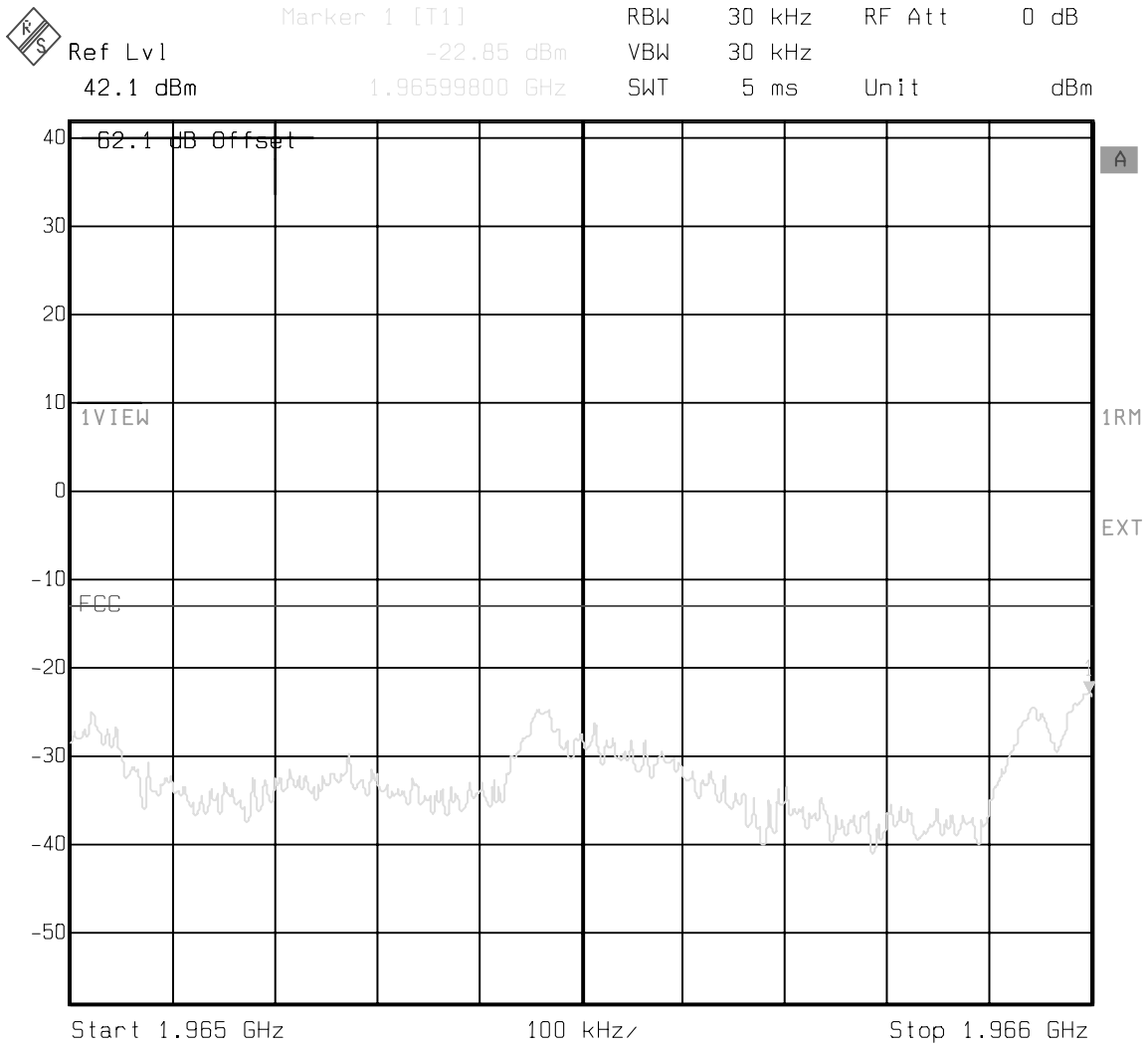

Title: SPURIOUS EMISSIONS AT ANTENNA PORT
 Comment A: FCC ID: AB6NT1900MFRM. CDMA 1900 MFRM CHANNEL 650 675
 Date: 5.MAR.2002 16:45:46

Figure 14 : Conducted Spurious Emissions - 2 Carrier, Channels 650, 675 (10 kHz - 2 GHz)

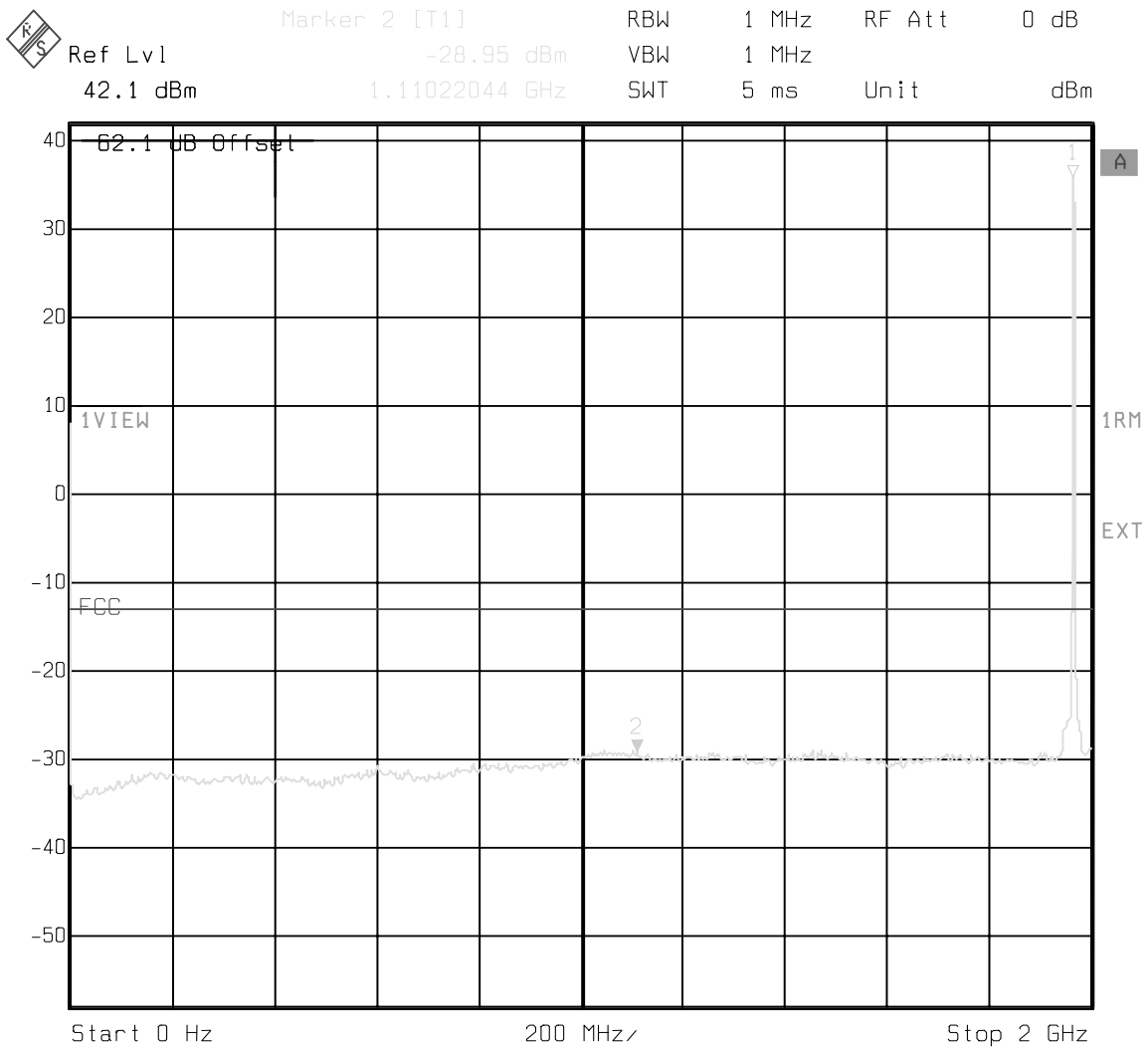

Title: SPURIOUS EMISSIONS AT ANTENNA PORT
 Comment A: FCC ID: AB6NT1900MFRM. CDMA 1900 MFRM CHANNEL 650 675
 Date: 5.MAR.2002 16:44:33

Figure 15 : Conducted Spurious Emissions - 2 Carrier, Channels 650, 675 (2 GHz - 7 GHz)

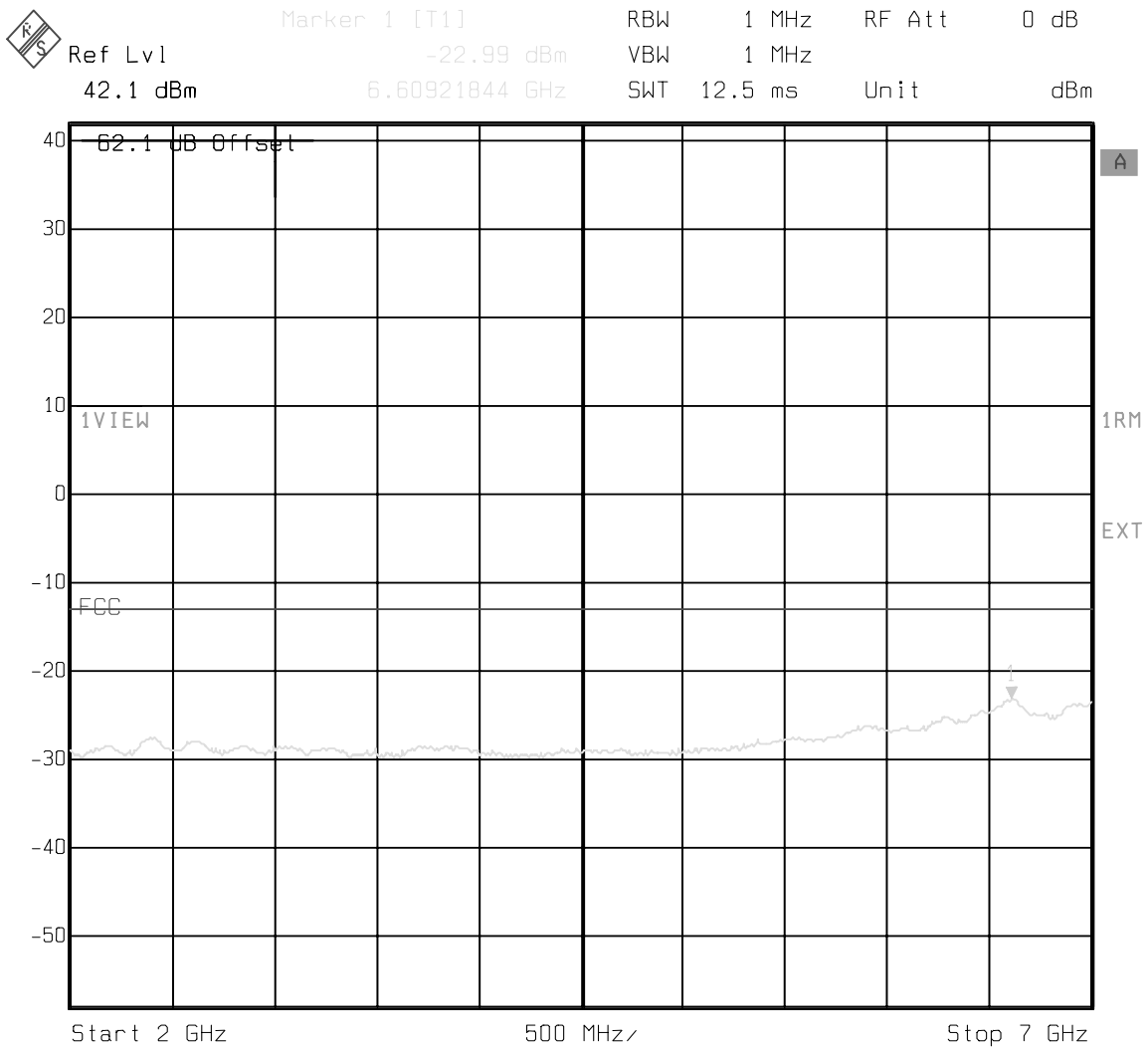

Title: SPURIOUS EMISSIONS AT ANTENNA PORT
Comment A: FCC ID: AB6NT1900MFRM. CDMA 1900 MFRM CHANNEL 650 675
Date: 5.MAR.2002 16:44:51

Figure 16 : Conducted Spurious Emissions - 2 Carrier, Channels 650, 675 (7 GHz - 20 GHz)

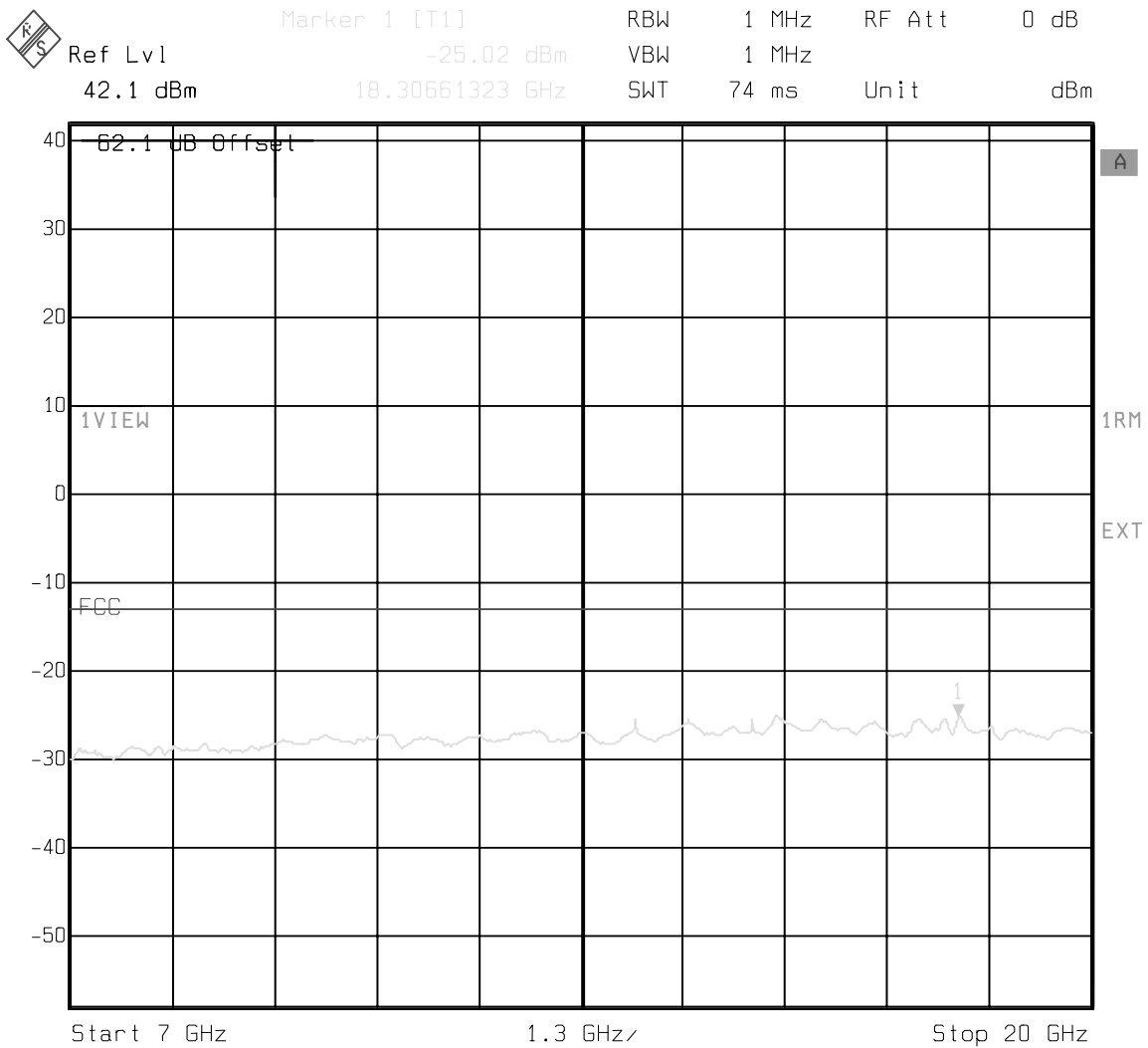

Title: SPURIOUS EMISSIONS AT ANTENNA PORT
 Comment A: FCC ID: AB6NT1900MFRM. CDMA 1900 MFRM CHANNEL 650 675
 Date: 5.MAR.2002 16:45:09

Figure 17 : Conducted Spurious Emissions - 3 Carrier, Channels 925, 950, 975 (Lower adjacent 1 MHz)

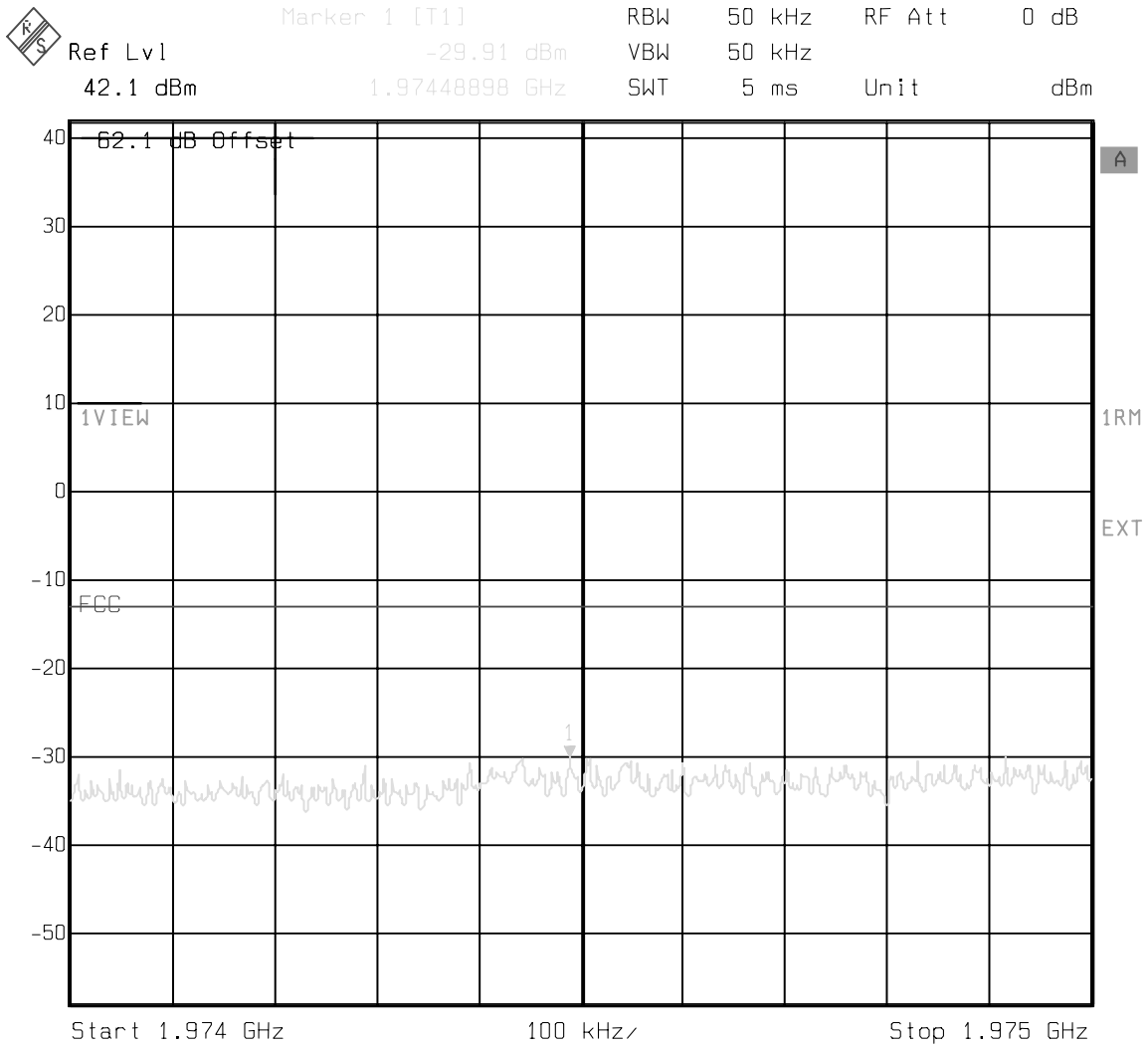

Title: SPURIOUS EMISSIONS AT ANTENNA PORT
 Comment A: FCC ID: AB6NT1900MFRM. CDMA 1900 MFRM CHANNEL 925 950 975
 Date: 1.MAR.2002 15:58:12

Figure 18 : Conducted Spurious Emissions - 3 Carrier, Channels 925, 950, 975 (Upper adjacent 1 MHz)

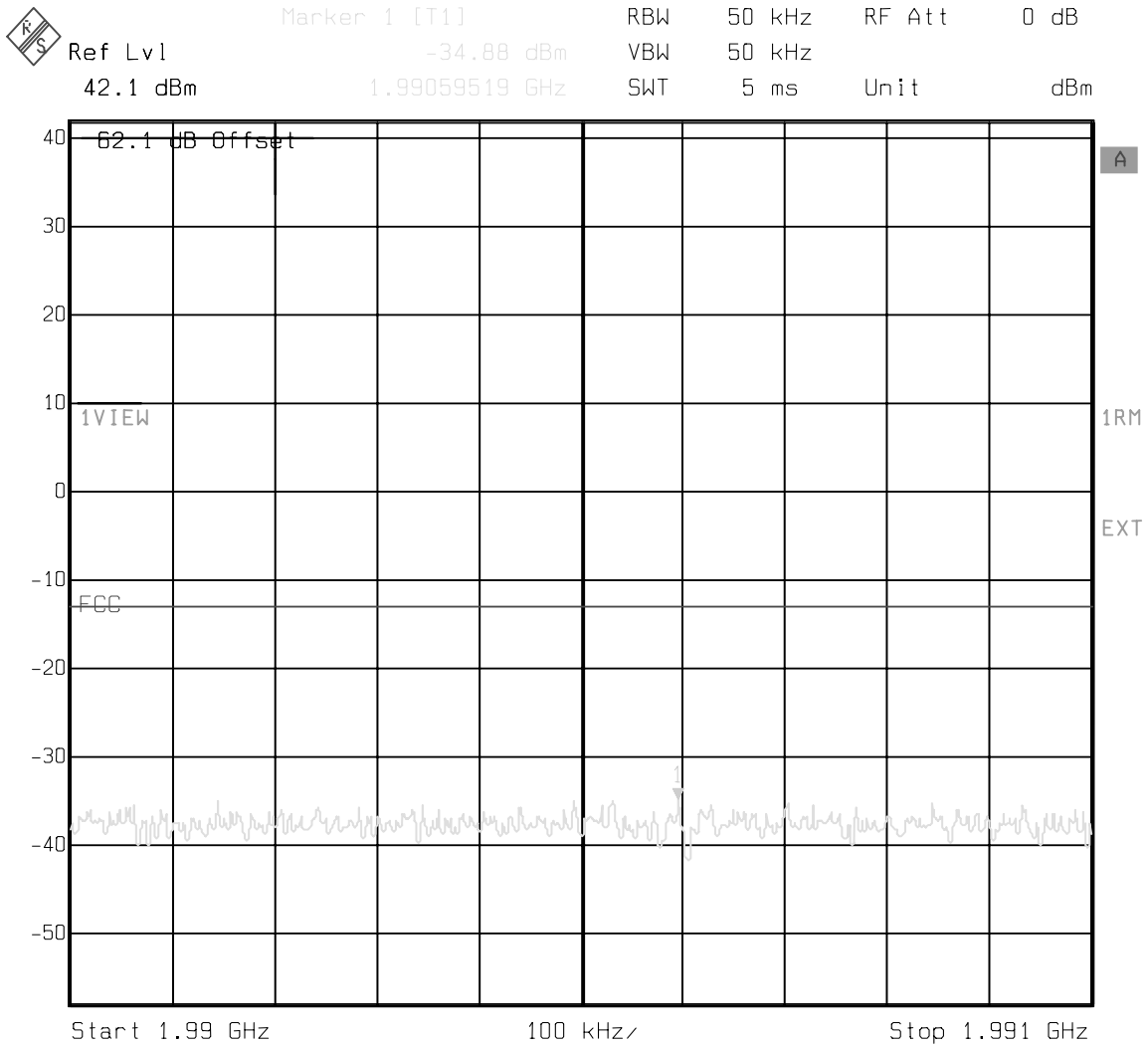

Title: SPURIOUS EMISSIONS AT ANTENNA PORT
 Comment A: FCC ID: AB6NT1900MFRM. CDMA 1900 MFRM CHANNEL 925 950 975
 Date: 1.MAR.2002 15:58:30

Figure 21 : Conducted Spurious Emissions - 3 Carrier, Channels 925, 950, 975 (7 GHz - 20 GHz)

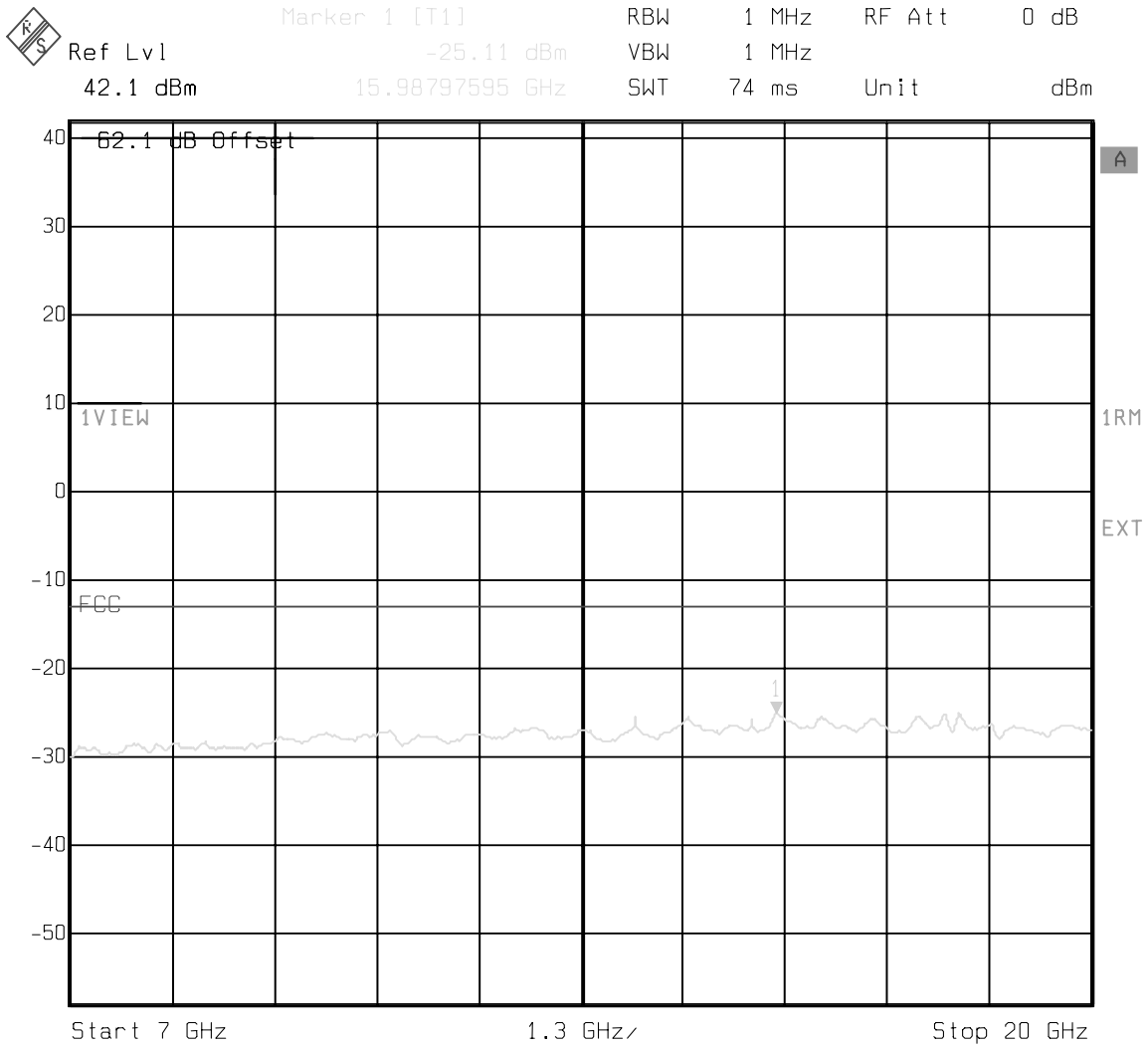

Title: SPURIOUS EMISSIONS AT ANTENNA PORT
 Comment A: FCC ID: AB6NT1900MFRM. CDMA 1900 MFRM CHANNEL 925 950 975
 Date: 1.MAR.2002 15:57:53

4.4 Frequency Stability

4.4.1 Frequency Stability Requirements

FCC Part 2.1055

(a) The frequency stability shall be measured with variation of ambient temperature as follows:

(1) From -30 to +50 centigrade for all equipment except that specified in subparagraphs (2) and (3) of this paragraph.

(b) Frequency measurements shall be made at the extremes of the specified temperature range and at intervals of not more than 10 centigrade through the range. A period of time sufficient to stabilize all of the components of the oscillator circuit at each temperature level shall be allowed prior to frequency measurement. The short term transient effects on the frequency of the transmitter due to keying (except for broadcast transmitters) and any heating element cycling normally occurring at each ambient temperature level also shall be shown. Only the portion or portions of the transmitter containing the frequency determining and stabilizing circuitry need be subjected to the temperature variation test.

(d) The frequency stability shall be measured with variation of primary supply voltage as follows:

(1) Vary primary supply voltage from 85 to 115 percent of the nominal value for other than hand carried battery equipment.

(2) For hand carried, battery powered equipment, reduce primary supply voltage to the battery operating end point which shall be specified by the manufacturer.

(3) The supply voltage shall be measured at the input to the cable normally provided with the equipment, or at the power supply terminals if cables are not normally provided. Effects on frequency of transmitter keying (except for broadcast transmitters) and any heating element cycling at the nominal supply voltage and at each extreme also shall be shown.

(e) When deemed necessary, the Commission may require tests of frequency stability under conditions in addition to those specifically set out in paragraphs (a), (b), (c) and (d) of this section. (For example, measurements showing the effect of proximity to large metal objects, or of various types of antennas, may be required for portable equipment.)

FCC Part 24.235 Limit

The frequency stability shall be sufficient to ensure that the fundamental emission stays within the authorized frequency block.

4.4.2 Results

The DE incorporates a GPS module from Trimble Navigation. This 10MHz GPS reference is used to synchronize the entire Base Station. The GPS module has a frequency stability of 0.8 ppb over the range of -5C to 70C. The Base Station complied with the requirement.

References

- [1] FCC Part 24 Subpart E, “Personal Communication Services”, http://www.access.gpo.gov/nara/cfr/waisidx_00/47cfr24_00.html
- [2] FCC Part 2 Subpart J, “Frequency allocations and radio treaty matters; general rules and regulations”, http://www.access.gpo.gov/nara/cfr/waisidx_00/47cfr2_00.html
- [3] TIA/EIA-97-D “Recommended Minimum Performance Standards for Base Stations Supporting Dual Mode Spread Spectrum Systems”, June 2001

END OF DOCUMENT