

CERTIFICATE OF COMPLIANCE

Product Name: Reunion 28-08M CTR
Model Identifier: NTVG16CB

On the basis of measurements here reported on October 30, 2000, the above referenced equipment is verified as meeting the requirements of FCC Part 101 (Fixed Microwave Services), and FCC Part 2 (Maximum Output Power and Occupied Bandwidth) requirements. The Test data included in this report applies to the product titled herein manufactured by Nortel Networks.

Certified by:

Denis Lalonde
C-MAC Engineering, Inc.
21 Richardson Side Road
Kanata, Ontario
K2K 2C1
Canada



Table of Contents

| | |
|--|-----------|
| 1. TEST AND RESULTS SUMMARY | 1 |
| 2. REFERENCE DOCUMENTATION..... | 2 |
| 2.1. SPECIFICATIONS | 2 |
| 2.2. STANDARDS | 2 |
| 2.3. OTHER REFERENCE DOCUMENTATION..... | 2 |
| 2.4. GLOSSARY OF ACRONYMS..... | 2 |
| 3. PRODUCT DESCRIPTION | 2 |
| 3.1. PRODUCT IDENTIFICATION | 3 |
| 3.2. FUNCTIONAL DESCRIPTION | 3 |
| 3.3. PRODUCT CONFIGURATION (EQUIPMENT UNDER TEST) | 4 |
| 4. GENERAL TEST CONDITIONS..... | 5 |
| 4.1. TEST FACILITY | 5 |
| 4.2. CLIMATIC CONDITIONS | 5 |
| 4.3. MEASUREMENT INSTRUMENTATION | 5 |
| 5. TEST RESULTS..... | 6 |
| 5.1. NAME OF TEST: MAXIMUM TRANSMIT POWER..... | 6 |
| 5.2. NAME OF TEST: OCCUPIED BANDWIDTH..... | 7 |
| 5.3. NAME OF TEST: RF SPECTRUM MASK..... | 8 |
| 6. TEST EQUIPMENT..... | 9 |
| 6.1. TEST CONFIGURATION | 9 |
| 6.1. TEST EQUIPMENT LIST..... | 9 |
| ANNEX A (NORTEL REUNION 28-08M CTR TEST PLOTS)..... | 10 |
| ANNEX B (NORTEL REUNION 28-08M CTR TEST PLAN)..... | 13 |

List of Tables

| | |
|--|---|
| Table 1-1: Test Case Summary | 1 |
| Table 3-1: Hardware descriptions | 4 |
| Table 6-1: Test equipment used | 9 |

List of Figures

| | |
|---|----|
| Figure 3-1: Nortel Networks Reunion TDMA system | 3 |
| Figure 5-1: Spectrum Mask limit | 8 |
| Figure 6-1: Test Configuration for Tx Output Power, Tx Nominal Output Power | 9 |
| Figure 6-1: Test Configuration for Occupied Bandwidth and Spectrum Mask | 9 |
| Figure A-1 (2808M 02 0001) | 10 |
| Figure A-2 (2808M 02 0002) | 10 |
| Figure A-3 (2808M 02 0003) | 11 |
| Figure A-4 (2808M 02 0004) | 11 |
| Figure A-5 (2808M 02 0005) | 12 |
| Figure A-6 (2808M 02 0006) | 12 |

1. Test and Results Summary

The system described in Section 3.0 meets the requirements FCC Part 101 and Part 2, Fixed Microwave Services (10-1-97 edition).

A summary of the test cases can be found in the following table.

Table 1-1: Test Case Summary

| Parameter | C | NC | NT | NA | Notes |
|--|---|----|----|----|-------|
| Transmitter characteristics | | | | | |
| Maximum output power (FCC Part 2.1046) | X | | | | |
| Occupied Bandwidth (FCC Part 2.1049) | X | | | | |
| RF spectrum mask (FCC Part 101.111) | X | | | | |
| Tx Conducted Spurious emissions (FCC Part 101.111) | | | | X | |
| Radiated Spurious emissions (FCC Part 101.111) | | | | X | |
| Tx Frequency Stability (FCC Part 101.107) | | | | X | |
| Legend: | | | | | |
| C: The parameter is compliant with the requirements | | | | | |
| NC: The parameter is not compliant with the requirements | | | | | |
| NT: The parameter is not tested | | | | | |
| NA: The test of this parameter is not applicable | | | | | |
| Notes: | | | | | |
| None | | | | | |

2. Reference Documentation

2.1. Specifications

Not applicable.

2.2. Standards

1. FCC Rules for Radio Frequency Devices, Title 47 of the Code of Federal Regulations amended per FCC 89-103 (GEN. Docket No. 87-389). Part 2 and 101, U.S. Federal Communications Commission 1995.
2. ANSI C63.4-1992, Methods of Measurement of Radio-Noise Emission from Low-Voltage Electrical and Electronic Equipment in the Range of 9 kHz to 40 GHz, May 1992.

2.3. Other Reference Documentation

Not applicable.

2.4. Glossary of Acronyms

| | |
|------|-------------------------------|
| ATM | Asynchronous Transfer Mode |
| AWM | ATM Wireless Multiplexer |
| BER | Bit Error Rate |
| BRM | Broadband Radio Modem |
| BTR | Base Station Transceiver |
| CIM | Chassis Interface Module |
| CTR | Customer Premise Transceiver |
| NA | Not Applicable |
| NIU | Network Interface Unit |
| NNE | Network Node Equipment |
| RPE | Radio Power Extractor |
| RSM | Redundancy Switching Matrix |
| TDMA | Time Division Multiple Access |
| UGB | Upstream Gain Block |

3. Product Description

3.1. Product Identification

The unit tested in this report consisted of a DC powered module (-48V). The product trade name is Reunion 28-08M CTR. This is a Reunion family product.

The model of this product is NTVG16CB.

The FCC ID of this product is AB6CTR2808M.

The emission designators tested are 7M0D7W (1 carrier) and 14M0D7W (2 carriers).

Manufacturer: Nortel Networks Canada Limited
Calgary, Alberta
Canada

No modifications were necessary in order to comply with requirements as detailed in FCC Part 101 requirements.

3.2. Functional Description

The Nortel Networks TDMA Reunion system is depicted in Fig. 3-1 and described in the text below.

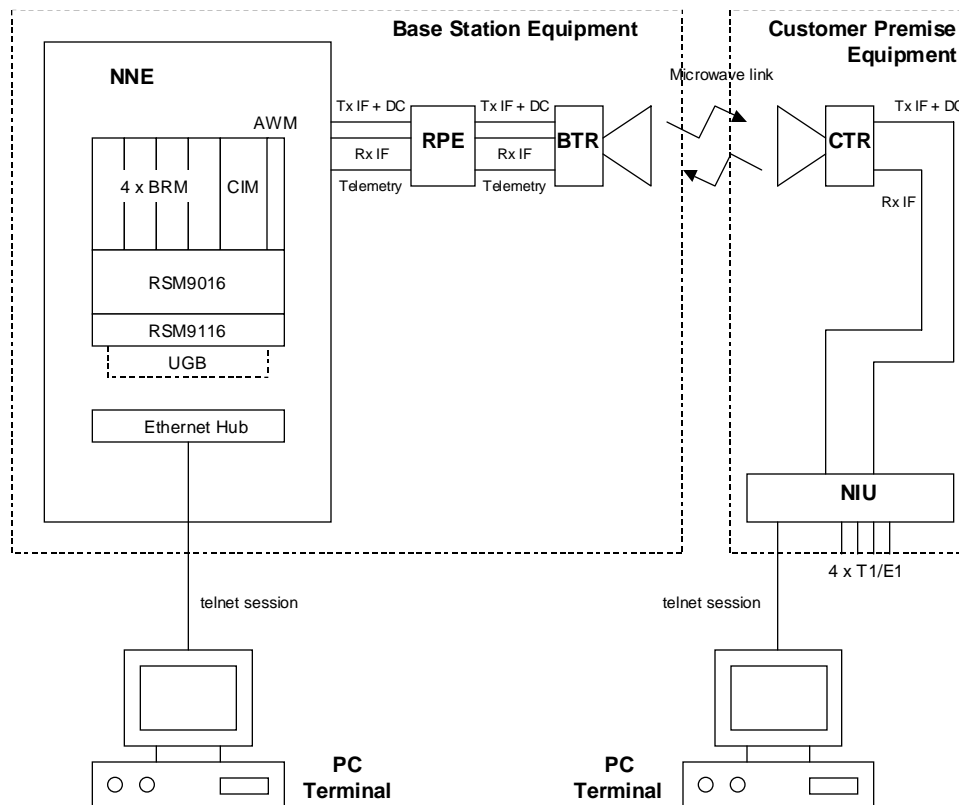

Fig. 3-1: Nortel Networks Reunion TDMA system

The Reunion Network Node Equipment (NNE) interfaces with the backbone ATM network. It also routes the ATM traffic to / from the Reunion Network Interface Units (NIU) located at the subscriber site through a set of modulators / demodulators. The BRM card contains one modulator and two demodulators. The BRM interfaces with the Reunion Base Station Transceivers (BTR) through the Redundancy Switching Matrix (RSM), which provides n : 1 redundancy switching for the BRM (RSM9016 for downstream and RSM9116 for upstream). The AWM provides a two-way interface to the network operator's ATM network through SONET / SDH link. The CIM controls the AWM and the output bit rate corresponding to the QAM modulation and symbol rate of the BRM. The RPE provides 1 : 1 redundancy switching for the base station transceiver. The UGB amplifies the upstream signal to compensate for the attenuation introduced by the RSM9116 Redundancy Switching Matrix.

The Customer Premise Equipment is a low cost unit that resides on the customer premises to provide a 10baseT Ethernet and four T1 / E1 connections. It can be connected to a variety of customer nodes that require any of aforementioned services. The unit consists of two major modules: the Network Interface Unit (NIU) and the Customer Premise Transceiver (CTR). The NIU is the indoor unit containing the TDMA modem and the interface to the network. The outdoor unit is a transceiver which converts the IF signals to / from the NIU to the required RF. These units are interconnected via coax cables that carries the IF signals and DC power for the CTR.

The software used during testing was representative of system performance under actual network usage conditions. Additional features required to activity and/or control specific radio functions (i.e. channel allocation, BER performance, power control) might be required as long as they are consistent with radio performance under actual network usage conditions.

3.3. Product Configuration (Equipment Under Test)

This system was configured with two NIUs (Network Interface Unit), a CTR, and the cables necessary to activate the hardware under investigation. Table 3-1 below provides a description of each component and the respective serial and model numbers.

Table 3-1: Hardware descriptions

| | Product and Firmware description | Model No. | Serial No. |
|--------------------------|---|------------------|-------------------|
| EUT | CTR | NTVG16CB | NNTM532GPHMF |
| Support Equipment | NIU | NTVJ27AA | NNTM532LNF3X |
| | NIU | NTVJ27AA | NNTM532LLUAF |

4. General test conditions

4.1. Test Facility

Emission testing was performed in the C-MAC Engineering Product Integrity Radio Compatibility laboratory, located at 21 Richardson Side rd, Kanata, Ontario, Canada.

4.2. Climatic Conditions

Climatic conditions are controlled within the following specifications:

- Ambient temperature: 15 to 25 deg. C
- Relative humidity: 20 to 50 %

4.3. Measurement Instrumentation

Calibration of the measurement instrumentation is maintained in accordance with the supplier's recommendations, or as necessary to ensure its accuracy as per ISO 25 requirements.

5. Test Results

5.1. Name of Test: Maximum Transmit Power

5.1.1. Test Procedure

As per FCC Part 2.1046

The maximum transmit power was measured using the average power detector on a power meter.

5.1.2. Test Results

Ambient Temperature: 15 to 25 deg. C

Relative Humidity: 20 to 50 %

Test Conditions: Nominal temperature, Nominal Power Supply Voltage

| Number of Carriers | Transmitter Power Level (dBm) | | |
|--------------------|-------------------------------|--------------------------|--------------------------|
| | Channel B 27.8535 GHz | Channel M 27.9250 GHz | Channel T 27.9965 GHz |
| 1 | 17.7 | 18.2 | 17.9 |
| 2 | 17.9 | 17.9 | 18.1 |

The equipment complies with the limits.

5.1.3. Limits

| | |
|---|-------------------------|
| Authorized Power (dBm) as quoted on Form 731 | 18.0 dBm (1/2 carriers) |
|---|-------------------------|

| | |
|---------------------|-------------------------------|
| Test Equipment Used | 1, 2, 3, 4, 5 (see Table 6-1) |
|---------------------|-------------------------------|

5.2. Name of Test: Occupied Bandwidth

5.2.1. Test Procedure

As per FCC Part 2.1049

5.2.2. Test Results

Ambient Temperature: 15 to 25 deg. C

Relative Humidity: 20 to 50 %

Test Conditions: Nominal temperature, Nominal Power Supply Voltage

| Number of Carriers | Occupied Bandwidth |
|--------------------|---------------------------------|
| | Channel M 27.9250 GHz |
| 1 | 5.533 MHz (Plot: 2808M 02 0001) |
| 2 | 12.4 MHz (Plot: 2808M 02 0002) |

| | |
|---------------------|-------------------------|
| Test Equipment Used | 4, 5, 6 (see Table 6-1) |
|---------------------|-------------------------|

5.3. Name of Test: RF Spectrum Mask

5.3.1. Test Procedure

As per FCC Part 101.111 a)
 This measurement was performed using a spectrum analyzer with 1 MHz resolution bandwidth.

5.3.2. Test Results

Ambient Temperature: 15 to 25 deg. C
 Relative Humidity: 20 to 50 %

| Number of Carriers | RF Spectrum Mask Results – 1/2 TDMA carrier(s) | |
|--------------------|--|--------------------------|
| | Channel B 27.8535 GHz | Channel T 27.9965 GHz |
| 1 | Plot: 2808M 02 0003 | Plot: 2808M 02 0004 |
| 2 | Plot: 2808M 02 0005 | Plot: 2808M 02 0006 |

The equipment complies with the limit.

5.3.3. Limits

| | |
|---------------------------|---|
| Allowed Power Range (dBm) | Attenuation = $11 + 0.4(P - 50) + 10 \text{ Log}_{10} B$. (Attenuation greater than 56 decibels is not required.) |
|---------------------------|---|

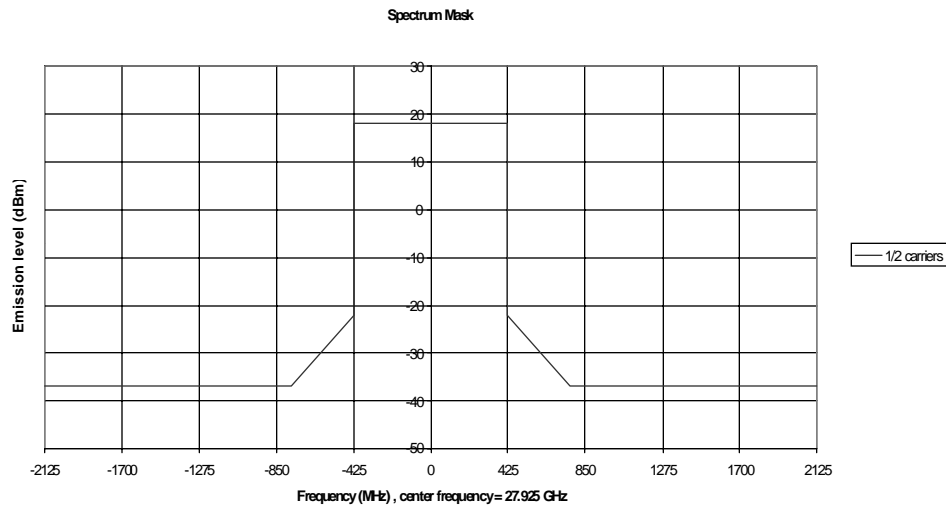

Figure 1: Spectrum Mask limit

| | |
|---------------------|----------------------------------|
| Test Equipment Used | 1, 2, 3, 4, 5, 6 (see Table 6-1) |
|---------------------|----------------------------------|

6. Test equipment

6.1. Test Configuration

The following figures describe the test configuration for the transmitter and receiver radio test cases.

Fig. 6-1: Test Configuration for Tx Output Power, Tx Nominal Output Power

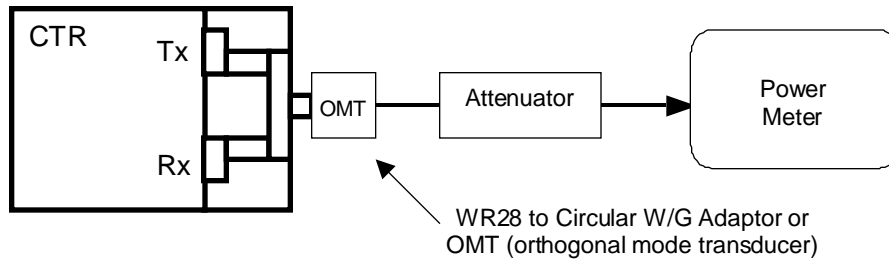
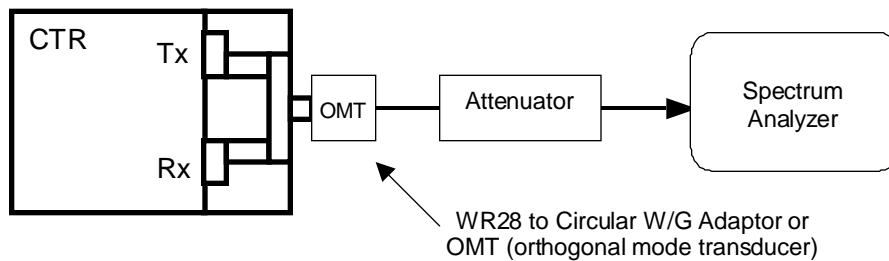

Fig. 6-2: Test Configuration for Occupied Bandwidth and Spectrum Mask



6.2. Test Equipment List

The following is a list of test equipment used to perform all tests described in this report:
 All measurement equipment were within their respective calibration periods

Table 6-1 Test equipment used

| Item | Description | Make | Model # | Asset # Or Serial # | Cal. due date |
|------|--------------------------------|--------------------|------------|---------------------------|---------------------|
| 1 | Power Meter | Anritsu | ML2438A | 98290019 | 10/00 |
| 2 | Power Sensor | Anritsu | MA2424A | 971397 | 09/00 |
| 3 | RF Signal Generator | Wiltron | 69369A | 670022 | NA |
| 4 | Coupler | PRD Electronics | A414-10FS1 | 111 | NA |
| 5 | 20dB coaxial K-type attenuator | Weinschel Corp | 54-20 | E6851 | NA |
| 6 | Spectrum Analyzer | HP | 8564E | Z0082288 | 11/00 |

Annex A: Nortel Reunion 28-08M CTR Test Plots

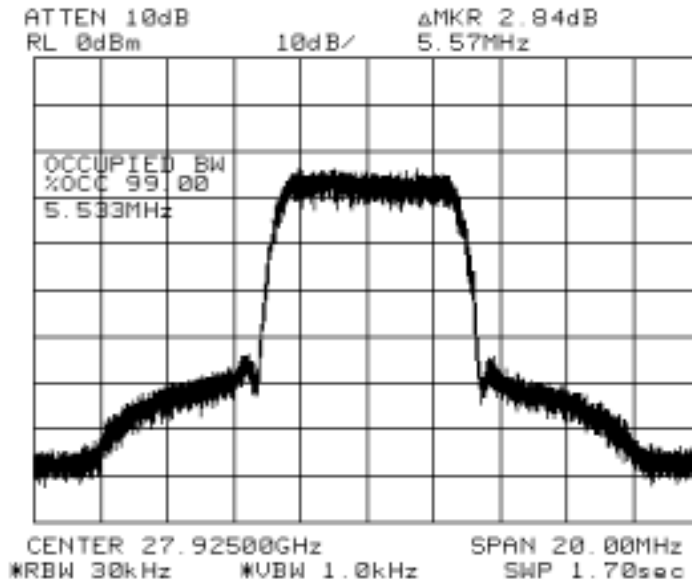

Fig. A-1 (2808M 02 0001: 1 carrier)

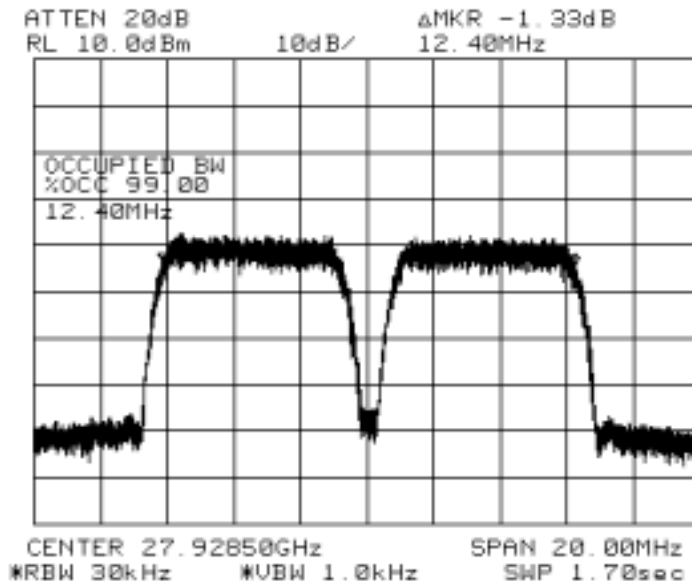

Fig. A-2 (2808M 02 0002: 2 carriers)

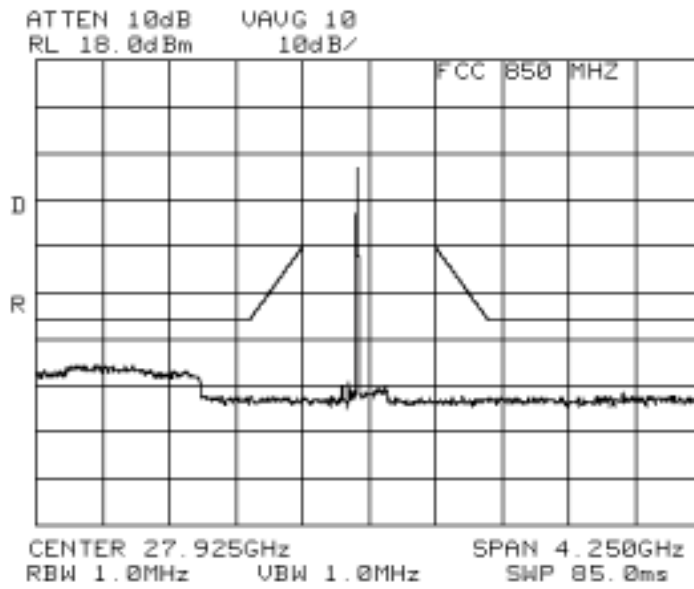

Fig. A-3 (2808M 02 0003: channel B, 1 carrier)

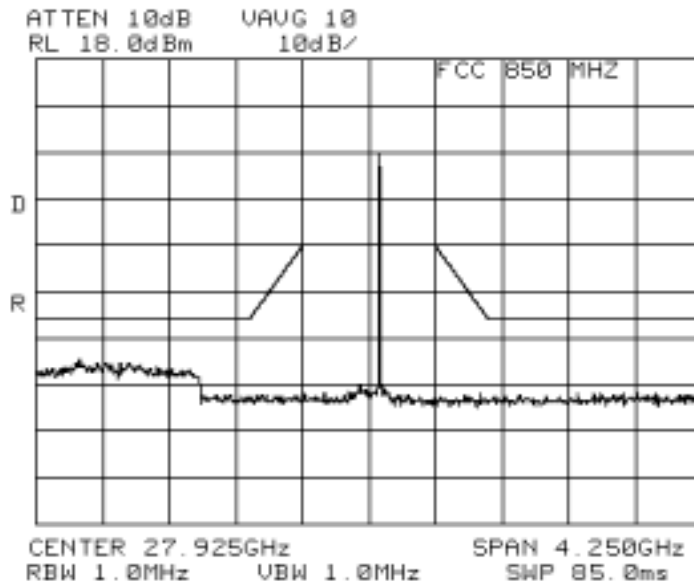

Fig. A-4 (2808M 02 0004: channel T, 1 carrier)

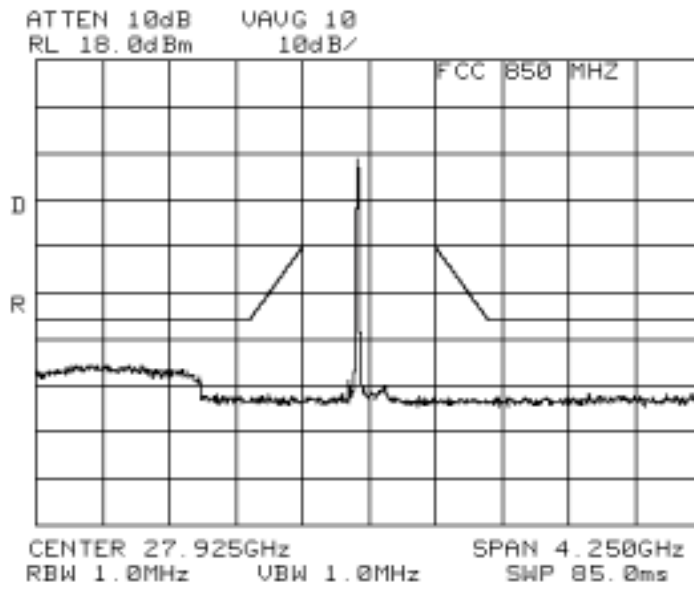

Fig. A-5 (2808M 02 0005: channel B, 2 carriers)

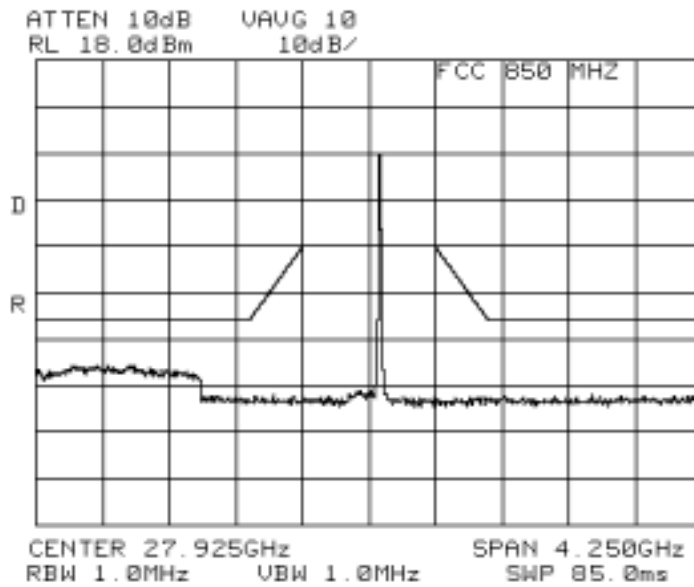

Fig. A-6 (2808M 02 0006: channel T, 2 carriers)

Annex B: Nortel Reunion 28-08M CTR Test Plan

Authorized bandwidth: 850 MHz
CTR bandwidth capability: 150 MHz

Channel B: IF Tx: 503.5 MHz, RF Tx: 27.8535 GHz
Channel M: IF Tx: 575.0 MHz, RF Tx: 27.9250 GHz
Channel T: IF Tx: 646.5 MHz, RF Tx: 27.9965 GHz

Channel spacing: 7 MHz
Symbol rate: 5.12 Msymbols/sec

Specified Output Power

4QAM

1 carrier: 18.0 dBm
2 carriers: 15.0 dBm

(These values are for individual carriers. In case of 2 carriers, the total power will be 3 dB higher)

Transmitted Power

Frequencies: B, M, and T
Number of carriers: 1 and 2

99% Occupied Bandwidth

Frequencies: M
Number of carriers: 1 and 2

Spectrum Mask

Frequencies: B and T
Number of carriers: 1 and 2

Reunion 28-08M CTR Radio Compatibility Test Plan

END OF REPORT

© Date: October 30, 2000 C-MAC Engineering
All rights reserved