

# CERTIFICATE OF COMPLIANCE

**Product Name:** iBWA System 5100 24-01MO BTR  
**Model Identifier:** NTVG11BC

On the basis of measurements here reported on January 22, 2001, the above referenced equipment is verified as meeting the requirements of FCC Part 101 (Fixed Microwave Services), and FCC Part 2 requirements. The Test data included in this report applies to the product titled herein manufactured by Nortel Networks.

**Certified by:**

**Denis Lalonde**  
C-MAC Engineering, Inc.  
21 Richardson Side Road  
Kanata, Ontario  
K2K 2C1  
Canada



## Table of Contents

---

<b><u>1.</u></b>	<b><u>TEST AND RESULTS SUMMARY</u></b> .....	<b>1</b>
<b><u>2.</u></b>	<b><u>REFERENCE DOCUMENTATION</u></b> .....	<b>2</b>
<b><u>2.1.</u></b>	<b><u>SPECIFICATIONS</u></b> .....	<b>2</b>
<b><u>2.2.</u></b>	<b><u>STANDARDS</u></b> .....	<b>2</b>
<b><u>2.3.</u></b>	<b><u>OTHER REFERENCE DOCUMENTATION</u></b> .....	<b>2</b>
<b><u>2.4.</u></b>	<b><u>GLOSSARY OF ACRONYMS</u></b> .....	<b>2</b>
<b><u>3.</u></b>	<b><u>PRODUCT DESCRIPTION</u></b> .....	<b>4</b>
<b><u>3.1.</u></b>	<b><u>PRODUCT IDENTIFICATION</u></b> .....	<b>4</b>
<b><u>3.2.</u></b>	<b><u>FUNCTIONAL DESCRIPTION</u></b> .....	<b>4</b>
<b><u>3.3.</u></b>	<b><u>PRODUCT CONFIGURATION (EQUIPMENT UNDER TEST)</u></b> .....	<b>6</b>
<b><u>4.</u></b>	<b><u>GENERAL TEST CONDITIONS</u></b> .....	<b>8</b>
<b><u>4.1.</u></b>	<b><u>TEST FACILITY</u></b> .....	<b>8</b>
<b><u>4.2.</u></b>	<b><u>CLIMATIC CONDITIONS</u></b> .....	<b>8</b>
<b><u>4.3.</u></b>	<b><u>MEASUREMENT INSTRUMENTATION</u></b> .....	<b>8</b>
<b><u>5.</u></b>	<b><u>TEST RESULTS</u></b> .....	<b>9</b>
<b><u>5.1.</u></b>	<b><u>MAXIMUM TRANSMIT POWER TEST</u></b> .....	<b>9</b>
<b><u>5.2.</u></b>	<b><u>OCCUPIED BANDWIDTH TEST</u></b> .....	<b>10</b>
<b><u>5.3.</u></b>	<b><u>RF SPECTRUM MASK TEST</u></b> .....	<b>11</b>
<b><u>5.4.</u></b>	<b><u>TRANSMITTER CONDUCTED SPURIOUS EMISSIONS TEST</u></b> .....	<b>12</b>
<b><u>6.</u></b>	<b><u>TEST EQUIPMENT</u></b> .....	<b>13</b>
<b><u>6.1.</u></b>	<b><u>TEST CONFIGURATION</u></b> .....	<b>13</b>
<b><u>6.2.</u></b>	<b><u>TEST EQUIPMENT LIST</u></b> .....	<b>14</b>
	<b><u>ANNEX A: NORTEL IBWA SYSTEM 5100 24-01MO BTR TEST PLOTS</u></b> .....	<b>15</b>
	<b><u>ANNEX B: NORTEL IBWA SYSTEM 5100 24-01MO BTR TEST PLAN</u></b> .....	<b>ERROR! BOOKMARK NOT DEFINED.</b>

---

## List of Tables

---

Table 1-1: Test Case Summary .....	1
Table 3-1: Hardware descriptions .....	6
Table 6-1: Test equipment used.....	14

---

## List of Figures

---

Figure 3-1: Nortel Networks Reunion TDMA system .....	3
Figure 5-1: Spectrum mask limit.....	8
Figure 6-1: Test configuration for Tx output power, Tx nominal output power .....	10
Figure 6-2: Test config. for occ. bandwidth, sp. mask and Tx conducted spurious emissions .....	10
Figure A-1 (99% Occupied Bandwidth, 1 carrier).....	12
Figure A-2 (99% Occupied Bandwidth, 4 carriers).....	12
Figure A-3 (Spectrum Mask, channel B, 1 carrier) .....	13
Figure A-4 (Spectrum Mask, channel T, 1 carrier) .....	13
Figure A-5 (Spectrum Mask, channel B, 4 carriers) .....	14
Figure A-6 (Spectrum Mask, channel T, 4 carriers).....	14
Figure A-7 (Conducted Spurious Emissions, 1 carrier, 30MHz - 10GHz).....	15
Figure A-8 (Conducted Spurious Emissions, 1 carrier, 10 - 24.17GHz).....	15
Figure A-9 (Conducted Spurious Emissions, 1 carrier, 24.53 - 40GHz).....	16
Figure A-10 (Conducted Spurious Emissions, 1 carrier, 40 - 60GHz).....	16
Figure A-11 (Conducted Spurious Emissions, 1 carrier, 60 - 90GHz).....	17
Figure A-12 (Conducted Spurious Emissions, 1 carrier, 90 - 140GHz).....	17
Figure A-13 (Conducted Spurious Emissions, 4 carriers, 30MHz - 10GHz) .....	18
Figure A-14 (Conducted Spurious Emissions, 4 carriers, 10 - 24.17GHz) .....	18
Figure A-15 (Conducted Spurious Emissions, 4 carriers, 24.53 - 40GHz) .....	19
Figure A-16 (Conducted Spurious Emissions, 4 carriers, 40 - 60GHz).....	19
Figure A-17 (Conducted Spurious Emissions, 4 carriers, 60 - 90GHz).....	20
Figure A-18 (Conducted Spurious Emissions, 4 carriers, 90 - 140GHz) .....	20

# 1. Test and Results Summary

The system described in Section 3.0 meets the requirements FCC Part 101 and Part 2, Fixed Microwave Services (10-1-97 edition).

A summary of the test cases can be found in the following table.

**Table 1-1: Test Case Summary**

Parameter	C	NC	NT	NA	Notes
<b>Transmitter characteristics</b>					
Maximum output power (FCC Part 2.1046)	X				
Occupied Bandwidth (FCC Part 2.1049)	X				
RF spectrum mask (FCC Part 101.111)	X				
Tx Conducted Spurious emissions (FCC Part 101.111)	X				
Radiated Spurious emissions (FCC Part 101.111)				X	
Tx Frequency Stability (FCC Part 101.107)				X	
<b>Legend:</b>					
C: The parameter is compliant with the requirements					
NC: The parameter is not compliant with the requirements					
NT: The parameter is not tested					
NA: The test of this parameter is not applicable					
<b>Notes:</b>					
None					

## 2. Reference Documentation

### 2.1. Specifications

Not applicable.

### 2.2. Standards

1. FCC Rules for Radio Frequency Devices, Title 47 of the Code of Federal Regulations amended per FCC 89-103 (GEN. Docket No. 87-389). Part 2 and 101, U.S. Federal Communications Commission 1995.
2. ANSI C63.4-1992, Methods of Measurement of Radio-Noise Emission from Low-Voltage Electrical and Electronic Equipment in the Range of 9 kHz to 40 GHz, May 1992.

### 2.3. Other Reference Documentation

Not applicable.

### 2.4. Glossary of Acronyms

ATM	Asynchronous Transfer Mode
AWM	ATM Wireless Multiplexer
BER	Bit Error Rate
BRM	Broadband Radio Modem
BTR	Base Station Transceiver
CIM	Chassis Interface Module
CTR	Customer Premise Transceiver
DC	Direct Current
FCC	Federal Communications Commission
ID	Identification Number
IF	Intermediate Frequency
ISDN	Integrated Services Digital Network
NA	Not Applicable
NIU	Network Interface Unit
NNE	Network Node Equipment
OMT	Orthogonal Mode Transducer
QAM	Quadrature Amplitude Modulation
RF	Radio Frequency
RPE	Radio Power Extractor
RSM	Redundancy Switching Matrix
SDH	Synchronous Digital Hierarchy
SONET	Synchronous Optical Network
TDMA	Time Division Multiple Access
UGB	Upstream Gain Block



## 3. Product Description

### 3.1. Product Identification

The unit tested in this report consisted of a DC powered module (-48V). The product trade name is iBWA System 5100 24-01MO BTR. The model of this product is NTVG11BC.

The emission designators tested are 6M0D9W (1 carrier) and 26M8D9W (4 carriers).

Manufacturer: Nortel Networks Canada Limited  
 Calgary, Alberta  
 Canada

No modifications were necessary in order to comply with requirements as detailed in FCC Part 101 requirements.

### 3.2. Functional Description

The Nortel Networks TDMA iBWA System 5100 is depicted in Fig. 3-1 and described in the text below.

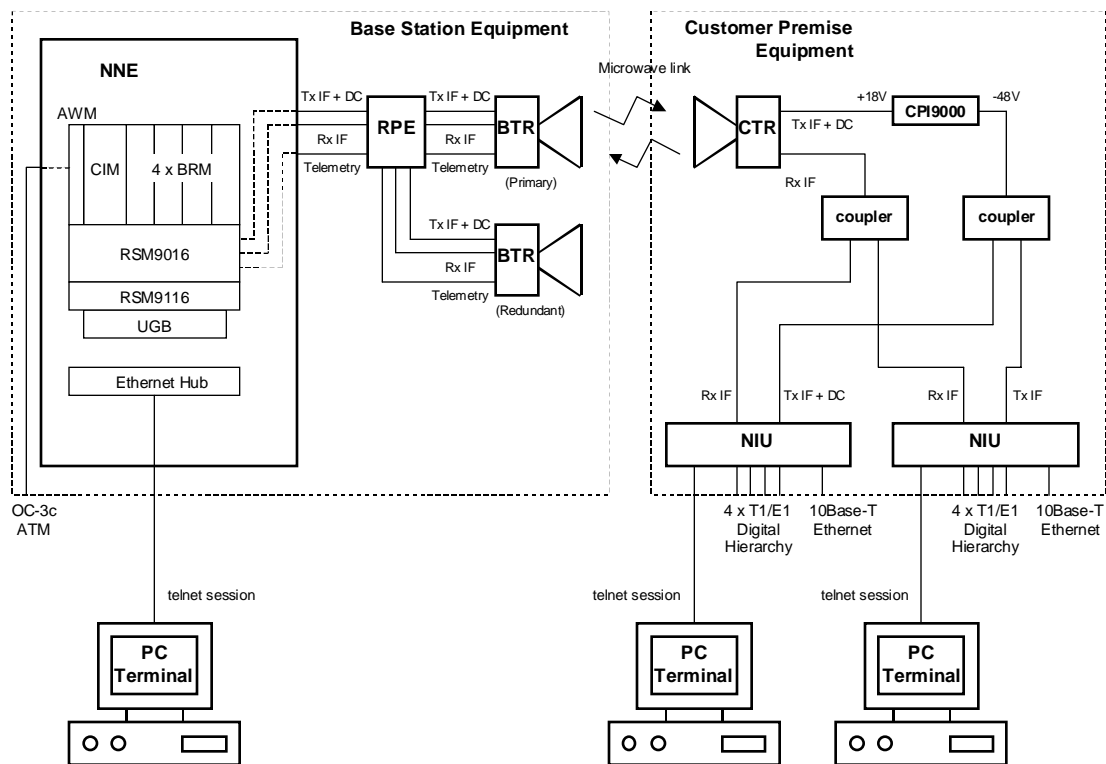

Fig. 3-1: Nortel Networks iBWA System 5100 TDMA

Within the Base Station NNE, the ATM Wireless Multiplexer (AWM) provides a two-way OC-3c interface to the network operator's ATM network through an optical SONET / SDH link. The Chassis Interface Module (CIM) is the main processor that controls information flow within the base station. It controls the AWM and the output bit rate corresponding to the QAM modulation and symbol rate of the Broadband Radio Modem (BRM). The BRM card contains one modulator and two demodulators. It interfaces with the Base Station Transceivers (BTR) through the

Redundancy Switching Matrix (RSM), which provides n : 1 redundancy switching of the BRM units connected (RSM9016 for downstream and RSM9116 for upstream).



In the configuration depicted in Fig. 3-1, four BRM units are indicated, but only one pair of Primary BTR and redundant BTR is shown. The RSM would permit any BRM to be connected to a given BTR. The Upstream Gain Block (UGB) amplifies the upstream signal to compensate for the attenuation introduced by the RSM9116 Redundancy Switching Matrix. Outdoor with the radios, the RPE provides 1 : 1 redundancy switching for the BTR. If the Primary BTR fails, the RSM automatically signals to the RPE (through the telemetry cable) to switch the BRM connection to the Redundant BTR.

The Customer Premise Equipment (CPE) is a low cost unit that resides on the customer premises to provide a 10baseT Ethernet and four T1 / E1 connections. It can be connected to a variety of customer nodes that require any of aforementioned services. The unit consists of two major modules: the Network Interface Unit (NIU) and the Customer Premise Transceiver (CTR). The NIU is the indoor unit containing the TDMA modem and the interface to the network. The outdoor unit is a transceiver which converts the IF signals to / from the NIU to the required RF. These units are interconnected via coax cables that carries the IF signals and DC power for the CTR.

The software used during testing was representative of system performance under actual network usage conditions. Additional features required to activity and/or control specific radio functions (i.e. channel allocation, BER performance, power control) might be required as long as they are consistent with radio performance under actual network usage conditions.

### 3.3. Product Configuration (Equipment Under Test)

This system was configured with a TDMA chassis, a BTR, and the cables necessary to activate the hardware under investigation. Table 3-1 below provides a description of each component and the respective serial and model numbers.

**Table 3-1:** Hardware descriptions

	Product and Firmware description	Model No.	Serial No.
<b>EUT</b>	BTR	NTVG11BC	NNTM532H45HD
<b>Support Equipment</b>	BRM5330	NTVH28AA	NNTM532LM2P4
	BRM5330	NTVH28AA	NNTM532LM2K0
	BRM5330	NTVH28AA	NNTM532LNYP2
	BRM5330	NTVH28AA	NNTM532LNHB8
	CIM5000C	NTVH25AA	NNTM5324JP7N
	AWM5010B	NTVH04AA	NNTM535L4F5L
	D-Link Ethernet Hub	DE-809TP	HD001200
	RSM9016	NTVH13BA	NNTM532GA1LH
	RSM9116	NTVH20BA	NNTM532GD7NV
	UGB	NTVH29AB	NNTM53219QJN
	Chassis	NTVH02CA	NNTM532JE5U2
	PSM5148	NTVH10AC	NNTM532JDT1V
	PSM5148	NTVH10AC	NNTM532JDG2K
	PSM5148	NTVH10AC	NNTM532JDWLJ
PSM5148	NTVH10AC	NNTM532JEGP9	
PSM5148	NTVH10AC	NNTM532JEGK5	

Report Number: 10000124  
Issue: 1.0  
January 22, 2001

Nortel Networks iBWA System 5100 24-01MO BTR  
Radio Compatibility Test Report  
Security status: Proprietary

	Power Supply	HP6010A	2824A-00522
--	--------------	---------	-------------

## **4. General test conditions**

### **4.1. Test Facility**

Emission testing was performed in the C-MAC Engineering Product Integrity Radio Compatibility laboratory, located at 21 Richardson Side rd, Kanata, Ontario, Canada.

### **4.2. Climatic Conditions**

Climatic conditions are controlled within the following specifications:

- Ambient temperature: 15 to 25 deg. C
- Relative humidity: 20 to 50 %

### **4.3. Measurement Instrumentation**

Calibration of the measurement instrumentation is maintained in accordance with the test equipment supplier's recommendations, or as necessary to ensure its accuracy as per ISO 25 requirements.

## 5. Test Results

### 5.1. Maximum Transmit Power Test

#### 5.1.1. Test Procedure

As per FCC Part 2.1046

The maximum transmit power was measured using the average power detector on a power meter.

#### 5.1.2. Test Results

Ambient Temperature: 15 to 25 deg. C

Relative Humidity: 20 to 50 %

Test Conditions: Nominal temperature, Nominal Power Supply Voltage

Number of Carriers	Transmitter Power Level (dBm)		
	Channel B 24.2535 GHz	Channel M 24.3500 GHz	Channel T 24.4465 GHz
1	19.9	19.9	20.3
4	17.4	17.6	17.4

The equipment complies with the limits.

#### 5.1.3. Limits

<b>Authorized Power (dBm) as quoted on Form 731</b>	20.0 dBm (1 carrier) 17.5 dBm (4 carriers)
---	---

<b>Test Equipment Used</b>	1, 2, 4, 5, 6 (see Table 6-1)
----------------------------	-------------------------------

## 5.2. Occupied Bandwidth Test

### 5.2.1. Test Procedure

As per FCC Part 2.1049

### 5.2.2. Test Results

Ambient Temperature: 15 to 25 deg. C

Relative Humidity: 20 to 50 %

Test Conditions: Nominal temperature, Nominal Power Supply Voltage

Number of Carriers	Occupied Bandwidth
	Channel M
	24.3500 GHz
1	6.033 MHz (Fig. A-1)
4	26.75 MHz (Fig. A-2)

Test Equipment Used	3, 5, 7 (see Table 6-1)
---------------------	-------------------------

## 5.3. RF Spectrum Mask Test

### 5.3.1. Test Procedure

As per FCC Part 101.111 a)

This measurement was performed using a spectrum analyzer with 100 kHz resolution bandwidth.

### 5.3.2. Test Results

Ambient Temperature: 15 to 25 deg. C

Relative Humidity: 20 to 50 %

Number of Carriers	RF Spectrum Mask Results – 1/4 TDMA carrier(s)	
	Channel B 24.2535 GHz	Channel T 24.4465 GHz
1	Fig. A-3	Fig. A-4
4	Fig. A-5	Fig. A-6

The equipment complies with the limit.

### 5.3.3. Limits

Allowed Power Range (dBm)	$\text{Attenuation} = 11 + 0.4(P - 50) + 10 \text{Log}_{10} B$ (Attenuation greater than 56 decibels is not required)
---------------------------	---

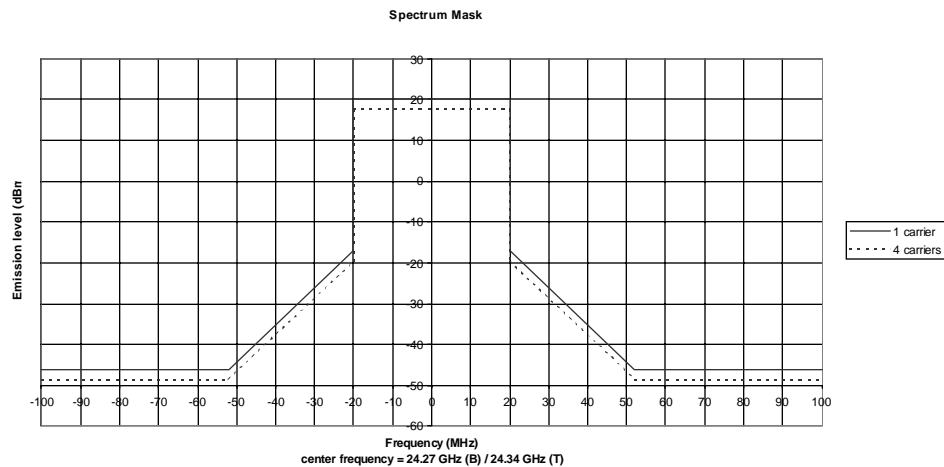

**Fig. 5-1:** Spectrum Mask limit

Note: The attenuation values on this spectrum mask limit were increased by 10dB in order to compensate for the spectrum analyzer resolution bandwidth of 100kHz.

Test Equipment Used	1, 2, 3, 4, 5, 7 (see Table 6-1)
---------------------	----------------------------------

## 5.4. Transmitter Conducted Spurious Emissions Test

### 5.4.1. Test Procedure

As per FCC Part 101.111 a)

This measurement was performed using a spectrum analyzer with 1 MHz resolution bandwidth. Down converting mixers are used for frequencies higher than 40 GHz.

### 5.4.2. Test Results

Ambient Temperature: 15 to 25 deg. C

Relative Humidity: 20 to 50 %

Frequency range (GHz)	Tx Conducted Spurious Emissions Results – 1/4 TDMA carrier(s) Channel M: 24.3500 GHz	
	1 carrier	4 carriers
0.03 – 10	Fig. A-7	Fig. A-13
10 – 24.17	Fig. A-8	Fig. A-14
24.53 – 40	Fig. A-9	Fig. A-15
40 – 60	Fig. A-10	Fig. A-16
60 – 90	Fig. A-11	Fig. A-17
90 – 140	Fig. A-12	Fig. A-18

The equipment complies with the limit.

### 5.4.3. Limits

Spurious Emissions Limit (dBm)	-13 dBm
--------------------------------	---------

Test Equipment Used	3, 4, 5, 7 - 15 (see Table 6-1)
---------------------	---------------------------------

## 6. Test equipment

### 6.1. Test Configuration

The following figures describe the test configuration for the radio transceiver test cases. Note that the antenna is removed and replaced by waveguide to coaxial adapters.

**Fig. 6-1:** Test Configuration for Tx Output Power, Tx Nominal Output Power

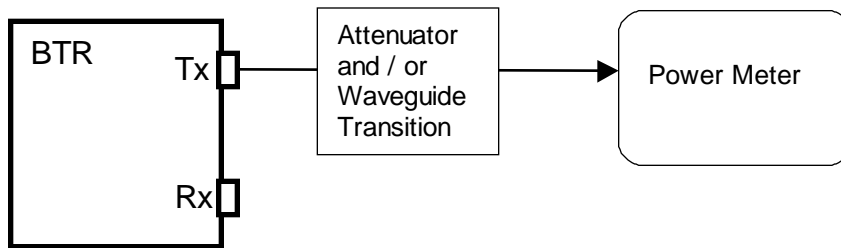

**Fig. 6-2:** Test Configuration for Occupied Bandwidth, Spectrum Mask and Tx Conducted Spurious Emissions

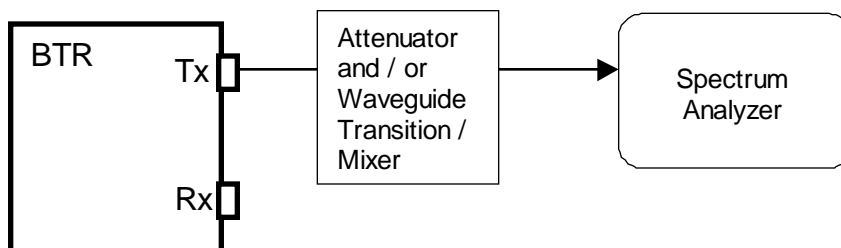



## 6.2. Test Equipment List

The following is a list of test equipment used to perform all tests described in this report:  
 All measurement equipment were within their respective calibration periods

**Table 6-1** Test equipment used

Item	Description	Make	Model #	Asset # Or Serial #	Cal. due date
1	Power Meter	Anritsu	ML2438A	98290019	12/01
2	Power Sensor	Anritsu	MA2424A	971397	11/01
3	Spectrum Analyzer	HP	8564E	Z0082288	11/01
4	RF Signal Generator	Anritsu / Wiltron	68369B	664005	09/02
5	Coupler	Lectronic Research Labs	559K-10/595	NA	NA
6	Waveguide 20dB attenuator	Lectronic Research Labs	521A-20/595	NA	NA
7	Waveguide 10dB attenuator	Lectronic Research Labs	521A-10/595	NA	NA
8	20dB coaxial K-type attenuator	INMET 64671	26A-20dB	NA	NA
9	Tapered Adapter WR42-WR28	Aircom Microwave	195K00	NA	NA
10	Down converting mixer 40 – 60 GHz	Oleson Microw	M19HWA HP	U90611-1	NA
11	Down converting mixer 60 – 90 GHz	Oleson Microw	M12HWA HP	E90611-1	NA
12	Down converting mixer 90 – 140 GHz	Oleson Microw	M08HWA HP	F90611-1	NA
13	Waveguide transition 40 – 60 GHz	Penn Eng.	4430-11B 4428-11B	S0634 S0549	NA NA
14	Waveguide transition 60 – 90 GHz	Penn Eng.	4426-11B 4424-11B	Z5001 S0930	NA NA
15	Waveguide transition 90 – 140 GHz	Penn Eng.	4422-11B 4420-11B	S0911 S0763	NA NA

# Annex A: Nortel iBWA System 5100 24-01MO BTR Test Plots

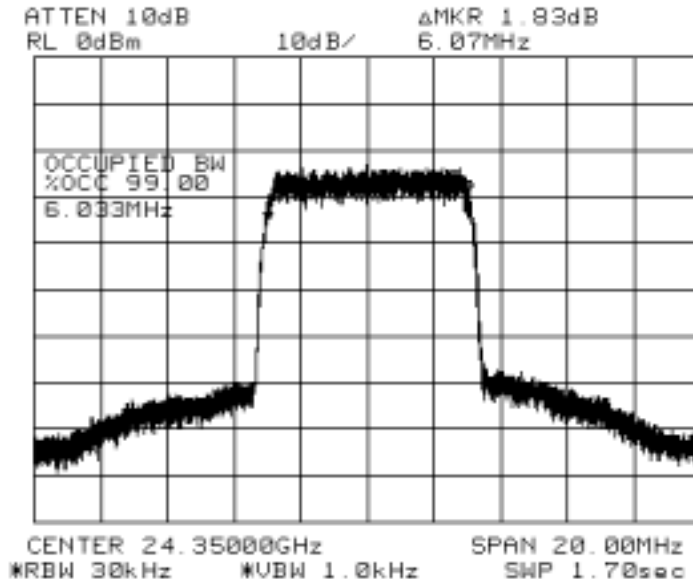

Fig. A-1 (99% Occupied Bandwidth, 1 carrier)

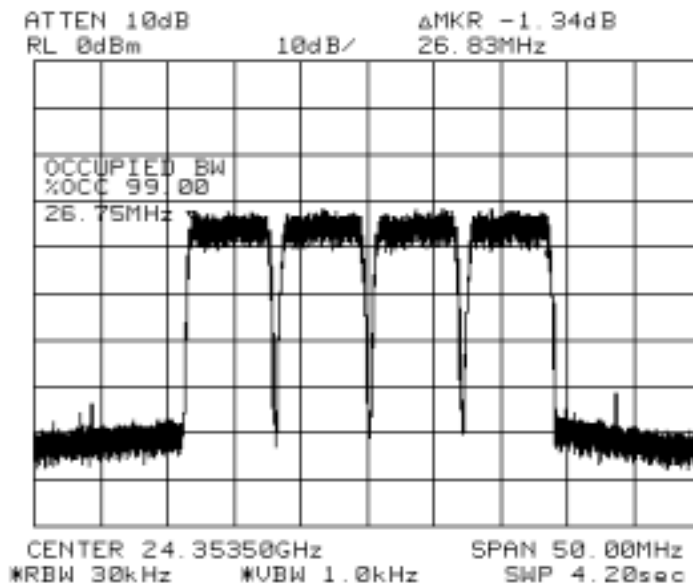

Fig. A-2 (99% Occupied Bandwidth, 4 carriers)

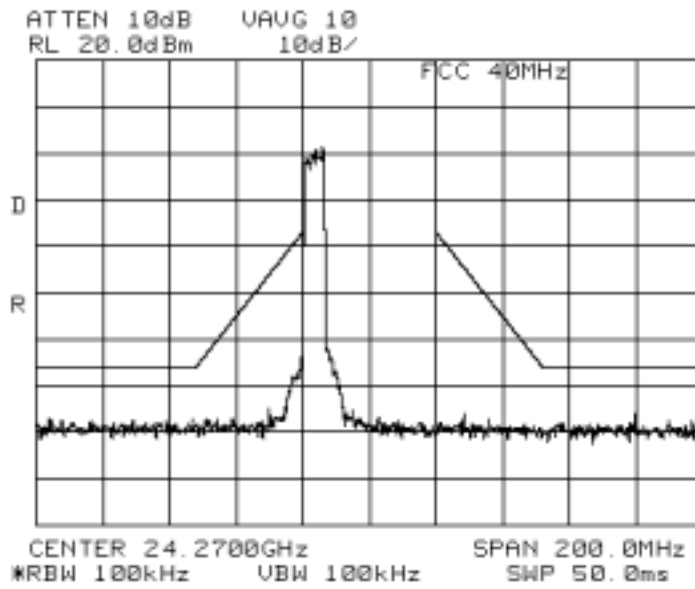

Fig. A-3 (Spectrum Mask, channel B, 1 carrier)

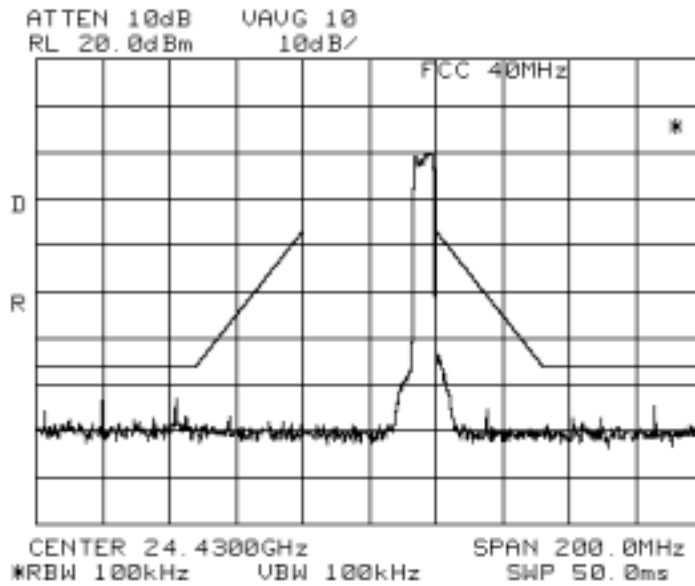

Fig. A-4 (Spectrum Mask, channel T, 1 carrier)

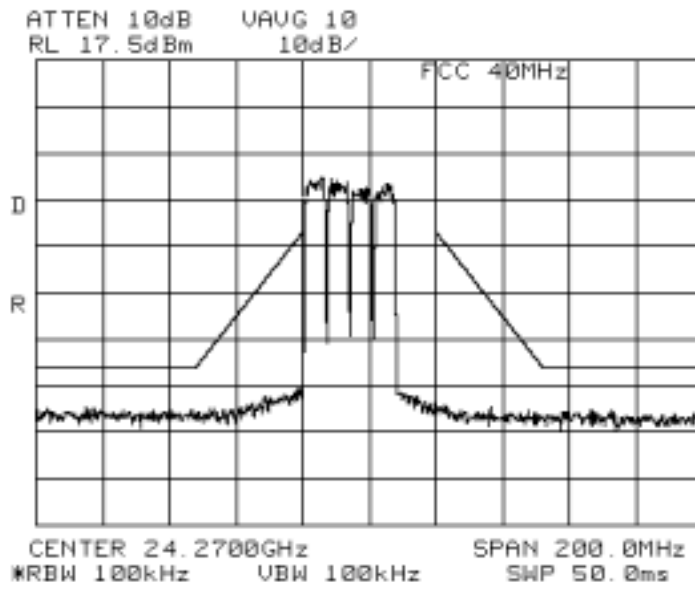

Fig. A-5 (Spectrum Mask, channel B, 4 carriers)

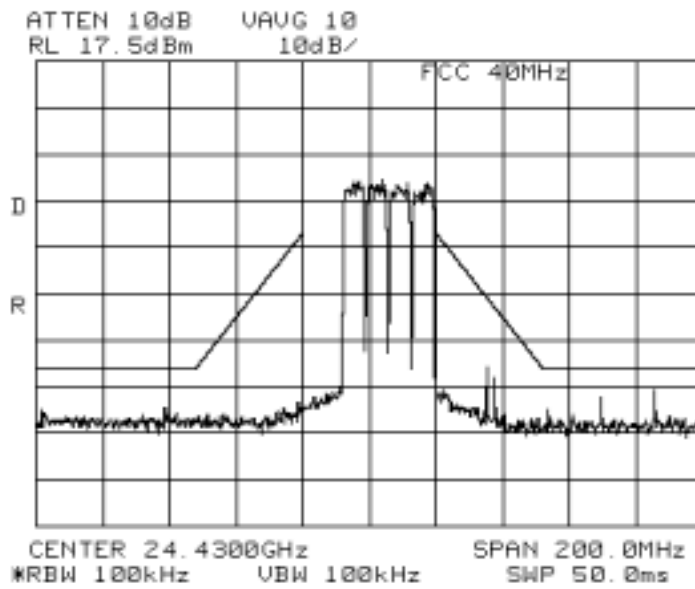
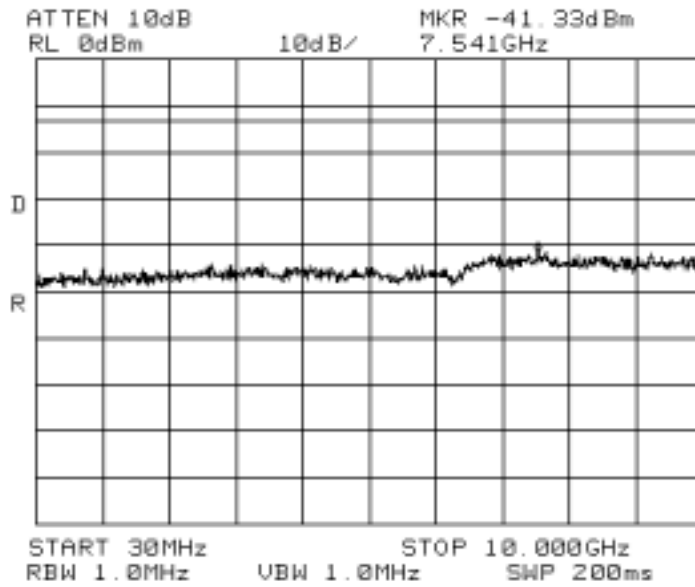
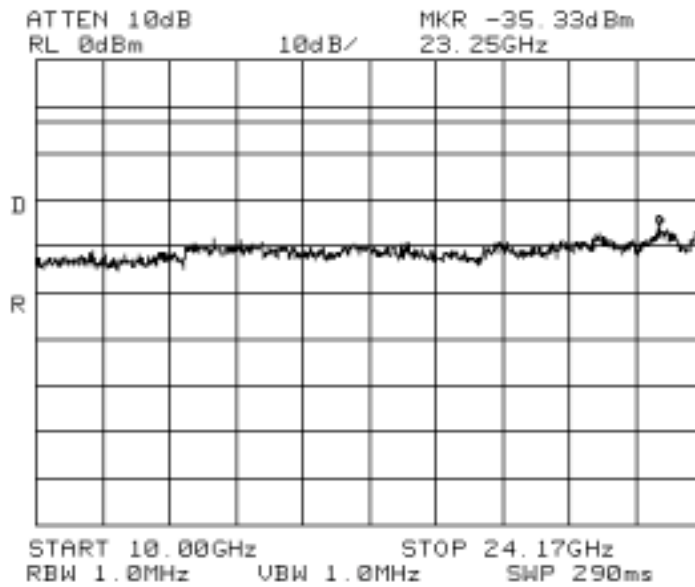

Fig. A-6 (Spectrum Mask, channel T, 4 carriers)



**Fig. A-7 (Conducted Spurious Emissions, 1 carrier, 30MHz – 10GHz)**



**Fig. A-8 (Conducted Spurious Emissions, 1 carrier, 10 – 24.17GHz)**

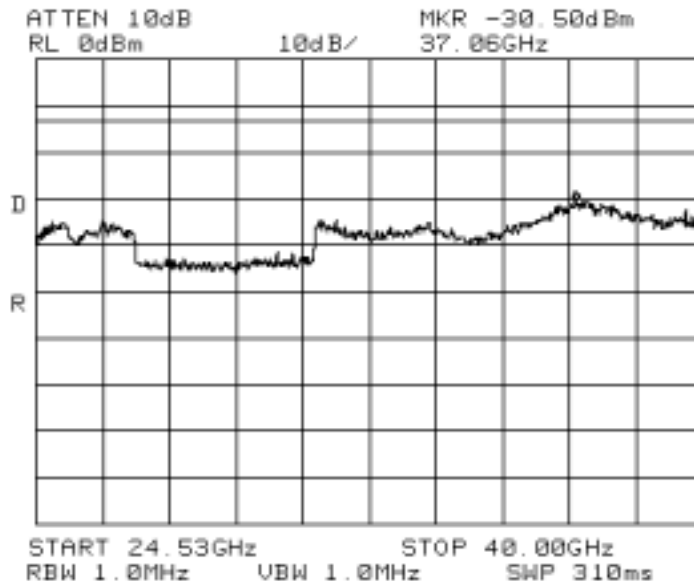

**Fig. A-9 (Conducted Spurious Emissions, 1 carrier, 24.53 – 40GHz)**

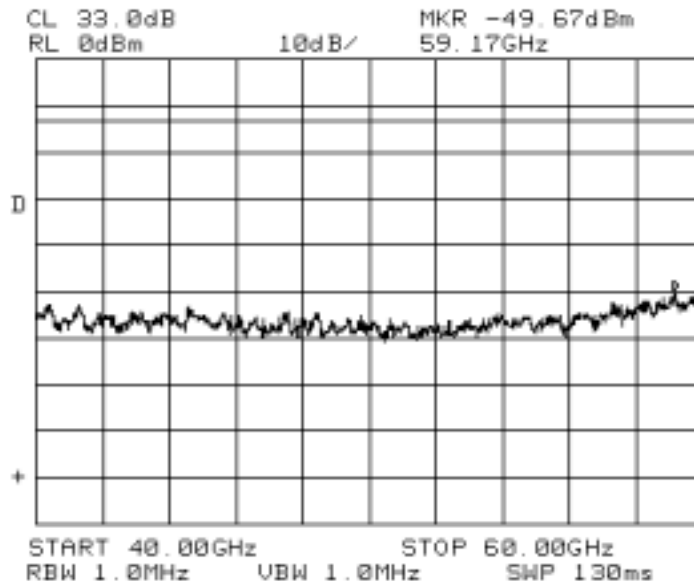

**Fig. A-10 (Conducted Spurious Emissions, 1 carrier, 40 – 60GHz)**

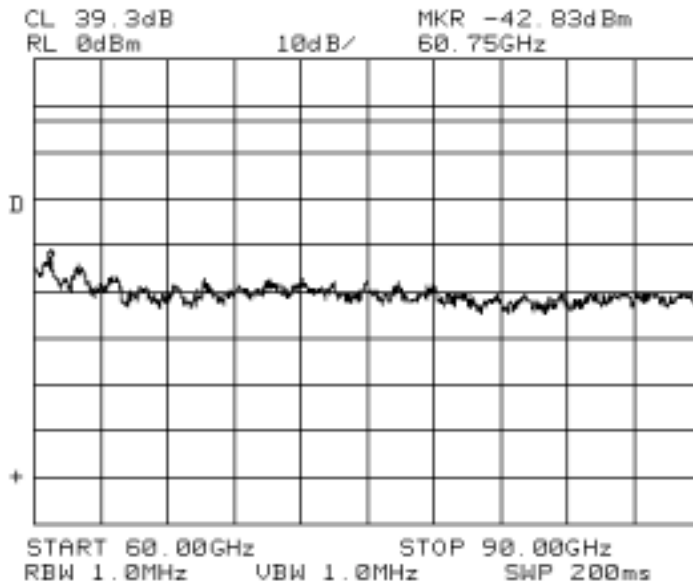

Fig. A-11 (Conducted Spurious Emissions, 1 carrier, 60 – 90GHz)

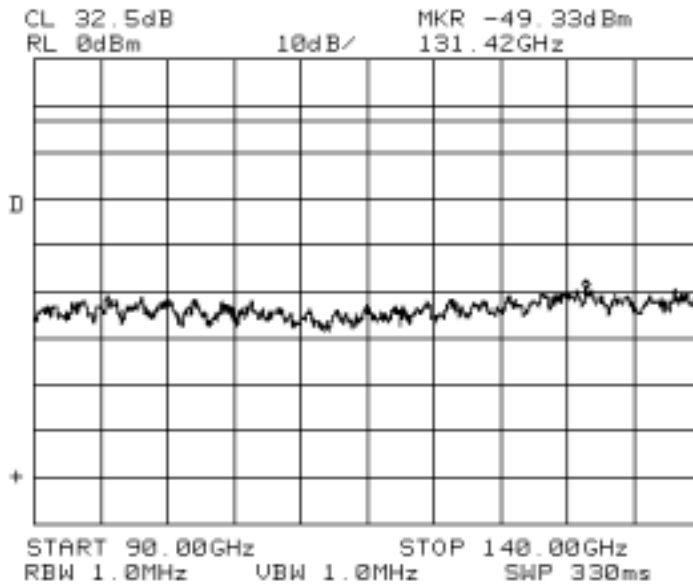
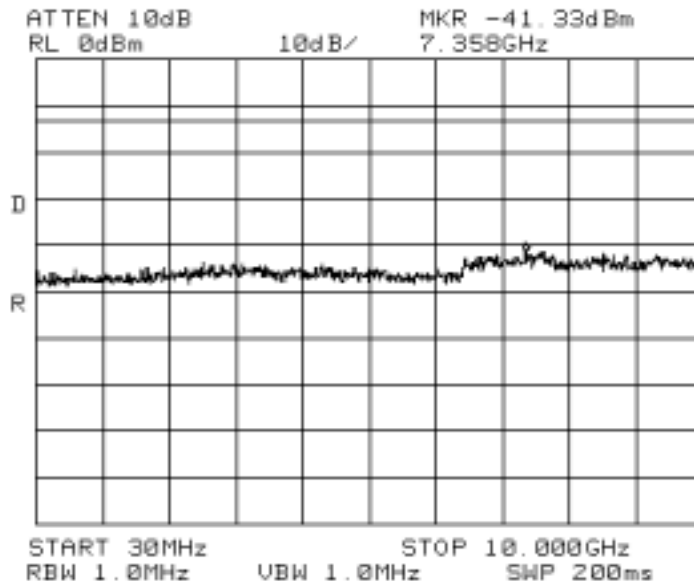
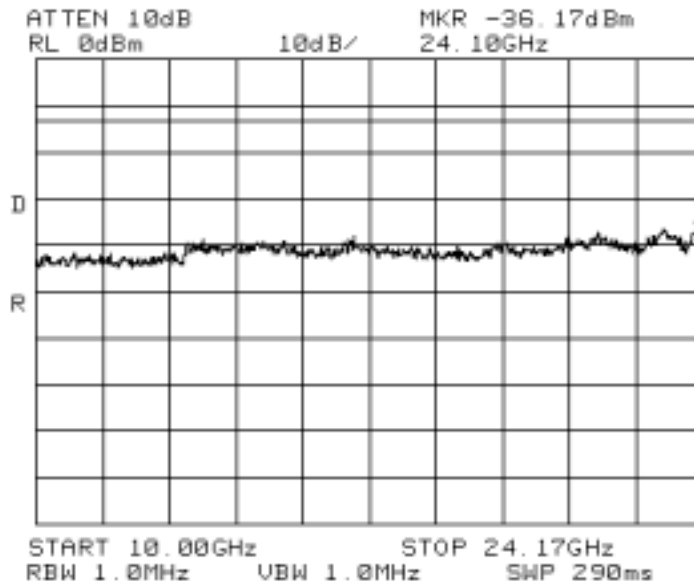

Fig. A-12 (Conducted Spurious Emissions, 1 carrier, 90 – 140GHz)



**Fig. A-13 (Conducted Spurious Emissions, 4 carriers, 30MHz – 10GHz)**



**Fig. A-14 (Conducted Spurious Emissions, 4 carriers, 10 – 24.17GHz)**



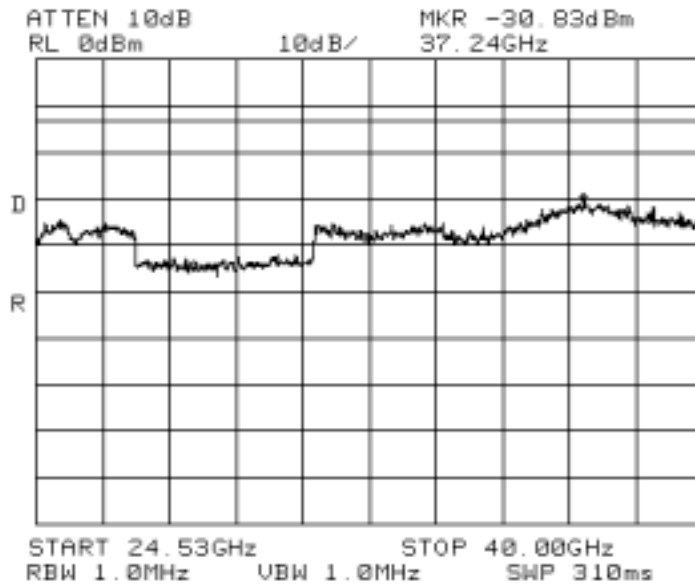

Fig. A-15 (Conducted Spurious Emissions, 4 carriers, 24.53 – 40GHz)

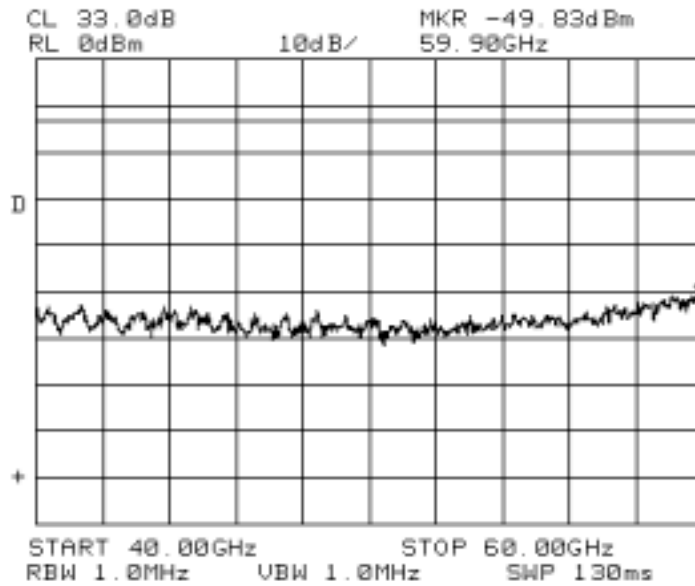

Fig. A-16 (Conducted Spurious Emissions, 4 carriers, 40 – 60GHz)

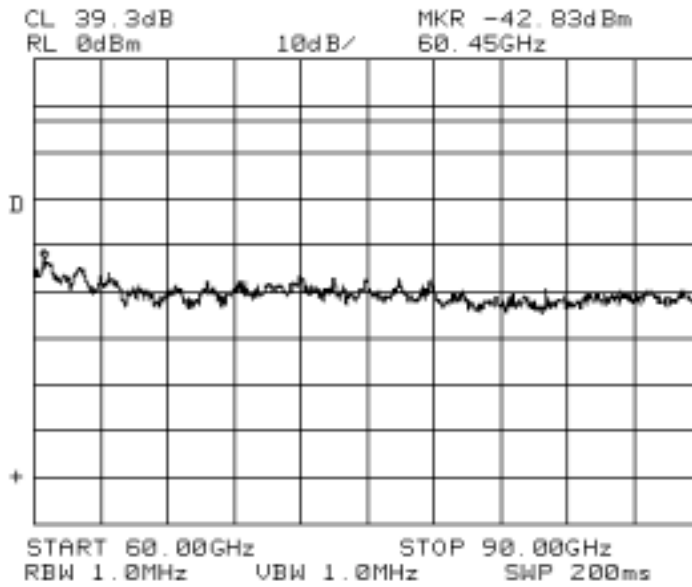

Fig. A-17 (Conducted Spurious Emissions, 4 carriers, 60 – 90GHz)

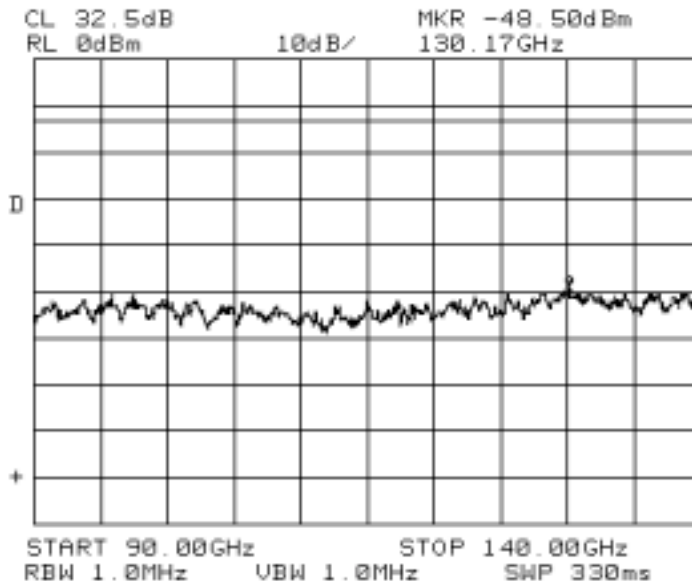

Fig. A-18 (Conducted Spurious Emissions, 4 carriers, 90 – 140GHz)

# **iBWA System 5100 24-01MO BTR**

## **END OF REPORT**

© Date: January 22, 2001 C-MAC Engineering  
All rights reserved