

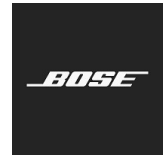

PRODUCT ASSURANCE ENGINEERING
SAR Exclusion Calculation



FCC ID: A94BMD0011 IC: 3232A-BMD0011

Test Type: SAR Exclusion Calculation

Product Type: Wireless Headphones

Product Name/Number: *Model Number(s): BMD0011*
FCC ID: A94BMD0011
IC: 3232A-BMD0011

Prepared For: *Product Assurance Engineering Department,*
Bose Corporation

Test Results: Pass Fail

Applicable Standards: FCC CFR 47 Part 15 Subpart C
Industry Canada RSS-247 Issue 2
Industry Canada RSS-GEN Issue 5

Report Number: *EMC.433948.20.174.5*

General Comments/Special Test Conditions:

This report relates only to the items tested. This report covers EMC marking requirements for model BMD0011

	Print Name	Signature	Date
Prepared By:	Karl Klemm		6/26/2020
Electrical Engineer Review* By:	Bryan Cerqua		6/24/2020

* Since every test result is separately reviewed after its completion, the electrical engineer review indicated above represents a higher level review to ensure this report lists and contains all applicable and appropriate requirements.

If the report carries the "accredited" logo, the reviewer must verify all the tests in this report are covered under the current ISO17025 accreditation. The A2LA-accredited logo must be removed if any of the tests in the report are not performed under the current scope of accreditation. It is the responsibility of the reviewer to ensure the A2LA advertising policy is followed.



PRODUCT ASSURANCE ENGINEERING
SAR Exclusion Calculation

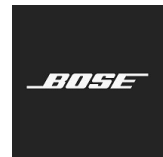

FCC ID: A94BMD0011 IC: 3232A-BMD0011

Table of Contents

Tests Performed (Table of Contents):

Test Report Summary 3

Test Requirements: 6

Objective/Summary/Conclusion: 8

Test Setup Details: 9

Data Collection: 10

Equipment Used: 13



PRODUCT ASSURANCE ENGINEERING
SAR Exclusion Calculation

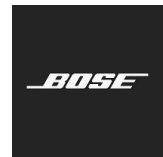

FCC ID: A94BMD0011 IC: 3232A-BMD0011

Test Report Summary

Product Information:

Description

The EUT is a wireless headphone that contains DSS/DTS transceivers, manufactured by Qualcomm Technologies, QCC5127. The EUT uses Adaptive Frequency Hopping (AFH) mode, using a reduced hop set if interference is detected in band, however a minimum of 20 channels is always maintained.

There are two frame styles (Soprano and Tenor) which use identical electronics and are differentiated only by cosmetic differences in the enclosure. The differences in the enclosures have no impact on the transmitter function or characteristics. The Soprano frame style was used for testing.

Setup (Cables and Accessories)

For radio tests the radio was configured with Qualcomm Blue Suite software (details provided in SOFTWARE AND FIRMWARE section).

EUT Antenna Description

The antenna is an internal PIF variant with antenna gain of 2.8 dBi formed by printed circuit board etch.

SOFTWARE AND FIRMWARE

The firmware installed in the EUT during testing was version 0.3.103

The test utility software used during testing was Polycomm, version 2.6.0 and Blue Suite version 3.2.3.

Scope:

This report covers EMC requirements. FCC CFR 47 PART 15 SUBPART C, Industry Canada RSS-247 Issue 2, and Industry Canada RSS-GEN Issue 5.

All measurements in this report were made with a direct connection to the antenna terminal, with the antenna disconnected.

Test Objective:

Verify product meets all applicable EMC requirements.

Measurement Method:

ANSI C63.10 (2013).

Results:

Product complies with all applicable EMC requirements. All final results represent worst-case emissions and/or immunity.

Conclusions:

The device under test (D.U.T.):

meets all test standards selected in section 2 of this report.

does not meet all test standards selected in section 2 of this report.

Affirmation of Test Results:

	Print Name	Signature	Date
Testing Engineer/Technician	Karl Klemm		6/26/2020



PRODUCT ASSURANCE ENGINEERING
SAR Exclusion Calculation

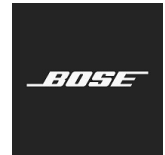

FCC ID: A94BMD0011 IC: 3232A-BMD0011



PRODUCT ASSURANCE ENGINEERING
SAR Exclusion Calculation

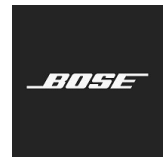

FCC ID: A94BMD0011 IC: 3232A-BMD0011

FCC Test Site Accreditation.

Firm Name	Location	Accreditation	MRA	Designation Number	Expiration Date	Contact	Contact Title
Bose Corporation	1 New York Avenue, Framingham, MA	American Association for Laboratory Accreditation	N/A	US1088	09/30/2020	Carole Park	Quality Manager

Canadian Test Site Registration.

Organization	CAB identifier	Scope / Recognition Date (yyyy-mm-dd)	Expiration (yyyy-mm-dd)
BOSE CORPORATION 1 New York Avenue Framingham, MA 01701 UNITED STATES Website: https://www.bose.com/en_us/index.html ISED#: 3232A Contact: Benjamin Cerretani benjamin_cerretani@bose.com	US0210	RSS-GEN (2019-02-11) RSS-210 (2019-02-11) RSS-247 (2019-02-11)	RECOGNIZED UNTIL: 2020-07-31 A2LA ISO/IEC 17025:2005 Expires: 2020-07-31

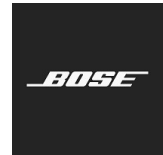

Test Requirements:

From FCC KDB 447498 D01 General RF Exposure Guidance v06:

4.3. General SAR test exclusion guidance

4.3.1. Standalone SAR test exclusion considerations

Unless specifically required by the *published RF exposure KDB procedures*, standalone 1-g head or body and 10-g extremity SAR evaluation for general population exposure conditions, by measurement or numerical simulation, is not required when the corresponding *SAR Test Exclusion Threshold* condition(s), listed below, is (are) satisfied. These test exclusion conditions are based on source-based time-averaged maximum conducted output power of the RF channel requiring evaluation, adjusted for tune-up tolerance, and the minimum *test separation distance* required for the exposure conditions.²⁸ The minimum *test separation distance* defined in 4.1 f) is determined by the smallest distance from the antenna and radiating structures or outer surface of the device, according to the host form factor, exposure conditions and platform requirements, to any part of the body or extremity of a user or bystander. To qualify for SAR test exclusion, the *test separation distances* applied must be fully explained and justified, typically in the SAR measurement or SAR analysis report, by the operating configurations and exposure conditions of the transmitter and applicable host platform requirements, according to the required *published RF exposure KDB procedures*. When no other RF exposure testing or reporting are required, a statement of justification and compliance must be included in the equipment approval, in lieu of the SAR report, to qualify for SAR test exclusion. When required, the device specific conditions described in the other *published RF exposure KDB procedures* must be satisfied before applying these SAR test exclusion provisions; for example, handheld PTT two-way radios, handsets, laptops and tablets, etc.²⁹

a) For 100 MHz to 6 GHz and *test separation distances* ≤ 50 mm, the 1-g and 10-g *SAR test exclusion thresholds* are determined by the following:

$[(\text{max. power of channel, including tune-up tolerance, mW}) / (\text{min. test separation distance, mm})] \cdot [\sqrt{f_{(\text{GHz})}}] \leq 3.0$ for 1-g SAR, and ≤ 7.5 for 10-g extremity SAR,³⁰ where

- $f_{(\text{GHz})}$ is the RF channel transmit frequency in GHz
- Power and distance are rounded to the nearest mW and mm before calculation³¹
- The result is rounded to one decimal place for comparison
- The values 3.0 and 7.5 are referred to as *numeric thresholds* in step b) below

The test exclusions are applicable only when the minimum *test separation distance* is ≤ 50 mm, and for transmission frequencies between 100 MHz and 6 GHz. When the minimum *test separation distance* is < 5 mm, a distance of 5 mm according to 4.1 f) is applied to determine SAR test exclusion.

RSS-102, Section 2.5.1

Exemption Limits for Routine Evaluation – SAR Evaluation

SAR evaluation is required if the separation distance between the user and/or bystander and the antenna and/or radiating element of the device is less than or equal to 20 cm, except when the device operates at or below the applicable output power level (adjusted for tune-up tolerance) for the specified separation distance defined in Table 1.

Frequency (MHz)	Exemption Limits (mW)				
	At separation distance of ≤5 mm	At separation distance of 10 mm	At separation distance of 15 mm	At separation distance of 20 mm	At separation distance of 25 mm
≤300	71 mW	101 mW	132 mW	162 mW	193 mW
450	52 mW	70 mW	88 mW	106 mW	123 mW
835	17 mW	30 mW	42 mW	55 mW	67 mW
1900	7 mW	10 mW	18 mW	34 mW	60 mW
2450	4 mW	7 mW	15 mW	30 mW	52 mW
3500	2 mW	6 mW	16 mW	32 mW	55 mW
5800	1 mW	6 mW	15 mW	27 mW	41 mW

Frequency (MHz)	Exemption Limits (mW)				
	At separation distance of 30 mm	At separation distance of 35 mm	At separation distance of 40 mm	At separation distance of 45 mm	At separation distance of ≥50 mm
≤300	223 mW	254 mW	284 mW	315 mW	345 mW
450	141 mW	159 mW	177 mW	195 mW	213 mW
835	80 mW	92 mW	105 mW	117 mW	130 mW
1900	99 mW	153 mW	225 mW	316 mW	431 mW
2450	83 mW	123 mW	173 mW	235 mW	309 mW
3500	86 mW	124 mW	170 mW	225 mW	290 mW
5800	56 mW	71 mW	85 mW	97 mW	106 mW

Notes:

4 The exemption limits in Table 1 are based on measurements and simulations of half-wave dipole antennas at separation distances of 5 mm to 25 mm from a flat phantom, providing a SAR value of approximately 0.4 W/kg for 1 g of tissue. For low frequencies (300 MHz to 835 MHz), the exemption limits are derived from a linear fit. For high frequencies (1900 MHz and above), the exemption limits are derived from a third order polynomial fit.

5 Transmitters operating between 0.003-10 MHz, meeting the exemption from routine SAR evaluation, shall demonstrate compliance to the instantaneous limits in Section 4.

Output power level shall be the higher of the maximum conducted or equivalent isotropically radiated power (e.i.r.p.) source-based, time-averaged output power. For controlled use devices where the 8 W/kg for 1 gram of tissue applies, the exemption limits for routine evaluation in Table 1 are multiplied by a factor of 5. For limb-worn devices where the 10 gram value applies, the exemption limits for routine evaluation in Table 1 are multiplied by a factor of 2.5. If the operating frequency of the device is between two frequencies located in Table 1, linear interpolation shall be applied for the applicable separation distance. For test separation distance less than 5 mm, the exemption limits for a separation distance of 5 mm can be applied to determine if a routine evaluation is required.

For medical implants devices, the exemption limit for routine evaluation is set at 1 mW. The output power of a medical implants device is defined as the higher of the conducted or e.i.r.p to determine whether the device is exempt from the SAR evaluation.

Objective/Summary/Conclusion:

FCC Calculation

Operating Mode	Duty Cycle	Max Output Power		D.C. Corrected Power	
	(%)	(dBm)	(mW)	(dBm)	(mW)
BT (A2DP sink)	1.01	11.70	14.79	-8.26	0.15
BT (Speakerphone)	6.34			-0.28	0.94
BLE	0.66	5.00	3.16	-16.80	0.02

Operating Mode	D.C. Corrected Power (mW)	Min. Separation (mm)	Frequency (GHz)	Exclusion		Result
				Calculation	Threshold	
BT (A2DP sink)	0	5*	2.45	0.0	3	Exempt
BT (Speakerphone)	1			0.3		Exempt
BLE	0			0.0		Exempt
*per KDB 447498, for separations <5 mm, use 5 mm						
D.C. Corrected power is rounded to the nearest mW						
Exclusion Calculation = (D.C. Corrected Power / Min. Separation) * √Frequency						

Conclusion: EUT is exempt from SAR testing.

RSS-102 Calculation

Operating Mode	Duty Cycle (%)	Max Conducted Output Power		EIRP (dBm)	Max Output Power (mW e.i.r.p.)	Time-averaged Output Power ¹ (mW e.i.r.p.)	Limit from Table 1 for <5 mm (mW e.i.r.p.)	Result
		(dBm)	(mW)					
BT (A2DP sink)	1.01	11.70	14.79	14.50	28.18	0.28	4.00	Exempt
BT (Speakerphone)	6.34							
BLE	0.66	5.00	3.16	7.80	6.03	0.04	4.00	Exempt
Antenna Gain (dBi): 2.8								
Note 1: Maximum output power corrected by duty cycle								

Conclusion: EUT is exempt from SAR testing.

Note: measured separation distance is 6.2 mm. Calculations will use a separation distance of ≤5 mm to account for differences in fit.

Test Setup Details:

The EUT is connected to a companion device in either A2DP (sink) mode or speakerphone (handsfree) mode, or in BLE mode sending link data to the companion device. The connection is made through a directional coupler with a power meter attached to monitor the transmissions from the EUT. Transmitter output power and duty cycle are monitored using an ETS power meter probe.

Maximum output power was measured conducted with the antenna disconnected; the antenna gain is added to the conducted output power to determine e.i.r.p, as appropriate. Data is taken from the Output Power sections in the DSS and DTS reports.

The duty cycle is used with the e.i.r.p. measurement to calculate the time-averaged output power.

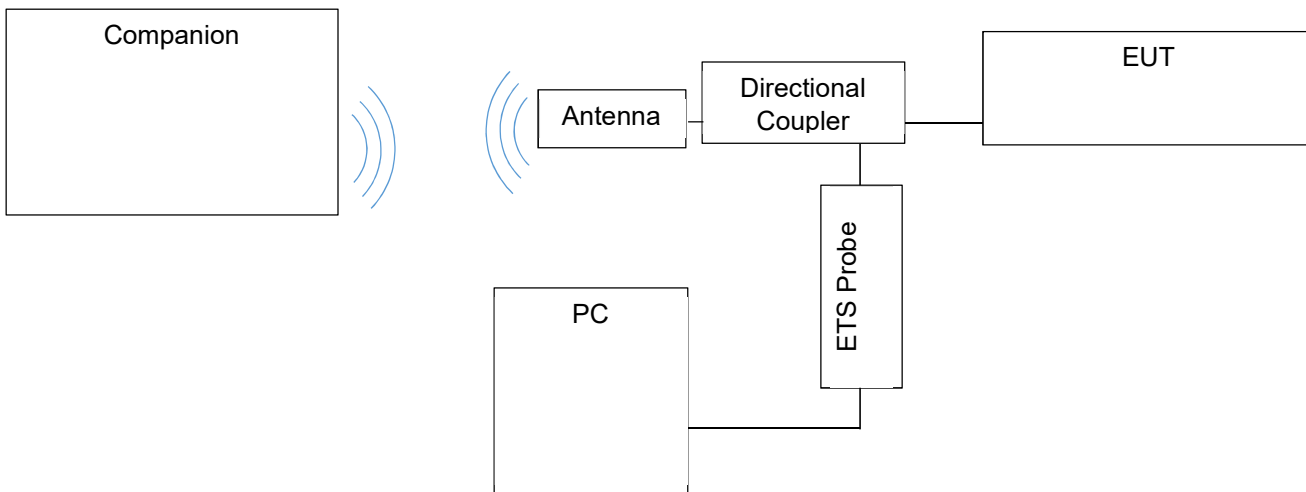

Data Collection:

Duty Cycle Measurements

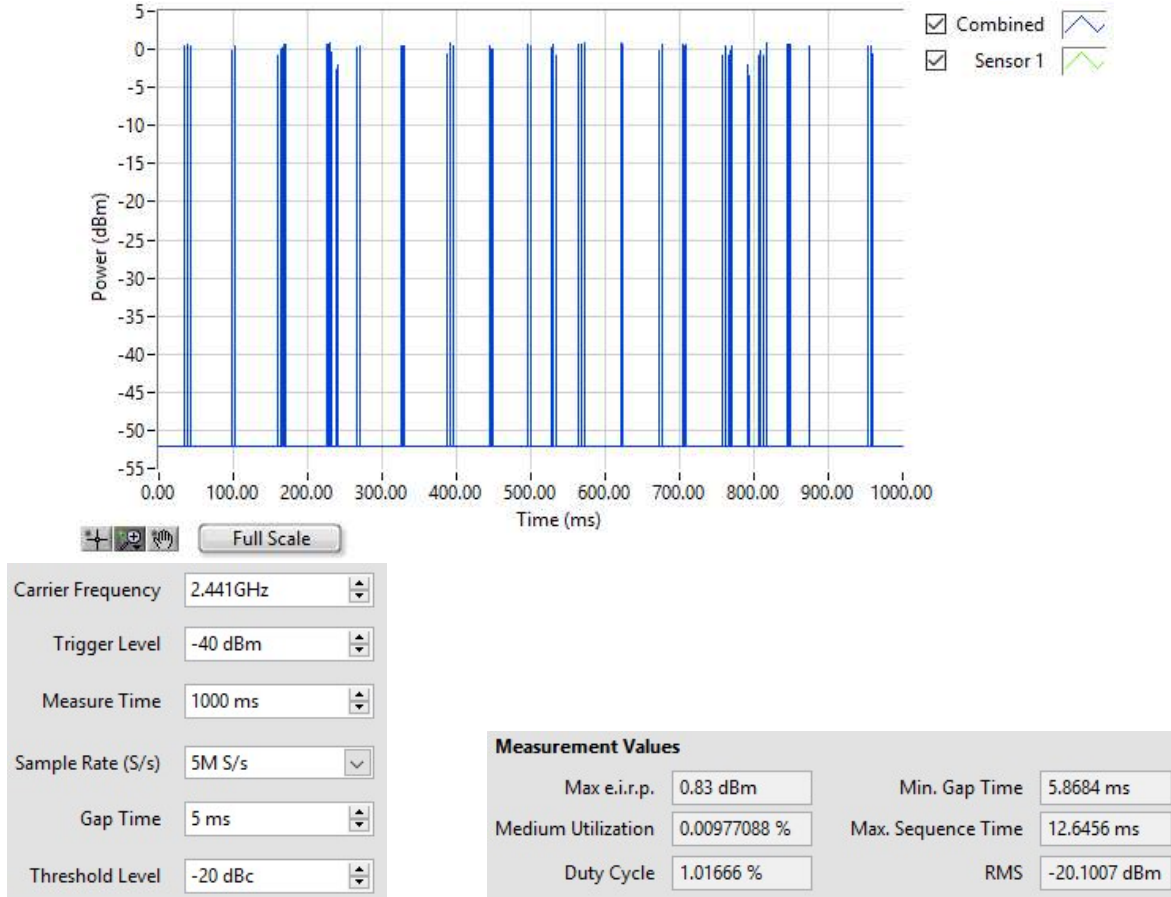

A2DP mode

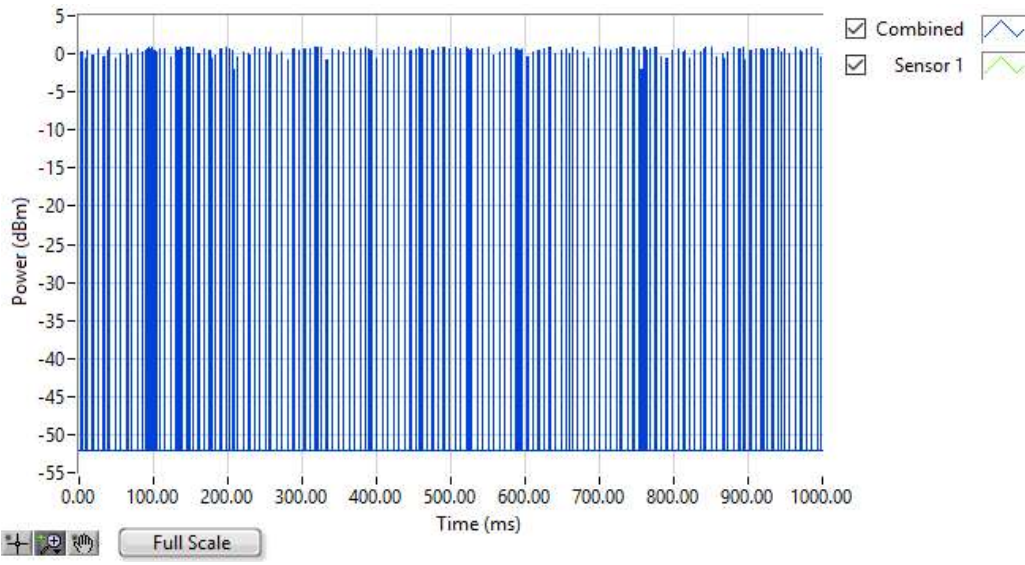

Carrier Frequency	2.441GHz
Trigger Level	-40 dBm
Measure Time	1000 ms
Sample Rate (S/s)	5M S/s
Gap Time	5 ms
Threshold Level	-20 dBc

Measurement Values			
Max e.i.r.p.	0.94 dBm	Min. Gap Time	5.8388 ms
Medium Utilization	0.0693531 %	Max. Sequence Time	22.9126 ms
Duty Cycle	6.34273 %	RMS	-11.5893 dBm

HF mode

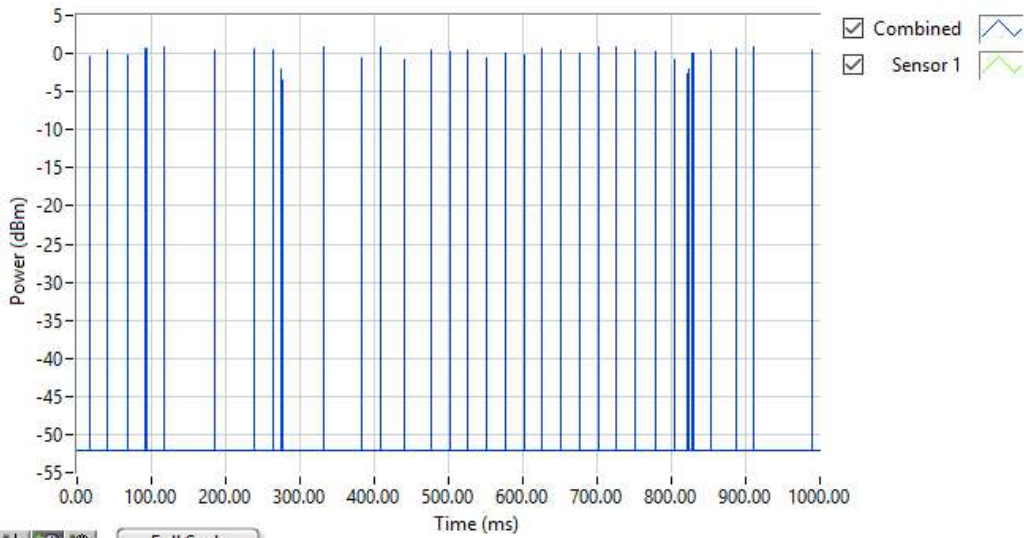

Full Scale

Carrier Frequency: 2.441GHz

Trigger Level: -40 dBm

Measure Time: 1000 ms

Sample Rate (S/s): 5M S/s

Gap Time: 5 ms

Threshold Level: -20 dBc

Measurement Values			
Max e.i.r.p.	0.84 dBm	Min. Gap Time	9.886 ms
Medium Utilization	0.00593132 %	Max. Sequence Time	6.9646 ms
Duty Cycle	0.660417 %	RMS	-22.2685 dBm

BLE



PRODUCT ASSURANCE ENGINEERING
SAR Exclusion Calculation



FCC ID: A94BMD0011 IC: 3232A-BMD0011

Equipment Used:

TN	Description	Model	S/N	Manufacturer	Most Recent Service	Service Due Date
2403	USB RF Power Sensor	7002-006	160036	ETS Lindgren	05-Sep-2019	04-Sep-2020

Date(s) of test: 15-Jun-2020

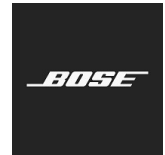

End of Report