

FCC Test Report (BT-LE)

Report No.: RF170113D04A-1

FCC ID: A94BL1R

Test Model: BL1R

Received Date: Jan. 17 2017

Test Date: Jan. 26, 2017 ~ Feb. 14, 2017

Issued Date: Apr. 17, 2017

Applicant: Bose Corporation

Address: 100 The Mountain Rd Framingham Massachusetts 01701 United States

Issued By: Bureau Veritas Consumer Products Services (H.K.) Ltd., Taoyuan Branch

Lab Address: No. 47-2, 14th Ling, Chia Pau Vil., Lin Kou Dist., New Taipei City, Taiwan, R.O.C.



This report is for your exclusive use. Any copying or replication of this report to or for any other person or entity, or use of our name or trademark, is permitted only with our prior written permission. This report sets forth our findings solely with respect to the test samples identified herein. The results set forth in this report are not indicative or representative of the quality or characteristics of the lot from which a test sample was taken or any similar or identical product unless specifically and expressly noted. Our report includes all of the tests requested by you and the results thereof based upon the information that you provided to us. You have 60 days from date of issuance of this report to notify us of any material error or omission caused by our negligence, provided, however, that such notice shall be in writing and shall specifically address the issue you wish to raise. A failure to raise such issue within the prescribed time shall constitute your unqualified acceptance of the completeness of this report, the tests conducted and the correctness of the report contents. Unless specific mention, the uncertainty of measurement has been explicitly taken into account to declare the compliance or non-compliance to the specification. The report must not be used by the client to claim product certification, approval, or endorsement by TAF or any government agencies.

Table of Contents

Release Control Record	4
1 Certificate of Conformity	5
2 Summary of Test Results	6
2.1 Measurement Uncertainty.....	6
2.2 Modification Record.....	6
3 General Information	7
3.1 General Description of EUT (BT-LE).....	7
3.2 Description of Test Modes	8
3.2.1 Test Mode Applicability and Tested Channel Detail.....	9
3.3 Duty cycle of test signal.....	10
3.4 Description of Support Units.....	11
3.4.1 Configuration of System under Test	12
3.5 General Description of Applied Standards.....	13
4 Test Types and Results	14
4.1 Radiated Emission and Bandedge Measurement.....	14
4.1.1 Limits of Radiated Emission and Bandedge Measurement.....	14
4.1.2 Test Instruments.....	15
4.1.3 Test Procedures	16
4.1.4 Deviation from Test Standard.....	16
4.1.5 Test Setup.....	17
4.1.6 EUT Operating Conditions.....	18
4.1.7 Test Results.....	19
4.2 Conducted Emission Measurement.....	23
4.2.1 Limits of Conducted Emission Measurement.....	23
4.2.2 Test Instruments.....	23
4.2.3 Test Procedures	24
4.2.4 Deviation From Test Standard.....	24
4.2.5 Test Setup.....	24
4.2.6 EUT Operating Condition.....	24
4.2.7 Test Results.....	25
4.3 6dB Bandwidth Measurement.....	29
4.3.1 Limits of 6dB Bandwidth Measurement.....	29
4.3.2 Test Setup.....	29
4.3.3 Test Instruments.....	29
4.3.4 Test Procedure	29
4.3.5 Deviation from Test Standard.....	29
4.3.6 EUT Operating Conditions.....	29
4.3.7 Test Result	30
4.4 Conducted Output Power Measurement.....	31
4.4.1 Limits OF Conducted Output Power Measurement.....	31
4.4.2 Test Setup.....	31
4.4.3 Test Instruments.....	31
4.4.4 Test Procedures	31
4.4.5 Deviation from Test Standard.....	31
4.4.6 EUT Operating Conditions.....	31
4.4.7 Test Results.....	32
4.5 Power Spectral Density Measurement.....	33

4.5.1	Limits of Power Spectral Density Measurement.....	33
4.5.2	Test Setup	33
4.5.3	Test Instruments.....	33
4.5.4	Test Procedure	33
4.5.5	Deviation from Test Standard.....	33
4.5.6	EUT Operating Condition.....	33
4.5.7	Test Results.....	34
4.6	Conducted Out of Band Emission Measurement.....	35
4.6.1	Limits of Conducted Out of Band Emission Measurement.....	35
4.6.2	Test Setup	35
4.6.3	Test Instruments.....	35
4.6.4	Test Procedure	35
4.6.5	Deviation from Test Standard.....	35
4.6.6	EUT Operating Condition.....	35
4.6.7	Test Results.....	36
5	Pictures of Test Arrangements.....	38
	Appendix – Information on the Testing Laboratories.....	39

Release Control Record

Issue No.	Description	Date Issued
RF170113D04A-1	Original release.	Apr. 17, 2017

1 Certificate of Conformity

Product: Wireless Headphones

Brand: BOSE

Test Model: BL1R

Sample Status: Engineering sample

Applicant: Bose Corporation

Test Date: Jan. 26, 2017 ~ Feb. 14, 2017

Standards: 47 CFR FCC Part 15, Subpart C (Section 15.247)
ANSI C63.10: 2013

The above equipment has been tested by **Bureau Veritas Consumer Products Services (H.K.) Ltd., Taoyuan Branch**, and found compliance with the requirement of the above standards. The test record, data evaluation & Equipment Under Test (EUT) configurations represented herein are true and accurate accounts of the measurements of the sample's EMC characteristics under the conditions specified in this report.

Prepared by :

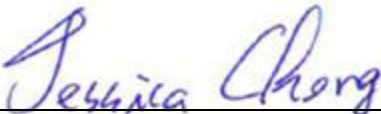

Jessica Cheng / Senior Specialist

Date:

Apr. 17, 2017

Approved by :



Rex Lai / Assistant Manager

Date:

Apr. 17, 2017

2 Summary of Test Results

47 CFR FCC Part 15, Subpart C (SECTION 15.247)			
FCC Clause	Test Item	Result	Remarks
15.207	AC Power Conducted Emission	PASS	Meet the requirement of limit. Minimum passing margin is -14.23 dB at 0.15007 MHz
15.205 & 209 & 15.247(d)	Radiated Emissions & Band Edge Measurement	PASS	Meet the requirement of limit. Minimum passing margin is -13.05dB at 2390.00MHz.
15.247(d)	Antenna Port Emission	PASS	Meet the requirement of limit.
15.247(a)(2)	6dB bandwidth	PASS	Meet the requirement of limit.
15.247(b)	Conducted power	PASS	Meet the requirement of limit.
15.247(e)	Power Spectral Density	PASS	Meet the requirement of limit.
15.203	Antenna Requirement	PASS	No antenna connector is used.

2.1 Measurement Uncertainty

Where relevant, the following measurement uncertainty levels have been estimated for tests performed on the EUT as specified in CISPR 16-4-2:

Measurement	Frequency	Expanded Uncertainty (k=2) (±)
Conducted Emissions at mains ports	150kHz ~ 30MHz	2.77 dB
Radiated Emissions up to 1 GHz	9kHz ~ 30MHz	2.38 dB
	30MHz ~ 1000MHz	5.54 dB
Radiated Emissions above 1 GHz	1GHz ~ 6GHz	4.47 dB
	6GHz ~ 18GHz	5.48 dB

2.2 Modification Record

There were no modifications required for compliance.

3 General Information

3.1 General Description of EUT (BT-LE)

Product	Wireless Headphones
Brand	BOSE
Test Model	BL1R
Status of EUT	Engineering Sample
Power Supply Rating	3.7Vdc from Battery/ 5Vdc from Charging Case
Modulation Type	GFSK
Transfer Rate	Up to 1Mbps
Operating Frequency	2402MHz ~ 2480MHz
Number of Channel	40
Output Power	2.858mW
Antenna Type	PCB Meander Line antenna with -0.3dBi gain
Antenna Connector	N/A
Accessory Device	Charging Case (BOSE/ 423729)
Data Cable Supplied	Shielded USB cable (0.3m)

Note:

1. The EUT is a Wireless Headphones.
2. The EUT was pre-tested with the following modes:
 - † Operating Mode (EUT stand-alone)
 - † Operating (EUT) + Charging Case Mode (Adapter)
 - † Operating (EUT) + Charging Case Mode (Notebook)
 The worst emission level was found when the EUT tested under **Operating (EUT stand-alone)** therefore, only its test data was recorded in this report.
3. The above EUT information is declared by manufacturer and for more detailed features description, please refer to the manufacturer's specifications or user's manual.

3.2 Description of Test Modes

40 channels are provided to this EUT:

CHANNEL	FREQ. (MHz)	CHANNEL	FREQ. (MHz)	CHANNEL	FREQ. (MHz)	CHANNEL	FREQ. (MHz)
0	2402	10	2422	20	2442	30	2462
1	2404	11	2424	21	2444	31	2464
2	2406	12	2426	22	2446	32	2466
3	2408	13	2428	23	2448	33	2468
4	2410	14	2430	24	2450	34	2470
5	2412	15	2432	25	2452	35	2472
6	2414	16	2434	26	2454	36	2474
7	2416	17	2436	27	2456	37	2476
8	2418	18	2438	28	2458	38	2478
9	2420	19	2440	29	2460	39	2480

3.2.1 Test Mode Applicability and Tested Channel Detail

EUT CONFIGURE MODE	APPLICABLE TO				DESCRIPTION
	RE \geq 1G	RE<1G	PLC	APCM	
A	√	√	-	√	Operating Mode (EUT stand-alone)
B	-	-	√	-	Operating (EUT) + Charging Case Mode (Adapter)
C	-	-	√	-	Operating (EUT) + Charging Case Mode (Notebook)

Where **RE \geq 1G**: Radiated Emission above 1GHz **RE<1G**: Radiated Emission below 1GHz
PLC: Power Line Conducted Emission **APCM**: Antenna Port Conducted Measurement

NOTE: The EUT had been pre-tested on the positioned of each 3 axis. The worst case was found when positioned on **Z-plane**.

Radiated Emission Test (Above 1GHz):

- Pre-Scan has been conducted to determine the worst-case mode from all possible combinations between available modulations, data rates and antenna ports (if EUT with antenna diversity architecture).
- Following channel(s) was (were) selected for the final test as listed below.

EUT CONFIGURE MODE	AVAILABLE CHANNEL	TESTED CHANNEL	MODULATION TYPE	DATA RATE (Mbps)
A	0 to 39	0, 19, 39	GFSK	1

Radiated Emission Test (Below 1GHz):

- Pre-Scan has been conducted to determine the worst-case mode from all possible combinations between available modulations, data rates and antenna ports (if EUT with antenna diversity architecture).
- Following channel(s) was (were) selected for the final test as listed below.

EUT CONFIGURE MODE	AVAILABLE CHANNEL	TESTED CHANNEL	MODULATION TYPE	DATA RATE (Mbps)
A	0 to 39	0	GFSK	1

Power Line Conducted Emission Test:

- Pre-Scan has been conducted to determine the worst-case mode from all possible combinations between available modulations, data rates and antenna ports (if EUT with antenna diversity architecture).
- Following channel(s) was (were) selected for the final test as listed below.

EUT CONFIGURE MODE	AVAILABLE CHANNEL	TESTED CHANNEL	MODULATION TYPE	DATA RATE (Mbps)
B	0 to 39	0	GFSK	1
C	0 to 39	0	GFSK	1

Antenna Port Conducted Measurement:

- This item includes all test value of each mode, but only includes spectrum plot of worst value of each mode.
- Pre-Scan has been conducted to determine the worst-case mode from all possible combinations between available modulations, data rates and antenna ports (if EUT with antenna diversity architecture).
- Following channel(s) was (were) selected for the final test as listed below.

EUT CONFIGURE MODE	AVAILABLE CHANNEL	TESTED CHANNEL	MODULATION TYPE	DATA RATE (Mbps)
A	0 to 39	0, 19, 39	GFSK	1

Test Condition:

APPLICABLE TO	ENVIRONMENTAL CONDITIONS	INPUT POWER	TESTED BY
RE≥1G	19deg. C, 70%RH	3.7Vdc	Ian Chang
RE<1G	19deg. C, 70%RH	3.7Vdc	Ian Chang
PLC (Mode B)	19deg. C, 73%RH	120Vac, 60Hz(Adapter)	John Liao
PLC (Mode C)	19deg. C, 73%RH	120Vac, 60Hz(Notebook)	John Liao
APCM	25deg. C, 76%RH	3.7Vdc	Saxon Lee

3.3 Duty cycle of test signal

Duty cycle of test signal is < 98%

Duty cycle = 0.391/0.649 = 0.602, Duty factor = 10 * log(1/0.602) = 2.204

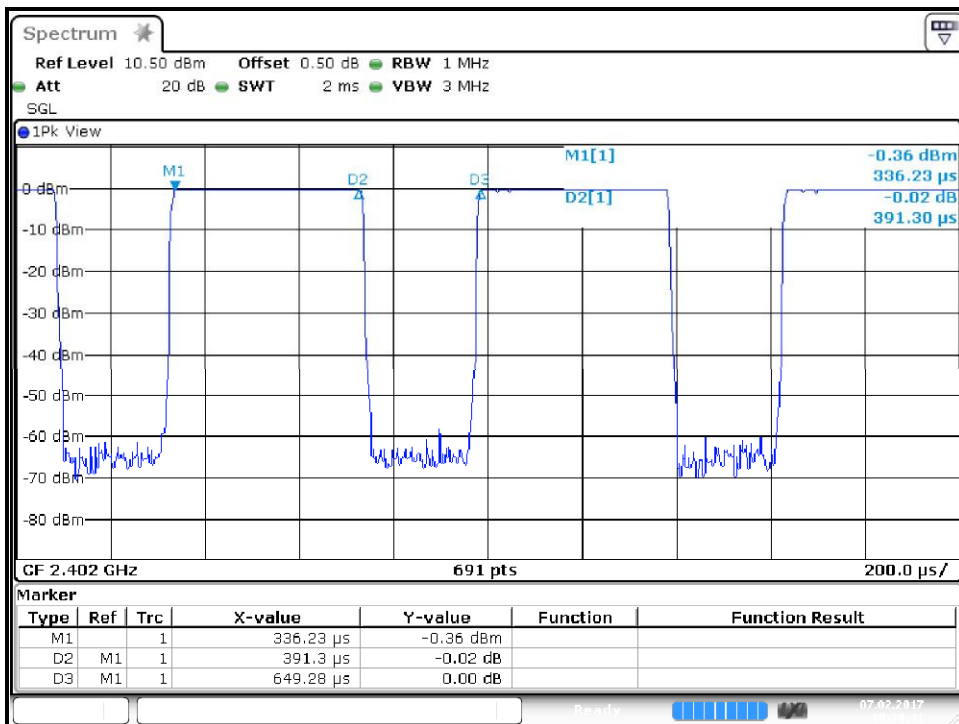

3.4 Description of Support Units

The EUT has been tested as an independent unit together with other necessary accessories or support units. The following support units or accessories were used to form a representative test configuration during the tests.

ID	Product	Brand	Model No.	Serial No.	FCC ID	Remarks
A.	Notebook PC	ASUS	PU401L	E9NXBC002007372	FCC DoC Approved	Provided by Lab
B.	24" LCD MONITOR	DELL	U2410	CN082WXD728720CC0L2L	FCC DoC Approved	Provided by Lab
C.	USB 3.0 Hard Disk	WD	WDBACY5000A BL-PESN	WXG1A81P6250	FCC DoC Approved	Provided by Lab
D.	USB Mouse	Microsoft	1113	9170515896850	FCC DoC Approved	Provided by Lab
E.	AC Adapter	UL	TC P450-US	N/A	N/A	Supplied by client

Note: All power cords of the above support units are non-shielded (1.8m).

ID	Descriptions	Qty.	Length (m)	Shielding (Yes/No)	Cores (Qty.)	Remarks
1.	USB cable	1	0.3	Y	0	Supplied by client
2.	HDMI cable	1	2.0	Y	0	Provided by Lab
3.	USB cable	1	0.5	Y	0	Provided by Lab
4.	USB cable	1	1.8	Y	1	Provided by Lab

Note: The core(s) is(are) originally attached to the cable(s).

3.4.1 Configuration of System under Test

Mode A

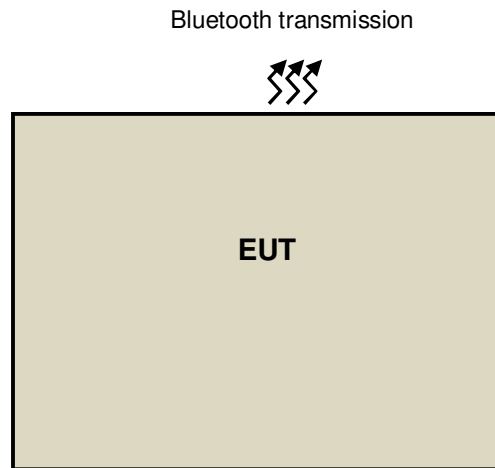

Mode B

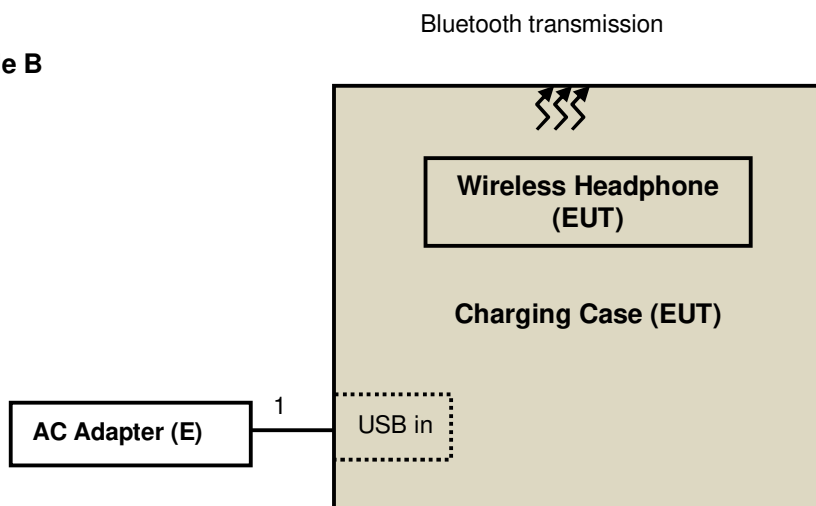

Mode C

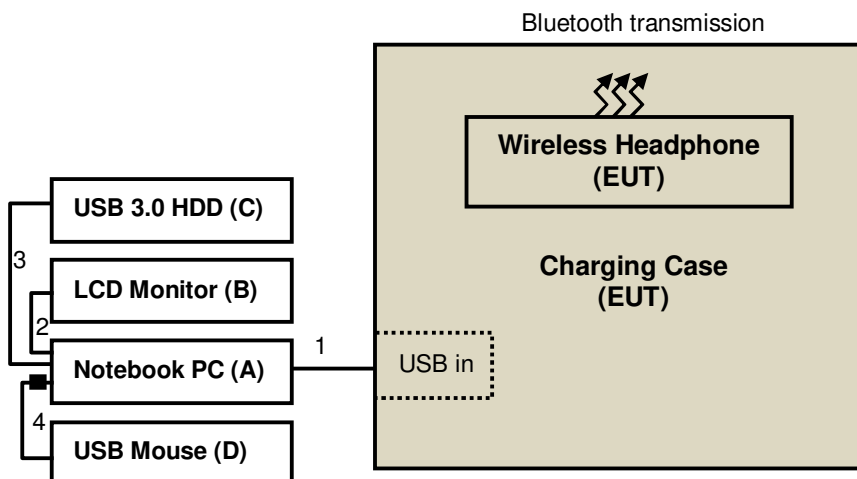

3.5 General Description of Applied Standards

The EUT is a RF Product. According to the specifications of the manufacturer, it must comply with the requirements of the following standards:

FCC Part 15, Subpart C (15.247)
KDB 558074 D01 DTS Meas Guidance v03r05
ANSI C63.10-2013

All test items have been performed and recorded as per the above standards.

4 Test Types and Results

4.1 Radiated Emission and Bandedge Measurement

4.1.1 Limits of Radiated Emission and Bandedge Measurement

Radiated emissions which fall in the restricted bands must comply with the radiated emission limits specified as below table. Other emissions shall be at least 20dB below the highest level of the desired power:

Frequencies (MHz)	Field Strength (microvolts/meter)	Measurement Distance (meters)
0.009 ~ 0.490	2400/F(kHz)	300
0.490 ~ 1.705	24000/F(kHz)	30
1.705 ~ 30.0	30	30
30 ~ 88	100	3
88 ~ 216	150	3
216 ~ 960	200	3
Above 960	500	3

NOTE:

1. The lower limit shall apply at the transition frequencies.
2. Emission level (dBuV/m) = 20 log Emission level (uV/m).
3. For frequencies above 1000MHz, the field strength limits are based on average detector, however, the peak field strength of any emission shall not exceed the maximum permitted average limits, specified above by more than 20dB under any condition of modulation.

4.1.2 Test Instruments

DESCRIPTION & MANUFACTURER	MODEL NO.	SERIAL NO.	CALIBRATED DATE	CALIBRATED UNTIL
HP Preamplifier	8447D	2432A03504	Feb. 26, 2016	Feb. 25, 2017
HP Preamplifier	8449B	3008A01201	Feb. 26, 2016	Feb. 25, 2017
MITEQ Preamplifier	AMF-6F-260400-33-8P	892164	Mar. 01, 2016	Feb. 28, 2017
Agilent TEST RECEIVER	N9038A	MY51210129	Feb. 08, 2017	Feb. 07, 2018
Schwarzbeck Antenna	VULB 9168	139	Dec. 13, 2016	Dec. 12, 2017
Schwarzbeck Antenna	VHBA 9123	480	May 29, 2015	May 28, 2017
Schwarzbeck Horn Antenna	BBHA-9170	212	Dec. 30, 2016	Dec. 29, 2017
Schwarzbeck Horn Antenna	BBHA 9120-D1	D130	Dec. 27, 2016	Dec. 26, 2017
ADT. Turn Table	TT100	0306	NA	NA
ADT. Tower	AT100	0306	NA	NA
Software	Radiated_V7.6.15.9.5	NA	NA	NA
SUHNER RF cable With 4dB PAD	SF104	CABLE-CH6	Aug. 15, 2016	Aug. 14, 2017
SUHNER RF cable With 3dB PAD	SF102	Cable-CH8-3.6m	Aug. 15, 2016	Aug. 14, 2017
KEYSIGHT MIMO Powermeasurement Test set	U2021XA	U2021XA-001	May 25, 2016	May 24, 2017
KEYSIGHT Spectrum Analyzer	N9030A	MY54490260	Jul. 26, 2016	Jul. 25, 2017
Loop Antenna EMCI	LPA600	270	Aug. 20, 2015	Aug. 19, 2017
EMCO Horn Antenna	3115	00028257	Dec. 15, 2016	Dec. 14, 2017
Highpass filter Wainwright Instruments	WHK 3.1/18G-10SS	SN 8	NA	NA
ROHDE & SCHWARZ Spectrum Analyzer	FSV40	101042	Sep. 30, 2016	Sep. 29, 2017
Anritsu Power Sensor	MA2411B	0738404	Apr. 28, 2016	Apr. 27, 2017
Anritsu Power Meter	ML2495A	0842014	Apr. 28, 2016	Apr. 27, 2017

- NOTE:**
1. The calibration interval of the above test instruments is 12/24 months. And the calibrations are traceable to NML/ROC and NIST/USA.
 2. The horn antenna and HP preamplifier (model: 8449B) are used only for the measurement of emission frequency above 1GHz if tested.
 3. The test was performed in Chamber No. 6.
 4. The Industry Canada Reference No. IC 7450E-6.
 5. The FCC Site Registration No. is 447212.
 6. Tested Date: Feb. 9 ~ 14, 2017

4.1.3 Test Procedures

For Radiated emission below 30MHz

- a. The EUT was placed on the top of a rotating table 0.8 meters above the ground at a 3 meter chamber room. The table was rotated 360 degrees to determine the position of the highest radiation.
- b. The EUT was set 3 meters away from the interference-receiving antenna, which was mounted on the top of a variable-height antenna tower.
- c. Both X and Y axes of the antenna are set to make the measurement.
- d. For each suspected emission, the EUT was arranged to its worst case and the rotatable table was turned from 0 degrees to 360 degrees to find the maximum reading.
- e. The test-receiver system was set to Quasi-Peak Detect Function and Specified Bandwidth with Maximum Hold Mode.

NOTE:

1. The resolution bandwidth and video bandwidth of test receiver/spectrum analyzer is 9kHz at frequency below 30MHz.

For Radiated emission above 30MHz

- a. The EUT was placed on the top of a rotating table 0.8 meters (for 30MHz ~ 1GHz) / 1.5 meters (for above 1GHz) above the ground at 3 meter chamber room for test. The table was rotated 360 degrees to determine the position of the highest radiation.
- b. The EUT was set 3 meters away from the interference-receiving antenna, which was mounted on the top of a variable-height antenna tower.
- c. The height of antenna is varied from one meter to four meters above the ground to determine the maximum value of the field strength. Both horizontal and vertical polarizations of the antenna are set to make the measurement.
- d. For each suspected emission, the EUT was arranged to its worst case and then the antenna was tuned to heights from 1 meter to 4 meters and the rotatable table was turned from 0 degrees to 360 degrees to find the maximum reading.
- e. The test-receiver system was set to quasi-peak detect function and specified bandwidth with maximum hold mode when the test frequency is below 1 GHz.
- f. The test-receiver system was set to peak and average detect function and specified bandwidth with maximum hold mode when the test frequency is above 1 GHz. If the peak reading value also meets average limit, measurement with the average detector is unnecessary.

Note:

1. The resolution bandwidth and video bandwidth of test receiver/spectrum analyzer is 120kHz for Quasi-peak detection (QP) at frequency below 1GHz.
2. The resolution bandwidth of test receiver/spectrum analyzer is 1 MHz and the video bandwidth is 3 MHz for Peak detection (PK) at frequency above 1GHz.
3. The resolution bandwidth of test receiver/spectrum analyzer is 1MHz and the video bandwidth is $\geq 1/T$ (Duty cycle < 98%) or 10Hz (Duty cycle $\geq 98\%$) for Average detection (AV) at frequency above 1GHz.
4. All modes of operation were investigated and the worst-case emissions are reported.

4.1.4 Deviation from Test Standard

No deviation.

4.1.5 Test Setup

For Radiated emission below 30MHz

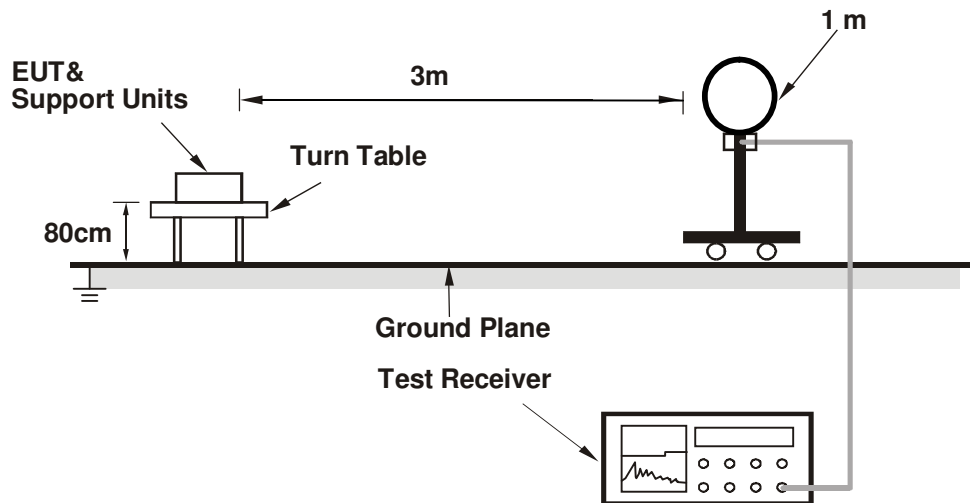

For Radiated emission 30MHz to 1GHz

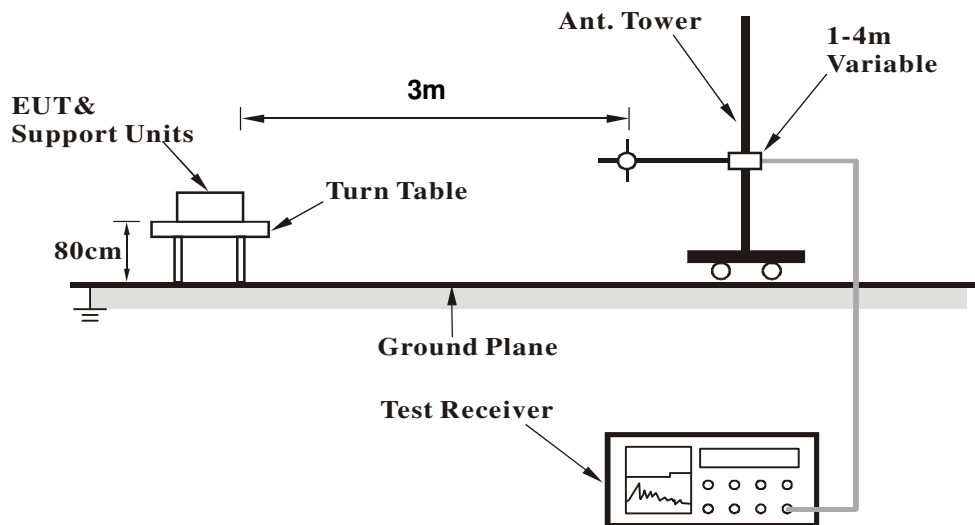

For Radiated emission above 1GHz

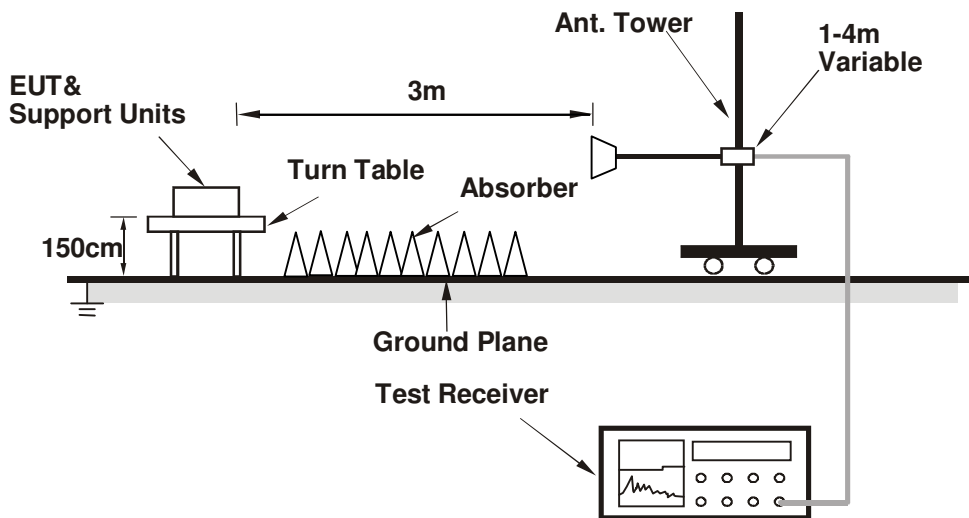

For the actual test configuration, please refer to the attached file (Test Setup Photo).

4.1.6 EUT Operating Conditions

- a. Placed the EUT on the testing table.
- b. Set the EUT under transmission condition continuously at specific channel frequency.

4.1.7 Test Results

Mode A Above 1GHz Data :

CHANNEL	TX Channel 0	DETECTOR FUNCTION	Peak (PK)
FREQUENCY RANGE	1GHz ~ 25GHz		Average (AV)

ANTENNA POLARITY & TEST DISTANCE: HORIZONTAL AT 3 M								
NO.	FREQ. (MHz)	EMISSION LEVEL (dBuV/m)	LIMIT (dBuV/m)	MARGIN (dB)	ANTENNA HEIGHT (m)	TABLE ANGLE (Degree)	RAW VALUE (dBuV)	CORRECTION FACTOR (dB/m)
1	2390.00	54.80 PK	74.00	-19.20	2.01 H	321	54.51	0.29
2	2390.00	40.95 AV	54.00	-13.05	2.01 H	321	40.66	0.29
3	*2402.00	97.59 PK			2.01 H	321	97.22	0.37
4	*2402.00	96.61 AV			2.01 H	321	96.24	0.37
5	4804.00	48.30 PK	74.00	-25.70	1.06 H	184	41.15	7.15
6	4804.00	34.99 AV	54.00	-19.01	1.06 H	184	27.84	7.15

ANTENNA POLARITY & TEST DISTANCE: VERTICAL AT 3 M								
NO.	FREQ. (MHz)	EMISSION LEVEL (dBuV/m)	LIMIT (dBuV/m)	MARGIN (dB)	ANTENNA HEIGHT (m)	TABLE ANGLE (Degree)	RAW VALUE (dBuV)	CORRECTION FACTOR (dB/m)
1	2390.00	53.93 PK	74.00	-20.07	1.97 V	329	53.64	0.29
2	2390.00	39.60 AV	54.00	-14.40	1.97 V	329	39.31	0.29
3	*2402.00	97.27 PK			1.97 V	329	96.90	0.37
4	*2402.00	96.25 AV			1.97 V	329	95.88	0.37
5	4804.00	47.67 PK	74.00	-26.33	2.20 V	193	40.52	7.15
6	4804.00	33.48 AV	54.00	-20.52	2.20 V	193	26.33	7.15

REMARKS:

1. Emission Level(dBuV/m) = Raw Value(dBuV) + Correction Factor(dB/m)
2. Correction Factor(dB/m) = Antenna Factor(dB/m) + Cable Factor(dB) – Pre-Amplifier Factor(dB)
3. The other emission levels were very low against the limit.
4. Margin value = Emission Level – Limit value
5. " * ": Fundamental frequency.

CHANNEL	TX Channel 19	DETECTOR FUNCTION	Peak (PK)
FREQUENCY RANGE	1GHz ~ 25GHz		Average (AV)

ANTENNA POLARITY & TEST DISTANCE: HORIZONTAL AT 3 M

NO.	FREQ. (MHz)	EMISSION LEVEL (dBuV/m)	LIMIT (dBuV/m)	MARGIN (dB)	ANTENNA HEIGHT (m)	TABLE ANGLE (Degree)	RAW VALUE (dBuV)	CORRECTION FACTOR (dB/m)
1	*2440.00	97.35 PK			1.99 H	321	96.67	0.68
2	*2440.00	96.31 AV			1.99 H	321	95.63	0.68
3	4880.00	48.46 PK	74.00	-25.54	1.32 H	142	41.23	7.23
4	4880.00	34.69 AV	54.00	-19.31	1.32 H	142	27.46	7.23

ANTENNA POLARITY & TEST DISTANCE: VERTICAL AT 3 M

NO.	FREQ. (MHz)	EMISSION LEVEL (dBuV/m)	LIMIT (dBuV/m)	MARGIN (dB)	ANTENNA HEIGHT (m)	TABLE ANGLE (Degree)	RAW VALUE (dBuV)	CORRECTION FACTOR (dB/m)
1	*2440.00	96.57 PK			1.89 V	319	95.89	0.68
2	*2440.00	95.55 AV			1.89 V	319	94.87	0.68
3	4880.00	47.97 PK	74.00	-26.03	1.55 V	205	40.74	7.23
4	4880.00	33.53 AV	54.00	-20.47	1.55 V	205	26.30	7.23

REMARKS:

1. Emission Level(dBuV/m) = Raw Value(dBuV) + Correction Factor(dB/m)
2. Correction Factor(dB/m) = Antenna Factor(dB/m) + Cable Factor(dB) – Pre-Amplifier Factor(dB)
3. The other emission levels were very low against the limit.
4. Margin value = Emission Level – Limit value
5. " * ": Fundamental frequency.

CHANNEL	TX Channel 39	DETECTOR FUNCTION	Peak (PK)
FREQUENCY RANGE	1GHz ~ 25GHz		Average (AV)

ANTENNA POLARITY & TEST DISTANCE: HORIZONTAL AT 3 M

NO.	FREQ. (MHz)	EMISSION LEVEL (dBuV/m)	LIMIT (dBuV/m)	MARGIN (dB)	ANTENNA HEIGHT (m)	TABLE ANGLE (Degree)	RAW VALUE (dBuV)	CORRECTION FACTOR (dB/m)
1	*2480.00	95.40 PK			1.95 H	322	94.39	1.01
2	*2480.00	94.38 AV			1.95 H	322	93.37	1.01
3	2483.50	54.66 PK	74.00	-19.34	1.95 H	322	53.63	1.03
4	2483.50	40.88 AV	54.00	-13.12	1.95 H	322	39.85	1.03
5	4960.00	47.64 PK	74.00	-26.36	1.77 H	244	40.21	7.43
6	4960.00	33.95 AV	54.00	-20.05	1.77 H	244	26.52	7.43

ANTENNA POLARITY & TEST DISTANCE: VERTICAL AT 3 M

NO.	FREQ. (MHz)	EMISSION LEVEL (dBuV/m)	LIMIT (dBuV/m)	MARGIN (dB)	ANTENNA HEIGHT (m)	TABLE ANGLE (Degree)	RAW VALUE (dBuV)	CORRECTION FACTOR (dB/m)
1	*2480.00	94.59 PK			1.85 V	332	93.58	1.01
2	*2480.00	93.57 AV			1.85 V	332	92.56	1.01
3	2483.50	53.27 PK	74.00	-20.73	1.85 V	332	52.24	1.03
4	2483.50	39.72 AV	54.00	-14.28	1.85 V	332	38.69	1.03
5	4960.00	46.76 PK	74.00	-27.24	1.35 V	106	39.33	7.43
6	4960.00	32.71 AV	54.00	-21.29	1.35 V	106	25.28	7.43

REMARKS:

1. Emission Level(dBuV/m) = Raw Value(dBuV) + Correction Factor(dB/m)
2. Correction Factor(dB/m) = Antenna Factor(dB/m) + Cable Factor(dB) – Pre-Amplifier Factor(dB)
3. The other emission levels were very low against the limit.
4. Margin value = Emission Level – Limit value
5. " * ": Fundamental frequency.

Mode A BELOW 1GHz WORST-CASE DATA

CHANNEL	TX Channel 0	DETECTOR FUNCTION	Quasi-Peak (QP)
FREQUENCY RANGE	9kHz ~ 1GHz		

ANTENNA POLARITY & TEST DISTANCE: HORIZONTAL AT 3 M

NO.	FREQ. (MHz)	EMISSION LEVEL (dBuV/m)	LIMIT (dBuV/m)	MARGIN (dB)	ANTENNA HEIGHT (m)	TABLE ANGLE (Degree)	RAW VALUE (dBuV)	CORRECTION FACTOR (dB/m)
1	52.02	15.23 QP	40.00	-24.77	1.99 H	7	24.45	-9.22
2	139.85	15.89 QP	43.50	-27.61	2.64 H	288	25.74	-9.85
3	161.73	15.74 QP	43.50	-27.76	1.45 H	197	24.92	-9.18
4	291.32	15.95 QP	46.00	-30.05	1.81 H	72	23.68	-7.73
5	420.57	20.08 QP	46.00	-25.92	1.27 H	49	25.20	-5.12
6	465.38	21.76 QP	46.00	-24.24	2.25 H	283	26.03	-4.27

ANTENNA POLARITY & TEST DISTANCE: VERTICAL AT 3 M

NO.	FREQ. (MHz)	EMISSION LEVEL (dBuV/m)	LIMIT (dBuV/m)	MARGIN (dB)	ANTENNA HEIGHT (m)	TABLE ANGLE (Degree)	RAW VALUE (dBuV)	CORRECTION FACTOR (dB/m)
1	45.33	17.27 QP	40.00	-22.73	1.23 V	3	27.01	-9.74
2	116.67	13.97 QP	43.50	-29.53	1.18 V	38	26.16	-12.19
3	141.21	15.96 QP	43.50	-27.54	1.69 V	298	25.72	-9.76
4	290.30	16.09 QP	46.00	-29.91	1.85 V	214	23.83	-7.74
5	373.82	18.48 QP	46.00	-27.52	2.09 V	133	24.48	-6.00
6	522.37	23.01 QP	46.00	-22.99	2.28 V	335	25.75	-2.74

REMARKS:

1. Emission Level(dBuV/m) = Raw Value(dBuV) + Correction Factor(dB/m)
2. Correction Factor(dB/m) = Antenna Factor(dB/m) + Cable Factor(dB) – Pre-Amplifier Factor(dB)
3. The other emission levels were very low against the limit.
4. Margin value = Emission Level – Limit value

4.2 Conducted Emission Measurement

4.2.1 Limits of Conducted Emission Measurement

Frequency (MHz)	Conducted Limit (dBuV)	
	Quasi-peak	Average
0.15 - 0.5	66 - 56	56 - 46
0.50 - 5.0	56	46
5.0 - 30.0	60	50

Note: 1. The lower limit shall apply at the transition frequencies.

2. The limit decreases in line with the logarithm of the frequency in the range of 0.15 to 0.50MHz.

4.2.2 Test Instruments

Description & Manufacturer	Model No.	Serial No.	Cal. Date	Cal. Due
ROHDE & SCHWARZ TEST RECEIVER	ESCS30	100292	Dec. 09, 2016	Dec. 08, 2017
SCHWARZBECK Artificial Mains Network (for EUT)	NSLK 8128	8128-244	Sep. 30, 2016	Sep. 29, 2017
LISN With Adapter (for EUT)	AD10	C05Ada-001	Sep. 30, 2016	Sep. 29, 2017
ROHDE & SCHWARZ 200-A Four-line V-Network	ENV4200	830326/018	Sep. 13, 2016	Sep. 12, 2017
EMCO Artificial Mains Network (for peripherals)	3625/2	9502-1041	May 16, 2016	May 15, 2017
Software	Cond_V7.3.7.4	NA	NA	NA
RF cable (JYEBAO) With 10dB PAD	5D-FB	Cable-C05.01	Feb. 05, 2016	Feb. 04, 2017
LYNICS Terminator (For R&S LISN)	0900510	E1-01-305	Feb. 15, 2016	Feb. 14, 2017

Notes: 1. The calibration interval of the above test instruments is 12 months and the calibrations are traceable to NML/ROC and NIST/USA.

2. The test was performed in Shielded Room No. 5.

3. The VCCI Site Registration No. C-1093.

4. The Industry Canada Reference No. IC 3789-5.

5. Tested Date: Jan. 26, 2017.

4.2.3 Test Procedures

- The EUT was placed 0.4 meters from the conducting wall of the shielded room with EUT being connected to the power mains through a line impedance stabilization network (LISN). Other support units were connected to the power mains through another LISN. The two LISNs provide 50 ohm/ 50uH of coupling impedance for the measuring instrument.
- Both lines of the power mains connected to the EUT were checked for maximum conducted interference.
- The frequency range from 150kHz to 30MHz was searched. Emission levels under (Limit - 20dB) was not recorded.

NOTE: The resolution bandwidth and video bandwidth of test receiver is 9kHz for quasi-peak detection (QP) and average detection (AV) at frequency 0.15MHz-30MHz.

4.2.4 Deviation From Test Standard

No deviation.

4.2.5 Test Setup

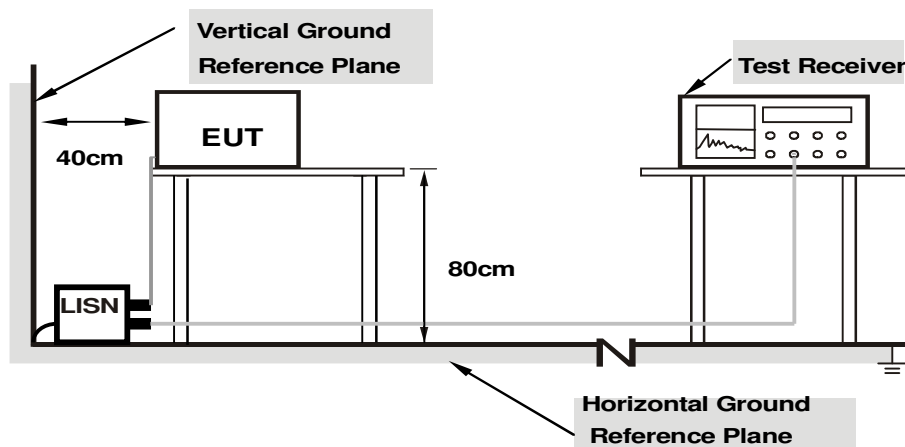

Note: 1.Support units were connected to second LISN.

For the actual test configuration, please refer to the attached file (Test Setup Photo).

4.2.6 EUT Operating Condition

Mode B

- Put the EUT into the charging case.
- Connected the charging case to Adapter with USB cable.
- Set the EUT under charging and transmission condition continuously at specific channel frequency.

Mode C

- Put the EUT into the charging case.
- Connected the charging case to Notebook with USB cable.
- Set the EUT under transmission condition continuously at specific channel frequency.

4.2.7 Test Results

Phase	Line (L)	Detector Function	Quasi-Peak (QP) / Average (AV)
Test Mode	Mode B		

Phase Of Power : Line (L)										
No	Frequency (MHz)	Correction Factor (dB)	Reading Value (dBuV)		Emission Level (dBuV)		Limit (dBuV)		Margin (dB)	
			Q.P.	AV.	Q.P.	AV.	Q.P.	AV.	Q.P.	AV.
1	0.17333	10.20	37.29	24.58	47.49	34.78	64.80	54.80	-17.31	-20.02
2	0.21095	10.18	30.65	19.87	40.83	30.05	63.17	53.17	-22.34	-23.12
3	0.51398	10.20	25.13	18.24	35.33	28.44	56.00	46.00	-20.67	-17.56
4	1.56250	10.34	22.05	15.11	32.39	25.45	56.00	46.00	-23.61	-20.55
5	4.06250	10.52	20.35	14.89	30.87	25.41	56.00	46.00	-25.13	-20.59
6	9.33984	10.80	20.05	13.97	30.85	24.77	60.00	50.00	-29.15	-25.23

Remarks:

1. Q.P. and AV. are abbreviations of quasi-peak and average individually.
2. The emission levels of other frequencies were very low against the limit.
3. Margin value = Emission level – Limit value
4. Correction factor = Insertion loss + Cable loss
5. Emission Level = Correction Factor + Reading Value

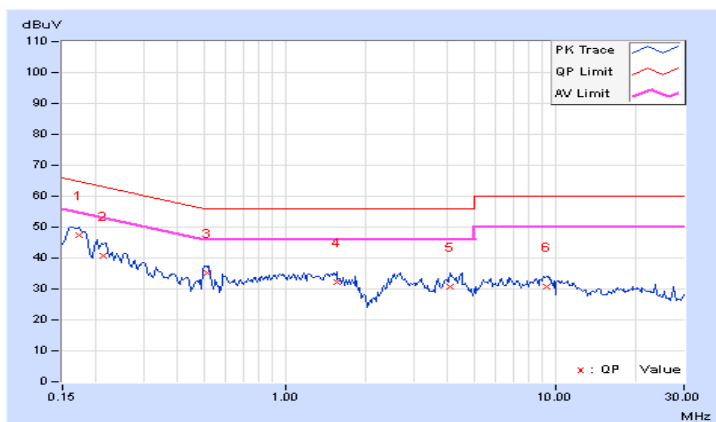

Phase	Neutral (N)	Detector Function	Quasi-Peak (QP) / Average (AV)
Test Mode	Mode B		

Phase Of Power : Neutral (N)										
No	Frequency (MHz)	Correction Factor (dB)	Reading Value (dBuV)		Emission Level (dBuV)		Limit (dBuV)		Margin (dB)	
			Q.P.	AV.	Q.P.	AV.	Q.P.	AV.	Q.P.	AV.
1	0.16953	10.19	39.11	26.78	49.30	36.97	64.98	54.98	-15.68	-18.01
2	0.20206	10.17	32.68	18.66	42.85	28.83	63.53	53.53	-20.68	-24.70
3	0.52109	10.26	24.63	14.52	34.89	24.78	56.00	46.00	-21.11	-21.22
4	1.19531	10.31	21.93	14.36	32.24	24.67	56.00	46.00	-23.76	-21.33
5	4.24219	10.57	22.09	13.97	32.66	24.54	56.00	46.00	-23.34	-21.46
6	9.59766	10.90	19.32	12.34	30.22	23.24	60.00	50.00	-29.78	-26.76

Remarks:

1. Q.P. and AV. are abbreviations of quasi-peak and average individually.
2. The emission levels of other frequencies were very low against the limit.
3. Margin value = Emission level – Limit value
4. Correction factor = Insertion loss + Cable loss
5. Emission Level = Correction Factor + Reading Value

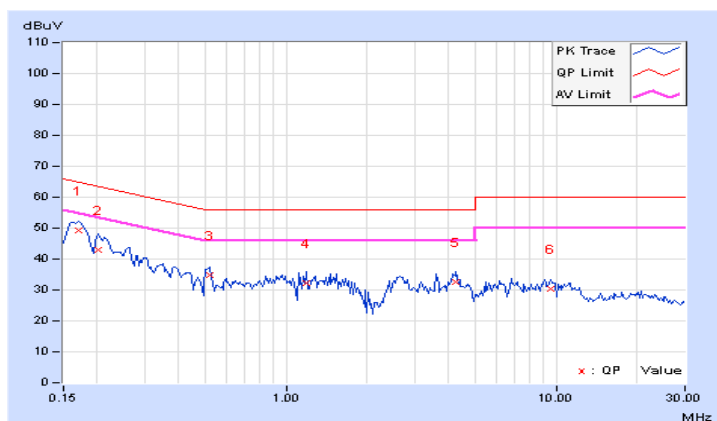

Phase	Line (L)	Detector Function	Quasi-Peak (QP) / Average (AV)
Test Mode	Mode C		

Phase Of Power : Line (L)										
No	Frequency (MHz)	Correction Factor (dB)	Reading Value (dBuV)		Emission Level (dBuV)		Limit (dBuV)		Margin (dB)	
			Q.P.	AV.	Q.P.	AV.	Q.P.	AV.	Q.P.	AV.
1	0.15007	10.21	41.56	29.28	51.77	39.49	66.00	56.00	-14.23	-16.51
2	0.20469	10.18	35.16	24.46	45.34	34.64	63.42	53.42	-18.08	-18.78
3	0.34531	10.17	30.82	20.07	40.99	30.24	59.07	49.07	-18.08	-18.83
4	1.32422	10.29	28.12	18.23	38.41	28.52	56.00	46.00	-17.59	-17.48
5	3.16797	10.39	27.11	18.69	37.50	29.08	56.00	46.00	-18.50	-16.92
6	4.22266	10.45	30.04	20.15	40.49	30.60	56.00	46.00	-15.51	-15.40
7	12.65234	10.80	26.02	18.65	36.82	29.45	60.00	50.00	-23.18	-20.55

Remarks:

1. Q.P. and AV. are abbreviations of quasi-peak and average individually.
2. The emission levels of other frequencies were very low against the limit.
3. Margin value = Emission level – Limit value
4. Correction factor = Insertion loss + Cable loss
5. Emission Level = Correction Factor + Reading Value

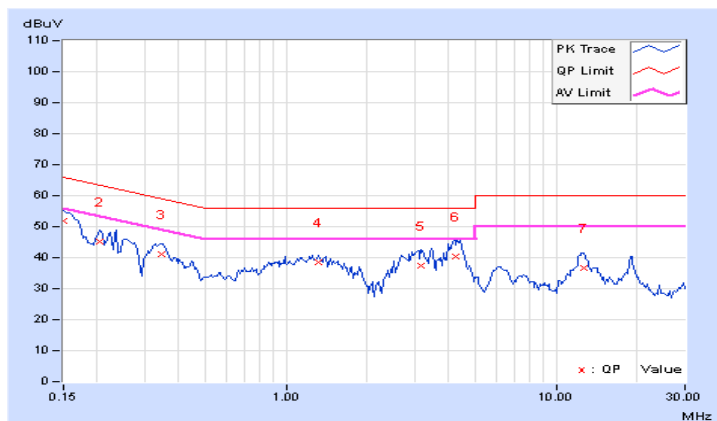

Phase	Neutral (N)	Detector Function	Quasi-Peak (QP) / Average (AV)
Test Mode	Mode C		

Phase Of Power : Neutral (N)										
No	Frequency (MHz)	Correction Factor (dB)	Reading Value (dBuV)		Emission Level (dBuV)		Limit (dBuV)		Margin (dB)	
			Q.P.	AV.	Q.P.	AV.	Q.P.	AV.	Q.P.	AV.
1	0.15782	10.20	40.35	26.19	50.55	36.39	65.58	55.58	-15.03	-19.19
2	0.22167	10.18	33.28	23.10	43.46	33.28	62.76	52.76	-19.30	-19.48
3	0.33751	10.23	31.27	21.38	41.50	31.61	59.26	49.26	-17.76	-17.65
4	1.25781	10.27	29.02	18.57	39.29	28.84	56.00	46.00	-16.71	-17.16
5	3.17578	10.41	27.89	19.34	38.30	29.75	56.00	46.00	-17.70	-16.25
6	4.43359	10.48	30.25	19.26	40.73	29.74	56.00	46.00	-15.27	-16.26
7	12.46706	10.84	27.85	21.08	38.69	31.92	60.00	50.00	-21.31	-18.08

Remarks:

1. Q.P. and AV. are abbreviations of quasi-peak and average individually.
2. The emission levels of other frequencies were very low against the limit.
3. Margin value = Emission level – Limit value
4. Correction factor = Insertion loss + Cable loss
5. Emission Level = Correction Factor + Reading Value

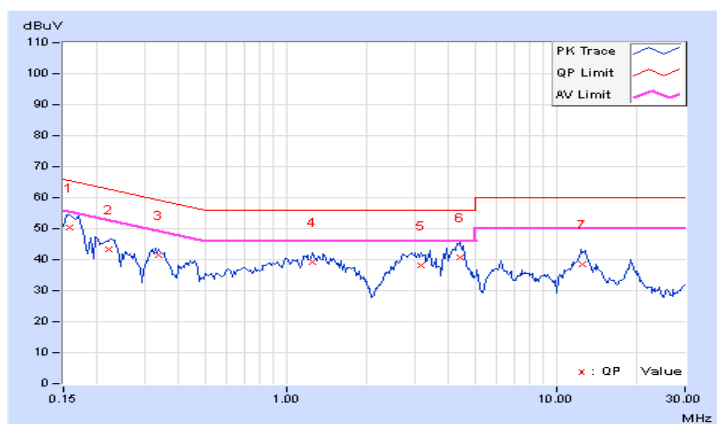

4.3 6dB Bandwidth Measurement

4.3.1 Limits of 6dB Bandwidth Measurement

The minimum of 6dB Bandwidth Measurement is 0.5 MHz.

4.3.2 Test Setup

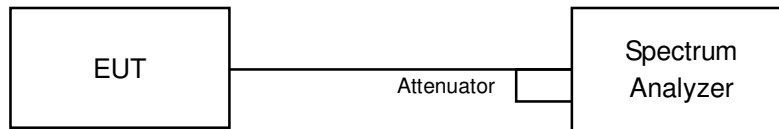

4.3.3 Test Instruments

Refer to section 4.1.2 to get information of above instrument.

4.3.4 Test Procedure

- a. Set resolution bandwidth (RBW) = 100kHz
- b. Set the video bandwidth (VBW) $\geq 3 \times$ RBW, Detector = Peak.
- c. Trace mode = max hold.
- d. Sweep = auto couple.
- e. Measure the maximum width of the emission that is constrained by the frequencies associated with the two amplitude points (upper and lower) that are attenuated by 6 dB relative to the maximum level measured in the fundamental emission

4.3.5 Deviation from Test Standard

No deviation.

4.3.6 EUT Operating Conditions

The software provided by client to enable the EUT under transmission condition continuously at lowest, middle and highest channel frequencies individually.

4.3.7 Test Result

Mode A

Channel	Frequency (MHz)	6dB Bandwidth (MHz)	Minimum Limit (MHz)	Pass / Fail
0	2402	0.70	0.5	Pass
19	2440	0.71	0.5	Pass
39	2480	0.71	0.5	Pass

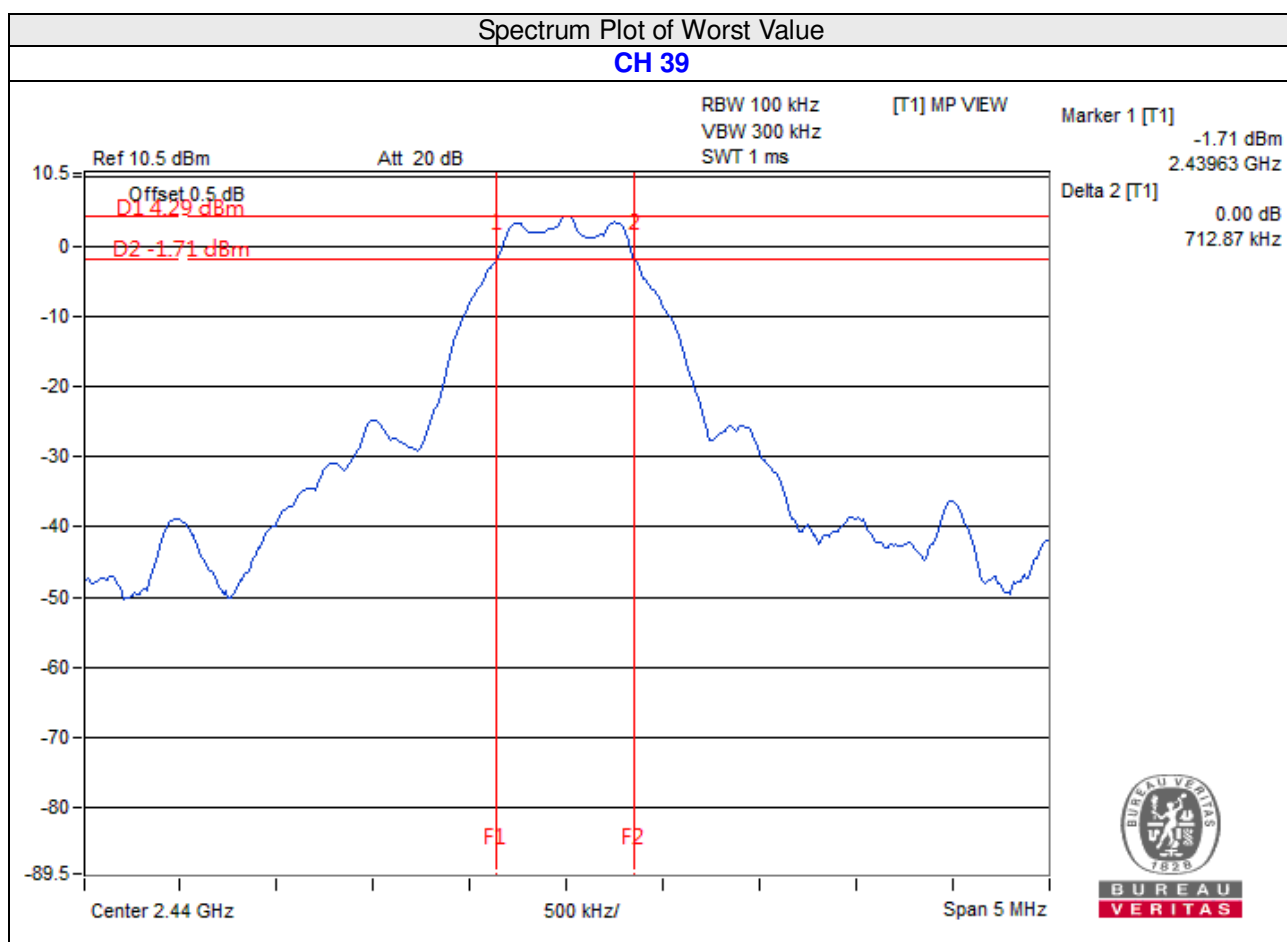

4.4 Conducted Output Power Measurement

4.4.1 Limits OF Conducted Output Power Measurement

For systems using digital modulation in the 2400–2483.5 MHz bands: 1 Watt (30dBm)

4.4.2 Test Setup

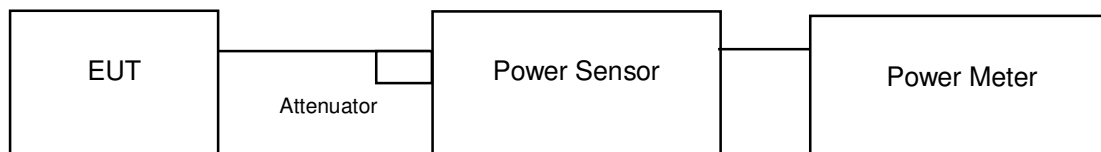

4.4.3 Test Instruments

Refer to section 4.1.2 to get information of above instrument.

4.4.4 Test Procedures

A peak / average power sensor was used on the output port of the EUT. A power meter was used to read the response of the peak / average power sensor. Record the power level.

4.4.5 Deviation from Test Standard

No deviation.

4.4.6 EUT Operating Conditions

Same as Item 4.3.6.

4.4.7 Test Results

Mode A

FOR PEAK POWER

Channel	Frequency (MHz)	Peak Power (mW)	Peak Power (dBm)	Limit (dBm)	Pass/Fail
0	2402	1.099	0.41	30	Pass
19	2440	2.858	4.56	30	Pass
39	2480	1.324	1.22	30	Pass

Mode A

FOR AVERAGE POWER

Channel	Frequency (MHz)	Average Power (mW)	Average Power (dBm)
0	2402	1.033	0.14
19	2440	2.793	4.46
39	2480	1.236	0.92

4.5 Power Spectral Density Measurement

4.5.1 Limits of Power Spectral Density Measurement

The Maximum of Power Spectral Density Measurement is 8dBm.

4.5.2 Test Setup

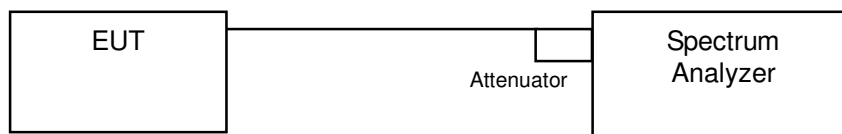

4.5.3 Test Instruments

Refer to section 4.1.2 to get information of above instrument.

4.5.4 Test Procedure

- a. Set analyzer center frequency to DTS channel center frequency.
- b. Set the span to 1.5 times the DTS bandwidth.
- c. Set the RBW to: $3 \text{ kHz} \leq \text{RBW} \leq 100 \text{ kHz}$.
- d. Set the VBW $\geq 3 \times \text{RBW}$.
- e. Detector = peak.
- f. Sweep time = auto couple.
- g. Trace mode = max hold.
- h. Allow trace to fully stabilize.
- i. Use the peak marker function to determine the maximum amplitude level within the RBW.

4.5.5 Deviation from Test Standard

No deviation.

4.5.6 EUT Operating Condition

Same as Item 4.3.6

4.5.7 Test Results

Mode A

Channel	Freq. (MHz)	PSD (dBm/3kHz)	Limit (dBm/3kHz)	Pass /Fail
0	2402	-14.87	8	Pass
19	2440	-11.18	8	Pass
39	2480	-14.35	8	Pass

Spectrum Plot of Worst Value

CH 19

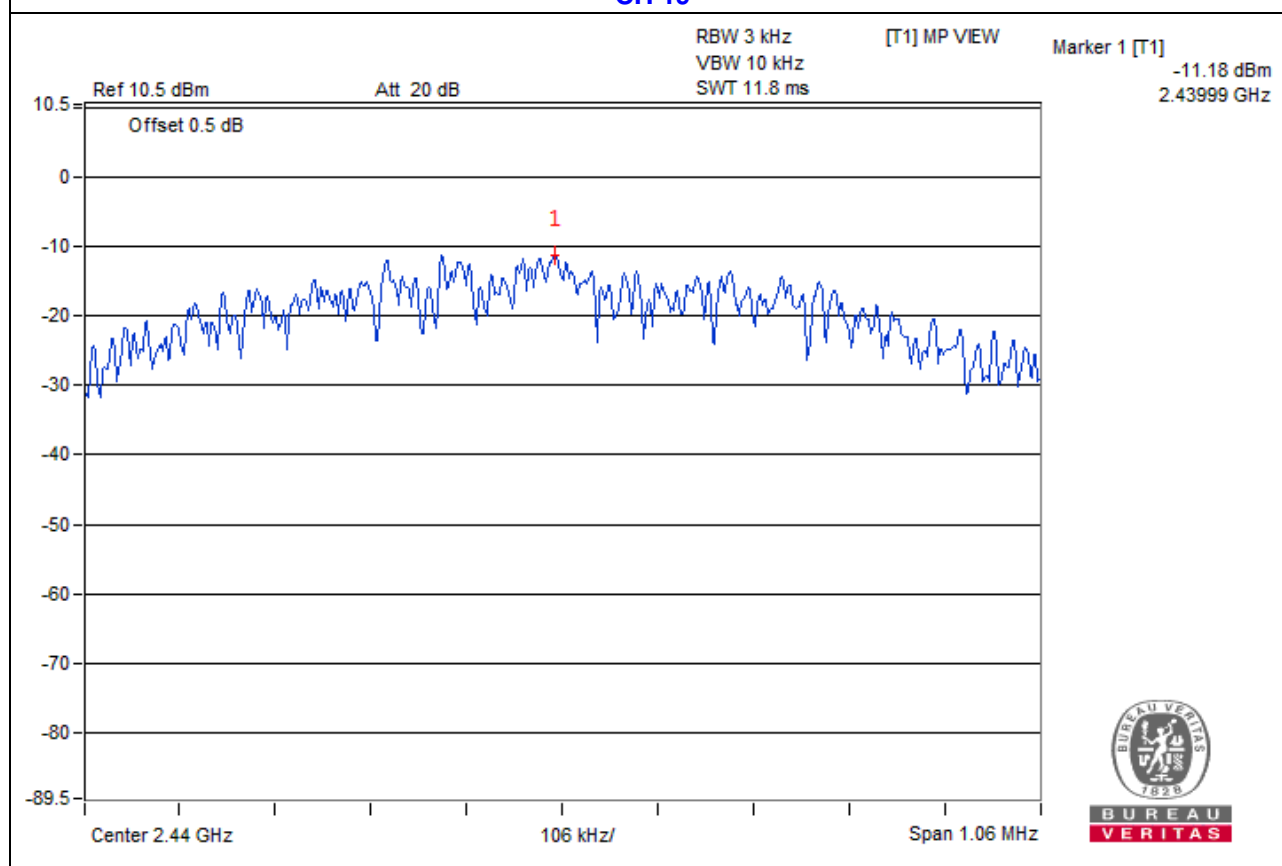

4.6 Conducted Out of Band Emission Measurement

4.6.1 Limits of Conducted Out of Band Emission Measurement

Below -20dB of the highest emission level of operating band (in 100kHz Resolution Bandwidth).

4.6.2 Test Setup

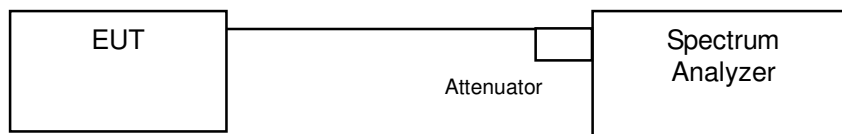

4.6.3 Test Instruments

Refer to section 4.1.2 to get information of above instrument.

4.6.4 Test Procedure

MEASUREMENT PROCEDURE REF

1. Set the RBW = 100 kHz.
2. Set the VBW \geq 300 kHz.
3. Detector = peak.
4. Sweep time = auto couple.
5. Trace mode = max hold.
6. Allow trace to fully stabilize.
7. Use the peak marker function to determine the maximum power level in any 100 kHz band segment within the fundamental EBW.

MEASUREMENT PROCEDURE OOB

1. Set RBW = 100 kHz.
2. Set VBW \geq 300 kHz.
3. Detector = peak.
4. Sweep = auto couple.
5. Trace Mode = max hold.
6. Allow trace to fully stabilize.
7. Use the peak marker function to determine the maximum amplitude level.

4.6.5 Deviation from Test Standard

No deviation.

4.6.6 EUT Operating Condition

Same as Item 4.3.6

4.6.7 Test Results

Mode A

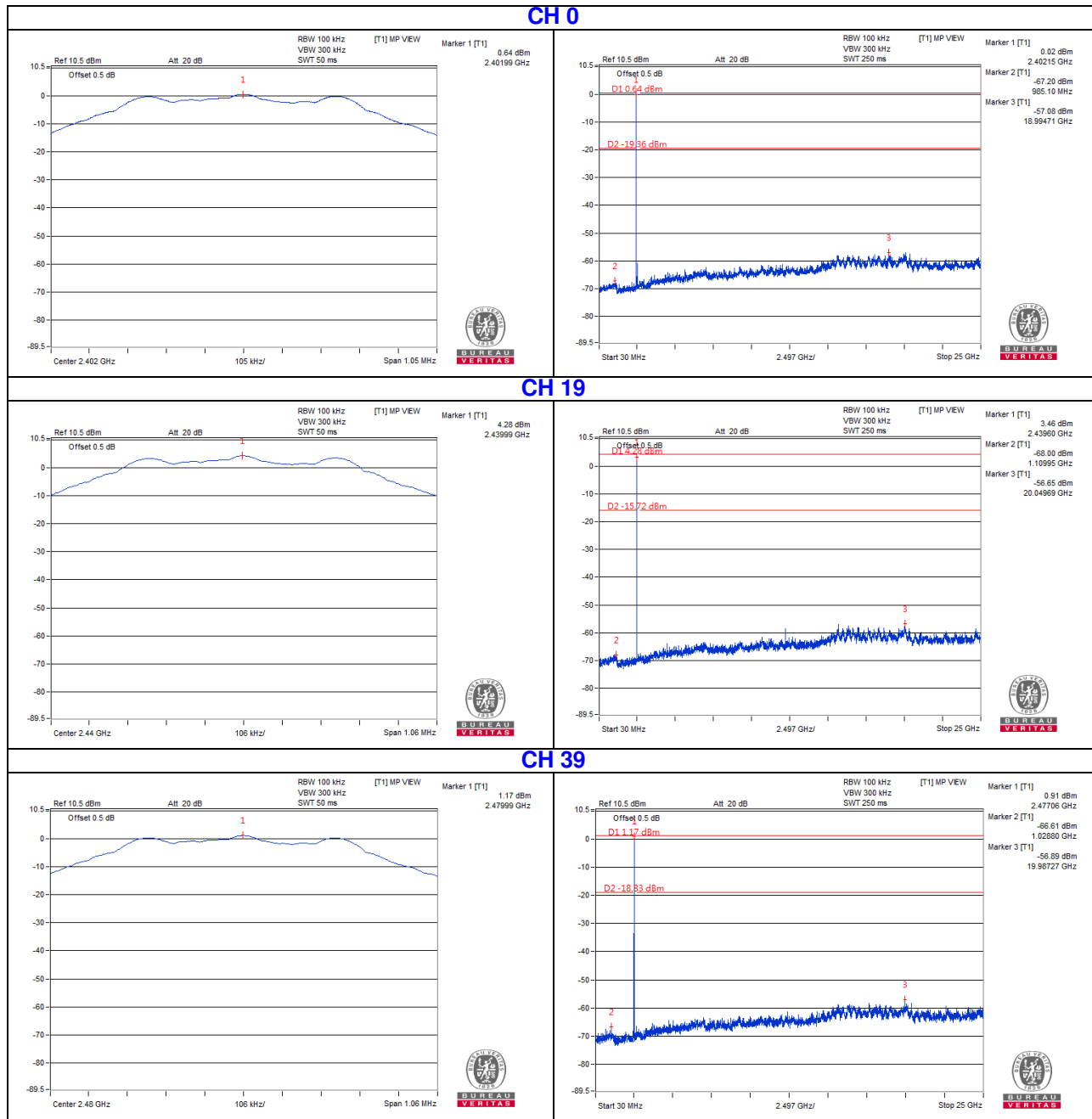



BUREAU
VERITAS

CH 0 Band edge

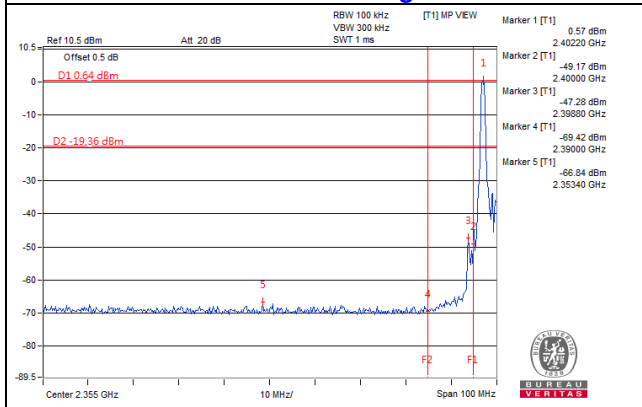

CH 39 Band edge

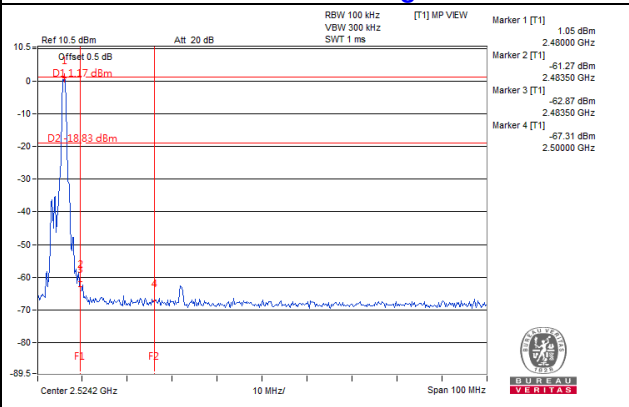

5 Pictures of Test Arrangements

Please refer to the attached file (Test Setup Photo).

Appendix – Information on the Testing Laboratories

We, Bureau Veritas Consumer Products Services (H.K.) Ltd., Taoyuan Branch, were founded in 1988 to provide our best service in EMC, Radio, Telecom and Safety consultation. Our laboratories are accredited and approved according to ISO/IEC 17025.

If you have any comments, please feel free to contact us at the following:

Linko EMC/RF Lab

Tel: 886-2-26052180

Fax: 886-2-26051924

Hsin Chu EMC/RF/Telecom Lab

Tel: 886-3-6668565

Fax: 886-3-6668323

Hwa Ya EMC/RF/Safety Lab

Tel: 886-3-3183232

Fax: 886-3-3270892

Email: service.adt@tw.bureauveritas.com

Web Site: www.bureauveritas-adt.com

The address and road map of all our labs can be found in our web site also.

--- END ---