

FCC Test Report (BT-LE)

Report No.: RF170113D04B-1

FCC ID: A94BL1L

Test Model: BL1L

Received Date: Jan. 13, 2017

Test Date: Jan. 26, 2017 & Apr. 7 ~ 10, 2017

Issued Date: Apr. 20, 2017

Applicant: Bose Corporation

Address: 100 The Mountain Rd Framingham Massachusetts 01701 United States

Issued By: Bureau Veritas Consumer Products Services (H.K.) Ltd., Taoyuan Branch

Lab Address: No. 47-2, 14th Ling, Chia Pau Vil., Lin Kou Dist., New Taipei City, Taiwan, R.O.C.



This report is for your exclusive use. Any copying or replication of this report to or for any other person or entity, or use of our name or trademark, is permitted only with our prior written permission. This report sets forth our findings solely with respect to the test samples identified herein. The results set forth in this report are not indicative or representative of the quality or characteristics of the lot from which a test sample was taken or any similar or identical product unless specifically and expressly noted. Our report includes all of the tests requested by you and the results thereof based upon the information that you provided to us. You have 60 days from date of issuance of this report to notify us of any material error or omission caused by our negligence, provided, however, that such notice shall be in writing and shall specifically address the issue you wish to raise. A failure to raise such issue within the prescribed time shall constitute your unqualified acceptance of the completeness of this report, the tests conducted and the correctness of the report contents. Unless specific mention, the uncertainty of measurement has been explicitly taken into account to declare the compliance or non-compliance to the specification. The report must not be used by the client to claim product certification, approval, or endorsement by TAF or any government agencies.

Table of Contents

| | |
|---|-----------|
| Release Control Record | 4 |
| 1 Certificate of Conformity | 5 |
| 2 Summary of Test Results | 6 |
| 2.1 Measurement Uncertainty..... | 6 |
| 2.2 Modification Record..... | 6 |
| 3 General Information | 7 |
| 3.1 General Description of EUT (BT-LE)..... | 7 |
| 3.2 Description of Test Modes..... | 8 |
| 3.2.1 Test Mode Applicability and Tested Channel Detail..... | 9 |
| 3.3 Duty cycle of test signal..... | 10 |
| 3.4 Description of Support Units..... | 11 |
| 3.4.1 Configuration of System under Test..... | 12 |
| 3.5 General Description of Applied Standards..... | 13 |
| 4 Test Types and Results | 14 |
| 4.1 Radiated Emission and Bandedge Measurement..... | 14 |
| 4.1.1 Limits of Radiated Emission and Bandedge Measurement..... | 14 |
| 4.1.2 Test Instruments..... | 15 |
| 4.1.3 Test Procedures..... | 16 |
| 4.1.4 Deviation from Test Standard..... | 16 |
| 4.1.5 Test Setup..... | 17 |
| 4.1.6 EUT Operating Conditions..... | 18 |
| 4.1.7 Test Results..... | 19 |
| 4.2 Conducted Emission Measurement..... | 23 |
| 4.2.1 Limits of Conducted Emission Measurement..... | 23 |
| 4.2.2 Test Instruments..... | 23 |
| 4.2.3 Test Procedures..... | 24 |
| 4.2.4 Deviation From Test Standard..... | 24 |
| 4.2.5 Test Setup..... | 24 |
| 4.2.6 EUT Operating Condition..... | 24 |
| 4.2.7 Test Results..... | 25 |
| 4.3 6dB Bandwidth Measurement..... | 29 |
| 4.3.1 Limits of 6dB Bandwidth Measurement..... | 29 |
| 4.3.2 Test Setup..... | 29 |
| 4.3.3 Test Instruments..... | 29 |
| 4.3.4 Test Procedure..... | 29 |
| 4.3.5 Deviation from Test Standard..... | 29 |
| 4.3.6 EUT Operating Conditions..... | 29 |
| 4.3.7 Test Result..... | 30 |
| 4.4 Conducted Output Power Measurement..... | 31 |
| 4.4.1 Limits OF Conducted Output Power Measurement..... | 31 |
| 4.4.2 Test Setup..... | 31 |
| 4.4.3 Test Instruments..... | 31 |
| 4.4.4 Test Procedures..... | 31 |
| 4.4.5 Deviation from Test Standard..... | 31 |
| 4.4.6 EUT Operating Conditions..... | 31 |
| 4.4.7 Test Results..... | 32 |
| 4.5 Power Spectral Density Measurement..... | 33 |

| | | |
|----------|--|-----------|
| 4.5.1 | Limits of Power Spectral Density Measurement..... | 33 |
| 4.5.2 | Test Setup | 33 |
| 4.5.3 | Test Instruments | 33 |
| 4.5.4 | Test Procedure | 33 |
| 4.5.5 | Deviation from Test Standard | 33 |
| 4.5.6 | EUT Operating Condition..... | 33 |
| 4.5.7 | Test Results..... | 34 |
| 4.6 | Conducted Out of Band Emission Measurement..... | 35 |
| 4.6.1 | Limits of Conducted Out of Band Emission Measurement | 35 |
| 4.6.2 | Test Setup | 35 |
| 4.6.3 | Test Instruments | 35 |
| 4.6.4 | Test Procedure | 35 |
| 4.6.5 | Deviation from Test Standard | 35 |
| 4.6.6 | EUT Operating Condition..... | 35 |
| 4.6.7 | Test Results..... | 36 |
| 5 | Pictures of Test Arrangements..... | 37 |
| | Appendix – Information on the Testing Laboratories..... | 38 |

Release Control Record

| Issue No. | Description | Date Issued |
|----------------|-------------------|---------------|
| RF170113D04B-1 | Original release. | Apr. 20, 2017 |

1 Certificate of Conformity

Product: Wireless Headphones

Brand: BOSE

Test Model: BL1L

Sample Status: Engineering sample

Applicant: Bose Corporation

Test Date: Jan. 26, 2017 & Apr. 7 ~ 10, 2017

Standards: 47 CFR FCC Part 15, Subpart C (Section 15.247)
ANSI C63.10: 2013

The above equipment has been tested by **Bureau Veritas Consumer Products Services (H.K.) Ltd., Taoyuan Branch**, and found compliance with the requirement of the above standards. The test record, data evaluation & Equipment Under Test (EUT) configurations represented herein are true and accurate accounts of the measurements of the sample's EMC characteristics under the conditions specified in this report.

Prepared by :



Date:

Apr. 20, 2017

Celia Chen / Supervisor

Approved by :



Date:

Apr. 20, 2017

Rex Lai / Assistant Manager

2 Summary of Test Results

| 47 CFR FCC Part 15, Subpart C (SECTION 15.247) | | | |
|--|--|--------|--|
| FCC Clause | Test Item | Result | Remarks |
| 15.207 | AC Power Conducted Emission | PASS | Meet the requirement of limit. Minimum passing margin is -14.23 dB at 0.15007 MHz |
| 15.205 & 209 & 15.247(d) | Radiated Emissions & Band Edge Measurement | PASS | Meet the requirement of limit. Minimum passing margin is -11.49dB at 2483.50MHz. |
| 15.247(d) | Antenna Port Emission | PASS | Meet the requirement of limit. |
| 15.247(a)(2) | 6dB bandwidth | PASS | Meet the requirement of limit. |
| 15.247(b) | Conducted power | PASS | Meet the requirement of limit. |
| 15.247(e) | Power Spectral Density | PASS | Meet the requirement of limit. |
| 15.203 | Antenna Requirement | PASS | No antenna connector is used. |

2.1 Measurement Uncertainty

Where relevant, the following measurement uncertainty levels have been estimated for tests performed on the EUT as specified in CISPR 16-4-2:

| Measurement | Frequency | Expanded Uncertainty (k=2) (±) |
|------------------------------------|-----------------|--------------------------------|
| Conducted Emissions at mains ports | 150kHz ~ 30MHz | 2.77 dB |
| Radiated Emissions up to 1 GHz | 9kHz ~ 30MHz | 2.38 dB |
| | 30MHz ~ 1000MHz | 5.54 dB |
| Radiated Emissions above 1 GHz | 1GHz ~ 6GHz | 4.47 dB |
| | Above 6GHz | 5.48 dB |

2.2 Modification Record

There were no modifications required for compliance.

3 General Information

3.1 General Description of EUT (BT-LE)

| | |
|---------------------|--|
| Product | Wireless Headphones |
| Brand | BOSE |
| Test Model | BL1L |
| Status of EUT | Engineering Sample |
| Power Supply Rating | 3.7Vdc from Battery/ 5Vdc from Charging Case |
| Modulation Type | GFSK |
| Transfer Rate | Up to 1Mbps |
| Operating Frequency | 2402MHz ~ 2480MHz |
| Number of Channel | 40 |
| Output Power | 8.750mW |
| Antenna Type | PCB Meander Line Antenna with -0.31dBi gain |
| Antenna Connector | N/A |
| Accessory Device | Charging Case (BOSE/ 423729) |
| Data Cable Supplied | Shielded USB cable (0.3m) |

Note:

1. The EUT is a Wireless Headphones.
2. The EUT was pre-tested with the following modes:
 - † Operating Mode (EUT stand-alone)
 - † Operating (EUT) + Charging Case (Adapter)
 - † Operating (EUT) + Charging Case Mode (Notebook)
 The worst emission level was found when the EUT tested under **Operating (EUT stand-alone)** therefore, only its test data was recorded in this report.
3. The above EUT information is declared by manufacturer and for more detailed features description, please refer to the manufacturer's specifications or user's manual.

3.2 Description of Test Modes

40 channels are provided to this EUT:

| CHANNEL | FREQ. (MHz) | CHANNEL | FREQ. (MHz) | CHANNEL | FREQ. (MHz) | CHANNEL | FREQ. (MHz) |
|---------|----------------|---------|----------------|---------|----------------|---------|----------------|
| 0 | 2402 | 10 | 2422 | 20 | 2442 | 30 | 2462 |
| 1 | 2404 | 11 | 2424 | 21 | 2444 | 31 | 2464 |
| 2 | 2406 | 12 | 2426 | 22 | 2446 | 32 | 2466 |
| 3 | 2408 | 13 | 2428 | 23 | 2448 | 33 | 2468 |
| 4 | 2410 | 14 | 2430 | 24 | 2450 | 34 | 2470 |
| 5 | 2412 | 15 | 2432 | 25 | 2452 | 35 | 2472 |
| 6 | 2414 | 16 | 2434 | 26 | 2454 | 36 | 2474 |
| 7 | 2416 | 17 | 2436 | 27 | 2456 | 37 | 2476 |
| 8 | 2418 | 18 | 2438 | 28 | 2458 | 38 | 2478 |
| 9 | 2420 | 19 | 2440 | 29 | 2460 | 39 | 2480 |

3.2.1 Test Mode Applicability and Tested Channel Detail

| EUT CONFIGURE MODE | APPLICABLE TO | | | | DESCRIPTION |
|--------------------|---------------|-------|-----|------|--|
| | RE \geq 1G | RE<1G | PLC | APCM | |
| A | √ | √ | - | √ | Operating Mode (EUT stand-alone) |
| B | - | - | √ | - | Operating (EUT) + Charging Case (Adapter) |
| C | - | - | √ | - | Operating (EUT) + Charging Case (Notebook) |

Where **RE \geq 1G**: Radiated Emission above 1GHz **RE<1G**: Radiated Emission below 1GHz
PLC: Power Line Conducted Emission **APCM**: Antenna Port Conducted Measurement

NOTE: The EUT had been pre-tested on the positioned of each 3 axis. The worst case was found when positioned on **X-plane**.

Radiated Emission Test (Above 1GHz):

- Pre-Scan has been conducted to determine the worst-case mode from all possible combinations between available modulations, data rates and antenna ports (if EUT with antenna diversity architecture).
- Following channel(s) was (were) selected for the final test as listed below.

| EUT CONFIGURE MODE | AVAILABLE CHANNEL | TESTED CHANNEL | MODULATION TYPE | DATA RATE (Mbps) |
|--------------------|-------------------|----------------|-----------------|------------------|
| A | 0 to 39 | 0, 19, 39 | GFSK | 1 |

Radiated Emission Test (Below 1GHz):

- Pre-Scan has been conducted to determine the worst-case mode from all possible combinations between available modulations, data rates and antenna ports (if EUT with antenna diversity architecture).
- Following channel(s) was (were) selected for the final test as listed below.

| EUT CONFIGURE MODE | AVAILABLE CHANNEL | TESTED CHANNEL | MODULATION TYPE | DATA RATE (Mbps) |
|--------------------|-------------------|----------------|-----------------|------------------|
| A | 0 to 39 | 19 | GFSK | 1 |

Power Line Conducted Emission Test:

- Pre-Scan has been conducted to determine the worst-case mode from all possible combinations between available modulations, data rates and antenna ports (if EUT with antenna diversity architecture).
- Following channel(s) was (were) selected for the final test as listed below.

| EUT CONFIGURE MODE | AVAILABLE CHANNEL | TESTED CHANNEL | MODULATION TYPE | DATA RATE (Mbps) |
|--------------------|-------------------|----------------|-----------------|------------------|
| B | 0 to 39 | 19 | GFSK | 1 |
| C | 0 to 39 | 19 | GFSK | 1 |

Antenna Port Conducted Measurement:

- This item includes all test value of each mode, but only includes spectrum plot of worst value of each mode.
- Pre-Scan has been conducted to determine the worst-case mode from all possible combinations between available modulations, data rates and antenna ports (if EUT with antenna diversity architecture).
- Following channel(s) was (were) selected for the final test as listed below.

| EUT CONFIGURE MODE | AVAILABLE CHANNEL | TESTED CHANNEL | MODULATION TYPE | DATA RATE (Mbps) |
|--------------------|-------------------|----------------|-----------------|------------------|
| A | 0 to 39 | 0, 19, 39 | GFSK | 1 |

Test Condition:

| APPLICABLE TO | ENVIRONMENTAL CONDITIONS | INPUT POWER | TESTED BY |
|---------------|--------------------------|-----------------------|-----------|
| RE≥1G | 19deg. C, 70%RH | 3.7Vdc | Ian Chang |
| RE<1G | 19deg. C, 70%RH | 3.7Vdc | Ian Chang |
| PLC (Mode B) | 19deg. C, 73%RH | 120Vac, 60Hz(Adapter) | John Liao |
| PLC (Mode C) | 19deg. C, 73%RH | 120Vac, 60Hz(System) | John Liao |
| APCM | 25deg. C, 76%RH | 3.7Vdc | Saxon Lee |

3.3 Duty cycle of test signal

Duty cycle of test signal is < 98%

Duty cycle = 0.394/0.652 = 0.604, Duty factor = 10 * log(1/0.604) = 2.2

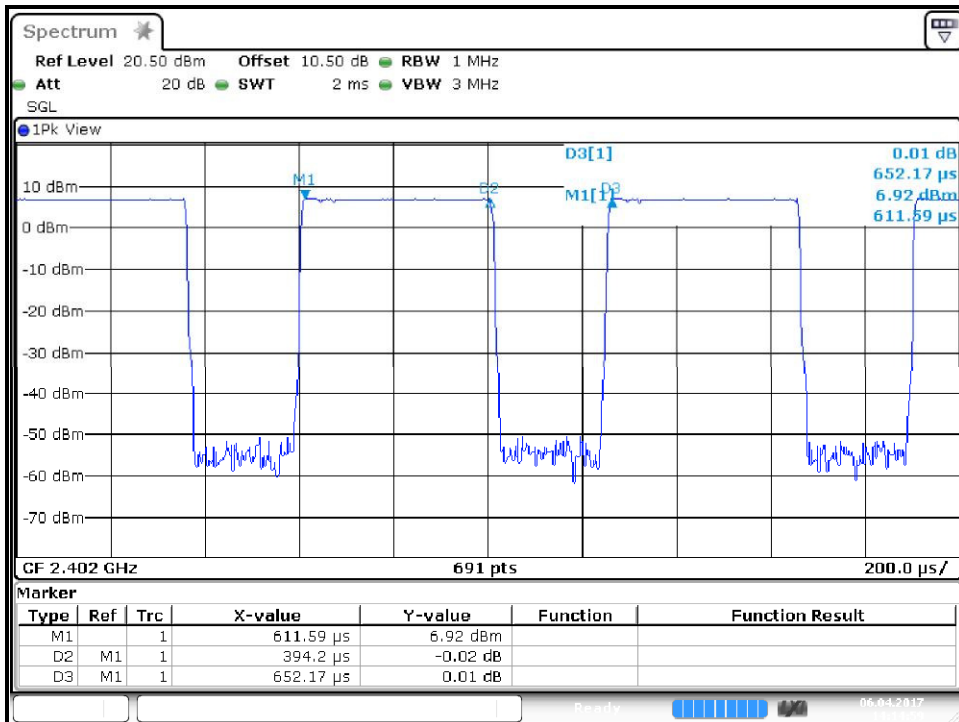

3.4 Description of Support Units

The EUT has been tested as an independent unit together with other necessary accessories or support units. The following support units or accessories were used to form a representative test configuration during the tests.

| ID | Product | Brand | Model No. | Serial No. | FCC ID | Remarks |
|----|-------------------|-----------|------------------------|----------------------|------------------|--------------------|
| A. | Notebook PC | ASUS | PU401L | E9NXBC002007372 | FCC DoC Approved | Provided by Lab |
| B. | 24" LCD MONITOR | DELL | U2410 | CN082WXD728720CC0L2L | FCC DoC Approved | Provided by Lab |
| C. | USB 3.0 Hard Disk | WD | WDBACY5000A BL-PESN | WXG1A81P6250 | FCC DoC Approved | Provided by Lab |
| D. | USB Mouse | Microsoft | 1113 | 9170515896850 | FCC DoC Approved | Provided by Lab |
| E. | AC Adapter | UL | TC P450-US | N/A | N/A | Supplied by client |

Note: All power cords of the above support units are non-shielded (1.8m).

| ID | Descriptions | Qty. | Length (m) | Shielding (Yes/No) | Cores (Qty.) | Remarks |
|----|--------------|------|------------|-----------------------|--------------|--------------------|
| 1. | USB cable | 1 | 0.3 | Y | 0 | Supplied by client |
| 2. | HDMI cable | 1 | 2.0 | Y | 0 | Provided by Lab |
| 3. | USB cable | 1 | 0.5 | Y | 0 | Provided by Lab |
| 4. | USB cable | 1 | 1.8 | Y | 1 | Provided by Lab |

Note: The core(s) is(are) originally attached to the cable(s).

3.4.1 Configuration of System under Test

Mode A

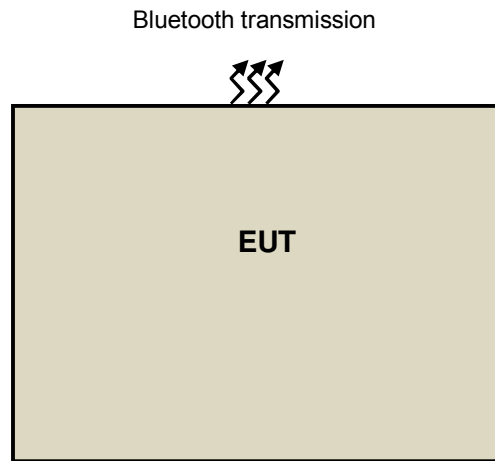

Mode B

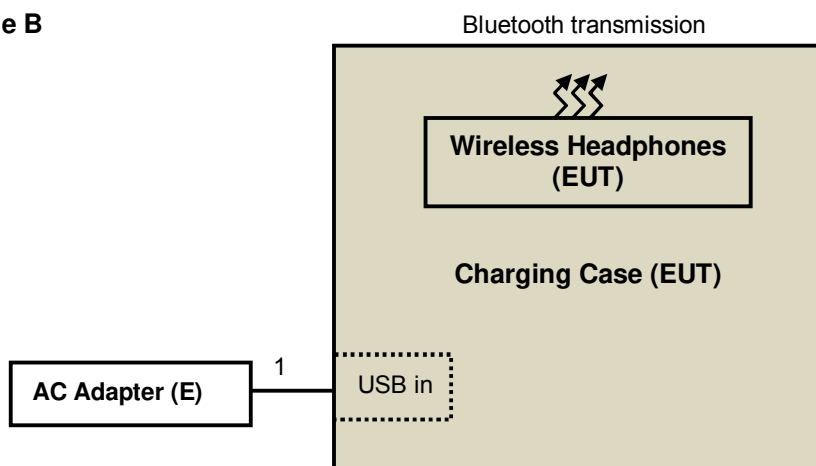

Mode C

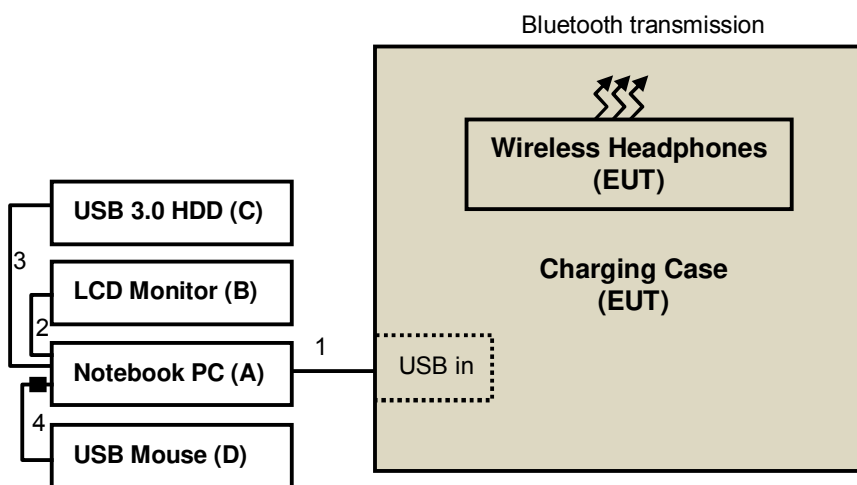

3.5 General Description of Applied Standards

The EUT is a RF Product. According to the specifications of the manufacturer, it must comply with the requirements of the following standards:

FCC Part 15, Subpart C (15.247)
KDB 558074 D01 DTS Meas Guidance v03r05
ANSI C63.10-2013

All test items have been performed and recorded as per the above standards.

4 Test Types and Results

4.1 Radiated Emission and Bandedge Measurement

4.1.1 Limits of Radiated Emission and Bandedge Measurement

Radiated emissions which fall in the restricted bands must comply with the radiated emission limits specified as below table. Other emissions shall be at least 20dB below the highest level of the desired power:

| Frequencies (MHz) | Field Strength (microvolts/meter) | Measurement Distance (meters) |
|-------------------|-----------------------------------|-------------------------------|
| 0.009 ~ 0.490 | 2400/F(kHz) | 300 |
| 0.490 ~ 1.705 | 24000/F(kHz) | 30 |
| 1.705 ~ 30.0 | 30 | 30 |
| 30 ~ 88 | 100 | 3 |
| 88 ~ 216 | 150 | 3 |
| 216 ~ 960 | 200 | 3 |
| Above 960 | 500 | 3 |

NOTE:

1. The lower limit shall apply at the transition frequencies.
2. Emission level (dBuV/m) = 20 log Emission level (uV/m).
3. For frequencies above 1000MHz, the field strength limits are based on average detector, however, the peak field strength of any emission shall not exceed the maximum permitted average limits, specified above by more than 20dB under any condition of modulation.

4.1.2 Test Instruments

| DESCRIPTION & MANUFACTURER | MODEL NO. | SERIAL NO. | CALIBRATED DATE | CALIBRATED UNTIL |
|--|----------------------|----------------|-----------------|------------------|
| HP Preamplifier | 8447D | 2432A03504 | Feb. 21, 2017 | Feb. 20, 2018 |
| HP Preamplifier | 8449B | 3008A01201 | Feb. 22, 2017 | Feb. 21, 2018 |
| MITEQ Preamplifier | AMF-6F-260400-33-8P | 892164 | Feb. 21, 2017 | Feb. 20, 2018 |
| Agilent TEST RECEIVER | N9038A | MY51210129 | Feb. 08, 2017 | Feb. 07, 2018 |
| Schwarzbeck Antenna | VULB 9168 | 139 | Dec. 13, 2016 | Dec. 12, 2017 |
| Schwarzbeck Antenna | VHBA 9123 | 480 | May 29, 2015 | May 28, 2017 |
| Schwarzbeck Horn Antenna | BBHA-9170 | 212 | Dec. 30, 2016 | Dec. 29, 2017 |
| Schwarzbeck Horn Antenna | BBHA 9120-D1 | D130 | Dec. 27, 2016 | Dec. 26, 2017 |
| ADT. Turn Table | TT100 | 0306 | NA | NA |
| ADT. Tower | AT100 | 0306 | NA | NA |
| Software | Radiated_V7.6.15.9.5 | NA | NA | NA |
| SUHNER RF cable With 4dB PAD | SF104 | CABLE-CH6 | Aug. 15, 2016 | Aug. 14, 2017 |
| SUHNER RF cable With 3dB PAD | SF102 | Cable-CH8-3.6m | Aug. 15, 2016 | Aug. 14, 2017 |
| KEYSIGHT MIMO Powermeasurement Test set | U2021XA | U2021XA-001 | May 25, 2016 | May 24, 2017 |
| KEYSIGHT Spectrum Analyzer | N9030A | MY54490260 | Jul. 26, 2016 | Jul. 25, 2017 |
| Loop Antenna EMCI | LPA600 | 270 | Aug. 20, 2015 | Aug. 19, 2017 |
| EMCO Horn Antenna | 3115 | 00028257 | Dec. 15, 2016 | Dec. 14, 2017 |
| Highpass filter Wainwright Instruments | WHK 3.1/18G-10SS | SN 8 | NA | NA |
| ROHDE & SCHWARZ Spectrum Analyzer | FSV40 | 101042 | Sep. 30, 2016 | Sep. 29, 2017 |
| Anritsu Power Sensor | MA2411B | 0738404 | Apr. 28, 2016 | Apr. 27, 2017 |
| Anritsu Power Meter | ML2495A | 0842014 | Apr. 28, 2016 | Apr. 27, 2017 |

- NOTE:**
1. The calibration interval of the above test instruments is 12/24 months. And the calibrations are traceable to NML/ROC and NIST/USA.
 2. The horn antenna and HP preamplifier (model: 8449B) are used only for the measurement of emission frequency above 1GHz if tested.
 3. The test was performed in Chamber No. 6.
 4. The Industry Canada Reference No. IC 7450E-6.
 5. The FCC Site Registration No. is 447212.
 6. Tested Date: Apr. 7 ~ 10, 2017

4.1.3 Test Procedures

For Radiated emission below 30MHz

- a. The EUT was placed on the top of a rotating table 0.8 meters above the ground at a 3 meter chamber room. The table was rotated 360 degrees to determine the position of the highest radiation.
- b. The EUT was set 3 meters away from the interference-receiving antenna, which was mounted on the top of a variable-height antenna tower.
- c. Both X and Y axes of the antenna are set to make the measurement.
- d. For each suspected emission, the EUT was arranged to its worst case and the rotatable table was turned from 0 degrees to 360 degrees to find the maximum reading.
- e. The test-receiver system was set to Quasi-Peak Detect Function and Specified Bandwidth with Maximum Hold Mode.

NOTE: The resolution bandwidth and video bandwidth of test receiver/spectrum analyzer is 9kHz at frequency below 30MHz.

For Radiated emission above 30MHz

- a. The EUT was placed on the top of a rotating table 0.8 meters (for 30MHz ~ 1GHz) / 1.5 meters (for above 1GHz) above the ground at 3 meter chamber room for test. The table was rotated 360 degrees to determine the position of the highest radiation.
- b. The EUT was set 3 meters away from the interference-receiving antenna, which was mounted on the top of a variable-height antenna tower.
- c. The height of antenna is varied from one meter to four meters above the ground to determine the maximum value of the field strength. Both horizontal and vertical polarizations of the antenna are set to make the measurement.
- d. For each suspected emission, the EUT was arranged to its worst case and then the antenna was tuned to heights from 1 meter to 4 meters and the rotatable table was turned from 0 degrees to 360 degrees to find the maximum reading.
- e. The test-receiver system was set to quasi-peak detect function and specified bandwidth with maximum hold mode when the test frequency is below 1 GHz.
- f. The test-receiver system was set to peak and average detect function and specified bandwidth with maximum hold mode when the test frequency is above 1 GHz. If the peak reading value also meets average limit, measurement with the average detector is unnecessary.

Note:

1. The resolution bandwidth and video bandwidth of test receiver/spectrum analyzer is 120kHz for Quasi-peak detection (QP) at frequency below 1GHz.
2. The resolution bandwidth of test receiver/spectrum analyzer is 1 MHz and the video bandwidth is 3 MHz for Peak detection (PK) at frequency above 1GHz.
3. The resolution bandwidth of test receiver/spectrum analyzer is 1MHz and the video bandwidth is $\geq 1/T$ (Duty cycle < 98%) or 10Hz (Duty cycle $\geq 98\%$) for Average detection (AV) at frequency above 1GHz.
4. All modes of operation were investigated and the worst-case emissions are reported.

4.1.4 Deviation from Test Standard

No deviation.

4.1.5 Test Setup

For Radiated emission below 30MHz

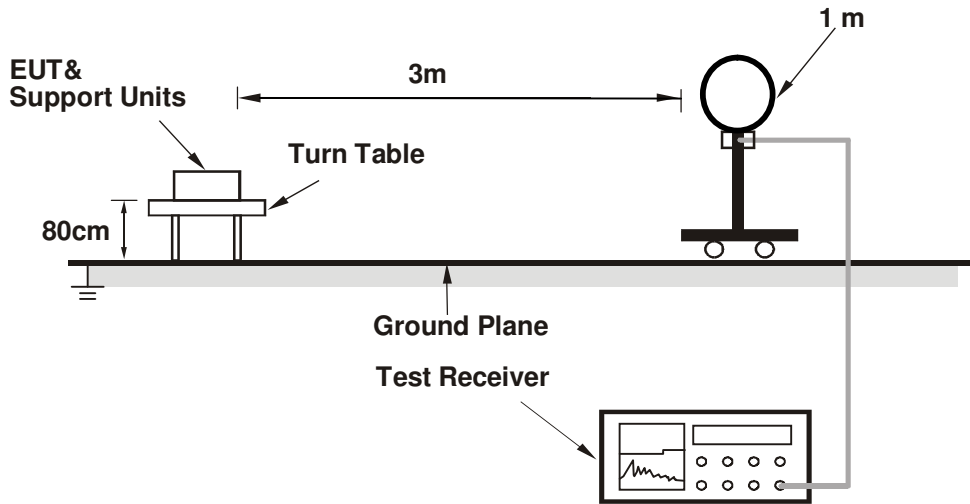

For Radiated emission 30MHz to 1GHz

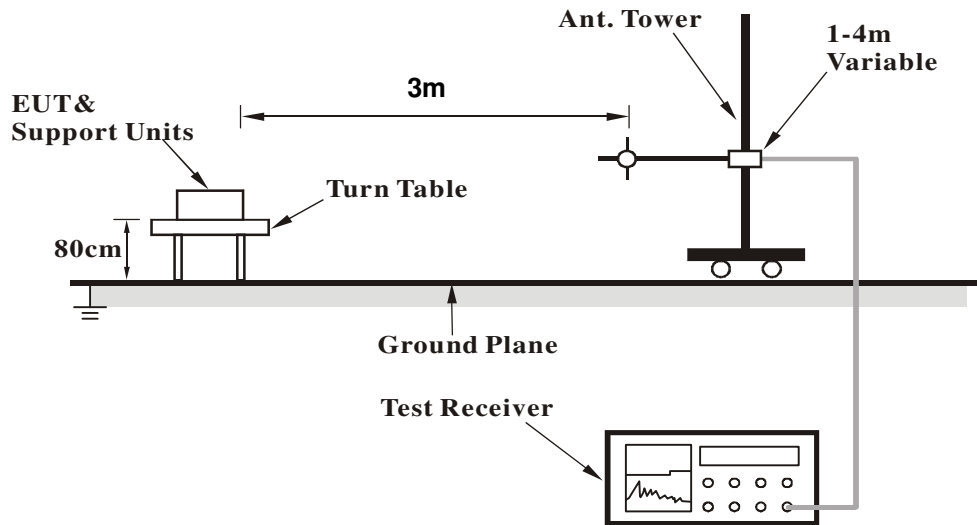

For Radiated emission above 1GHz

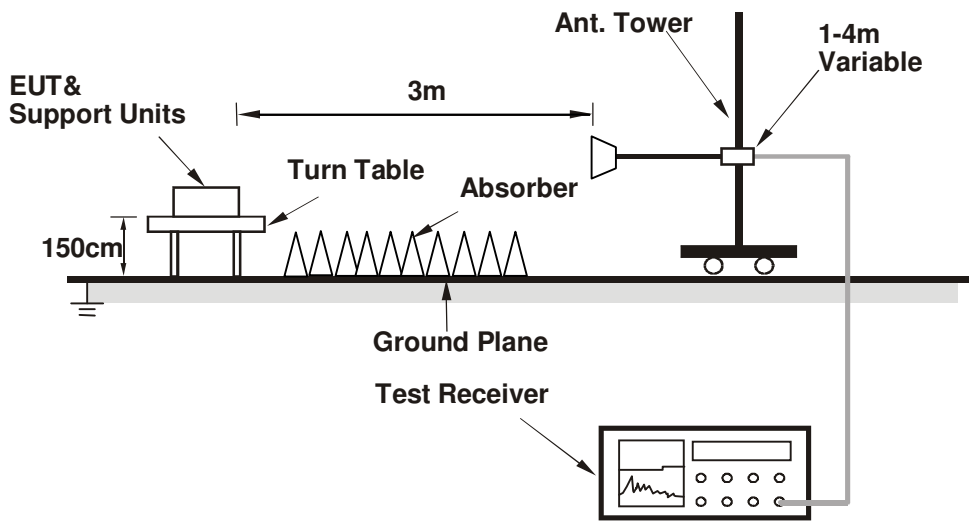

For the actual test configuration, please refer to the attached file (Test Setup Photo).

4.1.6 EUT Operating Conditions

Set the EUT under transmission condition continuously at specific channel frequency.

4.1.7 Test Results

Mode A

ABOVE 1GHz DATA

| | | | |
|------------------------|--------------|--------------------------|--------------|
| CHANNEL | TX Channel 0 | DETECTOR FUNCTION | Peak (PK) |
| FREQUENCY RANGE | 1GHz ~ 25GHz | | Average (AV) |

| ANTENNA POLARITY & TEST DISTANCE: HORIZONTAL AT 3 M | | | | | | | | |
|---|-------------|-------------------------|----------------|-------------|--------------------|----------------------|------------------|--------------------------|
| NO. | FREQ. (MHz) | EMISSION LEVEL (dBuV/m) | LIMIT (dBuV/m) | MARGIN (dB) | ANTENNA HEIGHT (m) | TABLE ANGLE (Degree) | RAW VALUE (dBuV) | CORRECTION FACTOR (dB/m) |
| 1 | 2390.00 | 53.58 PK | 74.00 | -20.42 | 1.21 H | 66 | 54.17 | -0.59 |
| 2 | 2390.00 | 40.07 AV | 54.00 | -13.93 | 1.21 H | 66 | 40.66 | -0.59 |
| 3 | *2402.00 | 97.08 PK | | | 1.21 H | 66 | 97.60 | -0.52 |
| 4 | *2402.00 | 95.97 AV | | | 1.21 H | 66 | 96.49 | -0.52 |
| 5 | 4804.00 | 47.24 PK | 74.00 | -26.76 | 1.27 H | 266 | 40.36 | 6.88 |
| 6 | 4804.00 | 34.02 AV | 54.00 | -19.98 | 1.27 H | 266 | 27.14 | 6.88 |

| ANTENNA POLARITY & TEST DISTANCE: VERTICAL AT 3 M | | | | | | | | |
|---|-------------|-------------------------|----------------|-------------|--------------------|----------------------|------------------|--------------------------|
| NO. | FREQ. (MHz) | EMISSION LEVEL (dBuV/m) | LIMIT (dBuV/m) | MARGIN (dB) | ANTENNA HEIGHT (m) | TABLE ANGLE (Degree) | RAW VALUE (dBuV) | CORRECTION FACTOR (dB/m) |
| 1 | 2390.00 | 53.54 PK | 74.00 | -20.46 | 3.80 V | 166 | 54.13 | -0.59 |
| 2 | 2390.00 | 39.30 AV | 54.00 | -14.70 | 3.80 V | 166 | 39.89 | -0.59 |
| 3 | *2402.00 | 93.42 PK | | | 3.80 V | 166 | 93.94 | -0.52 |
| 4 | *2402.00 | 92.29 AV | | | 3.80 V | 166 | 92.81 | -0.52 |
| 5 | 4804.00 | 46.14 PK | 74.00 | -27.86 | 1.55 V | 289 | 39.26 | 6.88 |
| 6 | 4804.00 | 33.77 AV | 54.00 | -20.23 | 1.55 V | 289 | 26.89 | 6.88 |

REMARKS:

1. Emission Level(dBuV/m) = Raw Value(dBuV) + Correction Factor(dB/m)
2. Correction Factor(dB/m) = Antenna Factor(dB/m) + Cable Factor(dB) – Pre-Amplifier Factor(dB)
3. The other emission levels were very low against the limit.
4. Margin value = Emission Level – Limit value
5. " * ": Fundamental frequency.

| | | | |
|------------------------|---------------|------------------------------|--------------|
| CHANNEL | TX Channel 19 | DETECTOR FUNCTION | Peak (PK) |
| FREQUENCY RANGE | 1GHz ~ 25GHz | | Average (AV) |

ANTENNA POLARITY & TEST DISTANCE: HORIZONTAL AT 3 M

| NO. | FREQ. (MHz) | EMISSION LEVEL (dBuV/m) | LIMIT (dBuV/m) | MARGIN (dB) | ANTENNA HEIGHT (m) | TABLE ANGLE (Degree) | RAW VALUE (dBuV) | CORRECTION FACTOR (dB/m) |
|-----|----------------|-------------------------------|-------------------|----------------|--------------------------|----------------------------|------------------------|--------------------------------|
| 1 | *2440.00 | 98.34 PK | | | 1.30 H | 85 | 98.61 | -0.27 |
| 2 | *2440.00 | 97.25 AV | | | 1.30 H | 85 | 97.52 | -0.27 |
| 3 | 4880.00 | 47.54 PK | 74.00 | -26.46 | 1.99 H | 234 | 40.52 | 7.02 |
| 4 | 4880.00 | 34.68 AV | 54.00 | -19.32 | 1.99 H | 234 | 27.66 | 7.02 |

ANTENNA POLARITY & TEST DISTANCE: VERTICAL AT 3 M

| NO. | FREQ. (MHz) | EMISSION LEVEL (dBuV/m) | LIMIT (dBuV/m) | MARGIN (dB) | ANTENNA HEIGHT (m) | TABLE ANGLE (Degree) | RAW VALUE (dBuV) | CORRECTION FACTOR (dB/m) |
|-----|----------------|-------------------------------|-------------------|----------------|--------------------------|----------------------------|------------------------|--------------------------------|
| 1 | *2440.00 | 94.62 PK | | | 3.79 V | 158 | 94.89 | -0.27 |
| 2 | *2440.00 | 92.99 AV | | | 3.79 V | 158 | 93.26 | -0.27 |
| 3 | 4880.00 | 46.50 PK | 74.00 | -27.50 | 1.33 V | 245 | 39.48 | 7.02 |
| 4 | 4880.00 | 33.86 AV | 54.00 | -20.14 | 1.33 V | 245 | 26.84 | 7.02 |

REMARKS:

1. Emission Level(dBuV/m) = Raw Value(dBuV) + Correction Factor(dB/m)
2. Correction Factor(dB/m) = Antenna Factor(dB/m) + Cable Factor(dB) – Pre-Amplifier Factor(dB)
3. The other emission levels were very low against the limit.
4. Margin value = Emission Level – Limit value
5. " * ": Fundamental frequency.

| | | | |
|------------------------|---------------|--------------------------|--------------|
| CHANNEL | TX Channel 39 | DETECTOR FUNCTION | Peak (PK) |
| FREQUENCY RANGE | 1GHz ~ 25GHz | | Average (AV) |

ANTENNA POLARITY & TEST DISTANCE: HORIZONTAL AT 3 M

| NO. | FREQ. (MHz) | EMISSION LEVEL (dBuV/m) | LIMIT (dBuV/m) | MARGIN (dB) | ANTENNA HEIGHT (m) | TABLE ANGLE (Degree) | RAW VALUE (dBuV) | CORRECTION FACTOR (dB/m) |
|-----|----------------|-------------------------|----------------|---------------|--------------------|----------------------|------------------|--------------------------|
| 1 | *2480.00 | 98.80 PK | | | 1.38 H | 96 | 98.81 | -0.01 |
| 2 | *2480.00 | 97.77 AV | | | 1.38 H | 96 | 97.78 | -0.01 |
| 3 | 2483.50 | 56.13 PK | 74.00 | -17.87 | 1.38 H | 96 | 56.13 | 0.00 |
| 4 | 2483.50 | 42.51 AV | 54.00 | -11.49 | 1.38 H | 96 | 42.51 | 0.00 |
| 5 | 4960.00 | 47.50 PK | 74.00 | -26.50 | 2.08 H | 145 | 40.29 | 7.21 |
| 6 | 4960.00 | 35.05 AV | 54.00 | -18.95 | 2.08 H | 145 | 27.84 | 7.21 |

ANTENNA POLARITY & TEST DISTANCE: VERTICAL AT 3 M

| NO. | FREQ. (MHz) | EMISSION LEVEL (dBuV/m) | LIMIT (dBuV/m) | MARGIN (dB) | ANTENNA HEIGHT (m) | TABLE ANGLE (Degree) | RAW VALUE (dBuV) | CORRECTION FACTOR (dB/m) |
|-----|-------------|-------------------------|----------------|-------------|--------------------|----------------------|------------------|--------------------------|
| 1 | *2480.00 | 94.85 PK | | | 3.99 V | 187 | 94.86 | -0.01 |
| 2 | *2480.00 | 93.75 AV | | | 3.99 V | 187 | 93.76 | -0.01 |
| 3 | 2483.50 | 54.88 PK | 74.00 | -19.12 | 3.99 V | 187 | 54.88 | 0.00 |
| 4 | 2483.50 | 41.63 AV | 54.00 | -12.37 | 3.99 V | 187 | 41.63 | 0.00 |
| 5 | 4960.00 | 47.10 PK | 74.00 | -26.90 | 1.73 V | 36 | 39.89 | 7.21 |
| 6 | 4960.00 | 34.17 AV | 54.00 | -19.83 | 1.73 V | 36 | 26.96 | 7.21 |

REMARKS:

1. Emission Level(dBuV/m) = Raw Value(dBuV) + Correction Factor(dB/m)
2. Correction Factor(dB/m) = Antenna Factor(dB/m) + Cable Factor(dB) – Pre-Amplifier Factor(dB)
3. The other emission levels were very low against the limit.
4. Margin value = Emission Level – Limit value
5. " * ": Fundamental frequency.

BELOW 1GHz WORST-CASE DATA

| | | | |
|------------------------|---------------|------------------------------|-----------------|
| CHANNEL | TX Channel 19 | DETECTOR FUNCTION | Quasi-Peak (QP) |
| FREQUENCY RANGE | 9kHz ~ 1GHz | | |

ANTENNA POLARITY & TEST DISTANCE: HORIZONTAL AT 3 M

| NO. | FREQ. (MHz) | EMISSION LEVEL (dBuV/m) | LIMIT (dBuV/m) | MARGIN (dB) | ANTENNA HEIGHT (m) | TABLE ANGLE (Degree) | RAW VALUE (dBuV) | CORRECTION FACTOR (dB/m) |
|-----|----------------|-------------------------------|-------------------|----------------|--------------------------|----------------------------|------------------------|--------------------------------|
| 1 | 47.95 | 17.51 QP | 40.00 | -22.49 | 1.18 H | 217 | 26.92 | -9.41 |
| 2 | 161.73 | 18.15 QP | 43.50 | -25.35 | 1.46 H | 351 | 27.10 | -8.95 |
| 3 | 285.64 | 19.13 QP | 46.00 | -26.87 | 2.69 H | 299 | 26.81 | -7.68 |
| 4 | 377.99 | 21.07 QP | 46.00 | -24.93 | 1.78 H | 360 | 26.89 | -5.82 |
| 5 | 447.92 | 23.33 QP | 46.00 | -22.67 | 1.64 H | 247 | 27.53 | -4.20 |
| 6 | 550.60 | 26.40 QP | 46.00 | -19.60 | 2.06 H | 282 | 28.49 | -2.09 |

ANTENNA POLARITY & TEST DISTANCE: VERTICAL AT 3 M

| NO. | FREQ. (MHz) | EMISSION LEVEL (dBuV/m) | LIMIT (dBuV/m) | MARGIN (dB) | ANTENNA HEIGHT (m) | TABLE ANGLE (Degree) | RAW VALUE (dBuV) | CORRECTION FACTOR (dB/m) |
|-----|----------------|-------------------------------|-------------------|----------------|--------------------------|----------------------------|------------------------|--------------------------------|
| 1 | 43.00 | 22.40 QP | 40.00 | -17.60 | 1.54 V | 360 | 32.10 | -9.70 |
| 2 | 102.65 | 17.75 QP | 43.50 | -25.75 | 1.87 V | 360 | 31.33 | -13.58 |
| 3 | 154.26 | 18.16 QP | 43.50 | -25.34 | 1.34 V | 189 | 27.13 | -8.97 |
| 4 | 283.75 | 19.45 QP | 46.00 | -26.55 | 2.61 V | 187 | 27.15 | -7.70 |
| 5 | 402.92 | 22.46 QP | 46.00 | -23.54 | 2.29 V | 110 | 27.78 | -5.32 |
| 6 | 531.73 | 25.98 QP | 46.00 | -20.02 | 1.97 V | 45 | 28.54 | -2.56 |

REMARKS:

1. Emission Level(dBuV/m) = Raw Value(dBuV) + Correction Factor(dB/m)
2. Correction Factor(dB/m) = Antenna Factor(dB/m) + Cable Factor(dB) – Pre-Amplifier Factor(dB)
3. The other emission levels were very low against the limit.
4. Margin value = Emission Level – Limit value
5. No emission was found between frequency from 9kHz to 30MHz

4.2 Conducted Emission Measurement

4.2.1 Limits of Conducted Emission Measurement

| Frequency (MHz) | Conducted Limit (dBuV) | |
|-----------------|------------------------|---------|
| | Quasi-peak | Average |
| 0.15 - 0.5 | 66 - 56 | 56 - 46 |
| 0.50 - 5.0 | 56 | 46 |
| 5.0 - 30.0 | 60 | 50 |

Note: 1. The lower limit shall apply at the transition frequencies.

2. The limit decreases in line with the logarithm of the frequency in the range of 0.15 to 0.50MHz.

4.2.2 Test Instruments

| Description & Manufacturer | Model No. | Serial No. | Cal. Date | Cal. Due |
|--|---------------|--------------|---------------|---------------|
| ROHDE & SCHWARZ TEST RECEIVER | ESCS30 | 100292 | Dec. 09, 2016 | Dec. 08, 2017 |
| SCHWARZBECK Artificial Mains Network (for EUT) | NSLK 8128 | 8128-244 | Sep. 30, 2016 | Sep. 29, 2017 |
| LISN With Adapter (for EUT) | AD10 | C05Ada-001 | Sep. 30, 2016 | Sep. 29, 2017 |
| ROHDE & SCHWARZ 200-A Four-line V-Network | ENV4200 | 830326/018 | Sep. 13, 2016 | Sep. 12, 2017 |
| EMCO Artificial Mains Network (for peripherals) | 3625/2 | 9502-1041 | May 16, 2016 | May 15, 2017 |
| Software | Cond_V7.3.7.4 | NA | NA | NA |
| RF cable (JYEBAO) With 10dB PAD | 5D-FB | Cable-C05.01 | Feb. 05, 2016 | Feb. 04, 2017 |
| LYNICS Terminator (For R&S LISN) | 0900510 | E1-01-305 | Feb. 15, 2016 | Feb. 14, 2017 |

Notes: 1. The calibration interval of the above test instruments is 12 months and the calibrations are traceable to NML/ROC and NIST/USA.

2. The test was performed in Shielded Room No. 5.

3. The VCCI Site Registration No. C-1093.

4. The Industry Canada Reference No. IC 3789-5.

5. Tested Date: Jan. 26, 2017.

4.2.3 Test Procedures

- The EUT was placed 0.4 meters from the conducting wall of the shielded room with EUT being connected to the power mains through a line impedance stabilization network (LISN). Other support units were connected to the power mains through another LISN. The two LISNs provide 50 ohm/ 50uH of coupling impedance for the measuring instrument.
- Both lines of the power mains connected to the EUT were checked for maximum conducted interference.
- The frequency range from 150kHz to 30MHz was searched. Emission levels under (Limit - 20dB) was not recorded.

NOTE: The resolution bandwidth and video bandwidth of test receiver is 9kHz for quasi-peak detection (QP) and average detection (AV) at frequency 0.15MHz-30MHz.

4.2.4 Deviation From Test Standard

No deviation.

4.2.5 Test Setup

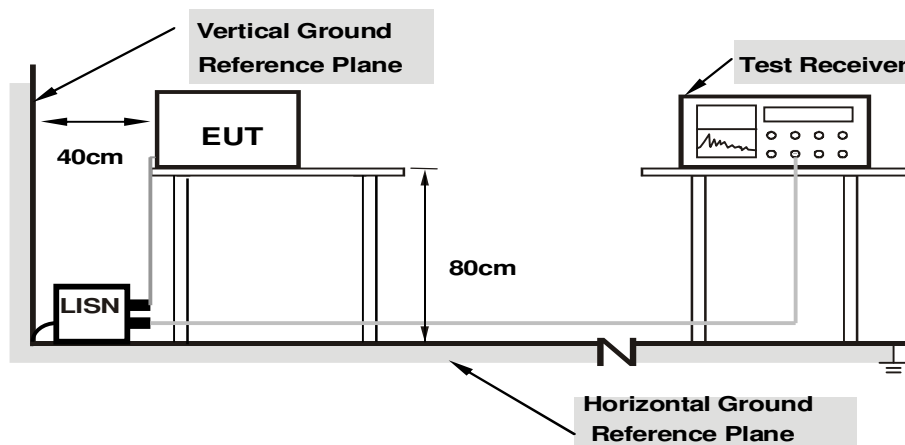

Note: Support units were connected to second LISN.

For the actual test configuration, please refer to the attached file (Test Setup Photo).

4.2.6 EUT Operating Condition

Mode B

- Put the EUT into the charging case.
- Connected the charging case to Adapter with USB cable.
- Set the EUT under charging and transmission condition continuously at specific channel frequency.

Mode C

- Put the EUT into the charging case.
- Connected the charging case to Notebook with USB cable.
- Set the EUT under charging and transmission condition continuously at specific channel frequency.

4.2.7 Test Results

| | | | |
|-----------|----------|-------------------|--------------------------------|
| Phase | Line (L) | Detector Function | Quasi-Peak (QP) / Average (AV) |
| Test Mode | Mode B | | |

| Phase Of Power : Line (L) | | | | | | | | | | |
|---------------------------|-----------------|------------------------|----------------------|-------|-----------------------|-------|--------------|-------|-------------|--------|
| No | Frequency (MHz) | Correction Factor (dB) | Reading Value (dBuV) | | Emission Level (dBuV) | | Limit (dBuV) | | Margin (dB) | |
| | | | Q.P. | AV. | Q.P. | AV. | Q.P. | AV. | Q.P. | AV. |
| 1 | 0.17333 | 10.20 | 37.29 | 24.58 | 47.49 | 34.78 | 64.80 | 54.80 | -17.31 | -20.02 |
| 2 | 0.21095 | 10.18 | 30.65 | 19.87 | 40.83 | 30.05 | 63.17 | 53.17 | -22.34 | -23.12 |
| 3 | 0.51398 | 10.20 | 25.13 | 18.24 | 35.33 | 28.44 | 56.00 | 46.00 | -20.67 | -17.56 |
| 4 | 1.56250 | 10.34 | 22.05 | 15.11 | 32.39 | 25.45 | 56.00 | 46.00 | -23.61 | -20.55 |
| 5 | 4.06250 | 10.52 | 20.35 | 14.89 | 30.87 | 25.41 | 56.00 | 46.00 | -25.13 | -20.59 |
| 6 | 9.33984 | 10.80 | 20.05 | 13.97 | 30.85 | 24.77 | 60.00 | 50.00 | -29.15 | -25.23 |

Remarks:

1. Q.P. and AV. are abbreviations of quasi-peak and average individually.
2. The emission levels of other frequencies were very low against the limit.
3. Margin value = Emission level – Limit value
4. Correction factor = Insertion loss + Cable loss
5. Emission Level = Correction Factor + Reading Value

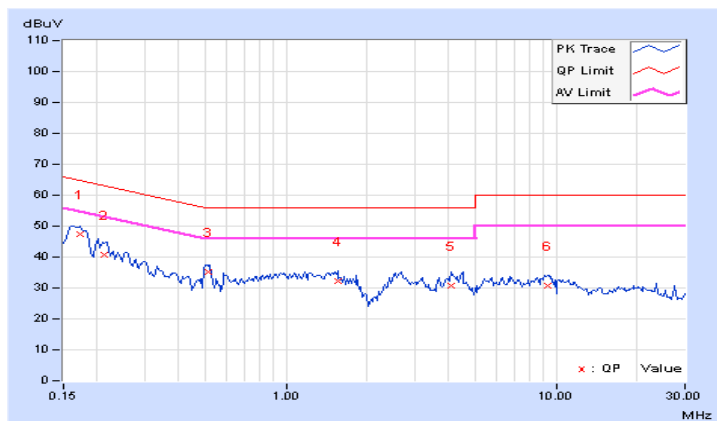

| | | | |
|-----------|-------------|-------------------|--------------------------------|
| Phase | Neutral (N) | Detector Function | Quasi-Peak (QP) / Average (AV) |
| Test Mode | Mode B | | |

| Phase Of Power : Neutral (N) | | | | | | | | | | |
|------------------------------|-----------------|------------------------|----------------------|-------|-----------------------|-------|--------------|-------|-------------|--------|
| No | Frequency (MHz) | Correction Factor (dB) | Reading Value (dBuV) | | Emission Level (dBuV) | | Limit (dBuV) | | Margin (dB) | |
| | | | Q.P. | AV. | Q.P. | AV. | Q.P. | AV. | Q.P. | AV. |
| 1 | 0.16953 | 10.19 | 39.11 | 26.78 | 49.30 | 36.97 | 64.98 | 54.98 | -15.68 | -18.01 |
| 2 | 0.20206 | 10.17 | 32.68 | 18.66 | 42.85 | 28.83 | 63.53 | 53.53 | -20.68 | -24.70 |
| 3 | 0.52109 | 10.26 | 24.63 | 14.52 | 34.89 | 24.78 | 56.00 | 46.00 | -21.11 | -21.22 |
| 4 | 1.19531 | 10.31 | 21.93 | 14.36 | 32.24 | 24.67 | 56.00 | 46.00 | -23.76 | -21.33 |
| 5 | 4.24219 | 10.57 | 22.09 | 13.97 | 32.66 | 24.54 | 56.00 | 46.00 | -23.34 | -21.46 |
| 6 | 9.59766 | 10.90 | 19.32 | 12.34 | 30.22 | 23.24 | 60.00 | 50.00 | -29.78 | -26.76 |

Remarks:

1. Q.P. and AV. are abbreviations of quasi-peak and average individually.
2. The emission levels of other frequencies were very low against the limit.
3. Margin value = Emission level – Limit value
4. Correction factor = Insertion loss + Cable loss
5. Emission Level = Correction Factor + Reading Value

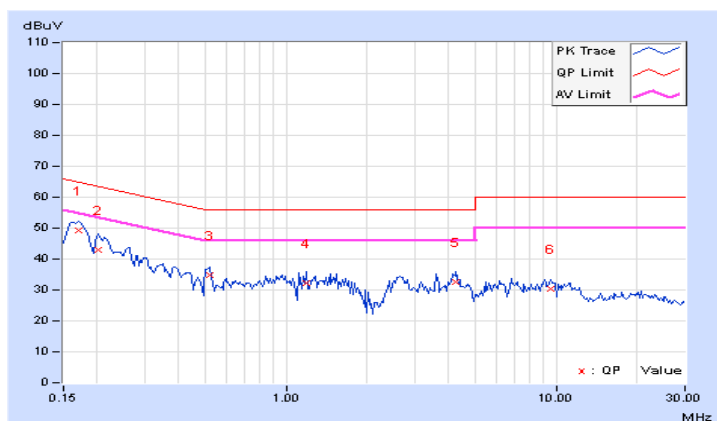

| | | | |
|-----------|----------|-------------------|--------------------------------|
| Phase | Line (L) | Detector Function | Quasi-Peak (QP) / Average (AV) |
| Test Mode | Mode C | | |

| Phase Of Power : Line (L) | | | | | | | | | | |
|---------------------------|-----------------|------------------------|----------------------|-------|-----------------------|-------|--------------|-------|-------------|--------|
| No | Frequency (MHz) | Correction Factor (dB) | Reading Value (dBuV) | | Emission Level (dBuV) | | Limit (dBuV) | | Margin (dB) | |
| | | | Q.P. | AV. | Q.P. | AV. | Q.P. | AV. | Q.P. | AV. |
| 1 | 0.15007 | 10.21 | 41.56 | 29.28 | 51.77 | 39.49 | 66.00 | 56.00 | -14.23 | -16.51 |
| 2 | 0.20469 | 10.18 | 35.16 | 24.46 | 45.34 | 34.64 | 63.42 | 53.42 | -18.08 | -18.78 |
| 3 | 0.34531 | 10.17 | 30.82 | 20.07 | 40.99 | 30.24 | 59.07 | 49.07 | -18.08 | -18.83 |
| 4 | 1.32422 | 10.29 | 28.12 | 18.23 | 38.41 | 28.52 | 56.00 | 46.00 | -17.59 | -17.48 |
| 5 | 3.16797 | 10.39 | 27.11 | 18.69 | 37.50 | 29.08 | 56.00 | 46.00 | -18.50 | -16.92 |
| 6 | 4.22266 | 10.45 | 30.04 | 20.15 | 40.49 | 30.60 | 56.00 | 46.00 | -15.51 | -15.40 |
| 7 | 12.65234 | 10.80 | 26.02 | 18.65 | 36.82 | 29.45 | 60.00 | 50.00 | -23.18 | -20.55 |

Remarks:

1. Q.P. and AV. are abbreviations of quasi-peak and average individually.
2. The emission levels of other frequencies were very low against the limit.
3. Margin value = Emission level – Limit value
4. Correction factor = Insertion loss + Cable loss
5. Emission Level = Correction Factor + Reading Value

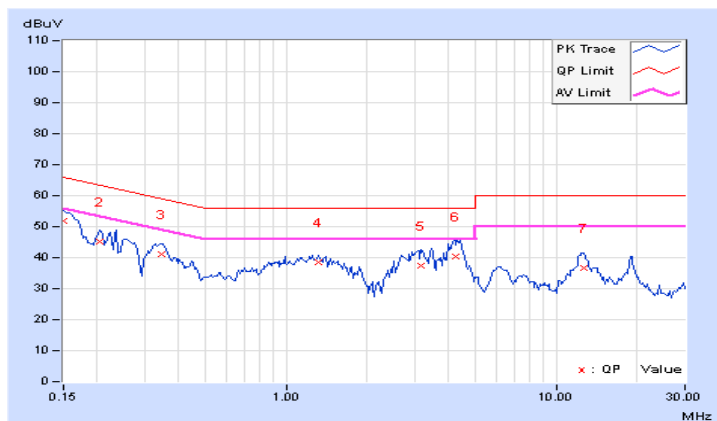

| | | | |
|-----------|-------------|-------------------|--------------------------------|
| Phase | Neutral (N) | Detector Function | Quasi-Peak (QP) / Average (AV) |
| Test Mode | Mode C | | |

| Phase Of Power : Neutral (N) | | | | | | | | | | |
|------------------------------|-----------------|------------------------|----------------------|-------|-----------------------|-------|--------------|-------|-------------|--------|
| No | Frequency (MHz) | Correction Factor (dB) | Reading Value (dBuV) | | Emission Level (dBuV) | | Limit (dBuV) | | Margin (dB) | |
| | | | Q.P. | AV. | Q.P. | AV. | Q.P. | AV. | Q.P. | AV. |
| 1 | 0.15782 | 10.20 | 40.35 | 26.19 | 50.55 | 36.39 | 65.58 | 55.58 | -15.03 | -19.19 |
| 2 | 0.22167 | 10.18 | 33.28 | 23.10 | 43.46 | 33.28 | 62.76 | 52.76 | -19.30 | -19.48 |
| 3 | 0.33751 | 10.23 | 31.27 | 21.38 | 41.50 | 31.61 | 59.26 | 49.26 | -17.76 | -17.65 |
| 4 | 1.25781 | 10.27 | 29.02 | 18.57 | 39.29 | 28.84 | 56.00 | 46.00 | -16.71 | -17.16 |
| 5 | 3.17578 | 10.41 | 27.89 | 19.34 | 38.30 | 29.75 | 56.00 | 46.00 | -17.70 | -16.25 |
| 6 | 4.43359 | 10.48 | 30.25 | 19.26 | 40.73 | 29.74 | 56.00 | 46.00 | -15.27 | -16.26 |
| 7 | 12.46706 | 10.84 | 27.85 | 21.08 | 38.69 | 31.92 | 60.00 | 50.00 | -21.31 | -18.08 |

Remarks:

1. Q.P. and AV. are abbreviations of quasi-peak and average individually.
2. The emission levels of other frequencies were very low against the limit.
3. Margin value = Emission level – Limit value
4. Correction factor = Insertion loss + Cable loss
5. Emission Level = Correction Factor + Reading Value

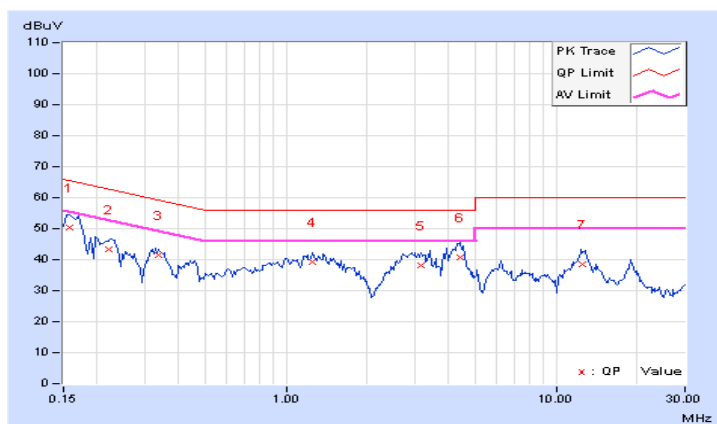

4.3 6dB Bandwidth Measurement

4.3.1 Limits of 6dB Bandwidth Measurement

The minimum of 6dB Bandwidth Measurement is 0.5 MHz.

4.3.2 Test Setup

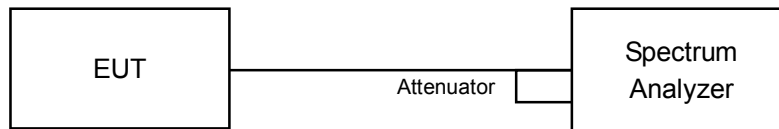

4.3.3 Test Instruments

Refer to section 4.1.2 to get information of above instrument.

4.3.4 Test Procedure

- a. Set resolution bandwidth (RBW) = 100kHz
- b. Set the video bandwidth (VBW) $\geq 3 \times$ RBW, Detector = Peak.
- c. Trace mode = max hold.
- d. Sweep = auto couple.
- e. Measure the maximum width of the emission that is constrained by the frequencies associated with the two amplitude points (upper and lower) that are attenuated by 6 dB relative to the maximum level measured in the fundamental emission

4.3.5 Deviation from Test Standard

No deviation.

4.3.6 EUT Operating Conditions

The software provided by client to enable the EUT under transmission condition continuously at lowest, middle and highest channel frequencies individually.

4.4 Conducted Output Power Measurement

4.4.1 Limits OF Conducted Output Power Measurement

For systems using digital modulation in the 2400–2483.5 MHz bands: 1 Watt (30dBm)

4.4.2 Test Setup

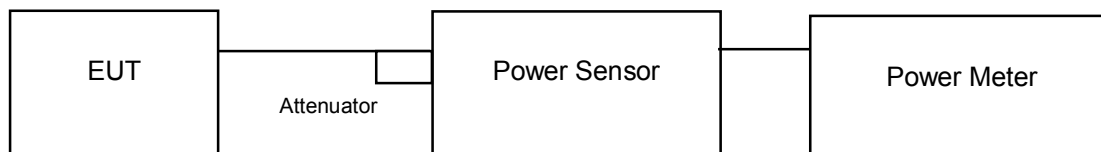

4.4.3 Test Instruments

Refer to section 4.1.2 to get information of above instrument.

4.4.4 Test Procedures

A peak / average power sensor was used on the output port of the EUT. A power meter was used to read the response of the peak / average power sensor. Record the power level.

4.4.5 Deviation from Test Standard

No deviation.

4.4.6 EUT Operating Conditions

Same as Item 4.3.6.

4.4.7 Test Results

Mode A

FOR PEAK POWER

| Channel | Frequency (MHz) | Peak Power (mW) | Peak Power (dBm) | Limit (dBm) | Pass/Fail |
|---------|-----------------|-----------------|------------------|-------------|-----------|
| 0 | 2402 | 5.598 | 7.48 | 30 | Pass |
| 19 | 2440 | 8.750 | 9.42 | 30 | Pass |
| 39 | 2480 | 6.209 | 7.93 | 30 | Pass |

FOR AVERAGE POWER

| Channel | Frequency (MHz) | Average Power (mW) | Average Power (dBm) |
|---------|-----------------|--------------------|---------------------|
| 0 | 2402 | 5.260 | 7.21 |
| 19 | 2440 | 8.356 | 9.22 |
| 39 | 2480 | 5.998 | 7.78 |

4.5 Power Spectral Density Measurement

4.5.1 Limits of Power Spectral Density Measurement

The Maximum of Power Spectral Density Measurement is 8dBm.

4.5.2 Test Setup



4.5.3 Test Instruments

Refer to section 4.1.2 to get information of above instrument.

4.5.4 Test Procedure

- Set analyzer center frequency to DTS channel center frequency.
- Set the span to 1.5 times the DTS bandwidth.
- Set the RBW to: $3 \text{ kHz} \leq \text{RBW} \leq 100 \text{ kHz}$.
- Set the VBW $\geq 3 \times \text{RBW}$.
- Detector = peak.
- Sweep time = auto couple.
- Trace mode = max hold.
- Allow trace to fully stabilize.
- Use the peak marker function to determine the maximum amplitude level within the RBW.

4.5.5 Deviation from Test Standard

No deviation.

4.5.6 EUT Operating Condition

Same as Item 4.3.6

4.5.7 Test Results

Mode A

| Channel | Freq. (MHz) | PSD (dBm/3kHz) | Limit (dBm/3kHz) | PASS /FAIL |
|---------|-------------|----------------|------------------|------------|
| 0 | 2402 | -8.60 | 8 | PASS |
| 19 | 2440 | -6.03 | 8 | PASS |
| 39 | 2480 | -8.01 | 8 | PASS |

SPECTRUM PLOT OF WORST VALUE

CH 19

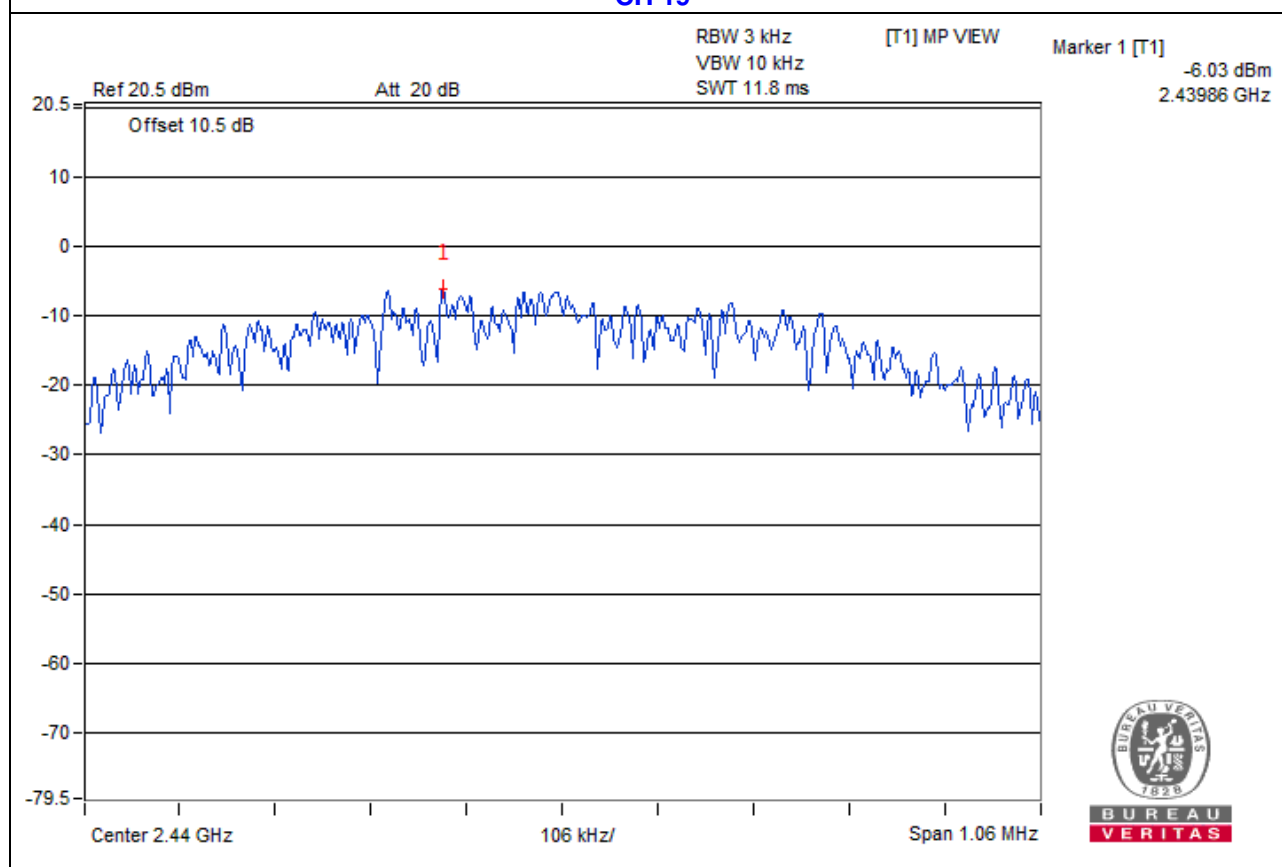

4.6 Conducted Out of Band Emission Measurement

4.6.1 Limits of Conducted Out of Band Emission Measurement

Below -20dB of the highest emission level of operating band (in 100kHz Resolution Bandwidth).

4.6.2 Test Setup

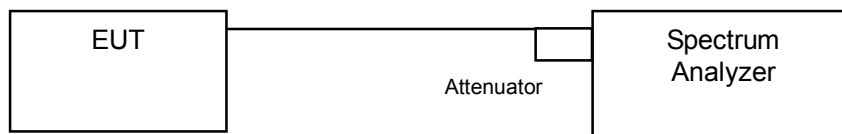

4.6.3 Test Instruments

Refer to section 4.1.2 to get information of above instrument.

4.6.4 Test Procedure

MEASUREMENT PROCEDURE REF

1. Set the RBW = 100 kHz.
2. Set the VBW \geq 300 kHz.
3. Detector = peak.
4. Sweep time = auto couple.
5. Trace mode = max hold.
6. Allow trace to fully stabilize.
7. Use the peak marker function to determine the maximum power level in any 100 kHz band segment within the fundamental EBW.

MEASUREMENT PROCEDURE OOB

1. Set RBW = 100 kHz.
2. Set VBW \geq 300 kHz.
3. Detector = peak.
4. Sweep = auto couple.
5. Trace Mode = max hold.
6. Allow trace to fully stabilize.
7. Use the peak marker function to determine the maximum amplitude level.

4.6.5 Deviation from Test Standard

No deviation.

4.6.6 EUT Operating Condition

Same as Item 4.3.6

4.6.7 Test Results

Mode A

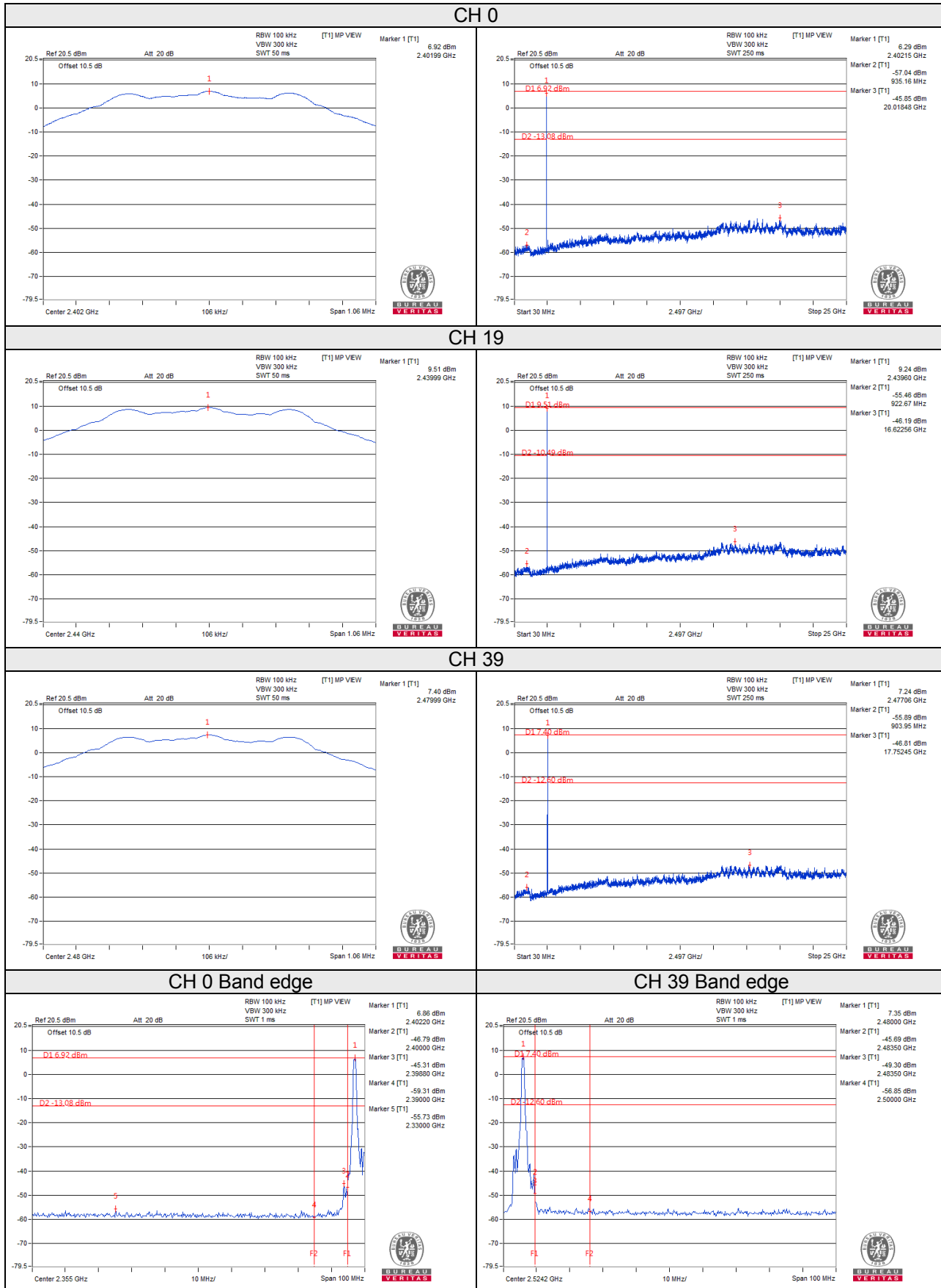

5 Pictures of Test Arrangements

Please refer to the attached file (Test Setup Photo).

Appendix – Information on the Testing Laboratories

We, Bureau Veritas Consumer Products Services (H.K.) Ltd., Taoyuan Branch, were founded in 1988 to provide our best service in EMC, Radio, Telecom and Safety consultation. Our laboratories are accredited and approved according to ISO/IEC 17025.

If you have any comments, please feel free to contact us at the following:

Linko EMC/RF Lab

Tel: 886-2-26052180

Fax: 886-2-26051924

Hsin Chu EMC/RF/Telecom Lab

Tel: 886-3-6668565

Fax: 886-3-6668323

Hwa Ya EMC/RF/Safety Lab

Tel: 886-3-3183232

Fax: 886-3-3270892

Email: service.adt@tw.bureauveritas.com

Web Site: www.bureauveritas-adt.com

The address and road map of all our labs can be found in our web site also.

--- END ---