



**FCC 47 CFR PART 15 SUBPART C
INDUSTRY CANADA RSS-247 ISSUE 1**

**BLUETOOTH LOW ENERGY
CERTIFICATION TEST REPORT**

WIRELESS HEADSET

MODEL NUMBER: AI1

**FCC ID: A94AI1
IC: 3232A-AI1**

REPORT NUMBER: R11043795-E2

ISSUE DATE: 2016-05-20

Prepared for
BOSE CORP.
**100 THE MOUNTAIN RD, FRAMINGHAM
MASSACHUSETTS, 01701, USA**

Prepared by
UL LLC
12 LABORATORY DR.
RESEARCH TRIANGLE PARK, NC 27709 USA
TEL: (919) 549-1400



NVLAP Lab code: 200246-0

Revision History

<u>Ver.</u>	<u>Issue Date</u>	<u>Revisions</u>	<u>Revised By</u>
1	2016-04-19	Initial Issue	Ron Reichard
2	2016-05-12	Added below 30 MHz data.	Jeff Moser
3	2016-05-17	Added statement regarding chamber characterizartion for below 30 MHz on page 48.	Jeff Moser
4	2016-05-20	Included below 30 MHz limits on page 39.	Jeff Moser

TABLE OF CONTENTS

1. ATTESTATION OF TEST RESULTS	5
2. TEST METHODOLOGY	6
3. FACILITIES AND ACCREDITATION	6
4. CALIBRATION AND UNCERTAINTY	6
4.1. MEASURING INSTRUMENT CALIBRATION	6
4.2. SAMPLE CALCULATION	6
4.3. MEASUREMENT UNCERTAINTY	7
5. EQUIPMENT UNDER TEST	8
5.1. DESCRIPTION OF EUT	8
5.2. MAXIMUM OUTPUT POWER	8
5.3. DESCRIPTION OF AVAILABLE ANTENNAS	8
5.4. SOFTWARE AND FIRMWARE	8
5.5. WORST-CASE CONFIGURATION AND MODE	9
5.6. DESCRIPTION OF TEST SETUP	10
6. TEST AND MEASUREMENT EQUIPMENT	13
7. MEASUREMENT METHODS	15
8. ANTENNA PORT TEST RESULTS	16
8.1. ON TIME AND DUTY CYCLE	16
8.2. 6 dB BANDWIDTH	18
8.3. 99% BANDWIDTH	22
8.4. OUTPUT POWER	26
8.5. AVERAGE POWER	27
8.6. POWER SPECTRAL DENSITY	28
8.7. CONDUCTED SPURIOUS EMISSIONS	32
9. RADIATED TEST RESULTS	39
9.1. LIMITS AND PROCEDURE	39
9.2. TRANSMITTER ABOVE 1 GHz	40
9.3. TX ABOVE 1 GHz FOR BLUETOOTH LOW ENERGY MODE IN THE 2.4 GHz BAND	40
9.4. WORST-CASE 18-26GHz	47
9.5. WORST-CASE BELOW 1 GHz	48

10. AC POWER LINE CONDUCTED EMISSIONS50
11. SETUP PHOTOS51

1. ATTESTATION OF TEST RESULTS

COMPANY NAME: Bose Corp.
100 The Mountain Rd.
Framingham, Massachusetts, 01701, USA

EUT DESCRIPTION: Wireless Headset

MODEL: AI1

SERIAL NUMBER: ID 2305610-EMC (Radiated sample);
ID EB77B5 (Conducted sample)

DATE TESTED: 2016-02-22 to 2016-03-07, 2016-05-05

APPLICABLE STANDARDS	
STANDARD	TEST RESULTS
CFR 47 Part 15 Subpart C	PASS
INDUSTRY CANADA RSS-247 Issue 1	PASS
INDUSTRY CANADA RSS-GEN Issue 4	PASS

UL LLC tested the above equipment in accordance with the requirements set forth in the above standards. All indications of Pass/Fail in this report are opinions expressed by UL LLC based on interpretations and/or observations of test results. Measurement Uncertainties were not taken into account and are published for informational purposes only. The test results show that the equipment tested is capable of demonstrating compliance with the requirements as documented in this report.

Note: The results documented in this report apply only to the tested sample, under the conditions and modes of operation as described herein. This document may not be altered or revised in any way unless done so by UL LLC and all revisions are duly noted in the revisions section. Any alteration of this document not carried out by UL LLC will constitute fraud and shall nullify the document. This report must not be used by the client to claim product certification, approval, or endorsement by NVLAP, NIST, any agency of the Federal Government, or any agency of any government.

Approved & Released
For UL LLC By:

Prepared By:



Jeff Moser
EMC Program Manager
UL – Consumer Technology Division



Ron Reichard
EMC Engineer
UL – Consumer Technology Division

2. TEST METHODOLOGY

The tests documented in this report were performed in accordance with FCC CFR 47 Part 2, FCC CFR 47 Part 15, ANSI C63.10-2013, RSS-GEN Issue 4, RSS-247 Issue 1.

3. FACILITIES AND ACCREDITATION

The test sites and measurement facilities used to collect data are located at 12 Laboratory Dr., Research Triangle Park, NC 27709, USA and 2800 Suite B, Perimeter Park Drive, Morrisville, NC 27560.

12 Laboratory Dr., RTP, NC 27709
<input type="checkbox"/> Chamber A
<input type="checkbox"/> Chamber C

2800 Suite B Perimeter Park Dr., Morrisville, NC 27560
<input checked="" type="checkbox"/> Chamber NORTH
<input checked="" type="checkbox"/> Chamber SOUTH

The onsite chambers are covered under Industry Canada company address code 2180C with site numbers 2180C -1 through 2180C-4, respectively.

UL LLC (RTP) is accredited by NVLAP, Laboratory Code 200246-0. The full scope of accreditation can be viewed at <http://www.nist.gov/nvlap/>

4. CALIBRATION AND UNCERTAINTY

4.1. MEASURING INSTRUMENT CALIBRATION

The measuring equipment utilized to perform the tests documented in this report has been calibrated in accordance with the manufacturer's recommendations, and is traceable to recognized national standards.

4.2. SAMPLE CALCULATION

Where relevant, the following sample calculation is provided:

$$\begin{aligned} \text{Field Strength (dBuV/m)} &= \text{Measured Voltage (dBuV)} + \text{Antenna Factor (dB/m)} + \\ &\text{Cable Loss (dB)} - \text{Preamp Gain (dB)} \\ 36.5 \text{ dBuV} + 18.7 \text{ dB/m} + 0.6 \text{ dB} - 26.9 \text{ dB} &= 28.9 \text{ dBuV/m} \end{aligned}$$

4.3. MEASUREMENT UNCERTAINTY

Where relevant, the following measurement uncertainty levels have been estimated for tests performed on the apparatus:

PARAMETER		UNCERTAINTY
Total RF power, conducted	+/-	0.45
RF power density, conducted	+/-	1.50
Spurious emissions, conducted	+/-	2.94
All emissions, radiated up to 26 GHz	+/-	5.36
Temperature	+/-	0.07
Humidity	+/-	2.26
DC and low frequency voltages	+/-	1.27
Conducted Disturbance, 0.15 to 30 MHz	+/-	2.37

Uncertainty figures are valid to a confidence level of 95%.

5. EQUIPMENT UNDER TEST

5.1. DESCRIPTION OF EUT

The EUT is a Wireless Headset that contains a Bluetooth transceiver.

The radio module is manufactured by Cambridge Silicon Radio, CSR8670.

5.2. MAXIMUM OUTPUT POWER

The transmitter has a maximum peak conducted output power as follows:

Frequency Range (MHz)	Mode	Output Power (dBm)	Output Power (mW)
2402 - 2480	BLE	9.22	8.36

5.3. DESCRIPTION OF AVAILABLE ANTENNAS

The radio utilizes a meander printed etch antenna, with a maximum gain of +0.6 dBi.

5.4. SOFTWARE AND FIRMWARE

The firmware installed in the EUT during testing was version 0.2.0.84.

The test utility and driver software used during testing was Polycomm, ver. 0.1.5.0 and CSR BlueSuite ver 2.5.8.

5.5. WORST-CASE CONFIGURATION AND MODE

Radiated emissions were performed with the EUT set to transmit at the channel with the highest output power as the worst-case scenario.

The fundamental of the EUT was investigated in three orthogonal orientations X,Y,Z, it was determined that the Y orientation was the worst-case orientation. Therefore, all final radiated testing was performed with the EUT in Y orientation.

5.6. DESCRIPTION OF TEST SETUP

SUPPORT EQUIPMENT

Support Equipment List				
Description	Manufacturer	Model	Serial Number	FCC ID
Laptop PC (for commissioning the EUT)	Lenovo	20BU-S04K00	PC-0A2UQS	N/A
AC Adapter (for laptop PC)	Lenovo	ADLX65NLC2A	54DE1T	N/A

I/O CABLES

I/O Cable List						
Cable No	Port	# of identical ports	Connector Type	Cable Type	Cable Length (m)	Remarks
1	USB	1	Micro USB	Unshielded	0.33	For USB charging cable.

TEST SETUP

The EUT is set up as a stand-alone device during radiated-emissions testing. For convenience, the device is connected to a laptop PC via a USB cable to configure the device for test during antenna-port measurements. Test software exercised the radio portion of the device.

SETUP DIAGRAM FOR CONDUCTED TESTS

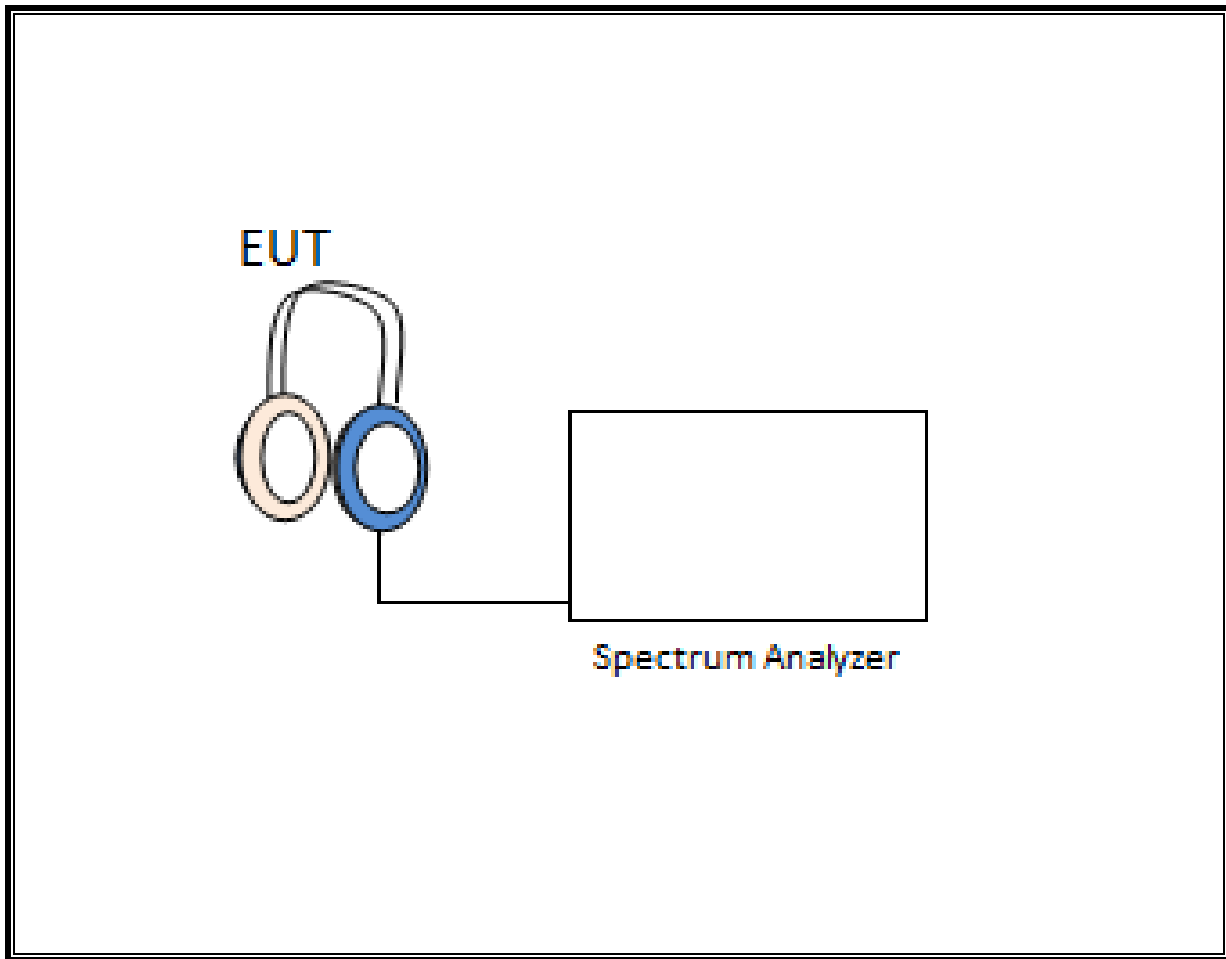

SETUP DIAGRAM FOR RADIATED TESTS

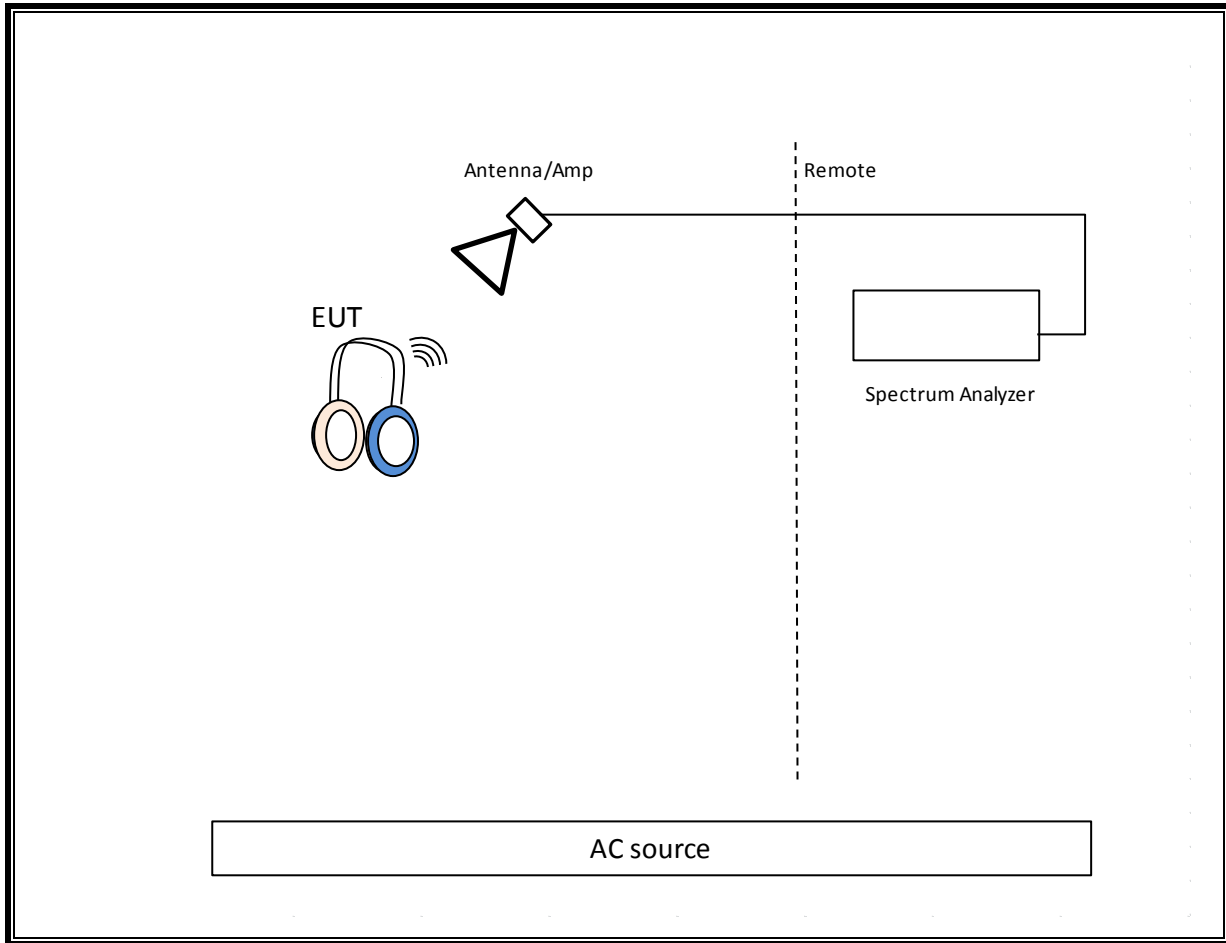

6. TEST AND MEASUREMENT EQUIPMENT

The following test and measurement equipment was utilized for the tests documented in this report:

Test Equipment Used - Wireless Conducted Measurement Equipment

Equipment ID	Description	Manufacturer	Model Number	Last Cal.	Next Cal.
Conducted Room 1					
SA0019	Spectrum Analyzer	Agilent Technologies	E4446A	2015-09-02	2016-09-30
PWM004	RF Power Meter	Keysight Technologies	N1911A	2015-06-08	2017-06-08
PWS004	Peak and Avg Power Sensor, 50MHz to 6GHz	Keysight Technologies	E9323A	2015-06-05	2016-06-05
HI0079	Temp/Humid/Pressure Meter	Springfield	PreciseTemp	2015-07-1	2016-07-31
MM0167	True RMS Multimeter	Agilent	U1232A	2015-08-17	2016-08-31
76022	DC Regulated Power Supply	CircuitSpecialists.Com	CSI3005X5	N/A	N/A
T1023	EMPower USB RF Power Sensor, 10MHz to 6GHz	ETS Lindgren	7002-006	2015-10-01	2016-10-01
Conducted Room 2					
SA0020	Spectrum Analyzer	Agilent Technologies	E4446A	2015-02-26	2016-02-29
PWM003	RF Power Meter	Keysight Technologies	N1911A	2015-06-08	2017-06-08
PWS003	Peak and Avg Power Sensor, 50MHz to 6GHz	Keysight Technologies	E9323A	2015-06-05	2016-06-05
1100502	Temp/Humid Chamber	Cincinnati Sub-Zero	ZPH-8-3.5-SCT/AC	2015-05-13	2016-05-31
43733	Temp/Humid/Pressure Meter	Cole-Parmer	99760-00	2014-03-24	2016-03-24
MM0168	True RMS Multimeter	Agilent	U1232A	2015-08-17	2016-08-31
76021	DC Regulated Power Supply	CircuitSpecialists.Com	CSI3005X5	N/A	N/A
T1024	EMPower USB RF Power Sensor, 10MHz to 6GHz	ETS Lindgren	7002-006	2015-10-01	2016-10-01

Note – All testing in Conducted Room 2 was performed prior to 2016-02-29.

Test Equipment Used - Radiated Disturbance Emissions Test Equipment (Morrisville - North Chamber)

Equip. ID	Description	Manufacturer	Model Number	Last Cal.	Next Cal.
AT0073	Hybrid Broadband Antenna, 30-1000MHz	Sunol Sciences Corp.	JB3	2015-06-10	2016-06-30
AT0072	Double-Ridged Waveguide Horn Antenna, 1 to 18 GHz	ETS Lindgren	3117	2015-02-17	2016-02-29
N-SAC02	Gain-loss string: 30-1000MHz	Various	Various	2015-06-04	2016-06-30
N-SAC03	Gain-loss string: 1-18GHz	Various	Various	2015-09-29	2016-09-30
SA0026	Spectrum Analyzer	Agilent	N9030A	2015-03-27	2016-03-31
SOFTEMI	EMI Software	UL	Version 9.5	NA	NA
HI0079	Temp/Humid/Pressure Meter	Springfield Precision	PreciseTemp	2015-07-01	2016-07-31

Note – All testing in this chamber was performed prior to 2016-02-29

Test Equipment Used - Radiated Disturbance Emissions Test Equipment (Morrisville - South Chamber)

Equip. ID	Description	Manufacturer	Model Number	Last Cal.	Next Cal.
AT0079	Active Loop Antenna	ETS-Lindgren	6502	2015-12-08	2016-12-31
AT0076	Horn Antenna, 18-26.5GHz	ARA	MWH-1826/B	2015-08-27	2016-08-31
S-SAC01	Gain-loss string: 0.009-30MHz	Various	Various	2015-10-07	2016-10-31
S-SAC04	Gain-loss string: 18-40GHz	Various	Various	2016-02-29	2017-02-28
SA0018	Spectrum Analyzer	Agilent	N9030A	2015-11-07	2016-11-30
SA0025	Spectrum Analyzer	Agilent	N9030A	2016-03-17	2017-03-31
SOFTEMI	EMI Software	UL	Version 9.5	NA	NA
HI0050	Temp/Humid/Pressure Meter	Cole-Parmer	99760-00	2015-07-01	2016-07-31

7. MEASUREMENT METHODS

6 dB BW: KDB 558074 D01 v03r05, Section 8.1.

Output Power: KDB 558074 D01 v03r05, Section 9.1.2.

Power Spectral Density: KDB 558074 D01 v03r05, Section 10.2.

Out-of-band emissions in non-restricted bands: KDB 558074 D01 v03r05, Section 11.0.

Out-of-band emissions in restricted bands: KDB 558074 D01 v03r05, Section 12.1.

8. ANTENNA PORT TEST RESULTS

8.1. ON TIME AND DUTY CYCLE

LIMITS

None; for reporting purposes only.

PROCEDURE

KDB 558074 Zero-Span Spectrum Analyzer Method.

RESULTS

Mode	ON Time B (msec)	Period (msec)	Duty Cycle x (linear)	Duty Cycle (%)	Duty Cycle Correction Factor (dB)	1/B Minimum VBW (kHz)
BLE	0.397	0.649	0.611	61.15%	2.14	2.520

DUTY CYCLE PLOT

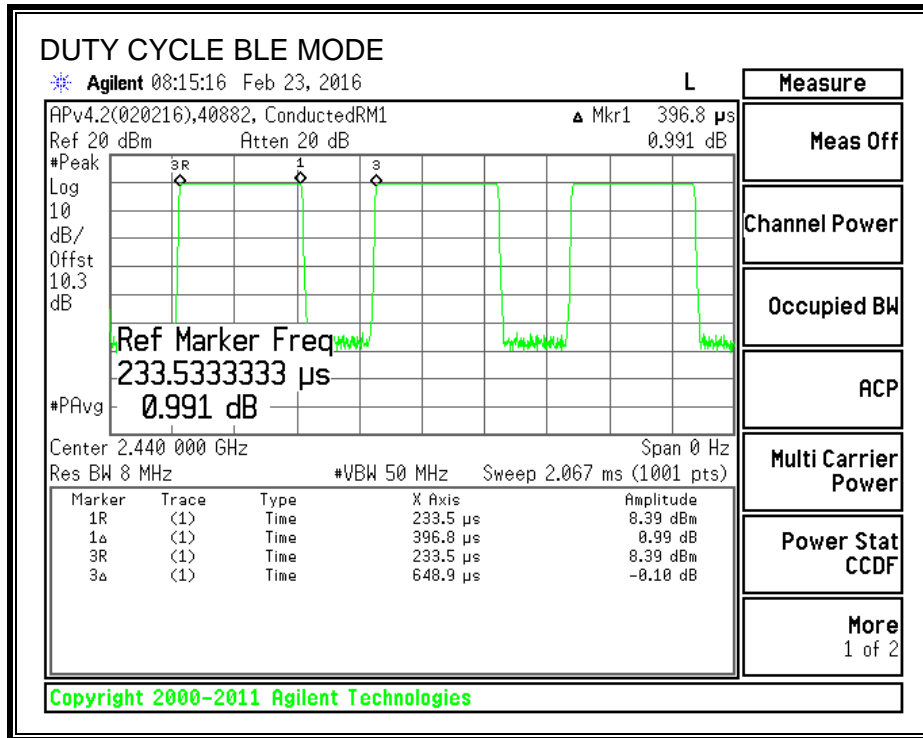

8.2. 6 dB BANDWIDTH

LIMITS

FCC §15.247 (a) (2)

IC RSS-247 5.2 (1)

The minimum 6 dB bandwidth shall be at least 500 kHz.

RESULTS

Channel	Frequency (MHz)	6 dB Bandwidth (MHz)	Minimum Limit (MHz)
Low	2402	0.7440	0.5
Middle	2440	0.6880	0.5
High	2480	0.6980	0.5

6 dB BANDWIDTH

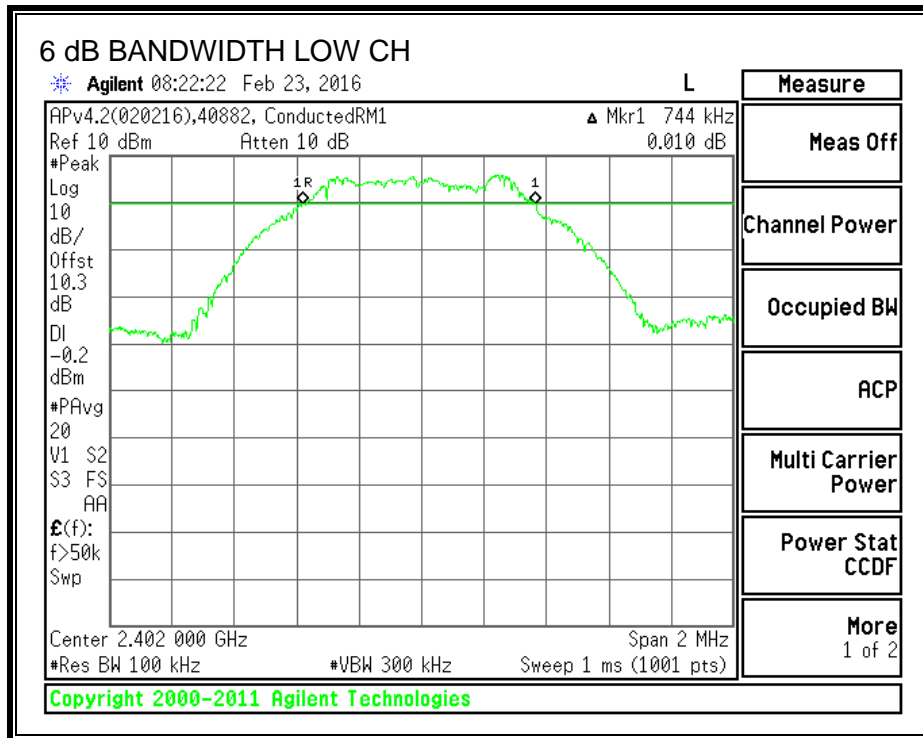

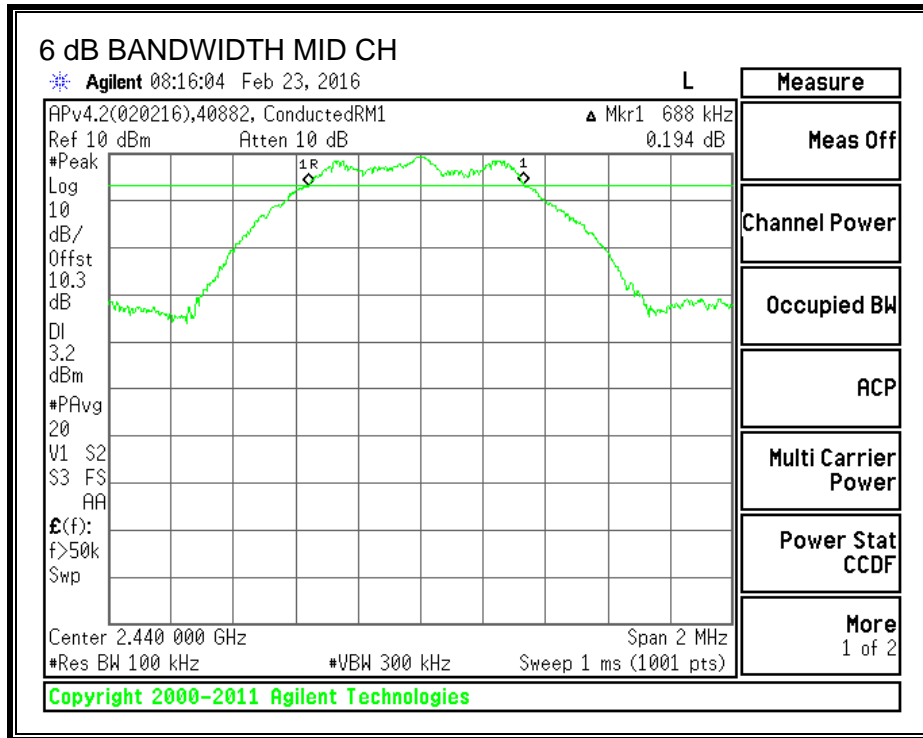

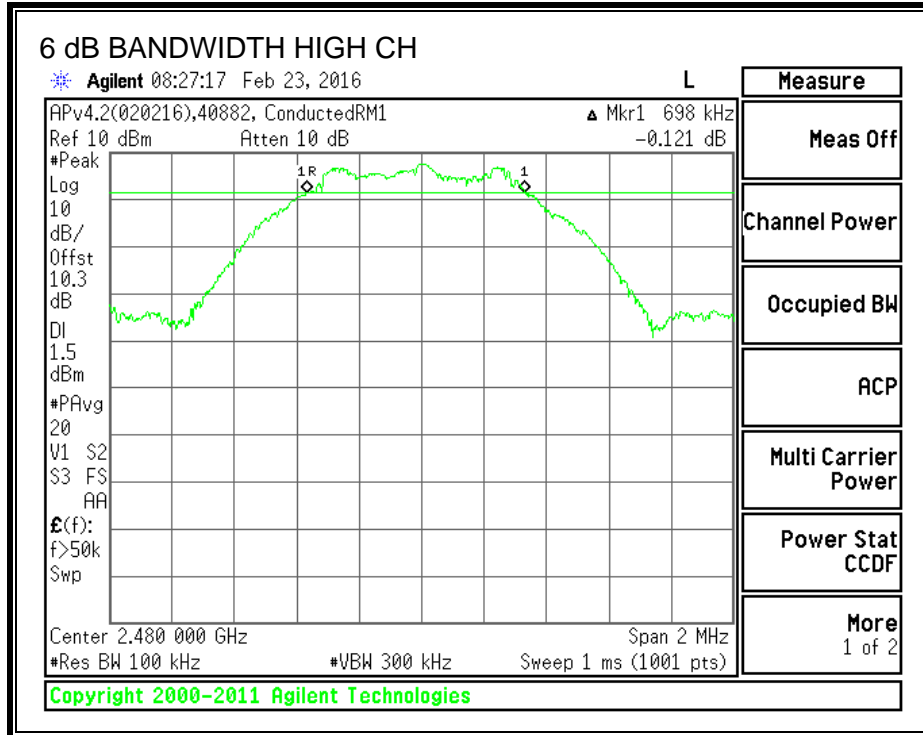

8.3. 99% BANDWIDTH

LIMITS

None; for reporting purposes only.

TEST PROCEDURE

The transmitter output is connected to the spectrum analyzer. The RBW is set to 1% to 5% of the 99 % bandwidth and to 1% of the span. The VBW is set to 3 times the RBW. The sweep time is coupled. The spectrum analyzer internal 99% bandwidth function is utilized.

RESULTS

Channel	Frequency (MHz)	99% Bandwidth (MHz)
Low	2402	1.0285
Middle	2440	1.0208
High	2480	1.0257

99% BANDWIDTH

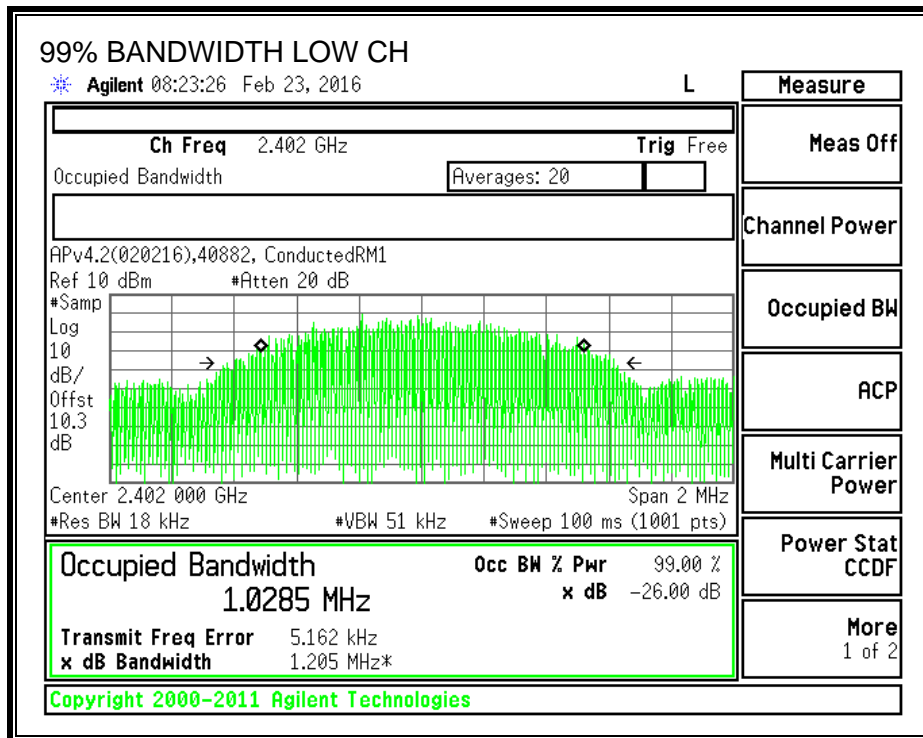

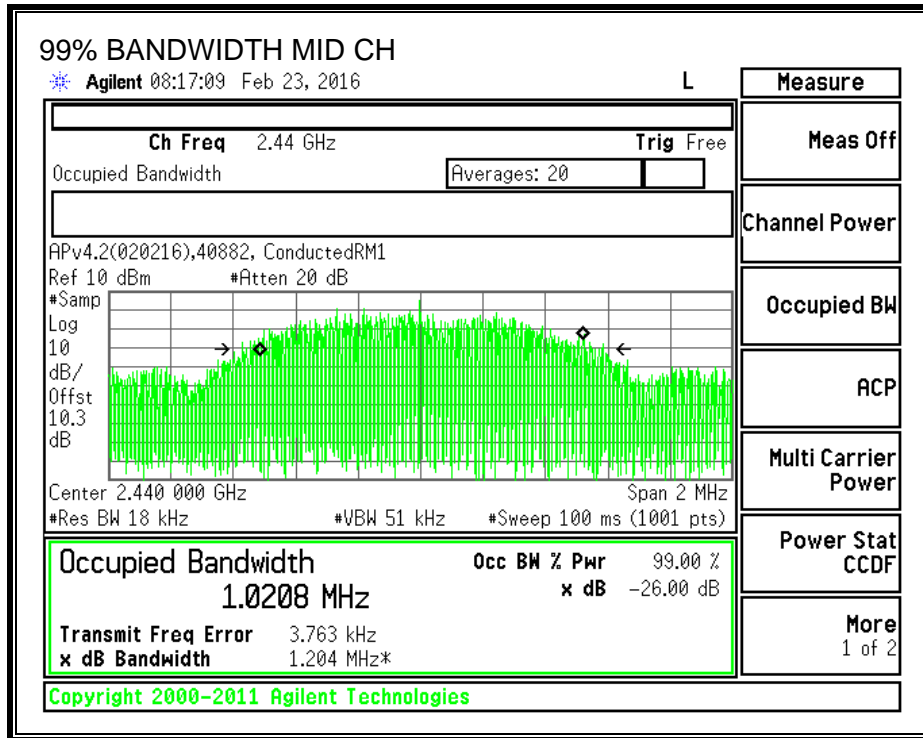

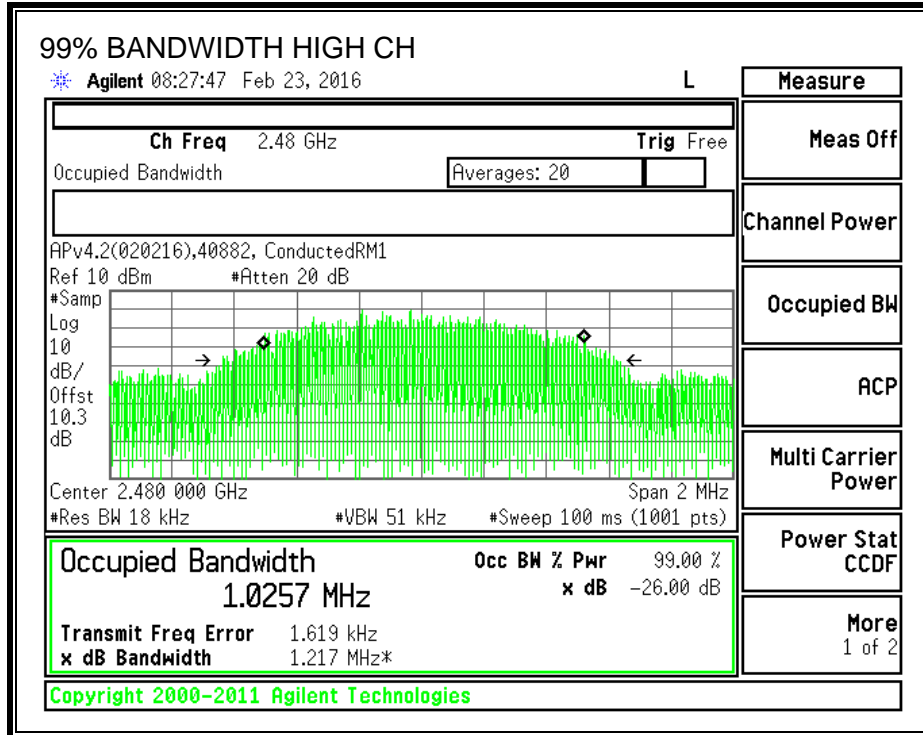

8.4. OUTPUT POWER

LIMITS

FCC §15.247 (b)

IC RSS-247 5.4

The maximum antenna gain is less than or equal to 6 dBi, therefore the limit is 30 dBm.

TEST PROCEDURE

The transmitter output was connected to a power meter equipped with a power sensor capable of measuring peak power. The cable assembly insertion loss of 10.294 dB (including 10 dB pad and 0.294 dB cable) was entered as an offset in the power meter to allow for direct reading of power.

RESULTS

Channel	Frequency (MHz)	Peak Power Reading (dBm)	Limit (dBm)	Margin (dB)
Low	2402	6.670	30	-23.330
Middle	2440	9.220	30	-20.780
High	2480	7.770	30	-22.230

8.5. AVERAGE POWER

LIMITS

None; for reporting purposes only.

TEST PROCEDURE

The transmitter output is connected to a power meter and a gated average power measurement was performed. The cable assembly insertion loss of 10.294 dB (including 10 dB pad and 0.294 dB cable) was entered as an offset in the power meter to allow for direct reading of power.

RESULTS

Channel	Frequency (MHz)	AV power (dBm)
Low	2402	6.38
Middle	2440	9.04
High	2480	7.53

8.6. POWER SPECTRAL DENSITY

LIMITS

FCC §15.247 (e)

IC RSS-247 5.2 (2)

The power spectral density conducted from the transmitter to the antenna shall not be greater than 8 dBm in any 3 kHz band during any time interval of continuous transmission.

RESULTS

Channel	Frequency (MHz)	PSD (dBm)	Limit (dBm)	Margin (dB)
Low	2402	-9.29	8	-17.29
Middle	2440	-6.39	8	-14.39
High	2480	-7.85	8	-15.85

POWER SPECTRAL DENSITY

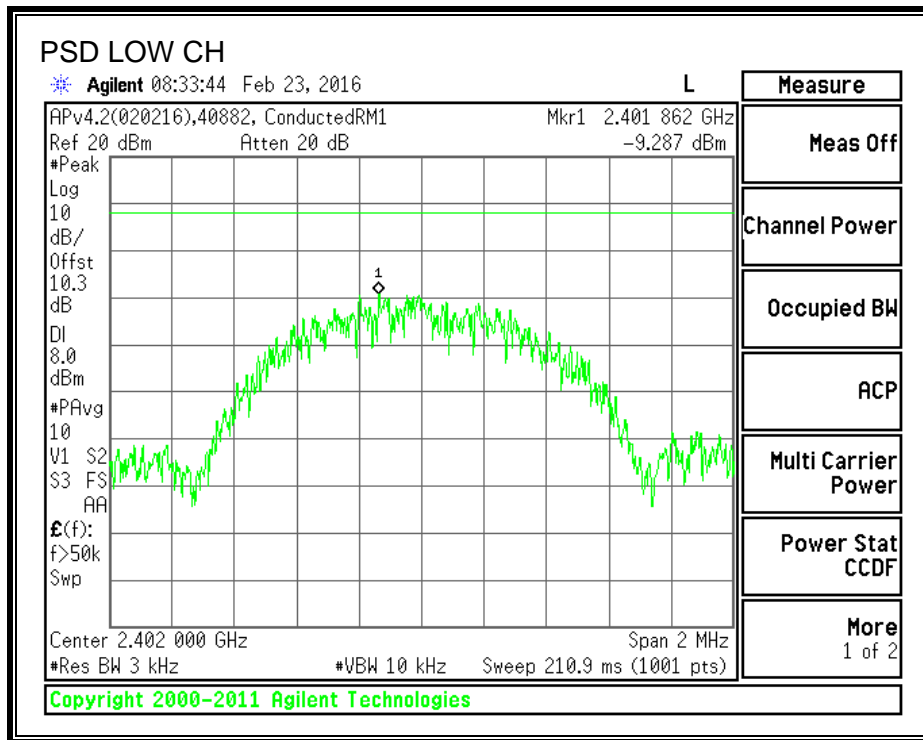

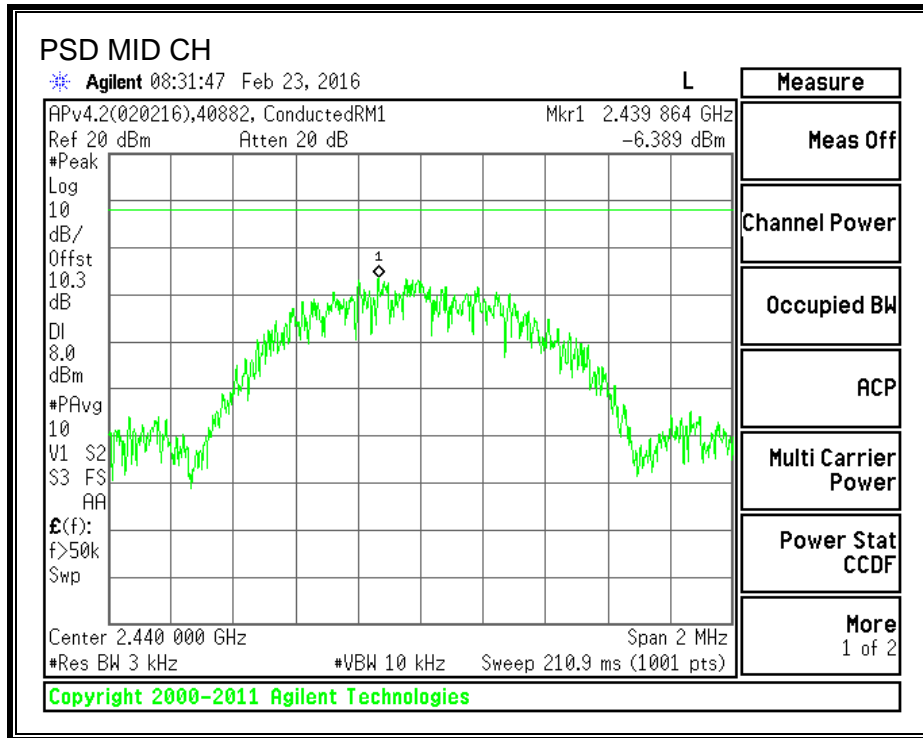

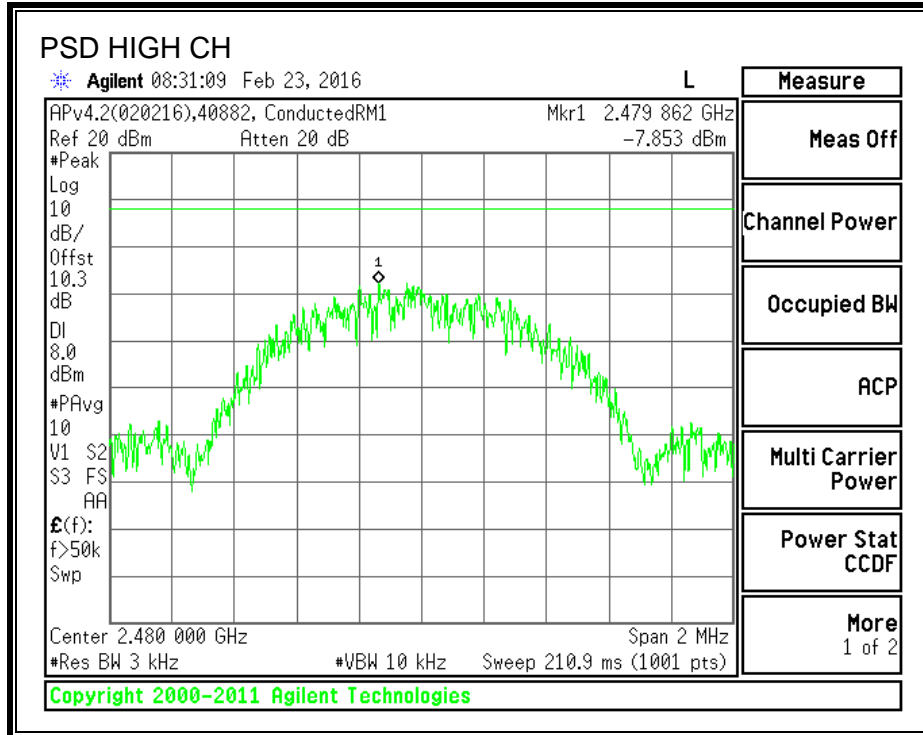

8.7. CONDUCTED SPURIOUS EMISSIONS

LIMITS

FCC §15.247 (d)

IC RSS-247 5.5

Output power was measured based on the use of a peak measurement, therefore the required attenuation is 20 dB.

RESULTS

SPURIOUS EMISSIONS, LOW CHANNEL

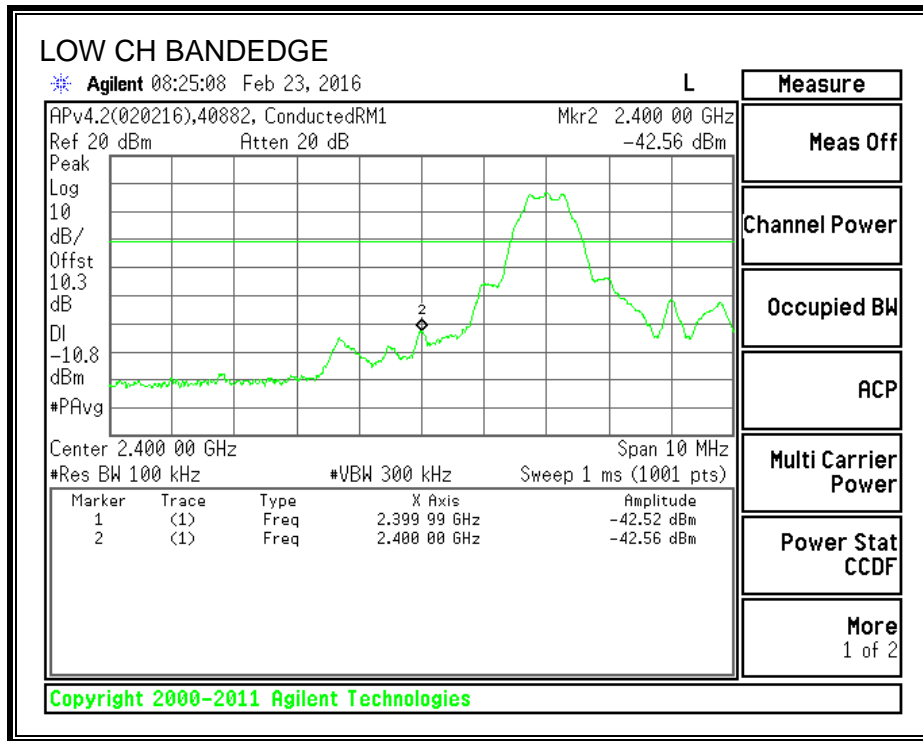

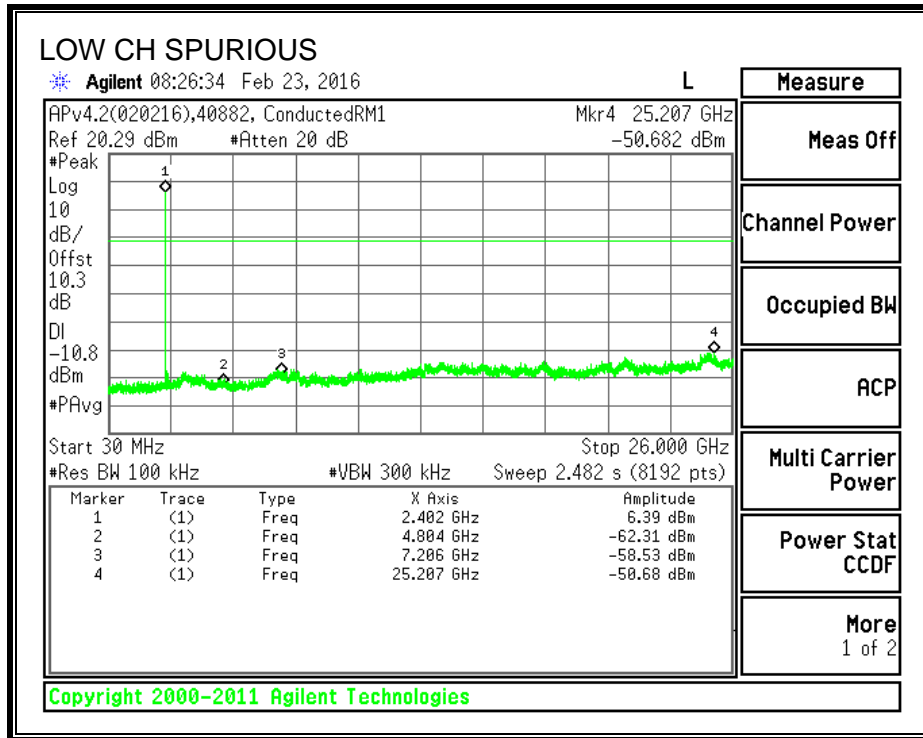

SPURIOUS EMISSIONS, MID CHANNEL

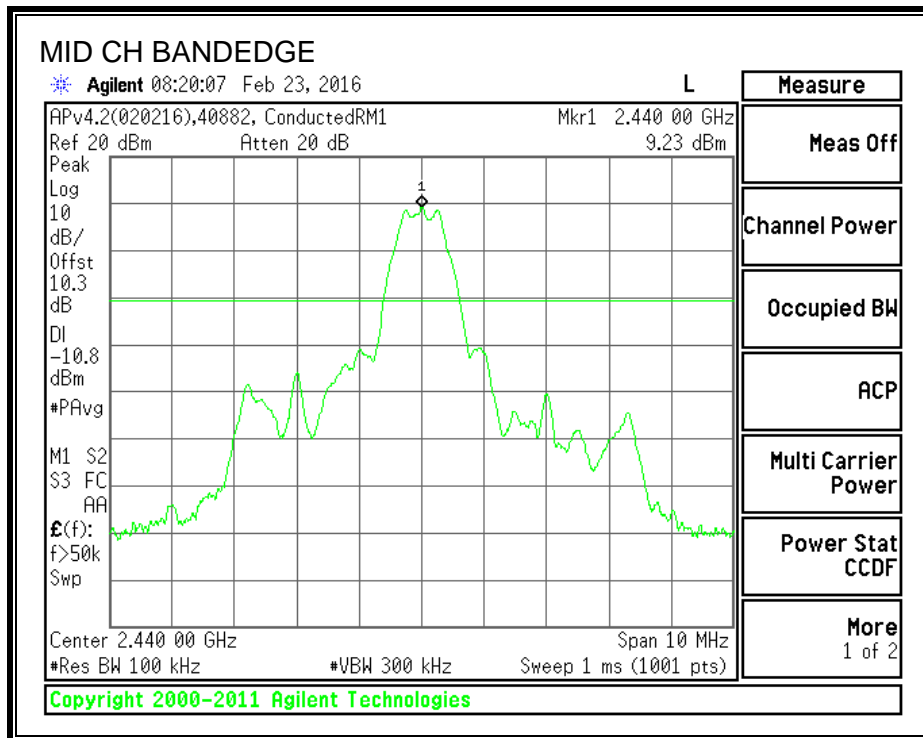

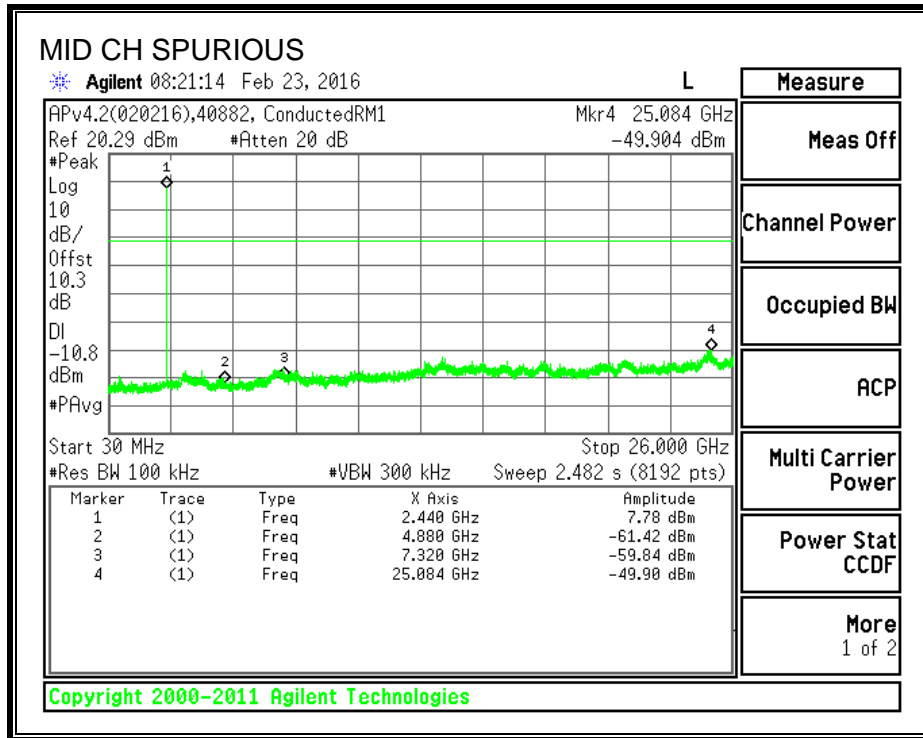

SPURIOUS EMISSIONS, HIGH CHANNEL

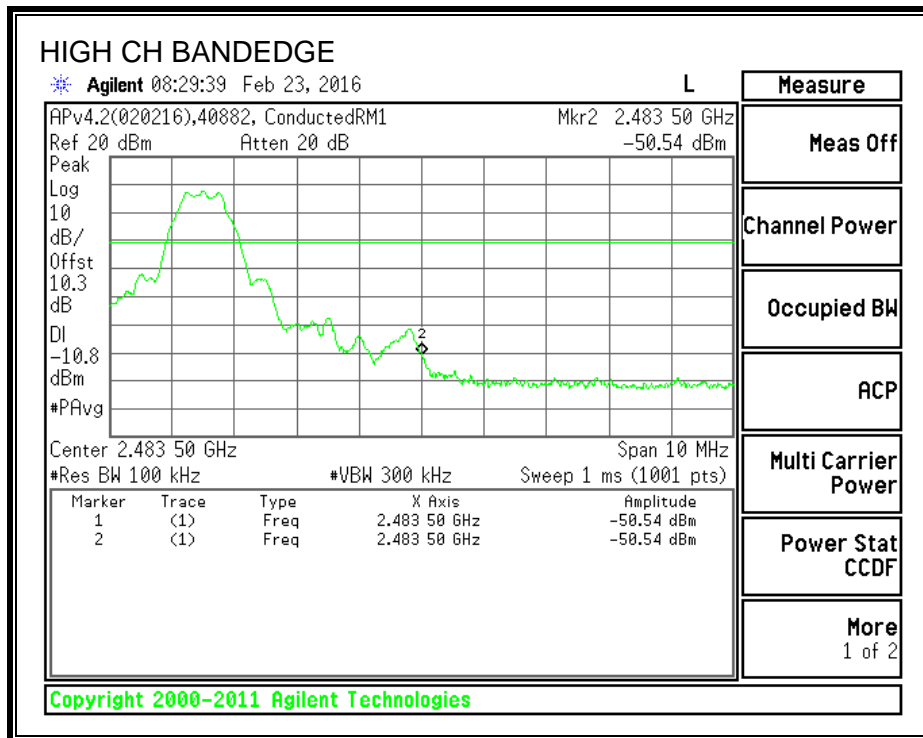

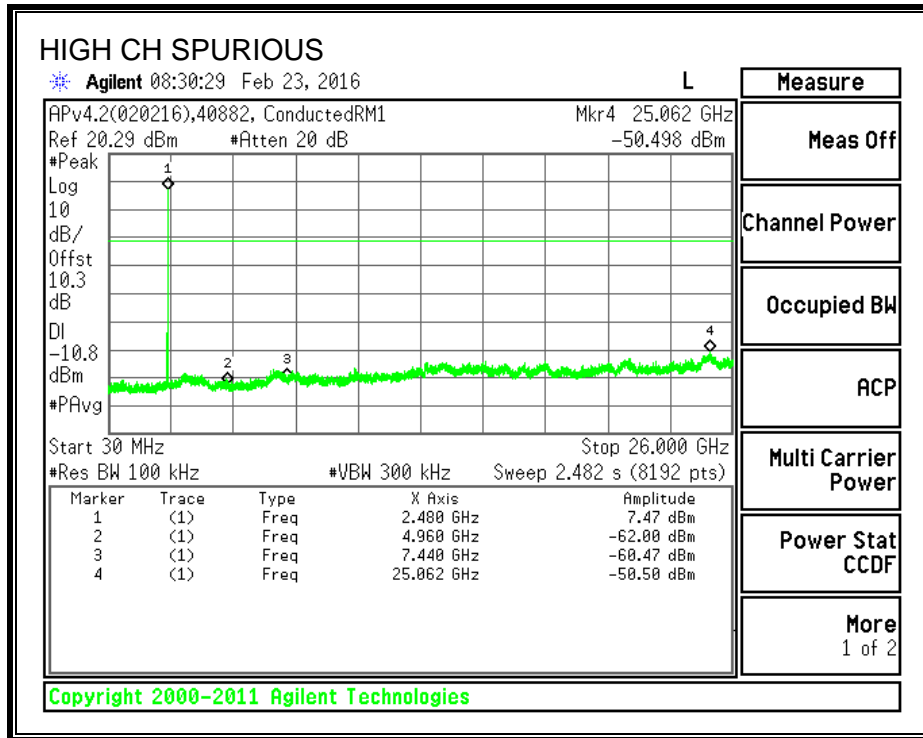

9. RADIATED TEST RESULTS

9.1. LIMITS AND PROCEDURE

LIMITS

FCC §15.205 and §15.209

IC RSS-GEN Clause 8.9 (Transmitter)

IC RSS-GEN Clause 7.1.2 (Receiver)

Frequency Range (MHz)	Field Strength Limit (uV/m) at 3 m	Field Strength Limit (dBuV/m) at 3 m
0.009-0.490	2400/F(kHz) @ 300 m	-
0.490-1.705	24000/F(kHz) @ 30 m	-
1.705 - 30	30 @ 30m	-
30 - 88	100	40
88 - 216	150	43.5
216 - 960	200	46
Above 960	500	54

TEST PROCEDURE

The EUT is placed on a non-conducting table 80 cm above the ground plane for below 1GHz measurements and 1.5 m above the ground plane for above 1GHz measurements. The antenna to EUT distance is 3 meters.

For measurements below 1 GHz the resolution bandwidth is set to 120 kHz for peak detection measurements or 120 kHz for quasi-peak detection measurements for the 30-1000 MHz range, 9 kHz for peak detection measurements or 9 kHz for quasi-peak detection measurements for the 0.15-30 MHz range and 200 Hz for peak detection measurements or 200 Hz for quasi-peak detection measurements for the 9 to 150 kHz range. Peak detection is used unless otherwise noted as quasi-peak.

For peak measurements above 1 GHz, the resolution bandwidth is set to 1 MHz and the video bandwidth is set to 3 MHz. For average measurements above 1GHz, the resolution bandwidth and video bandwidth are set as described in ANSI C63.10:2013 for the applicable measurement. For this evaluation, RMS Power Averaging was used and the resolution/video bandwidth settings were 1MHz/3MHz.

The spectrum from 9 kHz to 26 GHz is investigated with the transmitter set to the lowest, middle, and highest channels in each applicable band.

The frequency range of interest is monitored at a fixed antenna height and EUT azimuth. The EUT is rotated through 360 degrees to maximize emissions received. The antenna is scanned from 1 to 4 meters above the ground plane to further maximize the emission. Measurements are made with the antenna polarized in both the vertical and the horizontal positions.

9.2. TRANSMITTER ABOVE 1 GHz

9.3. TX ABOVE 1 GHz FOR BLUETOOTH LOW ENERGY MODE IN THE 2.4 GHz BAND

RESTRICTED BANDEDGE (LOW CHANNEL)

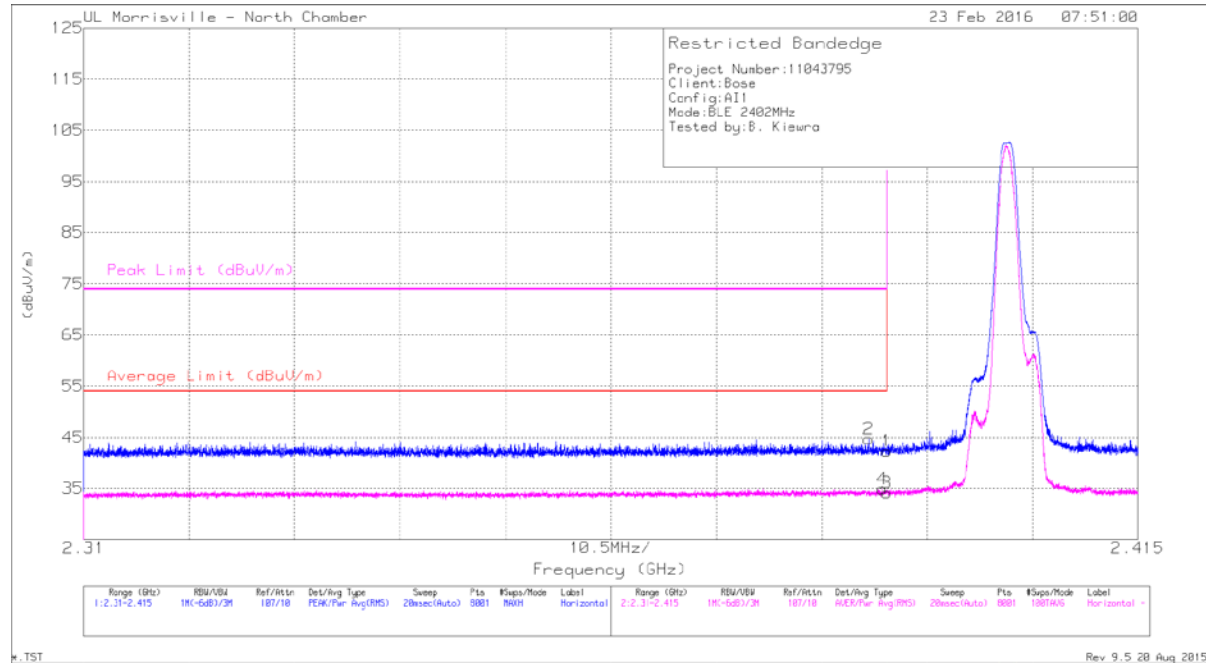

Marker	Frequency (GHz)	Meter Reading (dBuV)	Det	AF AT0072 (dB/m)	Amp/Cbl/ Fitr/Pad (dB)	DC Corr (dB)	Corrected Reading (dBuV/m)	Average Limit (dBuV/m)	Margin (dB)	Peak Limit (dBuV/m)	PK Margin (dB)	Azimuth (Degs)	Height (cm)	Polarity
1	* 2.39	35.19	Pk	31.9	-24.8	0	42.29	-	-	74	-31.71	321	275	H
2	* 2.388	37.58	Pk	31.9	-24.8	0	44.68	-	-	74	-29.32	321	275	H
3	* 2.39	24.9	RMS	31.9	-24.8	2.14	34.14	54	-19.86	-	-	321	275	H
4	* 2.39	25.64	RMS	31.9	-24.8	2.14	34.88	54	-19.12	-	-	321	275	H

* - indicates frequency in CFR47 Pt 15 / IC RSS-Restricted Band

Pk - Peak detector

RMS - RMS detection

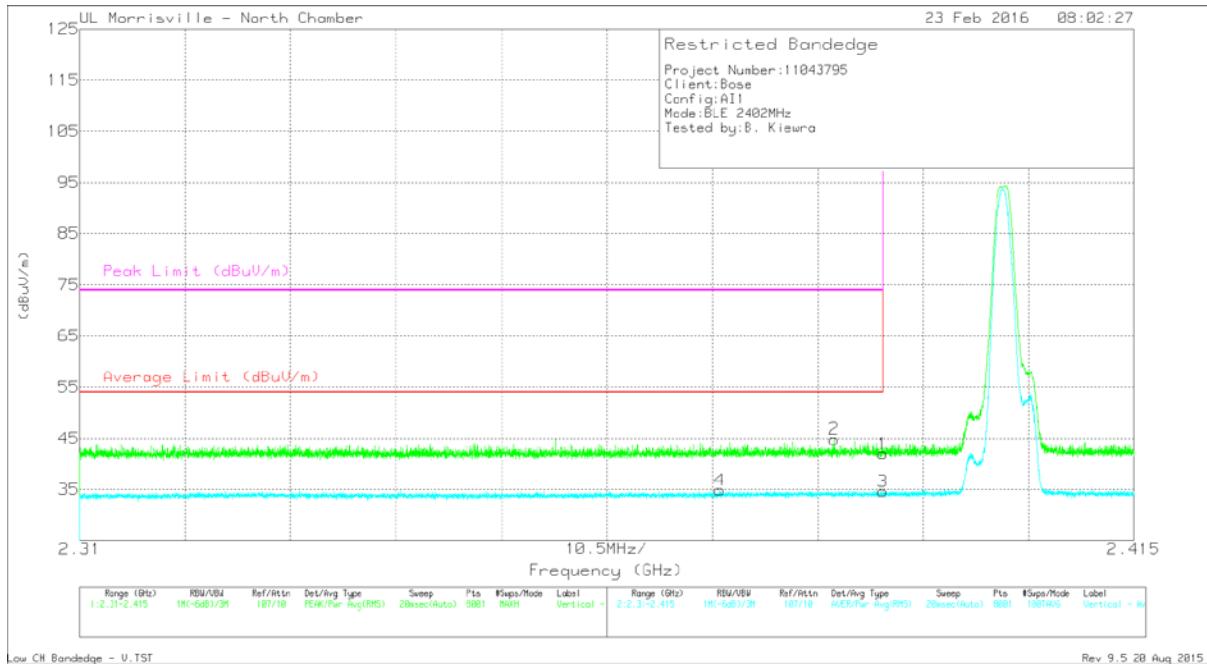

Marker	Frequency (GHz)	Meter Reading (dBuV)	Det	AF AT0072 (dB/m)	Amp/Cbl/Filtr/Pad (dB)	DC Corr (dB)	Corrected Reading (dBuV/m)	Average Limit (dBuV/m)	Margin (dB)	Peak Limit (dBuV/m)	PK Margin (dB)	Azimuth (Degs)	Height (cm)	Polarity
1	* 2.39	34.87	Pk	31.9	-24.8	0	41.97	-	-	74	-32.03	355	273	V
2	* 2.385	37.76	Pk	31.9	-24.8	0	44.86	-	-	74	-29.14	355	273	V
3	* 2.39	25.33	RMS	31.9	-24.8	2.14	34.57	54	-19.43	-	-	355	273	V
4	* 2.374	25.72	RMS	31.8	-24.8	2.14	34.86	54	-19.14	-	-	355	273	V

* - indicates frequency in CFR47 Pt 15 / IC RSS-Restricted Band

Pk - Peak detector

RMS - RMS detection

RESTRICTED BANDEDGE (HIGH CHANNEL)

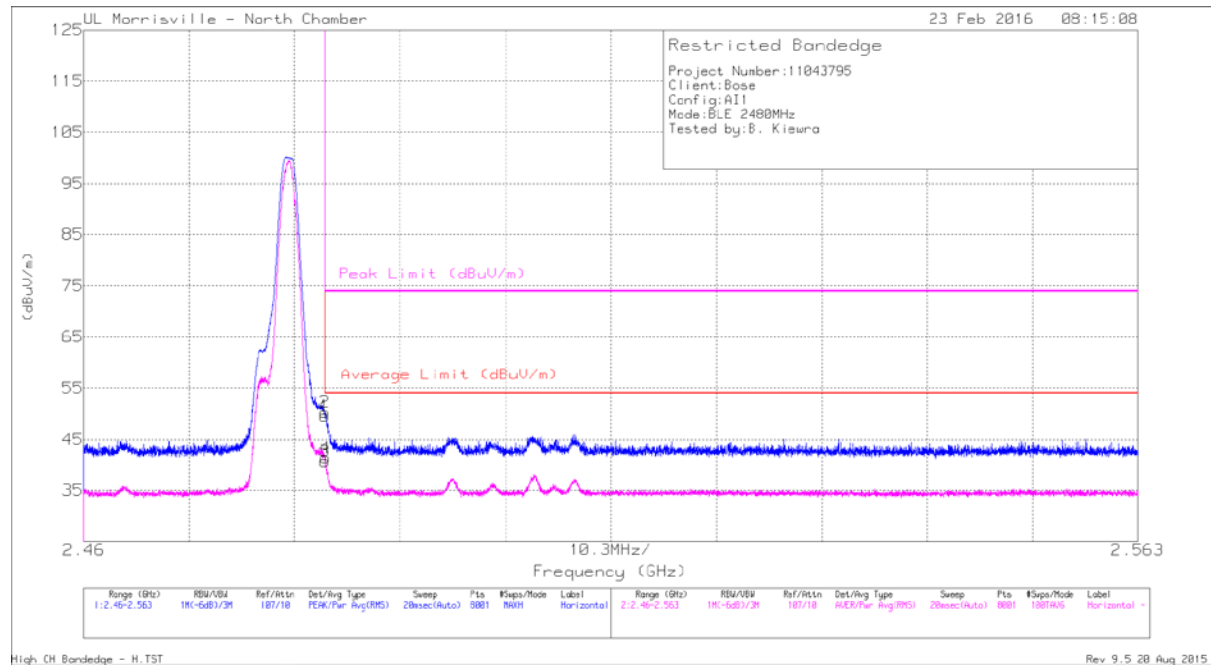

Marker	Frequency (GHz)	Meter Reading (dBuV)	Det	AF AT0072 (dB/m)	Amp/Cbl/Filtr/Pad (dB)	DC Corr (dB)	Corrected Reading (dBuV/m)	Average Limit (dBuV/m)	Margin (dB)	Peak Limit (dBuV/m)	PK Margin (dB)	Azimuth (Degs)	Height (cm)	Polarity
1	* 2.484	42.26	Pk	32.1	-24.8	0	49.56	-	-	74	-24.44	323	263	H
2	* 2.484	42.98	Pk	32.1	-24.8	0	50.28	-	-	74	-23.72	323	263	H
3	* 2.484	31.26	RMS	32.1	-24.8	2.14	40.70	54	-13.30	-	-	323	263	H
4	* 2.484	31.95	RMS	32.1	-24.8	2.14	41.39	54	-12.61	-	-	323	263	H

* - indicates frequency in CFR47 Pt 15 / IC RSS-Restricted Band

Pk - Peak detector

RMS - RMS detection

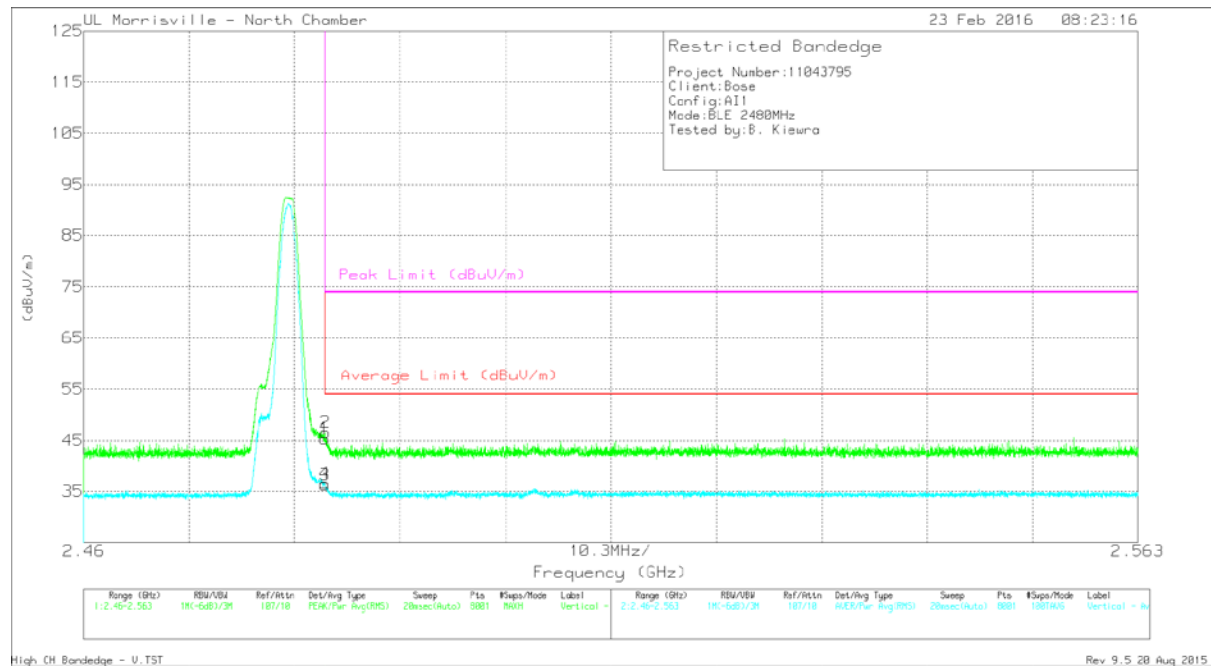

Marker	Frequency (GHz)	Meter Reading (dBuV)	Det	AF AT0072 (dB/m)	Amp/Cbl/Filtr/Pad (dB)	DC Corr (dB)	Corrected Reading (dBuV/m)	Average Limit (dBuV/m)	Margin (dB)	Peak Limit (dBuV/m)	PK Margin (dB)	Azimuth (Degs)	Height (cm)	Polarity
1	* 2.484	38.05	Pk	32.1	-24.8	0	45.35	-	-	74	-28.65	64	243	V
2	* 2.484	39.21	Pk	32.1	-24.8	0	46.51	-	-	74	-27.49	64	243	V
3	* 2.484	26.83	RMS	32.1	-24.8	2.14	36.27	54	-17.73	-	-	64	243	V
4	* 2.484	27.11	RMS	32.1	-24.8	2.14	36.55	54	-17.45	-	-	64	243	V

* - indicates frequency in CFR47 Pt 15 / IC RSS-Restricted Band

Pk - Peak detector

RMS - RMS detection

HARMONICS AND SPURIOUS EMISSIONS

LOW CHANNEL

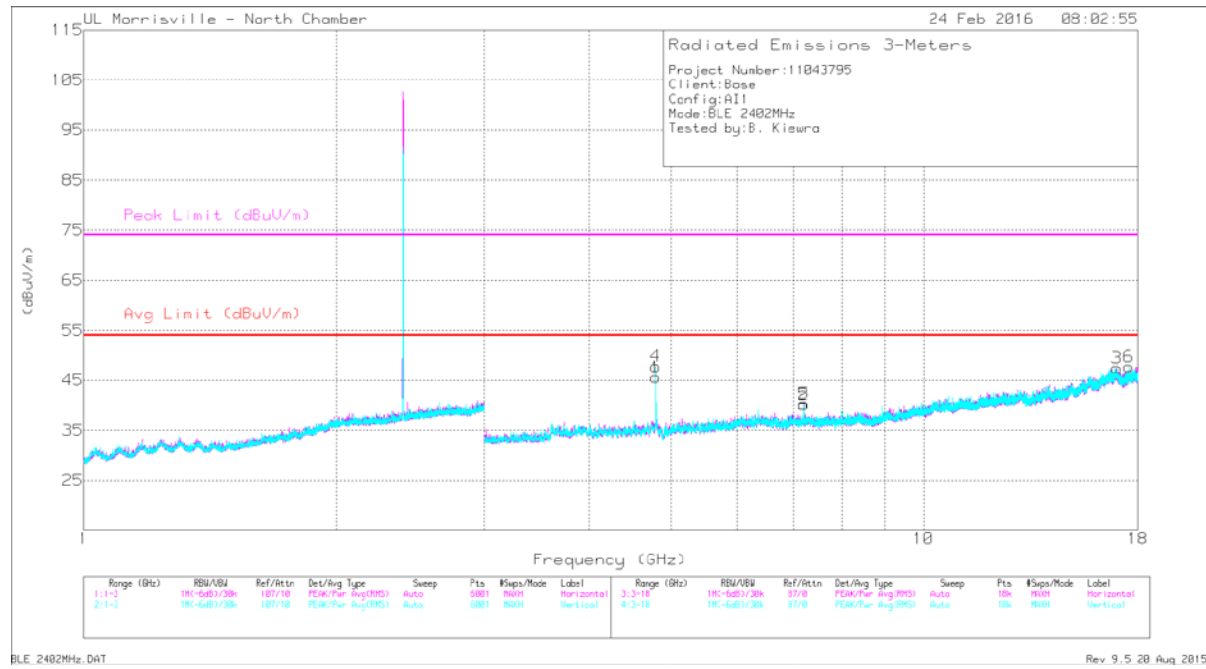

Marker	Frequency (GHz)	Meter Reading (dBuV)	Det	AF AT0072 (dB/m)	Amp/Cbl/Fitr/Pad (dB)	DC Corr (dB)	Corrected Reading (dBuV/m)	Avg Limit (dBuV/m)	Margin (dB)	Peak Limit (dBuV/m)	PK Margin (dB)	Azimuth (Degs)	Height (cm)	Polarity
1	* 4.803	47.53	PK2	34.1	-32.3	0	49.33	-	-	74	-24.67	266	104	H
	* 4.804	39.3	MAv1	34.1	-32.3	2.14	43.24	54	-10.76	-	-	266	104	H
4	* 4.803	48.71	PK2	34.1	-32.3	0	50.51	-	-	74	-23.49	347	111	V
	* 4.804	41.61	MAv1	34.1	-32.3	2.14	45.55	54	-8.45	-	-	347	111	V
2	7.205	35.35	Pk	35.7	-30.9	0	40.15	-	-	74	-33.85	0-360	101	H
5	7.206	35.52	Pk	35.7	-30.9	0	40.32	-	-	74	-33.68	0-360	101	V
3	17.006	31.14	Pk	42.2	-25.9	0	47.44	-	-	74	-26.56	0-360	199	H
6	17.567	30.99	Pk	41.8	-25.1	0	47.69	-	-	74	-26.31	0-360	101	V

* - indicates frequency in CFR47 Pt 15 / IC RSS-Restricted Band

Pk - Peak detector

PK2 - KDB558074 Method: Maximum Peak

MAv1 - KDB558074 Option 1 Maximum RMS Average

MIDDLE CHANNEL

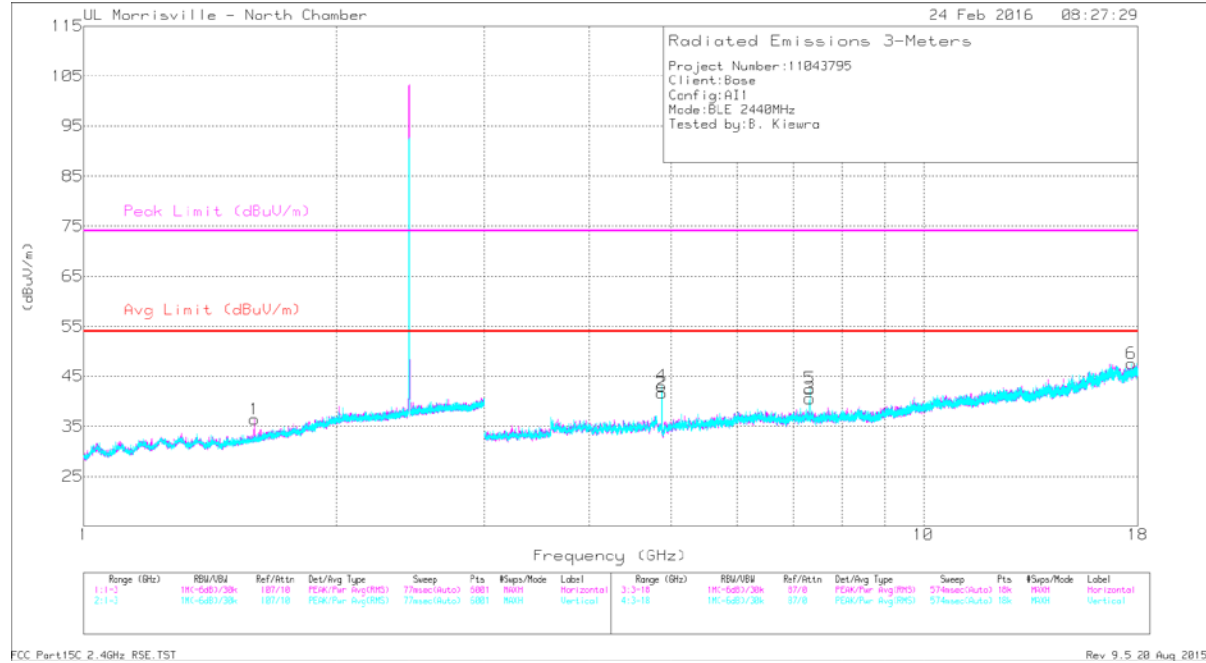

Marker	Frequency (GHz)	Meter Reading (dBuV)	Det	AF AT0072 (dB/m)	Amp/Cbl/Fltr/Pad (dB)	DC Corr (dB)	Corrected Reading (dBuV/m)	Avg Limit (dBuV/m)	Margin (dB)	Peak Limit (dBuV/m)	PK Margin (dB)	Azimuth (Degs)	Height (cm)	Polarity
1	* 1.595	36.02	PK2	28.5	-24.9	0	39.62	-	-	74	-34.38	35	395	H
	* 1.595	23.88	MAv1	28.5	-24.9	2.14	29.62	54	-24.38	-	-	35	395	H
2	* 4.88	44.88	PK2	34.1	-32.4	0	46.58	-	-	74	-27.42	226	101	H
	* 4.88	36.14	MAv1	34.1	-32.4	2.14	39.98	54	-14.02	-	-	226	101	H
3	* 7.319	40.34	PK2	35.7	-30	0	46.04	-	-	74	-27.96	0	104	H
	* 7.319	29.47	MAv1	35.7	-30	2.14	37.31	54	-16.69	-	-	0	104	H
4	* 4.879	45.28	PK2	34.1	-32.4	0	46.98	-	-	74	-27.02	338	107	V
	* 4.88	36.98	MAv1	34.1	-32.4	2.14	40.82	54	-13.18	-	-	338	107	V
5	* 7.321	41.98	PK2	35.7	-30	0	47.68	-	-	74	-26.32	273	105	V
	* 7.319	32.18	MAv1	35.7	-30	2.14	40.02	54	-13.98	-	-	273	105	V
6	17.681	30.02	Pk	41.9	-24.3	0	47.62	-	-	74	-26.38	0-360	199	V

* - indicates frequency in CFR47 Pt 15 / IC RSS-Restricted Band

Pk - Peak detector

PK2 - KDB558074 Method: Maximum Peak

MAv1 - KDB558074 Option 1 Maximum RMS Average

HIGH CHANNEL

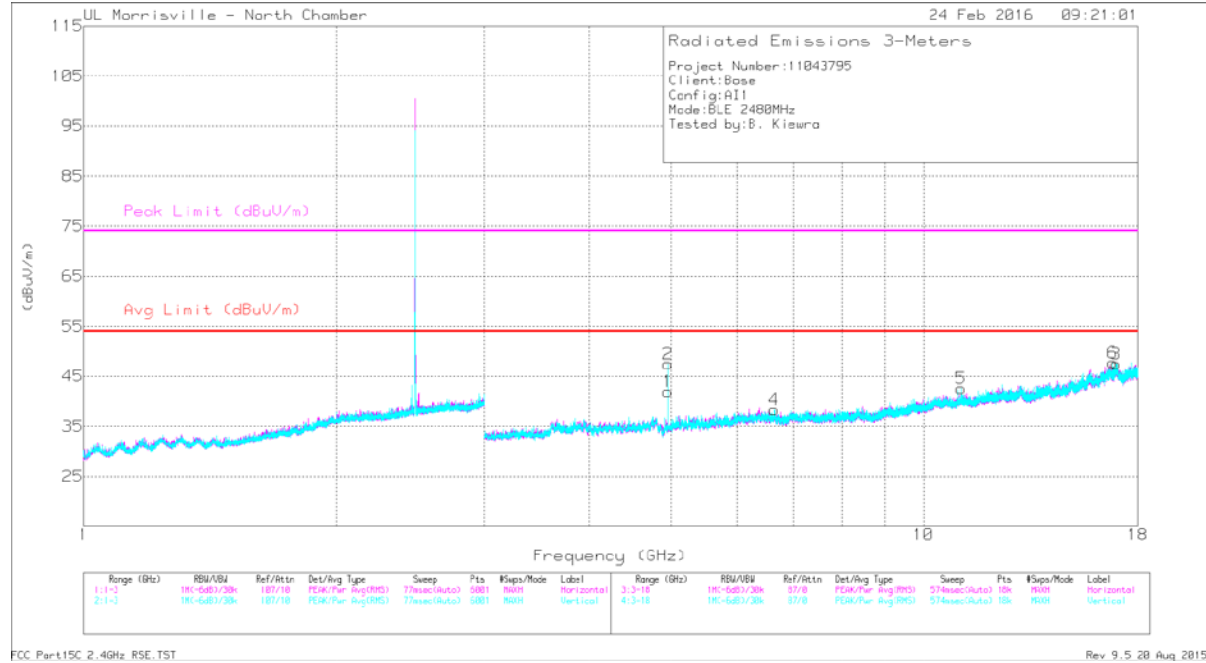

FCC Part15C 2.4GHz RSE_TST

Rev. 9.5.28 Aug 2015

Marker	Frequency (GHz)	Meter Reading (dBuV)	Det	AF AT0072 (dB/m)	Amp/Cbl/Fltr/Pad (dB)	DC Corr (dB)	Corrected Reading (dBuV/m)	Avg Limit (dBuV/m)	Margin (dB)	Peak Limit (dBuV/m)	PK Margin (dB)	Azimuth (Degs)	Height (cm)	Polarity
1	* 4.96	45.23	PK2	34.1	-33.2	0	46.13	-	-	74	-27.87	219	104	H
	* 4.96	36.08	MAv1	34.1	-33.2	2.14	39.12	54	-14.88	-	-	219	104	H
2	* 4.96	49.95	PK2	34.1	-33.2	0	50.85	-	-	74	-23.15	4	105	V
	* 4.96	42.7	MAv1	34.1	-33.2	2.14	45.74	54	-8.26	-	-	4	105	V
5	* 11.083	35.2	PK2	38	-26.3	0	46.9	-	-	74	-27.1	110	236	V
	* 11.084	23.99	MAv1	38	-26.3	2.14	37.83	54	-16.17	-	-	110	236	V
4	6.638	33.83	Pk	35.6	-31.1	0	38.33	-	-	74	-35.67	0-360	200	V
6	16.82	31.74	Pk	42.3	-26.3	0	47.74	-	-	74	-26.26	0-360	101	V
3	16.953	30.09	Pk	42.2	-24.8	0	47.49	-	-	74	-26.51	0-360	101	H

* - indicates frequency in CFR47 Pt 15 / IC RSS-Restricted Band

Pk - Peak detector

PK2 - KDB558074 Method: Maximum Peak

MAv1 - KDB558074 Option 1 Maximum RMS Average

9.4. WORST-CASE 18-26GHz

SPURIOUS EMISSIONS 18 TO 26GHz (WORST-CASE CONFIGURATION)

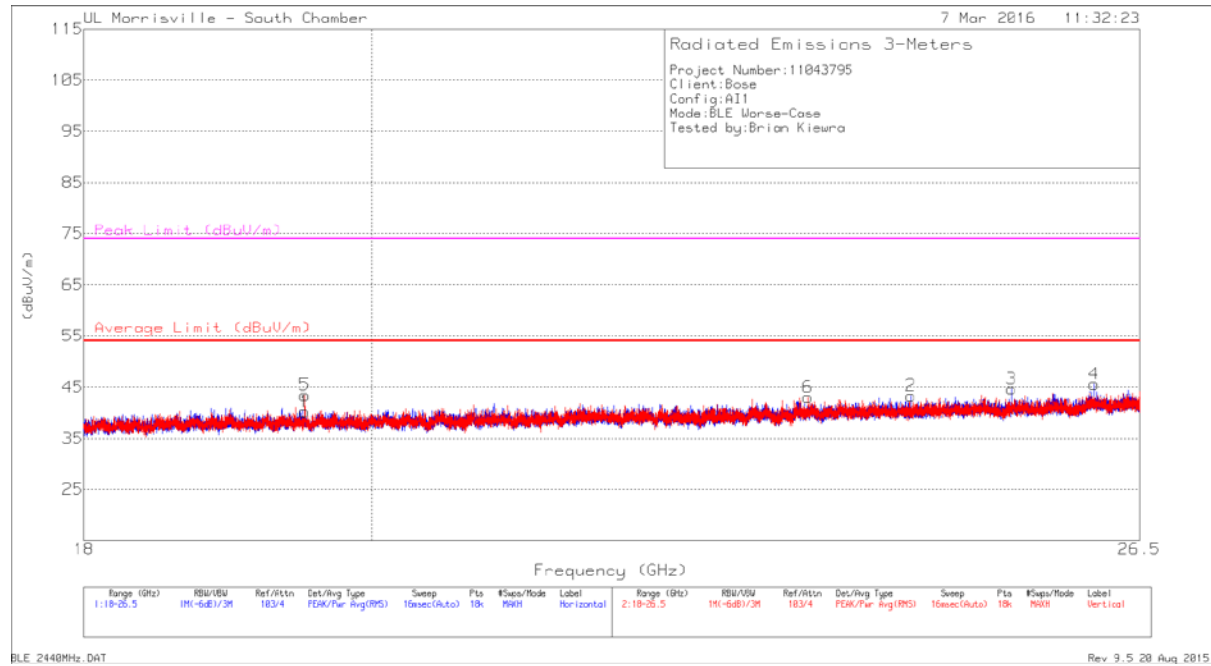

Marker	Frequency (GHz)	Meter Reading (dBuV)	Det	AF AT0076 (dB/m)	Amp/Cbl (dB)	DC Corr (dB)	Corrected Reading (dBuV/m)	Average Limit (dBuV/m)	Margin (dB)	Peak Limit (dBuV/m)	PK Margin (dB)	Azimuth (Degs)	Height (cm)	Polarity
1	* 19.516	51.67	PK2	32.9	-40.5	0	44.07	54	-9.93	74	-29.93	284	114	H
5	* 19.516	53.1	PK2	32.9	-40.5	0	45.5	54	-8.5	74	-28.5	29	254	V
2	24.369	47.73	Pk	34.4	-38.8	0	43.33	-	-	-	-	0-360	250	H
3	25.283	48.17	Pk	34.8	-38.3	0	44.67	-	-	-	-	0-360	199	H
4	26.062	48.08	Pk	35	-37.5	0	45.58	-	-	-	-	0-360	300	H
6	23.468	47.61	Pk	34.5	-39.1	0	43.01	-	-	-	-	0-360	201	V

* - indicates frequency in CFR47 Pt 15 / IC RSS-Restricted Band

Pk - Peak detector

PK2 - KDB558074 Method: Maximum Peak

MAv1 - KDB558074 Option 1 Maximum RMS Average

9.5. WORST-CASE BELOW 1 GHz

SPURIOUS EMISSIONS 9kHz-30 MHz (WORST-CASE CONFIGURATION)

Note: All measurements were made at a test distance of 3 m. The limits in the plots and tabular data are the FCC/IC limits extrapolated from the specification distance (300 m from 9-490 kHz and 30 m from 490 kHz – 30 MHz) to the measurement distance to clearly show the relative levels of fundamental and spurious emissions and demonstrate compliance with the requirement that the level of any spurious emissions be below the level of the intentionally transmitted signal. The extrapolation factor for the limits were $40 \cdot \log$ (specification distance / test distance).

The anechoic chamber has been properly calibrated so that the measurement results correspond to what would be obtained from an open field sites.

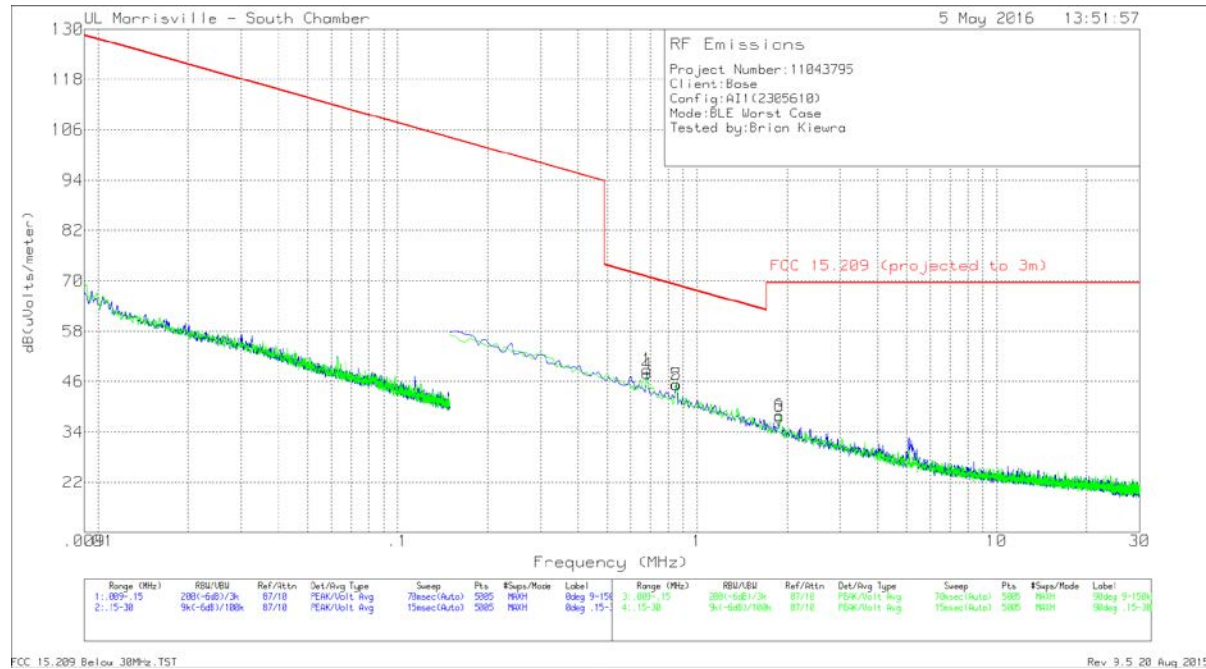

Marker	Frequency (MHz)	Meter Reading (dBuV)	Det	AT0079 AF (dB/m)	Cbl (dB)	Corrected Reading dB(uVolts/meter)	FCC 15.209 (projected to 3m)	Margin (dB)	Azimuth (Degs)
1	.68089	36.9	Pk	11.9	.1	48.9	70.94	-22.04	0-360
4	.68089	35.83	Pk	11.9	.1	47.83	70.94	-23.11	0-360
2	.84791	33.32	Pk	11.9	.1	45.32	69.04	-23.72	0-360
5	.85387	33.32	Pk	11.9	.1	45.32	68.98	-23.66	0-360
3	1.88582	25.29	Pk	12.1	.2	37.59	69.54	-31.95	0-360
6	1.88582	25.69	Pk	12.1	.2	37.99	69.54	-31.55	0-360

Pk - Peak detector
 FCC 15.209 Below 30MHz.TST
 Rev 9.5.20 Aug 2015

SPURIOUS EMISSIONS 30 TO 1000 MHz (WORST-CASE CONFIGURATION, HORIZONTAL)

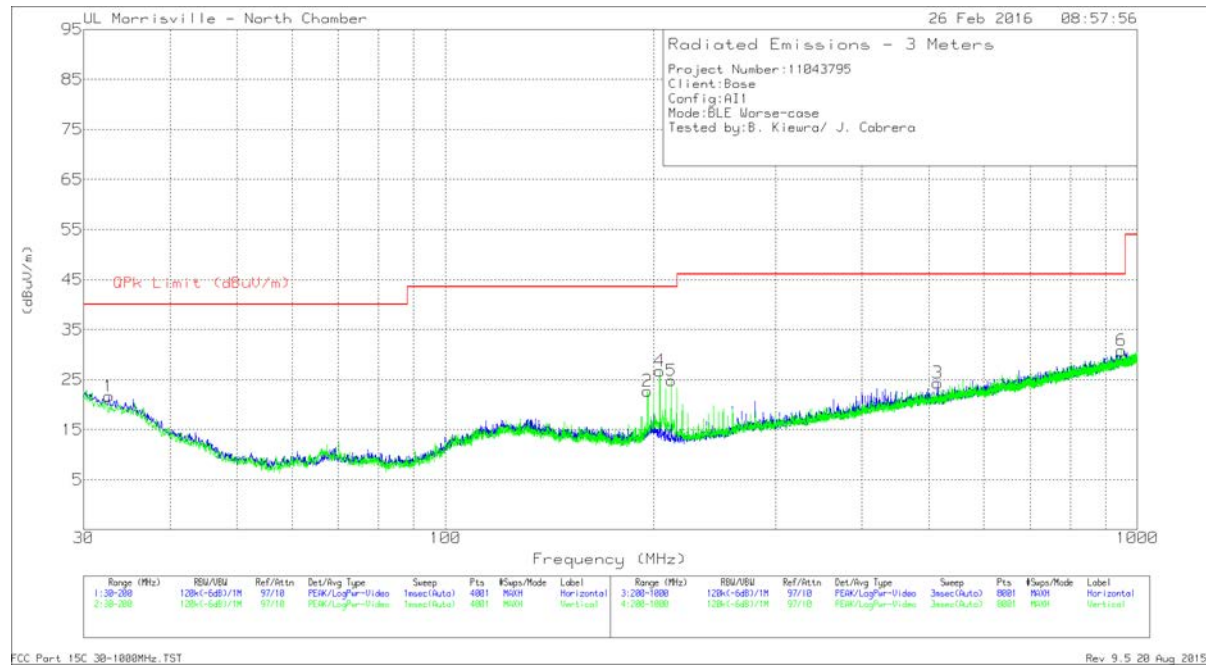

Marker	Frequency (MHz)	Meter Reading (dBuV)	Det	AT0073 AF (dB/m)	Amp/Cbl (dB)	Corrected Reading (dBuV/m)	QPk Limit (dBuV/m)	Margin (dB)	Azimuth (Degs)	Height (cm)	Polarity
1	32.635	29.26	Pk	24.1	-31.7	21.66	40	-18.34	0-360	300	H
3	514.3	30.66	Pk	22.3	-28.6	24.36	46.02	-21.66	0-360	102	H
2	196.005	35.93	Pk	16.9	-30.1	22.73	43.52	-20.79	0-360	102	V
4	204	40.86	Pk	16	-30.1	26.76	43.52	-16.76	0-360	102	V
5	212	39.61	Pk	15.2	-30	24.81	43.52	-18.71	0-360	199	V
6	948.8	29.21	Pk	27.6	-26	30.81	46.02	-15.21	0-360	102	V

Pk - Peak detector

10. AC POWER LINE CONDUCTED EMISSIONS

LIMITS

FCC §15.207 (a)

RSS-Gen 7.2.2

Frequency of Emission (MHz)	Conducted Limit (dBuV)	
	Quasi-peak	Average
0.15-0.5	66 to 56*	56 to 46*
0.5-5	56	46
5-30	60	50

*Decreases with the logarithm of the frequency.

TEST PROCEDURE

The EUT is placed on a non-conducting table 40 cm from the vertical ground plane and 80 cm above the horizontal ground plane. The EUT is configured in accordance with ANSI C63.10.

The receiver is set to a resolution bandwidth of 9 kHz. Peak detection is used unless otherwise noted as quasi-peak or average.

Line conducted data is recorded for both NEUTRAL and HOT lines.

RESULTS

Line conducted testing was considered but deemed not applicable because the EUT does not transmit or receive when the EUT is plugged in for charging. The Bluetooth radio is disabled when the USB is connected to a laptop or charger.